

**WPS-8 Word Processing System  
Reference Manual  
(Versions 2.7 and 3.0)**

Copyright © 1978 by Digital Equipment Corporation

The information in this document is subject to change without notice and should not be construed as a commitment by Digital Equipment Corporation. Digital Equipment Corporation assumes no responsibility for any errors that may appear in this document.

The software described in this document is furnished under a license and may not be used or copied except in accordance with the terms of such license.

Digital Equipment Corporation assumes no responsibility for the use or reliability of its software on equipment that is not supplied by DIGITAL.

Printed in U.S.A.

This document was typeset on DIGITAL's  
DECset-8000 computerized typesetting system.

The following are trademarks of Digital Equipment Corporation:

COMPUTER LABS	DIBOL	OS/8
COMTEX	DIGITAL	PDP
DDT	EDUSYSTEM	PHA
DEC	FLIP CHIP	RSTS
DECCOMM	FOCAL	RSX
DECsystem-10	INDAC	TYPESET-8
DECSYSTEM-20	LAB-8	TYPESET-10
DECtape	MASSBUS	TYPESET-11
DECUS	OMNIBUS	UNIBUS

# CONTENTS

Page

## PREFACE

### CHAPTER 1 INTRODUCTION

1.1	WORD PROCESSING EQUIPMENT.....	1-3
1.1.1	The Keyboard .....	1-7
1.1.2	The Display Screen.....	1-9
1.1.3	Storage.....	1-10
1.1.4	Printers .....	1-12
1.2	USING THE WORD PROCESSING SYSTEM .....	1-12

### CHAPTER 2 OPERATING THE WS78 EQUIPMENT

2.1	TURNING ON THE MACHINE .....	2-1
2.2	INSERTING THE DISKETTES .....	2-4
2.3	BOOTSTRAPPING .....	2-7
2.4	TYPING THE DATE AND TIME .....	2-10
2.5	MAIN MENU .....	2-10
2.6	RESETTING THE DATE AND TIME.....	2-12
2.7	STOPPING.....	2-12
2.8	POWER FAILURES AND BROWN-OUTS.....	2-13

### CHAPTER 2 OPERATING THE WS100 EQUIPMENT

2.1	TURNING ON THE MACHINE .....	2-1
2.2	BOOTSTRAPPING .....	2-4
2.3	INSERTING THE DISKETTES .....	2-5
2.4	TYPING THE DATE AND TIME .....	2-8
2.5	MAIN MENU .....	2-11
2.6	RESETTING THE DATE AND TIME.....	2-12
2.7	STOPPING.....	2-13
2.8	POWER FAILURES AND BROWN-OUTS.....	2-13

## CONTENTS (CONT.)

### CHAPTER 2 OPERATING THE WS102 AND WS202 EQUIPMENT

2.1	TURNING ON THE MACHINE.....	2-2
2.2	BOOTSTRAPPING .....	2-6
2.3	INSERTING THE DISKETTES .....	2-9
2.4	START MENU .....	2-12
2.5	TYPING THE DATE AND TIME .....	2-15
2.6	MAIN MENU .....	2-17
2.7	RESETTING THE DATE AND TIME.....	2-18
2.8	STOPPING .....	2-19
2.9	POWER FAILURES AND BROWN -OUTS.....	2-19

### CHAPTER 3 CREATING A DOCUMENT

3.1	HOW TO CREATE A DOCUMENT.....	3-1
3.1.1	Naming a Document.....	3-3
3.1.1.1	Correcting a Typo in the Document Name .....	3-3
3.1.1.2	Document Storage Location.....	3-3
3.1.2	Screen Display When a Document Is Created .....	3-4
3.2	TYPING NEW TEXT.....	3-5
3.2.1	Ending Lines: Word Wrap Versus Hard Return .....	3-6
3.2.2	Removing Errors Just Typed.....	3-7
3.2.3	Leaving Vertical Space for Insertions .....	3-7
3.2.4	Centering, Underlining, and Boldfacing.....	3-8
3.2.5	Problem: Running Out of Storage Space While Typing.....	3-8
3.3	FILING A DOCUMENT.....	3-8

### CHAPTER 4 DOCUMENT INDEX

4.1	EXAMINING THE INDEX.....	4-1
4.2	USING THE INDEX .....	4-3
4.3	PRINTING THE INDEX.....	4-4
4.4	DOCUMENT NUMBER ONE: CHANGING THE SPELLING OF A DOCUMENT NAME .....	4-7



## CONTENTS (CONT.)

### CHAPTER 5 EDITING A DOCUMENT

5.1	BRINGING AN EXISTING DOCUMENT TO THE SCREEN	5-2
5.1.1	Identifying a Document To Be Edited	5-3
5.1.1.1	Document Storage Location	5-4
5.1.1.2	Using the Index To Identify A Document	5-4
5.1.2	Screen Display	5-6
5.1.3	Getting an Extra Version of an Existing Document	5-7
5.2	MOVING THE CURSOR	5-8
5.2.1	Using the Mini Keyboard Grammatical Keys	5-9
5.2.2	Using the ADVANCE and BACK UP Keys To Scroll	5-10
5.2.3	Using the Gold TOP and BOT DOCMT Keys	5-11
5.3	INSERTING ADDITIONAL TEXT	5-12
5.4	MAKING CHANGES	5-12
5.4.1	Interchanging Two Characters	5-12
5.4.2	Deleting a Character or Word	5-13
5.4.3	Cutting: Deleting a Portion of Text	5-14
5.4.4	Cutting and Pasting	5-15
5.4.4.1	Preserving Rulers When Pasting	5-16
5.4.4.2	Summary of Different Cutting and Pasting Key Combinations	5-18

### CHAPTER 6 RULERS

6.1	USING A RULER	6-2
6.1.1	Displaying a Ruler	6-3
6.1.2	Making Ruler Settings	6-5
6.1.2.1	Left Margin and Vertical Line Spacing	6-6
6.1.2.2	Right Margin	6-8
6.1.2.3	Paragraph Indent	6-9
6.1.2.4	Automatic Word Wrap Indent	6-11
6.1.2.5	Tabs	6-12
6.1.2.6	Incorrect Settings	6-16
6.1.3	Clearing a Ruler Display	6-16
6.2	CHANGING RULERS IN TYPED TEXT	6-16
6.3	USING A WIDE RULER	6-17
6.4	SAVING RULERS FOR REUSE	6-20
6.5	CHANGING AN UNDESIREED RULER	6-21

## CONTENTS (CONT.)

### CHAPTER 7 SEARCHING

7.1	BASIC AND CONTINUED SEARCHING .....	7-2
7.1.1	Searching Qualifications.....	7-3
7.1.2	Direction Reversal.....	7-3
7.2	SEARCHING AND REPLACING .....	7-3

### CHAPTER 8 HIGHLIGHTING TEXT: CENTERING, UNDERLINING, BOLDFACING, AND CAPITALIZATION

8.1	CENTERING .....	8-2
8.1.1	Changing the Centering Point .....	8-4
8.1.2	Determining Whether Text Is Centered .....	8-5
8.2	UNDERLINING AND BOLDFACING .....	8-6
8.2.1	Underlining or Boldfacing While Typing.....	8-6
8.2.2	Underlining or Boldfacing After Typing .....	8-7
8.2.3	Determining Whether Text Is Underlined Or Boldfaced .....	8-8
8.2.4	Effect of Spaces on Underlining .....	8-8
8.2.4.1	Underlining Words and Spaces .....	8-8
8.2.4.2	Underlining Only Words.....	8-9
8.2.4.3	Effect of Right Margin On Underlining .....	8-9
8.3	CAPITALIZATION .....	8-11
8.4	REMOVING UNDERLINING, BOLDFACING AND CAPITALIZATION .....	8-12

### CHAPTER 9 SUBSCRIPTS, SUPERSCRIPTS, AND COMPOSITE CHARACTERS

9.1	SUBSCRIPTS AND SUPERSCRIPTS .....	9-1
9.1.1	Producing Subscripts and Superscripts with the Gold SUB SCRIPT and SUPER SCRIPT Keys .....	9-2
9.1.1.1	Removing a Subscript or Superscript .....	9-4
9.1.1.2	Qualifications .....	9-4
9.1.2	Producing Subscripts and Superscripts with Half-line Ruler Spacing .....	9-4
9.2	COMPOSITE CHARACTERS.....	9-10

## CONTENTS (CONT.)

### CHAPTER 10 REUSABLE TEXT: LIBRARY DOCUMENTS

10.1	CREATING A LIBRARY ENTRY .....	10-2
10.1.1	Creating an Abbreviation Entry .....	10-2
10.1.2	Creating a Paragraph Entry .....	10-3
10.2	USING AN ABBREVIATION OR PARAGRAPH ENTRY .....	10-4
10.3	INCLUDING A RULER IN AN ABBREVIATION OR PARAGRAPH ENTRY .....	10-5
10.4	QUALIFICATIONS .....	10-6
10.5	NONSTANDARD ABBREVIATIONS AND PARAGRAPH DOCUMENTS .....	10-7

### CHAPTER 11 HYPHENATION

11.1	COMPOUND WORDS .....	11-2
11.2	HYPHENATING TYPED TEXT BY PUSHING AND PULLING ..	11-3
11.3	USING INVISIBLE HYPHENS .....	11-6
11.4	EXAMINING TEXT FOR BREAKING AND INVISIBLE HYPHENS .....	11-7
11.5	IMPROVING RIGHT MARGIN APPEARANCE BY HYPHENATION ZONE .....	11-7
11.5.1	Using a Hyphenation Zone When Typing or Editing .....	11-8
11.5.2	Using a Hyphenation Zone When Paginating .....	11-10

### CHAPTER 12 PAGINATION

12.1	AUTOMATIC PAGINATION .....	12-1
12.2	FORCING PAGE ENDINGS .....	12-2
12.3	DISPLAYING AND MODIFYING PAGE ENDINGS .....	12-4
12.3.1	Changing PAGE MARKERs .....	12-7
12.3.2	Qualifications: Automatic Removal of PAGE MARKERs .....	12-7
12.3.3	Qualification: Word Wrapping .....	12-7
12.4	CHANGING THE NUMBER OF LINES PER PAGE .....	12-8

## CONTENTS (CONT.)

### CHAPTER 13 PRINTING A DOCUMENT

13.1	IDENTIFYING A DOCUMENT TO BE PRINTED .....	13-2
13.2	PRINT MENU .....	13-3
13.3	CHANGING PRINT MENU SETTINGS .....	13-7
13.3.1	Specifying Pagination .....	13-12
13.3.2	Specifying a Top Margin and Bottom Margin .....	13-12
13.3.3	Multiple Column Printing .....	13-15
13.3.3.1	Space Between Multiple Columns .....	13-17
13.3.3.2	Effect of Rulers .....	13-19
13.3.3.3	Advancing to New Columns and Pages .....	13-20
13.3.3.4	Printing Multiple Columns of Unequal Length .....	13-22
13.3.3.5	Qualifications .....	13-24
13.3.4	Specifying the Number of Copies To Be Printed .....	13-25
13.3.5	Specifying the Document Destination .....	13-25
13.3.6	Adding Extra Vertical Space .....	13-25
13.3.7	Specifying the First and Last Pages To Be Printed and the Number To Appear on the First Page .....	13-26
13.3.8	Specifying the Pitch .....	13-28
13.3.8.1	Proportional Spacing .....	13-29
13.3.8.2	Qualifications .....	13-29
13.3.9	Adding Extra Space in the Left Margin .....	13-30
13.3.10	Specifying the Physical Page Size .....	13-31
13.3.11	Using Extra Print Wheel Characters (Version 3.0 only) .....	13-31
13.3.12	Saving and Retrieving Print Menu Settings .....	13-31
13.3.13	Stopping the Printer To Insert Special Paper .....	13-32
13.3.14	Using Two Different Styles of Type .....	13-33
13.4	CHECKING OUT THE PRINTER .....	13-34
13.5	INTERRUPTING PRINTING .....	13-35
13.6	WHEN PRINTING FAILS TO START .....	13-37
13.7	PRINTING DOCUMENTS ON ANOTHER SYSTEM .....	13-39
13.7.1	Saving a List of Documents to Be Printed on Another System .....	13-39
13.7.2	Printing Documents from a Saved List .....	13-41
13.7.3	Qualifications .....	13-41

### CHAPTER 14 HEADERS AND FOOTERS

14.1	CREATING A HEADER OR FOOTER .....	14-2
14.2	CHANGING A HEADER OR FOOTER .....	14-4
14.3	PRINTING THE DATE AND PAGE NUMBERS .....	14-5
14.4	RESETTING PAGE NUMBERS .....	14-6
14.5	HEADER AND FOOTER POSITIONING ON A PAGE .....	14-6

## CONTENTS (CONT)

14.6	QUALIFICATIONS: EFFECT OF RULER .....	14-9
14.7	EFFECT OF ADDING EXTRA VERTICAL SPACE WHEN PRINTING .....	14-10

### CHAPTER 15 USER DEFINED KEYS

15.1	CREATING A USER DEFINED KEY .....	15-1
15.2	USING A USER DEFINED KEY .....	15-5
15.3	CHANGING A USER DEFINED KEY .....	15-5
15.4	RESTRICTIONS .....	15-6
15.5	INCLUDING ONE USER DEFINED KEY WITHIN ANOTHER .....	15-6

### CHAPTER 16 CUSTOMIZING

16.1	COMMENTS .....	16-1
16.2	DATE AND TIME STAMP .....	16-3
16.3	CUSTOMIZATION POINTS .....	16-3
16.4	LIST PROCESSING .....	16-4
16.4.1	Summary of Features .....	16-6
16.4.2	Using List Processing .....	16-9

### CHAPTER 17 MAINTAINING DISKETTES

17.1	DELETING A DOCUMENT .....	17-2
17.2	INITIALIZING, VERIFYING, AND COPYING DISKETTES .....	17-4
17.2.1	Initializing a Document Diskette .....	17-5
17.2.2	Initializing a System Diskette .....	17-6
17.2.3	Verifying a Diskette .....	17-6
17.2.3.1	How to Verify a Diskette .....	17-7
17.2.3.2	Recovering from Diskette Errors .....	17-10
17.2.3.3	Preventing Diskette Problems .....	17-11
17.2.4	Copying a Diskette .....	17-13

## CONTENTS (CONT.)

### CHAPTER 18 WS102 AND WS202 SPECIAL FEATURES

- 18.1 SHARING THE SAME SCREEN..... 18-3
- 18.2 ORDER IN WHICH DOCUMENTS ARE PRINTED ..... 18-3

### APPENDIX A WORD PROCESSING KEYS

- A.1 THE MAIN KEYBOARD..... A-2
- A.2 THE MINI KEYBOARD..... A-8

### APPENDIX B MAIN MENU OPTIONS

### APPENDIX C USING SYSTEMS THAT HAVE FOUR DISKETTE DRIVES

- C.1 REFERENCING A DOCUMENT ..... C-3
- C.2 USING THE DISKETTE INDEX ..... C-4

### APPENDIX D VIEWING TEXT

### APPENDIX E RULER SETTING CHARACTERS

### APPENDIX F HOW NONTEXT KEYSTROKES ARE DISPLAYED WHEN TYPED INTO A USER DEFINED KEY

### APPENDIX G USING THE WS78 AUXILIARY COMMUNICATIONS PORT

### GLOSSARY

### INDEX

## FIGURES

Figure No.	Title	Page
1-1	Display Screen .....	1-1
1-2	WS78 .....	1-3
1-3	WS100 .....	1-4
1-4a	WS102 .....	1-5
1-4b	WS202 .....	1-6
1-5	Keyboards .....	1-7
1-6	Example of Main Keyboard .....	1-8
1-7	Mini Keyboard .....	1-9
1-8	Diskette .....	1-10
1-9	Document Index .....	1-11
1-10	Printers .....	1-12
1-11	Main Menu (Versions 2.7 and 3.0) .....	1-13
1-12	Print Menu (Version 2.7) .....	1-14
	Print Menu (Version 3.0) .....	1-15
1-13	Example of Prompt .....	1-15
1-14	Example of Error Message .....	1-16
	WS78:	
2-1	WS78 Display Screen ON/OFF Switch .....	2-2
2-2	WS78 Terminal ON/OFF Switch .....	2-3
2-3	Diskette .....	2-4
2-4	Inserting System Diskette in Drive .....	2-5
2-5	Inserting Document Diskette in Drive .....	2-6
2-6	WS78 START Switch .....	2-7
2-7	WS78 Date/Time Menu .....	2-8
2-8	WS78 Intensity Control Switch .....	2-9
2-9	Main Menu Page One (Versions 2.7 and 3.0) .....	2-11
2-10	Finished Message .....	2-12
	WS100:	
2-1	WS100 Display Screen Switch .....	2-2
2-2	WS100 ON/OFF Switch .....	2-3
2-3	WS100 START Switch .....	2-4
2-4	Diskette .....	2-5
2-5	Inserting System Diskette in Drive .....	2-6
2-6	Inserting Document Diskette in Drive .....	2-7
2-7	WS100 Date/Time Menu .....	2-8
2-8	WS100 Intensity Control Switch .....	2-10
2-9	Main Menu Page One (Version 2.7) .....	2-11
	Main Menu Page One (Version 3.0) .....	2-12

## FIGURES (Cont)

Figure No.	Title	Page
2-10	Finished Message .....	2-13
	WS102/202:	
2-1	WS102 Display Screen Switch.....	2-2
2-2a	WS102 ON/OFF Switch.....	2-4
2-2b	WS202 ON/OFF Switch.....	2-5
2-3a	WS102 Start Switch.....	2-7
2-3b	WS202 START Switch.....	2-8
2-4	Diskette .....	2-9
2-5	Inserting System Diskette in Drive .....	2-10
2-6	Inserting Document Diskette in Drive.....	2-11
2-7a	WS102 Start Menu.....	2-12
2-7b	WS202 Start Menu.....	2-13
2-8	WS102 Intensity Control Switch .....	2-14
2-9	WS102 Date/Time Menu (Version 2.7).....	2-15
	WS102 Date/Time Menu (Version 3.0).....	2-16
2-10	Main Menu Page One (Version 2.7) .....	2-17
	Main Menu Page One (Version 3.0) .....	2-18
2-11	Finished Message .....	2-19
3-1	Document Create Prompt.....	3-2
3-2	Document Name Example.....	3-3
3-3	Example of Screen Display When Creating a Document .....	3-4
3-4	Viewed Text Showing Word Wrap and Hard Carriage Return .....	3-6
3-5	Main Keyboard RUB WORD OUT, RUB SENT, RUB CHAR OUT, RUB LINE Keys.....	3-7
3-6	Main Keyboard FILE DOCMT Key .....	3-8
4-1	Document Index Example .....	4-2
4-2	Copy Index Prompt.....	4-4
4-3	Example of Specifying Index Document.....	4-5
4-4	Prompt for Modifying an Existing Index Document.....	4-6
4-5	Example of Document One .....	4-7
5-1	Document Edit Prompt (1) .....	5-2
5-2	Document Edit Prompt (2) .....	5-3
5-3	Using the Document Index to Indicate Document to Be Edited (1) .....	5-4
5-4	Using the Document Index to Indicate Document to Be Edited (2) .....	5-5
5-5	Example of Screen Display When a Document Is Specified for Editing .....	5-6
5-6	Main Keyboard GET DOCMT Key.....	5-8
5-7	Mini Keyboard ADVANCE and BACK UP Keys .....	5-9
5-8	Main Keyboard TOP DOCMT and BOT DOCMT Keys .....	5-11
5-9	Mini Keyboard DEL WORD and DEL CHAR Keys.....	5-13
5-10	Mini Keyboard SEL and CUT Keys.....	5-14



## FIGURES (Cont)

Figure No.	Title	Page
5-11	Mini Keyboard PASTE and CUT Keys.....	5-15
5-12	Example of Cutting and Pasting Using the Mini Keyboard CUT and PASTE Keys.....	5-16
5-13	Example of Cutting and Pasting Using the CUT and GOLD Plus PASTE Keys..	5-17
5-14	Ruler Used as a Result of Different Removal and Replacement Methods .....	5-18
6-1	Example of Rulers.....	6-2
6-2	Main Keyboard RULER Key.....	6-3
6-3	Example of Displayed Ruler .....	6-4
6-4	Example of Different Left Margin Ruler Settings .....	6-7
6-5	Main Keyboard PARA MARKER Key.....	6-9
6-6	Example of Paragraph Indent .....	6-10
6-7	Example of Word Wrap Indent .....	6-11
6-8	Example of Left-Justified, Right-Justified, and Decimal-Aligned Tabs.....	6-13
6-9	Example of Using the Right Margin as a Tab .....	6-14
6-10	Example of Viewing Tabbed Text .....	6-15
6-11	Example of Wide Ruler .....	6-17
6-12	Displayed Example of Text Typed with Wide Ruler in Effect.....	6-18
6-13	Printed Example of Text Typed with Wide Ruler in Effect .....	6-19
6-14	Example of Text Before Pasting.....	6-21
6-15	Reformatted Example of Text After Pasting .....	6-22
7-1	Main Keyboard SRCH, CONT SRCH, CONT SRCH and SEL Keys.....	7-2
8-1	Main Keyboard CENTR Key.....	8-2
8-2	Example of Centering Text .....	8-3
8-3	Example of a User-Specified Centering Point .....	8-4
8-4	Example of Viewing Centered Text .....	8-5
8-5	Mini Keyboard BOLD and UNDERLINE Keys.....	8-6
8-6	Example of Viewing Underlined and Boldfaced Text.....	8-8
8-7	Main Keyboard SHIFT and CAPS LOCK Keys, Mini Keyboard SEL and UPPER CASE Keys .....	8-11
8-8	Example of Changing Uppercase Text to Lowercase.....	8-12
9-1	Main Keyboard SUB SCRIPT and SUPER SCRIPT Keys.....	9-2
9-2	Example of Viewing Subscripts and Superscripts .....	9-3
9-3	Typing an Example Equation: Step 1 .....	9-5
9-4	Typing an Example Equation: Step 2 .....	9-6
9-5	Typing an Example Equation: Step 3 .....	9-7
9-6	Typing an Example Equation: Step 4 .....	9-8
9-7	Typing an Example Equation: Final Results .....	9-9
9-8	Main Keyboard DEAD Keys.....	9-10
9-9	Example of Typing Composite Characters.....	9-11

## FIGURES (Cont)

Figure No.	Title	Page
10-1	Main Keyboard LIBRY and ABBRV Keys .....	10-4
10-2	Example of Inserting Ruler in Abbreviation Library Entry .....	10-5
10-3	Example of Text After Abbreviation Library Entry Which Includes Ruler Is Inserted .....	10-6
10-4	Editor Menu Showing Standard Abbreviation and Paragraph Library Documents. ....	10-8
10-5	Example of Editor Menu Showing User-Supplied Abbreviation and Paragraph Library Documents .....	10-9
11-1	Main Keyboard PRINT HYPH Key .....	11-2
11-2	Main Keyboard HYPH PUSH and HYPH PULL Keys .....	11-3
11-3	Main Keyboard SHIFT and PRINT HYPH Keys .....	11-6
11-4	Example of Viewing Text for Breaking, Nonbreaking, and Invisible Hyphens .....	11-7
11-5	Example of Using a Hyphenation Zone .....	11-9
12-1	Main Keyboard NEW PAGE Key .....	12-2
12-2	Example of Using a NEW PAGE Mark .....	12-3
12-3	Main Keyboard PAGE MARKER Key and Mini Keyboard PAGE Key ....	12-4
12-4	Example of a PAGE MARKER Inserted by the Word Processing System ...	12-5
12-5	Example of Page Ending Which Could Be Improved .....	12-6
12-6	Editor Menu Showing System-Supplied Text Sizes .....	12-8
12-7	Editor Menu Showing User-Supplied Text Sizes .....	12-9
12-8	Relationship of Editor and Print Menu Settings for Page Size .....	12-10
13-1	Printing Request Prompt .....	13-2
13-2	Example of Print Menu Page One (Version 2.7) .....	13-3
	Example of Print Menu Page One (Version 3.0) .....	13-4
13-3	Example of Print Menu Page Two (Versions 2.7 and 3.0) .....	13-5
13-4	Example of Print Menu Page Three .....	13-6
13-5	Relationship of Editor and Print Menu Settings for Page Size .....	13-13
13-6	Example of Two-Column Printed Text .....	13-15
13-7	Example of Typing Two-Column Text .....	13-16
13-8	Example of Two Column Text Separated by Two Spaces .....	13-17
13-9	Example of Specifying Different Widths in Multiple Columns .....	13-18
13-10	Example of Ruler Use with Multiple Columns .....	13-19
13-11	Example of Starting Multiple Column Text on a New Page .....	13-21
13-12	Example of a Complicated Multiple Column Table Produced by Word Processing ...	13-22
13-13	Example of Order in Which a Multiple Column Complicated Table Was Typed .....	13-23
13-14	Example of Screen Display for Typing a Multiple Column Complicated Table .....	13-24
13-15	Example of Printing the Third Stored Page as Number 23 .....	13-27
13-16	Example of Using Ten-Pitch Letter Quality Printer Print Wheel .....	13-28
13-17	Example of Using Twelve-Pitch Letter Quality Printer Print Wheel .....	13-28

## FIGURES (Cont)

Figure No.	Title	Page
13-18	Example of Using a Ten-Pitch Print Wheel with a Twelve-Pitch Setting.....	13-28
13-19	Example of Proportional Printing .....	13-29
13-20	Example of Adding Space in the Left Margin of a Printed Page .....	13-30
13-21	Example of Two-Typeface Text After Being Printed with the First Print Wheel .....	13-33
13-22	Example of Two-Typeface Text After Being Printed with Both Print Wheels .....	13-33
13-23	Stop Printer Menu .....	13-35
13-24	Prompt for Saving a List of Documents to Be Printed.....	13-39
13-25	Prompt for Modifying an Existing Printing List .....	13-40
13-26	Prompt for Printing Documents from a Saved List.....	13-41
14-1	Example of Headers and Footers .....	14-1
14-2	Main Keyboard CMND Key .....	14-2
14-3	Screen Display Showing a Header .....	14-3
14-4	Screen Display Showing a Footer, Page Numbering Request, and Date Request .....	14-5
14-5	Header Positioning Within Top Margin; Footer Positioning Within Bottom Margin .....	14-7
14-6	Relationship of Editor and Print Menu Settings for Page Size .....	14-8
14-7	Example of Printed Header and Text When Extra Vertical Space is Specified .....	14-10
15-1	Prompt for Defining a User Defined Key .....	15-2
15-2	Screen Display for Typing a User Defined Key .....	15-3
15-3	Example of a User Defined Key Displayed on the Screen .....	15-4
16-1	Example of a Comment .....	16-1
16-2	Main Keyboard CMND Key .....	16-2
16-3	Main Keyboard DATE + TIME Key .....	16-3
16-4	Example of Form Letters Produced by List Processing .....	16-5
16-5	Example of Customized Letter Produced by List Processing .....	16-7
16-6	List Processing Selection/Merging/Printing Production.....	16-9
17-1	Document Deletion Prompt.....	17-2
17-2	Deletion Confirmation Prompt.....	17-3
17-3	Diskette Maintenance Menu .....	17-4
17-4	Diskette Initialization Prompt.....	17-5
17-5	Diskette Verification Prompt .....	17-7
17-6	Example of Diskette Verification Screen Display for a Diskette Without Errors .....	17-8
17-7	Example of Diskette Verification Screen Display for a Diskette Having Errors .....	17-9
17-8	Diskette Verification Prompt .....	17-10
17-9	Diskette Copy Prompt.....	17-13
17-10	Prompt Displayed at Completion of Diskette Copy .....	17-14
18-1	WS102 Main Menu Page (Versions 2.7 and 3.0).....	18-2
18-2	Example of Document Printing Order: Both Users Set SP to YES .....	18-4
18-3	Example of Document Printing Order: Both Users Set SP to NO .....	18-5
18-4	Example of Document Printing Order: One User Sets SP to YES, Other to NO (1)...	18-5
18-5	Example of Document Printing Order: One User Sets SP to YES, Other to NO (2) ...	18-6

## FIGURES (Cont)

Figure No.	Title	Page
A-1	Word Processing Main and Mini Keyboards.....	A-1
A-2	Main Keyboard.....	A-2
A-3	Mini Keyboard.....	A-8
B-1	Main Menu Page One (Version 2.7).....	B-1
	Main Menu Page One (Version 3.0).....	B-2
B-2	Main Menu Page Two (Versions 2.7 and 3.0).....	B-3
B-3	Main Menu Page Three (Version 2.7).....	B-4
	Main Menu Page Three (Version 3.0).....	B-5
B-4	Main Menu Page Four (Versions 2.7 and 3.0).....	B-6
B-5	Main Menu Page Four (Versions 2.7 and 3.0).....	B-6
B-5	Main Menu Page Five (Version 2.7) (WS102 and WS202 Systems Only).....	B-7
	Main Menu Page Five (Version 3.0).....	B-8
C-1	Four Diskette Drives.....	C-2
D-1	Main Keyboard VIEW Key.....	D-1
G-1	Systems Options Menu.....	G-1
G-2	Communications Settings Menu.....	G-2

## TABLES

Table No.	Title	Page
13-1	Print Menu Settings.....	13-8
13-2	Stop Printer Menu Options.....	13-36
A-1	Main Keyboard Keys.....	A-3
A-2	Mini Keyboard Blue Keys.....	A-10
A-3	Mini Keyboard White Keys.....	A-11
A-4	Mini Keyboard Red Keys.....	A-13
A-5	Mini Keyboard Black Keys.....	A-13
D-1	Viewing Symbols.....	D-2
E-1	Summary of Ruler Setting Characters.....	E-1

## PREFACE

The *Word Processing System Reference Manual* explains how to use Digital Equipment Corporation's word processing systems. It provides complete information for every word processing feature, with examples such as what you'll see on the display screen or the results of giving an incorrect response. The manual has been specially designed and formatted so that you can readily see the basic steps to perform an operation, if that's all you need.

This manual has been written for anyone who has access to a DIGITAL word processing system - typists, programmers, engineers, lawyers, doctors, dentists. The only prerequisite knowl-

edge is the ability to use an office-grade or portable typewriter.

To use this manual most effectively, inspect the Index for references to the pages where particular features are described. If you would like to read the entire manual but your time is limited, use the following guide to selective reading.

Because you start each DIGITAL word processing system model by a slightly different procedure, there is a separate Chapter 2 for each. Read the Chapter 2 that applies to the model you have available.

## Application

Learning enough information to become productive

Typing and making changes

Laying out words on a page, both horizontally and vertically

Printing what was typed

Maintaining stored text

Learning more advanced features

## Chapters to Read

- 1 Introduction
- 2 Operating the Equipment
- 3 Creating a Document
- 5 Editing a Document
- 13 Printing a Document
- 17 Maintaining Diskettes
- Glossary

- 3 Creating a Document
- 5 Editing a Document
- 7 Searching
- 8 Highlighting Text: Centering, Underlining, Boldfacing, and Capitalization
- 9 Subscripts, Superscripts, and Composite Characters

- 6 Rulers
- 12 Pagination
- 14 Headers and Footers

- 13 Printing a Document
- 14 Headers and Footers

- 4 Document Index
- 17 Maintaining Diskettes

- 10 Reusable Text: Library Documents
- 15 User Defined Keys
- 16 Customizing
- 18 WS102 and WS202 Special Features

This manual is organized as follows:

- *Overviews of the subject matter* are located at the beginning of each chapter. These describe the different tasks you can accomplish and provide forward references (within the same chapter) to the detailed information.
- *Operating instructions* are listed in the order you should follow. Upper case letters are used in describing responses you may type to the word processing system. In most cases, however, you may type either upper or lower case letters. The manual points out when only upper or only lower case is required.
- *Drawings of the keyboards* show the location of the keys you should press while following the instructions.
- *Photographs of actual screen displays* show the information that will appear on the word processing display screen as you follow the instructions.
- *Appendixes*, located after the last chapter, provide information additional to the chapter instructions and descriptions.
- *A glossary*, located after the appendixes, provides definitions of all word processing words and terms.

---

Additional information may be obtained from the following DIGITAL documents:

<b>Document</b>	<b>Part Number</b>
Word Processing Operator Training Manual	JB034-A
Word Processing System List Processing User's Manual	AA - 5269B - TK
WPS-8/RCP Communications Options User's Guide	DEC-08-BWCOA-A-D
Letter Quality Printer User's Manual	EK-LQP78-UG-001
LA180 DECprinter I Maintenance Manual	EK-LA180-MM-001





## CHAPTER 1 INTRODUCTION

All members of the DIGITAL family of word processing systems contain the same features, provide you with the same capabilities, and operate in the same way. Material typed on one DIGITAL word processing system can be edited or printed on any other.

Here is a summary of features of the DIGITAL family of word processing systems:

- **You can always see your typing on the display screen in front of you.** When you spot a typo, you can correct it and the system will immediately display the results on the screen for your inspection.

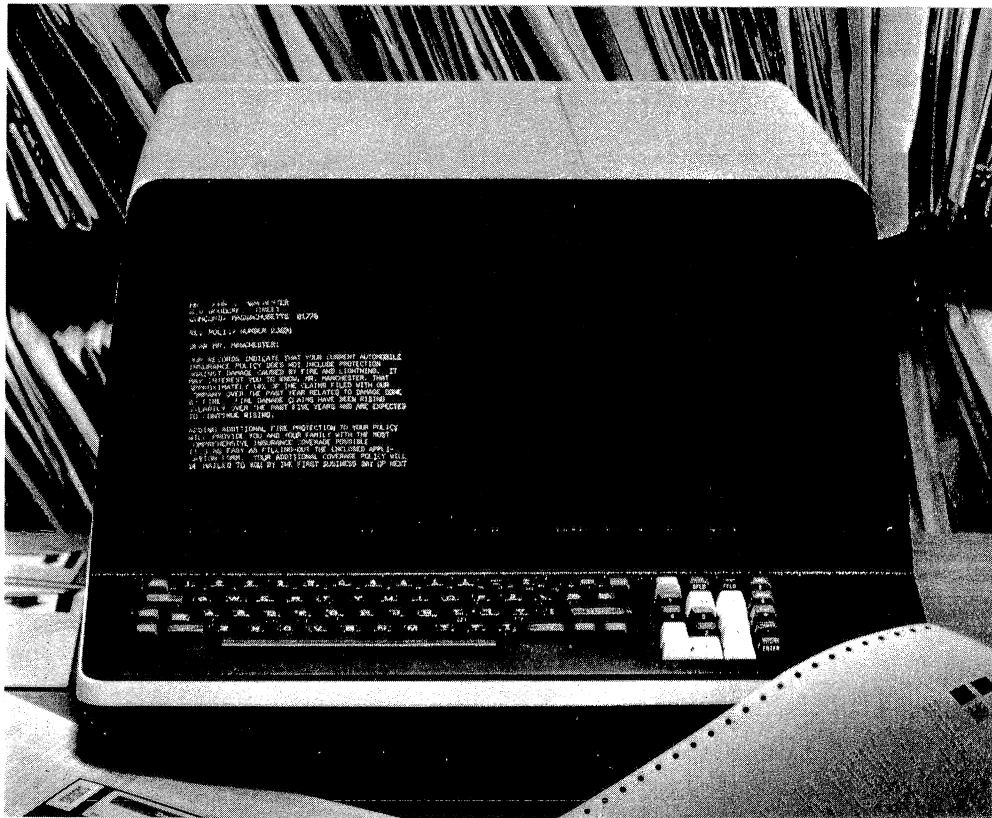

M-0805

Figure 1-1 Display Screen

- **You don't have to press the RETURN key when typing "straight" text.** The word processing system will determine where to end each line for you. This action is referred to as "word wrapping" because the system automatically puts a word at the beginning of the next line ("wraps" it down from the previous line).
- **Your typing will be saved automatically.** All you need to do is give your typing a document name. The system will decide where to store it, will keep track of all your other documents in storage, and will record the date and time each is used. Whenever you want to look at or edit some typing, just tell the system the document name and the beginning of it will automatically be displayed on the screen.
- **You can print one document while you type or edit another.** You'll print a document only when you need a copy, not every time

you use it. What's more, you can submit as many as eight documents for printing at one time, and the system will automatically print each in its turn. If you wish, you can have the system determine where to end each page, automatically number the pages, and add extra space between lines for rough drafts.

- **You can change, add, or delete portions of what you've typed without retyping the unchanged material.** The system will automatically expand or condense the spacing to accommodate your changes and will display the results on the screen.
- **You can change the margins or tabs to reformat your typing.** You don't have to retype a single word. The system will automatically readjust the typing to fit the new dimensions selected. You can preview on the screen how your typing looks with the new margins and tabs before printing.

## 1.1 WORD PROCESSING EQUIPMENT

The word processing **keyboard** lets you type text and tell the system what to do. The word processing **screen** lets you see your typed text plus various messages that help you use the system more efficiently. The word processing **storage** saves your work so you can use it again. The word processing **printer** produces paper copies of your typing. The **PDP-8 minicomputer** is the "brain" that makes the word processing systems work.

This Reference Manual describes how to use four configurations, or members, of the

DIGITAL family of word processing systems. They are the WS78, WS100, WS102, and WS202 (WS stands for Word Station).

The WS78 is a single-user word processing system and includes the following equipment:

- Main keyboard and mini keyboard,
- Display screen,
- One or two dual-diskette drives,
- Large scale integrated (LSI) PDP-8 minicomputer,
- Optional letter quality and/or draft printer.

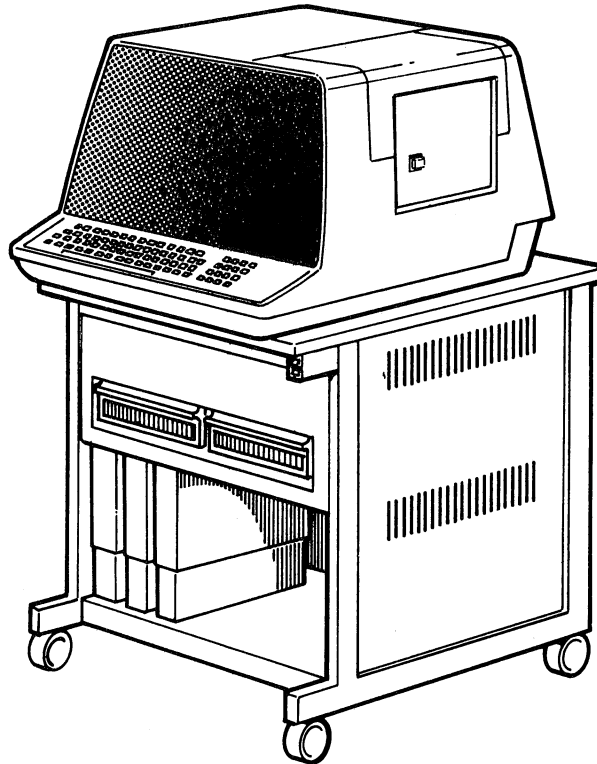

MK-0129

Figure 1-2 WS78

The WS100 is a single-user word processing system and includes the following equipment:

- Main keyboard and mini keyboard,
- Display screen,
- One or two dual-diskette drives,
- PDP-8A minicomputer,
- Optional letter quality and/or draft printer.

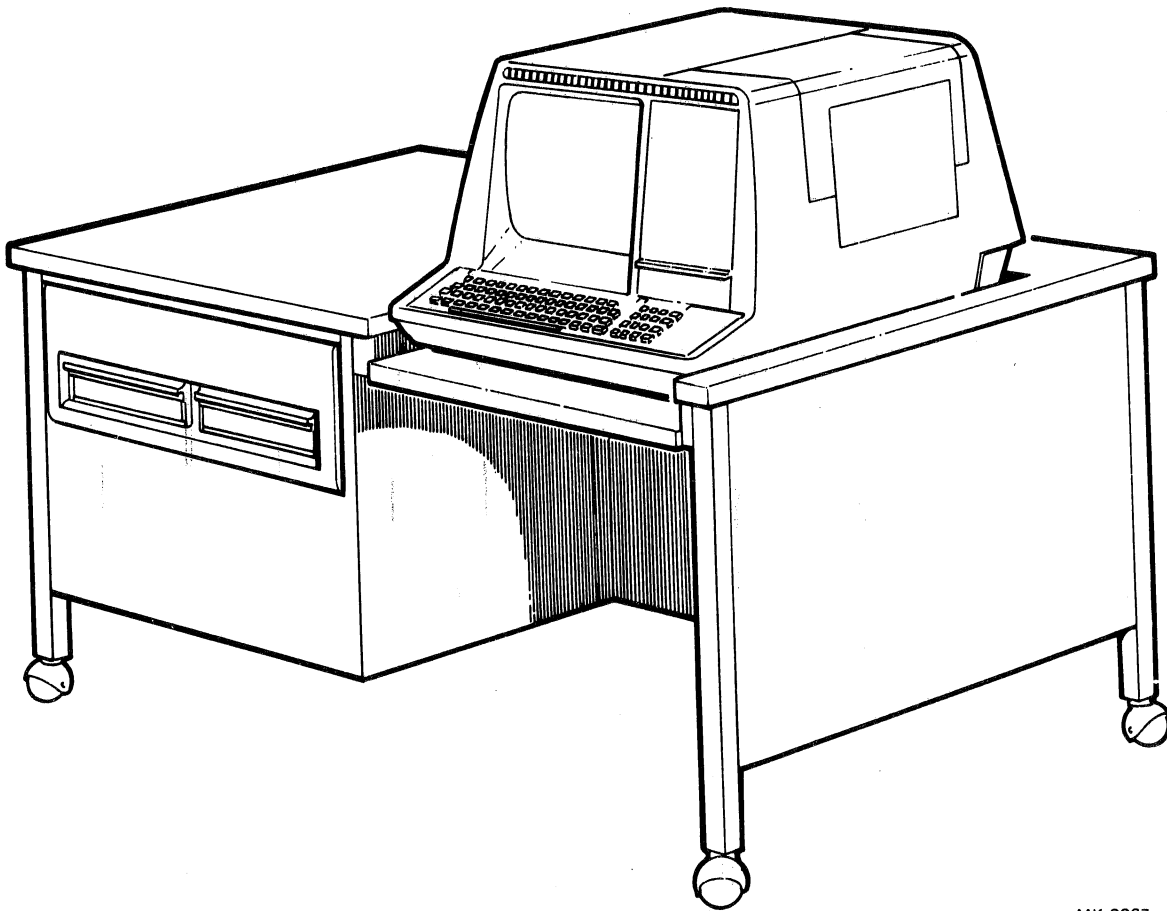

MK-0067

Figure 1-3 WS100

The WS102 and WS202 are two-user word processing systems and include the following equipment:

- Two main keyboards and mini keyboards,
- Two display screens,
- Two dual-diskette drives,

- PDP-8A minicomputer,
- Optional letter quality and/or draft printer.

See Figures 1-4a for the WS102 and 1-4b for the WS202.

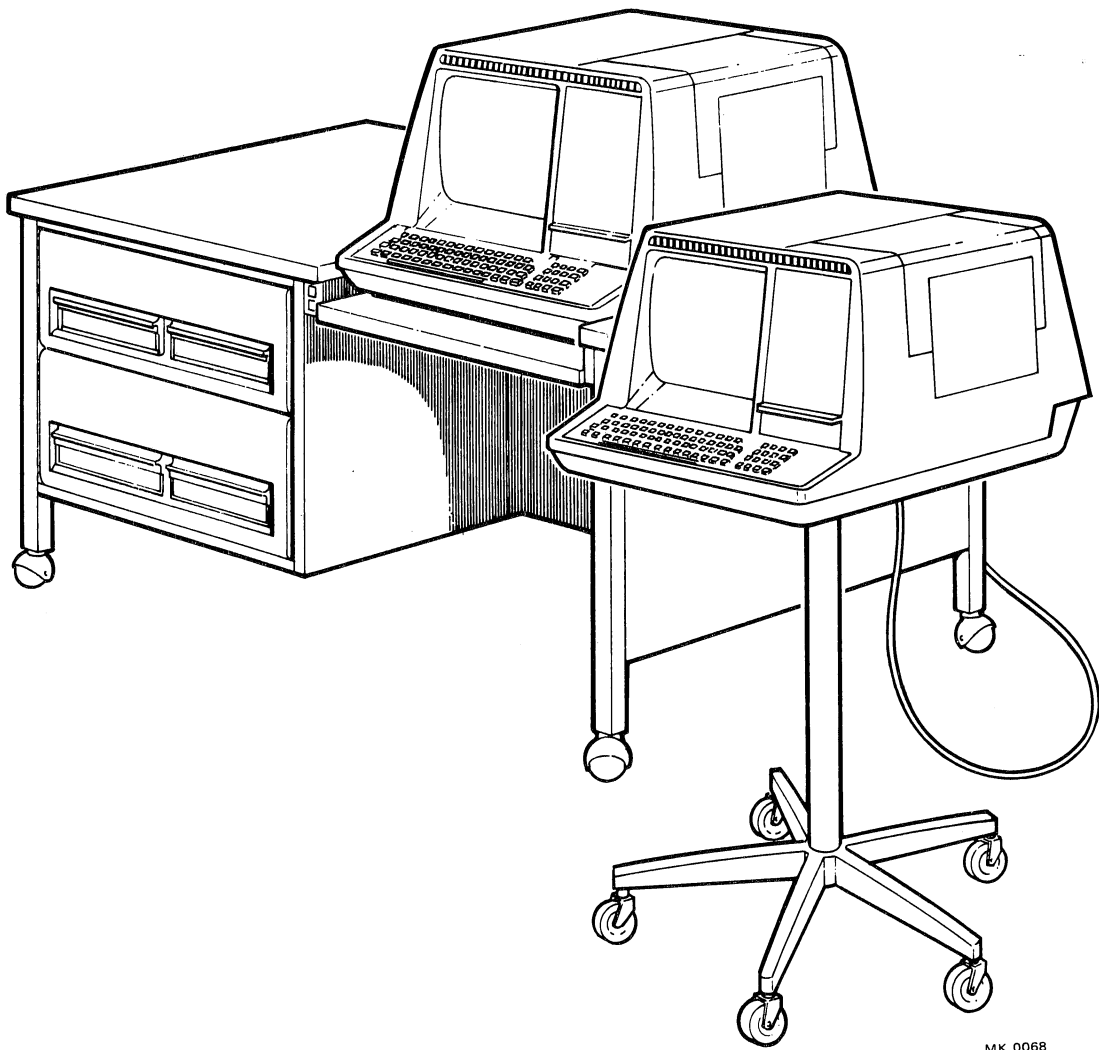

MK 0068

Figure 1-4a WS102

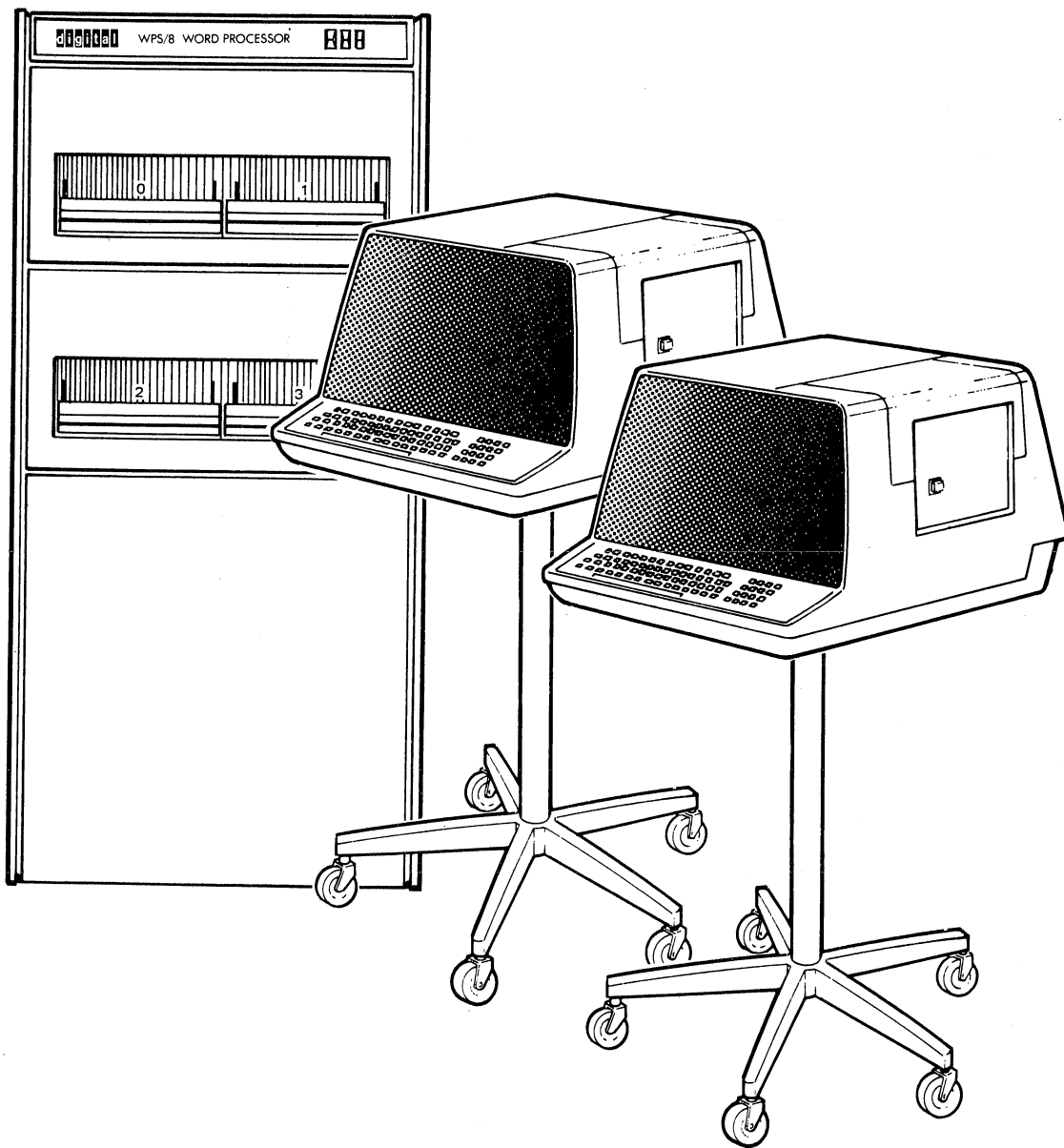

MK-0188

Figure 1-4b WS202

### 1.1.1 The Keyboard

The word processing system contains two keyboards: a main keyboard and a mini keyboard.

The main keyboard has a standard typewriter keyboard plus some special keys. The special

keys let you correct errors noticed while typing. For example, if you type "tha" instead of "the" you can erase the letter "a" just by pressing the RUB CHAR OUT key. If you type "rhe" instead of "the" you can erase the entire word just by pressing the RUB WORD OUT key.

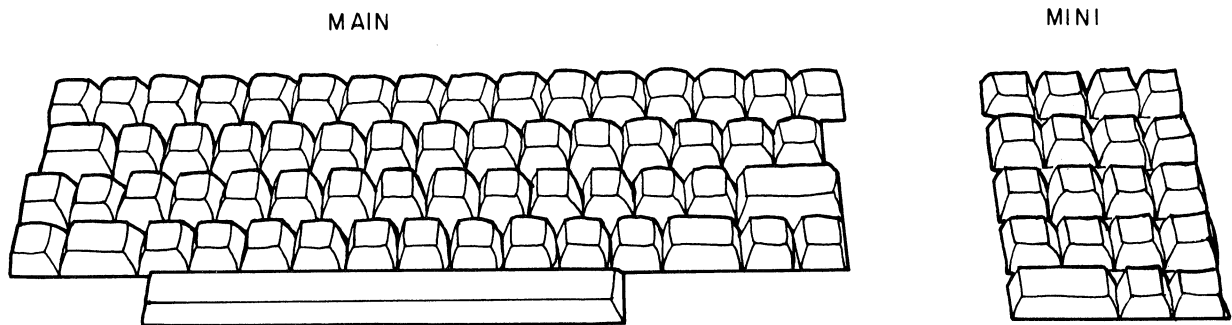

CP - 3249

Figure 1-5 Keyboards

Some main keyboard keys have gold lettering on their front face. When the gold key on the mini keyboard is pressed first, these keys perform the special operation indicated by the gold labels rather than their normal operation. For ex-

ample, you can automatically center a line just by pressing the gold and the CENTR keys (gold lettering on the front face of the "C" key). Appendix A.1 describes all main keyboard keys.

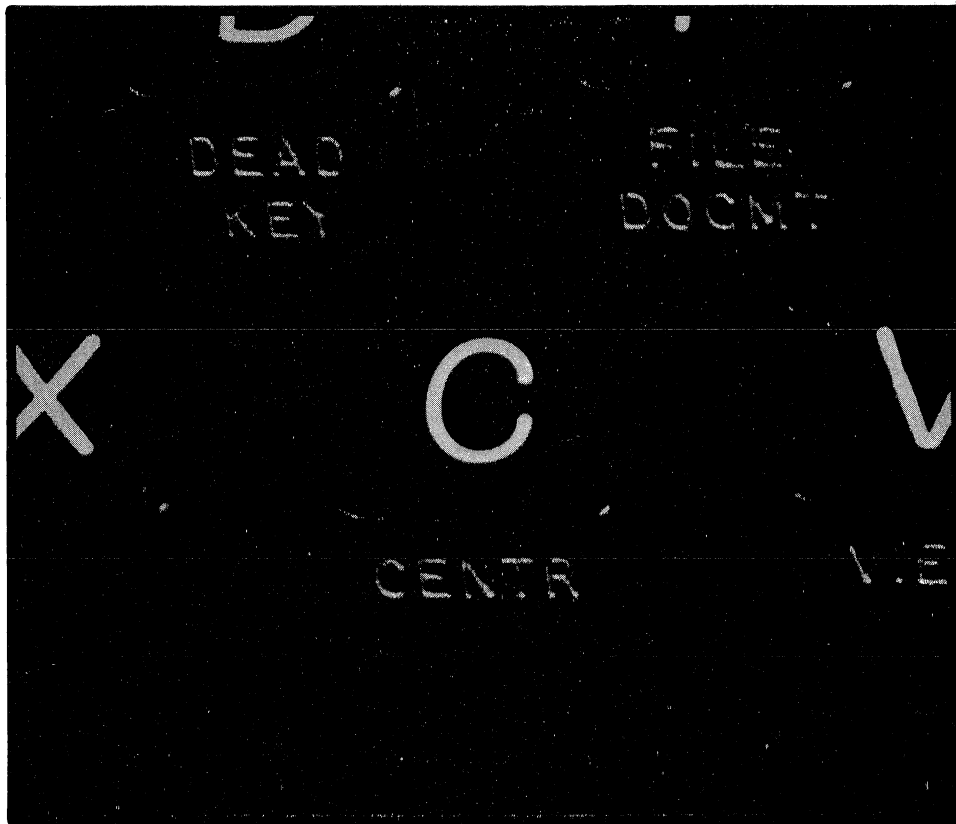

8018-215-A0060

Figure 1-6 Example of Main Keyboard



The mini keyboard, a set of 19 keys to the right of the main keyboard, is used for editing and organizing text. If you want to underline a sentence, for example, press the mini keyboard white UNDER LINE key to tell the system the

action to be performed. Then press the mini keyboard blue SENT (for SENTence) key to tell the system how much typing is to be underlined. Appendix A.2 describes all mini keyboard keys.

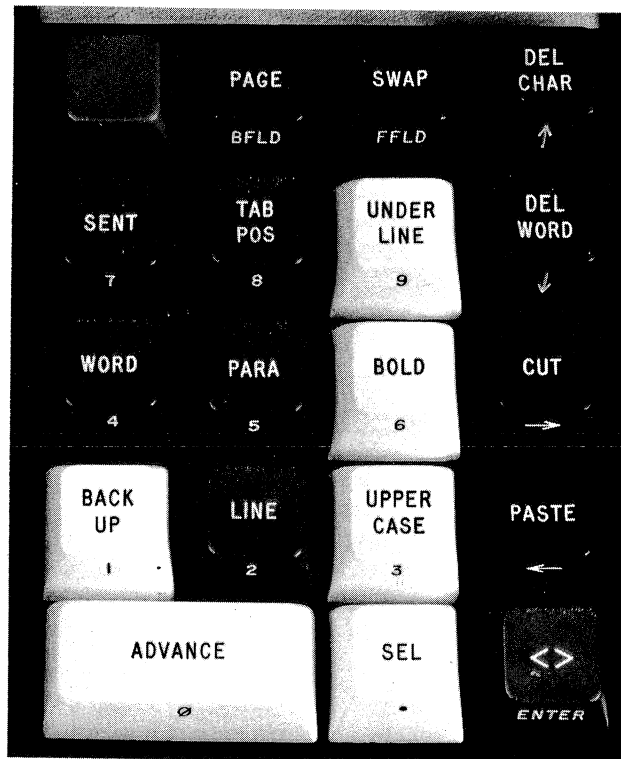

8018-214-A0145

Figure 1-7 Mini Keyboard

### 1.1.2 The Display Screen

The word processing screen displays 24 80-character lines of text (single-spaced). This display area lets you see what you have just typed and where you are at the present time. When you make changes or type new material, you can see the results instantly on the screen.

All typing and editing is shown on the bottom line of the display screen, just as on a familiar typewriter. The last screen line always contains a blinking underscore character, called a “cursor,” that marks your current position and indicates where the next typed character will appear. As you type additional material, the text

moves upward one line, similar to paper being rolled forward in a typewriter.

When working with a lengthy document, you can always find whatever portion you want by moving the text up or down on the screen. This is called scrolling, and is accomplished by mov-

ing the cursor through the document by using the mini keyboard keys.

### 1.1.3 Storage

The word processing system stores your documents on diskettes. A diskette is about the size and shape of a 45-rpm phonograph record.

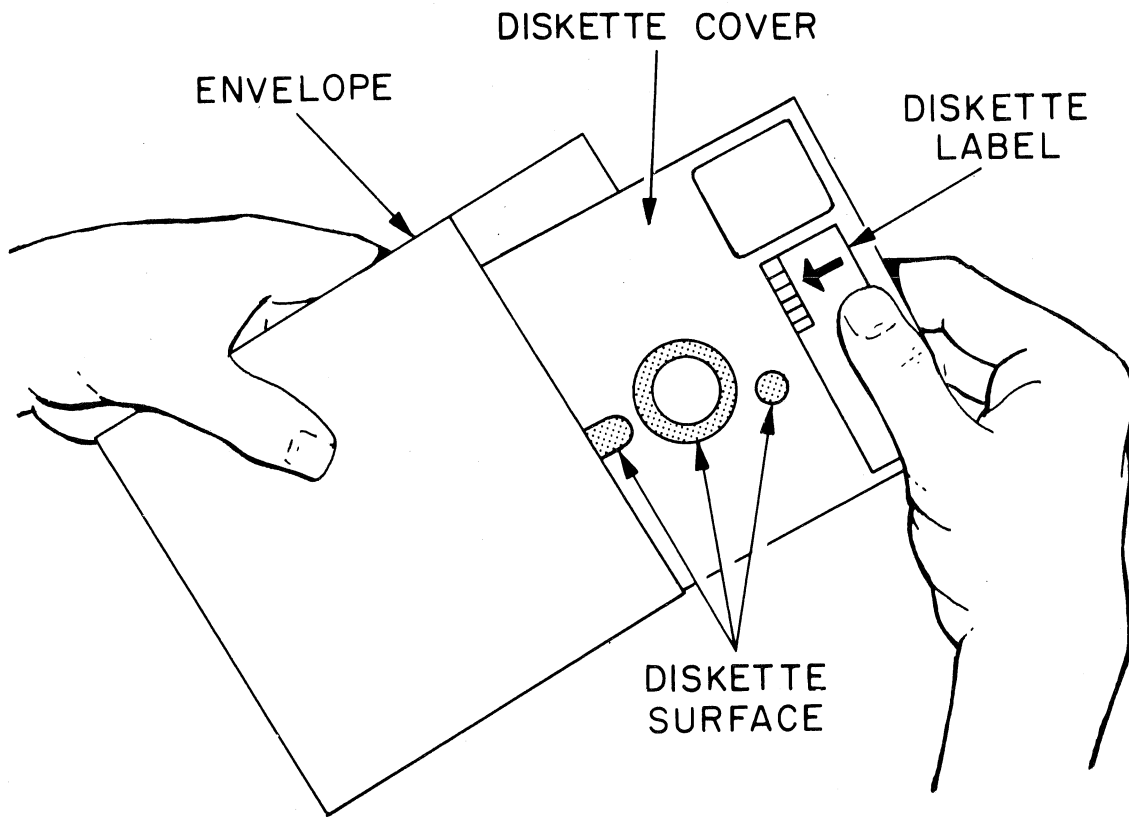

CP-3234

Figure 1-8 Diskette

Diskettes fit in the disk drives, which are similar to phonographs. The right drive holds the document diskette, which stores approximately 125 pages of typing. The left drive holds the system diskette, which contains the programs that run the system plus space for library text (such as form letters, or dictionaries of difficult words), and additional documents.

Document diskettes are completely interchangeable among all DIGITAL word processing systems. On word processing systems with four diskette drives, you potentially have two additional diskettes, or 250 more pages, for document storage. Document storage space is assigned according to the actual size of a docu-

ment. A two-line memo, for example, takes up a fraction of the space of a full page letter, so there is no wasted storage space.

The system automatically maintains an index of each diskette, showing the documents' names, sizes, and the dates each document was originally created and last edited. For example, you don't have to remember whether a document was called "Memo 8/26" or "Relocation Memorandum," because you can look at the index on your screen whenever you desire. In addition, you can print this index to keep a running log of typing activity, or attach it to the diskette jacket or put it in a notebook for quick reference.

```

-- DOCUMENT INDEX --
1/24/78 Tue 9:11:51
Drive: 3, Name: HELLO , # of Docs: 5, Blocks left: 439 (of 627)

```

Document Number	Name	Created	Modified	Size	Version	Elapsed Time Last	Total
* 6	index	1/5/78	1/16/78 9:54	3	2	0:00	0:00
5	Memo for basic information on preliminary plan	11/11/77	11/11/77 16:31	10	1	0:01	0:01
3	abbrv	11/4/77	11/4/77 11:12	1	3	0:01	0:05
2	intro part ii	11/2/77	11/7/77 10:07	168	22	0:06	4:43
1		11/2/77	1/16/78 9:53	1	9	0:00	0:00

Press RETURN to display more entries  
OR Gold MENU to recall the Main Menu.

9113-23R1-A0075

Figure 1-9 Document Index

### 1.1.4 Printers

Two types of printers are available for purchase with all DIGITAL word processing systems: a letter quality printer and a draft printer. The letter quality printer produces typing comparable

to a typewriter at an average speed of 540 words per minute. The draft printer produces typing comparable to a computer printout at an average speed of 2160 words per minute, or approximately four times faster.

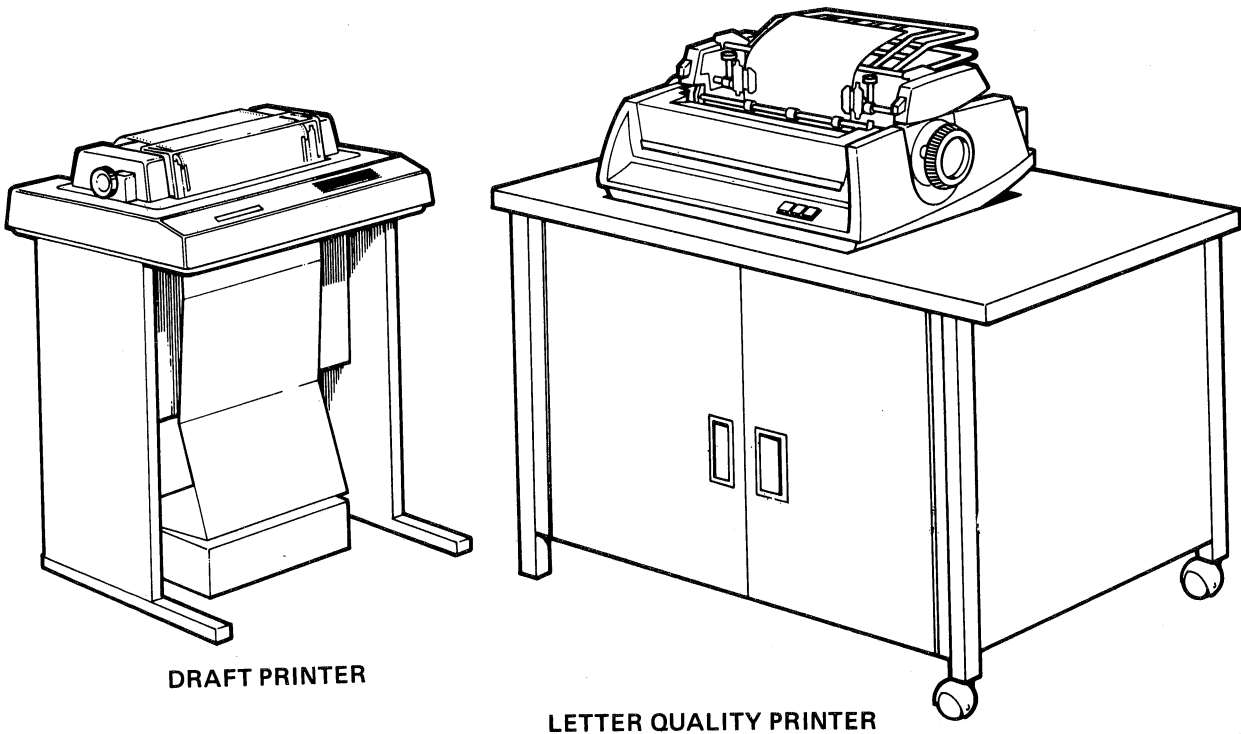

MK-0066

Figure 1-10 Printers

## 1.2 USING THE WORD PROCESSING SYSTEM

When you use a DIGITAL word processing system, you don't have to memorize special codes or instructions. The system leads the way by displaying menus, prompts, and error messages on the screen. You'll always know what to do next.

A *menu* is a list of options from which you can choose an action to perform. The Main Menu is the heart of the word processing system. It provides such "main" options as document creation, editing, and printing (similar to choosing your main course from a restaurant menu). Appendix B summarizes all Main Menu options and provides a cross-reference to where each is described in this Reference Manual.

```
-- MAIN MENU --                               1/24/78 Tue 9:06:00

C = Create a new letter or document
E = Edit an existing letter or document
P = Print a letter or document
I = Index of letters and documents on file
F = Finished using the system
M = More main menu selections...

Type the letter and then press RETURN.
```

9113-3R1-A0062

(Version 2.7)

```
-- MAIN MENU --                               4/6/78 Thu 10:37:37

C = Create a new letter or document
E = Edit an existing letter or document
P = Print a letter or document
I = Index of letters and documents on file
D = Delete a document
F = Finished using the system
M = More main menu selections...

Type the letter and then press RETURN.
```

M113-12A0385

(Version 3.0)

Figure 1-11 Main Menu

Depending on the Main Menu option selected, the system may display other menus from which you can choose suboptions (similar to deciding among "rare," "medium," and "well-done" after you've selected steak as your main course).

For example, if you select the Main Menu printing option, the system will display a Print Menu letting you choose how many copies to print or what size paper to use, to list just a few of the printing suboptions.

```
-- PRINT MENU --                               9/30/77 Fri 12:34:32
These are the current settings for printing document:

(1.28) s11 hyphenation
1 copy will be printed                          66 total lines per page
1 is the number on the first page               6 lines in the top margin
1 is the first page printed                     6 lines in the bottom margin
                                                10 characters per inch (pitch)

0 extra half-line space between lines
0 spaces added to the left margin
0 spaces between columns
do not stop before every page
automatically break into pages
do not print extra dark
do not print with two wheels
document destination is LQP

If all settings are correct type YES, otherwise type NO,
then press RETURN.
```

8920-14R3-A0061

Figure 1-12 Print Menu (Version 2.7)

```
— PRINT MENU —                                     4/6/78 Thu 10:57:42
These are the current settings for printing document:
  (0.2) index
  10 characters per inch (pitch)                   66 total lines per page
  1 copy will be printed                          6 lines in the top margin
  1 is the number on the first page               6 lines in the bottom margin
  1 is the first page printed                     0 spaces added to the left margin
                                                    0 spaces between columns

  0 extra half-line space between lines
  do not stop before every page
  automatically break into pages
  do not print extra dark
  do not print with two wheels
  document destination is LQP

If all settings are correct type YES, otherwise type NO,
then press RETURN.
```

M113-2BWA0382

Figure 1-12 Print Menu (Version 3.0)

A *prompt* is a request for additional information. The system displays prompts as the need arises. For example, if you tell the system you want to print a document, it will display the following prompt on the screen:

```
                                                    1/24/78 Tue 9:00:28

Type the name of the document you want to print and press RETURN
OR Just press RETURN if the document desired is (1.17) index
OR Press Gold MENU to recall the Main Menu.
```

9113-15R1-A0064

Figure 1-13 Example of Prompt

When responding to a prompt, always be certain to follow the spacing shown on the screen and to distinguish between the letter "l" and the numeral "1." These two characters are NOT interchangeable.

An *error message* is displayed on the screen whenever you make an inappropriate response to a menu or prompt. (See below.)

Whenever you try to do something that's not possible, the system will buzz to alert you. For example, if you try to move the cursor forward when it is located on the very last character of your document, the system will buzz.

If you're a fast typist, you can type instructions faster than the word processing system can re-

spond. The system will "stack" them for you and act on each only when the previous one has been completely processed. For example, if you know you want to add new material to the top of the second page of a document, you can type the letter E and the document's name (to tell the system you want to Edit a particular document), and start typing your new material even before the system has displayed the bottom of the document on the screen.

When typing text, you should press the RETURN key only at the end of a paragraph, list item, or table entry. Do NOT press the RETURN key when typing straight text (because the word processing system automatically "word wraps" your typing, or determines where to end each line).

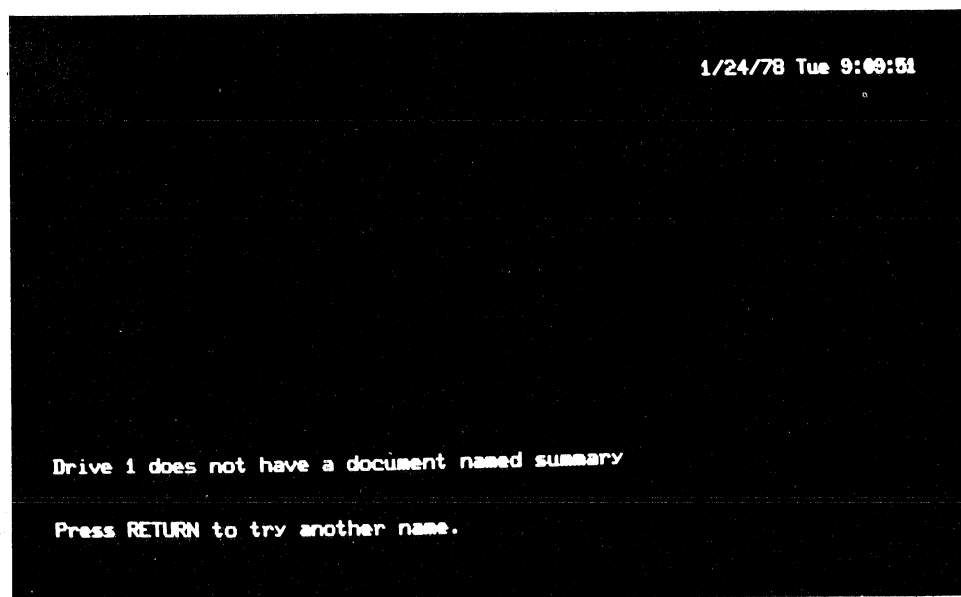

9113-17R1-A0063

Figure 1-14 Example of Error Message



## CHAPTER 2 OPERATING THE WS78 EQUIPMENT

The WS78 word processing system consists of hardware and software. *Hardware* is the actual equipment you can see – the keyboards, the display screen, the diskette drives and the computer. *Software* is computer programs that allow you to operate the equipment in a particular way. The word processing software allows you to type text, correct errors, save the text for using again, and print what you've typed.

To start up the WS78 word processing system, you must make both the hardware and the software operational. Start up requires two diskettes: (1) a system diskette, which contains the WS78 software, and (2) a document diskette, which contains (or will contain) the documents you create and edit. If you don't already have these diskettes, see your System Manager.

In summary, to start up the WS78 hardware and software, follow these steps:

1. Press the ON/OFF switches to supply electrical power to the hardware (see Section 2.1).

2. Insert the system and document diskettes (see Section 2.2).
3. Press the START switch to bootstrap, or activate, the software (see Section 2.3).
4. Type today's date and the time, and press the RETURN key (see Section 2.4).

Once you start up the hardware and software, the Main Menu is displayed on the screen. This menu gives you a selection of word processing work you may perform. See Section 2.5 for how to use the Main Menu.

### 2.1 TURNING ON THE MACHINE

If you see some words or a blinking underscore character on the screen, the machine is on already. All you then have to do is insert the diskettes, bootstrap, and type the date and time (see Sections 2.2 - 2.4). You can do this provided no one has left the terminal unattended (with work in process). It is available if the screen displays either the message "FINISHED USING THE SYSTEM" or some instructions that begin with "MAIN MENU."

To turn on the machine, follow these steps:

1. Make sure the ON/OFF switch (located on the back of the terminal) which supplies power to the display screen is in the ON position (up).

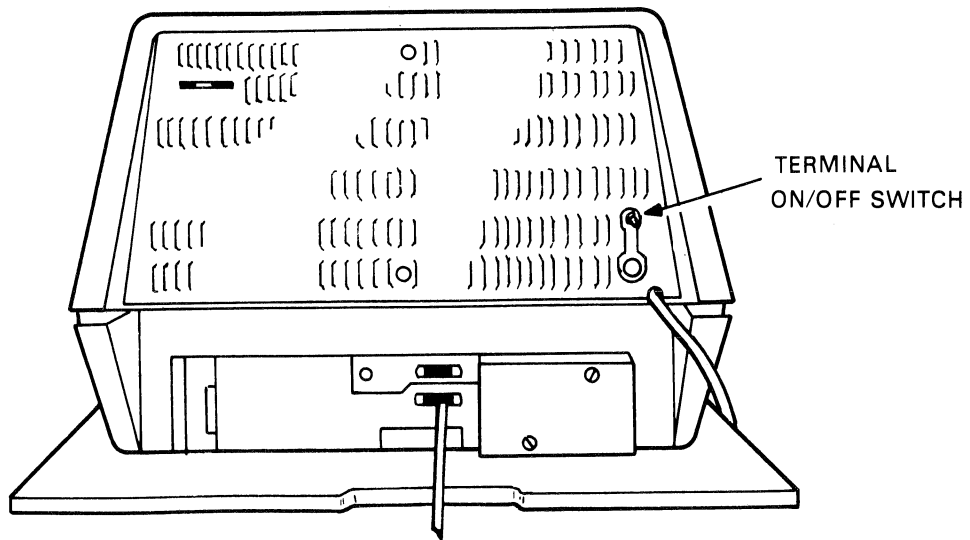

MK-0072

Figure 2-1 WS78 Display Screen  
ON/OFF Switch

2. Push up the ON/OFF switch which supplies power to the entire system (located on the stand under the right front of the terminal). The word processing system will start to hum. If nothing happens, check that the

power plug is securely in the wall socket. (If it is, and your system still does not respond, call your DIGITAL Field Service Representative.)

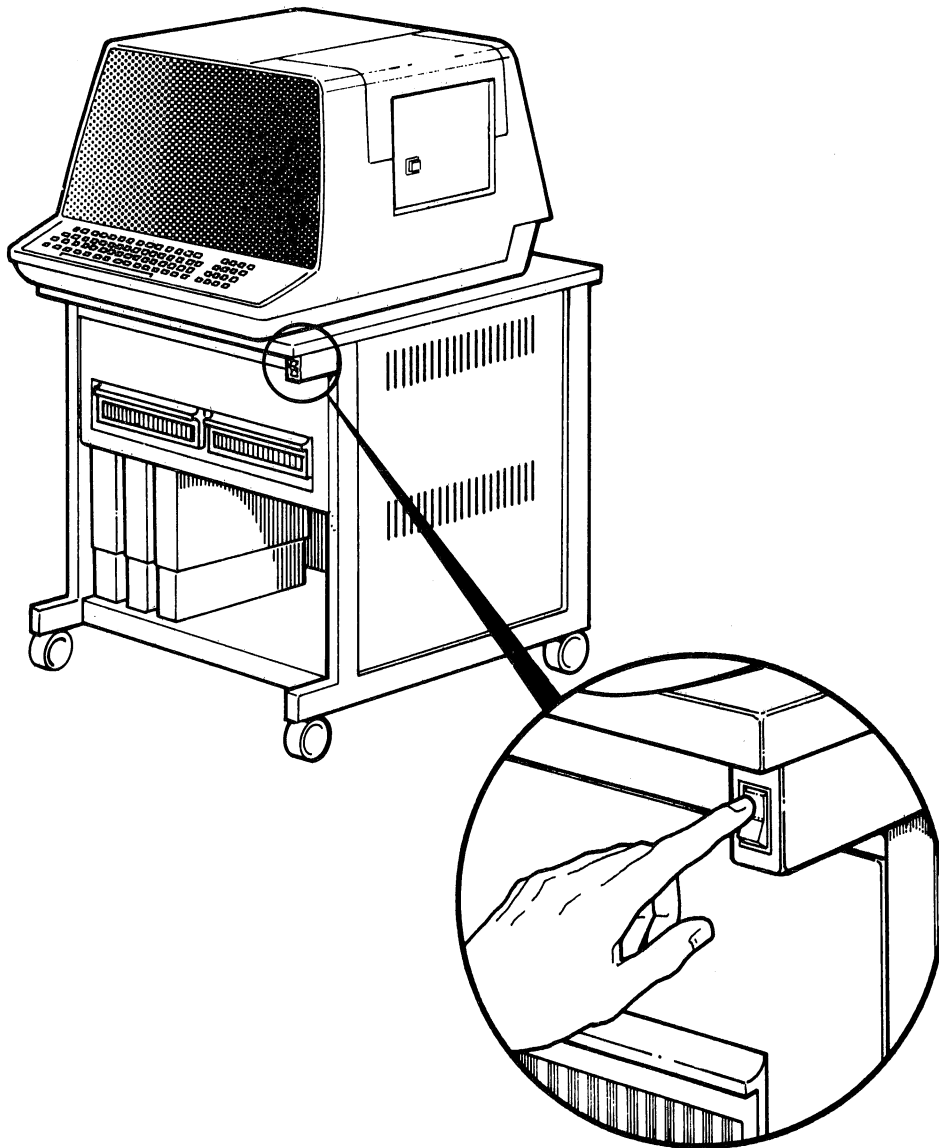

MK-0128

Figure 2-2 WS78 Terminal ON/OFF Switch

After the system warms up, the characters  
ABCDEF  
plus a line of dashes and the cursor (a blinking  
underscore character) will appear on the screen.

Insert your diskettes BEFORE proceeding fur-  
ther.

## 2.2 INSERTING THE DISKETTES

A diskette is a round piece of magnetic material, about the size of a 45-rpm record, kept inside a nonremovable square protective cover. The diskette and protective cover fit into a special envelope when not in use.

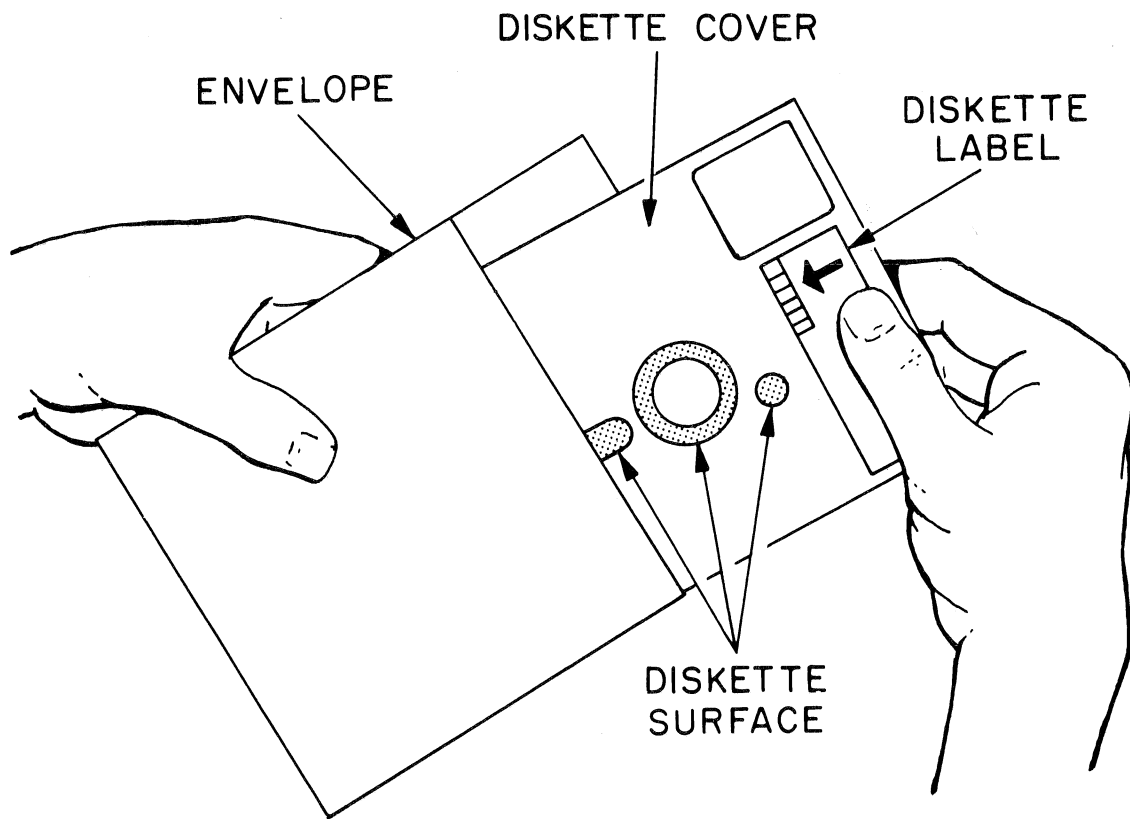

CP-3234

Figure 2-3 Diskette

To operate the WS78 word processing system, insert your system diskette and your document diskette by following these steps:

1. Open the diskette drives by squeezing the handles with your thumb and forefinger. If

either already contains a diskette (left there by the previous user), remove it.

2. Remove the system diskette from its envelope and insert it in the left diskette drive (drive zero). Push down on the handle until it snaps shut.

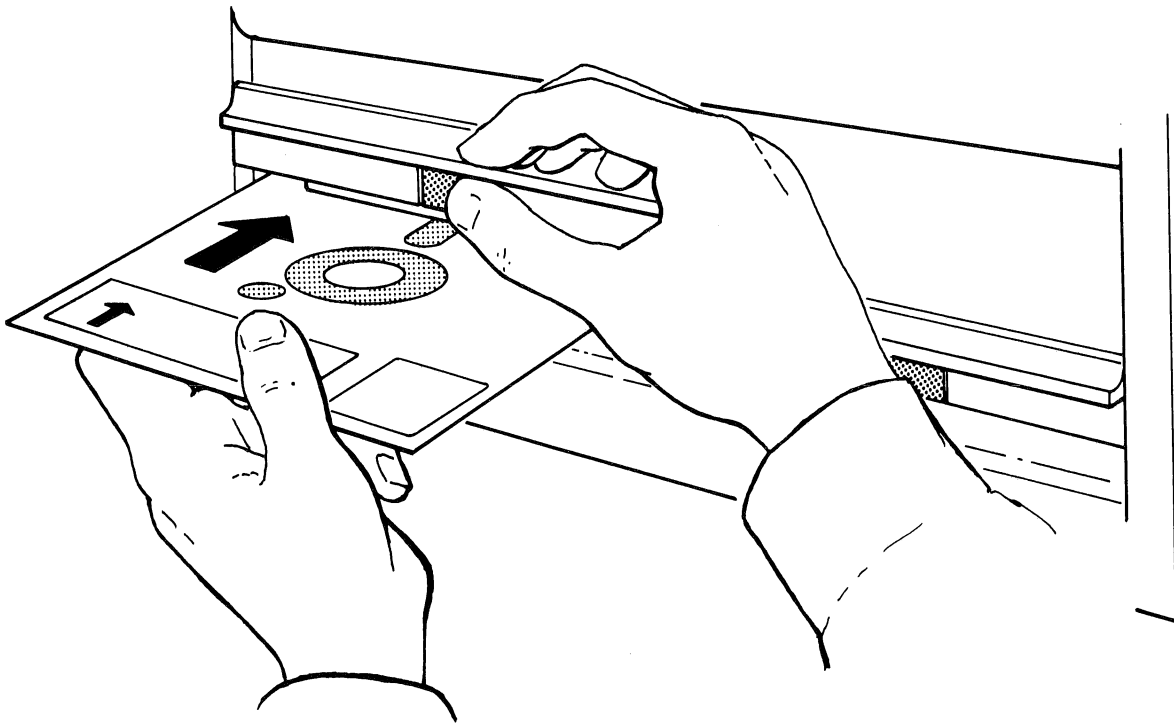

08-1519

Figure 2-4 Inserting System Diskette in Drive

3. Insert your document diskette in the right drive (drive one) the same way you inserted the system diskette.

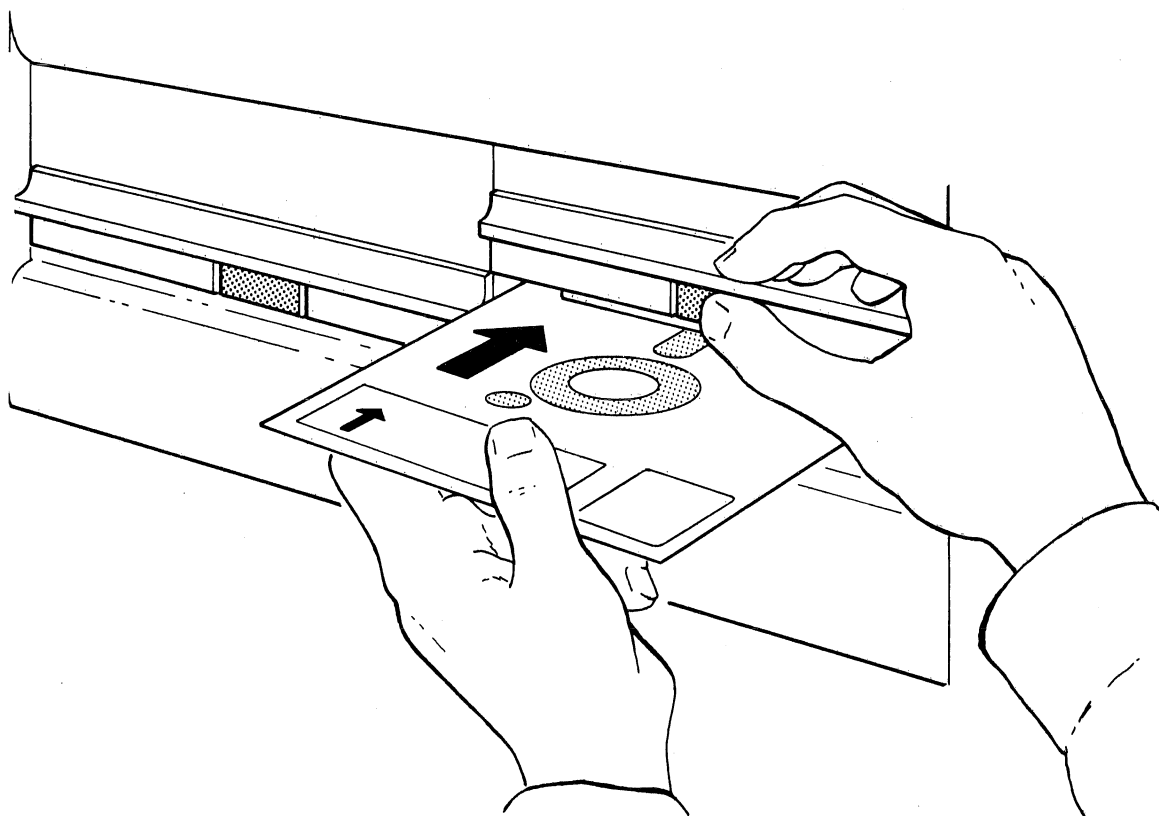

08-1530

Figure 2-5 Inserting Document Diskette  
in Drive

### 2.3 BOOTSTRAPPING

The first step in starting up the software is called *bootstrapping*. This term is derived from the adage "Pull yourself up by your bootstraps." Technically speaking, bootstrapping means to put a

small program into the computer memory which, in turn, inserts a larger program.

To bootstrap, press the blue START switch located on the right side of the terminal.

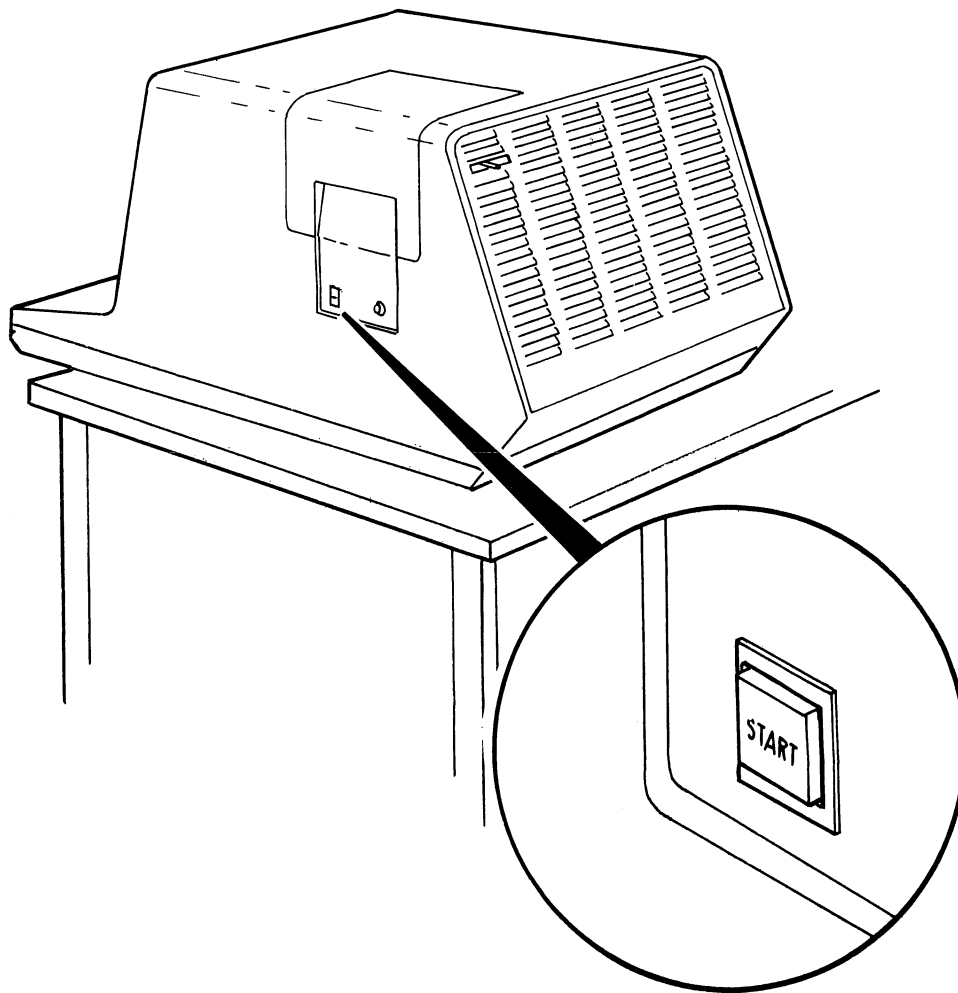

CP-3233

Figure 2-6 WS78 START Switch

A message that looks like the following will be displayed on the screen:

```
START 1000 1132; AC, MQ 4120 0000ABC
```

Do not be concerned that the numbers actually displayed on your screen differ from those above. These numbers are only an example.

The characters "ABC" will briefly be displayed on the screen and will be followed by the word processing Date/Time Menu.

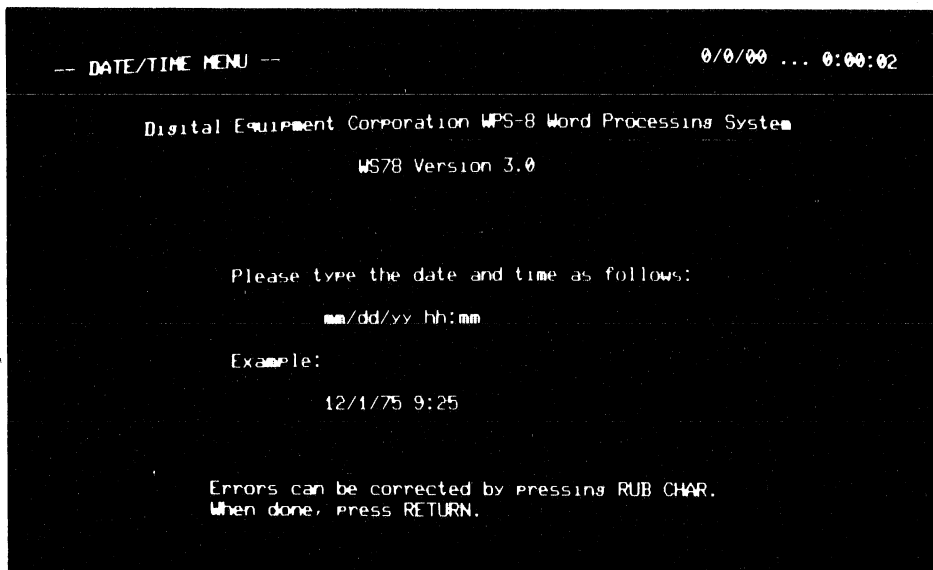

M113-7A0391

Figure 2-7 WS78 Date/Time Menu



Before going further, look at the white/black contrast on your screen. If it is too bright or too blurry, you can adjust it with the INTENSITY CONTROL switch (located on the back of the terminal).

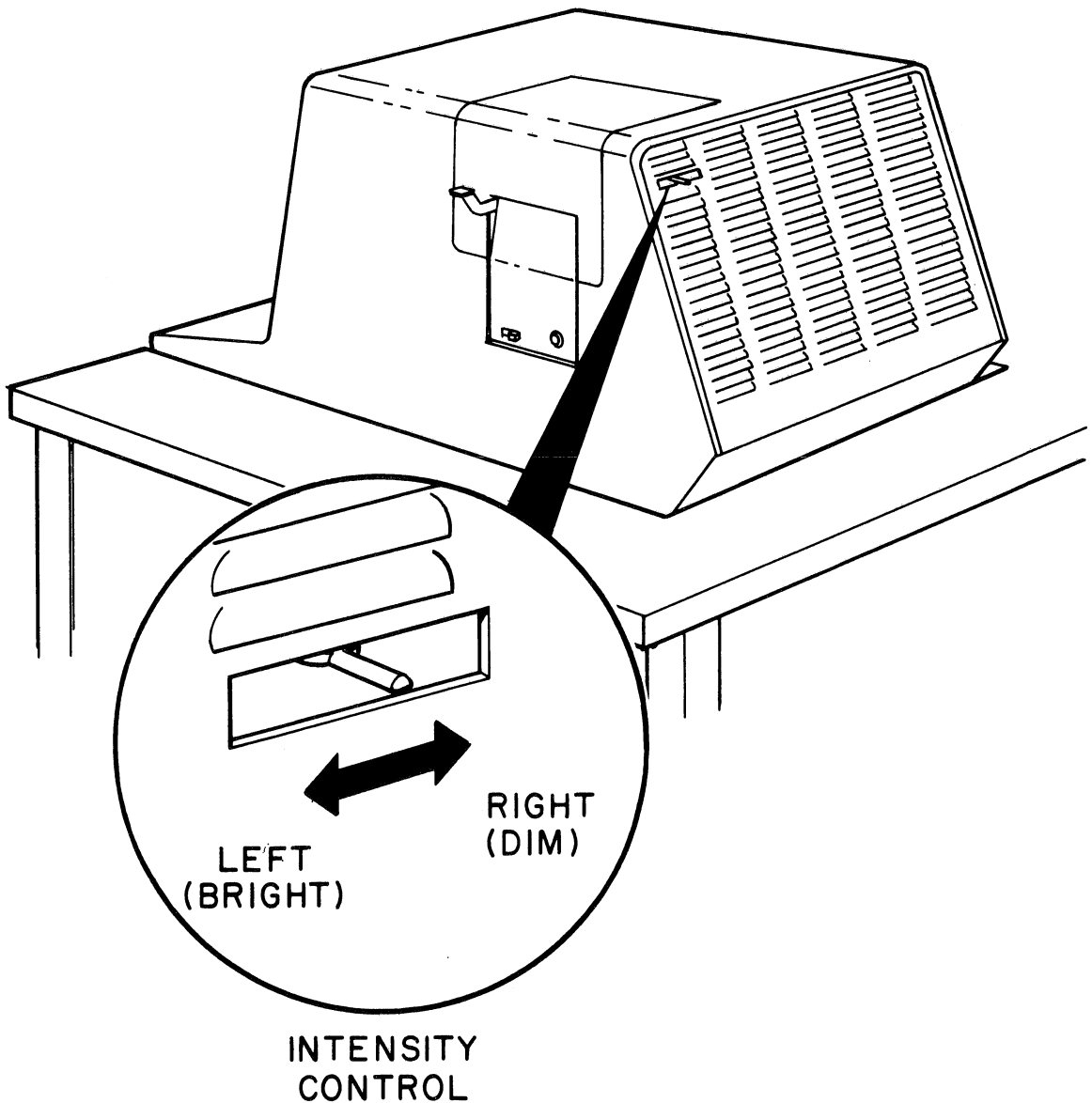

INTENSITY  
CONTROL

08-1560

Figure 2-8 WS78 Intensity Control Switch

## **2.4 TYPING THE DATE AND TIME**

Respond to the prompt by typing today's date and the present time and then press the RETURN key. Be sure to follow the format and spacing as the Date/Time Menu instructs and to use the number 1 instead of the letter l. It is preferable to use a 24 hour clock (for example, type 5 p.m. as 17:00).

If you make a mistake before pressing the RETURN key, press the RUB CHAR OUT key (second row, upper right of the main keyboard). Pressing RUB CHAR OUT causes a back space and erases the character to the left of the cursor. To remove the entire date or time, press the RUB WORD OUT key (located just left of the RUB CHAR OUT key). This causes a back space and erases the word to the left of the cursor.

If you don't specify the date and time correctly, the following message is displayed on the screen:

Date/Time typed incorrectly. Try again.

Retype the date and time and press the RETURN key.

You may omit typing the date or time and just press the RETURN key. No harm will be done, but your bookkeeping will not be entirely accurate. The word processing system keeps an index in which it records when you use each document (among other information). Therefore, if you don't specify a date, the word processing system cannot record the correct bookkeeping information.

## **2.5 MAIN MENU**

After you type the date and time, the first page of the Main Menu is displayed on the screen. Notice that the date and time are displayed in the upper right corner. The day of the week (abbreviated to three letters) and the time in seconds are also displayed there. If you should be working at midnight, the screen display will automatically change to reflect the new date and time (provided you specified the time in 24 hour clock format).

```
— MAIN MENU —                               1/24/78 Tue 9:06:00

C = Create a new letter or document
E = Edit an existing letter or document
P = Print a letter or document
I = Index of letters and documents on file
F = Finished using the system
M = More main menu selections...

Type the letter and then press RETURN.
```

9113-3R1-A0069

(Version 2.7)

```
— MAIN MENU —                               4/6/78 Thu 10:37:37

C = Create a new letter or document
E = Edit an existing letter or document
P = Print a letter or document
I = Index of letters and documents on file
D = Delete a document
F = Finished using the system
M = More main menu selections...

Type the letter and then press RETURN.
```

M113-12-A0183

(Version 3.0)

Figure 2-9 Main Menu Page One

The Main Menu lists the special options of the word processing system. To perform any option, type its letter(s) and press the RETURN key.

Because the system provides so many different options, there are several pages to the Main Menu. To display each successive page, type the letter M and press the RETURN key. If you type M and press the RETURN key when the last Main Menu page is on the screen, the first page will be displayed again. For a complete listing of all Main Menu options, refer to Appendix B.

You can type any Main Menu option regardless of what Main Menu page is displayed. For example, if you have completed your word processing work, you can type P (to Print a document) and press the RETURN key even if

the second or third Main Menu page is displayed.

## 2.6 RESETTING THE DATE AND TIME

The RD Main Menu option allows you to reset the date and time. This is useful if you accidentally type the wrong date or time (if it's January 1977 and you're still in the habit of typing 1976). To reset the date or time, type the letters RD (when any Main Menu page is displayed on the screen) and press the RETURN key. The Date/Time Menu is displayed once again. You can now proceed to type the correct date and time.

## 2.7 STOPPING

When you are finished using the word processing system, type the letter F (for Finished) and press the RETURN key. The following message is displayed on the screen:

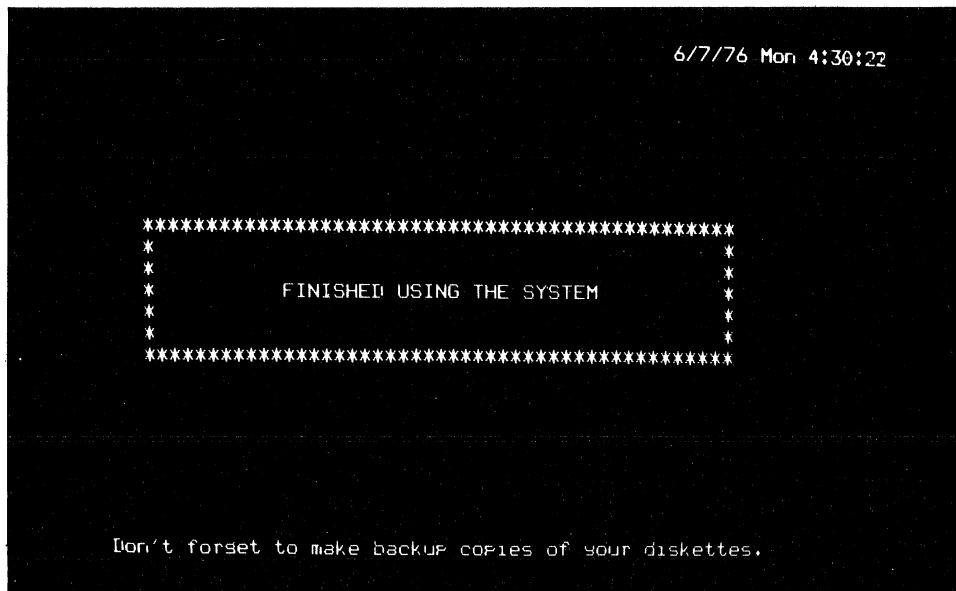

8018-78-A0067

Figure 2-10 Finished Message

If you intend to take a lengthy break and no one else wants to use the word processing system, remove your diskettes and turn off the machine to conserve energy. Just press the red OFF switch located on the front of the machine.

## **2.8 POWER FAILURES AND BROWN-OUTS**

If the power supply to your WS78 system ever fails, you may lose approximately one page of your most recent typing. When power is restored, do the following:

1. Bootstrap the system once again (see Section 2.3).

2. Verify your diskettes to make certain no electrical damage was done (see Section 17.2.3).

If the system ever stops responding to your typing, you have experienced a brown-out, a momentary drop in power supply. You may lose approximately one page of your most recent typing. If the characters "ABCDEF" are displayed on the screen instead of your document, portions of your document may be missing. Should this occur, perform the two steps described above for recovering from a power failure.



## CHAPTER 2 OPERATING THE WS100 EQUIPMENT

The WS100 word processing system consists of hardware and software. *Hardware* is the actual equipment you can see – the keyboards, the display screen, the diskette drives, and the computer. *Software* is computer programs that allow you to operate the equipment in a particular way. The word processing software allows you to type text, correct errors, save the text for using again, and print what you've typed.

To start up the WS100 word processing system, you must make both the hardware and the software operational. Start up requires two diskettes: (1) a system diskette, which contains the WS100 software, and (2) a document diskette, which contains (or will contain) the documents you create and edit. If you don't already have these diskettes, see your System Manager.

In summary, to start up the WS100 hardware and software, you follow these steps:

1. Press the ON/OFF switches to supply electrical power to the hardware (see Section 2.1).
2. Press the START switch to bootstrap, or activate, the software (see Section 2.2).

3. Insert the system and document diskettes (see Section 2.3).
4. Press the RETURN key to display the Date/Time Menu. Type today's date and the time, and press the RETURN key (see Section 2.4).

Once you start up the hardware and software, the Main Menu is displayed on the screen. This menu gives you a selection of word processing work you may perform. See Section 2.5 for how to use the Main Menu.

### 2.1 TURNING ON THE MACHINE

If you see some words or a blinking underscore character on the screen, the machine is on already. All you then have to do is bootstrap, insert the diskettes and type the date and time (see Sections 2.2 - 2.4). You can do this provided no one has left the terminal unattended (with work in process). It is available if the screen displays either the message "FINISHED USING THE SYSTEM" or some instructions that begin with "MAIN MENU."

To turn on the mainline, follow these steps:

1. Make sure the ON/OFF switch (black, located on the side of the terminal) which supplies power to the display screen is in the ON position.

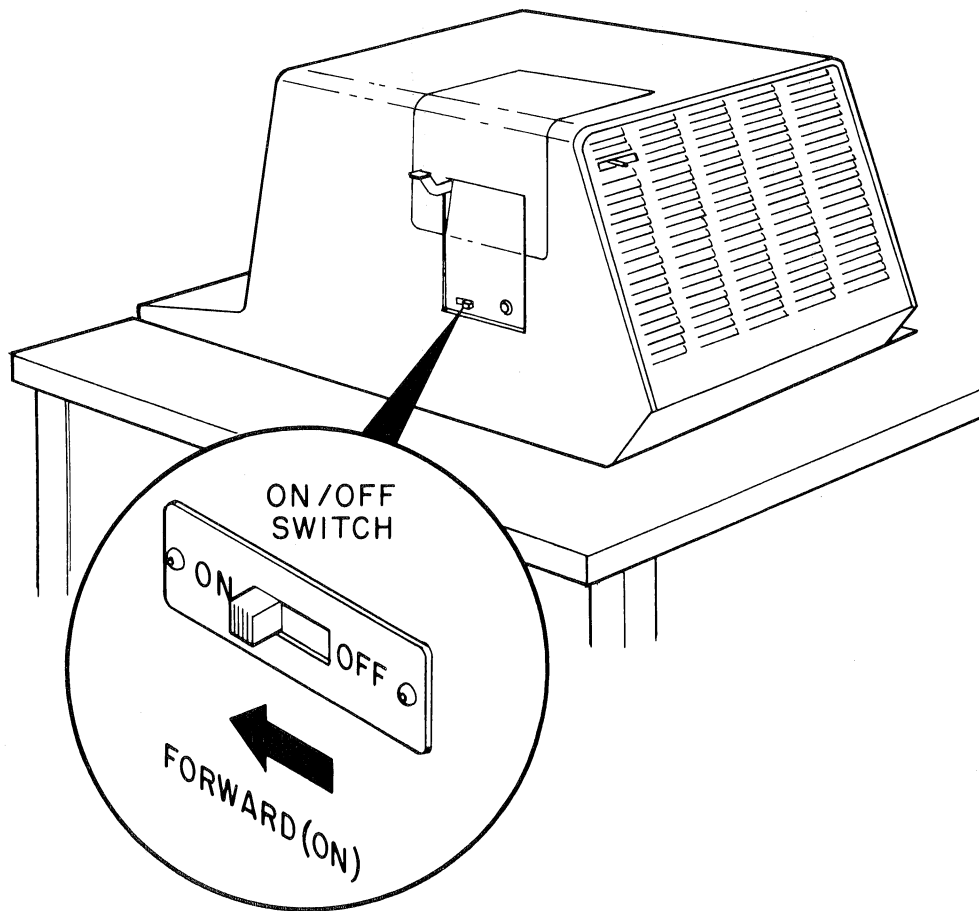

08-1558

Figure 2-1 WS100 Display Screen Switch



2. Push in the ON/OFF switch which supplied power to the entire system (red, located on the front of the system). The word processing system will start to hum. If nothing happens, check that the power plug is securely in the wall socket. (If it is, and your system still does not respond, call

your DIGITAL Field Service Representative.)

After the system warms up, the cursor (a blinking underscore character) will appear in the upper left corner of the screen.

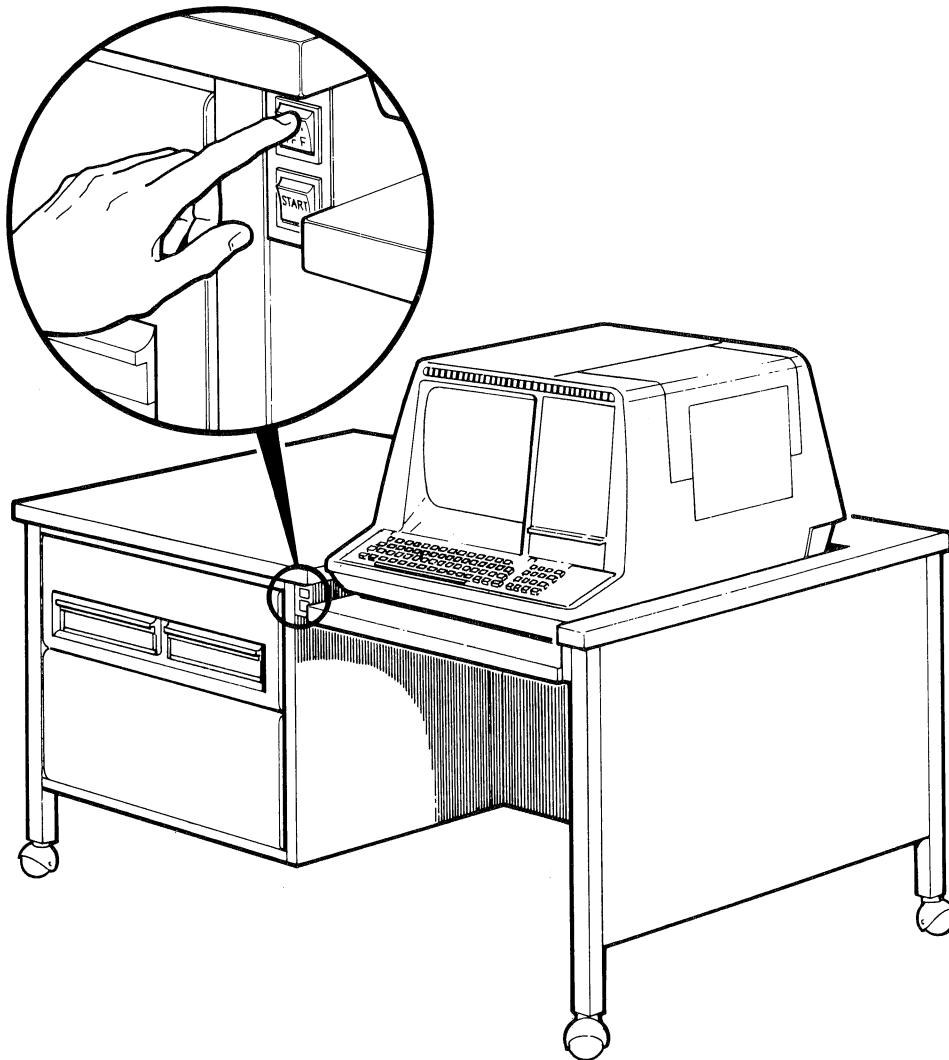

MK 0071

Figure 2-2 WS100 ON/OFF Switch

## 2.2 BOOTSTRAPPING

The first step in starting up the software is called *bootstrapping*. This term is derived from the adage "Pull yourself up by your bootstraps." Technically speaking, bootstrapping means to put a small program into the computer memory which, in turn, inserts a larger program.

To bootstrap, press the white START switch located on the front of the terminal right beneath the ON/OFF switch. The characters "0123" will be displayed in the upper left of the screen.

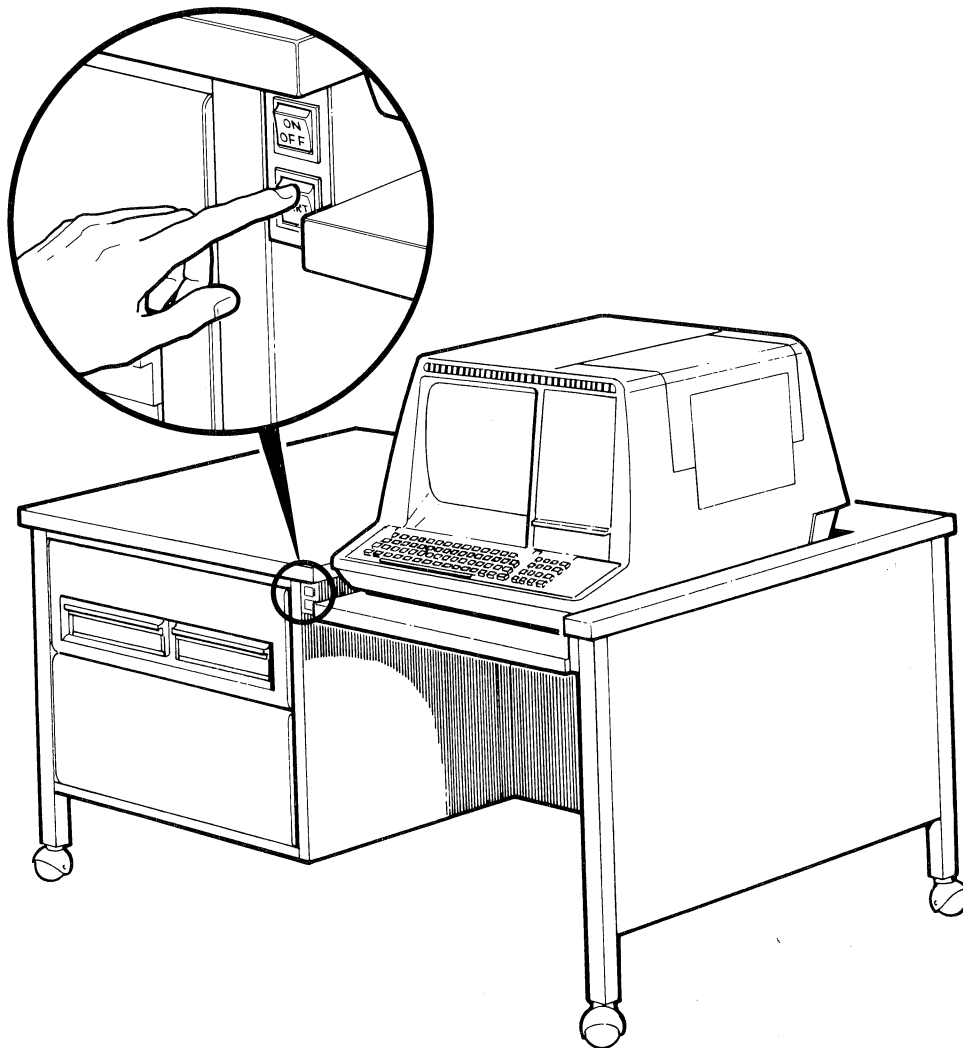

MK 0070

Figure 2-3 WS100 START Switch

### 2.3 INSERTING THE DISKETTES

A diskette is a round piece of magnetic material about the size of a 45-rpm record, kept inside a nonremovable square protective cover. The diskette and protective cover fit into a special envelope when not in use.

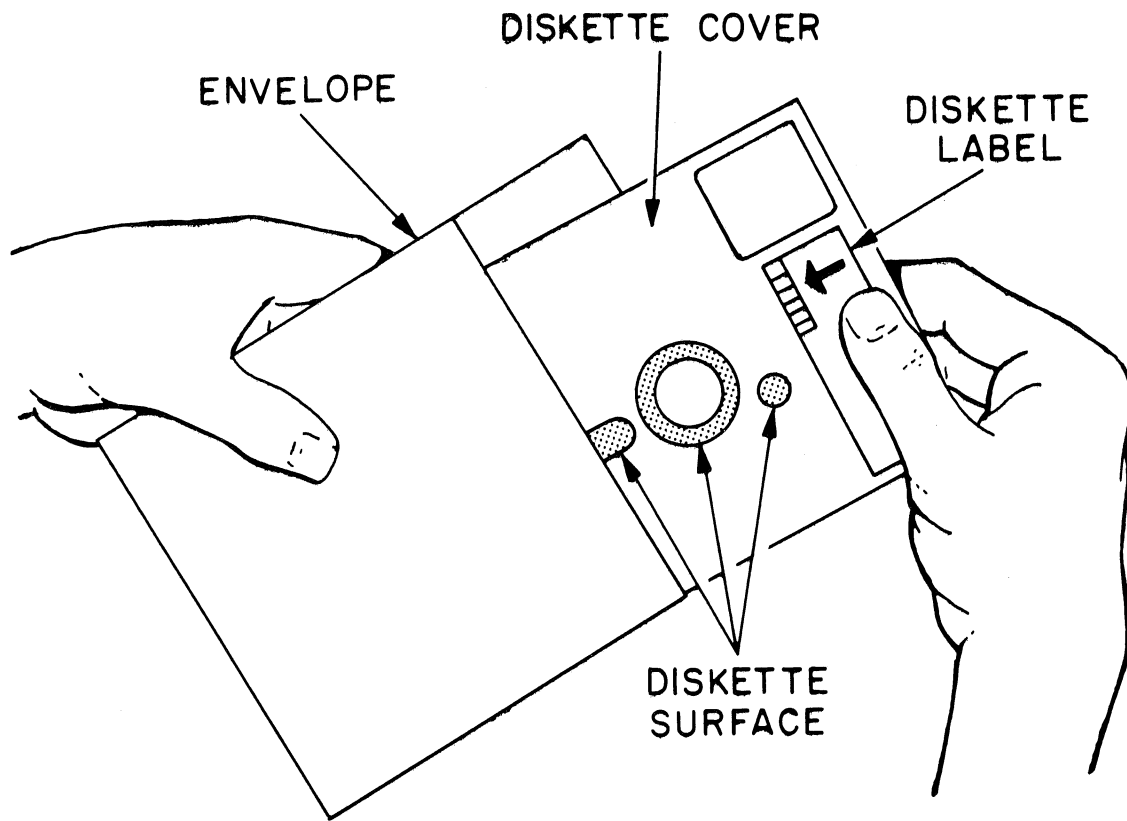

CP-3234

Figure 2-4 Diskette

To operate the WS100 word processing system, insert your system diskette and your document diskette by the following method. If your system has four diskette drives, use the top two.

1. Open the diskette drives by squeezing the handles with your thumb and forefinger. If

either already contains a diskette (left there by the previous user), remove it.

2. Remove the system diskette from its envelope and insert it into the left diskette drive (drive zero). Push down on the handle until it snaps shut.

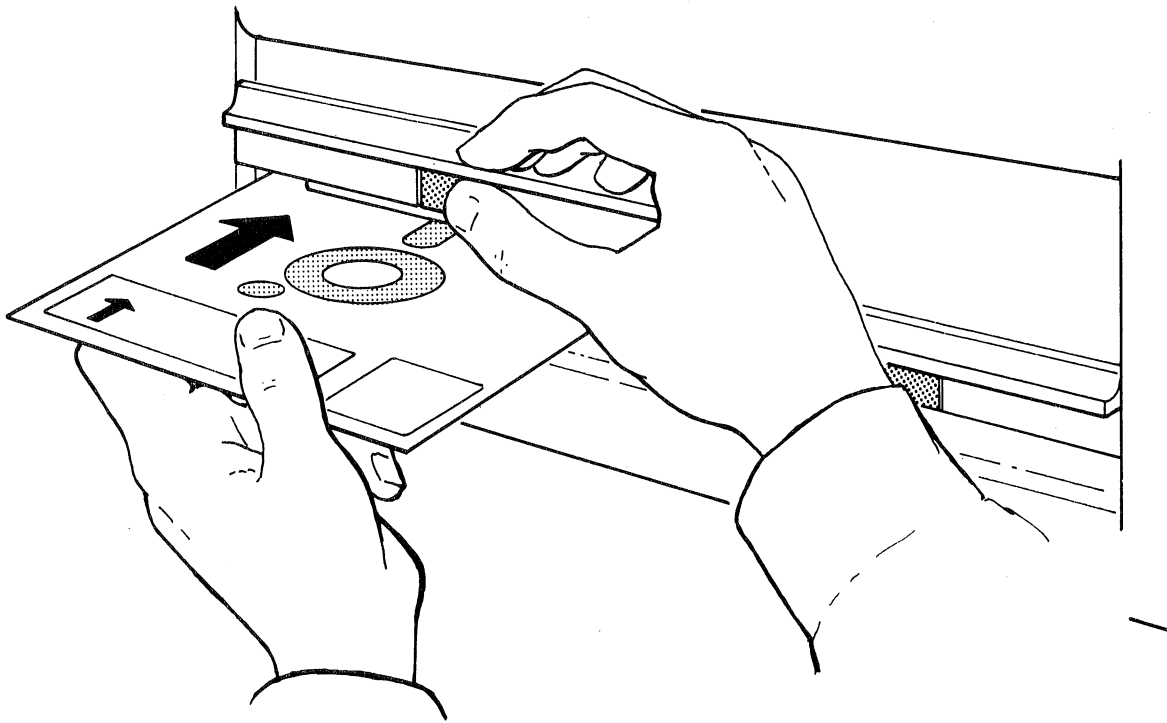

08-1519

Figure 2-5 Inserting System Diskette in Drive

3. Insert your document diskette into the right drive (drive one) the same way you inserted the system diskette.

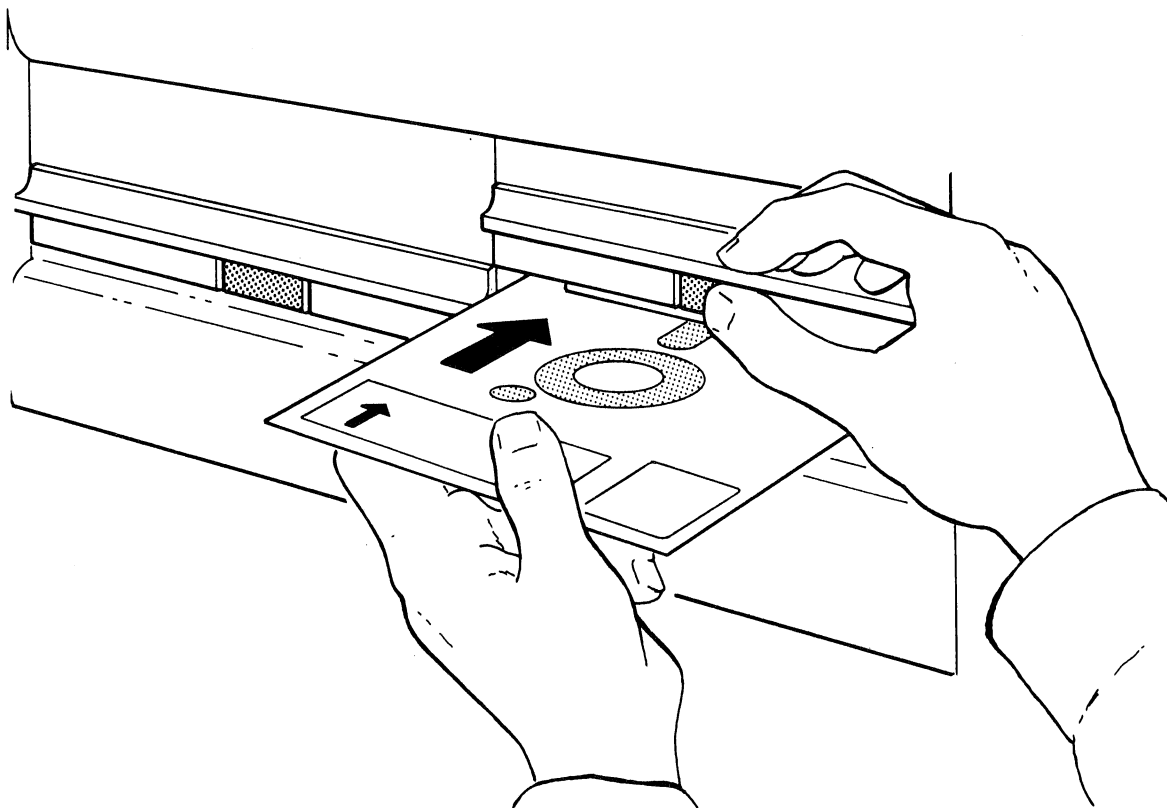

08-1530

Figure 2-6 Inserting Document Diskette  
in Drive

## 2.4 TYPING THE DATE AND TIME

After inserting the diskettes, press the RETURN key (located on the right of the main keyboard). The characters "ABC" will briefly be displayed on the screen and will be followed by the word processing Date/Time Menu.

```
-- DATE/TIME MENU --                                0/0/00 ... 0:01:25

Digital Equipment Corporation WPS-8 Word Processing System
WS100 Version 2.7

Please type the date and time as follows:
mm/dd/yy hh:mm

Example:
12/1/75 9:25

Errors can be corrected by pressing RUB CHAR.
When done, press RETURN.
```

9113-30R4-A0068

Figure 2-7 WS100 Date/Time Menu

Respond to the prompt by typing today's date and the present time and then press the RETURN key. Be sure to follow the format and spacing as the Date/Time Menu instructs and to use the number 1 instead of the letter l. It is preferable to use a 24 hour clock (for example, type 5 p.m. as 17:00).

If you make a mistake before pressing the RETURN key, press the RUB CHAR OUT key (second row, upper right of the main keyboard). Pressing RUB CHAR OUT causes a back space and erases the character to the left of the cursor. To remove the entire date or time, press the RUB WORD OUT key (located just left of the RUB CHAR OUT key). This causes a back space and erases the word to the left of the cursor.

If you don't specify the date and time correctly, the following message will be displayed on the screen:

Date/Time typed incorrectly. Try again.

Retype the date and time and press the RETURN key.

You may omit typing the date or time and just press the RETURN key. No harm will be done, but your bookkeeping will not be entirely accurate. The word processing system keeps an index in which it records when you use each document (among other information). Therefore, if you don't specify a date, the word processing system cannot record the correct bookkeeping information.

Before going further, look at the white/black contrast on your screen. If it is too bright or too blurry, you can adjust it with the INTENSITY CONTROL switch (located on the back of the terminal).

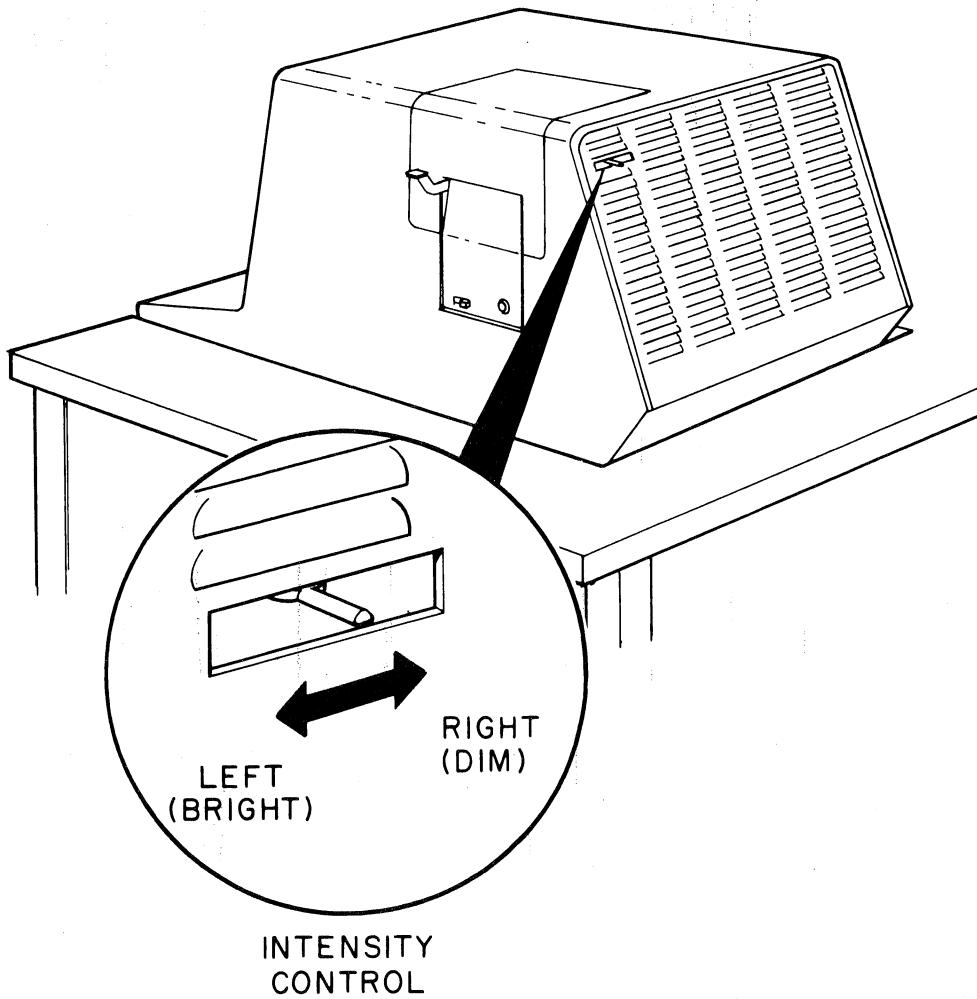

08-1560

Figure 2-8 WS100 Intensity Control Switch



## 2.5 MAIN MENU

After you type the date and time, the first page of the Main Menu will be displayed on the screen. Notice that the date and time are displayed in the upper right corner. The day of the week (abbreviated to three letters) and the time in seconds are also displayed there. If you should be working at midnight, the screen display will automatically change to reflect the new date and time (provided you specified the time in 24 hourclock format).

The Main Menu lists the special options of the word processing system. To perform any option, type its letter(s) and press the RETURN key.

Because the system provides so many different options, there are several pages to the Main

Menu. To display each successive page, type the letter M and press the RETURN key. If you type M and press the RETURN key when the last Main Menu page is on the screen, the first page will be displayed again. For a complete listing of all Main Menu options, refer to Appendix B.

You can type any Main Menu option regardless of what Main Menu page is displayed. For example, if you have completed your word processing work, you can type P (to Print a document) and press the RETURN key even if the second or third Main Menu page is displayed.

```
— MAIN MENU —                               1/24/78 Tue 9:06:00

C = Create a new letter or document
E = Edit an existing letter or document
P = Print a letter or document
I = Index of letters and documents on file
F = Finished using the system
M = More main menu selections...

Type the letter and then press RETURN.
```

9113-3R1-A0069

Figure 2-9 Main Menu Page One (Version 2.7)

```
— MAIN MENU —                                     4/6/78 Thu 10:37:37

C = Create a new letter or document
E = Edit an existing letter or document
P = Print a letter or document
I = Index of letters and documents on file
D = Delete a document
F = Finished using the system
M = More main menu selections...

Type the letter and then press RETURN.
```

M113-12A0385

Figure 2-9 Main Menu Page One (Version 3.0)

## 2.6 RESETTING THE DATE AND TIME

The RD Main Menu option allows you to reset the date and time. This is useful if you accidentally type the wrong date or time (if it's January 1977 and you're still in the habit of typing 1976). To reset the date or time, type the letters RD

(when any Main Menu page is displayed on the screen) and press the RETURN key. The Date/Time Menu is displayed once again. You can now proceed to type the correct date and time.

## 2.7 STOPPING

When you are finished using the word processing system, type the letter F (for Finished) and press the RETURN key. The following message is displayed on the screen:

If you intend to take a lengthy break and no one else wants to use the word processing system, remove your diskettes and turn off the machine to conserve energy.

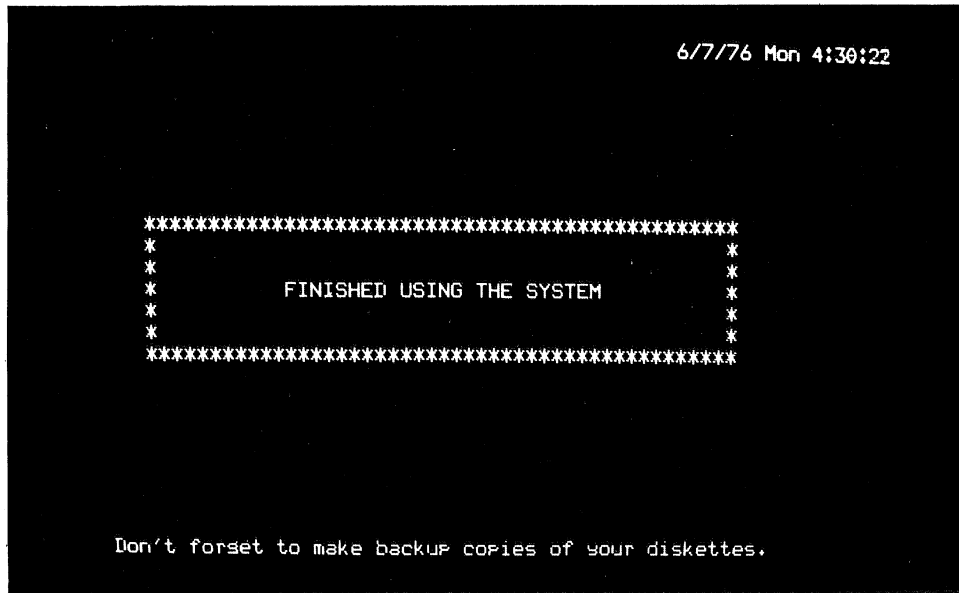

8018-78-A0067

Figure 2-10 Finished Message

## 2.8 POWER FAILURES AND BROWN-OUTS

If the power supply to your WS100 system ever fails, you will not lose any typing. When the power comes on again, do the following:

1. If the screen does not display your previous work, press the ON/OFF switch once to turn the machine off and a second time to turn it back on again. If you previously had been viewing a menu, you must also press the gold and the MENU keys.

2. Verify your diskettes to make certain no electrical damage was done (see Section 17.2.3).

3. If the power was off for a long time, reset the date and time (see Section 2.6). Otherwise you will still be using the old time (when power failed).

If the system ever stops responding to your typing, you have a brown-out, a momentary drop in power supply. To proceed with your work, press the ON/OFF switch twice and then verify your diskettes (see Section 17.2.3).



## CHAPTER 2 OPERATING THE WS102 AND WS202 EQUIPMENT

The WS102 and WS202 word processing systems consist of hardware and software. *Hardware* is the actual equipment you can see – the keyboards, the display screen, the diskette drives, and the computer. *Software* is computer programs that allow you to operate the equipment in a particular way. The word processing software allows you to type text, correct errors, save the text for using again, and print what you've typed.

To start up the WS102 and WS202 word processing system, you must make both the hardware and the software operational. Start up requires two diskettes: (1) a system diskette, which contains the WS102 software, and (2) a document diskette, which contains (or will contain) the documents you create and edit. If you don't already have these diskettes, see your System Manager.

You can start the WS102 and WS202 only from the terminal connected to the top two diskette drives (numbered zero and one). This terminal is referred to as the main terminal in this chapter.

In summary, to start up the WS102 and WS202 hardware and software, you follow these steps:

1. Press the ON/OFF switches to supply electrical power to the hardware (see Section 2.1).
2. Press the appropriate switches to bootstrap, or activate, the software (see Section 2.2).
3. Insert the system and document diskettes (see Section 2.3).
4. Press the RETURN key once to display the Start Menu (see Section 2.4).
5. Press the RETURN key again to display the Date/Time Menu, type today's date and the time, and press the RETURN key (see Section 2.5).

Once you start up the hardware and software, the Main Menu is displayed on the screen. This menu gives you a selection of word processing work you may perform. See Section 2.6 for how to use the Main Menu.

## 2.1 TURNING ON THE MACHINE

If you see some words or a blinking underscore character on the screen, the machine is on already. All you have to do is bootstrap, insert the diskettes, and type the date and time (see Sections 2.2 - 2.5). You can do this provided (1) no one is using the other terminal and (2) no one has left the main terminal unattended (with work in process). It is available if the screen displays either the message "FINISHED USING

THE SYSTEM" or some instructions that begin with "MAIN MENU."

To turn on the machine, follow these steps:

1. Make sure the ON/OFF switch (black, located on the side of each terminal) which supplies power to the display screen is in the ON position.

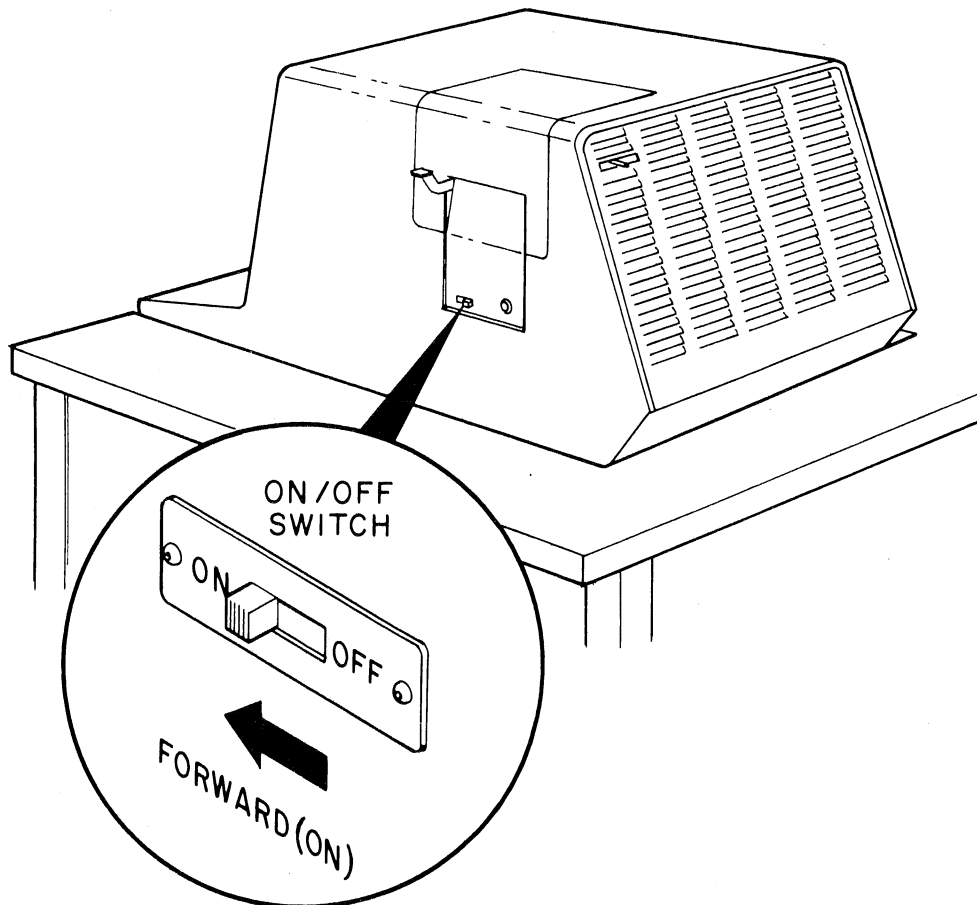

08-1558

Figure 2-1 WS102 Display Screen Switch

2. Push in the ON/OFF switch which supplies power to the entire system. The WS102 ON/OFF switch is red and is located on the front of the main terminal. The WS202 ON/OFF switch is white and the middle of three switches on the top of the diskette drive cabinet. The word processing system will start to hum. If nothing happens, check that the power plug is securely in the wall socket. (If it is and your

system still does not respond, call your DIGITAL Field Service Representative.)

See Figure 2-2a for the WS102 and Figure 2-2b for the WS202.

After the system warms up, the cursor (a blinking underscore character) will appear in the upper left corner of each terminal's screen.

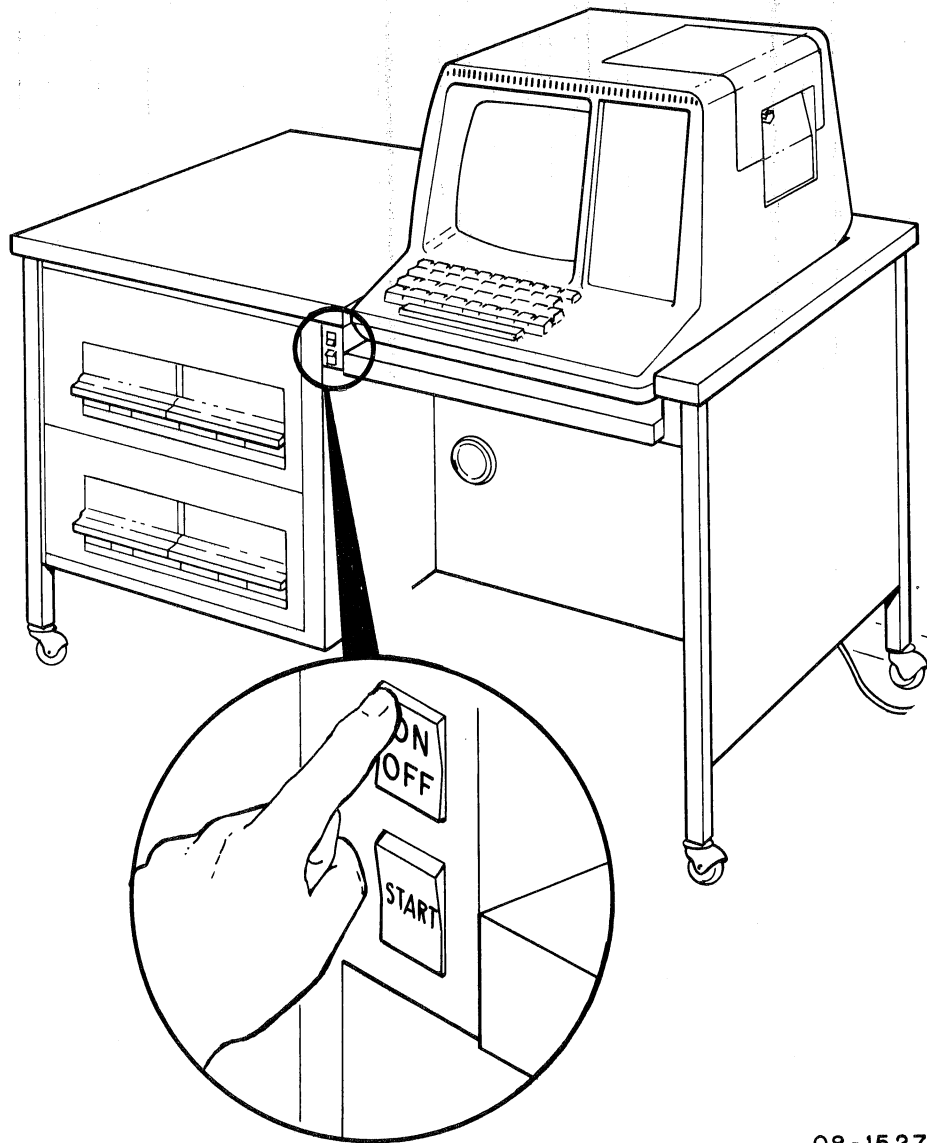

08-1527

Figure 2-2a WS102 ON/OFF Switch



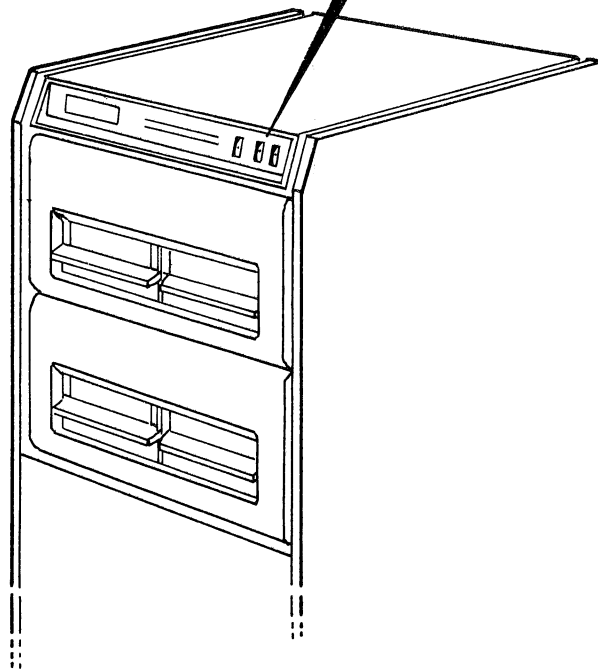
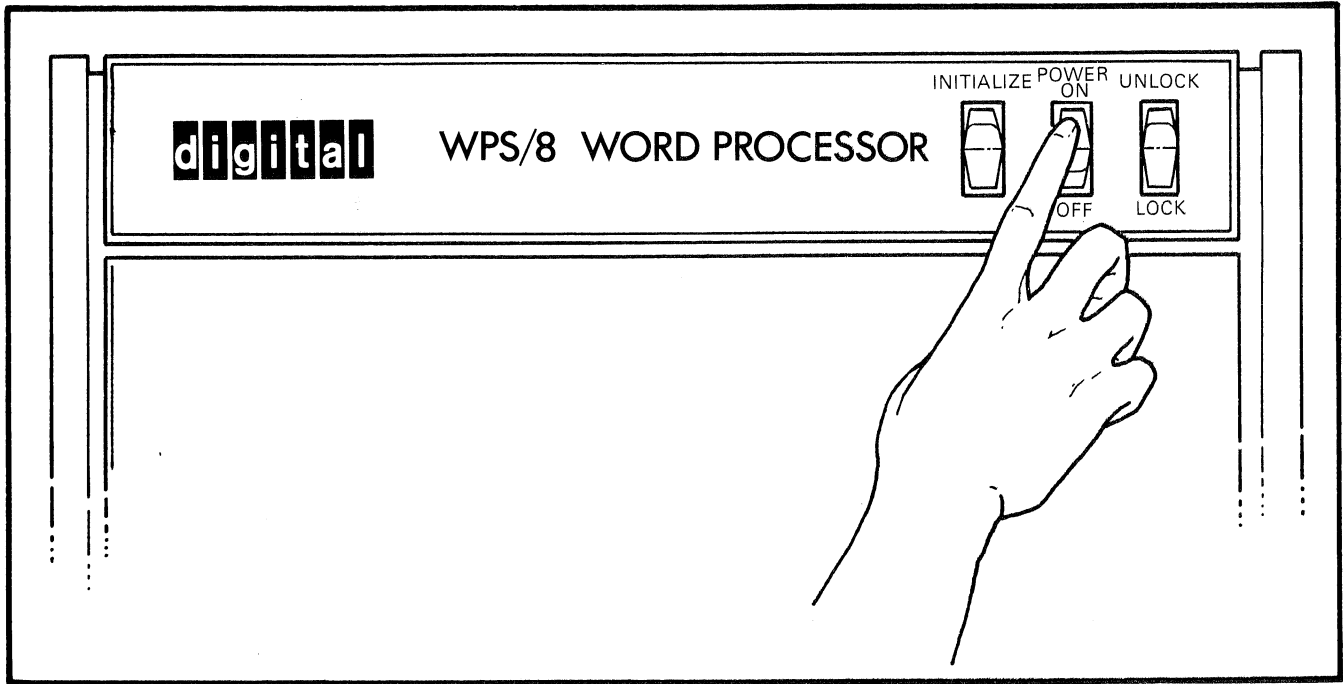

MK-0189

Figure 2-2b WS202 ON/OFF Switch

## 2.2 BOOTSTRAPPING

The first step in starting up the software is called *bootstrapping*. This term is derived from the adage "Pull yourself up by your bootstraps." Technically speaking, bootstrapping means to put a small program into the computer memory which, in turn, inserts a larger program.

To bootstrap the WS102 system, press the white START switch located on the front of the main terminal right beneath the ON/OFF switch. To bootstrap the WS202 system, push the rightmost

switch on the top of the diskette drive cabinet to the UNLOCK position. While holding that switch, press the leftmost switch to the INITIALIZE position.

When bootstrapping is complete, the characters "0123" will be displayed in the upper left of the main terminal's screen. The other terminal's screen will display the cursor.

See Figure 2-3a for the WS102 and Figure 2-3b for the WS202.

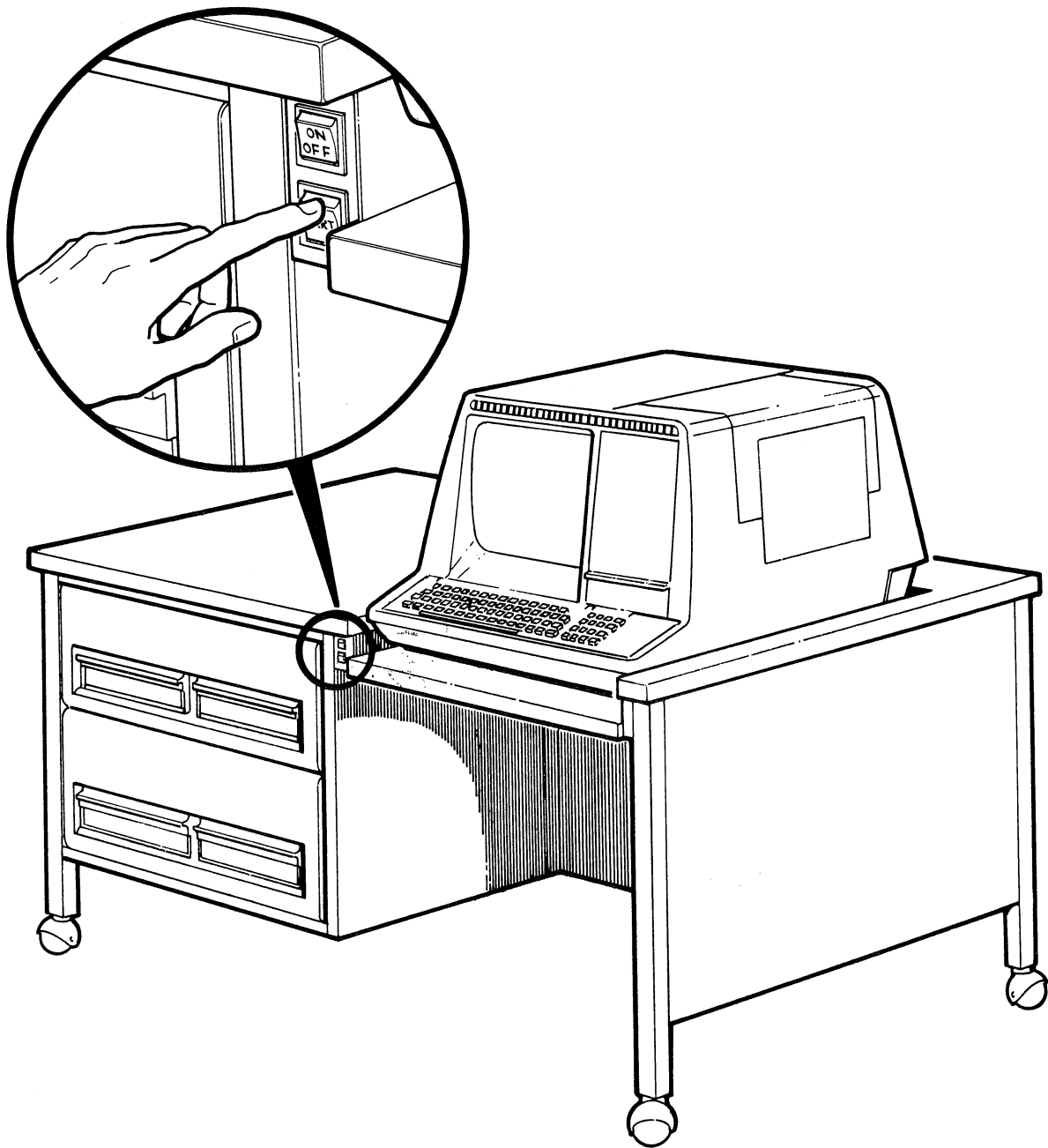

MK-0069

Figure 2-3a WS102 START Switch

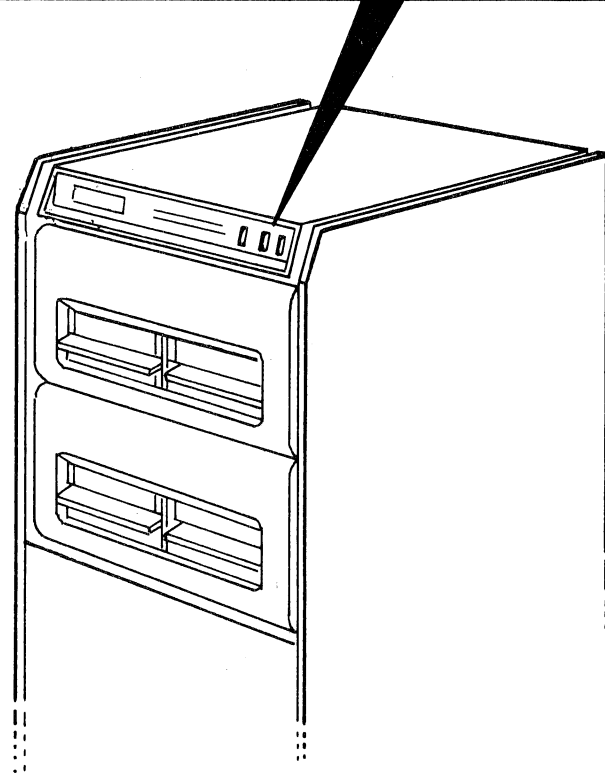
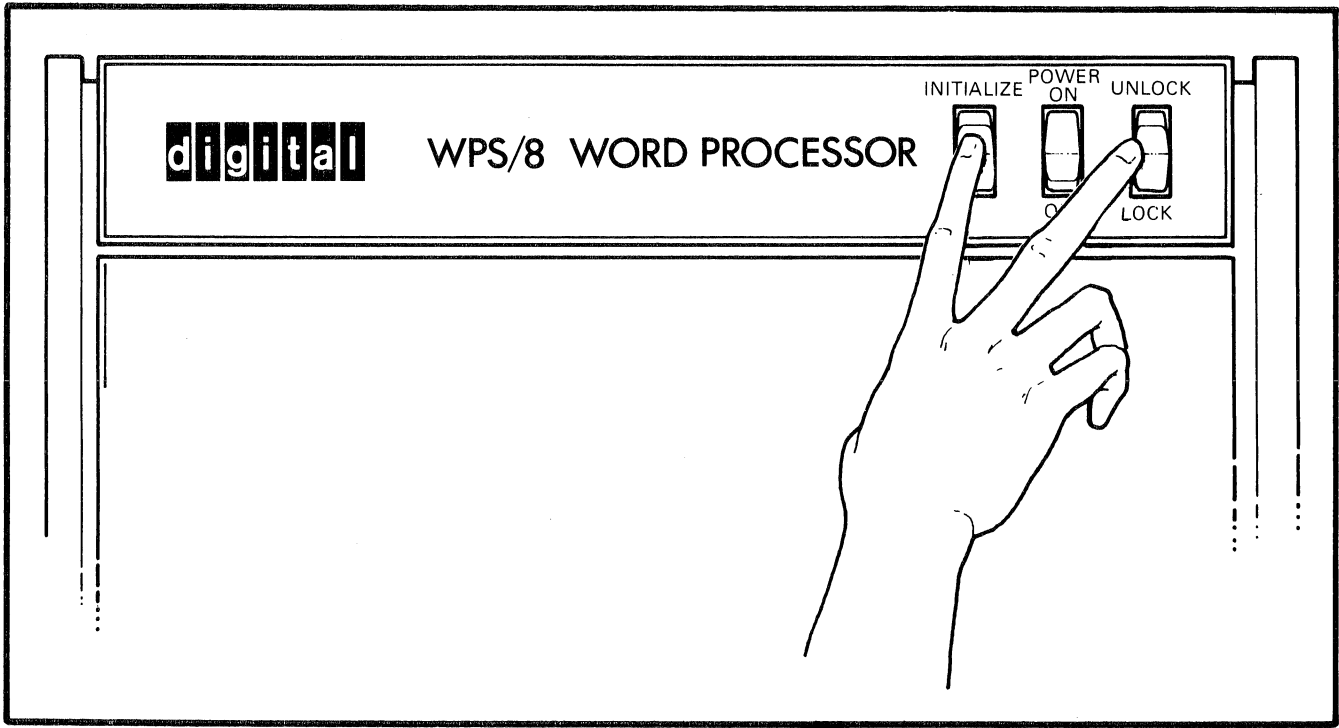

MK-0187

Figure 2-3b WS202 START Switch.

### 2.3 INSERTING THE DISKETTES

A diskette is a round piece of magnetic material about the size of a 45-rpm record, kept inside a nonremovable square protective cover. The diskette and protective cover fit into a special envelope when not in use.

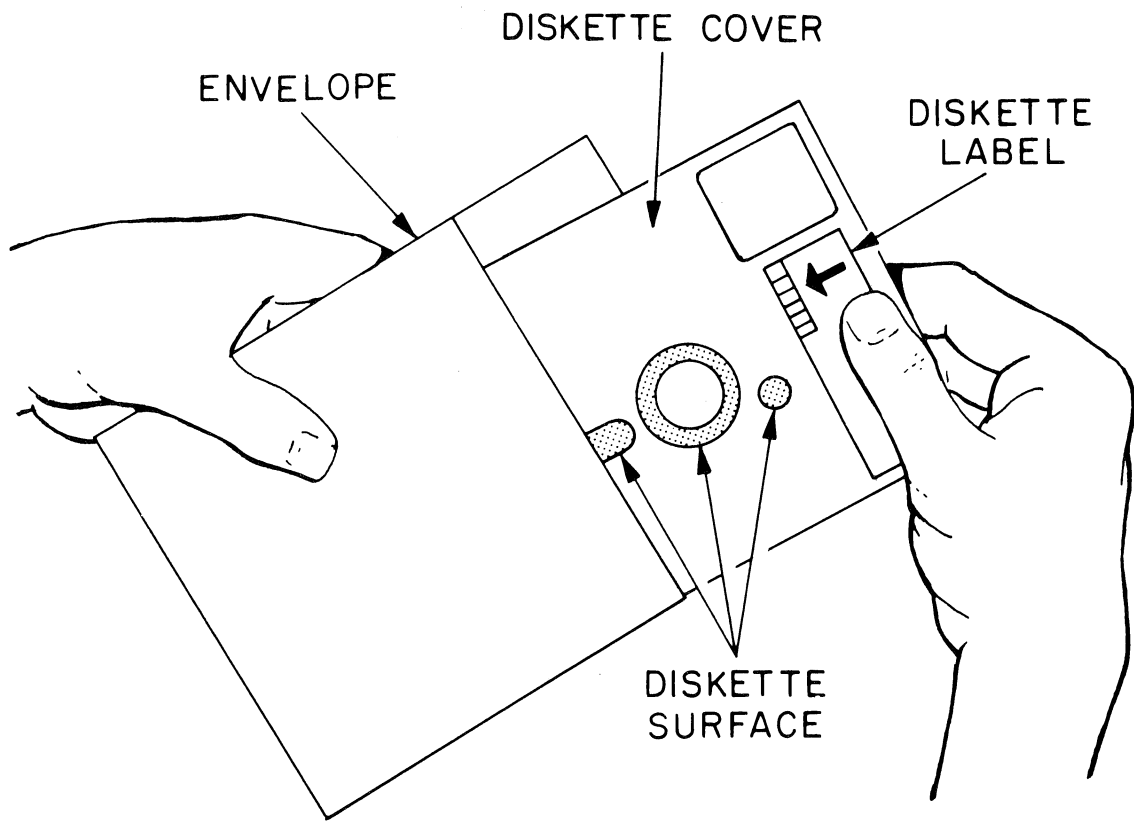

CP-3234

Figure 2-4 Diskette

To operate the WS102 and WS202 word processing systems, insert your system diskette into the top left diskette drive (drive zero) and your document diskette into the top right (drive one) by following these steps:

1. Open the diskette drives by squeezing the handles with your thumb and forefinger. If

either already contains a diskette (left there by the previous user), remove it.

2. Remove the system diskette from its envelope and insert it into the top left diskette drive (drive zero). Push down on the handle until it snaps shut.

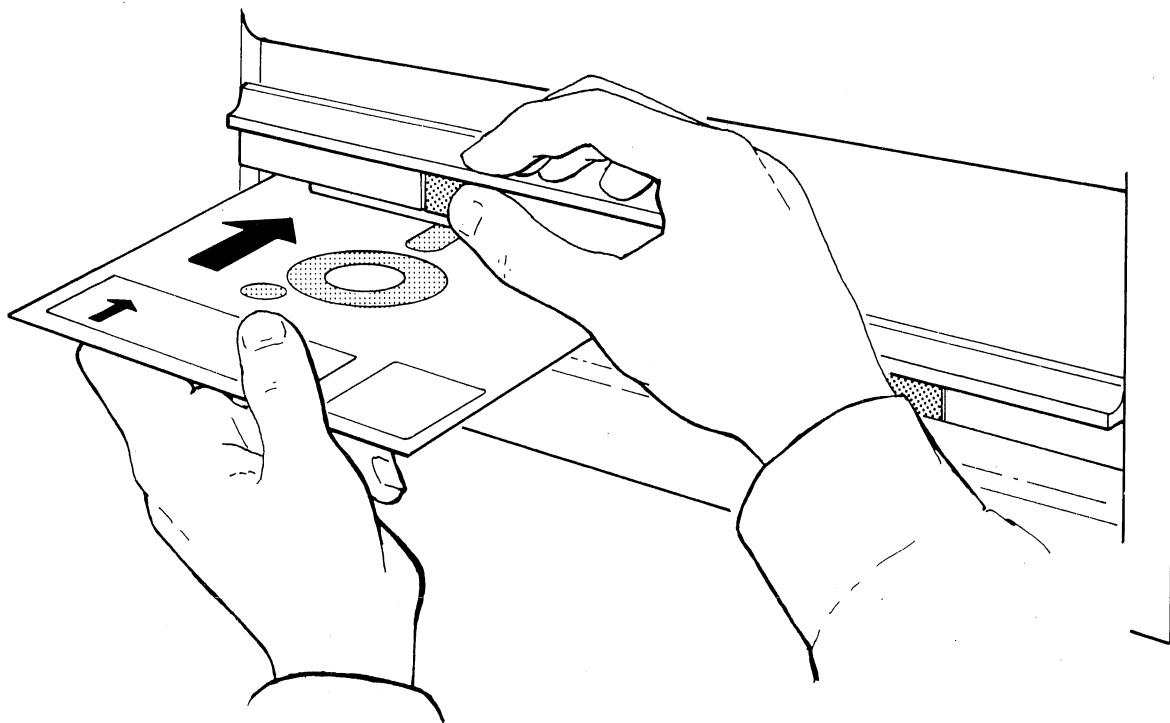

08-1519

Figure 2-5 Inserting System Diskette in Drive

3. Insert your document diskette into the top right drive (drive one) the same way you inserted the system diskette.

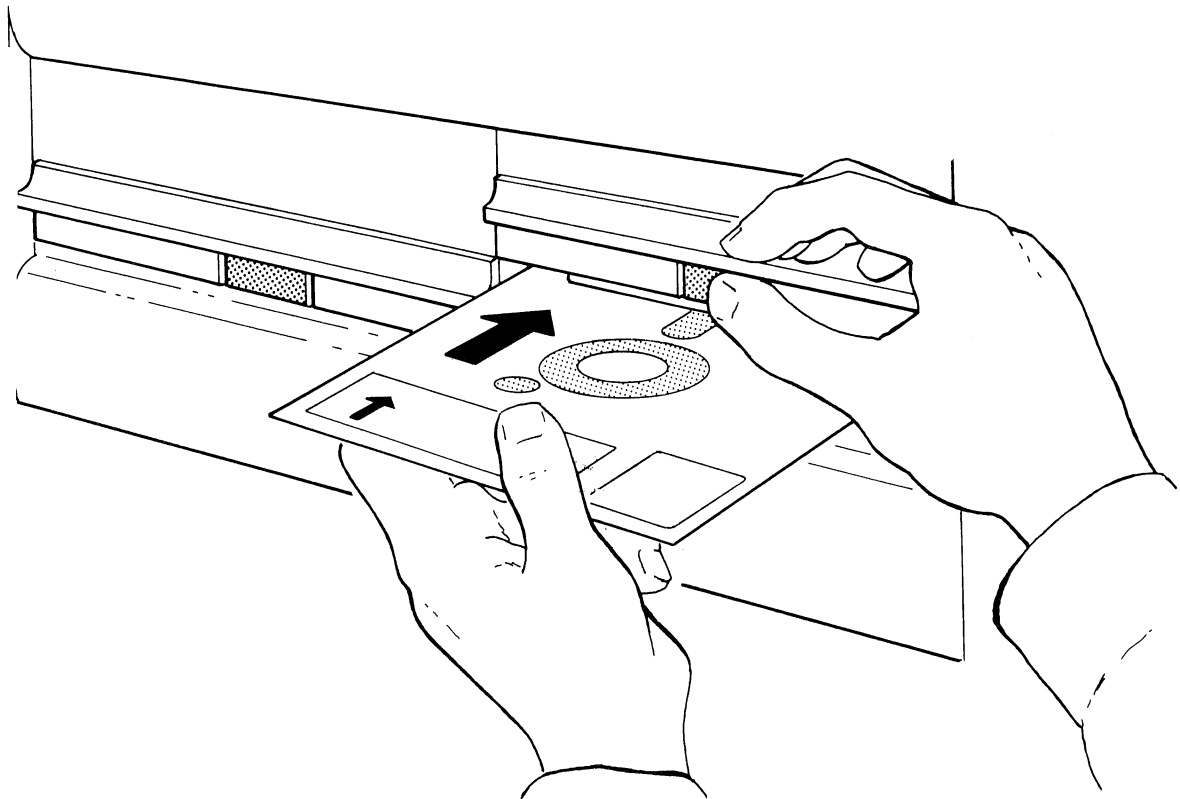

08-1530

Figure 2-6 Inserting Document Diskette  
in Drive

## 2.4 START MENU

After inserting the diskettes, press the RETURN key (located on the right of the main terminal's keyboard). The characters "ABC" will briefly be

displayed on the main terminal's screen. Then the word processing Start Menu will be displayed on each screen. Here is how the main terminal's screen appears:

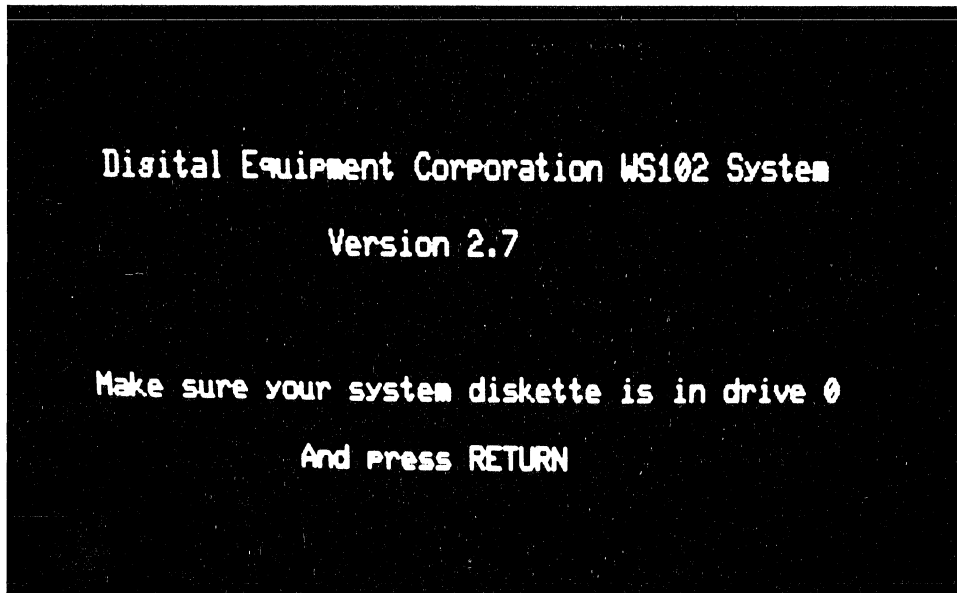

9113-31R4-A0070

Figure 2-7a WS102 Start Menu



Digital Equipment Corporation WS102 System

Version 3.0

Make sure your system diskette is in drive 0

And press RETURN

M113-8A0384

Figure 2-7b WS202 Start Menu

For the other terminal, the number 2 will appear on the screen instead of the number 0 (in the next to last line) for a WS102 system and the number 1 for a WS202 system.

Before going further, look at the white/black contrast on your screen. If it is too bright or too blurry, you can adjust it with the INTENSITY CONTROL switch (located on the back of the terminal).

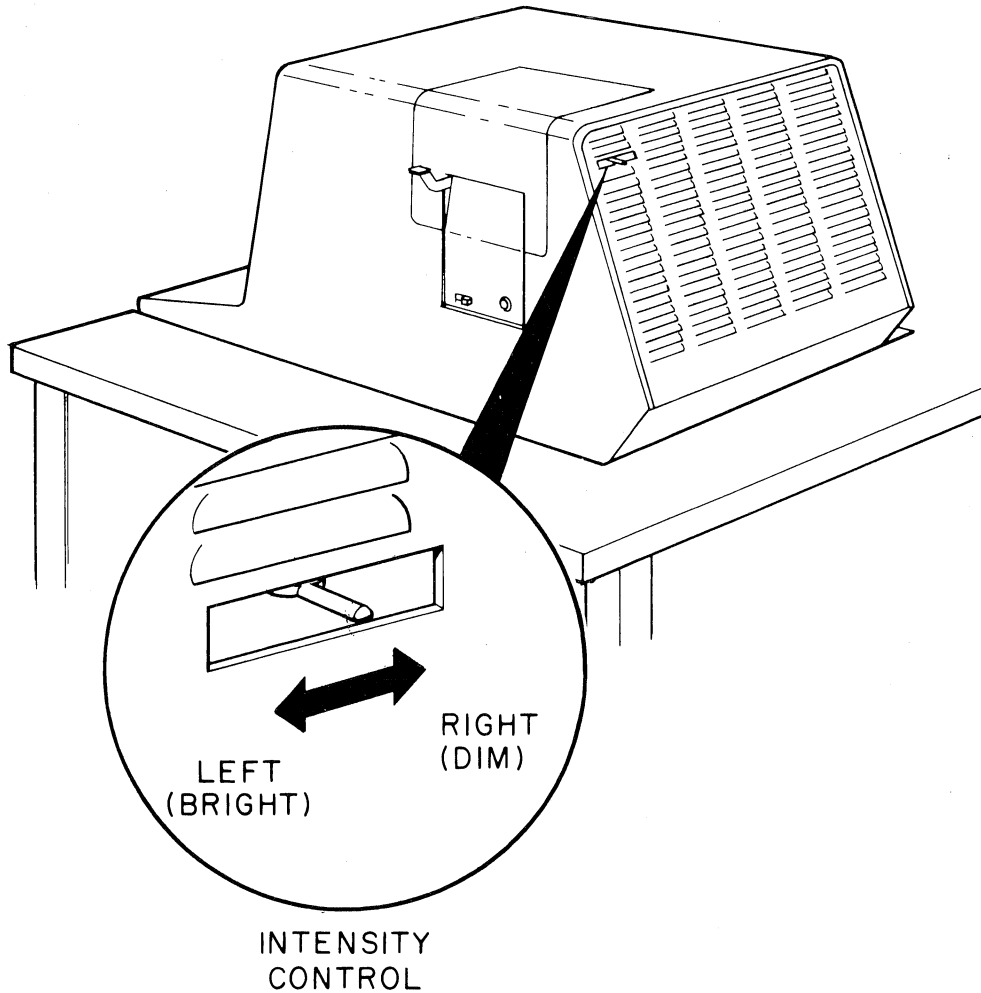

08-1560

Figure 2-8 WS102 Intensity Control Switch

## 2.5 TYPING THE DATE AND TIME

After you press the RETURN key in response to the Start Menu prompt, the word processing Date/Time Menu will be displayed on your screen (the other terminal's screen will continue displaying the Start Menu).

```
--- DATE/TIME MENU ---                               1/24/78 Tue 9:10:13

Digital Equipment Corporation WPS-8 Word Processing System
WS102 Version 2.7

Please type the date and time as follows:
      mm/dd/yy hh:mm
Example:
      12/1/75 9:25

Errors can be corrected by pressing RUB CHAR.
When done, press RETURN.
```

9113-19R1-A0071

Figure 2-9 WS102 Date/Time Menu (Version 2.7)

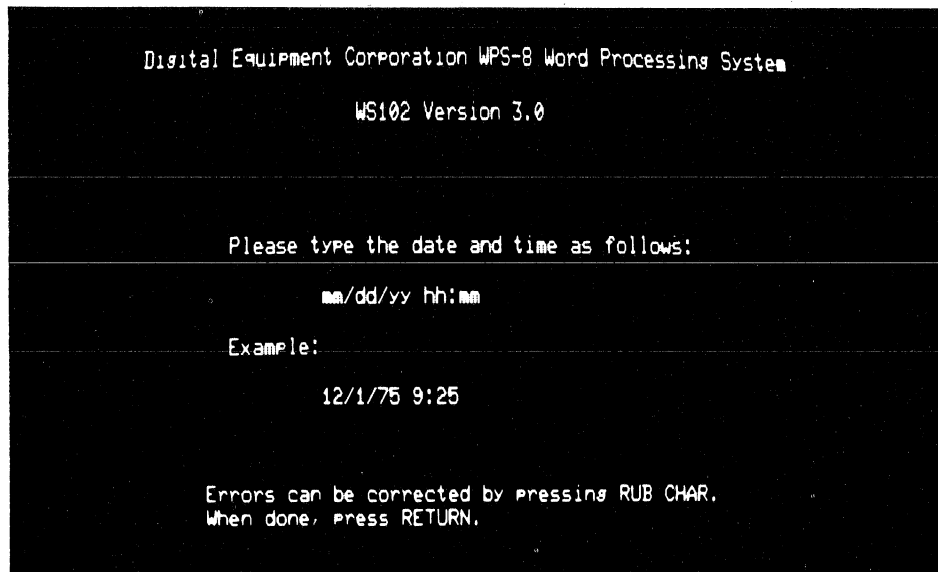

M113-9A0392

Figure 2-9 WS102 Date/Time Menu (Version 3.0)

Respond to the prompt by typing today's date and the present time from either terminal and then pressing the RETURN key. Be sure to follow the format and spacing as the Date/Time Menu instructs and to use the number 1 instead of the letter l. It is preferable to use a 24 hour clock (for example, type 5 p.m. as 17:00).

If you make a mistake before pressing the RETURN key, press the RUB CHAR OUT key (second row, upper right of the main keyboard). Pressing RUB CHAR OUT causes a back space and erases the character to the left of the cursor. To remove the entire date or time, press the RUB WORD OUT key (located just left of the RUB CHAR OUT key). This causes a back space and erases the word to the left of the cursor.

If you don't specify the date and time correctly, the following message is displayed on the screen:

Date/Time typed incorrectly. Try again.

Retype the date and time and press the RETURN key.

You may omit typing the date or time and just press the RETURN key. No harm will be done, but your bookkeeping will not be entirely accurate. The word processing system keeps an index in which it records when you use each document (among other information). Therefore, if you don't specify a date and time, the word processing system cannot record the correct bookkeeping information.

## 2.6 MAIN MENU

The first page of the Main Menu is automatically displayed on the main terminal screen after you type the date and time. In order for the Main Menu to be displayed on the screen of the other terminal, that user must press the RETURN key.

Notice that the date and time are displayed in the upper right corner. The day of the week (abbreviated to three letters) and the time in seconds are also displayed there. If you should be working at midnight, the screen display will automatically change to reflect the new date and time (provided you specified the time in 24 hour clock format).

The Main Menu lists the special options of the word processing system. To perform any option, type its letter(s) and press the RETURN key.

Because the system provides so many different options, there are several pages to the Main Menu. To display each successive page, type the letter M and press the RETURN key. If you type M and press the RETURN key when the last Main Menu page is on the screen, the first page will be displayed again. For a complete listing of all Main Menu options, refer to Appendix B.

You can type any Main Menu option regardless of what Main Menu page is displayed. For example, if you have completed your word processing work, you can type P (to Print a document) and press the RETURN key even if the second or third Main Menu page is displayed.

```
— MAIN MENU —                               1/24/78 Tue 9:06:00

C = Create a new letter or document
E = Edit an existing letter or document
P = Print a letter or document
I = Index of letters and documents on file
F = Finished using the system
M = More main menu selections...

Type the letter and then press RETURN.
```

9113-3R1-A0069

Figure 2-10 Main Menu Page One (Version 2.7)

```
— MAIN MENU —                                4/6/78 Thu 10:37:37

C = Create a new letter or document
E = Edit an existing letter or document
P = Print a letter or document
I = Index of letters and documents on file
D = Delete a document
F = Finished using the system
M = More main menu selections...

Type the letter and then press RETURN.
```

M113-12A0385

Figure 2-10 Main Menu Page One (Version 3.0)

## 2.7 RESETTING THE DATE AND TIME

The RD Main Menu option allows you to reset the date and time from either terminal. This is useful if you accidentally type the wrong date or time (if it's January 1977 and you're still in the habit of typing 1976).

To reset the date or time, type the letters RD (when any Main Menu page is displayed on the screen) and press the RETURN key. The Date/Time Menu will be displayed once again. You can now proceed to type the correct date and time. The new date and time will take effect on both terminals.

## 2.8 STOPPING

When you are finished using the word processing system, type the letter F (for Finished) and press the RETURN key. The following message is displayed on the screen:

If you intend to take a lengthy break and no one else wants to use the word processing system, remove your diskettes and turn off the machine to conserve energy.

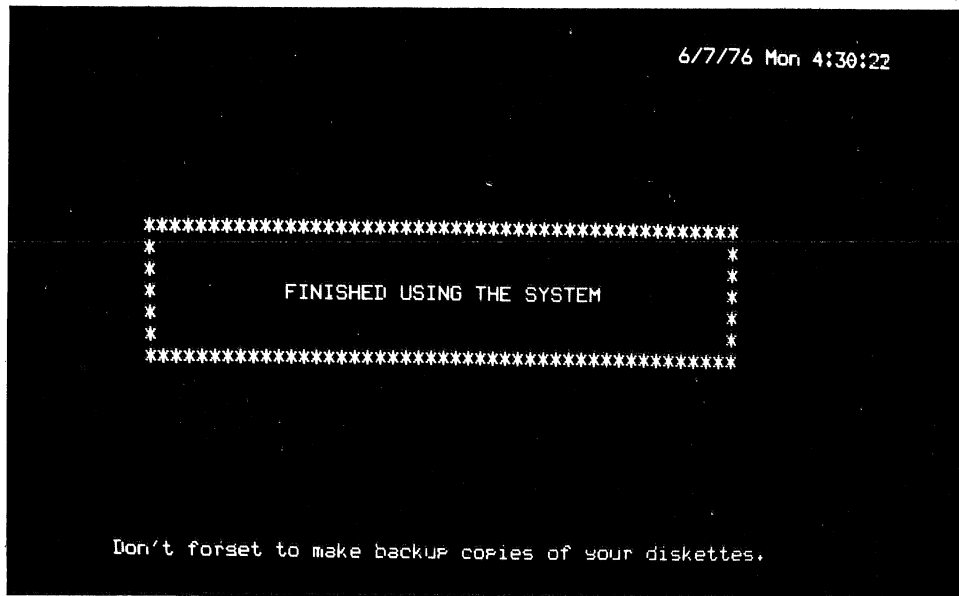

8018-78-A0067

Figure 2-11 Finished Message

---

## 2.9 POWER FAILURES AND BROWN-OUTS

If the power supply to your WS102 system ever fails, you will not lose any typing. When the power comes on again, do the following:

1. If the screen does not display your previous work, press the ON/OFF switch once to

turn the machine off and a second time to turn it back on again. If you previously had been viewing a menu, you must also press the gold and the MENU keys.

2. Verify your diskettes to make certain no electrical damage was done (see Section 17.2.3).

3. If the power was off for long time, reset the date and time (see Section 2.7). Otherwise you will still be using the old time (when power failed).

If the power supply to your WS202 system ever fails, you may lose approximately one page of your most recent typing. When power is restored, do the following:

1. Bootstrap the system once again (see Section 2.3).
2. Verify your diskette to make certain no electrical damage was done (see Section 17.2.3).

If the system ever stops responding to your typing, you have experienced a brown-out, a momentary drop in power supply. To proceed with your work, press the ON/OFF switch twice and then verify your diskettes (see Section 17.2.3).



## CHAPTER 3 CREATING A DOCUMENT

The process of telling the word processing system you want to type some new text is called creating a new document. To the word processing system a document is a unit of storage. The system saves documents on your diskette in much the same way as you save reports in a file cabinet drawer: it uses the document name just like a projecting file folder label. When creating a document, you give the document a name and the system gives you essentially a “clean sheet of paper” on which to type.

When you create a document, you will do the following:

1. Tell the word processing system the document name (see Section 3.1).
2. Type your text (see Section 3.2).

3. File the document onto your diskette (see Section 3.3).

### 3.1 HOW TO CREATE A DOCUMENT

To create a new document, type the letter C (for Create) when any Main Menu page is displayed on the screen and press the RETURN key. The screen will display a message asking you to name your document.

Now type the name you want to assign to the document and press the RETURN key.

You can save time creating a document by typing the letter C, a space, the document name, and pressing the RETURN key. When you use this method, the screen display asking for a document name is omitted.

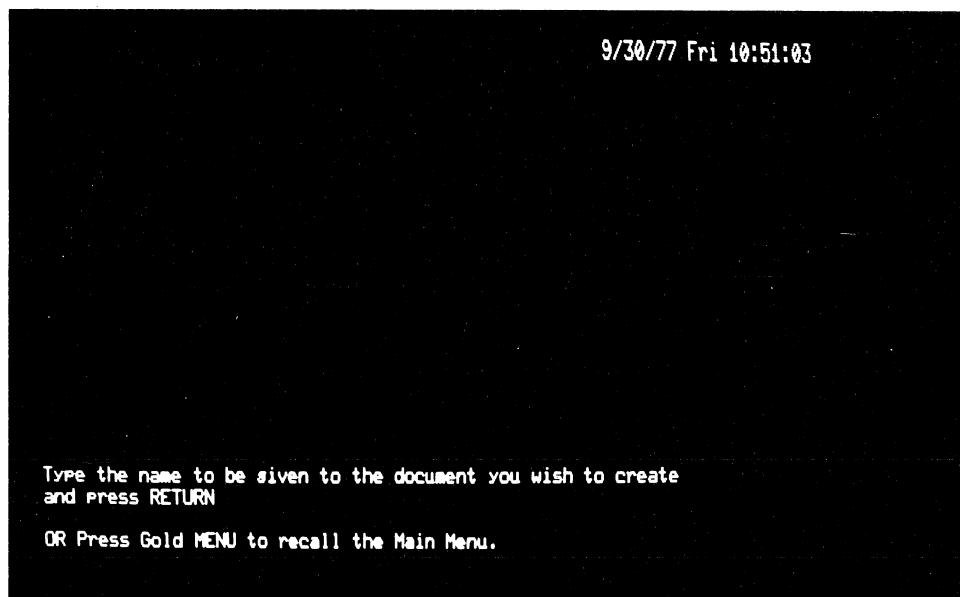

8920-15R1-A0074

Figure 3-1 Document Create Prompt

### 3.1.1 Naming a Document

A document name must conform to these requirements:

1. No more than 60 characters can be used.
2. First character must be a letter.
3. Second through last characters can be any letters, numbers, punctuation marks, or spaces except for the left and right angle brackets (< and >).
4. The name must be unique – you can't already have a document with this name on your diskette. If you use the same name twice, the word processing system will display an error message asking for another name. Also, you cannot use one or more words of a document's name as the complete name for another. For example, if you have a document named "quarterly report," you may not name another document "quarterly."
5. No extra spaces are allowed before or after a document name (before pressing the RETURN key).

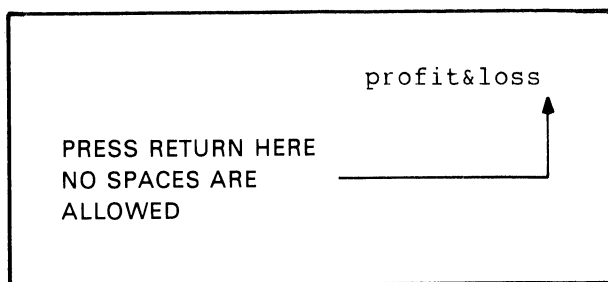

MK-0073

Figure 3-2 Document Name Example

Though not a requirement, it's a good idea to give your documents meaningful names. For example, "profit&loss" is more meaningful than "p&l" while "profit&loss, March 1977" is even more specific.

#### 3.1.1.1 Correcting a Typo in the Document Name

– If you make a mistake before pressing the RETURN key, press the RUB CHAR OUT key (second row, upper right of the main keyboard). Pressing RUB CHAR OUT causes a backspace and erases the character to the left of the cursor.

You can remove a word in the document name (or the entire name if it does not contain spaces) by pressing the RUB WORD OUT key (to the left of the RUB CHAR OUT key). Pressing this key causes a back space and erases the word to the left of the cursor. For example, if you type the following

c Smith memo3/30/77

and then discover the memo recipient's name is really spelled Smyth, press the RUB WORD OUT key once, the RUB CHAR OUT key three times, and retype the correct document name.

**3.1.1.2 Document Storage Location** – When you create a document you have the option of specifying where you want to store it: on either the system or the document diskette. The word processing system assumes you intend to use the document diskette unless you specify otherwise.

To store a document on the document diskette, just type a document name after typing the letter C. To store a document on the system diskette, type the { character in front of the document name.

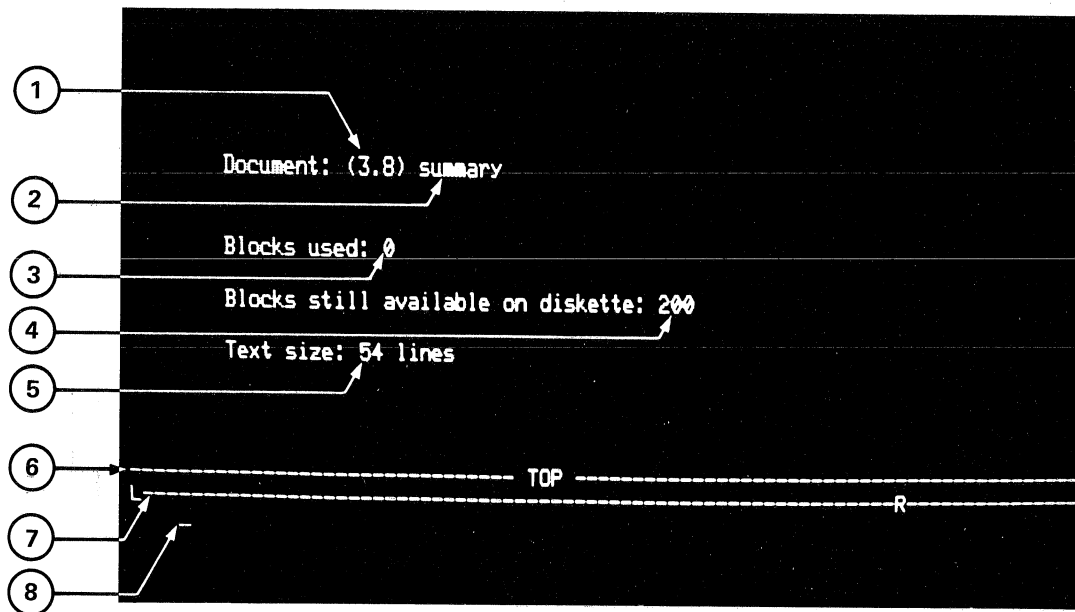

8920-16R1-A0073

Figure 3-3 Example of Screen Display When Creating a Document

If you are operating a system that contains four diskette drives, you have two additional drives available for document storage. Appendix C.1 supplies details for how to store documents in these systems.

### 3.1.2 Screen Display When a Document Is Created

Here is an example of the screen display when you create a new document:

- ① **Diskette drive number and document number.** The first number identifies the diskette drive where the document is stored. The possible values are 0 or 1 for a system with two diskette drives and 0, 1, 2, or 3 for a system with four

drives. The drive number is followed by a period and the document's number which was automatically assigned by the word processing system.

- ② **Document name.** This is the document name you specified.
- ③ **Amount of storage space used.** Storage space is measured in units called blocks, approximately 500 typed characters or one paragraph. As you haven't yet typed a single character, this position contains zero.
- ④ **Amount of storage space available.** This is the number of blocks still available

for document storage on your diskette. If this number is less than 25, you should either delete any obsolete documents from the diskette or use another diskette.

- ⑤ **Preset text size.** The word processing system will automatically put 54 lines of text on each page typed. You may change this to accommodate different sizes of paper (see Section 12.4).
- ⑥ **Top marker.** This marks the top of your text.
- ⑦ **Preset ruler.** This contains left and right margin settings, tabs, and vertical line spacing. The ruler you see when you create a document may differ from the one in the example above (see Section 6.5 for how to change a preset ruler).

- ⑧ **Cursor.** The cursor is a blinking underscore character which marks your current position in the document. As you haven't yet typed anything, the cursor is positioned at the beginning of your document.

### 3.2 TYPING NEW TEXT

You type text into the word processing system with the black keys on the main keyboard. These keys contain the letters, numbers, punctuation marks, and other special characters in the same positions as on an ordinary typewriter.

The main keyboard also has some extra keys, and some of the keys can be used to perform special gold-lettered functions only when the gold key on the mini keyboard is first pressed. Appendix A.1 presents a complete description of all main keyboard keys.

### 3.2.1 Ending Lines: Word Wrap Versus Hard Return

The word processing system automatically "word wraps" lines you type. That is, if a word cannot fit at the end of one line, the system automatically inserts a carriage return (called automatic or word wrap) and moves the word to the next line. Press the RETURN key only when you don't want text to be word wrapped, such as at the end of a paragraph or an entry in a table or list. This type of carriage return is referred to as a hard return.

Carriage returns – both word wrap and hard – are not displayed on the screen as you type. Sometimes you may need to know which type you have (perhaps you think you may have accidentally pressed the RETURN key). You can inspect your typing for carriage returns by viewing the text (see Appendix D). When you view text, an automatic or word wrap return is displayed as a  $\circ$  symbol. A hard return is displayed as a  $\downarrow$  symbol.

Here is an example of viewed text showing both word wrap and hard carriage returns:

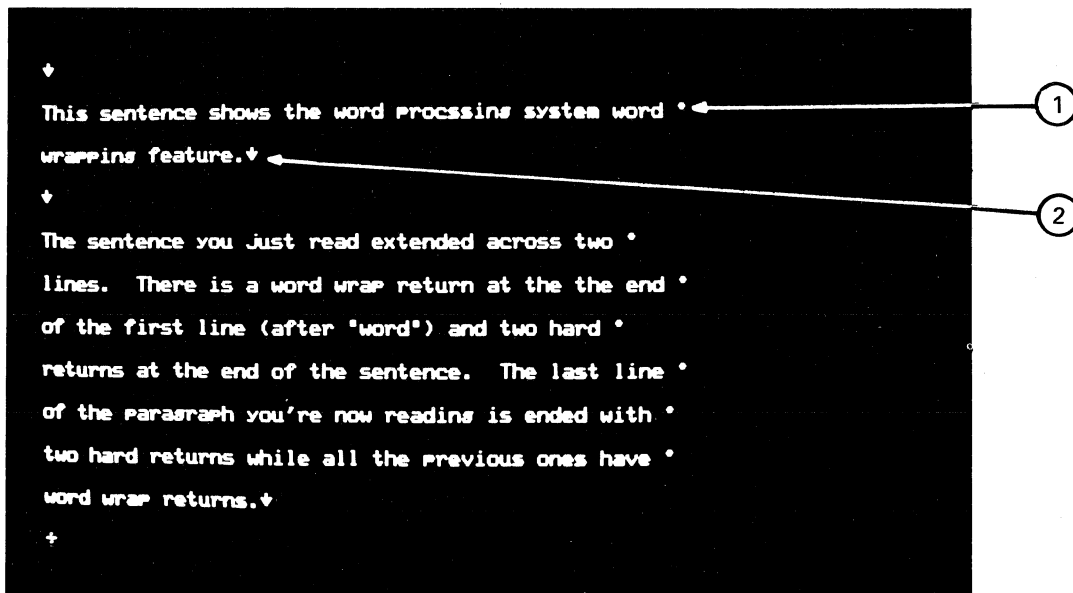

- ① WORD WRAP RETURN
- ② HARD RETURN

9113-21R1-A0072

Figure 3-4 Viewed Text Showing Word Wrap and Hard Carriage Return

Pressing the RETURN key inserts a mark for a hard return into your document. While this mark is not displayed on the screen (except when you view text), it nevertheless occupies one typing position. Therefore, you can remove it from your text with either the DEL CHAR or RUB CHAR OUT key.

### 3.2.2 Removing Errors Just Typed

If you notice an error as you are typing, you can remove it with the main keyboard RUB CHAR OUT, RUB WORD OUT, RUB LINE, or RUB SENT key. Each time you press one of these four keys, the word processing system removes the corresponding item to the immediate left of the cursor.

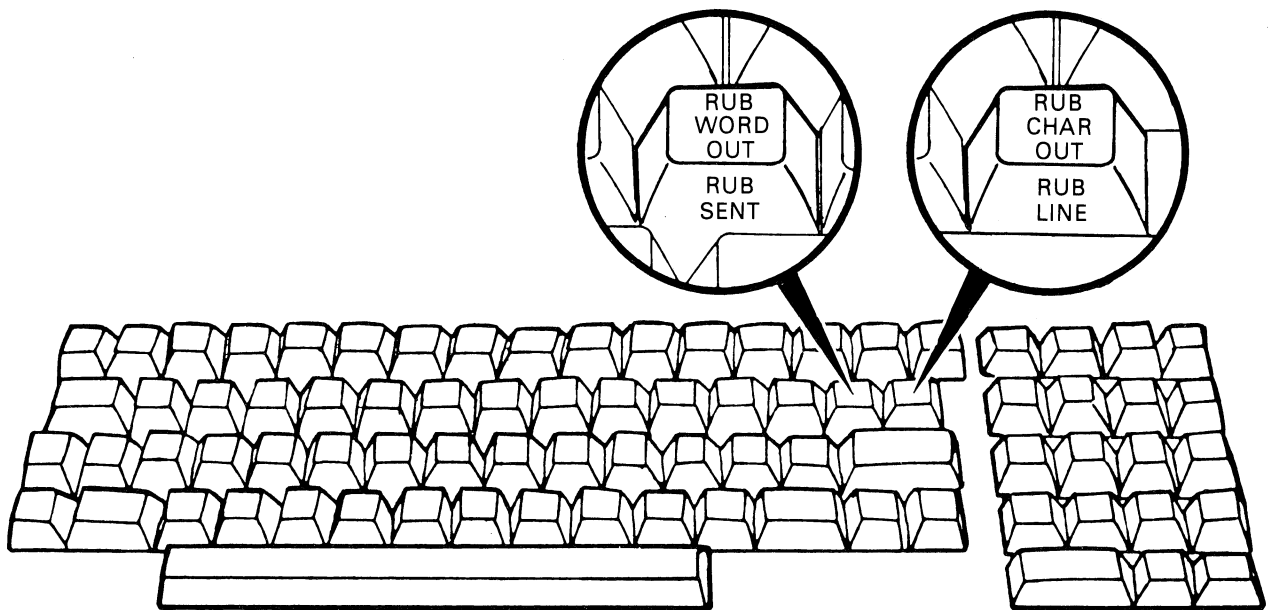

MK-0074

Figure 3-5 Main Keyboard RUB WORD OUT, RUB SENT, RUB CHAR OUT, RUB LINE Keys

You can also make other changes anywhere in your text. You can insert additional material, delete, or make other changes. Refer to Sections 5.2 - 5.4 for details.

### 3.2.3 Leaving Vertical Space for Insertions

If you need to leave vertical space for insertions,

such as a drawing or photograph, just press the RETURN key six times for each inch (when single-spacing is used). If you are not certain how many times you pressed RETURN, view your typing (by pressing the gold and VIEW keys) and count the number of symbols that appear. Each corresponds to a single pressing of the RETURN key.

### 3.2.4 Centering, Underlining, and Boldfacing

You can center, underline, or boldface text at the same time as you type it. Refer to Chapter 8 for details.

### 3.2.5 Problem: Running Out of Storage Space While Typing

If the warning message

-- Do not add much more to document --  
Only "number" blocks left on diskette.  
Press Return

appears on the screen while you are typing (an actual value will appear instead of "number"), proceed only a few more lines to a point where you can stop and then file the document. Either

delete obsolete documents from the diskette or get another one (be sure it is initialized before using it – See Section 17.2.1), create a new document, and continue your typing. Mark the label of the first diskette to indicate it is full so you won't accidentally try to add text to it at some future time.

If you ignore the warning message, not only will you lose some of your typing, but you may also destroy other documents stored on the diskette.

### 3.3 FILING A DOCUMENT

Filing a document means to save it for using again. You must file a document when you are through typing in order to work with another document or to print what you just typed. To file a document, press the gold and the FILE DOCMT keys.

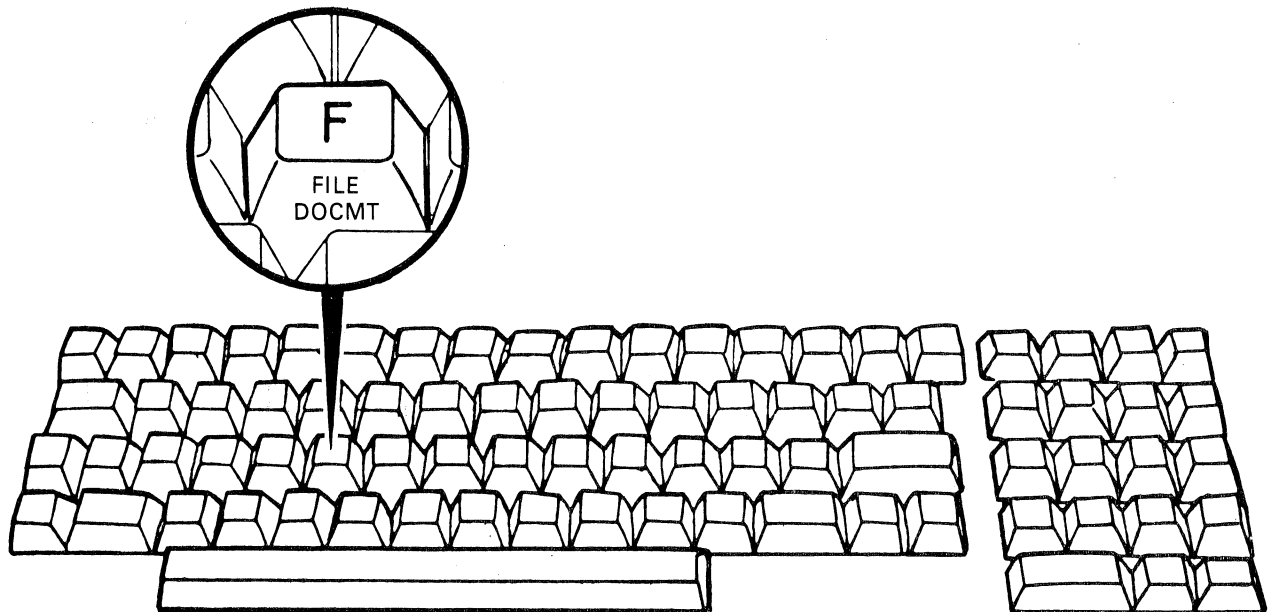

MK-0075

Figure 3-6 Main Keyboard FILE DOCMT Key



When you file a document the message

-- DOCUMENT FILING BEING COMPLETED --

is briefly displayed on the screen. After a few seconds the Main Menu is displayed on the screen (same page as was displayed when you directed the system to create a document).

The cursor can be located anywhere in a document - top, middle, or bottom - when you file.

C

C

C

C

C

## CHAPTER 4 DOCUMENT INDEX

The word processing system maintains an index of all documents for each of your diskettes. The index is stored on each diskette and contains the following information.

- How much space is used and how much is available on the diskette.
- The name and number of each document.
- When each document was originally created and most recently modified.
- The size of each document.

- The amount of time used in the most recent editing session for each document plus the total amount of time spent editing.

### 4.1 EXAMINING THE INDEX

To examine the index for your document diskette, type the letter I (for Index) and press the RETURN key (when any Main Menu page is displayed on the screen). To examine the index for your system diskette, type the letter I and { character (space between the two is optional). If you are using a system that has four diskette drives, you may also examine the indexes of two additional diskettes. Refer to Appendix C.2 for details.

1/24/78 Tue 9:11:51

Drive: 3, Name: HELLO , # of Docs: 5, Blocks left: 439 (of 627)

Document Number	Name	Created	Modified	Size	Version	Elapsed Time Last	Total
6	index	1/5/78	1/16/78 9:54	3	2	0:00	0:00
5	Memo for basic information on preliminary plan	11/11/77	11/11/77 16:31	10	1	0:01	0:01
3	abbrv	11/4/77	11/4/77 11:12	1	3	0:01	0:05
2	intro part ii	11/2/77	11/7/77 10:07	168	22	0:06	4:43
1		11/2/77	1/16/78 9:53	1	9	0:00	0:00

Press RETURN to display more entries  
OR Gold MENU to recall the Main Menu.

9113-23R1-A0075

Figure 4-1 Document Index Example

Here is an example of a document index:

- ① **Diskette drive number.** This is the number of the diskette drive whose index you are examining. The possible values are 0 or 1 for a system with two diskette drives and 0, 1, 2, or 3 for a system with four diskette drives.
- ② **Diskette name.** This is the name given to the diskette when it was initialized (see Section 17.2.1 for details).
- ③ **Total number of documents stored on your diskette.** You may have as many as 200 on a diskette.
- ④ **Amount of unused storage available.** This is specified in units called blocks, each of which contains approximately 500 characters or one paragraph. You can store as many as 627 blocks on the document diskette, fewer on the system diskette.
- ⑤ **Document number and name.** The documents are automatically listed in the order they were created, from the most recently-created to the first created. There are (at most) five listed on each index page displayed on the screen.

⑥ **Asterisk.** This appears in front of the first document entry. You can move it to an index entry and then direct the word processing system to let you edit, print, or delete that particular document. See Section 4.2 for how to use the asterisk.

⑦ **Creation date.** This is the date when you created the document. If you failed to specify a date when starting up the system, the characters

NO/DA/TE

will appear here.

⑧ **Modification date and time.** This indicates when you most recently edited the document. The same date appears here as in the creation date position if you failed to type a date when you started up the system and modified the document.

⑨ **Size.** This specifies the number of blocks used by the document on the diskette.

⑩ **Version number.** When you create and file a document, the system assigns it version number one. Each time you edit and file the document, the system increases the version number by one. This also happens each time you press the gold and TOP DOCMT keys.

⑪ **Amount of time in most recent use.** This is the amount of time spent the last time you used the document (creating, editing, examining, but not printing it). The time is specified in hours and minutes.

⑫ **Total amount of time.** This is the total of all time spent using the document (creating, editing, examining, but not printing it). The time is specified in hours and minutes.

⑬ **Document one.** This document is automatically created and maintained by the word processing system. It has no name. See Section 4.4 for details.

If the index contains more than five documents, the message

Press RETURN to display more entries

OR Gold MENU to recall the Main Menu.

is displayed at the bottom of each page. To see index information for the next five entries, do as the message says. Once you display the last index page, pressing the RETURN key will bring the Main Menu back on the screen.

## 4.2 USING THE INDEX

You can use the index when you want to edit, print, or delete a document and don't know the exact spelling of its name. You can also use it when you have a long document name to avoid typing it all out. Just move the asterisk character in the index to the document you want, by doing the following:

1. **Type the letter I and press the RETURN key** when any Main Menu page is displayed on the screen. This action displays the diskette index.
2. **Find the document** you want in the index.
3. **Press the ADVANCE key** (mini keyboard, white, left bottom) to move the asterisk in front of the document you want. Each time

you press the ADVANCE key, the asterisk advances to the next document entry. If you press ADVANCE when the asterisk is at the bottom of an index page (and there are more entries), the next index page will be displayed on the screen with the asterisk positioned in front of the first document entry. You can also move the asterisk backwards by pressing the BACK UP key (mini keyboard, white) through entries on the page being displayed. It is not possible to display a previous index page.

4. **Press the gold and the MENU keys.** A Main Menu page will now be displayed on the screen.

5. **Edit, print, or delete** the document which you marked by the asterisk.

### 4.3 PRINTING THE INDEX

Because the diskette index contains bookkeeping information about your documents, it's often useful to print it to have a record of your word processing activities. In order to print an index, you must first store it in a document, by doing the following:

1. **Type the letters CI** (for Copy Index) when any Main Menu page is displayed on the screen and press the RETURN key. The following prompt will be displayed.

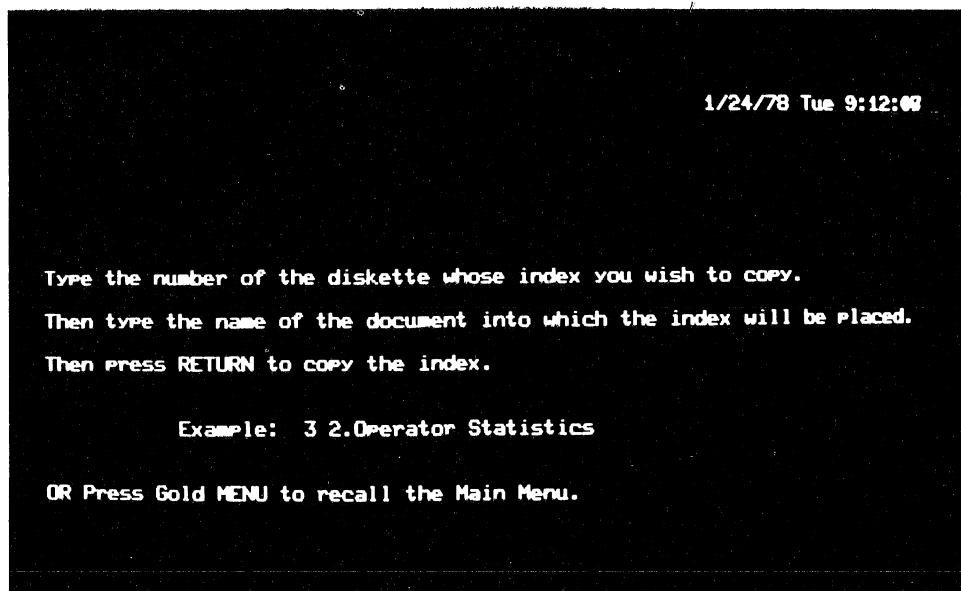

9113-25R1-A0076

Figure 4-2 Copy Index Prompt

2. Specify the diskette drive number whose index you want, type a space, identify the document to hold the index, and press the RETURN key. Use the following format:

You may omit specifying a drive number if you want the index of your document diskette or if you want to save the index on your document diskette.

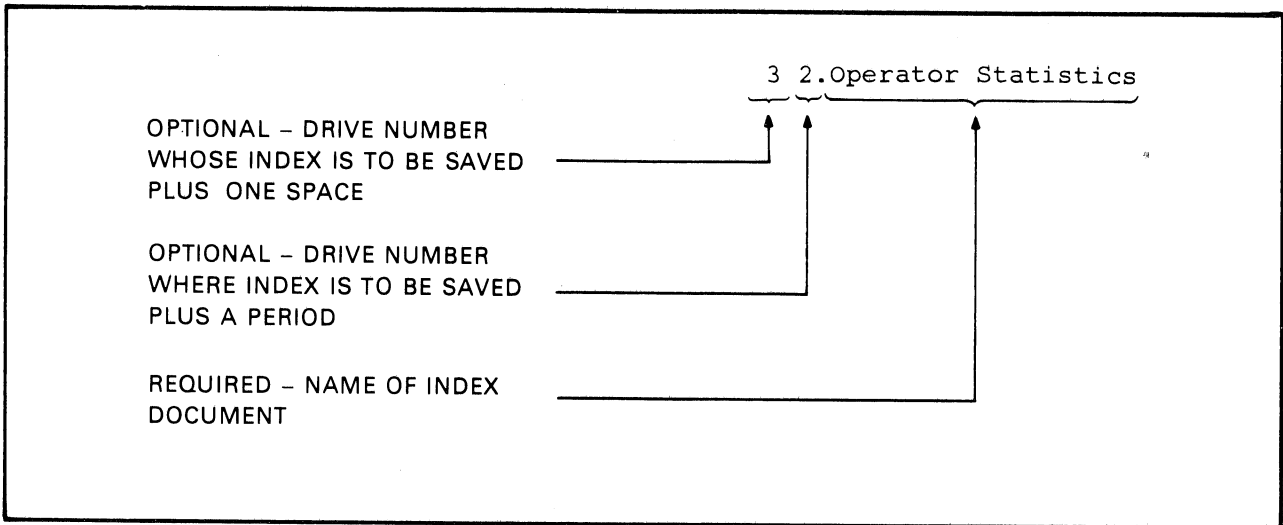

MK-0124

Figure 4-3 Example of Specifying Index Document

You may specify either a new document or one which already exists. If you specify a new document, the word processing system

will automatically create it. If you specify a document that already exists, the following prompt will be displayed on the screen.

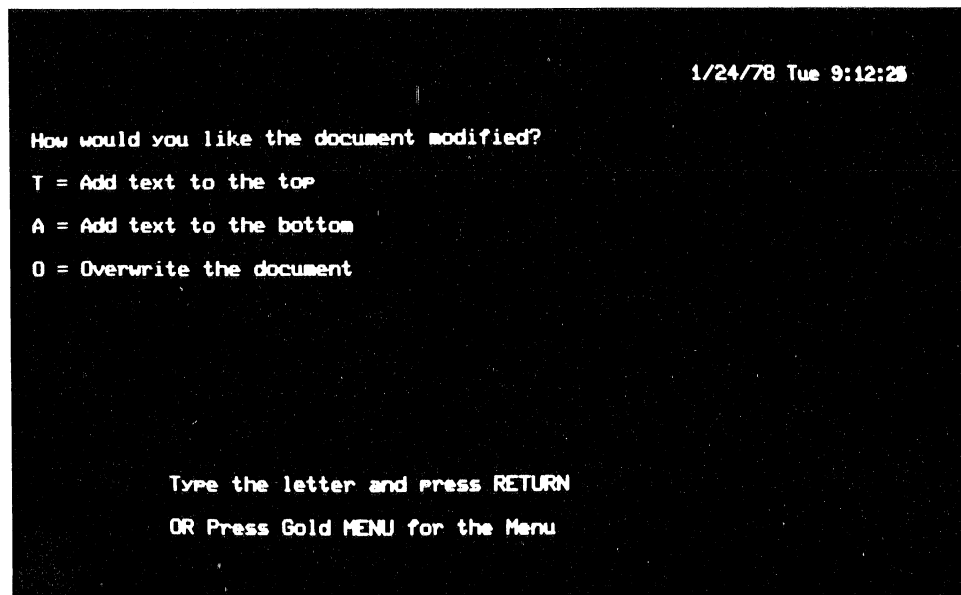

9113-27R1-A0077

Figure 4-4 Prompt for Modifying an Existing Index Document

This feature allows you to keep a “running index” by adding to a document that already contains other indexes. For example, you might want to save your index on a daily basis for a one-week period and print it on Friday. Every Monday you might want to start over again by replacing the previous week’s information. The index document will be displayed briefly on the screen. When complete, the Main Menu will again be displayed.

3. **Print the document** that contains the index (see Chapter 13). You can also edit the document before printing. This is useful if you want to delete some information or to add additional information, such as initials of the typists.

If you are using a system that has four diskette drives, you may save the indexes of two additional diskettes for printing. You may also use the two additional diskettes to save the index of



the system or document diskette. Refer to Appendix C.2 for details of specifying the two additional diskettes.

#### 4.4 DOCUMENT NUMBER ONE: CHANGING THE SPELLING OF A DOCUMENT NAME

Document number one on each diskette is a list

of document names and corresponding numbers. The word processing system provides this document so that you can change the spelling of a document name: just change its spelling in document one (using any of the techniques described in Sections 5.3 and 5.4).

Here is an example of a document one:

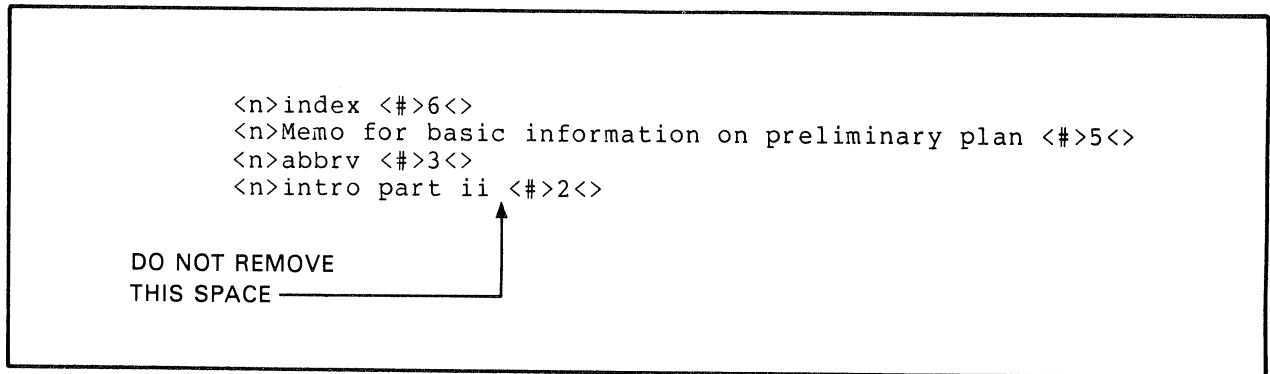

MK-0076

Figure 4-5 Example of Document One

---

Document number one is in a special format used by the word processing system. When editing document one, do not disturb the special format.



## CHAPTER 5 EDITING A DOCUMENT

You can add new material or make changes to any document – one you are currently creating or one you previously stored on a diskette. You can also examine a portion of your document which is not currently displayed on the screen. Once you are through editing, file your document (see Section 3.3) to save your changes.

In summary, this chapter describes the following:

1. **How to bring a stored document to the screen.** In order to examine a document or to make changes to it, it must be on the screen. See Section 5.1 for details.
2. **How to move the cursor through the document that is currently on the screen.** You tell the word processing system where you want to insert additional material or where you want to make a change by moving the cursor to the desired location. To examine a portion of your document not currently displayed, you must move the cursor to the desired location. See Section 5.2 for details.
3. **How to insert additional material.** Typing additional material into a stored document

is probably one of the tasks you most frequently have to do. See Section 5.3 for details.

4. **How to make changes.** You can interchange two characters (change “hte” to “the”), delete single characters, words, or larger portions of text, and move a piece of text from one location to another. All changes are automatically stored on the diskette. See Section 5.4 for details.

If the warning message

-- Do not add much more to document --  
Only “number” blocks left on diskette.  
Press Return

appears on the screen while you are typing (an actual value will appear instead of “number”), proceed only a few more lines to a point where you can stop and then file the document. Either delete obsolete documents from the diskette or get another one (be sure it’s initialized before using it – see Section 17.2.1), create a new document, and continue your typing. Mark the label

of the first diskette to indicate it is full so you won't accidentally try to add text to it at some future time.

If you ignore the warning message, not only will some of your typing be lost, but you will also destroy some other documents stored on your diskette.

### 5.1 BRINGING AN EXISTING DOCUMENT TO THE SCREEN

To bring an existing document to the screen for editing, type the letter E (for Edit) when any Main Menu page is displayed on the screen and press the RETURN key. The screen will display a message asking you to identify the document you want to use.

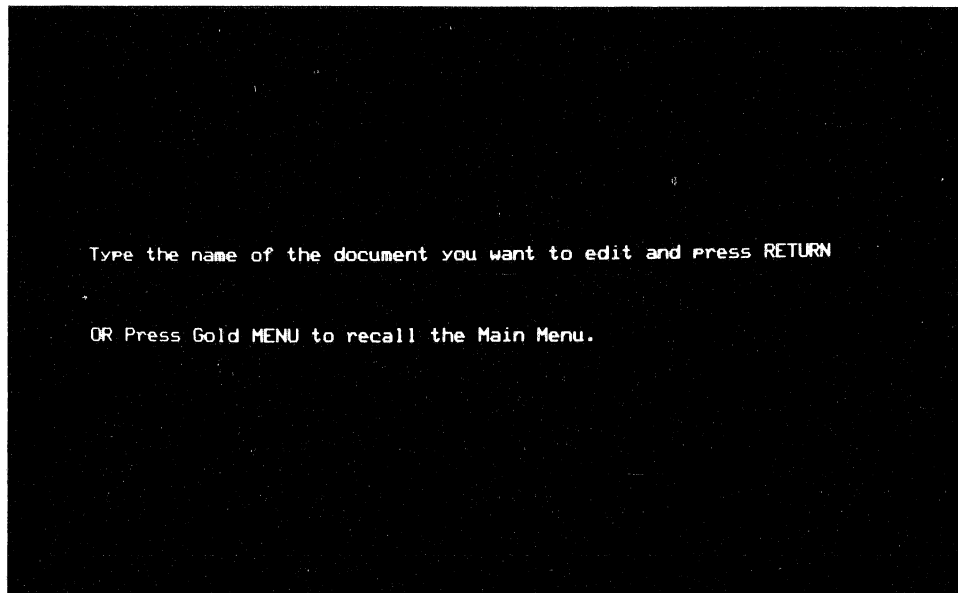

8920-22R1-A0078

Figure 5-1 Document Edit Prompt (1)

If you have previously worked on another document in the current word processing session, the system will ask you if you want to edit that document. If you have inspected the index, the system

will ask if you want to edit the document marked by the asterisk. For example, if you have just printed a document called "index" and you type the letter E, the screen display will look like this:

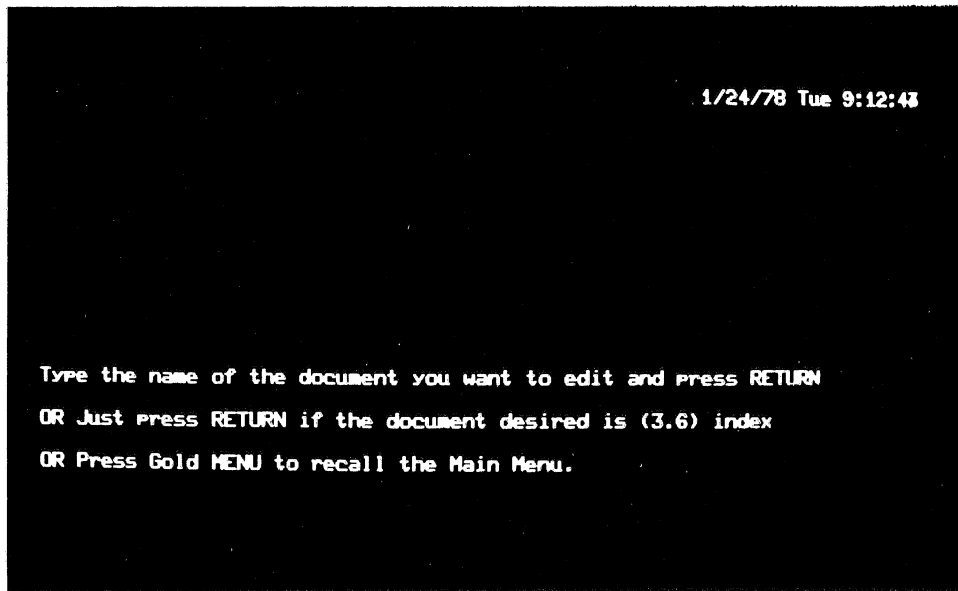

9113-29R1-A0079

Figure 5-2 Document Edit Prompt (2)

---

As a shortcut, you can type the letter E, a space, identify the document, and press the RETURN key. In this case the word processing system does not prompt for your document name because you've already typed it.

#### 5.1.1 Identifying a Document To Be Edited

To identify the document you want brought to the screen, type its name and press the RETURN key. If you specify a document which

does not exist, the system will display an error message asking you to try again.

You may use either upper case, lower case, or a combination of the two. For example, if your document is called "Profit&Loss" you may type "profit&loss" or "PROFIT&LOSS" and the word processing system will automatically find the correct document.

If your document name is long but has at least one space, you can type just the first word. For example, if you want to use a document called

Kimball memo9/9/77

you may type just the following:

Kimball

Be certain to type a complete word. If you don't, the word processing system will display an error message on the screen asking you for another name.

You may also type the document's number in the index instead of its name. This is useful if your document names are long and you know their numbers. For example, suppose you want to use a document called "carburetor.specifications" and you don't care to type all those letters. Suppose also that you print an index daily (see Section 4.3). All you have to do is look for "carburetor.specifications" in the printed index and type its number.

**5.1.1.1 Document Storage Location** – You can bring a document from either the document or the system diskette to the screen. To specify that a document is stored on the document diskette, just type its name (or number). To specify that a document is stored on the system diskette, type the character { in front of the name (or number).

If you are operating a system that contains four diskette drives, you have two additional drives available for document storage. Appendix C.1 supplies details for how to specify documents stored in these systems.

**5.1.1.2 Using the Index To Identify a Document** – You can also use the index to identify a document, by doing the following:

1. **Type the letter I and press the RETURN key** when any Main Menu page is displayed on the screen. The first page of the index will be displayed on the screen. Notice an asterisk at the left of the first entry.

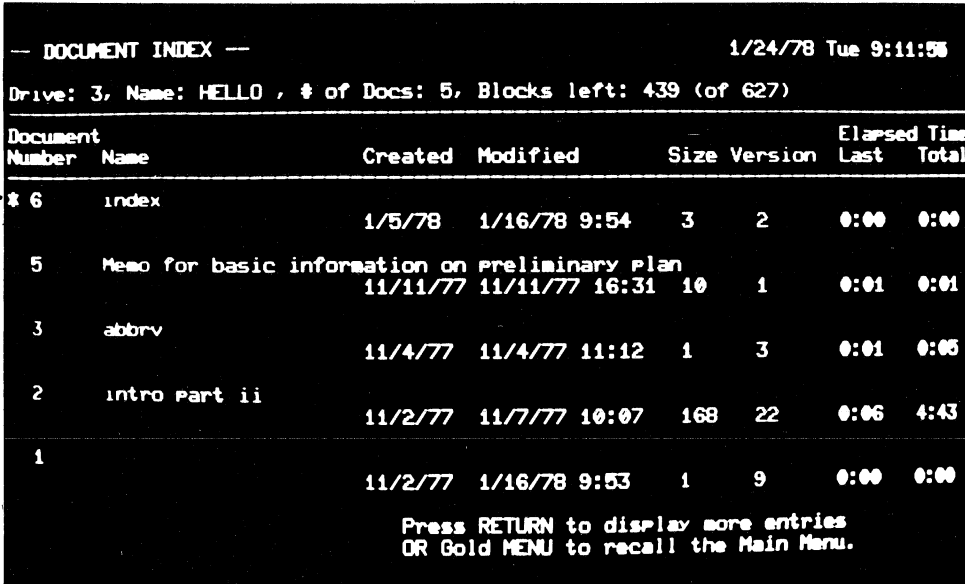

DOCUMENT INDEX		1/24/78 Tue 9:11:58							
Drive: 3, Name: HELLO, # of Docs: 5, Blocks left: 439 (of 627)									
Document Number	Name	Created	Modified	Size	Version	Elapsed Time			
						Last	Total		
* 6	index	1/5/78	1/16/78 9:54	3	2	0:00	0:00		
5	Memo for basic information on preliminary plan	11/11/77	11/11/77 16:31	10	1	0:01	0:01		
3	abbrv	11/4/77	11/4/77 11:12	1	3	0:01	0:05		
2	intro part ii	11/2/77	11/7/77 10:07	168	22	0:06	4:43		
1		11/2/77	1/16/78 9:53	1	9	0:00	0:00		

Press RETURN to display more entries  
OR Gold MENU to recall the Main Menu.

① ASTERISK

9113-24R1-A0082

Figure 5-3 Using the Document Index to Indicate Document to Be Edited (1)

2. Press the ADVANCE key (mini keyboard, white) until the asterisk is in front of the document you want. For example, if you want to edit the document called "abbrev" press the ADVANCE key twice. Here is what the index will then look like.

Pressing the ADVANCE key when the asterisk is positioned in front of the last index entry on the screen causes the next index page to be displayed (provided there are more entries). Pressing the BACK UP key (mini keyboard, white) moves the asterisk

back to other index entries displayed on the screen. You cannot display a previous index page by pressing the BACK UP key.

3. Press the gold and the MENU keys. The Main Menu will be displayed on the screen again.

Now when you type the letter E and press the RETURN key, the word processing system will ask you if you want to edit the document you just marked (with the asterisk) in the index.

The screenshot shows a terminal window titled "DOCUMENT INDEX" with a timestamp "1/24/78 Tue 9:14:34". Below the title, it displays "Drive: 3, Name: HELLO, # of Docs: 5, Blocks left: 439 (of 627)". A table lists five documents with columns for Document Number, Name, Created, Modified, Size, Version, Elapsed Time Last, and Elapsed Time Total. Document 3, named "abbrev", has an asterisk next to its document number. A circled number 1 with an arrow points to this asterisk. At the bottom of the screen, instructions read: "Press RETURN to display more entries OR Gold MENU to recall the Main Menu."

Document Number	Name	Created	Modified	Size	Version	Elapsed Time Last	Elapsed Time Total
6	index	1/5/78	1/24/78 9:13	3	3	0:01	0:01
5	Memo for basic information on Preliminary plan	11/11/77	11/11/77 16:31	10	1	0:01	0:01
* 3	abbrev	11/4/77	11/4/77 11:12	1	3	0:01	0:05
2	intro part ii	11/2/77	11/7/77 10:07	168	22	0:06	4:43
1		11/2/77	1/16/78 9:53	1	9	0:00	0:00

① ASTERISK

9113-33R1-A0081

Figure 5-4 Using the Document Index to Indicate Document to Be Edited (2)

### 5.1.2 Screen Display

Here is what the screen looks like when you bring an existing document to the screen for editing:

- ① **Diskette drive number and document number.** The first number is the diskette drive where the document is stored. The second is the document's number in the index.
- ② **Document name.** This is the name you specified after typing the letter C. If you specified one word of a longer name, only that word is displayed in this position. If you specified a document number, this position on the screen contains that number.
- ③ **Amount of storage space used.** This is the number of blocks (approximately 500 typed characters or one paragraph) which the document occupies on the diskette.
- ④ **Amount of storage space available.** This is the number of blocks still available for document storage on the diskette. If this number is less than 25 (preferably less than 50), you should either delete any obsolete documents or use another diskette.
- ⑤ **Number of text lines per page.** This is the maximum number of text lines that may appear on each page typed.

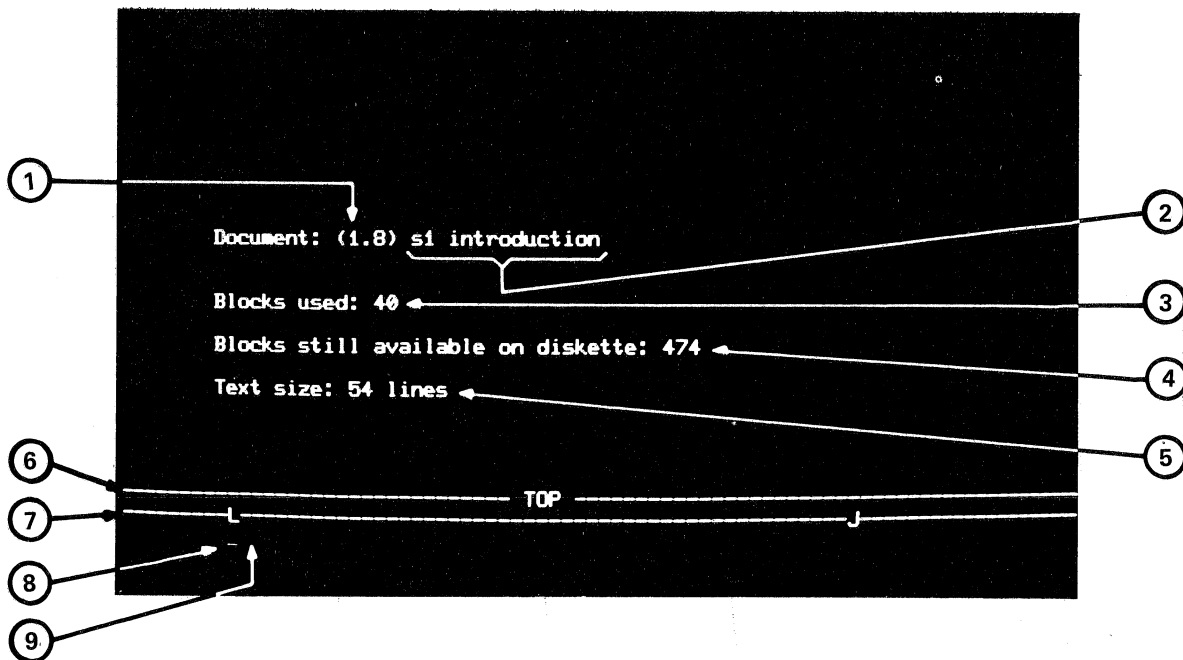

9113-35R1-A0080

Figure 5-5 Example of Screen Display When a Document Is Specified for Editing



- ⑥ **Top marker.** This marks the top of your text.
- ⑦ **Ruler.** These are the margin, tab, and vertical line spacing settings used at the beginning of your document.
- ⑧ **First line of text.** This is the first line that was typed when the document was created.
- ⑨ **Cursor.** This is a blinking underscore character which marks your current position in the document. Since you haven't yet edited anything, the cursor

is positioned at the beginning of the document.

### **5.1.3 Getting an Extra Version of an Existing Document**

When you bring a document to the screen for editing and make changes to it, you no longer have a stored copy of your original document. Sometimes you may want to retain a copy of the original as an extra, or backup, version. This is useful if, for example, your boss makes pen and ink changes to a report but cautions you that the changes are not firm – just type them to see how they look before deciding to keep them.

To get an extra version of an existing document, follow these steps:

1. Create a new document.
2. Press the gold and the GET DOCMT keys. The system will ask for the name of the document to be copied.
3. Type the name (or number) of the document that you want to retain as the original. A complete copy of the original document will now be placed into the newly-created document.
4. File the document.

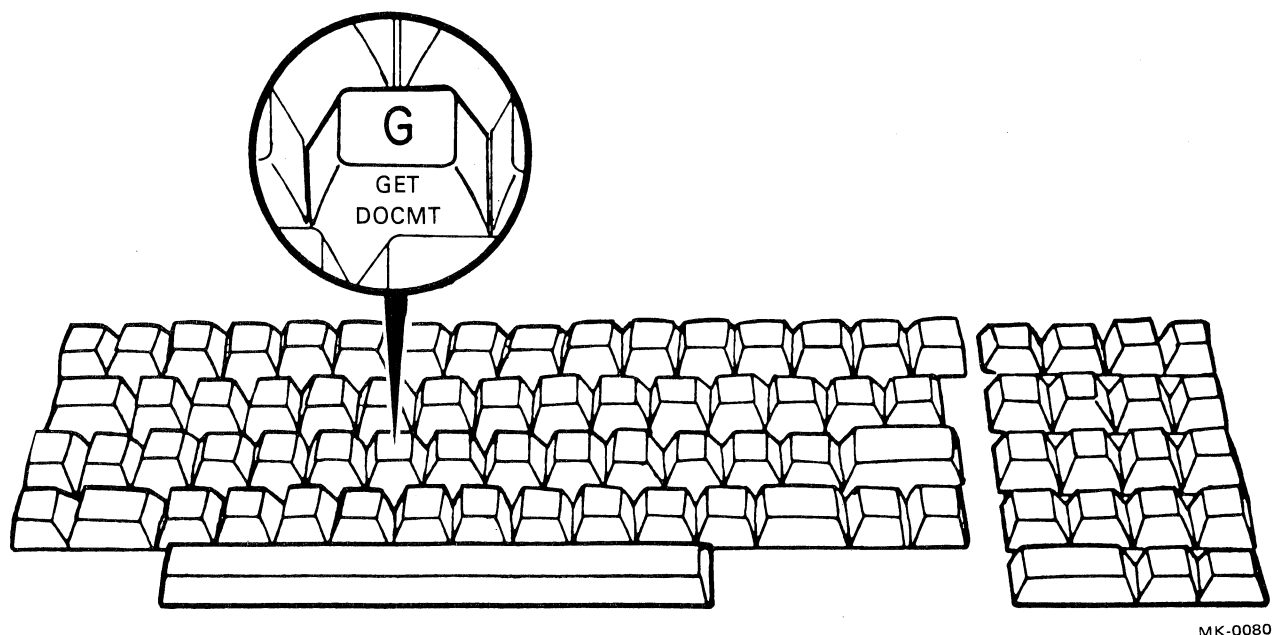

MK-0080

Figure 5-6 Main Keyboard GET DOCMT Key

## 5.2 MOVING THE CURSOR

In order to make changes, insert additional material, or examine a portion of your document not currently displayed on the screen, you must move the cursor to the desired location. You can move the cursor either forwards or backwards. There are three ways of moving the cursor through a document.

1. **With the mini keyboard grammatical keys**, to move over a particular word, line, sentence, tab position, paragraph, page, or > character (see Section 5.2.1).
2. **With the gold and the ADVANCE or BACK UP keys**, to move continuously through the text (see Section 5.2.2). This displays your

entire document on the screen as though it were a scroll. Hence, this technique is referred to as *scrolling*.

3. With the gold TOP DOCMT and BOT DOCMT key to move immediately to the top or bottom of the document (see Section 5.2.3).

You can also move the cursor to a particular word or group of words with a technique called *searching*. This is especially useful if you know exactly where you want the cursor to be located. For example, if your first change occurs under a section heading called "Survey Results" you can

search for "Survey Results" and have the cursor positioned there quickly. See Chapter 7 for details.

### 5.2.1 Using the Mini Keyboard Grammatical Keys

When you press the ADVANCE key located on the mini keyboard, the cursor moves forward one character, space, tab position, hard return, or word wrap return. If you press the ADVANCE key when the cursor is at the end of a line, it moves to the beginning of the next line. Similarly, when you press the mini keyboard BACK UP key, the cursor moves backward one position.

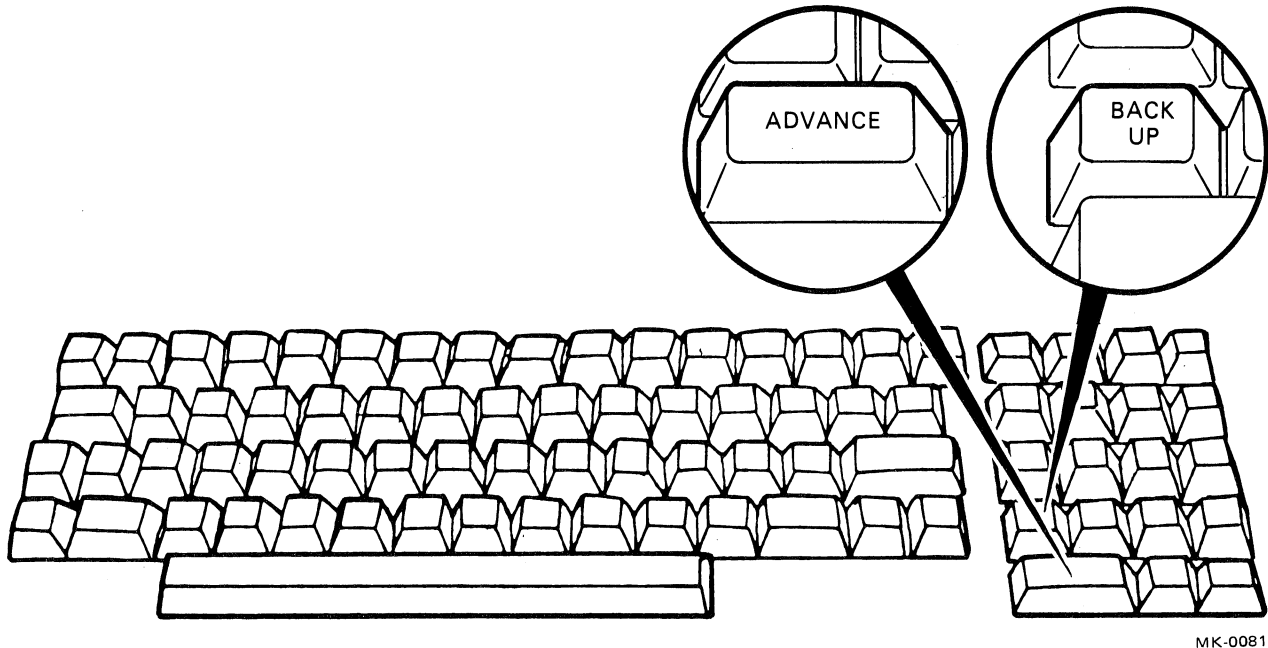

MK-0081

Figure 5-7 Mini Keyboard ADVANCE and BACK UP Keys

In addition, pressing either the **ADVANCE** or **BACK UP** key "sets" the direction of cursor movement. You can then use one of the blue grammatical keys to indicate how much text to move over.

Refer to Appendix A.2 for a description of each blue grammatical key.

You can also use the blue grammatical keys in the following ways:

1. **Repeating Movement.** You can move the cursor more than one grammatical item at a time by holding down the **REPEAT** key (main keyboard, bottom row) at the same time as either the **ADVANCE** key, **BACK UP** key, or one of the blue grammatical keys.
2. **Canceling Movement.** Once you press the **ADVANCE** or **BACK UP** key and one of the blue grammatical keys, you can stop the cursor from reaching its destination by pressing the gold and the **HALT** keys.
3. **Reaching the top or bottom of a document.** If you attempt to go forward when the cursor

is at the end of a document, the system will buzz and the cursor will not move. However, if you attempt to go backward when the cursor is at the top of a document, the system will buzz and the cursor will then move forward.

### 5.2.2 Using the **ADVANCE** and **BACK UP** Keys To Scroll

You can scroll, or move the cursor continuously through your entire document, by pressing the gold key before pressing either the **ADVANCE** or the **BACK UP** key.

If you do either of the following, the system will buzz.

1. Press the gold and **ADVANCE** keys when the cursor is located under the last typed position.
2. Press the gold and **BACK UP** keys when the cursor is located under the first typed position.

To stop scrolling, press the gold and the **HALT** keys.

### 5.2.3 Using The Gold TOP and BOT DOCMT Keys

You can move the cursor directly to the very first typed position in a document by pressing

the gold and the TOP DOCMT keys. You can move the cursor directly to the very last typed position by pressing the gold and the BOT DOCMT keys.

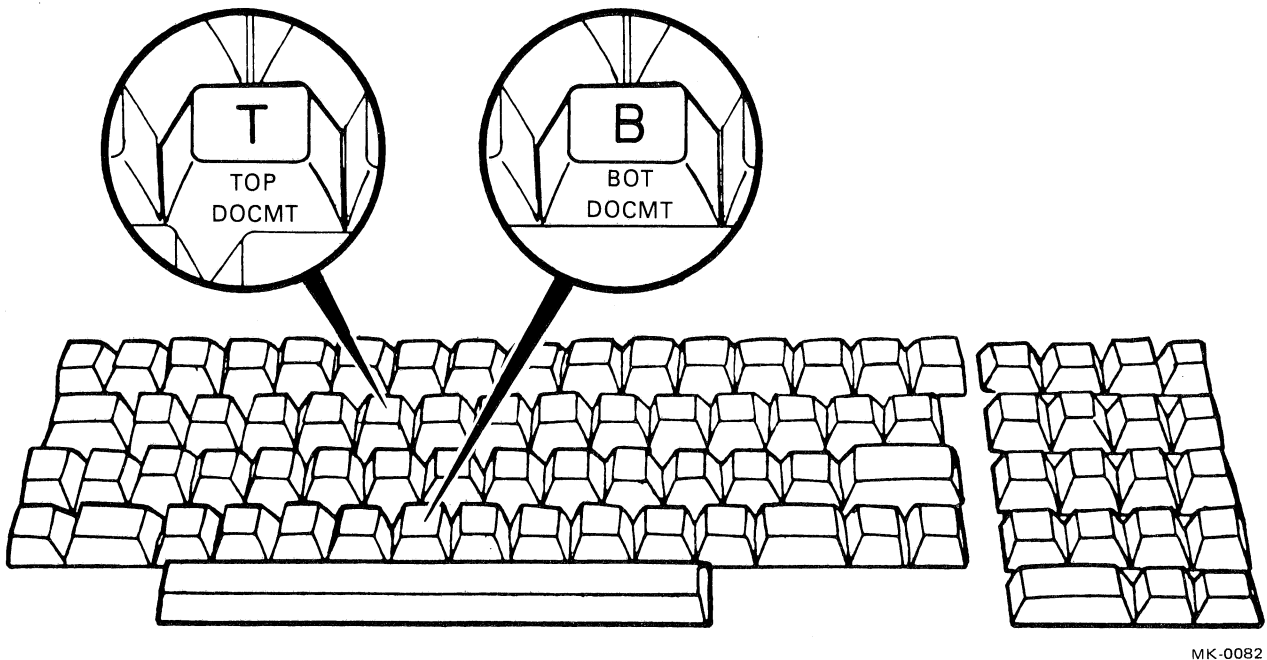

MK-0082

Figure 5-8 Main Keyboard TOP DOCMT and BOT DOCMT Keys

When you press the gold and the TOP DOCMT keys, the message

-- DOCUMENT FILING BEING COMPLETED --

is displayed on the screen. Then the top of your document is displayed with the cursor positioned under the first typed position. This method is equivalent to filing the document and bringing it to the screen to edit again.

Since you can move the cursor to the top of a document by pressing either the gold and BACK UP keys or the gold and TOP DOCMT keys, which method should you use? It all depends on how big your document is and where the cursor currently is located.

1. If the cursor is located near the beginning of your document, press the gold and BACK UP keys.

2. If your document is large and the cursor isn't located near the beginning, it's faster to press the gold and TOP DOCMT keys.

When you press the gold and the BOT DOCMT keys, the screen will momentarily go blank, the last 24 lines of your document (only 11 if your right margin is set beyond typing position 79) will be displayed on the screen, and the cursor will be located under the last typed position.

If you change your mind after pressing the gold and BOT DOCMT keys, you can cancel the effect by pressing the gold and the HALT keys. However, you cannot stop the system once you press the gold and the TOP DOCMT keys.

### 5.3 INSERTING ADDITIONAL TEXT

You can insert additional text into any document - one which you've just created or one which you've brought to the screen for editing.

To insert additional text, follow these steps:

1. **Position the cursor where the new text is to begin.** Use any of the cursor movement techniques described in Section 5.2.
2. **Type the additional text.** What you type is added to your document to the left of the cursor. As you type, the new text is displayed on the screen and the cursor moves forward.
3. **Word wrap the paragraph.** When you insert text, the line endings are "thrown off" so that succeeding lines extend beyond the right margin. To reformat the text, press the mini keyboard PARA key (it also advances the cursor forward to the next paragraph).

### 5.4 MAKING CHANGES

There are many different ways to change a document. They range from simply correcting a typo to picking up text and moving it to another location in the same (or even a different) document.

Here are four ways of making a change to a document (in addition to using the RUB OUT keys described in Section 3.2.2):

1. Interchange two characters by using the SWAP key located on the mini keyboard (see Section 5.4.1).
2. Delete characters or words by pressing the red DEL CHAR or DEL WORD key located on the mini keyboard (see Section 5.4.2).
3. Delete several words, lines, sentences or paragraphs by using the SEL and CUT keys located on the mini keyboard (see Section 5.4.3).
4. Move some text from one location to another by using the CUT and PASTE keys located on the mini keyboard (see Section 5.4.4).

You can also search for a particular phrase (word or group of words) and replace it with another phrase. Refer to Section 7.2 for details.

#### 5.4.1 Interchanging Two Characters

If you accidentally reverse two characters, such as typing "teh" instead of "the," you can easily interchange them with the mini keyboard SWAP key. Just move the cursor so it's underneath the first character to be swapped and press the SWAP key. The two characters will be interchanged with the cursor positioned underneath the second.

### 5.4.2 Deleting a Character or Word

The red mini keyboard DEL CHAR key allows you to delete a single character, space, tab, hard return, PAGE MARKER, or NEW PAGE mark located above the cursor. The red mini

keyboard DEL WORD key allows you to delete a single word that begins where the cursor is located (including the character directly above the cursor).

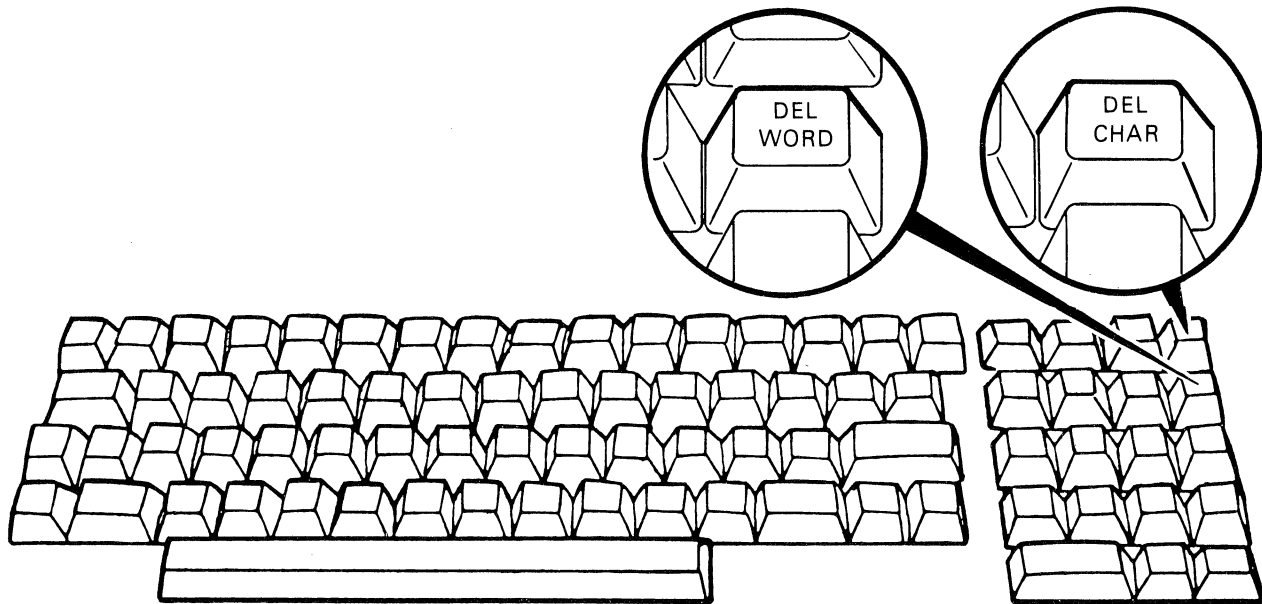

MK-0077

Figure 5-9 Mini Keyboard DEL WORD and DEL CHAR Keys

If you accidentally press the DEL CHAR or DEL WORD key, you can restore the deleted information by pressing the gold key and then either the DEL CHAR or DEL WORD key again.

While it is possible to remove more than one character or word, by holding down the REPEAT key (main keyboard) at the same time as the DEL CHAR or DEL WORD key, you might also delete more than you intended. Therefore, it is advisable to delete a larger portion of text by cutting.

### 5.4.3 Cutting: Deleting a Portion of Text

You can delete a group of words, lines, sentences, or paragraphs by using the SEL (for SE-lect) and CUT keys located on the mini keyboard.

To use these keys to delete a portion of text, follow these steps:

1. **Move the cursor to the beginning of the text and press the SEL key.** A select mark, or white square, will appear on the screen and the text will move down one line. If you accidentally press SEL in the wrong place, just press it again to remove the select mark.
2. **Move the cursor to right after the end of the text and press the CUT key.** All the text just

marked plus the white square is deleted. If you accidentally delete the wrong portion of text, you can restore it to your document. That's because the text just deleted was put in the system's paste area. Just press the PASTE key located on mini keyboard to restore the deleted text.

The maximum amount of text that can be cut at one time is 7500 characters, or approximately three pages. If you mark off more, only the first 7500 will be cut and the system will buzz (to warn you to return and cut the rest).

You can also press the SEL key at the end of the text to be deleted, move the cursor backwards, and then press the CUT key.

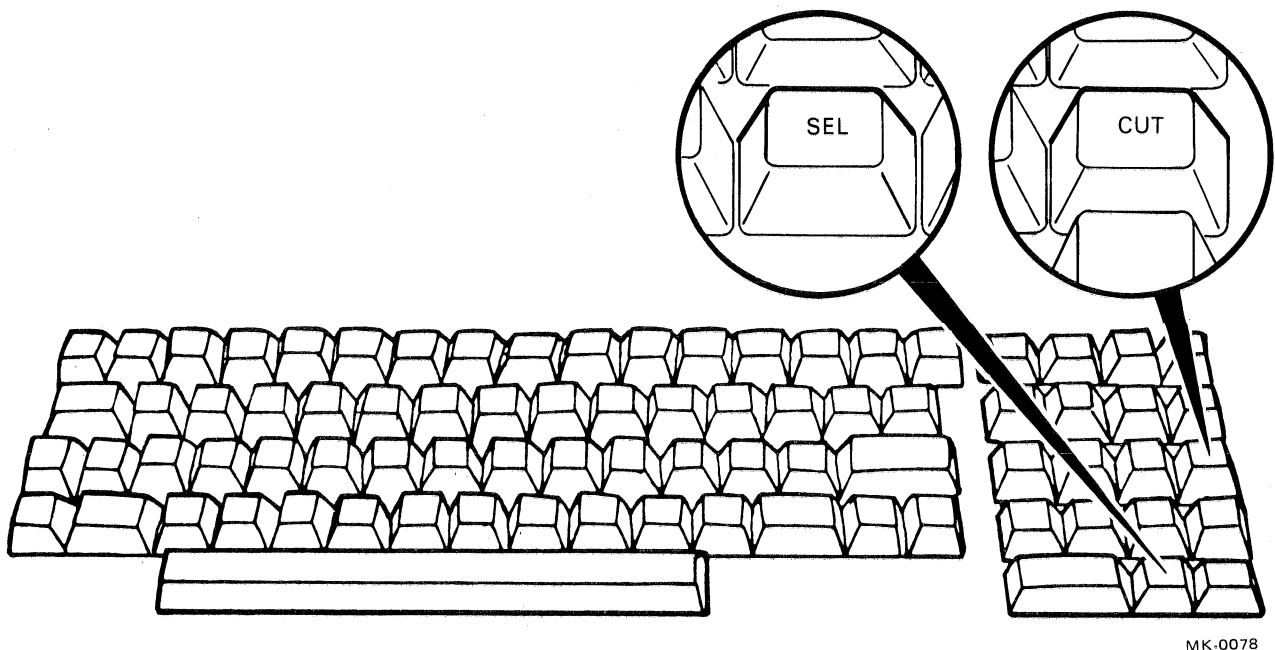

MK-0078

Figure 5-10 Mini Keyboard SEL and CUT Keys



#### 5.4.4 Cutting and Pasting

You can remove a piece of text from a word processing document by *cutting* and then insert the same text elsewhere in your document by *pasting*. You can paste the same piece of text many times in many different places without ever having to retype it.

The CUT (red) and PASTE (black) mini keyboard keys are used for cutting and pasting.

To move text from one location to another by cutting and pasting, follow these steps:

1. **Put the text in the paste area by cutting it** (position the cursor at the beginning and press the SEL key, then position the cursor at the end and press the CUT key).
2. **Position the cursor** where you want to insert the text. This location may be in the same or an entirely different document (this latter requires you to file the document from which you have just cut and bring the document to receive the text to the screen for editing).
3. **Press the PASTE key.** The word processing system automatically inserts the text from the paste area and adjusts the rest of the text down to accommodate the addition. The inserted text is automatically adjusted to the ruler (margin and tab settings) in effect at the insertion point.
4. **Press the PARA key** (blue, mini keyboard) only if you have pasted into the middle of a

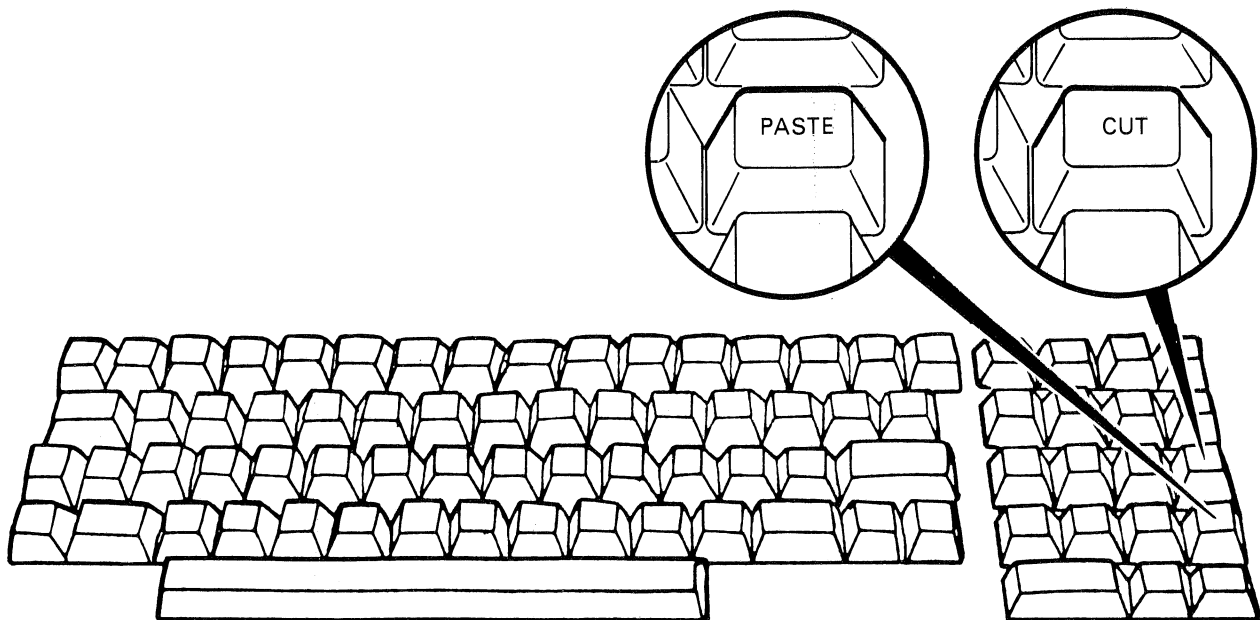

MK-0079

Figure 5-11 Mini Keyboard PASTE and CUT Keys

paragraph: line endings are "thrown off" so that the following text extends beyond the right margin. To reformat your text, press the PARA key. This action word wraps the remainder of the paragraph (advances the cursor forward to the next paragraph). If your pasted text is followed by a hard return, this step is not necessary.

Repeat steps 2-4 as many times as desired.

If you want to retain the text in its original location in addition to inserting it elsewhere, press the gold key BEFORE pressing the CUT key in step 1 above.

**5.4.4.1 Preserving Rulers When Pasting** - When a piece of text is cut and pasted, the margins and tabs (ruler) in effect in the new location are applied to the pasted text instead of the original ones.

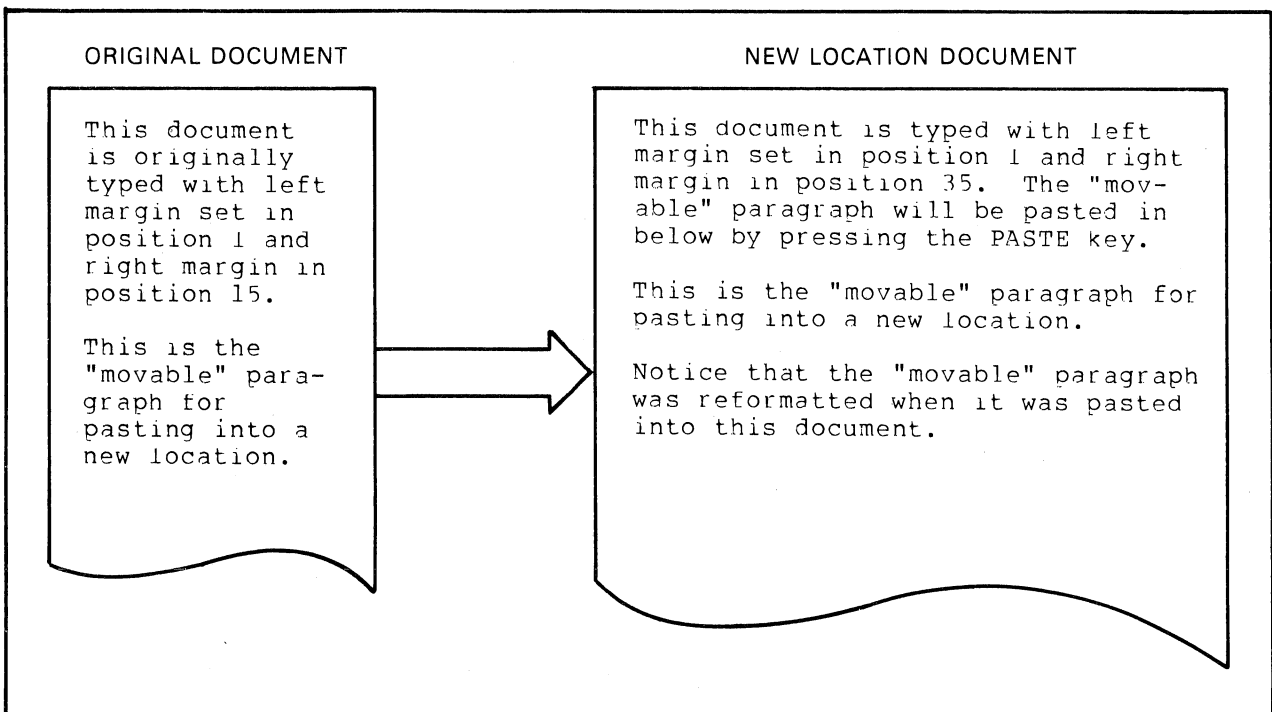

MK-0083

Figure 5-12 Example of Cutting and Pasting Using the Mini Keyboard CUT and PASTE Keys

In order to apply the ruler in effect in the original location to the pasted text, press the gold key BEFORE pressing the PASTE key. When cutting the text, use only the CUT key to put the text into the paste area. If you use the gold and the CUT keys, the original ruler will not be retained with the text when it is pasted.

In order to (1) cut and paste a piece of text keeping the original ruler and also (2) leave the text in its original location, then do the following:

1. Cut it from its original location by means of the SEL and CUT keys.
2. Immediately paste it right back by means of the PASTE key.
3. Paste it into the receiving location by means of the gold and PASTE keys.

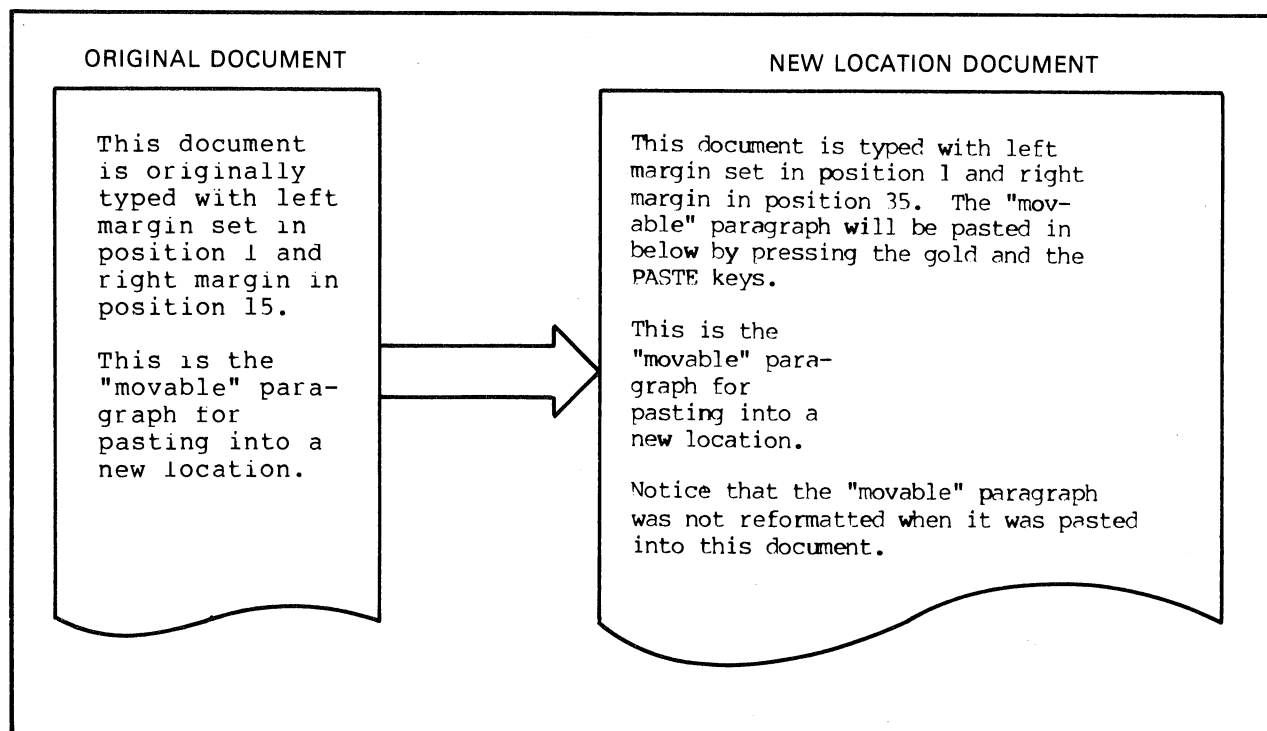

MK-0084

Figure 5-13 Example of Cutting and Pasting Using the CUT and Gold Plus PASTE Keys

**5.4.4.2 Summary of Different Cutting and Pasting Key Combinations** – The following table summarizes the ruler that is used as a result of pressing different combinations of the gold, CUT, and PASTE keys.

REPLACEMENT METHOD REMOVAL METHOD	PASTE KEY	GOLD AND PASTE KEYS
CUT KEY	NEW LOCATION RULER USED	ORIGINAL RULER USED
GOLD AND CUT KEYS	NEW LOCATION RULER USED	NEW LOCATION RULER USED

MK-0085

Figure 5-14 Ruler Used as a Result of Different Removal and Replacement Methods

## **CHAPTER 6 RULERS**

Before you start typing on a typewriter, you generally set left and right margins in whatever positions you want and set vertical line spacing (single, double, space and a half, etc.) by moving a switch, button, or lever. You may also set up tabs for columns in a table or for text you want indented.

You work the same way with the word processing system except the procedure is easier. Instead of moving switches, buttons, levers, or knobs, you type a single character code in a particular

position in a ruler. A ruler contains your word processing left and right margin settings, vertical line spacing, and tabs (if any).

A ruler allows you to type text in one long stream without pressing the RETURN key. The system uses your right margin ruler settings to determine where to end each line and start the next. In addition, a ruler allows you to reformat text without having to retype: simply change the margin or tab settings in the ruler.

A ruler appears on the screen as a dashed line with characters in place of some of the dashes. Each dashed line corresponds to a typing posi-

tion (from 1 to 80) while each character corresponds to a particular kind of setting. Here is an example of two rulers:

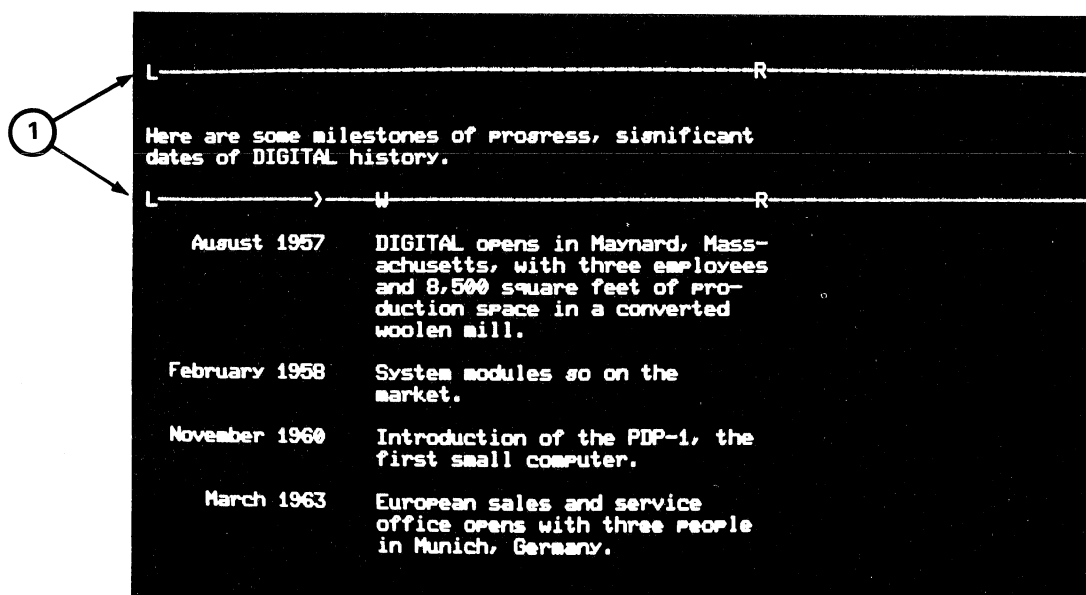

1 RULER

9113-2R2-A0088

Figure 6-1 Example of Rulers

As you type or edit, the ruler may move off the top of the screen with your text. However, the word processing system will retain the ruler settings and continue using them to format your document.

### 6.1 USING A RULER

When you create a document, the word processing system automatically supplies a ruler that has preassigned settings (see Section 6.5 for how to change this "standard" ruler). If you are satisfied with the ruler, you can proceed with your

typing or editing. If you are not, change it. You may change a ruler anyplace in a document as many times as desired by doing the following:

1. Display the ruler (see Section 6.1.1).
2. Make all the desired ruler settings (see Section 6.1.2).
3. Clear the display and embed the ruler (see Section 6.1.3).

### 6.1.1 Displaying a Ruler

Displaying a ruler means the word processing system is ready to accept any new or changed settings you care to make. To display a ruler, press the gold and the RULER keys.

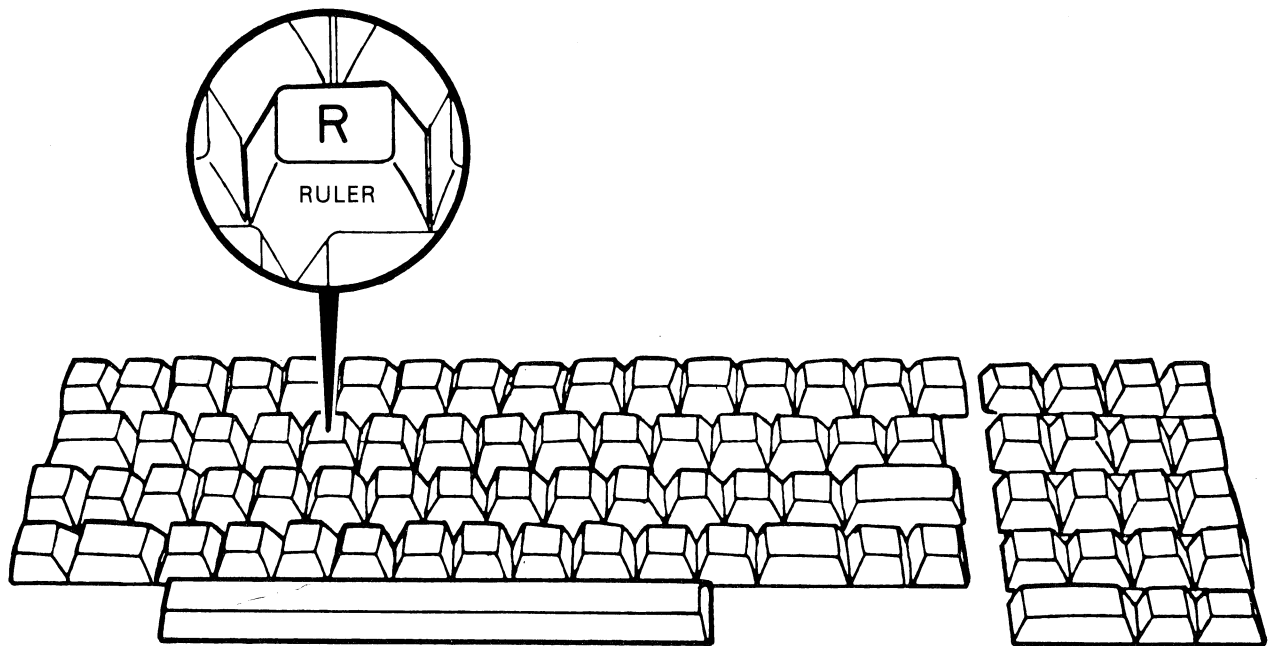

MK-0087

Figure 6-2 Main Keyboard RULER Key

A displayed ruler contains more detail than the dashes and characters ruler: every tenth position is marked with a single number (1, 2, 3, ... is used instead of 10, 20, 30, ...) and every fifth position with a dot.

You can display a ruler and make changes anywhere in a document. For best results, however, it is advisable to make changes only after a hard return (or at the beginning of the document).

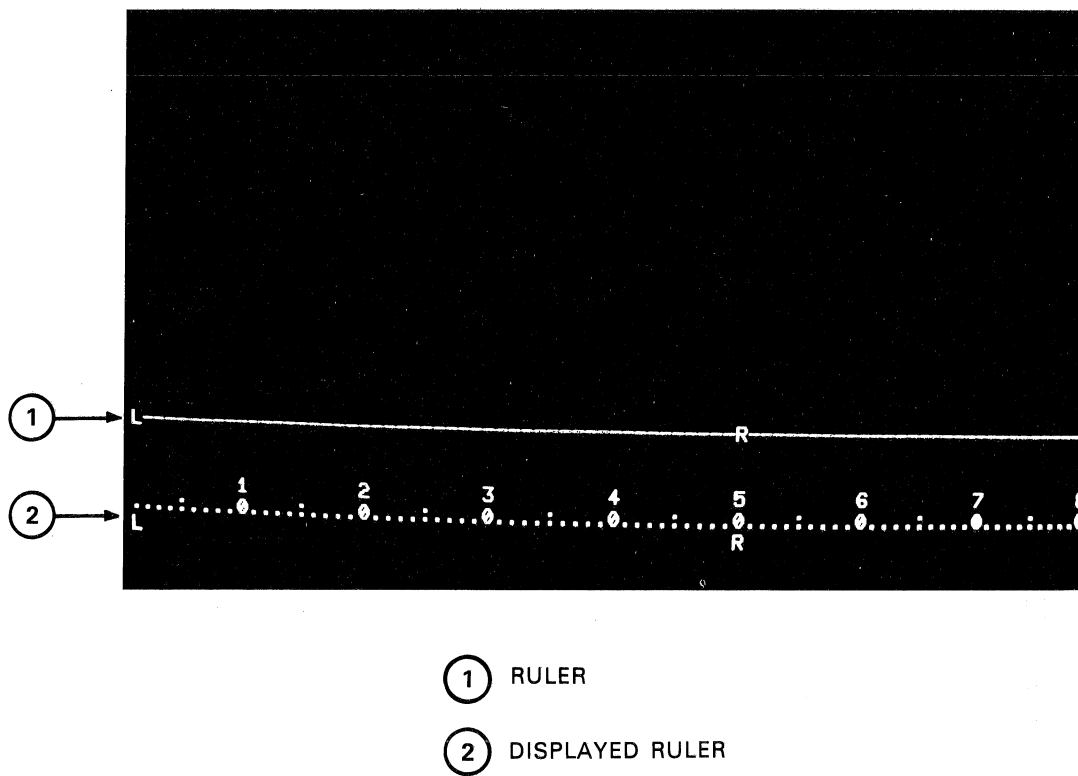

9113-6R2-A0087

Figure 6-3 Example of Displayed Ruler



### 6.1.2 Making Ruler Settings

To make a ruler setting, display the ruler, move the cursor to the desired position, and type the character that corresponds to the setting you want.

When you display a ruler, the cursor is in the same position as it was in the text. You can move the cursor to any other position with the following mini keyboard keys:

Key	Action
ADVANCE	Moves the cursor forwards one typing position at a time. Pressing ADVANCE when the cursor is located in position 79 causes the ruler display to “split” in half and gives you a “wide” ruler, or 158 positions (see Section 6.3).
BACK UP	Moves the cursor backwards one typing position at a time. If you press BACK UP when the cursor is at ruler position 1, the terminal will buzz and the cursor will remain where it is.
WORD	Moves the cursor to the next ruler setting character. If you have previously pressed the BACK UP key, WORD moves the cursor backwards to the previous ruler setting.
LINE	Moves the cursor to position 80. If you have previously pressed the BACK UP key, LINE moves the cursor to position 1. When a wide ruler is in effect (see Section 6.3), pressing LINE when the cursor is located beyond position 80 moves the cursor to and from positions 81 and 158.

You can also hold down the REPEAT (main keyboard, bottom right) key with ADVANCE, BACK UP, or WORD to speed up the cursor’s movement.

Once the cursor is in the correct position, you can remove the current setting character by pressing the space bar or you can type a new one.

The following actions occur when you type a ruler setting:

1. The character you just typed appears above the cursor. This new character replaces any character previously there. Therefore, it isn’t necessary to delete a character before replacing it.
2. The cursor remains in the same position and is ready to move in the direction it previously was moving.

If you change your mind after making ruler settings, you can retrieve your original settings by pressing the = key (main keyboard, upper right). You can do this only while your ruler is displayed. (Once you clear the ruler display, your changed settings take effect.)

The different kinds of allowable ruler settings are:

Character	Description
F L N D	Left margin plus vertical spacing (see Section 6.1.2.1)
R J	Right margin (see Section 6.1.2.2)
P	Indent for the first word of a paragraph (see Section 6.1.2.3)

Character	Description
W	Automatic, or word wrap, indent for several lines of continuous text (see Section 6.1.2.4)
T >	Tab stops (see Section 6.1.2.5)
C	Centering point (see Section 8.1)
H	Hyphenation zone (see Section 11.5)

Appendix E contains a complete summary of all ruler setting characters.

**6.1.2.1 Left Margin and Vertical Line Spacing –** Both the position of the left margin and the amount of vertical line spacing are controlled by

typing a single character. There are four characters, or four kinds of vertical line spacing, to use.

**Left Margin**

Character	Spacing Produced
F	Half-line
L	Single
N	Space and one half
D	Double

Text is always displayed on the screen single spaced. The F, L, N, and D characters take effect when a document is printed (it is also possible to add extra vertical space when printing a document without changing its rulers – see Section 13.3.6 for details).

Here is how some text typed with the four different left margin ruler settings appears on the screen:

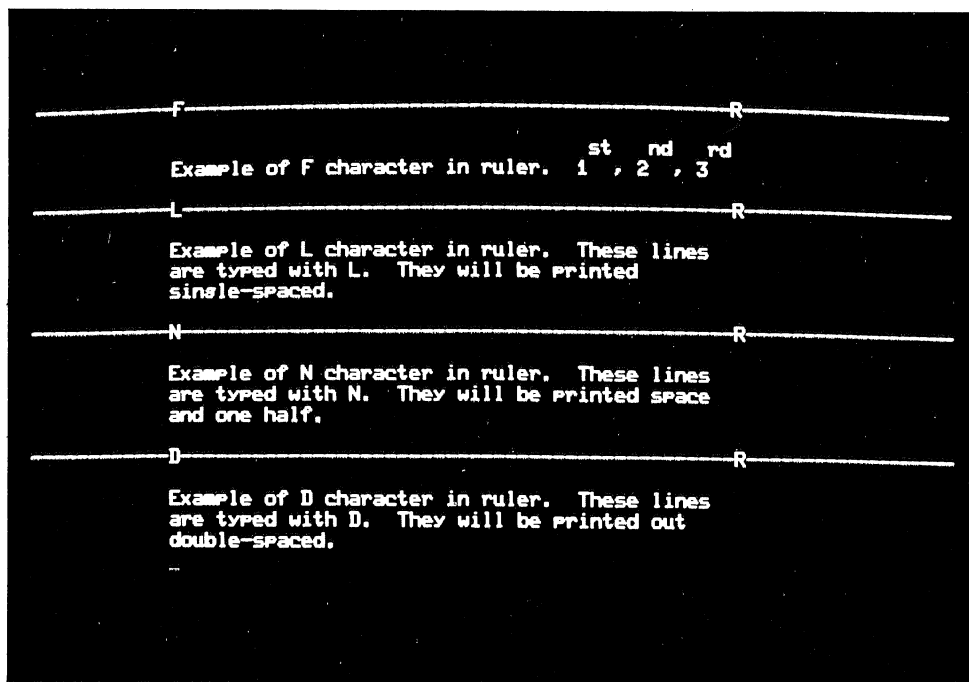

M123-5-A0192

Figure 6-4 Example of Different Left Margin Ruler Settings

Here is how the same text looks when it is printed:

Example of F character in ruler. 1<sup>st</sup>, 2<sup>nd</sup>, 3<sup>rd</sup>

Example of L character in ruler. These lines are typed with L. They will be printed single-spaced.

Example of N character in ruler. These lines are typed with N. They will be printed space and one half.

Example of D character in ruler. These lines are typed with D. They will be printed out double-spaced.

You must put one (and only one) of the left margin characters in a ruler.

**6.1.2.2 Right Margin** - The right margin setting in a ruler marks the last position on a line where a character may appear. There are two kinds of right margin ruler settings: ragged (R) and justified (J). Whether you use J or R in your ruler does not affect what word appears at the end of a line. It affects only how the line is spaced after the last word of each is determined.

Character	Meaning
R	Ragged right margin. All word wrapped lines are printed exactly as they appear on the screen. Lines with ragged right margins look the same as those produced on an ordinary typewriter, just as these lines do.

**Character**

**Meaning**

J

Justified right margin. All word wrapped lines are lined up uniformly on the right when printed, like the lines you're now reading. However, justified lines are displayed on the screen the same as ragged lines.

Justification is performed differently on the two types of word processing printers. If a letter quality printer is used, lines are justified by adding space in 1/120 inch units between both characters and words. If a draft printer is used, lines are justified by adding space in 1/10 inch units only between words.

You must put one (and only one) of the right margin characters in a ruler.

**6.1.2.3 Paragraph Indent** – The P ruler setting character allows you to type indented paragraphs. These are indented from the regular left margin and are separated from the previous paragraph by a single carriage return.

To indent a paragraph, follow these steps:

1. **Put the letter P in your ruler** at the typing position where you want the paragraph to start. You can have only one P setting in a ruler. If you type a second one, the system will automatically remove the first.
2. **Press the gold and the PARA MARKER keys** at the beginning of each paragraph.

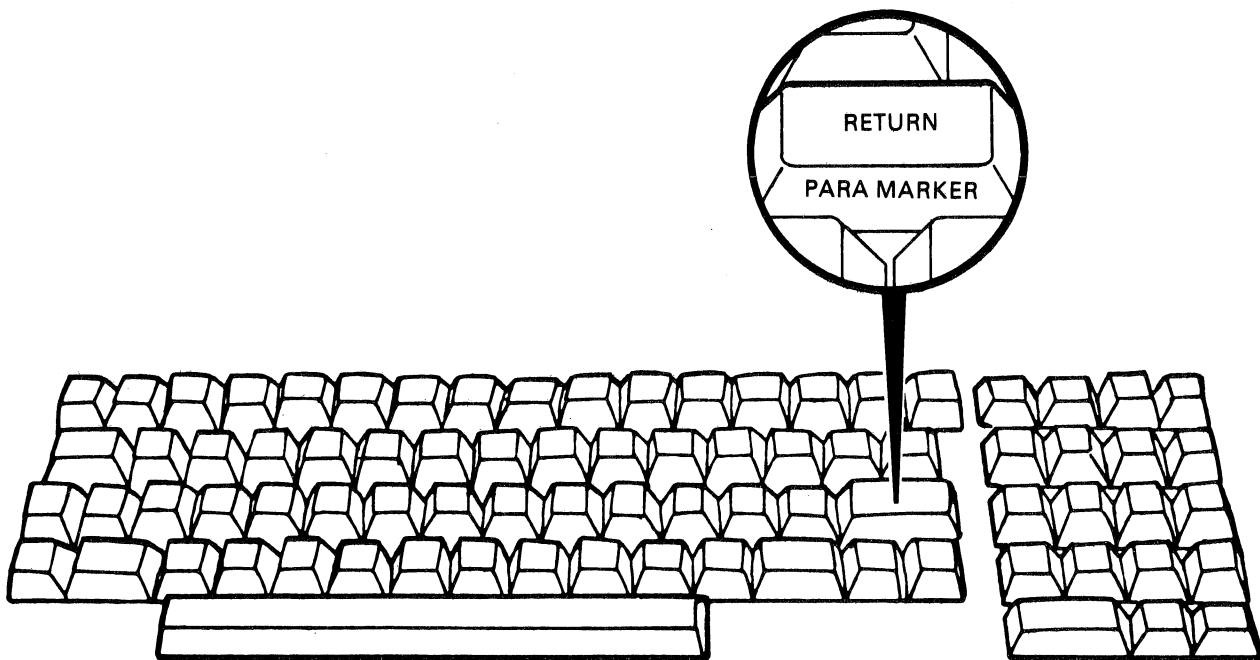

MK-0088

Figure 6-5 Main Keyboard PARA MARKER Key

Pressing the PARA MARKER key inserts a paragraph mark into your document. While this mark is not displayed on the screen (except when you view text), it nevertheless occupies one typing position. Therefore, you can remove it from your text with either the DEL CHAR or RUB CHAR OUT key.

It is not readily obvious (either in the screen display or in the printed document) whether in-

dentented text was spaced in, tabbed, or typed with a paragraph indent. To determine how the paragraph was typed, you must view it by pressing the gold and the VIEW keys (see Appendix D). When viewed, a paragraph mark is displayed on the screen as a ¶.

Here is an example of viewing a paragraph indented by means of ruler setting character P and the PARA MARKER key:

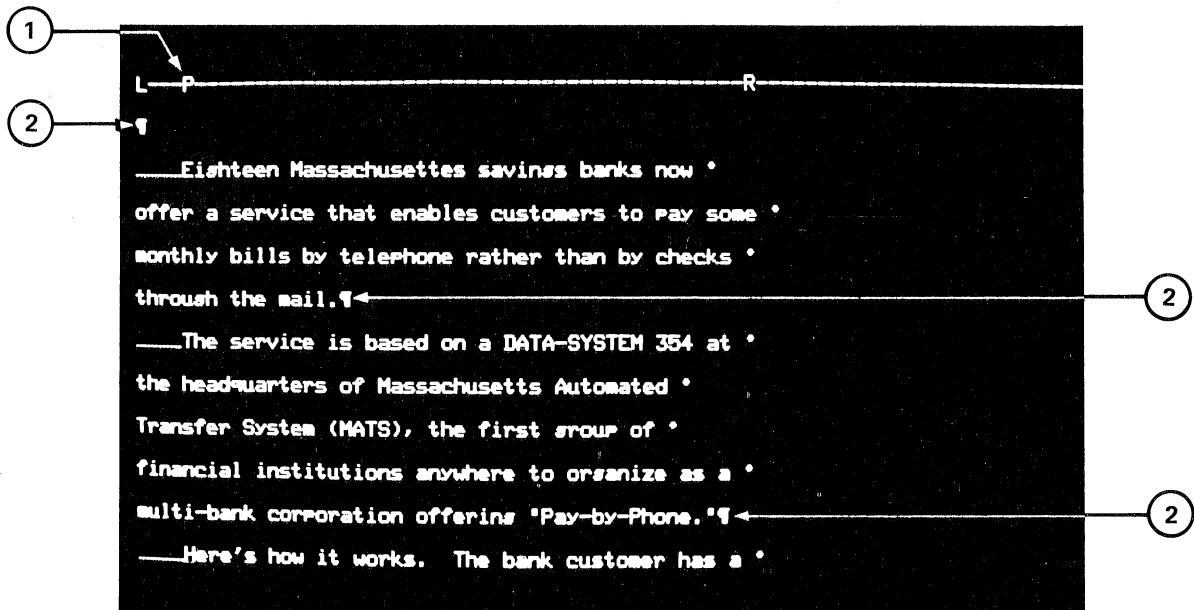

- ① LETTER P IN RULER
- ② PARAGRAPH MARKS IN TEXT

9113-10R2-A0092

Figure 6-6 Example of Paragraph Indent

If you always indent paragraphs (instead of separating them with two hard returns), you should use ruler setting P. This allows you to use the mini keyboard PARA key to move from one paragraph to another when editing. While you could also produce indented paragraphs by tabbing (or typing spaces), this method does not allow you to edit with the PARA key.

**6.1.2.4 Automatic Word Wrap Indent** – The W ruler setting character allows you to specify a position for automatic indenting. All lines after the first will automatically be indented by the word processing system. These lines are an example of word wrap indent. In order to indent the first line, press the TAB key.

Here is an example of how automatically indented text is displayed on the screen:

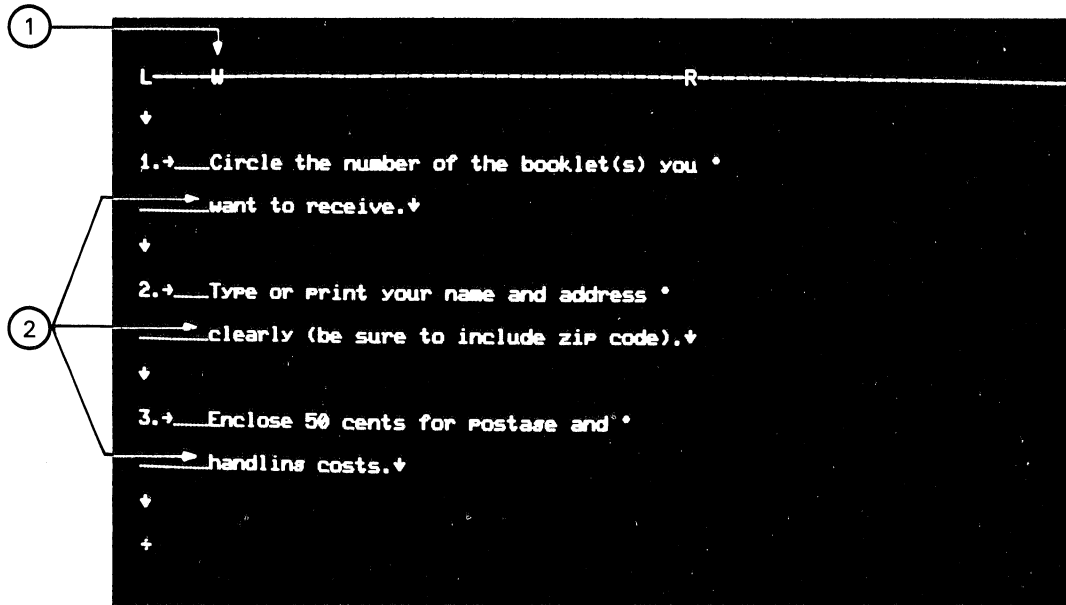

- ① LETTER W IN RULER
- ② WORD WRAPPED LINES  
AUTOMATICALLY  
INDENTED

9113-12R2-A0093

Figure 6-7 Example of Word Wrap Indent

You can have only one W setting in a ruler. If you type a second, the system will automatically remove the first.

**6.1.2.5 Tabs** – Tabs allow you to advance immediately from one position on a line to another by pressing the TAB key just once (instead of typing several spaces).

To produce tabbed text, follow these steps:

1. Put a tab setting character in your ruler to mark the location of each tab.
2. Press the TAB key (blue, upper left of main keyboard) before typing each word to be tabbed.
3. Press the RETURN key after the last tabbed entry on each line.

The following is a summary of the ruler setting characters for tabbed text.

<b>Character</b>	<b>Meaning</b>
T	<b>Left-justified tab.</b> Tabbed text is lined up on the leftmost character.
>	<b>Right-justified tab.</b> Tabbed text is lined up on the rightmost character.
.	<b>Decimal-aligned tab.</b> Tabbed text is lined up on a decimal point. If no decimal point is present, the tabbed text is lined up on rightmost hard return or tab. The text may start with a dollar sign (\$), plus (+), minus (-), or any other characters followed by a space.



Here is an example of using these three ruler setting characters:

Year-to-date		
January	46	.123
February	3	1.23
March	127	12.3
April	0	123.
May	15	123
June	8414	\$ 123

- ① LEFT-JUSTIFIED TABBED TEXT
- ② RIGHT-JUSTIFIED TABBED TEXT
- ③ DECIMAL-ALIGNED TABBED TEXT

9113-14R2-A0090

Figure 6-8 Example of Left-Justified, Right-Justified, and Decimal-Aligned Tabs

You can also use a paragraph indent (ruler setting character P) or an automatic word wrap indent (ruler setting character W) as a left-justified

tab and the right margin (ruler setting character R or J) as a right-justified tab. Here is an example of using the right margin as a tab:

Table of Contents		
Chapter 1	INTRODUCTION	
1.1	Review of the Project	1-1
1.2	Summary of Results	1-5
1.3	Intended Audience	1-9
1.4	How To Use This Report	1-10

① TEXT TABBED AT RIGHT MARGIN

9113-16R2-A0089

Figure 6-9 Example of Using the Right Margin as a Tab

It is not readily obvious (either in the screen display or in the printed document) whether text has been positioned by tabbing or by typing spaces. To determine how the text was typed, you must view it by pressing the gold and the VIEW keys (see Appendix D for complete details). When viewed, spaces are displayed on the screen as blanks while tab marks are displayed as follows:

1. A → character at the typing position where the TAB key is pressed.
2. A series of dots for each typing position up to the next tab mark.

Here is an example of how text produced by both tabbing and spacing looks when viewed:

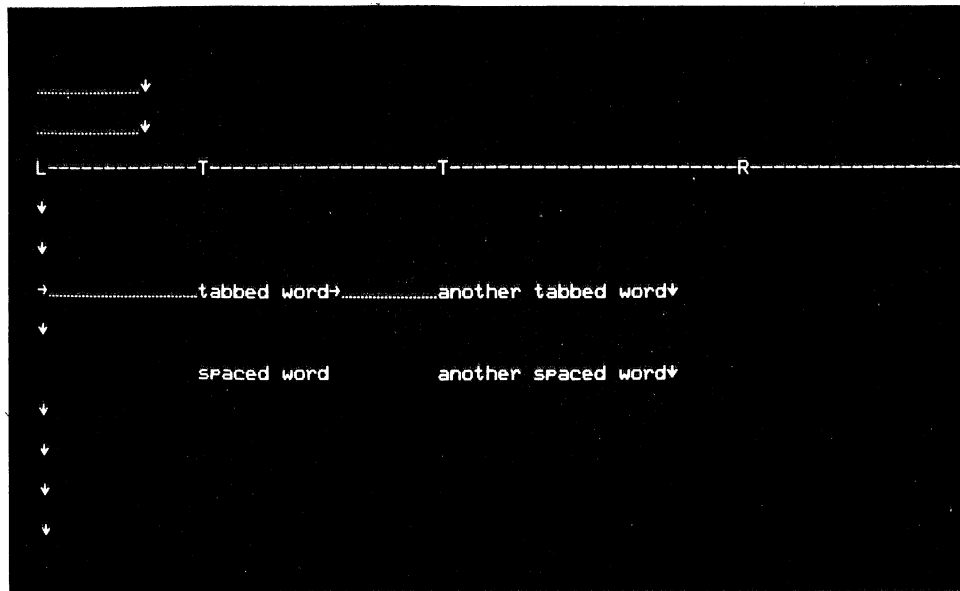

8920-12R2-A0083

Figure 6-10 Example of Viewing Tabbed Text

Pressing the TAB key inserts a tab mark into your document. While this mark is not displayed on the screen (except when you view text), it nevertheless occupies one typing position. Therefore, you can remove it from your text with

either the DEL CHAR or RUB CHAR OUT key. This action removes both the tab mark and ALL of the spaces that follow it (you cannot remove tabbed spaces individually as you can with spaces produced with the space bar).

**6.1.2.6 Incorrect Settings** – The word processing system does not allow you to type incorrect ruler setting characters. Here is what happens if you try.

1. **You type a character which cannot be used in a ruler.** The system will buzz and not display that character.
2. **You type a second left or right margin, paragraph indent, or automatic word wrap indent setting.** The system will automatically remove the previous setting.
3. **You type too many settings.** The maximum number of settings allowable in an 80-character ruler is 20; in a wide ruler, 40. If you exceed these limits, the system will not let you clear the ruler display. When you try, the system will buzz (to warn you of the error condition) and the cursor will be positioned under the first setting that exceeds the limit.

### 6.1.3 Clearing a Ruler Display

When you are satisfied with a ruler, clear the display by pressing the RETURN key. Clearing the display produces these results:

1. The ruler will be *embedded* in your document. If you changed or added at least one setting, you'll now see your new settings in the dashes and characters type of ruler (the old ruler no longer appears). Embedding means the word processing system will use the new ruler settings on all succeeding text. These settings will be in effect until the next ruler change.
2. You can now type and change text.

To clear a displayed ruler without saving the settings just typed, press the gold and the RULER keys.

When you embed a ruler in a document, line endings may possibly be “thrown off” so that succeeding lines extend beyond the right margin. To reformat, or word wrap the text, press the mini keyboard PARA key until the cursor comes to the next ruler (or end of document).

## 6.2 CHANGING RULERS IN TYPED TEXT

If you don't like the format of your typed text, you can reformat it without doing any retyping. Just change your ruler settings. The system will automatically readjust your text to fit the new settings.

For example, you can convert an entire document typed with margins at 1 and 65 to a narrower one, with margins at 1 and 50, just by changing a ruler. Similarly, you can change the column placement in a table by changing its ruler. Suppose, for example, you set up tabs and type the following lines.

Employee	Telephone
Davis	223-3167
London	457-9920

When you go to type a line for the next employee, named Cunningham, you discover you did not set your tabs to leave enough space between columns. All you have to do to correct this situation is place the cursor at the top of the table and move the tab setting to the right. The system will automatically adjust the placement of telephone numbers for Davis and London.

### 6.3 USING A WIDE RULER

If you type charts, summaries, or tables with many columns, you may need more than 79 typing positions per line. You can have as many as 158 typing positions per line with a wide ruler.

To use a wide ruler, press the gold and the RULER keys and advance the cursor beyond position 79. Ruler positions 1-80 will be displayed at the bottom of the screen; ruler positions 81-158, at the top.

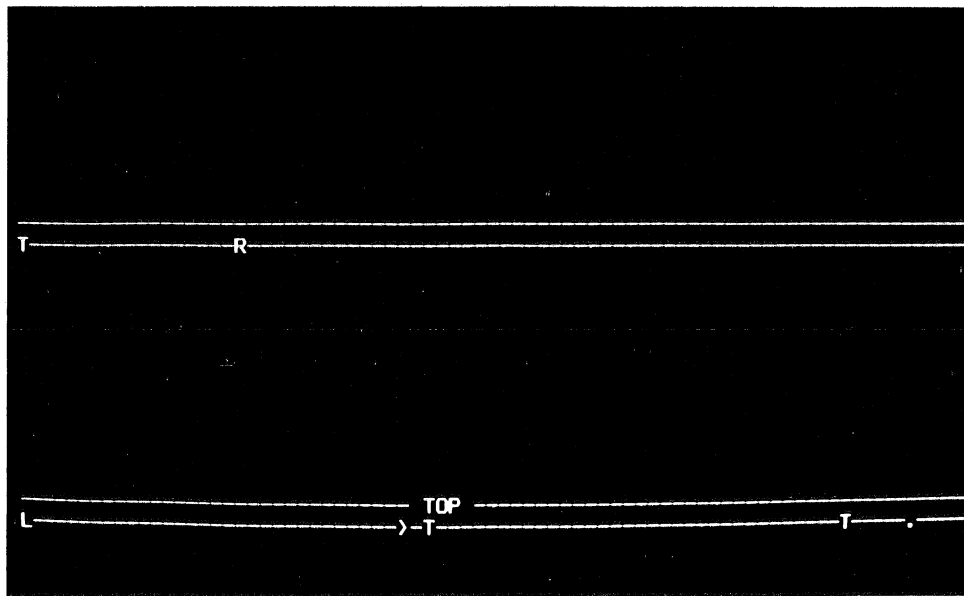

9113-18R2-A0094

Figure 6-11 Example of Wide Ruler

By setting your right margin in any position between 80 and 158, all text that follows the ruler will be stored and printed out as “wide lines” (it is not possible to make any settings in positions 159 and 160).

Because a single line of the screen can display only 80 positions, a wide text line is split in two.

The first half of each wide line is displayed at the bottom of the screen and the second half at the top. At most, 11 full lines are displayed on the screen at one time. The right half of the 11 lines is displayed at the top, the left half at the bottom. They are separated by two blank lines.

Here is how some text appears on the screen when a wide ruler is in effect:

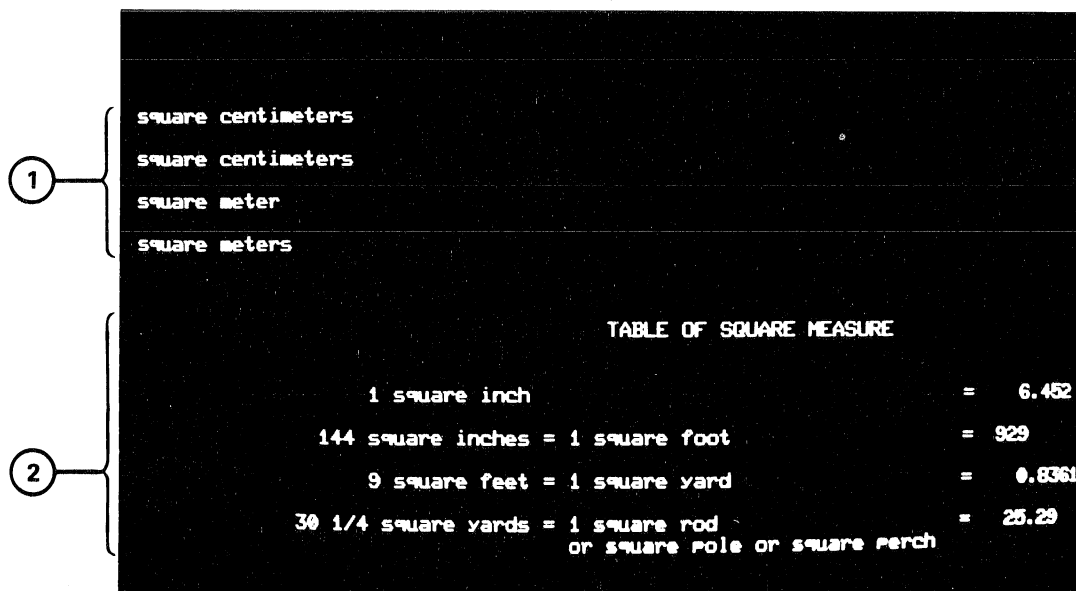

- ① CHARACTERS 81 TO 158 OF EACH LINE
- ② FIRST 80 CHARACTERS OF EACH LINE

9113-20R2-A0091

Figure 6-12 Displayed Example of Text Typed with Wide Ruler in Effect

The following page shows how the same text looks when printed.

You need special, wide paper to print a document typed with a wide ruler. For this reason, it is advisable to place wide line text in a separate document.

TABLE OF SQUARE MEASURE

1 square inch	=	6.452	square centimeters
144 square inches = 1 square foot	=	929	square centimeters
9 square feet = 1 square yard	=	0.8361	square meter
30 1/4 square yards = 1 square rod or square pole or square perch	=	25.29	square meters
160 square rods or 4,840 square yards or 43,560 square feet = 1 acre	=	0.4047	hectare
640 acres = 1 square mile	=	259	hectares or
		2.59	square kilometers

MK-0086

Figure 6-13 Printed Example of Text Typed  
with Wide Ruler in Effect

#### 6.4 SAVING RULERS FOR REUSE

You can save all the settings in a particular ruler to use again (with either the same or a different document). You may save as many as ten different rulers.

To save a ruler, follow these steps:

1. Display the ruler and make any desired settings.
2. **Hold down** the SHIFT key and type a single number between 0 and 9. The settings saved with ruler number 0 are what you automatically get when you create a document. Therefore, type the number 0 only when you want to use the particular ruler settings with every document you create.
3. Clear the ruler display.

To retrieve a ruler you must use the same system diskette with which you saved the rulers (because they are stored on the system diskette). Follow these steps:

1. **Press the gold and the RULER keys** to display the ruler.
2. **Type the ruler's number.** The settings which you previously saved will automatically be displayed on the screen.
3. **Clear the ruler display.**

You can examine all stored rulers by typing the numbers 0 through 9 while a ruler is displayed. Each corresponding ruler will be displayed on the screen.



## 6.5 CHANGING AN UNDESIRED RULER

When you edit portions of text, you may sometimes be left with an undesired ruler. For example, suppose you have text that looks like this:

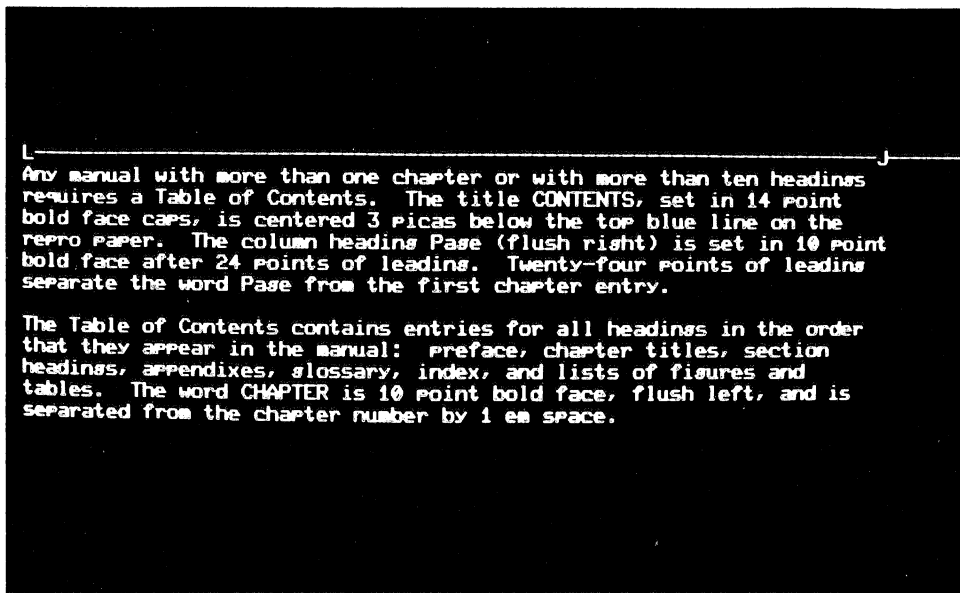

9113-22R2-A0084

Figure 6-14 Example of Text Before Pasting

If you should add a new paragraph with a different ruler between the first and second paragraphs, the new ruler will cause the second and succeeding paragraphs to be reformatted.

Any manual with more than one chapter or with more than ten headings requires a Table of Contents. The title CONTENTS, set in 14 point bold face caps, is centered 3 picas below the top blue line on the repro paper. The column heading Page (flush right) is set in 10 point bold face after 24 points of leading. Twenty-four points of leading separate the word Page from the first chapter entry.

NOTE

1 → Leading is defined as the total distance measured from baseline to baseline; it is not just the white space appearing between the lines of text.

2 → The Table of Contents contains entries for all headings in the order that they appear in the manual: preface, chapter titles, section headings, appendixes, glossary, index, and lists of figures and tables. The word CHAPTER is 10 point bold face, flush left, and is separated from the chapter number by 1 em space.

9113-24R2-A0085

- 1 PARAGRAPH INSERTED WITH NEW RULER.
- 2 PARAGRAPH REFORMATTED BECAUSE OF INSERTED PARAGRAPH.

Figure 6-15 Reformatted Example of Text After Pasting

To achieve the desired results in this example, you must replace the undesired ruler at the beginning of ② .

To restore a correct ruler, follow these steps:

1. Position the cursor in text that contains the desired ruler and then:
  - Display the ruler.
  - Store the ruler with a number you are not using for other text (generally, you

should reserve one ruler number especially for this purpose).

- Clear the ruler display.
2. Position the cursor where the ruler is to be changed and then:
    - Display the ruler.
    - Retrieve the ruler stored in step 1.
    - Clear the ruler display.



## CHAPTER 7 SEARCHING

If there is a particular phrase (group of characters or words) in your document that you want to inspect or edit, you can quickly move the cursor there by searching. For example, suppose you want to add some new material to a section of your document that begins with "Executive Summary." Just tell the word processing system to search for these two words. The system will automatically display the line containing "Executive Summary" at the bottom of the screen with the cursor positioned under the first character ("E"). This is a basic search, which is described in Section 7.1.

Suppose that you have the words "Executive Summary" in your table of contents so that the word processing system actually found this particular occurrence. As you don't want to make

any changes to the table of contents, you can tell the system to search for the next occurrence of "Executive Summary." This is a continued search, which is also described in Section 7.1.

You can also search for a particular phrase and replace it with another by pressing just two keys. For example, you could search for "Summary" and replace it with "Overview." After you find "Summary" the word processing system gives you the opportunity to verify whether you really want to replace it. If you don't (perhaps the system located "Summary" in "Summary of Results" instead of in "Executive Summary"), you can proceed to the next occurrence of "Summary." Searching and replacing is described in Section 7.2.

The gold SRCH, CONT SRCH, and CONT SRCH & SEL keys are used for all types of searching.

### 7.1 BASIC AND CONTINUED SEARCHING

The basic searching and continue searching procedure is:

1. Press the gold and the SRCH keys. The message

ENTER PHRASE:

will be displayed on the screen.

2. Type the phrase that you want to locate.

3. Press either the ADVANCE (mini keyboard) or the RETURN (main keyboard) key to search forwards, the BACK UP (mini keyboard) key to search backwards. After a pause, the cursor will be positioned underneath the first character in the phrase. If no match is found, the system will buzz and the cursor will be positioned at the bottom of the document (for a forward search, at the top for a backward search).

4. To search for another occurrence of the same phrase, press the gold and the CONT SRCH keys. The search will continue in the same direction as you specified in step 3.

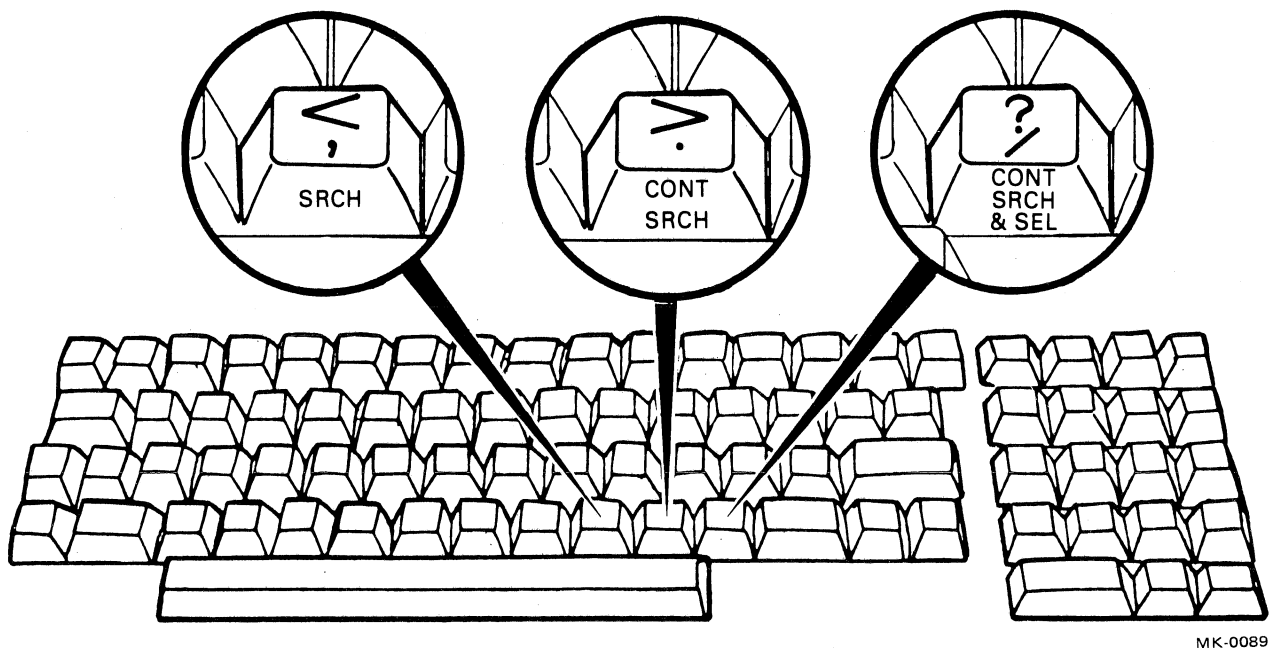

MK-0089

Figure 7-1 Main Keyboard SRCH, CONT SRCH, CONT SRCH & SEL Keys

You can cancel a search by pressing the gold and the HALT keys. This is useful if: (1) you have a large document, (2) the cursor is located near the beginning, (3) you initiate a search for a particular phrase, and then (4) you realize the document doesn't contain that phrase. Instead of wasting time while the word processing system searches for your nonexistent phrase, cancel the search. Just press the gold and the HALT keys.

### 7.1.1 Searching Qualifications

The phrase to be searched for is subject to the following qualifications:

1. **Size.** The phrase may not be longer than 50 characters.
2. **Contents.** The phrase may contain only letters, numbers, spaces, or punctuation and other special marks. You cannot search for tabs or centering marks. If you try, the system buzzes and waits for you to continue typing the phrase. You cannot search for a hard return because the system starts searching as soon as you press the RETURN key.
3. **Upper versus lower case.** If you type the phrase in lower case, the word processing system will find that same phrase if it's typed in either upper or lower case. However, if you type the phrase (or any part) in upper case, the word processing system will stop the cursor only where it finds an exact upper case match.

For example, suppose you are typing directions for operating electric grass shears. Your document contains several occurrences of the instruction "Push the ON button" except that sometimes it's spelled ON, sometimes On, and sometimes on. You want to find every place that the name of

the button is mentioned. Therefore, search for the phrase "on" to have the word processing system match any spelling. (If you type "On" it will match either "On" or "ON." If you type "ON" it will match only the exact upper case spelling.)

### 7.1.2 Direction Reversal

The direction of a search reverses when the cursor stops at either the top or bottom of a document (because no match was found). This means if you continue the search, the word processing system will look for a match in the direction opposite from that which you originally specified.

## 7.2 SEARCHING AND REPLACING

You can search for a phrase and possibly replace it with another. Why "possibly"? Because the word processing system gives you the option of deciding whether you really want to replace it. For example, suppose you've just typed what you thought was section 3 of a report. All your subsection headings, figure and table titles, and cross-references use the number 3. You find out that the report has been reorganized so that section 3 is now 4. With the word processing system the problem is easy to correct. You can search for "3" and inspect each occurrence before replacing it with "4." In this way you can avoid changing too much, such as the "3" in "September 3, 1977," for example.

To search and replace, follow these steps:

1. **Press the SEL key, type the replacement phrase, and then press the CUT key.** This action stores the replacement phrase in the word processing system's paste area (and removes it from your document).
2. **Press the gold and the SRCH keys, type the phrase you want replaced, and press the gold and the CONT SRCH & SEL keys.** This

action initiates a forward search. A select mark (white square) will be positioned under the first character in the next occurrence of the phrase (provided a match was found) and the cursor will be positioned under the last character.

3. **Press the gold and the REPLC keys to replace the phrase.** The selected phrase will

automatically be removed and replaced with what you put into the paste area. If you do not wish to replace this occurrence of the phrase, just press the gold and the CONT SRCH & SEL keys to search for the next occurrence.

You may repeat step 3 as many times as necessary.



## CHAPTER 8 HIGHLIGHTING TEXT: CENTERING, UNDERLINING, BOLDFACING AND CAPITALIZATION

The word processing system has four features that let you highlight, or add emphasis to, your text.

1. **Centering.** You can automatically center a line by pressing just two keys. Word processing centering is much faster than centering on an ordinary typewriter because you don't have to count the number of letters, halve that number, and then back-space. See Section 8.1 for details.
2. **Underlining.** You can underline at the same time you type (faster than on an ordinary

typewriter) in addition to underlining after typing. See Section 8.2 for details.

3. **Boldfacing.** You can print portions of your document extra dark (struck three times) to add **emphasis to certain words**. See Section 8.2 for details.
4. **Capitalization.** Not only can you capitalize original text, but you can change text that is already typed from lower to upper case (or vice versa) just by pressing a few keys. See Section 8.3 for details.

## 8.1 CENTERING

You can have the word processing system center a line of text by using the gold and the CENTR keys.

Type the line to be centered and press the gold and the CENTR keys. To center a line that is already typed, move the cursor to the end of the line and press the gold and the CENTR keys.

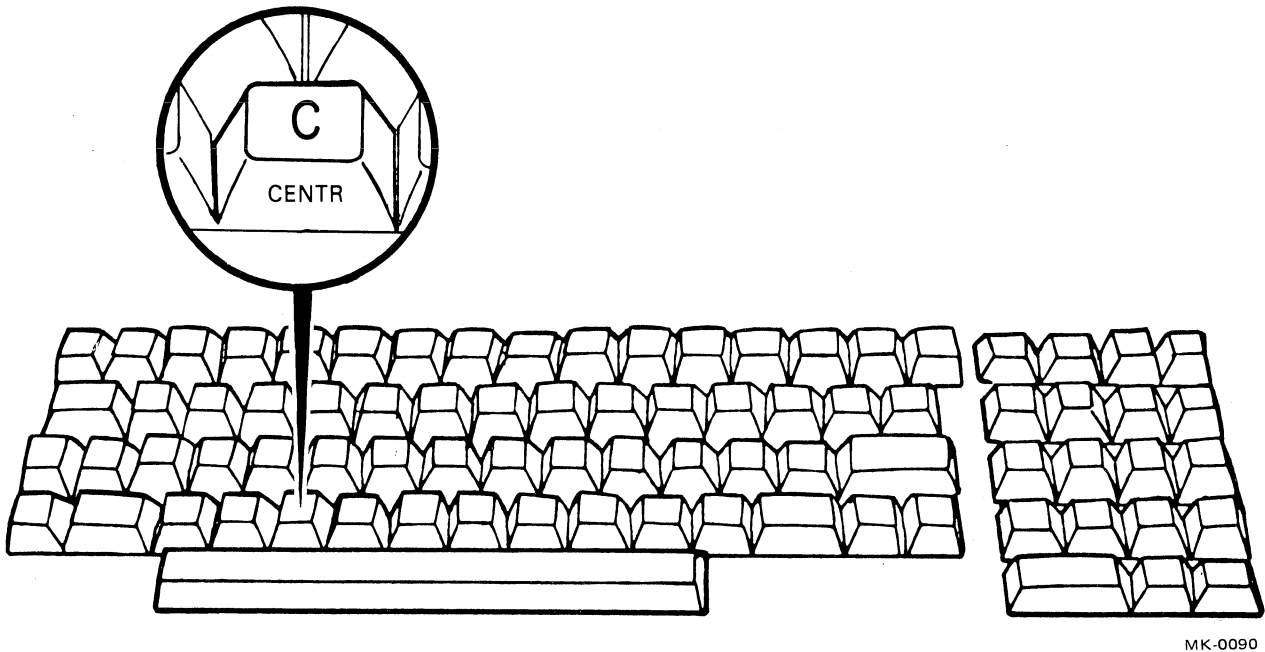

MK-0090

Figure 8-1 Main Keyboard CENTR Key

Here is an example of the procedure to center text:

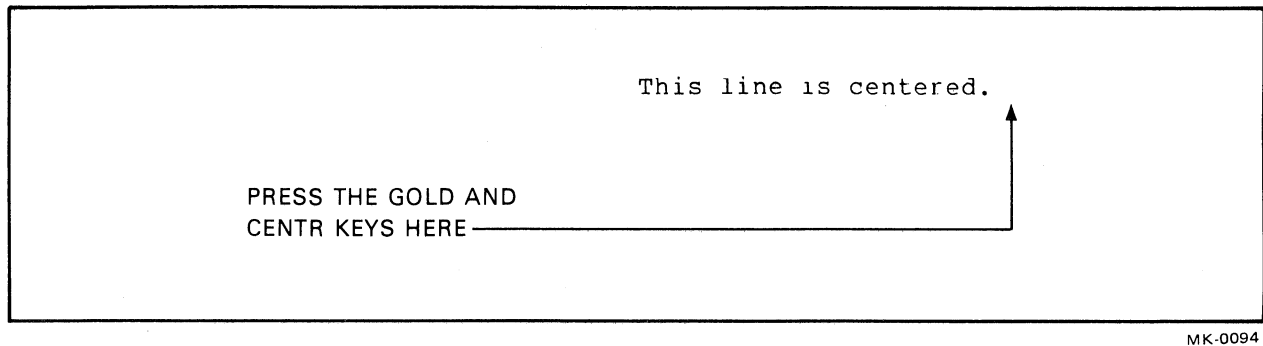

Figure 8-2 Example of Centering Text

Here is what the word processing system does when you center a line:

1. Determines in what typing position the line should start and automatically places it there.
2. Inserts a centering mark at the end of the centered line. This mark occupies one typing position yet is neither displayed on the

screen nor printed. It can be displayed on the screen only when text is viewed (see Section 8.1.2).

3. Moves the cursor to the beginning of the next line.

To remove a centering mark, position the cursor immediately after the last (visible) character of the centered line and press the DEL CHAR key.

### 8.1.1 Changing the Centering Point

Unless you direct the word processing system otherwise, a line is automatically centered between the left and right margins. To specify a different centering point, or typing position, on which text will be entered, follow these steps:

1. Press the gold and the RULER keys to display the ruler.
2. Advance the cursor to the desired centering position and type the letter C. You can have

only one centering point in a ruler. If you type the letter C a second time, the word processing system automatically removes the first.

3. Press the RETURN key to clear the ruler display and embed the ruler back into the document.

Here is an example of a line typed with an off-center centering point in effect:

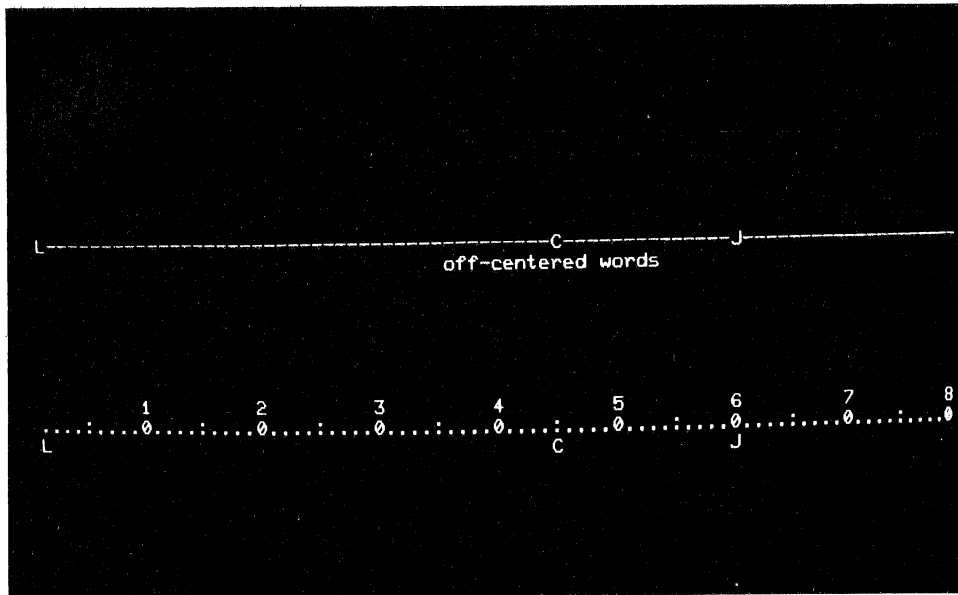

8920-28R2-A0096

Figure 8-3 Example of a User-Specified Centering Point

### 8.1.2 Determining Whether Text Is Centered

Sometimes you might have a typed line that appears centered on the screen or in a printed document, but you're not really certain whether it was typed with spaces, tabbed, or centered with the gold CENTR key. To determine how the line was typed, you must view the text by

pressing the gold and the VIEW keys (see Appendix D). When viewed, the end of a centered line is marked with a `␣` symbol.

Here is an example of a screen display for viewing a centered line:

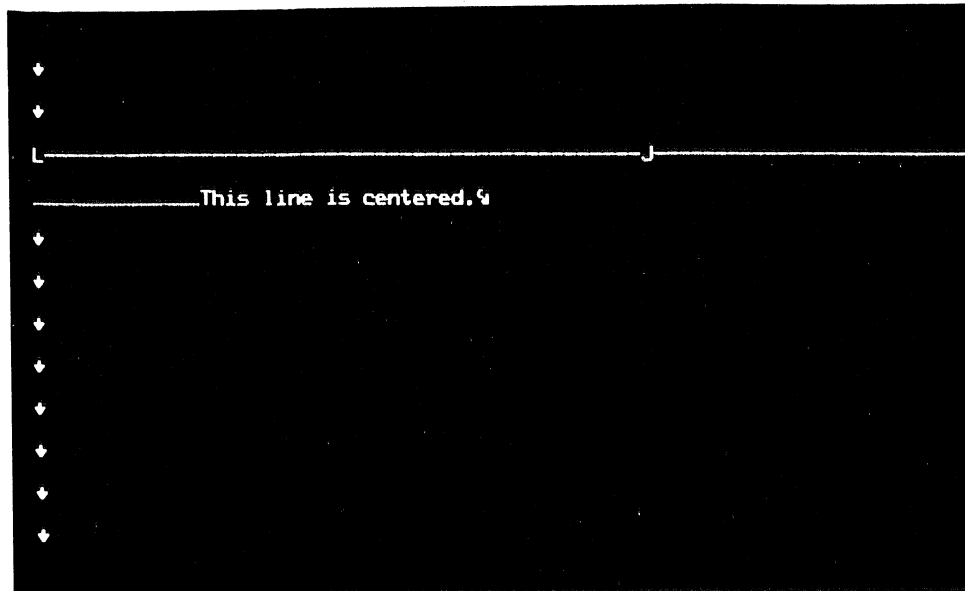

9113-26R2-A0095

Figure 8-4 Example of Viewing Centered Text

## 8.2 UNDERLINING AND BOLDFACING

The mini keyboard UNDER LINE and BOLD keys can be used to highlight text.

You can use these keys along with the SEL key to underline or boldface text at the same time as you type it (see Section 8.2.1). You can use these keys along with either the SEL key or the mini keyboard blue grammatical keys to add highlighting to text after it is typed (see Section 8.2.2). You can also use these keys along with the gold key to remove highlighting (see Section 8.4).

### 8.2.1 Underlining or Boldfacing While Typing

To underline or boldface text at the same time as you type:

1. **Press the SEL key.** A select mark, or white square, will appear on the screen.
2. **Type the desired text.** This will be displayed right after the select mark (dropped down one line on the screen).
3. **Press the UNDER LINE or BOLD key.** The select mark will be removed and what you just typed will again be displayed on the same line level as your previous typing.

Underlined or boldfaced text is marked for such highlighting but is displayed on the screen without the highlighting (see Section 8.2.3 for determining whether text is underlined or boldfaced).

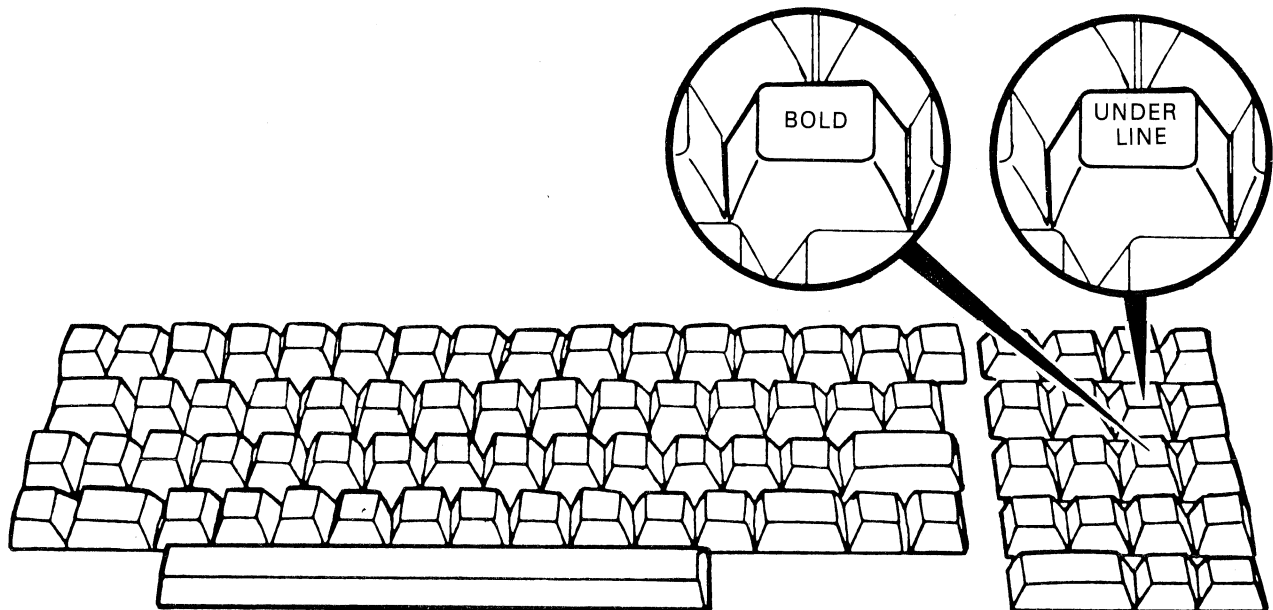

MK-0091

Figure 8-5 Mini Keyboard BOLD and UNDERLINE Keys

When steps 1 - 3 are used to underline text, both words and the spaces between them are underlined. Refer to Section 8.2.4.2 for how to underline only the words.

### 8.2.2 Underlining or Boldfacing After Typing

You can underline or boldface any portion of text after it has been typed by moving the cursor to the beginning, pressing the SEL key, moving the cursor to the character or space right after the end, and pressing the UNDER LINE or BOLD key. (If you press SEL in the wrong place, just press it again and the select mark will automatically be removed from the screen.) This method underlines the words plus the spaces between them.

For example, suppose you type

This is an important sentence.

and then decide you want the words "important sentence" underlined, for emphasis. Just move the cursor to the beginning of "important," press the SEL key, move the cursor to immediately after the period, and press the UNDER LINE key. The result will look like this:

This is an important sentence.

You can also use the UNDER LINE and BOLD keys with the blue mini keyboard grammatical keys. This method underlines only words and not the spaces between them.

1. **Position the cursor at the beginning of the text and press either the UNDER LINE or BOLD key.** This action "turns on" highlighting so that all text over which you move the cursor will be highlighted.
2. **Press any blue grammatical key** (WOORD, LINE, SENT, TAB POS, PARA, PAGE, or <>), until you have moved through the desired amount of text.
3. **Press either the ADVANCE or BACK UP key** to "turn off" the highlighting (and move the cursor one position forward or backward). If you don't turn off highlighting and proceed to move the cursor forward, all the rest of your text will also be highlighted.

Underlining and boldfacing are also turned off when you do one of the following: (1) type additional text, (2) use the mini keyboard DEL CHAR, DEL WORD, SWAP, or PASTE key, or (3) use one of the main keyboard rubout keys (RUB CHAR OUT, RUB WORD OUT, RUB LINE OUT, or RUB SENT OUT).

Another way to highlight text that is already typed is to position the cursor at the beginning and then press the UNDER LINE or BOLD key while holding down the REPEAT key. This method also turns on highlighting. Be sure to turn it off when you are through as described above.

### 8.2.3 Determining Whether Text is Underlined or Boldfaced

Text marked for underlining or boldfacing is displayed on the screen like ordinary text. To determine whether text is underlined or boldfaced, you must view it by pressing the gold and the

VIEW keys (see Appendix D). When viewed, an underscore character appears under text marked for underlining, a \* character under text marked for boldfacing, and an = character under text marked for both underlining and boldfacing.

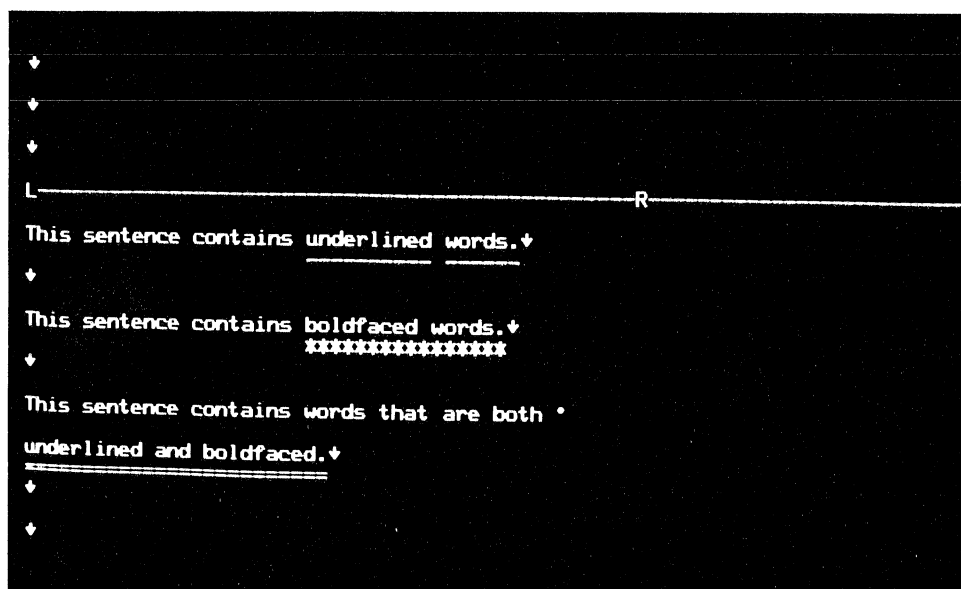

9113-28R2-A0097

Figure 8-6 Example of Viewing Underlined and Boldfaced Text

### 8.2.4 Effect of Spaces on Underlining

The word processing system gives you the choice of underlining words and the spaces between them or just the words themselves. For example, you can underline these few words or the entire rest of this sentence.

**8.2.4.1 Underlining Words and Spaces** - There are three different ways to underline words and the spaces between them.

1. For original typing or already-typed text:  
Press the SEL key at the beginning of the



group of words, either type the text or move the cursor to the character or space right after the end (if the text is already typed), and press the UNDER LINE key.

2. For already-typed text: Press the UNDER LINE key and then any blue grammatical key (LINE, SENT, TAB POS, PARA, PAGE, or <>) except WORD. When you have moved the cursor through all desired text, press either the ADVANCE or BACK UP key to turn off underlining.
3. For already-typed text: Press the UNDER LINE key and hold down the REPEAT key (main keyboard, bottom right). Release the two keys after you have moved the cursor through the desired amount of text. Press either the ADVANCE or BACK UP key to turn off underlining.

**8.2.4.2 Underlining Only Words** – To underline words and not spaces, press the UNDER LINE

key and then the WORD key as many times as necessary. You can use this method only with already-typed text. You cannot underline words and not the spaces between them as you type text.

When you use this method, tabbed spaces will be underlined but typed spaces (inserted by pressing the space bar) will not.

**8.2.4.3 Effect of Right Margin on Underlining** – If your text is typed with a justified right margin (letter J used in the ruler), the way you underline may affect the appearance of a line printed on a letter quality printer.

1. If a complete line including spaces is underlined, the word processing system will justify the line by adding space between both characters and words AFTER the line is underlined. This action may cause the line to be stretched, thereby breaking the underlining.

These few lines are completely underlined and are typed with a justified right margin. Notice how the underlining is broken.

2. If only the words and not the spaces are underlined or if only a partial line is underlined, the word processing system will justify by adding space only between words. Then none of the underlining will be broken.

Only the words and not the spaces in these few lines are underlined. They are typed with a justified right margin. Notice how the underlining looks.

However, if a line is completely underlined and is typed with a ragged right margin (letter R used in the ruler), the underlining will not be stretched or broken.

These few lines are completely under-lined and are typed with a ragged right margin. Notice that the underlining is solid.

### 8.3 CAPITALIZATION

To capitalize text as you type, press either the CAPS LOCK or the SHIFT key, type the text, and press the same key again to resume typing in lower case. You can also capitalize by pressing the mini keyboard SEL key, typing the text, and then pressing the mini keyboard UPPER CASE key.

To capitalize already-typed text, move the cursor to the beginning, press the SEL key, move the cursor to the character or space right after the end, and press the UPPER CASE key.

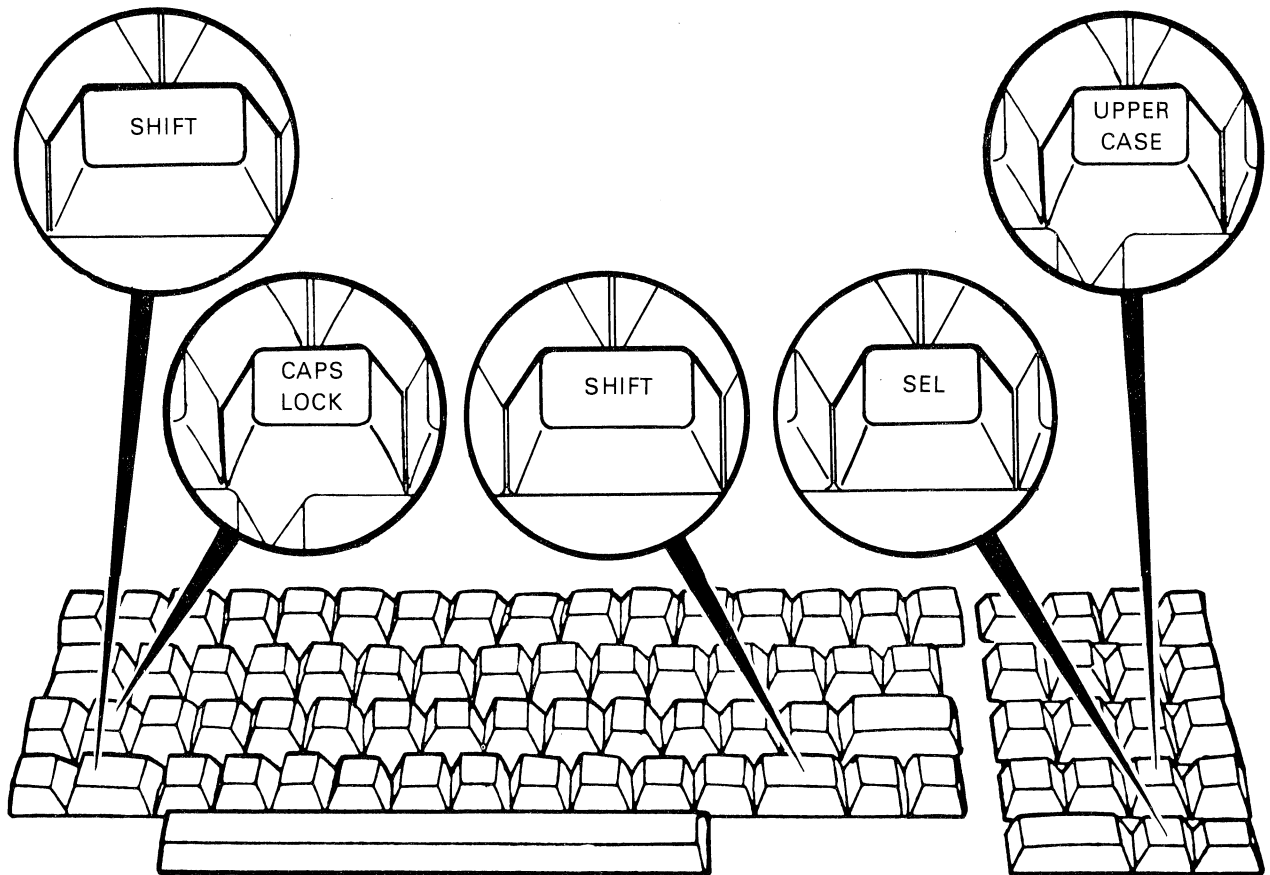

MK-0092

Figure 8-7 Main Keyboard SHIFT and CAPS LOCK Keys, Mini Keyboard SEL and UPPER CASE Keys

#### 8.4 REMOVING UNDERLINING, BOLD-FACING AND CAPITALIZATION

You can remove underlining, boldfacing, or capitalization if necessary. Move the cursor to the beginning of the text to be changed, press the mini keyboard SEL key, position the cursor at the end, and press the gold and the UNDERLINE, BOLD, or UPPER CASE key. Nothing

will happen if you attempt to remove underlining, boldfacing, or capitalization when your text is not marked for such highlighting.

For example, suppose you accidentally type an entire name in upper case instead of just the first initial. To fix it, follow these steps:

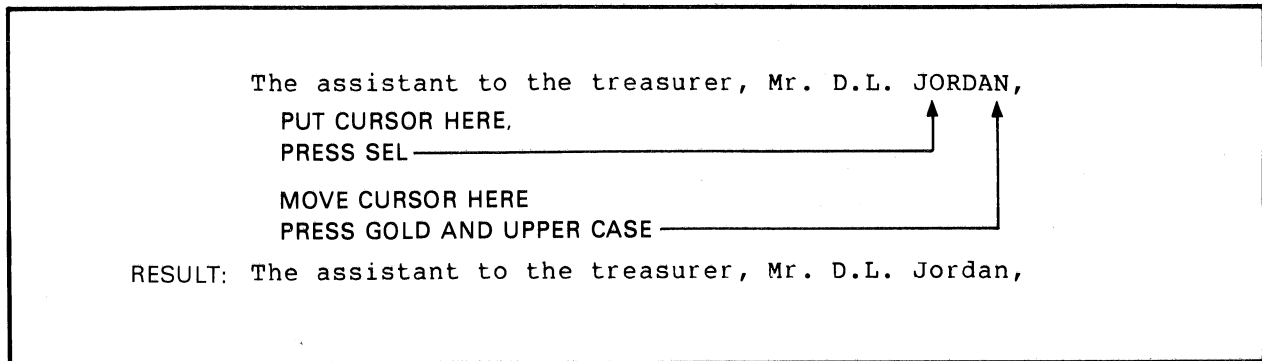

MK-0093

Figure 8-8 Example of Changing Uppercase Text to Lowercase

## CHAPTER 9 SUBSCRIPTS, SUPERSCRIPTS, AND COMPOSITE CHARACTERS

With the word processing system you can easily type subscripts, superscripts, and composite characters.

A subscript is a character or characters typed one half-space below the rest of the line. For example, the number 2 in the chemical formula for water is a subscript.



Similarly, a superscript is a character or characters typed one half-space above the rest of the line. For example, the number 2 in the equation for the area of a circle is a superscript.

$$\text{area} = \text{pi} * \text{radius}^2$$

A composite character is a character printed by striking two or more characters on top of one another. You can use a composite character to create a special character that is not found on the main keyboard. For example, you can print ≠ by forming a composite character with the equal sign (=) and slash (/) or ÷ with the colon (:), and minus sign (-).

### 9.1 SUBSCRIPTS AND SUPERSCRIPTS

There are two ways of producing word processing subscripts and superscripts.

1. **With the gold SUB SCRIPT and SUPER SCRIPT keys.** Use this method with a short subscript or superscript, such as



2. **With half-line ruler spacing.** Use this method with lines that contain complicated subscripts and superscripts, such as the following:

$$\underset{m}{(a_x + b_x)}^2 = \underset{m}{a_x^2} + 2 \underset{m}{a_x} \underset{n}{b_x} + \underset{n}{b_x^2}$$

Subscripts and superscripts can be printed properly only when using a letter quality printer. They will be printed on the same line as the rest of the typing when using a draft printer.

### 9.1.1 Producing Subscripts and Superscripts With the Gold SUB SCRIPT and SUPER SCRIPT Keys

The gold SUB SCRIPT and gold SUPER SCRIPT keys are used for short subscripts and superscripts.

To produce a subscript or superscript, follow these steps:

1. Press the SEL key.
2. Type the character(s) to be printed below or above the line level.
3. Press the gold and either the SUB SCRIPT or SUPER SCRIPT key.

Here is what happens:

1. The cursor will be positioned under the character to the immediate right of the subscripted or superscripted ones.
2. The characters will continue to be displayed on the screen like ordinary text, on the same level as the line. However, the system has "marked" them for subscripting or superscripting. To determine whether text is subscripted or superscripted, you must view it by pressing the gold and the VIEW keys (see Appendix D).

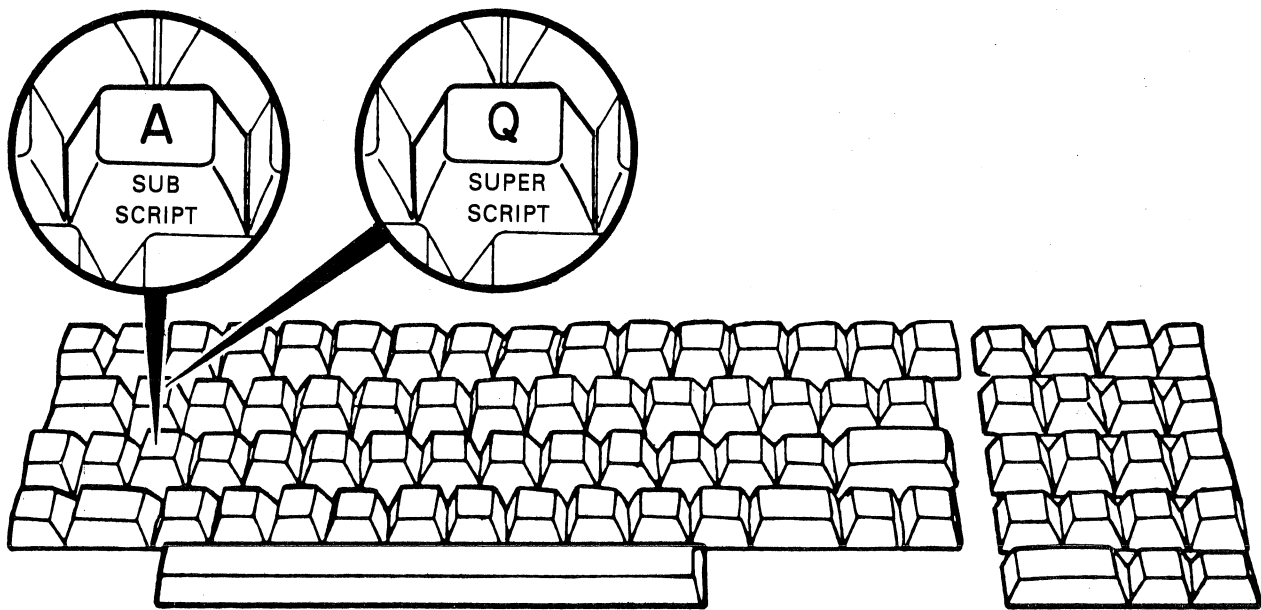

MK-0095

Figure 9-1 Main Keyboard SUB SCRIPT and SUPER SCRIPT Keys

When text is viewed, it appears as follows:

1. **Subscripted.** A lower case letter “a” appears underneath the text (upper case “A” if the subscript was boldfaced).

2. **Superscripted.** A lower case letter “q” appears underneath the text (upper case “Q” if the superscript was boldfaced).

Here is an example of viewing subscripts and superscripts:

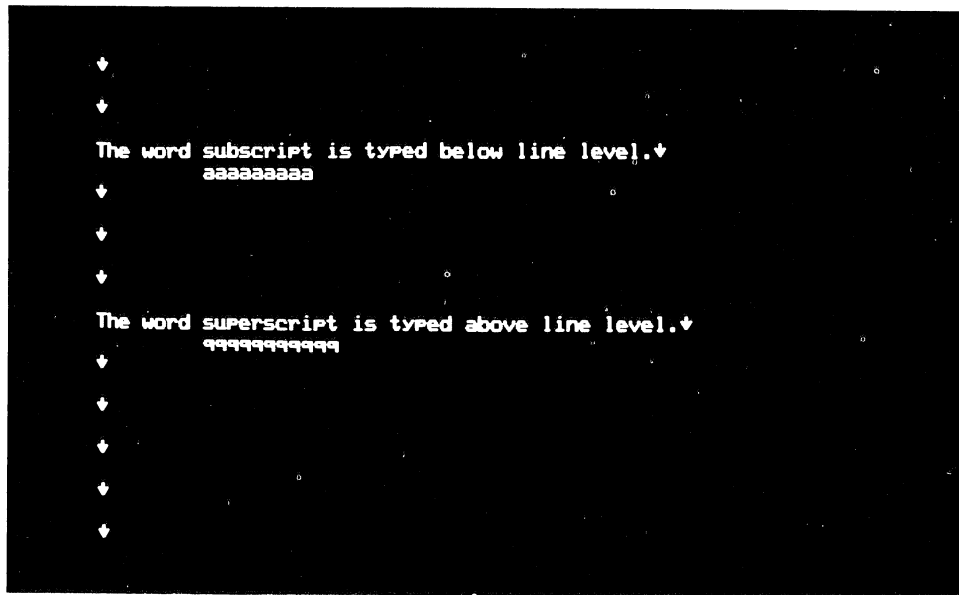

9113-30R2-A0098

Figure 9-2 Example of Viewing Subscripts and Superscripts

Here is how the example looks when printed:

The word subscript is typed below line level.  
The word superscript is typed above line level.

### 9.1.1.1 Removing a Subscript or Superscript -

To restore a subscript or superscript to normal line level, do the opposite of what you originally typed.

1. **To go from subscript to line level.** Superscript the characters.
2. **To go from superscript to line level.** Subscript the characters.

Of course, you can also delete the characters and retype them.

### 9.1.1.2 Qualifications -

The following qualifications apply to subscripts and superscripts produced with the gold SUB SCRIPT and SUPER SCRIPT keys.

1. You cannot underline with the UNDERLINE key. Instead, make a composite character (see Section 9.2) with the underscore character and the subscript or superscript.
2. It is advisable to use double-spacing (or at least space and a half). If you don't, your printing will be too crowded, as in the following:

H<sub>2</sub>O is the chemical equation for  
w<sub>a</sub>t<sub>e</sub>r. The number 2 is a subscript.

3. You cannot subscript a subscript or superscript a superscript. For example, you cannot have the following:

$$a_{x_m} + 2a_{x_m} b_{x_m} + b_{x_m}$$

Also, you cannot have a subscript and superscript in the same typing position, such as the subscript x and superscript 2 in the following:

$$a_x^2$$

You can, however, produce the above by using either half-line ruler spacing (see Section 9.1.2) or composite characters (see Section 9.2).

### 9.1.2 Producing Subscripts and Superscripts with Half-line Ruler Spacing

To type complicated subscripts and superscripts, use half-line ruler spacing.

1. **Press the gold and the RULER keys** to display the ruler.
2. **Move the cursor to the location of the left margin and type the letter F.**
3. **Press the RETURN key** to clear the ruler display and embed the ruler back into the document.



Next, type each line of your equation separately while inspecting the spacing on the screen (the lines will be displayed single-spaced but will be printed with space and a half). Type the main line of your equation first, then each level of subscript, and lastly each level of superscript.

For example, to type the following equation:

$$(a_m + b_n)^2 = a_m^2 + 2 a_m b_n + b_n^2$$

1. Type only the main line, leaving enough space for the subscripts and superscripts, and press the RETURN key. For the example you would type the following:

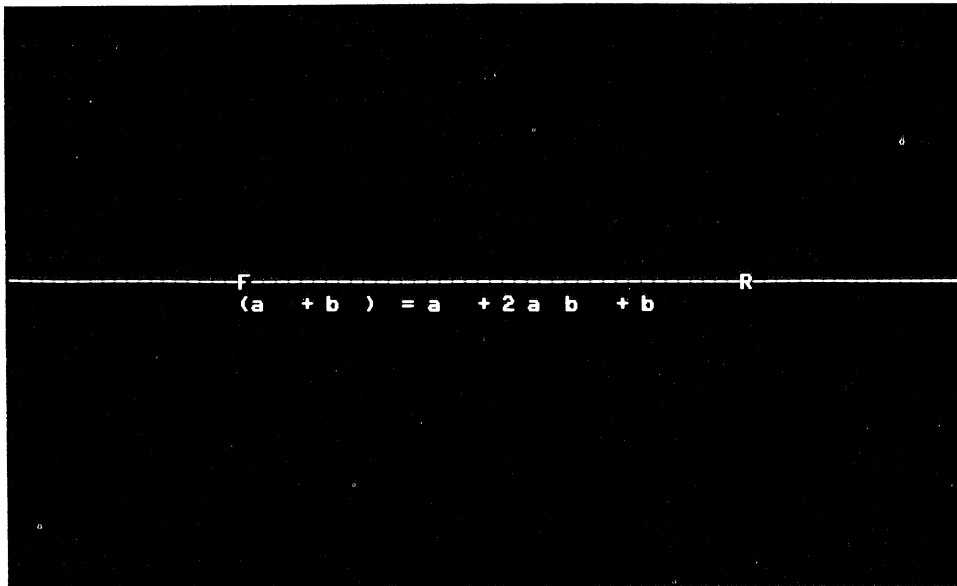

9113-32R2-A0099

Figure 9-3 Typing an Example Equation: Step 1

2. Type the first level of line with the subscripts (the letter x six times) directly beneath the main line and press the RETURN key. You should now have the following:

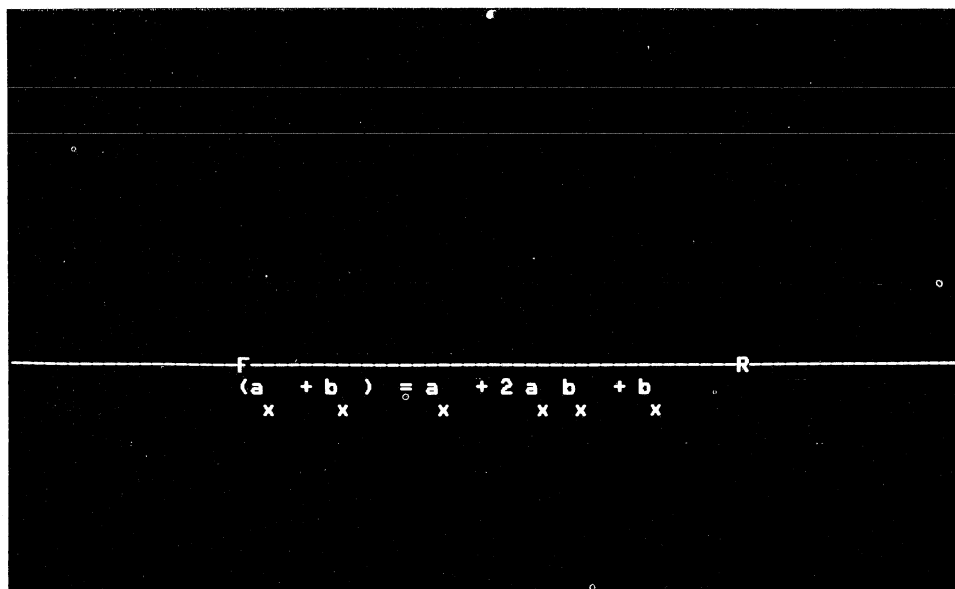

The image shows a terminal window with a black background and a white horizontal line. Below the line, the equation  $(a + b)^2 = a^2 + 2ab + b^2$  is displayed. Each letter in the equation has a small 'x' centered directly beneath it as a subscript. The characters are spaced out to align with the subscripts. The letters 'F' and 'R' are visible at the beginning and end of the line, respectively, indicating the start and end of the command or output.

9113-34R2-A0100

Figure 9-4 Typing an Example Equation: Step 2

3. Type the second level of line with the subscripts (the letters m and n three times each) directly beneath your previous lines and press the RETURN key. You should now have the following:

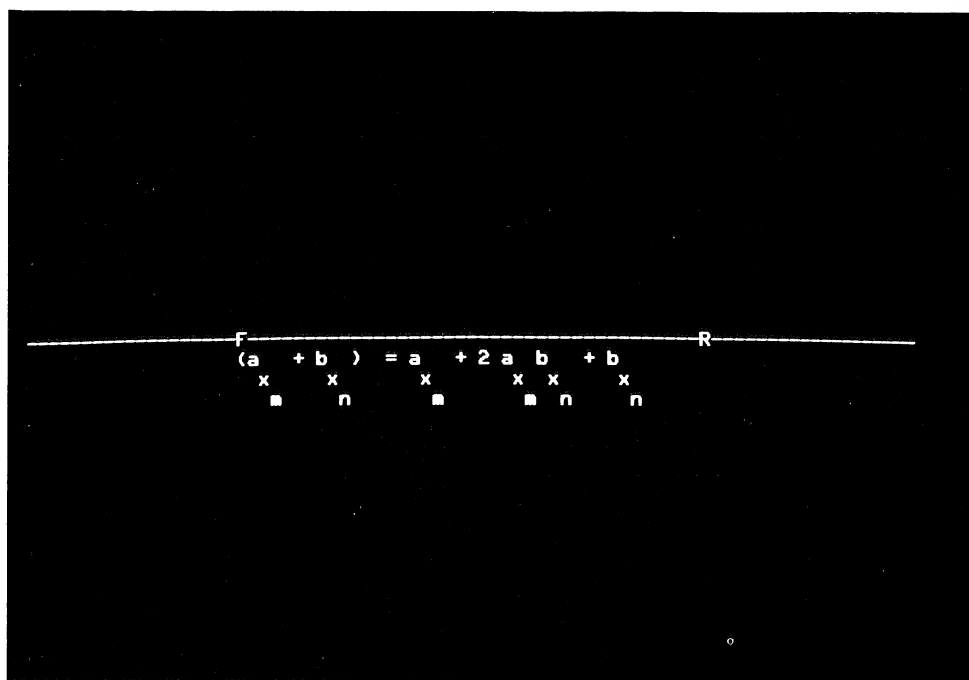

M123-7-A0195

Figure 9-5 Typing an Example Equation: Step 3

4. Type the line with the superscripts (the number 2 three times) directly beneath your previous lines and press the RETURN key. Follow the spacing on the screen. You should now have the following:

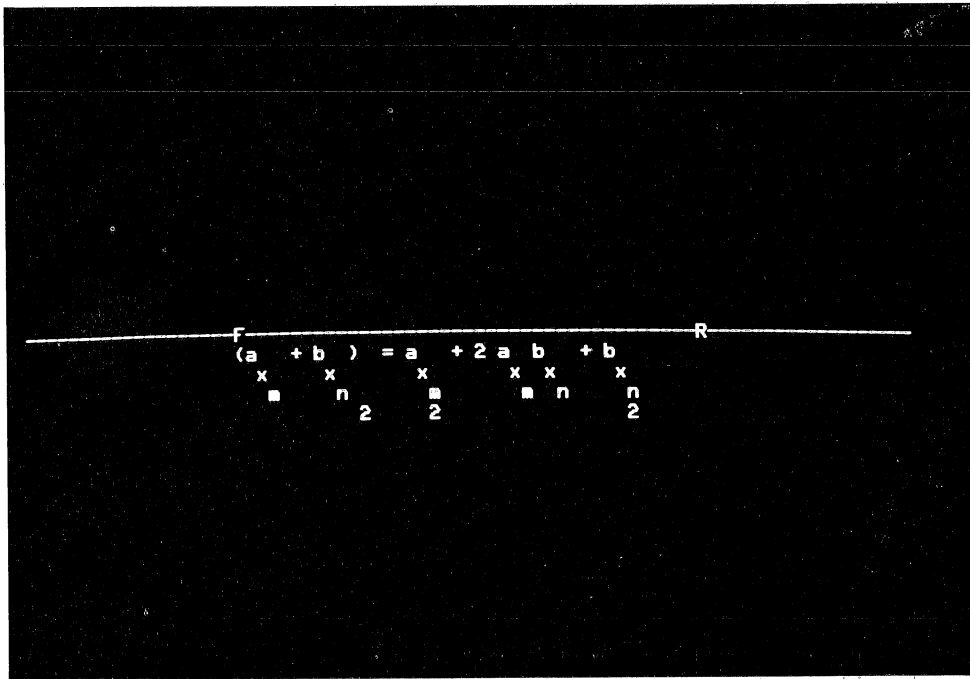

M123-7-A0193

Figure 9-6 Typing an Example Equation: Step 4

5. Now cut out the bottom line (with the 2's)  
 and paste it in above the main line to complete the equation:

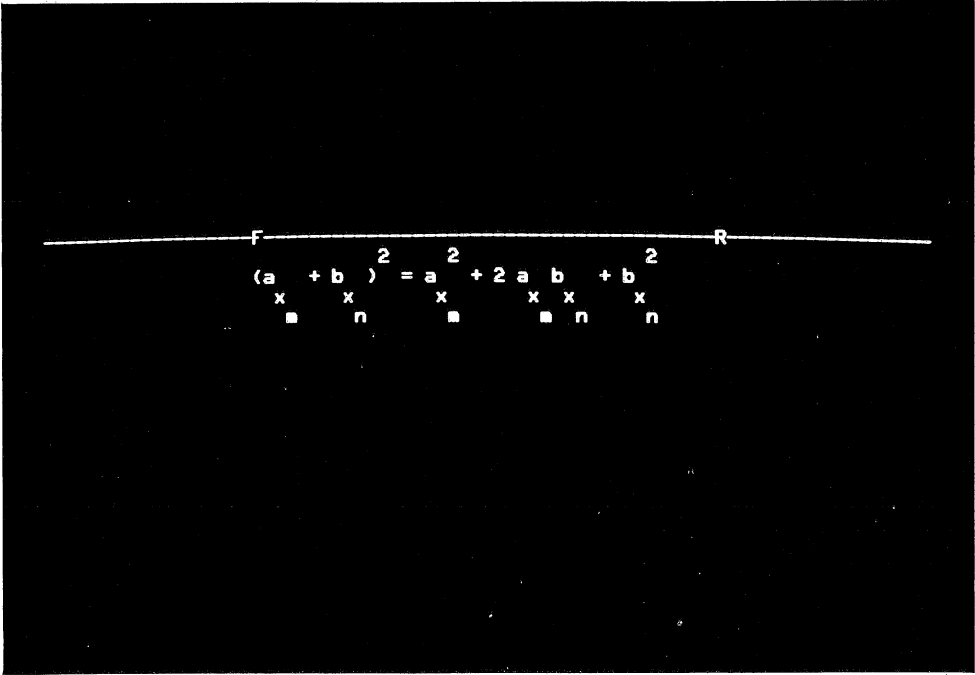

M123-10-A0194

Figure 9-7 Typing an Example Equation:  
 Final Results

## 9.2 COMPOSITE CHARACTERS

A composite character is a character printed by striking two or more characters on top of one another (overstruck). Use the gold and the DEAD keys to produce a composite character.

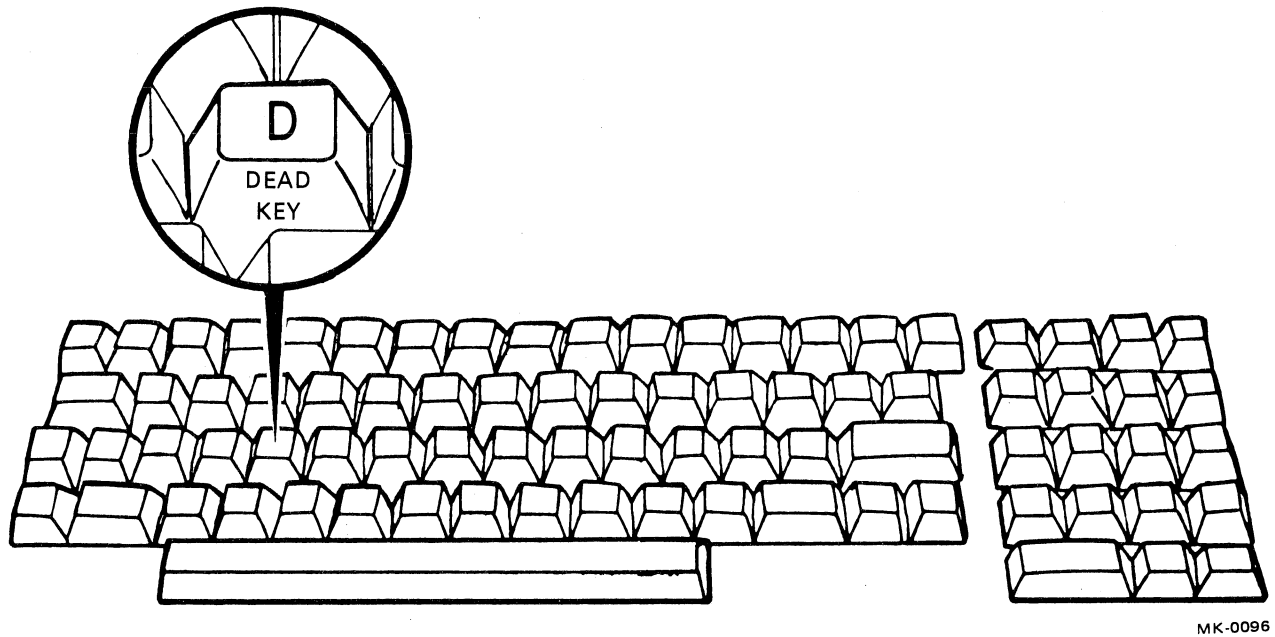

Figure 9-8 Main Keyboard DEAD Key

It is necessary to have a special key to produce a composite character because you cannot overstrike on the word processing system as you do on an ordinary typewriter (all the characters you type are automatically inserted in a separate position).

To form a composite character, follow these steps:

1. Type the first two characters.
2. Move the cursor backwards one character.
3. Press the gold and the DEAD keys. The special symbol  $\pm$  is displayed on the screen

in place of the two or more overstruck characters.

To add another character to the same group, type the next character and repeat steps 2 - 3.

To restore a composite character to its individual characters, position the cursor under the  $\pm$  and press the gold and the DEAD keys. The two or more individual characters will be displayed on the screen with the cursor positioned under the second. (Even if the composite character was composed of several, the cursor will still be under the second.)

A maximum of 100 characters may be formed into composite characters on the screen at the same time.

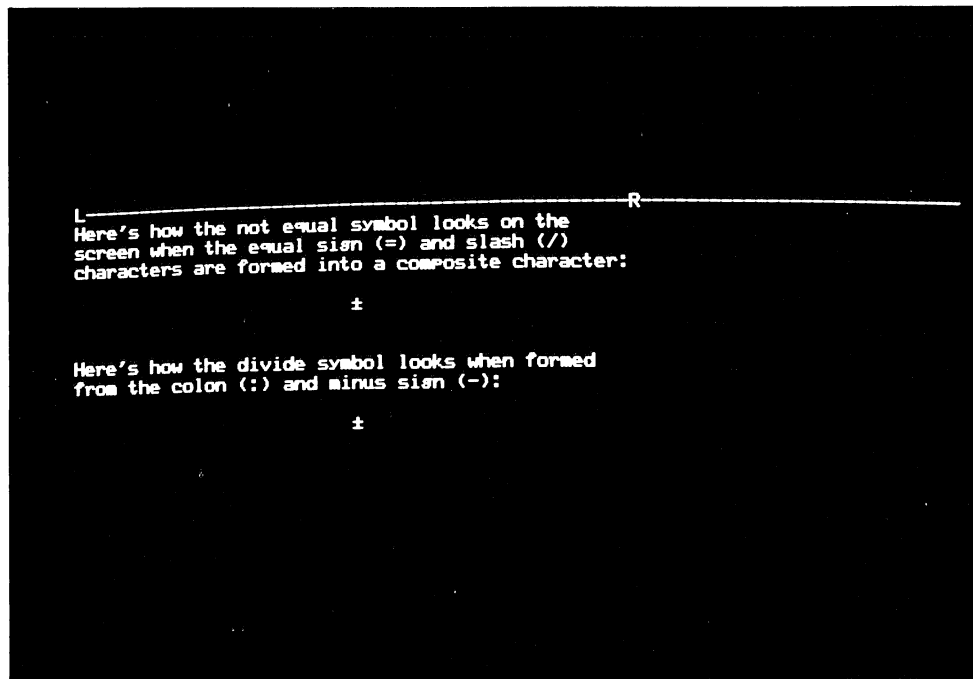

M123-13-A0196

Figure 9-9 Example of Typing Composite Characters





## CHAPTER 10 REUSABLE TEXT: LIBRARY DOCUMENTS

The word processing library document feature allows you to minimize repetitious typing. For example, you might have to type the same words, phrases, or paragraphs many times in a single day – your company’s name and address, names and numbers for different products or projects, or a signature block on a letter (“Yours truly, Joseph G. Greenwood, President”). You might be typing an instruction manual, for example, and need to use the term “the drill pressing system” many times. Or you might work in a law office where you use different combinations of standard or “canned” paragraphs to type a contract or will.

With a typewriter you’ve got to retype the words, phrases, or paragraphs each time they are used. With the word processing system you can type something just once, store it in a library document, and then use it as many times as needed.

There are two kinds of word processing library documents.

1. **Abbreviation.** This document is for saving words or phrases which you use frequently or whose spelling is difficult to remember. For example, if you work in a dental office, you might regularly need to use the following phrases:

Panoramic, maxilla and mandible

Recalcification (CaOH, temporary restoration)

Alveoplasty with ridge extension

Apicoectomy including apical curettage

2. **Paragraph.** This library document is similar to the abbreviation library except that it should be used for saving paragraphs or larger pieces of text.

With the word processing library document feature, all you do is give each phrase or paragraph a name and type it just once. For example, you might give "panoramic, maxilla and mandible" the abbreviation name "pn." Then, whenever you are typing a dental invoice or report, just press two keys and type the abbreviation or paragraph name. The word processing system will automatically insert all the text that corresponds to the name.

You can also reuse the same piece of text by cutting and pasting, or typing some text once and then inserting it one or more times at different places in a document. Cutting and pasting is intended for use when changing a document during one particular typing session whereas library documents are intended for permanent storage of reusable text. See Section 5.4.4 for details on cutting and pasting.

You can also avoid extra typing by inserting a copy of a document at any point in the document you're currently working on by means of the gold GET DOCMT key. See Section 5.1.3 for details.

## 10.1 CREATING A LIBRARY ENTRY

Abbreviation and paragraph library entries are created by bringing a copy of the library document to the screen for editing, typing the entry's name and its associated words or paragraphs, and then filing the library document.

### 10.1.1 Creating an Abbreviation Entry

To make an abbreviation entry, bring a copy of document number two on the system diskette to the screen for editing. This is the document automatically used by the word processing system for abbreviations (see Section 10.5 for how to use a different abbreviation library document).

Here is an example of the format to use for typing an abbreviation entry:

<<wp>>the word processing system<<>>

① ② ③                      ④    ⑤ ⑥

The following explains each item in the abbreviation entry format:

- ① << must be used in front of the abbreviation name.
- ② The abbreviation name. This must contain exactly two characters (letters, numbers, punctuation marks, or special characters). The name must be unique, that is it should not be the same as another entry in the abbreviation library document (if you have two entries with the same name, the system will always find the first one when you use the abbreviation).
- ③ >> must be used after the name.
- ④ The word(s) you want saved for reuse. This may be tabbed, centered, and include hard returns or new rulers. Do not put spaces or hard returns between an abbreviation entry and the next << because such spaces or returns are considered part of the abbreviation itself (when you use it, you may get more than intended).
- ⑤,⑥ <<>> followed by a hard return may be used to mark the end of the abbreviation. Though these are not required, their use enables you to start each abbreviation on a separate line. Here is an example of two abbreviation entries:

```
<<wp>>the word processing system<<>>  
<<ad>>the abbreviation library document<<>>
```

If you do not place the <<>> characters and a hard return at the end of an abbreviation, you must start the next one on the same line. Here is

how the above abbreviation entries would appear if the <<>> and hard return were omitted:

```
<<wp>>the word processing system<<ab>>the  
abbreviation library document
```

### 10.1.2 Creating a Paragraph Entry

To make an entry in the paragraph library document, follow the format for making an abbreviation entry with these exceptions.

1. The paragraph library document automatically used by the word processing system is

number three (the standard abbreviation document is two) on your system diskette.

2. A paragraph entry name may contain between one and 16 characters (an abbreviation name must contain two).

Here is an example of two paragraph entries:

```
<<CLASS I>>  
DIAGNOSIS: CLASS I, NEGATIVE FOR NEOPLASTIC CELLS
```

Present are endocervical cells with enlarged nuclei and a coarsely granular chromatin pattern and acute inflammatory exudate of polymorphonuclear leukocytes related to trichomonas and fungus organisms present. <<>>

```
<<CLASS II>>  
DIAGNOSIS: CLASS II, NEGATIVE FOR NEOPLASTIC CELLS
```

Present are squamous cells with enlarged reactive nuclei and an acute inflammatory exudate of polymorphonuclear leukocytes related to fungus organisms present. No endocervical cells are seen. <<>>

## 10.2 USING AN ABBREVIATION OR PARAGRAPH ENTRY

The gold and the ABBRV keys are used for in-

serting an abbreviation into a document while the gold and the LIBRY keys are used for inserting a paragraph entry.

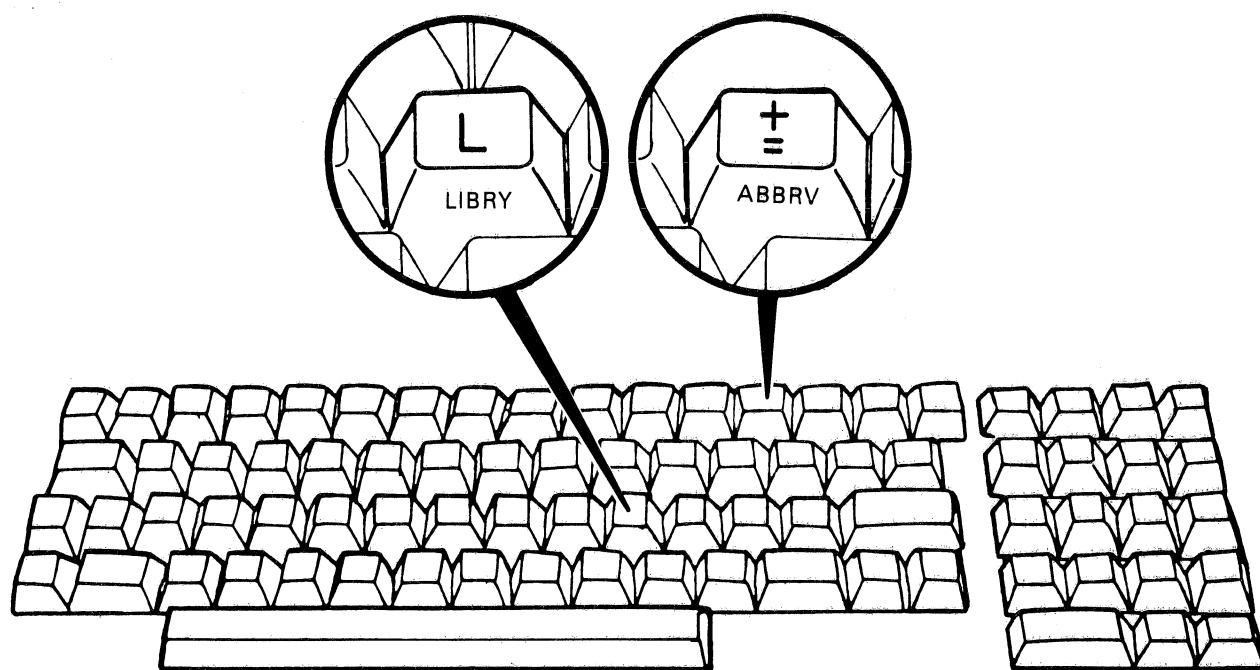

MK-0097

Figure 10-1 Main Keyboard LIBRY and ABBRV Keys

To use an abbreviation or paragraph entry, position the cursor where you want to insert the abbreviation or paragraph entry. Then do the following:

1. **For an abbreviation entry, press the gold and the ABBRV keys and type the abbreviation name.** (It is not displayed on the screen.) The contents of the abbreviation will be inserted into your document, and the cursor will be positioned immediately after the last character inserted. If you type a name that doesn't exist, the terminal will buzz. When
2. **For a paragraph entry, press the gold and the LIBRY keys.** The screen displays the following:  
  
ENTER NAME:  
  
Now type the paragraph name and press the RETURN key. After the contents of the paragraph entry are inserted into your

document, the cursor will be positioned immediately after the last character inserted. If you type a name that doesn't exist, the screen will display the following message:

NOT FOUND - REENTER:

Now type another name. If you can't remember the correct name, press the RETURN key to continue typing or editing your document.

If you create many abbreviation or paragraph entries, it may become difficult to remember the

exact name of each. For this reason, it's generally a good idea to keep a printed copy of the library document handy for reference.

### 10.3 INCLUDING A RULER IN AN ABBREVIATION OR PARAGRAPH ENTRY

When the contents of an abbreviation or paragraph entry are inserted into a document, they are formatted according to the ruler in effect at the insertion point. However, it is possible to specify a ruler along with an abbreviation or paragraph entry and have that ruler take effect when the entry is used. Here is an example of the format to follow:

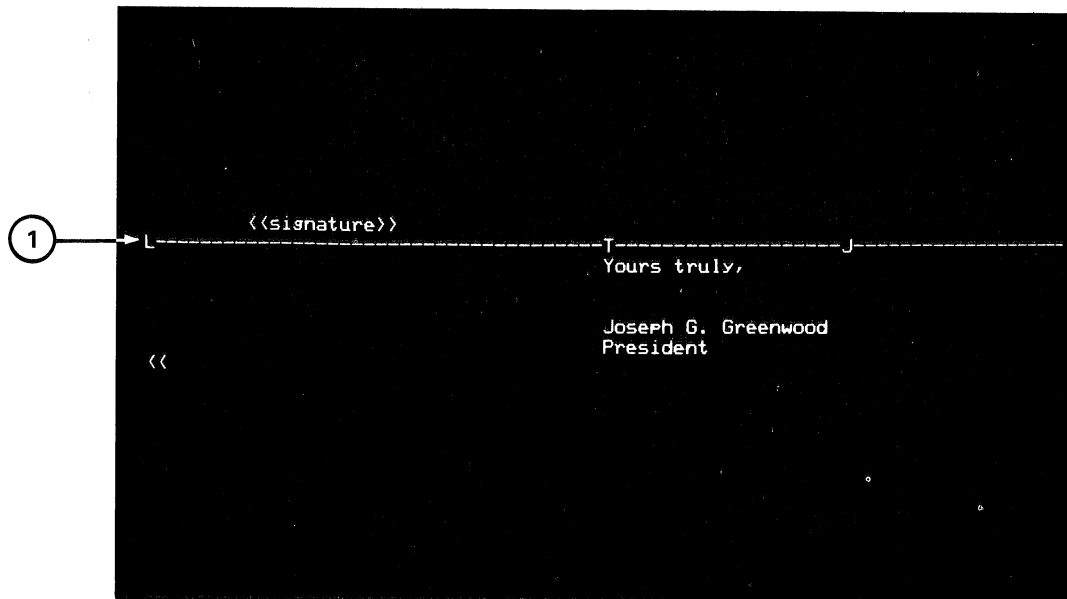

① PUT RULER HERE, AFTER ENTRY NAME

8920-4R3-A0108

Figure 10-2 Example of Inserting Ruler in Abbreviation Library Entry

In order to specify a ruler with an abbreviation or paragraph entry and have that ruler take effect when the entry is used, put the ruler immediately AFTER the >> characters that end the entry's name.

Here is what happens when the above abbreviation is inserted into a document:

Notice that the abbreviation's ruler is retained when the abbreviation is inserted into the letter.

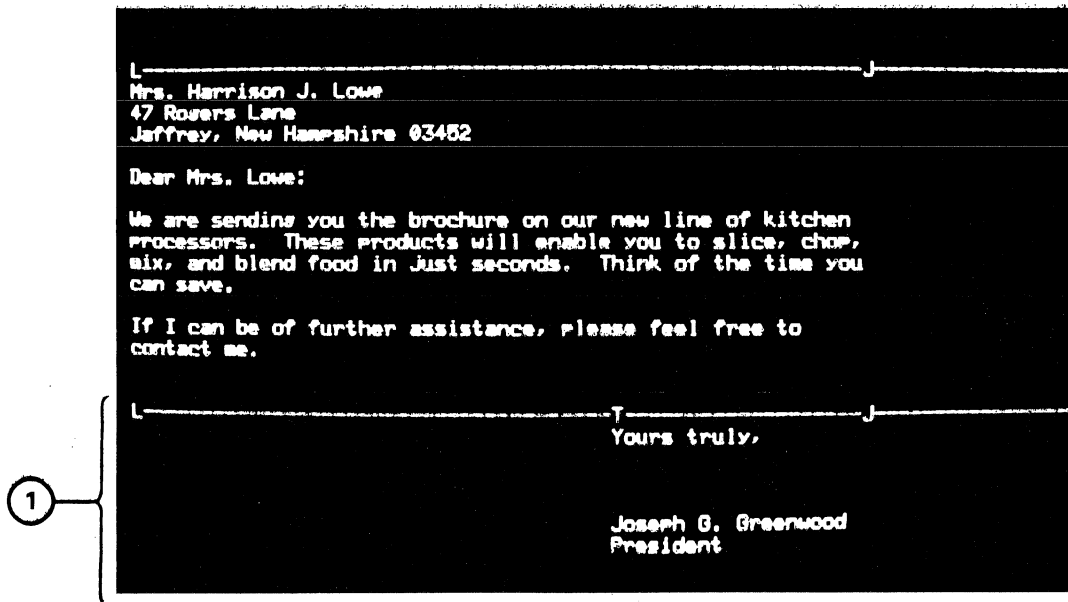

① TEXT PLUS RULER INSERTED INTO DOCUMENT

9113-9R3-A0105

Figure 10-3 Example of Text After Abbreviation  
Library Entry Which Includes Ruler Is Inserted

#### 10.4 QUALIFICATIONS

Abbreviation and paragraph documents are subject to the following qualifications.

1. **Name spelling.** If you spell an abbreviation or paragraph name with upper case letters in the library document, you can use it by typing either lower or upper case letters.

However, if you spell it with lower case letters, you can use it only by typing lower case.

For example, suppose you have the following entries in your abbreviation library document:

<<PN>>panoramic, maxilla and mandible<<>>

<<al>>alveoplasty with ridge extension<<>>

To have the words “panoramic, maxilla and mandible” inserted in a document, you can type either “pn” or “PN.” You can type only “al” to have the words “alveoplasty with ridge extension” inserted in a document.

- 2. Organization.** When you type an abbreviation or paragraph name, the word processing system searches the entire library document for a match. You can speed up processing by placing frequently-used names near the top of the document. Also, if you work on different projects for which each has its own terminology, create separate abbreviation or paragraph documents for each project (see Section 10.5 for how to create your own abbreviation and paragraph library documents).
- 3. Editing.** You can easily inspect and edit an abbreviation library document by pressing the mini keyboard <> key (bottom right). Pressing this key positions the cursor after a right angle bracket (>) character.

## 10.5 NONSTANDARD ABBREVIATION AND PARAGRAPH DOCUMENTS

Unless you specify otherwise, the word processing system uses documents two and three on the system diskette for abbreviation and paragraph library documents respectively. There are situa-

tions where it may be more convenient for you to create additional abbreviation and paragraph documents or to use other, nonstandard ones. For example, if you work on several different projects and each has its own terminology, you might want to maintain one abbreviation document for each separate project. Or you might want to maintain a separate paragraph document for each task you assemble from paragraphs, such as having one paragraph document for wills, another for contracts, and a third for invoices.

Another reason for specifying nonstandard abbreviation or paragraph documents is to use the same document diskette on different terminals or by different typists (who all have their own system diskettes with possibly different abbreviation and paragraph documents). Storing the abbreviation and paragraph documents on your document diskette instead of on your system diskette allows you to use the document diskette with any system diskette.

Create a nonstandard abbreviation paragraph document the same as you would any other document (see Section 3.1). Follow the format described in Section 10.1 for making entries.

You can use a nonstandard abbreviation or paragraph document when typing or editing any document by following this procedure:

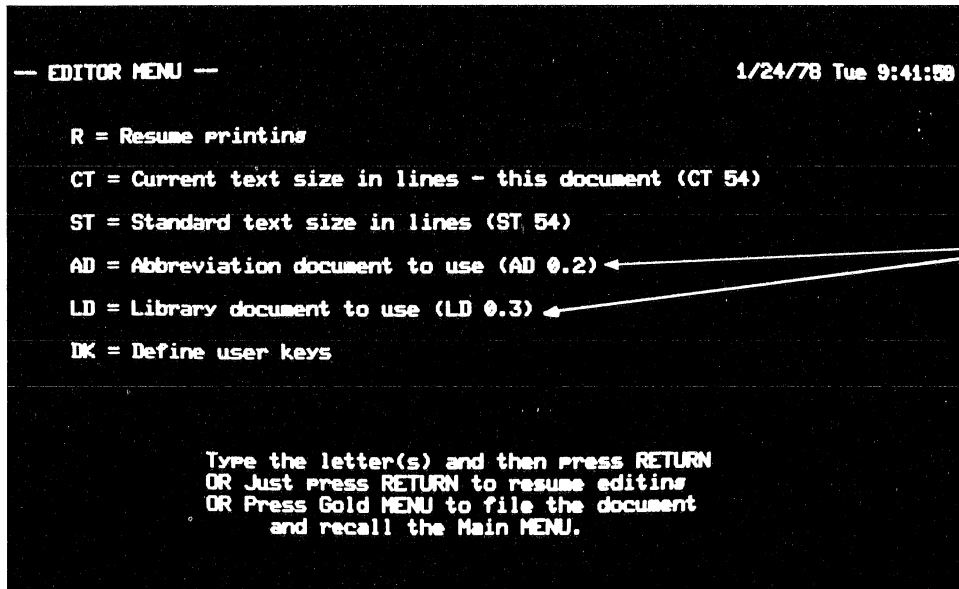

① STANDARD ABBREVIATION AND PARAGRAPH LIBRARY DOCUMENTS

9113-11R3-A0106

Figure 10-4 Editor Menu Showing Standard Abbreviation and Paragraph Library Documents

1. Press the gold and the MENU keys. The word processing Editor Menu will be displayed on the screen.
2. Type the letters AD to specify an abbreviation document or LD to specify a paragraph

document, a space, identify your library document, and press the RETURN key. The screen display will now show the diskette drive number and new document number (not the name) of the abbreviation or paragraph library document.



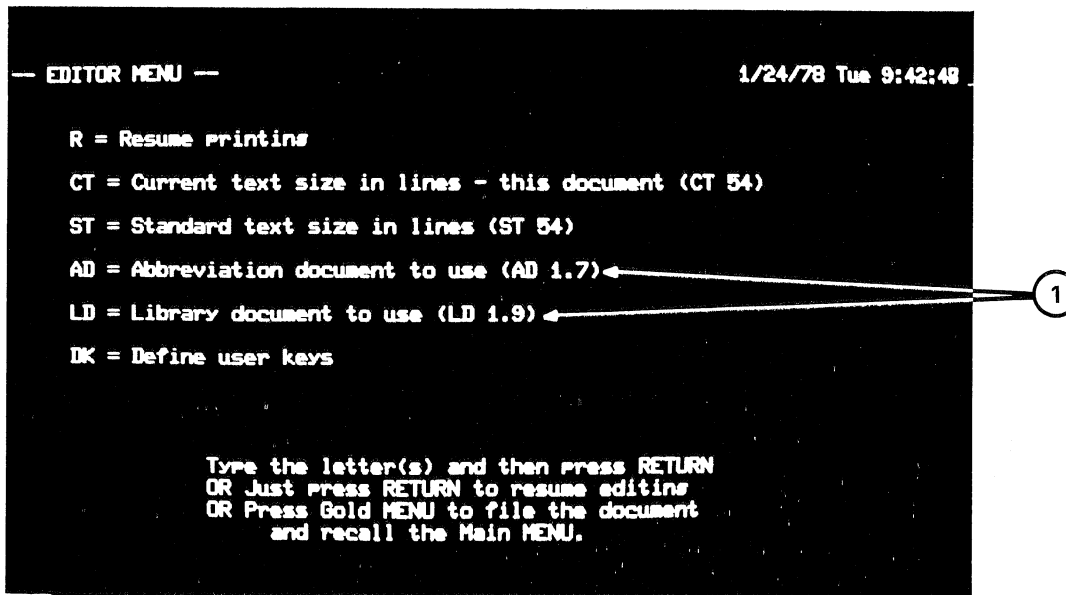

1 USER-SUPPLIED ABBREVIATION AND PARAGRAPH LIBRARY DOCUMENTS

9113-13R3-A0107

Figure 10-5 Example of Editor Menu Showing User-Supplied Abbreviation and Paragraph Library Documents

You can type either a document name or its number when identifying the new library document. You can also specify the diskette drive where the document is stored. Refer to Appendix C-1 for details on specifying different drive numbers.

3. **Press the RETURN key.** The document you were working on is again displayed on the screen with the cursor in the same position as previously.

Once you specify a nonstandard abbreviation or paragraph library document, the system auto-

matically checks that document whenever you press the gold and the ABBRV or the gold and the LIBRY keys.

When you specify a nonstandard abbreviation or paragraph document, it takes effect in the document you are currently using plus in any new documents you create with the same system diskette. If you do not wish to use the nonstandard abbreviation or paragraph document with a newly-created document, you must repeat the procedure described above and specify the desired abbreviation or paragraph document.



## CHAPTER 11 HYPHENATION

Hyphenation allows you to improve the visual appearance of your document. Some of the features of hyphenating with the word processing system are:

1. **You can use a “breaking” hyphen in a compound word** to improve the appearance of your document. When a word with this kind of hyphen crosses the right margin, the word processing system will attempt to split the word at the hyphen. For words that must not be split across two lines, such as the telephone number 1-617-897-6000, you can always use a nonbreaking hyphen. See Section 11.1 for details.
2. **You can inspect your document for awkward line endings** – lines that end with a lot of unused space followed by a multisyllable word at the beginning of the next line. You can then “push” some of the characters up to the preceding line to fill up some of the space. If you push too many characters,

you can reverse the process and “pull” some back down. See Section 11.2 for details.

3. **You can also specify an “invisible” hyphen** in addition to the visible type. This is a hyphen which may be invisible to you (on the screen or in your printed document) but which is visible to the word processing system. Whenever a word containing such a hyphen crosses the right margin, the word processing system will automatically attempt to break it at the invisible hyphenation point. See Section 11.3 for details.
4. **You can specify a hyphenation zone**, the maximum number of unused spaces at the end of a line that you will accept in your printed document. If a line contains more than this number of spaces, the system will automatically notify you so you can either place some additional characters there or decide to tolerate it. See Section 11.5 for details.

### 11.1 COMPOUND WORDS

You can form a compound word by joining two or more separate words with a hyphen. The main keyboard hyphen key is used for forming compound words.

There are two kinds of hyphens that you can type on the word processing system.

1. **Nonbreaking.** Use this kind of hyphen in compound words that must appear entirely on the same line. Generally, such words are

people's names, telephone numbers, acronyms, or names of products or projects, as in the following examples:

Mr. Colin Moore-Batty  
617-899-9000  
DECsystem-10

If a compound word joined with a non-breaking hyphen does not fit at the end of a line, the entire word is placed at the beginning of the next line.

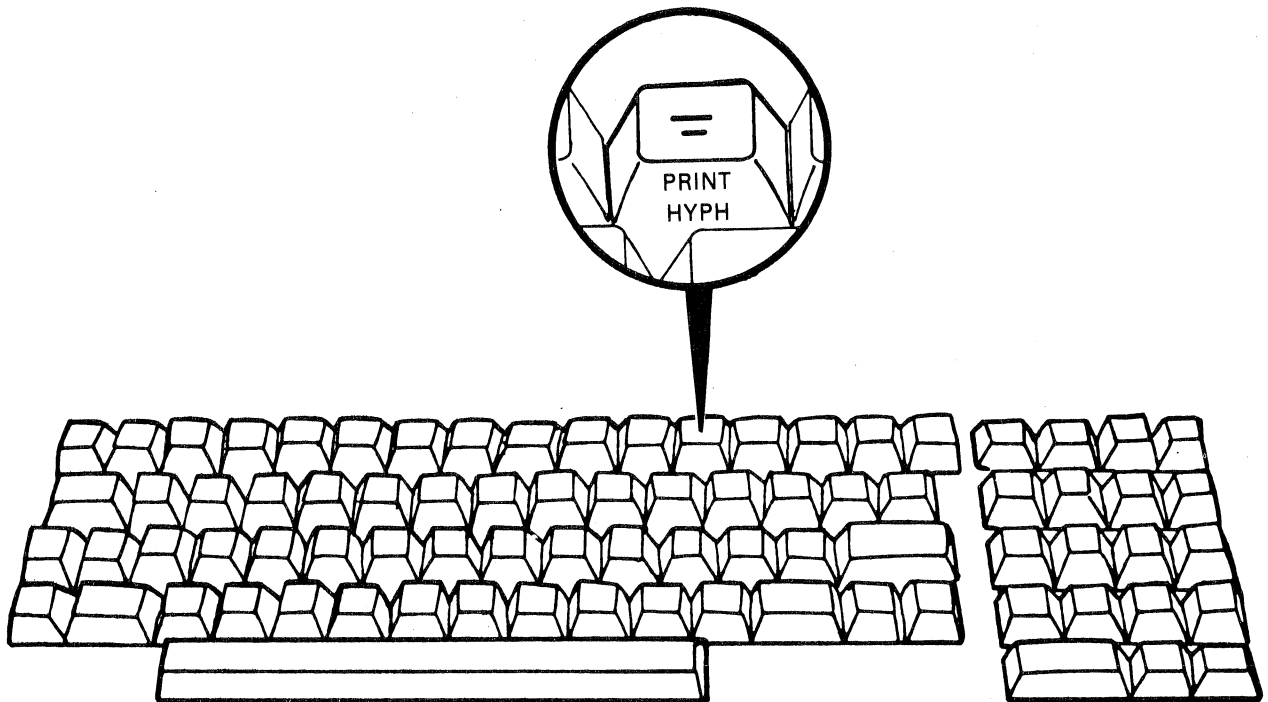

MK-0099

Figure 11-1 Main Keyboard PRINT HYPH Key

To produce a nonbreaking hyphen, press the main keyboard hyphen key.

2. **Breaking.** Use this kind of hyphen in compound words which may be split at the end of a line. For example:

There was a two-thirds majority on the current subject of right-to-life.

If a compound word joined with a breaking hyphen does not entirely fit at the end of a line, the system may possibly break it at the hyphen.

To produce a breaking hyphen, press the gold and the hyphen keys.

## 11.2 HYPHENATING TYPED TEXT BY PUSHING AND PULLING

You can hyphenate words to produce a neat-looking right margin after you've finished typing by using the HYPH PUSH and gold HYPH PULL keys.

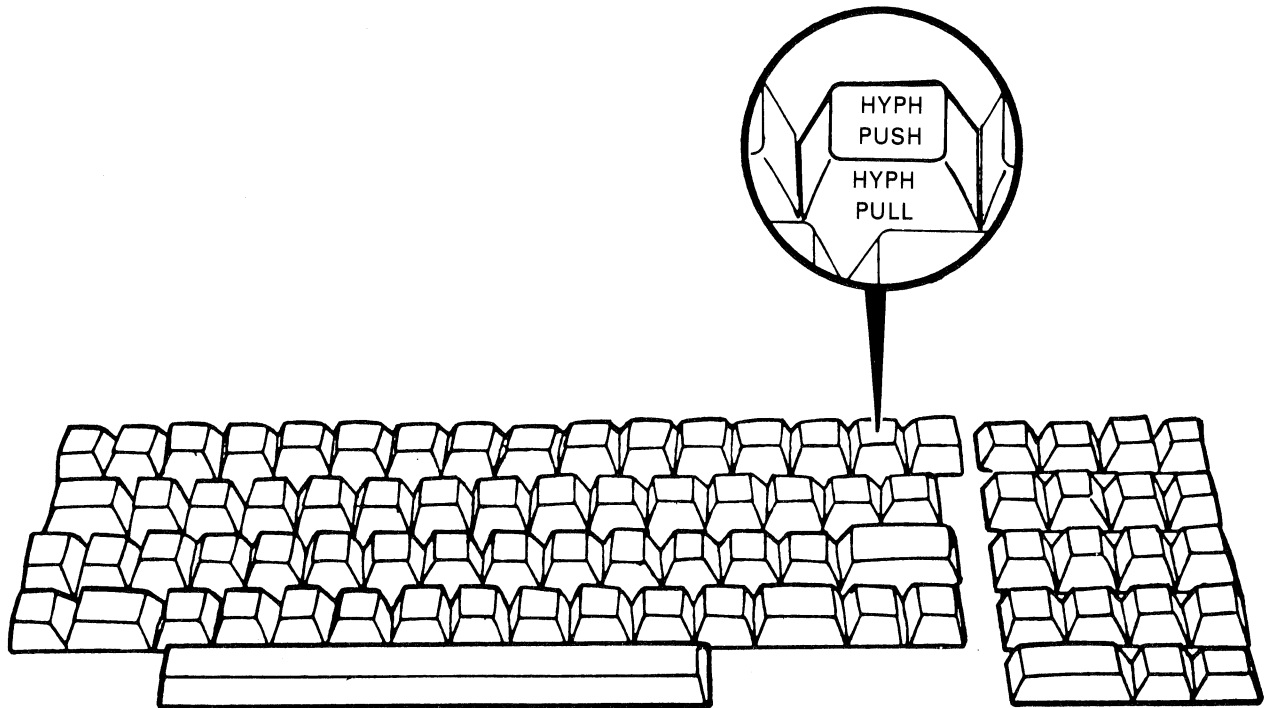

MK-0100

Figure 11-2 Main Keyboard HYPH PUSH and HYPH PULL Keys

After you've typed some text, inspect the line endings on the screen. If one line is short (top line) and the next (bottom line) starts with a long word, you can hyphenate the long word by pushing part of it up to the short line.

1. **Position the cursor** anywhere on the bottom line.
2. **Press the HYPH PUSH key.** The first character from the bottom line is moved up to the top, and a hyphen mark is automatically inserted after it.
3. **Continue to press the HYPH PUSH key** until you are satisfied with the hyphenation just produced. Each time you press this

key, one character moves up to the top line to the left of the hyphen mark. If you push more characters than can fit inside the right margin, the entire word is automatically brought back down to the bottom line.

If you push too many characters to the top line, press the gold and the HYPH PULL keys. This action moves a single character at a time back to the line with the cursor.

4. **Press the PARA key.** This reformats the remainder of your paragraph to fit the right margin. Now you can perform other typing or editing.

For example, here is how some text looked before it was hyphenated:

Press the HYPH PUSH key. The first character from the bottom line is moved up to the top, and a hyphen mark is automatically inserted after it. If you like the results, proceed to another line.

Notice how uneven the lines are. The first is short and is followed by a multisyllable word ("character") at the beginning of the second. To

make the first line look better, the first syllable of the word "character" should be pushed up to give the following:

Press the HYPH PUSH key. The first character from the bottom line moves up to the top, and a hyphen mark is automatically inserted after it. If you like the results, proceed to another line.

Notice that now the third line is short and is followed by a multisyllable word (“automatically”) at the beginning of the next. Therefore, some syl-

lables of “automatically” should be pushed up. As a result, the paragraph looks good so no further hyphenation is performed.

**Press the HYPH PUSH key. This first character from the bottom line moves up to the top, and a hyphen mark is automatically inserted after it. If you like the results, proceed to another line.**

When you hyphenate a word by pushing or pulling, the word processing system “remembers” your hyphen as an “invisible” hyphen. This means that, if you change your text so that the word no longer crosses the right margin, the hyphen will disappear. If the word ever crosses the

right margin again, the hyphen will automatically reappear where you originally specified.

To remove a hyphen inserted by pushing or pulling, delete the character in front of the hyphen. This action removes both the character and the hyphen.

### 11.3 USING INVISIBLE HYPHENS

You can put an “invisible” hyphen into a word with the gold PRINT HYPH and and the SHIFT keys.

This hyphen is invisible to you because it is not displayed on the screen. However, it is not invisible to the word processing system. Whenever a word containing an invisible hyphen crosses the right margin, the system will automatically try to hyphenate it. An invisible hyphen has no effect if the word is not located at the end of a line.

To put an invisible hyphen into a word, follow these steps:

1. Position the cursor under the character that is to follow the hyphen.
2. Press the gold, **hold down** the SHIFT, and press the PRINT HYPH keys.

Invisible hyphens can be used with abbreviation and paragraph library entries (see Chapter 10). If you put invisible hyphens in these entries, not only will you avoid unnecessary typing but you will also have your text hyphenated if a word in the inserted abbreviation or paragraph crosses the right margin.

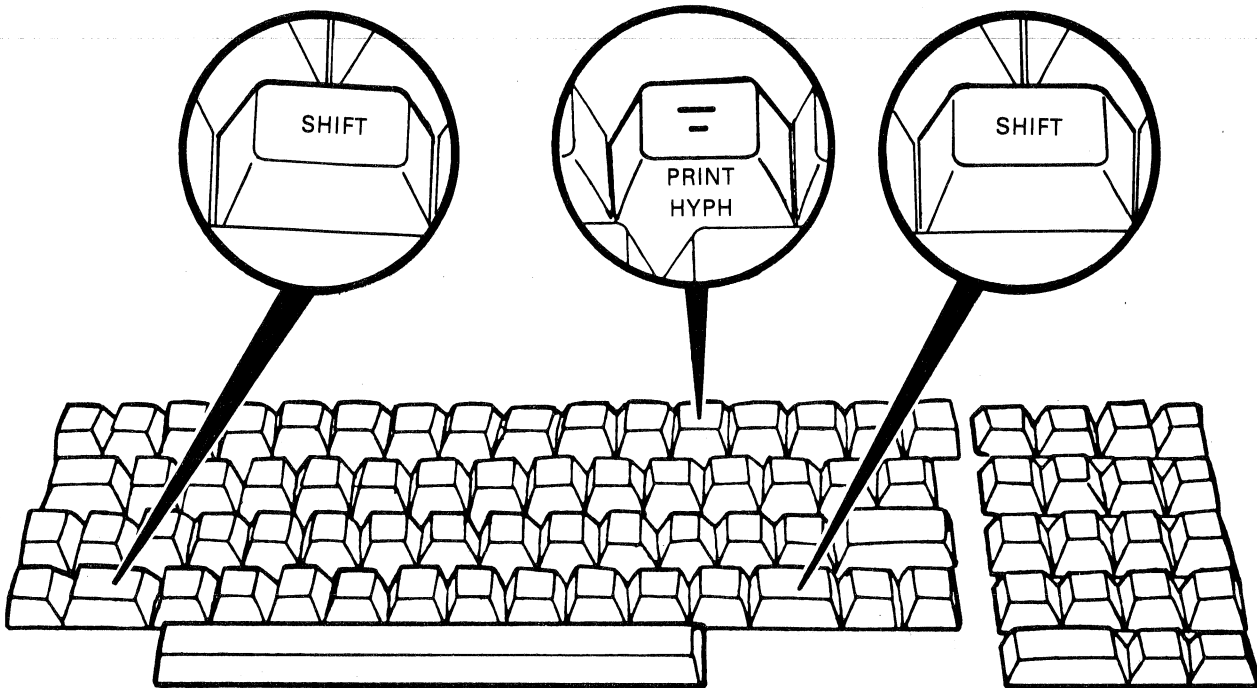

Figure 11-3 Main Keyboard SHIFT and PRINT HYPH Keys

MK-0098



#### 11.4 EXAMINING TEXT FOR BREAKING AND INVISIBLE HYPHENS

To determine whether your text contains any invisible hyphens, you must view it (see Appendix D). You must also view text to determine whether a visible hyphen is the breaking or non-breaking kind. A / mark appears under a breaking hyphen; nothing appears under a

nonbreaking hyphen. A / mark also indicates an invisible hyphen; the / mark appears under the character preceding the one where you pressed the gold, PRINT HYPH, and SHIFT keys. In addition, a / mark appears under the last character of a word that was hyphenated.

Here is an example of hyphens in viewed text:

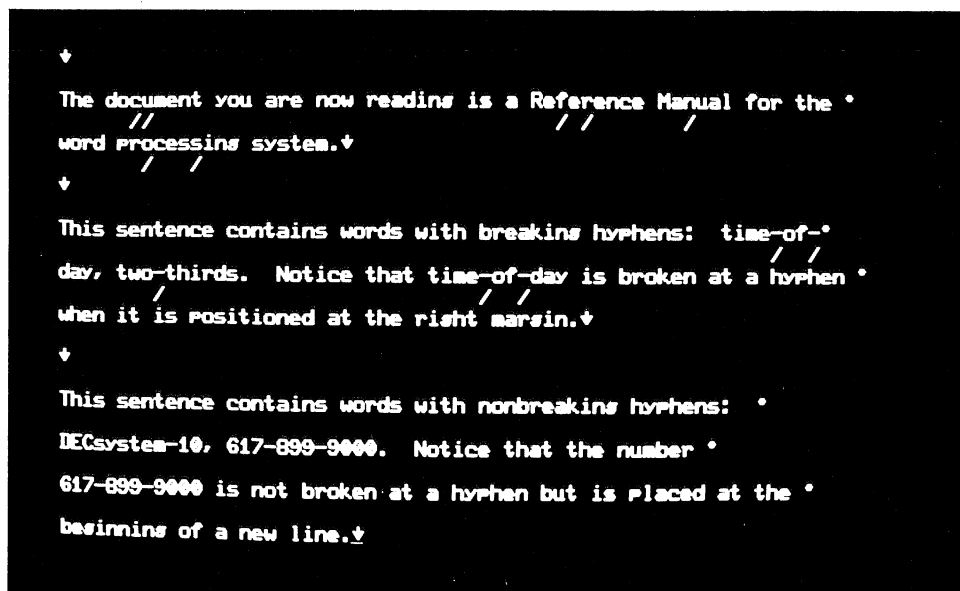

9113-17R3-A0110

Figure 11-4 Example of Viewing Text for Breaking, Nonbreaking, and Invisible Hyphens

#### 11.5 IMPROVING RIGHT MARGIN APPEARANCE BY HYPHENATION ZONE

You can improve the appearance of your right margin by specifying a *hyphenation zone*. This is the maximum number of typing positions in front of the right margin that may remain unused on a line.

A hyphenation zone takes effect by making the system buzz at you whenever a line ends with no characters in the hyphenation zone. The buzzing is to alert you to take action: either hyphenate by pushing up some characters from the next line or decide to accept the line with all its unused space.

For example, if you type the following lines without a hyphenation zone, you might not notice that the first line ends with a lot of space and

is followed with a large word (“synthesization”) on the next line. If you use a hyphenation zone, the word processing system will buzz when you type “synthesization.”

The subject of this report is the  
synthesization of the optimization and  
maximization principles.

If you use a hyphenation zone, the system will buzz when you type or edit a document (see Section 11.5.1) or when you paginate (see Section 11.5.2).

#### **11.5.1 Using a Hyphenation Zone When Typing or Editing**

To use a hyphenation zone when typing or editing a document, follow these steps:

1. **Put the letter H in your ruler(s)** where the hyphenation zone is to begin (see Section 6.1.2 for making ruler settings). Generally, it is most effective to mark the zone between five and ten characters inside the right margin.

2. **Type or edit your text.** If the system buzzes, the last line you used ends with no characters in the hyphenation zone. If desired, push up some characters from the next line (see Section 11.2). You may ignore the buzzing and accept the line as it appears.

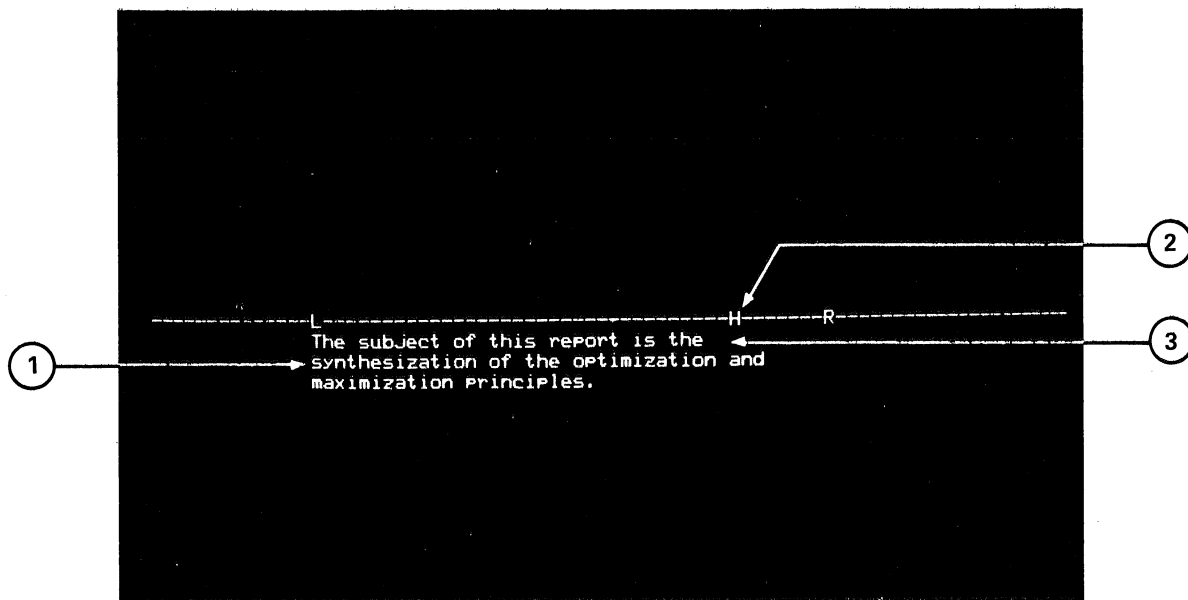

- ① LARGE WORD AT START OF LINE THAT COULD BE HYPHENATED
- ② HYPHENATION ZONE IN RULER
- ③ LINE CONTAINS ALL BLANKS IN ZONE  
RESULT: SYSTEM BUZZES

8920-12R3-A0109

Figure 11-5 Example of Using a Hyphenation Zone

### 11.5.2 Using a Hyphenation Zone When Paginating

To use a hyphenation zone when paginating a document, follow these steps:

1. **Put the letter H in your ruler(s)** where the hyphenation zone is to begin (see Section 6.1.2 for making ruler settings). Generally, it is most effective to mark the zone between five and ten characters inside the right margin.
2. **Press the gold and mini keyboard PAGE keys** to display the end of a page (see Section 12.3). The system will attempt to count down a preassigned number of lines and mark the bottom of the page. If there's a "short" line, one that ends with no characters in the hyphenation zone, the system

buzzes and stops counting. (The bottom-most line on the screen will be the one following the short line and will contain the cursor.)

3. **Inspect the line ending.** If the screen displays "---PAGE MARKER---" the system was able to mark the end of the page. Repeat steps 2 and 3. If the system buzzed, the second from last line on the screen ends with no characters in the hyphenation zone. If desired, push up some characters from the next line (see Section 11.2) and repeat steps 2 and 3.

Continue repeating steps 2 and 3 until pagination is complete.

## CHAPTER 12 PAGINATION

*Pagination* means determining where to end a printed page and start a new one. There are three different ways of paginating a document with the word processing system. This chapter explains when to use each:

1. **When you want the system to automatically end each page as it prints your document.** The system will print a preassigned, or standard, number of lines on a page and then automatically start a new page. It will repeat this process until it comes to the end of the document. See Section 12.1 for details.
2. **When you have text that absolutely must start on a new page.** For example, if your document contains a table, you can prevent it from being broken in the middle by telling the system to always print the table on a new page. This is accomplished by inserting a NEW PAGE mark in your document. See Section 12.2 for details.

3. **When you want to inspect each page ending before the document is printed** so you can change any you don't like. The system will count down a preassigned number of lines, insert a PAGE MARKER in your document, and display the page ending for your inspection. See Section 12.3 for details.

### 12.1 AUTOMATIC PAGINATION

To have the word processing system automatically paginate a document while printing, set the value of Print Menu setting AP to YES. The system will determine where to end each page and start the next. Whenever the document contains a NEW PAGE mark (see Section 12.2), the system will automatically advance to the top of a new page.

The number of lines printed per page is equal to the total number of lines per page (Print Menu setting PS) less the number of lines in the top margin (Print Menu setting TM) less the number of lines in the bottom margin (Print Menu setting BM).

## 12.2 FORCING PAGE ENDINGS

You can force the system to always print certain text (such as each new chapter, a figure, or a table) at the start of a new page with the gold and NEW PAGE keys.

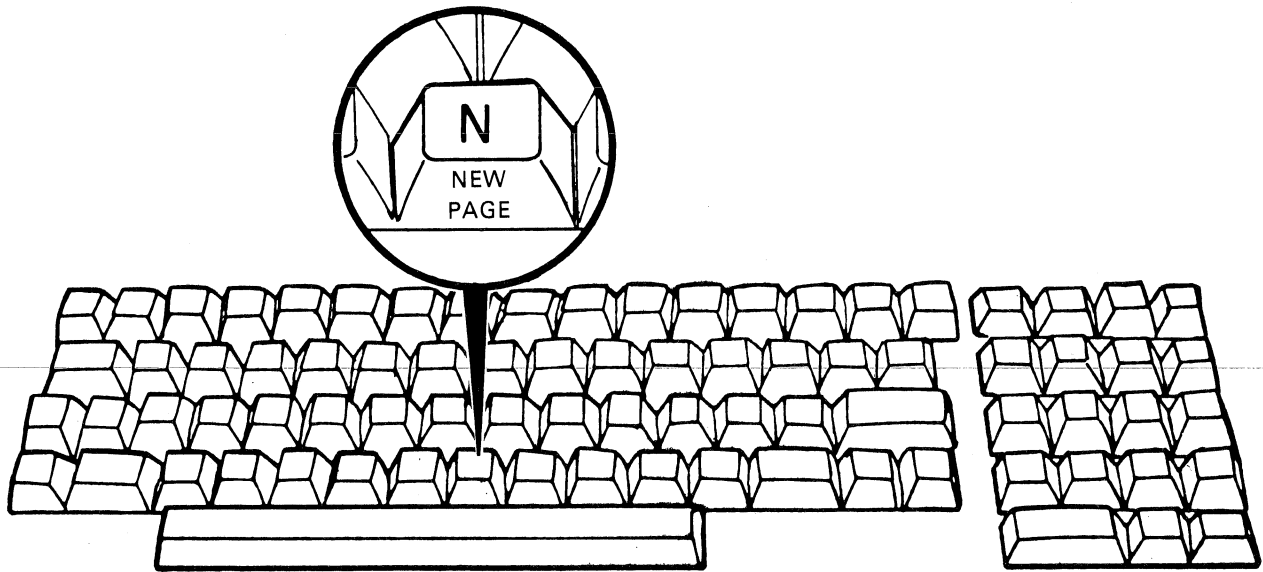

MK-0101

Figure 12-1 Main Keyboard NEW PAGE Key

To force page breaks, follow these steps:

1. **Position the cursor** where a new page is to start.
2. **Press the gold and the NEW PAGE keys.** This action inserts a NEW PAGE mark (a

line of dashes with the words NEW PAGE in the center) into your document.

Repeat steps 1 and 2 for each place in your document that must always be printed on a new page.

Here is an example of a document that contains NEW PAGE marks:

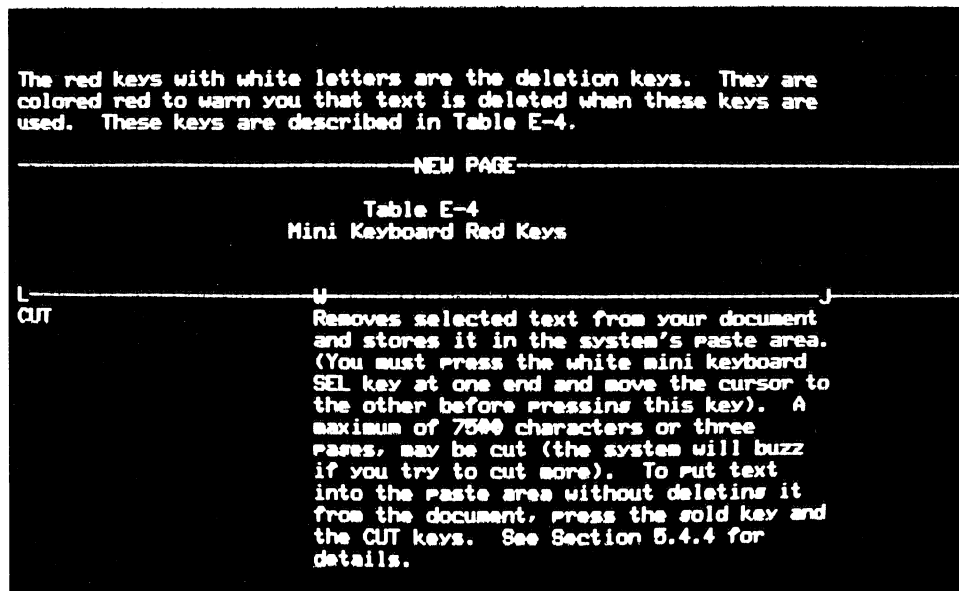

9113-10R3-A0115

Figure 12-2 Example of Using a NEW PAGE Mark

To remove a NEW PAGE mark, use either the RUB CHAR OUT or DEL CHAR key. (Even though a NEW PAGE mark occupies a full screen line, it is nevertheless only a single character.)

### 12.3 DISPLAYING AND MODIFYING PAGE ENDINGS

You can have the word processing system show you where each page would end if you were to paginate automatically (as it would if you set the value of Print Menu setting AP to YES). The system will insert a PAGE MARKER into your document (displayed on the screen as a line of dashes with the words PAGE MARKER in the

center) to show you where each page will end when printed. If you don't like this page ending, you can change it.

Use the mini keyboard PAGE key to display page endings that the system determines. Use the gold and the PAGE MARKER keys to modify page endings.

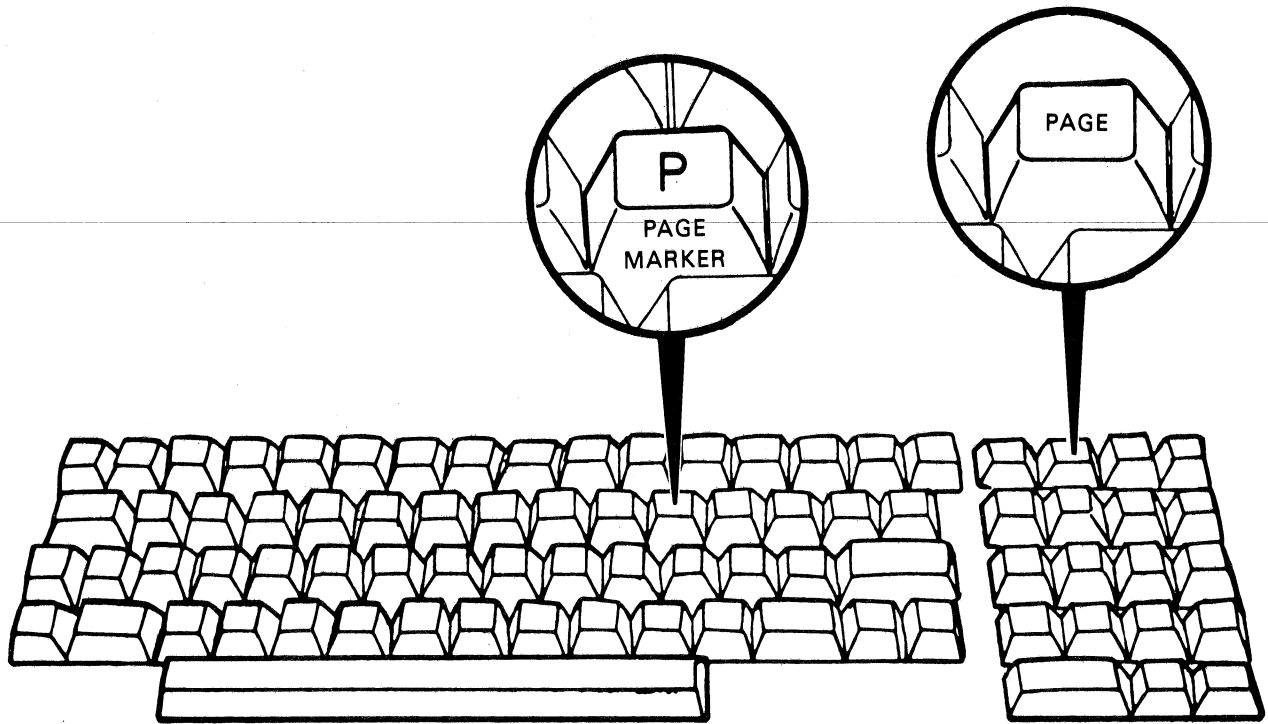

MK-0102

Figure 12-3 Main Keyboard PAGE MARKER Key and Mini Keyboard PAGE Key



To display page endings and modify them if desired, follow these steps:

1. **Position the cursor** at the top of your document.
2. **Press the gold and the mini keyboard PAGE keys.** The system will count down a pre-assigned number of lines (determined by

the setting CT in the document's Editor Menu), insert a PAGE MARKER into the document, and position the cursor under the first character of the next line. Once the system starts counting lines, you cannot stop it.

Here is an example of a PAGE MARKER inserted by the system:

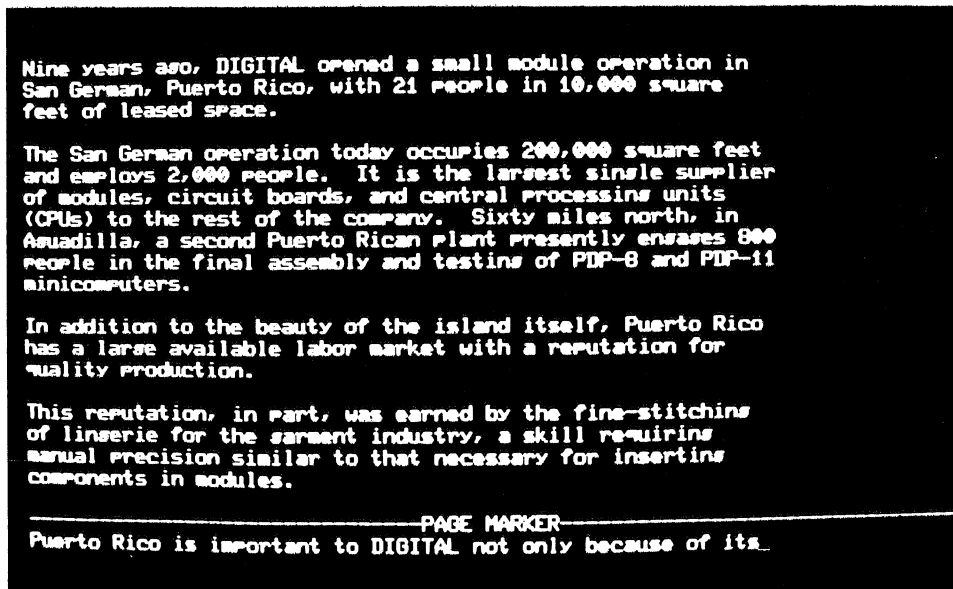

9113-21R3-A0114

Figure 12-4 Example of a PAGE MARKER  
Inserted by the Word  
Processing System

The system will stop and not insert a PAGE MARKER if any of the following conditions occurs:

- There is a NEW PAGE mark. The cursor will be located under the first character of the next line. To proceed with pagination, repeat step 2.
- There is a "short" line, one that ends with too much space when a hyphenation zone (see Section 11.5) is in effect. If this happens, the system will buzz and display the short line on the second from last screen line (the last line contains the cursor). You can either hyphenate by

pushing up some characters (see Section 11.2) or accept the line with its unused space. To proceed with pagination, repeat step 2. (The system may again stop and buzz if you have another short line.)

- The end of the document was reached.

3. **Inspect the page ending.** If you are satisfied with it, repeat step 2. If the page ending is not satisfactory, change it. For example, suppose the system inserts a PAGE MARKER in the following location, thereby giving you one short line at the top of a page:

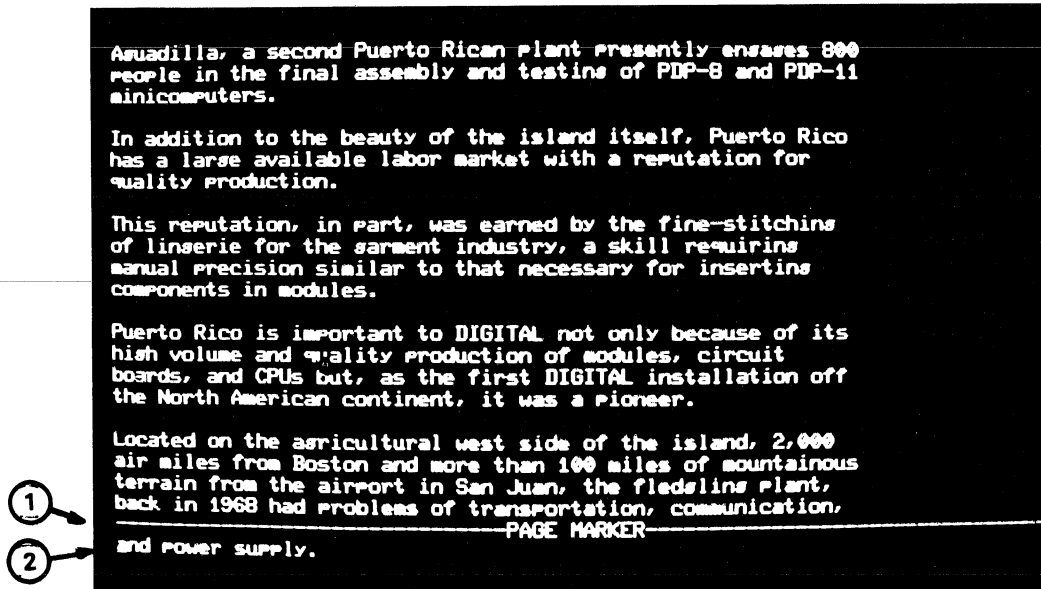

① PAGE MARKER INSERTED BY WORD PROCESSING SYSTEM

② RESULT: SHORT LINE TO APPEAR ON NEW PAGE

9113-23R3-A0111

Figure 12-5 Example of Page Ending Which Could Be Improved

To change an awkward page ending, move the cursor backwards to a suitable place to end the page and press the gold and the PAGE MARKER keys. This action inserts another PAGE MARKER. (The system

will automatically remove the first PAGE MARKER when you continue pagination.)

4. **Repeat steps 2 and 3** until you reach the end of your document.

It is possible to move a PAGE MARKER forward to squeeze a few extra lines on a page. Just remove the PAGE MARKER (if you don't, the document will be printed with an extra page break), move the cursor down the few lines, and press the gold and the mini keyboard PAGE keys. However, be careful when doing this because the additional lines (beyond where the system wanted to end the page) are printed in the bottom margin. Either (or both) of the following undesirable conditions might result.

- If you add more lines to the page than can physically fit there, the printing may extend over the bottom edge of the paper. If you're using continuous-form paper, your printing could extend right over the fold. If you're using single sheets, your printing could appear on the roller (platen) of the printer.
- If you're using a footer (see Chapter 14), the printing will extend into the footer. The footer will then be printed at the bottom of the next page, thereby producing a page almost entirely empty.

When you are ready to print your paginated document, set the value of Print Menu setting AP to NO. If you don't, the system will ignore the page endings you just inserted and will paginate automatically instead. See Section 13.3.1 for details.

### **12.3.1 Changing PAGE MARKERS**

If you add new text to a document that contains PAGE MARKERS, you must repaginate. If you don't, your printed document may extend over the edge of the page. Of course, if you print a document and don't like where the pages end, you can always repaginate it. Just position the cursor at the beginning of the first page to be

repaginated (right after a PAGE MARKER, NEW PAGE, or top of document) and follow steps 2 - 3 in Section 12.3.

If you do not position the cursor at the beginning of a page when you press the gold and PAGE keys, the system will automatically find the beginning for you. However, if your document contains many lines of text without any PAGE MARKERS or NEW PAGE marks, the system may not be able to paginate properly. When this occurs, the system will buzz and no PAGE MARKER will be inserted.

### **12.3.2 Qualification: Automatic Removal of PAGE MARKERS**

If you do any of the following three actions while editing a document, the system will automatically remove PAGE MARKERS.

1. Change a ruler when there is a PAGE MARKER before the next ruler. This PAGE MARKER will be removed.
2. Modify some text when there's a PAGE MARKER before the next hard return. This PAGE MARKER will be removed.
3. Insert a copy of another document (by means of the gold and GET DOCMT keys). All PAGE MARKERS are removed from the inserted document.

### **12.3.3 Qualification: Word Wrapping**

If you insert a PAGE MARKER or NEW PAGE mark in the middle of a paragraph, the line endings are "thrown off" so that existing text extends beyond the right margin. To reformat the text, press the mini keyboard PARA key. This action word wraps the remainder of the paragraph and advances the cursor forward to the next paragraph.

## 12.4 CHANGING THE NUMBER OF LINES PER PAGE

The system uses the value of Editor Menu setting CT (Current Text size) in determining page endings. Change the value of CT if you want to specify a different number of lines per page for the document you're currently using. You can also specify a number of lines per page for all new documents you create by changing the value of Editor Menu setting ST (Standard Text size).

To find out the values of CT and ST in effect and to change them, follow these steps:

1. Press the gold and the MENU keys when you are editing the document. This action displays the Editor Menu. If the values of CT and ST are satisfactory, press the RETURN key to redisplay your document. Here is an example of an Editor Menu:

```
— EDITOR MENU —                               1/24/78 Tue 9:41:59

R = Resume printing
CT = Current text size in lines - this document (CT 54) ←
ST = Standard text size in lines (ST 54) ←
AD = Abbreviation document to use (AD 0.2)
LD = Library document to use (LD 0.3)
DK = Define user keys

Type the letter(s) and then press RETURN
OR Just press RETURN to resume editing
OR Press Gold MENU to file the document
and recall the Main MENU.
```

① SYSTEM-SUPPLIED TEXT SIZES

9113-11R3-A0112

Figure 12-6 Editor Menu Showing System-Supplied Text Sizes

2. Type the letters CT or ST, a space, the new value, and press the RETURN key to change the number of lines of text per page. The number just typed replaces the pre-

vious value of CT or ST on the screen. Now press the RETURN key to redisplay your document. Here is an example of an Editor Menu after changing the value of ST:

```
— EDITOR MENU —                               1/24/78 Tue 9:43:13

R = Resume printing
CT = Current text size in lines - this document (CT 54)
ST = Standard text size in lines (ST 60) ← ①
AD = Abbreviation document to use (AD 0.2)
LD = Library document to use (LD 0.3)
DK = Define user keys

Type the letter(s) and then press RETURN
OR Just press RETURN to resume editing
OR Press Gold MENU to file the document
and recall the Main MENU.
```

① USER-SUPPLIED TEXT SIZE

9113-15R3-A0113

Figure 12-7 Editor Menu Showing User-Supplied Text Sizes

3. Repaginate the document (see Section 12.3).
4. Change the value of Print Menu setting PS (page size), TM (top margin), or BM (bottom margin) when you go to print the docu-

ment. See Section 13.3. Such action is necessary because these Print Menu settings must satisfy the following relationship:

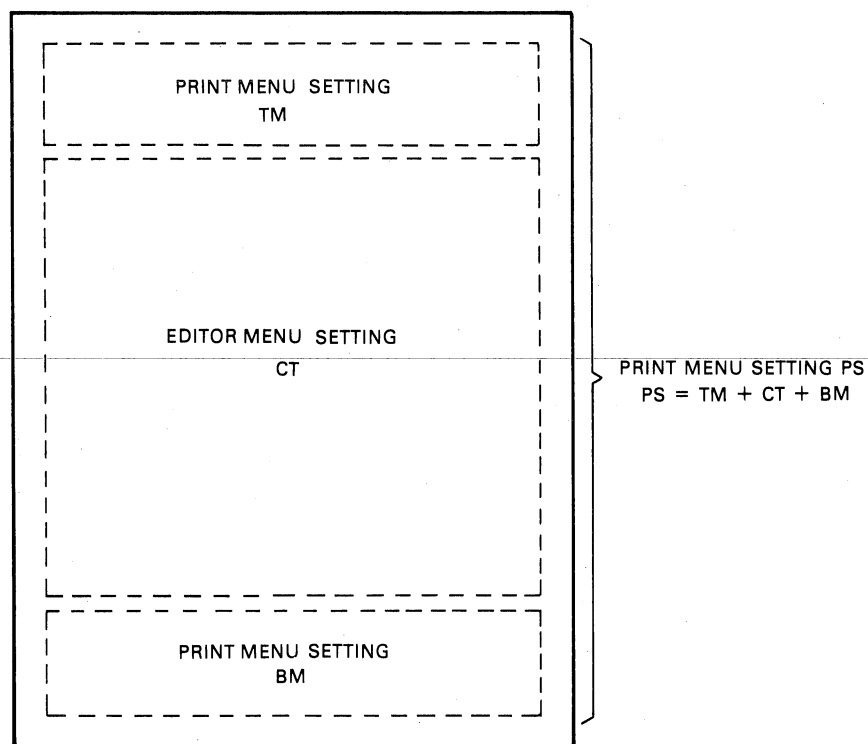

Figure 12-8 Relationship of Editor and Print Menu Settings for Page Size

---

If you change CT in the Editor Menu and do not change PS, TM, or BM, your document will not be printed correctly.

## CHAPTER 13 PRINTING A DOCUMENT

Some of the features of printing with the word processing system are:

- **Simultaneous printing and editing.** While a document is being printed, you can create or edit another document (not the same one). This feature enables both you and the system to operate efficiently. You don't waste time waiting for printing.
- **Unattended printer operation.** You can submit as many as eight documents for printing and then leave the area. The system will automatically print each document in its turn. You can use continuous form-feed paper so you won't have to keep an eye on the system while it's printing.
- **Number of copies and pages.** You can print one entire copy of a document, several copies of it, or just certain selected pages.
- **Extra space.** You can have the system add extra vertical space between lines to produce a draft copy, one which can easily be marked up. You can also add extra space in the left margin (horizontal) to leave room for notations.

- **Adaptability to reproduction.** If a printed document is intended to be used for photographic reproduction, you can have it printed extra dark. In addition, you can print a document with two different styles of type to produce a visually-attractive printed page.

Follow these steps to print a document:

1. **Type the letter P and press the RETURN key** when any Main Menu page is displayed on the screen.
2. **Identify the document to be printed** (see Section 13.1). The Print Menu, which contains different printing options (how many copies, what page to start with, line spacing, etc.), will be displayed on the screen.
3. **Inspect the print settings** and make any changes desired (see Section 13.3). As the Print Menu is set up with preassigned values, you may not have to change any settings (see Section 13.2).
4. **Make certain that the equipment and paper supply are ready** (see Section 13.4).

5. Type the word YES (or OK) and press the RETURN key when you are ready to print.

6. Type the letter N and press the RETURN key when printing is completed. You can perform this action when either the Main Menu or Stop Printer Menu (see Section 13.5) is displayed on the screen. This action advances the paper one page so you can easily rip it off.

You can interrupt printing at any time, even before the end of document is reached. This feature is useful if you see something that doesn't quite look right like a spot on the paper or poor printing quality. After fixing whatever caused you to halt, you can then perform one of several actions: (1) resume where you left off, (2) print only to the end of the page, (3) start printing the

entire document from the very beginning, (4) go back a few pages and resume printing (thereby avoiding reprinting those pages which are correct), or (5) altogether stop printing the document. See Section 13.5 for details.

You can submit printing requests even when your system does not have the desired printer. The system will put your requests into a "waiting to print" list without actually printing the documents. You can later take the diskette with the list to another system (which has the desired printer) and print the documents. See Section 13.7 for details.

### 13.1 IDENTIFYING A DOCUMENT TO BE PRINTED

After you type the letter P and press the RETURN key, the system asks you to identify the document to be printed.

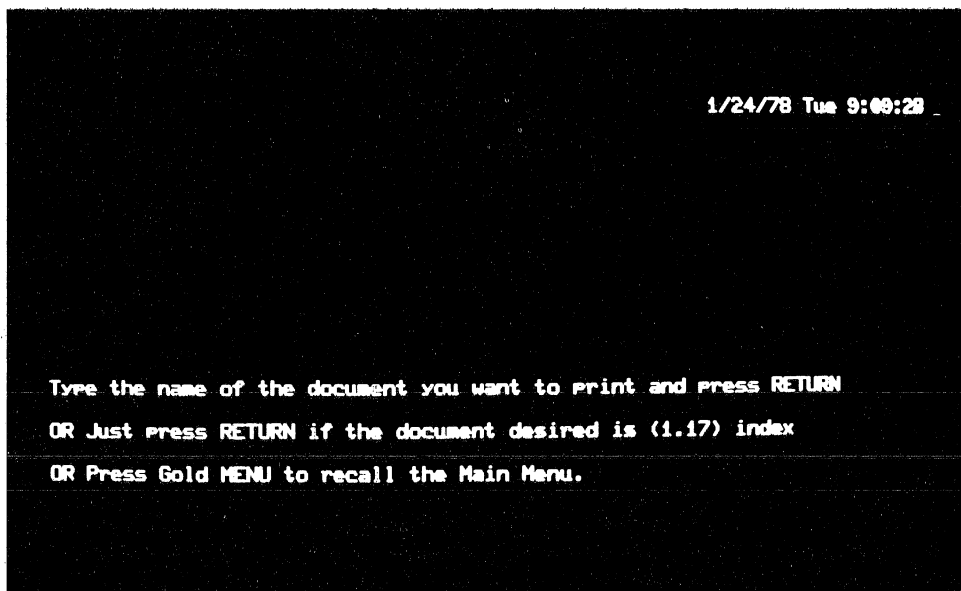

9113-15R1-A0117

Figure 13-1 Printing Request Prompt



If you have previously worked on another document in the current word processing session, the system will ask you if you want to print that document. If you have inspected the index, the system will ask if you want to print the document marked by the asterisk.

Type either the document's name or its number in the index. If the screen displays the correct document, just press the RETURN key.

As a shortcut, you can type the letter P, a space, identify the document, and press the RETURN key. In this case the word processing system does not prompt for your document name because you've already typed it.

### 13.2 PRINT MENU

Settings in the Print Menu control how a document is printed. After inspecting them, you can tell the system to go ahead and print according to the settings displayed, or you can change as many as desired.

The Print Menu actually consists of three pages. The first contains a summary of the print settings and their current values. This Print Menu page is displayed on the screen when you direct the system to print.

Here is an example of the first Print Menu page:

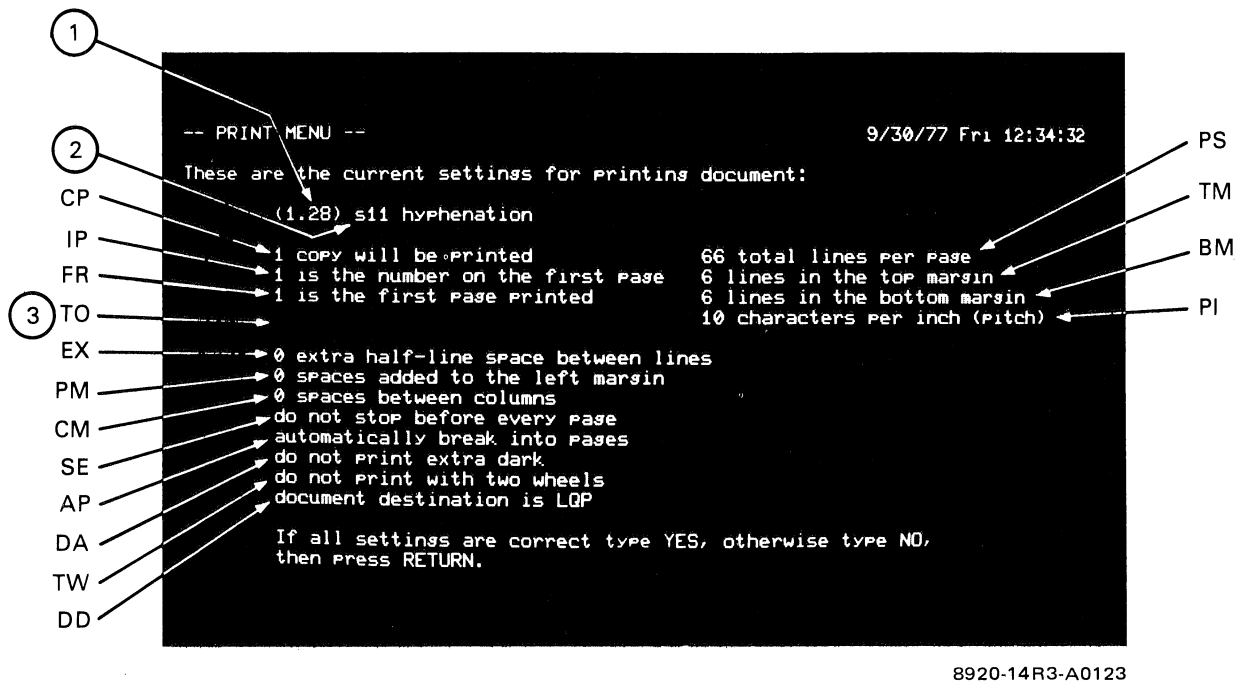

Figure 13-2 Example of Print Menu Page One (Version 2.7)

Items ①, ②, ③, ④, and ⑤ in the screen display are explained below. Items in the screen display marked with two letters are abbreviations and are explained in Table 13-1.

- ① **Diskette drive number and document number.** The first number is the diskette drive where the document is stored. The second is the document's number in the index.
- ② **Document name.** The document name you specified is displayed in this position. If you specified a document number, this screen position contains that number.

- ③ **Number of last page to be printed.** This line is blank (as in the example above) if you are printing to the last page of the document. This line contains information only if you specify printing is to stop before the last page of the document.

- ④, ⑤ **First and second replacement characters (Version 3.0 only).** These characters will be used in printing the document only if other characters have previously been relinquished.

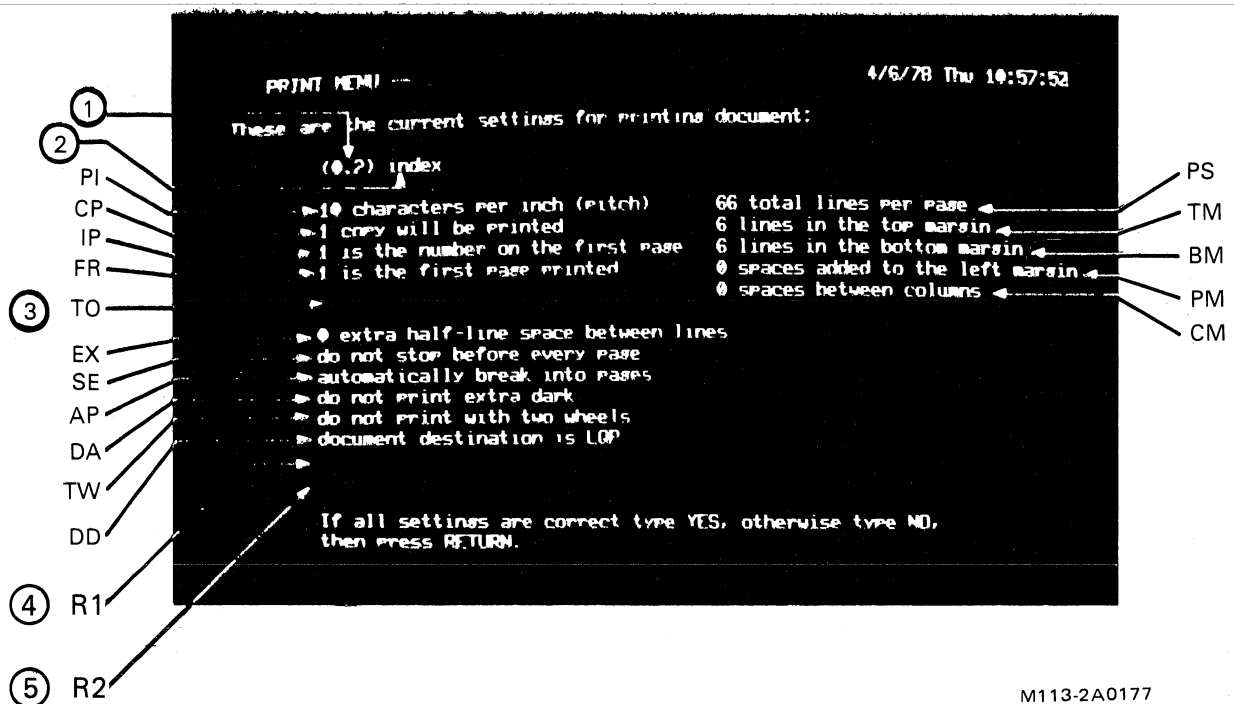

M113-2A0177

Figure 13-2 Example of Print Menu Page One (Version 3.0)

The second Print Menu page is displayed on the screen by typing NO and pressing the RETURN

key in response to the first Print Menu page. Here is an example of the second Print Menu page:

```
— PRINT MENU (cont.) —                               1/24/78 Tue 9:47:58
To change a setting type the letters and the new settings and press RETURN.
1 → CP = Number of copies to be printed (CP 1)
   IP = Initial page number (IP 1)
   FR = Print from this page number (FR 1)
   TO = Print up to and including this page number (TO 0)
   SE = Stop before each sheet (SE no)
   AP = Automatically break into pages (AP yes)
   DA = Darkness (DA normal)
   TW = Use two wheels (TW no)
   DD = Document destination (LOP)

   SS = Store print settings
   RS = Retrieve stored print settings

   PL = Show page layout settings (page size, margins, etc.)
   OK = All settings correct, print document.

       Press Gold MENU to go back to the Main Menu without printing.
```

① ABBREVIATION

② CURRENT VALUE

9113-25R3-A0122

(Version 2.7)

```
— PRINT MENU (cont.) —                               4/6/78 Thu 11:00:00
To change a setting type the letters and the new settings and press RETURN.

PL = Show page layout settings (page size, margins, etc.)

SE = Stop before each sheet (SE no)           CP = Number of copies (CP 1)
AP = Automatically paginate (AP yes)          FR = Print from page number (FR 1)
DD = Document destination (LOP)              TC = Print thru page number (TO 0)
DA = Darkness (DA normal)                    IP = Initial page number (IP 1)
TW = Use two wheels (TW no)

R1 = Replacement character for extra print wheel position 1
R2 = Replacement character for extra print wheel position 2

SS = Store print settings
RS = Retrieve stored print settings

       If all settings are correct, type OK and press RETURN
       OR Press Gold MENU to go back to the Main Menu without printing.
```

M113-3A0383

(Version 3.0)

Figure 13-3 Example of Print Menu Page Two

The second Print Menu page contains the following information for each setting:

- ① **Two-letter abbreviation.** Type this to change the value of a particular setting (same abbreviation as shown on the first Print Menu page).
- ② **A brief explanation** of the abbreviation's meaning.

- ③ **Current value** of the abbreviation. This is the number or word that follows the abbreviation within parentheses.

There is a third page to the Print Menu. It contains still more settings and their current values, specifically settings that control the appearance of the printed page. To display the third Print Menu page, type the letters PL (when either page one or two is displayed) and press the RETURN key. Page three will be similar to this:

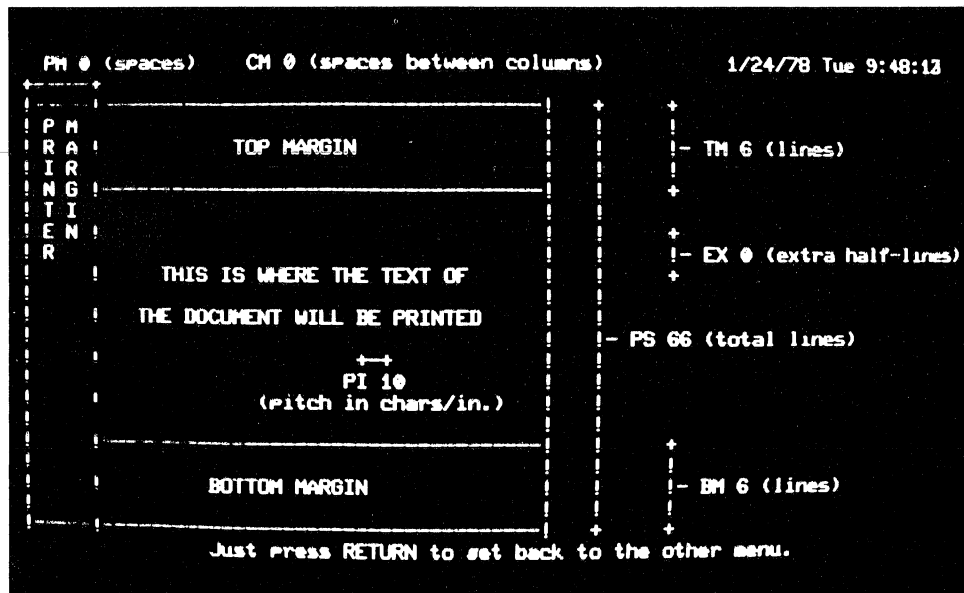

9113-27R1-A0119

Figure 13-4 Example of Print Menu Page Three

### 13.3 CHANGING PRINT MENU SETTINGS

If you are satisfied with the values of the Print Menu settings displayed, you can tell the system to start printing. Type YES or OK and press the RETURN key (see Section 13.4 for how to position the paper correctly).

To change a print setting, follow these steps:

1. **Type NO and press the RETURN key** when any Print Menu page is displayed on the screen.
2. **Type a two-letter abbreviation to identify the setting you want to change, a space, the new value, and press the RETURN key.** When you change a setting, the new value will be displayed on the screen (provided the ap-

propriate Print Menu page is displayed at that time). Repeat this step for each setting you want to change.

3. **Type OK or YES and press the RETURN key when you are ready to print.**

You can change any Print Menu setting no matter what Print Menu page is displayed on the screen. Therefore, if you remember the two letters for the abbreviation to be changed, you can omit typing NO (step 1).

Table 13-1 summarizes, in alphabetical order, all Print Menu abbreviations, their meaning, the values you can supply for each, and where to find more detailed information. The following sections present more detailed information.

Table 13-1  
Print Menu Settings

Abbreviation	Meaning	Possible Value Settings	Resets After Printing?	Printer On Which Values Take Effect	Refer Here for Additional Information
AP	Automatic Pagination. Page endings can automatically be determined by the system if desired.	YES, for having the system automatically paginate while printing. NO, for having the system use the page endings you specified.	NO	Letter quality printer Draft printer	Sections 12.1, 13.3.1
BM	Bottom Margin. Number of lines between the last line of text and the bottom edge.	Any number. This value plus the value of TM plus the value of Editor Menu setting CT must equal the value of PS if you have previously paginated the document.	NO	Letter quality printer Draft printer	Sections 13.3.2, 14.5
CM	Column Margin. Number of spaces (typing positions) to be added between multiple columns.	Any number between 0 and 999.	NO	Letter quality printer	Section 13.3.3
CP	Number of original copies to be printed. Copies are printed completely from beginning to end.	Any number between 0 and 999.	YES, to 1	Letter quality printer Draft printer	Section 13.3.4
DA	Darkness, or number of times characters are struck.	NORMAL, for striking each character once (except for boldface characters which are struck three times). DARK, for striking each character twice.	NO	Letter quality printer Draft printer	Section 13.3.5
DD	Document Destination. The output device to be used for printing.	LQP, for letter quality printer. DP, for draft printer. HOST, for output over the communications line. DP2, for a serial output device attached to the second communications port of a WS78 system.	NO	Letter quality printer Draft printer	

Table 13-1 (Cont.)  
Print Menu Settings

Abbreviation	Meaning	Possible Value Settings	Resets After Printing?	Printer on Which Values Take Effect	Refer Here for Additional Information
EX	Extra half-line vertical spacing. Number of extra, blank half-lines to be used between printed lines. This value is used in addition to the vertical spacing in the document's ruler(s).	0, 1, 2, 3	NO	Letter quality printer Draft printer	Section 13.3.6
FR	Print from this page number. Allows you to skip over some pages in the document before starting to print.	Any number between 1 and 999.	YES, to 1	Letter quality printer Draft printer	Section 13.3.7
IP	Initial Page number. This number appears in the header and/or footer of the first page printed (provided you specify the page number is to be printed).	Any number between 1 and 999.	NO	Letter quality printer Draft printer	Section 13.3.7
PI	Pitch, the number of characters that can be printed per inch.	Any number between 1 and 64 or THEME (for proportional spacing).	NO	Letter quality printer	Section 13.3.8
PL	Display the page layout.	Not applicable. Typing this abbreviation causes the third Print Menu page to be displayed on the screen.	Not applicable	Letter quality printer Draft printer	Section 13.2
PM	Print Margin. Number of spaces (typing positions) to be added to the left of each printed page.	Any number between 0 and 999.	NO	Letter quality printer Draft printer	Section 13.3.9
PS	Page Size. Number of lines that can fit on a page from the top edge to the bottom (6 lines = 1 inch).	Any number between 1 and 200. Here are some suggested values: 66, for 11-inch long paper 84, for 14-inch long paper	NO	Letter quality printer Draft printer	Section 13.3.10

Table 13-1 (Cont.)  
Print Menu Settings

Abbreviation	Meaning	Possible Value Settings	Resets After Printing?	Printer on Which Values Take Effect	Refer Here for Additional Information
RS	Retrieve stored print settings. Values of all Print Menu settings associated with the number typed after RS are to be used in printing the document.	Any number between 0 and 9. The settings associated with 0 are used the first time each document is printed.	Not applicable	Letter quality printer Draft printer	Section 13.3.12
R1	Replacement character for extra print wheel position 1.	Any character.	NO	Letter quality printer	Section 13.3.11
R2	Replacement character for extra print wheel position 2.	Any character.	NO	Letter quality printer	Section 13.3.11
SE	Stop every page (so you can insert special paper).	YES, for stopping at the beginning of each page. NO, for printing continuously from the first through the last page. FIRST, for stopping only at the beginning of the first page of a document.	NO	Letter quality printer	Section 13.3.13
SS	Save stored print settings. Saves the values of all this document's print settings and associates them with the number typed after SS (see RS also).	Any number between 0 and 9. The settings associated with 0 are used the first time each document is printed.	NO	Letter quality printer Draft printer	Section 13.3.12
TO	Print to this page number. Allows you to stop printing prior to the last document page.	Any number between 0 and 999 (0 means print to the last document page).	YES to 0	Letter quality printer Draft printer	Section 13.3.7

MK 0585



Table 13-1 (Cont.)  
Print Menu Settings

Abbreviation	Meaning	Possible Value Settings	Resets After Printing?	Printer on Which Values Take Effect	Refer Here for Additional Information
TM	Top Margin. Number of lines between the top edge of each page and the first text line printed. A header, if used, will be printed here.	Any number. This value plus the value of BM plus the value of Editor Menu setting CT must equal the value of PS.	NO	Letter quality printer Draft printer	Sections 13.3.2, 14.5
TW	Two wheels. Two different type styles can be used to print a document (done by means of two different print wheels).	YES, for using two print wheels. NO, for using one print wheel.	NO	Letter quality printer	Section 13.3.14

MK 0588

### 13.3.1 Specifying Pagination

Print Menu setting AP (Automatic Pagination) lets you automatically paginate a document while printing. If you set AP to YES, the word processing system will determine where to end each page and start the next. The number of text lines automatically printed per page will be equal to the total number of lines per page (Print Menu setting PS) less the number of lines in the top margin (Print Menu setting TM) less the number of lines in the bottom margin (Print Menu setting BM).

If you set AP to NO, the word processing system will use PAGE MARKER and NEW PAGE marks which you have placed in the document (see Chapter 12 for details). If you set AP to NO without paginating your document, it will be

printed as one long page. This means it may extend across the paper fold if you're using form-feed paper or onto the roller (platen) if you're using single sheet paper.

### 13.3.2 Specifying a Top Margin and Bottom Margin

Print Menu setting TM (Top Margin) lets you specify a top margin, a number of lines above printed text on each page. Similarly, Print Menu setting BM (Bottom Margin) lets you specify a bottom margin, a number of lines below the printed text on each page. You can leave these margins blank, use them for a header and/or footer (see Chapter 14), or eliminate them altogether and allow the text to be printed from the very top edge of a page to the bottom.

By changing TM or BM you are effectively changing the number of text lines that may appear on a page, because the following relationship exists:

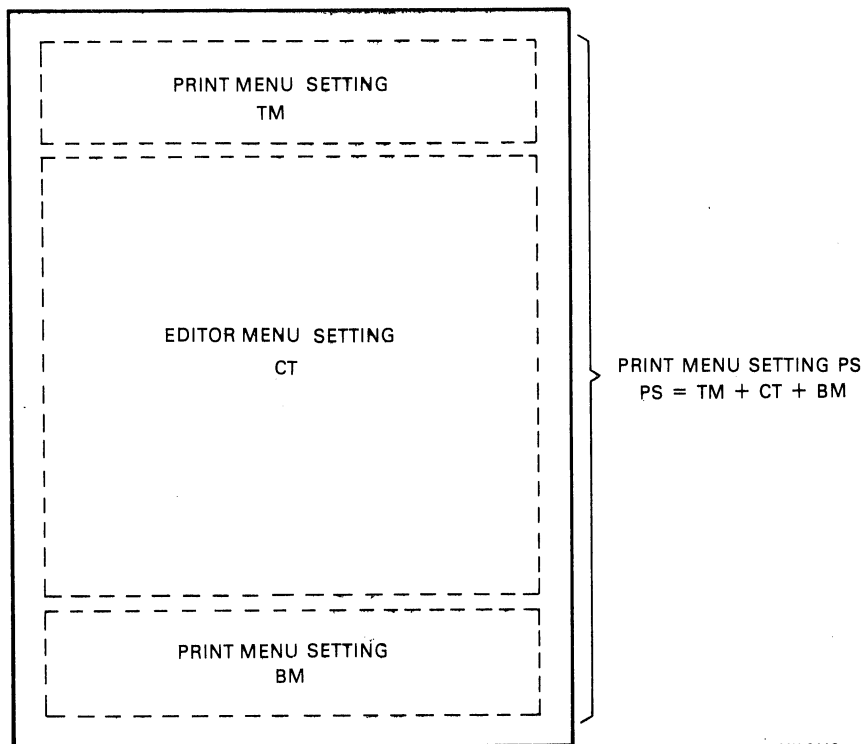

MK-0110

Figure 13-5 Relationship of Editor and Print Menu Settings for Page Size

If you have paginated the document and have directed the word processor to use your page endings (by setting AP to NO), you must also change the value of the current text size (setting CT in the document's Editor Menu) when changing TM or BM. This action is necessary to preserve the relationship shown above.

To change the value of CT, follow these steps:

1. Add the values of TM and BM together and then subtract the sum from the value of Print Menu setting PS, the total number of lines that can fit on a page. Remember this value. For example, if you change TM to 13 and BM to 8 when PS is 66, then the value to remember is 45.
2. Type the word NO and press the RETURN key to redisplay the Main Menu.

3. Bring the document to the screen for editing.
4. Press the gold and the MENU keys to display the Editor Menu.
5. Type the letters CT, a space, the value computed in step 1, and press the RETURN key. The CT value just typed will be displayed on the screen.
6. Press the RETURN key again. The document will return to the screen.
7. If you have previously paginated the document, you must repaginate it to accommodate the new text size (see Section 12.3.1).
8. File the document.
9. Submit the document for printing.

### 13.3.3 Multiple Column Printing

You can type text as one long continuous column and then have it printed with two or more columns per page. For example, here is some text which is printed as two columns:

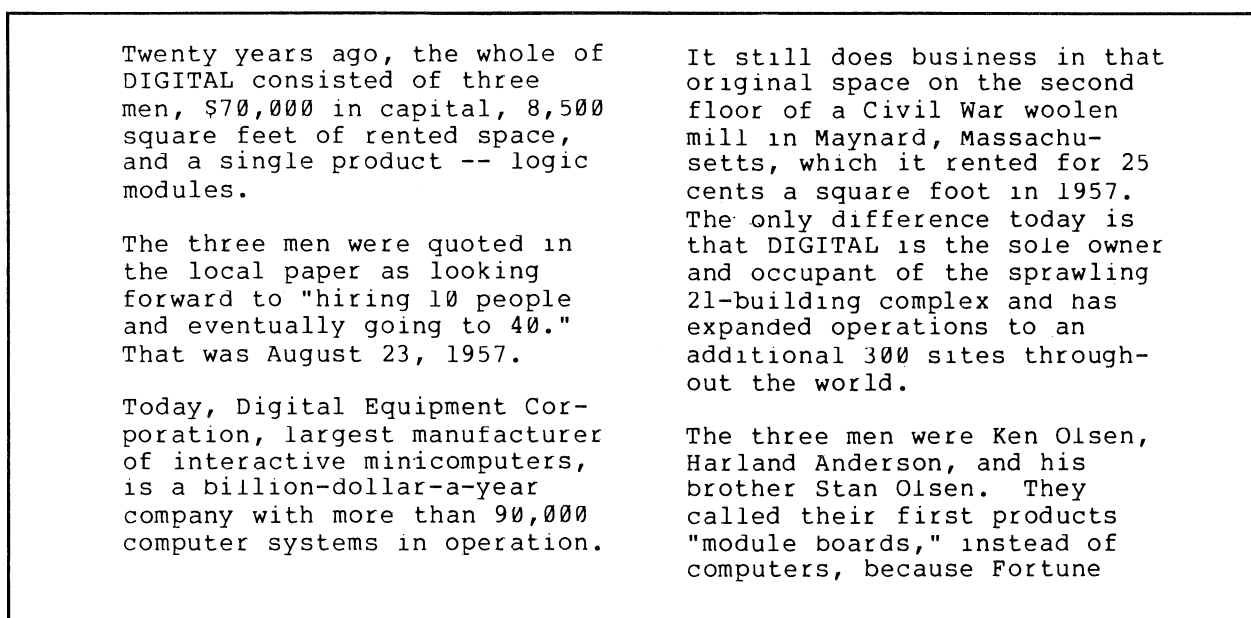

MK-0329

Figure 13-6 Example of Two-Column Printed Text

The system prints each column completely from top to bottom before starting the next. In the above example, the entire first column was printed, then the paper was automatically turned back to the top of the page, and the entire second column was printed.

To indicate that text is to be printed with two or more columns, you must put a "multicolumn" command into your document.

1. **Position the cursor in your document where multiple column printing is to begin.** Be certain the ruler to be used with the multiple column text is in effect.
2. **Press the gold and the CMND keys.** A line of dashes with the words START PRINT CONTROL will be displayed on the screen (this line counts as one word processing character so you can remove it with either

the DEL CHAR or RUB CHAR OUT key).

3. Type the word MULTI and press the RETURN key.

4. Type the number of columns you want printed and press the RETURN key again.

5. Press the gold and the CMND keys again. A line of dashes with the words END PRINT CONTROL will be displayed on the screen (this line also counts as only one word processing character).

Here is how the above example was typed on the word processing system:

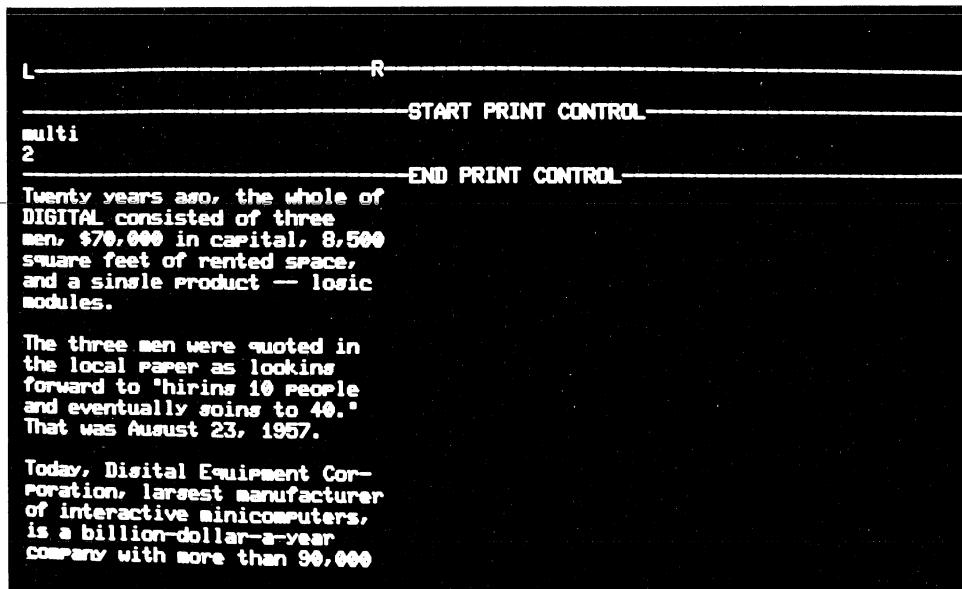

9113-29R3-A0126

Figure 13-7 Example of Typing Two-Column Text

When you tell the system to print your document, it will print the number of columns you specified in the multicolumn command (step 4 above) on each page. If you want to change the number of columns printed, just insert another multicolumn command into your document and specify a different number. For example, if you

want only the first part of a document printed in two columns and the last part in just one, put a multicolumn command with the number 2 at the beginning of your document and another one with the number 1 where the single column is to start.

**13.3.3.1 Space Between Multiple Columns -**  
You can print multiple columns separated by an equal amount of space. Set the value of Print Menu setting CM (Column Margin) to the num-

ber of blank typing positions desired between the printed columns. Here is an example of columns separated by two spaces:

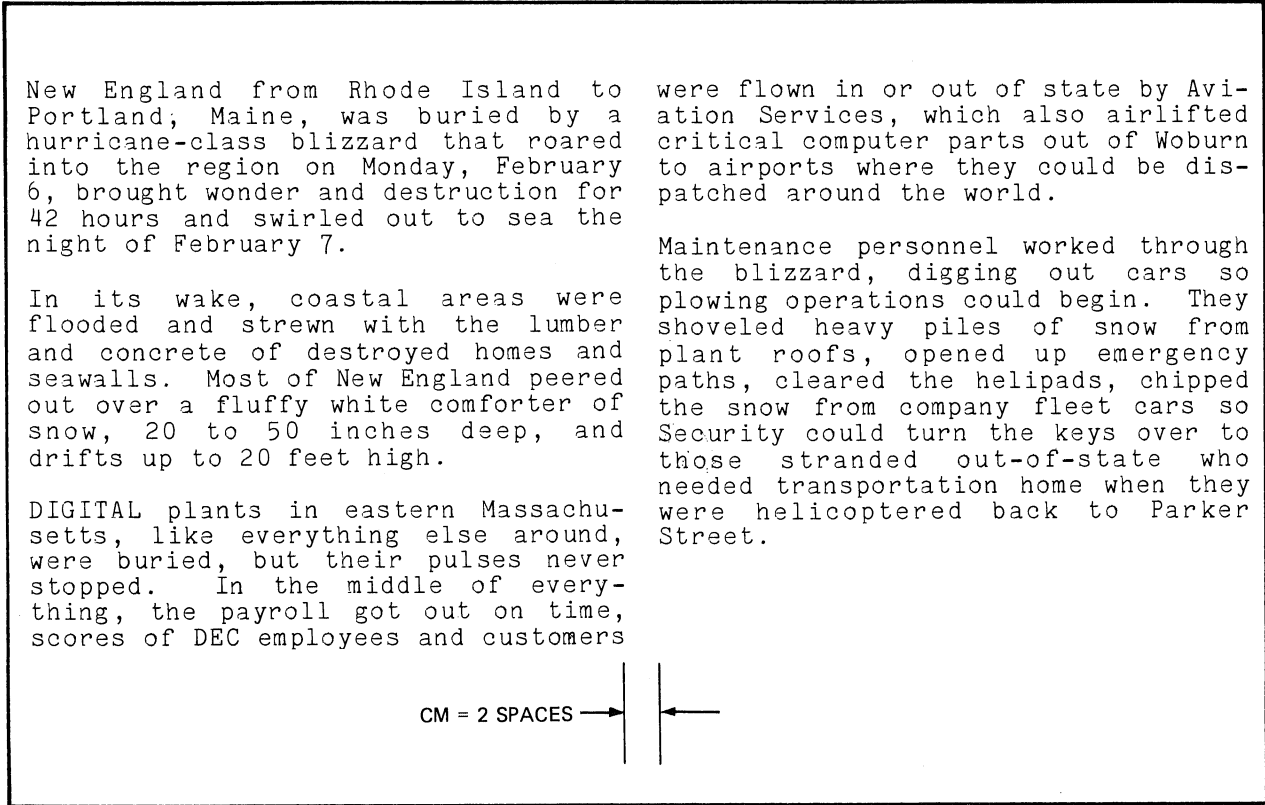

MK-0330

Figure 13-8 Example of Two-Column Text Separated by Two Spaces

If you want to print multiple columns separated with different amounts of space, specify the width (number of typing positions) of each column within the multicolumn command. On the multicolumn command line immediately following the number of columns, put the number of typing positions to appear in the first column

and press the RETURN key. Type a similar line for each of your multiple columns.

Here is an example of a multicolumn command that specifies different widths for each of three columns:

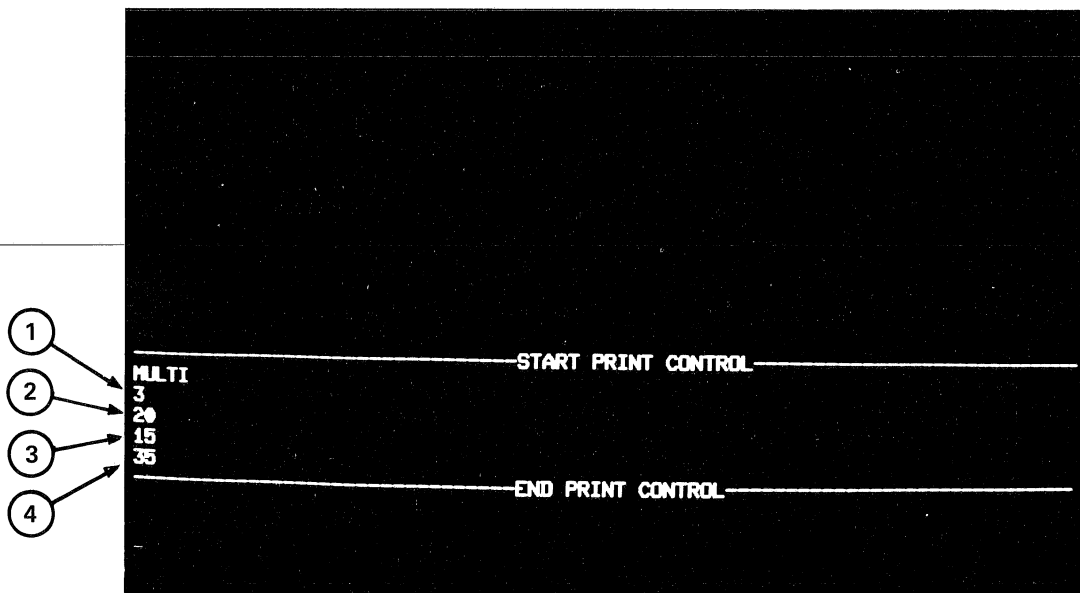

- ① 3 COLUMNS
- ② WIDTH OF FIRST COLUMN
- ③ WIDTH OF SECOND COLUMN
- ④ WIDTH OF THIRD COLUMN

9113-31R3-A0121

Figure 13-9 Example of Specifying Different Widths in Multiple Columns



When giving the number of typing positions in each of your multiple columns, be careful to specify a number that is larger than the value of the right margin ruler position. For example, if your ruler is set up with a right margin at typing position 30, you should specify a number greater than 30 for that particular column in your multi-column command. If you don't, your columns may be printed on top of one another.

ruler and "puts it down" so that typing position number 1 is next to the previous column's right margin ruler position (either setting J or R). Because the system "puts down" more than one ruler on a single page, be careful to use a ruler narrow enough that all your columns will fit on the paper.

The following diagram illustrates how the system uses rulers in multiple column printing:

**13.3.3.2 Effect of Rulers** - When you print with multiple columns, the system "picks up" your

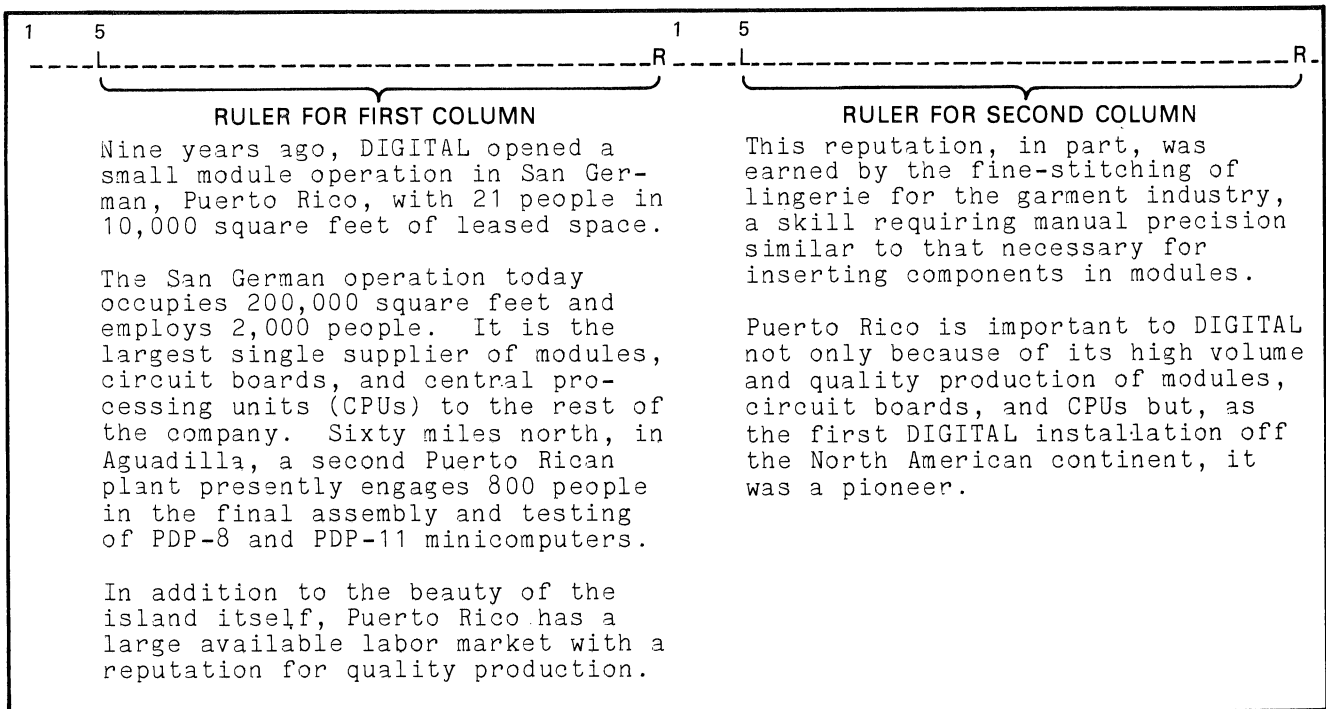

MK-0331

Figure 13-10 Example of Ruler Use with Multiple Columns

### 13.3.3.3 Advancing to New Columns and Pages

– When using single column printing, both a PAGE MARKER and NEW PAGE mark indicate the beginning of a new page. When using multiple column printing, however, a PAGE MARKER and NEW PAGE mark indicate the beginning of a new column. Similarly, when you direct the system to determine page endings while printing (by setting AP to YES), the system will automatically start a new page if single column printing is used, a new column if multiple column printing.

To indicate that multiple column text is to be printed at the beginning of a new column, insert

a NEW PAGE mark in your document by pressing the gold and the NEW PAGE keys.

To indicate that multiple column text is to be printed at the beginning of a new page, do the following:

1. Put a multicolumn command immediately after the last word on a page. This command should contain just the word MULTI or the word MULTI followed by either the number 0 or 1.
2. Press the gold and the NEW PAGE keys to insert a NEW PAGE mark.
3. Insert a multicolumn command.

Here is an example of how to set up a report to be printed with two columns so that each chapter starts on a new page:

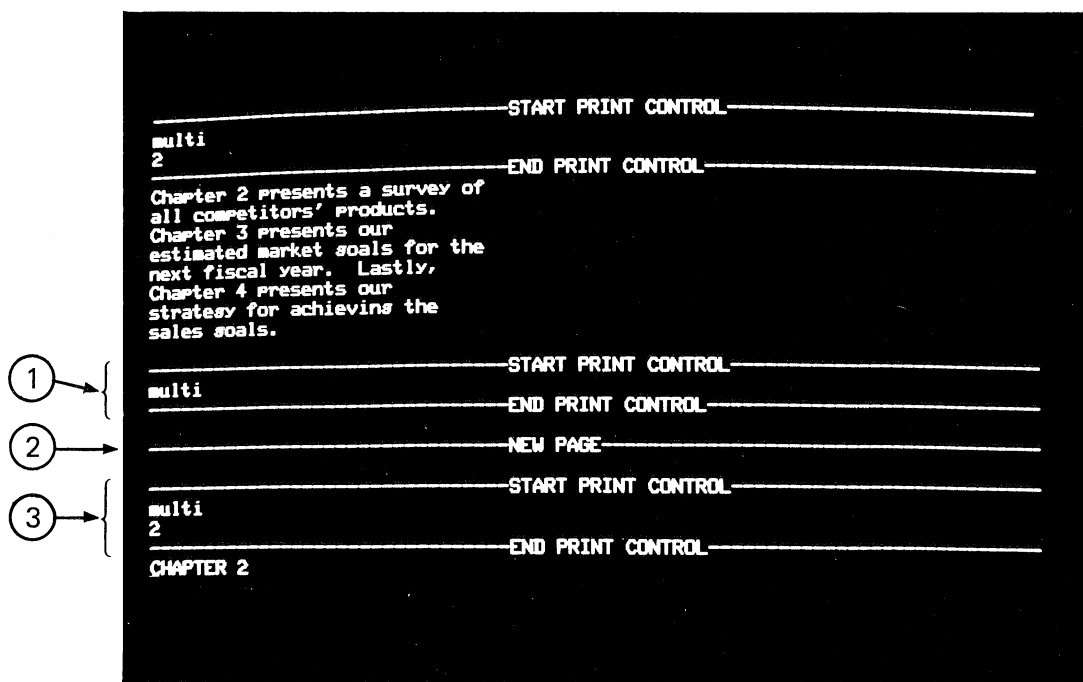

M123-16-A0197

- ① MULTICOLUMN COMMAND
- ② NEW PAGE MARK
- ③ MULTICOLUMN COMMAND

Figure 13-11 Example of Starting Multiple Column Text on a New Page

**13.3.3.4 Printing Multiple Columns of Unequal Length** - You can print columns of unequal length across a page and then correctly start again at the left margin. For example, you can print paragraphs in one language on the left side

of each page and the same paragraphs translated to another language on the right.

Here is an example of a complicated table that was produced with the word processing multiple column feature:

Operating Controls and Indicators		
<u>Control/Indicator</u>	<u>Type</u>	<u>Function</u>
Power circuit breaker	Switch with associated pilot light.	Controls application of ac power to printer power supply and, consequently, controls application of dc power to printer.
PAUSE switch	Illuminated pushbutton	Allows the operator to interrupt printer action to service exhaustible supplies such as ribbon, paper, and print wheel. When pressed, the switch cap illuminates; the printer finishes all commands currently in process; and the CHARACTER, CARRIAGE, and PAPER RIGHT READY lines are de-activated.

Figure 13-12 Example of a Complicated Multiple Column Table Produced by Word Processing

Here is how to use the multiple column feature with unequal portions of text:

first two rows of the "Operating Controls and Indicators" table, type the text in the order shown below.

1. Type the text for each column in horizontal order. For example, if you want to print the

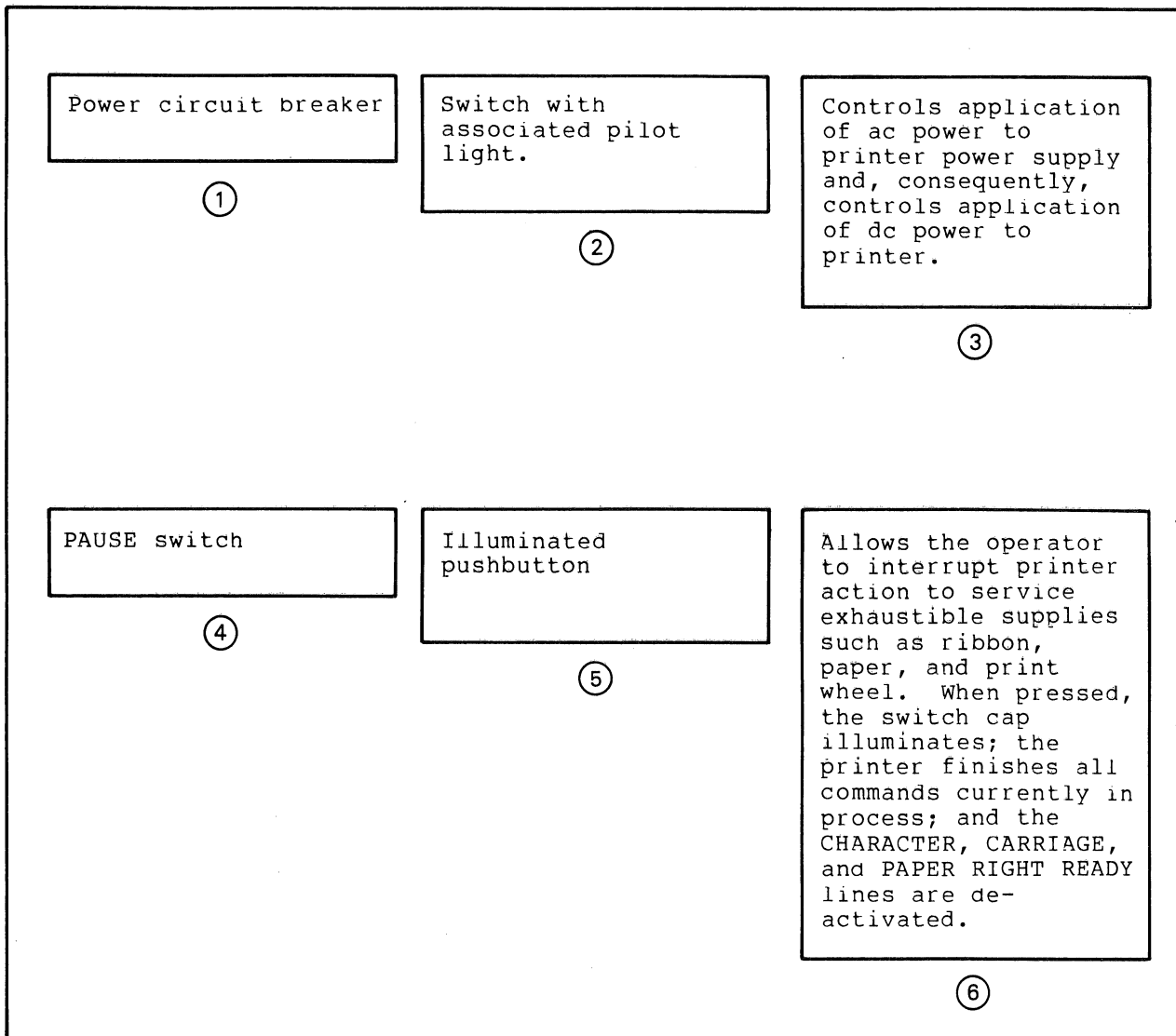

MK-0111

Figure 13-13 Example of Order in Which a Multiple Column Complicated Table Was Typed

2. Put a NEW PAGE mark at the end of each portion except the last in each horizontal group. For the above example, put a NEW PAGE mark at the end of portions 1, 2, 4, and 5.

above example, put the same multicolumn command at the beginning of portions 1 and 4.

3. Put the same multicolumn command at the beginning of each horizontal group. For the

Here is how the beginning of the "Operating Controls and Indicators" table was typed:

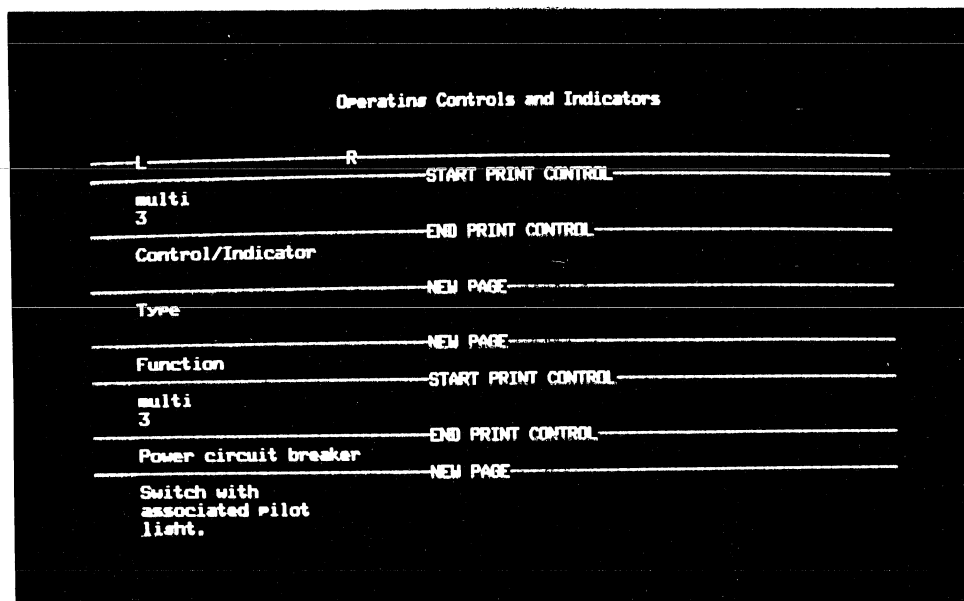

M105-27-A0133

Figure 13-14 Example of Screen Display for Typing a Multiple Column Complicated Table

**13.3.3.5 Qualifications** – The following qualifications apply to multiple column printing.

1. In order to determine correct page endings when printing multiple columns, first print your document automatically (with AP set to YES). Then inspect the printed document, decide where each page should end,

edit the document, insert a NEW PAGE mark at the end of each page, and reprint the document.

2. If two columns are reversed when printed, insert an additional NEW PAGE mark where you want the previous page to end. Then reprint the document.

### 13.3.4 Specifying the Number of Copies To Be Printed

Print Menu setting CP (CoPies) lets you indicate how many original copies are to be printed. Each copy is printed completely from beginning to end.

If desired, you can set CP to a very large number. Just be certain that there is an adequate supply of paper.

After the document is printed, CP is automatically reset to one.

### 13.3.5 Specifying the Document Destination

Print Menu setting DD (Document Destination) lets you indicate the kind of printer to be used. The possible settings are: LQP, for a letter quality printer; DP, for a draft printer; HOST, for output over the communications line; and (for Version 3.0 only) DP2, for connecting a serial draft printer to the auxiliary port of a WS78 system. The HOST value may be used for a DIGITAL serial line printer or a photocomposition machine.

When DD is set to DP2, the value of System Options Menu setting DP2 must indicate the baud rate (communications line speed) of the serial draft printer (see Appendix G).

If your word processing system has only one kind of printer, you must correctly set DD to indicate that particular printer. If you don't, your document will not start printing when you tell the system you are through changing Print Menu settings. To correct this situation, do the following:

1. Type the letter S and press the RETURN key. The Stop Printer Menu (see Section 13.5) along with the message "The printer is stopped for nonexistent printer" will be displayed on the screen.
2. Type the letter S and press the RETURN key again. The Main Menu will be displayed on the screen.
3. Submit the same document for printing again (by typing the letter P and identifying the document). The Print Menu will be displayed on the screen.
4. Set the value of DD correctly.
5. Tell the system to print your document (by typing YES or OK and pressing the RETURN key).

### 13.3.6 Adding Extra Vertical Space

The EX (EXtra) Print Menu setting lets you add extra vertical space between printed lines to leave room for marking changes (rough draft). After you have incorporated all changes into the document, you can print it without the extra vertical space. The extra space added by EX does not affect how the document is stored.

The allowable values for EX when a letter quality printer is used are 0, 1, 2, and 3. These values denote the number of extra half-lines to be added to whatever spacing is specified in the document's rulers.

If you set EX for extra vertical space (to either 1, 2, or 3) when using a draft printer, you'll get a different effect than you would with a letter quality printer. That's because the draft printer can print only in whole line increments. Sometimes you will get an extra whole line and other times no additional vertical spacing (effect depends on a combination of EX value and ruler line spacing).

An alternative method of adding extra vertical space is to change the line spacing in the document's rulers. However, this method requires

you to change all your rulers again when ready for final printing. The advantage of adding extra space by means of EX is that you don't have to make any changes to document rulers.

If you have previously paginated the document and are using EX to add extra vertical space, set AP to YES to have the system automatically determine where each page should end as the document is printed. The system will then ignore any page endings you previously specified (with PAGE MARKERS). These endings were calculated using a different number of text lines per page (inserted before you decided to add extra vertical space) and are no longer correct. Once you reset EX to zero to remove the extra line spacing, you can also reset AP to NO so the system will use your page endings.

You can specify your own page endings and not have the system determine them by doing the following:

1. Change the value of the number of text lines per page (setting CT in the document's Editor Menu) to account for the extra vertical line spacing.
2. Repaginate the entire document.

See Section 12.4 for how to perform the above steps.

Should you decide to specify your own page endings when adding vertical space with setting EX, here are recommended values to use for CT. These CT values assume your text is typed single-spaced (ruler setting character L) and the number of lines in the top margin and bottom

margin (Print Menu settings TM and BM, respectively) are each equal to six.

EX Value	CT Value for 8 1/2 by 11 Inch Paper	CT Value for 8 1/2 by 14 Inch Paper
0	54	72
1	36	48
2	27	36

### 13.3.7 Specifying the First and Last Pages To Be Printed and the Number To Appear on the First Page

The FR (FRom) and TO Print Menu settings let you print a selected range of document pages. This feature is useful if you make just a few changes to the text of a large document which has already been printed: all you need print again are the changed pages. For example, if you want to print only page four, set both FR and TO to four.

Once printing is complete, the values of the FR and TO settings are reset to their original values. The value zero for TO means printing is to continue through the last page of the document.

The IP (Initial Page) Print Menu setting lets you set the number to be printed on the first page of a document. (See Section 12.1 for how to direct the word processing system to automatically number pages.) This feature is useful if you maintain separate documents for a large report and want each segment of the report numbered in sequence. If the first document, or segment, contains pages one through ten of the report, set IP to eleven before printing the second document.



Always set the value of IP to the number that would appear on the first page of the document even if you are not printing the first page. Be sure to take the value of IP into consideration

when setting FR. For example, if you want to start printing with the third page of a document and want it numbered 23, set the value of IP to 21 and FR to 23.

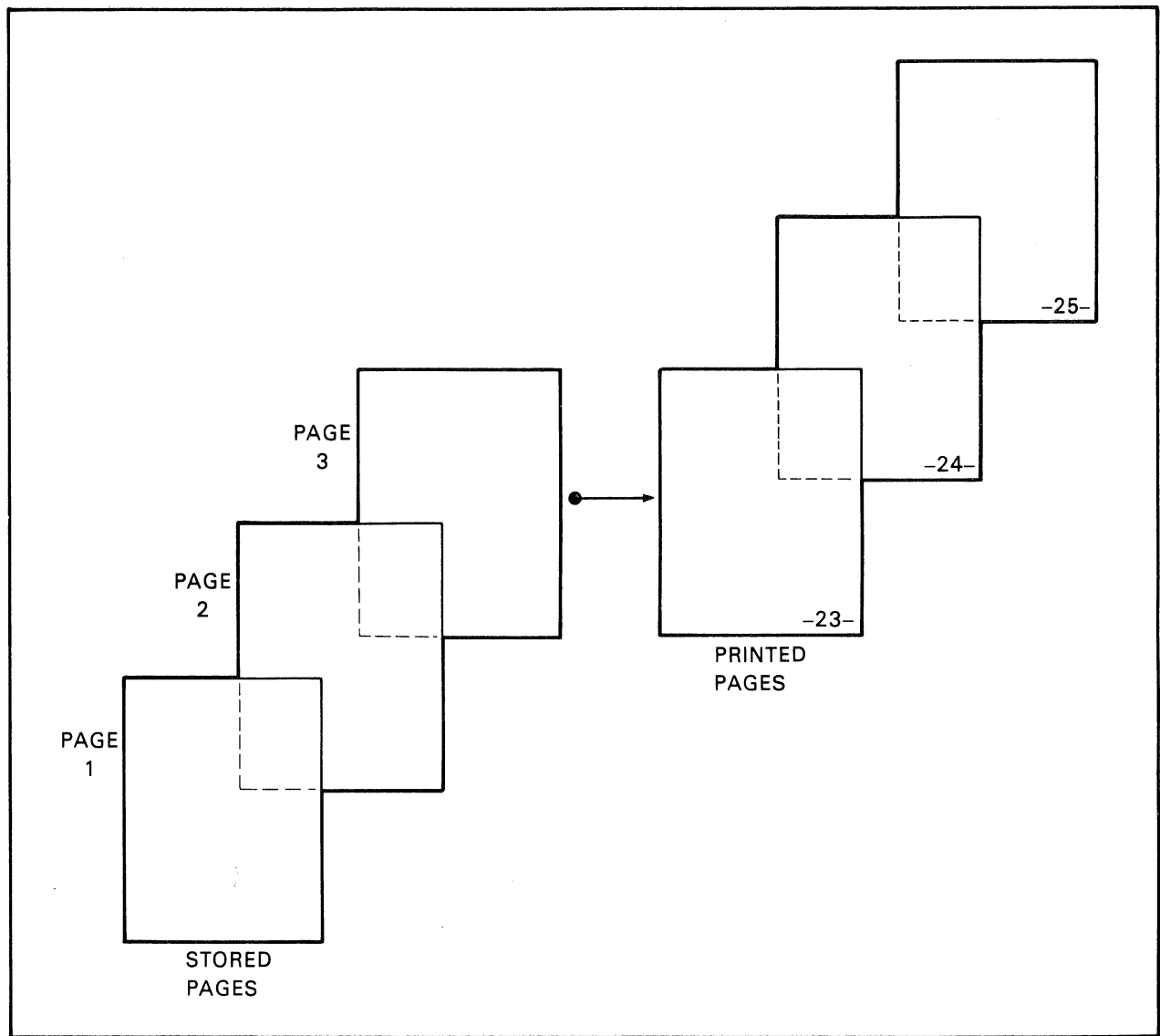

MK-0112

Figure 13-15 Example of Printing the Third Stored Page as Number 23

### 13.3.8 Specifying the Pitch

*Pitch* means the maximum number of characters to be printed per inch. When using a letter quality printer, set the value of PI to whatever number appears in the center of the print wheel. Because a draft printer can print only ten pitch, do not change the value of setting PI when using a draft printer. (While you can change it, the new value will have no effect.)

Here are two examples of different pitch settings:

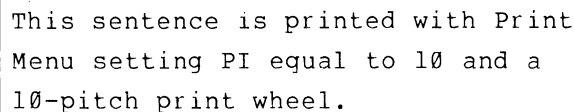

This sentence is printed with Print  
Menu setting PI equal to 10 and a  
10-pitch print wheel.

Figure 13-16 Example of Using Ten-Pitch  
Letter Quality Printer  
Print Wheel

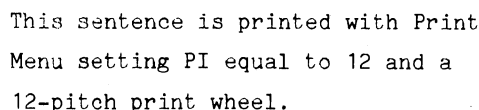

This sentence is printed with Print  
Menu setting PI equal to 12 and a  
12-pitch print wheel.

MK-0104

Figure 13-17 Example of Using Twelve-Pitch  
Letter Quality Printer  
Print Wheel

The system prints PI characters per inch regardless of what pitch print wheel is actually used. Therefore, setting the value of PI to a number larger than what appears on the print wheel will cause compressed printing. Similarly, setting PI to a number smaller than on the print wheel will cause “stretched out” printing. For example:

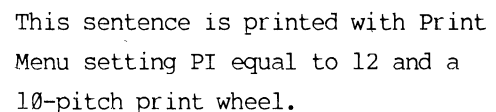

This sentence is printed with Print  
Menu setting PI equal to 12 and a  
10-pitch print wheel.

MK-0105

Figure 13-18 Example of Using a Ten-Pitch  
Print Wheel with a  
Twelve-Pitch Setting

If a line is justified, the number of characters printed per inch may be less than the value of PI because the system adds extra space between characters when justifying to “stretch” a line so it lines up with the right margin. Therefore, if the system adds much extra space when justifying the line, it will have less than the number of characters per inch you specified for PI.

**13.3.8.1 Proportional Spacing** - You can also print a document with proportional spacing. This causes different characters to be printed with different widths.

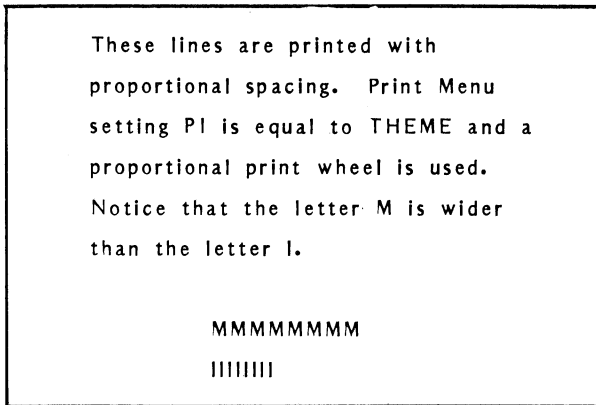

MK-0106

Figure 13-19 Example of Proportional Printing

To print a document with proportional spacing, follow these steps:

1. **Tell the system you want to print a particular document** (by typing the letter P and identifying the document) and change any Print Menu settings desired.
2. **Set the value of Print Menu setting PI to THEME** (the name of the proportional print wheel).

3. **Tell the system to start printing** (by typing either OK or YES and pressing the RETURN key).

**13.3.8.2 Qualifications** - The following qualifications apply to proportional printing:

1. If you know (1) other documents have been submitted for printing before yours or (2) the printer is not set up with the proportional print wheel, you should also set the value of Print Menu setting SE to FIRST. This action guarantees that your document will not start printing before you have installed the proportional print wheel. When the printer stops, type the letter S and press the RETURN key. The following message will be displayed on the screen:

The printer is stopped for SE first

Make sure the proportional print wheel is installed in the printer. Then type the letter R and press the RETURN key. The system should now start printing your document.

2. If you have short, single lines of indented text (such as items in a list or entries in table columns), indent such lines by changing your left margin position rather than by tabbing. This action is necessary to properly line up entries in table columns.

### 13.3.9 Adding Extra Space in the Left Margin

The PM (Printing Margin) Print Menu setting lets you add extra spaces (typing positions) in the left margin. This word processing feature can

be used to print text that might appear too close to the left edge of the paper (if the document's rulers have the left margin near typing position one).

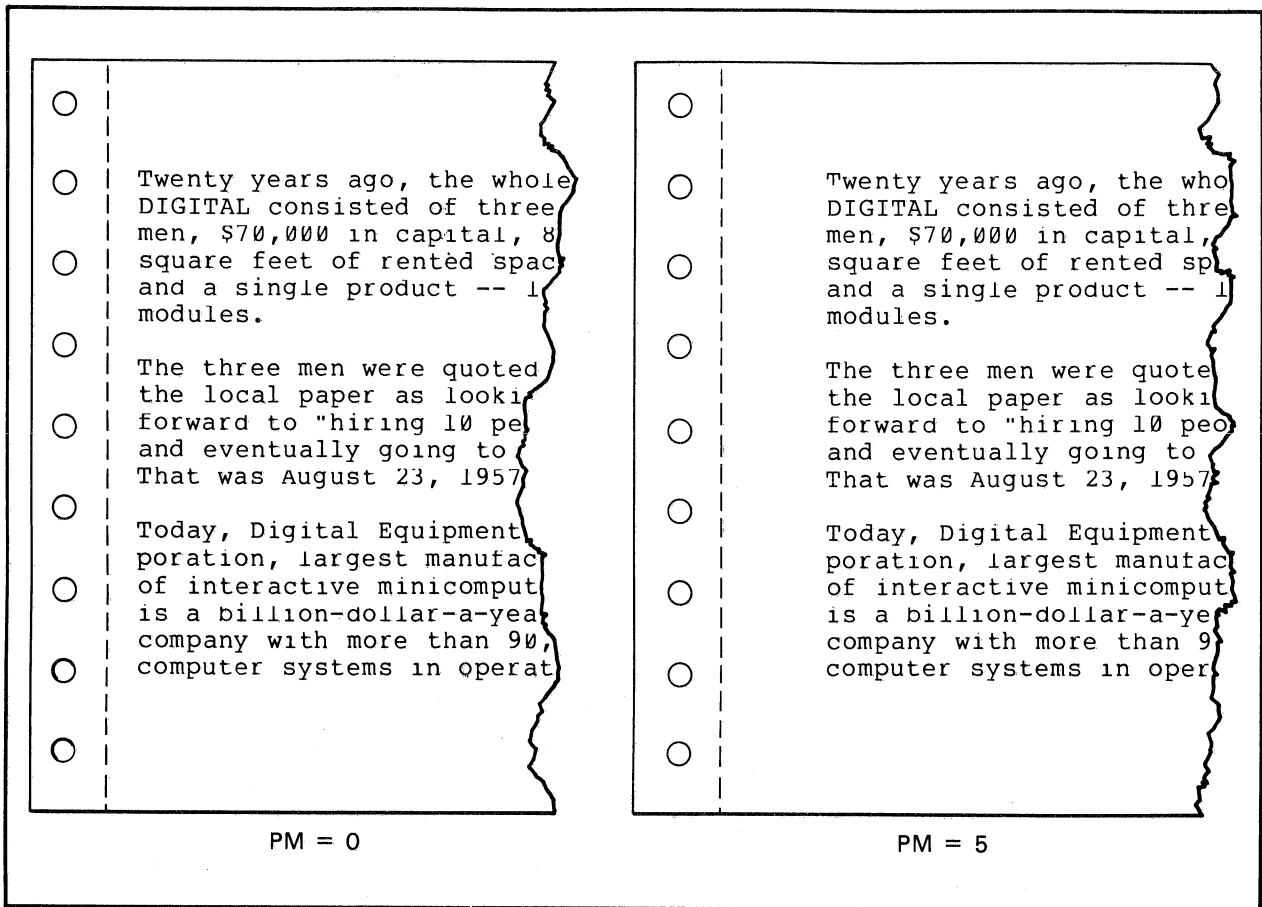

MK-0107

Figure 13-20 Example of Adding Space in the Left Margin of a Printed Page

Be certain you do not set PM so large that the printed document runs off the right side of the paper. The system will not check if the value you specify for PM is too big.

### 13.3.10 Specifying the Physical Page Size

The PS (Page Size) Print Menu setting lets you specify the total number of lines that fit on a page of paper, from the top edge to the bottom. Set PS so it is consistent with the paper size. Multiply the paper length (number of inches) by six (the number of printed lines per inch). Set PS to the value just computed. For example, set PS to 66 for 11-inch long paper and to 84 for 14-inch paper.

### 13.3.11 Using Extra Print Wheel Characters (Version 3.0 only)

The letter quality printer contains two more print wheel characters than word processing main keyboard keys. The R1 and R2 (Replacements 1 and 2) Print Menu settings let you print these two additional characters. It is necessary, however, to relinquish use of two other characters.

To use the extra print wheel characters, follow these steps:

1. Type the letters R1, a space, the first printing character to be replaced, and press the RETURN key when any Print Menu page is displayed on the screen. When the document is printed, the character you just typed will be replaced with the first extra print wheel character.
2. Type the letters R2, a space, the second printing character to be replaced, and press the RETURN key when any Print Menu page is displayed on the screen if you wish to use the second extra print wheel character.

3. Type the word OK or YES and press the RETURN key after changing any other Print Menu settings desired.

When a document is completely printed, the replacement characters specified for R1 and R2 remain set. To reset them before you next print the document, type the letters R1 and R2 and press the RETURN key when any Print Menu page is displayed on the screen.

The two extra characters may differ among the many available letter quality printer print wheels. If you are uncertain what the two are, replace any two characters and print a single page of a document. Then inspect the printed page to determine which two extra characters are present.

### 13.3.12 Saving and Retrieving Print Menu Settings

The SS (Store Settings) Print Menu setting lets you save as many as ten different groups of particular Print Menu values. The RS (Retrieve Settings) print setting lets you automatically retrieve a group of previously-saved print settings and apply them to any other document. This feature is useful if, for example, you always print rough drafts double-spaced on a letter quality printer.

You must type the values of each group of Print Menu settings once and then save them. Each time you go to print a document, you can automatically retrieve the saved settings and avoid unnecessary retyping.

Use the SS and RS Print Menu settings as follows:

1. **To save settings.** Change the values of all desired Print Menu settings, type the letters SS, a space, a single number between 0 and

9, and press the RETURN key. The group of Print Menu setting values saved with the number 0 are automatically used when a document is submitted for printing for the first time, unless you specify otherwise. Therefore, type the number 0 after the letters SS only when you want to use those particular Print Menu settings with all other documents.

2. **To reuse a group of saved settings.** Type the letters RS, a space, the number of the saved group of desired settings, and press the RETURN key. You must use the system diskette with which you previously saved the settings (because they are stored on the system diskette).
3. **To change a group of saved print settings.** Type the letters RS, a space, and the group's number. This action displays the first Print Menu page with the previously stored values. Change as many settings as desired. Then type SS, a space, the number of the group, and press the RETURN key.

### 13.3.13 Stopping the Printer To Insert Special Paper

The SE (Stop Every) Print Menu setting lets you stop the printer to insert special paper. There are three possible values: NO, YES, and FIRST.

Set SE to NO to use continuous-form paper that is already inserted in the printer. In this case, the printer will not stop at all once you tell it to print. You can submit as many as eight different documents for printing, leave the word processing area of your office, let someone else use the system, and return later to pick up the printed copies.

Set SE to YES when you want to stop before printing each page, such as when using single let-

terheads or special forms. In addition, you must also do the following.

1. **Insert your special sheet of paper in the printer.** After you tell the printer to start (by typing OK or YES and pressing the RETURN key) and a Main Menu page is displayed on the screen, line up your paper (see Section 13.4) and pull the paper bail forwards.
2. **Type the letter R (for resume printing) and press the RETURN key.** You can do this in three different word processing situations:
  - When any Main Menu page is displayed on the screen.
  - When you are editing or creating a document and the Editor Menu is displayed on the screen (by pressing the gold and MENU keys). The document you were previously editing or creating will be displayed again as soon as printing resumes.
  - When the Stop Printer Menu is displayed on the screen (see Section 13.5).
3. **Flip the paper bail down** once printing begins so the paper will be held securely.

Repeat steps 1 - 3 each time the printer stops, at the beginning of each new page.

Set SE to FIRST when you want the printer to stop only before printing the first page. This setting allows you to print a document with different paper, a different print wheel, or a different ribbon from the one used for the previous document. To print with SE set to FIRST, follow steps 1 and 2 above.

### 13.3.14 Using Two Different Styles of Type

The TW (Two Wheels) Print Menu setting lets you print a document with two different type styles. Set TW to YES to print with two wheels. (It is generally preset to NO to print with just one.)

Printing two styles of type is done with two separate print wheels. First you print just part of a document from beginning to end with the first print wheel. This leaves "holes," or blank spaces that are to be printed with the second print wheel.

Here is how a paragraph looks after it has been printed with just the first wheel:

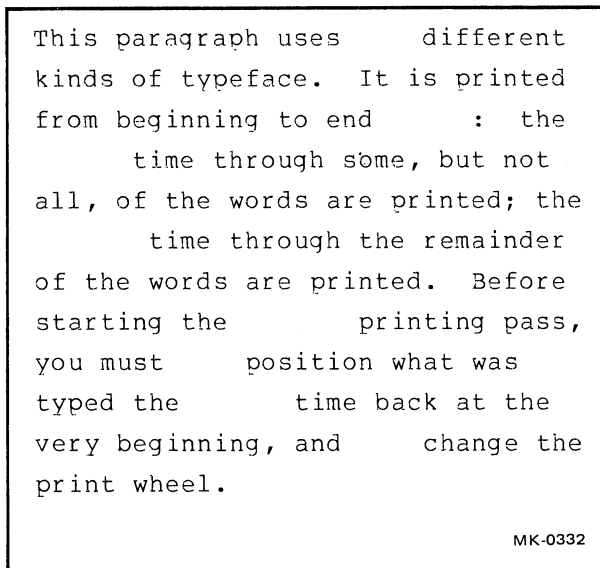

This paragraph uses different kinds of typeface. It is printed from beginning to end : the time through some, but not all, of the words are printed; the time through the remainder of the words are printed. Before starting the printing pass, you must position what was typed the time back at the very beginning, and change the print wheel.

MK-0332

Figure 13-21 Example of Two-Typeface Text After Being Printed with the First Print Wheel

Next you remove the print wheel, insert the second wheel, reposition the paper back at the top, and print again, this time filling in the holes. Here is how the example paragraph looks after it has been printed the second time:

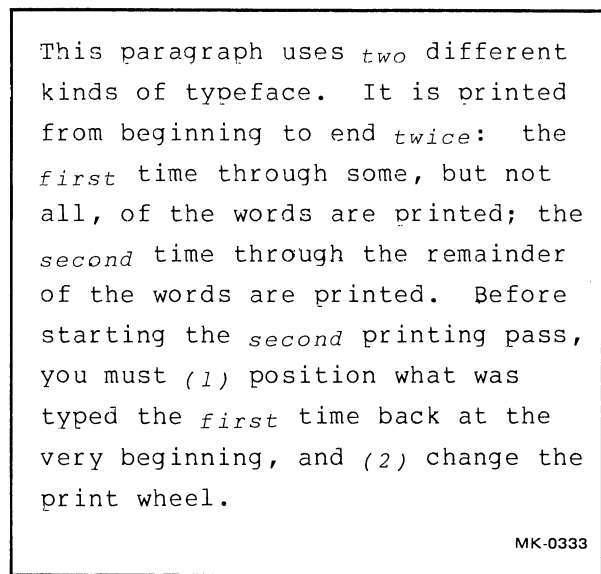

This paragraph uses two different kinds of typeface. It is printed from beginning to end twice: the first time through some, but not all, of the words are printed; the second time through the remainder of the words are printed. Before starting the second printing pass, you must (1) position what was typed the first time back at the very beginning, and (2) change the print wheel.

MK-0333

Figure 13-22 Example of Two-Typeface Text After Being Printed with Both Print Wheels

To print a document with two print wheels, follow these steps:

1. Edit the document and mark all text to be printed with the second wheel as if you wanted it printed in boldface (see Section 8.2).
2. Press the printer's PAUSE button, put the first wheel to be used into the printer, align the paper (see Section 13.4), and press the PAUSE button again.

3. Display the Print Menu, set TW to YES, change any other print settings, type OK, and press the RETURN key. The printer will print all text except what you marked for boldface.
4. When printing stops, put the second wheel into the printer. Reposition the printed document so the top edge of the first page is lined up. As the printer is going to fill in "holes" in lines that are already printed, be careful to get the paper lined up correctly.
5. Type the letter R (for resume) and press the RETURN key when the Main Menu, Editor Menu, or Stop Printer Menu is displayed on the screen. The printer will use the second print wheel to fill in the missing text.
6. When the printing stops, replace the print wheel with the one that was in the printer before you started your two wheel printing. Now type the letter R and press the RETURN key. If you don't, the system will not print another document.

If you set the value of SE to YES (for using single sheet paper) when printing with two wheels, the printer will stop at the beginning of every page. You then must type the letter R and press the RETURN key. After you have inserted the second print wheel, you must type R and press the RETURN key twice.

### 13.4 CHECKING OUT THE PRINTER

Before you tell the system to start printing (by typing either YES or OK and then pressing the RETURN key), check that the printer is properly set up. Follow this checklist.

1. **The printer is powered up and not paused.** If you're using a letter quality printer, the PRINTER READY button should be lit and the PAUSE button not lit. If you're using a draft printer, the POWER switch should be in the ON position and the ON LINE/OFF LINE switch in the ON LINE position.
2. **The correct print wheel (letter quality printer only) is properly in place.**
3. **The paper is correctly positioned at the top of a new page.** If it is not, your printing might start in the middle of a page and extend across the paper fold. To align the paper when using a letter quality printer, follow these steps:
  - Press the gold and the MENU keys. A Main Menu page will be displayed on the screen. Now type the letter N and press the RETURN key. This action advances the paper to the top of a new page.
  - If the paper is not positioned correctly, line up the top edge of the paper so it is even with the paper alignment point. Then roll the knob up two stops (clicks).
  - Type the letter P, press the RETURN key, and specify the document to be printed.
4. **The paper supply is adequate.**



### 13.5 INTERRUPTING PRINTING

You can interrupt printing at any time, even before the end of the document being printed is reached, by typing the letter S (for Stop) and

pressing the RETURN key (when any Main Menu page is displayed on the screen). This action stops the printer (after a few more lines are printed) and displays the Stop Printer Menu on the screen.

```
-- STOP PRINTER MENU --                               9/30/77 Fri 13:07:45

R = Resume printing and return to the last menu
N = New page, bring the printer to the top of the paper
S = Stop printing this document and return to the Main Menu
P = Continue printing until the end of this page
B = Start printing this document from the beginning
T = Go back a number of pages and resume printing from the top of the page
L = List the documents waiting to print

Type the letter and then press RETURN.
```

8920-20R3-A0124

Figure 13-23 Stop Printer Menu

At this point you have only interrupted printing. The Stop Printer Menu presents you with a list of options of what to do next. You can either cancel printing the rest of the document or resume printing (in several different ways). To

cancel printing, press the gold and the MENU keys. To resume printing, type the Stop Printer Menu letter for the desired option and press the RETURN key. The different options are described on the next page.

Table 13-2  
Stop Printer Menu Options

Stop Printer Menu Letter	Description	Stop Printer Menu Letter	Description
R	Resume printing. Printing continues exactly where it was interrupted and a Main Menu page (same one that was displayed before you typed the letter S) will be displayed on the screen. Use this option if, for example, you have interrupted printing to insert paper, a ribbon, or a print wheel.	B	Beginning. The printer will advance to a new page and start printing the interrupted document from the very beginning. The Main Menu will be displayed on the screen. Use this option if, for example, your ribbon is too light or you used the wrong kind of paper.
N	New page. The printer will advance the paper to the top of the next page but will not start printing. The Stop Printer Menu will still be displayed on the screen, and the printer will be waiting to continue printing the interrupted document. You must select another option.	T	Top of a few pages back. To use this option you must type the letter T, a space, and then a number specifying how many pages to go back. The printer will advance to a new page and start printing again where you specified. A Main Menu page will be displayed on the screen. Use this option if, for example, your last few pages are spotted or wrinkled.
S	Stop printing (cancel) the interrupted document. A Main Menu page will be displayed on the screen. If there's another document waiting to be printed, it will be printed.	L	List waiting documents. All the documents which you have submitted for printing (including the interrupted one) will be displayed on the screen in the order they will be printed. This gives you a general estimate of how much more printing you have to do (because it doesn't tell you how large each document is). Use this option if, for example, your paper supply is running low and you want to know how soon you will have to insert a new box.
P	Page end. Printing will continue to the end of the current page only. The Main Menu will be displayed on the screen and the printer will be waiting to continue printing the interrupted document. Redisplay the Stop Printer Menu and select another option.		

If you type S to interrupt the printer when it is not in use, the message "The printer is not in use now." will be displayed on the screen.

### 13.6 WHEN PRINTING FAILS TO START

Sometimes when you submit a printing request your document might fail to start printing. There are four reasons why this might happen.

1. **Other printing requests were submitted before yours.** When this occurs, the system will print your document as soon as all previously-submitted requests are printed. If the system is not currently printing a document, you can rule out this reason.
2. **The system cannot accept any more printing requests until the document currently being printed is done.** You can submit as many as seven additional requests while a document is being printed. The following message will be displayed on the screen if you try to submit too many document printing requests:

There are already 8 documents waiting to print. Press RETURN to recall the Main Menu.

If the screen does not display the above message, you can rule out this reason.

3. **The printer is not turned on or is paused.** If you're using a letter quality printer, the PRINTER READY button should be lit and the PAUSE and END OF RIBBON

buttons not lit. If you're using a draft printer, the POWER switch should be in the ON position and the ON LINE/OFF LINE switch in the ON LINE position.

4. **You made an incorrect Print Menu setting or you directed the system to stop so you could perform some special action** (such as inserting special paper or a different print wheel).

If the last reason appears to be the cause, you can get more information from the system and then take action to get your printing started. Type the letter S and press the RETURN key when any Main Menu page is displayed on the screen. If the following message is displayed on the screen, you never submitted the request that you thought you did.

The printer is not in use now.  
Press RETURN to recall the Main Menu

Just resubmit your request to start the document printing.

If the system is not printing because you directed it to stop or you made an incorrect Print Menu setting, a descriptive message will be displayed on the screen. The following summary of all messages that might appear (in alphabetical order) explains what to do to get your document to start printing.

## Message

Printer not active  
(Type AK NO and press RETURN)

The printer is stopped at the end of the page

The printer is stopped for nonexistent printer

The printer is stopped for "R" to print a proportional-spaced document (Version 2.7)  
The printer is stopped for "R" to begin dedicated printing (Version 3.0)

The printer is stopped for SE first

The printer is stopped for SE yes

The printer is stopped for the print wheel change

## Action

1. Type the letters AK, a space, and press the RETURN key.
2. Type the letter R and press the RETURN key.

1. Select one of the Stop Printer Menu options listed in Section 13.5, type its corresponding letter, and press the RETURN key.

1. Type the letter S and press the RETURN key. This action cancels printing your document.
2. Resubmit your document for printing.
3. Set the value of Print Menu setting DD (for document destination) so it correctly specifies the printer which is connected to your system (see Section 13.3.5)
4. Tell the system to start printing (by typing OK or YES and pressing the RETURN key).

1. Type the letter R and press the RETURN key. As soon as you take this action, you won't be able to create, edit, transmit, or receive a document until your document is completely printed. If you must continue other word processing work, press the gold and the MENU keys (type R and press the RETURN key only when you're ready to print).

1. Insert your special paper.
2. Type the letter R and press the RETURN key.

1. Insert your special paper.
2. Type the letter R and press the Return key.

1. Insert your print wheel.
2. Type the letter R and press the Return key.

### 13.7 PRINTING DOCUMENTS ON ANOTHER SYSTEM

The SL (Store List) Main Menu command lets you put printing requests into a "waiting to print" list without actually printing the documents on your system. The RL (Retrieve List) Main Menu command lets you use a different system and print the documents from the list. This feature is useful if, for example, your system has a letter quality printer but you want to print on a draft printer or if your system does not have a printer at all.

#### 13.7.1 Saving a List of Documents To Be Printed on Another System

To save a document in the print list, follow these steps:

1. **Submit all documents for printing** (as many as eight) by displaying the Print Menu, changing any desired settings, typing OK or YES, and pressing the RETURN key.
2. **Type the letters SL and press the RETURN key** when any Main Menu page is displayed on the screen. The following will be displayed on the screen:

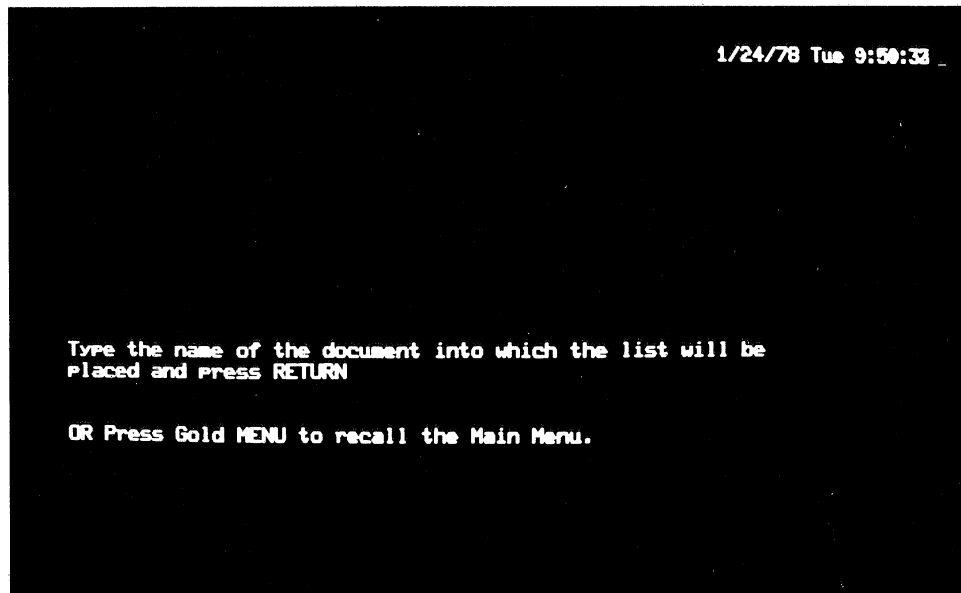

9113-35R3-A0125

Figure 13-24 Prompt for Saving a List of Documents to Be Printed

Respond to the prompt and then press the RETURN key (you could also type a space and identify the document immediately after typing SL). If you specify a document

which does not exist, the word processing system will automatically create it. If you specify one which does exist, the system will display the following:

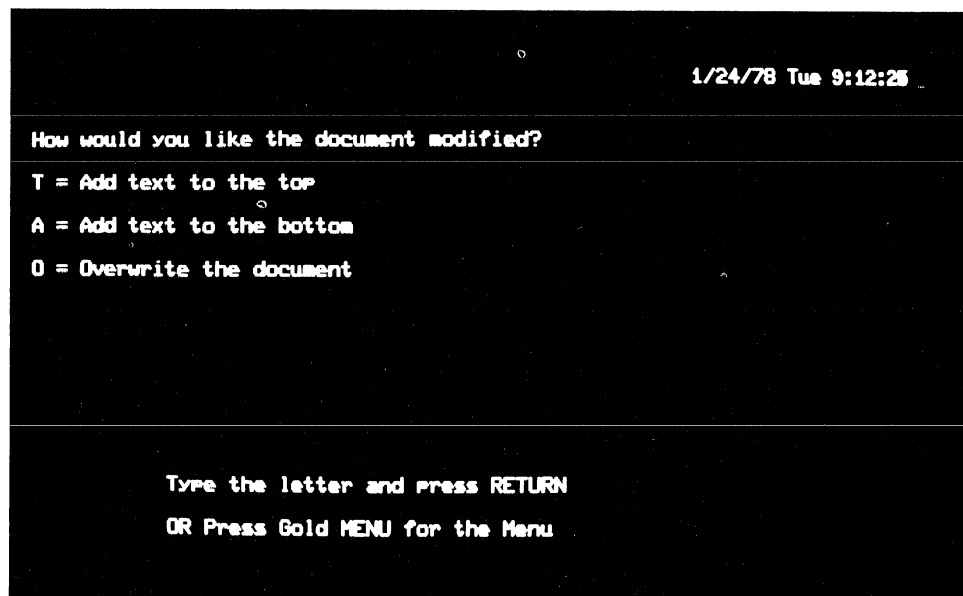

9113-27R3-A0116

Figure 13-25 Prompt for Modifying an Existing Printing List

After you specify the document to contain your printing list, the Main Menu will again be displayed on the screen.

### 13.7.2 Printing Documents from a Saved List

To print documents from a saved printing list, follow these steps:

1. Remove your document diskette from its drive and insert it into a drive on the system with the desired printer.

2. Type the letters RL and press the RETURN key when any Main Menu page is displayed on the screen. The following will be displayed on the screen:

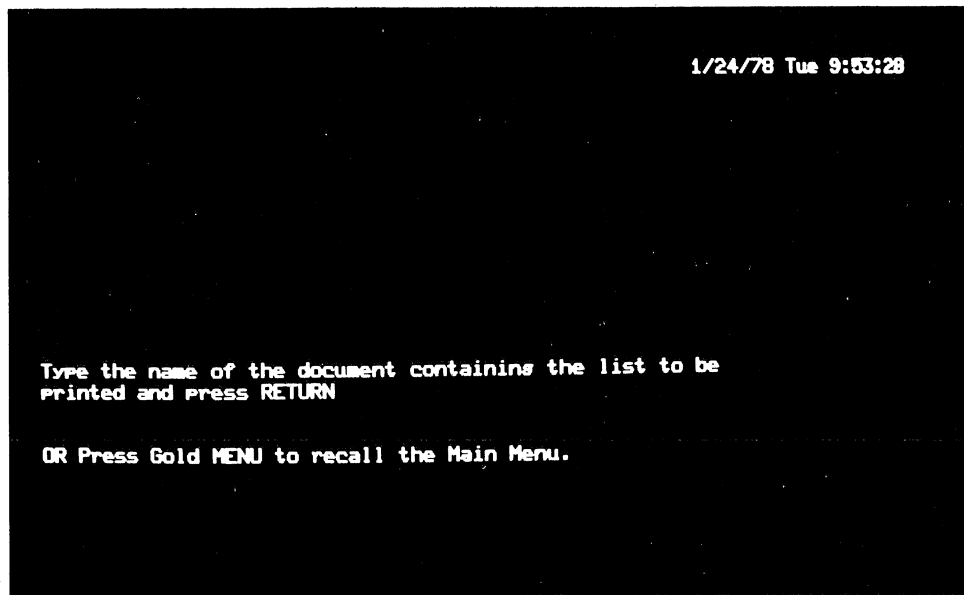

9113-2R4-A0118

Figure 13-26 Prompt for Printing Documents from a Saved List

3. Respond to the prompt and press the RETURN key (you could also type a space and identify the document immediately after typing RL).

After the documents are printed, the Main Menu will again be displayed on the screen.

### 13.7.3 Qualifications

The following qualifications apply to using the SL and RL commands:

1. Printing requests will be put into a list only if the documents to be printed are stored on the same diskette as the printing list document. Any documents on a different diskette will not be added to the list.
2. The RL command will be processed only if no documents are currently printing or waiting to print.





## CHAPTER 14 HEADERS AND FOOTERS

A header is text that appears at the top of printed pages and a footer is text that appears at the bottom of printed pages. Here is an example:

<pre> ***** History of the Mills FIRST DRAFT Jane Underwood, x315 ***** Building 3 dates from 1859, making it the oldest part of the mill in existence today, but several additions were made afterwards. the late 1800s arches over the ions were made to s. </pre>	<pre> ***** History of the Mills FIRST DRAFT Jane Underwood, x315 ***** The mill's best-known feature is the clock donated in memory of Amory Maynard by his son Lorenzo in 1892. Its four faces, each nine feet in diameter, are mechanically controlled ie tower. DIGITAL steps to wind the rns for the timer er. aw the changeover Until the 1930s, its own power but nard and several 1960s, power pro- used for outdoor hristmas tree near </pre>
<pre> ***** History of the Mills FIRST DRAFT Jane Underwood, x315 ***** CHAPTER 1 HISTORY  The mill buildings occupied by Digital Equipment Corporation in Maynard, Massa- chusetts, are modern examples of two old New England traditions. One is the classic mill town pattern: the development of industry and the growth of a community around it. The other is the "make it do" principle: the idea that it's better to get the most from what you have than to abandon it and buy something new and expensive.  The site of the mill was once part of the town of Sudbury, while the opposite bank of the Assabet River belonged to Stow. The present town, formed in 1871, was named for the man most responsible for its development, Amory Maynard.  ----- Page 1-1 Printed: 1/19/78 </pre>	<pre> ----- Page 1-2 Printed: 1/19/78  ----- Page 1-3 Printed: 1/19/78 </pre>

Figure 14-1 Example of Headers and Footers

You can use a header or footer to print identifying information on every page. This information may include the page number (automatically counted by the system) or the date the document is printed.

#### 14.1 CREATING A HEADER OR FOOTER

To create a header or footer, follow these steps:

1. **Position the cursor.** Edit your document and move the cursor to the top of the first page that will contain a header. If you do not put the cursor at the very top of the page, the header will not be printed until the next page. Footers are not so restrictive. You can position the cursor anywhere on the page that is to contain a footer.
2. **Press the gold and the CMND keys.** A line of dashes with the words START PRINT CONTROL will appear on the screen.
3. **Specify either a header or footer.** Type the word TOP for a header or the word BOTTOM for a footer, and press the RETURN key.
4. **Type the text of your header or footer and press the RETURN key.**
5. **Press the gold and the CMND keys again.** A line of dashes with the words END PRINT CONTROL will appear on the screen. If you leave out this step, you won't be able to print the remainder of your document.

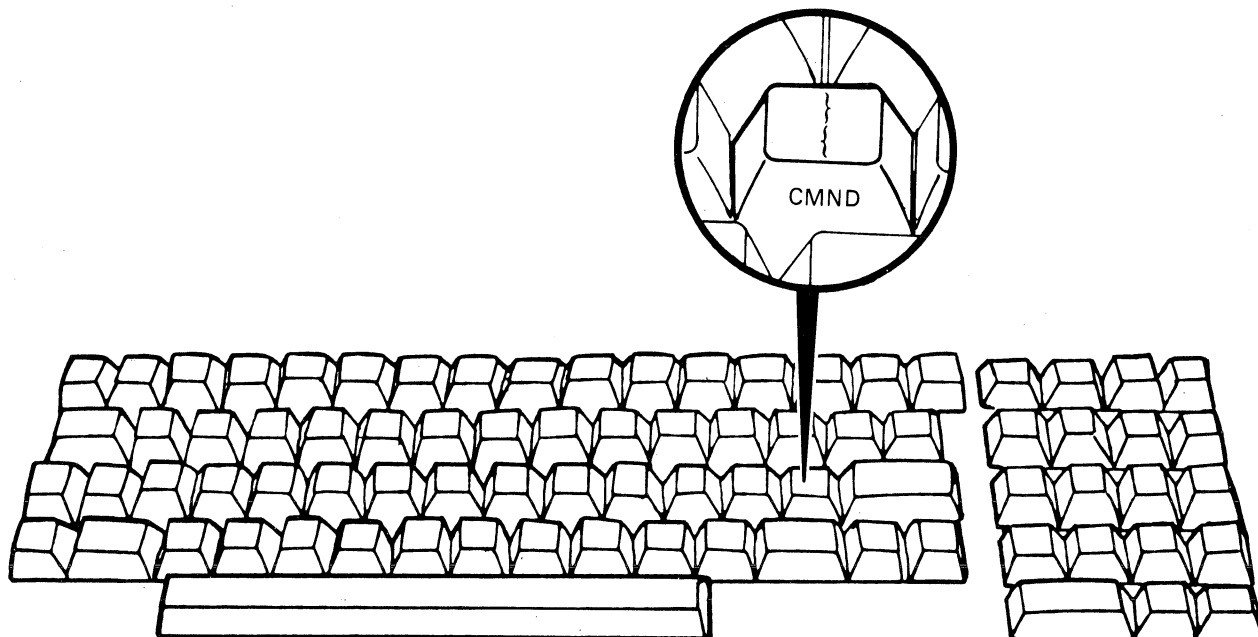

MK-0115

Figure 14-2 Main Keyboard CMND Key

You can have only a single header or footer between the “----START PRINT CONTROL----” and “-----END PRINT CONTROL-----” markers. To specify both a header and a footer, you must repeat steps 2-5.

Here is an example of how a header is typed:

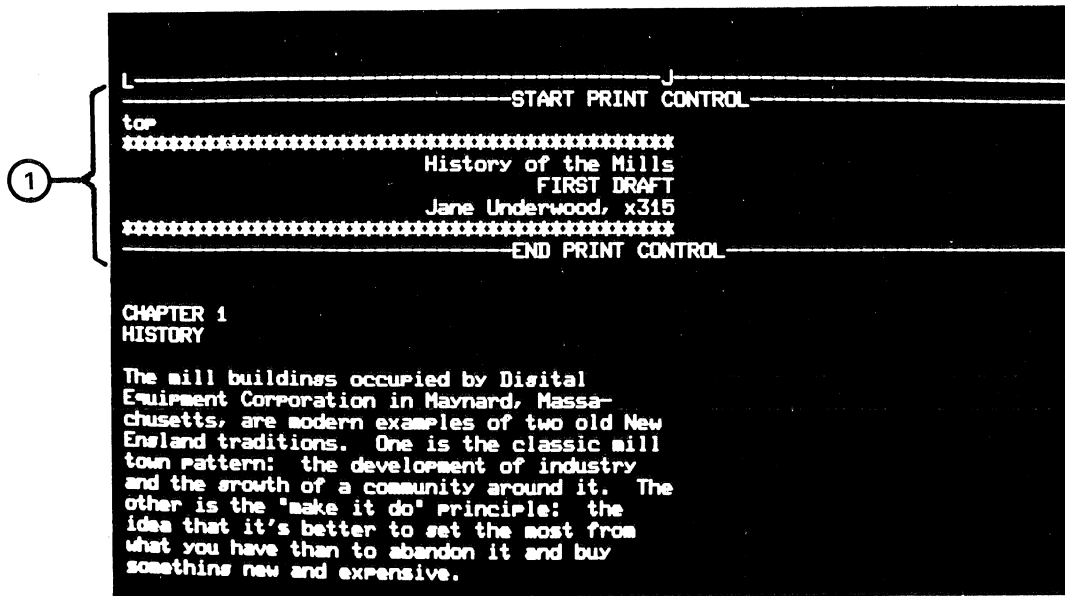

(1) HEADER

9113-4R4-A0128

Figure 14-3 Screen Display Showing a Header

Though not a requirement, it is a good idea to follow these guidelines when typing headers and footers.

1. Press the RETURN key an extra time after typing a header (before pressing the gold and the CMND keys). This sets the header

off from the first text on each page of your document by one line.

2. Press the RETURN key before typing a footer (after pressing the gold and the CMND keys). This sets the footer off from the text of your document by one line.

For additional space between a header or footer and your text, press the RETURN key the desired number of times.

#### **14.2 CHANGING A HEADER OR FOOTER**

It is not necessary to have the same information at the top or bottom of every printed page. You can change a header or footer as many times as needed. For example, you might want to print four pages of "Chapter 2" and then six of "Chapter 3." Just type a new header at the top of the first page of the third chapter.

Do not put two headers or footers on the same document page; only the last one will be printed.

The "----START PRINT CONTROL----" and "----END PRINT CONTROL----" markers each occupy only one character even though they are displayed as an entire line. Therefore, to remove either marker, use the DEL CHAR or RUB CHAR OUT key.

### 14.3 PRINTING THE DATE AND PAGE NUMBERS

You can also have the system automatically print the date at the top or bottom of each page. To have this done, put the two characters \d (only lower case may be used) into a header or footer. The system will use the date you specified when you started up (if you did not specify a date and time, 0/0/00 will be printed).

You can also have the system automatically print the number of each page. To have this done, put the two characters \p (only lower case may be used) into the header or footer in your document. It is possible to combine the page number with other text, as shown in the following example.

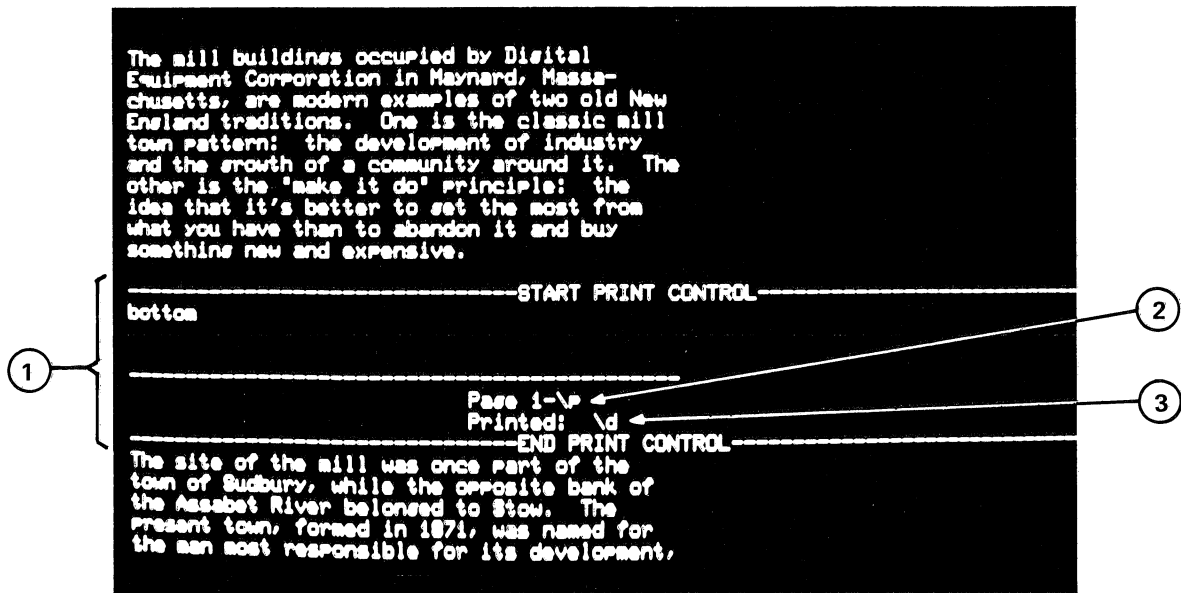

- ① FOOTER
- ② PAGE NUMBERING REQUEST
- ③ DATE REQUEST

9113-6R4-A0127

Figure 14-4 Screen Display Showing a Footer, Page Numbering Request, and Date Request

When specifying a date or page number to be printed use the \ character (located on the upper right of the main keyboard) and not the / character.

To have the date underlined or printed in boldface, underline or boldface the letter d in the header or footer (see Section 8.2). Similarly, to have a page number underlined or printed in boldface, underline or boldface the letter p in the header or footer.

In order to use a \ character as part of a header or footer, type two \ characters. Only one will be printed.

#### **14.4 RESETTING PAGE NUMBERS**

You can have the page numbering start over again in the middle of a document. This is useful if, for example, you want to print four pages of a "Sales Report, Year To Date" followed by one page of "Quarterly Sales Report" and want the last page to be renumbered with one.

To reset page numbers, follow these steps:

1. **Position the cursor** at the top of the first page to be renumbered.
2. **Press the gold and the CMND keys.** A line of dashes with the words **START PRINT CONTROL** will appear on the screen.

3. **Type the word RESET and press the RETURN key.** Do not type any other information. (If you also want a new header or footer, you must put the new information inside a separate set of markers.)

4. **Press the gold and the CMND keys again.** A line of dashes with the words **END PRINT CONTROL** will appear on the screen.

When you reset page numbers, the system automatically starts numbering with the value of Print Menu setting IP (see Section 13.3.7).

If the page numbering is part of a header and you are setting up a new header as well as resetting the page numbering, you must reset before specifying the new header. If the page numbering is part of a footer and you are setting up a new one as well as resetting, you must reset before specifying the new footer.

#### **14.5 HEADER AND FOOTER POSITIONING ON A PAGE**

A header is printed in the top margin of a page directly above the text. Similarly, a footer is printed in the bottom margin of a page immediately after the text. For example, if you have a four-line header with a six-line top margin and a three-line footer with a six-line bottom margin, you will get the following results:

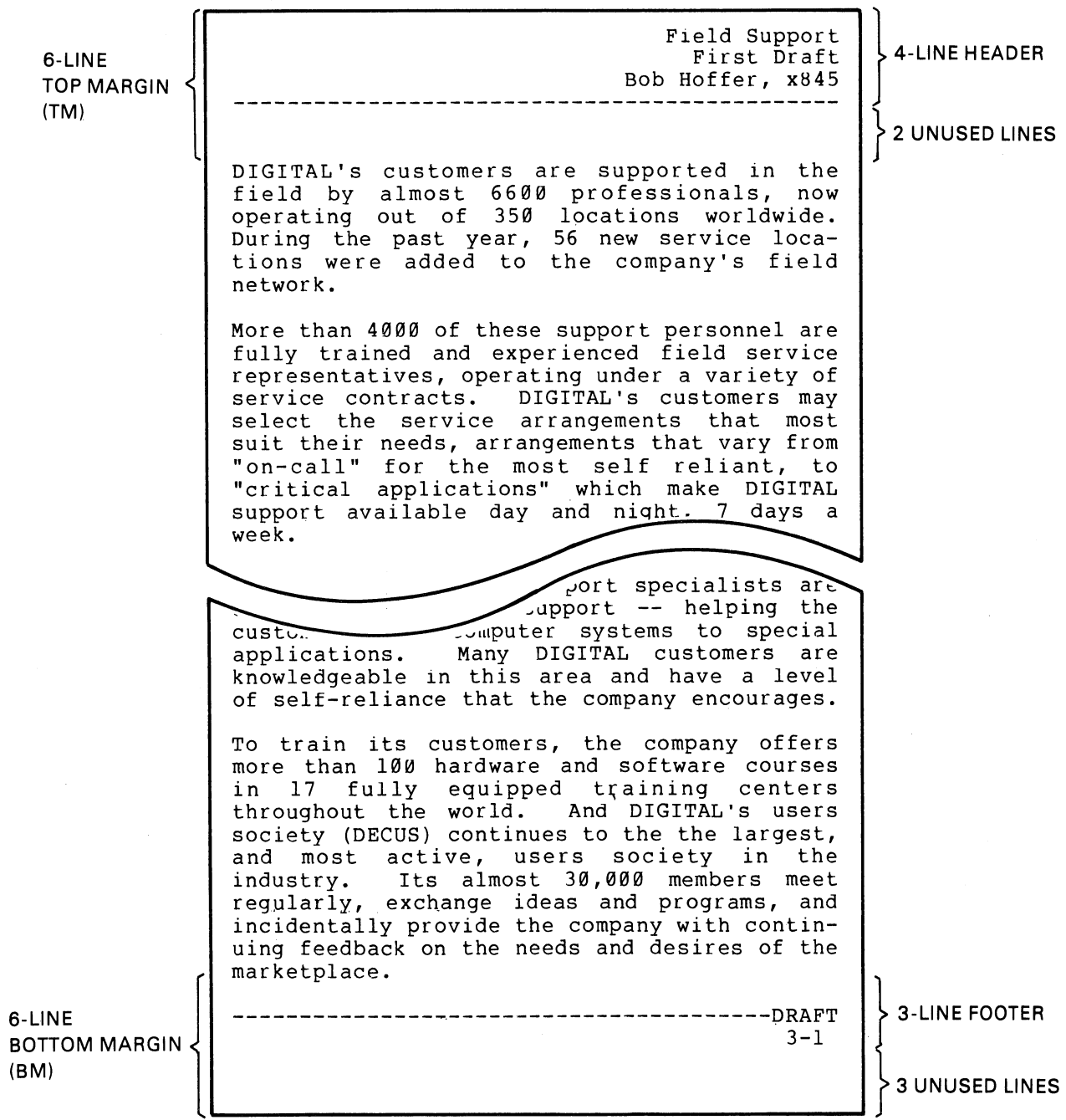

Figure 14-5 Header Positioning Within Top Margin; Footer Positioning Within Bottom Margin

MK-0116

The number of lines used in a header must not exceed the value of Print Menu setting TM (Top Margin). If it does, the extra lines at the top of the header will not be printed. For example, if you want to print the following eight-line header when TM is equal to six, the top two lines will not be printed.

```
*****
Chapter 4, Survey of Competition
      Document #4 of 5
      Created: 1/19/78
      Printed: \d
      Typed by: Mary C. Williams
*****
```

The number of lines used in a footer must not exceed the value of Print Menu setting BM (Bottom Margin). If it does, the extra lines at the bottom of the footer will not be printed.

In order to have all lines in a header printed, increase the value of Print Menu setting TM; in a footer, increase the value of Print Menu setting BM (see Section 13.3.2). When changing these values, you should also change the value of Editor Menu setting CT (Current Text size) in order to preserve the following relationship.

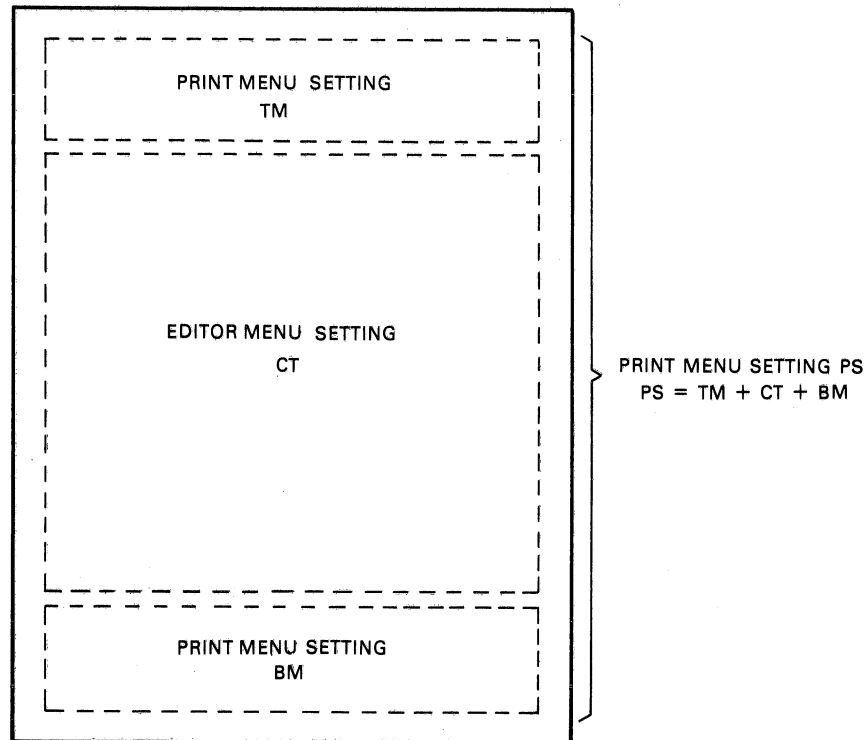

MK-0110

Figure 14-6 Relationship of Editor and Print Menu Settings for Page Size



## **14.6 QUALIFICATIONS: EFFECT OF RULER**

Headers and footers are subject to the following qualifications:

1. A header or footer is printed according to the ruler with which it was created and not the ruler in effect where it is printed.
2. The vertical line spacing in the first ruler (F, L, N, or D) of a header or footer will be

used to print it. Even if you put another ruler with different vertical line spacing in the header or footer, the system will still use the first one.

3. A header or footer will be printed justified only when proportional spacing is used (the value of Print Menu setting PI is equal to THEME). This qualification applies only to WS78 and WS100 systems.

### 14.7 EFFECT OF ADDING EXTRA VERTICAL SPACE WHEN PRINTING

A header or footer is always printed with the same amount of line spacing (half, single, space and a half, double) as it is typed with. It is not affected by extra vertical space added when printing a document (by means of Print Menu

setting EX). For example, here is a document which was typed single-spaced and printed space and a half (Print Menu setting EX equal to one).

Notice that the spacing in the header is the same whereas the spacing in the rest of each page differs.

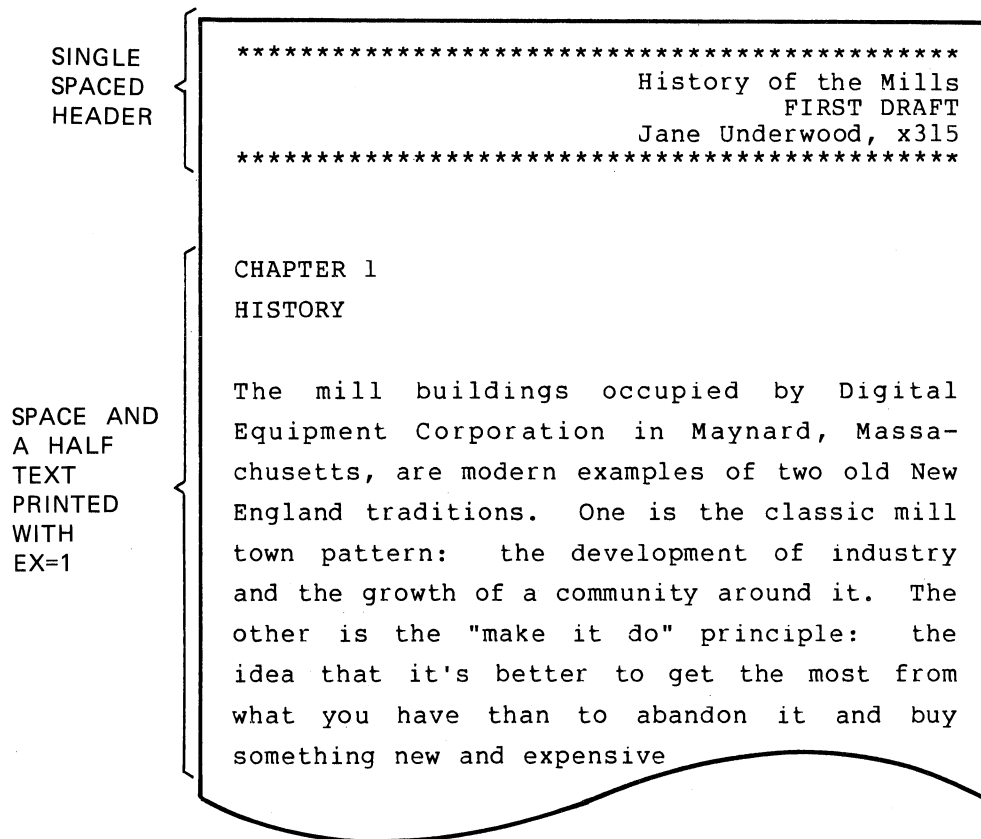

MK-0117

Figure 14-7 Example of Printed Header and Text When Extra Vertical Space Is Specified

## CHAPTER 15 USER DEFINED KEYS

A user defined key allows you to press any series of keystrokes (text, gold-lettered keys, mini keyboard keys) just once and save them (see Section 15.1). Whenever you need to reuse that series of keystrokes, all you have to do is recall the user defined key and the word processing system responds as if you had just typed each one (see Section 15.2).

Suppose, for example, that when you finish typing a 20-page report you find out you typed "CT" every place you were supposed to type "Cooling Tower." So you put the words "Cooling Tower" into the system's paste area, and then do the following: (1) press the gold key, (2) press the CONT SRCH & SEL key, (3) press the gold key, and (4) press the REPLC key. In order to replace all occurrences of "CT" you must re-

peat the above sequence of four keystrokes many, many times. If you save the keystrokes as a user defined key, you need type them only once.

### 15.1 CREATING A USER DEFINED KEY

To create a user defined key:

1. **Type the letters AK, a space, the word YES, and press the RETURN key** only if you are using a WS78 or WS100 system. If you are using a WS102 system, go to step 2 below. You can set AK (Activate user defined Keys) to YES when any Main Menu page is displayed on the screen or when typing or editing a document (first press the gold and the MENU keys to display the Editor Menu). Once AK is set to YES, you cannot print any documents.

2. Type the letters DK (Definition of user Key) and press the RETURN key. You can do this when any Main Menu page is displayed on the screen or when typing or editing a document (first press the gold and the MENU keys to display the Editor Menu). Typing DK causes the following to be displayed on the screen:

If you are using a WS78 or WS100 system and type DK when AK is set to NO, the system will display the message "User Keys not active. Type AK YES and press RETURN." on the screen. If this occurs, go to step 1 above.

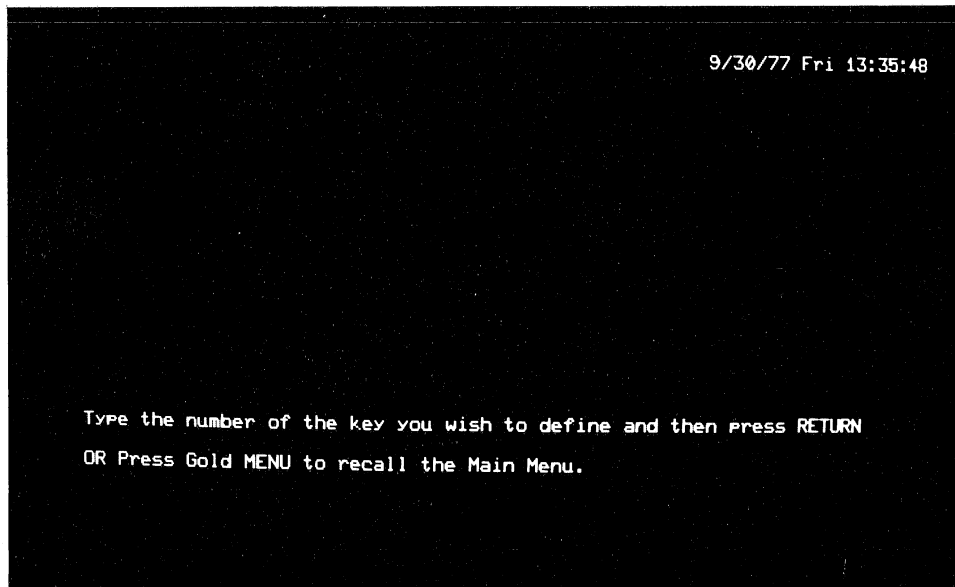

8920-12R4-A0130

Figure 15-1 Prompt for Defining a User Defined Key

3. **Type a number between 0 and 9 and press the RETURN key.** This is the number you will later use to refer to the user defined key. Typing the number causes the following to be displayed on the screen:

You can also type the number right after the letters DK (space in between). In this case, the screen display asking for the number is omitted.

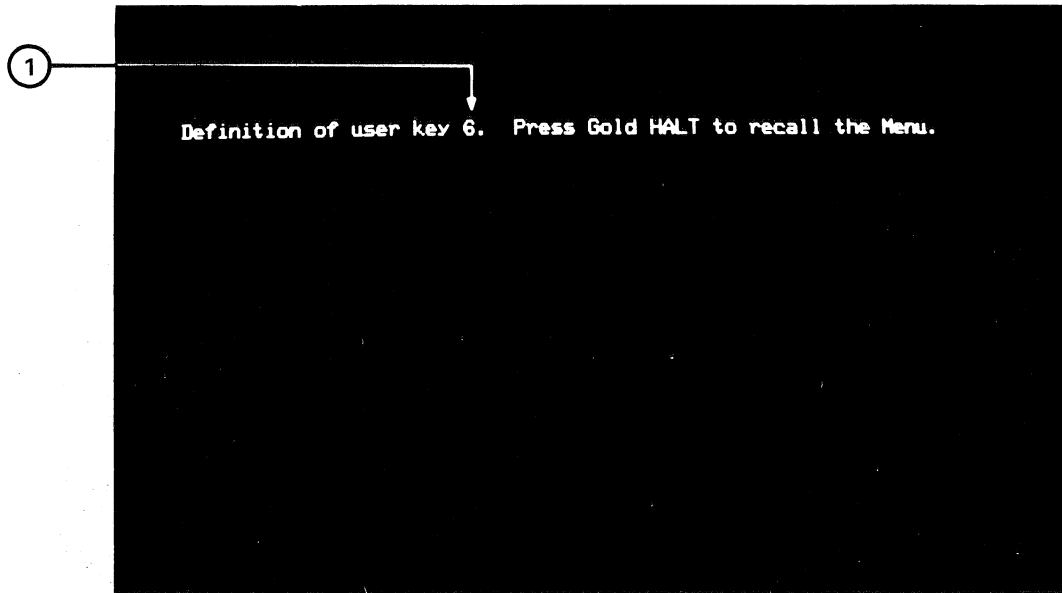

① USER TYPED THE NUMBER 6 AFTER "DK"

9113-10R4-A0129

Figure 15-2 Screen Display for Typing a User Defined Key

4. Type the keystrokes that you want saved with the user defined key number. Each letter, number, punctuation mark, or special character that you type will be displayed on the screen with a space before and after it. Any other (nontext) keystroke will be displayed with a descriptive name. Appendix F lists all nontext keystrokes and the corre-

sponding name that is displayed when each is typed into a user defined key.

Here is an example of a user defined key which reformats text by inserting a new ruler and then adds a hard return both before and after the reformatted text:

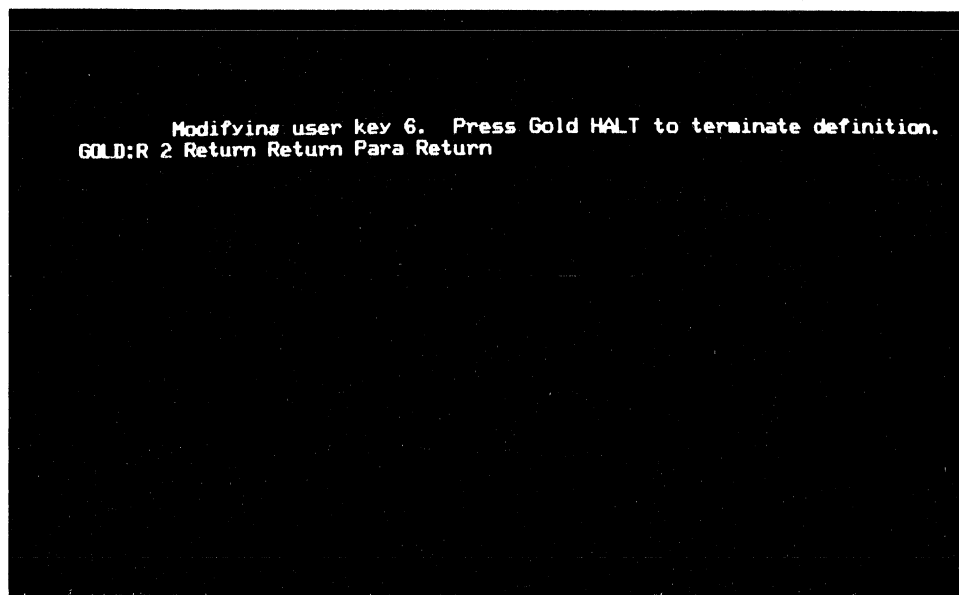

9113-12R4-A0131

Figure 15-3 Example of a User Defined Key Displayed on the Screen

The word "Definition" in the screen display will be changed to "Modifying" as soon as you press the first keystroke.

If you make a mistake while typing the definition, press the gold key and type the user defined key's number again. This acts as if

you had pressed the RUB CHAR OUT key and removes the previous keystroke. To change any other keystroke in the definition, you must repeatedly press the RUB CHAR OUT key to remove the preceding keystrokes.

5. **Press the gold and the HALT keys** when you have typed all keystrokes. The screen will now display whatever Main Menu page was previously displayed; if you were previously typing or editing a document, it will display your text.
6. **Type the letters AK, a space, the word NO, and press the RETURN key** only if you are using a WS78 or WS100 system and don't intend to use the user defined key right away (see step 1 for details of setting AK from both the Main and Editor Menus). This step is not necessary if you are using a WS102 or WS202 system.

## 15.2 USING A USER DEFINED KEY

In order to use a user defined key, you must start up the word processing system with the same system diskette as you used in creating the user defined key. This action is necessary because user defined keys are stored on your system diskette.

Follow these steps to use a user defined key:

1. **Type the letters AK, a space, the word YES, and press the RETURN key** only if you are using a WS78 or WS100 system. If you are using a WS102 system, go to step 2 below. You can set AK to YES when any Main Menu page is displayed on the screen or when typing or editing a document (first press the gold and the MENU keys to display the Editor Menu). Once AK is set to YES, you cannot print any documents.
2. **Press the gold key and type the number of the user defined key.** You can be typing or editing a document, or you can also be looking at any menu display.
3. **Type the letters AK, a space, the word NO, and press the RETURN key** only if you are using a WS78 or WS100 system and don't intend to use the user defined key in the near future (see step 1 for details of setting AK from both the Main and Editor Menus). This step is not necessary if you are using a WS102 or WS202 system.

Whenever you press the gold key and type the number of the user defined key, the word processing system responds as if you had just pressed all the keystrokes in the key's definition.

## 15.3 CHANGING A USER DEFINED KEY

Once you save a user defined key, you cannot insert additional keystrokes or change any existing ones. The only way to make changes is to replace the entire definition with a new one. To do so, you must first display the user defined key on the screen.

To display a user defined key, type the letters DK, a space, the number of the user defined key, and press the RETURN key to display the entire definition on the screen. You can do this when any Main Menu page is displayed on the screen or when typing or editing a document (first press the gold and the MENU keys to display the Editor Menu).

After displaying a user defined key, you have three options:

1. **Save the user defined key.** Press the gold and the HALT keys.
2. **Replace a user defined key.** Just type the new definition. When you have typed all keystrokes, press the gold and the HALT keys to save the user defined key.

3. **Eliminate a user defined key.** Press any key. The definition is replaced with the single keystroke just pressed. To remove this keystroke, press the gold key and type the user defined key's number. Then press the gold and the HALT keys.

The screen will now display whatever Main Menu page was previously displayed; if you were previously typing or editing a document, it will display your text.

#### 15.4 RESTRICTIONS

User defined keys are subject to the following restrictions:

1. The keystrokes for pressing the gold and the HALT keys cannot be included in a user defined key. Pressing these two keys saves all keystrokes just typed.
2. The combined total of keystrokes in all user defined keys used with your system diskette cannot exceed 250. An error message will be displayed on the screen if you try to use more.

Because user defined keys are stored on your system diskette, you can create additional user defined keys by obtaining a new system diskette. (However, if you get a new system diskette you

will no longer be able to use your original user defined keys.)

#### 15.5 INCLUDING ONE USER DEFINED KEY WITHIN ANOTHER

The keystrokes for one user defined key may be included within another. To do so, press the gold key and type the number of the user defined key to be included when you are typing the new user key's definition.

As an example of using this feature, consider the situation in which you already have a user defined key number 3 that inserts two hard returns, a ruler change, and a tab. Should you sometimes wish to have the words ACTION ITEM typed after the tab, all you do is define a new user defined key, number 4, for example, which contains the following key strokes:

1. Press the gold key,
2. Press the 3 key, and
3. Type ACTION ITEM.

It is not possible to include a particular user defined key number within itself. That is, you cannot specify user defined key number 3 when you type the definition string for user defined key number 3. Doing so removes the previous keystroke in the definition.



## CHAPTER 16 CUSTOMIZING

You can customize a document by using word processing features that make it more readable, usable, and reusable. Customization features available include the following.

1. Comments (see Section 16.1).
2. Date and time stamp (see Section 16.2).

3. Customization points (see Section 16.3).
4. List processing (see Section 16.4).

### 16.1 COMMENTS

A comment is text which displays on the screen but does not print out. It is useful for adding extra information or instructions to a document.

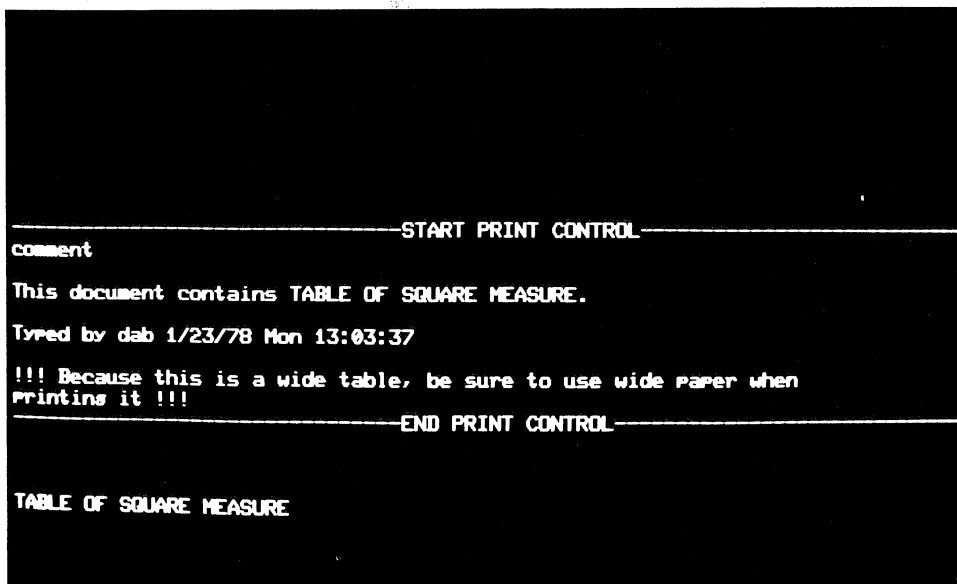

9113-14R4-A0132

Figure 16-1 Example of a Comment

The gold and the CMND keys are used to produce a comment.

There is no limit to how many comments you can use in a document.

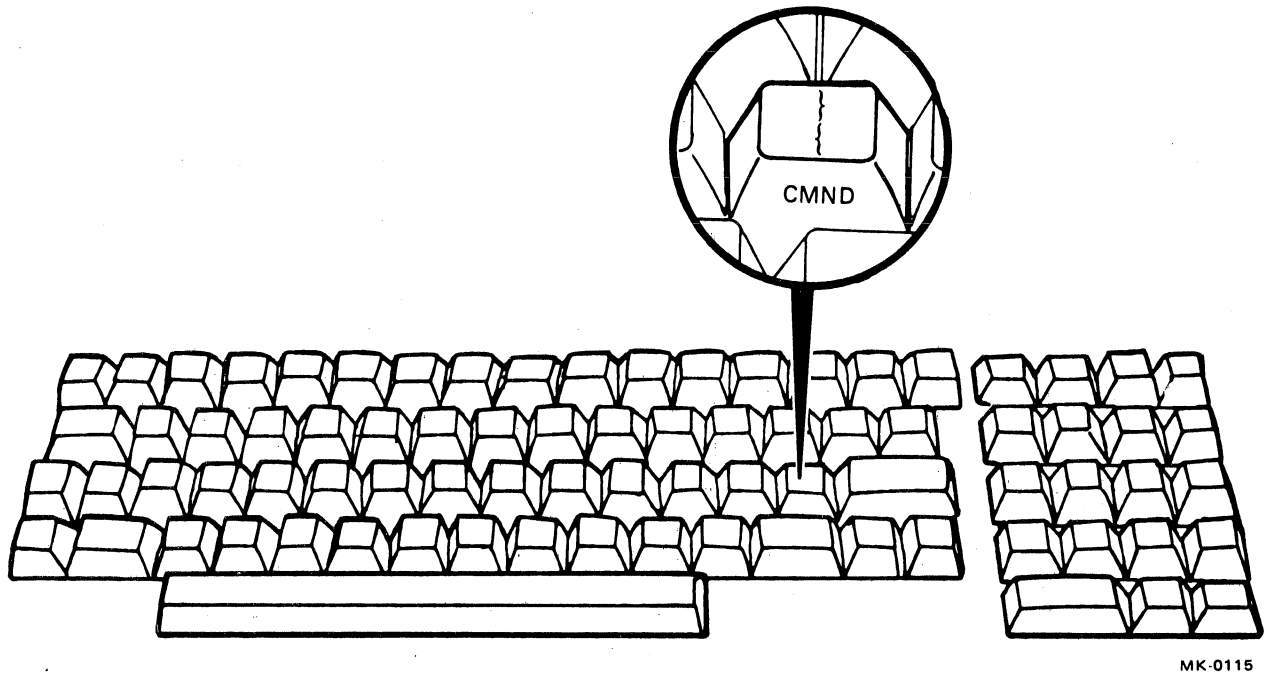

Figure 16-2. Main Keyboard CMND Key

To produce a comment, follow these steps:

1. **Position the cursor** where the comment is to begin. While you can place a comment anywhere in a document, it is best to do so at the beginning of a line.
2. **Press the gold and the CMND keys.** A line of dashes with the words START PRINT CONTROL will be displayed on the screen. This line counts as only one word processing character so you can use either the DEL CHAR or RUB CHAR OUT key to remove it.
3. **Type the word COMMENT and press the RETURN key.**
4. **Type your comment.** There is no size limitation to a comment.
5. **Press the gold and the CMND keys again.** A line of dashes with the words END PRINT CONTROL will be displayed on the screen. This line also counts as only one word processing character so you can use either the DEL CHAR or RUB CHAR OUT key to remove it.

## 16.2 DATE AND TIME STAMP

You can automatically insert the current date and time in your document by pressing the gold and the DATE+TIME key.

This key is useful when you need to put the date into a document. In the comment example of Section 16.1, the DATE+TIME key was used to indicate when the document was typed.

In order for the DATE+TIME key to take effect, you must type the date and time when you start up the word processing system. If you do not, a date of 0/0/00 and the amount of elapsed time since you started the system will be inserted into your document when you use the DATE+TIME key.

## 16.3 CUSTOMIZATION POINTS

A customization point is text which is surrounded with the angle bracket (< and >) characters. You can rapidly move the cursor to such text with the mini keyboard <> key. Therefore, type the angle bracket characters at places in your document which you intend to change later.

For example, suppose you are typing a chapter of a report which you know is going to be reorganized and revised. By surrounding all section heading numbers and cross-references with the angle bracket characters, you can rapidly find each place and update it when you produce the final revision. The following example shows a use of angle brackets surrounding changeable text (a section number).

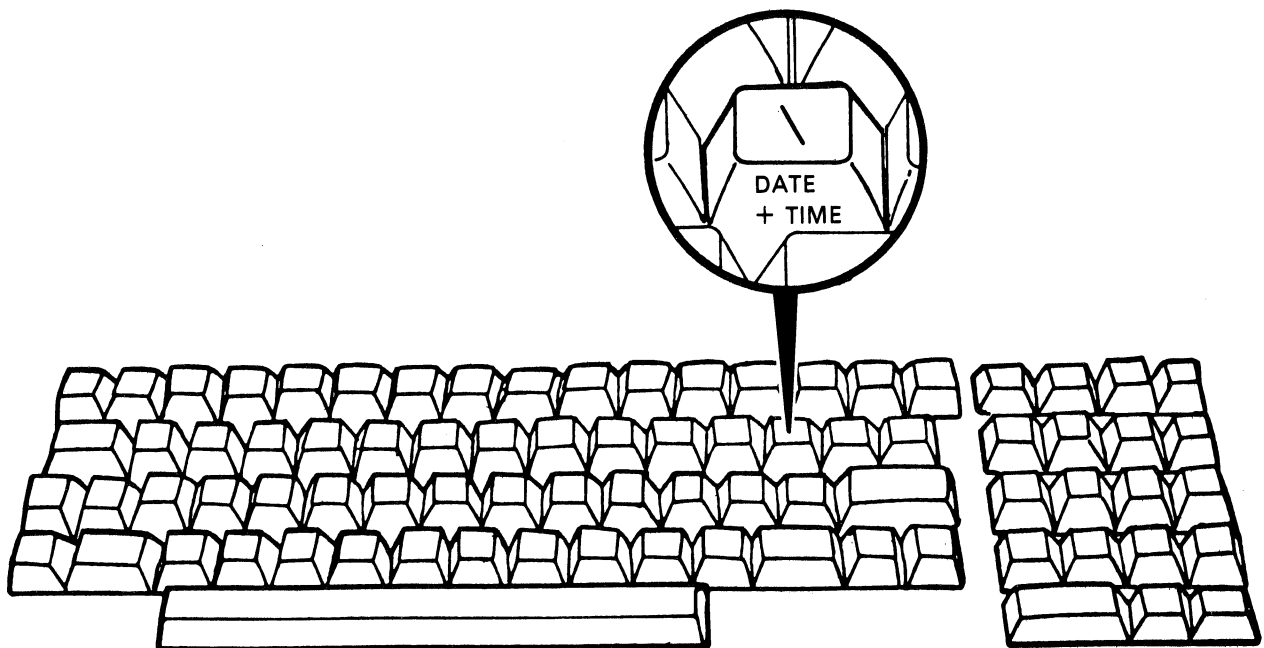

MK-0118

Figure 16-3 Main Keyboard DATE + TIME Key

### <7.3.1> How To Use the ON/OFF Switch

If the machine is already in use, skip this section and go to Section <7.3.2>. Otherwise, press the red ON/OFF switch located on the front of the machine.

You can use the angle bracket (< and >) characters to indicate places where information is to be added. For example, you can set up a reusable memo header that looks like this:

```
TO:      <>
FROM: M.F. TAUB
DATE:   <>
SUBJECT: <>
```

Whenever you need to type a new memo, just get a copy of your form (you can use a paragraph library document effectively for this), and press the <> key to advance to each customization point. Then remove the angle bracket characters and type your information.

### 16.4 LIST PROCESSING

With list processing you can produce the same kind of typing over and over again – letters to people on a mailing list, purchase requisitions, baseball box scores, rows in tables – while just certain information varies from one piece of typing to another. For example, each letter produced by list processing contains the same body but is addressed to a different recipient. Similarly, each line in a table is typed in the same format, contains the same kind of information, but has different actual values.

Figure 16-4 shows some form letters produced with list processing

SOUTHPORT BOOK STORE  
Greentree Shopping Mall  
Bedford, Mass. 01730

December 25, 1976

Mrs. Alice Hartford  
Brook Hill Road  
Reading, Mass. 01867

Dear Mrs. Hartford:

All of us at the Southport Book Store would like to thank you for your patronage in the past year. We consider you one of our valued customers and look forward to many more years of supplying your reading needs.

Sincerely yours,  
*Thomas Flanders*  
Thomas Flanders  
President

SOUTHPORT BOOK STORE  
Greentree Shopping Mall  
Bedford, Mass. 01730

December 25, 1976

Mrs. John Driscoll  
256 Walnut Avenue  
Brighton, Mass. 02135

Dear Mrs. Driscoll:

All of us at the Southport Book Store would like to thank you for your patronage in the past year. We consider you one of our valued customers and look forward to many more years of supplying your reading needs.

Sincerely yours,  
*Thomas Flanders*  
Thomas Flanders  
President

SOUTHPORT BOOK STORE  
Greentree Shopping Mall  
Bedford, Mass. 01730

December 25, 1976

Mr. Arthur Mitchell  
407 Memorial Drive  
Cambridge, Mass. 02140

Dear Mr. Mitchell:

All of us at the Southport Book Store would like to thank you for your patronage in the past year. We consider you one of our valued customers and look forward to many more years of supplying your reading needs.

Sincerely yours,  
*Thomas Flanders*  
Thomas Flanders  
President

CP-2781

Figure 16-4 Example of Form Letters  
Produced by List Processing

### 16.4.1 Summary Of Features

Some of the features of list processing are:

**Efficiency.** List processing saves typing time by automatically typing repetitious information. Form letters are a good example of this efficiency. All you have to do is type the names and addresses just once, type a "skeleton" form that contains the body of the letter plus indicators showing where the names and addresses are to

be plugged in, and tell the system to perform list processing. It will then type out a separate letter to each recipient.

**Variety.** You can produce many different kinds of output from the same collection of information. For example, you can type letters addressed to people on a mailing list (who do not have overdue balances) and can also produce a table listing those with overdue accounts, such as the following:

Outstanding Accounts Payable		
Name	Amount Due in \$	Overdue Code in months
Hartford, Alice	8.95	2
Mahoney, Charles	84.50	1
McDonald, Joseph	107.16	4

In addition, dunning letters (requests for payment) to overdue accounts, can also be produced. Figure 16-5 shows how these might look.

SOUTHPORT BOOK STORE  
Greentree Shopping Mall  
Bedford, Mass. 01730

December 25, 1976

Mrs. Alice Hartford  
Brook Hill Road  
Reading, Mass. 01867

Dear Mrs. Hartford:

Our records indicate that you have owed the Southport Book Store \$8.95 for more than 2 months. We would appreciate your attention to this matter with no further delay.

Sincerely yours,



Ralph McKelvey  
Treasurer

P.S. If you have recently paid this small amount, please accept our apologies for this letter.

SOUTHPORT BOOK STORE  
Greentree Shopping Mall  
Bedford, Mass. 01730

December 25, 1976

Mr. Joseph McDonald  
23 Hampshire Street  
Waltham, Mass. 02154

Dear Mr. McDonald:

Our records indicate that you have owed the Southport Book Store \$107.16 for more than 4 months. We would appreciate your attention to this matter with no further delay.

Sincerely yours,

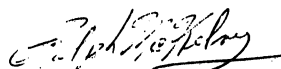

Ralph McKelvey  
Treasurer

P.S. Unless this balance is paid within ten days, we will be forced to turn your account over to our lawyers.

CP-2779

Figure 16-5 Example of Customized Letter  
Produced by List Processing

**Selectivity.** You can be selective in deciding what to type out: you can produce output for every entry in the list (the Southport Book Store's thank you letters), or you can be choosy and process only a select group (the dunning letters to overdue accounts).

**Customization.** By incorporating the same piece of information several times in the same piece of output you can get a "customized product." For example, you can produce a letter that looks like this:

Miss Mary Canfield  
101 North Chelsea Avenue  
Warwick, Rhode Island 02889

Dear Mary,

We are sure you will agree, Mary, that reading a newspaper helps keep you aware of what's happening. Many of your neighbors on North Chelsea Avenue already subscribe to the Daily Mercury and ...



### 16.4.2 Using List Processing

List processing operates by merging certain pieces of information from a list into a form and printing the merged result. This process is then repeated for each entry in the list. You can be selective in processing by telling the word pro-

cessing system which list entries are to be merged with the form for printing, for example, only those entries whose account balances are two or more months overdue. Figure 16-6 illustrates this process:

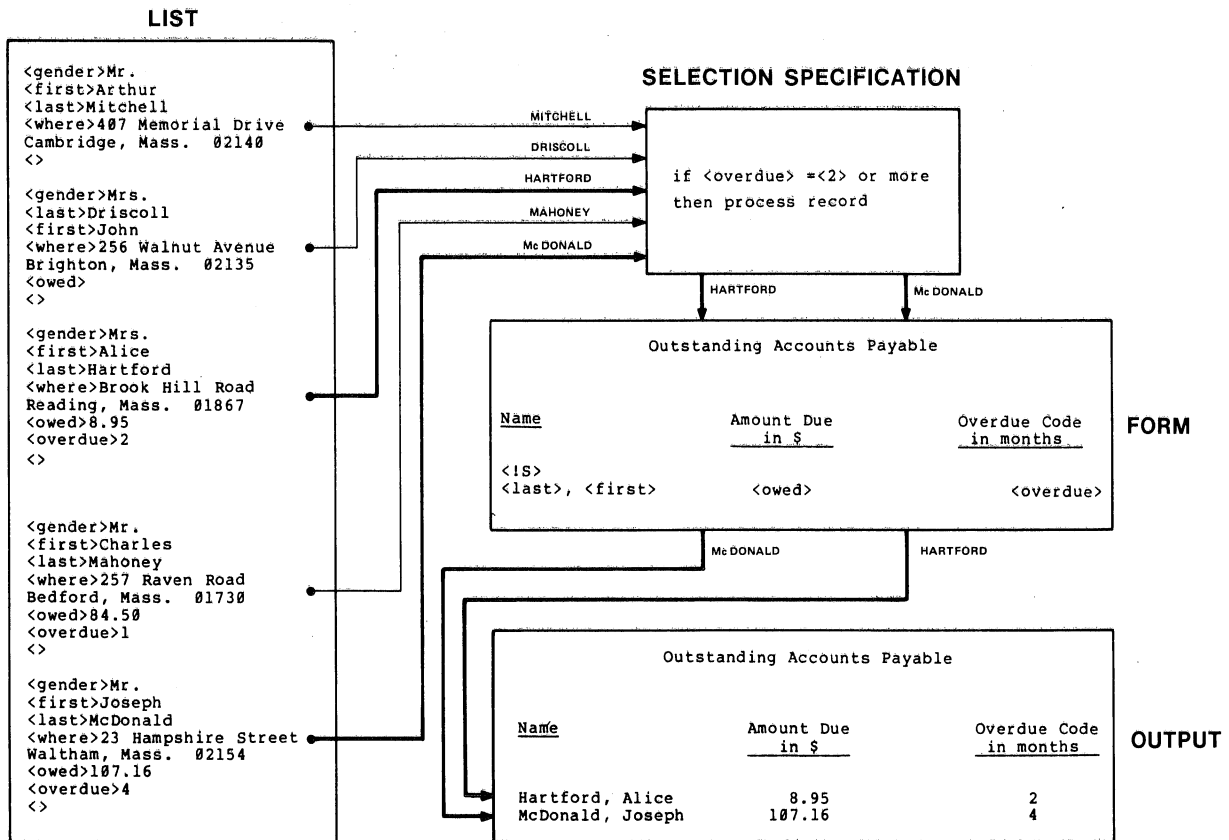

CP-2863

Figure 16-6 List Processing Selection/ Merging/Printing Production

To use list processing you need to have three documents:

1. **List.** This document contains the data that may possibly be merged into a form for printing.
2. **Form.** This document contains the text to be printed plus indicators showing where

and what kind of information (from the list document) is to be inserted.

3. **Selection specification.** This document specifies exactly which list entries are to be selected for merging with the form document.

Complete details for using list processing may be found in the *Word Processing System List Processing User's Manual*, AA - 5269B - TK.

## CHAPTER 17 MAINTAINING DISKETTES

Using the word processing system is similar to using a typewriter, automobile, or any other piece of equipment: a certain amount of maintenance is necessary.

One type of maintenance is deleting documents which you no longer need. If you delete such documents, the system can reuse the diskette space for storing other documents. See Section 17.1 for details of deleting a document.

Another type of maintenance is initializing, verifying, and copying diskettes. Initializing means

to remove whatever is currently stored on a diskette and process the diskette so you can use it either for creating documents or for copying the word processing system software (see Sections 17.2.1 and 17.2.2). Verifying means to inspect the condition of a diskette after some odd symptom occurs, such as after you spill coffee on it or when a document contains text you never typed (see Section 17.2.3). Copying means to make an exact copy of one diskette onto another to maintain a "backup" of your work in case you accidentally destroy the original diskette (see Section 17.2.4).

### 17.1 DELETING A DOCUMENT

When you delete a document, the system removes all its text plus all its bookkeeping information from the index.

To delete a document, type the letter D when any Main Menu page is displayed on the screen and press the RETURN key. The system will ask you to identify the document to be deleted.

If you have previously worked on another document in the current word processing session, the system will ask you if you want to delete that

document. If you have inspected the index, the system will ask if you want to delete the document marked by the asterisk.

Type either the document's name or its number in the index. If the screen displays the correct document, just press the RETURN key.

As a shortcut, you can type the letter D, a space, identify the document, and press the RETURN key. In this case the word processing system does not prompt for your document name because you have already typed it.

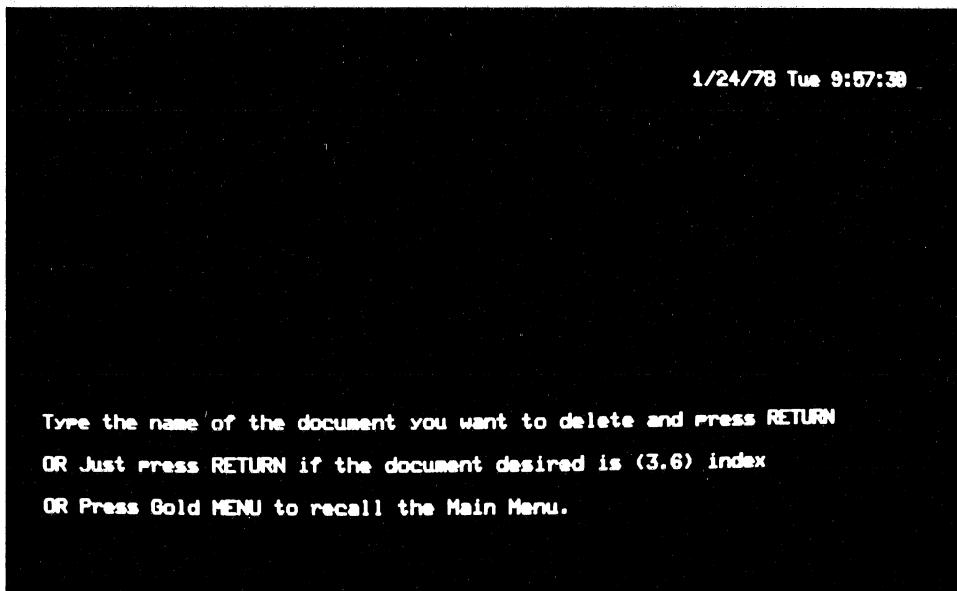

9113-16R4-A0139

Figure 17-1 Document Deletion Prompt

After you identify the document, the word processing system will display its first ten lines and ask you to confirm your choice. This action prevents you from deleting the wrong document as

the system will delete a document only if you answer YES to the confirmation. Here is an example of a delete confirmation:

```
— Beginnings of the document to be deleted —                1/24/78 Tue 9:58:08 _
6   index                                                    1/5/78  1/5/78 1:28   3   2   0:00  0:00
5   Memo for basic information on preliminary plan           11/11/77 11/11/77 16:31 10   1   0:01  0:01
3   abbrev                                                    11/4/77  11/4/77 11:12   1   3   0:01  0:05
2   intro part ii
— Entries in the index document for 3.6 —
index
— Is this the document you wish to delete? (yes or no) —
```

9113-18R4-A0138

Figure 17-2 Deletion Confirmation Prompt

## 17.2 INITIALIZING, VERIFYING, AND COPYING DISKETTES

To initialize, verify, or copy a diskette, type the letters MC (for Maintenance Commands) when any Main Menu page is displayed on the screen and press the RETURN key. The Diskette Maintenance Menu is then displayed.

The Diskette Maintenance Menu gives you four processing options. To perform any one, type its corresponding letter and press the RETURN key. Use these guidelines to choose the appropriate option:

### 1. To initialize a document diskette (option D).

- For brand new diskettes.

- To discard obsolete documents. You can delete all documents on a single diskette so it can be used for storing new documents (this is easier than deleting each individual document).

### 2. To initialize a system diskette (option S).

- For brand new diskettes.
- To create a copy of the system software only (without any additional documents that the system diskette may contain).

```
— DISKETTE MAINTENANCE MENU —                               1/24/78 Tue 9:58:29

D = Initialize a document diskette
S = Initialize a system diskette
V = Verify diskette structure
C = Copy diskette

Type the letter and then press RETURN
OR Press Gold MENU to recall the Main Menu.
```

9113-20R4-A0141

Figure 17-3 Diskette Maintenance Menu

### 3. To verify a diskette (option V).

- When something odd happens such as being unable to create, edit, print, or delete a document, finding text you never typed in a document, or seeing a message that your diskette has errors.
- After a power failure. Electrical damage could destroy portions of a diskette or could create incorrect text.

### 4. To copy a diskette (option C).

- To create a "backup" copy of your typing so if you accidentally delete or lose a document, you can still recover your work.

- To create an extra copy of your typing for distribution to other typists, offices, or for permanent storage.

#### 17.2.1 Initializing a Document Diskette

Initializing a document diskette prepares a diskette so documents can be stored on it. Any documents already stored on the diskette are deleted.

To initialize a document diskette, follow these steps:

1. **Type the letters MC and press the RETURN key** when any Main Menu page is displayed on the screen.
2. **Type the letter D and press the RETURN key.** The screen will display the following instructions:

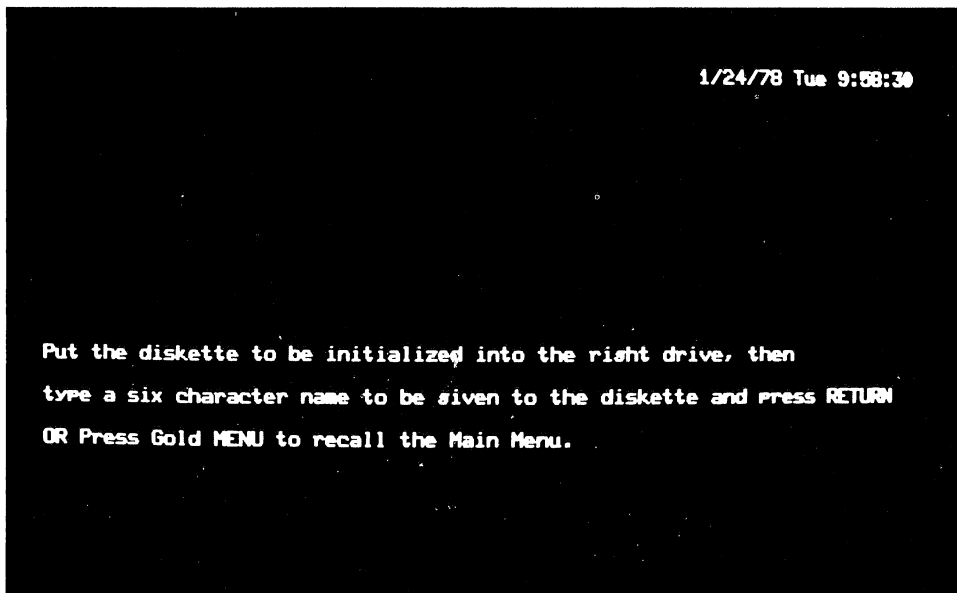

9113-21R4-A0140

Figure 17-4 Diskette Initialization Prompt

3. **Follow the instructions on the screen.** Put the diskette to be initialized into the right diskette drive. Type a diskette name (between one and six characters) and press the RETURN key. You will see this name when you display the diskette's index of documents.
4. **Observe the elapsed time clock on the screen.** Initialization takes a minute or two and, once begun, cannot be stopped (so you have some time for other activities).
5. **Press the gold and the MENU keys** when the screen displays the ending time plus a message telling you to "Press Gold MENU to recall the Main Menu."

### 17.2.2 Initializing a System Diskette

When you initialize a system diskette, the word processing software is copied from the system diskette you are currently using onto your new one (after the previous contents of the new diskette are first deleted). Initialization does not copy any documents that are stored on the system diskette currently being used (if you want a new diskette with both those documents and the software, copy the system diskette as described in Section 17.2.4).

To initialize a system diskette, follow these steps:

1. **Type the letters MC and press the RETURN key** (when any Main Menu page is displayed on the screen).
2. **Type the letter S and press the RETURN key.** The screen displays the same instructions as for initializing a document diskette (see Section 17.2.1 above).
3. **Follow the instructions on the screen.** Put the diskette to be initialized into the right diskette drive. Type a diskette name (between one and six characters) and press the RETURN key. You will see this name when you display the diskette's index of documents.
4. **Observe the elapsed time clock on the screen.** Initialization takes a minute or two and, once begun, cannot be stopped (so you have some time for other activities).
5. **Press the gold and the MENU keys** when the screen displays the ending time plus a message telling you to "Press Gold MENU to recall the Main Menu."

### 17.2.3 Verifying a Diskette

You should verify a diskette after a power failure, when garbled characters appear in a document, when text you typed has disappeared, when text appears out of order, when the system displays a disk error message, when any other strange symptom appears, when you remove a diskette without filing the document you were using, or when you perform any other action which may have damaged the diskette or its contents.

The system verifies a diskette in two stages.

1. **Physical, or readability, check.** The diskette may have physical damage which you cannot visually detect. Because the system examines the diskette by "reading" it, this check is referred to as *readability*.
2. **Format check.** Even though the information (text or software) on a diskette may be read successfully, that information may be formatted incorrectly (not located in the correct places on the diskette). Therefore, the system examines the entire diskette for formatting errors.



When the system finishes verifying a diskette, it not only informs you whether the diskette contains errors but it also supplies the capability of salvaging valid text from the damaged diskette and correcting certain errors.

**17.2.3.1 How To Verify a Diskette** – To verify a diskette, follow these steps:

1. **Type the letters MC and press the RETURN key** when any Main Menu page is displayed on the screen.
2. **Type the letter V and press the RETURN key.** The screen displays the following instructions:

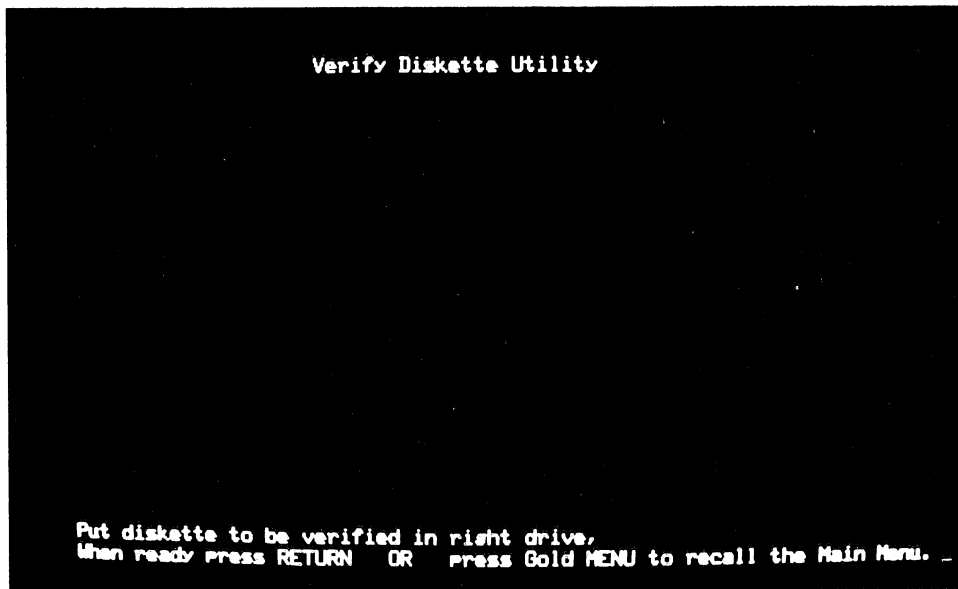

9113-24R4-A0134

Figure 17-5 Diskette Verification Prompt

3. Follow the instructions on the screen.

When you press the RETURN key to proceed with verification, the word processing system examines each of the diskette's 632 blocks and displays the following message. The system continually updates this message as it examines successive diskette blocks.

Verify Diskette Utility

① block checked, ② errors detected.

Checking diskette for readability...

Numbers will appear in the display in place of the circled number above and indicate:

① **Block currently being examined.** This number is incremented by 10 until the maximum value of 632 is reached.

② **Number of errors detected.** This is incremented by 1 as each error is detected.

You can stop verification before it is complete by pressing the gold and the HALT keys.

When the system finishes examining the last block, it displays a summary of the diskette's physical condition. Here is an example of this display:

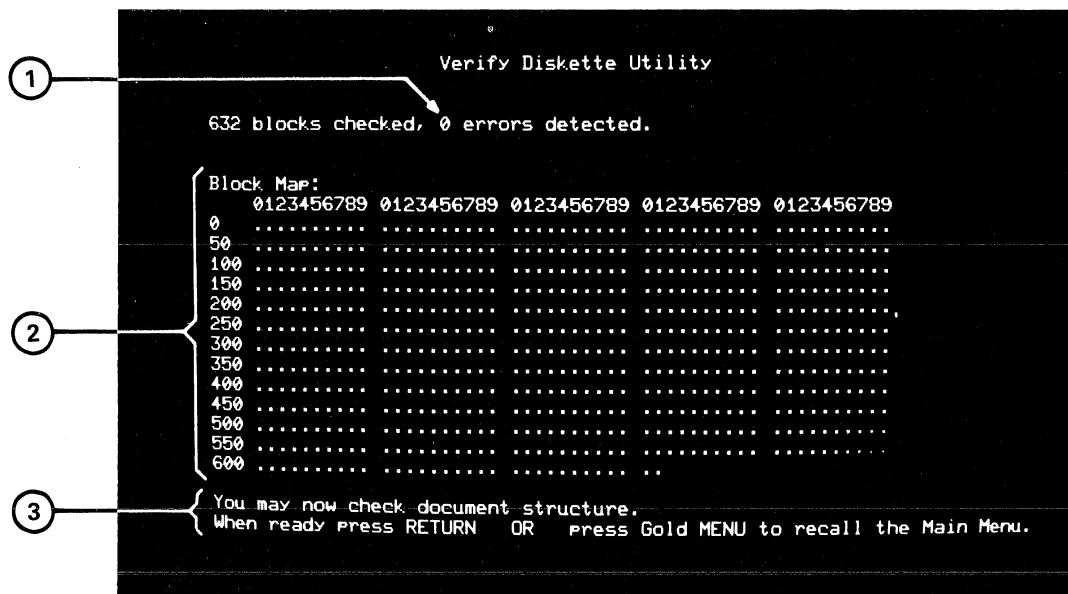

8920-24R4-A0137

Figure 17-6 Example of Diskette Verification Screen Display for a Diskette Without Errors

- ① **Number of errors found.** This is the number of physical diskette errors detected.
- ② **Block map.** This indicates which blocks are valid (the ones with dots) and which are physically damaged (the ones with exclamation points).
- ③ **A message** asking whether you want the diskette verified for additional errors.

Even if the screen display indicates zero errors, your diskette may still contain errors of another

type: text incorrectly formatted. These errors will be detected by the system provided you type YES and press the RETURN key in response to the prompt. While you can answer NO and proceed with other word processing work (a Main Menu page will be displayed on the screen), you may later have difficulties using the diskette.

During formatting verification, the system again examines each of the diskette's 632 blocks and displays a constantly-updated message. When formatting verification is complete, the system displays a summary. Here is an example of this display for a diskette that contains formatting errors:

```

Verify Diskette Utility

Disk "EXAMPL" has 29 documents, 473 free blocks, 1 unreadable blocks.
Of 29 documents, 0 will be deleted.

Block Map:
  0 0123456789 0123456789 0123456789 0123456789 0123456789
  0 UUUUUUUUU UUUUUUUUU UUUUUUUUU UUUUUUUUU UUUUUUUUU
  50 UUUUUUUUU UUUUUUUUU UUUUUUUUU UUUUUUUUU UUUUUUUUU
  100 UUUUUUUUU UUUUUUUUU UUUUUUUUU UUUUUUUUU UUUUUUUUU
  150 UUUUUUUUU AAAAAAAAAA AAAAAAAAAA AAAAAAAAAA AAAAAAAAAA
  200 AAAAAAAAAA AAAAAAAAAA AAAAAAAAAA AAAAAAAAAA AAAAAAAAAA
  250 AAAAAJAAAA AAAAAAAAAA AAAAAAAAAA AAAAAAAAAA AAAAAAAAAA
  300 AAAAAAAAAA AAAAAAAAAA AAAAAAAAAA AAAAAAAAAA AAAAAAAAAA
  350 AAAAAAAAAA AAAAAAAAAA AAAAAAAAAA AAAAAAAAAA AAAAAAAAAA
  400 AAAAAAAAAA AAAAAAAAAA AAAAAAAAAA AAAAAAAAAA AAAAAAAAAA
  450 AAAAAAAAAA AAAAAAAAAA AAAAAAAAAA AAAAAAAAAA AAAAAAAAAA
  500 AAAAAAAAAA AAAAAAAAAA AAAAAAAAAA AAAAAAAAAA AAAAAAAAAA
  550 AAAAAAAAAA AAAAAAAAAA AAAAAAAAAA AAAAAAAAAA AAAAAAAAAA
  600 AAAAAAAAAA AAAAAAAAAA AAAAAAAAAA AA

① Your diskette has errors, to correct them you must copy the diskette.
   To do this press RETURN OR press Gold MENU to recall the Main Menu.

```

① INSPECT THIS MESSAGE

9113-25R4-A0136

Figure 17-7 Example of Diskette Verification Screen Display for a Diskette Having Errors

Inspect the last two lines of your screen display. If the following message appears in the next to last line, then your diskette has no errors and you may proceed to use it.

```
No errors found.  
Press Gold MENU to recall the Main  
Menu.
```

As many errors as possible will be corrected by the system provided you press the RETURN key in response to the prompt. While you can ignore the warning and proceed with other word processing work (a Main Menu page will be displayed on the screen), you will later have difficulties using the diskette.

**17.2.3.2 Recovering from Diskette Errors** – You can correct certain errors and salvage valid text

from a damaged diskette with the verification recovery procedure. In summary, the system will copy as much text as possible onto a new document diskette (even if your original diskette is a system diskette). It will correct as many errors as possible and then store the corrected text on the new diskette. If the system cannot salvage any portion of a document from the original diskette, it will not put anything for that document onto the new diskette. The original diskette is not altered.

To use the verification recovery procedure, follow these steps:

1. **Press the RETURN key** in response to the prompt that is displayed at the conclusion of formatting verification. The system will display the following instructions:

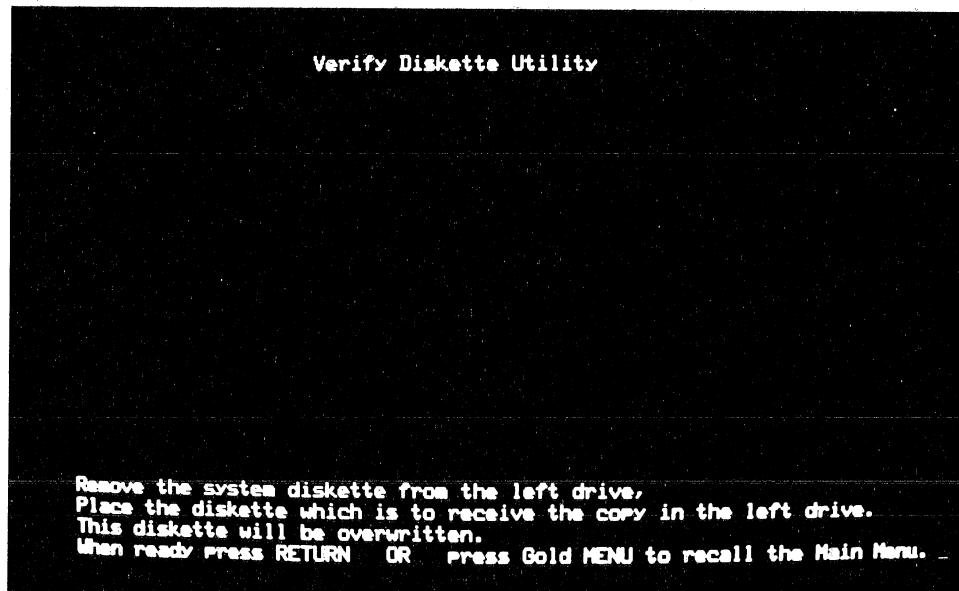

9113-26R4-A0157

Figure 17-8 Diskette Verification Prompt

2. **Remove the system diskette, insert a new diskette into the left drive, and press the RETURN key.** The system will proceed to copy as much text as possible onto the new diskette, will reverify each document copied, and will display a constantly-updated message of the number of documents copied on the screen. This process will take at least five minutes.

When complete, the system will display a list of those documents which either were not copied at all or which are not entirely complete (a portion could not be copied) on the screen.

3. **Remove the two diskettes, insert the system diskette in the left drive, insert the new document diskette in the right drive and press the gold and the MENU keys.**
4. **Examine the affected documents** on the new diskette. If only portions of a document are missing, you can retype them. If most of a document is missing, use your backup diskette to get a new copy of the entire document (or retype if you have no backup).
5. **Examine the index of documents** for the new diskette. The message "There is no document with the number" will appear in the index after the name of each document which the system was not able to copy from the original diskette (because the document was so badly damaged that no text could be salvaged). Either make a new copy of the document from your backup diskette or retype it.
6. **Initialize the original diskette** (see Sections 17.2.1 and 17.2.2). If the system displays a message that the diskette contains an error, discard it. Otherwise, you can now reuse

the diskette for storing either documents or the word processing system software.

The following qualifications apply to the diskette recovery procedure.

1. **The new diskette may have the name "FIXED"** instead of the same name as the original one. This results when the original diskette has certain types of uncorrectable errors.
2. **A document may still contain errors even though it was not listed as "affected."** This results from errors that the system cannot detect. For example, if a portion of text or a ruler is missing from a document on the original diskette, the system will still copy that document onto the new one.
3. **When you type a document name, you may not be able to use a document from the new diskette even though it was copied there.** This results when document one (see Section 4.4) on the original diskette was damaged and the system could not correct the errors. Without document one, the system cannot find the other documents on a diskette even though they are there. (If document one was destroyed, you will still be able to use a document by typing its number.) You can salvage such a diskette by creating a new document one and typing the names and corresponding numbers of all documents on that diskette.

**17.2.3.3 Preventing Diskette Problems** – Some of the common causes of diskette problems and ways to avoid them include:

1. **Power failures during typing or editing.** Some of these, such as failures caused by thunderstorms, are unavoidable; others

you can guard against. For example, never unplug the system while typing or editing a document.

2. **Human errors.** The most common human error is removing a diskette from its drive before filing the document you are working with. Even worse, you could remove a diskette without filing the document and insert another diskette in the drive. Then, you not only lose text from the document on the first diskette, but you can also destroy text on the second diskette.

Always check whether documents are still being processed before you remove a diskette. This is especially critical with the WS102 system: the person at the other terminal may be using documents from your diskette. Type the letter F (for Finish) when any Main Menu page is displayed on the screen. If any documents are being processed from your diskette, the system will display a warning message. If no documents are being processed, the system will display the message "FINISHED USING THE SYSTEM."

3. **Dirt, grease, or other foreign matter on the surface of the diskette** resulting from improper handling. To avoid this problem, do not touch the brown, shiny diskette surface, and don't bend, fold, spindle, or mutilate the diskette. Write out the label **before** attaching it to the diskette. If you change the label, use a felt-tip pen and press lightly.

4. **Physical damage to the surface of the diskette** resulting from using a faulty diskette drive. If your diskette appears torn or bent after removal from the drive, call your DIGITAL Field Service Representative and do not use the drive until it is repaired.

5. **Diskette overflow.** This results from attempting to type or edit text after the system has warned you that the diskette is almost full. If you ever see the following message, file your document and use another diskette.

-- Do not add much more to document --

Only "number" blocks left on diskette.

Press Return

An actual number will appear in place of "number" in the second line of the warning message.

The best precaution is to copy your diskettes (see Section 17.2.4) regularly.

The Diskette Maintenance Menu copy option (see Section 17.2.4) should be used to do this. Copying takes only a few minutes and, in the long run, is well worth it. At the end of each day, make it a point to copy each diskette you used. Then label each with the name, date, and the fact that it is a backup copy. If you've done a lot of complicated work, such as editing a long document with extensive changes, it is a good idea to back up your diskette immediately.

#### 17.2.4 Copying a Diskette

To copy an entire diskette (either document or system) onto another, follow these steps:

1. **Type the letters MC and press the RETURN key** when any Main Menu page is displayed on the screen.
2. **Type the letter C and press the RETURN key.** The screen will display the following instructions:

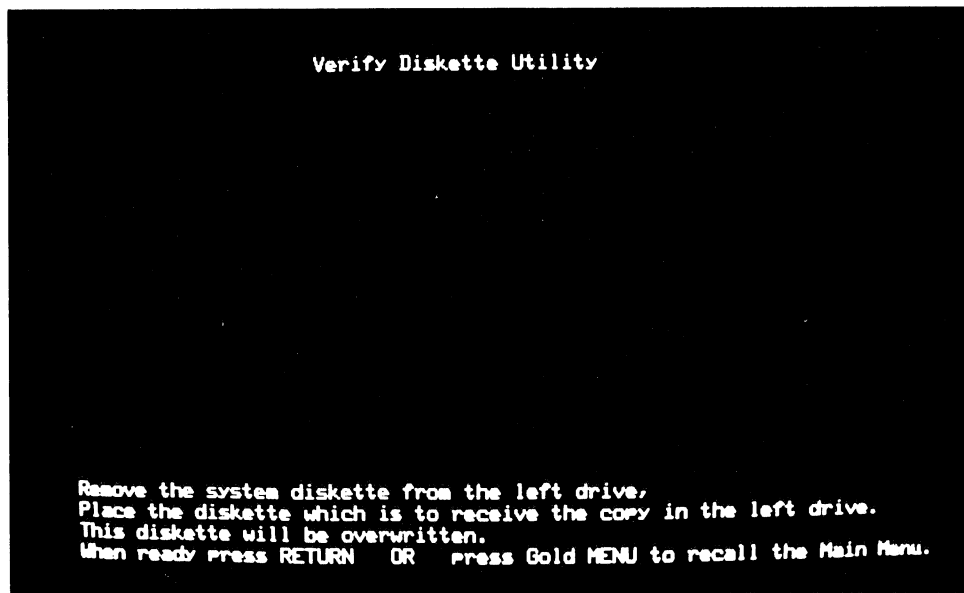

9113-26R4-A0157

Figure 17-9 Diskette Copy Prompt

3. Follow the instructions on the screen CAREFULLY. Insert the diskette to receive the copy in the left drive and the original diskette in the right. It is not necessary to initialize the diskette to receive the copy.

4. Observe the elapsed time clock on the screen. Copying takes a few minutes and, once begun, cannot be stopped (so you have some time for other activities). When copying is complete, the following instructions will be displayed on the screen:

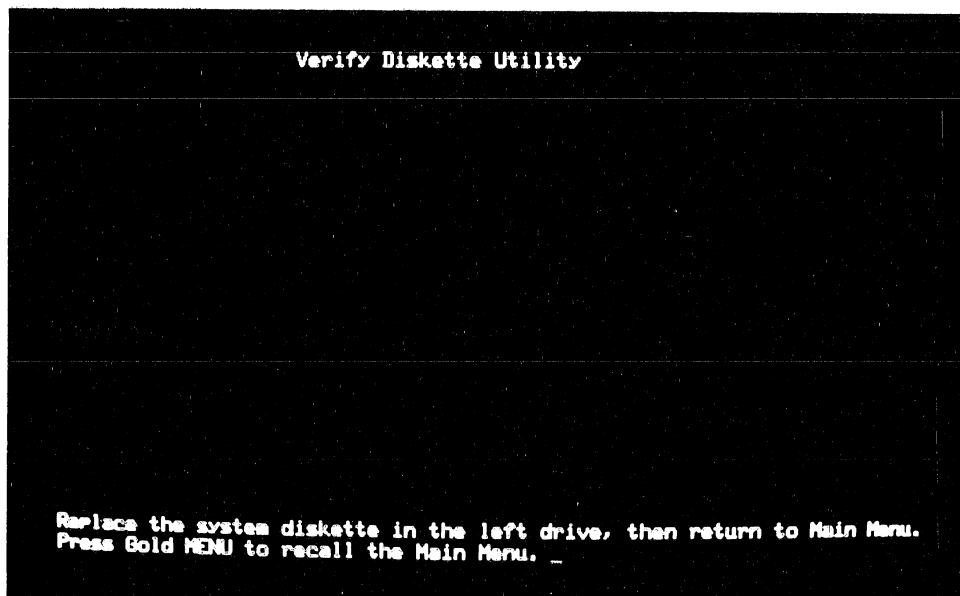

9113-26R4-A0135

Figure 17-10 Prompt Displayed at Completion of Diskette Copy

5. Follow the instructions on the screen carefully.

The following qualifications apply to copying a diskette:

1. Both users of a WS102 or WS202 system should not copy documents at the same time.

The copying process would then take three or four times longer.

2. A diskette's name is copied to the new diskette. This means that if you initialized the new diskette, the name you assigned will be replaced with the name of the diskette being copied.



## CHAPTER 18 WS102 AND WS202 SPECIAL FEATURES

Two special features are unique to the WS102 and WS202 systems.

1. **Both users can look at the same screen** and thereby share the same document. See Section 18.1 for details.
2. **Each user can specify the order in which documents are printed.** You can alternate printing your documents with the other

user, have all yours printed first, or allow all the other user's documents to be printed before yours. See Section 18.2 for details.

Both of these features are controlled by Main Menu settings which appear only in WS102 and WS202 systems.

References to the WS102 system in this chapter also apply to the WS202 system.

```
— MAIN MENU (continued) —                               1/24/78 Tue 9:08:00

SS = Allow other terminal to share your screen (SS yes)
VS = View the screen of the other terminal
XK = Exchange keyboard with the other terminal
SP = Share printer (SP no)
SD = Send document to other terminal
M = More main menu selections...

Type the letter(s) and then press RETURN
```

9113-11R1-A0142

(Version 2.7)

```
— MAIN MENU (continued) —                               4/28/78 Fri 14:00:30

SS = Allow other terminal to share your screen (SS no)
VS = View the screen of the other terminal
XK = Exchange keyboard with the other terminal
SP = Share printer (SP no)
M = More main menu selections...

Type the letter(s) and then press RETURN
```

M123-17-A0260

(Version 3.0)

Figure 18-1 WS102 Main Menu Page

## 18.1 SHARING THE SAME SCREEN

Both WS102 users may look at the same document on their screens. However, only one user may type into or edit the document, while the other user may only view the results. In the instructions which follow, the user who can type into the document is referred to as the controlling user because he or she has keyboard control, and the other user is referred to as the viewing user.

To share a document, each user follows a specific procedure:

1. **Controlling user.** Type the letters SS, a space, the word YES, and press the RETURN key when any Main Menu is displayed on the screen (if the last Main Menu page is currently displayed, YES will appear on the same line as SS).
2. **Viewing user.** Type the letters VS, a space, the word YES, and press the RETURN key when any Main Menu page is displayed on the screen. You must do this AFTER the other user sets SS to YES. If you try to set VS to YES while the other user's SS value is still NO, the word processing system displays an error message saying "The other terminal is not set to allow you to view its screen."

If you set VS to YES when the controlling user has already displayed a document, your screen will go blank. You will see the document only when the controlling user moves the cursor.

If you set VS to YES when the controlling user is still displaying the Main Menu, you will see only the date and time. As soon as

the controlling user specifies a document, you will see the beginning of that document.

While viewing the other user's document, you can retain control of your keyboard by pressing the gold and the MENU keys. The Main Menu will be displayed on the screen, and you can proceed with other word processing work. If you want to look at the other user's screen again, set VS to YES.

It is possible to exchange keyboard control when sharing a document so that the user who previously was only viewing can now type and edit.

1. **Currently controlling user.** Type the letters XK (eXchange Keyboard), and press the RETURN key when any Main Menu page is displayed on the screen. If you type XK when the other user has SS set to NO, the word processing system displays an error message saying "Keyboards may not be exchanged unless screens are being shared."
2. **Currently viewing user.** You will have keyboard control as soon as the other user types XK and presses the RETURN key.

## 18.2 ORDER IN WHICH DOCUMENTS ARE PRINTED

When both users on a WS102 system submit documents to be printed, the system always prints the first one submitted. What happens next depends on the values of Main Menu setting SP (Share Printer). If both users have SP set to YES, the system alternates between users, servicing the user who submitted the first printing request and then the other, and then returning to the first user, etc. It is also possible to have all your printing requests serviced before the other user's. Set SP to NO to have all your documents printed first.

To change the value of SP, follow these steps:

1. When the Main Menu is displayed on the screen, type the letter M and press the RETURN key until the page with SP is displayed on the screen.
2. Inspect the value of SP. If it is satisfactory, proceed with your work. To change it, type the letters SP, a space, either YES or NO, and press the RETURN key. The new value you just typed is automatically displayed on the screen.

There are three possible combinations of SP settings: (1) both users set SP to YES, (2) both users

set SP to NO, and (3) one user sets SP to YES while the other sets SP to NO. Here is how the word processing system handles each of these SP setting combinations.

1. **Both users set SP to YES.** The word processing system prints a single document for the user who submitted the first printing request and then prints a single document for the other user. The system continues this process until all documents submitted are printed. In the following example, User #1 submitted the first printing request and User #2 the second.

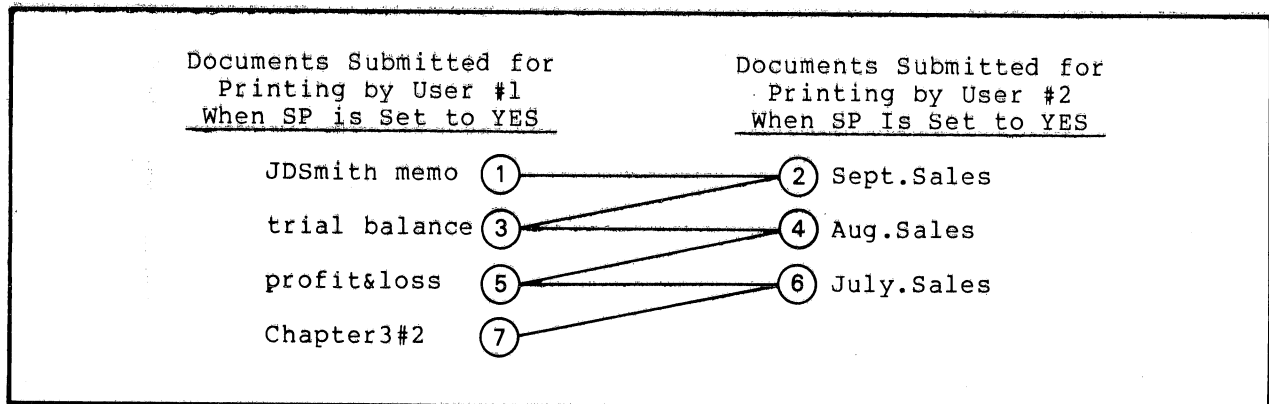

MK-0119

Figure 18-2 Example of Document Printing  
Order: Both Users Set SP to YES

2. **Both users set SP to NO.** The word processing system prints all documents for the user who submitted the first printing request

(User #1 in the example) and then prints all documents for the second user (User #2 in the example).

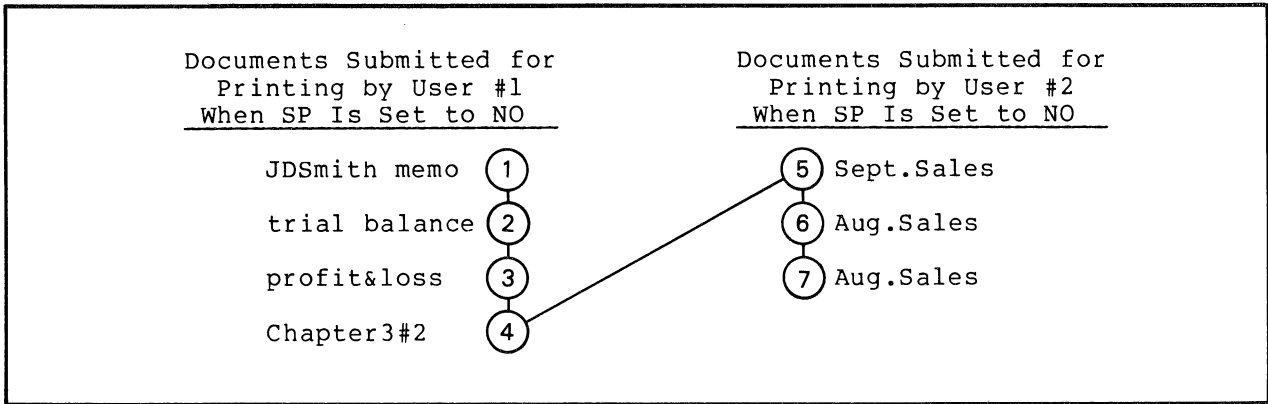

MK-0120

Figure 18-3 Example of Document Printing  
Order: Both Users Set SP to NO

3. **One user sets SP to YES and the other to NO.** The word processing system prints a single document for the user who submitted the first printing request (User #1 in

the example) and then prints all documents for the second user (User #2 in the example).

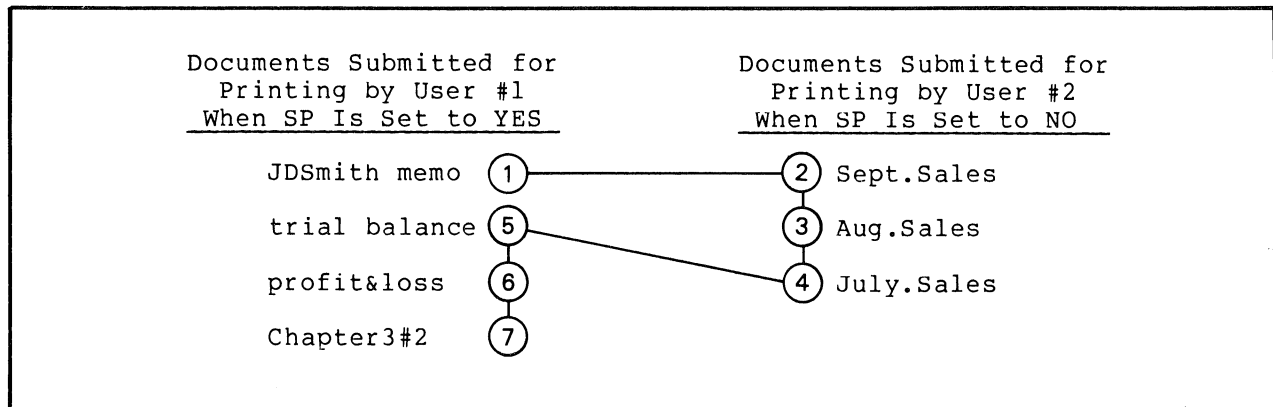

MK-0121

Figure 18-4 Example of Document Printing  
Order: One User Sets SP to YES, Other to NO (1)

If any documents are submitted for printing by the user with SP set to NO when a document is being printed for the other user, all these documents are printed next (when the current one is complete). To con-

tinue the above example, if User #2 submits "June.Sales" and "May.Sales" for printing while "profit&loss" is being printed, the system follows this order of printing:

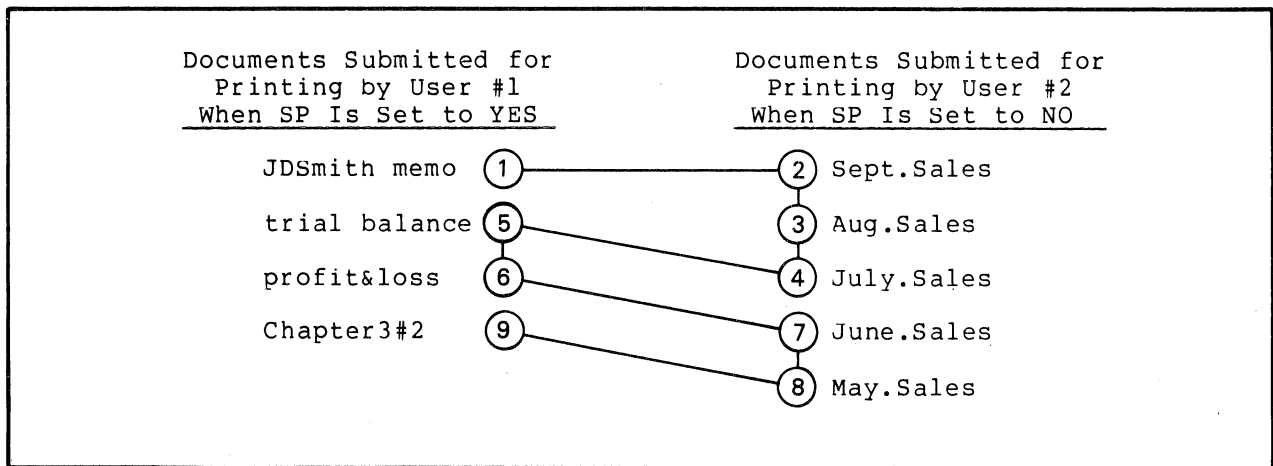

MK-0122

Figure 18-5 Example of Document Printing Order: One User Sets SP to YES, Other to NO (2)

# APPENDIX A WORD PROCESSING KEYS

The word processing system contains two keyboards: a main one and a mini.

Appendix A.1 describes the main keyboard keys while Appendix A.2 describes the mini keyboard.

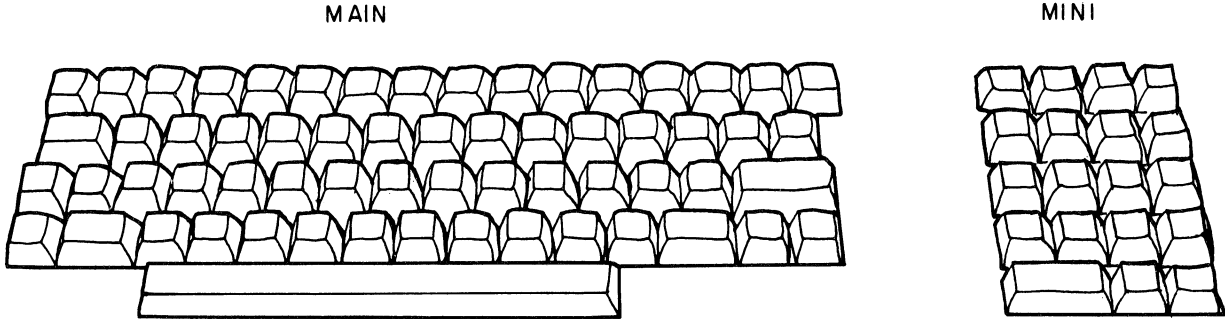

CP-3249

Figure A-1 Word Processing Main and Mini Keyboards

## A.1 THE MAIN KEYBOARD

The main keyboard has a standard typewriter keyboard plus special keys.



8018-215-A0143

Figure A-2 Main Keyboard

Some main keyboard keys have two sets of color-coded labels. The top of each key is labelled with a letter, number, or special mark while the front face of some keys is labelled with gold letters. Pressing one of these keys is equivalent to typing the letter, number, or special mark. When the gold key on the mini keyboard is pressed first, these keys perform the special operation indicated by the gold labels rather

than their normal operation. (The sides of some of these keys are labelled with white letters; however, these functions are not used for word processing.)

Each main keyboard special key (not found on a standard typewriter) and gold-lettered key is described in Table A-1.



**Table A-1**  
**Main Keyboard Keys**

**ABBRV**

(Black key, gold lettering)

Pressing the gold and this key copies frequently-used words or phrases from the abbreviation library document into the document currently being used. After pressing the gold and ABBRV keys, type a two character name to identify the abbreviation. See Chapter 10 for details.

**BOT DOCMT**

(Black key, gold lettering)

Moves the cursor to last character of the document. The screen will be blank until repositioning is completed.

**BREAK (Red)**

This key is not used for word processing.

**CAPS LOCK**

(Blue)

Pressing the gold and this key lets you type the letters A through Z in upper case. When pressed, this key stays locked until pressed again. Pressing this key does not affect the numbers or punctuation marks.

**CENTR**

(Black key, gold lettering)

Pressing the gold and this key centers the line of text. Press the gold and the CENTR keys at the end of the line to be centered. See Section 8.1 for details.

**CMND**

(Black key, gold lettering)

Pressing the gold and this key the first time inserts a line of dashes centered with the words START PRINT CONTROL. The second time the gold and the CMND keys are pressed inserts a line of dashes centered with the words END PRINT CONTROL. Between these two lines must be typed a header or footer (see Chapter 14), comment (see Section 16.1), multicolumn printing command (see Section 13.3.3), or page numbering reset command (see Section 14.4).

Each of these lines counts as one word processing character so you can remove it by positioning the cursor on the line and pressing the DEL CHAR key.

**CONT SRCH**

(Black key, gold lettering)

Pressing the gold and this key continues searching for the same phrase again after the first occurrence is located. Searching continues in the same direction as it started. See Chapter 7 for details.

**CONT SRCH & SEL**

(Black key, gold lettering)

Pressing the gold and this key searches for a specified phrase and automatically selects it for subsequent action (cutting, or replacing with other text). See Chapter 7 for details.

**COPY (Red)**

This key is not used for word processing.

**Table A-1 (Cont)**  
**Main Keyboard Keys**

**CTRL (Red)**

This key is not used for word processing.

**DATE & TIME**

(Black key, gold lettering)

Pressing the gold and this key inserts the current date and time in the document at the point where the cursor is presently located, e.g. 3/29/76 Mon 12:02:10. Date and time must be typed when you start up the system. See Section 2.4 for details if you are using either a WS78 or WS100 system; Section 2.5, for a WS102 system.

**DEAD KEY**

(Black key, gold lettering)

Pressing the gold and this key causes two or more characters to be printed on top of one another (overstruck). Position the cursor under the second character before pressing the gold and this key. The character above the cursor and the one to its left will be replaced with the ± symbol (the two characters will no longer be displayed). Overstruck characters can be redisplayed by positioning the cursor under the ± symbol and pressing the gold and the DEAD keys again. See Section 9.2 for details.

**ESC (Red)**

This key is not used for word processing.

**FILE DOCMT**

(Black key, gold lettering)

Pressing the gold and this key stores the document that is currently being used. The system will prompt you for the name of the document to be inserted. See Section 3.3 for details.

**GET DOCMT**

(Black key, gold lettering)

Pressing the gold and this key inserts a copy of a document into the document currently being used. The system will prompt you for the name of the document to be inserted. See Section 5.1.3 for details.

**HALT**

(Black key, gold lettering)

Pressing the gold and this key stops the following current word processing operations: the gold key followed by either ABBRV, LIBRY, GET DOCMT, SEARCH, ADVANCE, BACK UP, BOT DOCMT, a list processing merge, any blue grammatical key, or a user defined key.

**HYPH PULL**

(Black key, gold lettering)

Pressing the gold and this key pulls the last letter from the previous line to the beginning of the current line. Use this key if you push too many characters with the HYPH PUSH key. See Section 11.2 for details.

**Table A-1 (Cont)**  
**Main Keyboard Keys**

**HYPH PUSH**

(Black key, white lettering)

Pressing this key pushes the first letter on the current line back to the end of the last line where it will appear (if it fits) followed by a hyphen. See Section 11.2 for details.

**LIBRY**

(Black key, gold lettering)

Pressing the gold and this key copies text from the paragraph library document into the document currently being used. See Section 10.2 for details.

**MENU**

(Black key, gold lettering)

Pressing the gold and this key displays the Main Menu. If pressed while creating or editing a document, displays the Editor Menu on the screen.

**NEW PAGE**

(Black key, gold lettering)

Pressing the gold and this key inserts a NEW PAGE mark in the document. The text which follows the mark will always be printed on a new page. Use this for text that must start on a new page (such as a title page or new chapter). The cursor will stop on the first nonblank line following this mark when the mini keyboard PAGE key is pressed. This mark counts as one

word processing character and can be removed by positioning the cursor on the line and pressing the DEL CHAR key. See Section 12.2 for details.

**Numbers 0 through 9**

(Black key, white lettering)

Pressing the gold key and then typing one of the numbers 0 through 9 inserts the keystrokes previously saved with a user defined key into your document. See Chapter 15 for details.

**PAGE MARKER**

(Blue key, gold lettering)

Pressing the gold and this key inserts a PAGE MARKER in the document. This causes the text which follows to be printed on a new page only when you tell the system to use the PAGE MARKERS and not automatically determine page endings while printing. See Section 12.3 for details.

**PARA MARKER**

(Black key, gold lettering)

Pressing the gold and this key inserts a mark in the text to identify the beginning of a new paragraph. The following text will start on a new line. In addition, if a paragraph indent (letter P) is set in the current ruler, succeeding text is indented to the indicated typing position. When the mini keyboard PARA key is pressed, the cursor will stop on the first character after this mark. See Section 6.1.2.3 for details.

**Table A-1 (Cont)**  
**Main Keyboard Keys**

**PRINT HYPH**

(Black key, gold lettering)

Pressing the gold and this key inserts a visible hyphen in a compound word. This hyphen will always appear in the word regardless of its position on a line. If the word crosses the right margin, the system will attempt to break it at the hyphen. See Section 11.1 for details.

Holding down the shift key at the same time as pressing PRINT HYPH inserts an "invisible" hyphen in a word. This hyphen will appear in the text only if the word crosses the right margin. See Section 11.3 for details.

**REPEAT (Blue)**

Pressing this key lets you repeat the action of a main or mini keyboard key (such as typing a line of periods or dashes). Hold REPEAT down when pressing the key you want repeated. Be careful when using the REPEAT key; it is very easy to repeat more than intended.

**REPLC**

(Black key, gold lettering)

Pressing the gold and this key replaces selected text with text you previously put into the paste area (by cutting). Use this key in conjunction with the gold CONT SRCH & SEL key to locate and change multiple occurrences of the same phrase throughout a document. See Section 7.2 for details.

**RUB CHAR OUT**

(Black key, white lettering)

Pressing this key deletes (erases) the character to the left of the cursor.

**RUB LINE**

(Black key, gold lettering)

Pressing the gold and this key deletes (erases) a complete line to the left of the cursor.

**RUB SENT**

(Black key, gold lettering)

Pressing the gold and this key deletes (erases) a complete sentence to the left of the cursor. A word processing sentence is any amount of text followed by a period, question mark, exclamation point, tab, hard return, PAGE MARKER, or NEW PAGE mark. If any spaces appear to the immediate left of the cursor, pressing the RUB SENT key removes both the spaces and the preceding sentence.

**RUB WORD OUT**

(Black key, white lettering)

Pressing this key deletes (erases) the word plus all spaces, hard returns, tabs, paragraph marks, PAGE MARKERS, or NEW PAGE MARKS, to the immediate left of the cursor.

**Table A-1 (Cont)**  
**Main Keyboard Keys**

**RULER**

(Black key, gold lettering)

Pressing the gold and this key displays the current ruler settings. See Chapter 6 for details.

**SCROLL (Red)**

This key is not used for word processing.

**SHIFT (Blue)**

Pressing the gold and this key lets you type a character that appears at the top position of a number or punctuation mark key or a single upper case letter. There are two SHIFT keys, one at the left of the bottom row and one at the right. These keys do not lock; you must hold SHIFT down for each keystroke.

**SRCH**

(Black key, gold lettering)

Pressing the gold and this key moves the cursor forward (or backward) in the text to the first match with the phrase typed after the prompt "ENTER PHRASE:" is displayed on the screen. Press the ADVANCE key after specifying the phrase to start a forward search, the BACK UP key to start a backward search. Use the RUB CHAR OUT or RUB WORD OUT keys to correct characters in the phrase. Upper case (capital letters) in the phrase will match only upper case letters in the text but lower case will match either case. The system will buzz if no match is found. See Chapter 7 for details.

**SUB SCRIPT**

(Black key, gold lettering)

Pressing the gold and this key moves a character down one half-line when printed (not shown on the display screen). See Section 9.1 for details.

**SUPER SCRIPT**

(Black key, gold lettering)

Pressing the gold and this key moves a character up one half-line when printed (not shown on the display screen). See Section 9.1 for details.

**TAB CENTER (Blue)**

This key is not operational. Pressing the gold and this key causes the system to buzz.

**TOP DOCMT**

(Black key, gold lettering)

Pressing the gold and this key moves the cursor directly to the top (first line) of the document. The screen will display the message "--DOCUMENT FILING--" until repositioning is completed. This action is equivalent to filing a document and then requesting to edit it again (because the system updates bookkeeping information as if the document had been filed).

**VIEW**

(Black key, gold lettering)

Pressing the gold and this key shows the results of certain typing actions that are not normally displayed on the screen (such as tabs, underlines, hard and word wrap returns). After pressing the gold and VIEW keys, you can view successive lines by pressing the mini keyboard LINE key. You can redisplay the text in its original format by pressing the gold and VIEW keys again. Pressing any other key when viewing text redisplay the original text format but also inserts that keystroke into your document. See Appendix D for details.

## A.2 THE MINI KEYBOARD

The mini keyboard contains keys used for editing and organizing text. They are grouped by color (blue, white, red, black, and gold) according to the functions performed.

The blue keys with white letters are used to position the cursor in a document so you can inspect the text, make changes, or type new material. They are called grammatical keys because they move the cursor by a grammatical amount (word, line, sentence, paragraph, page). The blue mini keyboard keys are described in Table A-2.

The white keys with black letters are mode keys. Two of them, the ADVANCE and BACK UP

keys, set a direction mode and also move the cursor one character forward or backward. After pressing either of these mode keys, you can then move the cursor with any of the blue grammatical keys in the direction just set. The SEL (for SELEct), UPPER CASE, BOLD, and UNDER LINE keys set an action mode in addition to setting a forward direction mode. After pressing one of these four mode keys, you can then use any of the blue grammatical keys to indicate how much text is to be selected (for other action), displayed as upper case characters, marked for boldface printing, or marked for underlined printing. The white mini keyboard keys are described in Table A-3.

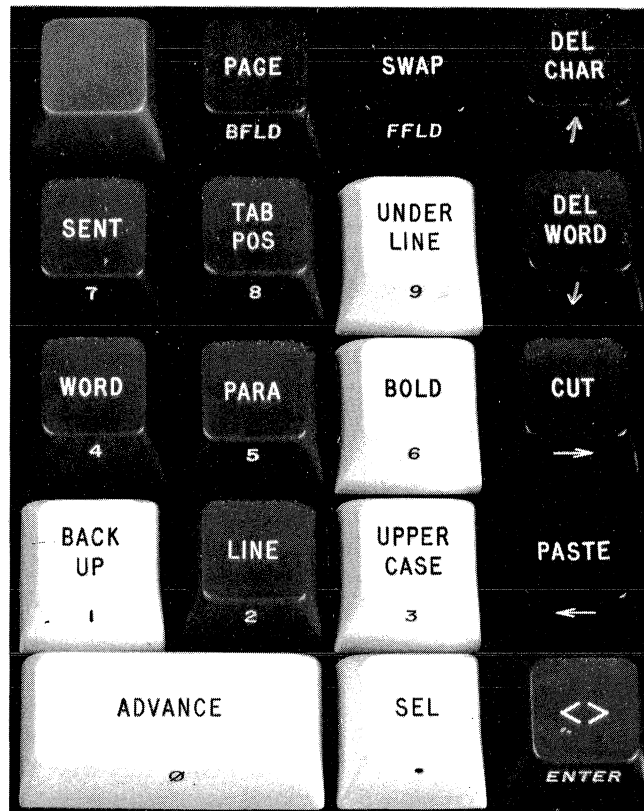

Figure A-3 Mini Keyboard

8018-214

The red keys with white letters are the deletion keys. They are colored red to warn you that text is deleted when these keys are used. These keys are described in Table A-4.

The black keys are used for two special editing functions: SWAP transposes two characters, and

PASTE inserts previously-typed text. These keys are described in Table A-5.

The gold key activates the gold-lettered functions of the main keyboard keys. If you accidentally press the gold key, press the HALT key to cancel its effect.

**Table A-2**  
**Mini Keyboard Blue Keys**

**LINE**

Moves the cursor from the beginning of one line to another. A line is what is displayed on the screen between the left and right margins.

**PAGE**

Moves the cursor from the beginning of one page to the beginning of the next provided you previously inserted PAGE MARKERs or NEW PAGE marks in your document (see Chapter 12). If the document does not contain any, pressing this key is equivalent to pressing either the gold and the ADVANCE or the gold and the BACK UP keys. (Even though you may have printed your document and noticed that the word processing system automatically allocated it to pages, you cannot then use the PAGE key to move by pages through the document.)

**PARA**

Moves the cursor from the beginning of one paragraph to the next. A paragraph is either of the following:

1. Text that is separated by two hard returns.
2. Text that is marked with a paragraph mark (by pressing the gold and the PARA MARKER keys) when the ruler contains a paragraph indent (letter P) setting. See Section 6.1.2.3 for details on typing indented paragraphs.

**SENT**

Moves the cursor from the beginning of one sentence to the beginning of the next sentence. A word processing sentence is any amount of text which is followed by a period, question mark, exclamation point, tab, hard return, PAGE MARK, or NEW PAGE mark. A word processing sentence may not be the same as defined by English grammar. For example, "Is pi equal to 3.1416?" is really two word processing sentences because it contains one question mark and one period.

**TAB POS**

Moves the cursor from the beginning of one tab position to the next. If no tabs are present on the current line, moves the cursor to the beginning of the next line.

**WORD**

Moves the cursor from word to word. A word is a group of characters followed by a space, tab, hard carriage, return, or page break marker. For example, "easy-to-use" is one word. If it were typed "easy - to - use" it would be five words ("easy," "to," "use," plus two dashes). Each dash is an individual word because it is followed by a space.

<>

Moves the cursor from the first character after one right angle bracket (>) character to another.



**Table A-3**  
**Mini Keyboard White Keys**

**ADVANCE**

Moves the cursor forward one character at a time. Also, places the system in the advance direction mode, allowing the cursor to be moved toward the bottom of the document by using the WORD, LINE, SENT, PARA, TAB POS, <>, and PAGE keys. Pressing the gold and the ADVANCE keys moves the cursor continuously toward the bottom of the document (this action can be stopped by pressing the gold and the HALT keys). The system will buzz if the ADVANCE key is pressed when the cursor is positioned at the bottom of the document.

**BACK UP**

Moves the cursor backward one character at a time. Also, places the system in the backup direction mode, allowing the cursor to be moved toward the top of the document by using the WORD, LINE, SENT, PARA, TAB POS, <>, and PAGE keys. Pressing the gold and the BACK UP keys moves the cursor continuously toward the top of the document (this action can be stopped by pressing the gold and the HALT keys). The system will buzz if the BACK UP key is pressed when the cursor is at the top of the document. It will then reverse the direction mode to forward.

**BOLD**

Marks the character above the cursor for boldfacing when printed. Also, places the system in

the advance and boldface mode so that pressing the WORD, LINE, SENT, PARA, TAB POS, PAGE, and <> keys marks additional text for boldfacing. Press the ADVANCE or BACK UP key to terminate the boldface mode. Boldfacing can be removed by pressing the gold key before pressing the BOLD key. This puts the system in the advance and boldface removal mode, similar to the advance and boldface mode. Once boldfacing is removed, press the ADVANCE or BACK UP key to terminate the mode. See Section 8.2 for details.

**SEL**

Marks the beginning or end of text for subsequent word processing action (cutting and pasting, changing to upper or lower case, marking for boldface or underlined printing, removing boldface or underline markings, subscripting, superscripting, or forming into a composite character) by placing a white square on the display screen. After pressing this key, either move the cursor to the other end of the selected text or type additional text (when you press SEL, the character above the cursor will be part of the selected text if you move the cursor forward but will not be part if you move the cursor backward). Then press the desired key(s). The selected text will be changed according to the key(s) just pressed and the white square removed from the screen. If you accidentally press the SEL key, press it a second time (the cursor will then be located where the SEL key was first pressed).

**Table A-3 (Cont)**  
**Mini Keyboard White Keys**

**UNDER LINE**

Marks the character above the cursor for underlining when printed. Also, places the system in the advance and underline mode so that pressing the WORD, LINE, SENT, PARA, TAB POS, PAGE, and <> keys marks additional text for underlining. Press the ADVANCE or BACK UP key to terminate the underline mode. Underlining can be removed by pressing the gold key before pressing the UNDERLINE key. This puts the system in the advance and underline removal mode, similar to the advance and underline mode. Once underlining is removed from all characters, press the ADVANCE or BACK UP key to terminate the mode. See Section 8.2 for details.

**UPPER CASE**

Changes the character above the cursor to upper case (capital letter). Also, places the system in the advance and upper case mode so that pressing the WORD, LINE, SENT, PARA, TAB POS, PAGE, or <> changes additional text to upper case. Press the ADVANCE or BACK UP key to terminate the upper case mode. Upper case letters can be changed to lower case by pressing the gold key before pressing the UPPER CASE key. This puts the system in the advance and upper case removal mode, similar to the advance and upper case mode. Once all characters are changed to lower case, press the ADVANCE or BACK UP key to terminate the mode. See Section 8.2 for details.

**Table A-4**  
**Mini Keyboard Red Keys**

**CUT**

Removes selected text from your document and stores it in the system's paste area. (You must press the white mini keyboard SEL key at one end and move the cursor to the other before pressing this key). A maximum of 7500 characters, or three pages, may be cut (the system will buzz if you try to cut more). To put text into the paste area without deleting it from the document, press the gold key and the CUT keys. See Section 5.4.4 for details.

**DEL CHAR**

Deletes (erases) the character above the cursor. The character can be restored by pressing the

gold key and then the DEL CHAR key again. Repeatedly pressing this key deletes characters to the right of the cursor. However, only the last character deleted can be restored.

**DEL WORD**

Deletes (erases) the remainder of the word above and to the right of the cursor including any spaces, hard returns, tabs, paragraph or centering marks, PAGE MARKERS, or NEW PAGE marks that follow. The word can be restored by pressing the gold key and then the DEL WORD key again. Repeatedly pressing this key deletes words to the right of the cursor. However, only the last word deleted can be restored.

**Table A-5**  
**Mini Keyboard Black Keys**

**PASTE**

Copies the text from the paste area into your document so that it conforms to the current text ruler. The text in the paste storage area may be repeatedly inserted by pressing the PASTE key again. To preserve the pasted text's ruler, place the text into the paste area by using the CUT key (and not the gold and CUT keys), position the cursor at the insertion point, and press the gold

key before the PASTE key. See Section 5.4.4 for details.

**SWAP**

Interchanges the character above the cursor with the character immediately to its right. Positions the cursor under the character just moved forward (i.e., the one on the right). See Section 5.4.1 for details.

C

C

C

C

C

## APPENDIX B MAIN MENU OPTIONS

This Appendix provides cross-references for all Main Menu options. Where the option is described in this Reference Manual, a cross-reference to the exact chapter or section is supplied. Where the option is described in a separate

document, the title and DIGITAL part number of the document are supplied.

Here is the first Main Menu page:

```
— MAIN MENU —                                     1/24/78 Tue 9:06:00

C = Create a new letter or document
E = Edit an existing letter or document
P = Print a letter or document
I = Index of letters and documents on file
F = Finished using the system
M = More main menu selections...

Type the letter and then press RETURN.
```

9113-11R1-A0146

Figure B-1 Main Menu Page One  
(Version 2.7)

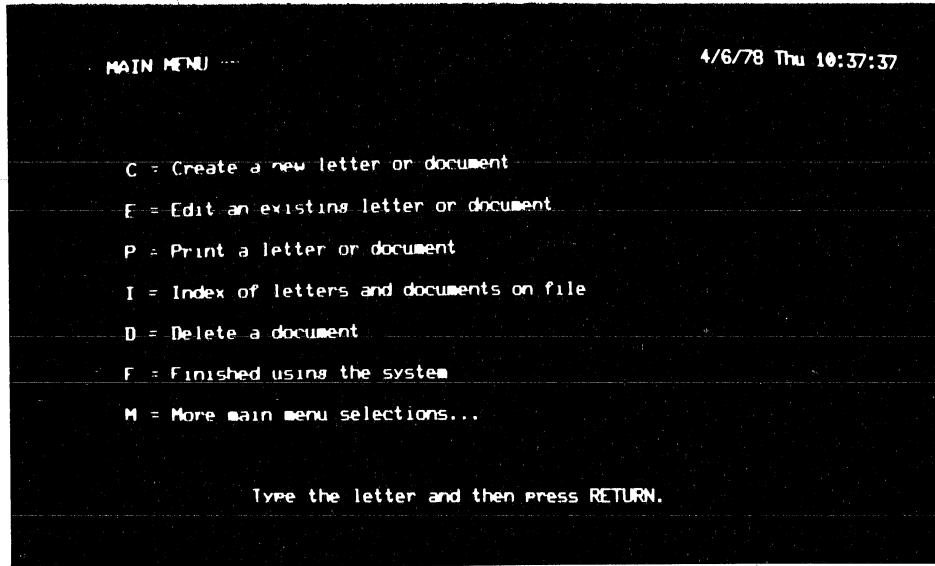

M113-12A0385

Figure B-1 Main Menu Page One  
(Version 3.0)

Option	Cross-reference	Option	Cross-reference
C	Chapter 3	F	Section 2.7 for WS78 and WS100 Section 2.8 for WS102 and WS202
E	Chapter 5		
P	Chapter 13		
I	Section 4.1	M	Typing the letter M and pressing the RETURN key causes the next Main Menu page to be displayed on the screen.
D	Section 17.1 (Version 3.0 only)		

Here is the second Main Menu page:

```
— MAIN MENU (continued) —                               1/24/78 Tue 9:06:38

S = Stop printing
R = Resume printing
N = New page, bring the printer to the top of the paper
D = Delete a document
SL = Store list of documents waiting to print
RL = Retrieve list of documents waiting to print
M = More main menu selections...

Type the letter(s) and then press RETURN.
```

9113-5R1-A0149

(Version 2.7)

```
— MAIN MENU (continued) —                               4/6/78 Thu 10:43:56

S = Stop printing
R = Resume printing
N = New page, bring the printer to the top of the paper
SL = Store list of documents waiting to print
RL = Retrieve list of documents waiting to print
CI = Copy index into a document
M = More main menu selections...

Type the letter(s) and then press RETURN.
```

M113-13A0386

(Version 3.0)

Figure B-2 Main Menu Page Two

Option	Cross-reference	Option	Cross-reference
S	Sections 13.5 and 13.6	RL	Section 13.7
R	Sections 13.5 and 13.6	CI	Section 4.3 (Version 3.0 only)
N	Section 13.5	M	Typing the letter M and pressing the RETURN key causes the next Main Menu page to be displayed on the screen.
D	Section 17.1 (Version 2.7 only)		
SL	Section 13.7		

Here is the third Main Menu page:

```

-- MAIN MENU (continued) --                               1/24/78 Tue 9:07:40

MC = Maintenance commands for diskettes
RD = Reset Date/Time
CI = Copy index into a document
DK = Define user keys
LP = List Processing Package
M = More main menu selections...

Type the letter(s) and then press RETURN.

```

9113-7R1-A0150

Figure B-3 Main Menu Page Three  
(Version 2.7)



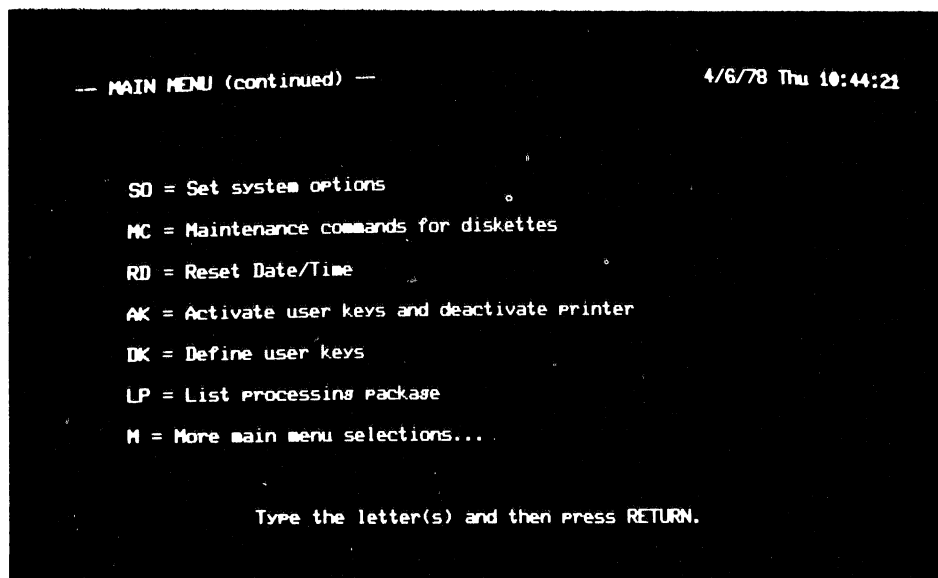

M113-14A0387

Figure B-3 Main Menu Page Three  
(Version 3.0)

Option	Cross-reference	Option	Cross-reference
SO	Appendix G, Word Processing System Communications Options User's Manual, AA-5264C-TK (Version 3.0 only)	DK	Section 15.1
MC	Section 17.2	LP	Word Processing System List Processing User's Manual, AA-5269B - TK
RD	Sections 2.6 for WS78 and WS100 Section 2.7 for WS102 and WS202	M	Typing the letter M and pressing the RETURN key causes the next Main Menu page to be displayed on the screen.
CI	Section 4.3 (Version 2.7 only)		

Here is the fourth Main Menu page:

```
— MAIN MENU (continued) —                               1/24/78 Tue 9:07:00

CX = Character transmission package
DX = Document transmission with a WP system
AD = Automatic Document Receive
M = More main menu selections...

Type the letter(s) and then press RETURN.
```

9113-9R1-A0147

(Version 2.7)

```
— MAIN MENU (continued) —                               4/6/78 Thu 10:45:38

CX = Character transmission package
DX = Document transmission with a WP system
AX = Automatic document transmission
M = More main menu selections...

Type the letter(s) and then press RETURN.
```

M113-15A0388

(Version 3.0)

Figure B-4 Main Menu Page Four

Option	Cross-reference	Option	Cross-reference
CX	Word Processing System Communications Options User's Manual, AA-5264C-TK	M	For WS78 and WS100 systems, typing the letter M and pressing the RETURN key causes the first Main Menu page to be displayed on the screen.
DX	Word Processing System Communications Options User's Manual, AA-5264C-TK		
AD	Word Processing System Communications Options User's Manual, AA-5264C-TK (Version 2.7 only)		For WS102 and WS202 systems, typing the letter M and pressing the RETURN key causes the next Main Menu page to be displayed on the screen.
AX	Word Processing System Communications Options User's Manual, AA-5264C-TK (Version 3.0 only)		

---

Here is the fifth Main Menu page. This page appears only in WS102 and WS202 systems.

```

-- MAIN MENU (continued) --                               1/24/78 Tue 9:00:00

SS = Allow other terminal to share your screen (SS yes)
VS = View the screen of the other terminal
XK = Exchange keyboard with the other terminal
SP = Share printer (SP no)
SD = Send document to other terminal
M = More main menu selections...

Type the letter(s) and then press RETURN

```

9113-11R1-A0148

Figure B-5 Main Menu Page Five (Version 2.7)  
(WS102 and WS202 Systems Only)

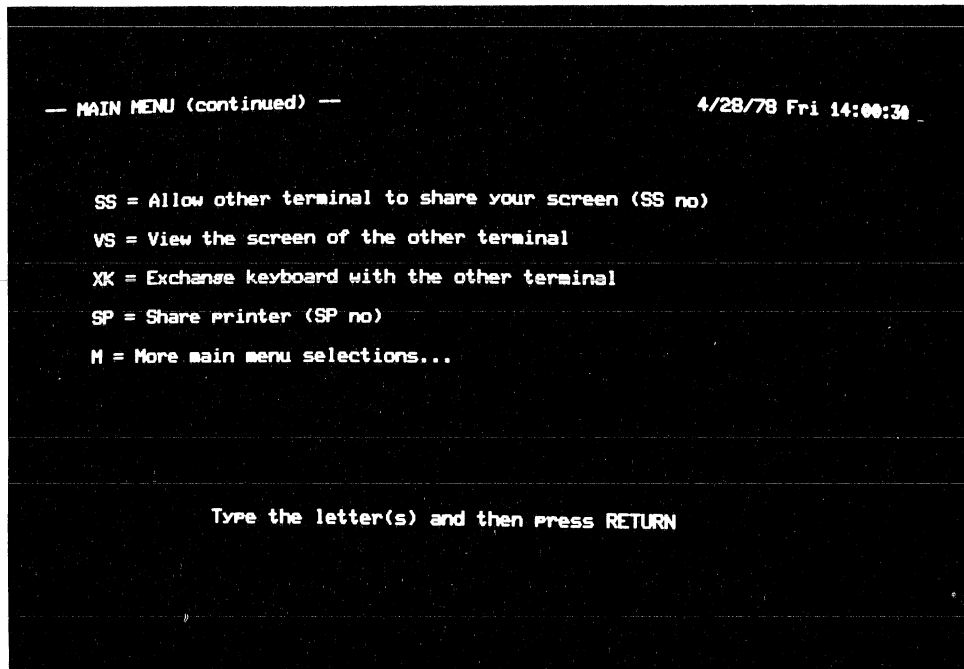

M123-17-A0260

Figure B-5 Main Menu Page Five  
(Version 3.0)

Option	Cross-reference	Option	Cross-reference
SS	Section 18.1	SD	Word Processing System Communications Options User's Manual, AA-5264C-TK (Version 2.7 only)
VS	Section 18.1		
XK	Section 18.1		
SP	Section 18.2	M	Typing the letter M and pressing the RETURN key causes the first Main Menu page to be displayed on the screen.

## APPENDIX C USING SYSTEMS THAT HAVE FOUR DISKETTE DRIVES

If you are operating a word processing system that has four diskette drives, you can reference documents on all four diskette drives. *Referencing* a document means to create, edit, print, delete, or copy it, or to specify a nonstandard abbreviation or paragraph library document. In addition, you can use the index of each of the four diskettes.

The numbers that appear above the diskette drive handles (0,1,2,3) are used in identifying documents by both you and the system. You have to type a diskette drive number only when you want a document that is stored on other than your system or document diskette. The system always uses the diskette drive number in any menu or message that includes information about a document (such as asking you if you want to edit the document you used previously).



8899-6BW-A0144

Figure C-1 Four Diskette Drives

## C.1 REFERENCING A DOCUMENT

To reference a document, precede the document name or number with the diskette drive number and a period. No spaces are permitted. For example, to print a document called "inventory" which is stored on a diskette in drive two, type the following:

P 2.inventory

You may omit typing the diskette drive number when referencing a document stored on a document diskette in any one of the following situations.

1. Drive one in a WS78 or WS100 system having either two or four drives.
2. Drive one for the main user of a WS102 or WS202 system.
3. Drive three for the other user of a WS102 or WS202 system.

For example, to create a document called "outline" to be stored on a diskette in drive one for the main WS102 user, type either of the following:

C outline  
C 1.outline

Similarly, you may reference documents stored on your system diskette by preceding the document name or number with either a { character or the number zero and a period.

The following restrictions apply to referencing documents in a WS102 or WS202 system.

1. Two users may not edit or print a document at the same time. Two users may,

however, both get a copy of the same document simultaneously (by means of the gold and GET DOCMT keys) or may use the same abbreviation or paragraph library document simultaneously.

2. If one user is performing a diskette maintenance operation, the other user cannot reference any document on that diskette. The system will display a warning message if this occurs.
3. If only one person is operating the system, there may be one system diskette (drive zero) and three document diskettes in the drives. However, if two people are operating the system, there must be two system diskettes (drives zero and two) and may be only two document diskettes (drives one and three).

If you switch terminals (WS102 and WS202 systems only), the system automatically adjusts for the standard abbreviation and paragraph library documents (documents two and three respectively on the system diskette). For example, you might use documents on WS102 diskette drive number one in the morning. After lunch you return to the WS202 system, find the main terminal in use, and therefore use the second terminal. When you insert your system and document diskettes (same ones as used in the morning) in drives two and three, the word processing system automatically recognizes that the standard abbreviation and boilerplate documents are now stored on diskette drive two.

If you use nonstandard library documents (see Section 10.5) and switch terminals, the system will nevertheless assume you want to use the

standard library documents. Either respecify the library documents (see Section 10.5), or do the following:

1. Insert the system diskette previously used in the left drive.
2. Type the letter F when any Main Menu page is displayed on the screen and press the RETURN key. The "FINISHED USING THE SYSTEM" message will be displayed on the screen.
3. Press the RETURN key to display the Main Menu.

## C.2 USING THE DISKETTE INDEX

To use a diskette index, type the letter I, a space, the diskette drive number (you may optionally put a period after the number) and press the RETURN key. For example, to use the index for diskette drive number three, type the following:

I 3

You may omit typing the diskette number to use the index for the document diskette in any one of the following situations:

1. Drive one in a WS78 or WS100 system having either two or four drives.
2. Drive one for the main user of a WS102 or WS202 system.
3. Drive three for the other user of a WS102 or WS202 system.

You may type either of the following to use the index for the system diskette (drive zero) for a WS78 system having four diskette drives or for the main user of a WS102 system.

I {  
I 0

The second user of a WS102 or WS202 system may type either of the following to use the index for the system diskette (drive two).

I {  
I 2



## APPENDIX D VIEWING TEXT

“Viewing” text allows you to inspect your document for the results of certain typing actions that are not displayed on the screen (tabs, underlines, etc.). To view text, press the gold and the VIEW keys.

The screen display will show half as many lines as previously plus viewing symbols wherever relevant. Table D-1 describes the viewing symbols that may be displayed.

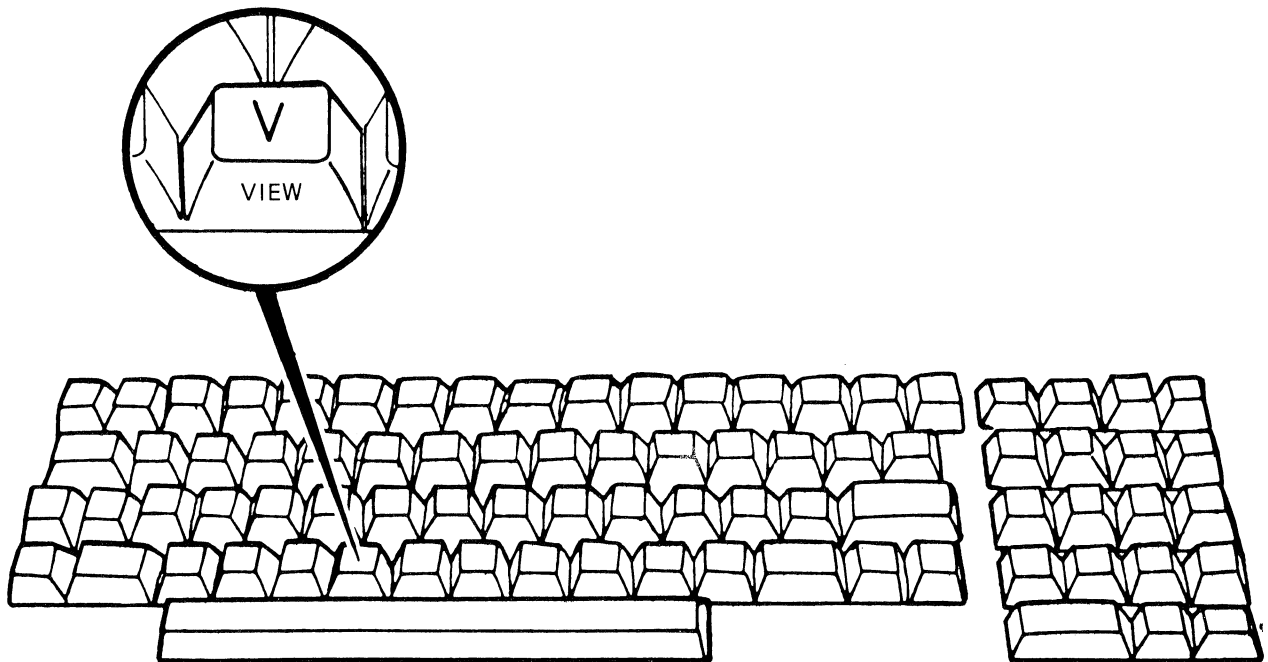

MK-0065

Figure D-1 Main Keyboard VIEW Key

When text is viewed, you can do one of the following actions:

1. **View additional, successive lines of text** by pressing the mini keyboard LINE key.

2. **Restore the standard screen display** by pressing either the gold and VIEW keys again or the ADVANCE key.

Pressing any other key (main or mini keyboard) when viewing text restores the standard screen display in addition to performing the key's action.

**Table D-1 Viewing Symbols**

Symbol	Means	Explanation
↓	Hard return	User pressed the RETURN key at end of line.
°	Word wrap return	System automatically inserted a return at the end of a line.
→	Tab	User pressed the TAB key (see Section 6.1.2.5).
••••	Spaces	<p>Inserted by the system in three different places:</p> <ol style="list-style-type: none"> <li>1. Between the typing position where the TAB key was pressed and the next tabbed word (or the right margin if the line does not contain another tab stop).</li> <li>2. Between typing position 1 and the left margin (when the left margin is set beyond position 1).</li> <li>3. Between the left margin and the first character of centered text.</li> </ol>
¶	Paragraph indent	The next word starts on a new line and is indented (provided the ruler contains the letter P). Created with the gold and PARA MARKER keys and the letter P in the ruler (see Section 6.1.2.3).
c <sub>d</sub>	Centered text	All text on the line is centered. Created with the gold and CENTR keys (see Section 8.1).
*	Boldface	Character will be printed in boldface (overprinted three times). Created with the BOLD key (see Section 8.2).
—	Underline	Character will be underlined when printed. Created with the UNDER LINE key (see Section 8.2).

**Table D-1 Viewing Symbols (Cont)**

<b>Symbol</b>	<b>Means</b>	<b>Explanation</b>
=	Bold and underline	Character will be overprinted three times and also underlined. Created with both the BOLD and UNDER LINE keys (see Section 8.2).
q	Superscript	Character will be printed one half-line above the level of the line. Created with the gold and SUPER SCRIPT keys (see Section 9.1.1).
Q	Superscript and bold	Character will be printed as a superscript and boldfaced. Created with the gold and SUPER SCRIPT keys and the BOLD key (see Sections 9.1.1 and 8.2).
a	Subscript	Character will be printed one half-line below the level of the line. Created with the gold and SUB SCRIPT keys (see Section 9.1.1).
A	Subscript and bold	Character will be printed as a subscript and boldfaced. Created with the gold and SUB SCRIPT keys and the BOLD key (see Sections 9.1.1 and 8.2).
/	Possible hyphenation point	User did one of the following actions :  <ol style="list-style-type: none"> <li>1. Pressed the gold and PRINT HYPH keys to insert a breaking hyphen in a word (see Section 11.1).</li> <li>2. Hyphenated a word by using the gold, HYPH PUSH, and/or HYPH PULL keys (see Section 11.2).</li> <li>3. Inserted an invisible hyphen in a word (see Section 11.3).</li> </ol>
±	Composite character	Two or more characters will be printed in the same position. Created with the gold and DEAD keys (see Section 9.2).
÷	End of text	Supplied by the word processing system to indicate the end of the document.
■	Select point	User pressed the mini keyboard SEL key.



## APPENDIX E RULER SETTING CHARACTERS

Table E-1 summarizes all allowable ruler setting characters and supplies a cross-reference to the

appropriate location in this Reference Manual for additional information.

**Table E-1**  
**Summary of Ruler Setting Characters**

<b>Ruler Character</b>	<b>Meaning</b>	<b>For Additional Information</b>
C	Centering point	Section 8.1
D	Left margin position double-spaced	Section 6.1.2.1
F	Left margin position, half-line spaced	Section 6.1.2.1
H	Hyphenation zone	Section 11.5
J	Right margin position, justified (lined up evenly on right)	Section 6.1.2.2
L	Left margin position, single-spaced	Section 6.1.2.1

**Table E-1**  
**Summary of Ruler Setting Characters (Cont)**

<b>Ruler Character</b>	<b>Meaning</b>	<b>For Additional Information</b>
N	Left margin position, space and one half spaced	Section 6.1.2.1
P	Automatic paragraph indent	Section 6.1.2.3
R	Right margin position, ragged	Section 6.1.2.2
T	Left-justified tab	Section 6.1.2.5
W	Automatic word wrap indent	Section 6.1.2.4
>	Right-justified tab	Section 6.1.2.5
.	Decimal-aligned tab	Section 6.1.2.5

**APPENDIX F**

**HOW NONTEXT KEYSTROKES ARE DISPLAYED  
WHEN TYPED INTO A USER DEFINED KEY**

<b>Keystroke</b>	<b>Displays As</b>
Gold and ABBRV	Gold:=
Gold and ADVANCE	G-Adv
ADVANCE	Advanc
Gold and BACK UP	G-Back
BACK UP	Backup
Gold and BOLD	G-Bold
BOLD	Bold
Gold and BOT DOCMT	Gold:B
Gold and CENTR	Gold:C
Gold and CMND	Gold:{
Gold and CONT SRCH	Gold:.
Gold and CONT SRCH & SEL	Gold:/
Gold and CUT	G-Cut
CUT	Cut
Gold and DATE + TIME	Gold:\
Gold and DEAD KEY	Gold:D
Gold and DEL CHAR	G-Del
DEL CHAR	Delchr
Gold and DEL WORD	G-Del
DEL WORD	Del Wrd:
Gold and FILE DOCMT	Gold:F
Gold and GET DOCMT	Gold:G
Gold and HALT	Not possible to include Terminates definition.
Gold and HYPH PULL	Hypull
HYPH PUSH	Hypush
Gold and LIBRY	Gold:L
LINE	Line
Gold and MENU	Gold:M

**Keystroke**

Gold and NEW PAGE  
PAGE  
Gold and PAGE  
Gold and PAGE MARKER  
PARA  
Gold and PARA MARKER  
Gold and PASTE  
PASTE  
Gold and PRINT HYPH  
Gold and REPLC  
RETURN  
RUB CHAR OUT  
Gold and RUB LINE  
Gold and RUB SENT  
RUB WORD OUT  
Gold and RULER  
SEL  
SENT  
Space  
Gold and SRCH  
Gold and SUB SCRIPT  
Gold and SUPER SCRIPT  
SWAP  
TAB  
TAB POS  
Gold and TOP DOCMT  
Gold and UNDER LINE  
UNDER LINE  
Gold and UPPER CASE  
UPPER CASE  
Gold and VIEW  
WORD  
<>

**Displays As**

Gold:N  
Page  
G-Page  
Gold:P  
Para  
Parmrk  
G-Pste  
Paste  
Gold:-  
Gold:'  
Return  
Rubchr  
Rublin  
Rubsen  
Rubwrđ  
Gold:R  
Sel  
Sent  
Space  
Gold:,  
Gold:A  
Gold:Q  
Swap  
Tab  
Tabpos  
Gold:T  
G-Undr  
Under  
G-Uppr  
Upper  
Gold:V  
Word  
<>



## APPENDIX G USING THE WS78 AUXILIARY COMMUNICATIONS PORT

This Appendix applies to version 3.0 only.

When a serial draft printer (DIGITAL part number LA180-Ex) is connected to the WS78 auxiliary communications port, it is necessary that the value of System Options Menu setting DP2 indicate the printer's baud rate (communications line speed). Do the following:

1. **Type the letters SO and press the RETURN key** when any Main Menu page is displayed on the screen. This action causes the System Options Menu to be displayed on the screen.

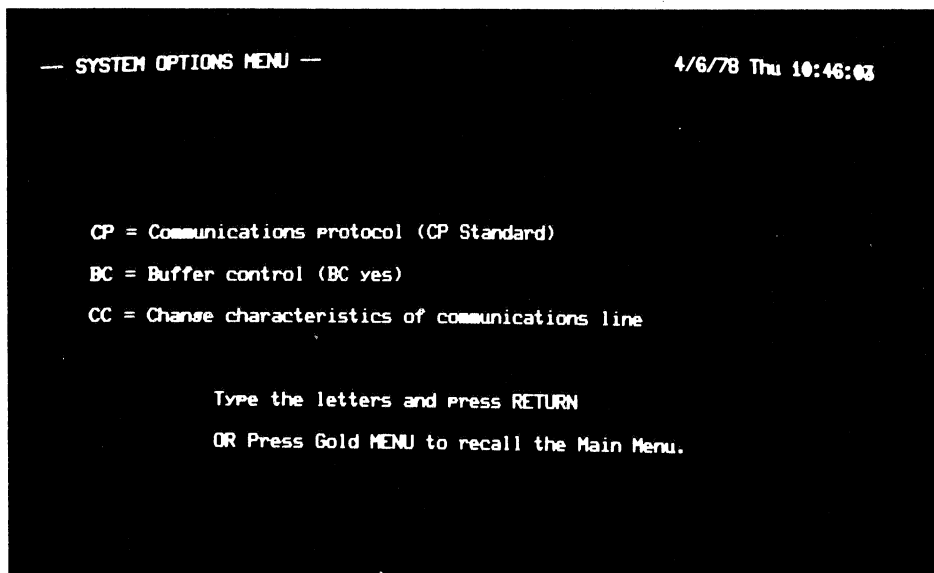

M113-16A0389

Figure G-1 System Options Menu

2. **Type the letters CC and press the RETURN key.** This action causes the Communications Settings Menu to be displayed on the screen (see below).
3. **Inspect the baud rate value displayed for setting DP2.** If this value is equal to the baud rate of the serial printer attached to the auxiliary communications port, omit step 4 below and return to other word processing work. Just press the gold and the MENU keys once, to redisplay the System Options Menu, and a second time, to redisplay the Main Menu.
4. **Type the letters DP2, a space, the baud rate of the serial printer, and press the RETURN key** to change the value of setting DP2. Then press the gold and the MENU keys once, to redisplay the System Options Menu, and a second time, to redisplay the Main Menu.

Here are the allowable values for DP2.

50	1800
75	2000
110	2400
134.5	3600
150	4800
300	7200
600	9600
1200	19200

The value specified for DP2 will always be in effect whenever the same system diskette (as used to set DP2) is used. This system action occurs because the value of DP2 is stored on the system diskette.

```

— COMMUNICATION SETTINGS MENU —                               4/6/78 Thu 10:56:25

  B = Baud rate (B 2000)
  P = Parity (P no)
  D = Data bits (D 8)
  S = Stop bits (S 2)

DP2 = DP2 Baud rate (DP2 9600)

Type the desired option and press RETURN
OR Press Gold MENU to recall the System Option Menu

```

M113-1A0381

Figure G-2 Communications Settings Menu

## GLOSSARY

### **ABBREVIATION:**

The two letters which denote a particular Print Menu setting. For example, CP denotes the "number of Copies" setting.

### **ABBREVIATION LIBRARY DOCUMENT:**

A document that contains groups of words or short phrases saved in association with a two-character abbreviation. Whenever an abbreviation is used, the word processing system automatically inserts the corresponding words or phrase into the document currently being typed or edited.

### **ALIGNED:**

To be lined up at a particular typing position. For example, if successive entries in a column of a table all start at the same typing position, then they are aligned on the left. Conversely, if table entries all end at the same position, they are aligned on the right.

### **ALPHABETIC:**

Either an upper or lower case letter (A-Z) of the alphabet.

### **ASTERISK:**

Appears in the index to the left of a document entry. The asterisk can be moved to

any index entry and then the word processing system can be directed to edit, delete, or print that particular document.

### **AUTOMATIC:**

Performed by the word processing system with no assistance from the typist.

### **AUTOMATIC RETURN:**

A carriage return automatically inserted by the word processing system.

### **BLOCK:**

The word processing unit in which text is stored. A block is 512 characters, or approximately one paragraph.

### **BOLDFACE:**

Text which is printed extra dark (**this text is boldface**). Word processing boldfaced text is struck three times.

### **BOOTSTRAP:**

To put a computer program into the terminal so it can begin functioning as a word processor.

### **BOTTOM MARGIN:**

Lines between the last line of text printed per page and the bottom edge of the paper.

**BREAK:**

To end a printed page and start a new one (see Chapter 12) or to hyphenate a word across two lines.

**BREAKING HYPHEN:**

A '-' mark used to join two (or more) words which may be divided at the end of a line.

**BROWN-OUT:**

A momentary drop in electrical power supply.

**CAPITALIZE:**

To produce upper case letters (A-Z) such as THESE WORDS.

**CARRIAGE RETURN:**

The word processing system has two kinds of carriage return: word wrap and hard. A word wrap return occurs when the system determines where a line is to end. A hard return occurs when the typist presses the RETURN key to end a line.

**CENTER:**

To indicate that a typed line is to be automatically located an equal distance from both the left and right margin positions.

**CENTER POINT:**

Typing position indicated in the document's ruler, around which text is to be centered.

**CHARACTER:**

A single letter, digit, punctuation mark, or special symbol produced by pressing a main keyboard key.

**CLEAR A RULER:**

To instruct the word processing system that no further ruler changes are to be made to a displayed ruler.

**COLUMN MARGIN:**

Number of spaces separating multiple columns.

**COMMENT:**

Text which displays on the screen but is not printed.

**COMPOSITE CHARACTER:**

A printed character produced by striking two or more characters on top of one another.

**COMPOUND WORD:**

Two or more separate words joined together with a user-supplied hyphen mark, such as "user-supplied."

**CONFIGURATION:**

A grouping of equipment that constitutes a particular member of the DIGITAL family of word processing systems.

**CONTROLLING USER:**

The WS102 or WS202 user who can type or edit a document when the two screens are shared.

**COPY:**

To make an extra version of a word processing document or to make a duplicate of a diskette.

**CREATE:**

To tell the word processing system a new document is to be typed and the name that document is to be called.

**CREATION DATE:**

The date on which a document is created.

**CURRENT TEXT SIZE:**

The number of text lines per page used by the word processing system for the current document being typed or edited.

**CURSOR:**

A blinking underscore character displayed on the screen that marks the current position in text. New typed text is inserted to the left of the cursor.

**CUSTOMIZATION POINT:**

A place in a document marked with the < and > characters. Such a point may easily be located by pressing the mini keyboard <> key.

**CUT:**

To remove a piece of text from a word processing document (by means of the CUT key). Removed text is placed in a word processing paste area and can be inserted anywhere (more than once) in the same or a different document.

**DATE AND TIME STAMP:**

Automatic insertion of the current date and time into a document.

**DECIMAL-ALIGNED TAB:**

Typing position with which a decimal point in a number will be lined up.

**DEFINITION:**

All the characters and keystrokes that are acted on when a particular user defined key is used.

**DELETE:**

To remove a character, word, line, sentence, or larger text portion from a document or to remove a document from storage.

**DIGIT:**

The single character numbers 0, 1, 2, ..., 9.

**DISKETTE:**

A round piece of magnetic material, about the size of a 45-rpm record, on which documents and the word processing system software are stored.

**DISPLAY:**

Text, prompts, and error messages which are shown on the word processing screen.

**DISPLAY A RULER:**

To instruct the word processing system to accept new or changed ruler settings.

**DISPLAY SCREEN:**

The television-like word processing equipment on which typed text, prompts, and error messages are shown.

**DOCUMENT:**

The word processing unit of storage in which typed text is saved, similar to a file folder in a file cabinet.

**DOCUMENT DESTINATION:**

The type of printer or output device (communications line, photocomposition machine) on which a document is to be printed.

**DOCUMENT NUMBER ONE:**

A document which contains the names of all other documents on a particular diskette. To change the spelling of a document name, edit document number one and retype the new name.

**DRAFT PRINTER:**

The word processing printer which produces typing comparable to a computer printout at an average speed of 2160 words per minute.

**DRIVE:**

The word processing equipment which holds a diskette, similar to a phonograph.

**EDIT:**

To bring an existing document to the screen for the purposes of inspecting it, adding new text, and/or making changes.

**EMBED:**

To place new or changed ruler settings into a document.

**ERASE:**

To remove the character, word, line, or sentence to the immediate left of the cursor by pressing the RUB CHAR OUT, RUB WORD OUT, RUB LINE, or RUB SENT key respectively.

**ERROR MESSAGE:**

Information which is automatically displayed on the screen when you type an incorrect response.

**FIELD SERVICE REPRESENTATIVE:**

The DIGITAL person to contact in the event of a word processing hardware or software failure.

**FILE:**

To tell the word processing system that typing and editing of a particular document are complete and it is to be saved for reuse.

**FLOPPY:**

Colloquialism for diskette.

**FOOTER:**

Text that appears in the bottom margin of printed pages such as a document title, page number, or date.

**FORM:**

A document containing text to be printed plus indicators of where and what kind of information is to be merged when using list processing.

**FORM-FEED PAPER:**

A long, continuous sheet of paper whose pages are separated by perforations. This type of paper is used with the word processing system so lengthy documents can be printed without having to repeatedly insert individual pages.

**HARD RETURN:**

A carriage return inserted by pressing the RETURN key.

**HARDWARE:**

The word processing equipment including the keyboards, display screen, diskette drives, and computer.

**HEADER:**

Text that appears in the top margin of printed pages such as a document title, page number, or date.

**HIGHLIGHT:**

To center, underline, boldface, or capitalize word processing text.

**HYPHEN:**

A '-' mark used (1) at the end of a line to divide a word into two parts and (2) between two words to join them into a compound word.

**HYPHENATE:**

To divide a word into two parts at the end of a line, putting the first part with a hyphen mark on one line and the second part at the beginning of the next line.

**HYPHENATION ZONE:**

The maximum number of typing positions in front of the right margin that may remain unused on a line.

**INDEX:**

A screen display showing all documents on a diskette with the following information: available number of blocks in the area for new typing, name and number of each document, when each was created and most recently modified, the size of each, the amount of time used in the most recent editing session, and the total amount of time spent editing. The index is automatically created and updated by the word processing system.

**INITIALIZE:**

To process a diskette so it can be used for storing either documents or the word processing software.

**INVISIBLE HYPHEN:**

A nondisplaying mark indicating where a word may be hyphenated should it be positioned at the right margin of a line.

**JUSTIFIED:**

To have text lined up evenly at the right margin of a page.

**KEYBOARD:**

The keys by which word processing characters are typed and instructions are supplied.

**LEFT MARGIN:**

The typing position where the beginning of each line is to appear. Indicated in a document's rulers.

**LEFT-JUSTIFIED TAB:**

The typing position where tabbed text is to begin.

**LETTER:**

A single alphabetic character (A-Z) produced by pressing one of the main keyboard keys. Can be either lower or upper case.

**LETTER QUALITY PRINTER:**

The word processing printer which produces typing comparable to a typewriter at an average speed of 540 words per minute.

**LIBRARY DOCUMENT:**

A document that contains groups of text saved in association with a "shorthand" name. A word processing abbreviation library document contains groups of words or short phrases while a paragraph library document contains groups of paragraphs.

**LINE:**

All text displayed on the screen between one particular left margin and right margin.

**LINE LEVEL:**

The invisible horizontal line on which characters are printed. A subscript or superscript is used to print characters below or above line level respectively.

**LIST:**

A document containing information that may possibly be merged into a form for printing when using list processing.

**LIST PROCESSING:**

A word processing feature that allows you to produce the same kind of typing many times with just certain information varying from one piece of typing to another.

**MAIN KEYBOARD:**

The keys by which word processing characters are typed. Some main keyboard keys may also be used to perform special word processing actions.

**MENU:**

A list of word processing options from which the typist can choose an action to perform, similar to a restaurant menu.

**MINI KEYBOARD:**

A group of 19 word processing keys used for editing and organizing text.

**MODIFICATION DATE:**

The date on which a document was last edited.

**MULTIPLE COLUMN COMMAND:**

A word processing feature that enables text to be typed as one continuous column and then be printed with two or more columns per page.

**NEW PAGE MARK:**

A mark inserted in a document by pressing the gold and NEW PAGE key that forces the following text to always be printed on a new page. Generally used for the beginning of new chapters or for long tables which should appear undivided on a single page.

**NONBREAKING HYPHEN:**

A '-' mark used to join two (or more) words which cannot be divided at the end of a line, such as the hyphens in the telephone number 617-899-9000.

**NUMBER:**

A single digit (0, 1, 2, ..., 9) or several digits typed together (no spaces between any). Examples are 3, 25, 1977, 567890.

**OVERWRITE:**

To save word processing typing in a document that already contains some text. The old text is replaced with the new.

**PAGE MARKER:**

A mark inserted in a document to indicate that the following text may be printed on a new page.

**PAGE SIZE:**

Number of lines that fit on a printed page from the top edge to the bottom.

**PAGINATION:**

To determine where to end a printed page and start a new one.

**PARAGRAPH:**

Any text that begins with either two or more hard returns or a paragraph mark.



**PARAGRAPH INDENT:**

Typing position where the first word of an indented paragraph is to appear.

**PARAGRAPH LIBRARY DOCUMENT:**

A document that contains groups of paragraphs saved in association with a name (maximum of 16 characters). Whenever the name is used, the word processing system automatically inserts the corresponding paragraph into the document currently being typed or edited.

**PARAGRAPH MARK:**

A mark, indicating the start of a new paragraph inserted by pressing the gold and the PARA MARKER keys. When a paragraph indent position is specified in the ruler, a paragraph so marked will be indented.

**PASTE:**

To insert a piece of already-typed text into a document. The same piece of text may be inserted several times in the same or different documents. Requires use of the CUT and PASTE keys.

**PASTE AREA:**

Word processing location where the most recently-cut text is kept. Paste area contents remain unchanged until another cut is made.

**PHRASE:**

The characters, word, or group of words to be searched for.

**PITCH:**

The number of characters printed per horizontal inch.

**PRINT:**

To direct the word processing system to produce a paper copy of stored typing.

**PRINTER:**

The word processing equipment which produces a paper copy of stored typing.

**PRINTING MARGIN:**

Spaces added to the left margin of a page when a document is printed.

**PRINT QUEUE:**

The documents waiting to be printed.

**PRINT SETTING:**

A control on how a document is printed (number of copies, lines per page, characters per inch, etc.). Displayed on the screen in the Print Menu.

**PRINT WHEEL:**

A round plastic device which prints characters in the letter quality printer. The printing characters are located at the end of spokes on the print wheel. When struck by a hammer, these spokes produce printed characters.

**PROMPT:**

A message displayed on the screen either asking for some information or giving instructions.

**PROPORTIONAL SPACING:**

Capability of printing characters that occupy different widths, the letter M being wider than the letter l, for example.

**PULL:**

To hyphenate a word by bringing a character down from the end of one line to the beginning of the next.

**PUSH:**

To hyphenate a word by (1) placing a character from the beginning of a line at the end of the previous line and (2) inserting a hyphen.

**QUEUE:**

A waiting line (like the teller's window at a bank) into which the word processing system puts all documents submitted for printing.

**REFERENCE:**

To create, edit, print, delete, or copy a word processing document.

**REPLACE:**

To automatically locate a particular phrase in a document and insert some previously-typed text.

**RIGHT MARGIN:**

The typing position where the last character of each line may appear. Indicated in a document's rulers.

**RIGHT-JUSTIFIED TAB:**

The typing position where the last character of a tabbed word is to be placed.

**RULER:**

The margin settings, vertical line spacing, and tabs (if any) for a document.

**SCROLL:**

To move the cursor continuously through a document, displaying all text on the screen.

**SEARCH:**

To instruct the word processing system to locate and position the cursor at the beginning of a particular phrase.

**SELECT:**

To mark one end of a piece of text for (potential) word processing editing. The editing may be underlining, boldfacing, capitalization, subscripting or superscripting, the removal of one of these, or deletion.

**SELECT MARK:**

A white rectangle on the display screen marking the position where the SEL key was pressed.

**SELECTION SPECIFICATION:**

A document that specifies exactly which list entries are to be selected for merging with a form document when using list processing.

**SENTENCE:**

Any combination of characters, words, spaces, or lines which are followed by a period, question mark, exclamation point, tab, hard return, PAGE MARKER, or NEW PAGE mark.

**SHARING THE SCREEN:**

Capability of the WS102 system which allows both users to view the same document on the screens.

**SOFTWARE:**

Computer programs that cause the terminal to function as a word processor.

**SPACE:**

Blank character, occupying one typing position, which is produced with the space bar.

**SPLIT SCREEN:**

Text whose first 80 characters of each line are displayed at the bottom of the screen and the rest at the top. This occurs when a wide ruler (right margin set beyond typing position 79) is in effect.

**STANDARD RULER:**

The ruler settings automatically supplied for each new document created. These are associated with ruler number zero.

**STANDARD TEXT SIZE:**

The number of text lines per page used by the word processing system for all newly-created documents.

**STORED PRINT SETTINGS:**

A collection of all Print Menu settings that are saved in the system for reuse.

**STORED RULER:**

A particular ruler saved on the system diskette for reuse.

**SUBSCRIPT:**

One or more characters that are printed one half-line below the level of the typed line, like the number 2 in H<sub>2</sub>O.

**SUPERSCRIPT:**

One or more characters that are printed one half-line above the the level of the typed line, such as the number 2 in the following example.

$$e=mc^2$$

**SWAP:**

To reverse the position of the character above the cursor with the one to its immediate right by pressing the mini keyboard SWAP key.

**SYSTEM MANAGER:**

The person who is responsible for total operation of a word processing system.

**TAB:**

To press the TAB key and thereby cause the cursor to advance immediately to a previously-set tab position.

**TAB MARK:**

A mark, inserted by pressing the TAB key, which causes text to be formatted according to previously-set tab positions in the ruler.

**TAB POSITION:**

Typing position where text is to be placed when the TAB key is pressed. Word processing tab positions are indicated in a document's rulers.

**TABBED TEXT:**

Text which is typed immediately after the TAB key is pressed.

**TEXT:**

The words, characters, numbers, and information that constitute a word processing document.

**TOP MARGIN:**

Lines between the top edge of a page and the first line of text printed.

**UNDERLINE:**

To print a line under some text such as right here.

**USER DEFINED KEY:**

A number which, when pressed immediately after the gold key, activates previously-stored key-strokes.

**VERIFY:**

To inspect the condition of a diskette after an odd symptom occurs.

**VERSION NUMBER:**

The number of times a particular document has been edited. The version number can be seen by inspecting the document index.

**VIEWING USER:**

The WS102 user who cannot type or edit a document when screens are shared.

**VIEW:**

To inspect a document for the results of certain typing actions that are not displayed on the screen.

**WIDE LINE:**

A typed line whose right margin setting is located anywhere between typing position 80 and 158.

**WIDE RULER:**

A ruler that allows for between 80 and 158 characters per typed line.

**WORD:**

Any combination of characters plus all following spaces, hard returns, tabs, paragraph marks, PAGE MARKERs, or NEW PAGE marks.

**WORD WRAP:**

To allow the word processing system to automatically place a word that crosses the right margin boundary at the beginning of the next line.

**WORD WRAP RETURN:**

A carriage return automatically inserted by the word processing system.

**WORD WRAP INDENT:**

A typing position, indented from the left margin, where a word is automatically placed when it crosses the right margin. These lines illustrate word wrap indent.

## INDEX

### A

Abbreviation documents. See *Library documents*.  
Auxiliary communications port, 13-8, G-1 to G-2

### B

Boldfacing, 8-6 to 8-10  
  After typing, 8-7  
  Determining whether text is boldfaced, 8-8  
  Effect of right margin, 8-9 to 8-10  
  Effect of spaces, 8-8 to 8-9  
  Only words, 8-9  
  Removing, 8-12  
  While typing, 8-6  
Bootstrapping,  
  The WS78, 2-7 to 2-8 WS78  
  The WS100, 2-4 WS100  
  The WS102, 2-6 to 2-8 WS102/202  
  The WS202, 2-6 to 2-8 WS102/202  
Brownout, 2-13 WS78, 2-13 WS100, 2-19 to 2-20 WS102/202

### C

Capitalization, 8-11 to 8-12  
  Removing, 8-12  
Centering text, 8-2 to 8-5  
  Changing the centering point, 8-4  
  Determining whether text is centered, 8-5  
Changing spelling of a document name, 4-3  
Comments, 16-1 to 16-2  
Composite characters, 9-10 to 9-11  
Compound words, 11-2 to 11-3  
Copying,  
  A diskette, 17-5, 17-13 to 17-14  
  A document, 5-7 to 5-8  
Creating a document, 3-1 to 3-9  
  Correcting a typo in the document name, 3-3  
  Naming restrictions, 3-3  
  Screen display, 3-4 to 3-5  
  Storage location, 3-3

Cursor, 2-4 WS78, 2-3 WS100, 2-3 WS102/202, 3-5, 5-8  
  Moving location of, 5-8 to 5-12  
Customization points, 16-3 to 16-4  
Cutting, 5-15 to 5-18  
  Cutting and pasting, 5-16 to 5-18  
  Preserving rulers when pasting, 5-16 to 5-17

### D

Date and time, 2-10 WS78, 2-8 to 2-9 WS100, 2-15 to 2-16 WS102/202  
  Inserting into a document, 16-3  
  Printing, 14-6 to 14-7  
  Resetting, 2-12 WS78, 2-12 WS100, 2-18 WS102/202  
Deleting a document, 17-2 to 17-3  
Diskette drives, 1-3 to 1-5  
  Referencing a document on different drives, C-3 to C-4  
  Using systems that have four, C-1 to C-4  
Diskettes, 1-10 to 1-11. See also *Document diskette*, *System diskette*.  
Copying, 17-4 to 17-5, to 17-13 to 17-14  
  Initializing, 17-4 to 17-6  
  Inserting into drives, 2-4 to 2-6 WS78, 2-5 to 2-7 WS100, 2-9 to 2-11 WS102/202  
  Maintaining, 17-1 to 17-14  
  Preventing problems, 17-11 to 17-12  
  Recovering from errors, 17-10 to 17-11  
  Verifying, 17-5 to 17-10  
Display screen, 1-1, 1-3 to 1-5, 1-9 to 1-10  
  Adjusting the intensity of, 2-9 WS78, 2-10 WS100, 2-14 WS102/202  
Document diskette, 1-11, 2-6 WS78, 2-7 WS100, 2-11 WS102/202  
Document number one, 4-3, 4-7  
Draft printer, 1-12, 13-25  
Drives. See *Diskette drives*.

## E

- Editing a document, 5-1 to 5-18
  - Identifying the document by name, 5-3 to 5-4
  - Identifying the document through the index, 5-4 to 5-5
  - Screen display, 5-6 to 5-7
- Editor Menu,
  - In conjunction with top and bottom page margins, 13-12 to 13-14
  - Used to activate user defined keys, 15-1, 15-5
  - Used to specify nonstandard library documents, 10-8 to 10-9
  - Used to specify number of text lines per page, 12-8 to 12-10
- Error messages, 1-16
  - While printing, 13-38
- Extra copy of a document, 5-7 to 5-8

## F

- Filing a document, 3-8 to 3-9
- Footers, 14-1 to 14-10
  - Changing, 14-4
  - Creating, 14-2 to 14-4
  - Effect of ruler, 14-9
  - Positioning on a page, 14-6 to 14-8
  - Printing date, 14-5 to 14-6
  - Printing page number, 13-9, 13-10, 13-26 to 13-27, 14-5 to 14-6
  - Resetting page number, 14-6

## G

- Glossary, GLOSSARY-1 to GLOSSARY-10
- Gold key, 1-8, A-9

## H

- Hardware, 2-1 WS78, 2-1 WS100, 2-1 WS102/202

## Headers, 14-1 to 14-10

- Changing, 14-4
- Creating, 14-2 to 14-4
- Effect of ruler, 14-9
- Positioning on a page, 14-6 to 14-8
- Printing date, 14-5 to 14-6
- Printing page number, 13-9, 13-10, 13-26 to 13-27, 14-5 to 14-6
- Resetting page number, 14-6
- Hyphenation, 11-1 to 11-10
  - Compound words having breaking hyphens, 11-3
  - Compound words having nonbreaking hyphens, 11-2 to 11-3
  - Examining text for breaking and invisible hyphens, 11-7
  - Hyphenation zone, 11-7 to 11-10
  - Pushing and pulling, 11-3 to 11-5
  - Using invisible hyphens, 11-6

## I

- Index, 1-11, 4-1 to 4-7
  - Examining the document diskette index, 4-1
  - Examining the system diskette index, 4-1
  - Printing, 4-4 to 4-7
  - Screen display, 4-2 to 4-3
  - Using, 4-3 to 4-4, 5-4 to 5-5
  - Using the index in a system having four diskettes, C-4

## K

- Keyboard, 1-3 to 1-5, 1-7 to 1-9, A-1 to A-13.  
See also *Main keyboard*, *Mini keyboard*.

## L

- Letter quality printer, 1-12, 13-25
- Library documents, 10-1 to 10-9
  - Creating an entry, 10-2 to 10-3
  - Including a ruler within an entry, 10-5 to 10-6
  - Nonstandard library documents, 10-7 to 10-9
  - Using an entry, 10-4 to 10-5

Line endings, 3-6 to 3-7  
List processing, 16-4 to 16-10

## M

Main keyboard, 1-7 to 1-8, A-1 to A-7  
Main Menu, 1-13, 2-1 WS78, 2-10 to 2-12  
WS78, 2-1 WS100, 2-11 to 2-12 WS100, 2-1  
WS102/202, 2-17 to 2-18 WS102/202,  
B-1 to B-8  
Maintaining diskettes, 17-1 to 17-14  
Copying, 17-4 to 17-5, 17-13 to 17-14  
Deleting a document, 17-2 to 17-3  
Initializing a document diskette, 17-4 to 17-6  
Initializing a system diskette, 17-4, 17-6  
Preventing diskette problems, 17-11 to 17-12  
Recovering from errors, 17-10 to 17-11  
Verifying, 17-4 to 17-10  
Menu, 1-12 to 1-15  
Mini keyboard, 1-9, A-8 to A-13  
Multiple column text, 13-15 to 13-24  
Advancing to new columns and pages, 13-20  
to 13-21  
Effect of rulers, 13-19  
Having unequal length, 13-22 to 13-24  
Restrictions, 13-24  
Space between, 13-8, 13-17 to 13-19

## O

Overstruck characters, 9-10 to 9-11

## P

Pagination, 12-1 to 12-10  
Automatically while printing, 12-1, 13-9,  
13-12  
Changing number of lines per page, 12-8 to  
12-10  
Displaying and modifying page endings, 12-4  
to 12-7  
Forcing page endings, 12-2 to 12-3  
NEW PAGE marks, 12-2 to 12-3  
PAGE MARKERS, 12-4 to 12-8

## Pagination (Cont)

Printing page number, 13-9, 13-10,  
13-26 to 13-27, 14-5 to 14-6  
Resetting page number to be printed,  
13-9, 14-6  
Paragraph documents. See *Library documents*.  
Pasting. See *Cutting*.  
PDP-8 minicomputer, 1-3 to 1-5  
Power failure, 2-13 WS78, 2-13 WS100, 2-19  
to 2-20 WS102/202  
Print Menu 1-14 to 1-15, 13-3 to 13-11  
Printer, 1-3 to 1-5, 1-12. | See also *Draft  
Printer, Letter quality printer, Serial draft  
printer*.  
Checking out, 13-34  
Printing a document, 13-1 to 13-41  
Adding extra vertical space, 13-25 to 13-26  
Automatically paginating while printing,  
13-8, 13-12  
Bottom margin, 13-12 to 13-14  
Changing Print Menu settings, 13-7 to 13-34  
Checking out the printer, 13-34  
Document destination, 13-25  
Draft copies, 13-8, 13-25  
Error messages, 13-37 to 13-38  
Extra print wheel characters, 13-31  
Extra space in the left margin, 13-30 to  
13-31  
First page, 13-26 to 13-27  
Identifying the document, 13-2 to 13-3  
Interrupting, 13-35 to 13-36  
Last page, 13-26 to 13-27  
Multiple columns, 13-15 to 13-24  
Advancing to new columns and pages  
13-20 to 13-21  
Effect of rulers, 13-19  
Having unequal length, 13-22 to 13-24  
Restrictions, 13-24  
Space between, 13-8, 13-17 to 13-19  
Number of copies, 13-25  
Order in which WS102 and WS202  
documents are printed, 18-3 to 18-6

## Printing multiple columns (Cont)

- Paper size, 13-31
- Page number, 13-26 to 13-27, 14-5 to 14-6
- Pitch, 13-28
- Physical page size, 13-31
- Print Menu, 13-3 to 13-11
- Printing documents from a saved list, 13-41
- Retrieving Print Menu settings, 13-31 to 13-32
- Saving a list of documents to be printed on another system, 13-39 to 13-41
- Saving Print Menu settings, 13-31 to 13-32
- Stopping to insert special paper, 13-32
- Top margin, 13-12 to 13-14
- Using two different styles of type, 13-33 to 13-34
- Prompt, 1-15

## R

- Referencing a document on different drives, C-3 to C-4
- Resetting date and time, 2-12 WS78, 2-12 WS100, 2-18 WS102/202
- Ruler, 6-1 to 6-23
  - Changing, 6-16, 6-21 to 6-23
  - Clearing, 6-16
  - Displaying, 6-3 to 6-4
  - Effect on header or footer, 14-10
  - Effect on multiple column text, 13-19
  - Embedding, 6-16
  - Including within a library document entry, 10-5 to 10-6
  - Making settings, 6-5 to 6-16, E-1 to E-2
    - Centering point, 8-4
    - Hyphenation zone, 11-7 to 11-10
    - Left margin setting, 6-6 to 6-8
    - Paragraph indent setting, 6-9 to 6-11
    - Right margin setting, 6-8
    - Tab settings, 6-12 to 6-16

## Ruler (Cont)

- Vertical line spacing setting, 6-6 to 6-8
- Word wrap indent setting, 6-11
- Preserving while pasting, 5-16 to 5-17
- Preset, 3-5
- Saving for reuse, 6-20
- Used to produce subscripts and superscripts, 9-4 to 9-9
- Using, 6-2 to 6-16
- Wide line ruler, 6-17 to 6-19

## S

- Searching, 7-1 to 7-4
  - Direction reversal, 7-3
  - Phrase restrictions, 7-3
  - Replacing, 7-3 to 7-4
- Serial draft printer, 13-8, 13-25, G-1 to G-2
- Sharing the same WS102 or WS202 terminal screens, 18-3 to 18-6
- Software, 2-1 WS78, 2-1 WS100, 2-1 WS102/202
- Starting up a word processing system. See *Turning on a word processing system.*
- Stopping, 2-12 to 2-13 WS78, 2-13 WS100, 2-19 WS102/202
- Storage, 1-3, 1-10 to 1-11, 3-3 to 3-4, 5-6
  - Running out of while typing, 3-8, 5-1
  - Amount used per diskette, 4-2
- Subscripts,
  - Producing, 9-1 to 9-9
  - Removing, 9-4
- Superscripts,
  - Producing, 9-1 to 9-9
  - Removing, 9-4
- System diskette, 1-11, 2-5 WS78, 2-6 WS100, 2-10 WS102/202
- System Options Menu, G-1 to G-2



## T

- Tab settings, 6-12 to 6-16
  - Turning on a word processing system,
    - WS78, 2-1 to 2-4 WS78
    - WS100, 2-1 to 2-3 WS100
    - WS102, 2-1 to 2-8 WS102/202
    - WS202, 2-1 to 2-8 WS102/202
  - Typing
    - Changing, 5-12
    - Compound words, 11-2 to 11-3
    - Ending lines, 3-6 to 3-7
    - Inserting additional text, 5-12
    - Leaving vertical space for insertions, 3-7
    - Multiple columns, 13-15 to 13-24
      - Advancing to new columns and pages, 13-20 to 13-21
      - Effect of rulers, 13-19
      - Having unequal length, 13-22 to 13-24
      - Restrictions, 13-24
      - Space between, 13-17 to 13-24
    - Removing errors just typed, 3-7
    - Tab settings, 6-12 to 6-16
    - Typing new text, 3-5 to 3-9
- ## U
- Underlining, 8-6 to 8-10
    - After typing, 8-7
    - Determining whether text is underlined, 8-8
    - Effect of right margin, 8-9 to 8-10
    - Effect of spaces, 8-8 to 8-9
    - Only words, 8-9
    - Removing, 8-12
    - While typing, 8-6
  - User defined keys, 15-1 to 15-6
    - Changing, 15-5 to 15-6
    - Creating, 15-1 to 15-5
    - Eliminating, 15-6
    - How nontext keystrokes are displayed within, F-1 to F-2
    - Including one within another, 15-6
    - Replacing, 15-5
    - Saving, 15-5
  - User description, xvii

## V

- Viewing text, D-1 to D-3

## W

- Word wrapping, 1-2, 3-6 to 3-7
- WS78, 1-3, 2-1 WS78 to 2-13 WS78
  - Bootstrapping, 2-7 to 2-8 WS78
  - Inserting diskettes, 2-4 to 2-6 WS78
  - Turning on, 2-1 WS78 to 2-4 WS78
- WS100, 1-4, 2-1 to 2-13 WS100
  - Bootstrapping, 2-4 WS100
  - Inserting diskettes, 2-5 to 2-7 WS100
  - Turning on, 2-1 to 2-3 WS100
- WS102, 1-5, 18-1 to 18-7, 2-1 WS102/202 to 2-20 WS102/202
  - Bootstrapping, 2-6 to 2-8 WS102/202
  - Inserting diskettes, 2-9 to 2-11 WS102/202
  - Order in which documents are printed, 18-3 to 18-7
  - Sharing the same screen, 18-3
  - Turning on, 2-2 to 2-5 WS102/202
- WS202, 1-5, 1-6, 2-1 to 2-20 WS102/202
  - Bootstrapping, 2-6 to 2-8 WS102/202
  - Inserting diskettes, 2-9 to 2-11 WS102/202
  - Order in which documents are printed, 18-3 to 18-7
  - Sharing the same screen, 18-3
  - Turning on, 2-2 to 2-5 WS102/202



Your comments and suggestions will help us in our continuous effort to improve the quality and usefulness of our publications.

What is your general reaction to this manual? In your judgment is it complete, accurate, well organized, well written, etc.? Is it easy to use? \_\_\_\_\_

What features are most useful? \_\_\_\_\_

What faults or errors have you found in the manual? \_\_\_\_\_

Does this manual satisfy the need you think it was intended to satisfy? \_\_\_\_\_

Does it satisfy *your* needs? \_\_\_\_\_ Why? \_\_\_\_\_

Please send me the current copy of the *Technical Documentation Catalog*, which contains information or the remainder of DIGITAL's technical documentation.

Name \_\_\_\_\_ Street \_\_\_\_\_  
Title \_\_\_\_\_ City \_\_\_\_\_  
Company \_\_\_\_\_ State/Country \_\_\_\_\_  
Department \_\_\_\_\_ Zip \_\_\_\_\_

Additional copies of this document are available from:

Digital Equipment Corporation  
444 Whitney Street  
Northboro, Ma 01532  
Attention: Communications Services (NR2/M15)  
Customer Services Section

Order No. AA-5267C-TA

Fold Here

Do Not Tear - Fold Here and Staple

FIRST CLASS  
PERMIT NO. 33  
MAYNARD, MASS.

**BUSINESS REPLY MAIL**  
**NO POSTAGE STAMP NECESSARY IF MAILED IN THE UNITED STATES**

Postage will be paid by:

Digital Equipment Corporation  
Technical Documentation Department  
Maynard, Massachusetts 01754

