

**A Pre-history of Green Architecture: Otto Koenigsberger and Tropical
Architecture, from Princely Mysore to Post-colonial London**

By

Vandana Baweja

A dissertation submitted in partial fulfillment
of the requirements for the degree of
Doctor of Philosophy
(Architecture)
in The University of Michigan
2008

Doctoral Committee:

Professor Robert L. Fishman, Chair
Assistant Professor Andrew H. Herscher
Assistant Professor Fernando Luiz Lara
Assistant Professor Christi Ann Merrill

Acknowledgements

I would like to thank Robert Fishman, my advisor at the University of Michigan-Ann Arbor, for his enormous support, guidance, and mentorship. I could not have hoped to work with a better advisor than Robert Fishman, for whom I have tremendous respect as a scholar and teacher. I hope I can be as wonderful and generous a mentor and teacher to my students as Professor Fishman has been to me.

I've also received outstanding support from other faculty at the University of Michigan. Many thanks in particular to my dissertation committee, Andrew Herscher, Fernando Lara, and Christi Merrill, for their feedback, support, and advice. Christi Merrill has been a particularly supportive mentor and a wonderful friend whose criticism and advice enriched this dissertation tremendously. Christi's exemplar mentoring skills have informed my pedagogical thinking and the kind of teacher I hope to be. David Scobey, who served on my exam committee, introduced me to a wonderful set of readings on architecture and nationalism. I owe him a great debt of gratitude for mentoring me through the preliminary exams. Thanks to Lydia Soo for offering two great doctoral colloquia in our department, the first of which helped me write my dissertation proposal and the second of which provided a great support group for finishing my dissertation chapters. Lydia also provided incredibly valuable feedback on the second chapter in this dissertation.

I also appreciate the feedback provided by Caroline Constant, Despina Stratigakos, and Claire Zimmerman in this dissertation's early stages. Finally, thanks to Jean Wineman, the chair of the doctoral program in architecture, for serving on my exam committee and providing excellent leadership for our program.

I also deeply appreciate the support offered by various faculty mentors and friends in other departments. First and foremost, I would like to thank Ram Mahalingam in the Psychology department for being a friend and a superb mentor. I am also thankful to Anna Sloan in Art History, Manishita Dass in Screen Arts, and Kali Israel in History for their friendship and guidance. I am especially thankful to Tom Metcalf and Sumathi Ramaswamy in History for a discussion on princely Mysore during the early stages of this dissertation.

My sincerest thanks to Mark Cousins, my teacher and M.A. advisor at the Architectural Association School of Architecture in London from 1998-1999. Mark has been a guru *par excellence* to me since 1998 and encouraged me think about Tropical Architecture in terms of environmental histories. I doubt I will ever work in my lifetime with a better teacher than Mark.

I am also grateful for the graduate student support services at the University of Michigan-Ann Arbor, particularly those offered through the Rackham Graduate School, the International Center, the Sweetland Writing Center, the LGBT office, and the Center for the Education of Women (CEW). I have benefitted tremendously from several graduate student workshops offered by Rackham and the CEW. Special thanks go to John Godfrey, Assistant Dean for

International Education at Rackham Graduate School, for his immense support and guidance. I cannot thank former Rackham Student Affairs Program Manager Jayne London enough for mentoring me through graduate school and walking me through the many difficult steps that a doctoral education entails. I also truly appreciate and benefitted from the advice and help provided by Rachel Persico, Student Advisor at the International Center. Unfortunately, we lost Rachel to cancer in 2008; she would have been thrilled to see me done with graduate school. I want to thank Sarah Ely, former counselor at the Center for Education of Women, for mentoring me as an international student, and I appreciate the assistance provided by Jen Michaels at the Sweetland Writing Center in helping me refine my writing.

I also owe a debt of gratitude to the staff at various libraries and archives where I conducted my research. I am deeply appreciative of the University of Michigan library staff at the Art, Architecture, and Engineering Library reserve desk and at the Inter-Library Loan. I also appreciate all the help provided by Dr. Ambujakshi, archivist at the Karnataka State Archives (KSA), Bangalore. I thank Bayyana and Mani at KSA for their assistance. Aileen Smith and Edward Bottoms at the Architecture Association Library helped me during my research at the AA, and many thanks to Mary Daniels and Inés Zalduendo for their expert advice in using the Peter and Allison Smithson papers at the Special Collections of the Frances Loeb Library at the Graduate School of Design, Harvard University.

Very special thanks goes to Dr. Renate Koenigsberger, Otto Koenigsberger's widow, for letting me access Otto Koenigsberger's private papers in her possession in London. Renate's warmth, humor, and generosity in letting me access the archives made my research in London a pleasant experience. I truly appreciate her patience in talking to me for hours and letting me invade her privacy for several weeks during my research.

Great thanks go to Patrick Wakely at the Development Planning Unit (DPU) at the University College London (UCL), who generously allowed me to access the manuscript of an unpublished book on Tropical Architecture by Otto Koenigsberger. I also appreciated chatting with Koenigsberger's colleagues T.G. Ingersoll and Steven Szokolay, and I thank Eduard Le Maistre at the Architectural Association for his assistance during my research at the AA.

Thanks also to my colleagues and friends in the doctoral program in architecture. Ela Cil and Andre Wilson are the two most wonderful people I met in Ann Arbor, and their love and friendship have meant so much to me during graduate school. Ela's humor and generosity is appreciated by all of us in the doctoral program. Andre's courage and tenacity have always been a source of strength to me. I appreciate the support and friendship of my colleagues, especially Didem Ekici and Deirdre Hennebury, and I would like to thank Omar Baghdadi, Itohan Osayimwese, Stephanie Pilat, and Dale Winling for their feedback on my dissertation. I would like to thank Jean Ellis, former doctoral program secretary and Lisa Hauser, the current doctoral program secretary for their excellent administrative support. Lisa tirelessly produced several letters of

permission for me to be able to access several archives and buildings during my field work.

My friends in Ann Arbor made who made it home for me deserve a special mention. Pavitra Sundar and Shradha Shah have been my most supportive friends; bike rides and summer evenings with them at the Autbar made my life so much more fun. Their love, warmth, and generosity pulled me through some very tough times. Mike O'Keefe and Eric Gill, with whom brunch in Kerrytown over lots of laughter, warmth, and tea became my favorite weekend ritual, made me miss Ann Arbor when I was in India and London doing my field work. Their friendship, love, and humor sustained me through the harsh and depressing Michigan winters. I also have to thank Mike for introducing me to camping in Michigan. Our camping trip to Manitou Island after my prelims was the best holiday during my years in Michigan. Clara Kawanishi has also been a warm and supportive friend. Shaji Mathews, David Lehmann, and Sandeep Tata's friendship in Michigan has been so valuable. Charu Kambo, one of my oldest friends from Delhi has always welcomed me into her home in New York City and been a close friend ever since I started working as an architect in Delhi.

Venky Nagar has been a superb friend and I truly appreciate his emotional support after my father's death. His parents in Bangalore welcomed me into their family during my fieldwork and provided a home away from home. His mom never missed an opportunity to pamper me with home cooked food. His sister Anu enriched my time in Bangalore with her friendship and really helped me

confront my father's death. Thanks as well to my friends in Delhi, Debashish Roy, Indrani Chatterjee, and Rajiv Agarwal, for helping me with my field work.

Finally, I would like to thank my parents for their support and patience with my doctoral work. In order to complete this doctorate, I have missed a number of *holies, dushsheras, diwalies*, birthdays, and weddings in Delhi, absences that I can never make up to my parents. I wish to thank my extended family for their support. Without them, I would have had a much harder time during my father's illness and death.

My father, who fell seriously ill and passed away during the writing of this dissertation, would have been the happiest of all to see this dissertation done. I therefore dedicate this dissertation to his memory.

Vandana Baweja
Ann Arbor, Michigan
April 2008

Table of Contents

Acknowledgments	ii
List of Figures	xi
List of Tables	xvi
List of Abbreviations	xvii
Glossary	xviii
Abstract	xix
Chapter 1 : Introduction	1
Historiography of Green Architecture 1970-1990s	1
Dissertation Objectives	7
Brief Biography of Otto Koenigsberger (1908-1999)	8
Climate-Responsive Design	11
Tropical Architecture in the Historiography of Green Architecture	13
Dissertation Outline	14
Sources and Archives	17
Contribution to the Field	18
Chapter 2: Otto Koenigsberger in Princely Mysore	19
Mysore	19
<i>Swadeshi</i>	22

<i>Swadeshi</i> and Architecture	26
German Architects in Mysore	28
<i>Swadeshi</i> Building Materials	32
Indigenization of Concrete	35
Architecture and Nationalism: Style and Taste	38
Koenigsberger's Response to Mysore	46
The Berlin Zoo: Unbuilt 1933	51
Outdoor Living: Pavilions for the Malleswaram School, Bangalore, 1939	52
Rational Versus National, Shimoga College, Shimoga, 1940.	53
Mysore Engineers' Association, Bangalore, 1940: Coming to Terms with Porticos	55
Mysore Broadcasting House, Mysore, 1942: The Limits of Energy	57
Victory Hall, Bangalore, 1944-45: The Limits of Resources	59
Dining Hall at the Indian Institute of Science, Bangalore, 1946	62
Beyond Mysore: Prefabricated Houses, New Delhi, 1949-1951	64
Conclusion	62
Chapter 3: Tropical Architecture	107
Origins of Tropical Architecture in Hygiene	107
The Circulation of Tropical Architecture	112
International Federation for Housing and Planning Conference Mexico 1938	114
Post-Second World War Conferences on Tropical Architecture	115
Washington D.C. Conference, November 18 and 19, 1952.	117

UNESCO Conference in New Delhi, December 21-22, 1952	119
London Conference in 1953	123
The Individual and Institutional Actors in UK	129
The Department of Tropical Architecture at the AA	130
Tropical Architecture at the AA	132
Conclusion	133
Chapter 4 : Otto Koenigsberger's Contribution to Tropical Architecture	138
Vernacular Architecture as a Pedagogic Model for Climatic Design	138
Tropical Architects and Vernacular Architecture in The 1950s	143
Koenigsberger and Vernacular Architecture	148
Critical Rethinking of the Architectural Program: Sustainable Consumption	154
Naturally Conditioned Buildings	158
Kuwait Mat Project, Unbuilt, 1969	162
Building Within Local Technological and Material Capacity	164
Chapter 5: Green and Tropical Architecture	188
Three Museums by Harris Sobin	194
Debates Over Green and Tropical Architecture	197
Epilogue	200
Bibliography	206

List of Figures

Figure .2.1 India in 1912.	66
Figure 2.2 The Location of Mysore State in South India.	67
Figure 2.3 Mirza Ismail the Prime Minister of Mysore.	69
Figure 2.4 Otto Koenigsberger (center) with his colleagues in the PWD, in Mysore 194?	79
Figure 2.5 The Epigraph for Victory Hall, Bangalore, 1944-45.	71
Figure 2.6 The Epigraph for the <i>Ayurvedic</i> Hospital, Bangalore, 1948.	71
Figure 2.7 Epigraph for the Krishna Rao Pavilion, Bangalore, 1940.	72
Figure 2.8 Epigraph for Mysore Engineer's Association, Bangalore, 1940.	72
Figure 2.9 The Elevation of the Municipal Office designed by Krumbiegel, Bangalore, 1927.	73
Figure 2.10 A photograph of the Municipal offices as built based on the design by Government architect Lakshminarasappa, Bangalore, 1936.	73
Figure 2.11 Epigraph of the Municipal Office Building, Bangalore, 1936.	74
Figure 2.12 Mysore Sugar Offices in Bangalore, 1941.	74
Figure 2.13 Epigraph for the Mysore Sugar Building, Bangalore, 1941.	75
Figure 2.14 Associated Cement Companies Advertisement.	76

Figure 2.15 Concrete Pavilion in the Municipal Park, Kolar. Designed by Consulting Architect G. H. Krumbiegel.	77
Figure 2.16 Stall of Mr. J. P. Kennette, Civil Engineer, Madura, at the 7th All India Swadeshi and Industrial Exhibition Conducted by the Madura-Ramand Chamber of Commerce at Madura.	78
Figure 2.17 Nellore Agricultural Swadeshi Industrial and Khadi Exhibition and Cattle Show.	79
Figure 2.18 Concrete products display at the Mysore Dasara Exhibition.	80
Figure 2.19 Puttanna Chetty Town hall offices designed by the Government architect Lakshminarasappa, Bangalore, 1935.	81
Figure 2.20 Koenigsberger (extreme right) with the Maharajah (center), 194?.	82
Figure 2.21 Boys High School at Malleswaram, Bangalore, 1939.	83
Figure 2.22 The Front Elevation of the Serum Institute, Hebbal, Bangalore, 1942.	84
Figure 2.23 Koenigsberger's notes on the Serum Institute Bangalore, 1942.	85
Figure 2.24 Koenigsberger's Notes on the Bus Terminal at Kalasapalyam, Bangalore, 1940.	86
Figure 2.25 The Bus Terminal at Kalasapalyam, Bangalore, 1940.	87
Figure 2.26 The Berlin Zoo Elevation, Unbuilt, 1933.	87
Figure 2.27 Koenigsberger's Sketch for the Tiffin <i>mantap</i> (Lunch pavilion) /cycle shed outside the Malleswaram Boys High School, Bangalore, 1939.	88
Figure 2.28 Koenigsberger's sketch for the plan of the Tiffin mantap/cycle shed (Lunch pavilion) outside the Malleswaram Boys High School, Bangalore, 1939.	88
Figure 2.29 Tiffin mantap (lunch pavilion)/cycle shed outside the Malleswaram Boys High School, Bangalore, 1939.	90

Figure 2.30 A conceptual Sketch of the PWD Type Design.	90
Figure 2.31 Koenigsberger's memo about the Shimoga College to the General Secretary of Government of Mysore.	91
Figure 2.32 Part Elevations of the Maharajah and <i>Yuvraja</i> college.	92
Figure 2.33 Sketch plan of the Maharajah College, Mysore City.	93
Figure 2.34 Plan of Shimoga College, Shimoga, 1940.	93
Figure 2.35 The Arcade in Shimoga College, Shimoga, 1940.	94
Figure 2.36 Photograph of the Maharajah's College Mysore	94
Figure 2.37 Shimoga College, Shimoga, 1940.	95
Figure 2.38 Plan of Mysore Engineers Association Building, Bangalore, 1940.	96
Figure 2.39 Mysore Engineers' Association Building, Bangalore, 1940.	97
Figure 2.40 Mysore Engineers' Association Building, Bangalore, 1940.	98
Figure 2.41 Mysore Engineers' Association Building, Bangalore 1940.	99
Figure 2.42 Photograph of the Mysore Broadcasting House, (now All India Radio), Mysore, 1942.	100
Figure 2.43 A Section through the Mysore Broadcasting House, Mysore, 1942.	100
Figure 2.44 Victory Hall, Bangalore, 1944-45.	101
Figure 2.45 Section through the Victory Hall, Bangalore, 1944-45.	101
Figure 2.46 Dining Hall at the Indian Institute of Science, Bangalore, 1945.	102
Figure 2.47 Section through the Dining Hall at the Indian Institute of Science, Bangalore, 1945.	102

Figure 2.48 Plan of the Dining Hall, Indian Institute of Science, Bangalore, 1945.	103
Figure 2.49 Housing Factory in Jang Pura, New Delhi, 1949.	104
Figure 2.50 The Plan of the Pre-fabricated Housing Units, New Delhi, 1949.	105
Figure 2.51 Photograph of the Pre-Fabricated Unit, New Delhi, 1949.	106
Figure 3.1 Design Solution proposed by O. J. Pereira from Kenya for the design of the sunshade at the AA Tropical Studio, 1962.	137
Figure 4.1 A photograph of a <i>bustee</i> . (settlement of huts)	168
Figure 4.2 A Malay House in Malacca.	169
Figure 4.3 A sketch of a <i>Jali</i> .(screen)	169
Figure 4.4 A Photo of a Street in Tangiers, Morocco.	170
Figure 4.5 A Sketch of a Street Scene in Bahrein Island.	171
Figure 4.6 A picture of a wide street in Jidda Arabia.	172
Figure 4.7 Dense hot-dry settlement in Marrakesh, Morocco.	173
Figure 4.8 Recent low cost housing in Touggort Algeria.	174
Figure 4.9 A photograph of people pounding corn and cooking outdoors in Southern Rhodesia.	175
Figure 4.10 Interior of a Zulu Hut.	176
Figure 4.11 An image of the Bidonville pre-fabricated Shacks for the shanty towns.	177
Figure 4.12 Thermal Principles of a Courtyard.	178
Figure 4.13 Peter and Alison Smithson	179
Figure 4.14 Axonometric of the Kuwait Mat Building, 1969.	180

Figure 4.15 The stepped profile of the Kuwait Mat Building raised on pilotis.1969.	181
Figure 4.16 A sketch of a section through the courtyard, Kuwait Mat Building, 1969.	181
Figure 4.17 Part plan of the Kuwait Mat Building, 1969.	182
Figure 4.18 Calculation of Sun-patches for the inner galleries for noon (12:00) and four in the evening (16:00) for March 8 and October 6 for a North-South Orientation for the Kuwait Mat Project.	184
Figure 4.19 Calculation of Sun-patches for the inner galleries for noon (12) for June 22 for a North-South Orientation for the Kuwait Mat Project.	185
Figure 4.20 Calculation of Sun-patches for the inner galleries for 4:00 pm (16:00) for June 22 for a North-South Orientation for the Kuwait Mat Project.	186
Figure 4.21 Conoid Shells over the Town Hall Designed By Colin Frank for the Tropical Design Studio, 1963-1964.	187
Figure 4.22 A section through the Town Hall designed by Colin Frank for the Tropical Design Studio, 1963-1964.	187
Figure 5.1 Plan of the Museum in London, Tropical Design Studio Exercise, AA, 1961	203
Figure 5.2 Section through the Museum in London, Tropical Design Studio Exercise, AA, 1961.	203
Figure 5.3 Plan of the Museum in Khartoum, Sudan, Tropical Design Studio Exercise, AA, 1961.	204
Figure 5.4 Section through the Museum in Khartoum, Sudan, Tropical Design Studio Exercise, AA, 1961.	204
Figure 5.5 Plan of the Museum in Port Harcourt, Nigeria, Tropical Design Studio Exercise, AA, 1961.	205
Figure 5.6 Section through the Museum in Port Harcourt, Nigeria, Tropical Design Studio Exercise, AA, 1961.	205

List of Tables

Table 2-1 Timeline of Maharajahs and <i>Dewans</i> of Mysore.	68
Table 3-1 Tropical Architecture Conferences.	136
Table 4-1 Calculation for the best possible orientation for the galleries by calculating sun patches on the ground for different times during the day (10:00 am, Noon, 4:00 pm) for three days during the year (March 8, October 6, and June 22).	183

List of Abbreviations

AA	Architectural Association
DPU	Development Planning Unit, London
GOM	Government of Mysore
KSA	Karnataka State Archives
OKPP	Otto Koenigsberger's Private Papers
PWD	Public Works Department
UCL	University College London

Glossary

Bustee	A settlement of huts.
Chhajja	Sunshade.
Chunam	Lime.
Mysore Dasara	A royal festival that celebrates the killing of the demon Mahishasuran by Goddess Chamundeeswari or Durg, an event from Hindu mythology. Dasara is now celebrated as a state festival in Karnataka.
Dewan	Prime Minister.
Durbar	Princely Court.
Jaali	A lattice screen, often in stone or wood.
Khadi	Coarse, home spun cotton.
Kuddapah	A black colored slate.
Kutchcha	Perishable, temporary, fragile.
Mangalore Tiles	Terra cotta clay tiles used for roofing.
Pukka	Permanent, strong, firm.
Swadeshi	Indigenously produced.
Swaraj	Self-rule.

ABSTRACT

A Pre-history of Green Architecture:
Otto Koenigsberger and Tropical Architecture
From Princely Mysore to Post-Colonial London
by

Vandana Baweja

Chair: Robert Fishman

In this dissertation, I investigate how trans-colonial histories of architecture intersect with transnational environmental histories of architecture. I locate Tropical Architecture, which I define as climate-responsive and energy-conservative design, in the pre-history of environmentalism. I argue that the corpus of knowledge that developed through Tropical Architecture in the 1950's constitutes the pre-cursor to Green Architecture.

I locate Tropical Architecture as a trans-colonial set of architectural practices that originated in the colonial experiences of European modernist architects. As a crucial part of this hypothesis, I trace the career trajectory of émigré architect Otto Koenigsberger (1909-99), who escaped Nazi Berlin in 1933 to go to Egypt and subsequently immigrated to India in 1939. In India, Koenigsberger served as the chief architect for the Maharajah of Princely Mysore from 1939 to 1948 and as the Federal Director of Housing for Nehru's government from 1948 to 1951. In 1951, he immigrated to London to become

one of the founders of the Department of Tropical Architecture (1954-1971) at the Architectural Association (AA) School of Architecture.

I argue that working in exile in Princely Mysore fundamentally transformed Koenigsberger's architectural thinking and practice. The most significant change in his thinking was his cognizance of the limits of resources and energy. Through his experience in Mysore, Koenigsberger theorized Tropical Architecture as a discourse that was climate responsive, energy conscious, and built with local resources.

Existing histories locate Tropical Architecture as a neo-colonial project that emerged in the 1950s along the networks of the diminishing British Empire. I propose that Tropical Architecture embodied a vision of environmentalism. Green Architecture, which is considered a recent discourse, cannot therefore be fully grasped unless it is historicized in relationship to Tropical Architecture. The careers of tropical architects are the missing link between histories of architecture in the colonies and histories of Green Architecture. I make my argument by establishing continuities between Tropical and Green architectural practices and by demonstrating how people trained in Tropical Architecture made their careers in the field of Green Architecture.

Chapter 1

Introduction

In this dissertation, I challenge the 1970-1990s periodization of the history of Green Architecture. I propose that one of the origins of Green Architecture lies in the colonies of the British Empire in Tropical Architecture, which developed in the 1950s as a transcolonial discourse. I shift the genealogy of Green Architecture to the colonial experience of architects in London who worked in the tropics. As part of this hypothesis, I locate the émigré architect Otto Koenigsberger (1908-99) and Tropical Architecture in the pre-history of Green Architecture. I present Koenigsberger's contribution to Tropical Architecture and its significance in the contemporary discourse on Green Architecture.

Historiography of Green Architecture 1970-1990s

The modern environmental movement is often perceived to have begun in the United States in 1962 with the Rachel Carson's *Silent Spring*, the publication of which caused a paradigm shift in understanding the environmental impact of pesticide use.¹

¹ Shirley A. Briggs, "Remembering Rachel," *EPA Journal* 18, no. 2 (May-June 1992), M. Jimmie Killingsworth and Jacqueline S. Palmer, *Ecospeak: Rhetoric and Environmental Politics in America* (Southern Illinois UP: Carbondale, 1992), Linda J. Lear, "Rachel Carson's Silent Spring," *Environmental History Review* Vol. 17, no. 2 (1993), Craig Waddell, ed., *And No Birds Sing: Rhetorical Analyses of Rachel Carson's Silent Spring*

The subsequent ban on DDT usage and the formation of the United States Environment Protection Agency are both widely attributed to *Silent Spring's* publication.² In addition to Rachel Carson, Modern Environmentalism is also associated with 1960s American countercultural thinking, epitomized in Steward Brand's *Whole Earth Catalogue*³ and Steve Baer's *Dome Cookbook*.⁴

While American histories dominate the field of environmental historiography, the origins of the environmentalism and its American historiographic dominance are challenged by a number of claims about the origins of environmentalism. These claims include the assertion that Mahatma Gandhi was an early environmentalist⁵ and Appropriate Technologist,⁶ that the Nazi Party was the first green party;⁷ and that the genealogy of environmentalism originates in the colonies of the British Empire.⁸ This dissertation benefits from these histories as they displace the origins of environmentalism outside the United States.

(Carbondale: Southern Illinois University Press, 2000).

² Craig Waddell, ed., *And No Birds Sing: Rhetorical Analyses of Rachel Carson's Silent Spring* (Carbondale: Southern Illinois University Press, 2000).

³ Stewart Brand, ed., *Whole Earth Catalog* (California: Portola Institute, 1968). For a detailed account of the contribution of the *Whole Earth Catalogue* to Environmental thinking see Andrew G. Kirk, *Counterculture Green: The Whole Earth Catalog and American Environmentalism* (Lawrence, Kansas: University Press of Kansas, 2007).

⁴ Steve Baer, *Dome Cookbook* (Corrales, N.M.: Lama Foundation, 1967). Also See Simon Sadler, "Drop City Revisited," *Journal of Architectural Education* Vol. 59, no. 3 (February 2006): 5–14. and Felicity D. Scott, "Acid Visions," *Grey Room* 23 (Spring 2006): 22-39.

⁵ Ramachandra Guha and J Martinez-Alier, "Mahatma Gandhi and the Environmental Movement," in *Varieties of Environmentalism: Essays North and South* (Delhi; New York: Oxford University Press, 1998), 153-168.

⁶ Witold Rybczynski, *Paper Heroes: A Review of Appropriate Technology* (Garden City, N.Y.: Anchor Press/Doubleday, 1980).

⁷ Anna Bramwell, *Blood and Soil: Richard Walther Darré and Hitler's "Green Party"* (Abbotsbrook, Bourne End, Buckinghamshire: Kensal Press, 1985).

⁸ Greg Barton, *Empire Forestry and the Origins of Environmentalism*, Cambridge Studies in Historical Geography (Cambridge: Cambridge University Press, 2002), Richard Grove, *Green Imperialism: Colonial Expansion, Tropical Island Edens, and the Origins of Environmentalism, 1600-1860* (Cambridge; New York: Cambridge University Press, 1995).

American histories also dominate the narrative of how histories of architecture first intersected with environmental histories. American and British architectural histories trace the beginning of environmental consciousness to the emergence of energy conservation in the mainstream of architectural discourse in the 1970s, linking environmental consciousness to the first Earth Day in 1970 and the OPEC⁹ oil crises of 1973.¹⁰ These historiographies propose a chronology of events beginning with the 1973 oil crises that lead to the emergence of “Green Architecture” in the 1990s.¹¹ In this section, I elaborate this 1973-to-1990s chronology. Subsequently, I will challenge this narrative to include earlier transcolonial histories in the genealogy of Green Architecture.

As energy conservation entered the dominant discourse in Europe and America in the 1970s, Appropriate Technology (AT) also emerged from the countercultural margins into the mainstream. AT followers questioned the application of high technology and conventional economic “growth”. In 1968, the Intermediate Technology Development Group organized a meeting at St. Cross College, Oxford University to inaugurate the concept of intermediate technology,

⁹ The 1973 oil crisis began on October 17, 1973, when the members of Organization of Arab Petroleum Exporting Countries (OPEC) announced, that they would no longer ship oil to nations (the United States, its allies in Western Europe, and Japan) that had supported Israel in its conflict with Syria and Egypt.

¹⁰ In 2008, the Canadian Centre for Architecture organized an exhibit called “Sorry out of gas” which reinforces the idea that the architectural response to the environmentalism surfaced after the OPEC crises in the 1970s. See Giovanna Borasi, ed., *Sorry, out of Gas: Architecture's Response to the 1973 Oil Crisis* (Montreal: Edizioni Corraini and Canadian Centre for Architecture, 2008). Also a number of Green Architecture practitioners such as Andrew Scott support this chronology. See Andrew Scott, “Design Strategies for Green Practice,” *Journal of Green Building* Vol.1, no. 4 (2006): 11-27.

¹¹ The two historiographic essay that connect architectural histories with environmental histories are: R Ingersoll, “Unpacking the Green Man's Burden,” *Design Book Review* Spring, no. 20 (1991): 19-26, Pauline Madge, “Design, Ecology, Technology: A Historiographical Review,” *Journal of Design History* Vol. 6 no. 3 (1993): 149-166.

which was subsequently renamed Appropriate Technology in 1973.¹² E. F. Schumacher, a Gandhian follower regarded as the pioneer of the AT movement, had coined the term “intermediate technology” after his 1963 visit to India. In his book *Small is Beautiful*, Schumacher challenged the idea of growth in conventional economics, which regarded natural resources as income rather than as capital investment. Schumacher called for a paradigmatic shift in the way economists took natural resources such as fossil fuels for granted. With his view of economics, Schumacher defined intermediate technology as a means of empowerment for the rural population, who could improve their life with simple labor-intensive technologies without reliance on industrialization.¹³

Concern about human environmental impact grew exponentially in the 1980s, during which the environmental discourse was dominated by industrial accidents, including the 1984 Bhopal gas disaster, the 1986 Chernobyl nuclear disaster, and the 1989 Exxon Valdez oil spill. These accidents highlighted the magnitude of human processes and their environmental impact. In 1987, the United Nations established the World Commission on Environment and Development (WCED), which became known as the Brundtland commission after its Chair Gro Harlem Brundtland, the Norwegian prime minister. The commission’s report, known as the Brundtland Report,¹⁴ introduced the term

¹² Rybczynski, *Paper Heroes: A Review of Appropriate Technology*

¹³ E. F. Schumacher, *Small Is Beautiful: Economics as Is People Mattered* (New York Harper Perennial, 1989).

¹⁴ World Commission on Environment and Development, *Our Common Future* (Oxford; New York: Oxford University Press, 1987).

“sustainability” into the environmental discourse, thereby transforming architectural discourse and establishing “Green Architecture”.

The Brundtland Report defined sustainable development as a mode of development that “*ensures that the needs of the present are met without compromising the needs of the future.*”¹⁵ The report identified excessive natural resource consumption by the affluent and the existence of abject poverty as constitutive of the environmental problem. The Brundtland Report stressed that sustainability could not be achieved without social equity because sustainable development requires not only an equitable distribution of resources over time for the future generations but also across space synchronically, thereby bridging the gap between the rich and the poor nations. The report prescribed a cut in energy consumption for the rich nations, which had a direct and significant impact on the definition of Sustainable Architecture.

After the 1987 Brundtland Report, the next significant milestone in the history of Green Architecture was the formulation of *Agenda 21* at the 1992 United Nations Conference on Environment and Development at Rio.¹⁶ *Agenda 21*, a prescriptive blueprint for sustainable development, contained specific guidelines for the practice of Sustainable Architecture. The key points prescribed in *Agenda 21* for a sustainable construction industry are the use of indigenous materials and technologies; labor-intensive construction technologies; energy-efficient designs; recycling of materials; waste prevention; development of

¹⁵ Ibid.

¹⁶ United Nations Conference on Environment and Development, ed., *Agenda 21: The Earth Summit Strategy to Save Our Planet* (Boulder, Colorado: EarthPress, 1993).

knowledge on the environmental impact of buildings; and self-help housing for the poor.¹⁷

While these post-1970 environmental and architectural discourses are undoubtedly significant to the evolution of Green Architecture, I am interested in how environmental consciousness manifested itself in the field of Urban Planning and Architecture *prior* to the 1970s. In the sphere of urban planning, early environmental thinkers such as Frederick Law Olmsted,¹⁸ Patrick Geddes,¹⁹ and Lewis Mumford²⁰ are being reexamined in the context of environmental histories. The Greek architect and planner Doxiadis and the field of Ekistics attributed to him also constitute mid-twentieth-century environmental thinking.²¹ In early twentieth to mid-twentieth-century India, Gandhi's philosophy imagined an environmentalist utopia focused on the village life that offers no solution for urban life but nonetheless offers a blueprint for sustainability.²² To deepen understanding of this pre-1970s environmentalism in architecture, I focus particularly in this dissertation on Otto Koenigsberger who worked in India and through his Indian experience formulated Tropical Architecture.

¹⁷ United Nations Conference on Environment and Development, "Chapter 5: The Management of Human Settlements," in *Agenda 21: The Earth Summit Strategy to Save Our Planet*, ed. Daniel Sitarz (Boulder, Colorado: EarthPress, 1993).

¹⁸ Donald Worster, *American Environmentalism: The Formative Period, 1860-1915*, Wiley Sourcebooks in American Social Thought (New York: Wiley, 1973).

¹⁹ Ramachandra Guha, "Afterword: Some Who Don't Fit: Patrick Geddes, Lewis Mumford, and Radhakamal Mukherjee," in *Environmentalism: A Global History* (New York: Longman, 2000), 59-62.

²⁰ Ramachandra Guha and J. Martinez-Alier, "The Forgotten American Environmentalist " in *Varieties of Environmentalism: Essays North and South* (Delhi; New York: Oxford University Press, 1998), Mark Luccarelli, *Lewis Mumford and the Ecological Region: The Politics of Planning*, Critical Perspectives (New York: Guilford Press, 1995), Worster, *American Environmentalism: The Formative Period, 1860-1915*.

²¹ Panayiota I. Pyla, "Ekistics, Architecture and Environmental Politics, 1945-1976: A Prehistory of Sustainable Development" (Unpublished Ph. D. Dissertation, Massachusetts Institute of Technology, September 2002).

²² Guha and Martinez-Alier, "Mahatma Gandhi and the Environmental Movement."

Dissertation Objectives

In this dissertation, I locate Tropical Architecture, which I define as climate-responsive and energy-conservative design, in the pre-history of environmentalism. I argue that the corpus of knowledge that developed through Tropical Architecture in the 1950s constitutes the pre-cursor to Green Architecture. I locate Tropical Architecture as a trans-colonial set of architectural practices that originated in the colonial experiences of European modernist architects. As a crucial part of this hypothesis, I trace the career trajectory of émigré architect Otto Koenigsberger.

Existing histories locate Tropical Architecture as a neo-colonial project that emerged in the 1950s along the networks of the diminishing British Empire. I propose that Tropical Architecture embodied a vision of environmentalism. Green Architecture, which is considered a recent discourse, cannot therefore be fully grasped unless it is historicized in relationship to Tropical Architecture. The careers of tropical architects are the missing link between histories of architecture in the colonies and histories of Green Architecture. I make my argument by establishing continuities between Tropical and Green architectural practices and by demonstrating how people trained in Tropical Architecture made their careers in the field of Green Architecture.

Brief Biography of Otto Koenigsberger (1908-1999)

Otto Koenigsberger was trained as an architect at the Technical University of Berlin as a student of Hans Poelzig from 1927 to 1931. His mentors included

Bruno Taut and Heinrich Tessenow. He worked briefly with Ernst May and won the Schinkel Prize in 1933 for a design of the forthcoming 1936 Olympics in Berlin. He was dismissed from service by Hitler's government in 1933, at which point he proceeded from Berlin to Egypt and worked as an archeologist. During his work in Egypt, he produced his doctoral thesis on the construction of the ancient Egyptian door. Koenigsberger's thesis was accepted in Berlin in 1935.²³

In 1939, Koenigsberger had the choice of two jobs: teaching hieroglyphics at the University of Michigan at Ann Arbor and becoming the chief architect of the Mysore State in India. Koenigsberger chose India, arriving in Mysore in 1939 as an émigré architect at the invitation of Sir Mirza Ismail, the *Dewan* (Prime Minister) of Mysore State. Mysore was a South Indian province under indirect British rule, which meant that the Maharajah of Mysore paid a subsidy to the British for military protection. In 1956, princely Mysore was territorially subsumed into the larger Mysore state, and in 1973, it was renamed Karnataka.

Koenigsberger served as Chief Architect of the Public Works Department (PWD) in Mysore from 1939 to 1948. While in India, Koenigsberger also served as a planner to corporate houses (such as the Tatas) and to the government of India. In 1945, Koenigsberger prepared third-phase plans for the industrial town of Jamshedpur.²⁴ In 1948, he also served as planner for Bhubaneswar, the capital of Orissa.²⁵

²³ Otto H. Koenigsberger, *Die Konstruktion Der ägyptischen Tür* (Glückstadt: Verlag von J.J. Augustin, 1936).

²⁴ See Otto H. Koenigsberger, "Jamshedpur Development Plan," (Bombay: Tata Iron and Steel Company, 1945).; Otto Koenigsberger, "The Story of a Town: Jamshedpur," *Marg* 1, no. 1

In 1948 as India became independent and Princely Mysore became part of the Union of India, Koenigsberger moved to Delhi and became the Federal Director of Housing (1948-51) for the ministry of health in Nehru's government. His work for Nehru involved both planning and architecture projects to resettle partition refugees. From 1948 to 1951, Koenigsberger served as planning advisor to the New Towns of Faridabad, Rajpura, Gandhidham and Sindri,²⁶ which were developed to resettle partition refugees. Koenigsberger also served as a member of the Greater Delhi Development Committee from 1948 to 1951 and was a member of the Technical Committee for the revision of Bye-laws for Delhi in 1951.

To solve this massive housing demand problem posed by partition refugees under Nehru, Koenigsberger proposed a pre-fabricated housing module for resettling the refugees. The housing units did not succeed, and Koenigsberger subsequently resigned from his position as the Federal Director of Housing and went to England. In 1951, he moved to London and in 1954 founded the Department of Tropical Architecture (1954-1971) at the Architectural Association (AA) School of Architecture. Koenigsberger headed the Department of Tropical Architecture from 1957 until its closure in 1971. In 1970, Koenigsberger established the Development Planning Unit (DPU) at the

(October 1946): 18-29.; Maya Dutta, *Jamshedpur : The Growth of the City and Its Regions* (Calcutta [now Kolkata]: Asiatic Society, 1977).

²⁵ See the master plan prepared by Koenigsberger, which is Otto H. Koenigsberger, "Master Plan for the New Capital of Orissa at Bhubaneswar," (Bhubaneswar: Government of Orissa, 1948). and Ravi Kalia, *Bhubaneswar: From A temple Town to a Capital City* (Carbondale: Southern Illinois University Press, 1994).

²⁶ Otto H. Koenigsberger, "New Towns in India," *Town Planning Review* 23, no. 2 (1952): 95-131.

University College London (UCL), which he led until he retired in 1988. He died in London in 1999.

Along with his position at the AA, Koenigsberger worked with Charles Abrams as a UN consultant advising new governments on planning in Third-World cities. His collaborations with Charles Abrams on UN Housing missions included Ghana (1956),²⁷ Pakistan (1957),²⁸ The Philippine Islands (1959),²⁹ Singapore(1963),³⁰ Zambia (1964), Lagos(1964),³¹ Ceylon (1966), Brazil (1968), Penang (1970), and The Philippines (1978). Koenigsberger theorized the planning paradigm called “Action Planning”, which was implemented in the Singapore UN Mission with Charles Abrams and Susumu Kobe.³²

Koenigsberger is perhaps best known for his treatise on Tropical Architecture called *Manual of Tropical Housing and Building*,³³ a textbook on climate-responsive design for the tropics. This volume continues to be prescribed for undergraduate curricula in the tropics and also appears on reading lists for Green Architecture. Based on Koenigsberger’s writings, I define Tropical

²⁷ Charles Abrams, Vladimir Bodiensky, and Otto H. Koenigsberger, *Report on Housing in the Gold Coast* (New York: United Nations Technical Assistance Administration, 1956).

²⁸ Otto H. Koenigsberger and Charles Abrams, *A Housing Program for Pakistan with Special Reference to Refugee Rehabilitation: Prepared for the Government of Pakistan* (New York: United Nations Technical Assistance Administration, 1957).

²⁹ Charles Abrams and Otto H. Koenigsberger, *A Housing Program for the Philippine Islands* (New York: United Nations Technical Assistance Administration, 1959).

³⁰ Charles Abrams, Susumu Kobe, and Otto H. Koenigsberger, *Growth and Urban Renewal in Singapore: Report Prepared for the Government of Singapore*, (New York United Nations 1963).

³¹ Otto H. Koenigsberger, *Metropolitan Lagos* (New York Commissioner for Technical Assistance, Department of Economic and Social Affairs, 1964).

³² Otto H. Koenigsberger, "Action Planning," *Architectural Association Journal* 79, no. 882 (May 1964): 306-312.

³³ Otto H. Koenigsberger, T. G. Ingersoll, Alan Mayhew, and S. V. Szokolay, *Manual of Tropical Housing and Building* (London: Longman, 1974).

Architecture paradigmatically as climate-responsive and energy-conservative design that makes the best use of locally available resources.

Climate-Responsive Design

Climate-responsive design constitutes an important phase in the development of passive technology, solar architecture³⁴, and Green Architecture. From the early 1930s to the end of the 1960s, climate-responsive design matured as a global phenomenon, developing as “Bio-Climatic Architecture” in the United States and as “Tropical Architecture” in Asia and Africa along the networks of the British Empire. In the United States, the Hungarian-born twins Victor Olgyay and Aladar Olgyay produced a significant corpus of knowledge on Bio-Climatic design.³⁵ From its inception in the 1930s through the 1950s, Tropical Architecture also developed and circulated through a network of global conferences.³⁶ In the UK, Tropical Architects such as Otto Koenigsberger, Jane

³⁴ Jeffrey Cook, "Six Evolutionary Phases toward Solar Architecture: Thermal Application of Solar Energy in Buildings," in *Solar World Congress: Proceedings of the Eighth Biennial Congress of the International Solar Energy Society, Perth, 14-19 August, 1983*, ed. International Solar Energy Society and S. V. Szokolay (Oxford [Oxfordshire]; New York: Pergamon Press, 1984), 4-15.

³⁵ Victor Olgyay, *Design with Climate: Bioclimatic Approach to Architectural Regionalism* (Princeton, N.J.: Princeton University Press, 1963).

³⁶ Jean Royer, *L'urbanisme Aux Colonies Et Dans Les Pays Tropicaux; Communications & Rapports Du Congrès International De L'urbanisme Aux Colonies Et Dans Les Pays De Latitude Intertropicale*, ed. Anonymous, Congrès International De L'urbanisme Aux Colonies Et Dans Les Pays De Latitude Intertropicale (1931, : Paris) (La Charité-sur-Loire: Delayance, 1932).; International Federation for Housing and Planning, "Papers and Reports : Xvi International Housing and Town Planning Congress, Mexico, 1938" (paper presented at the XVI International Housing and Town Planning Congress, Mexico, 1938).; Fello Atkinson, "Style and Tropical Architecture," in *Conference on Tropical Architecture: A Report of the Proceedings of the Conference Held at University College London March 1953*, ed. A. M. Foyle (London: George Allen and Unwin Ltd, 1954).; Mira Behn, "Needs for a Rural Housing in India," in *Proceedings of the Symposium: Scientific Principles and Their Application in Tropical Building Design and Construction* (New Delhi: National Institute of Sciences of India, 1955).; F. Buckens, "Considérations Sur L'étude Climatologique Quantitative De L'habitation Tropicale" (paper presented at the Académie royale des sciences coloniales. Classe des sciences techniques. Mémoires in-8o, nouv. sér., t. 3, fasc. 2, Bruxelles, 1956).; P. H. Connell, "Architecture in the

Drew, Maxwell Fry, Leo De Syllas, Fello Atkinson, and George Atkinson were engaged in the production of knowledge on energy-conservative climatic design.

Tropical Architecture occupies a marginal position in Euro-centric modernist architectural historiography both because of its engagement with the tropics and because energy-conservative design seemed redundant to European and American architects prior to 1970s. In the 1950s and 1960s, the cheap and abundant availability of energy sharply decreased interest in climatic design and energy-conservative design practices.³⁷ Only after the OPEC oil crises in 1973 did energy conservation emerge as a popular environmental concern in American and European architectural discourse,³⁸ which resulted in establishment of The American Institute of Architects an energy task force in 1973 and a committee on energy conservation in 1975.

In this dissertation, I show that tropical architects, particularly Koenigsberger, first developed and circulated the ideas eventually listed in 1992's *Agenda 21*, a document that defined Green Architecture. I argue that Green Architecture has subsumed the knowledge and theories produced through Tropical Architecture even though Tropical Architecture does not figure into the popular historiography of Green Architecture. Tropical Architecture has been seen as a colonial construct, as a British neo-colonial project in the tropics at the

Tropics," in *Symposium on Design for Tropical Living* (Durban: The Natal Regional Committee of the South African Council For Scientific and Industrial Research and The University of Natal at Durban, 1957).

³⁷ Adam Ward Rome, *The Bulldozer in the Countryside: Suburban Sprawl and the Rise of American Environmentalism*, Studies in Environment and History (Cambridge; New York: Cambridge University Press, 2001).

³⁸ See *Journal of Architectural Education*, vol. 30 No. 3, Energy and Architecture (1977).

end of the empire,³⁹ or, alternately, as a value-neutral scientific climatic design discourse.⁴⁰ In response, I argue that although Tropical Architecture was intended to be a neo-colonial project, it also paradoxically became a platform for climate-responsive design and architectural practices that were critical of reckless energy and resource consumption.

I make my argument for Tropical Architecture as pre-cursor to Green Architecture by establishing continuities between Tropical and Green architectural practices. I also demonstrate how people trained in the Tropical School made their careers in Green Architecture, tracing particularly the influence of architect Otto Koenigsberger, his contemporaries, and their students trained in Tropical Architecture who later made their careers in Green Architecture.

Tropical Architecture in the Historiography of Green Architecture

I propose that Tropical Architecture historiographically illuminates how transcolonial histories of architecture intersect with environmental histories of architecture. The role of places, architects, planners, and experiences outside Europe and North America in the development of Green Architecture remains under-examined, but I claim that tracing the development of environmental

³⁹Mark Crinson, *Modern Architecture and the End of Empire* (Aldershot, England; Burlington, VT: Ashgate, 2003), Anthony King, "Exporting Planning: The Colonial and Neo-Colonial Experience," in *Shaping an Urban World*, ed. Gordon Cherry (London: Mansell Publishing, 1980), 203-226, Hannah Le Roux, "The Networks of Tropical Architecture," *The Journal of Architecture* 8, no. 3 (2003): 337-354.

⁴⁰Cook, "Six Evolutionary Phases toward Solar Architecture: Thermal Application of Solar Energy in Buildings," 14-19.

consciousness in the European and American architectural discourse cannot exclude the colonial experience of tropical architects.

Tropical Architecture, which architects in the metropole originally intended as an imperial discourse, was later subsumed within the discourse of Green Architecture. Despite the fact that Green Architecture represents a complex and competing set of practices, discourses, and agencies, the idea of energy and resource conservation through architectural design is universally accepted as fundamentally definitive of Green Architecture. I therefore propose that the corpus of knowledge on climate-responsive design developed through Tropical Architecture constitutes a significant component of Green Architecture.

Dissertation Outline

In the first chapter, I give evidence that American environmental histories dominate environmental historiography. The dominant history of Green Architecture suggests that modern environmentalism intersected with the architectural discourse in the 1970s with the beginning of the OPEC crises, subsequently leading to the Brundtland Report (1987) and to the document that defined Green Architecture, the UN's *Agenda 21* (1991). I challenge this dominant narrative to argue that Tropical Architecture was the pre-cursor to Green Architecture. I locate Otto Koenigsberger, one of the key actors in developing Tropical Architecture, in the pre-history of Green Architecture.

In the second chapter, I address the question: What did Otto Koenigsberger learn through his architectural experiences in Mysore? When

Koenigsberger immigrated to Mysore in 1931, neither he nor the Maharajah of Mysore's government had any foresight of how incompatible their architectural taste and ideological tendencies would be. Koenigsberger, who had been persecuted by the nationalism of the National Socialist Party in Germany, had emigrated from a context where nationalism was a xenophobic phenomenon to being the chief architect in a regime that was deeply engaged in deploying nationalism as a form of resistance against colonialism. Koenigsberger saw himself as a politically disengaged émigré, yet found himself an architect in exile in the service of nation building for the Maharajah of Mysore.

In this second chapter, I show that Koenigsberger's buildings in Mysore reflect tensions with the Maharajah over taste and nationalism, forcing Koenigsberger to embark on an intellectual journey of confronting a different milieu. Koenigsberger stripped the demands of the Mysorean architectural program of its nationalistic ideological underpinnings into a rational climate-responsive discourse that would later be theorized as Tropical Architecture in London.

I argue that working in exile in Princely Mysore fundamentally transformed Koenigsberger's architectural thinking and practice. I infer that the most significant change in his thinking was a cognizance of limits in resources and energy. Koenigsberger saw his architecture in Mysore as a response to the *swadeshi* (indigenously produced) ideology of Princely Mysore, which strongly promoted use of indigenously produced Mysorean materials and imposed severe limitations on using non-indigenous Mysorean materials. I show that through his

experience in Mysore, Koenigsberger theorized Tropical Architecture as a discourse that was climate responsive, energy conscious, and built with local resources.

In chapter three, I argue that Tropical Architecture originated in the discourse of hygiene and circulated through colonial hygiene manuals. I also show that in the 1950s, Tropical Architecture shifted from hygiene to the discipline of architecture. Tropical Architecture circulated as a transcolonial discourse through a series of conferences held globally not only in imperial capitals such as Paris, Lisbon, Washington D.C., and London, but also in the former and existing colonies such as India, Uganda, and Kenya. The 1950s conferences paradigmatically defined Tropical Architecture as a set of climate-responsive design practices. The conferences debated the kind of technology that would be suitable or appropriate for the tropics. Architects debated the efficacy of simple low-impact technologies. Koenigsberger deployed the tropics as a critique of Euro-centric architectural and planning paradigms; he viewed Tropical Architecture as an opportunity to develop a new paradigm in architecture and planning that was based on energy and resource conservation.

In chapter four, I discuss Koenigsberger's contribution to Tropical Architecture and its relevance to Green Architecture today. I propose that to achieve energy and resource efficiency, Koenigsberger theorized four key strategies, including critical rethinking of the architectural program, naturally conditioned buildings (also known as passive technology), building within local technological and material capacity, and using vernacular architecture as a

pedagogic model for climatic design. These doctrines continue to remain vital in the practice of Green Architecture.

In chapter five, I discuss how Tropical Architecture acted as a precursor to Green Architecture. I look at continuities between Tropical and Green architectural practices not only in terms of energy and resource conservation but also how Tropical Architecture embodied a vision of distributive justice of resources. I also demonstrate how second-generation architects who collaborated with Koenigsberger, such as T. G Ingersoll and Steven Szokolay, made their careers in Green Architecture.

Sources and Archives

In conducting research for this dissertation, I have relied on several archives and libraries. They include Otto Koenigsberger's private papers (OKPP) in the custody of his widow Renate Koenigsberger in London; The Karnataka State Archives (KSA) in Bangalore, Karnataka, India; The Architectural Association (AA) Library in London; The British Library in London; The Development Planning Unit (DPU) at the University College London (UCL); and the Peter and Allison Smithson papers at the Special Collections of Frances Loeb Library, Graduate School of Design at Harvard University. I also relied extensively on Inter-Library Loan through the University of Michigan Library System. I photographed and measured several of Otto Koenigsberger's buildings in Bangalore and Mysore and interviewed some of Koenigsberger's students and

colleagues, including Patrick Wakely in London, Steven Szokolay in Australia, and T.G Ingersoll, in Massachusetts.

Contribution to the Field

My doctoral work will be of interest to scholars in multiple disciplines, including the History of Architecture, Environmental History, Post-Colonial Studies, and South Asian Studies. My work fills in a critical, un-examined area in scholarship on Green Architecture by considering how places, architects, planners, and experiences from *outside* Europe and North America contributed to Green Architecture's development. My dissertation highlights how the architectural experience of European architects in the colonies was constitutive of the discourse of sustainability. My work will be of interest to academics interested in transnational histories of modern architecture and in the intersection of colonialism and modernism.

Chapter 2

Otto Koenigsberger in Princely Mysore

In this chapter, my central question is: what did Koenigsberger learn through his experience in Mysore? In order to answer the question of how Koenigsberger's architectural thinking changed in India, I raise these questions: Why did the Maharajah of Mysore invite Koenigsberger? During Koenigsberger's tenure in Mysore, how was the discourse on architecture tied to nationalism in Mysore? How did Koenigsberger respond to the architectural culture of Mysore? How did Koenigsberger use his experience in Mysore to theorize Tropical Architecture in London? In the following sections, I answer these questions.

Mysore

The South Indian kingdom of Mysore lasted from 1399 to 1947 and was primarily ruled by the Wodeyer dynasty. (Figure 2.1) In the fourth quarter of the eighteenth century, Haider Ali (1761-1782) overthrew the Wodeyer dynasty. He was succeeded by his son Tipu Sultan (1782-1799), whose rule ended in 1799 when the East India Company and their allies killed Tipu at Srirangapattinam in the Fourth Anglo-Mysore War. The British then restored the Wodeyers as the rulers of Mysore.

After Tipu was defeated, the state of Mysore came under indirect British rule from 1799 to 1831, during which the Maharajah paid the British a subsidy in exchange for military defense of his territory. The British established a military station at Srirangapattinam, which was abandoned in 1811 due to the poor health of the troops.¹ The British moved their military base to Bangalore, which enjoyed a milder climate.

From 1831-1881, Mysore state came under direct British rule and Bangalore emerged as the administrative center of the British Raj.² Under direct rule, Bangalore became capital of both the District of Bangalore and the State of Mysore. (Figure 2.2) Mysore was under indirect rule from 1799-1831 and 1881-1947, and the city of Mysore remained the king's residence and capital of the Mysore state under indirect British rule.³ In 1948, the princely state of Mysore was subsumed into the Union of India. In 1956, princely Mysore was territorially subsumed into the larger Mysore state, and in 1973, it was renamed Karnataka. Bangalore continues to be the capital of Karnataka.

Princely India accounted for one-third of the territory and one-quarter of the population of Britain's Indian empire. Tropes such as collaboration⁴ and patron-client relationship⁵ have been used to describe the operative structure of indirect rule and the transactions between the princely government and the

¹ Sir William Wilson Hunter, *The Imperial Gazetteer of India* (London: Trübner & Co., 1885).

² Benjamin Lewis Rice, *Mysore: A Gazetteer Compiled for Government* (London: Archibald Constable and Company, 1897).

³ Since Mysore is the name both the city and state, like New York state and New York City, I will refer to Mysore city and Mysore state/princely Mysore to distinguish between the two.

⁴ Rice, *Mysore: A Gazetteer Compiled for Government*.

⁵ Barbara N. Ramusack, *The Princes of India in the Twilight of Empire: Dissolution of a Patron-Client System, 1914-1939* (Columbus: Published for the University of Cincinnati by the Ohio State University Press, 1978).

British Raj. However, these collaborative models do not account for resistance against the Raj and the autonomy of the princely governance.⁶ From the early twentieth century, Mysore had the sole objective of establishing an economically and politically autonomous princely state through economically collaborative enterprises between the state and bourgeois private capital.⁷ If nations are political communities constructed in the cultural sphere through ideological cultural endeavors,⁸ then what kind of cultural and political sovereignty could Mysore claim for itself under indirect British rule?

The princes occupied a politically ambiguous position under indirect rule. The Mysore *Durbar* (princely government) was an ambiguous political entity, both as an agent of colonialism and nationalism. Today, Mysore nationalism is viewed positively as a mode of challenging colonial authority through economic and cultural autonomy. It is also seen negatively as a force that marginalized the working classes in the society.⁹ From the point of view of a rising, self-assertive, modernizing bourgeois class, the Maharajah's government was an agent that facilitated modernity grounded in the promise of the Mysore nation.¹⁰ Yet from a working class perspective, the Maharajah's government and their bourgeois nationalism was the agency that suppressed labor unrest, student activism, democratic institutions, and trade unions.

⁶ Manu Belur Bhagavan, *Sovereign Spheres: Princes, Education and Empire in Colonial India* (New Delhi: Oxford University Press, 2003).

⁷ Björn Hettne, *The Political Economy of Indirect Rule: Mysore 1881-1947*, *Scandinavian Institute of Asian Studies Monograph Series; No. 32* (London: Curzon Press, 1978)..

⁸ Geoff Eley and Ronald Grigor Suny, "Introduction: From the Moment of Social History to the Work of Cultural Representation," in *Becoming National: A Reader*, ed. Geoff Eley and Ronald Grigor Suny (New York: Oxford University Press, 1996), 3-38.

⁹ Janaki Nair, *Miners and Millhands: Work, Culture, and Politics in Princely Mysore* (Walnut Creek, California: AltaMira Press, 1998).

¹⁰ Hettne, *The Political Economy of Indirect Rule: Mysore 1881-1947*.

Although Mysoreans were politically semi-autonomous, they were able to assert themselves as a nation in an autonomous cultural sphere.¹¹ I propose to show how architecture constituted a significant aspect of this autonomous, but tangled and complicated, cultural sphere. I also show how Koenigsberger entered this complex cultural sphere and how he made sense of the nation-building agenda in Mysore. Later, he would draw upon his architectural experience in Mysore to articulate his position on architecture in the tropics.

Swadeshi

In the early twentieth century, the Congress' anti-colonial movement against the British Raj started in the presidency cities of Bombay, Calcutta, and Madras. Gradually, the nationalistic movement spread to all parts of the Indian subcontinent. The four formally organized Congress nationalistic movements are the *Swadeshi* movement in 1905, the Non-Cooperation Movement of 1921-22, the *Satyagraha* of the early 1930's, and the Quit India Movement of 1942.¹² Of these four, I am most interested in the *Swadeshi* movement.

Swadeshi, which translates as "indigenously manufactured", began as a nationalist movement of anti-colonial resistance to protest the partitioning of Bengal.¹³ Gandhi developed the *Swadeshi* discourse theorized in Tagore's *Swadeshi Samaj*.¹⁴ Gandhi popularized and deployed *Swadeshi* as an ideological refashioning of consumer habits, encouraging people to consume

¹¹ See Partha Chatterjee, *The Nation and Its Fragments : Colonial and Postcolonial Histories*, Princeton Studies in Culture/Power/History (Princeton, N.J: Princeton University Press, 1993).

¹² Hettne, *The Political Economy of Indirect Rule: Mysore 1881-1947*.

¹³ For a detailed account of swadeshi and the partition of Bengal see, Sumit Sarkar, *The Swadeshi Movement in Bengal, 1903-1908* (New Delhi: People's Pub. House, 1973).

¹⁴ Ibid.

self-manufactured products to protest against the global circulation of capital through the exploitative colonial economy. *Swadeshi* comprised active protests, including performative spectacles like burning heaps of Manchester cloth in bonfires, and passive protests, including boycotting industrial British cotton and wearing *khadi*, the home-spun coarse cotton cloth that became the most robust symbol of the *Swadeshi* Movement.¹⁵ Gandhi defined *Swadeshi* as:

For the purpose of the All India Swadeshi League, Swadeshi covers useful articles manufactured in the India through small industries which are in need of popular education for their support and which will accept the guidance if the All India Swadeshi League in regulating prices and in the matter of the wages and welfare of labour under their control. Swadeshi will, therefore exclude articles manufactured through the large and organized industries which are in no need of the services of the All India Swadeshi League and which can or do command state aid.¹⁶

The *Swadeshi* emphasis on self-reliance, self-sufficiency, small-scale cottage industries, consuming less, consuming self-produced products, and recycling was not only an anti-colonial nation-building strategy,¹⁷ but also contained a vision of sustainability and Appropriate Technology that would be later emphasized in texts such as *Small is Beautiful*.¹⁸

The Mysore regime, which adopted *Swadeshi* around 1910,¹⁹ used *Swadeshi* as an act of claiming political, cultural, and economic autonomy.²⁰

¹⁵ For a more detailed account of the production and consumption of Khadi in the nationalistic discourse see, Lisa Trivedi, *Clothing Gandhi's Nation Homespun and Modern India* (Bloomington: Indiana University Press, 2007).

¹⁶ M. K. Gandhi, "A New Orientation," in *Cent Per Cent Swadeshi or the Economies of Village Industries* (Ahmedabad: Navajivan publishing house, 1948).

¹⁷ For Gandhi's manifesto on Swadeshi see M. K. Gandhi, *Cent Per Cent Swadeshi or the Economies of Village Industries* (Ahmedabad: Navajivan publishing house, 1948).

¹⁸ E. F. Schumacher, *Small Is Beautiful: Economics as If People Mattered* (New York Harper Perennial, 1989).

¹⁹ Hettne, *The Political Economy of Indirect Rule: Mysore 1881-1947*.

Mysore's vision of *Swadeshi* coincided with Gandhi's ideas insofar as they both aimed at achieving *Swaraj* (self-rule) through *Swadeshi* production to achieve self-reliance. However, Mysorean *Swadeshi* departed from Gandhian *Swadeshi* on several counts. Gandhi's logic of self-reliance worked at the scale of the individual's relationship to consumption and production. He emphasized maintaining a balance between production and consumption at the village level. The ideal unit of the Gandhian economy is the self-contained village, which acts as consumer of self-produced goods through small-scale and low-tech cottage industries. Gandhi envisioned weakening the colonial empire through the consumer boycott of products, which circulated within the global economy of the British Empire.

Mysore, by contrast, envisioned self-reliance at the scale of the Mysore nation-state. Mysore chose industrialization as the route to development and modernization, which distanced it from the Gandhian *Swadeshi* ideal. Visvesvaraya, the prime minister of Mysore from 1912 to 1918, framed the "Mysore Model of Development" as a mode of development through industrialization actuated by collaboration between state and private capital to achieve political and economic autonomy.²¹ (Table 2-1) Visvesvaraya coined the slogan "industrialize or perish", which established his vision of development along the lines of the Nehruvian industrial model of development.

²⁰ Autonomy meant claiming independence from the British, establishing the Maharajah as an independent ruler and Mysore as a sovereign state.

²¹ Bjørn Hettne, "The Emergence of a Mixed Economy," in *The Political Economy of Indirect Rule: Mysore 1881-1947*, *Scandinavian Institute of Asian Studies Monograph Series No. 32* (London and Malmö: Curzon Press, 1978), 280-331.

In the sphere of architecture, Visvesvaraya's model of development led to a collaboration between the bourgeoisie and government. The majority of the public buildings in Mysore, especially schools, dispensaries, and hospitals, were produced through philanthropic alliances between the elite of Mysore and the princely government. Mirza Ismail, the *Dewan* of Mysore from 1926 to 1941, continued Visvesvaraya's model of development. This model relied on an authoritarian mode of autocratic governance that was softened by populist measures.²² I propose that in the field of architecture and urbanism, these populist measures translated into the beautification of Mysore and an extensive architectural program.

Mysore's suppression of labor unrest further distanced their top-down bourgeoisie development approach from the Gandhian grass roots and small-scale developmental ideology. The Mysore government appropriated *Swadeshi* ideology to promote industrially manufactured products made in Mysore government's factories, and they frequently employed European non-British scientists, engineers, and technocrats. The Mysore government frequently collaborated with American and European technocrats to modernize every aspect of the state.

When Gandhi was questioned about the use of the term *Swadeshi* for industrially manufactured goods and the use of foreign technocrats, he did not readily endorse the practice, but expanded the definition of *Swadeshi* to include

²² Ibid.

industries that were fully managed and controlled by Indians.²³ Thus I interpret the Mysorean *Swadeshi* as loosely aligned with Gandhian ideology. Cent Per Cent Swadeshi or the Economies of Village Industries

The important questions for the purposes of this paper are: How was architecture linked to *Swadeshi*, and how did Koenigsberger fit into this equation? Why and how was Koenigsberger recruited by Mysore? What impact would *Swadeshi* have on Koenigsberger's work and thinking?

***Swadeshi* and Architecture**

In promoting the Mysore *Swadeshi* in 1939, *Dewan* Mirza Ismail (Figure 2.3) called upon Mysoreans in a radio speech to consume products manufactured by the state:

We are very proud of the products of these (local Mysore) factories and at the risk of being called provincial, try to set before all true Mysoreans the ideal that they should wash themselves with Mysore soap, dry themselves with Mysore towels, clothe themselves in Mysore silks, ride Mysore horses, eat the abundant Mysore food, drink Mysore Coffee with Mysore sugar, build their homes with Mysore cement, Mysore timber and Mysore steel, furnish their houses with Mysore furniture, light them with Mysore lamps and write their letters on Mysore paper.²⁴

Although Ismail encouraged the use of Mysorean indigenous materials in buildings, he did not hesitate to invite Otto Koenigsberger, the former German, then-stateless émigré architect, to be the chief architect of Princely Mysore in 1939. (Figure 2.4) Koenigsberger was asked to design "indigenous" Mysorean state buildings. But how could architecture in Mysore designed by a German

²³ M. K. Gandhi, "Swadeshi Industries and Discrimination," in *Cent Per Cent Swadeshi or the Economies of Village Industries* (Ahmedabad: Navajivan publishing house, 1948), 115-117.

²⁴ Sir Mirza Ismail, "Broadcast Talk on Mysore," in *Speeches by Amin-UI-Mulk: Sir Mirza Ismail* (Bangalore: Superintendent at the Government Press, 1940), 365-358.

cosmopolitan architect be seen as indigenous and an act of nation building? How did the Mysorean regime define architecture in relationship to nationalism?

In Mysore indigenous architecture was understood in the *Swadeshi* sense of being locally manufactured out of local materials. Indigeneity in architecture was defined in terms material territorial relationship between the building and the state. It did not imply a rejection of architectural knowledge developed through culture contact with the British, but indigenous Mysorean architecture was a modern project that defined Mysore through its architecture. The definitions of indigenous and indigeneity in the context of *Swadeshi* and nationalism become extremely complicated and cannot be understood in terms of opposition to modernity or cosmopolitanism.

I propose that both cosmopolitanism and territorial autochthony were constitutive of indigeneity in Mysore. I will problematize the cultural sphere of architecture within which the *Swadeshi* movement was consolidated. I argue that the architectural production in Princely Mysore illuminates the construct of indigeneity as a modern project constitutive of cosmopolitanism. I will focus on three aspects of the relationship between nationalism and architectural production: recruiting German architects such as Koenigsberger, Krumbiegel, and Exener; the use of Mysorean indigenous materials; and architectural taste. In the final section of this chapter, I answer the question of how Koenigsberger responded to the imperatives of architecture and nationalism in Mysore.

Architectural production in Mysore illuminates how indigeneity and cosmopolitanism intersect within nationalism to include modern materials such as

concrete and steel; both Europeanate and Indo-Saracenic styles; and a German cosmopolitan architect such as Koenigsberger. Otto Koenigsberger's buildings in princely Mysore from 1939-1948 were the sites of political battles over architectural taste that reflected competing imaginations of the Mysore nation and the internal contradictions of the Mysore *Swadeshi* ideology. Koenigsberger's exposure to *Swadeshi*, the environmental vision embedded in this ideology, and his Mysorean experience of working with resource scarcity and energy restrictions, would inform his theories on Tropical Architecture. Those theories constitute a pre-history of Green Architecture.

German Architects in Mysore

Although Mysore was under the indirect British rule during Koenigsberger's tenure there, the Maharajah's government exercised a fair amount of cultural autonomy. The Mysore nation was imagined in this autonomous cultural sphere, and the regime's gesture of recruiting German architects, as opposed to British architects, is definitely significant in asserting cultural autonomy.

Koenigsberger was not the first German architect to be recruited by the Maharajah's government; indeed, the Maharajah had earlier recruited German architects G.H. Krumbiegel and U. G. Exener. Krumbiegel left Germany in 1888 to work at the Kew Gardens in England. He came to the princely state of Baroda in 1893 and moved to Mysore in 1908. Krumbiegel headed the horticulture department and was asked to step in occasionally as an architectural consultant for projects such as Municipal offices. The Dewan proposed using Krumbiegel's

services at no extra fee to him besides the remuneration by the horticulture department. Exener left Germany in 1928-29 to live in Holland. He moved to Mysore in October 1936 and began working for the Mysore government as an interior architect.²⁵

Ismail was keen to employ German architects to improve the quality of the Public Works Department (PWD) design process. He intended to streamline the implementation of well-worked-out plans to eliminate costs associated with poor planning.²⁶ However, the PWD was largely comprised of Indian engineers who objected to Krumbiegel's services. His foreign-ness and his architectural background made him unwelcome in an office dominated by Indian engineers. On the *Dewan's* suggestion that Krumbiegel be appointed, one of the members of Council objected and noted:

As far I am concerned, I may say that I have not failed to avail myself of Mr. Krumbiegel's services whenever there was any opportunity. I am extremely doubtful however if Mr. Krumbiegel will hit it off with the Public Works Department. There is what is usually known as professional jealousy and the fact that Mr. Krumbiegel is not a regular engineer by profession goes somewhat against him. Personally, I have not the least objection to the proposal and the Chief engineer may be consulted.²⁷

Despite objections from members of council, Ismail's decision led to the appointment of Krumbiegel as a consulting architect. Although there is no archival evidence to specify why Koenigsberger and Exener were appointed, I

²⁵ Dr. Gualtherus H. Mees Mees, Demi-Official Letter from Dr. Gualtherus H. Mees, "Badri", Vontikoppal, Mysore, to the Secretary to the Hon'ble the Resident in Mysore., Enemy Foreigners: 1) G.H. Krumbiegel; 2) Dr. O. H. Koenigsberger; 3) Otto Schmidt; 4) Captain Charles Chimani, September 22, 1939, File No. 66-40, S. No.1-28, GOM War, KSA, Bangalore, Karnataka.

²⁶ Final Note by the First Member of Council to the Maharajah of Mysore, Appointment of Mr. Krumbiegel as Consulting Architect to Government, 1922, File No. 24-23, S. Nos. 1-3, GOM General and Miscellaneous, KSA, Bangalore, Karnataka.

²⁷ Ibid.

speculate that they were appointed to improve the technological quality of buildings.

The Mysore Government went through a considerable amount of negotiation with the British resident in Mysore to retain Krumbiegel, Exener, and Koenigsberger as government architects during the Second World War, during which the German architects were classified as enemy subjects and confined to internment camps.²⁸ The Mysore *Durbar* (court) exercised considerable pressure on the British residency not only for their immediate release, but also for these three architects to continue working on architectural designs while they were in their internment camps.²⁹

Of these three architects, Koenigsberger was the first to be released. His internment camp files reveal that the Mysore Government persuaded the British resident to release him immediately from the camp on account of his Jewish anti-Nazi political viewpoint.³⁰ Subsequently, the Mysore government periodically and repeatedly negotiated with the British resident in Mysore to keep Koenigsberger out of the internment camp as his work was seen as highly “technical and specialized.”³¹

²⁸ Chief Secretary to H. Trevelyan Esqr. Secretary to the Hon'ble Resident of Mysore Enemy Foreigners: 1) G.H. Krumbiegel; 2) Dr. O. H. Koenigsberger; 3) Otto Schmidt; 4) Captain Charles Chimani, September 6, 1939, File No. 66-40, S. No.1-28, GOM War, KSA, Bangalore, Karnataka.

²⁹ Ibid.

³⁰ The Mysore Resident to Rajasevapasakta Mr. B. T. Kesavaiengar, Chief Secretary to the Government of His Highness, Re: War: Release of Certain Internees, Enemy Foreigners: 1) G.H. Krumbiegel; 2) Dr. O. H. Koenigsberger; 3) Otto Schmidt; 4) Captain Charles Chimani, September 22, 1939 File No. 66-40, S. No.1-28, GOM War, KSA, Bangalore, Karnataka.

³¹ Note from the Pwd Chief Engineer Attached to the Letter from Mr. B. T. Kesavaiengar to the Resident of Mysore, Enemy Subjects - Mr. O. H. Koenigsberger, December 11, 1940, File No. 13-40, S. No. 20-21, GOM War, KSA, Bangalore, Karnataka.

Although, the Mysore government employed German architects, they never acknowledged the contribution of German architects on stone epigraphs in buildings. The Mysore state had a practice of creating a granite Epigraph to commemorate the date of the foundation stone laying ceremony and inauguration of each state building. Indian architects often served as consultants to government buildings. When an Indian architect was recruited, the regime promptly listed the architect's name on the epigraph. While, it has been impossible to photograph all the epigraphs on Mysore state buildings, during my visits to several buildings designed by Koenigsberger, his name does not figure on a single epigraph. The epigraphs for buildings designed by Koenigsberger, which include: the Victory Hall (Figure 2.5), the Ayurvedic Hospital (Figure 2.6), the Krishna Rao Pavilion (Figure 2.7), and the Mysore Engineers Association (Figure 2.8) do not mention his name as the architect. I speculate this could be because the government wanted the German architects to maintain a low profile in the public sphere and the PWD's reservations against foreign architects interfering in their work.

Krumbiegel prepared the initial Indo-saracenic design for the Bangalore Municipal Building, colloquially known as the corporation office.³² (Figure 2.9) Later, the building was redesigned by the Liverpool trained architect Lakshminarasappa, whose name figured on the epigraph. (Figure 2.11) Krumbiegel's and Lakshminarasappa's designs for the municipal building are completely different in plan, but both the designs were proposed in an Indo-

³² G. H. Krumbiegel to M.S.Ramachandra Rao, Construction of a New Municipal Office at Bangalore Amounting to Rs.85,000, June 26, 1928, File No. 121-127, S. No. 1, 6, 8, GOM Municipal, KSA, Bangalore, Karnataka.

saracenic style and their elevations are somewhat similar. (Figure 2.10) Likewise, the architect for Mysore Sugar Office T. S. Narayan Rao was acknowledged through the epigraph on the Mysore Sugar building. (Figure 2.12 and Figure 2.13)

Krumbiegel, Exener, and Koenigsberger's names did not figure on any of the Mysore epigraphs. Their architectural contribution to Mysore state has been deleted from the architectural histories of Bangalore and Mysore.³³ Though Krumbiegel is remembered for his contribution to horticulture in the histories of Bangalore,³⁴ his contribution as an architect has been forgotten.

***Swadeshi* Building Materials**

Driven by *Swadeshi* ideology, the Mysorean regime encouraged the use of Mysorean materials in buildings. But how were Mysorean materials defined? What made a particular building material indigenous to Mysore? The drive to use indigenous materials was not only ideologically driven, but also determined by cost considerations, energy expenses, and resource scarcity. Because of this, there are interesting intersections between *Swadeshi* ideology and Appropriate Technology.

The building materials used prior to 1930 were granite, brick, Basel Mission terra cotta (clay) tiles, *kuddapah* (local slate), teak, lime, and steel girders. After 1930, Reinforced Cement Concrete (RCC) entered the repertoire of

³³ T. P. Issar, *Mysore, the Royal City* (Bangalore: Marketing Consultants & Agencies, 1991), T. P. Issar and Bangalore Urban Arts Commission, *The City Beautiful a Celebration of the Architectural Heritage and City-Aesthetics of Bangalore* (Bangalore: Bangalore Urban Arts Commission, 1988).

³⁴ Issar and Bangalore Urban Arts Commission, *The City Beautiful a Celebration of the Architectural Heritage and City-Aesthetics of Bangalore*.

Mysorean materials. Initially RCC was used sparingly for sunshades, but by the 1940s, RCC began to be used for roofing.

Mysore government buildings specified stone concrete jelly in *chunam* (lime) mortar for foundation, burnt stone walls in *chunam* mortar for higher-end buildings, and burnt brick in *surkhi* (clay) mortar for less important buildings. The floor was finished in *kuddapah* (local slate) stone on a concrete bed with cement pointing or unglazed terra cotta tiles. For *chajjas* (sunshades), terra cotta tiles on teak frame, RCC, stone slabs, and zinc sheets fixed on teakwood were used. When Mangalore/terra cotta tiles were used for roofing, intermediate floors were supported on steel girders.³⁵

Until mid-1930, terracotta tiles on teakwood rafters was the most preferred roof form. In this roofing method, a small amount of cement was used to seal in the ridge tiles. Until the early 1930s, clay tiles manufactured by Basel Mission were specified for government buildings. In the mid-nineteenth century, the Basel Mission set up an industrial mission in South India to manufacture cloth and tiles with centers located in located in Mangalore, Cannanore, and Calicut. The mission employed Christian converts, who upon conversion were ostracized from their original communities and thus lost property rights. The mission manufactured terracotta tiles for roofing and flooring, through the labor of Christian converts and used the profits to build communities of converts, pay

³⁵ I compiled and inferred this information from several volumes of the *Mysore Gazette* from 1925 to 1948.

them a living wage, and further their missionary work. The Basel Mission saw itself in competition with “native manufacturers” and the English.³⁶

In 1930, Shanmugam Mudaliar, a Mysorean, established The Standard Brick and Tile Company in Yelahanka, near Bangalore, which continues to make tiles to this day. The Standard Brick and Tile Company used labor-intensive, low technology methods of production and provided employment to unskilled people.³⁷ Because Yelahanka is on the outskirts of Bangalore, transport costs for these tiles were less than those for the Basel Mission tiles. This mode of production would make these Standard Brick and Tile Company tiles not only a *Swadeshi* ideal material, but also the appropriate technologist’s preferred material for roofing.³⁸

By the mid-thirties, four years prior to Ismail’s *Swadeshi* speech, the government tender notices published in the Mysore Gazette began to specify Mysorean materials with greater rigor. This meant that the notices specified using Yelahanka tiles and not Basel Mission tiles; Mysore Teakwood procured from the Government Forest Depot;³⁹ Chamundi cement; and painting doors and windows with government factory paint.⁴⁰ The notices also recommended Tata steel for girders and rolled steel joists instead of those from British companies. Until

³⁶ L. J. Frohnmeyer, "The Basel Industrial Missions in India," in *Report of the Ecumenical Conference on Foreign Missions, Held in Carnegie Hall and Neighboring Churches, April 21-May 1* (New York; London: American Tract Society; Religious Tract Society, 1900), 157-164.

³⁷ I. Priyadarshini, "Surviving the Test of Time," *Deccan Herald* Tuesday, June 22, 2004.

³⁸ S.W. Harrison and B.P. Sinha, "A Study of Alternative Building Materials and Technologies for Housing in Bangalore, India," *Construction and Building Materials* 9, no. 4 (August 1995): 211-217.

³⁹ Office of the Executive Engineer Shimoga Division, "Notification Dated 7th February 1935 (Tender Notice for Constructing Srimati Bhoopalam Subhadramma Maternity Hospital at Shimoga)," *Mysore Gazette* February 7, 1935, 179-182.

⁴⁰ B Tirumalachar, "Abstract of the Estimate for Constructing a Maternity Home at Hosdurga. Chitaldrug District," *Ibid.* May 16, 1940, 1093-1095.

1936, the government tender notices had given contractors the choice of using Tata steel or British steel companies like Dormon Long Company,⁴¹ but as of 1936, a higher proportion of tender notifications began to insist on Tata steel. Tata steel was not a Mysore government product, but the Tata's were one of the *Swadeshi* industries that had a historical collaborative relationship with the Mysore government.⁴² The Mysore Iron and Steel Works plant at Bhadravati was not producing steel at that time.

The government stipulated that only Mysorean building materials be used in government buildings. Mysorean "indigenous" was not necessarily defined in opposition to cosmopolitanism, but rather inclusive of cosmopolitanism. Indigeneity was defined as territorial boundedness to Mysore through production.⁴³ The repertoire of indigenous *swadeshi* materials was fast expanding to include included modern materials such cement, steel, and concrete, which were not necessarily indigenous.

Indigenization of Concrete

How was concrete indigenized? Concrete was advertised as a modern plastic material, which could be cast into ornamental features. Cement companies tried to capture the construction market by advertising concrete's wide applications as new structural material which could be put to modern

⁴¹ Office of the Executive Engineer Shimoga Division, "Notification Dated 7th February 1935 (Tender Notice for Constructing Srimati Bhoopalam Subhadramma Maternity Hospital at Shimoga)," *Ibid.* February 7, 1935.

⁴² The Maharaja of Mysore generously offered land to the Tatas, to set up the Indian Institute of Science in 1912.

⁴³ Manu Goswami, *Producing India: From Colonial Economy to National Space*, Chicago Studies in Practices of Meaning (Chicago; London: University of Chicago Press, 2004). and Trivedi, *Clothing Gandhi's Nation Homespun and Modern India*.

technological uses such making bridges, dams, and modern multi-story buildings. Cement and concrete were also advertised as a new material, which could be cast into ornamental forms, which were earlier done in stone. In the Associated Cement Companies' advertisement for the promotion of cement concrete in the Indian Concrete Journal in 1940, the illustration depicts the wide consumption of cement concrete, which ranged from the modern bridge to the temple. (Figure 21.4) The image of the cemented road on which the car and the bullock cart coexist is a metaphor for concrete's applications to transcend cultural, technological, aesthetic, and temporal barriers in the imagination of the Indian nation.

Concrete was being indigenized through its consumption and production. Through its consumption as a material, which could lend itself to indigenous features such as *jails* (lattice screens), domes, and *chajjas*, concrete made its entry into the construction industry as a substitute for stone. For instance, in the domed pavilion designed by G. H. Krumbiegel in the Municipal Park at Kolar, cement concrete dome, *jails*, *chhajjas* were constructed in concrete. (Figure 2.15) Concrete's plasticity made it a good material for casting it into any shape and it was being marketed as a modern substitute for stone.

Concrete elements such as railings, signboards, *jails*, *chhajjas*, balusters, were being manufactured at small scale through local cottage industries. The production of concrete ornamental elements had entered the realm of indigenous craft. In its small-scale production concrete was seen as a *Swadeshi* material, which made its inclusion possible into the All India Khadi and Swadeshi

Exhibitions (Figure 2.16 and Figure 2.17) and Mysore *Dasara* Exhibition. (Figure 2.18) Concrete was exhibited in the same category as *khadi*. In Figure 2.17 we see a photograph of the All India Khadi Exhibition at Nellore with a photograph of the ACC agent dressed in a *khadi* cap (known as *Gandhi topi*) standing next to his display of concrete elements. *Khadi* and concrete were coalesced in the realm of *Swadeshi* as indigenous objects.

Scholars of *Swadeshi* have argued that territorially bounded production was definitive of *Swadeshi*.⁴⁴ I propose that by the late 1930s, concrete was made *Swadeshi* not only through its territorially bounded small scale local manufacture, but also by means of its application to ornamental architectural objects. The taste of ornamentation through which these objects were realized made them distinctly Indian and therefore, national. These objects were imagined as Indian, not only through production, but also through their taste. Refashioning aesthetics and exercising choice through taste in consumption also defined *Swadeshi* as much as territorially bounded production.

The repertoire of indigenous *Swadeshi* materials was fast expanding to include modern materials such cement, steel, and concrete. Several *Swadeshi* construction materials and technologies, such as the use of local granite, local timber, terra cotta tiles, and lime, are now regarded as appropriate technologies for Bangalore.⁴⁵ After independence, brick and RCC construction became the

⁴⁴ Trivedi, *Clothing Gandhi's Nation Homespun and Modern India*. and Goswami, *Producing India: From Colonial Economy to National Space*.

⁴⁵ Harrison and Sinha, "A Study of Alternative Building Materials and Technologies for Housing in Bangalore, India."

norm and displaced these eco-friendly technologies, which were widely applied during Koenigsberger's tenure in Mysore.

Architecture and Nationalism: Style and Taste

Beyond the regulation of building materials and construction technologies, the Mysore government also controlled architectural production through its iconographic content. The Mysore government deployed beauty as a nation-building strategy in the sphere of architecture to construct Mysorean identity by monitoring architectural taste. Historians of Bangalore have noted that the drive to construct Bangalore physically as a site of natural and architectural beauty called "Garden City" intensified after the Silver Jubilee celebrations of the rule of Maharajah Krishnaraja Wodeyar IV on September 7, 1927.⁴⁶ I propose that the ideological efforts to beautify Bangalore architecturally were driven by Mysorean nationalism. Bangalore was imagined as beautiful garden city that represented the Mysore nation. Following the Silver Jubilee celebrations, a number of monumental buildings were erected in Bangalore through the collaborative alliances between the government and the elite.⁴⁷

Bangalore was divided into two cities: the Civil and Military station (C&M station) or the cantonment, which was under British administration, and the Bangalore city (or just the "city" or *pettah* or Bengaluru or native city), which was under princely jurisdiction.⁴⁸ These two cities, the European and native city, had

⁴⁶ M. Fazlul Hasan, *Bangalore through the Centuries* (Bangalore: Historical Publications, 1970), 211-221.

⁴⁷ *Ibid.*

⁴⁸ Janaki Nair, *The Promise of the Metropolis: Bangalore's Twentieth Century* (New Delhi; New York: Oxford University Press, 2005).

separate municipalities. The C&M station was abundant with colonial formations of architecture in Neo-Classical and Gothic styles, the most celebrated type of which was the Bungalow.⁴⁹ For the princely institutional buildings in the city, the Mysore regime chose eclectic Europeanate styles.

In Indian colonial historiography, British architecture in India is stylistically pedigreed as Greco-Roman, Gothic, or Indo-Saracenic. The stylistic debates over colonial architecture in India were polarized between the imperialists, who believed that British architecture in India should embody British-ness, and the nativists, who believed in the revival of Indian historic architecture through the eclectic Indo-Saracenic style.⁵⁰ The British prescribed Indo-Saracenic style for princely buildings, but my research suggests that Mysore did not really follow the British architectural prescription.

By the 1920s, the Mysore government had already recruited Indian and German architects and was avoiding using the services of British architects. The regime deployed both eclectic Europeanate and Indo-Saracenic styles, though the former was used more than the latter. Their ideological drive to keep the PWD comprised of Indian Engineers indicates that the regime exercised a fair degree of autonomy in the field of architecture. For example, the Municipal Office or Corporation Building in Bangalore (1933-36, see Figure 2.10) was built in an Indo-Saracenic style, while the Puttanna Chetty Town Hall (1935, see Figure 2.19) located close to the Corporation Building was built in a Greco-Roman style.

⁴⁹ Janet Pott, Elizabeth Staley, and Romola Chatterjee, *Old Bungalows in Bangalore, South India* (London: Pott, 1977).

⁵⁰ Philip Davies, *Splendours of the Raj: British Architecture in India, 1660-1947* (London: Penguin Books, 1987), Thomas R. Metcalf, *An Imperial Vision: Indian Architecture and Britain's Raj* (Berkeley: University of California Press, 1989).

The Corporation Building and the Town Hall were designed around the same time, both by the Indian architect Lakshminarasappa, but in completely different styles. The historiographic idea that the British prescribed Indo-Saracenic as a princely style for public buildings does not explain why the Mysore *Durbar* commissioned two public buildings in close proximity by the same architect but in different styles. The meanings of Europeanate and Indo-Saracenic styles constructed through colonial historiography are inadequate to explain the architectural endeavors of Mysore state.

If the regime built with Neo-Classical and Indo-Saracenic styles, both of which are colonial, then how could the princely regime lay its claim to an “indigenous” architecture? I propose that for the government of Mysore, stylistic authenticity or inventing a new style for Mysore was not as important as architectural autonomy. The fact that the Mysore PWD could master modern technology, Europeanate styles, and make technically sound buildings without British architects was important for the regime in asserting its autonomy. Just as the British architects felt a sense of power by mastering indigenous styles to produce Indo-Saracenic buildings, Mysore engineers felt empowered through mastering and transforming Europeanate styles.

I propose that in this cultural sphere, the princely regime imagined the Mysore nation through architectural and urban aesthetics. Therefore, the discursive category of taste was operative in the imagination of nation. The category of style is inadequate to understand the relationship between architecture and nationalism. As I proposed earlier, the Mysore nation was

imagined within an autonomous cultural sphere, thus for Mysore, the ability to exercise aesthetic choice from the palette of available styles through taste was a means of asserting cultural autonomy.

The nationalistic debates in Mysore were not over any particular style, but over the seemingly extravagant and monumental taste of the regime. The prime ministers of Mysore, *Dewan Visveswaraya* and *Dewan Mirza Ismail*, were concerned with making Bangalore and Mysore beautiful. Ismail Mirza did not have a stylistic preference, but he associated domes, clock towers, and axial symmetry with beauty through his taste.

So why was taste a matter of national concern?⁵¹ The literature on politics in princely Mysore suggests that there existed competing nationalisms: the regional nationalism of the Maharajah's government and an emerging elite class, which I will call "Mysore nationalism", and the nationalism of the emergent Congress, which I will call "Indian nationalism".⁵² Princely Mysore wanted to establish a Mysore state as an independent state while the Congress wanted Mysore to merge into the larger Indian nation-state. Architecture and Urbanism were important in the imagination of both of these competing nationalisms. Mysore deployed architecture in not only defining itself as distinct from the British Raj, but also from Indian nationalism. The imagination of the Mysore nation was contested between Mysore nationalism and Indian nationalism.

⁵¹ My understating of taste and nationalism is informed by Leora Auslander, *Taste and Power Furnishing Modern France*, Studies on the History of Society and Culture ; 24 (Berkeley: University of California Press, 1996).

⁵² Hettne, *The Political Economy of Indirect Rule: Mysore 1881-1947*.

Architecture and Urbanism were important sites of nationalistic ideological endeavors where Mysore was imagined through refashioning of architectural taste, technologies, and material practices. The nationalistic project of casting state buildings as *indigenously* Mysorean included contradictory methods, such as the state's promotion of an eclectic architectural aesthetic including clock towers and revivalist temple elements; the employment of German architects; and indigenizing modern materials such as concrete. Indigenous architecture was a modern ideological cultural project that comprised constructing indigeneity.

The Congress Party representatives criticized the Mysore government's extravagant building program and expenditure on urban beautification. The Congress opposed the princely state's suppression of mass movements, student unrest, and labor movements; it denounced princely Mysore's nation-building program of urban beautification through parks and grandiose buildings as superfluous expenditure at the cost of providing basic amenities to the poor. Congressperson K. T. Bhashyam criticized the princely regime's extravagant architecture, noting that:

Though the cities of Bangalore and Mysore and certainly beauty spots like Brindavana and Chamundi Hills, the few tarred roads and parks, the profusion of electric lights in the two cities, and the huge piles of buildings attractively colored, lend an enchantment to the view the casual visitor and impress him with a sense of prosperity in the State, the naked truth is that the people are utterly poor, indebted, ignorant, helpless prey to famine and disease, living in huts and dilapidated homes amidst unsanitary surroundings, and always on the verge of starvation! A visit to any village will convince you of this. And there are more than twelve thousand villages in which nearly 85 per cent of the population live! They are a contrast to the

extravagance of the cities, most of which are financed by a ruinous policy of borrowing.⁵³

Architectural taste was contested for reasons beyond aesthetic preferences. In condemning princely Mysore's architectural and urban taste, the Congress attacked the princely regime's autocratic mode of governance; its collaborative alliances with both the British and the elite classes of Mysore; and its suppression of democracy. The state buildings of the princely regime were realized through philanthropic alliances between the Maharajah's government and elite of Mysore, who aspired to establish Mysore as an autonomous princely state. A moral critique of the architectural taste in Mysore and Bangalore was directed at the regime's imagination of Mysore as a nation deeply fissured by class inequities.

In criticizing Mysore's nation building through architectural beauty, the Congress voiced the concerns of the people who felt excluded by the bourgeoisie nationalism of Mysore. Not all Mysoreans imagined Mysore through beauty and the regime's architectural program. For example, in 1943, the residents of Hassan town protested against granting of plot of land and license to construct a Third cinema for the town of Hassan. In a petition to the Minister of the Local Self Government, they wrote:

In these hard days, when people have no food to eat and when the price of every article has gone up, it is very unwise on the part of the municipal council to allow for the construction of a third cinema theatre at Hassan.⁵⁴

⁵³ K. T. Bhashyam, *How Mysore Won a Responsible Government: Being a True Record of the Efforts of the People of Mysore over a Period of 17 Years (1930-1947) to Reach the Goal of Political Freedom* (Bangalore: S. N. Gupta Kataka Advertizing Agency, 1951).

⁵⁴ Petition from H. S. Venkatachala Setty and Other Residents of Hassan Town to H. B. Gundappa Gowda, Minister Local Self Government and Public Health, Construction of Third

The weekly newspaper *Rationalist* often critiqued the regime's extravagant architectural ambitions. In a report on hospital patients being robbed, while they were admitted in the Sri Cheluvamba and Sri Krishnarajendra Hospitals, the *Rationalist* reported:

In the Railways however it is different. Pilfering of parcels and goods is a matter of routine, and is rousing considerable public disgust. But that our hospitals, with their inviting outsides, with their glazed tiles, polished handles, and bleached robes, should give rise to such complaints is unbearable.⁵⁵

The *Rationalist* did not overtly criticize the government's penchant for beauty. Implicit in its sarcastic reportage of the glossy finishes of the hospital, contrasted with petty thefts, is the censure that while the government was keen to spend on magnificent buildings, it was not cognizant of a class of people who were economically depressed. I speculate that the Congress built their criticism of Mysore's beauty on these sentiments.

In a sarcastic rebuttal to the Congress' criticism of Mysore's beauty, Mirza Ismail responded by ridiculing their insensitivity to beauty and their lack of taste. He retorted:

A prominent politician from Bombay visited Bangalore and Mysore during a Congress non-cooperation agitation and gave us much trouble. He excited the students and others to such an extent that the police had to open fire to control the unruly crowds. He criticized in the strongest possible terms, everything the Government of Mysore did....The visitor did not like Mysore City – its beauty and its cleanliness, its parks and its lights. They seemed to have offended his eye. Nor was he pleased with the sight

Cinema Theatre in Hassan Town, Aug. 5, 1943, File No. 197-43, S. No. 112, GOM Municipal, KSA, Bangalore, Karnataka.

⁵⁵ Editor, "Sri Cheluvamba and Sri Krishnarajendra Hospitals," *Rationalist* June 26, 1942.

of the vast crowd gathered for the *Dasara* festival. They appeared to him hungry: the Government could not feed them on beauty'.⁵⁶

Mirza Ismail viewed urban cleanliness, beauty, and parks as issues of Mysorean national importance, which were crucial in the self-definition of Mysore as a nation and in fashioning responsible citizenship. Ismail despised the idea of the integration of Mysore into the Indian nation. In criticizing the Congress representative's lack of appreciation of architectural taste, Ismail obliquely pointed at the infringement of the "outsider" from Bombay who simply did not understand Mysorean aesthetics and accomplishments. The lack of taste of the Congress representative deemed him ineligible to imagine Mysore as a nation.

Despite his taste for Europeanate classical forms, Ismail unwittingly recruited the German modernist architect Otto Koenigsberger, who would later be deeply critical of Ismail's taste and skeptical of nationalism. Prior to working together, neither the Maharajah's government nor Koenigsberger had any foresight of how incompatible their architectural taste and ideological tendencies would be. Koenigsberger, persecuted by the nationalism of the National Socialist Party in Germany, had emigrated from a context where nationalism was a xenophobic phenomenon to being the chief architect in the service of the Maharajah of Mysore, whose regime was engaged in deploying nationalism as a form of resistance against colonialism. Disenfranchised by nationalism, Koenigsberger saw himself as a politically disengaged émigré yet found himself as an architect in exile in the service of nation building for the Maharajah of

⁵⁶ Sir Mirza Ismail, "Chapter V: Amenities in Town and Country," in *My Public Life: Recollections and Reflections* (London: George Allen and Unwin Ltd., 1954), 48-57.

Mysore. Koenigsberger's situation in exile in Mysore is best represented through his photograph with the Maharaja in which everyone, except Koenigsberger who stands erect, is acknowledging the presence of the Maharaja through an obeisant gesture. (Figure 2.20)

Koenigsberger's Response to Mysore

How did Koenigsberger's architectural ideas change in Mysore? How did Koenigsberger interpret Mysore's architectural needs? How did Koenigsberger, with his conscious cosmopolitan identity in exile, negotiate the ideological architectural program of Mysore given his disbelief in nationalism? The two most significant problems that Koenigsberger faced in India were the aesthetic mandate of the Mysore regime and the limitations of building materials and energy, especially the shortage of modern building materials such as cement, steel, and glass. While the conflicts over architectural taste directly impacted Koenigsberger's self-definition as a Modernist architect, the limitations of materials and energy were easy for him to overcome. These two problems were to define Koenigsberger's work in Mysore.

. I propose that Koenigsberger's experience in India sensitized him to the limits of energy and resources, in a way that was not possible in Germany. His modernist training equipped him to define the Mysore architectural program in terms of energy and resource consumption. His ideas developed in response to the *Swadeshi* drive to use local construction materials, limited resources, and passive technologies. This was to later inform Tropical Architecture, a discourse solely predicated upon energy and resource consumption. While Modernism had

the seeds to address energy and resource limitations as programmatic requirements, it is not until the development of Sustainable Architecture that Western Modernism became a discourse centered around energy and resource conservation. It is only when modernist architects such as Koenigsberger confronted colonial cultures in India and Africa, that they began to theorize Tropical Architecture solely in terms of energy and resources.

In the subsequent sections, I will demonstrate how the two factors of conflicts over taste and the limits of resources resulted in his theorizing Tropical Architecture in London. Since I am most concerned with the interaction between Mirza Ismail and Otto Koenigsberger, I will focus here on Ismail's architectural taste. The Maharajah's government and Koenigsberger had completely different visions of what architecture ought to be. Mirza Ismail might have recruited Koenigsberger to cut down costs due to ill-planned buildings, but Ismail did not hesitate to spend on clock towers, domes, and other ornamental features, which Koenigsberger abhorred.

All buildings constructed by the Mysore PWD for the regime had to be aesthetically approved by the *Dewan's* office, therefore Ismail's architectural taste played a significant role in Koenigsberger's work. Ismail regarded monumentality, axiality, domes, and clock towers constitutive of architectural beauty, as is evident from Koenigsberger's notes in portfolio.⁵⁷ For Ismail, the ideal beautiful building was a structure with a tripartite symmetrical elevation with the central section of the elevation raised and emphasized through a dome and/or a clock tower. For example, in the Serum Institute in Hebbal, on the

⁵⁷ Otto Koenigsberger, Portfolio: Serum Institute Mysore, OKPP, London.

outskirts of Bangalore, (Figure 2.22) Ismail instructed Koenigsberger to make the building symmetrical and reinforce the axiality by elevating the ventilators. (Figure 2.22) Koenigsberger resented the interference by Ismail, yet conformed to Ismail's taste.

The Boys High School at Malleswaram (Figure 2.21) is a perfect example of what Ismail endorsed. This was one of the first buildings finished under Koenigsberger's tenure as the chief architect of the PWD in 1939. I speculate that Koenigsberger executed this building based on PWD-type designs but that he did not design the building.

Ismail liked the building to have a pronounced sense of entry through a projecting porch. For him, architectural beauty was expressed through the volumetric and spatial organization of the plan and elevation along axial symmetry. Ismail was less concerned with decorative details such as friezes, architraves, brackets, cornices which made buildings ornate, rather he was more occupied with clock towers and domes. For example in the bus station at Kalasapalyam in Bangalore, Koenigsberger used minimal surface ornament

Officially, Koenigsberger often used rational arguments like cutting down cost, better construction techniques, climate responsiveness, and functionalism to justify his modernist architectural taste rather than contest the *Dewan's* taste. Unofficially, Koenigsberger cringed at the bad taste of the princely regime, which offended his modernist sensibilities. Although Koenigsberger left no evidence of condemning Mysorean nationalism, I conclude that his intense dislike for the Mysore's state-sponsored taste originated from his cynicism about nationalism.

However, Koenigsberger accepted the *Swadeshi* nationalistic drive to use local materials and technologies as a rational solution to building in Mysore.

Koenigsberger's buildings in exile in Mysore reflect tensions over taste, nationalism, and his intellectual journey of confronting a different milieu. He stripped the demands of the Mysorean architectural program of its ideological underpinnings. I interpret Koenigsberger's frequent complaints about the architectural taste of the regime as not *mere* differences over taste, but tied to tensions over nationalism, indigeneity, and cosmopolitanism. Koenigsberger occupied an ambiguous position with respect to the state's architectural program of nation building; he saw himself as a cosmopolitan, stateless, and nationless architect in exile in Mysore, which was a modernizing not-quite-a-state and not-quite-a-colony in the process of becoming a nation-state. Yet Mysore had not entered the global economy of Modern architecture where steel, glass, concrete, and energy were freely available.

I propose that Koenigsberger's work in exile in India exposed him to the limits of energy and resources. There is no single building in India that completely sums up all aspects of his experience in India, so I have chosen to reflect upon a series of buildings to locate the genealogy of the various tenets of Tropical Architecture canon at the Architectural Association in London. While in India, Koenigsberger learnt and theorized the use of passive technologies, local materials, local construction techniques, and the lack of industrialized methods of architectural production (which had been superseded in Germany). He saw the limitations of resources and energy, as well as the *Swadeshi* imperative to use

local materials, as “design” problems and not as political problems. While he understood, learned, and embraced the logic of maximizing the use of local materials and construction technologies, he resented the Mysore government’s ideologically motivated architectural taste. He stripped indigenuity of its ideological program and theorized it as a regional architectural programmatic requirement.

The abundance of energy and modern materials such as steel, glass, and concrete that Koenigsberger had taken for granted in Berlin was completely reversed in Mysore. In terms of architectural practice, Koenigsberger interpreted the differences between Mysore and Berlin as designing for a different climate, maximizing the use of resources, using a restricted palette of materials, the unavailability of mechanical conditioning, and the adaptation of indigenous construction techniques.

I infer that the most significant change in his thinking was the cognizance of the limits of resources and how architecture could contribute to equity in consumption. He learned and theorized how buildings could be made with restricted resources. In noting the transformations in his practice from Berlin to Mysore, the most important change that occurred in his buildings was the adaptation of climate-responsive design through outdoor living spaces, indigenous construction technologies, passive conditioning, and renewable sources of energy. Here it is important to mention that Mysore and Bangalore enjoyed mild climates, and therefore one might argue that designing climate-responsive buildings would be easy in these two cities. I propose that even though these two cities had mild climates, designing in these cities exposed

Koenigsberger conceptually to architectural design without mechanical conditioning. Later, in London, Koenigsberger would theorize Tropical Architecture around these ideas.

To understand how Koenigsberger's architectural ideas were transformed in Mysore, I would like to compare the Berlin Zoo Project to his work in India. The Berlin Zoo was an inbuilt project for which Koenigsberger won the Schinkel Prize in 1933. Koenigsberger was trained within German Modernist paradigm of functionalism and rationalism. I define functionalism as a modernist design philosophy that defined the generation of architectural form strictly through the given programmatic requirements. Rationalism, in the context of functionalism, meant that the architectural form was generated through the architectural requirements strictly through reason.

The Berlin Zoo: Unbuilt 1933

In 1933, while Koenigsberger worked for Ernst May, he prepared plans for the Berlin Zoo and won the Schinkel Prize for his design. This is glass and timber building, where Koenigsberger paid attention to energy efficiency by using double glazed windows. (Figure 2.26) Compared to his subsequent buildings in India, this building relied on mechanical conditioning and industrial materials that were readily available. Efficiency, rationalism, and functionalism were embodied in this project. However, when Koenigsberger arrived in India and began working in a context where modern materials and energy were scarce, his notion of efficiency of resources and materials was pushed to new limits.

Ideas about efficiency were not new to Koenigsberger. Ernst May's office had mastered efficiency in construction and planning in the low cost row housing in the various Seiddlungen executed by May's office between 1925 and 1933. The housing in Siedlung Westhausen in Frankfurt pushed the limits of established norms of space to establish new models of dwelling design.⁵⁸ The fact that Koenigsberger readily adapted himself to design for energy and resource maximization is not surprising, however what Koenigsberger might have considered efficient and low-cost in Germany was unaffordable by the masses in India.

Outdoor Living: Pavilions for the Malleswaram School, Bangalore, 1939

One of Koenigsberger's first assignments for the Mysore government was the design of two *tiffin mantaps* (lunch pavilions) at the entrance of a school. (Figure 2.28 and Figure 2.29) The main school building based on the PWD-type design was executed under Koenigsberger's supervision, which he represented as the background in his sketches. The fact that he included pavilions in his portfolio, which is part of his archive, meant that he thought it was worthy of showing to people and that he could claim authorship for the pavilions' design. Koenigsberger called it the "propylon" for the Malleswaram High School. (Figure 2.27) The quotation marks around propylon (which are original to Koenigsberger's portfolio) I interpret as his discontent with the enforced monumental taste of the regime. Having satisfied their requirements of axiality, symmetry, and monumentality, he could design the pavilion details to his taste.

⁵⁸ See Barbara Miller Lane, *Architecture and Politics in Germany, 1918-1945*. (Cambridge, Mass.: Harvard University Press, 1968) 87-124

He used plain granite columns in rough masonry, RCC roof, and steel trellis with an abstract square pattern.

The significance of this project in Koenigsberger's career is that he learned that semi-enclosed spaces with minimal "shelter" could be built with limited resources without air conditioning and artificial lighting. Koenigsberger would theorize this later at the Tropical Architecture conference in London in 1954.⁵⁹ He proposed that planners and architects could build a lot less in tropical climates and continue existing traditions of outdoor living, thus saving on building resources and energy.

Rational Versus National, Shimoga College, Shimoga, 1940.

In 1939, the Shimoga Intermediate College was one of the buildings where Koenigsberger negotiated his architectural taste and preferences through the logic of reducing construction costs. The PWD originally intended to copy the plans of the Intermediate College of Mysore, also known Maharajah's College, to build the new Shimoga College. Koenigsberger proposed that he could prepare new designs for the Shimoga College that would reduce construction expenditure.⁶⁰ Ironically, in Koenigsberger's memo to the government about the Shimoga College, the word "rationalizations" got mistyped as "nationalizations", which Koenigsberger promptly corrected. (Figure 2.31)

⁵⁹ Otto H. Koenigsberger, "Tropical Planning Problems," in *Conference on Tropical Architecture 1953. A Report on the Proceedings of the Conference Held at University College, London, March, 1953*, ed. Arthur M. Foyle (London: G. Allen & Unwin, 1954), 13-20.

⁶⁰ Otto Koenigsberger, Government Architect in Mysore, Bangalore, to the General Secretary to the Government of Mysore, Construction of the Building for Locating the Intermediate College at Shimoga Together with the Estimate, December 5, 1939, File No. 221-39, S. No.1,2,4,8, GOM Education, KSA, Bangalore, Karnataka.

The Shimoga College building is made of exposed granite masonry. The PWD operated through standardized designs for each building type. The Shimoga College plan is based on the PWD's arcaded building type planned around a courtyard. (Figure 2.30) The arcades served as transitional spaces between the inside and outside and as outdoor social spaces. The arches also spanned the colonnade without the use of concrete lintels. (Figure 2.32) The arcaded courtyard plan was used for most public buildings, and it was a climatically and culturally appropriate plan. While Koenigsberger had aesthetic reservations about the axial symmetry, arcaded verandahs, Mangalore tile roofs, clock towers, and porticos, he eventually learnt to appreciate the climatic and cultural common sense of verandah corridors and porticoes.

In plan, the Shimoga College (Figure 2.34) was not different from the Maharaja's College in Mysore (Figure 2.33) as a building type. The superstructure differed insofar as the Shimoga College elevations were quite stark through the minimal use of decorative elements, which Koenigsberger regarded as superfluous costs. He stripped the Shimoga College (Figure 2.35) building of all ornament by eliminating decorative elements like impost moldings, mansard roofs, and pilaster capitals, which made the Mysore College ornate. (Figure 2.36) The Maharaja's College was plastered, while the Shimoga College was finished with exposed granite masonry. The lack of ornament satisfied Koenigsberger's taste to some extent, and cut down costs, which pleased the regime.

Both the Mysore College and the Shimoga College were monumental buildings marked by axial symmetry, much to Koenigsberger's anguish. In a letter to his mother, he wrote:

Of course some of my Mysore buildings are modern too, but that applies to only to the smaller ones. In all large schemes the desire of all concerned is to be "monumental" to boast with domes and porticoes, in short: 'to get something for their money' has been stronger than my simple puritanical taste. I do not think that my Intermediate College in Shimoga or my design for the High Court are bad designs. But they are old-fashioned in their conceptions that it is not worthwhile showing them to anybody who knows the subject. They will be useful for my reputation (it is always good if you can show people what huge buildings you have constructed) but they will be nothing I can be really proud of.⁶¹

Koenigsberger dismissed the Shimoga College as a building he was not keen to claim authorship of. He did so by not including the building in his portfolio, which is now part of his archive in London. But the Shimoga College and Malleswaram School served as pedagogic design exercises that indoctrinated him in what was climatically, materially, and culturally appropriate in Bangalore and Shimoga. The Shimoga College and Malleswaram School buildings continue to be used today without air conditioning or artificial lighting during the daytime.

Mysore Engineers' Association, Bangalore, 1940: Coming to Terms with Porticos

In smaller projects such as the Mysore Engineer's Association (MEA) building, Koenigsberger had a little more control over the aesthetics of the building. There is no written memoir about the MEA, but the absence of a dome and a clock tower reflect more of Koenigsberger's preferences than Ismail's.

⁶¹ Otto Koenigsberger, Letter to His Mother from Mysore, OKPP, London.

The MEA building comprises a small lecture hall with a collection of books for reference. It served as a space for lectures and scholarly discussions amongst engineers. It's a single block building, on a small scale without a courtyard. It is a rectangular in plan, with rounded corners and a portico on the front side of the building. (Figure 2.38)

In the existing Europeanate and Indo-Saracenic buildings in Mysore, the portico projected out of the main elevational plane of building, rested on columns, created a plane beyond main elevational plane, therefore reinforcing the monumentality, frontality, and a tripartite symmetrical elevation. The portico was axially aligned with the clock tower and dome of the building, which made it further undesirable for Koenigsberger. The possible solutions to avoid the neo-classical aesthetic enforced by the portico are to get rid of the portico, embed the portico within the building, or cantilever the portico.

Koenigsberger liked to maintain a clean geometric footprint of the building in plan without monumental projecting porticos, which enforced a tripartite symmetry. However much he may disliked porticos earlier, he began to realize the transitional function of the portico in the climate of Bangalore and the outdoor social life which the portico made possible.

The MEA building has a portico (Figure 2.40) embedded in the geometry of the footprint and the mass of the building, rather than a structure which projects from the footprint of the building. (Figure 2.38) It's a symmetrical building with curved building corners and *chajjas* (sunshades). (Figure 2.41) The building

is built with granite masonry, with stone columns, lintels, and mullions; RCC *chajjas*; and cement ventilators. (Figure 2.39)

With smaller buildings like the MEA, Koenigsberger began to experiment with the design of spaces like the portico, which he regarded as old-fashioned relics of colonial architecture.⁶² He believed that although verandahs offered protection from sun and rain, having verandahs on both sides of the building reduced the illumination levels inside the building.⁶³ The MEA building and subsequent PWD buildings in Mysore were to serve as design exercises for Koenigsberger to come to terms with a different palette of architectural elements like verandahs, porticos, courtyards, and *chajjas*, which he would eventually learn to work with.

Mysore Broadcasting House, Mysore, 1942: The Limits of Energy

In the Mysore Broadcasting House building, now the All India Radio (AIR) Building at Mysore, Koenigsberger had freer reign. (Figure 2.42) He was under no pressure to add domes or clock towers because this was a highly technical building. In an article on the Broadcasting House building at Mysore, Koenigsberger wrote how he derived the form of the building purely from the functional requirements.⁶⁴ Even though Mysore has a pleasant climate, the contradictory requirements of acoustics and thermal comfort posed a challenge for Koenigsberger. Acoustics demanded a hermetically sealed building, but

⁶² Otto H. Koenigsberger, "Master Plan for the New Capital of Orissa at Bhubaneswar," (Bhubaneswar: Government of Orissa, 1948).

⁶³ Ibid.

⁶⁴ O. H. Koenigsberger, "The New Studios of the Mysore Broadcasting House at Mysore," *Electrotechnics* 15 and 16 (Sept. 1943): 45-49.

thermal comfort demanded the opening of windows in the studios or the installation of air conditioning. However, due to cost and energy constraints, the building could not be air-conditioned.

Koenigsberger was impelled to theorize climate-responsive design through the use passive techniques, which became to be known as naturally conditioned in the discourse of Tropical Architecture. He devised a method by which the building would be ventilated during the hours when the studio was off air. (Figure 2.43)The studio has double glazed ventilators placed at high level, yet accessible by attendants. The shutters were opened when the studio was off air, but closed for the brief time that the studio went on air.

He recorded his AIR project as an example of how architectural form ought to be generated strictly through the functions of the program and for no external reasons. Between the lines, the article implied that domes and clock towers were uncalled for. Without any overt criticism of Ismail's architectural mandate, Koenigsberger clearly articulated his problem with the Mysore regime's architectural taste. This project furthered Koenigsberger's interest in theorizing climate-responsive architecture as a balancing act between contradictory requirements of competing building services through passive technologies using renewable sources of energy such as wind and natural light.

To use passive techniques in order to design for conflicting requirements, like letting in breeze without letting in excessive light, would be a recurring theme in the discourse of Tropical Architecture later in London. This kind of contradiction frequently constituted studio design problems at the AA later. After

his experience in India, Koenigsberger would practice universal energy conservation as a principle, not just as a specific design requirement. Even in places where energy was abundant and cheap, he always recommended passive design techniques to conserve energy.

Victory Hall, Bangalore, 1944-45: The Limits of Resources

In 1941, Mirza Ismail resigned after the death of the Maharaja Krishnaraja Wodeyar. Upon Ismail's resignation, Koenigsberger had mixed feelings, which he expressed to his mother in a letter:

Sir Mirza's resignation means a good deal for me and for the whole State. He was the Dewan and that meant nearly Dictator – for 15 years. They were years of an immense activity. He had no sense for regularity of procedure, but he got things done inspite of all red tape. It was also due to him that I had such an enormous amount of work, but also due to his interference that I could never do this work as well as I should have liked to. I liked him personally, but then at the same time I hated his interference with my work. His personal interest gave me greater powers and greater influence than I would have had otherwise, but also much more work than an officer in India normally has.⁶⁵

The new Maharajah, Jayachamaraja Wodeyar, appointed N. Madhav Rao as the *Dewan* from 1941 to 1946. Rao did not interfere with Koenigsberger's work as much as his predecessor, but how did Koenigsberger's work for the Mysore Government change after Ismail's resignation? I use the example of the Victory Hall to illustrate that Koenigsberger still continued to work with conserving resources and energy, but that he resisted the pressure to add clock towers and domes.

⁶⁵ Koenigsberger, Letter to His Mother from Mysore. Otto Koenigsberger, letter to his mother dated May 24, 1941, in *Otto Koenigsberger Private papers* (uncatalogued in the possession of Renate Koenigsberger London, 1941)

In 1945, Koenigsberger designed Victory Hall (now Bal Bhavan) in Cubbon Park. Although Ismail was no longer in power to interfere with the project, the bourgeoisie who funded the Victory Hall seemed upset with Koenigsberger's design. Koenigsberger wrote:

The Victory Hall was one of the not infrequent cases where the success depends on humbleness and where nothing is more harmful than self-assertion on the part of the architect. Restraint of this kind, obviously, need not exclude *originality of artistic* conception, but as a rule it is unpopular with the taxpayer client who wants his money's worth of frills and fireworks. The hall was not a success with the businessmen who had contributed funds for construction and had expected to see something more glamorous.⁶⁶

In the absence of any political pressure, Koenigsberger chose not comply with the taste of the bourgeoisie who funded the project. He explained his design and the generation of form as a response to the shortage of cement and steel. He used local granite masonry for load-bearing walls and used concrete vault shells as roofs over the lobby and the verandahs.⁶⁷ (Figure 2.44) It was possible to construct the shells with a relatively thin section of concrete, saving extensively on both steel and cement. (Figure 2.45) Bowstring girders used to span the roof in the building were more economical than RCC beams. This building, like the Mysore Broadcasting House, works without air conditioning. The doors and windows are closed for the short duration of events, and the building uses artificial light during children's drama, dance, and music performances.

The project also defined Koenigsberger's austere aesthetic taste and identity in opposition to the Mysore bourgeois nationalistic taste. The Victory Hall never made it into any of the architectural histories of Bangalore because these

⁶⁶ Otto Koenigsberger, "The Victory Hall at Bangalore," *Marg* IV, no. 3 (Dipavali 1950): 25-26.

⁶⁷ *Ibid.*

histories are based on Bangalore's identity as a city of monumental and ornamental buildings.

Victory Hall affirms my speculation on how Koenigsberger confronted the relationship between architecture and nationalism with discomfort. The Victory Hall was monument commissioned with memorializing intentions. Yet when Koenigsberger published this project in *MARG* (the journal of the Modern Architects Research Group) as an example how modern buildings could be built in India with minimal resources. He omitted all the overt rhetoric around the memorializing functions of the Victory Hall from his narrative. He felt appropriate to express sensitivity to the physical attributes of the site such as topography and climate, which were outside the discursive sphere of nationalism.

Koenigsberger designed the shells of the Victory Hall to imitate the profile of the eaves of the South Indian temples and their volumetric composition gave the building a boulder like appearance, which imitated the huge granite boulders, which constituted the surrounding landscape.⁶⁸ For Koenigsberger drawing inspiration from the eaves of the South Indian temples was *purely* a formal gesture. I speculate that the profile of the eaves not only helped him establish a formal continuity with the temple, but also satisfied his expressionistic taste for doubly curved architectural surfaces. In establishing historic formal continuity with the temple architecture in Mysore through the eaves, he inadvertently participated in the discourse on nationalism by establishing continuity between a building with memorializing functions and the temples, which were crucial to the self-definition of Mysore as a nation.

⁶⁸ Ibid.

The concrete shells deployed in Victory Hall expanded Koenigsberger's repertoire of Appropriate Technology. Koenigsberger enjoyed the challenge of constructing with a limited palette of local resources and was beginning to theorize his design philosophy in terms of the limits of materials and energy.

Dining Hall at the Indian Institute of Science, Bangalore, 1946

This program of this project demanded a multipurpose building, which could be used as dining hall and as an auditorium. (Figure 2.46) For this project, brick and timber were abundantly and easily available. The challenge for Koenigsberger was design with extremely limited quantities of cement, steel, and glass. He solved the problem by designing timber trusses to construct frame of the auditorium. (Figure 2.47) For the acoustic requirements, Koenigsberger designed a parabolic roof. Koenigsberger designed the Dining Hall without state interference, insofar, as the use of domes, clock towers, axially symmetrical elevations were concerned.⁶⁹ Projects like the dining hall, not only sharpened Koenigsberger's ability to work with local materials and technologies, but also introduced him the need to maximize resource uses by designing multi-purpose buildings. This experience would later inform his thinking on resource conservation in theorizing Tropical Architecture.

Beyond Mysore: Prefabricated Houses, New Delhi, 1949-1951

In 1948, with the formation of the Union of India and independence, Koenigsberger moved to Delhi and accepted the position of the Federal Director

⁶⁹ Otto Koenigsberger, "The Common Dining Hall at the Indian Institute of Science," *The Architectural Forum* 85 (1946).

of Housing in the Department of Health in the Government of India, headed by Nehru. With partition of India, millions of people were displaced and needed urgent housing. As part of the effort to provide affordable homes fast, Koenigsberger proposed prefabricated houses for the partition refugees. Consequently, a housing factory was set up in Jang Pura in New Delhi.

Koenigsberger designed the single family units of these houses. These units were designed as twin units mirrored along a common wall. (Figure 2.50) The units shared a verandah and comprised one bedroom, one living room, with a kitchen and bathroom placed outside. The kitchen was connected to the room by a covered corridor, but to go the toilet, one had to walk through an open yard, as in a bungalow. Koenigsberger had no reservation against maintaining continuity with cultural usage of space in placing the toilet outside.

In terms of production, this project was the complete antithesis of the kind of work Koenigsberger accomplished in Mysore under restrictions of using local materials and technologies. (figure 2.51) Koenigsberger and Nehru shared the dream of industrialized mass production of houses. However, this project failed because the concrete joints made by a Swedish company were ill-adapted to the hot Indian climate. Due to the unavailability of archival evidence, I have unable to get the details of what exactly happened. Koenigsberger resigned from his post as the Federal Director of Housing and came to England in 1951.

The failure of his pre-fabricated housing units had a deep impact on Koenigsberger's thinking about the technological capacities of societies and the extent to which the application of technology is appropriate.

Conclusion

The afterlife of Gandhian *Swadeshi* ideology exists in the environmental discourse not only in India, but globally. Central to Gandhi's vision of *Swadeshi* was the idea of equity, without which sustainability is not viable. The Indian environmental movement attributes its ideological origins to the Gandhian philosophy, and Gandhi's writings have informed Appropriate Technology.

To what extent Gandhi was an environmentalist remains debatable. As Guha points out, Gandhi's lifestyle was a pedagogical model for sustainable living, and his most famous one-liner "The earth provides enough to satisfy every man's need, but not every man's greed" is the perfect aphorism for sustainable development.⁷⁰ Gandhi's imagination of a self-reliant, collectively managed rural life independent of industrialization and global capitalism is the perfect environmentalist utopia. Gandhi's environmentalist critics point out that his writings offer no clue for environmental management of cities and nature reserves.⁷¹

Koenigsberger's career offers the link between the synthesis of *Swadeshi* ideology and Modernist architecture, and how these two discourses informed Tropical Architecture. The milieu in Mysore exposed Koenigsberger to the ideological battles over taste, the tension between cosmopolitanism and indiginity, and the state's *Swadeshi* nation-building architectural project, which enabled him to theorize Tropical Architecture as a rational discourse based on

⁷⁰ Ramachandra Guha and J. Martinez-Alier, "Mahatma Gandhi and the Environmental Movement," in *Varieties of Environmentalism: Essays North and South* (Delhi; New York: Oxford University Press, 1998), 153-168.

⁷¹ *Ibid.*

climate responsiveness. The *Swadeshi* ideology embodied a utopian environmental vision, which made the application of appropriate indigenous construction technologies ideologically driven. The debates on development and industrialization within the context of nationalism were all about the extent of application of technology. Nationalism in Mysore was linked to indigeneity, which translated into the use of indigenous materials and technologies. Koenigsberger saw himself as a cosmopolitan citizen dissociated with nationalism, yet he readily accepted the use indigenous technologies and materials, which were ideologically motivated in Mysore.

In 1951, Koenigsberger emigrated to London and in 1954, he founded the Department of Tropical Architecture at the Architectural Association (AA) School of Architecture. In London, he theorized Tropical Architecture as a design method based on climate responsiveness, indigenous technologies, energy conservation, and local materials. The Mysorean experience had a discursive impact on his architectural thinking, which enabled him to address to developing architecture, which would in turn be theorized as Tropical Architecture in the metropole.

Existing histories locate Tropical Architecture within colonial and post-colonial paradigms, as neo-colonial interventions by British Architects in the tropics.⁷² I depart from these histories by locating the intellectual genealogy of Tropical Architecture in Koenigsberger's Mysorean oeuvre.

⁷² Mark Crinson, *Modern architecture and the end of empire* (Aldershot, England; Burlington, VT: Ashgate, 2003).; Hannah Le Roux, "The networks of tropical architecture," *The Journal of Architecture* Vol. 8, no. 3 (2003): pp337-354.; Ola Uduku, "Modernist architecture and 'the tropical' in West Africa: The tropical architecture movement in West Africa, 1948–1970," *Habitat International* 30 (2006): pp396–411.

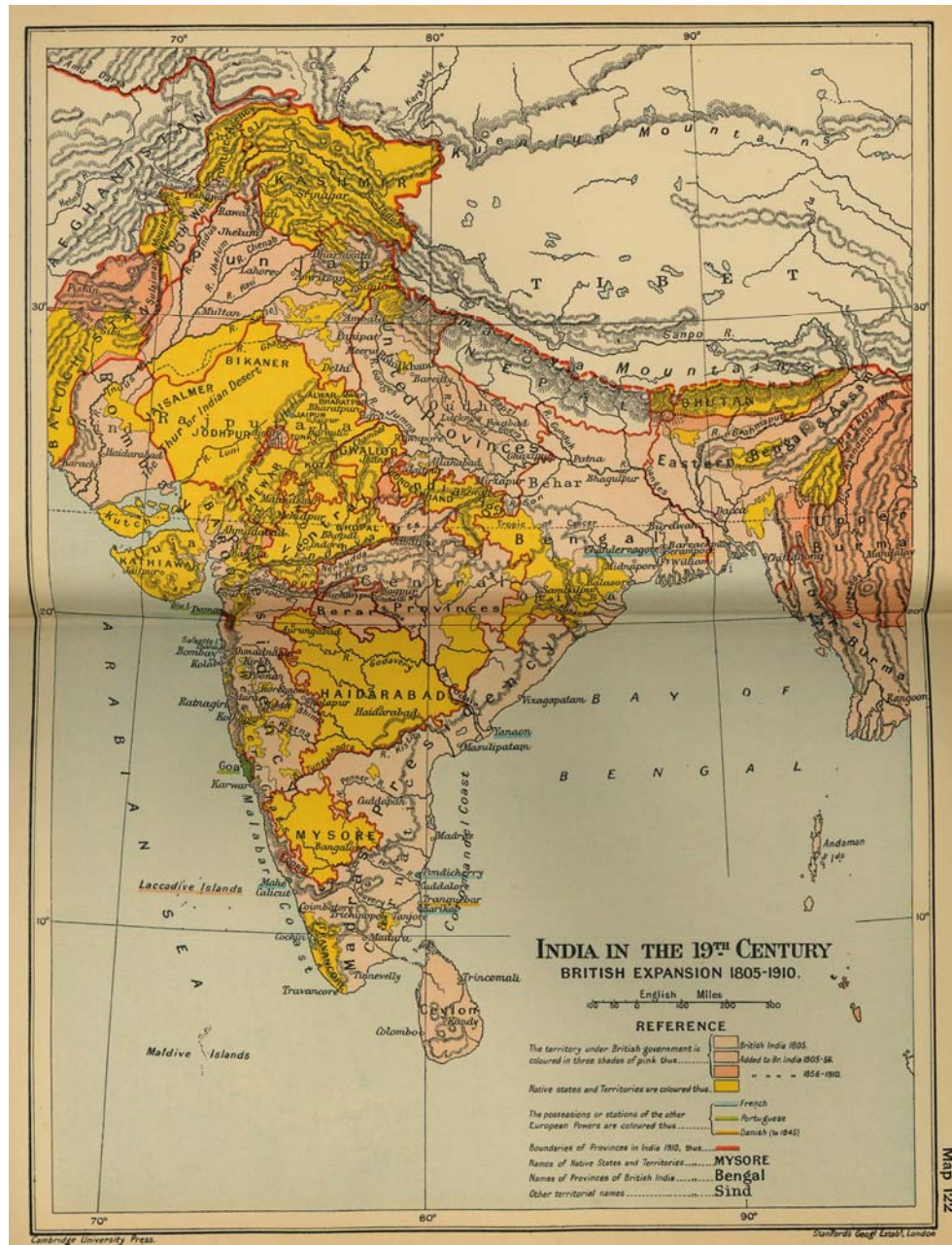

Figure .2.1 India in 1912.

Source: *The Cambridge Modern History Atlas*, Edited by Sir Adolphus William Ward, G.W. Prothero, Sir Stanley Mordaunt Leathes, and E.A. Benians (London: Cambridge University Press, 1912) Digital Source: http://www.Lib.Utexas.Edu/Maps/Historical/Ward_1912/India_British_Expansion_1805.Jpg

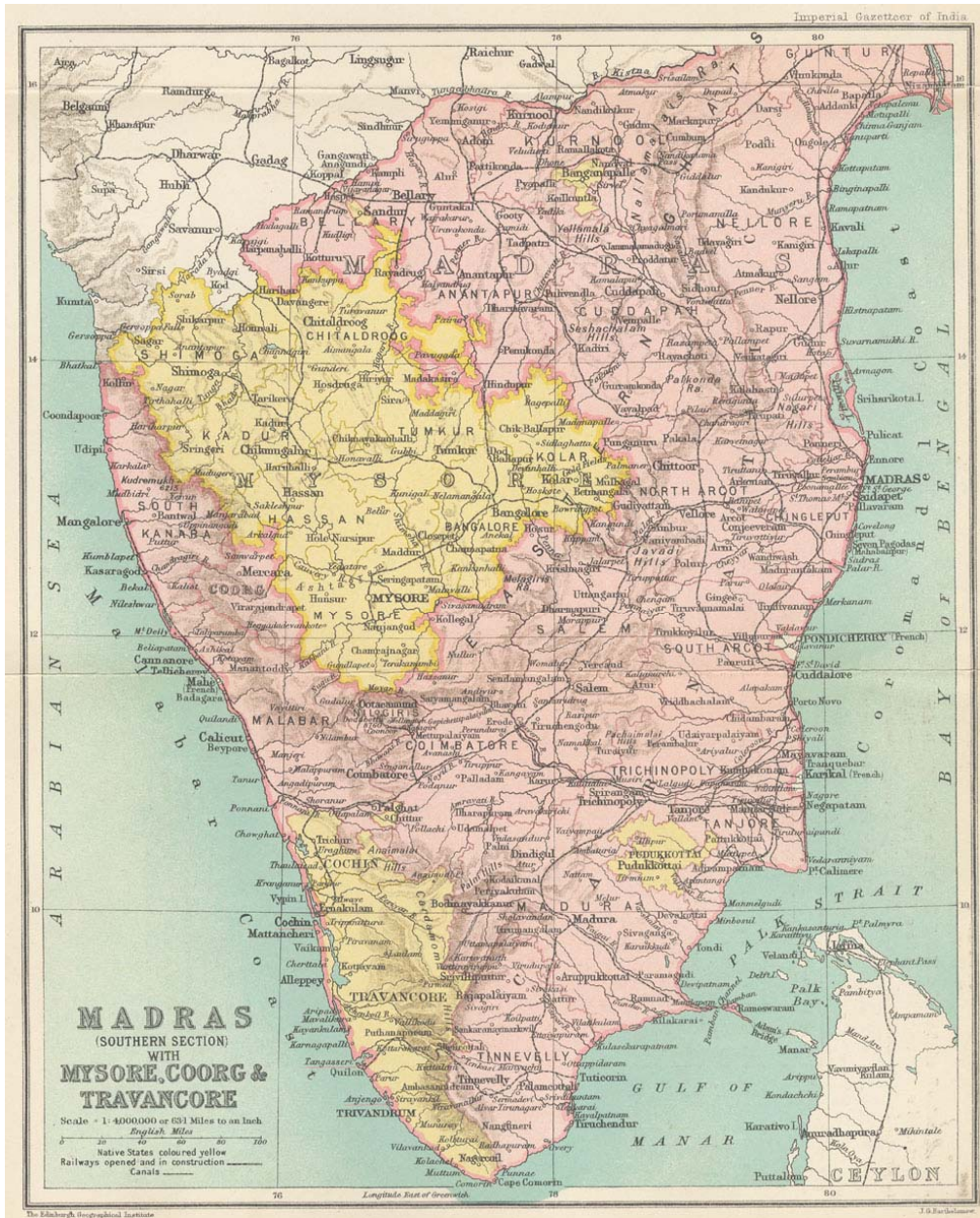

Figure 2.2 The Location of Mysore State in South India.

Source: Bartholomew, J.G. "Madras (Southern Section) with Mysore, Coorg, and Travancore" in the *Imprint: Imperial Gazetteer of India*. New Edition, Published under the Authority of His Majesty's Secretary of State for India in Council. (Oxford: Clarendon Press, 1907-1909.) Volume 18, Opposite Page 250 Digital Source:

http://Dsal.Uchicago.Edu/Maps/Gazetteer/Images/Gazetteer_V18_Pg250.Jpg

MAHARAJA'S OF MYSORE

DEWANS OF MYSORE

Chamaraja Wodeyar 1881-1894	C. V. Rangacharlu 1881-1882
	Sir K. Seshadri Iyer 1883-1901
Krishnaraja Wodeyar 1902-1940	P. N. Krishnamurthi 1901-1906
	V.P. Madhava Rao 1906-1909
	T. Anand Rao 1909-1912
	Sir M. Visvesvaraya 1912-1918
	M. Kantharaja Urs 1918-1922
	Sir Albion Banerjee 1922-1926
	Sir Mirza Ismail 1926-1941
Jayachamraja Wodeyar 1940-1947	N. Madhava Rao 1941-1946
	Sir Arcot Ramaswamy Mudaliar 1946-1949

Table 2-1 Timeline of Maharajahs and *Dewans* of Mysore

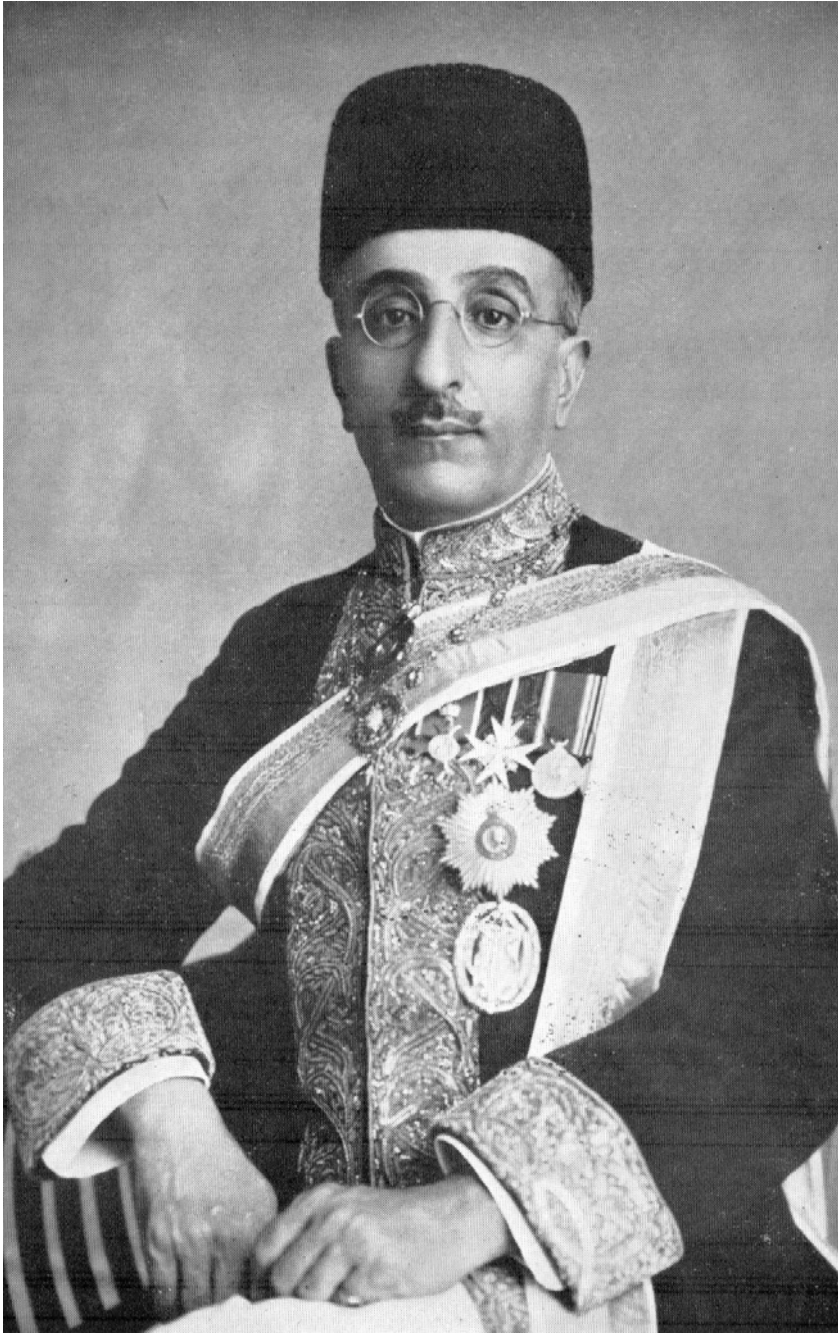

Figure 2.3 Mirza Ismail the Prime Minister of Mysore.

Source: Sir Mirza Ismail, *My Public Life: Recollections and Reflections* (London: George Allen and Unwin Ltd., 1954).



Figure 2.4 Otto Koenigsberger (center) with his colleagues in the PWD, in Mysore 194?

Source: OKPP

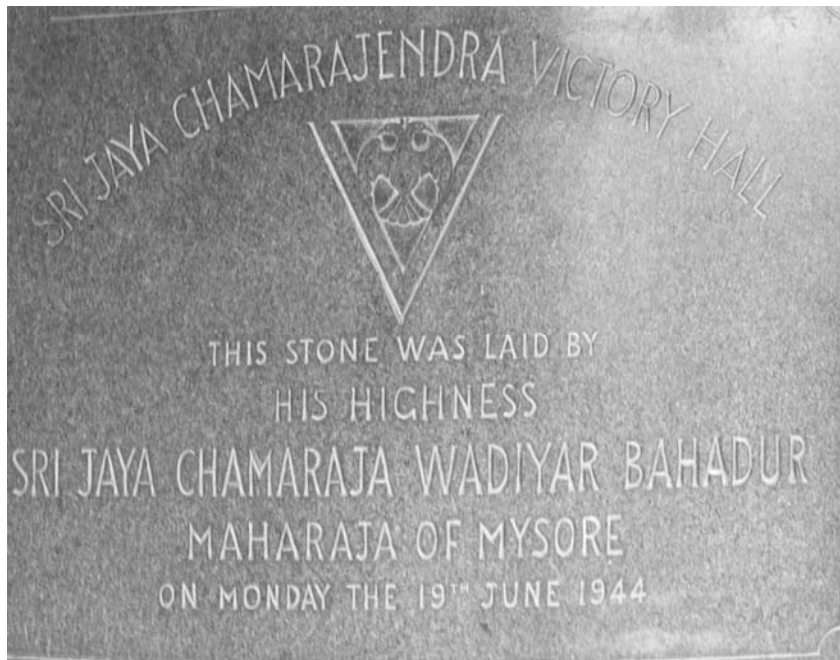

Figure 2.5 The Epigraph for Victory Hall, Bangalore, 1944-45.
Source: Photo by author, 2006.

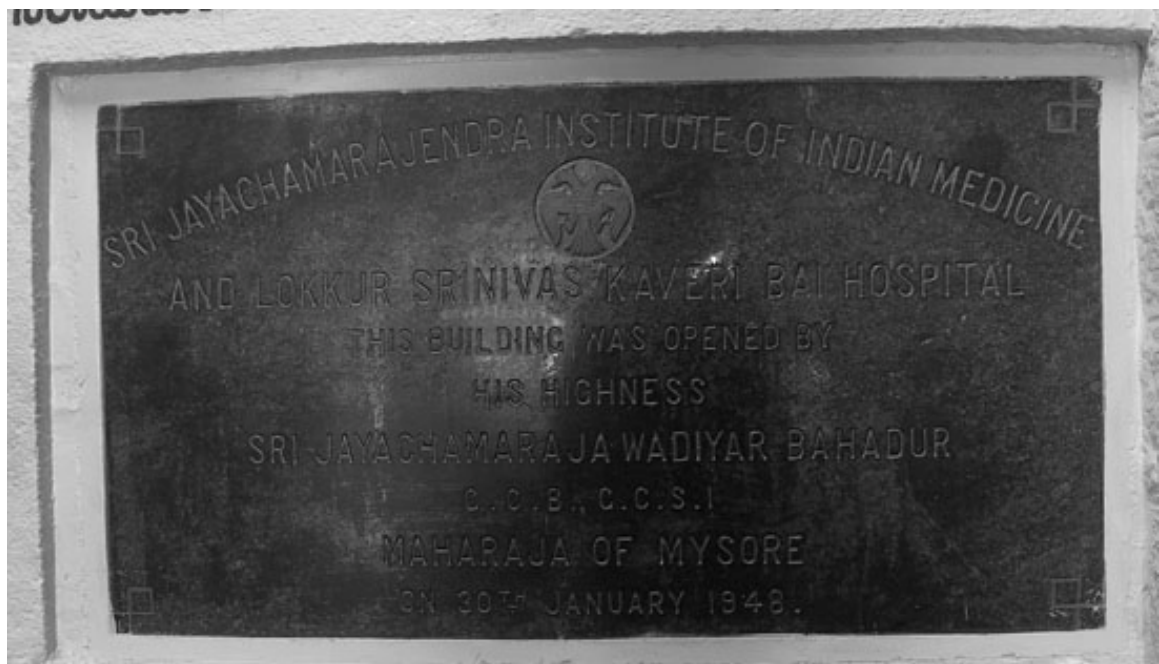

Figure 2.6 The Epigraph for the Ayurvedic Hospital, Bangalore, 1948.
Source: Photograph by the author, 2006



Figure 2.7 Epigraph for the Krishna Rao Pavilion, Bangalore, 1940.

Source: Photograph by the author, 2006.

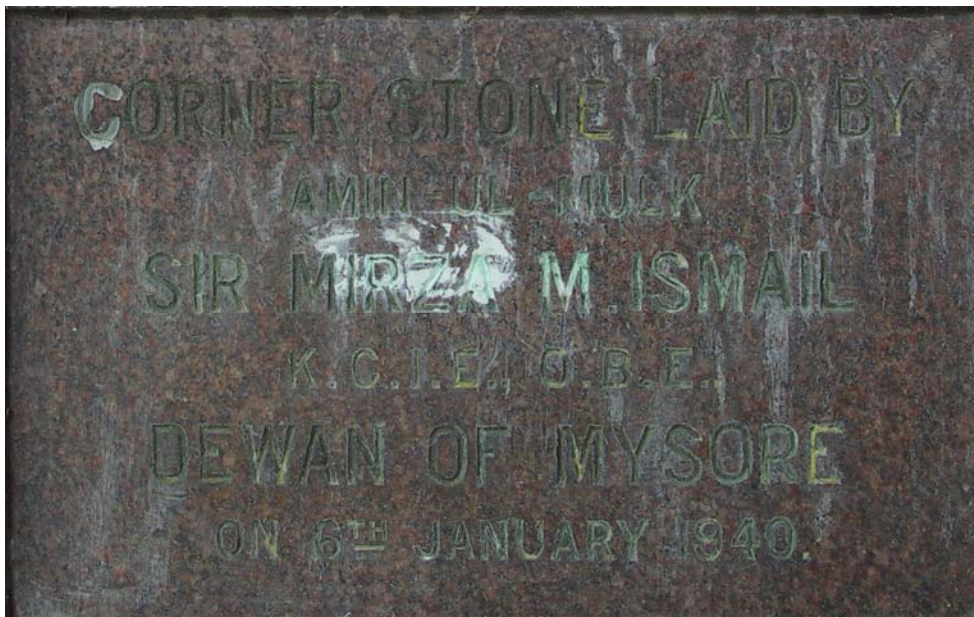

Figure 2.8 Epigraph for Mysore Engineer's Association, Bangalore, 1940.

Source: Photograph by the author, 2006



Figure 2.9 The Elevation of the Municipal Office designed by Krumbiegel, Bangalore, 1927.

Source: G. H. Krumbiegel, Elevation of the Proposed Municipal Office, Construction of a New Municipal Office at Bangalore Amounting to Rs.85,000/- for Constructing a New Municipal Office, December 14, 1927, File No. 121-27, S. No. 1,6, &8, GOM Municipal, KSA, Bangalore, Karnataka.



Figure 2.10 A photograph of the Municipal offices as built based on the design by Government architect Lakshminarasappa, Bangalore, 1936.

Source: M. Fazlul Hasan, Bangalore through the centuries (Bangalore: Historical Publications, 1970).

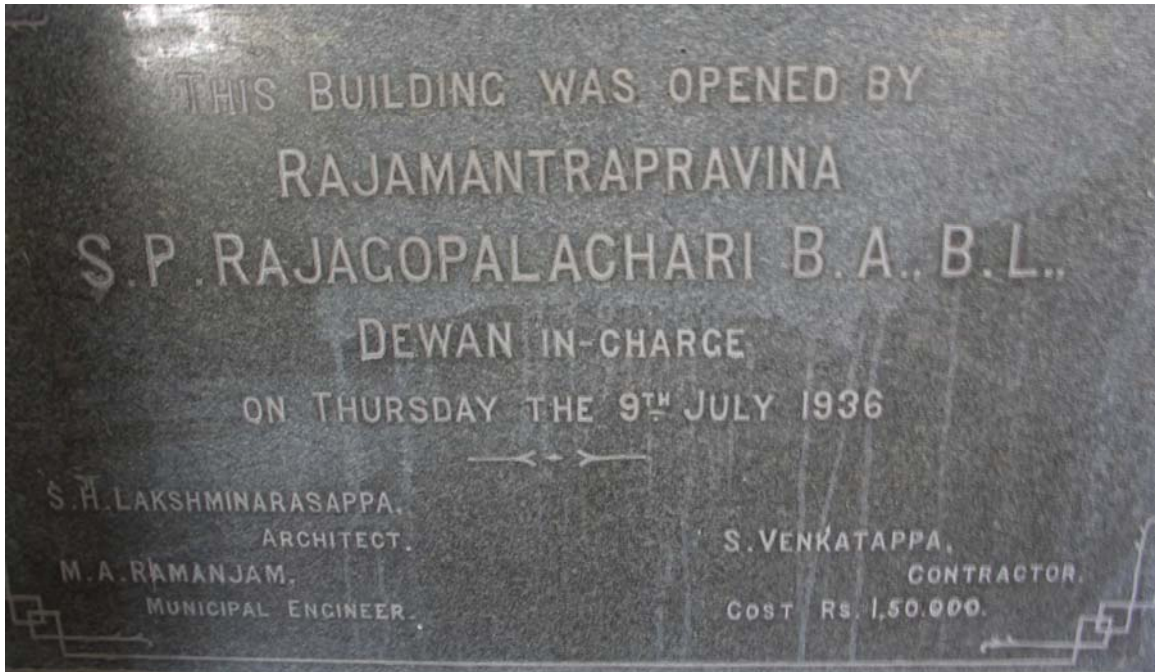

Figure 2.11 Epigraph of the Municipal Office Building, Bangalore, 1936.

Source: Photograph by the author, 2005



Figure 2.12 Mysore Sugar Offices in Bangalore, 1941.

Source: Photograph by the author 2006.

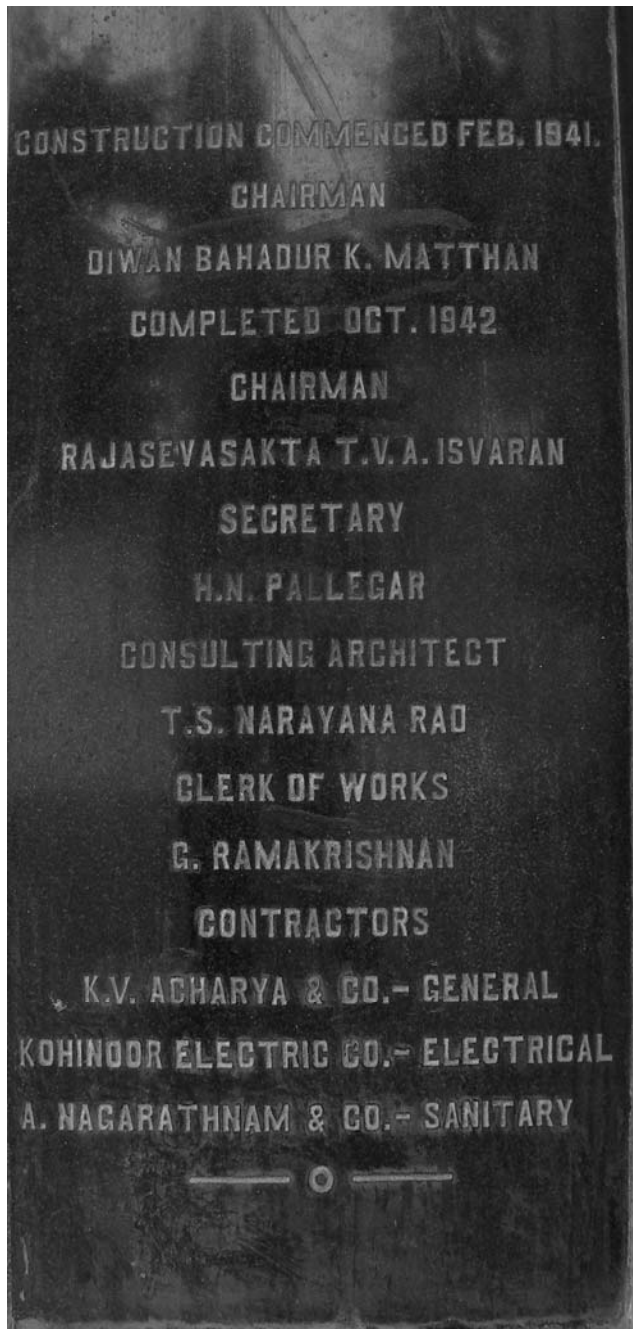

Figure 2.13 Epigraph for the Mysore Sugar Building, Bangalore, 1941.
Source: Photograph by the author, 2006.

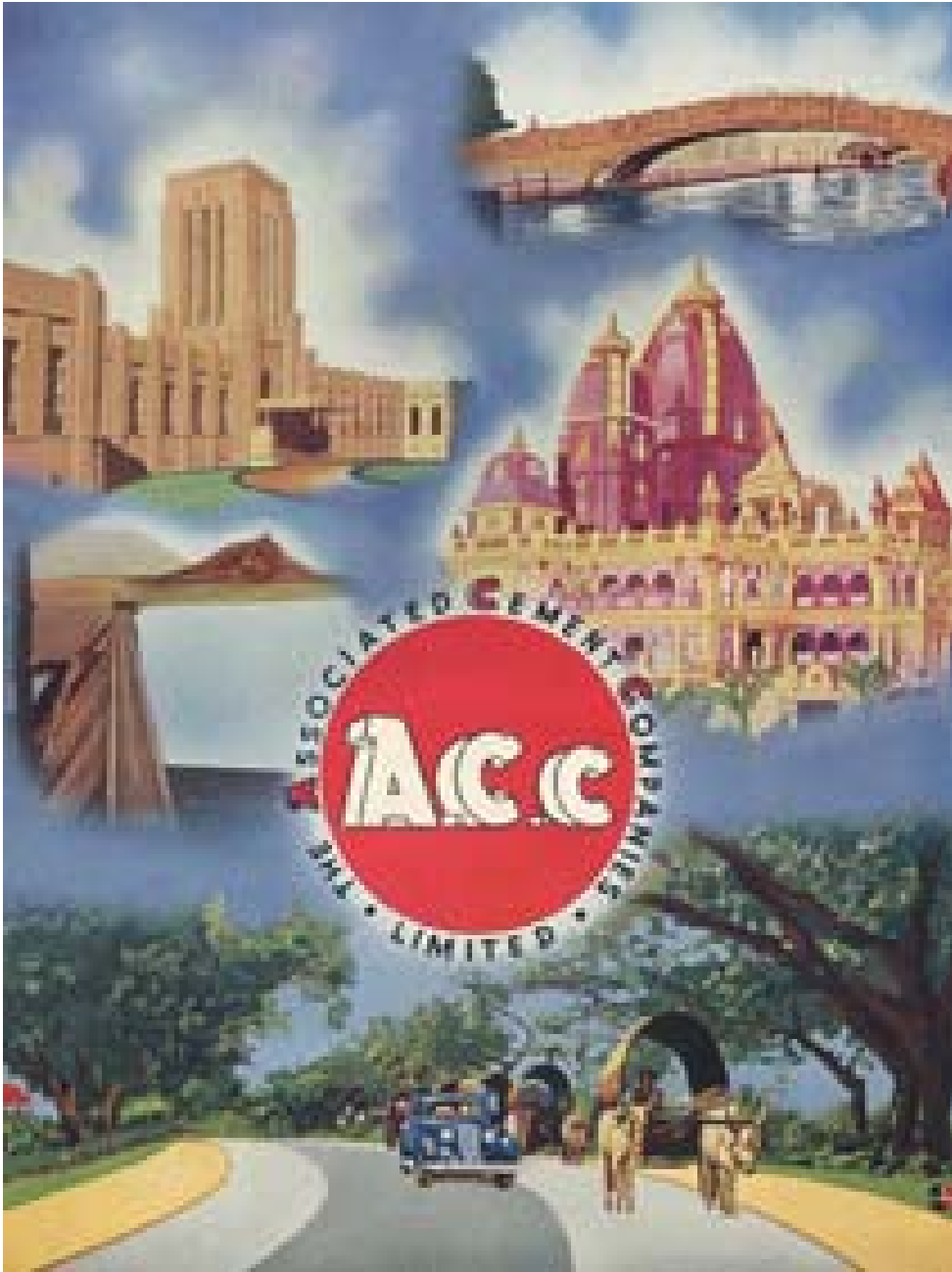

Figure 2.14 Associated Cement Companies Advertisement.

Source: "Associated Cement Companies Advertisement." *Indian Concrete Journal* Vol. 14, no. 2 (February 15, 1940).



Figure 2.15 Concrete Pavilion in the Municipal Park, Kolar. Designed by Consulting Architect G. H. Krumbiegel.

Source: "Band Stand in the Municipal Park, Kolar." *Indian Concrete Journal* Vol. 15, no. 2 (February 15, 1941).



Figure 2.16 Stall of Mr. J. P. Kennette, Civil Engineer, Madura, at the 7th All India Swadeshi and Industrial Exhibition Conducted by the Madura-Ramand Chamber of Commerce at Madura.

Source: *Indian Concrete Journal* Vol. 15, no. 8 (August 15, 1941)275.

**Nellore Agricultural Swadeshi Industrial
and Khadi Exhibition and Cattle Show.**



*Stall of A. C. C. Stockists,
Alapati, Ramamurthy & Co.,
Bezwada, showing Concrete
products.*

Figure 2.17 Nellore Agricultural Swadeshi Industrial and Khadi Exhibition and Cattle Show.

Source: *Indian Concrete Journal* Vol. 14, no. 6 (June 15, 1940):202.

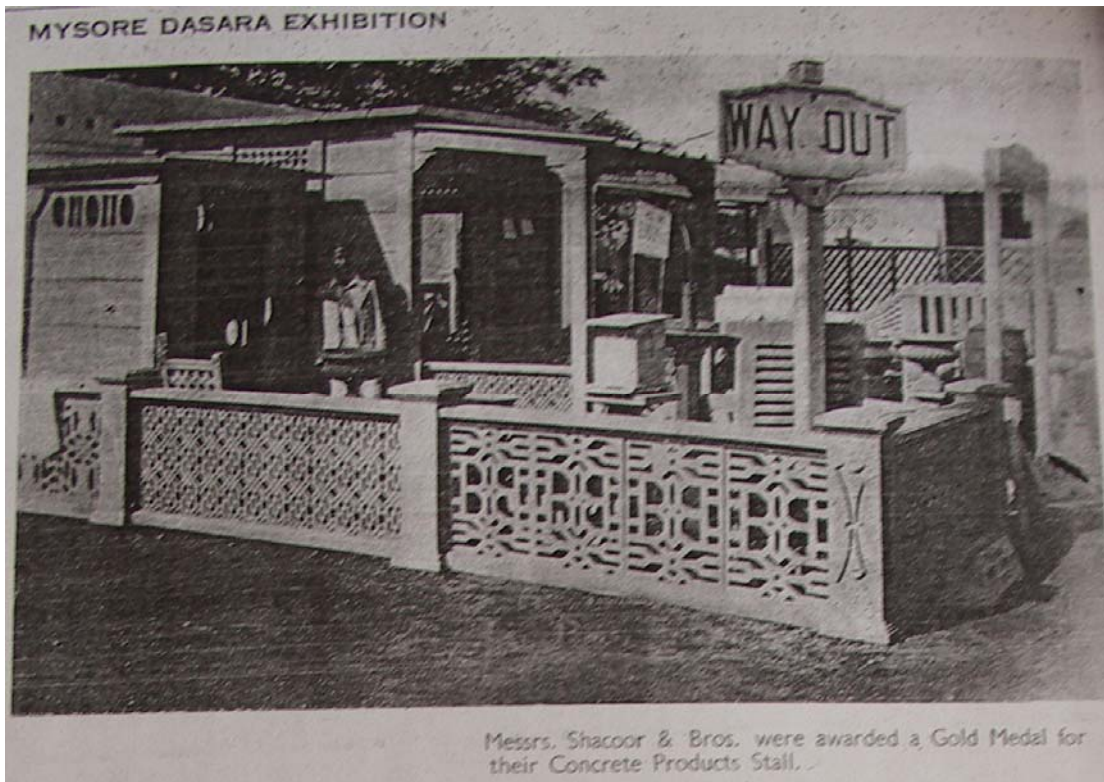

Figure 2.18 Concrete products display at the Mysore *Dasara* Exhibition
Source: *Indian Concrete Journal*, Vol. 10, No. 5 (May 15, 1937): 200



The Town-Hall, Bangalore (See page 216)

Figure 2.19 Puttanna Chetty Town hall offices designed by the Government architect Lakshminarasappa, Bangalore, 1935.

Source: M. Fazlul Hasan, Bangalore through the centuries (Bangalore: Historical Publications, 1970).



Figure 2.20 Koenigsberger (extreme right) with the Maharajah (center).
Source: OKPP



Figure 2.21 Boys High School at Malleswaram, Bangalore, 1939.
Source: Photograph by the author, 2006.



Figure 2.22 The Front Elevation of the Serum Institute, Hebbal, Bangalore, 1942.
Source: Otto Koenigsberger's Portfolio, OKPP.

SERUM INSTITUTE

Government insisted
on these items:

- (a) that the building should be symmetrical to one axis,
- (b) that all three blocks should be visible from the road ("we want to see what has cost us so much")
- (c) that the ventilators over the side-blocks should be made higher than originally planned.

The building is still under construction. The small piles of tiles on the roof will disappear.

Special "inside-lit" show cases for the Museum have been sanctioned.

T.O.

Figure 2.23 Koenigsberger's notes on the Serum Institute Bangalore, 1942. Source: Otto Koenigsberger's Portfolio, OKPP.

BUS TERMINUS

Kalasapalyam, Bangalore-City

Petrol Bunks and part of the restaurant (No.4) were completed before I took charge. The direction of the central platform was fixed.

Government insisted on clock-tower with dome (!!!).

Trees, shrubs, and lawns are not yet planted, - fittings in lamp-posts not yet completed.

*With the same plan my work
to the station but not me*

Figure 2.24 Koenigsberger's Notes on the Bus Terminal at Kalasapalyam, Bangalore, 1940.

Source: Otto Koenigsberger's Portfolio, OKPP



Figure 2.25 The Bus Terminal at Kalasapalyam, Bangalore, 1940.

Source: Otto Koenigsberger's Portfolio, OKPP

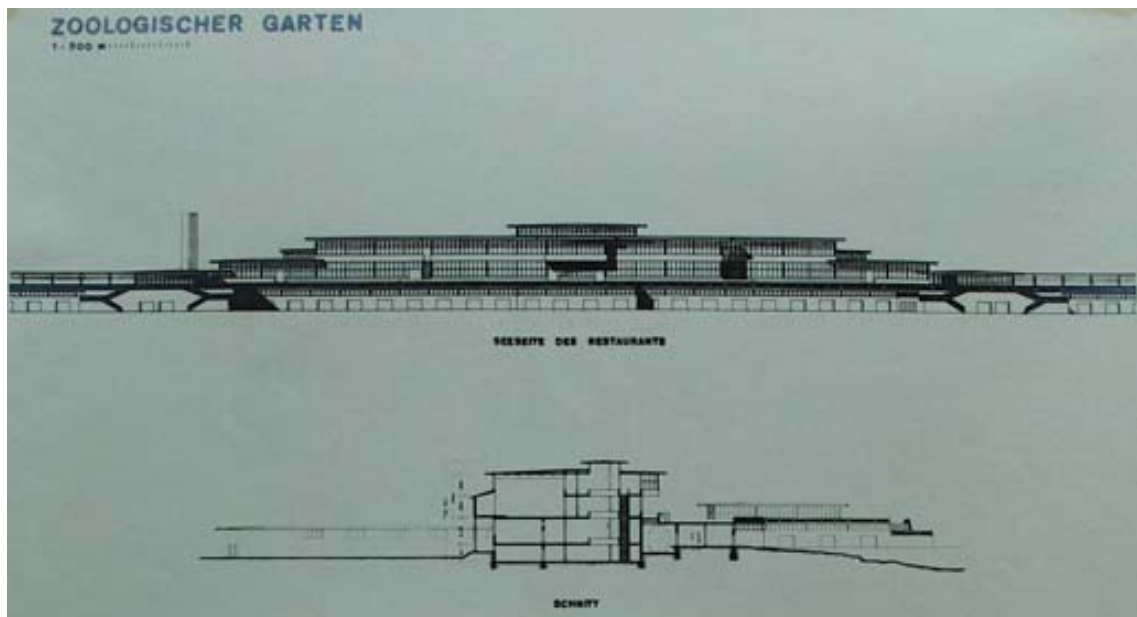

Figure 2.26 The Berlin Zoon, Elevation.

Source: OKPP

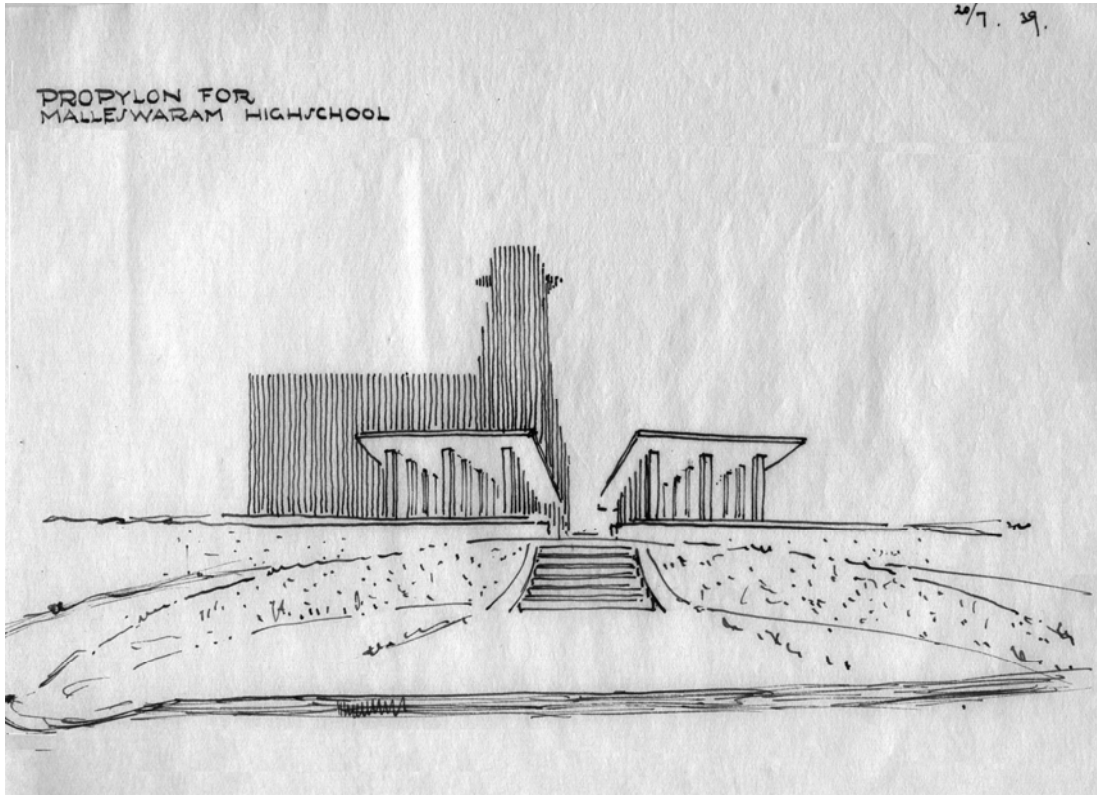

Figure 2.27 Koenigsberger's Sketch for the Tiffin mantap/cycle shed (Lunch pavilion) outside the Malleswaram Boys High School, Bangalore, 1939. Source: Otto Koenigsberger's Portfolio, OKPP

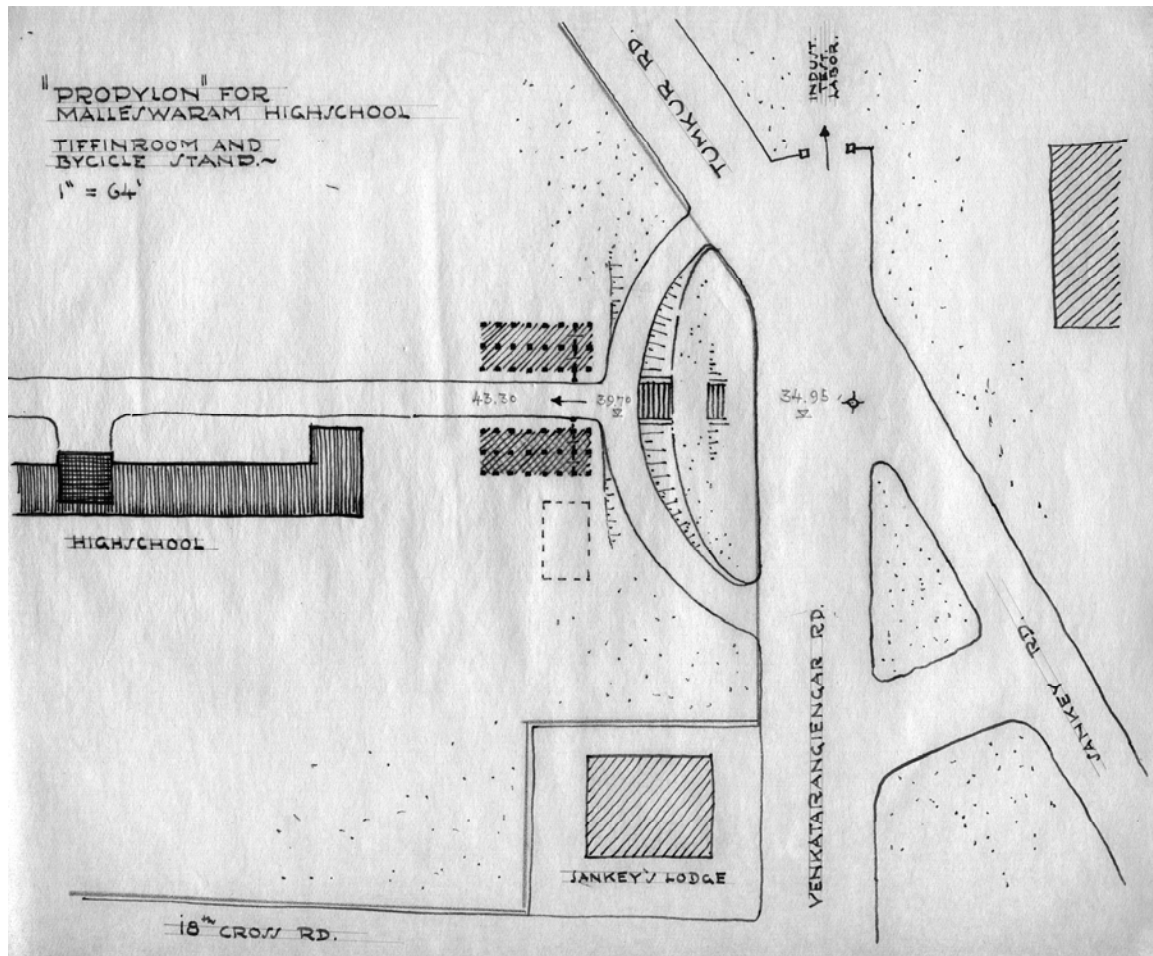

Figure 2.28 Koenigsberger's sketch for the plan of the Tiffin mantap/cycle shed (Lunch pavilion) outside the Malleswaram Boys High School, Bangalore, 1939. Source: Koenigsberger's Portfolio, OKPP.

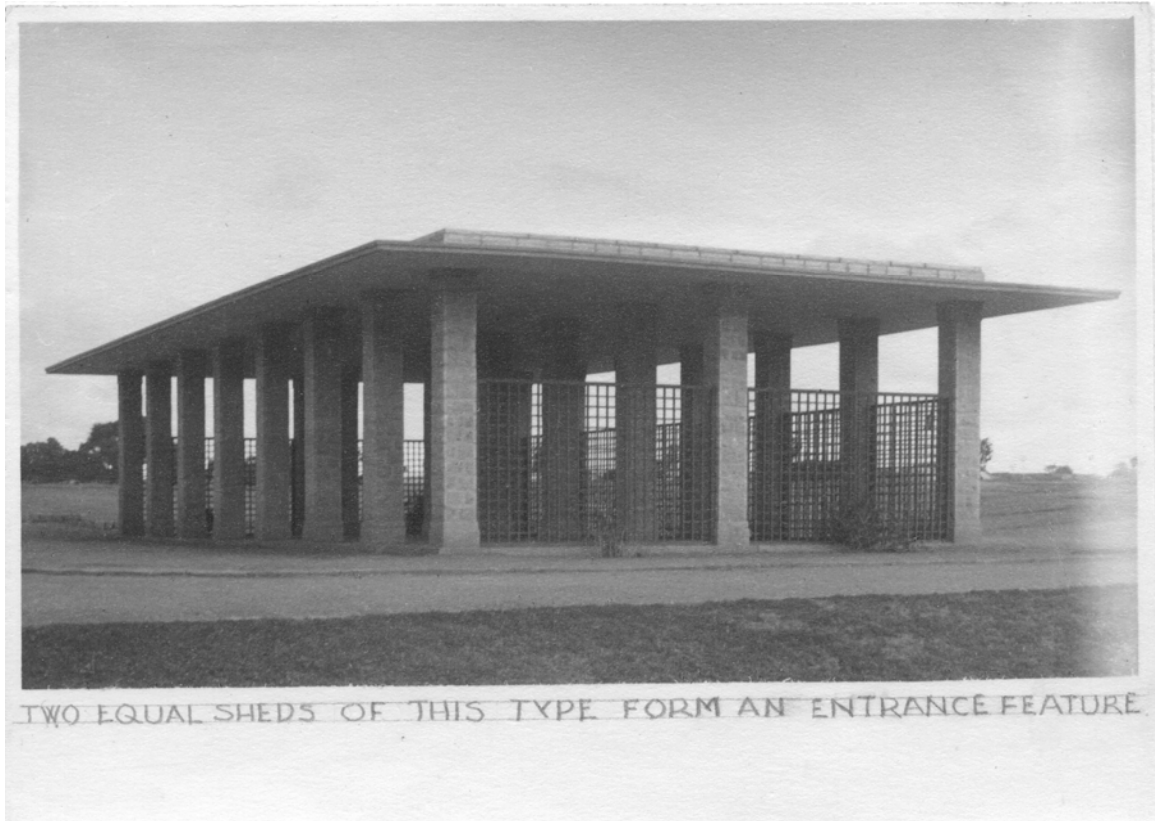

Figure 2.29 *Tiffin mantap* (lunch pavilion)/cycle shed outside the Malleswaram Boys High School, Bangalore, 1939.
 Source: Koenigsberger's Portfolio, OKPP.

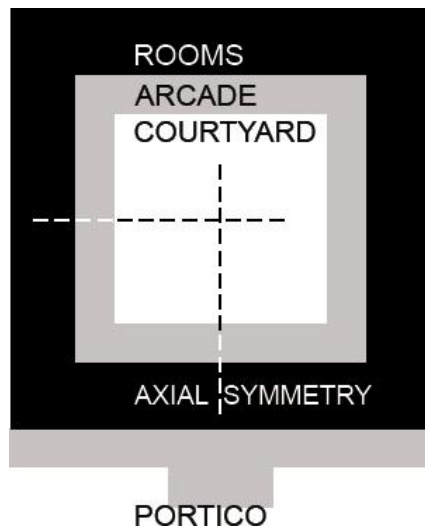

Figure 2.30 A conceptual Sketch of the PWD Type Design. Source: Sketch by the author.

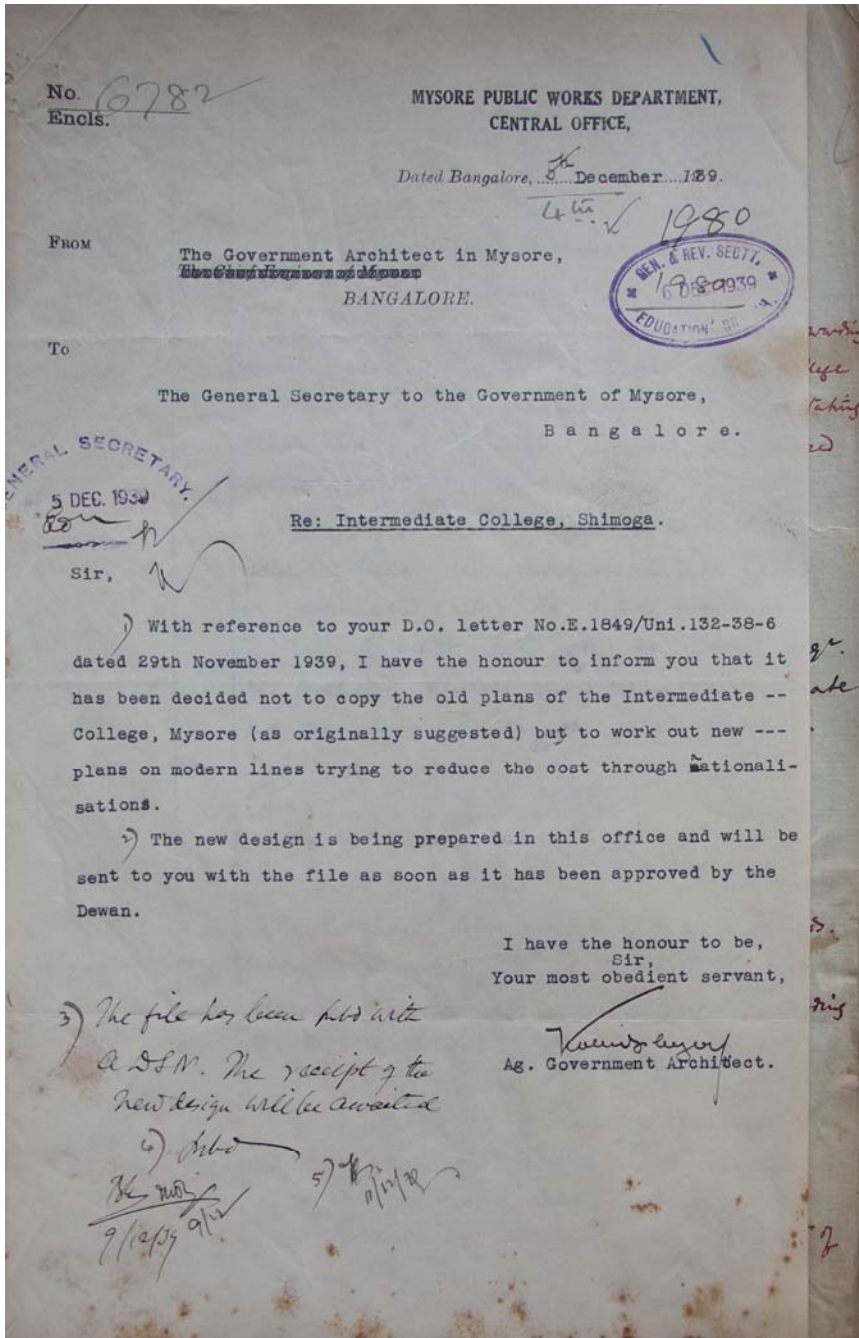

Figure 2.31 Koenigsberger's memo about the Shimoga College to the General Secretary of Government of Mysore.

Source: Otto Koenigsberger, Government Architect in Mysore, Bangalore, to the General Secretary to the Government of Mysore, Construction of the Building for Locating the Intermediate College at Shimoga Together with the Estimate, December 5, 1939, File No. 221-39, S. No.1,2,4,8, GOM Education, KSA, Bangalore, Karnataka.



Maharaja

Yuvaraja

Figure 2.32 Part Elevations of the Maharajah and Yuvaraja college.

Source: T. P. Issar, *Mysore, the royal city* (Bangalore: Marketing Consultants & Agencies, 1991) 91.

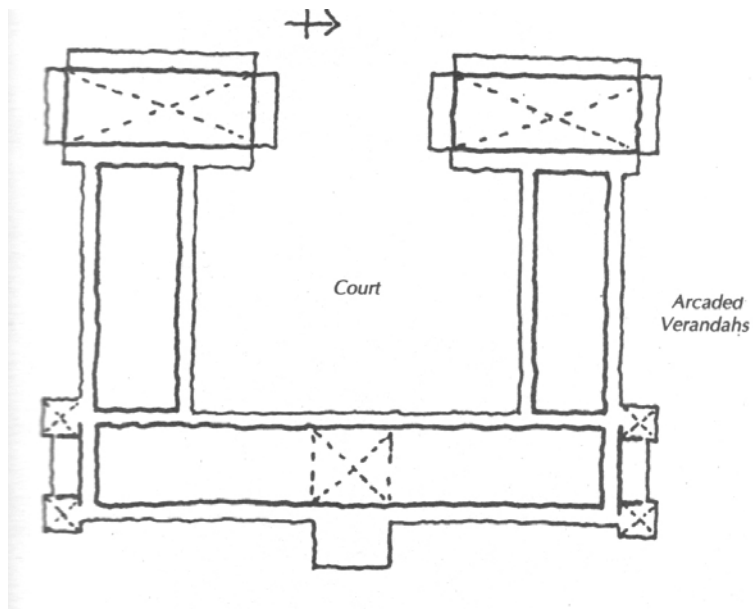

Figure 2.33 Sketch plan of the Maharajah College, Mysore City.
 Source: T. P. Issar, *Mysore, the royal city* (Bangalore: Marketing Consultants & Agencies, 1991) 91.

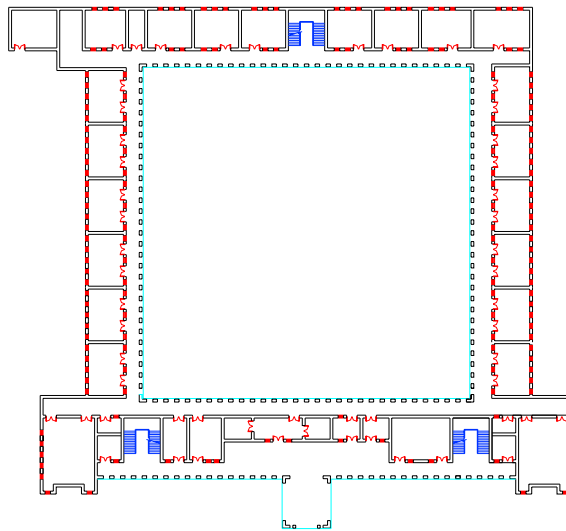

Figure 2.34 Plan of Shimoga College, Shimoga, 1940.
 Source: Measured drawing by the author, 2007.



Figure 2.35 The Arcade in Shimoga College, Shimoga, 1940..

Source: Photograph by the author, 2006.



Figure 2.36 Photograph of the Maharajah's College Mysore.

Source: T. P. Issar, *Mysore, the royal city* (Bangalore: Marketing Consultants & Agencies, 1991) 91



Figure 2.37 Shimoga College, Shimoga, 1940.
Source: Photograph by the author, 2006.

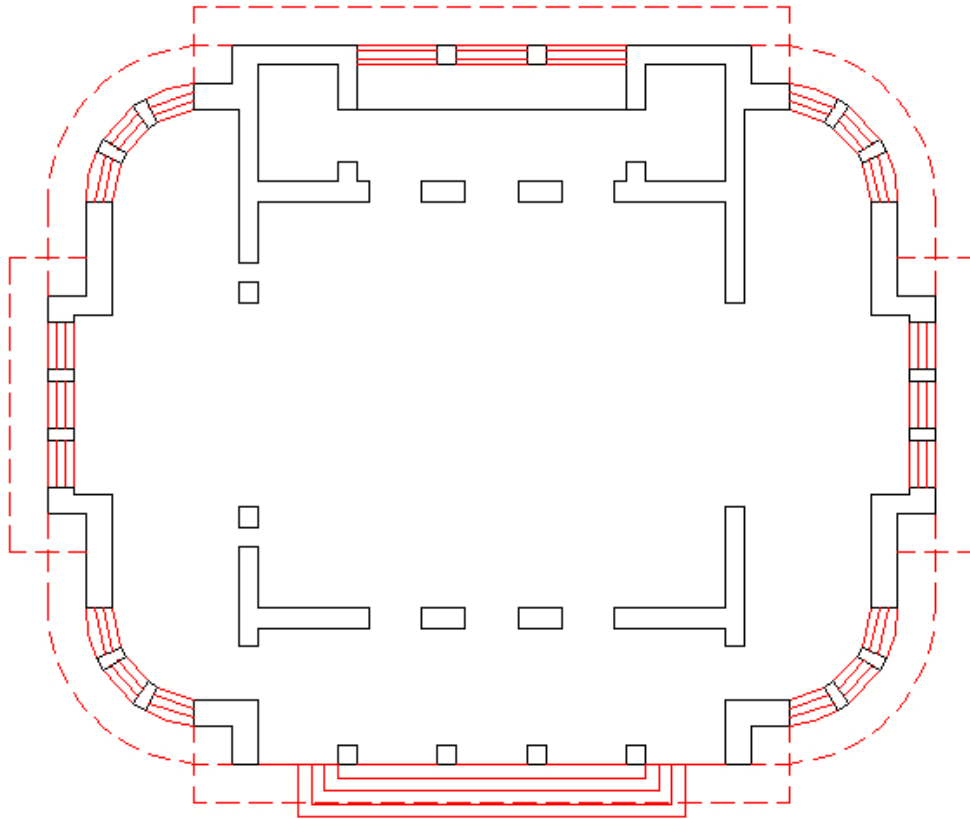

Figure 2.38 Plan of Mysore Engineers Association Building, Bangalore, 1940.

Source: Measured drawing by the author, 2006.



Figure 2.39 Mysore Engineers' Association Building, Bangalore, 1940.
Source: Photograph by the author, 2006.



Figure 2.40 Mysore Engineers' Association Building, Bangalore, 1940.
Source: Photograph by the author, 2006.

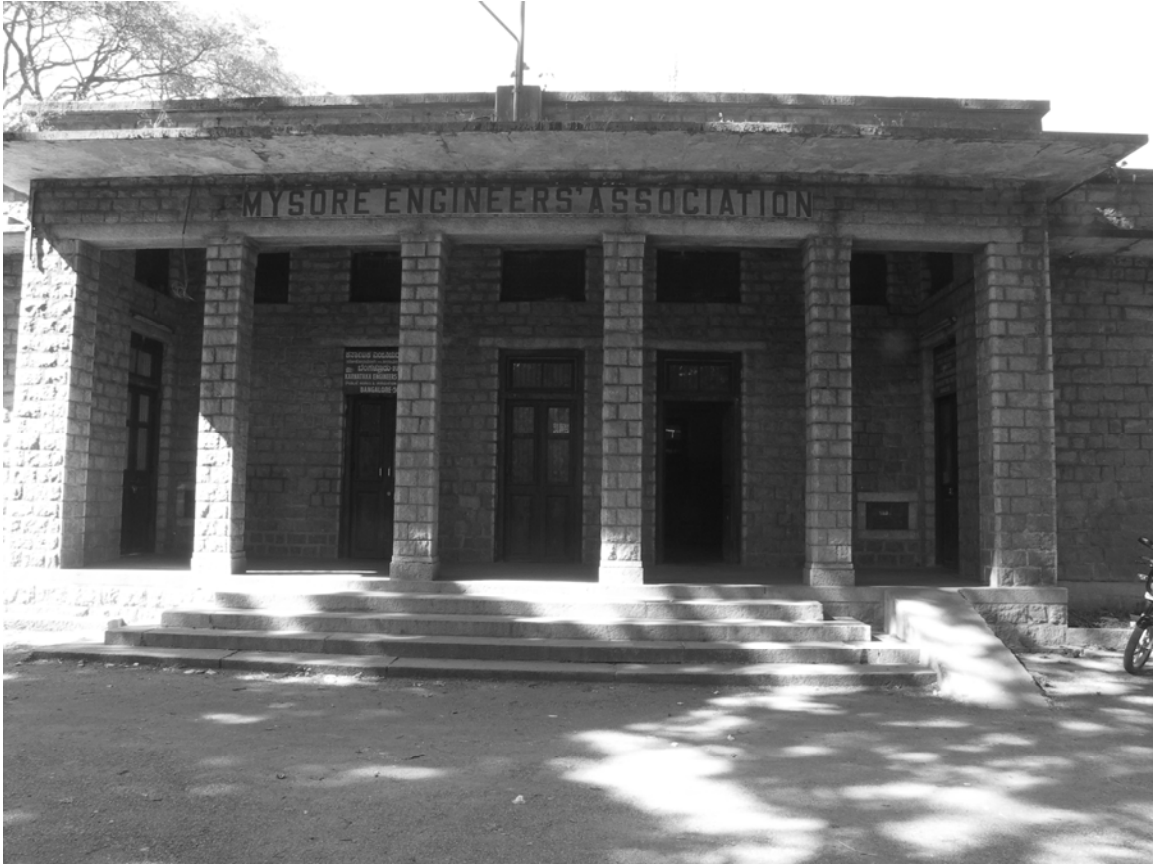

Figure 2.41 Mysore Engineers' Association Building, Bangalore 1940.

Source: Photograph by the author, 2006.



Figure 2.42 Photograph of the Mysore Broadcasting House, (now All India Radio), Mysore, 1942.

Source: Photograph by the author, 2006.

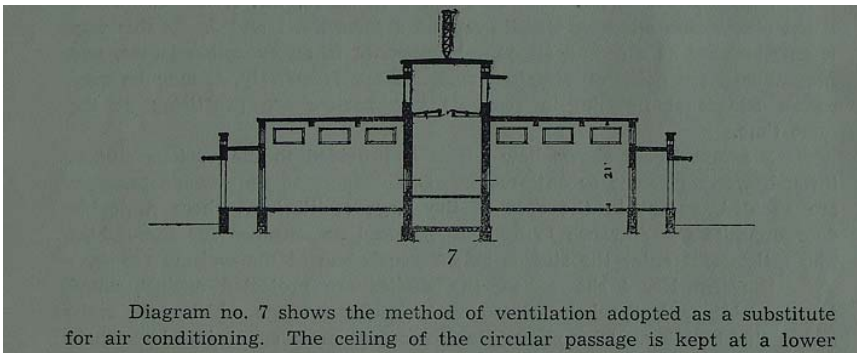

Diagram no. 7 shows the method of ventilation adopted as a substitute for air conditioning. The ceiling of the circular passage is kept at a lower

Figure 2.43 A Section through the Mysore Broadcasting House, Mysore, 1942. Source: O. H. Koenigsberger, "The New Studios of the Mysore Broadcasting House at Mysore," *Electrotechnics* 15 and 16 (Sept.1943).



Figure 2.44 Victory Hall, Bangalore, 1944-45.

Source: Otto Koenigsberger, "The Victory Hall at Bangalore," *Marg* Vol. IV, no. 3 (Dipavali 1950).

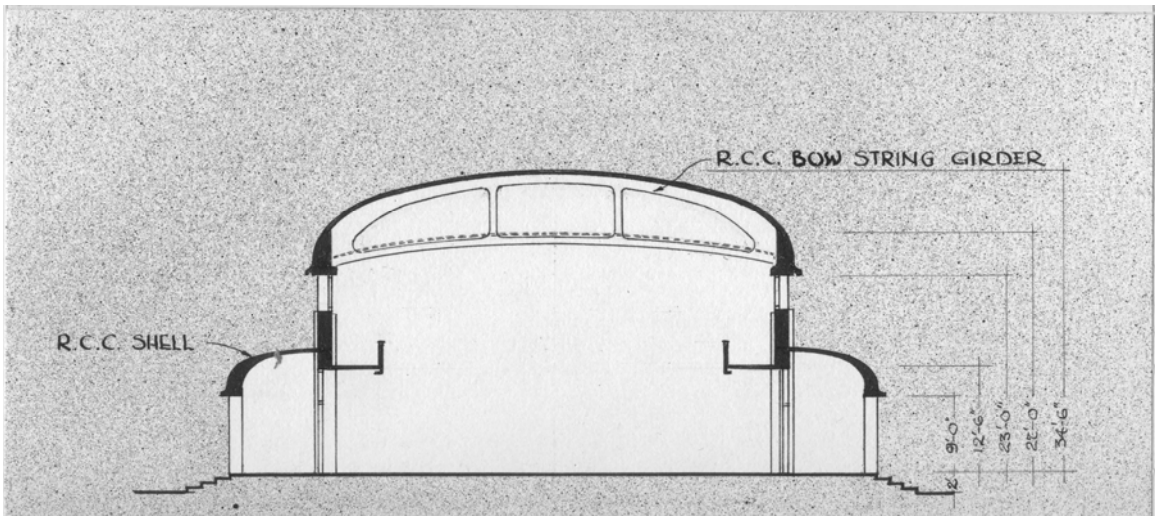

Figure 2.45 Section through the Victory Hall, Bangalore, 1944-45.

Source: Otto Koenigsberger, "The Victory Hall at Bangalore," *Marg* Vol. IV, no. 3 (Dipavali 1950).



Figure 2.46 Dining Hall at the Indian Institute of Science, Bangalore, 1945.

Source: OKPP

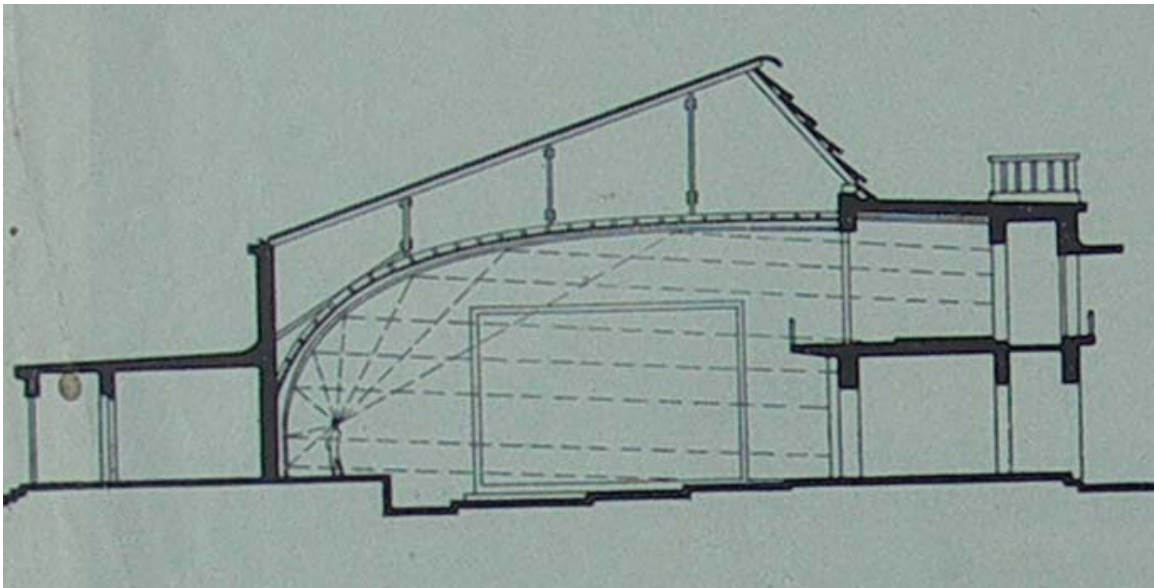

Figure 2.47 Section through the Dining Hall at the Indian Institute of Science, Bangalore, 1945.

Source: OKPP

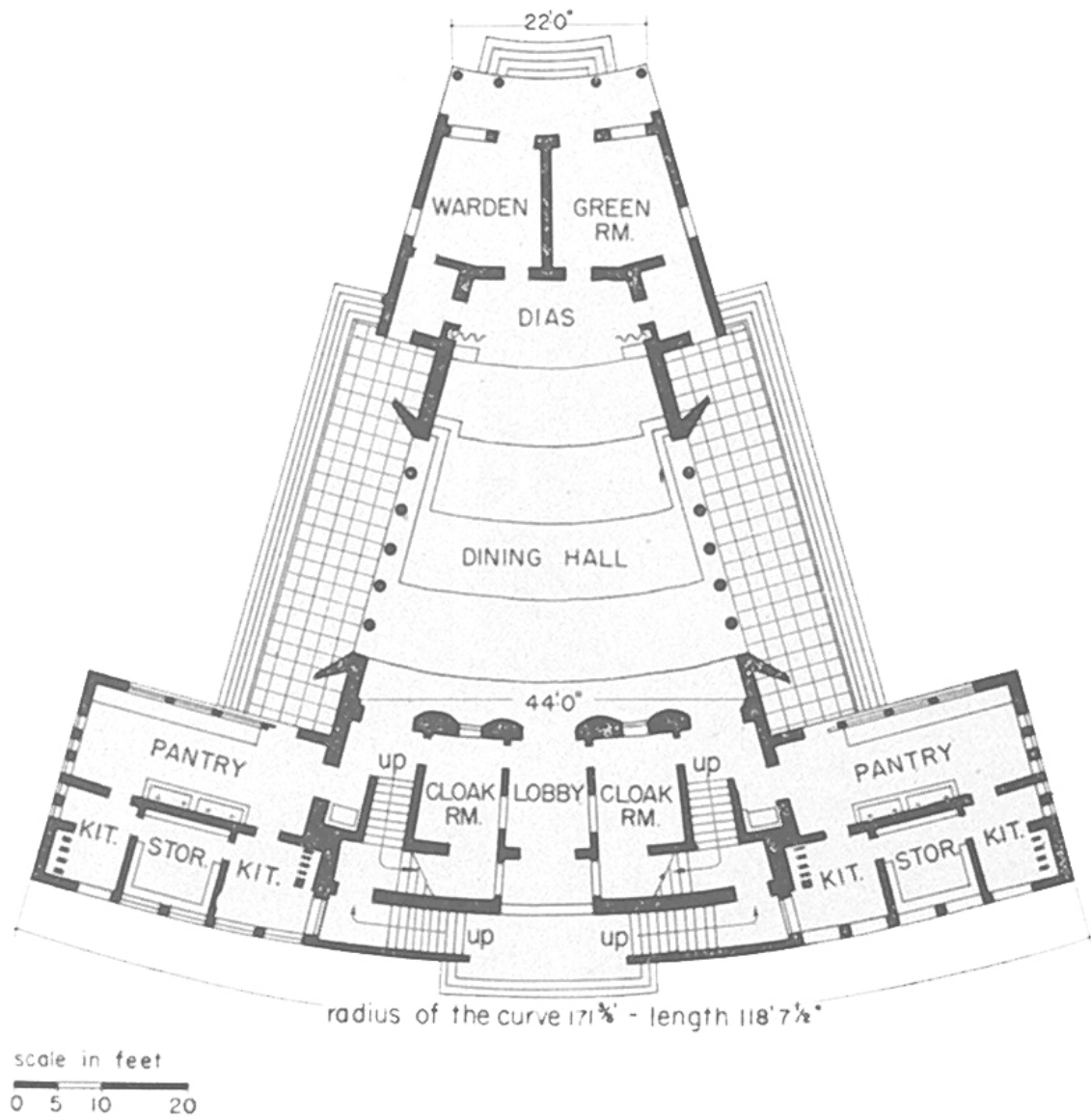

Figure 2.48 Plan of the Dining Hall, Indian Institute of Science, Bangalore, 1945.
Source: OKPP



Figure 2.49 Housing Factory in Jang Pura, New Delhi, 1949.

Source: OKPP

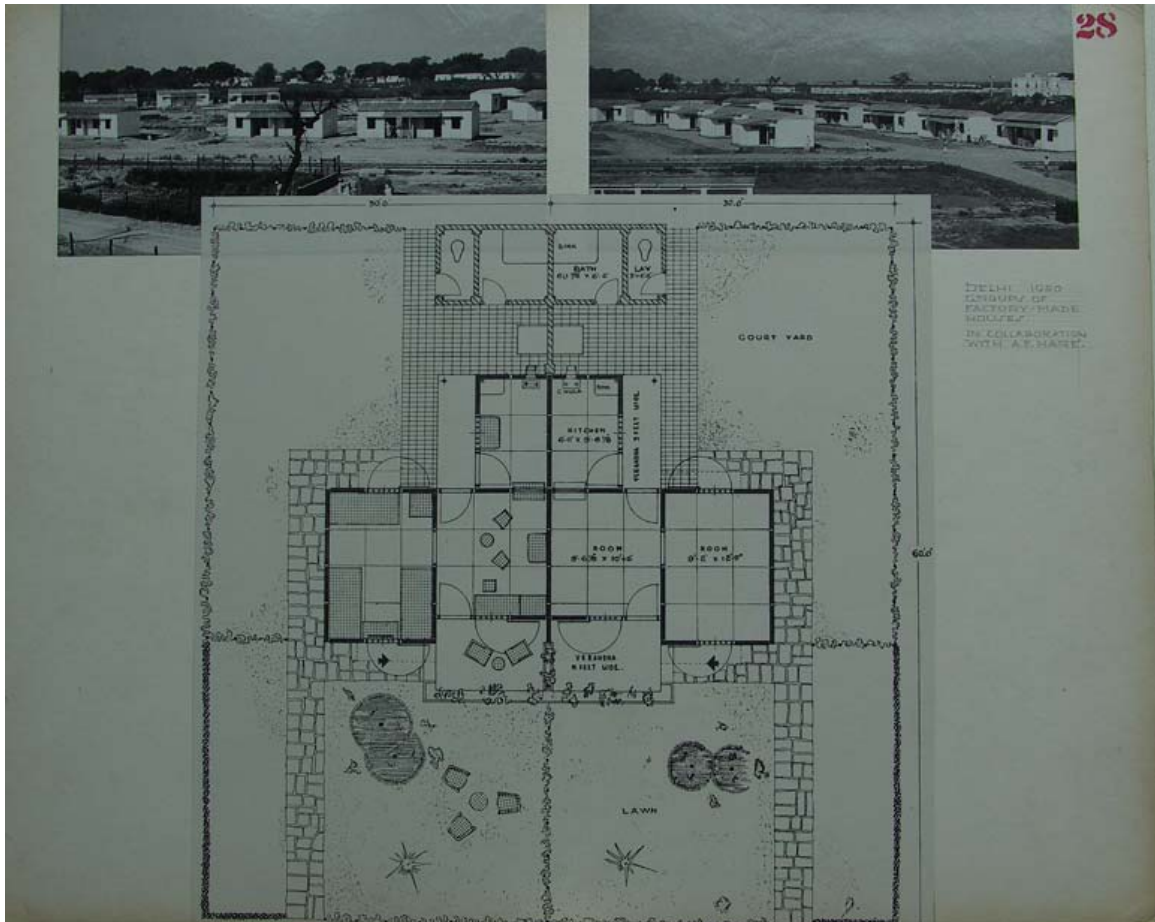

Figure 2.50 The Plan of the Pre-fabricated Housing Units, New Delhi, 1949. Source: OKPP.



Our first Prefab . 1949.
With my Christmas
Greetings and New Years wishes
to
all the Rabbinis
Li and you
from
To
p. t. o

Figure 2.51 Photograph of the Pre-Fabricated Unit, New Delhi, 1949.
Source: OKPP.

Chapter 3

Tropical Architecture

This chapter looks at the following questions: What were the origins of Tropical Architecture? How was Tropical Architecture transformed and redefined in the 1950s? Who were actors in the field of Tropical Architecture in 1950s? How was Tropical Architecture circulated? What were the debates on Tropical Architecture? What was Koenigsberger's contribution to these debates?

Origins of Tropical Architecture in Hygiene

In the late nineteenth and early twentieth century, the concept of Tropical Architecture developed in the discipline of Hygiene, which circulated through colonial hygiene manuals. The authors of these manuals included medical personnel, sanitary engineers, and home scientists. For example, *Moore's Manual of Family Medicine and Hygiene For India* was authored by an M.D., Cuthbert Allan Sprawns; *The Home and Health in India* was authored by Kate Platt M.D.; *The Manual of Hygiene* was written by a surgeon, Captain A. E. Grant of the Indian Medical Service and Professor of

Hygiene at the Madras Medical College; *A Manual of Hygiene, Sanitation, and Sanitary Engineering with Special References to Indian Conditions* was written by J. A. Jones, who served as a sanitary and civil engineer to the Government of Madras.¹

The contents of the manuals varied according to their authorship. The manuals authored by medical professionals were primarily intended for the survival of the novice European in the tropics. The contents of these manuals included bodily practices such as personal hygiene and clothing, methods to ensure clean drinking water and food, information about tropical diseases, monitoring of servants, the relationship between health and climate, and building sanitation. The medical manuals invariably included a chapter or two on buildings while the sanitary engineering manuals contained more knowledge on building construction. Sanitary engineering manuals were professional treatises intended for engineers. They contained professional information on construction and were often accompanied by type designs. The overriding concern of the tropical hygiene manuals was the physiological well being of the European body under tropical climatic conditions.

In the late nineteenth and early twentieth century, the European body was the site upon which Tropical Architecture was constructed as a discourse.

¹ A.E. Grant, *The Indian Manual of Hygiene: Being the King's Manual of Hygiene* vol. 1 (Madras (now called Chennai), India: Higginbotham and Co., 1894), J. A. Jones, *A Manual of Hygiene, Sanitation and Sanitary Engineering : With Special References to Indian Conditions* (Madras: Printed and published by the Superintendent, Government Press, 1896), Kate Anne Platt, *The Home and Health in India and the Tropical Colonies* (London: Baillière, Tindal & Cox, 1923), Cuthbert Allen Sprawns, *Moore's Manual of Family Medicine and Hygiene for India* (London: J. & A. Churchill, 1921).

Architecture was seen as an object of mediation between the body and the climate, with the definition of climate encompassing far more than temperature:

From the point of view of a sanitarian, the climate of a place may be defined as the sum of the local atmospheric and physical conditions in their relationship to animal and vegetable life.²

The idea that architecture should be designed according to the tropical climate to protect the European body from tropical diseases was the foundation principle of Tropical Architecture as a subset of Hygiene. Consequently, the hygiene manuals not only provided specifications for construction and building materials, but also prescribed techniques of ventilation, lighting, sewage disposal, water supply, and sanitation as preventive measures to circumvent the spread of diseases.

For example, this definition of a healthy habitation in A. E. Grant's *Indian Manual of Hygiene* best sums up how the discourse of hygiene defined architecture (italics from original):

What then are the requisite conditions for a healthy habitation? They are chiefly these, as defined by Parkes:--

1. *A site dry and not malarious*, and an aspect which gives light and cheerfulness.
2. *A pure supply and proper removal of water*; by means of which perfect cleanliness of all parts of the house can be insured.
3. *A system of immediate and perfect sewage removal* which renders it impossible that the air or water shall be contaminated from excreta.
4. *A system of ventilation* which carries off all respiratory impurities.
5. A condition of house which insures *perfect dryness of the foundations, walls, and roof*.³

² A.E. Grant, "Chapter VI: Climate and Meteorology," in *The Indian Manual of Hygiene: Being the King's Manual of Hygiene* (Madras [now called Chennai], India: Higginbotham and Co., 1894), 282-417.

³ A.E. Grant, "Chapter V: Buildings," in *The Indian Manual of Hygiene: Being the King's Manual of Hygiene* (Madras [now called Chennai], India: Higginbotham and Co., 1894), 218-281.

Sanitation and Hygiene manuals frequently discussed the relationship between the tropical climate and the European body. The *Indian Manual of Hygiene* devoted an entire chapter to the topic of “Climate and Meteorology” to discuss the impact of climatic variables such as temperature, atmospheric pressure, and humidity on the body.⁴ Climate was spatialized through the mapping of colonial climatic taxonomies onto the cartographic space of India. Each place was defined by its geographic coordinates and its climatic attributes, an exercise that continued well into the 1950s and 1960s. These were then used to determine a particular set of spatial and material practices for architecture suited to that climate. This method of design, generated by sanitary engineers in the nineteenth and early twentieth century, was adopted in the mid-twentieth century by architects who invented the discourse of Tropical Architecture. From the 1930s onwards, as British modernist architects looked for opportunities to work in the tropics, the disciplinary home of Tropical Architecture shifted from its origins in Hygiene to towards its natural disciplinary home, that is, architecture. In the early 1950s, after the Second World War, Tropical Architecture had completed its migration from hygiene to architecture with the establishment of the Department of Tropical Architecture at the AA in 1954. This disciplinary relocation catalyzed several consequential changes that affected how Tropical Architecture evolved in the 1950s.

Among these changes was that the authorship of texts on Tropical Architecture shifted from medical personnel and sanitary engineers to modernist architects. It is no coincidence that when Otto Koenigsberger first started

⁴ Grant, "Chapter VI: Climate and Meteorology," 282-417.

teaching in London, his first job was not at the AA, but at the London School of Hygiene & Tropical Medicine (LSHTM). Although the discipline of Tropical Architecture shifted from hygiene to architecture, hygiene remained a significant component of Tropical Architecture through the 1950s and hygiene specialists from the LSHTM taught at the AA.

The clients for whom Tropical Architecture was intended were no longer European colonizers, but the inhabitants of decolonizing tropics, or the “natives”.

G. A. Atkinson, a professor of Tropical Architecture at the AA wrote:

We must remember that our clients are more the people of the Tropics not Europeans: that we have to work there as equals, only privileged because of our special knowledge.⁵ As a consequence, the European body was no longer the site upon which the discourse of Tropical Architecture was constructed. In the 1950s, the colonized or “native” body was the site upon which the discourse of Tropical Architecture was fashioned.

Through the 1950s and 1960s, as Tropical Architecture further evolved into an architectural discourse, the site upon which the discourse was constructed shifted from the body to architecture. The objective of Tropical Architecture shifted from the survival of the European colonizer body in the “alien” tropics to the physiological comfort of the colonized body at “home”. The focus of the architects in the 1950s was less on disease prevention and more on comfort, which was defined comprehensively in terms of thermal, hygrometric, ergonomic, acoustic, and psychological well-being.

⁵ George Anthony Atkinson, "British Architects in the Tropics," *Architectural Association Journal* 69 (June 1953): 7-21.

While hygiene professionals dealt with architectural production in terms of prescriptive construction techniques to a certain extent, they were by no means devoted to architectural production to the extent that architects in later decades would be. In the 1950s, the content of Tropical Architecture texts consisted entirely of architectural production in the tropics. Architects debated what kind of construction technologies and materials were feasible in the tropics in the context of limited resources.

Despite the discontinuities between the early-twentieth- and mid-twentieth-century discourses of Tropical Architecture, the one continuity between these discourses that remained was the reciprocal relationship between architecture and climate. In the 1950s, the mantra of Tropical Architects became “designing for the climate”, which was defined as designing buildings without mechanical conditioning. By the end of 1950s, the objective of Tropical Architecture became achieving maximum resource and energy efficiency.

The Circulation of Tropical Architecture

Existing histories define Tropical Architecture as a neo-colonial discourse that continued the relationship between imperial Britain and the former colonies.⁶ These histories propose that the networks of the British Empire define the identity of Tropical Architecture⁷ and rely on a bilateral model of the metropole as the

⁶ Anthony King, "Exporting Planning: The Colonial and Neo-Colonial Experience," in *Shaping an Urban World*, ed. Gordon Cherry (London: Mansell Publishing, 1980), 203-226.

⁷ Hannah Le Roux, "The Networks of Tropical Architecture," *The Journal of Architecture* 8, no. 3 (2003): 337-354.

“center” and the “colony” as the periphery.⁸ This scholarship is inadequate to understand the role of a transnational actor like Otto Koenigsberger, who emigrated from an imperial site (Berlin) to a colonial site (Mysore) and then back to another imperial site (London). I therefore propose that Tropical Architecture developed and circulated as a transcolonial discourse that cannot be fully grasped within the colony-metropole transactions of knowledge. Tropical Architecture developed along inter-imperial, intra-colonial, and transnational networks.⁹ These included the exchange of knowledge from one colony to another—for example, ideas developed in India were disseminated in Africa. Inter-imperial flows of knowledge between imperial sites such as Paris and London meant that knowledge on architecture that developed in French colonies was also consumed in London.

The institutional actors in the production of knowledge on Tropical Architecture included many actors: imperial actors in the UK and white settler colonies; transnational actors like Otto Koenigsberger; international agencies such as the United Nations; and national actors in newly formed nations. White settler colonies like South Africa, Australia, and the United States produced knowledge for the tropics within their national territories. International agencies such as the United Nations (UN) and the International Congress for Housing and Town Planning provided an inter-imperial network for circulation of Tropical

⁸ Ola Uduku, "Modernist Architecture and 'the Tropical' in West Africa: The Tropical Architecture Movement in West Africa, 1948–1970," *Habitat International* 30 (2006): 396–411.

⁹ I developed the idea of transcolonialism through an unpublished reading by Antoinette Burton circulated in a workshop at the University of Michigan. I also benefited from a discussion with her. See Tony Ballantyne and Antoinette Burton, "Global Empires, Transnational Connections: Anti-Colonialism and the Cross Currents of Modern Imperialism " in *Empire and Imperial Encounters, 1875-1945*, ed. Antoinette Burton (Forthcoming).

Architecture. In newly formed nations like India, national institutes such as the National Institute of Sciences of India developed Tropical Architecture with a clear nation-building agenda.

The circulation of Tropical Architecture was enabled by series of conferences held globally, not only in the imperial capitals like Paris, Lisbon, Washington D.C., and London, but also in the former and existing colonies, such as India, Uganda, and Nairobi. The first conference on Tropical Architecture was organized in Paris under the chairmanship of Henri Prost and Marshall Lyautey.¹⁰ The next conference on Tropical Architecture was organized by the International Federation for Housing and Planning and was held in Mexico in 1938.¹¹ These interwar conferences served as a forum of exchange for colonial architects and planners. In the next section, I examine how the content of the conferences before the Second World War differed significantly from those in the 1950s.

International Federation for Housing and Planning Conference, Mexico 1938

The International Federation for Housing and Planning conference in Mexico followed a standard format for papers. Each paper focused on the housing in one colonial territory that was defined in terms of geographical coordinates and climate. The places discussed in the conference included British Malaya, Nairobi, Madras, Burma, Singapore, Johannesburg, Palestine, the

¹⁰ Jean Royer, *L'urbanisme Aux Colonies Et Dans Les Pays Tropicaux; Communications & Rapports Du Congress International De L'urbanisme Aux Colonies Et Dans Les Pays De Latitude Intertropicale*, Congrès International De L'urbanisme Aux Colonies Et Dans Les Pays De Latitude Intertropicale, Paris, 1931. (La Charité-sur-Loire: Delayance, 1932).

¹¹ International Federation for Housing and Town Planning, *Housing in Tropical and Sub-Tropical Countries*, International Federation for Housing and Town Planning, 16th Congress, Held at Mexico, 1938 (Mexico: Editorial Cultura, 1938).

Netherlands Indies, Egypt, Belgian Congo, and the Italian East African Empire. The housing of each colony was presented in terms of its house types, climate responsiveness, local materials, and sanitation problems. This conference comprised a series of imperial vignettes on housing in the colonies. While there was no central debate over tropical housing, this conference served as an inter-colonial exchange of knowledge that represented British, Dutch, Belgian, and Italian imperial interests. The intention of this conference was to showcase what kind of construction techniques and climatic design was being used in the colonies.

Post-Second World War Conferences on Tropical Architecture

In the 1950s, a number of conferences on Tropical Architecture were organized worldwide. These conferences were significant in redefining the meaning of Tropical Architecture in the post-WWII period and in generating new knowledge. There are significant differences between the interwar conferences on Tropical Architecture and the post-WWII debates on Tropical Architecture. The inter-war conferences on Tropical Architecture belonged to the genre of colonial reportage—that is, they simply described the housing situation in the colonies in terms of resources, skills, indigenous architecture, and sanitary conditions. In contrast, the 1950s conferences facilitated debates that self-consciously declared manifestoes for Tropical Architecture.

The post-WWII conferences on Tropical Architecture were politically motivated by decolonization. New nations like India fashioned Tropical

Architecture as a nation-building project, while institutions and actors in imperial capitals like London, Lisbon, and Washington D.C. viewed Tropical Architecture as a neo-colonial project to define new imperial relationships at a time when nineteenth-century colonialism had declined. Despite its contradictory political objectives of behaving both as an instrument of anti-colonial nationalism and as a mechanism of post-WWII imperialism, Tropical Architecture in the 1950s emerged as an architectural discourse that explicitly addressed the limits of building resources and energy.

In 1952, three conferences inaugurated the post-WWII discourse on Tropical Architecture: the International Congress for Housing and Town Planning conference on housing in tropical climates in Lisbon;¹² the Building Research Advisory Board (USA) conference in Washington D.C.; and the National Institute of Sciences of India's collaborative conference with UNESCO on Tropical Architecture in New Delhi. After 1952, the next two significant conferences on Tropical Architecture were the 1953 conference in London at the University College London (UCL) and the 1957 Symposium on Design for Tropical Living organized by the South African Council for Scientific and Industrial Research and the University of Natal in Durban. (See Table 3-1) In the next section, I look at how these conferences facilitated development of a manifesto of Tropical Architecture in the 1950s.

Each individual conference defined Tropical Architecture in a different way. For example, the Lisbon conference constructed Tropical Architecture as an

¹² International Congress for Housing and Town Planning, *Housing in Tropical Climates*, Papers and Reports: XXI International Congress for Housing and Town Planning, Held at Lisbon, 1952. (Amsterdam: N.V. Van Munster's Drukkerijen, 1952).

inter-imperial forum for exchange of knowledge to represent the interests of European imperial powers. The conference in New Delhi defined Tropical Architecture as a national project in terms of alternative materials and technologies (what we now understand as Appropriate Technology). The conference in Washington D.C. defined Tropical Architecture purely as a technological body of knowledge in terms of climate responsiveness; it also inaugurated the American strain of climatic design, which was called “Bio-climatic Design.” The conference in London defined Tropical Architecture as an imperial project based on climate responsiveness and the technological capacity of the tropics. Each of these sites contributed something different to the discourse of Tropical Architecture, and in the following section, I illuminate the differences and similarities between these conferences and how Koenigsberger was situated in this transcolonial discourse.

Washington D.C. Conference, November 18-19, 1952.

In contrast to the 1952 New Delhi conference, the conferences held at imperial sites like London, Lisbon, and Washington D.C. were geared at promoting the imperial plans of European and American architects who aspired to seek commissions in the tropics. The neo-colonial objectives of Tropical Architecture were accompanied by a redefinition of imperialism after the Second World War.

The 1952 Washington D.C. conference titled “Housing and Building in Hot-Humid and Hot-Dry Climates” was organized by the Building Research Advisory

Board.¹³ Ralph Walker, an American architect with the firm of Voorhees, Walker, Foley and Smith, presented a paper at the Washington D.C. conference on tropical living in which he noted the change in the paradigm of imperialism after the Second World War. Walker defined nineteenth-century imperialism as one in which the white man lived in the tropics temporarily, “made a killing”, then “retired back home”. However, Walker identified the American imperialistic objective of building in the tropics as building *permanently* in the tropics:

As the world’s population increases, as the raw materials so vital to our type of civilization are discovered and exploited, the white man will be forced not only to build permanently in the tropics but he will be required to develop a new kind of imperialism—the returns from which will grow from specialized knowledge generously given to backward peoples most of whom require humane leadership to overcome the curable debilities arising from starvation diets.¹⁴

This conference addressed not only the imperial motives in developing climate responsive architecture for the colonial tropics, but also how these principles could be applied domestically within the southern hot belt in the United States (places like Texas and Arizona). The American conference focused solely on the technological aspects of building in hot climates. The emphasis was on passive techniques of climatic design and the performance of materials under

¹³ The Building Research Advisory Board, *Housing and Building in Hot-Humid and Hot-Dry Climates*, Building Research Advisory Board, Research Conference Report No. 5, Conference Held at Washington D.C, November 18 and 19, 1952 (Washington D.C.: The Building Research Advisory Board, Division of Engineering and Industrial Research, May 1953).

¹⁴ Ralph Walker, Voorhees, and Foley & Smith Walker, "Living in Hot Environments: Practical Aspects of Tropical Living," in *Housing and Building in Hot-Humid and Hot-Dry Climates*, ed. The Building Research Advisory Board, *Building Research Advisory Board, Research Conference Report No. 5, Conference Held at Washington D.C, November 18 and 19, 1952* (Washington D.C.: The Building Research Advisory Board, Division of Engineering and Industrial Research, May 1953), 3-5.

high temperatures. The technological solutions proposed in this conference were aimed at middle-income and high-income housing.

At this conference, the Hungarian-born Olgay brothers, Victor and Aldar Olgay, presented papers about Bio-climatic Design for domestic consumption. In the 1950s and 1960s, Tropical Architecture and the Bio-climatic Architecture pioneered by the Olgay brothers in the United States developed as homologous discourses on climate-responsive design. Tropical Architecture was intended for imperial consumption along the web of the British and French Empires while Bio-climatic Architecture was meant for domestic application within the United States.

UNESCO Conference in New Delhi, December 21-22, 1952

The UNESCO conference in New Delhi titled “Symposium on Scientific Principles and Their Applications in Tropical Building, Design, and Construction in India” opened up a set of questions and problems that were subsequently debated globally in conferences in London and Durban.¹⁵ Here I would like to stress that whereas the conferences in London, Washington D.C., and Durban were geared at the imperial objectives of architects in those locations, the New Delhi conference had a distinct anti-imperial nation-building agenda.

Indian Prime Minister Nehru defined Tropical Architecture as the antithesis of colonial architecture. This anti-colonial conception of Tropical Architecture was crucial to the self-definition of India as a new nation. This new architecture would

¹⁵ National Institute of Sciences of India, *Proceedings of the Symposium on Scientific Principles and Their Application in Tropical Building Design and Construction, Held at New Delhi, December 21-24, 1952*, Bulletin of the National Institute of Sciences of India, No. 6 (New Delhi: National Institute of Sciences of India, 1955).

be a solution specifically for India's climatic and technological needs. In a speech at the conference, Nehru pointed out the problem with colonial architecture in India and articulated how Tropical Architecture would overcome the problems of colonial architecture:

Unfortunately, the type of houses developed in India during the past 70 years or more is of a mongrel type unsuited to local conditions, neither suitable for our own country, nor for any other country. That was due to the fact that the administration adopted half Indian ideas and half British ideas which were quite unsuited to Indian conditions. The result was unfortunate for both, because the climate is different from that in Britain and conditions are too. Even there the houses might not have suited. The problem was not considered from the point of view of Indian conditions, Indian ways of living, Indian habits, sun, air, climate, etc.¹⁶

The Delhi conference considered the question of how to build in South Asia, where resources for modern building were scarce. The issue debated was the application of technology in architecture. On the one hand, the state saw itself responsible for facilitating housing for its citizens, yet the resource limitations were a major impediment in achieving this objective. The debates in the conference were about the application of building technology. These questions were necessitated by resource shortages in India. Architects, political leaders, academicians, scientists, and social activists debated the extent to which technology could be applied for mass housing in India.

The central question in the New Delhi conference was what kind of architectural production and materials were appropriate for India to be self-reliant

¹⁶ Jawaharlal Nehru, "Inaugural Address," in *Proceedings of the Symposium on Scientific Principles and Their Application in Tropical Building Design and Construction, Held at New Delhi, December 21-24, 1952*, ed. National Institute of Sciences of India, *Bulletin of the National Institute of Sciences of India*, No. 6 (New Delhi: National Institute of Sciences of India, 1955), xiv-xv.

in the field of housing. The conference was geared at promoting national self-sufficiency in the field of architecture with minimal reliance on imports. The building problem in India was framed in this manner:

Shortages of the traditional raw materials for modern construction, and restrictions in foreign exchange for the purchase of these materials from abroad, have directed attention to the importance of new materials of construction, to new designs of building, and also to new techniques for using indigenous raw materials satisfactorily for speeding the housing programmes and reducing their cost.¹⁷

The primary materials for construction in India, brick and lime, were unaffordable by the vast majority in need of housing and were inadequate in supply to meet the demand for housing. Physiological comfort in a tropical climate was a peripheral concern in New Delhi, although most presenters agreed upon climate-responsive design through proper orientation, insulation, and ventilation. The papers presented addressed how to solve the problem of shortage of building materials and how to make houses affordable. The answers to these problems ranged from the minimalist Gandhian solution proposed by Gandhi's associate Mira Behn to air conditioned buildings proposed by Calcutta-based architect Bernard Matthews, a principal in the firm of Ballardie, Thompson, and Matthews.

Mira Behn, formerly Madelene Slade, was an Englishwoman who became a Gandhian follower and was given the name "Mira" by Gandhi. She spent time in India as a young girl while her father Sir Edmond Slade was posted in Bombay as Commander-in-Chief of the East Indies Squadron. In 1925, Mira Behn moved

¹⁷ National Institute of Sciences of India, "Introduction," *Ibid.*, ed. National Institute of Sciences of India, *Bulletin of the National Institute of Sciences of India*, No. 6 (New Delhi: National Institute of Sciences of India, 1955), ix-xi.

into Sabharmati Ashram as Gandhi's disciple and adopted the Gandhian way of life. She worked in villages as a social worker and Gandhian activist.¹⁸

At the New Delhi conference, Behn presented a Gandhian view of how to solve the problem of rural housing. She noted that it was unrealistic to drastically change rural housing because the villagers would not be able to afford anything that was too expensive. Her recommendation was to not make any extreme changes in the rural settlements but to improve them slightly in terms of drainage and sanitation. Her views were grounded in the Gandhian imagination of utopian rural life, which offered no feasible solution for the urban tropics. She stressed that rural housing needed some material improvements, like fire-proofing the thatch for the roof and a water-resilient exterior plaster, that would improve the longevity of the mudhouses. She wrote:

The interior of the village houses should remain *kutchha* (easily perishable). My experience of 27 years has been that there is nothing so clean and so healthy as a *kutchha* interior. Cement, even in a very small percentage, should not be mixed with the interior plaster, not merely because of unavailability of the material on so large a scale, but because cement produces dampness and chillness which is very unhealthy.¹⁹

Mira Behn's Gandhian view was located at one extreme end of the technology spectrum that proposed minimal intervention in rural buildings. This would continue to be the eco-centric view in the debates on environmentalism later.

¹⁸ Krishna Murti Gupta, *Mira Behn: Gandhiji's Daughter Disciple* (New Delhi: Himalaya Seva Sangh, 1992).

¹⁹ Mira Behn, "Needs of Rural Housing in India," in *Proceedings of the Symposium on Scientific Principles and Their Application in Tropical Building Design and Construction, Held at New Delhi, December 21-24, 1952*, ed. National Institute of Sciences of India, *Bulletin of the National Institute of Sciences of India No. 6* (New Delhi: National Institute of Sciences of India, 1955), 122-123.

The emphasis of the Delhi conference was on alternative building materials like cemented soil, stabilized earth, bituminous soil, bamboo, bamboo boards, and bamboo-reinforced concrete. There was considerable excitement about recycling agricultural waste like tapioca stems, coconut shells, areca nut husk, pine bark, and used tea leaves to make construction boards.²⁰

The key recommendations of the New Delhi conference became the manifesto for Tropical Architecture in the 1950s and were articulated as follows:

- 1) There should be greater application of more precise climatic data in architectural design.
- 2) Vernacular architecture should be scientifically studied to understand climatic design.
- 3) There should be more research on non-traditional or alternative materials such as bamboo concrete and stabilized earth.
- 4) Knowledge on Tropical Architecture should be institutionalized and disseminated widely.

London Conference in 1953

In 1953, in an article on British architects in the tropics in the AA journal, George Anthony Atkinson, an English architect, clearly articulated the British neo-colonial agenda of Tropical Architecture:

The last hundred years and especially the last quarter of century have witnessed great changes in the relationship between Britain and the peoples of the tropics. It is a phase in which it is in the mutual interest of

²⁰ D. Narayanmurti, "Non-Traditional Building Materials with Particular Reference to Bamboo Boards and Boards Produced from Various Forest and Agricultural Wastes," *Ibid.*, ed. National Institute of Sciences of India, *Bulletin of the National Institute of Sciences of India*. No. 6 (New Delhi: National Institute of Sciences of India, 1955), 149-167.

the tropical peoples and ourselves to cooperate because we need what the other has to offer. We need Malaya's Rubber and Tin; Gold Coast's Cocoa; Ceylon's Tea; the sugar of the Caribbean and Mauritius. They need our machinery, manufactures and technical advice.²¹

Following G. A. Atkinson's prompt to treat architectural knowledge as a commodity, the central question in the London conference was how to build in the tropics. British architects debated whether tropical building problems should be solved by exporting high technology from Britain to the tropics or by using the architectural wisdom of existing vernacular architecture in the tropics. Fello Atkinson, an architect who presented a paper at the London UCL Tropical Architecture conference, summed up the central question that the British architects confronted:

Either we use what local materials and building methods there are and try and improve them, or we import present day up-to-date materials techniques and methods of training, and I think that we must realize that although we can accomplish a great deal by improving local means and methods this is by no means the whole answer to the tropical building problem.²²

The central debate in the London conference was on the extent to which technology ought to be applied in building construction. This debate figures into environmentalism as the contestation between Ecocentrists and Technocentrists.

In 1957, the South African Council for Scientific and Industrial Research and the University of Natal organized a symposium on Design for Tropical Living in Durban. In the Natal conference, the central question about building in the

²¹ Atkinson, "British Architects in the Tropics," 7-21.

²² Fello Atkinson, "Style and Tropical Architecture," in *Conference on Tropical Architecture*, ed. Arthur M. Foyle, *A Report on the Proceedings of the Conference Held at University College, London, March, 1953* (London: G. Allen & Unwin, 1954), 71-79.

tropics was quite similar to the one raised at the London conference. P. H. Connell, a professor of architecture at the University of Natal, articulated that the free flow of architectural technology from Europe to the tropics was a problem of cultural and technological incompatibility between the two regions:

A paradox is seen to exist: In most tropical situations in which local traditions based on an intimate knowledge of the tropics often lack the technical skills needed to raise the buildings above a relatively primitive level, whilst a more advanced technology imported into the tropical zone from an entirely different background is frequently applied with little understanding of local conditions.²³

Architects at the London conference debated the application of technology in the tropics. Arthur M. Foyle (-2002), lecturer at Bartlett School of Architecture, presented a paper on "Traditional Materials and Construction" that advocated preserving the traditional systems of building because "they represented a balance between climate; geography; socio-cultural patterns; the materials available and the economy."²⁴ He ended his paper with a proposal to have architects study traditional modes of building that had never been documented and to make that knowledge freely available.

²³ P. H. Connell, "Architecture in the Tropics," in *Symposium on Design for Tropical Living, Held at Durban, October 18, 1957* (Durban: The Natal Regional Committee of the South African Council For Scientific and Industrial Research and The University of Natal at Durban, 1957), H1-H44.

²⁴ Arthur M. Foyle, "Traditional Materials and Construction," in *Conference on Tropical Architecture 1953*, ed. Arthur M. Foyle, *A Report on the Proceedings of the Conference Held at University College, London, March, 1953* (London: G. Allen & Unwin, 1954), 83-88.

Sir William Holford (1907-1975), British architect and town planner,²⁵ proposed that British architects should use British technology but adopt the visual motifs of the indigenous peoples. He wrote:

Indigenous crafts and materials could be made use of for the decoration and embellishment of buildings and indeed generally for civic furnishing, but for fittings of a mechanical and technical nature, only the best of modern and metropolitan designs should be used.²⁶

Holford was obviously interested in promoting the interest of the British construction companies in the tropics.

G. A. Atkinson laid out principles of climatic design and how climatic data could be related to design.²⁷ Through his journal publications, Atkinson introduced categories of climatic and geographical data that architects would require, including latitude, altitude, distance from the sea, annual range of temperature, daily range of temperature, wind regime, and pattern. He also began to list the repertoire of techniques and design features that an architect

²⁵ William Graham Holford was born in South Africa and studied architecture at Liverpool University. He was one of the planner who formulated the Town and Country Planning Act 1947. He was a Professor of Town Planning at University College of London from 1948 to 1970.

²⁶ Sir William Holford, "Tropical Planning Problems," in *Conference on Tropical Architecture*, ed. Arthur M. Foyle, *A Report on the Proceedings of the Conference Held at University College, London, March, 1953* (London: G. Allen & Unwin, 1954), 9-11.

²⁷ For G A Atkinson's contribution to tropical architecture see the following:

George Anthony Atkinson "British Architects in the Tropics" *The Architectural Association Journal* 69 (June 1953) 7-21

George Anthony Atkinson "Building in the Tropics" *Royal Institute of British Architects, Journal* 57 (June 1950) 313-319

George Anthony Atkinson "Mass housing in Rapidly Developing Tropical Areas" *The Town Planning Review* 31:2 (July 1960) 85-102

George Anthony Atkinson "Urbanization and Town Growth in Africa: Problems of mass housing and techniques assisting towards their solution" *Paper for the Inter-African Conference on Housing and Urbanization, Nairobi, 19th to 30th, January 1959* (Gerston, England: Building Research Station, 1958)

George Anthony Atkinson "West Indian Houses" *Architectural Association Journal* 67 (February 1952) 194-199

could use in the tropics though existing examples of successful climatic design in the tropics.

How did Koenigsberger situate himself in the debate on Tropical Architecture in London? Having worked in India on both ends of the technology spectrum using prefabricated construction in New Delhi and local technologies in Mysore, he was skeptical of using high technology. At the UCL conference, Koenigsberger presented a paper on tropical planning problems in which he clearly opposed the application of Euro-centric programs and technologies. He warned:

‘Underdeveloped’ ... is often merely a euphemistic expression for ‘poor’, and it is the poverty of most of the tropical countries which severely limits the application of schemes and programmes which have proved successful in the West.²⁸

Koenigsberger believed that the tropics needed a solution uniquely suitable to the social, economic, and climatic conditions. Koenigsberger had no political allegiance to the British Empire, nor did he have the kind of position that G. A. Atkinson took in terms of using architecture as way to continue colonial relationships. For Koenigsberger, the tropics represented a virgin territory where a new kind of climate-responsive architecture and new paradigms of planning could be developed without *repeating* the mistakes of Western Europe. For him, the socio-economic reality of the tropics represented a critique of European architecture and planning paradigms.

²⁸ Otto H Koenigsberger, "Tropical Planning Problems," in *Conference on Tropical Architecture 1953*, ed. Arthur M. Foyle, *A Report on the Proceedings of the Conference Held at University College, London, March, 1953* (London: G. Allen & Unwin, 1954), 13-20.

In 1954, Koenigsberger understood climate responsiveness conceptually and intuitively, but he did not have detailed plan of how architects could consume climatic data, relate it to building, and design climate-responsive buildings in the tropics. He wrote:

Shade and protection from dust storms have the highest priority in some regions, while in others ventilation and the catching of light draughts and breezes are the first considerations. The investigation of these problems offers a wide and still almost completely untouched field of building research.²⁹

Koenigsberger belonged to the group of architects who inaugurated the paradigmatic definition of Tropical Architecture as climatic design in the 1950s. His contribution to climate design eventually led to his publication of the *Manual of Tropical Housing and Building*,³⁰ a textbook on climate-responsive design for the tropics that continues to be prescribed for undergraduate curricula in the tropics and is also included on reading lists for sustainable architecture.

The proposition that emerged out of the London conference reinforced the New Delhi manifesto on Tropical Architecture. The London conference called for a greater application of climatic data in architectural design, the institutionalization of knowledge on Tropical Architecture, an increase in production of knowledge on vernacular architecture's climate responsiveness, and greater circulation of knowledge through publications.

²⁹ Ibid.

³⁰ Otto H. Koenigsberger, T. G. Ingersoll, Alan Mayhew, and S. V. Szokolay, *Manual of Tropical Housing and Building* (London: Longman, 1974).

The Individual and Institutional Actors in UK

In the UK, two key institutions, namely the Building Research Station (BRS) and the Architectural Association School of Architecture (AA), entered a self-proclaimed neo-colonial phase of producing knowledge on Tropical Architecture. The Building Research Station (BRS) began in 1920 in Acton, England and moved to Garston, England in 1925. Its objective was to generate knowledge on building materials with a greater application of science on materials research.

In 1944, the Colonial Office and the BRS collaborated to extend BRS operations into the colonies. The BRS began exploring questions regarding improvement of housing conditions and the development of local resources for building in colonial territories. In 1948, a Colonial Liaison Organization was set up at the BRS to inaugurate research and disseminate knowledge on Tropical Architecture. From 1948 to 1950, information on Tropical Architecture circulated through a circular letter about colonial building. In 1950, the BRS began circulating a newsletter called *Colonial Building Notes*, which was renamed *Overseas Building Notes*. In 1958, the BRS added to its publications on Tropical Architecture through a new series called *Tropical Building Studies*. The BRS's most famous contribution to Tropical Architecture and Bio-climatic Architecture is the device called the Heliodon, which simulates the action of the sun on an architectural model through a point source of light. The Heliodon comprises a table that can be shifted and tilted to get the exact position of the sun on any given day, at any given time, and at any geographical coordinate.

The Department of Tropical Architecture at the AA

The Architectural Association School of Architecture established in 1847 is an independent school that is also the oldest school of architecture in the UK. The AA began to be internationalized in the post-WWII period and soon became the imperial home for Tropical Architecture. Several AA alums, including Jane Drew, Leo De Syllas, and Fello Atkinson, became engaged with Tropical Architecture as they found greater opportunities to practice modernism in the colonies than they did in the UK.

In 1953, the AA School invited Dr. Otto Koenigsberger, George Atkinson, and Leo De Syllas to form an advisory committee to prepare a detailed program for study for the AA's Department of Tropical Architecture.³¹ At the time of the department's founding, the teachers at the AA included Otto Koenigsberger, George Anthony Atkinson, Fello Atkinson, Hope Bagenal, T. Bedford, G.P. Crowden, Jane Drew, D. Forde (professor of anthropology), E. Maxwell Fry, Alfred Harries, J. McKay Spence, and Leo De Syllas.³²

G.A. Atkinson (1915-) was the Colonial Liaison Officer at the Building Research Station at Watford and the Housing Advisor to the British Council Office in England. Atkinson had studied architecture at Bartlett, had traveled to several British colonies to study building construction, and had established himself as an expert on Tropical Architecture. He presented papers at the New Delhi, Washington D.C., and London conferences.

³¹ J. McKay Spence, "The New Role of the Architect in the Tropics," *Architectural Association journal* 71 (July-Aug 1955): 56-50.

³² Architectural Association, *School of Architecture: Department of Tropical Architecture Prospectus* (London: Architectural Association 1955).

Fello Atkinson (1919-1982) graduated from the AA in 1936. He later joined James Cubbitt and Partners (founded 1948), who had accomplished several projects in Africa. Hope Bagenal (1888-1979) was an acoustician who taught at the AA before the establishment of the Tropical Department; he was well known for his acoustic design of the Royal Festival Hall (1948-1951). T. Bedford and G.P. Crowden taught at the London School of Medicine and Hygiene. Jane Drew (1911-1996) and Maxwell Fry (1899-1987) were a husband-and-wife team of architects who had worked on designing houses in Chandigarh, India with Le Corbusier. They were also well known for their design of the University of Ibadan, Nigeria. D. Forde taught anthropology at the University College London.

Leo De Syllas (1917-1964) was one the eleven founding partners of the Architects Co-Partnership (ACP), an English architectural practice set up by AA alums. In 1943, de Syllas went to the British West Indies to work for the Colonial Development and Welfare Organization. While in the West Indies, he designed buildings for education, housing, and health. In 1946, he worked as an architect and planner for the government of Barbados and prepared a master plan of Bridgetown. Upon his return to Britain in 1947, De Syllas rejoined the pre-war partnership, which in 1951 was renamed Architects Co-Partnership (ACP). In 1954, De Syllas set up the ACP branch of Lagos, Nigeria. The major works by him at ACP Lagos included the Bristol Hotel in Lagos, completed in 1961.³³

³³ Anthony Cox and rev. Alan Powers, "Syllas, Stelios Messinesos De (1917–1964)," in *Oxford Dictionary of National Biography* (Oxford University Press, 2004).

Tropical Architecture at the AA

The curriculum at the AA comprised climatology, building materials, climate-responsive design, building services, and sanitation and hygiene. The introduction to climatology in the first term introduced students to the acquisition and reading of climatic data. Students were required to relate abstract climatic data to architectural formal elements. By the 1960s, the Tropical Department had completely redefined Tropical Architecture in terms of environmental design. Studio exercises in the early 1960s represented this development in the evolution of Tropical Architecture.

In 1962, in a one week first-term introductory studio exercise, students were asked to design a shading device. They were given a building with known latitude, a fixed orientation, and a window of given size. They had to plot the sun paths, then design a shading device, such as a sunshade or louvers. The students were given the conflicting requirements of balancing shading, adequate illumination through daylight, and a view from the window.³⁴

In the solution proposed by O. J. Pereira from Kenya, the design of the sunshade had moved from the realm of rule-of-thumb estimation to precise calculations made through plans, elevations, and sections using sun path diagrams. (Figure 3.1) These kinds of presentations became the signature of the Tropical Department. In studio exercises like designing a school or a hospital, students were asked to incorporate climatic data into design decisions based on

³⁴ "Department of Tropical Studies: A Cross-Section of Recent Work and Teaching Methods," *Architectural Association Journal* 78 (April 1963): 302-313.

precise calculations. Studio exercises also involved designing construction details and the choice of suitable materials and technology.

Conclusion

By the end of the 1950s, two distinct strains of climatic design, Tropical Architecture and Bio-climatic Architecture, had emerged from debates in the conferences. Tropical Architecture had migrated from hygiene to architecture. The conferences in the 1950s paradigmatically defined Tropical Architecture as a set of climate-responsive design practices. The conferences debated the kind of technology that would be suitable or appropriate for the tropics. Architects debated the efficacy of simple low-impact technologies and vernacular architecture. Koenigsberger developed Tropical Architecture as a critique of Euro-centric architectural and planning paradigms. He viewed Tropical Architecture as an opportunity to develop a new paradigm in architecture and planning based on energy and resource conservation.

Although Tropical Architecture and Bio-climatic Architecture prescribe similar techniques of climatic design, their objectives, audience, and operative fields are remarkably different. The Olgay brothers approached Bio-climatic Architecture as a method to design regional architecture based on the premise that each climatic region determines certain architectural forms. The Olgay brothers saw this work on Bio-climatic Architecture as a critique of the homogenization produced by industrial architecture in the United States. Their

work is particularly relevant in the post-modern intellections over critical regionalism.³⁵

In contrast to Tropical Architects, who addressed resource scarcity in the decolonizing tropics, the Olgyays specifically addressed an American audience. In *Tropical Architecture*, energy conservation was the central objective of designing with the climate; the Olgyays believed that just as climate determined regional variations in plant morphology, buildings ought to be determined regionally by the climate.³⁶ As the name suggests, Bio-climatic Architecture emerged at the intersection of Biology, Architecture, and Climatology. Bio-climatic Design proposes that our existence ought to follow the rhythms of nature and respect the natural variations by region imposed by the environment.

While tropical architects treated vernacular architecture as a pedagogic object of climatic design, the Olgyay brothers' work romanticized nature and the harmony that vernacular architecture maintained with nature. Tropical Architects were preoccupied with reduction of waste, recycling, and conservation of materials; for the Olgyay brothers, reduction of waste was one of the peripheral arguments for architectural regionalism, and they saw waste was an undesirable outcome of building homogenously. The Olgyay brothers' book on Bio-climatic

³⁵ Alexander Tzonis, Bruno Stagno, and Liane Lefaivre, *Tropical Architecture: Critical Regionalism in the Age of Globalization* (Chichester ; New York; The Netherlands: Wiley-Academic; C. Fonds, 2001).

³⁶ Victor Olgyay, *Design with Climate: Bioclimatic Approach to Architectural Regionalism* (Princeton, N.J.: Princeton University Press, 1963).

Architecture was published in 1963³⁷ and constituted an important text in the tropical curriculum at the AA.³⁸

I argue that Tropical Architecture and Bio-climatic Architecture represent different strains of architectural environmentalism. Tropical Architecture focused on conservation of resources by consuming less and on the use of appropriate technologies in service of a utopian intention to raise the overall standard of living for the poor at a global scale. Bio-climatic Architecture, by contrast, was concerned with living in harmony with nature and with conserving the intrinsic balance within nature that industrial processes threatened to disrupt. Thus, it is no coincidence that environmentalism in the United States tends to be focused more the rights of nature while Third World environmentalism is preoccupied with issues of equity and access to resources.³⁹

³⁷ Ibid.

³⁸ Architectural Association School of Architecture, "Department of Tropical Studies: Bibliography," (London: Architectural Association School of Architecture, 1967).

³⁹ Ramachandra Guha, *Environmentalism: A Global History* (New York: Longman, 2000).

Timeline of Tropical Architecture Conferences		
Year	Place	Conference Title
		Organizer
1931	Paris, France	L'urbanisme Aux Colonies Et Dans Les Pays Tropicaux.
		Congrès International De L'urbanisme Aux Colonies Et Dans Les Pays De Latitude Intertropicale.
1938.	Mexico City, Mexico	Housing in Tropical and Sub-Tropical Countries.
		International Federation for Housing and Town Planning, 16 th Congress.
1952	Lisbon, Portugal	Housing in Tropical Climates.
		XXI International Congress for Housing and Town Planning.
1952 November 18 and 19.	Washington D.C., USA	Housing and Building in Hot-Humid and Hot-Dry Climates.
		Building Research Advisory Board.
1952 December 21-24.	New Delhi, India	Symposium on Scientific Principles and Their Application in Tropical Building Design and Construction.
		National Institute of Sciences of India.
October 18, 1957	Durban, South Africa	Symposium on Design for Tropical Living, Held at Durban.
		The Natal Regional Committee of the South African Council for Scientific and Industrial Research and The University of Natal at Durban.

Table 3-1 Tropical Architecture Conferences

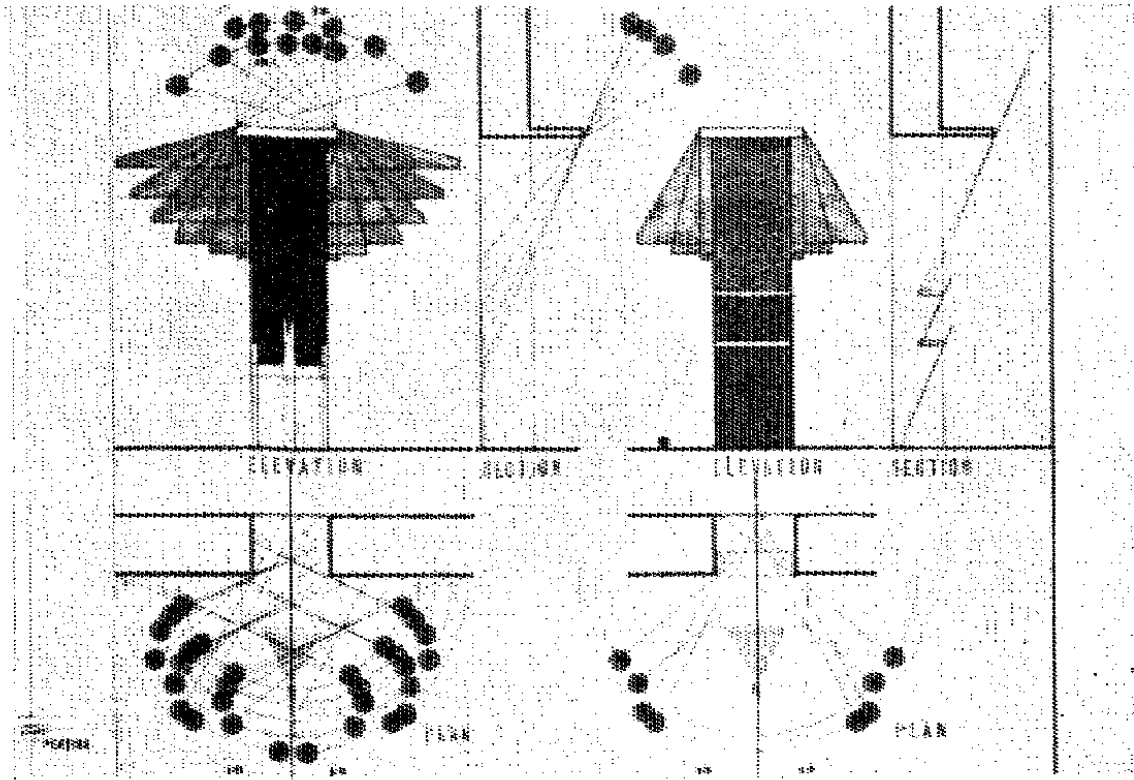

Figure 3.1 Design Solution proposed by O. J. Pereira from Kenya for the design of the sunshade at the AA Tropical Studio, 1962

Source: "Department of Tropical Studies: A Cross-Section of Recent Work and Teaching Methods," *Architectural Association Journal* 78 (April 1963): 302-313.

Chapter 4

Otto Koenigsberger's Contribution to Tropical Architecture

Koenigsberger's most important contribution to Tropical Architecture and Green Architecture is universal energy conservation through climatic design. He pushed for energy conservation as a conviction even in contexts where energy was abundant and cheap. Tropical Architects theorized some key principles that constitute Green Architecture well before environmentalism transformed the discourse of architecture. To achieve energy and resource efficiency, Koenigsberger theorized strategies that included

1. Using vernacular architecture as a pedagogic model for climatic design
2. Critical rethinking of the architectural program
3. Naturally conditioned buildings, which is known as passive technology
4. Building within local technological and material capacity.

In the following section, I discuss Koenigsberger's ideas and their relevance in Green Architecture.

Vernacular Architecture as a Pedagogic Model for Climatic Design

Agenda 21 recommends the use of indigenous building sources as a means to achieve sustainability. This includes using local materials, technologies, skills, and designs that have been used in the vernacular

architecture of a particular region.¹ Treatises on sustainable architecture construct vernacular architecture as an object that represents a balance with the environment.² In this section, I explore the origins of the idea of the relationship between vernacular architecture and its climate responsiveness. I raise the questions: How and when did vernacular architecture become a repository of knowledge on sustainability?

Susan Ubbelohde proposes that the myth of the ecological competence of vernacular architecture was invented through publications from 1963 to 1972, including *House Form and Culture*, *Architecture without Architects*, and *Design with Nature*.³ Indeed, these were canonical texts that reinforced the connection between vernacular architecture and its environmental friendliness. However, I argue that vernacular architecture's ecological qualities were first elaborated through the writings of tropical architects. Ubbelohde proposes that the Olgyay brothers' text on Bio-climatic architecture and that Jane Drew and Maxwell Fry's treatise on Tropical Architecture cannot be regarded as inaugural moments in the construct of vernacular architecture as the prototype for sound ecological practices. I challenge Ubbelohde's claim here to argue that since the 1950s, architects such as Otto Koenigsberger, G. A. Atkinson, Arthur M. Foyle, P.

¹ United Nations Conference on Environment and Development, ed., *Agenda 21: The Earth Summit Strategy to Save Our Planet* (Boulder, Colorado: EarthPress, 1993).

² Joseph F. Kennedy, *Building without Borders: Sustainable Construction for the Global Village* (Gabriola, B.C.: New Society Publishers, 2004).

³ Susan Ubbelohde, "The Myth of the Ecological Vernacular," *Design Book Review* 20 (Spring 1991): 27-29. See Ian L. McHarg and History American Museum of Natural, *Design with Nature* (Garden City, N.Y.: Published for the American Museum of Natural History [by] the Natural History Press, 1969), Amos Rapoport, *House Form and Culture* (Englewood Cliffs, N.J.: Prentice-Hall, 1969), Bernard Rudofsky, *Architecture without Architects, an Introduction to Nonpedigreed Architecture* (New York: Museum of Modern Art; distributed by Doubleday, Garden City, N.Y., 1964).

Johnson Marshall, and the Olgyay brothers began to promote the idea that vernacular architecture existed in harmony with nature and could educate modern architects on climate-responsive design. Ubbelohde does not offer an explanation for why vernacular architecture became associated with sustainability.

In order to understand why vernacular architecture became a repository of knowledge on sustainability, we need to examine the origins of this idea in the transcolonial histories of the British Empire and Tropical Architecture. It is my contention that vernacular architecture served a twofold purpose: on the one hand, modernist architects learnt to use unfamiliar passive techniques of design, and on the other hand, connecting the work of modernist British architects genealogically with pre-colonial vernacular architecture legitimized the work of British architects in the tropics.

Tropical architects contributed to the shifting attitudes towards vernacular architecture by foregrounding the climate responsiveness of vernacular buildings, and in doing so, they departed from the colonial discourse on vernacular architecture. As recently as the early twentieth century, colonial sanitation discourse attributed several tropical diseases to the poor quality of vernacular architecture in terms of lack of hygiene, natural light, and ventilation. As I have noted in the last chapter, in the late nineteenth and early twentieth century, Tropical Architecture developed in the discipline of Hygiene, which was circulated through colonial hygiene manuals. The hygiene manuals wrote of vernacular architecture in pejorative terms. Written by sanitary engineers, these hygiene

treatises acknowledged the climate responsiveness of these architectures but saw little value in the cumulative knowledge which vernacular architecture represented.

J. A. Turner, author of a sanitation manual, judged the poor construction of working-class housing as representative of the *lack* of knowledge on construction and hygiene practices:

It must be carefully remembered that in India and Burmah the actual construction of dwellings is almost universally done by ignorant native workmen upon whom the unwritten rules of by which their forefathers worked are equally binding, and this in spite of official "supervision" ...that disease will continue to claim its victims in excess until, by slow degrees, the narrow streets are cleaned and widened and the wretchedly built houses replaced by others of suitable form and construction.⁴

Sanitary engineers criticized vernacular architecture for its bad design and viewed it as an object in need of technical improvement. Birendranath Ghosh in *A treatise on hygiene and public health, with special reference to the Tropics* defined the hut as a structure devoid of masonry above the plinth level. He listed why the construction of these huts was unhealthy and how they could be materially improved with minor changes:

The floors of such huts are commonly earth without any damp proof course or bed of concrete and consequently very damp. Huts may also be floored either with split bamboos or with *jargool* planks. The plinth should be at least 2 ft. or 3 ft. high. This will keep the floors dry and properly drained. The walls are either of wood, unburnt bricks, bamboo matting, plastered over with mud, or corrugated iron or tin. The roofs are made either of thatch, paddy straw, *ooloo* grass, palm leaves or country tiles (*kharpals*), or corrugated iron... The use of cowdung as a covering for the floor and walls should be stopped. Mud floors should be dug up and removed every few months.⁵

⁴ J.A. Turner, "Chapter Xii: Housing of the Working Classes in Large Cities in India," in *Sanitation in India* (Bombay [renamed Mumbai]: Times of India, 1922), 956-976.

⁵ Birendra Nath Ghosh, "Houses and Buildings," in *A Treatise on Hygiene and Public Health, with Special Reference to the Tropics* (Calcutta: Hilton, 1924), 113-125.

Not only were the *bustees* (settlements of these huts) criticized for their poor material choices, but they also were disapproved in terms of site planning. The *bustees* lacked proper light and ventilation. (Figure 4.1) Sanitation manuals recommended how the *bustees* could be made healthier by more outdoor spaces between individual units and better ventilation. The sanitation manuals rarely appreciated any aspect of vernacular architecture.

To the hygienists, the climate effectiveness of materials such as thatch, was less important than the poor hygiene performance of thatch. The *Moore's Manual of Family Hygiene*, recommended *pukka* (permanent roofs) as opposed to thatch *kutcha* (temporary, perishable roofs) and critiqued thatch for its poor sanitation and fire risks:

There are few stations in which the newcomer has much choice of a bungalow; he is generally obliged to take whatever house may be vacant at the time and suited his modest pay. Thatched roofed bungalows are cooler, and in the rains drier than those with terraced roofs, but they are burdened with many disadvantages. If cool, they are dark, and swarms of mosquitoes hide about the bamboos and thatching of their verandahs. Rats take up their residence above the ceiling cloths, occasionally snakes, or civet cats; the latter in the breeding stink abdominally. In the rains the thatch rots, and during the annual repairs the bungalow is filled with the most objectionable dust. There is, moreover, the danger of fire, not only arising from arising from the carelessness of one's own servants, but also originating elsewhere from the carelessness, of others, and carried on to the thatch in the form of floating sparks. It is impossible to keep such a dwelling free from mosquitoes. Of late improvement is manifest in the type of houses built for the European residents. The old-fashioned thatch roof has been largely replaced by *pucca* or tile roofs.⁶

⁶ Cuthbert Allen Sprawnson, *Moore's Manual of Family Medicine and Hygiene for India* (London: J. & A. Churchill, 1921), 543-560.

After the Second World War, the disciplinary home of Tropical Architecture shifted from sanitary engineering to architecture. Sanitary engineers considered the unhygienic qualities of vernacular architecture as symptomatic of ignorance. In the 1950s, architects departed from the discourse on vernacular architecture constructed by sanitary engineers and debated the efficacy of vernacular architecture. Otto Koenigsberger, G. A. Atkinson, Fello Atkinson, Arthur Foyle, and P. Johnson Marshall in England, and the Olgyay brothers in the United States revered vernacular architecture as a repository of knowledge on climate responsiveness and resource maximization. This coincided with the 1950s rise of the European architectural community's increasing interest in vernacular architecture, which preceded the 1960s Rudofsky moment of *Architecture without Architects*.⁷

Tropical Architects and Vernacular Architecture in The 1950s

How did tropical architects in the 1950s view vernacular architecture? In the early 1950s, journals in the UK published extensively on architecture in the tropics. These publications belonged to the genre of architectural travelogues, which documented and circulated two extreme genres of architecture: the new modern tropical architecture by European architects and vernacular architecture. British architects juxtaposed these two extreme genres to legitimize modern architecture by establishing continuities between these two genres through climatic design.

⁷ Rudofsky, *Architecture without Architects, an Introduction to Nonpedigreed Architecture*. Also see Felicity Scott, "'Bernard Rudofsky' Allegories of Nomadism and Dwelling " in *Anxious Modernisms: Experimentation in Postwar Architectural Culture*, ed. Sarah Goldhagen and Rejean Legault (Cambridge: MIT Press, 2000), 215-237.

Vernacular architecture served a twofold purpose: it not only was meant to provide modern architects with guidance on how to use passive techniques of design but also to show how modern architecture in the tropics followed the same rational principles that were developed through the wisdom of vernacular architecture over centuries. In appraising vernacular architecture as a pedagogic object, British architects not only translated indigenous knowledge into scientific discourse easily consumable in Anglophone world but also established continuity between pre-colonial vernacular architecture and modern architecture.

These travelogues on vernacular architecture were comprehensive in their breadth of knowledge, but they lacked scientific depth. These publications began recording how vernacular architecture responded to the climate at a theoretical level and how certain architectural features could make the indoor climate pleasant. These compendiums were largely anecdotal in nature and did not contain any empirical presentation of climatic data to ascertain the efficacy of vernacular architecture. For instance, if architects argued that shading devices helped ameliorate the effects of the sun by lowering temperature, there were no actual measurements of temperatures with and without the sunshade to empirically quantify the temperature reduction due the use of the sunshade. These publications accomplished a change in attitude towards vernacular architecture and carried the promise to translate everyday practices of vernacular architecture into academic knowledge for architects.

The journal articles on vernacular architecture ranged from ethno-scientific observations on climatic design to the study of vernacular architecture as a

socio-cultural object. In 1953 and 1954, *Architectural Design* published two issues on architecture in the tropics. The 1953 issue constructed vernacular architecture as an object that represented social, climatic, spiritual, and material harmony with the environment. In 1953, E. A. Gutkind published an essay titled, "How the Other Half Builds" in *Architectural Design* in which he called for anthropological investigations of vernacular architecture to understand the socio-spatial relationships in societies:

The building of houses in primitive and past societies is an integral part of the social and spiritual life of the people, of the group and of the environmental experience. It is more than a mere utilitarian adaptation to the needs of the everyday life. We have lost the high sense of social awareness which distinguished these societies and we fail to express in most of our dwellings in their layout and in the simple houses of past generations. We should try to understand why these buildings of other peoples excel in functional and social clarity, why they express the social and religious aspirations, and how this has been achieved.⁸

For G. A. Atkinson, vernacular architecture represented a rich source of knowledge on climate design. In a conference paper titled "The Effects of Warm Climates on Building Design" presented in New Delhi, India, G. A. Atkinson proposed:

Traditional building almost always demonstrates the effect of climate on design. Unfortunately, descriptions of traditional building in warm climates are not readily available; further studies, prepared against a background of climatological data are required.⁹

Atkinson continued to travel to most conferences in the 1950s worldwide and continued to argue that the climatic design of a region could be learnt from vernacular architecture. In a paper presented at the Tropical Architecture

⁸ E. A. Gutkind, "How the Other Half Builds," *Architectural Design* Vol. XXIII (January 1953): 2-4.

⁹ George Anthony Atkinson, "The Effects of Warm Climates on Building Design" (paper presented at the Proceedings of the Symposium on Scientific Principles and their Application in Tropical Building Design and Construction, held at New Delhi, December 21-24, 1952, New Delhi, 1955), 42-50.

conference in Washington D.C., Atkinson advanced how a traditional Malay house was made comfortable in a hot and humid climate. Atkinson explained that architects needed to take advantage of the breeze to maintain thermal and hygrometric comfort. For that, the first step would be to determine the orientation of the building by striking a balance between orienting the building openings in the direction of the breeze and also preventing sun penetration by keeping a north-south orientation. By keeping window openings below the sill level and at the ceiling level, the intake of cool air and expunging of hot air could be ensured. The Malay house with a low-eaved verandah embodied these principles.¹⁰ (Figure 4.2) In the figure of the Malay house in Malacca, being raised on stilts keeps the floors dry during the rain. The high ventilators and the porous bamboo construction ensure a steady breeze flow through the structure. Atkinson suggested that by documenting vernacular architecture in terms of its climatic design, modern architects could learn how to design buildings without use of mechanical conditioning.

For Arthur M. Foyle, vernacular architecture was a repository of knowledge on the use of local materials and construction techniques that had evolved through trial and error. He regarded African vernacular architecture built with mud as part of complete societal system and as the only kind of architecture that would be feasible in the tropical African villages. In a paper titled, "Traditional

¹⁰ George Anthony Atkinson, "Building in Warm Climates," in *Housing and Building in Hot-Humid and Hot-Dry Climates*, Building Research Advisory Board, Research Conference Report No. 5, Conference Held at Washington D.C, November 18 and 19, 1952 (Washington D.C.: The Building Research Advisory Board, Division of Engineering and Industrial Research, 1953), 66-73.

Materials and Construction” presented at the Tropical Architecture conference in London, Foyle advocated:

The development of stabilized earth construction is likely to have a great significance in the future for through its increased use there lies a real hope of raising the standard of village building. Earth is likely to be the only material which the average villager will be able to afford, the only cost being that of transport, while in many localities there is already a firm tradition of earth building. There is still room, however, for an immense amount of research into stabilized earth construction particularly important being the collection of data on weathering.¹¹

For Foyle, the role of the tropical architect was to apply climatic data to the weathering of temporary materials such as mud and to improve the longevity of that material. In order to accomplish research on mud construction, the British architects would have to learn and document existing techniques of construction. The notion that mud is probably the only material that the rural inhabitant might be able to afford continues to be perpetuated in treatises on sustainability.¹²

For the Olgay brothers, vernacular architecture offered a lesson in how architecture was determined by a specific region and its climate. By analyzing several examples of architecture in similar climatic regions and comparing them, the Olgay brothers found similarities between their architectural solutions. For them, vernacular architecture could teach modern architects how to design regional architecture and respect nature.¹³

The practice of formulating vernacular architecture as a didactic object of climatic design was inaugurated through the travelogues of Tropical Architects

¹¹ Arthur M. Foyle, "Traditional Materials and Construction," in *Conference on Tropical Architecture 1953*, ed. Arthur M. Foyle, *A Report on the Proceedings of the Conference Held at University College, London, March, 1953* (London: G. Allen & Unwin, 1954), 83-88.

¹² Kennedy, *Building without Borders: Sustainable Construction for the Global Village*.

¹³ Victor Olgay, *Design with Climate: Bioclimatic Approach to Architectural Regionalism* (Princeton, N.J.: Princeton University Press, 1963).

and continues in the practice of Green Architecture. These 1950s publications inaugurated the drive for accurate documentation and scientific interpretation of vernacular architecture so that indigenous knowledge could be translated into global architectural knowledge.

Koenigsberger and Vernacular Architecture

Koenigsberger proposed to not only modernize vernacular architecture as an architectural object through material and technological improvements but also proposed that vernacular architecture represented a body of knowledge to be scientifically interpreted for global consumption. Tropical Architects constructed vernacular architecture as pedagogic tectonic objects from which they could draw ethnographic knowledge on climatic design; construction practices; and resource conservation.

Otto Koenigsberger was not always enamored with vernacular architecture. In 1939, he traveled to several parts of India to study pre-colonial and colonial architecture. On this trip, he focused on big buildings like government offices, hospitals, and museums. He took notes on the construction techniques and cost of the buildings. The result of this trip was an unpublished travel report. He began documenting pre-colonial monuments and colonial buildings for their technological competency, use of materials, and spatial configuration in the context of local materials, climate responsiveness, and overall efficiency. He noticed how *Mughal* monuments, which did not belong to the genre of vernacular architecture, used features such as the *Jalis* (stone screens) to control light and temperature. (Figure 4.3) His notes were replete with

how colonial buildings were poorly constructed and maladapted to the Indian context. During this trip, he saw vernacular architecture as “primitive”. He observed the vernacular-inspired architecture of Santiniketan and Sriniketan, noting that “they are lodged in primitive buildings in a poor country and suffer from want of funds.”¹⁴

There is no archival evidence regarding what Koenigsberger specifically thought of vernacular architecture in Mysore, but he seemed to respect “indigenous” architecture (by which he meant architecture that was not colonial) more than colonial architecture. While in Mysore, he drew lessons from monuments such as *Mughal* tombs and keenly observed the technological mistakes in colonial buildings.

As an educator in Bangalore in India, Koenigsberger was asked to prepare a report on the training of architects. In the report titled “Report on the Teaching of Architecture at the College of Engineering, Bangalore” he questioned the redundancy of colonial ethno-stylistic taxonomies of Ferguson’s architectural history¹⁵, Koenigsberger proposed that architects ought learn from historic buildings about the use of materials, technologies, and design. He argued:

Ferguson’s book was written about 100 years ago, in 1840, Banister Fletcher’s was first published in 1896. Ferguson merits as a teacher of Architecture in general ...It is wrong to teach them [students] anything about Dravidian, Chalukayan, and Indo-Aryan style. These are names and

¹⁴ O. H. Koenigsberger, *Journey of Studies of the Mysore Government Architect to Madras and North India February 29, to April 1, 1940*, OKPP, London.

¹⁵ James Fergusson, *History of Indian and Eastern Architecture* (New York: Dodd, Mead & Co., 1891).

classifications invented by Ferguson for the first and preliminary classification of Indian Architecture. They were useful for the beginning but they have been given up now-a-days as not in keeping with the facts and as not sufficiently systematic because they mix up geographical, historical, philological, and architectural principles of classification.”¹⁶

Koenigsberger, therefore, called for a modern interpretation of recent Indian architecture that departed from Ferguson's colonial classification. As the chief architect of a modern Mysore PWD where innovation and experimentation were the norm, he realized how architecture in princely Mysore in the past hundred years had changed. He called for an ethnographic analysis of buildings in Mysore to document their construction techniques and functionality. According to Koenigsberger, the knowledge generated through this documentation ought to constitute the modern training of architects.¹⁷ While in India, Koenigsberger called for interpreting all kinds of buildings, including monuments, for technological finesse. Later in London, his emphasis would shift entirely towards learning from vernacular architecture. His formulation of vernacular architecture certainly changed in London. I speculate that after the failure of the prefabricated housing units in Delhi and his subsequent arrival in London, Koenigsberger became acutely aware of the technological capacity of societies and became a strong advocate of learning from vernacular architecture.

In 1953 at the Tropical Architecture conference at University College London, Koenigsberger presented a paper titled “Tropical Planning Problems” in

¹⁶ Otto H. Koenigsberger, Report on the Teaching of Architecture at the College of Engineering, Bangalore, OKPP, London.

¹⁷ Ibid.

which he announced that the sanitary engineering discourse on vernacular architecture was problematic and overrated. He proposed:

It is already becoming clear that the virtues of wide streets are not as uncontested and axiomatic as the sanitary engineers of the earlier decades of this century believed. The arid tropics, for instance, have a tradition of narrow arcaded and sometimes even covered streets which provide shade and relief from heat and glare. Traditions of this type should not cast aside lightly, and may well find a place in the most modern planning scheme.¹⁸

After immigrating to London, Koenigsberger prepared a photographic inventory of global tropical buildings with the intention of publishing a book on Tropical Architecture. In this unpublished manuscript on Tropical Architecture, each photograph documented how architectural elements had been used for climatic design. Koenigsberger presented vernacular architecture as an object from which modernist European architects could learn the climatic logic of vernacular architecture. For example, he collected photographs of narrow streets in locations like Tangiers, Morocco (Figure 4.4) and Bahrein Island, (Figure 4.5) to show how narrow streets protected from the harsh sun in hot dry climates. The text of the caption in Koenigsberger's manuscript reads: "Street scene in Tangiers: Streets in hot/dry regions are narrow and care is given to provide shade through projecting roofs and overhanging plants."¹⁹ Likewise, the sketch of street in Bahrein Island was meant to educate designers about sun-protecting architectural features such as archways, projecting balconies, and sunshades,

¹⁸ Otto H Koenigsberger, "Tropical Planning Problems," in *Conference on Tropical Architecture 1953*, ed. Arthur M. Foyle, *A Report on the Proceedings of the Conference Held at University College, London, March, 1953* (London: G. Allen & Unwin, 1954), 13-20.

¹⁹ Otto H. Koenigsberger, Unpublished Book Manuscript: Tropical Architecture Private Papers in the collection of Patrick Wakley (Uncatalogued), Development Planning Unit, University College London, London

which ought to be included in the tropical architect's design repertoire. To argue that narrow streets were useful, he contrasted pictures of narrow streets with wide ones to show how ineffective wide streets were in a hot dry climate. (Figure 4.6) Koenigsberger's approval of narrow streets would continue in his later published treatise of Tropical Architecture in which he persistently promoted the merits of narrow streets as effective shading devices. (Figure 4.7) He also never failed to mention how narrow streets consumed less resources and space. (Figure 4.8)

By the early 1950s, Koenigsberger viewed vernacular architecture not only as a pedagogic object of climate responsiveness but also an exemplar of resource maximization. Even slums offered lessons in how buildings could be made by recycling materials and consuming fewer resources. For instance, he cited a picture of a *Bidonville* in Morocco and used it as an example of how kerosene tins could be recycled to make a shelter. (Figure 4.11)

Likewise, he cited other examples of how vernacular architecture could teach architects in Western Europe to work with lower space standards. Koenigsberger was an ardent advocate of the use of outdoor space. He frequently cited how the culture of outdoor living in the tropics could mean that architects could build less. He used photographs of outdoor living to show how cooking, sleeping, dining, and social activities were performed outside in hot climates and could mean cutting down on building. For example, a photograph taken in southern Rhodesia of people pounding corn and cooking outdoors was included in his unpublished manuscript to support his argument that by

preserving outdoor living, architects could consume less. (Figure 4.9) Koenigsberger cited examples from vernacular and historic architecture in the tropics to constantly stress why European standards and style of living ought not to be replicated in the tropics.

In the 1950s, like his colleagues, Koenigsberger's explanation of how vernacular architecture saved energy and resources was anecdotal. There was no empirical data on how much energy and resources could be saved by using the knowledge implicit in the practice of vernacular architecture. By 1973 when Koenigsberger published the *Manual of Tropical Housing and Building*, some aspects of vernacular architecture were explained with greater theoretical rigor. For example, in the manual, Koenigsberger explained why and how a courtyard cooled down temperatures by reducing heat admission and absorption during daytime and by radiating heat during the night.²⁰(Figure 4.12)

In the field of sustainable construction and environmental design, the practice of explaining how vernacular architecture utilizes passive techniques to moderate the external climate has now entered the field of computer simulation. In a 2007 paper titled "Passive cooling effect of traditional Japanese building's features", the authors Hiroshi Yoshino, Kenichi Hasegawa, and Shin-ichi Matsumoto quantify the cooling effects of natural ventilation, solar shading achieved through a thatched roof, and the thermal mass gained by an earthen

²⁰ Otto H. Koenigsberger, T. G. Ingersoll, Alan Mayhew, and S. V. Szokolay, *Manual of Tropical Housing and Building* (London: Longman, 1974).

floor.²¹ The authors of this paper argue that their scholarly contribution lies in the field of promoting the use of vernacular architecture in sustainable construction. The practice of drawing knowledge on climatic design from vernacular architecture continues to this day in the discourse of Green Architecture.

Critical Rethinking of the Architectural Program: Sustainable Consumption

The Second Chapter in *Agenda 21* titled "The Quality of Life on Earth" proposes that excessive consumption accompanied by reckless use of energy and generation of large amounts of waste is unsustainable in the long run.²² Sustainable consumption has been defined in terms of consuming fewer natural resources, using minimal energy, producing less waste, minimizing the production of toxic materials, and reducing pollutants so that the environmental quality for the future generations is not jeopardized.²³ Regulating and reducing consumption contradicts the free market consumer culture of rich nations, and the developing world resents being told to consume less. Nations like India and China are going through intense development right now and argue that the so-called rich nations have had their turn of polluting and consuming in the past; they further argue that now that it is their turn to experience the lifestyles of the First World, they are being asked to consume less. The problem here is how to convince people to consume in a way that does not hurt the environment.

²¹ Hiroshi Yoshino, Kenichi Hasegawa, and Shin-ichi Matsumoto, "Passive Cooling Effect of Traditional Japanese Building's Features," *Management of Environmental Quality: An International Journal* 18, no. 5 (2007): 578-590.

²² United Nations Conference on Environment and Development, "Chapter 2: The Quality of Life on Earth," in *Agenda 21: The Earth Summit Strategy to Save Our Planet*, ed. Daniel Sitarz (Boulder, Colorado: EarthPress, 1993), 60-128.

²³ Sylvi Ofstad, Liv Westly, and Tone Bratelli, (paper presented at the Symposium: Sustainable Consumption, Oslo, Norway, 19-20 January 1994).

In the developed world, the ideological and epistemological construct of sustainable consumption has been shaped by a number of discourses, which include making the environment part of the consumer preference, forging environmental citizenship, disseminating environmental knowledge, and voluntary simplicity.²⁴ How do these discourses translate into architecture? Or, in other words, how does sustainable consumption translate into the Green Architectural discourse?

The answer is efficiency of energy and materials. This translates into energy-efficient designs, using renewable sources of energy such as wind and daylight, and passive techniques of controlling the indoor climate. In terms of using materials, sustainable consumption means using materials that are not toxic or do not produce toxic by-products, do not permanently deplete natural resources, consume less energy in production and transport, and produce minimal waste. While there is abundant literature on energy and resource efficiency, one of the key ideas emerging in field of sustainable consumption is dematerialization. When translated in the field of building, this calls for critically assessing consumer needs and consuming less, or dematerialization, to really minimize building requirements for a given project.

In 1998 in a seminar on sustainable architecture at MIT, William Mitchell proposed dematerialization as an important strategy of building “less” and

²⁴ Kersty Hobson, "Competing Discourses of Sustainable Consumption: Does the 'Rationalization of Lifestyles' Make Sense?," in *The Earthscan Reader in Sustainable Consumption*, ed. Tim Jackson (London, Sterling VA: Earthscan, 2006), 305-327.

therefore using less material resources.²⁵ Mitchell argued that with increased telecommuting and electronic services, architects could drastically reduce the quantity of buildings needed, which would contribute to the conservation of energy and resources. The idea of critically examining the architectural program to cut down building needs to build less in the first place so as to consume less was theorized by Otto Koenigsberger in 1953.

In a paper presented at the Tropical Architecture Conference at the University College London, Koenigsberger suggested a critical reformulation the architectural and urban program in the tropics.²⁶ He warned that architects working in Europe tended to work with inflated architectural programs, which were redundant in the tropics. Because a lot of living functions in the tropics could be performed outdoors, the architect could build less and maximize the use of building materials.²⁷ Koenigsberger proposed that the culture of outdoor living is something that architects should not dismiss or discourage. He proposed:

A distinct advantage of working in the tropics is the large scope for outdoor living. In temperate regions, most of the functions of everyday life take place indoors, but in southern countries, workings, cooking, eating and sleeping rarely require closed rooms. This is important because it allows lower standards of accommodation provided there is nearby, sufficient space for outdoor activities. In view of the poverty of most tropical countries, this reduction of the need for expensive building work is most welcome, but it results in a tendency for towns to develop into widely spread or even sprawling one-storied settlements. Settlements of this kind have [problems and disadvantages of their own. Most important among these are large distances and high cost of roads and services.²⁸

²⁵ J. William Mitchell, "Dematerialization, Demobilization, and Adaptation," in *Dimensions of Sustainability : Architecture Form, Technology, Environment, Culture*, ed. Andrew Scott (London ; New York: E & FN Spon, 1998), 7-12

²⁶ Koenigsberger, "Tropical Planning Problems."

²⁷ Ibid.

²⁸ Ibid.

It could be easily argued that Koenigsberger's statement could be contradicted in the same way that sustainable consumption has been challenged by the Third World--, that is, while the First World consumes excessively, they blame the Third World's excessive population for environmental problems and ask the Third World to consume less. The question here is whether Koenigsberger, being a European architect in an imperial center like London, recommended that the tropics build less and consume less while endorsing the consumption patterns in Europe and America.

Koenigsberger cautioned that American standards of planning based on high rates of automobile ownership would have a disastrous application in Tropical countries, which had much lower rates of car ownership. He proposed that tropical cities and towns should be designed as a group of neighborhood units on pedestrian scale, which ought to be connected by public transport. He also criticized the car-intensive urbanism as a mistake in the West.²⁹

Tropical architects like Koenigsberger who had immersed themselves in tropics for sustained periods of time were beginning to see the limits of resources and the impossibility of the car-dependent single family home lifestyle on a global scale. This is the reason why resource and energy efficiency were central to Koenigsberger's thinking, even in places where resources and energy were abundant. It is paradoxical that these ideas, which definitely are precursors to the concept of sustainable consumption, developed in a neo-colonial context. On the one hand, architects in London were consciously trying to continue a colonial relationship with the tropics, and on the other hand, Tropical Architecture

²⁹ Ibid.

embodied a genuine critique of colonialism in terms of exploitation and consumption of natural resources. This paradox continues to this day in the debates on sustainability and Green Architecture in terms of the relationship between the First and the Third World.

Naturally Conditioned Buildings

In 1965, the architectural research conducted by the Department of Tropical Architecture was implemented in practice through the establishment of a consultancy service called the Tropical Advisory Service, initiated for practicing architects and government departments on the design of buildings in the tropics. Its first commission was to advise about the design of a British High Commission building at Islamabad. Subsequently, the Tropical Advisory Service advised the British architects Peter and Alison Smithson on the British Embassy in Brasilia in 1966 and the Kuwait Mat Building in 1969.

Koenigsberger theorized that one of the objectives of Tropical Architecture was to design naturally conditioned buildings. For the purpose of Tropical Architecture, he classified buildings into two kinds: naturally conditioned and mechanically conditioned, which translates into passively³⁰ and actively³¹ conditioned. He defined a naturally conditioned building as one “which has a planned thermal response without the use of mechanical conditioning methods,

³⁰ Building configurations which take advantage of a natural, renewable resource (like sunlight, cooling breezes, etc.) Passive design strategies typically do not involve any moving part or mechanical processes.

³¹ Traditional heating, cooling and ventilating systems which use mechanical means to artificially condition (cool, heat, ventilate) the air supply in buildings, and draw power for these mechanical processes from electricity or gas.

but it is not an unconditioned building".³² By the mid-sixties, Koenigsberger specifically used climate responsiveness to achieve what Reynar Banham called "selective design" to conserve energy.³³ "Selective Design" translated into "naturally conditioned" in Koenigsberger's vocabulary, which he defined as selecting and controlling the environmental features to minimize exposure to unwanted climatic conditions and maximize exposure to desirable climatic features.³⁴

As I have shown in chapter two, the state architectural requirements in Mysore necessitated Koenigsberger's engagement with passive conditioning techniques. In the early 1950s, numerous publications on Tropical Architecture recorded several passive methods of achieving comfort. In one of the early publications, G. A. Atkinson recommended design techniques such as shading, passively induced wind movements, and thermal insulation.³⁵ Through the 1950s, these publications were anecdotal in nature—that is, they merely listed what kind of passive techniques could be used. These publications circulated globally to serve as a platform for consolidating techniques of passive climatic design.

Over the course of the 1950s and 1960s, Tropical Architecture evolved into a discourse, which quantified passive techniques of conditioning buildings by correlating calculations of architectural elements with meteorological data.

³² Tropical Advisory Service, "British High Commission, Islamabad: Climatic Design Report," (London Prepared for the Ministry of Public Building and Works, London by Tropical Advisory Service, Department of Tropical Studies, Architectural Association School of Architecture 1965-66).

³³ Reynar Banham, *The Architecture of the Well-Tempered Environment* (London; Chicago: Architectural Press; University of Chicago 1973).

³⁴ Tropical Advisory Service, "British High Commission, Islamabad: Climatic Design Report."

³⁵ George Anthony Atkinson, "Mass Housing in Rapidly Developing Tropical Areas," *Town Planning Review* 31, no. 2 (July 1960): 85-102.

Tropical architects drew on a wide variety of sources, which included their colonial experience of working in the tropics, older colonial architectures, ethnoscientific studies of tropical vernacular architectures, research conducted by the Building Research Station, and the sciences of climatology, biology, and hygiene.

Techniques for energy and resource conservation evolved through studio exercises at the Department of Tropical Architecture and the work of the Tropical Advisory Service, initiated for practicing architects and government departments on the design of buildings in the tropics. The Tropical Advisory Service comprised teams of students and staff at the Tropical Department at the AA, who collaborated to develop energy-conservative techniques for their assigned commissions.

As early as the 1960s, Koenigsberger had started using the term “climate consciousness” in the reports of the Tropical Advisory Service. Climatic consciousness was a paradigm predicated upon design strategies to minimize energy consumption of a building without compromising on physiological comfort. This meant designing a building to minimize the penetration of unwanted environmental elements and maximize the exposure to desirable climatic features.³⁶ “Climate conscious” later appeared as “energy conscious” in the “Western” discourse of sustainability. An “energy conscious” design primer for European architecture published in 1992, almost thirty years after Koenigsberger used the term “climate conscious”, resonated with the doctrine of the Tropical Architects in its opening statement:

³⁶ Tropical Advisory Service, "British High Commission, Islamabad: Climatic Design Report."

To make a building is to create a system linked to its surrounding environment, and subject to a range of interactions affected by the seasonal and daily changes in climate.³⁷

Here it is important to stress that Koenigsberger did not invent passive techniques of conditioning a building, but his contribution lies in developing knowledge on how meteorological data could be correlated to architectural design to calculate the architectural features best suited for passive design. This was an era where computer applications in the field of environmental design were in the process of being inaugurated.

Koenigsberger's repertoire of design strategies through which energy consumption could be minimized included building orientation; size of the building; internal planning; use of appropriate building materials; external surface treatments; control of solar penetration; induced external air movement; the design of external spaces around the building; the size and design of external openings; construction of solid elements; and the building's connection with the ground.³⁸

Koenigsberger did not use the term "renewable energy", but he made the use renewable natural sources of energy, like the use of wind in cooling buildings and sunlight for indoor lighting. These techniques are widely used in passive design in Green Architecture. Koenigsberger theorized and quantified these

³⁷ John R. Goulding, J. Owen Lewis, and Theo C. Steemers, eds., *Energy Conscious Design: A Primer for Architects* (London: B. T. Batsford for the Commission of The European Communities; Solar Energy Applications to Buildings Programme and Directorate General XIII for Telecommunications, Information Technology and Innovation, 1992).

³⁸ Tropical Advisory Service, "British High Commission, Islamabad: Climatic Design Report."

design variables correlated with climatic data in the form of knowledge easily accessible and usable by architects.

Kuwait Mat Project, Unbuilt, 1969

Koenigsberger served as a consult to Peter and Alison Smithson for the Kuwait Mat Project (1969), which was a mixed-use government office project. This project was never built, but it demonstrates a crucial point about the paradigmatic differences between Tropical Architecture and the mainstream of English architecture represented by Peter and Alison Smithson. There were no financial or energy constraints in Kuwait on the use of air-conditioning in public buildings,³⁹ yet Koenigsberger recommended a series of climate-responsive design features, which would cut down energy consumption. I argue that Koenigsberger proposed to cut down energy consumption because Tropical Architecture had evolved into a paradigm of universal energy conservation and resource maximization. Tropical architects did not merely argue for energy conservation in contexts where energy was scarce, but followed universal energy conservation even in places like Kuwait that would seemingly never run out of energy. To me, this signifies a sense of distributive justice on a global scale even though Tropical Architecture was founded on a neo-colonial agenda.

The Smithsons designed the government complex on a grid of 20m by 20m, interspersed by courtyards and open interstitial spaces that made it look like a Mat (Figure 4.14) of open and covered spaces, hence the name “Mat

³⁹ Tropical Advisory Service, "Climate Analysis and Design Recommendations for Kuwait Old City," (London Prepared for Peter and Alison Smithson by Tropical Advisory Service, Department of Tropical Architecture, Architectural Association School of Architecture 1969).

Building". The building was raised on *pilotis* (Figure 4.15) to provide shaded walkways and parking. The stepped profile of the building was designed to shade the external walls. (Figure 4.15 and Figure 4.16)The plan comprises stair and service hooded towers placed diagonally at 40 m intervals. (Figure 4.17) These towers were supposedly in a visual dialogue with the existing minarets in the city.

In the Kuwait project, Koenigsberger proposed to cut down sun exposure and sun penetration through a North-South orientation; clustered layout organized around courtyards; restricted openings on the North-South walls; and heavy insulated external walls and roofs.⁴⁰In addition, he proposed shaded walkways and parking spaces. The Smithsons followed these recommendations to a large extent in preparing their designs.

However, these suggestions made by Koenigsberger were not merely anecdotal bits of climatic advice but backed by precise calculations based on sun diagrams. In the early 1950s, tropical architects merely suggested passive techniques at a theoretical level, but by the 1960s, they had developed precise methods to quantify passive design. For example, in determining the best possible orientation for the galleries, he calculated the sun penetration into the interstitial spaces within the building for four possible orientation angles: 0°, 22.5°, 40°, and 67.5°. These calculations were made by a series of sun diagrams, which calculated the width of the sun-patch for each angle to determine the best possible orientation for the Kuwait complex. (Figure 4.18, Figure 4.19, and Figure 4.20)

⁴⁰ Ibid.

Students of the Tropical Department used meteorological data to calculate wall thickness, window openings, ventilation methods, and other passive methods to arrive at architectural solutions. The climate included geographical coordinates such as latitude, longitude, and altitude as well as meteorological data such as annual range of temperature, daily range of temperature, rainfall pattern, and wind flow diagrams.⁴¹ The architectural presentations of the tropical students were distinguished by the juxtaposition of visual representations of meteorological data in the form of solar path diagrams, wind flow diagrams, and rainfall charts, which rationalized architectural form.

Building Within Local Technological and Material Capacity

The *Agenda 21* recommends the use of local materials and indigenous technologies.⁴² One of the objectives of Green architecture is to provide “shelter for all”. Architects engaged with sustainable construction uniformly acknowledge that this goal is simply impossible if the exemplar for shelter is the Western European or American notion of a middle-class house.⁴³ Practitioners of sustainable development agree that the Earth simply does not have the resources to sustain the American dream lifestyle for all. The right to shelter for all is attainable through self-help, use of simple inexpensive technologies, local materials, and technologies. This idea was widely circulated and developed through the writings of Tropical Architects. Although they never used the term

⁴¹ George Anthony Atkinson, "Mass Housing in Rapidly Developing Tropical Areas," *Town Planning Review* Vol. 31, no. 2 (1960).

⁴² United Nations Conference on Environment and Development, "Chapter 2: The Quality of Life on Earth."

⁴³ Kennedy, *Building without Borders: Sustainable Construction for the Global Village*.

“sustainable”, tropical architects discussed the appropriate use of technology and materials in contexts where resources were scarce and importing technologies and materials was difficult or expensive.

As a tropical consultant to construction of the British Embassy in Islamabad, Koenigsberger proposed:

The objectives of the Tropical Advisory Service was threefold: to assist in the design of buildings that would be “climate conscious” that is designed to provide maximum comfort at minimum capital cost; to assist in keeping down recurring costs for air-conditioning and heating; and to assist in bringing the project within the scope of local technological standards.⁴⁴

Climate consciousness and building within the local technological capacity became the assessment criteria used to evaluate designs at the AA tropical studios. The studios had a conviction of utilizing local materials as much as possible. Typically, tropical studio exercises were programmatically framed to include not just the spatial requirements of the project but also climatic data, local materials, and the technological skills of construction available at a given place. These studio exercise programs reinforced Tropical Architecture as a paradigm of designing buildings by using non-mechanical methods of conditioning and using local materials.

For example, in 1963-1964, students were given a studio exercise to design a Town Hall in Khartoum, the capital city of Sudan. The program comprised a council chamber for 100 councilors, reception suites, public and press galleries, and a public restaurant. The challenge of the studio exercise was to design according to the composite climate of Khartoum, which was a desert-

⁴⁴ Tropical Advisory Service, "British High Commission, Islamabad: Climatic Design Report."

type hot/dry from April to September, hot/humid during the July rainy season, and mild in the winter. The students were also asked to use local materials and locally available construction skills in their designs, which meant a brick and reinforced concrete construction. Khartoum had skilled labor to do concrete work, but cement and steel had to be imported. Asbestos and glass metal products also had to be imported.⁴⁵

Colin Frank, a student from the UK at the Department of Tropical Architecture, proposed a solution that succeeded in meeting the challenges of a climate-responsive design using the locally available technologies of brick and concrete. Frank cut down the amount of concrete for roofing by using conoid shell roofs, which are constructed with thinner sections than the beam and flat slab reinforced concrete structure, therefore the use of shells saved on imported materials such as cement and steel. (Figure 4.21) The doubly curved surface of the shells served as a good reflector of solar heat while their large surface also helped cooling at night. The shells were designed to provide north light through skylights placed between the overlapping shells. The section was designed to induce controlled wind movements. (Figure 4.22)

By designing largely within the local technological capacity, architects can ensure that local communities benefit from the construction project by employing local construction labor and contractors. One of the objectives of sustainable development is to strike a balance between society, environment, and economy. By using locally available societal skills and capacity to construct buildings,

⁴⁵ T.G. Ingersoll, "Aa Department of Tropical Studies 1963-64," *Architectural Association Journal* 80 (June 1964): 29-36.

construction of a project would benefit the local community in economic terms. The awareness that construction projects that place an excessive technological stress on a society tend to be unfeasible was a lesson that Koenigsberger learnt from the failure of the pre-fabricated housing units in New Delhi.



Figure 4.1A photograph of a *bustee* (settlement of huts)

Source: Birendra Nath Ghosh, "Houses and Buildings," in *A Treatise on Hygiene and Public Health, with Special Reference to the Tropics* (Calcutta: Hilton, 1924), 113-125.



Fig. 2.33—MALAY HOUSE, MALACCA (2°14'N.). Traditional Asian design for a hot humid climate (day temperature 88°-98°F., night 72°-73°F., vapour pressure 32-33 m. bars). Note the low-eaved verandah giving protection against sky glare as well as rain.

Figure 4.2 A Malay House in Malacca.

Source: George Anthony Atkinson, "Building in Warm Climates," in *Housing and Building in Hot-Humid and Hot-Dry Climates*, Building Research Advisory Board, Research Conference Report No. 5, Conference Held at Washington D.C, November 18 and 19, 1952 (Washington D.C.: The Building Research Advisory Board, Division of Engineering and Industrial Research, 1953), 66-73.

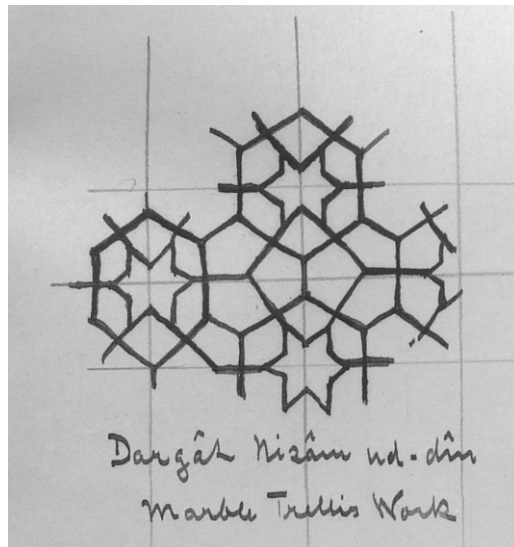

Figure 4.3 A sketch of a *Jali*.

Source: O. H. Koenigsberger, *Journey of Studies of the Mysore Government Architect to Madras and North India February 29, to April 1, 1940*, OKPP, London.

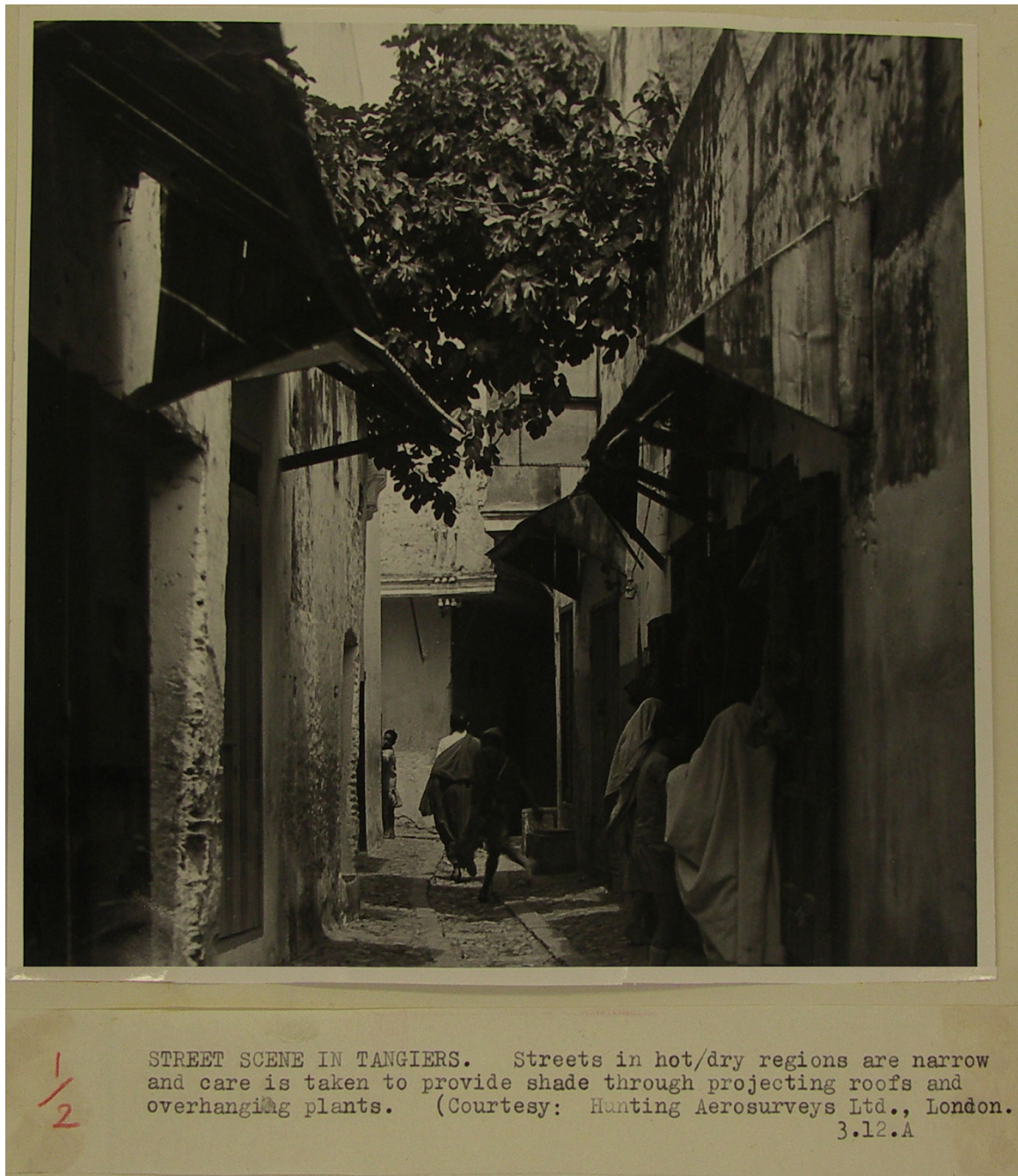

Figure 4.4 A Photo of a Street in Tangiers, Morocco.
Source: Otto Koenigsberger's Unpublished Book Manuscript on Tropical Architecture, in the possession of Patrick Wakely, Development Planning Unit, at the University College London.



STREET SCENE ON BAHREIN ISLAND. The picture shows various method of providing shade, including masonry archways, balconies, projecting hoods and awnings, a roof covering the whole street, and an umbrella for the policeman. (Courtesy: Hunting Aerosurveys Ltd., London.) 3.12. B

Figure 4.5 A Sketch of a Street Scene in Bahrein Island.

Source: Otto Koenigsberger's Unpublished Book Manuscript on Tropical Architecture, in the possession of Patrick Wakely, Development Planning Unit, at the University College London.



Figure 4.6 A picture of a wide street in Jidda Arabia.
Source: Otto Koenigsberger's unpublished book manuscript on Tropical Architecture, in the possession of Patrick Wakely, Development Planning Unit, at the University College London.

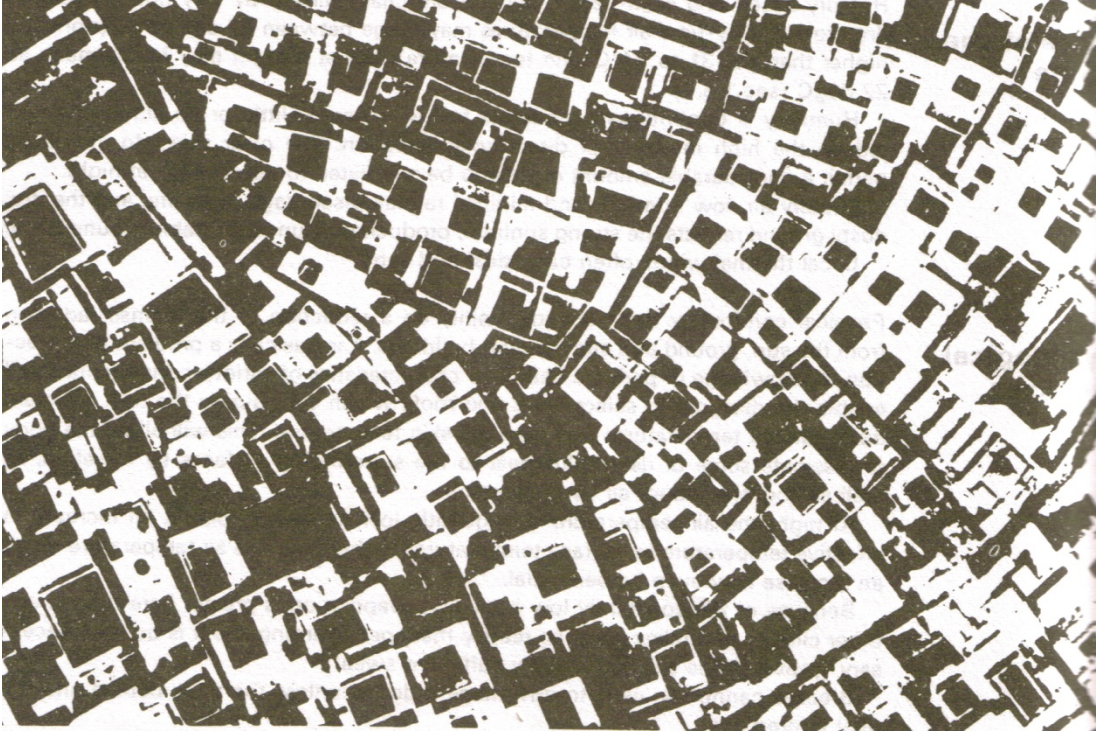

Figure 4.7 Dense hot-dry settlement in Marrakesh, Morocco.

Source: Otto H. Koenigsberger, T. G. Ingersoll, Alan Mayhew, and S. V. Szokolay, *Manual of Tropical Housing and Building* (London: Longman, 1974).

Recent low cost housing in Touggourt, Algeria (compare with traditional lay-out, Fig 143. The old city streets are narrow and shaded, the new streets in Touggourt are wide, sun-drenched and dusty.)

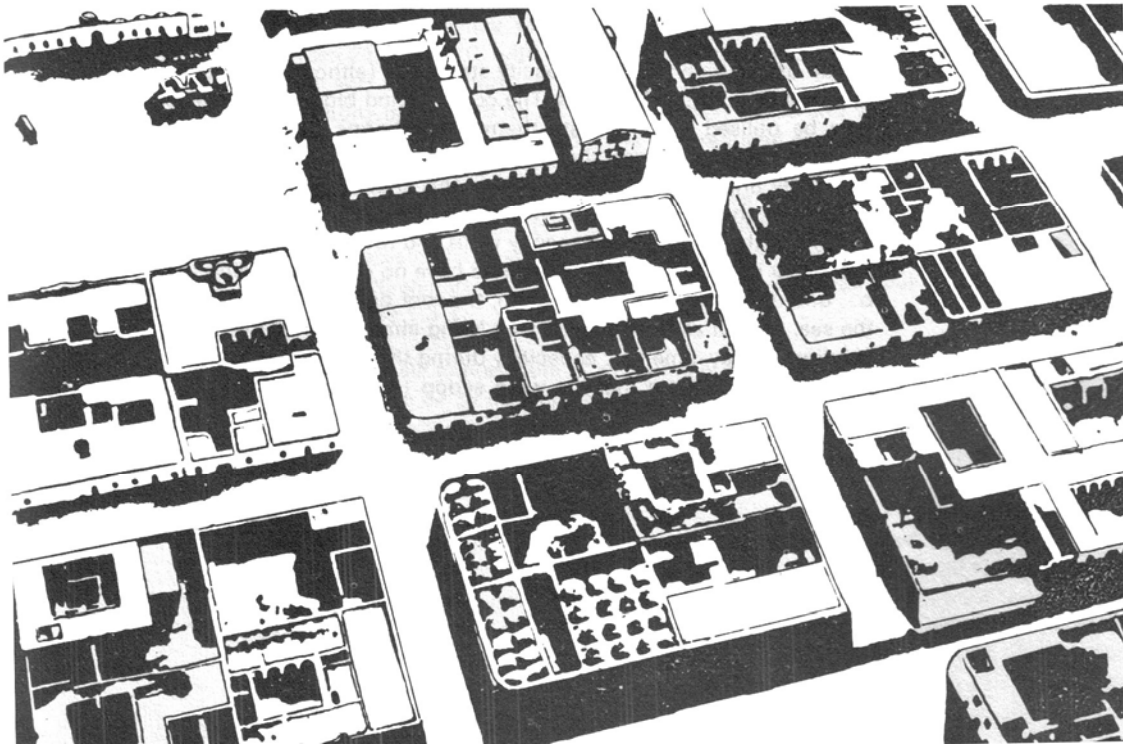

Figure 4.8 Recent low cost housing in Touggort Algeria.

Source: Otto H. Koenigsberger, T. G. Ingersoll, Alan Mayhew, and S. V. Szokolay, *Manual of Tropical Housing and Building* (London: Longman, 1974).



OUTDOOR LIVING IN AFRICA. The pounding of corn and the cooking of meals are occupation which are normally carried out in the open. (Courtesy: Public Relations Dept. Southern Rhodesia.) 3.5

Figure 4.9 A photograph of people pounding corn and cooking outdoors in Southern Rhodesia.

Source: Otto Koenigsberger's unpublished book manuscript on Tropical Architecture, in the possession of Patrick Wakely, Development Planning Unit, at the University College London.



Figure 4.10 Interior of a Zulu Hut.

Source: Otto Koenigsberger's unpublished book manuscript on Tropical Architecture, in the possession of Patrick Wakely, Development Planning Unit, at the University College London.

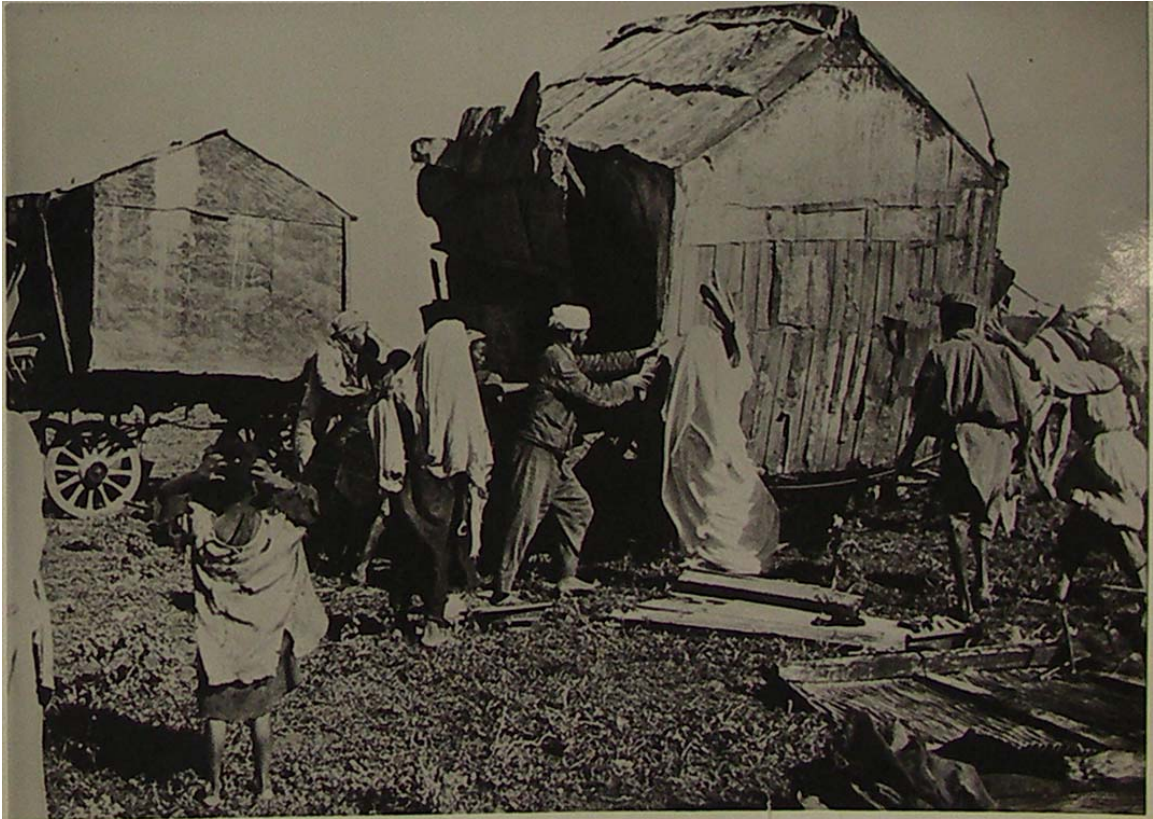

3/4

PREFABRICATED SHACKS FOR SHANTY TOWNS. Huts made of flattened out kerosene tins (hence "Bidonvilles") are brought to the site complete and then sold or rented at exorbitant prices to newcomers to the towns.

(Courtesy : ATBAT, Paris)

Ib

Figure 4.11 An image of the Bidonville pre-fabricated Shacks for the shanty towns.

Source: Otto Koenigsberger's unpublished book manuscript on Tropical Architecture, in the possession of Patrick Wakely, Development Planning Unit, at the University College London.

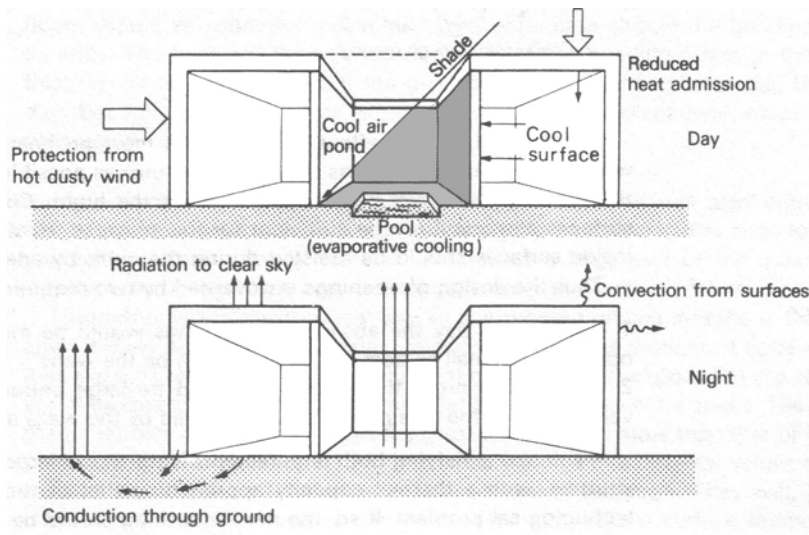

Figure 4.12 Thermal Principles of a Courtyard.
 Source: Otto H. Koenigsberger, T. G. Ingersoll, Alan Mayhew, and S. V. Szokolay, *Manual of Tropical Housing and Building* (London: Longman, 1974).



Figure 4.13 Peter and Alison Smithson
Source: Alison and Peter Smithson, *The Charged Void--Architecture* (New York: Monacelli Press, 2001)

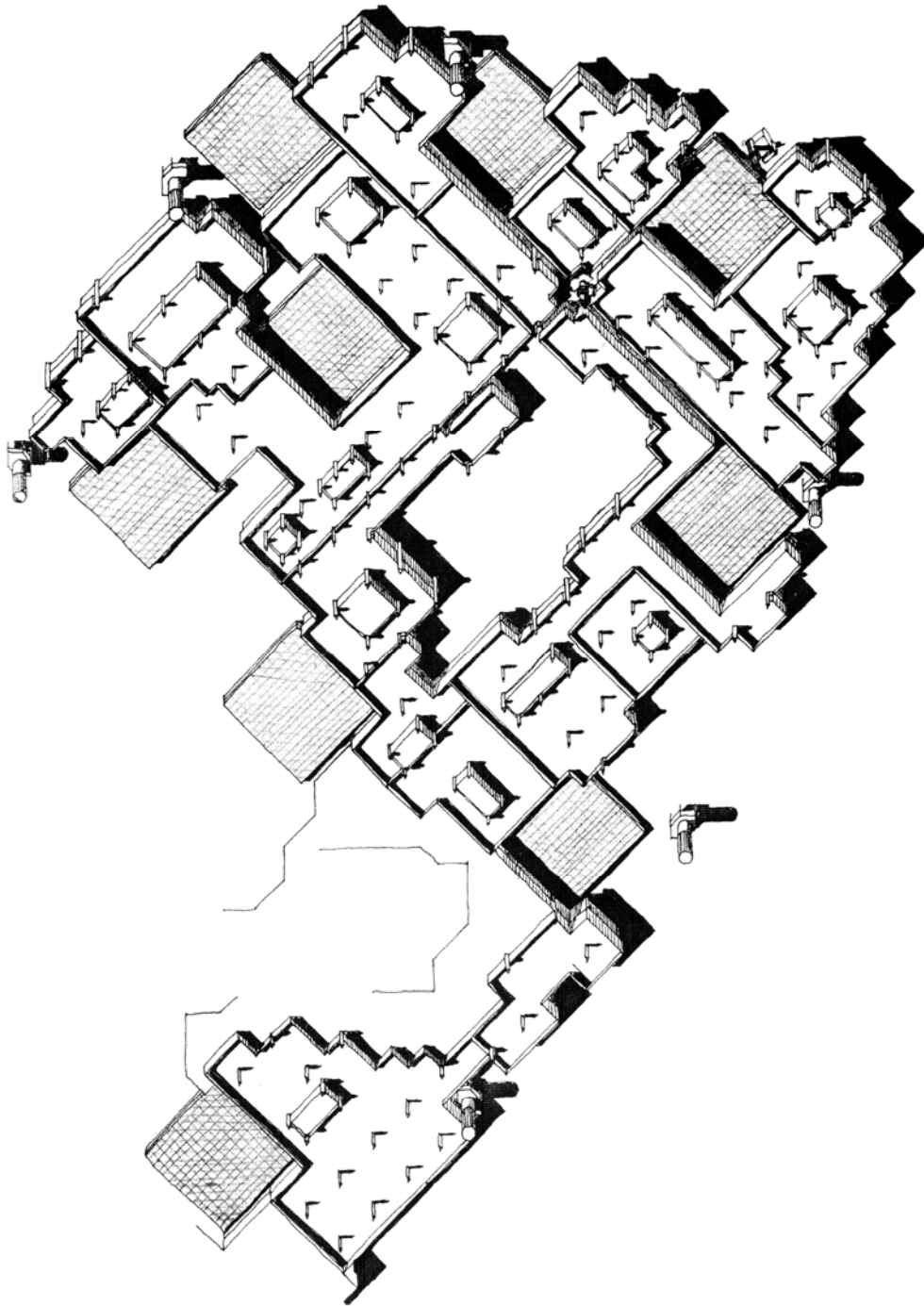
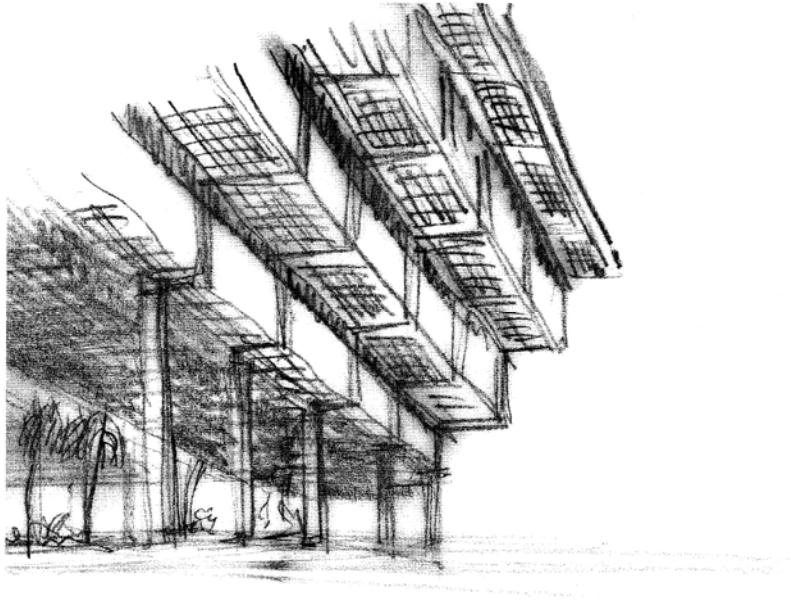

Figure 4.14 Axonometric of the Kuwait Mat Building.1969.
Source: Alison and Peter Smithson, *The Charged Void--Architecture* (New York: Monacelli Press, 2001)



Kuwait Urban Study and Mat-Building. Sketch of an overhang intended to cut sky glare, cast shade, and create air movement. AS.

Figure 4.15 The stepped profile of the Kuwait Mat Building raised on *pilotis*. 1969. Source: Alison and Peter Smithson, *The Charged Void--Architecture* (New York: Monacelli Press, 2001)

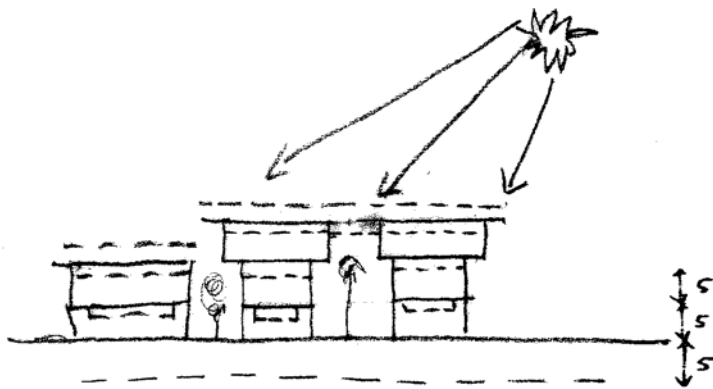

Figure 4.16 A sketch of a section through the courtyard, Kuwait Mat Building, 1969. Source: Alison and Peter Smithson, *The Charged Void--Architecture* (New York: Monacelli Press, 2001)

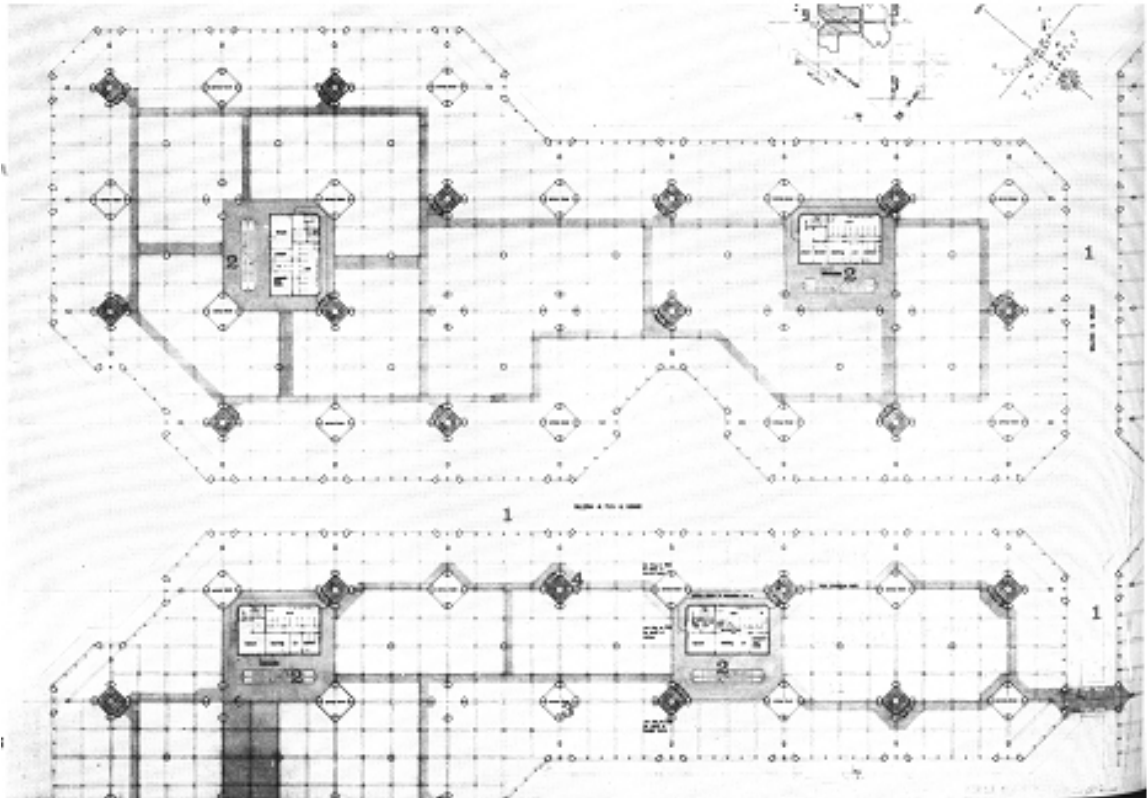

Figure 4.17 Part plan of the Kuwait Mat Building, 1969.
Source: Alison and Peter Smithson, *The Charged Void--Architecture* (New York: Monacelli Press, 2001)

Date and Time	ORIENTATION OF THE GALLERIES			
March 8 th October 6 th	0° East-West and North South	22½° North of East 22½° West of North	40° North of East 40° West of North	67½° North of East 67½° West of North
10:00 am	1.0+0.8=1.8	0.0+2.2=2.2	0.0+4.4=4.4	0.0+3.4=3.4
Noon	1.2+5.0=6.2	1.8+3.8=5.6	2.6+3.1+5.7	3.6+3.4=7.0
4:00 pm	0.0+0.0=0	4.5+0.4=4.9	0.0+0.0=0.0	0.0+0.0+0.0
TOTAL	Total=8.0	Total=12.7	Total=10.1	Total=10.4
June 22 nd				
10:00 am	4.8+2.4+7.2	3.8+2.6=6.4	3.2+3.0=6.2	4.0+2.6=6.6
Noon	4.6+5.0=9.6	4.5+4.8=9.3	4.5+4.8=9.3	4.5+4.6=9.1
4:00 pm	4.0+0.0=4.0	0.0+0.5=0.5	0.0+0.0=0.0	3.4+2.8=6.2
TOTAL	Total=20.8	Total=16.2	Total=15.5	Total=21.9

Table 4-1 Calculation for the best possible orientation for the galleries by calculating sun patches on the ground for different times during the day (10:00 am, Noon, 4:00 pm) for three days during the year (March 8, October 6, and June 22)

Source: Tropical Advisory Service, "Climate Analysis and Design Recommendations for Kuwait Old City,," (London prepared for Peter and Alison Smithson by Tropical Advisory Service, Department of Tropical Architecture, Architectural Association School of Architecture 1969).

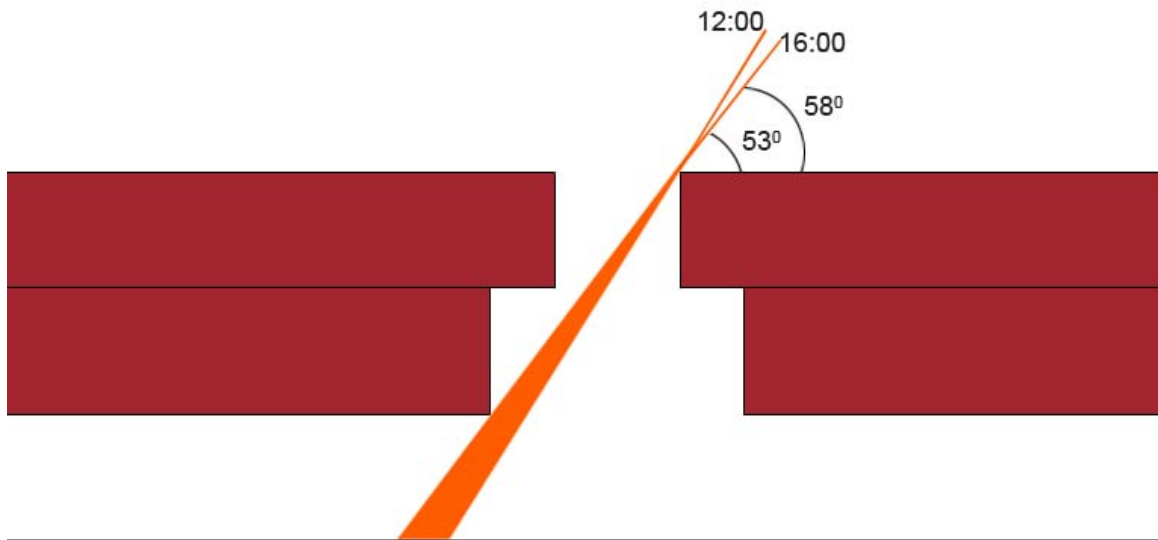

Figure 4.18 Calculation of Sun-patches for the inner galleries for noon (12:00) and four in the evening (16:00) for March 8 and October 6 for a North-South Orientation for the Kuwait Mat Project.

Source: Tropical Advisory Service, "Climate Analysis and Design Recommendations for Kuwait Old City,," (London prepared for Peter and Alison Smithson by Tropical Advisory Service, Department of Tropical Architecture, Architectural Association School of Architecture 1969).

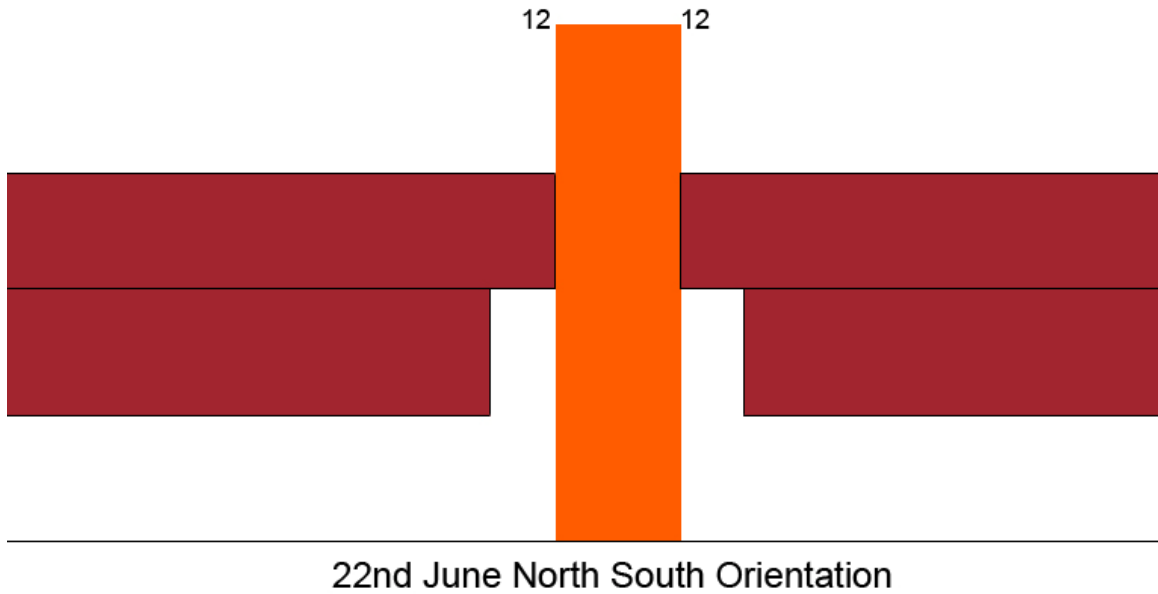

Figure 4.19 Calculation of Sun-patches for the inner galleries for noon (12) for June 22 for a North-South Orientation for the Kuwait Mat Project.

Source: Tropical Advisory Service, "Climate Analysis and Design Recommendations for Kuwait Old City,," (London prepared for Peter and Alison Smithson by Tropical Advisory Service, Department of Tropical Architecture, Architectural Association School of Architecture 1969).

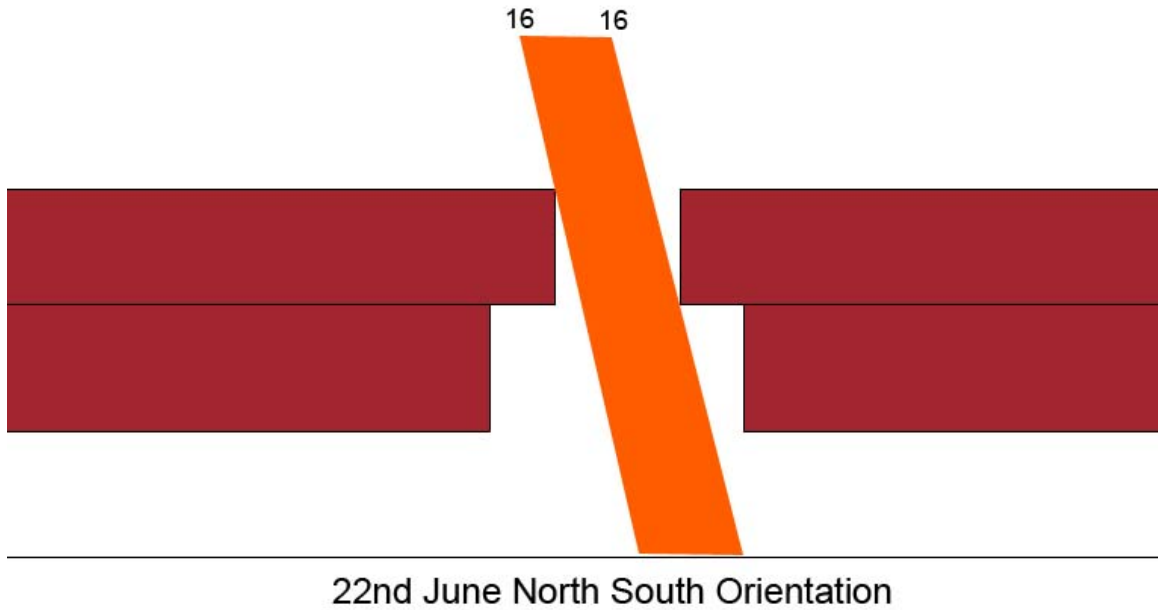

Figure 4.20 Calculation of Sun-patches for the inner galleries for 4:00 pm (16:00) for June 22 for a North-South Orientation for the Kuwait Mat Project.

Source: Tropical Advisory Service, "Climate Analysis and Design Recommendations for Kuwait Old City,," (London prepared for Peter and Alison Smithson by Tropical Advisory Service, Department of Tropical Architecture, Architectural Association School of Architecture 1969).

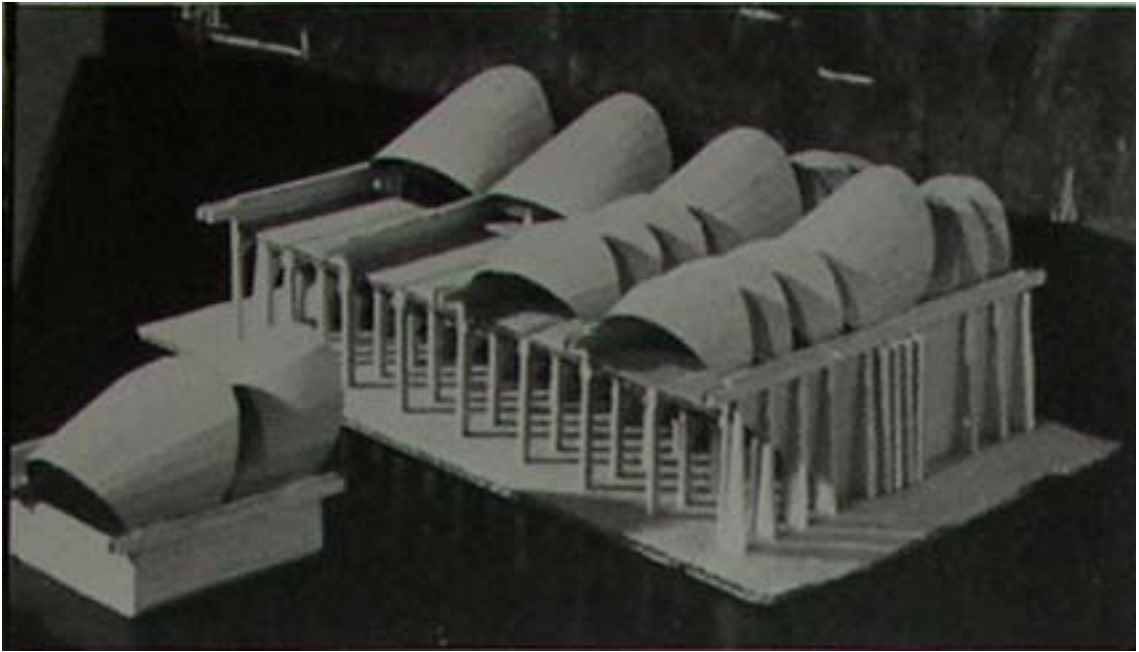

Figure 4.21 Conoid Shells over the Town Hall Designed By Colin Frank for the Tropical Design Studio, 1963-1964.

Source: T.G. Ingersoll, "AA Department of Tropical Studies 1963-64," *Architectural Association Journal* 80 (June 1964): 29-36.

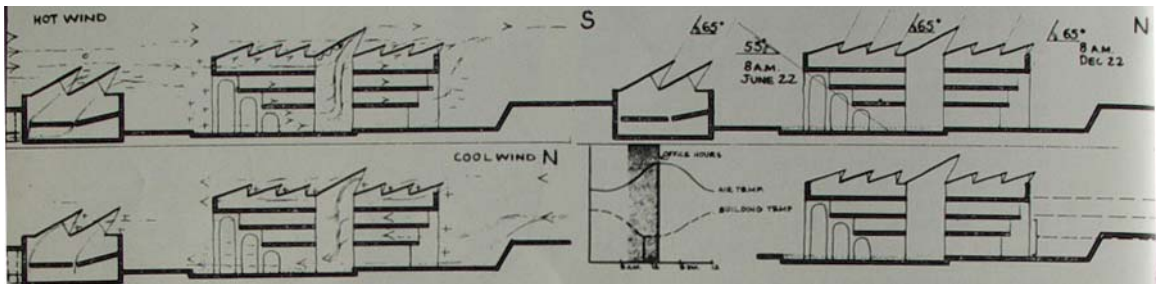

Figure 4.22 A section through the Town Hall designed by Colin Frank for the Tropical Design Studio, 1963-1964.

Source: T.G. Ingersoll, "AA Department of Tropical Studies 1963-64," *Architectural Association Journal* 80 (June 1964): 29-36.

Chapter 5

Green and Tropical Architecture

In this chapter, I address this question: What is the relationship between Green and Tropical Architecture? I argue that Tropical Architecture was one of the precursors to Green Architecture. Green Architecture is a much larger and comprehensive discourse compared to Tropical Architecture, but the former subsumes the theories and knowledge produced through the latter.

Just like Tropical Architecture, Green Architecture is not a monolithic discourse and represents several competing interests and conflicting terrains.¹ The continuities and discontinuities between Tropical and Green Architectures offer a vantage point from which I view how Green Architecture subsumes Tropical Architecture. The shift from the climatic approach of Tropical Architecture to the environmental approach of Green Architecture is predicated upon the development of environmental science, which generated new meanings for climate and architecture.

Green and Tropical Architecture prescribe similar means, including energy conservation, resource maximization, and minimizations of waste, to achieve seemingly different ends. It would appear at first glance that Green and Tropical

¹ Simon Guy and Graham Farmer, "Contested Constructions: The Competing Logics of Green Buildings and Ethics," in *Ethics and the Built Environment*, ed. Warwick Fox (London ; New York: Routledge, 2000), 73-87.

Architecture are conceptualized inversely insofar as the relationship between the body and environment is concerned. Green Architecture's main thrust is to protect the environment from the body, conceptualizing the body as a voracious consumer of natural resources and as an agent of irreversible destructive environmental processes. Tropical Architecture's principal objective, however, was to protect the body from the tropical climate.²

I contradict this seemingly apparent difference between Green and Tropical Architecture because Green Architecture does not altogether exclude the protection of the body from the environment. Admittedly, the impact of the human processes on the environment was not overtly articulated in Tropical Architecture—instead, resource and energy conservation were central. However, this means that environmental concerns were implicitly embedded in the practice of Tropical Architecture. It is too simplistic to assume that energy and resources were scarce in the tropics and hence the need to conserve was need based rather than inspired by convictions. Tropical Architectural theories may have been developed to address the needs of resource scarcity in the “poor” tropics, but as Tropical Architecture matured into a climate-responsive design paradigm, energy conservation was practiced even in contexts where building resources, energy, and wealth were abundantly available. The two examples that I use to support my case are Koenigsberger's recommendations for the Kuwait project designed by Peter and Alison Smithson (discussed in the last chapter) and Harris

² Arthur M. Foyle, ed., *Conference on Tropical Architecture 1953. A Report on the Proceedings of the Conference Held at University College, London, March, 1953* (London: G. Allen & Unwin, 1954).

Sobin's London Museum as a Tropical Studio project, which I discuss later in this chapter.

Environmentalism is predicated upon a dialogic relationship between the body and the environment; human processes impact the environment, and the quality of the environment affects bodily health, well-being, and survival. The modern environmental movement is largely perceived to have begun with Rachel Carson's *Silent Spring*. The fear that we are surrounded by a toxic sea of chemicals had seeped into public consciousness by the end of the 1970s. Several environmental concerns were directly motivated by the impact of environmental chemical and nuclear contamination on the body.³ Anxieties about the impact on the human body of pollution of land, air, and water through pesticides and chemicals brought environmental concerns into the global public sphere.⁴ The impact of the toxicity of building materials such as asbestos, toxic fumes from paints, and indoor air quality on the body constitutes a significant corpus of knowledge in the Green Architecture discourse. In the environmental discourse, architecture itself becomes a Frankenstein-like object of human industrial creation; architecture produces "sick buildings" from which the body needs protection. However, the conception of architecture as "shelter" that protects the body from the climate is a stable, unquestioned category in Tropical

³ Industrial accidents in the 1980's such as: the Bhopal gas disaster in which a Union Carbide subsidiary pesticide plant in Bhopal India released 40 tons of methyl isocyanate (MIC) gas lead to 22,000 deaths; the Chernobyl nuclear disaster in 1986, in which a reactor at the Chernobyl Nuclear Power Plant located near Pripjat in Ukraine exploded and the 1989 Exxon Valdez oil spill, highlighted the magnitude of the impact of human processes on the very survival of human species and the eco-system.

⁴ Samuel P. Hays and Barbara D. Hays, "The Toxic Environment " in *Beauty, Health, and Permanence : Environmental Politics in the United States, 1955-1985, Studies in Environment and History*. (Cambridge [Cambridgeshire]; New York: Cambridge University Press, 1987), 171-206.

Architecture. The concept of diseases like cancer as “environmental” is analogous to the understanding of tropical diseases like typhoid and cholera.

In the early 1950s, Koenigsberger and Tropical Architects believed in the colonial construct of climate as a deterministic factor in the definition of tropical architectural problems. Koenigsberger defined the tropics as

Countries where winter never comes and with temperatures above an annual average of 69 F – irrespective whether they are hot and dry or warm and humid – produces cycles of living and conceptions of home and shelter which are fundamentally different from those of northern regions.⁵

Tropical Architects debated whether the connection between the climate and the “underdevelopment” of the tropical people was causal or contingent. Jane Drew and Maxwell Fry clearly argued that civilizations were determined by climate: “The reasons for the so called ‘backwardness’ of the people in the humid-tropics are: climate; ignorance and economic difficulty.”⁶ Beisheuvel in South Africa challenged this view to suggest that attributing a whole civilization to climate was reductive.⁷ Irrespective of whether Tropical Architects perceived the relationship between climate and cultures as causal or contingent, they unanimously defined climate as a stable and quantifiable variable that was a “given” characteristic of a place and from which the body needed to be protected through architecture.

⁵ Otto H. Koenigsberger, "Tropical Planning Problems," in *Conference on Tropical Architecture 1953*, ed. Arthur M. Foyle, *A Report on the Proceedings of the Conference Held at University College, London, March, 1953* (London: G. Allen & Unwin, 1954), 13-20.

⁶ Maxwell Fry and Jane Drew, "Chapter Six: Health, Hygiene and Hospitalisation," in *Tropical Architecture in the Humid Zone* (New York: Reinhold Publishing Corporation, 1956), 232-251.

⁷ Dr. S. Biesheuvel "Psychological Aspects of living in a warm climate"

In contrast, in the environmental discourse, climate is a vulnerable and unstable phenomenon subject to change because of human processes, such as global warming due to excessive greenhouse gases.⁸ Buildings produce a significant amount of greenhouse gases through burning fossil fuels and thus contribute to climate change. In the Green Architecture discourse, there is reciprocity between architecture and climate. With effective green design, environmental climate change can be controlled and Green Architecture still fulfills its primitive function as shelter.

None of the Tropical Architects ever overtly articulated a concern for the environment as we see it articulated in the modern environmental discourse since the 1970s. In the Tropical Studio exercises and writings of the architects, environmental concerns were manifested as anxieties about the limits of resources and energy. Koenigsberger's definition of Tropical Architecture was "an architecture suited to the tropics."⁹ I interpret this as a synthesis of the resource- and energy-conservative practices acquired through architectural experience in India.

The colonial objectives of Tropical Architecture seem contradictory to its environmentalist tendencies. Equity in the distribution of natural resources is one of the objectives of sustainable development and, thus, of Green Architecture.

⁸ According to the carbon cycle theory, carbon constitutive of living beings is gradually released into the atmosphere after they perish. Plants maintain the carbon balance in the atmosphere by consuming carbon via carbon dioxide. The carbon consumed by plants is contributes to their growth through photosynthesis. Animals eat plants, thus the carbon keeps circulating within the ecosystem, maintaining a certain carbon balance. The burning of fossil fuels adds a further 6 billion tones of carbon per year into the atmosphere more than what is generated through natural processes.

⁹ Koenigsberger, "Tropical Planning Problems.", Otto H. Koenigsberger, T. G. Ingersoll, Alan Mayhew, and S. V. Szokolay, *Manual of Tropical Housing and Building* (London: Longman, 1974).

The Tropical Architecture department at the AA was established with the intention of reconstituting post-WWII colonial relationships with the colonized and decolonizing tropics¹⁰ Paradoxically, Tropical Architecture also became a forum for developing knowledge on energy conservative practices; low-impact, environmentally gentle technologies; housing for the poor; and scientific interpretation of vernacular knowledge, all of which are foundational tenets of sustainable architecture as specified in *Agenda 21*. The discourse of Tropical Architecture evolved into a critique of the European and American high-energy-consuming architectural designs and their wasteful use of resources.

The most significant point of dissonance between Tropical Architecture and Green Architecture would appear to be the Green Architecture's vision of sustainability through social equity. The colonial logic of Tropical Architecture would imply an imperial distribution pattern of energy and resource consumption—that is, while the tropics were being encouraged to minimize their energy consumption, the imperial powers consumed cheap energy and natural resources without any inhibitions. I want to contend this assumption by stressing that Tropical Architecture was being developed as a utopian discourse on climatically responsive architecture irrespective of place specificity.

Tropical Architecture evolved into a universal paradigm of energy conservation that was applicable both in the metropole and in the tropics. Sustainability calls for a distributive justice in resource consumption by bridging

¹⁰ George Anthony Atkinson, "British Architects in the Tropics," *Architectural Association Journal* 69 (June 1953): 7-21.

the gap between rich and poor nations.¹¹ These utopian and contradictory objectives of sustainability were embedded implicitly in the studio work of the AA Tropical Department, as is obvious in the studio work of Harris Sobin, a student at the AA.

Three Museums by Harris Sobin

As a Tropical Design Studio exercise, Harris Sobin designed three museums in three different climates—London, Khartoum, and Port Harcourt—with three different corresponding architectural solutions. The objective of the studio project assigned to the students was to highlight the relationship between architectural form and the climate. The students were given a design problem in which they had to pay equal attention to the conflicting demands of thermal comfort and natural lighting. The use of air conditioning was prohibited. Sobin treated lighting and ventilation as functions and proposed a horizontal division of these functions: daylight above and ventilation below. Sobin designed roof profiles to let in natural light that illuminated the exhibits, and the wall sections were designed to meet the ventilation needs.

These three museums had identical architectural programs and similar plans. Sobin used these projects to demonstrate the impact of climate on the design of cross-sections, windows, and skylights. Several passive techniques deployed by Sobin had been successfully used in these regions as vernacular architectural techniques. In the Tropical studio, these techniques were developed

¹¹ Charles J. Kibert, *Reshaping the Built Environment: Ecology, Ethics, and Economics* (Washington, D.C.: Island Press, 1999).

into universal knowledge. Meteorological data was quantified and correlated to corresponding quantified architectural features such as wall thickness, window size, the depth of shading devices, and so on.

In the London museum, Sobin utilized earth insulation, orientation, natural light, and natural ventilation to conserve energy. The building was designed to conserve heat through its east-west orientation, the use of stone masonry walls, timber truss roof, and sinking into an earth mound made from excavated fill. The building uses natural light, which is diffused through light hoods facing south and north. Electric lighting was used as a reserve for cloudy dark days, not as the primary source of lighting.

For the museum in Khartoum, the architectural problem was designing for a hot-dry climate with little rainfall and some dust storms. Sobin proposed two courtyards between the museum and street to create an enclosed open space. He used heavy mud walls with high thermal capacity. The roof was spanned by heavy timber beams and covered with mud. The roof and walls mediate the peak day and night temperatures, which tend to be very hot and very cold, thereby facilitating a median temperature that makes the museum comfortable. In Khartoum, the problem was the strong sunlight, but as in the London museum, Sobin used natural light. He proposed south-facing light hoods that reflected light from the ground into the exhibition galleries, ensuring that direct sunlight did not get directly into the exhibit spaces. The galleries were further illuminated by footlights in the form of arched openings at the base of the exhibits.

The museum in the warm and humid climate of Port Harcourt utilizes natural light, wind, and materials with low thermal mass. In a warm and humid climate, it is important to ensure that a continuous current of wind is maintained through the building. Since wind speeds decrease closer to the ground due to frictional losses, the Port Harcourt museum is raised on stilts to catch maximum wind. Because greater wind movements are generated when outlet openings are larger than inlet openings, the wind circulation is also increased by keeping the openings on the leeward side larger than those on the windward side. The temperatures do not vary drastically across the day and night, therefore Sobin proposed lightweight construction materials with low thermal mass.

Historically speaking, what is important about Sobin's design project is its universal application of energy-conservative design. He used a combination of local and industrial materials, stressing the principles that would later be central to *Agenda 21*.¹² The utopian intention that a museum in London could and would use the same low-impact climate-responsive design principles and construction materials as museums in Khartoum and Port Harcourt underscores the notion that Tropical Architecture was concerned with decreasing consumption at a global level. Sobin's museums flatten out the inequity of energy and resource consumption between the tropics and the metropole, just as sustainable architecture calls for a distributive justice in energy consumption across the First and Third World. This project, however unrealistic it may seem, is a testament to the AA Tropical Department's commitment to universal energy conservation

¹² Harris J. Sobin, "3 Museums," *Architectural Association Journal* 77, no. 860 (March 1962): 209-215.

irrespective of cost or place concerns. Both discourses are utopian in their vision and propose to solve the problem of global inequity in the distribution and consumption of resources. Despite criticism from the avant-garde and the lack of popularity of energy conservative technologies in the 1960's in transatlantic architectural circles, the tropical architects persisted in their subversive approach to climatic architectural design.

Debates Over Green and Tropical Architecture

The tension between architects who supported environmentally responsible design and those who viewed architecture as an autonomous discipline immune to concerns of environment is not new.¹³ One of the current debates over the goal of architecture vis-à-vis substantiality is whether it is sufficient for a building to meet the standards set by sustainable design criteria such as LEED¹⁴ or BREEAM¹⁵ to qualify as exemplary architecture, or whether a good building is one that satisfies the cultural, formal, spatial, and tectonic

¹³ See Reinhold Martin, "Environment," *Grey Room* 14 (2004): 78-101.

¹⁴ In the US, The Leadership in Energy and Environmental Design (LEED) Green Building Rating System™ is the nationally accepted benchmark for the design, construction, and operation of high performance green buildings. LEED gives building owners and operators the tools they need to have an immediate and measurable impact on their buildings' performance. LEED promotes a whole-building approach to sustainability by recognizing performance in five key areas of human and environmental health: sustainable site development, water savings, energy efficiency, materials selection, and indoor environmental quality. U.S. Green Building Council (USGBC), "Leadership in Energy and Environmental Design," U.S. Green Building Council (USGBC), www.usgbc.org/LEED/.

¹⁵ In the UK, BREEAM (Building Research Establishment Environmental Assessment Method) is an environmental assessment method for buildings. Since its launch in 1990, BREEAM has been increasingly accepted in the UK construction and property sectors as offering best practice in environmental design and management. Building Research Establishment, "Breeam: Bre Environmental Assessment Method," <http://www.breeam.org>.

sensibilities revered by the profession.¹⁶ The debate about the role of architecture with respect to environment is resonant of the debate about the role of climate responsiveness in architecture in the 1960s.

While the Tropical Architects proposed utopian projects that used local technologies and low energy, critics of climatic design and the Tropical paradigm, including Peter and Alison Smithson, questioned the reductiveness of the climatic design approach. In an article published in *Architectural Design* in 1960, they noted:

It is no good looking to the climate and the physical environment to give the form of the building. Technically, a glass box and a mass-concrete cave can produce the same comfort conditions, if one can afford the right mechanical equipment. It all depends what you are after. The shape of the culture can only be built up separate individual form-giving decisions towards a common ideal – however vague this ideal may seem at the present.¹⁷

The Smithson's critique in the year 1960 reflected the mid-century position of architects in Europe and America who felt liberated by the constraints of climate through mechanical means of conditioning buildings. In the 1950s, with abundant cheap energy, the interest in developing energy-efficient buildings in Europe and America declined in the absence of a market for these design strategies.¹⁸ The European and American architects were busy experimenting with the formal expression of mechanical services. The thrust was on how building services could generate form. As Banham notes, in the 1960s, the formal expression of

¹⁶ Andrew Scott, "Design Strategies for Green Practice," *Journal of Green Building* 1, no. 4 (Fall 2006): 11-27.

¹⁷ Alison and Peter Smithson, "The Function of Architecture in Cultures-in-Change," *Architectural Design* 30, no. 4 (April 1960): 149-150.

¹⁸ Colin Porteus, "Green Trail to Now - Ecology Vs Economy," in *The New Eco-Architecture: Alternatives from the Modern Movement* (London and New York Spon Press, 2002), 121-125.

mechanical services ranged from invisibility (as in the glass box) to Kahn's formal experiments with the servant and served spaces.¹⁹ In the USA, after 1965, two interrelated developments led to excessive energy consumption in buildings. The level of environmental control implemented through environmental specifications became more precise and comprehensive. These increased levels of environmental specifications to control indoor climates in buildings demanded mechanical equipment that consumed more energy. The availability of cheap and abundant energy provided a *carte blanche* for environmental engineers to pursue rigorous environmental control with a complete disregard for energy consumption.²⁰

At this point in history, Tropical Architects were acutely aware of the prohibitive capital and recurring costs of mechanical conditioning of buildings and the limits of resources. Tropical architects at the AA led by Koenigsberger built a body of knowledge to generate design techniques that would minimize energy consumption. The Tropical Department closed at the AA in 1971. By this time, Koenigsberger's interest had shifted to planning, and he moved to the University College London (UCL) and inaugurated the Development Planning Unit (DPU). The concept of a low-energy, climate-responsive architecture did not diminish with the closure of the Tropical Department but instead entered the dominant architectural discourse in both the UK and USA.

¹⁹ Reyner Banham, *The Architecture of the Well-Tempered Environment* (London; Chicago: Architectural Press; University of Chicago 1973).

²⁰ Charles W. Moore, Jeffrey Cook, Murray Milne, John Eberhard, William Borner, Dean Hawkes, Gerald McCue, William Turner, Richard Bender, Larry Spielvogel, and Reyner Banham, "Educators Roundtable," *Journal of Architectural Education* 30, no. 3, Energy and Architecture (February, 1977): 2-5.

Epilogue

In 1973, the Rational Technology unit at the AA School of Architecture was established in response to the energy crisis precipitated by the Middle Eastern Yom Kippur War. This unit claimed that a significant shift in the western architectural paradigm had taken place that resulted in the end of the “current technocratic, highly wasteful and energy intensive society”.²¹ Tropical Architecture was intended to be a commodity in the global circulation of capital,²² and yet it ended up being domesticated at the Rational Technology Unit at the AA as energy-conscious architecture. The unit conducted research on alternative forms of energy and on architectural techniques for lowering energy consumption in buildings. Its research was published as a collection of essays, and the bibliography included UN seminar proceedings held in India in the 1950s. In the process of “exporting” architectural knowledge overseas, British architects unwittingly established themselves as vanguards of environmental architecture, which returned to the AA in 1973 as mainstream *revolutionary* architecture. The tropics were not just “out there” but the within the AA, in the heart of the former empire.

Eventually Koenigsberger collaborated with T. G. Ingersoll, Alan Mayhew, and Steven Szokolay to present tropical design methods in the *Manual of*

²¹ Goerge Kasabov, Charlotte Nassim, and Gerry Foley, eds., *Rational Technology Unit at the Architectural Association 1973-74* (London: Architectural Association 1974).

²² Anthony King, "Exporting Planning: The Colonial and Neo-Colonial Experience," in *Shaping an Urban World* ed. Gordon Cherry (London: Mansell Publishing, 1980), 203-206.

Tropical Housing and Architecture.²³ After the Tropical Department at the AA closed down and as environmental discourse became a popular concern, several of Koenigsberger's students and co-authors of the Tropical Manual, Szokolay and Ingersoll, made their careers in Green Architecture. T.G. Ingersoll practiced in Massachusetts with a firm called "massdesign" that specialized in solar heated houses.

In 1964, Steven Szokolay began his academic career at Liverpool University as a lecturer. His job got him to Nairobi, where Liverpool University was helping the University of East Africa to start a course in architecture. Szokolay had attended a course at the AA run by Koenigsberger on teaching in developing countries. He had also spent two years in Nairobi and did some field work on tropical building, which he used for a Master of Architecture degree. Just as Koenigsberger's work in India got him interested in energy conservation, Szokolay's work in Nairobi got him interested in Solar Architecture and low-energy designs. In 1975, right after the OPEC energy crises, his book *Solar Energy and Building* moved beyond the tropics to engage with knowledge on energy-conservative practices on a global scale. Steven Szokolay established his career in academia in Australia and become a solar energy and Sustainable Architecture expert.²⁴

²³ Koenigsberger, Ingersoll, Mayhew, and Szokolay, *Manual of Tropical Housing and Building*.

²⁴ See S. V. Szokolay, *Solar Energy and Building* (London; New York: Architectural Press; Halsted Press Division, Wiley, 1977).; S. V. Szokolay, *Environmental Science Handbook for Architects and Builders*, ed. Anonymous (New York: Wiley, 1980).; S. V. Szokolay, *World Solar Architecture*, ed. Anonymous (London; New York: Architectural Press; Halsted Press, 1980).; S. V. Szokolay and Congress International Solar Energy Society, *Solar World Congress* :

Sobin became devoted to teaching environmental design in the United States in Arizona. K.K. Mumtaz, another alum of the AA Tropical Department, practices Green Architecture in Pakistan.²⁵ Carl Mahoney, who collaborated with Koenigsberger to develop the Mahoney Tables,²⁶ established himself an expert in Passive and Low Energy Architecture.

Proceedings of the Eighth Biennial Congress of the International Solar Energy Society, Perth, 14-19 August, 1983, ed. Anonymous (Oxford Oxfordshire] ; New York: Pergamon Press, 1984).

²⁵ Minhas, Salman S "Kamil Khan Mumtaz: The Grand Master of Traditional & Green Architecture in Pakistan." *The-south-asian.com* October 2004, 1-4.

²⁶ Koenigsberger, Ingersoll, Mayhew, and Szokolay, *Manual of Tropical Housing and Building*.

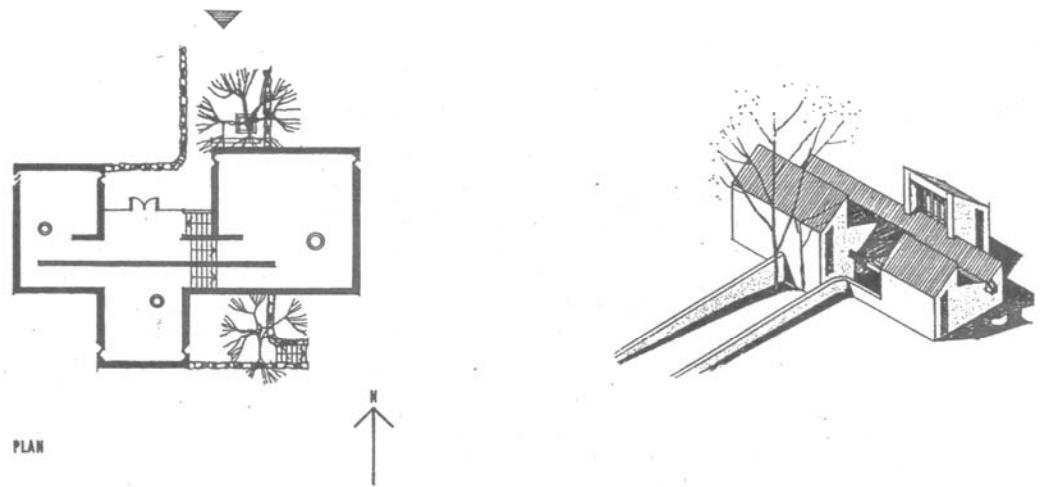

Figure 5.1 Plan of the Museum in London, Tropical Design Studio Exercise, AA, 1961

Source: Harris J. Sobin, "3 Museums," *Architectural Association Journal* 77, no. 860 (March 1962):209-215.

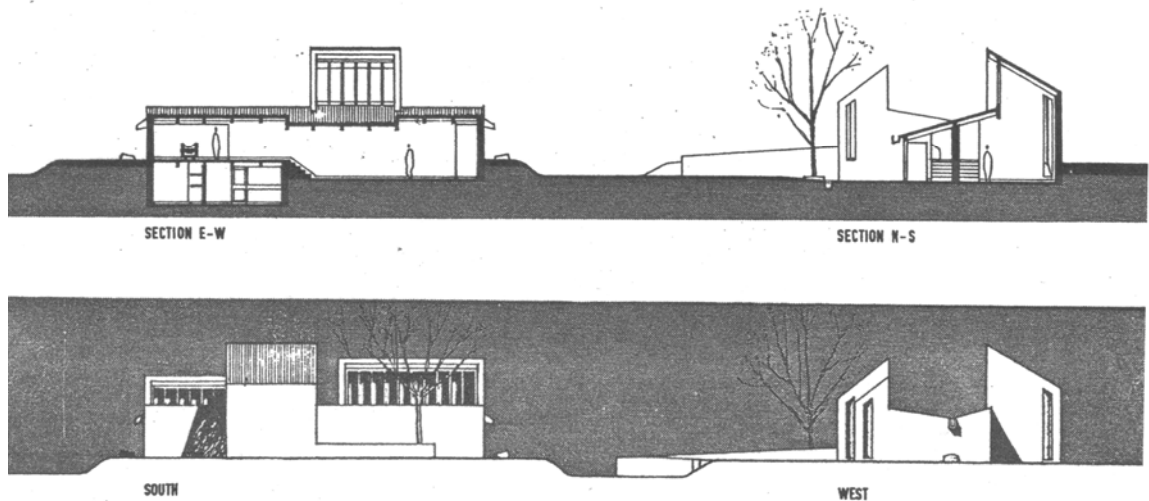

Figure 5.2 Section through the Museum in London, Tropical Design Studio Exercise, AA, 1961

Source: Harris J. Sobin, "3 Museums," *Architectural Association Journal* 77, no. 860 (March 1962):209-215.

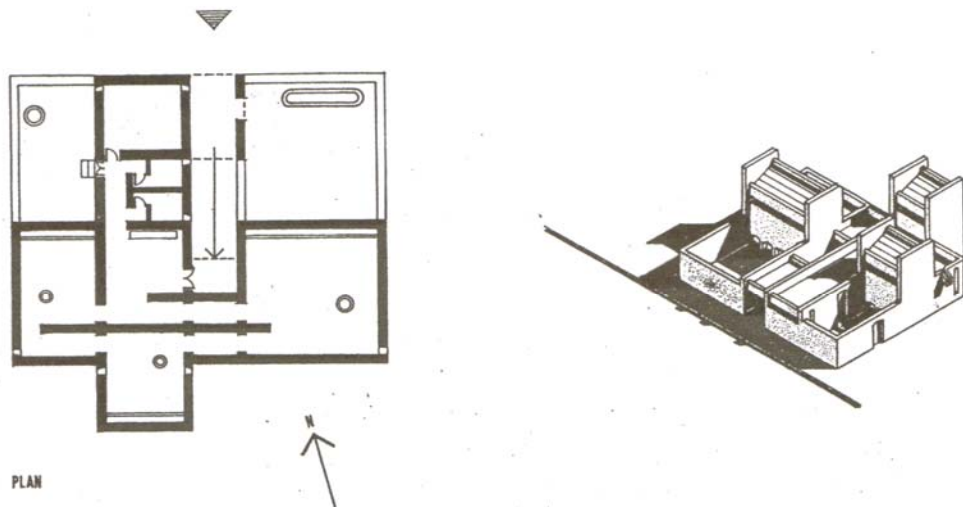
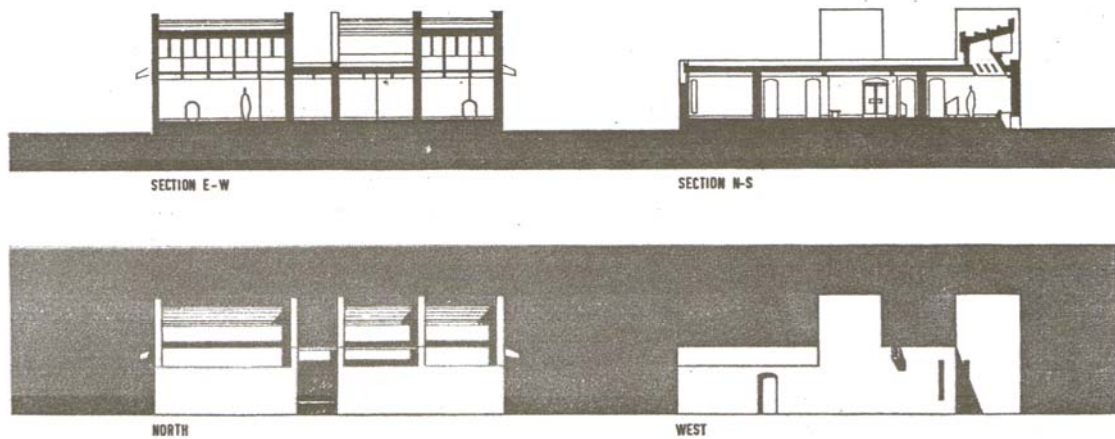

Figure 5.3 Plan of the Museum in Khartoum, Sudan, Tropical Design Studio Exercise, AA, 1961

Source: Harris J. Sobin, "3 Museums," *Architectural Association Journal* 77, no. 860 (March 1962):209-215.



125

Figure 5.4 Section through the Museum in Khartoum, Sudan, Tropical Design Studio Exercise, AA, 1961

Source: Harris J. Sobin, "3 Museums," *Architectural Association Journal* 77, no. 860 (March 1962):209-215.

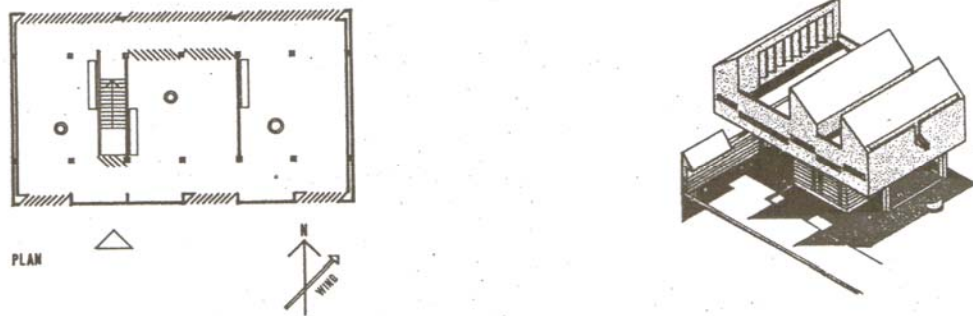

Figure 5.5 Plan of the Museum in Port Harcourt, Nigeria, Tropical Design Studio Exercise, AA, 1961

Source: Harris J. Sobin, "3 Museums," *Architectural Association Journal* 77, no. 860 (March 1962):209-215.

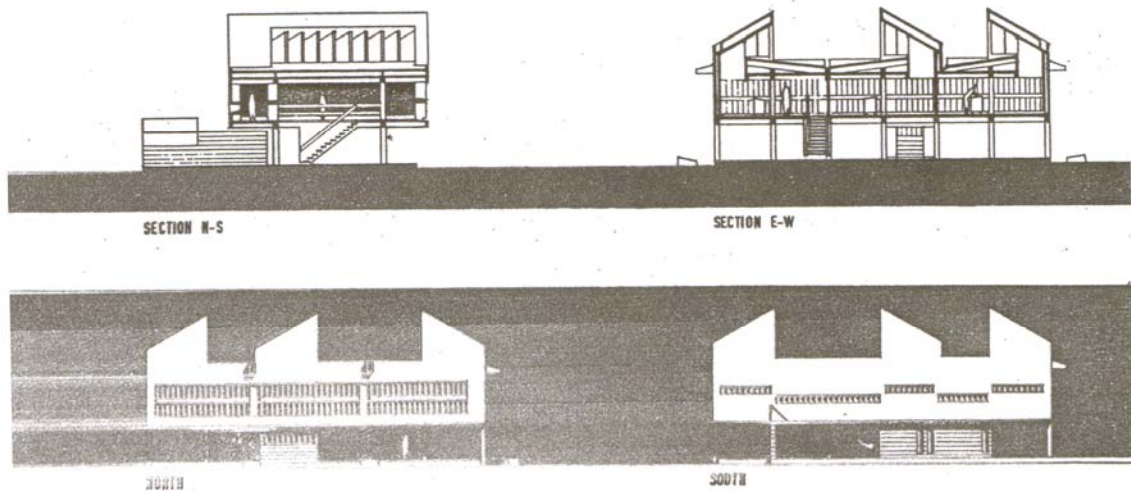

Figure 5.6 Section through the Museum in Port Harcourt, Nigeria, Tropical Design Studio Exercise, AA, 1961

Source: Harris J. Sobin, "3 Museums," *Architectural Association Journal* 77, no. 860 (March 1962):209-215.

Bibliography

Primary Sources: Unpublished.

- Government of Mysore (GOM) Archive at the Karnataka State Archives (KSA)
GOM Education. KSA. Bangalore, Karnataka, India.
GOM. General and Miscellaneous. KSA. Bangalore, Karnataka, India.
GOM Municipal. KSA. Bangalore, Karnataka, India.
GOM War. KSA. Bangalore, Karnataka, India.
- Otto Koenigsberger's Private Papers (OKPP). In the possession of Dr. Renate Koenigsberger. London, UK.
- Otto Koenigsberger's Unpublished Book Manuscript on Tropical Architecture. Development Planning Unit (DPU), University College London (UCL). In the possession of Patrick Wakely. London, UK.
- Peter and Allison Smithson papers. Special Collections of Frances Loeb Library. Graduate School of Design. Harvard University. Cambridge, Massachusetts, USA.

Primary Sources: Journal and Serials.

- Architectural Association Journal
Architectural Design
Deccan Herald (Newspaper, Mysore)
Indian Concrete Journal
Marg
Rationalist (Newspaper, Mysore)
The Architectural Forum
Town Planning Review

Primary Sources: Published Books, Journal Articles, and Serials.

- Abrams, Charles, Vladimir Bodiensky, and Otto H. Koenigsberger. *Report on Housing in the Gold Coast* New York: United Nations Technical Assistance Administration, 1956.
- Abrams, Charles, Susumu Kobe, and Otto H. Koenigsberger. *Growth and Urban Renewal in Singapore: Report Prepared for the Government of Singapore*. New York United Nations 1963.

- Abrams, Charles, and Otto H. Koenigsberger. *A Housing Program for the Philippine Islands*. New York: United Nations Technical Assistance Administration, 1959.
- Architectural Association. *School of Architecture: Department of Tropical Architecture Prospectus* London: Architectural Association 1955.
- Architectural Association School of Architecture. "Department of Tropical Studies: Bibliography." London: Architectural Association School of Architecture, 1967.
- Atkinson, George Anthony. "British Architects in the Tropics." *Architectural Association Journal* 69 (June 1953): 7-21.
- . "British Architects in the Tropics." *Architectural Association Journal* 69 (June 1953): 7-21.
- . "Mass Housing in Rapidly Developing Tropical Areas." *Town Planning Review* 31, no. 2 (July 1960): 85-102.
- "Associated Cement Companies Advertisement." *Indian Concrete Journal* 14, no. 2 (February 15, 1940).
- Baer, Steve. *Dome Cookbook*. Corrales, N.M.: Lama Foundation, 1967.
- "Band Stand in the Municipal Park, Kolar." *Indian Concrete Journal* 15, no. 2 (February 15, 1941).
- Bhashyam, K. T. *How Mysore Won a Responsible Government: Being a True Record of the Efforts of the People of Mysore over a Period of 17 Years (1930-1947) to Reach the Goal of Political Freedom*. Bangalore: S. N. Gupta Kataka Advertizing Agency, 1951.
- Brand, Stewart, ed. *Whole Earth Catalog*. California: Portola Institute, 1968.
- "Department of Tropical Studies: A Cross-Section of Recent Work and Teaching Methods." *Architectural Association Journal* 78 (April 1963): 302-313.
- Editor. "Sri Cheluvamba and Sri Krishnarajendra Hospitals." *Rationalist* June 26, 1942, 3.
- Foyle, Arthur M., ed. *Conference on Tropical Architecture 1953. A Report on the Proceedings of the Conference Held at University College, London, March, 1953*. London: G. Allen & Unwin, 1954.
- Fry, Maxwell, and Jane Drew. *Tropical Architecture in the Humid Zone*, New York: Reinhold Publishing Corporation, 1956.
- Gandhi, M. K. *Cent Per Cent Swadeshi or the Economies of Village Industries*. Ahmedabad: Navajivan publishing house, 1948.
- Grant, A.E. *The Indian Manual of Hygiene: Being the King's Manual of Hygiene* Vol. 1. Madras (now called Chennai), India: Higginbotham and Co., 1894.
- Ghosh, Birendra Nath. *A Treatise on Hygiene and Public Health, with Special Reference to the Tropics*, Calcutta: Hilton, 1924.
- Gutkind, E. A. "How the Other Half Builds." *Architectural Design* Vol. XXIII (January 1953): 2-4.
- Hunter, Sir William Wilson. *The Imperial Gazetteer of India*. London: Trübner & Co., 1885.
- Ingersoll, T.G. "AA Department of Tropical Studies 1963-64." *Architectural Association Journal* 80 (June 1964): 29-36.

- International Congress for Housing and Town Planning. *Housing in Tropical Climates*, Papers and Reports: Xxi International Congress for Housing and Town Planning, Held at Lisbon, 1952. Amsterdam: N.V. Van Munster's Drukkerijen, 1952.
- International Federation for Housing and Town Planning. *Housing in Tropical and Sub-Tropical Countries*, International Federation for Housing and Town Planning ,16th Congress, Held at Mexico, 1938. Mexico: Editorial Cultura, 1938.
- Ismail, Sir Mirza. *Speeches by Amin-Ul-Mulk: Sir Mirza Ismail*. Bangalore: Superintendent at the Government Press, 1940.
- Ismail, Sir Mirza. *My Public Life: Recollections and Reflections*. London: George Allen and Unwin Ltd., 1954.
- Jones, J. A. *A Manual of Hygiene, Sanitation and Sanitary Engineering: With Special References to Indian Conditions*. Madras: Printed and published by the Superintendent, Government Press, 1896.
- Kasabov, Goerge , Charlotte Nassim, and Gerry Foley, eds. *Rational Technology Unit at the Architectural Association 1973-74* London: Architectural Association 1974.
- Koenigsberger, O. H. . "The New Studios of the Mysore Broadcasting House at Mysore." *Electrotechnics* 15 and 16 (Sept. 1943): 45-49.
- Koenigsberger, Otto. "The Common Dining Hall at the Indian Institute of Science." *The Architectural Forum* 85 (1946).
- . "The Story of a Town: Jamshedpur." *Marg* 1, no. 1 (October 1946): 18-29.
- . "The Victory Hall at Bangalore." *Marg* IV, no. 3 (Dipavali 1950): 25-26.
- Koenigsberger, Otto H. "Action Planning." *Architectural Association Journal* 79, no. 882 (May 1964): 306-312.
- . *Die Konstruktion Der ägyptischen Tür*. Glückstadt: Verlag von J.J. Augustin, 1936.
- . "Jamshedpur Development Plan." Bombay: Tata Iron and Steel Company, 1945.
- . "Master Plan for the New Capital of Orissa at Bhubaneswar." Bhubaneswar: Government of Orissa, 1948.
- . *Metropolitan Lagos*. New York Commissioner for Technical Assistance, Department of Economic and Social Affairs, 1964.
- . "New Towns in India." *Town Planning Review* 23, no. 2 (1952): 95-131.
- Koenigsberger, Otto H. , and Charles Abrams. *A Housing Program for Pakistan with Special Reference to Refugee Rehabilitation: Prepared for the Government of Pakistan*. New York: United Nations Technical Assistance Administration, 1957.
- Koenigsberger, Otto H., T. G. Ingersoll, Alan Mayhew, and S. V. Szokolay. *Manual of Tropical Housing and Building*. London: Longman, 1974.

- National Institute of Sciences of India. *Proceedings of the Symposium on Scientific Principles and Their Application in Tropical Building Design and Construction, Held at New Delhi, December 21-24, 1952*, Bulletin of the National Institute of Sciences of India, No. 6. New Delhi: National Institute of Sciences of India, 1955.
- "Nellore Agricultural Swadeshi Industrial and Khadi Exhibition and Cattle Show." *Indian Concrete Journal* 14, no. 6 (June 15, 1940): 202.
- Office of the Executive Engineer Shimoga Division. "Notification Dated 7th February 1935 (Tender Notice for Constructing Srimati Bhoopalam Subhadramma Maternity Hospital at Shimoga)." *Mysore Gazette* February 7, 1935, 179-182.
- Olgyay, Victor. *Design with Climate: Bioclimatic Approach to Architectural Regionalism*. Princeton, N.J.: Princeton University Press, 1963.
- Platt, Kate Anne. *The Home and Health in India and the Tropical Colonies*. London: Baillière, Tindal & Cox, 1923.
- Priyadarshini, I. "Surviving the Test of Time." *Deccan Herald* Tuesday, June 22, 2004.
- Report of the Ecumenical Conference on Foreign Missions, Held in Carnegie Hall and Neighboring Churches, April 21-May 1*, 2 vols. Vol. 2, . New York; London: American Tract Society; Religious Tract Society, 1900.
- Rice, Benjamin Lewis. *Mysore: A Gazetteer Compiled for Government*. London: Archibald Constable and Company, 1897.
- Royer, Jean. *L'urbanisme Aux Colonies Et Dans Les Pays Tropicaux; Communications & Rapports Du Congress International De L'urbanisme Aux Colonies Et Dans Les Pays De Latitude Intertropicale*, Congrès International De L'urbanisme Aux Colonies Et Dans Les Pays De Latitude Intertropicale , Paris,1931. La Charité-sur-Loire: Delayance, 1932.
- Smithson, Alison and Peter. "The Function of Architecture in Cultures-in-Change." *Architectural Design* 30, no. 4 (April 1960): 149-150.
- Sobin, Harris J. "3 Museums." *Architectural Association Journal* 77, no. 860 (March 1962): 209-215.
- Spence, J. McKay. "The New Role of the Architect in the Tropics." *Architectural Association journal* 71 (July-Aug 1955): 56-60.
- Sprawnson, Cuthbert Allen. *Moore's Manual of Family Medicine and Hygiene for India* London: J. & A. Churchill, 1921.
- "Stall of Mr. J. P. Kennette, Civil Engineer, Madura, at the 7th All India Swadeshi and Industrial Exhibition Conducted by the Madura-Ramand Chamber of Commerce at Madura." *Indian Concrete Journal* 15, no. 8 (August 15, 1941): 275.
- The Building Research Advisory Board. *Housing and Building in Hot-Humid and Hot-Dry Climates*, Building Research Advisory Board, Research Conference Report No. 5, Conference Held at Washington D.C, November 18 and 19, 1952. Washington D.C.: The Building Research Advisory Board, Division of Engineering and Industrial Research, May 1953.

- Tirumalachar, B. "Abstract of the Estimate for Constructing a Maternity Home at Hosdurga. Chitaldrug District." *Mysore Gazette* May 16, 1940, 1093-1095.
- Tropical Advisory Service. "British High Commission, Islamabad: Climatic Design Report." London Prepared for the Ministry of Public Building and Works, London by Tropical Advisory Service, Department of Tropical Studies, Architectural Association School of Architecture 1965-66.
- . "Climate Analysis and Design Recommendations for Kuwait Old City." London Prepared for Peter and Alison Smithson by Tropical Advisory Service, Department of Tropical Architecture, Architectural Association School of Architecture 1969.
- Turner, J.A. *Sanitation in India*. Bombay [renamed Mumbai]: Times of India, 1922.

Secondary Sources

- Auslander, Leora. *Taste and Power Furnishing Modern France*, Studies on the History of Society and Culture; 24. Berkeley: University of California Press, 1996.
- Ballantyne, Tony, and Antoinette Burton. "Global Empires, Transnational Connections: Anti-Colonialism and the Cross Currents of Modern Imperialism " In *Empire and Imperial Encounters, 1875-1945*, edited by Antoinette Burton, Forthcoming.
- Banham, Reyner. *The Architecture of the Well-Tempered Environment*. London; Chicago: Architectural Press; University of Chicago 1973.
- Barton, Greg. *Empire Forestry and the Origins of Environmentalism*, Cambridge Studies in Historical Geography Cambridge: Cambridge University Press, 2002.
- Bhagavan, Manu Belur. *Sovereign Spheres: Princes, Education and Empire in Colonial India*. New Delhi: Oxford University Press, 2003.
- Borasi, Giovanna, ed. *Sorry, out of Gas: Architecture's Response to the 1973 Oil Crisis*. Montreal: Edizioni Corraini and Canadian Centre for Architecture, 2008.
- Bramwell, Anna. *Blood and Soil: Richard Walther Darré and Hitler's "Green Party"*. Abbotsbrook, Bourne End, Buckinghamshire: Kensal Press, 1985.
- Briggs, Shirley A. . "Remembering Rachel." *EPA Journal* 18, no. 2 (May-June 1992): 62.
- Building Research Establishment. "BREEAM: BRE Environmental Assessment Method." <http://www.breeam.org>.
- Chatterjee, Partha. *The Nation and Its Fragments : Colonial and Postcolonial Histories*, Princeton Studies in Culture/Power/History. Princeton, N.J: Princeton University Press, 1993.
- Cherry, Gordon ed. *Shaping an Urban World*. London: Mansell Publishing, 1980.

- Cox, Anthony, and rev. Alan Powers. "Syllas, Stelios Messinesos De (1917–1964)." In *Oxford Dictionary of National Biography*. Oxford University Press, 2004.
- Crinson, Mark. *Modern Architecture and the End of Empire*. Aldershot, England; Burlington, VT: Ashgate, 2003.
- Davies, Philip. *Splendours of the Raj: British Architecture in India, 1660-1947*. London: Penguin Books, 1987.
- Dutta, Maya. *Jamshedpur : The Growth of the City and Its Regions*. Calcutta [now Kolkata]: Asiatic Society, 1977.
- Eley, Geoff, and Ronald Grigor Suny, eds. *Becoming National: A Reader*. New York: Oxford University Press, 1996.
- Fergusson, James. *History of Indian and Eastern Architecture*. New York: Dodd, Mead & Co., 1891.
- Fox, Warwick. *Ethics and the Built Environment*, Professional Ethics. London ; New York: Routledge, 2000.
- Goswami, Manu. *Producing India: From Colonial Economy to National Space*, Chicago Studies in Practices of Meaning. Chicago; London: University of Chicago Press, 2004.
- Goulding, John R., J. Owen Lewis, and Theo C. Steemers, eds. *Energy Conscious Design: A Primer for Architects*. London: B. T. Batsford for the Commission of The European Communities; Solar Energy Applications to Buildings Programme and Directorate General XIII for Telecommunications, Information Technology and Innovation, 1992.
- Grove, Richard. *Green Imperialism: Colonial Expansion, Tropical Island Edens, and the Origins of Environmentalism, 1600-1860*. Cambridge; New York: Cambridge University Press, 1995.
- Guha, Ramachandra. *Environmentalism: A Global History*. New York: Longman, 2000.
- , and J Martinez-Alier, eds. *Varieties of Environmentalism: Essays North and South*. Delhi; New York: Oxford University Press, 1998.
- Gupta, Krishna Murti. *Mira Behn: Gandhiji's Daughter Disciple*. New Delhi: Himalaya Seva Sangh, 1992.
- Goldhagen, Sarah, and Rejean Legault, eds. *Anxious Modernisms: Experimentation in Postwar Architectural Culture*. Cambridge: MIT Press, 2000.
- Harrison, S.W., and B.P. Sinha. "A Study of Alternative Building Materials and Technologies for Housing in Bangalore, India." *Construction and Building Materials* 9, no. 4 (August 1995): 211-217.
- Hasan, M. Fazlul. *Bangalore through the Centuries*. Bangalore: Historical Publications, 1970.
- Hays, Samuel P., and Barbara D. Hays. *Beauty, Health, and Permanence: Environmental Politics in the United States, 1955-1985*, Studies in Environment and History. Cambridge [Cambridgeshire]; New York: Cambridge University Press, 1987.

- Hettne, Björn. *The Political Economy of Indirect Rule: Mysore 1881-1947*, Scandinavian Institute of Asian Studies Monograph Series; No. 32. London: Curzon Press, 1978.
- Hobson, Kersty. "Competing Discourses of Sustainable Consumption: Does the 'Rationalization of Lifestyles' Make Sense?" In *The Earthscan Reader in Sustainable Consumption*, edited by Tim Jackson, 305-327. London, Sterling VA: Earthscan, 2006.
- Ingersoll, R. "Unpacking the Green Man's Burden." *Design Book Review* Spring, no. 20 (1991): 19-26.
- Issar, T. P. *Mysore, the Royal City*. Bangalore: Marketing Consultants & Agencies, 1991.
- Issar, T. P., and Bangalore Urban Arts Commission. *The City Beautiful a Celebration of the Architectural Heritage and City-Aesthetics of Bangalore*. Bangalore: Bangalore Urban Arts Commission, 1988.
- Journal of Architectural Education*. Vol. 30 No. 3, Energy and Architecture, 1977.
- Kalia, Ravi. *Bhubaneswar: From a temple Town to a Capital City*. Carbondale: Southern Illinois University Press, 1994.
- Kennedy, Joseph F. *Building without Borders: Sustainable Construction for the Global Village*. Gabriola, B.C.: New Society Publishers, 2004.
- Kibert, Charles J. *Reshaping the Built Environment: Ecology, Ethics, and Economics*. Washington, D.C.: Island Press, 1999.
- Killingsworth, M. Jimmie, and Jacqueline S. Palmer. *Ecospeak: Rhetoric and Environmental Politics in America*. Southern Illinois UP: Carbondale, 1992.
- Kirk, Andrew G. *Counterculture Green: The Whole Earth Catalog and American Environmentalism*. Lawrence, Kansas: University Press of Kansas, 2007.
- Le Roux, Hannah. "The Networks of Tropical Architecture." *The Journal of Architecture* 8, no. 3 (2003): 337-354.
- Lear, Linda J. "Rachel Carson's Silent Spring." *Environmental History Review* Vol. 17, no. 2 (1993): 23-48.
- Luccarelli, Mark. *Lewis Mumford and the Ecological Region: The Politics of Planning*, Critical Perspectives. New York: Guilford Press, 1995.
- Madge, Pauline. "Design, Ecology, Technology: A Historiographical Review." *Journal of Design History* Vol. 6 no. 3 (1993): 149-166.
- Martin, Reinhold. "Environment." *Grey Room* 14 (2004): 78-101.
- McHarg, Ian L., and History American Museum of Natural. *Design with Nature*. Garden City, N.Y.: Published for the American Museum of Natural History [by] the Natural History Press, 1969.
- Metcalf, Thomas R. *An Imperial Vision: Indian Architecture and Britain's Raj*. Berkeley: University of California Press, 1989.
- Moore, Charles W. , Jeffrey Cook, Murray Milne, John Eberhard, William Borner, Dean Hawkes, Gerald McCue, William Turner, Richard Bender, Larry Spielvogel, and Reyner Banham. "Educators Roundtable." *Journal of Architectural Education* 30, no. 3, Energy and Architecture (February, 1977): pp. 2-5.
- Nair, Janaki. *Miners and Millhands: Work, Culture, and Politics in Princely Mysore*. Walnut Creek, California: AltaMira Press, 1998.

- . *The Promise of the Metropolis: Bangalore's Twentieth Century*. New Delhi; New York: Oxford University Press, 2005.
- Ofstad, Sylvi , Liv Westly, and Tone Bratelli. Symposium: Sustainable Consumption, Oslo, Norway 19-20 January 1994.
- Porteus, Colin. *The New Eco-Architecture: Alternatives from the Modern Movement*, London and New York Spon Press, 2002.
- Pott, Janet, Elizabeth Staley, and Romola Chatterjee. *Old Bungalows in Bangalore, South India*. London: Pott, 1977.
- Pyla, Panayiota I. . "Ekistics, Architecture and Environmental Politics, 1945-1976: A Prehistory of Sustainable Development." Unpublished Ph. D. Dissertation, Massachusetts Institute of Technology, September 2002.
- Ramusack, Barbara N. *The Princes of India in the Twilight of Empire: Dissolution of a Patron-Client System, 1914-1939*. Columbus: Published for the University of Cincinnati by the Ohio State University Press, 1978.
- Rapoport, Amos. *House Form and Culture*. Englewood Cliffs, N.J.: Prentice-Hall, 1969.
- Rome, Adam Ward. *The Bulldozer in the Countryside: Suburban Sprawl and the Rise of American Environmentalism*, Studies in Environment and History. Cambridge; New York: Cambridge University Press, 2001.
- Rudofsky, Bernard. *Architecture without Architects, an Introduction to Nonpedigreed Architecture*. New York: Museum of Modern Art; distributed by Doubleday, Garden City, N.Y., 1964.
- Rybczynski, Witold. *Paper Heroes: A Review of Appropriate Technology* Garden City, N.Y.: Anchor Press/Doubleday, 1980.
- Sadler, Simon. "Drop City Revisited." *Journal of Architectural Education* Vol. 59, no. 3 (February 2006): 5-16.
- Sarkar, Sumit. *The Swadeshi Movement in Bengal, 1903-1908*. New Delhi: People's Pub. House, 1973.
- Schumacher, E. F. *Small Is Beautiful: Economics as If People Mattered*. New York Harper Perennial, 1989.
- Scott, Andrew. "Design Strategies for Green Practice." *Journal of Green Building* 1, no. 4 (2006): 11-27.
- Scott, Andrew, ed. *Dimensions of Sustainability: Architecture Form, Technology, Environment, Culture*. London; New York: E & FN Spon, 1998.
- Scott, Felicity D. "Acid Visions." *Grey Room* 23 (Spring 2006): 22-39.
- Szokolay, S. V. *Environmental Science Handbook for Architects and Builders*. Edited by Anonymous. New York: Wiley, 1980.
- . *Solar Energy and Building*. London; New York: Architectural Press; Halsted Press Division, Wiley, 1977.
- . *World Solar Architecture*. London; New York: Architectural Press; Halsted Press, 1980.
- Szokolay, S. V., and Congress International Solar Energy Society. *Solar World Congress: Proceedings of the Eighth Biennial Congress of the International Solar Energy Society, Perth, 14-19 August, 1983*. Oxford Oxfordshire] ; New York: Pergamon Press, 1984.

- Trivedi, Lisa. *Clothing Gandhi's Nation Homespun and Modern India*. Bloomington: Indiana University Press, 2007.
- Tzonis, Alexander, Bruno Stagno, and Liane Lefaivre. *Tropical Architecture: Critical Regionalism in the Age of Globalization*. Chichester ; New York; The Netherlands: Wiley-Academic; C. Fonds, 2001.
- U.S. Green Building Council (USGBC). "Leadership in Energy and Environmental Design." U.S. Green Building Council (USGBC), www.usgbc.org/LEED/.
- Ubbelohde, Susan. "The Myth of the Ecological Vernacular." *Design Book Review* 20 (Spring 1991): 27-29.
- Uduku, Ola. "Modernist Architecture and 'the Tropical' in West Africa: The Tropical Architecture Movement in West Africa, 1948–1970." *Habitat International* 30 (2006): 396–411.
- United Nations Conference on Environment and Development, ed. *Agenda 21: The Earth Summit Strategy to Save Our Planet* Edited by Daniel Sitarz. Boulder, Colorado: EarthPress, 1993.
- Waddell, Craig, ed. *And No Birds Sing: Rhetorical Analyses of Rachel Carson's Silent Spring* Carbondale: Southern Illinois University Press, 2000.
- World Commission on Environment and Development. *Our Common Future*. Oxford; New York: Oxford University Press, 1987.
- Worster, Donald. *American Environmentalism: The Formative Period, 1860-1915*, Wiley Sourcebooks in American Social Thought. New York: Wiley, 1973.
- Yoshino, Hiroshi, Kenichi Hasegawa, and Shin-ichi Matsumoto. "Passive Cooling Effect of Traditional Japanese Building's Features." *Management of Environmental Quality: An International Journal* 18, no. 5 (2007): 578-590.