



Research White Paper

WHP199

July 2011

RESULTS OF THE DRM+ HIGH POWER FIELD TRIAL IN THE UNITED KINGDOM

Lindsay Cornell

BRITISH BROADCASTING CORPORATION

RESULTS OF THE DRM+ HIGH POWER FIELD TRIAL IN THE UNITED KINGDOM

Lindsay Cornell

Abstract

The DRM Consortium carried out a high-power field trial of the DRM system in the FM band in the central Scotland area, centred on the city of Edinburgh, in the United Kingdom during January to May 2011. The DRM Consortium members contributed their expertise and equipment to the trial to enable the system to be tested in a real commercial environment with a wide variety of reception conditions. The BBC provided project management and measuring effort for the trial. This document describes the trial and results.

This document was submitted to the ITU-R WP6A meeting in May 2011 and after processing by the secretariat given the reference R07-WP6A-C-0532!!MSW-E.docx.

Additional key words: DRM+

White Papers are distributed freely on request.
Authorisation of the Head of External Relations is
required for publication.

RESULTS OF THE DRM+ HIGH POWER FIELD TRIAL IN THE UNITED KINGDOM

Lindsay Cornell

1 Location and environment for the trial

The trial was conducted in the eastern Central belt area of Scotland from the Craigmally transmitting station located just to the north of the town of Burntisland, Fife. The area is characterised by a mixture of dense urban, urban, suburban, and rural terrain, including the city of Edinburgh, several towns, open farmland and light industrial districts. The physical geography includes open water, gently undulating hills and rocky outcrops which contribute to various challenges for radio services, including multipath and terrain shielding.



Figure 1: DRM+ trial location

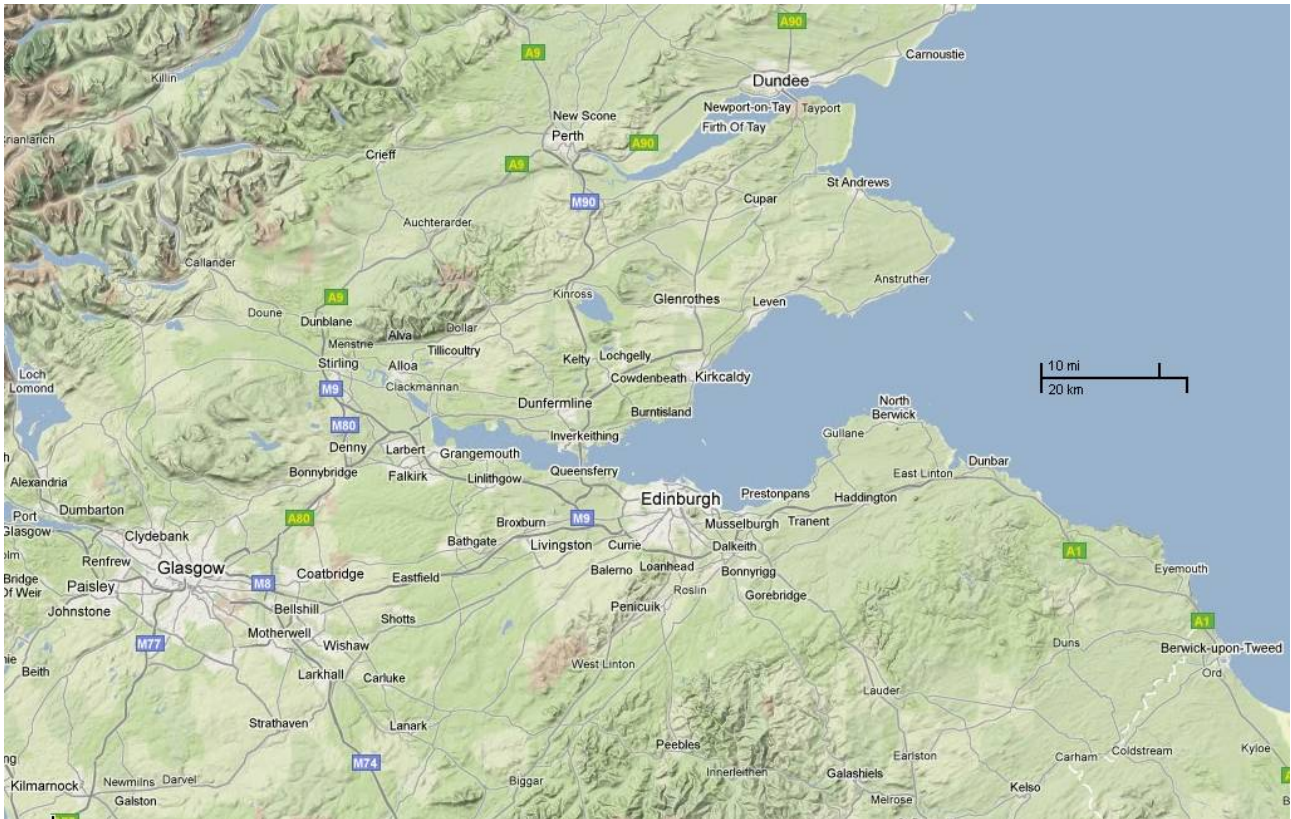

Figure 2: DRM+ trial location - detail with terrain

2 The Transmission Site

The Craiggelly transmission site is owned and operated by Arqiva. It is a commercial broadcasting site which provides transmission facilities for analogue and digital television (using the PAL-I and DVB-T standards), analogue and digital radio (using the FM and DAB standards), and a variety of ancillary mobile communications, links facilities, etc. The site is 182m above sea level.

The FM radio services use two antenna systems providing mixed horizontal and vertical polarisation. Each antenna system is fed from a combiner. The site provides the following FM services:

Table 1: FM radio services from Craiggelly

Station name	Frequency	Power	Antenna	Antenna height
BBC Radio Nan Gàidheal	104.1 MHz	5 kW erp	A	119m
Capital FM	105.7 MHz	10 kW erp	B	107m
Forth FM	97.3 MHz	9.8 kW erp	A	119m
Real Radio	101.1 MHz	9.6 kW erp	B	107m
Talk 107*	107.0 MHz	10 kW erp	A	119m
* Note: Talk 107 is no longer on-air				



Figure 3: Craigkelly tower (left) and top section showing FM arrays (right)

The trial made use of the licensed assignment at 107.0 MHz. The antenna pattern is shown in figure 4. This pattern has a restriction to the east due to the Firth of Forth estuary and open sea.

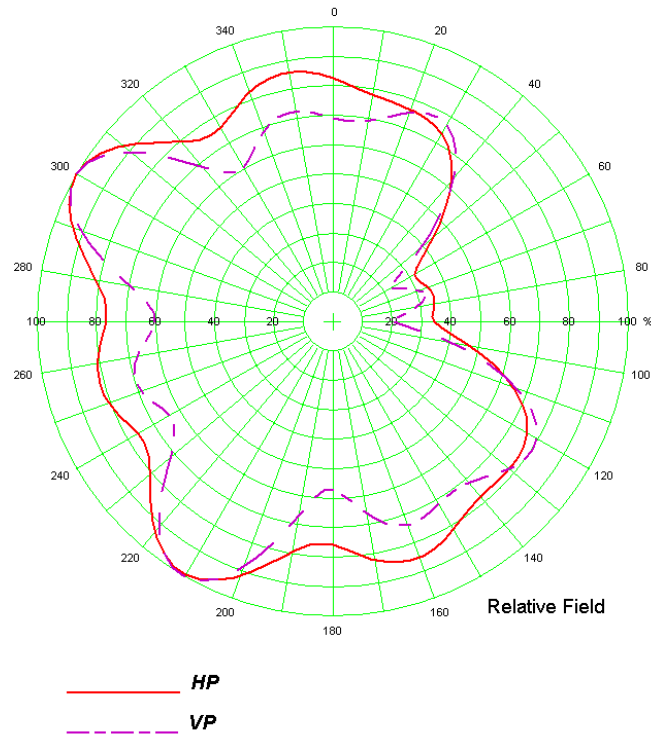

Figure 4: Antenna pattern of antenna A

All frequencies and powers used at the site are coordinated and licensed by UK Ofcom, as are the frequencies used from neighbouring transmission sites. For reference, the frequencies and powers of all services on-air in the 106.5 to 107.5 MHz range are shown in figure 5.

It can be seen that there are no co-channel transmissions in the area, and the only close adjacent transmission with any significant power is from Durris on 106.8 MHz at 10 kW erp. However, a range of hills provides terrain shielding to maintain the required planning rules.

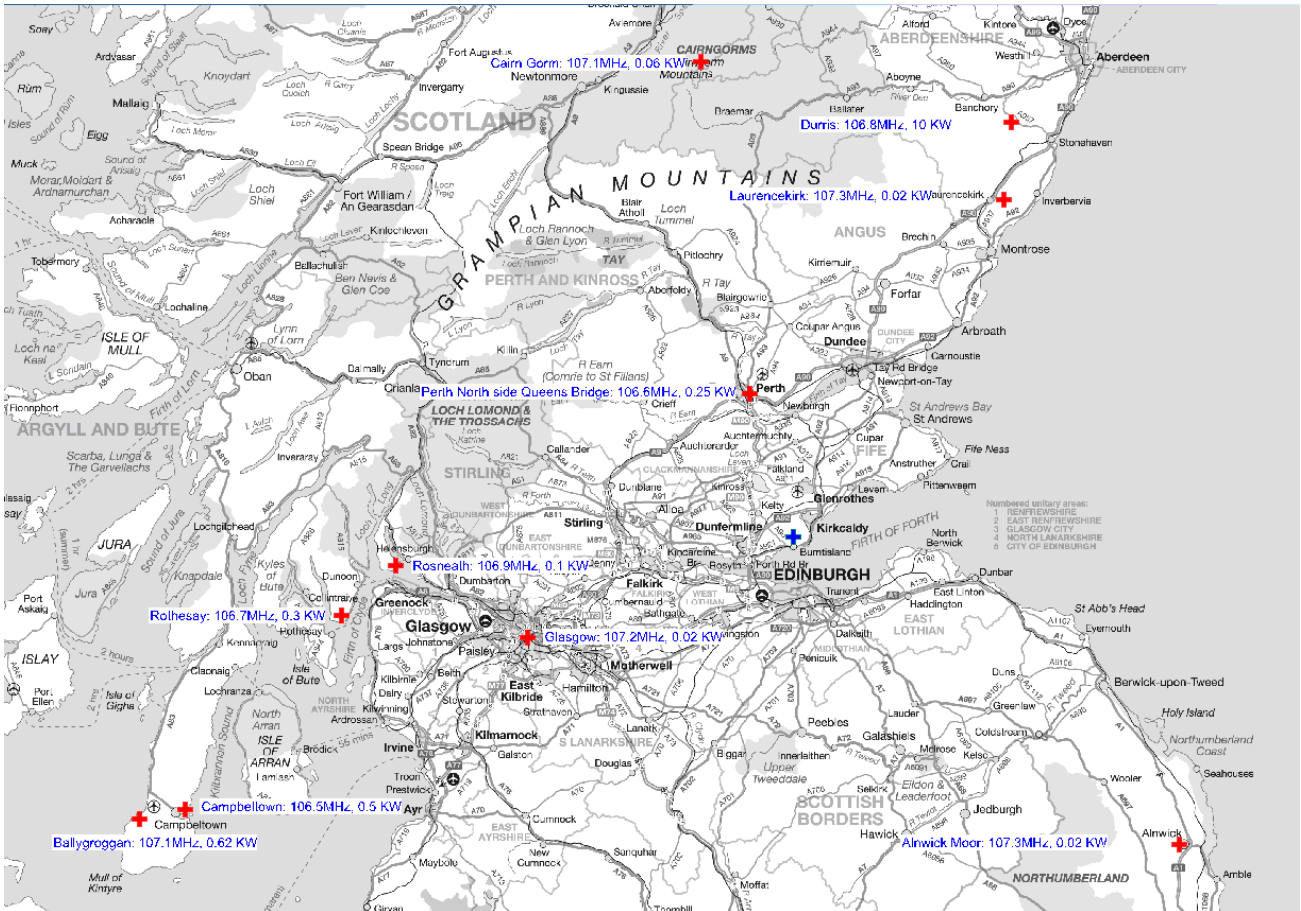

Figure 5: FM transmissions operating on frequencies from 106.5 to 107.5 MHz (Craigkelly marked with blue cross)

3 Transmission Equipment

The transmission equipment was provided by DRM Consortium members for the duration of the trial. The block diagram of the equipment configuration is shown in figure 6. The transmitter formerly used for Talk 107 was removed and replaced by the DRM+ transmitter and associated equipment. The main audio source for the trial was the BBC Gaelic language service BBC Radio nan Gàidheal which is also radiated as an FM service from the same antenna system. This allowed a direct comparison to be made between the analogue FM and DRM coverage.

The outputs of the two FM transmitters for Forth FM and BBC Radio nan Gàidheal are fed into a combiner which is then fed into the wideband port of a constant impedance module. The output of the DRM+ transmitter was fed into the narrowband port formerly used by the FM service Talk 107. The output of the constant impedance module is fed to the high power splitter and antenna.

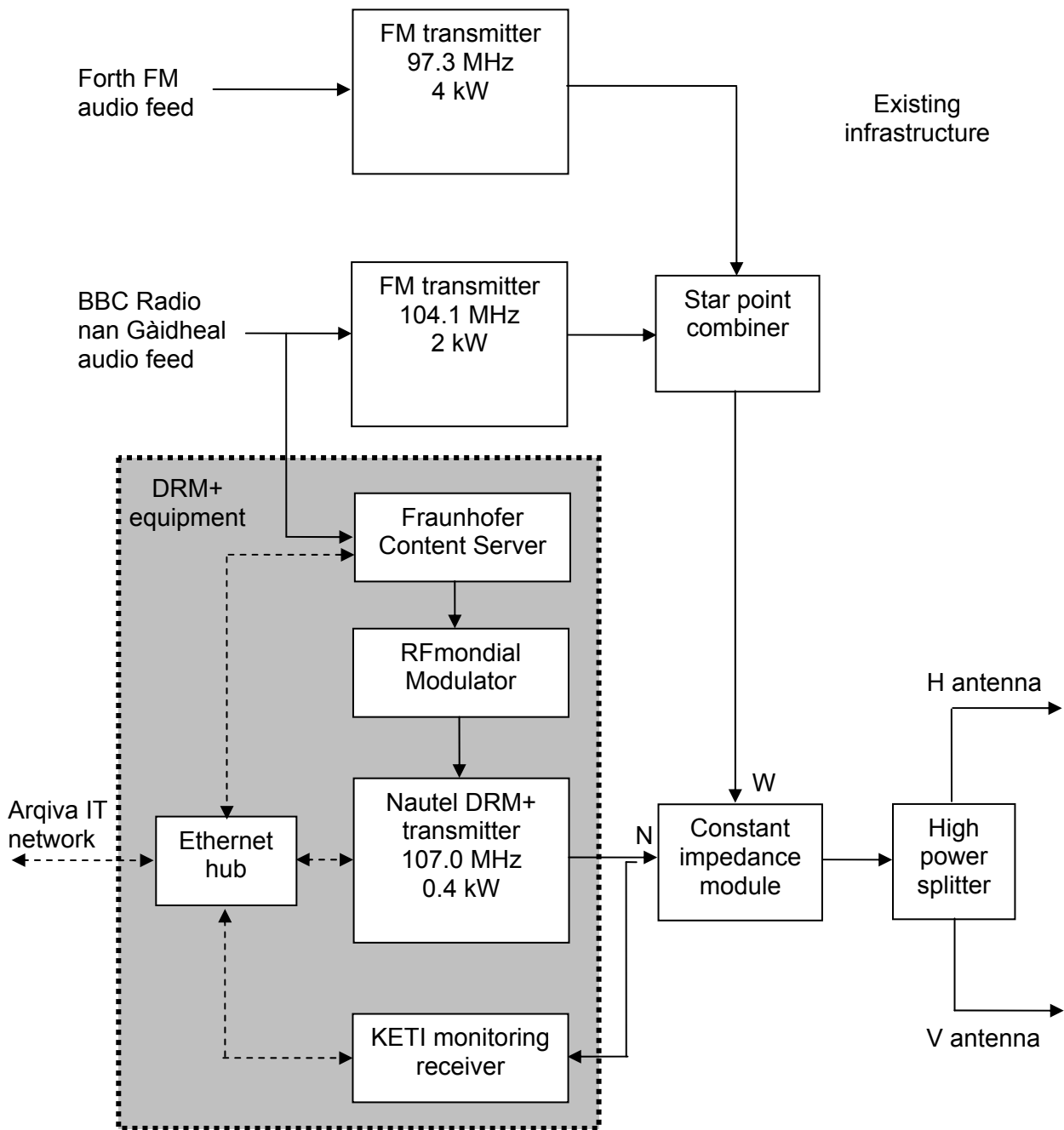

Figure 6: Block diagram of transmission system (simplified) showing existing infrastructure and additional DRM+ equipment

The Fraunhofer content server was configured to allow two DRM+ parameter sets to be switched to air - a more robust mode using 4-QAM modulation and rate 1/3 coding, which provided 49.7 kbps payload, and a higher capacity mode using 16-QAM modulation and rate 1/2 coding, which provided 149.1 kbps. In each case, BBC Radio nan Gàidheal was broadcast with text messages and a PRBS sequence to allow bit error ratio (BER) measurements to be made. In the higher capacity mode, the audio bit rate was increased and a second audio service consisting of music stored on the hard disk of the content server was included.

The content server was connected to the RFmondial modulator which in turn fed the Nautel NV5 transmitter. The transmitter was set to radiate at 107.0 MHz with a transmit power of 400 W. The

antenna system provides a 4 dBi gain and therefore the DRM signal was broadcast at 1 kW erp. The KETI DRM+ receiver was fed from a directional coupler on the output of the transmitter.

The content server, transmitter and monitoring receiver were each connected via an ethernet hub to the Arqiva technical IT network. This allowed remote control and monitoring of the equipment permitting mode changes as required during the measuring process. It also ensured that the DRM+ system was monitored 24/7 by the Arqiva central control facility.



Figure 7: The DRM+ transmitter (left) and content server, modulator and monitoring receiver (right)

4 Acceptance Tests

A test and development license was issued by the UK regulator, Ofcom, for the duration of the trial. Prior to the start of transmissions, Ofcom visited the Craigmally site to carry out an acceptance test to ensure that existing services using the same antenna would not suffer as a result of the introduction of the DRM+ trial service. A full compliance test was carried out to ensure that no spurious intermodulation products or out-of-band emissions were radiated that could impact on other broadcast services or to aeronautical services using the spectrum immediately above the FM band. The full test procedure was followed, starting with measuring the transmitter into a dummy load, and continuing through the transmission chain. No problems were found with the installation and permission to begin the trial was given.

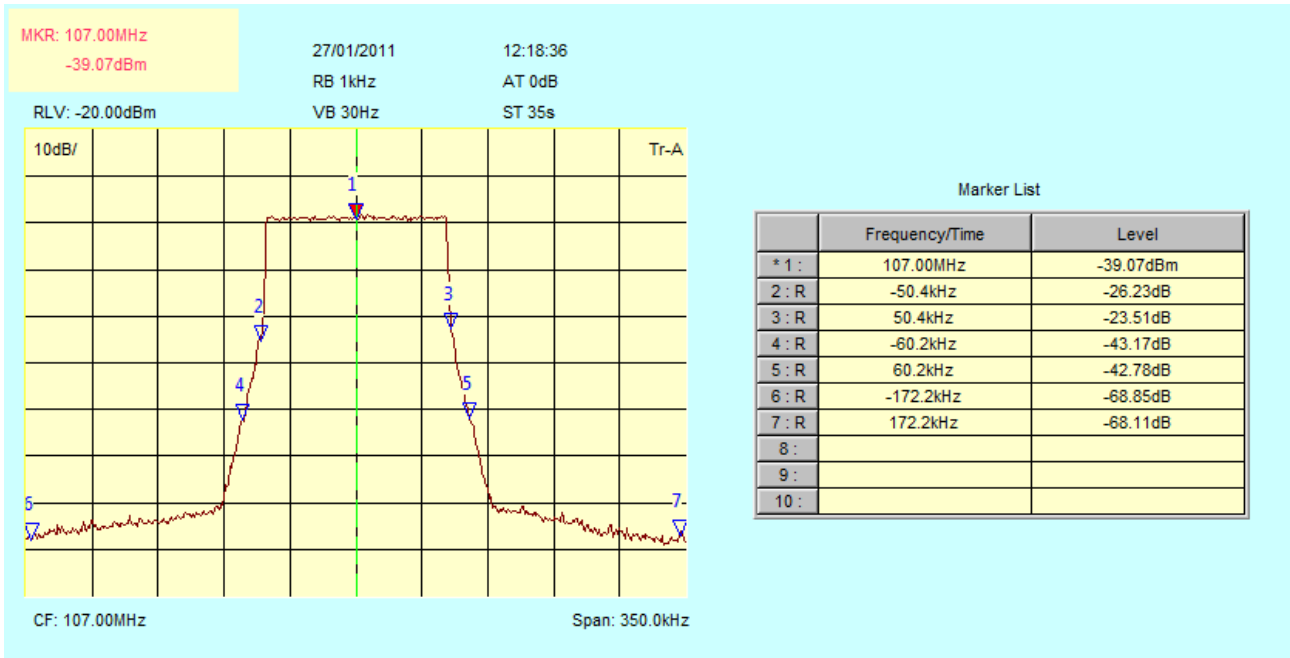

Figure 8: Recorded spectrum of DRM+ signal

5 Receiving Equipment

Mobile measurements were carried out using a BBC measuring vehicle. This was a VW Sharan which has a technical power supply and various items of standard measuring equipment installed. For the DRM+ trial additional equipment was installed.



Figure 9: Measuring vehicle

The schematic of the DRM+ measuring equipment is shown in figure 10.

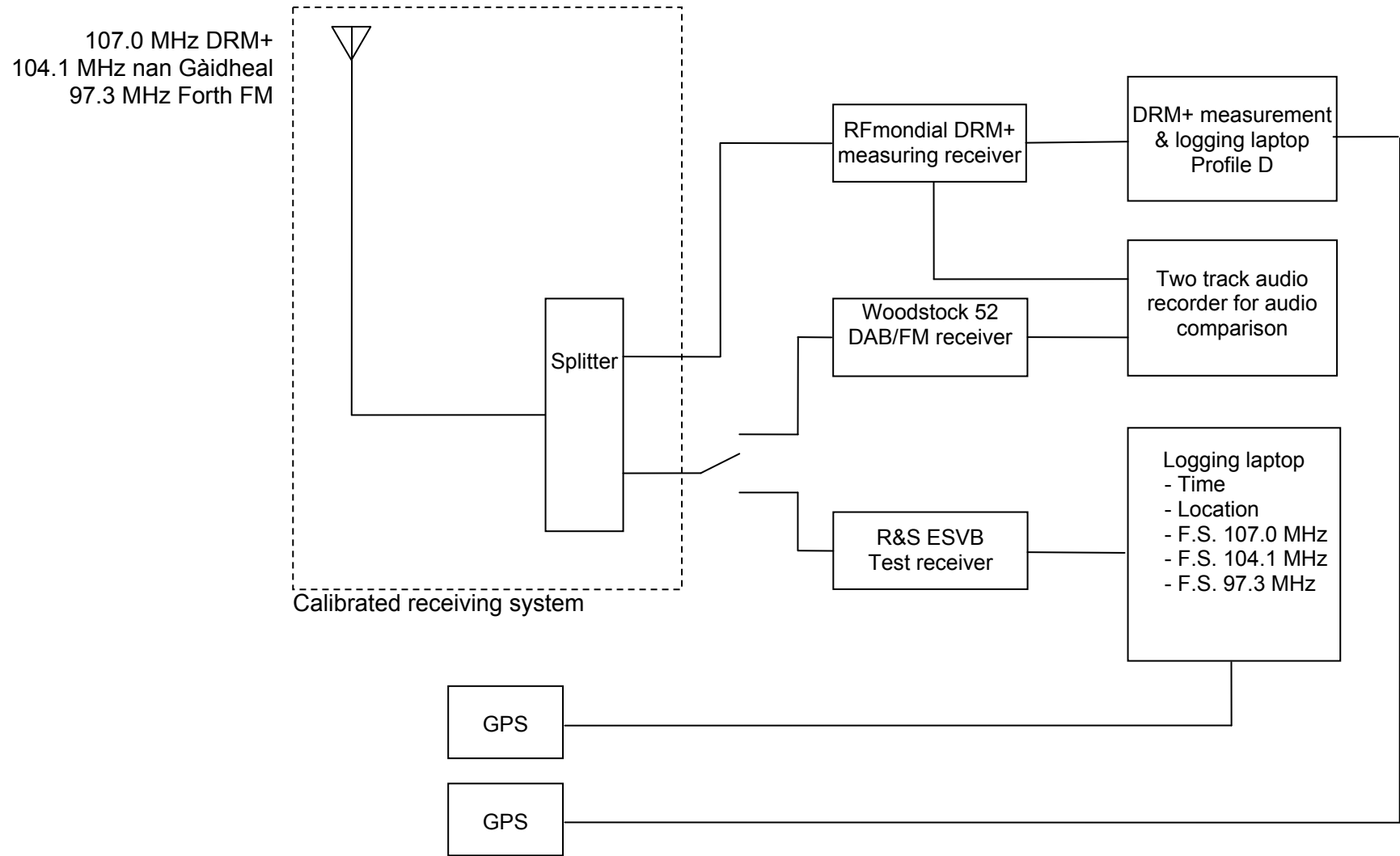

Figure 10: Receiver equipment schematic

The antenna is mounted on the roof at a height of approximately 1.5m above ground level and fed to a 3dB splitter. One output of the splitter was fed to the RFmondial DRM+ measuring receiver, the other to a switch to allow either the Blaupunkt Woodstock 52 receiver or the Rohde & Schwartz ESVB measuring receiver to be connected. The audio outputs of both the DRM+ receiver and the DAB/FM receiver were connected to an audio recorder to allow offline listening when analysing the recorded data. The DRM+ reception was monitored in real-time on a laptop computer, which also continuously recorded the DRM RSCI profile D [2] data for later analysis. A second laptop computer was used to log the field strength measurements from the R&S ESVB receiver which was set up to measure the field strength of each of the three signals from the common antenna. GPS data was provided to both laptops to allow the data to be geographically referenced.

6 Predicted Coverage

The UK planning model, derived from the output of the GE84 planning conference, was used to predict coverage from the Craigmally antenna for a DRM+ station operating at 1 kW and in 4-QAM, rate 1/3. The prediction is for mobile reception, interference limited for 50% time and 99% locations exceeding a field strength of 39 dB μ V/m at 10m.



Figure 11: Predicted coverage area for a 1kW DRM+, 4QAM, rate 1/3 station

For comparison, the official licensed coverage area of Forth FM, radiated from the same antenna system, is given in figure 12, corresponding to areas where the minimum median field strength is greater than 54 dB μ V/m. Note that coverage is made up of 9.8 kW erp from Craigmally, plus two repeaters with 500 W erp from Penicuik and 100 W erp from Black Hill.

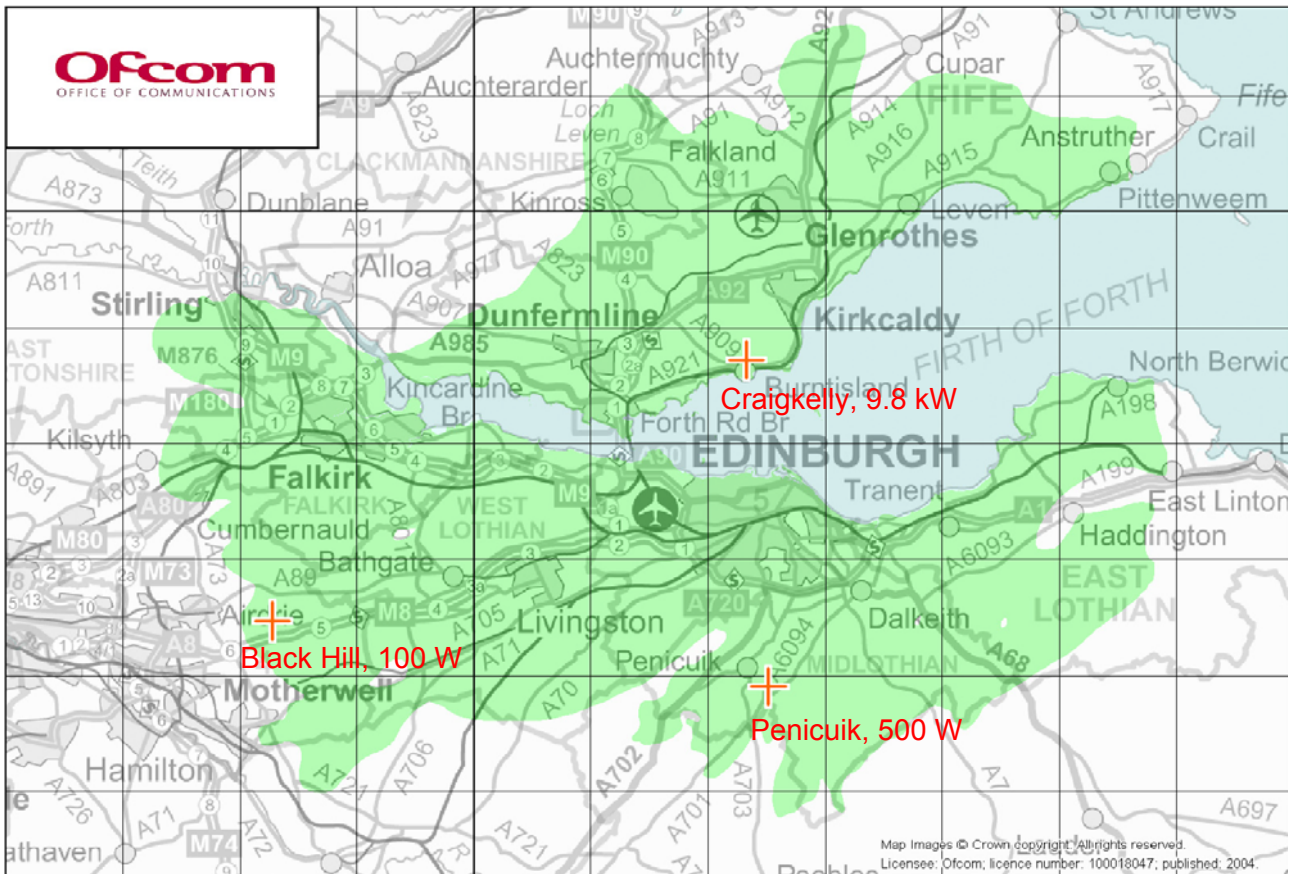

Edinburgh FM MCA (Forth FM) - 29th December 2003

Figure 12: Official licensed coverage area of Forth FM

7 Trial Routes and Analysis Method

The measurement of the coverage area was conducted over two two-week periods during February and March 2011. Note that additional measuring periods, including both mobile and indoor measurements, were made during April with final tests due to be made in May, but the results from these measurements are not included in this report.

Overall coverage was measured by driving along all major routes through the region, around 600 route miles in total. Several roads were passed more than once as each route crossed across another. First, measurements were made in the 4-QAM mode, and then the driving was repeated for the 16-QAM mode, although the precise driving routes used were varied according to local traffic conditions.

In addition, the performance in a dense urban environment was measured by driving many of the smaller roads in the city of Edinburgh, an area known to be extremely challenging for FM reception due to the hilly nature of the city, the narrowness of the streets and the height of the buildings.

The total distance covered during the four weeks of measuring was in excess of 1500 miles.

The RFmondial receiver was configured to record RSCI profile D. This essentially means that all parameters are decoded and recorded for later analysis, including the coded audio.

For the preparation of the maps showing coverage, the data was divided into two sets, one corresponding to measurements made whilst receiving the 4-QAM transmission mode, and the other for the 16-QAM mode. Each set was processed to aggregate all reception points within 100 x 100m squares for display. The audio quality flag is provided in the RSCI "rsta" TAG item for each received audio super frame and provides a binary indication of correctly received audio for the 200 ms audio super frame period, or impaired audio (i.e. not all audio frames decodable). The percentage of error free audio super frames is assigned to each square for plotting calculated as the number of error free audio super frames divided by the total number of audio super frames decoded within the 100 x 100m square.

8 Results

The results of the trial are presented as a series of maps showing the quality of the audio received. Additional information is provided as appropriate to assist with the interpretation of the presented data. A spectrum analyser was used to measure the spectrum at two locations approximately equidistant from the transmitter at North Queensferry and Leith Docks. The locations and plots are shown in figures 13 and 14.



Figure 13: Map showing location of Craigmyle transmitting station and reception sites at North Queensferry (left) and Leith Docks (right).

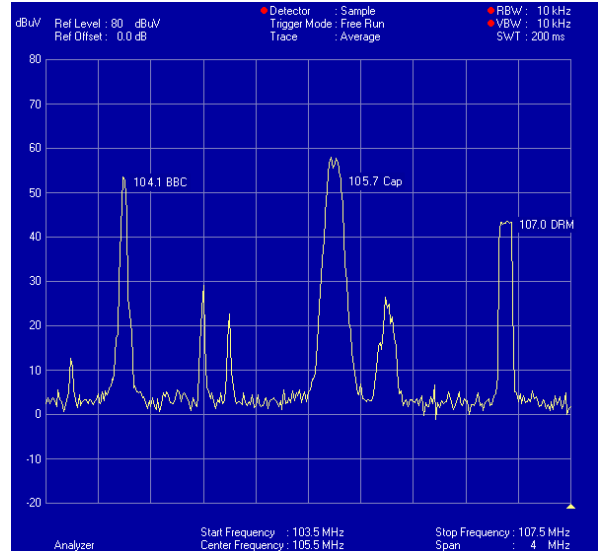
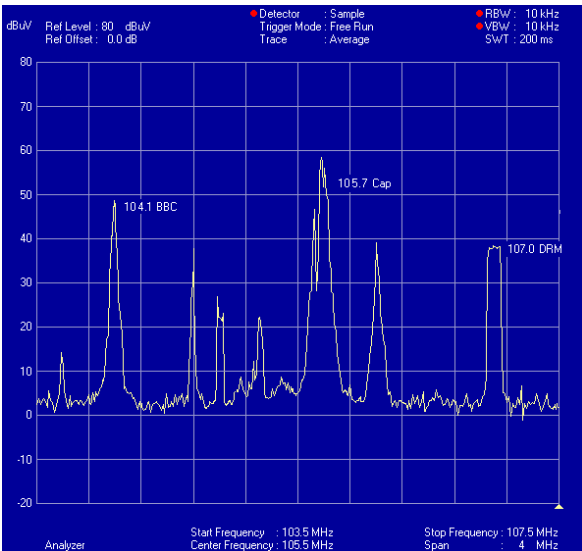

Figure 14: Spectrum plots taken at North Queensferry (left) and Leith Docks (right) showing BBC Radio nan Gaidheal, Capital FM and the DRM signal.

BBC Radio nan Gaidheal and the DRM signal share the same antenna, whilst Capital FM uses the lower antenna from Craighkelly. Also visible are FM services from other transmitters.

All maps in the following results sections are © Crown copyright and database rights 2011 Ordnance Survey 100039117.

The colouring of the reception paths on the maps is as follows:

- green > 99% audio super frames within the square are error free
- yellow 70% < audio super frames within the square are error free ≤ 99%
- orange 50% < audio super frames within the square are error free ≤ 70%
- red ≤ 50% audio super frames within the square are error free

8.1 Overall results for 4-QAM, rate 1/3

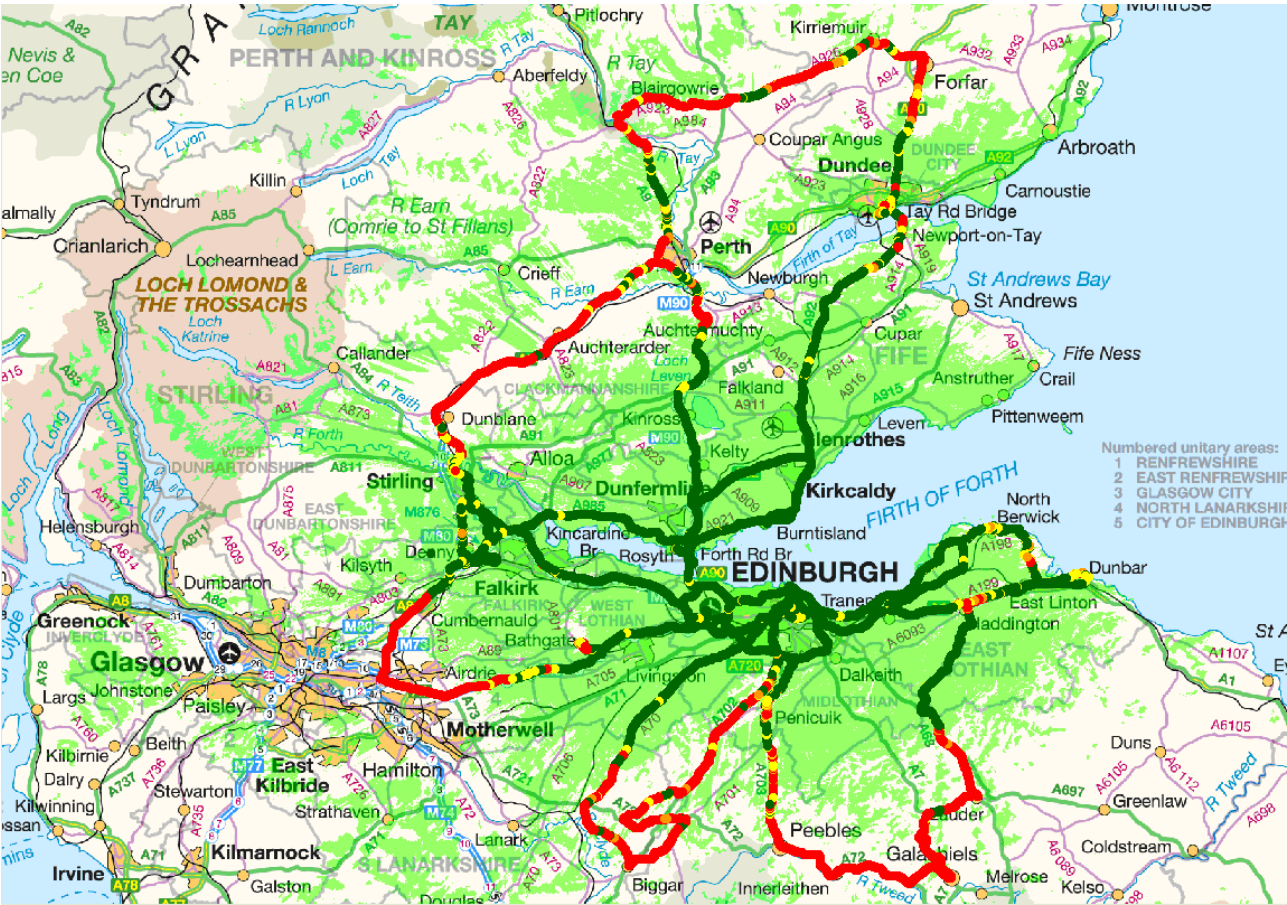

Figure 15: Overall coverage, 4-QAM rate 1/3.

The coverage is shown overlaid onto the predicted coverage. There is very strong correlation between the prediction and the measured results.

8.2 Overall results for 16-QAM, rate 1/2

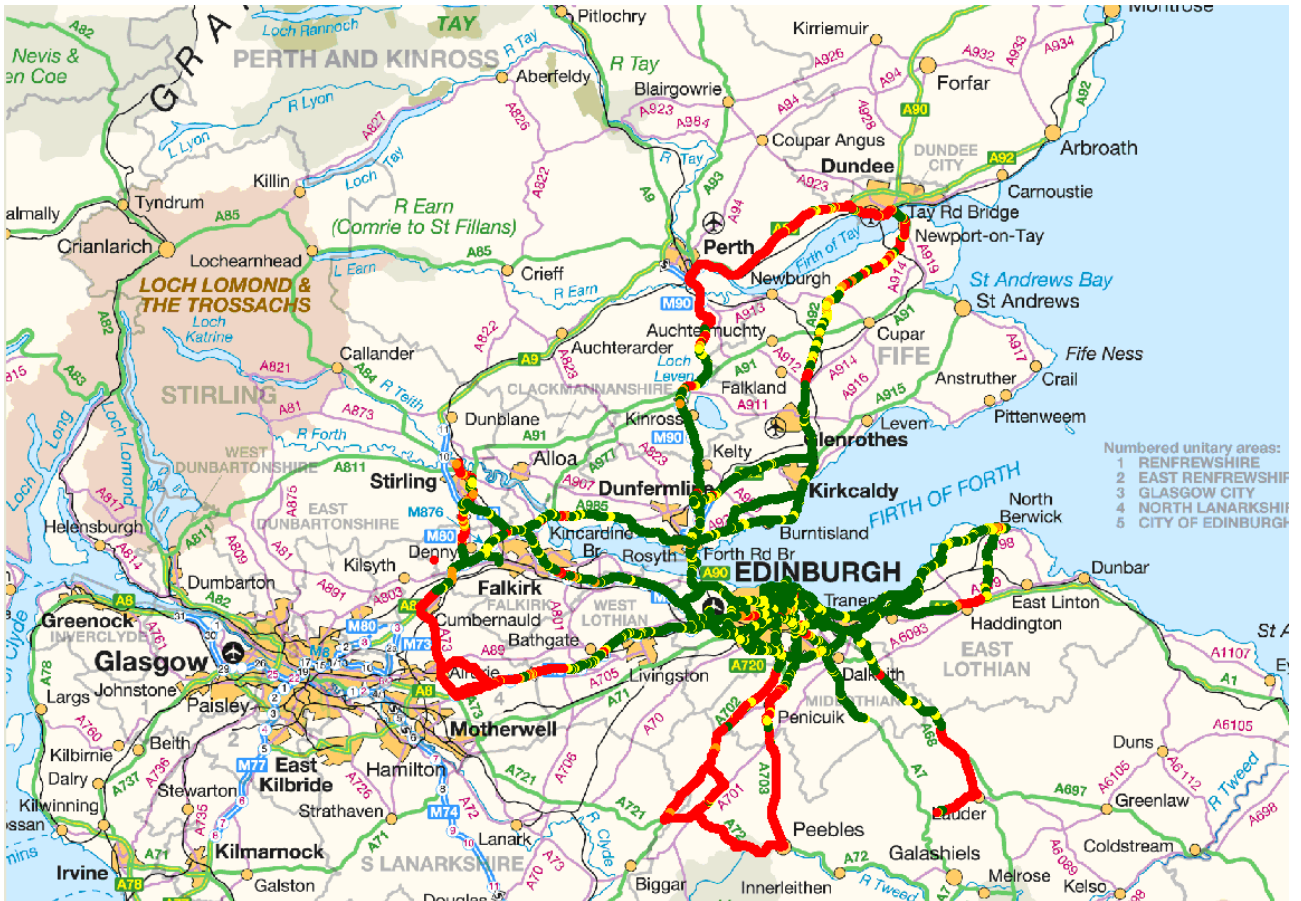

Figure 16: Overall coverage, 16-QAM rate 1/2.

The coverage is slightly less than that for 4-QAM as expected. The difference in the required SNR for the two modes is approximately 8 dB in a Gaussian channel.

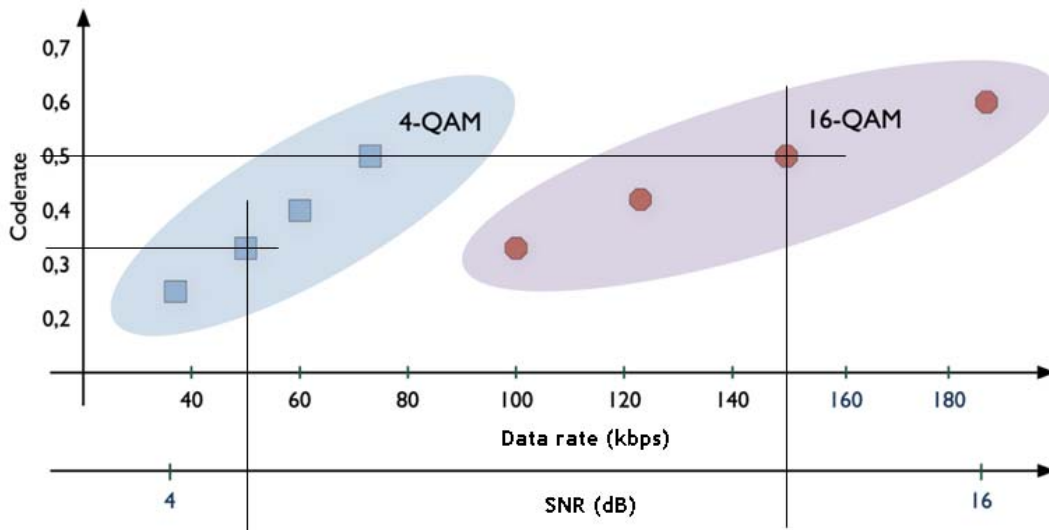

Figure 17: Comparison of data rate and required SNR in a Gaussian channel for different constellations and coderates.

8.3 Detailed results comparing 4-QAM and 16-QAM coverage

8.3.1 Edinburgh



Figure 18: Edinburgh city centre

Edinburgh suffers from extensive multipath effects on FM causing regular noise, clicks and fuzz at various locations. The hilly nature of the city also produces some dead areas where terrain prevents reception. In spite of this, the proximity of the transmitter means that in general Edinburgh receives a strong signal.

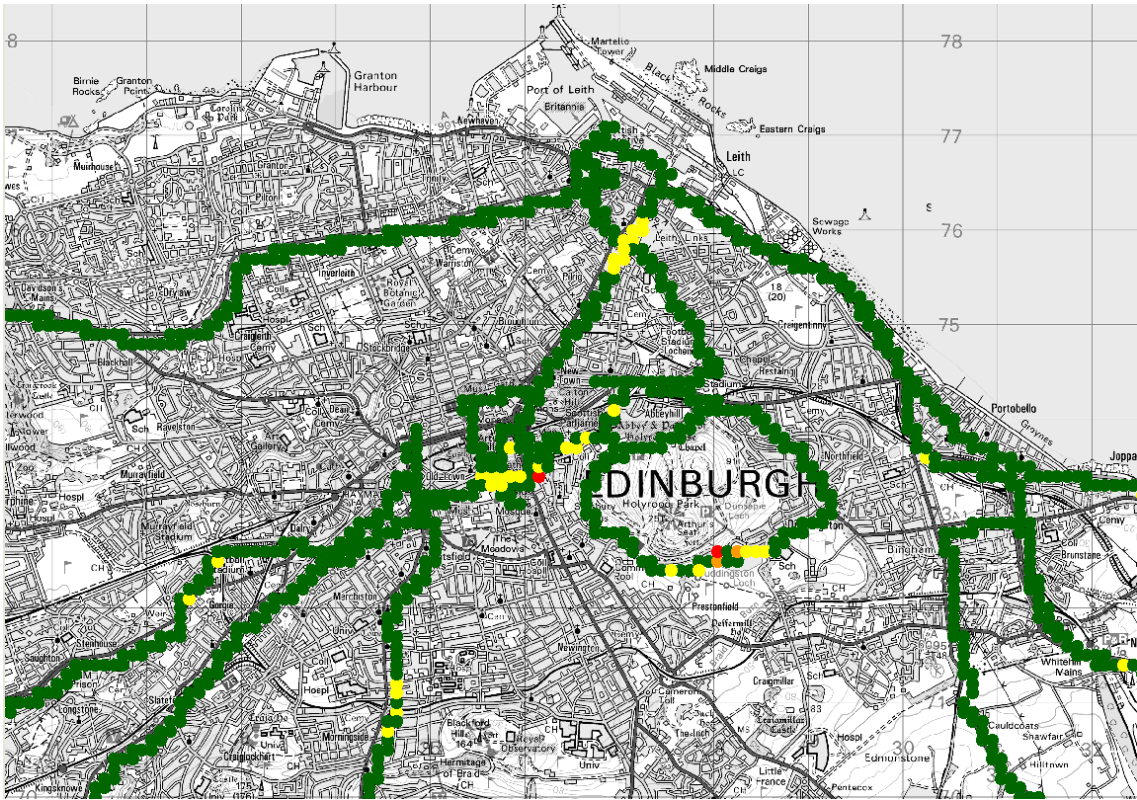

Figure 19: Edinburgh coverage, 4-QAM rate 1/3.

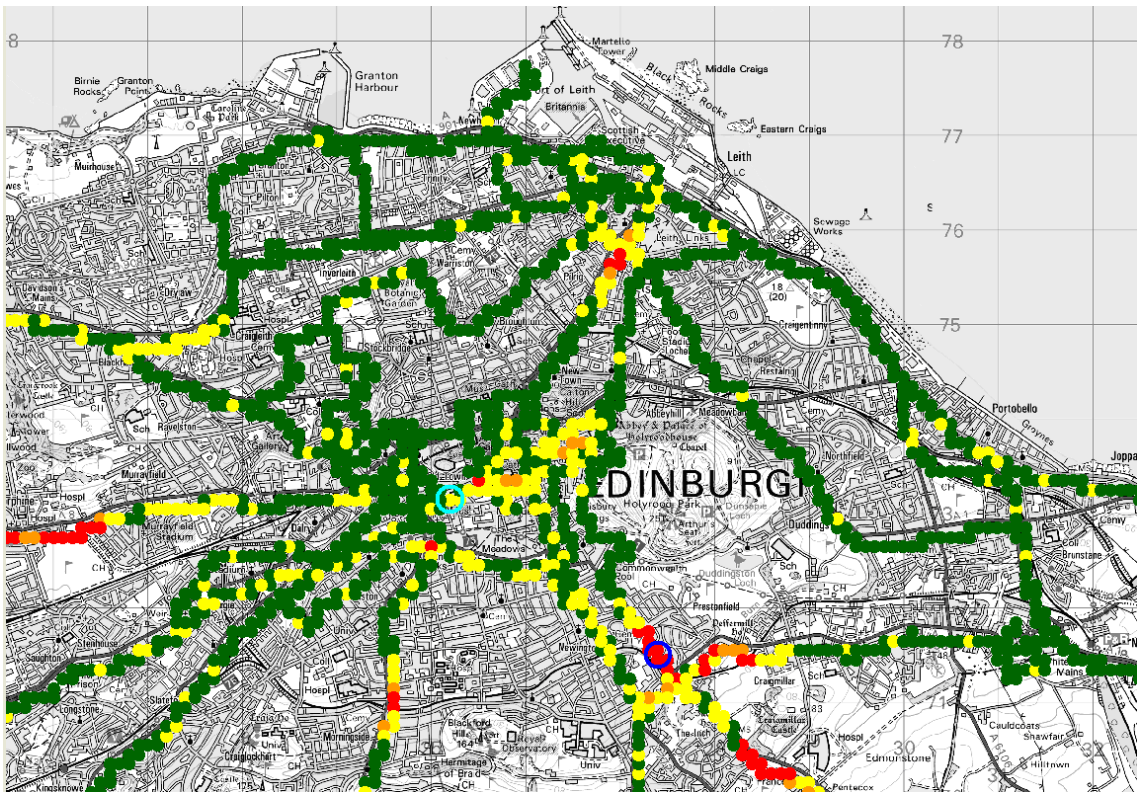

Figure 20: Edinburgh coverage, 16-QAM rate 1/2.

It can be seen that areas of poor reception in the 4-QAM mode are exacerbated in the 16-QAM mode. Two areas of poor reception on the 16-QAM plot are marked with blue circles for which terrain path profiles were plotted.

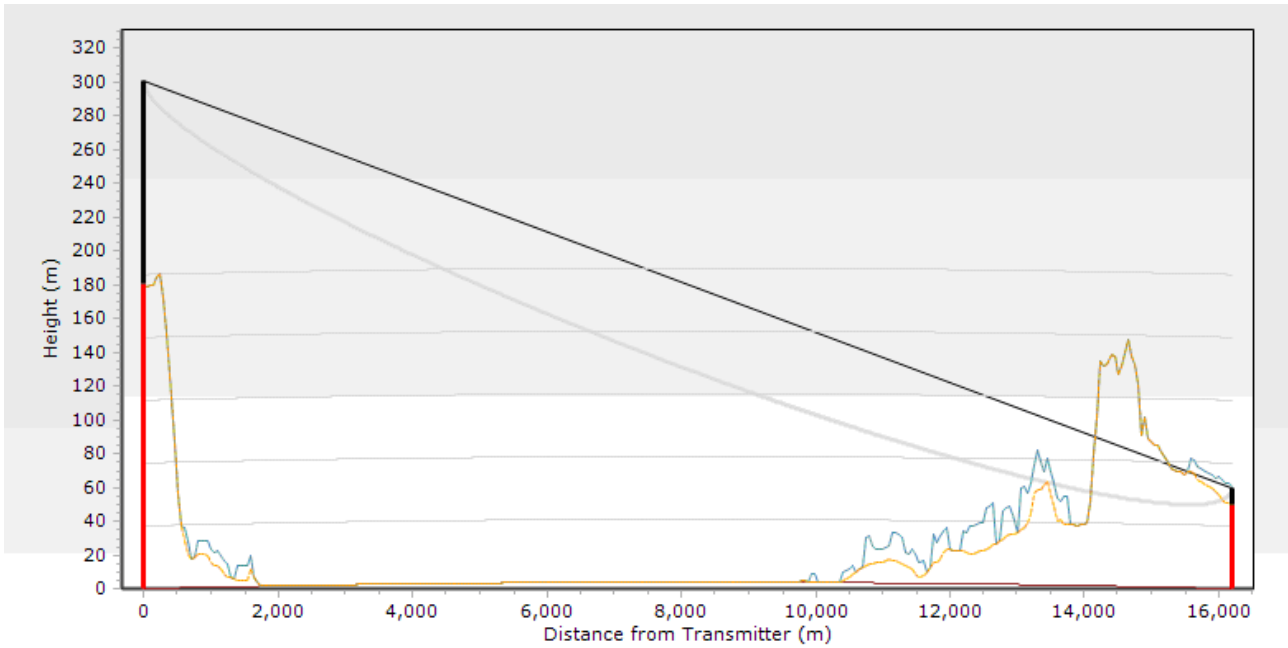

Figure 21: Path profile for dark blue ring.

The path profile shows terrain with the brown trace and building clutter with the blue trace. It can be seen that this area of poor reception is caused by terrain shielding from the rocky promontory known as Arthur's Seat.

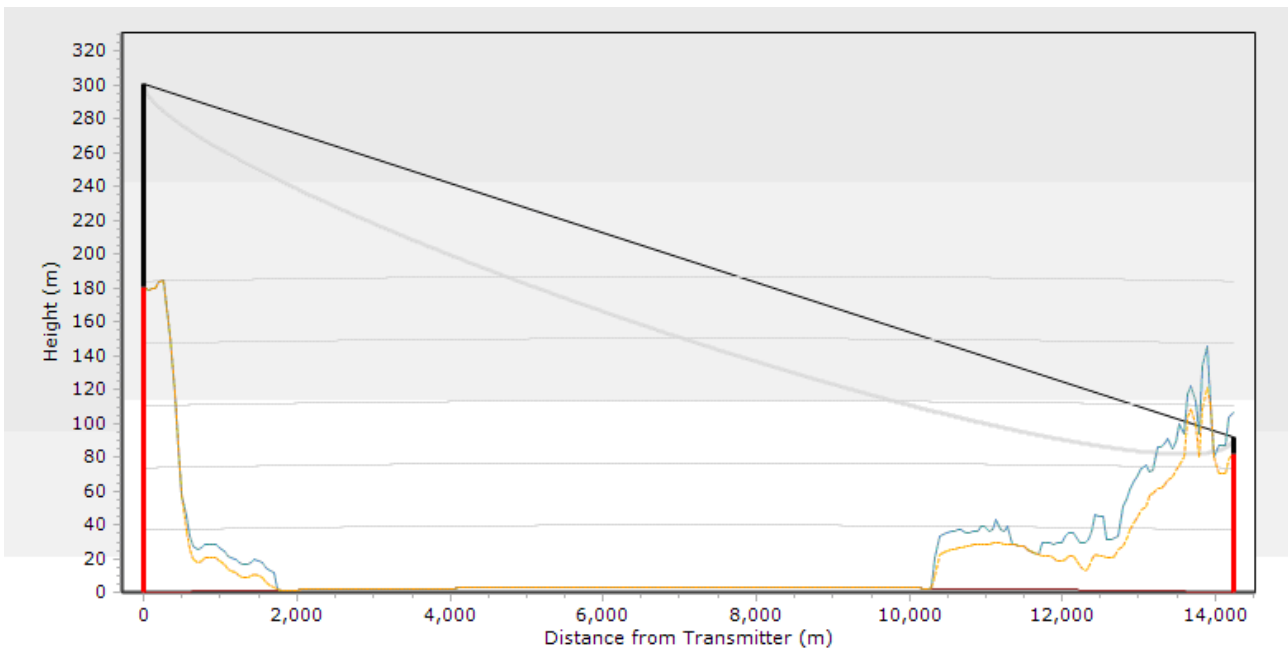

Figure 22: Path profile for light blue ring.

The path profile for light blue ring corresponds to the junction of Grassmarket and Victoria Street, where again the path is obscured by physical geography and building clutter. Google Earth allows an alternate view to be constructed showing the obstructions from the transmitter to reception location.

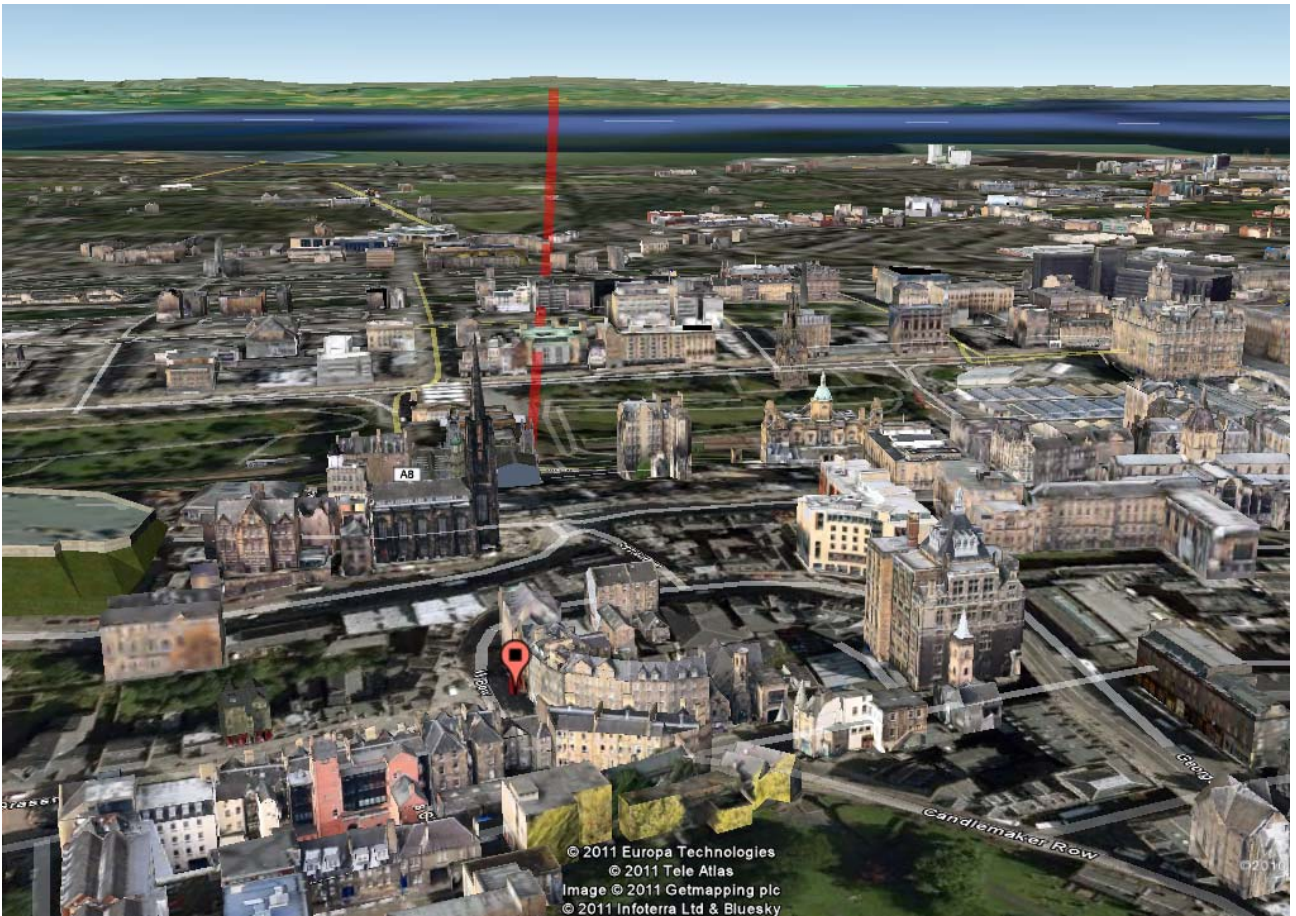

Figure 23: Google Earth plot for dark blue ring.

8.3.2 Edinburgh west and airport

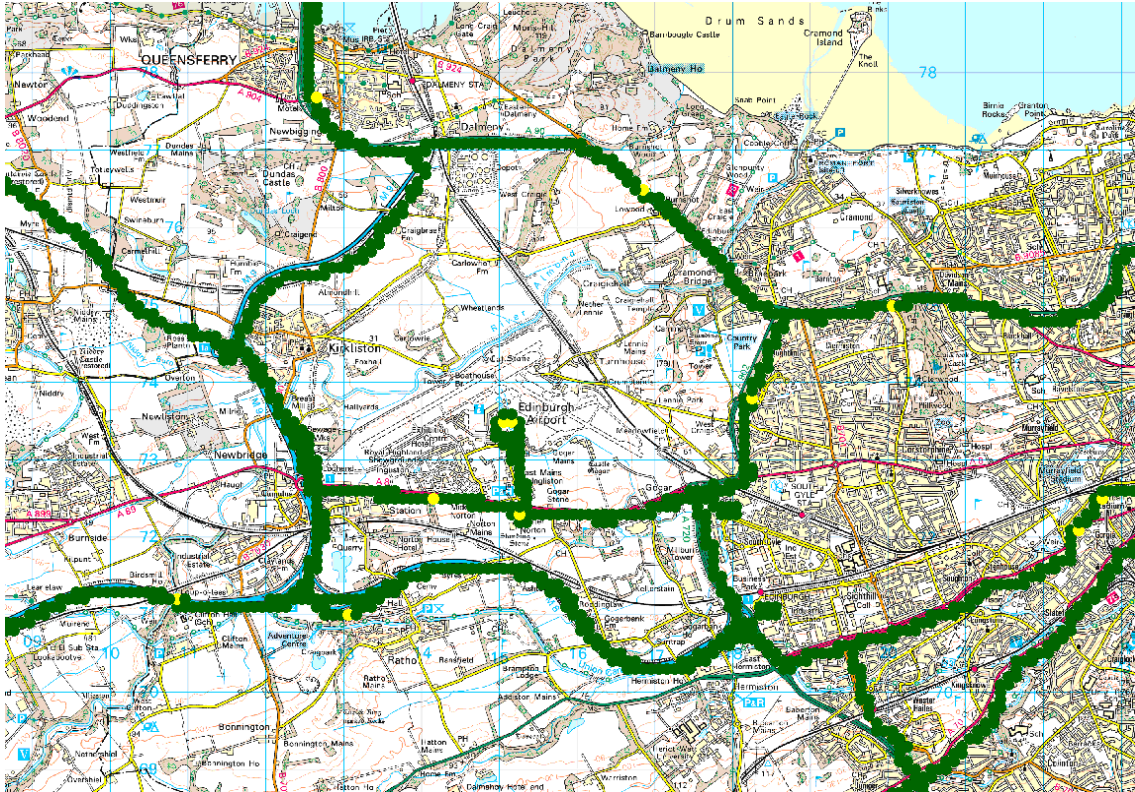

Figure 24: Edinburgh west and airport coverage, 4-QAM rate 1/3.



Figure 25: Edinburgh west and airport coverage, 16-QAM rate 1/2.

For the 4-QAM mode, reception was very good with only occasional points with less than 100% audio quality. In practice, these manifested themselves as very short mutes. In both the modes used, each audio super frame contained five audio frames (24 kHz sampling with SBR). Therefore at the onset of impairment the audio super frame flag will indicate an errored audio super frame,

but the impairment may actually be only a single audio frame of the five in error. This can be concealed by the audio decoder reconstructing the errored frame from the previous and following frames. The plots therefore show impairments that may not be heard by a listener.

For the 16-QAM mode the impairments are more frequent and more severe, with several stretches of road with short interruptions to the audio. The 16-QAM plot shows one area of severe audio loss, indicated by the red trail and corresponding to fewer than half of the audio super frames being received error free. A terrain profile plot was created for the location marked with the blue ring.

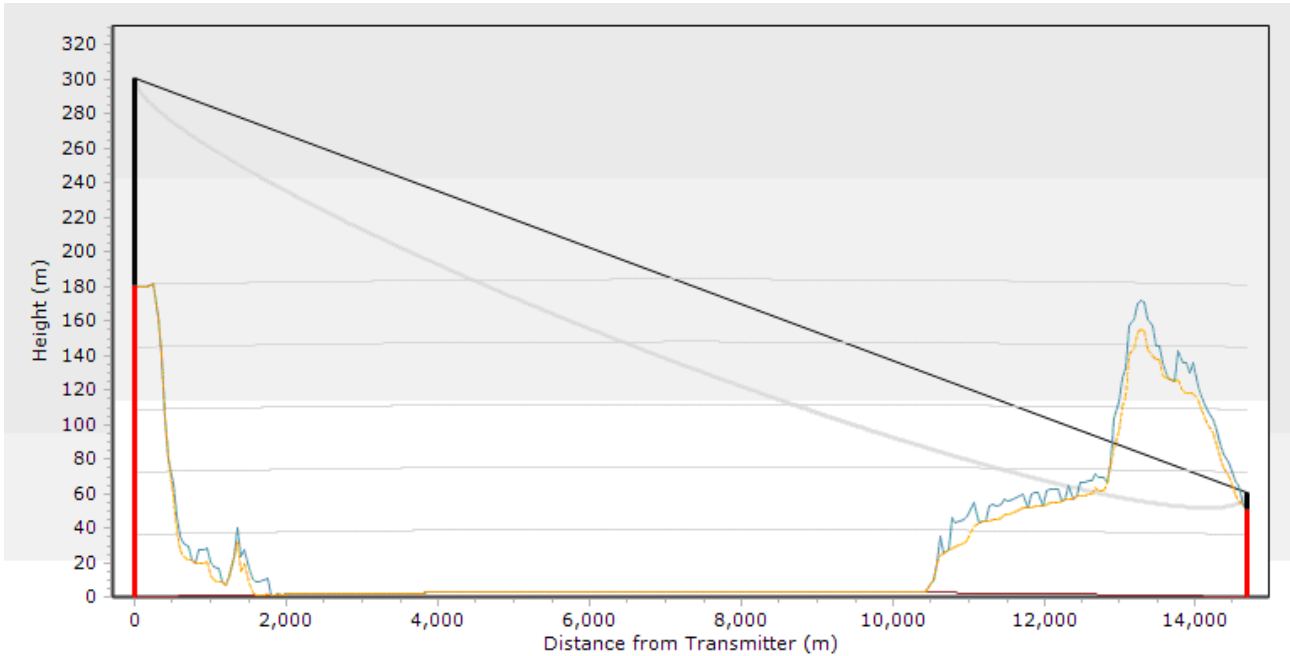

Figure 26: Path profile for dark blue ring.

Again the cause of the impairment is clear - the reception location is close to a significant terrain barrier.

8.3.3 Dundee

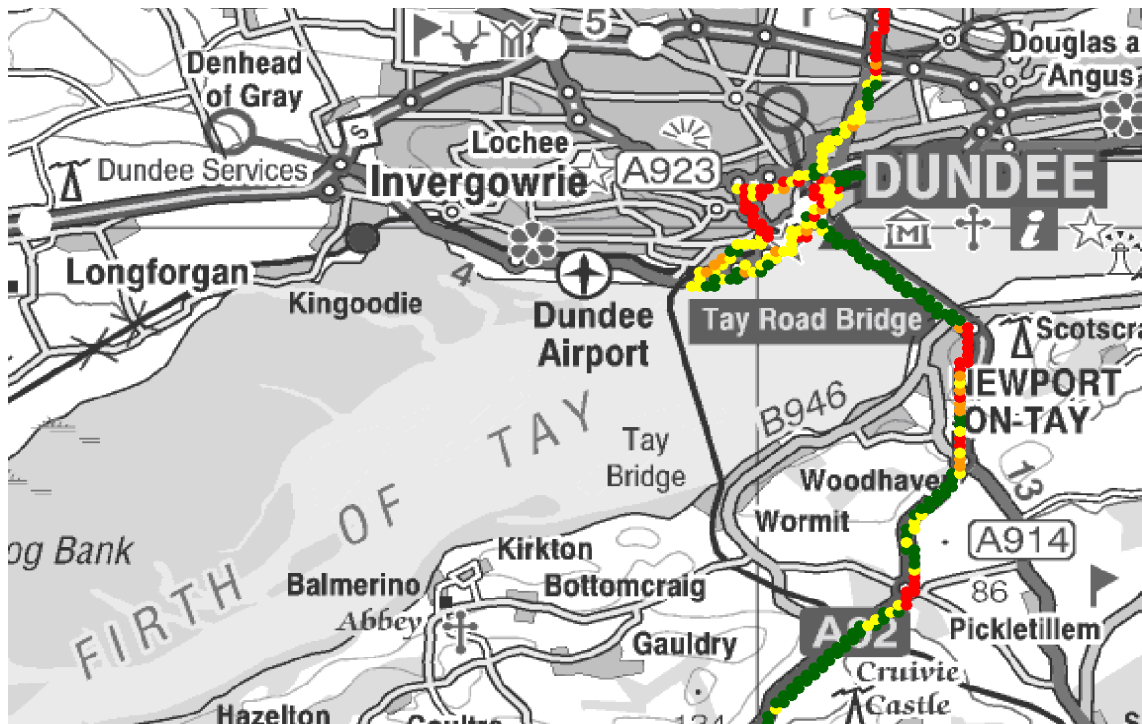

Figure 27: Dundee coverage, 4-QAM rate 1/3.

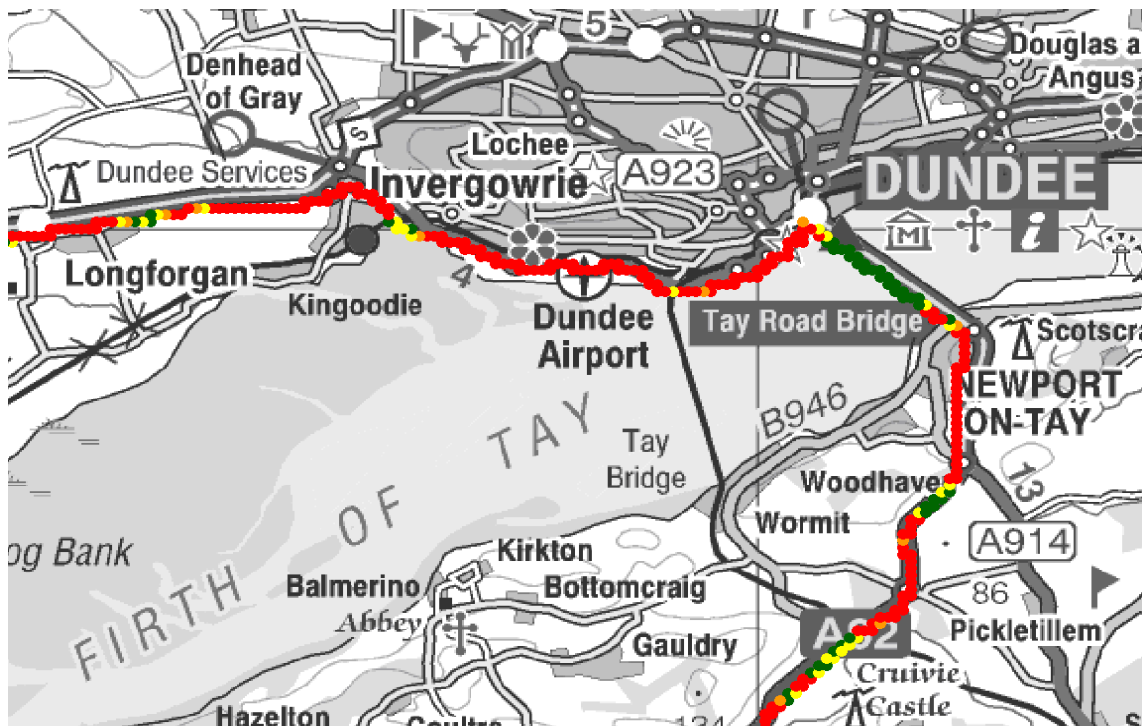

Figure 28: Dundee coverage, 16-QAM rate 1/2.

Dundee is at the edge of coverage for 4-QAM and beyond the coverage for 16-QAM. The ground also dips down to the Firth of Tay, and the maps mark three small transmitter sites close to the city to provide repeaters for analogue radio and television.

8.3.4 Falkirk to Stirling

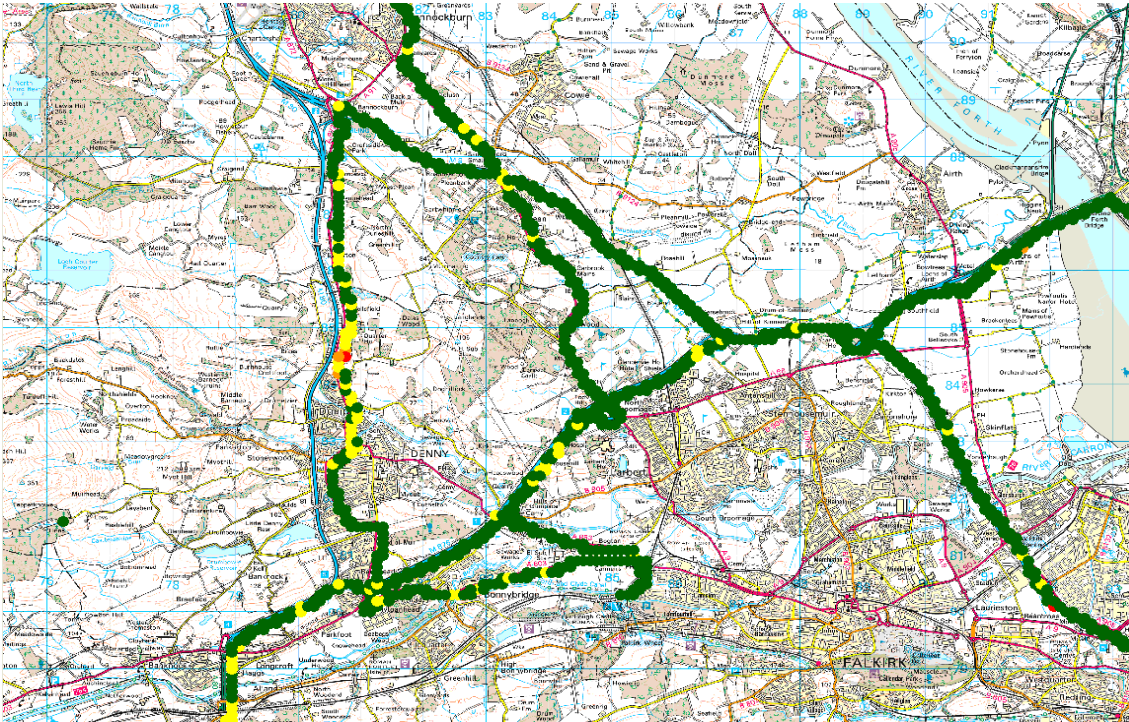

Figure 29: Falkirk to Stirling coverage, 4-QAM rate 1/3.

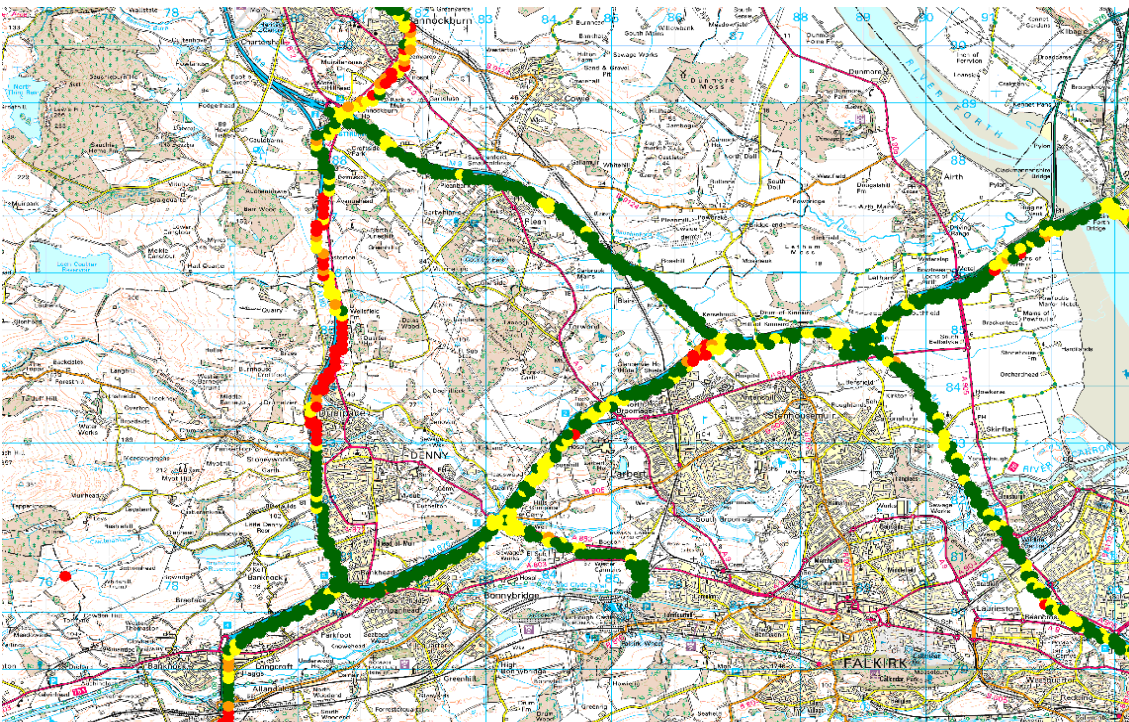

Figure 30: Falkirk to Stirling coverage, 16-QAM rate 1/2.

This area has very good coverage in the 4-QAM mode with only occasional impairments. Again the 16-QAM mode exacerbates the impairments, with the western vertical route no longer served.

8.3.5 North Berwick

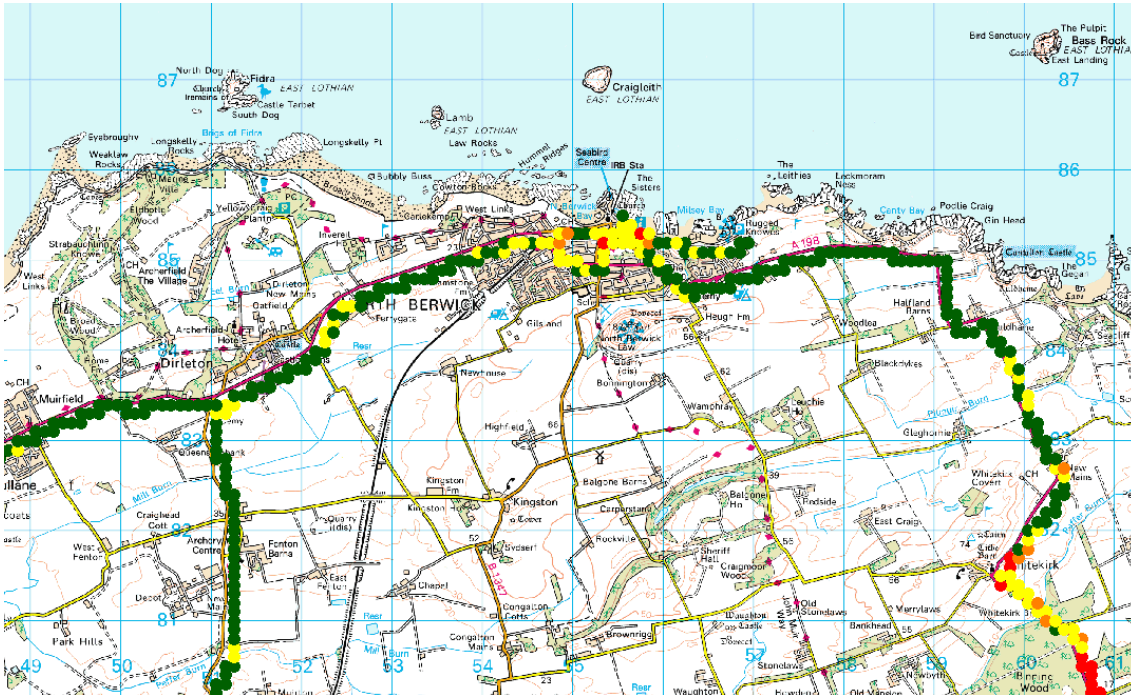

Figure 31: Falkirk to Stirling coverage, 4-QAM rate 1/3.

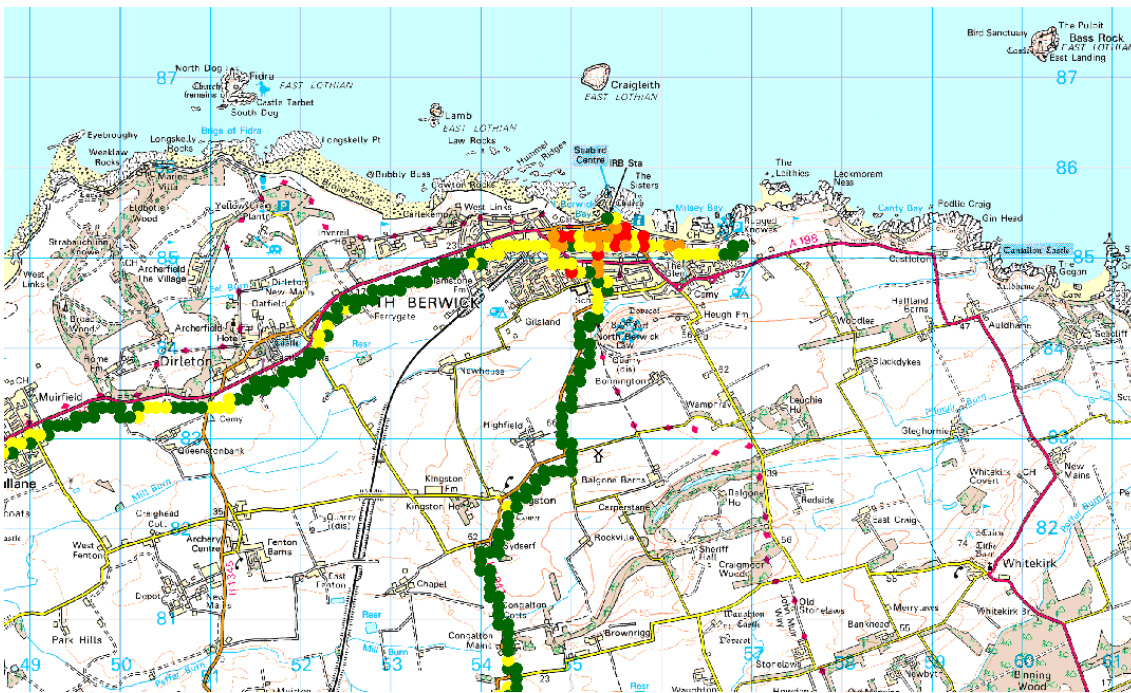

Figure 32: Falkirk to Stirling coverage, 16-QAM rate 1/2.

Finally, North Berwick shows the eastern edge of coverage with impairments in the town centre for both 4-QAM and 16-QAM.

9 Conclusions

DRM+ was extensively tested in the UK in a highly credible 'real environment'. The frequency and antenna system was previously used by a commercial FM station. A large number of measurements were taken over an extended period and extensive geography with a calibrated receiving system and analysis was performed on the data.

The trial has shown that DRM+ is capable of excellent coverage in good quality at reduced power levels compared with FM and that as expected 4-QAM was more robust than 16-QAM. Urban coverage was superior to FM, especially in the more rugged 4-QAM mode, because despite a few drop-outs, the overall subjective experience was found to be better than that of FM with noise, clicks and fuzz. The audio decoding method includes error concealment algorithms to fade-out to silence when audio frame errors are detected and fade-in again when the error rate falls. In rural areas, the coverage was also excellent although terrain shielding did cause some audio failure, although this was comparable to the experience with FM from the co-sited transmitters.

10 References

- [1] ETSI. ES 201 980, "Digital Radio Mondiale (DRM), System specification". 2009.
- [2] ETSI. TS 102 349, "Digital Radio Mondiale (DRM), Receiver Status and Control Interface (RSCI)". 2009.