

GCOR

General Code of Operating Rules

Seventh Edition

Effective April 1, 2015

These rules herein govern the operations of the railroads listed and must be complied with by all employees regardless of gender whose duties are in any way affected thereby. They supersede all previous rules and instructions inconsistent therewith.

**© 2015 General Code of Operating Rules Committee,
All Rights Reserved**

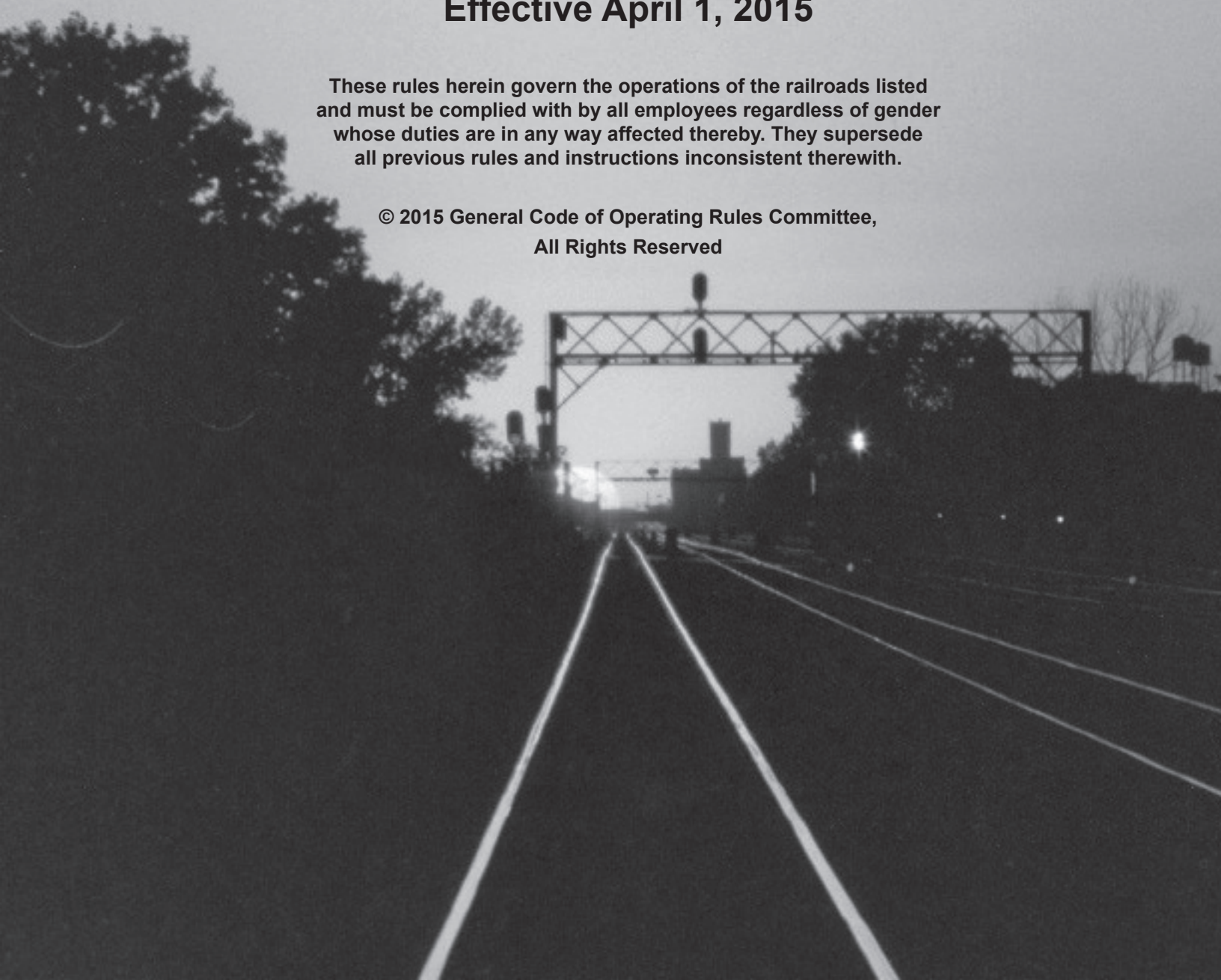

Front cover photo by Geneva May Short

Adopted by:

Aberdeen Carolina & Western Railway
 Aberdeen & Rockfish Railroad
 Acadiana Railway Company
 Affton Terminal Railroad
 Ag Valley Railroad
 Alabama & Gulf Coast Railway
 Alabama Southern Railroad
 Alabama & Tennessee River Railway, LLC
 Alabama Warrior Railroad
 Alaska Railroad Corporation
 Albany & Eastern Railroad Company
 Aliquippa & Ohio River Railroad
 Alliance Terminal Railway, LLC
 Altamont Commuter Express Rail Authority
 Alton & Southern Railway
 Amtrak—Chicago Terminal
 Amtrak—Michigan Line
 Amtrak—NOUPT
 AN Railway
 Ann Arbor Railroad
 Apache Railway Company
 A&R Terminal Railroad Company
 Arizona & California Railroad
 Arizona and California Railway Company
 Arizona Central Railroad
 Arizona Eastern Railway Company
 Arkansas Louisiana & Mississippi Railroad
 Arkansas Midland Railroad Company Inc.
 Arkansas & Missouri Railroad Company
 Arkansas-Oklahoma Railroad
 Arkansas Southern Railroad
 Ashtabula, Carson & Jefferson Railroad
 AT&L Railroad Company
 Atlantic & Western Railway
 Austin Western Railroad
 Autauga Northern Railroad
 Baton Rouge Southern Railroad
 Bauxite & Northern Railway
 Bay Coast Railroad
 Bay Line Railroad
 Belt Railway Company of Chicago

BHP Nevada Railway Company
 B&H Rail Corp
 Birmingham Terminal Railroad
 Blackwell Northern Gateway Railroad
 BNSF Railway
 Boise Valley Railroad
 Buffalo & Pittsburg Railroad
 Burlington Junction Railway
 Butte, Anaconda & Pacific Railroad
 California Northern Railroad
 California Western Railroad
 Camas Prairie RailNet, Inc.
 Canadian Pacific
 Caney Fork & Western Railroad
 Canon City and Royal Gorge Railroad
 Capital Metropolitan Transportation Authority
 Carolina Piedmont Railroad
 Carrizo Gorge Railway
 Cascade and Columbia River Railroad
 Cedar Rapids & Iowa City Railway Company
 Central California Traction Company
 Central Illinois Railroad
 Central Kansas Railway
 Central Midland Railway
 Central Montana Rail
 Central Oregon & Pacific Railroad, Inc.
 Central Railroad of Indiana
 Central Railroad of Indianapolis
 Chattahoochee Bay Railroad
 Chattahoochee Industrial Railroad
 Chattooga & Chickamauga Railway
 Chesapeake & Albemarle Railroad Company, Inc.
 Chicago and Chemung Railroad
 Chicago, Ft. Wayne & Eastern Railroad
 Chicago Rail Link
 Chicago SouthShore & South Bend Railroad
 City of Prineville Railway
 Cleveland Commercial Railroad LLC
 C&NC Railroad Corporation
 Columbia Basin Railroad Co.
 Columbia and Cowlitz Railway
 Columbia Terminal
 Columbus & Greenville Railway
 Columbus & Ohio River Railroad
 Commonwealth Railway

Conecuh Valley Railroad
Connecticut Southern Railroad
Connex Railroad
Corpus Christi Terminal Railroad
Council Bluffs Railway
D&I Railroad
Dakota, Minnesota & Eastern Railroad
Dakota, Missouri Valley & Western Railroad, Inc.
Dakota Southern Railway
Dallas, Garland & Northeastern Railroad, Inc.
Dardanelle & Russellville Railroad
Decatur Junction Railway Company
Denton County Transit Authority
Denver Regional Transportation District Commuter Railroad
Denver Rock Island Railroad
DeQueen & Eastern Railroad Company
Eagle Rail
East Chattanooga Belt Railroad
East Tennessee Railway
Eastern Alabama Railway
Eastern Idaho Railroad
Ellis & Eastern Company
Escanaba & Lake Superior Railroad
Farmrail Corporation
First Coast Railroad
Florida East Coast Railway
Fordyce & Princeton Railroad
Fort Worth & Western Railroad
Fox Valley & Western
Fulton County Railway, LLC
Galveston Railroad
Gateway Western Railway
Georgetown Railroad Company
Georgia Central Railway
Georgia & Florida Railway
Georgia Southwestern Railroad, Inc.
Georgia Woodlands Railroad
Golden Isles Terminal Railroad
Golden Triangle Railroad
Grain Belt Corp
Grand Canyon Railway
Grand Elk Railroad
Grand Rapids Eastern Railroad
Great Northwest Railroad
Great Western Railway
Gulf Colorado & San Saba Railroad
Heart of Georgia Railroad
Herzog Transit Services, Inc.
Hiwassee River Railroad
Huron and Eastern Railway Company, Inc.
Hutchinson and Northern Railway Company
Idaho Northern & Pacific Railroad Company
Illinois & Midland Railroad, Inc.
Illinois Railway, Inc.
Indiana Business Railroad
Indiana & Ohio Railway
Indiana Rail Road Company
Indiana Southern Railroad, Inc.
International Bridge & Terminal Company
Iowa Chicago & Eastern Railroad
Iowa Interstate Railroad Ltd.
Iowa Northern Railway Company
Jaxport Terminal Railway
Kansas City Southern Railway
Kansas City Terminal Railway Company
Kansas & Oklahoma Railroad
Kaw River Railroad
Kentucky West Tennessee Railway
Keokuk Junction Railway Company
Kettle Falls International Railway, LLC
Kiamichi Railroad
Knoxville & Holston River Railroad
Kyle Railroad Company
Lahaina Kaanapali & Pacific Railroad
Lake State Railway
Lake Superior and Ishpeming Railroad
Laurinberg & Southern Railroad
Lavonia, Avon and Lakeville Railroad
Lewis and Clark Railway Company
Little Rock and Western Railway, LP
Longview Switching Company
Los Angeles Junction Railway
Louisiana and Delta Railroad Company
Louisiana & North West Railroad
Louisiana Southern Railroad
Louisville & Indiana Railroad
Luxapalila Valley Railroad
Mahoning Valley Railroad
Manning Rail, Inc.

Manufacturers Junction Railway
 Maryland Midland Railway
 Maumee & Western Railroad
 McCloud Railway Company
 Meridian and Bigbee Railroad
 Meridian Southern Railway, LLC
 Messena Terminal Railroad Company
 Michigan Air-Line Railway Company
 Michigan Central Railway
 Michigan Shore Railroad
 Mid-Michigan Railroad, Inc.
 Minnesota Commercial Railway Company
 Minnesota, Dakota & Western Railway Company
 Minnesota Northern Railroad, Inc.
 Minnesota Prairie Line Incorporated
 Minnesota Southern Railway
 Minnesota Valley Transportation Company
 Mission Mountain Railroad
 Mississippi Export Railroad Company
 Mississippi Southern Railroad
 Mississippi & Tennessee RailNet, Inc.
 Mississippi Tennessee Railroad
 Missouri & Northern Arkansas RR Company, Inc.
 Missouri & Valley Park Railroad
 Modesto & Empire Traction Company
 Modoc Railroad Academy
 Montana Rail Link
 Mount Vernon Terminal Railway, Inc.
 Napa Valley Railroad Company
 Nash County Railroad
 Nashville and Eastern Railroad
 Nashville and Western Railroad
 National Coal Rail Line
 Nebkota Railway, Inc.
 Nebraska Central Railroad Company
 Nebraska Kansas Colorado Railway, Inc.
 Nebraska Northeastern Railway Company
 New England Central Railroad, Inc.
 New Mexico Rail Runner Express
 New Orleans & Gulf Coast Railway Company
 New Orleans Lower Coast Railroad
 New Orleans Public Belt Railroad
 Newburgh & South Shore Railroad Company
 New York & Atlantic Railway
 North Carolina & Virginia Railroad Company, Inc.
 Northeast Illinois Regional Commuter Railroad Corp.
 Northern Indiana Commuter Transportation District
 Northern Lines Railway
 Northern Ohio & Western Railway
 Northern Plains Railroad
 Ohio Central Railroad
 Ohio & Pennsylvania Railroad
 Ohio Southern Railroad
 Omaha, Lincoln & Beatrice Railway Company
 Osceola and St. Croix Valley Railroad Company
 Otter Tail Valley Railroad Company, Inc.
 Pacific Harbor Line
 Pacific Sun Railroad
 Palouse River and Coulee City Railroad
 Panhandle Northern Railroad
 Pecos Valley Southern Railway Company
 Pend Oreille Valley Railroad
 Peninsula Corridor Joint Powers Board (Caltrain)
 Pennsylvania Southwestern Railroad
 Pittsburgh Industrial Railroad
 Pittsburgh & Ohio Central Railroad
 Point Comfort & Northern Railway Company
 Port Bienville Railroad
 Port of Tillamook Bay Railroad
 Portland Terminal Railroad Company
 Portland Vancouver Junction Railroad
 Portland & Western Railroad
 Progressive Rail Inc.
 Puget Sound & Pacific Railroad
 Rarus Railway, Inc.
 Red River Valley & Western Railroad Co.
 Riceboro Southern Railway
 Richmond Pacific Railroad
 Richmond Terminal Railroad Company
 Rio Valley Switching Company
 Rochester & Southern Railroad
 Rockdale, Sandow & Southern Railroad Company
 Rogue Valley Terminal Railroad
 Sacramento Valley Railroad
 Saginaw Valley Railroad Company
 San Antonio Central Railroad
 San Diego & Imperial Valley Railroad Company, Inc.
 San Diego Northern Railway
 San Francisco Bay Railroad
 San Joaquin Valley Railroad Co., Inc.

San Luis Central Railroad Company
San Pedro and Southwestern Railway Company
Sand Springs Railway Company
Santa Cruz, Big Trees & Pacific Railway Company
Santa Fe Southern Railway, Inc.
Sault Ste. Marie Bridge Company
Savage Bingham & Garfield Railroad Company
Savannah Port Terminal Railroad
SEMO Port Railroad
Sequatchie Valley Railroad
Sierra Railroad Company
Sound Transit
South Buffalo Railway
South Carolina Central Railroad Company, Inc.
South Central Tennessee Railroad
South East Kansas Railroad
South Kansas and Oklahoma Railroad
South Plains Lamesa Railroad Ltd.
Southern California Regional Rail Authority
Southern Switching Company
Southwestern Railroad Company, Inc.
St. Croix Valley Railroad Company
St. Maries River Railroad Company
Stillwater Central Railroad
Swan Ranch Railroad
Tacoma Municipal Belt Line Railway
Talleyrand Terminal Railroad
Tazewell & Peoria Railroad
Temple & Central Texas Railway
Tennessee Southern Railroad
Tennessee Valley Railroad
Tennessee Valley Railroad Museum, Inc
Tennken Railroad Company Inc.
Terminal Railroad Association of St. Louis
Texas, Gonzales & Northern Railway Company
Texas - New Mexico Division
Texas Northeastern Railroad
Texas North Western Railway Company
Texas Rock Crusher Railway Co.
Three Notch Railroad
Timber Rock Railroad
Toledo, Peoria & Western Railway
Tomahawk Railroad
TransitAmerica Services Inc.
Transportación Ferroviaria Mexicana
Trinity Railway Express
Trona Railway Company
Tulare Valley Railroad
Tulsa-Sapulpa Union Railway Company
Twin Cities & Western Railroad Company
Union Pacific Railroad
United States Army Military Railroad System
Utah Central Railway
Utah Railway Company
Utah Transit Authority
V&S Railroad Inc.
Valdosta Railway
Ventura County Railway Company
Verde Canyon Railroad
Vermont Rail System
Vicksburg Southern Railroad
Virginia Southern Division
Wabash Central Railroad
Walking Horse & Eastern Railroad
Warren & Trumbull Railroad
WATCO Transportation Services
West Tennessee Railroad, LLC
West Tennken Railroad Corp.
West Texas and Lubbock Railroad
Western New York and Pennsylvania Railroad, LLC
Wichita Terminal Association
Wichita, Tillman & Jackson Railway
Willamette & Pacific Railroad, Inc.
Willamette Valley Railroad
Willamina and Grand Ronde Railway
Wilmington Terminal Railroad
Wiregrass Central Railroad
Wisconsin & Southern Railroad Company
Wyoming/Colorado Railroad Company
Yadkin Valley Railroad
Yellowstone Valley Railroad
York Railway
Youngstown & Austintown Railroad
Youngstown Belt Railroad
Yreka Western Railroad

Table of Contents

1.0	General Responsibilities.....	1-1		
1.1	Safety	1-1		
1.1.1	Maintaining a Safe Course	1-1		
1.1.2	Alert and Attentive.....	1-1		
1.1.3	Accidents, Injuries, and Defects	1-1		
1.1.4	Condition of Equipment and Tools	1-1		
1.2	Personal Injuries and Accidents	1-1		
1.2.1	Care for Injured.....	1-1		
1.2.2	Witnesses	1-1		
1.2.3	Equipment Inspection	1-1		
1.2.4	Mechanical Inspection	1-2		
1.2.5	Reporting	1-2		
1.2.6	Statements.....	1-2		
1.2.7	Furnishing Information.....	1-2		
1.3	Rules.....	1-2		
1.3.1	Rules, Regulations, and Instructions ...	1-2		
1.3.2	General Orders.....	1-3		
1.3.3	Circulars, Instructions, and Notices	1-3		
1.4	Carrying Out Rules and Reporting Violations	1-3		
1.4.1	Good Faith Challenge.....	1-3		
1.5	Drugs and Alcohol	1-4		
1.6	Conduct.....	1-5		
1.6.1	Motor Vehicle Driving Records	1-5		
1.6.2	Notification of Felony Convictions.....	1-5		
1.6.3	Notification of Deteriorating Vision or Hearing	1-5		
1.7	Altercations	1-5		
1.8	Appearance.....	1-5		
1.9	Respect of Railroad Company	1-5		
1.10	Games, Reading, or Other Media	1-6		
1.11	Sleeping.....	1-6		
1.11.1	Napping	1-6		
1.12	Weapons	1-7		
1.13	Reporting and Complying with Instructions.....	1-7		
1.14	Employee Jurisdiction	1-7		
1.15	Duty—Reporting or Absence.....	1-7		
1.16	Subject to Call	1-7		
1.17	Hours of Service Law	1-7		
1.18	Unauthorized Employment.....	1-7		
1.19	Care of Property.....	1-8		
1.20	Alert to Train Movement.....	1-8		
1.21	Occupying Roof.....	1-8		
1.22	Unauthorized Persons on Equipment	1-8		
1.23	Altering Equipment.....	1-8		
1.24	Clean Property	1-8		
1.25	Credit or Property.....	1-8		
1.26	Gratuities.....	1-8		
1.27	Divulging Information	1-9		
1.28	Fire	1-9		
1.29	Avoiding Delays	1-9		
1.30	Riding Engine.....	1-9		
1.31	Repairs to Foreign Cars	1-9		
1.32	Overheated Wheels	1-9		
1.33	Inspection of Freight Cars	1-10		
1.34	Flat Spots	1-10		
1.35	Dump Doors.....	1-10		
1.36	Excessive Dimension Loads	1-10		
1.37	Open Top Loads.....	1-11		
1.38	Shipments Susceptible to Damage.....	1-11		
1.39	Accuracy of Speed Indicator	1-11		
1.40	Reporting Engine Defects	1-11		
1.41	Engines Coupled to Occupied Passenger Cars	1-11		
1.42	Trains Detoured	1-11		
1.43	Stopped in Tunnels	1-12		
1.44	Duties of Train Dispatchers	1-12		
1.45	Duties of Control Operators and Operators	1-12		
1.46	Duties of Yardmasters.....	1-12		
1.47	Duties of Crew Members.....	1-12		
1.48	Time	1-14		
2.0	Railroad Radio and Communication Rules.....	2-1		
2.1	Transmitting	2-1		
2.2	Required Identification	2-1		
2.3	Repetition	2-1		
2.4	Ending Transmissions	2-2		
2.5	Communication Redundancy	2-2		
2.6	Communication Not Understood or Incomplete	2-2		
2.7	Monitoring Radio Transmissions	2-2		
2.8	Acknowledgment.....	2-2		
2.9	Misuse of Radio Communications.....	2-2		
2.10	Emergency Calls	2-3		
2.11	Prohibited Transmissions	2-3		
2.12	Fixed Signal Information	2-3		
2.13	Not Used	2-3		
2.14	Transmission of Mandatory Directives	2-3		
2.14.1	Verbally Transmitting and Repeating Mandatory Directives	2-4		
2.15	Phonetic Alphabet	2-4		
2.16	Assigned Frequencies.....	2-4		
2.17	Radio Testing	2-4		
2.18	Malfunctioning Radio.....	2-4		
2.19	Blasting Operations.....	2-4		
2.20	Internal Adjustments.....	2-4		
2.21	Electronic Devices.....	2-5		
3.0	Section Reserved	3-1		

4.0	Timetables	4-1	5.12	Protection of Occupied Outfit Cars.....	5-13
4.1	New Timetable	4-1	5.13	Blue Signal Protection of Workmen	5-16
	4.1.1 Notice of New Timetable.....	4-1	5.13.1	Utility Employees	5-19
4.2	Special Instructions	4-1	5.14	Signs Protecting Equipment.....	5-20
4.3	Timetable Characters	4-1	5.15	Improperly Displayed Signals.....	5-20
5.0	Signals and Their Use	5-1	6.0	Movement of Trains and Engines	6-1
5.1	Signal Equipment.....	5-1	6.1	Repeat Instructions	6-1
5.2	Receiving and Giving Signals	5-1	6.2	Initiating Movement.....	6-1
	5.2.1 Looking for Signals	5-1	6.2.1	Train Location	6-1
	5.2.2 Signals Used by Employees	5-1	6.3	Main Track Authorization.....	6-1
5.3	Hand and Radio Signals	5-2	6.3.1	Train Coordination	6-2
	5.3.1 Hand Signals	5-2	6.4	Reverse Movements	6-3
	5.3.2 Giving Signals.....	5-2	6.4.1	Permission for Reverse Movements....	6-3
	5.3.3 Signal Disappearance.....	5-2	6.4.2	Movements Within Control Points or Interlockings.....	6-3
	5.3.4 Signal to Stop	5-2	6.5	Shoving Movements.....	6-4
	5.3.5 Acknowledge Stop Signal.....	5-2	6.5.1	Remote Control Movements	6-4
	5.3.6 Radio and Voice Communication.....	5-2	6.6	Back Up Movements	6-5
	5.3.7 Radio Response	5-3	6.7	Remote Control Zone.....	6-5
5.4	Flags for Temporary Track Conditions	5-3	6.8	Stopping Clear for Meeting or Passing	6-6
	5.4.1 Temporary Restrictions.....	5-3	6.9	Meeting or Passing Precautions	6-6
	5.4.2 Display of Yellow Flag.....	5-3	6.10	Instructions to Clear a Following Train	6-6
	5.4.3 Display of Yellow-Red Flag.....	5-4	6.11	Mandatory Directive	6-6
	5.4.4 Authorized Protection by Yellow or Yellow-Red Flag.....	5-5	6.12	FRA Excepted Track	6-6
	5.4.5 Display of Green Flag.....	5-5	6.13	Yard Limits	6-7
	5.4.6 Display of Flags Within Current of Traffic.....	5-6	6.14	Restricted Limits.....	6-8
	5.4.7 Display of Red Flag	5-6	6.15	Block Register Territory (BRT)	6-8
	5.4.8 Flag Location	5-6	6.16	Approaching Railroad Crossings, Drawbridges, and End of Multiple Main Track.....	6-8
5.5	Permanent Speed Signs	5-7	6.17	Switches at Junctions.....	6-9
5.6	Unattended Fusee.....	5-7	6.18	Stopping Clear of Crossings and Junctions	6-9
5.7	Not Used	5-8	6.19	Flag Protection.....	6-10
5.8	Bell and Whistle Signals.....	5-8	6.20	Equipment Left on Main Track	6-11
	5.8.1 Ringing Engine Bell	5-8	6.21	Precautions Against Unusual Conditions	6-11
	5.8.2 Sounding Whistle.....	5-8	6.21.1	Protection Against Defects.....	6-11
	5.8.3 Whistle Failure	5-9	6.21.2	Water Above Rail	6-12
	5.8.4 Whistle Quiet Zone	5-9	6.21.3	Track Obstruction / Unusual Conditions.....	6-12
	5.8.5 Silenced Whistle	5-10	6.22	Maintaining Control of Train or Engine.....	6-12
5.9	Headlight Display	5-10	6.23	Emergency Stop or Severe Slack Action	6-12
	5.9.1 Dimming Headlight	5-10	6.24	Movement on Double Track	6-12
	5.9.2 Headlight Off.....	5-11	6.25	Movement Against the Current of Traffic.....	6-13
	5.9.3 Headlight Failure.....	5-11	6.26	Use of Multiple Main Tracks	6-13
	5.9.4 Displaying Headlights Front and Rear	5-11	6.27	Movement at Restricted Speed.....	6-13
	5.9.5 Displaying Ditch Lights	5-11	6.28	Movement on Other than Main Track.....	6-13
	5.9.6 Displaying Oscillating White Headlight	5-12	6.28.1	Sidings of Assigned Direction	6-14
	5.9.7 Displaying Oscillating or Flashing Red Light.....	5-12	6.28.2	Stopping Clear in Siding	6-14
5.10	Markers	5-12	6.28.3	Cars or Equipment Left on Siding.....	6-14
	5.10.1 Highly Visible Markers	5-12	6.29	Inspecting Trains.....	6-14
	5.10.2 Alternative Markers.....	5-13	6.29.1	Inspecting Passing Trains.....	6-14
5.11	Engine Identifying Number.....	5-13	6.29.2	Train Inspections by Crew Members ...	6-15

6.30	Receiving or Discharging Passengers	6-15
6.31	Maximum Authorized Speed	6-16
6.31.1	Permanent Speed Restrictions	6-16
6.32	Road Crossings.....	6-16
6.32.1	Providing Warning Over Road Crossings.....	6-16
6.32.2	Automatic Warning Devices.....	6-16
6.32.3	Providing Warning for Adjacent Tracks	6-17
6.32.4	Clear of Crossings and Signal Circuits	6-18
6.32.5	Actuating Automatic Warning Devices Unnecessarily	6-18
6.32.6	Blocking Public Crossings	6-18
7.0	Switching.....	7-1
7.1	Switching Safely and Efficiently	7-1
7.2	Communication Between Crews Switching.....	7-1
7.3	Additional Switching Precautions	7-1
7.4	Precautions for Coupling or Moving Cars or Engines	7-2
7.5	Testing Hand Brakes	7-2
7.6	Securing Cars or Engines	7-2
7.7	Kicking or Dropping Cars	7-2
7.7.1	Gravity Switch Moves	7-2
7.8	Coupling or Moving Cars on Tracks Where Cars are Being Loaded or Unloaded.....	7-3
7.9	Switching Passenger or Occupied Outfit Cars...	7-3
7.10	Movement Through Gates or Doorways	7-3
7.11	Charging Necessary Air Brakes	7-4
7.12	Movements Into Spur Tracks	7-4
7.13	Protection of Employees in Bowl Tracks	7-4
8.0	Switches	8-1
8.1	Hand Operation of Switches	8-1
8.2	Position of Switches	8-1
8.3	Main Track Switches	8-1
8.4	Lining Main Track Switch	8-2
8.5	Not Used	8-2
8.6	Restoring Switch to Normal Position.....	8-2
8.7	Clear of Main Track Switches.....	8-2
8.8	Switches Equipped with Locks, Hooks or Latches.....	8-3
8.9	Movement Over Spring Switches.....	8-3
8.9.1	Testing Spring Switch	8-3
8.9.2	Trailing Through and Stopping on a Spring Switch.....	8-4
8.9.3	Hand Operating a Spring Switch Before Making a Trailing Movement ...	8-4
8.9.4	During Snow or Ice Storms	8-5
8.9.5	Spiking Spring Switch.....	8-5
8.9.6	Approaching a Spring Switch in Non- Signaled Territory.....	8-5
8.10	Switch Point Indicator.....	8-5
8.11	Switches in Sidings	8-5

8.12	Hand-Operated Crossover Switches.....	8-5
8.13	Scale Track Switches	8-6
8.14	Conflicting Movements Approaching Switch	8-6
8.15	Switches Run Through.....	8-6
8.16	Damaged or Defective Switches	8-6
8.17	Avoid Sanding Over Moveable Parts	8-6
8.18	Variable Switches	8-6
8.19	Automatic Switches.....	8-7
8.19.1	Radio Controlled Switches.....	8-7
8.20	Derail Location and Position	8-8
9.0	Block System Rules	9-1
9.1	Signal Aspects and Indications	9-1
9.2	Location of Signals.....	9-1
9.3	What Signals Govern	9-1
9.4	Improperly Displayed Signals or Absent Lights..	9-1
9.5	Where Stop Must Be Made.....	9-2
9.5.1	Changing Established Route	9-2
9.5.2	Protection if Signal Appliance or Track is Damaged.....	9-2
9.5.3	Protection During Repairs.....	9-2
9.5.4	Authority to Proceed	9-2
9.5.5	Reporting Delays	9-2
9.5.6	Track Occupancy Indicator	9-3
9.6	Change of Signal Indication	9-3
9.7	Failure to Display Most Restrictive Indication	9-3
9.8	Next Governing Signal	9-3
9.9	Train Delayed Within a Block	9-3
9.9.1	Approach to Automatic Interlocking	9-4
9.10	Initiating Movement Between Signals	9-4
9.11	Movement from Signal Requiring Restricted Speed.....	9-4
9.12	Stop Indications.....	9-5
9.12.1	CTC Territory	9-5
9.12.2	Manual Interlockings.....	9-5
9.12.3	Automatic Interlockings.....	9-6
9.12.4	ABS Territory.....	9-6
9.13	When Instructed to Operate Dual Control Switches by Hand	9-6
9.13.1	Hand Operation of Dual Control Switches	9-7
9.14	Movement with the Current of Traffic	9-7
9.14.1	Reporting Clear of a Track Having a Current of Traffic.....	9-7
9.15	Track Permits	9-7
9.15.1	Issuing Track Permits	9-8
9.15.2	Clearing Track Permits	9-8
9.16	Stop and Proceed Indication	9-9
9.17	Entering Signaled Track at Hand-Operated or Spring Switch	9-10
9.17.1	Signal Protection in ABS by Lining Switch	9-11
9.18	Electrically Locked Switches and Derails.....	9-12

9.19 Leaving Equipment in Signal Systems..... 9-12

9.20 Clear Track Circuits..... 9-13

9.21 Overlap Circuits..... 9-13

9.22 Standing on Sanded Rail 9-13

9.23 Suspension of Block System..... 9-13

9.23.1 Guidelines While Block System is Suspended..... 9-13

9.24 Call Lights 9-14

10.0 Rules Applicable Only in Centralized Traffic Control (CTC) 10-1

10.1 Authority to Enter CTC Limits..... 10-1

10.2 Clearing Through Hand-Operated Switches 10-1

10.3 Track and Time 10-3

10.3.1 Protection of Limits 10-4

10.3.2 Protection of Machines, Track Cars, or Employees 10-4

10.3.3 Joint Track and Time..... 10-4

10.3.4 Track and Time Acknowledgment..... 10-4

11.0 Rules Applicable in ACS, ATC and ATS Territories 11-1

11.1 Establishing Absolute Block 11-1

11.2 Signal Indications with Absolute Block..... 11-1

11.3 Broken or Missing Seals 11-2

12.0 Rules Applicable Only in Automatic Train Stop System (ATS) Territory 12-1

12.1 Required Equipment 12-1

12.1.1 ATS Seals and Keys 12-1

12.2 ATS Device Cut Out, Not Equipped, or Not Working 12-1

12.3 Unusual Conditions 12-1

12.3.1 ATS Penalty Brake Application 12-1

12.3.2 ATS Inoperative 12-1

12.3.3 Damaged Inductor 12-1

12.4 ATS Testing 12-2

12.4.1 Test Inductor Locations..... 12-2

12.4.2 No Test Inductors..... 12-2

13.0 Rules Applicable Only in Automatic Cab Signal System (ACS) Territory 13-1

13.1 General Information 13-1

13.1.1 Observance of Signals..... 13-1

13.1.2 Conforming with Block Signals 13-1

13.1.3 Does Not Indicate Conditions Ahead... 13-1

13.1.4 Cab Signals Cut In and Out..... 13-1

13.2 Normal Operation..... 13-2

13.2.1 Restrictive to More Favorable..... 13-2

13.2.2 Favorable to More Restrictive..... 13-2

13.2.3 Elimination of Audible Indicator..... 13-3

13.3 Unusual Conditions..... 13-3

13.3.1 Cab Signal and Block Signal Do Not Agree 13-3

13.3.2 Inoperative Cab Signal Device 13-3

13.3.3 Movement with an Inoperative Cab Signal Device..... 13-4

14.0 Rules Applicable Only Within Track Warrant Control (TWC) Limits 14-1

14.1 Authority to Enter TWC Limits..... 14-1

14.2 Designated Limits..... 14-2

14.3 Operating with Track Warrants..... 14-2

14.3.1 Leaving the Main Track..... 14-3

14.4 Occupying Same Track Warrant Limits..... 14-3

14.4.1 Radio Blocking..... 14-3

14.5 Protecting Men or Equipment..... 14-4

14.6 Movement Against the Current of Traffic..... 14-4

14.7 Reporting Clear of Limits..... 14-5

14.8 Track Warrant Requests 14-5

14.9 Copying Track Warrants..... 14-5

14.9.1 Duplicating Track Warrants..... 14-5

14.10 Track Warrant in Effect..... 14-6

14.11 Changing Track Warrants 14-6

14.12 Not Used 14-6

14.13 Mechanical Transmission of Track Warrants 14-6

15.0 Track Bulletin Rules 15-1

15.1 Track Bulletins..... 15-2

15.1.1 Changing Address of Track Warrants or Track Bulletins 15-2

15.2 Protection by Track Bulletin Form B..... 15-2

15.2.1 Protection for On-Track Equipment 15-3

15.3 Authorizing Movement Against the Current of Traffic 15-3

15.4 Protection When Tracks Removed from Service 15-4

15.5 Protection When Tracks Blocked with Equipment..... 15-5

15.6 Change of a General Order, Special Instruction, or Rule..... 15-5

15.7 Copying Track Bulletins..... 15-5

15.8 Duplicating Track Bulletins 15-5

15.9 Mechanical Transmission of Track Bulletins 15-5

15.10 Retaining Track Bulletins..... 15-5

15.11 Not Used 15-5

15.12 Relief of Engineer or Conductor During Trip 15-6

15.13 Voiding Track Bulletins..... 15-6

15.14 Delivering Track Bulletins..... 15-6

16.0 Rules Applicable Only in Direct Traffic Control (DTC) Limits 16-1

16.1 Authority to Enter DTC Limits..... 16-1

16.1.1 Switches Between DTC Blocks 16-1

16.2 DTC Authority..... 16-1

16.3 Movement in a Specified Direction..... 16-2

16.3.1 Leaving the Main Track..... 16-3

16.4 Work and Time 16-3

16.5 Changing DTC Authority 16-4
16.6 Releasing DTC Authority..... 16-4
16.7 Communication Failure 16-5

17.0 Rules Applicable Only in Automatic Train Control (ATC) Territory 17-1

17.1 Automatic Train Control Territory..... 17-1
17.2 Taking Charge 17-1
17.3 Cut In and Cut Out Requirements..... 17-1
17.4 Departure Test Requirements 17-2
 17.4.1 Departure Test Reporting..... 17-2
17.5 High Speed Setting 17-3
 17.5.1 Over 40 MPH 17-3
 17.5.2 Under 40 MPH..... 17-3
 17.5.3 Restricting Cab Signal 17-3
17.6 Conforming with Block Signals..... 17-3
 17.6.1 Approaching Diverging Route..... 17-4
17.7 ATC Failure/Cut Out Enroute 17-4
 17.7.1 Speed Indicator in ATC 17-5
 17.7.2 ATC Motion Light 17-5
 17.7.3 Audible Indicator 17-5
17.8 Improper Display 17-5

18.0 Section Reserved 17-6

19.0 Section Reserved 17-6

Glossary GL-1

Abbreviations..... GL-1

Index IN-1

1.0 General Responsibilities

1.1 Safety

Safety is the most important element in performing duties. Obeying the rules is essential to job safety and continued employment.

1.1.1 Maintaining a Safe Course

In case of doubt or uncertainty, take the safe course.

1.1.2 Alert and Attentive

Employees must be careful to prevent injuring themselves or others. They must be alert and attentive when performing their duties and plan their work to avoid injury.

1.1.3 Accidents, Injuries, and Defects

Report by the first means of communication any accidents; personal injuries; defects in tracks, bridges, or signals; or any unusual condition that may affect the safe and efficient operation of the railroad. Where required, furnish a written report promptly after reporting the incident.

1.1.4 Condition of Equipment and Tools

Employees must check the condition of equipment and tools they use to perform their duties. Employees must not use defective equipment or tools until they are safe to use. Employees must report any defects to the proper authority.

1.2 Personal Injuries and Accidents

1.2.1 Care for Injured

When passengers or employees are injured, do everything reasonable to care for them.

1.2.2 Witnesses

If equipment is involved in personal injury, loss of life, or damage to property, the employee in charge must immediately secure the names, addresses, and occupations of all persons involved, including all persons at the scene when the accident occurred and those that arrived soon after. The employee in charge must secure the names regardless of whether these persons admit knowing anything about the accident.

The employee in charge must also obtain the license numbers of nearby automobiles. When necessary, other employees can assist in obtaining this information, which must be included in reports covering the incident.

Where signaling devices are provided or a flagman is on duty, the employee in charge and assisting employees must try to determine who, among the witnesses, can testify whether the signaling devices were functioning properly or if the flagman was performing his duties properly.

When possible, obtain the names of witnesses who can testify about the bell and whistle signals.

1.2.3 Equipment Inspection

If an accident results in personal injury or death, all tools, machinery, and other equipment involved, including the accident site, must be inspected promptly by the foreman, another person in charge of the work, or other competent inspectors. The inspector must promptly forward to his manager a report of the inspection. The report must include the condition of the equipment and the names of those making the inspection.

The equipment inspected must be marked for identification and placed in custody of the responsible manager or employee until the claims department is contacted and determines disposition.

1.2.4 Mechanical Inspection

When engines, cars, or other equipment are involved in an accident that results in personal injury or death, the equipment must be inspected before it leaves the accident site.

A mechanical department employee must further inspect the equipment at the first terminal. This employee must promptly report inspection results to the proper manager.

1.2.5 Reporting

All cases of personal injury, while on duty or on company property, must be immediately reported to the proper manager and the prescribed form completed.

A personal injury that occurs while off duty that will in any way affect employee performance of duties must be reported to the proper manager as soon as possible. The injured employee must also complete the prescribed written form before returning to service.

If an employee receives a medical diagnosis of occupational illness, the employee must report it immediately to the proper manager.

1.2.6 Statements

Except when authorized by the proper manager:

- Information concerning accidents or personal injuries that occur to persons other than employees may be given only to an authorized representative of the railroad or an officer of the law.
- Information about the facts concerning the injury or death of an employee may be given only to a person in interest such as the injured employee, an immediate relative of the injured or deceased employee, an authorized representative of the railroad, or an officer of the law.
- Information in the files or in other privileged or confidential reports of the railroad concerning accidents or personal injuries may be given only to an authorized representative of the railroad.

1.2.7 Furnishing Information

Employees must not withhold information, or fail to give all the facts to those authorized to receive information regarding unusual events, accidents, personal injuries, or rule violations.

1.3 Rules

1.3.1 Rules, Regulations, and Instructions

Safety Rules. Employees must have a copy of, be familiar with, and comply with all safety rules issued in a separate book or in another form.

General Code of Operating Rules. Employees governed by these rules must have a current copy they can refer to while on duty.

Hazardous Materials. Employees who in any way handle hazardous materials must have a copy of the instructions or regulations for handling these materials. Employees must be familiar with and comply with these instructions or regulations.

Air Brakes. Employees whose duties are affected by air brake operation must have a copy of the rules and instructions for operating air brakes and train handling. Employees must know and obey these rules and instructions.

Timetable and Special Instructions. Employees whose duties are affected by the timetable and special instructions must have a current copy they can refer to while on duty.

Train Dispatchers and Control Operators. The train dispatchers and control operators must have a copy of the rules and instructions for train dispatchers and control operators. They must be familiar with and obey those rules and instructions.

Classes. Employees must be familiar with and obey all rules, regulations, and instructions and must attend required classes. They must pass the required examinations.

Explanation. Employees must ask their supervisor for an explanation of any rule, regulation, or instruction they are unsure of.

Issued, Canceled, or Modified. Rules may be issued, canceled, or modified by track bulletin, general order, or special instructions.

1.3.2 General Orders

General orders:

- Are numbered consecutively.
- Are issued and canceled by the designated manager.
- Contain only information and instructions related to rules or operating practices.
- Replace any rule, special instruction, or regulation that conflicts with the general order.

Before beginning each day's work or trip, crew members and any others whose duties require, must review general orders that apply to the territory they will work on.

1.3.3 Circulars, Instructions, and Notices

Circulars, instructions, notices, and other information are issued and canceled by the designated manager. Before beginning each day's work or trip, crew members and any others whose duties require, must review those that apply to the territory they will work on.

1.4 Carrying Out Rules and Reporting Violations

Employees must cooperate and assist in carrying out the rules and instructions. They must promptly report any violations to the proper supervisor. They must also report any condition or practice that may threaten the safety of trains, passengers, or employees, and any misconduct or negligence that may affect the interest of the railroad.

1.4.1 Good Faith Challenge

A. Right to Challenge

Federal Regulations have provisions that allow an employee the right to challenge a directive which, based upon the employee's good faith determination, would violate a railroad operating rule relating to:

- Shoving movements.
 - Leaving equipment foul of an adjacent track.
- or
- Handling of hand-operated switches or fixed derails.

B. Good Faith Challenge Procedure

1. An employee may inform a supervisor issuing a directive that a good faith determination has been made that the directive would violate a railroad operating rule relating to:
 - Shoving movements.
 - Leaving equipment foul of an adjacent track.

or

 - Handling of hand-operated switches or fixed derails.

2. The supervisor will not require the employee to comply with the directive until the challenge is resolved. The supervisor may:
 - Require the challenging employee to perform other tasks not related to the challenge until the challenge is resolved.
 - or
 - Direct an employee, other than the challenging employee, to perform the challenged task before the challenge is resolved. Employee so directed will be informed of the challenge, and determine that the challenged task does not violate the rules.

C. Resolving Good Faith Challenge

1. A challenge may be resolved by one of the following:
 - The supervisor's acceptance of the employee's request.
 - An employee's acceptance of the directive.
 - An employee's agreement to a compromise solution acceptable to the person issuing the directive.
2. If the challenge cannot be resolved because the supervisor issuing the directive has determined that the employee's challenge has not been made in good faith or there is no alternative to the direct order, the railroad will:
 - Provide immediate review by at least one manager, which must not be conducted by the supervisor issuing the challenged directive or that supervisor's subordinate.
 - Resolve the challenge using the same options available for resolving the challenge as the initial supervisor.
3. If the manager making the final decision concludes that the challenged directive would not cause the employee to violate any requirement of the involved rules, the reviewing manager's decision shall be final and not subject to further immediate review.
 - The manager will inform the employee that Federal law may protect the employee from retaliation, if the employee's refusal to do the work is a lawful, good faith act.
 - The employee making the challenge will be afforded an opportunity to document, in writing or electronically, any protest to the manager making the final decision before the employee's tour of duty is complete. The employee will be afforded the opportunity to retain a copy of the protest.

D. Request for Review and Verification of Decision

Upon written request, at the time of the challenge, the employee has the right for further review by the "Designated Review Manager". Within 30 days after the expiration of the month during which the challenge occurred, the "Designated Review Manager" will verify the proper application of the rule in question. The verification decision shall be made in writing to the employee.

E. Employee Rights and Remedies

The Good Faith Challenge is not intended to abridge any rights or remedies available to the employee under a collective bargaining agreement or any Federal law.

1.5 Drugs and Alcohol

The use or possession of alcoholic beverages while on duty or on company property is prohibited. Employees must not have any measurable alcohol in their breath or in their bodily fluids when reporting for duty, while on duty, or while on company property.

The use or possession of intoxicants, over-the-counter or prescription drugs, narcotics, controlled substances, or medication that may adversely affect safe performance is prohibited while on duty or on company property, except medication that is permitted by a medical practitioner and used as prescribed. Employees must not have any prohibited substances in their bodily fluids when reporting for duty, while on duty, or while on company property.

1.6 Conduct

Employees must not be:

1. Careless of the safety of themselves or others.
 2. Negligent.
 3. Insubordinate.
 4. Dishonest.
 5. Immoral.
 6. Quarrelsome.
- or
7. Discourteous.

Any act of hostility, misconduct, or willful disregard or negligence affecting the interest of the company or its employees is cause for dismissal and must be reported. Indifference to duty or to the performance of duty will not be tolerated.

1.6.1 Motor Vehicle Driving Records

A certified conductor, engineer or person seeking initial certification convicted for operating a motor vehicle under the influence of/ impaired by alcohol or a controlled substance must report the conviction to their supervisor within 48 hours of being notified.

As applied to this rule, a conviction also includes:

- Refusal to undergo such testing when a law enforcement official seeks to find out whether a person is operating under the influence/impaired by alcohol or a controlled substance.
- Participation in state sponsored diversion program, guilty pleas, and completed state actions to cancel, revoke, suspend or deny a driver's license.

1.6.2 Notification of Felony Convictions

The conduct of any employee leading to conviction of any felony is prohibited. Any employee convicted of a felony must notify the proper authority of that fact within 48 hours after the employee receives notice of the conviction.

1.6.3 Notification of Deteriorating Vision or Hearing

A certified conductor, engineer or person seeking initial certification who has knowledge their hearing or vision has deteriorated and cannot be corrected to the minimum acceptable requirement as outlined in federal regulations (20/40 distant visual acuity, 70 degree field of vision, ability to recognize/distinguish between railroad color signals, hearing loss no greater than 40 decibels) must report that fact immediately to the proper authority or the medical department.

1.7 Altercations

Employees must not enter into altercations with each other, play practical jokes, or wrestle while on duty or on railroad property.

1.8 Appearance

Employees reporting for duty must be clean and neat. They must wear the prescribed uniform when required.

1.9 Respect of Railroad Company

Employees must behave in such a way that the railroad will not be criticized for their actions.

1.10 Games, Reading, or Other Media

Employees on duty must not:

- Play games.
- Use personal electronic devices other than provided for in Rule 2.21 (Electronic Devices).
or
- Read magazines, newspapers, or other literature not related to their duties when:
 - On a train or engine.
 - Performing safety related activities.or
- It would delay or interfere with required duties.

This does not prohibit employees from having such material enclosed in their personal luggage.

1.11 Sleeping

Employees must not sleep while on duty, except as outlined under Rule 1.11.1 (Napping). Employees reclined with their eyes closed will be in violation of this rule.

1.11.1 Napping

Napping is permitted by train crews, except crews in passenger, commuter or yard service, under the following conditions:

- The crew is waiting for departure of their train.
or
- The train is stopped enroute waiting to be met or passed by a train, waiting for track work, waiting for helper locomotive, or similar conditions.

Restrictions are as follows:

- A job briefing must be conducted, with agreement reached as to who will nap and who must remain awake. Each crew member has the right and responsibility to refuse to allow another crew member to take a nap if doing so could jeopardize the personal safety of employees, the train, or the public.
- One crew member must remain awake at all times.
- The nap period must not exceed 45 minutes, which includes the time needed to fall asleep. The napping employee is relieved of all duties.
- Train must not be delayed for an employee to take a nap. When conditions allow the train to move, the employee who is to remain awake must immediately waken the napping employee.
- Before napping, while waiting for the arrival of their train, employees must ensure all duties have been completed. These duties include reviewing general orders and notices; securing and reviewing track warrants, track bulletins, and other paperwork, if available.
- Before napping is allowed enroute, the employee in charge of the locomotive controls must:
 1. Make at least a 10-lb. brake pipe reduction.
 2. Place generator field switch in the "OFF" position.
 3. Center the reverser and remove, if removable.
- The employee who is to remain awake must remain on the locomotive while others on the locomotive are napping, except when inspecting passing trains.
- If waiting for the arrival of or make-up of train, one crew member must remain awake while waiting for their train's arrival or make-up at their initial terminal unless arrangements have been made with a third party to wake up all crew members.

All crew members that are deadheading or otherwise relieved of duties may nap.

1.12 Weapons

While on duty or on railroad property, employees must not have firearms or other deadly weapons, including knives with a blade longer than 3 inches. However, railroad police are authorized to possess firearms in the course of their work.

1.13 Reporting and Complying with Instructions

Employees will report to and comply with instructions from supervisors who have the proper jurisdiction. Employees will comply with instructions issued by managers of various departments when the instructions apply to their duties.

1.14 Employee Jurisdiction

Employees are under the jurisdiction of the supervisors of the railroad they are operating on.

When operating on another railroad, unless otherwise instructed, employees will be governed by:

- Safety rules, air brake and train handling rules, and hazardous materials instructions of the railroad they are employed by.
- The operating rules, timetable and special instructions of the railroad they are operating on.

1.15 Duty—Reporting or Absence

Employees must report for duty at the designated time and place with the necessary equipment to perform their duties. They must spend their time on duty working only for the railroad. Employees must not leave their assignment, exchange duties, or allow others to fill their assignment without proper authority. Continued failure by employees to protect their employment will be cause for dismissal.

1.16 Subject to Call

Employees subject to call must indicate where they can be reached and must not be absent from their calling place without notifying those required to call them.

1.17 Hours of Service Law

Employees must be familiar and comply with the requirements of the federal hours of service law. Employees are expected to use off-duty time so they are prepared for work.

If an employee is called to report for duty before legal off-duty time has expired, before accepting the call to work, the employee must notify the individual making the call that off-duty time has not expired.

A. Notification

When communication is available, employees must notify the train dispatcher or another authority of the time the law requires them to be off duty. Employees must provide notification early enough that they may be relieved, or transportation provided, before they exceed the hours of service.

B. Exceeding the Law

Employees must not exceed the hours of service law without proper authority. However, they must not leave trains, engines, or cars on the main track without proper protection. Employees must secure trains properly and, if possible, before they exceed the hours of service. Except as provided by this paragraph, employees are then relieved of all duties.

1.18 Unauthorized Employment

Employees must not engage in another business or occupation that would create a conflict of interest with their employment on the railroad or would interfere with their availability for service or the proper performance of their duties.

1.19 Care of Property

Employees are responsible for properly using and caring for railroad property. Employees must return the property when the proper authority requests them to do so. Employees must not use railroad property for their personal use.

1.20 Alert to Train Movement

Employees must expect the movement of trains, engines, cars, or other movable equipment at any time, on any track, and in either direction.

Employees must not stand on the track in front of an approaching engine, car, or other moving equipment.

Employees must be aware of location of structures or obstructions where clearances are close.

1.21 Occupying Roof

Employees whose duties require them to occupy the roof of a car or engine must do so only with proper authority and when the equipment is standing.

1.22 Unauthorized Persons on Equipment

Do not permit unauthorized persons on equipment.

Promptly notify the train dispatcher or supervisor when unauthorized persons or emergency responders are observed on, under or between railroad equipment.

When made aware of emergency responders on, under or between railroad equipment, train dispatcher or supervisor must arrange for a qualified employee to inspect all affected equipment to verify proper securement as soon as practical.

1.23 Altering Equipment

Without proper authority, employees must not alter, nullify, change the design of, or in any manner restrict or interfere with the normal function of any device or equipment on engines, cars, or other railroad property, except in the case of an emergency. Employees must report to the proper supervisor changes made in an emergency.

1.24 Clean Property

Railroad property must be kept in a clean, orderly, and safe condition. Railroad buildings, facilities, or equipment must not be damaged or defaced. Only information authorized by the proper manager or required by law may be posted on railroad property.

1.25 Credit or Property

Unless specifically authorized, employees must not use the railroad's credit and must not receive or pay out money on the railroad account. Employees must not sell or in any way get rid of railroad property without proper authority. Employees must care for all articles of value found on railroad property and promptly report the articles to the proper authority.

1.26 Gratuities

Employees must not discriminate among railroad customers. Employees must not accept gifts or rewards from customers, suppliers, or contractors of the railroad unless authorized by the proper manager.

1.27 Divulging Information

Employees who make up, handle, or care for any of the following must not allow an unauthorized person to access them or disclose any information contained in them:

- Correspondence.
- Reports.
- Books.
- Bills of Lading.
- Waybills.
- Tickets.
- Statistics.

1.28 Fire

Employees must take every precaution to prevent loss and damage by fire.

Employees must report promptly to the train dispatcher any fires seen on or near the right of way, unless the fires are being controlled. If there is danger of the fire spreading to a bridge or other structure, crew members must stop their train and help extinguish the fire.

Cause of fire, if known, must be promptly reported.

1.29 Avoiding Delays

Crew members must operate trains and engines safely and efficiently. All employees must avoid unnecessary delays.

When possible, train or engine crews wanting to stop the train to eat must ask the train dispatcher at least one hour and thirty minutes before the desired stop.

1.30 Riding Engine

When possible, crew members on the head end of freight trains must ride in the control compartment of the engine.

When riding on the head end, the conductor will ride in the control compartment.

1.31 Repairs to Foreign Cars

Crew members who repair foreign cars must report the repairs on the prescribed form.

1.32 Overheated Wheels

When overheated wheels are found on a train, the train must be stopped and held a minimum of 10 minutes to allow the heat to equalize through the wheel.

1.33 Inspection of Freight Cars

When personnel are not on duty primarily to inspect freight cars, each car placed in the train may be moved after it receives a safety inspection as follows:

- Cars must be checked for:
 - Leaning.
 - Sagging.
 - Improper position on the truck.
 - Objects hanging or dragging from the car or extending from the side.
 - Insecurely attached doors.
 - Broken or missing safety appliances.
 - Contents leaking from placarded hazardous material car.
 - Insecure coupling device.
 - Overheated wheel or journal.
 - Broken or cracked wheel.
 - Brake that fails to release.
 - Staff type brake not in fully raised position.
 - Any apparent hazard that could cause an accident.
- Open top loads, including trailers and containers on flat cars, must be loaded safely.
- If width or height approaches clearance restrictions, movement must be cleared with the proper authority.

A freight car with any defect that makes movement unsafe must be corrected or set out of the train. When a defect is discovered enroute, note the type of defect on proper tag and attach a tag on each side of the car.

A freight car with three bad order tags indicating that the car is safe to move may be moved to the nearest car repair point. The conductor will remove one bad order tag from the side with two tags. The conductor will use this written information from the tag to inform other crew members of the restrictions.

1.34 Flat Spots

If a wheel on a piece of equipment has a flat spot more than 2 1/2 inches long, or if the wheel has adjoining flat spots that are each at least 2 inches long, the equipment must not be moved faster than 10 MPH. Such equipment must be set out at the first available point.

1.35 Dump Doors

Be sure dump doors on cars are closed after a load is dumped. If car must be moved short distances with the dump doors open, make sure the doors and chains will clear tracks and crossings.

1.36 Excessive Dimension Loads

Place excessive dimension loads on or near the head end of trains.

Instructions will be issued to trains handling excessive dimension loads. If no instructions have been issued regarding handling the car, the conductor will immediately notify the train dispatcher.

Crew members handling excessive dimension equipment must ensure that the equipment will clear nearby objects, including equipment on adjacent tracks. If the train cannot reach a point with enough clearance, crew members must make sure protection is provided against movements on adjacent tracks.

1.37 Open Top Loads

Flat cars, open top cars, and open top TOFCs/COFCs with loads that are likely to shift must not be placed in trains next to the following if train length and make-up permit:

- Occupied outfit car.
- Passenger car.
- Engine.
- Caboose.
- Shipment of automotive vehicles and machinery that is not fully enclosed.

This restriction does not apply to cars with permanent tie-downs.

1.38 Shipments Susceptible to Damage

Shipments with painted or finished surfaces susceptible to damage, such as automobiles, trucks, tractors, combines, and other similar equipment or machinery, must not be placed closer than the fifth car behind open top cars loaded with commodities such as coal, sand, gravel, lime, soda ash, etc. subject to wind, vapor, or fume action on adjacent cars. Exceptions include shipments susceptible to damage that are:

- Loaded in cars that fully enclose the shipments.
- or
- Fully protected by a covering.

An open top car loaded with sand, gravel, lime, soda ash, etc. subject to wind, vapor, or fume action in other than a solid unit train must not be placed immediately ahead of an occupied caboose.

1.39 Accuracy of Speed Indicator

The engineer must verify speed indicator accuracy as soon as possible after taking charge of the engine. If the speed indicator is not accurate to within 3 MPH plus or minus at speeds of 10 to 30 MPH and to within 5 MPH plus or minus at speeds above 30 MPH, the engineer must immediately report the variance to the train dispatcher.

1.40 Reporting Engine Defects

The engineer will report any engine defect on the proper form and notify the relieving engineer, when needed.

1.41 Engines Coupled to Occupied Passenger Cars

Engines coupled to equipment that includes occupied passenger cars must not be left without an authorized employee in charge.

1.42 Trains Detoured

When trains are detoured over another railroad, the engineer of the detoured train will operate the engine, unless otherwise approved by a manager of the railroad the train is being detoured over.

The pilot will inform the engineer of speed restrictions, signals, sidings, etc. to make sure the train detours over the railroad safely.

1.43 Stopped in Tunnels

A. Engine or Train Stopped in Tunnel

When an engine is stopped in a tunnel and cannot move promptly, crew members must:

1. Shut down diesel engine at once.
2. Shut down Waukesha or similar type engines.
3. Make a full service air brake application.
4. Apply hand brakes to prevent movement in case the air brakes leak off.

B. Passenger Train Stopped in Tunnel or Deep Snow

Crew members of a passenger train stopped in a tunnel or deep snow must:

1. Shut off any air circulating systems including:
 - a. Air conditioning.
 - b. Ice machines.
 - c. Generators.
2. Shut air intake shutters.
3. Turn off blower fans.

C. Notification if Stopped in Tunnel or Deep Snow

The train dispatcher should be notified immediately so that proper arrangements can be made to protect persons and equipment.

D. When These Requirements Will Not Apply

These requirements will not apply if air currents carry the exhaust gases away from the train. Safety of passengers and crew members must be the first consideration.

1.44 Duties of Train Dispatchers

Train dispatchers supervise train movement and any employees connected with that movement.

1.45 Duties of Control Operators and Operators

Control operators and operators are under the direction of the train dispatcher when their duties concern handling track warrants, track bulletins, lineups, the movement of trains, and any other instructions issued by the train dispatcher.

1.46 Duties of Yardmasters

The yardmaster is responsible for and shall directly supervise yard crews, clerks, and all other employees working in the yard. The yardmaster must see that they work in a safe, efficient, and economical manner, according to the rules, regulations, and instructions of the railroad. Yardmasters must ensure the prompt and regular movement of cars, especially the proper make-up of trains and their movement into and out of the yard.

At locations where yardmasters are on duty, employees in train, engine, and yard service must comply with the yardmaster's instructions. At locations where no yardmaster is on duty, these employees will work according to the instructions of designated employees.

1.47 Duties of Crew Members

The conductor and the engineer are responsible for the safety and protection of their train and observance of the rules. They must ensure that their subordinates are familiar with their duties, determine the extent of their experience and knowledge of the rules. They must instruct them, when necessary, how to perform their work properly and safely. If any conditions are not covered by the rules, they must take precautions to provide protection.

A. Conductor Responsibilities

1. The conductor supervises the operation and administration of the train (if trains are combined with more than one conductor on board, the conductor with the most seniority takes charge). All persons employed on the train must obey the conductor's instructions, unless the instructions endanger the train's safety or violate the rules. If any doubts arise concerning the authority for proceeding or safety, the conductor must consult with the engineer who will be equally responsible for the safety and proper handling of the train. Certified conductors must have a current certificate in their possession while on duty.
2. The conductor must advise the engineer and train dispatcher of any restriction placed on equipment being handled.
3. The conductor must remind the engineer that the train is approaching an area restricted by:
 - Limits of authority.
 - Track warrant.
 - Track bulletin.or
 - Radio speed restriction.

The conductor must inform the engineer after the train passes the last station, but at least 2 miles from the restriction.

4. When the conductor is not present, other crew members must obey the instructions of the engineer concerning rules, safety, and protection of the train.
5. Freight conductors are responsible for the freight carried by their train. They are also responsible for ensuring that the freight is delivered with any accompanying documents to its destination or terminals. Freight conductors must maintain any required records.

B. Engineer Responsibilities

1. The engineer is responsible for safely and efficiently operating the engine. Crew members must obey the engineer's instructions that concern operating the engine. A student engineer or other qualified employee may operate the engine under close supervision of the engineer. Any employee that operates an engine must have a current certificate in their possession.
2. The engineer must check with the conductor to determine if any cars or units in the train require special handling.

C. All Crew Members' Responsibilities

1. To ensure the train is operated safely and rules are observed, all crew members must act responsibly to prevent accidents or rule violations. Crew members in the engine control compartment must communicate to each other any restrictions or other known conditions that affect the safe operation of their train sufficiently in advance of such condition to allow the engineer to take proper action. If proper action is not being taken, crew members must remind engineer of such condition and required action.
2. Crew members in the engine control compartment must be alert for signals. As soon as signals become visible or audible, crew members must communicate clearly to each other the name of signals affecting their train. They must continue to observe signals and announce any change of aspect until the train passes the signal. If the signal is not complied with promptly, crew members must remind the engineer and/or conductor of the rule requirement. If crew members do not agree on the signal indication, regard the signal as the most restrictive indication observed.
3. When the engineer and/or conductor fail to comply with a signal indication or take proper action to comply with a restriction or rule, crew members must immediately take action to ensure safety, using the emergency brake valve to stop the train, if necessary.

1.48 Time

While on duty, crew members must have a watch. Other employees must have access to a watch or clock.

The watch or clock must:

- Be in good working condition and reliable.
- Display hours, minutes, and seconds.
- Not vary from the correct time by more than 30 seconds.
- Be compared with the time source designated in special instructions.

2.0 Railroad Radio and Communication Rules

2.1 Transmitting

Any employee operating a radio must do the following:

- Before transmitting, listen long enough to make sure the channel is not being used.
- Give the required identification.
- Not proceed with further transmission until acknowledgment is received.

2.2 Required Identification

Employees transmitting or acknowledging a radio communication must begin with the required identification.

The identification must include the following in this order:

- For base or wayside stations:
 - Name or initials of the railroad.
 - Name and location or other unique designation.
- For mobile units:
 - Name or initials of the railroad.
 - Train name (number), engine number, or words that identify the precise mobile unit.

If communication continues without interruption, repeat the identification every 15 minutes.

Short Identification

After making a positive identification for switching, classification, and similar operations within a yard, fixed and mobile units may use a short identification after the initial transmission and acknowledgment.

2.3 Repetition

An employee who receives a transmission must repeat it to the person transmitting the message, except when the communication:

- Concerns yard switching operations.
 - Is a recorded message from an automatic alarm device.
- or
- Is general and does not contain any information, instruction, or advice that could affect the safety of a railroad operation.

2.4 Ending Transmissions

Employees using a radio for transmissions must state to the employee receiving the transmission the following as it applies to indicate the communication has ended or is completed:

“OVER” — when a response is expected.

or

“OUT” preceded by required identification — when no response is expected.

However, these requirements do not apply to yard switching operations.

2.5 Communication Redundancy

The controlling unit on any train that requires an air brake test must be equipped with an operative radio, unless relieved by Rule 2.18 (Malfunctioning Radio). In addition, trains must have a second means of communication, which may include:

- An operative radio on any unit in the consist.
 - A portable radio.
- or
- Other wireless communication device.

2.6 Communication Not Understood or Incomplete

An employee who does not understand a radio communication or who receives a communication that is incomplete must not act upon the communication and must treat it as if it was not sent.

EXCEPTION: An employee who receives information that may affect the safety of employees or the public or cause damage to property must take the safe course. When necessary, stop movement until the communication is understood.

2.7 Monitoring Radio Transmissions

Radios in attended base stations or mobile units must be turned on to the appropriate channel with the volume loud enough to receive communications. Employees attending base stations or mobile units must acknowledge all transmissions directed to the station or unit.

2.8 Acknowledgment

An employee receiving a radio call must acknowledge the call immediately, unless doing so would interfere with safety.

2.9 Misuse of Radio Communications

Employees must not use radio communication to avoid complying with any rule.

2.10 Emergency Calls

Emergency calls will begin with the words “Emergency, Emergency, Emergency”. These calls will be used to cover initial reports of hazardous conditions which could result in death or injury, damage to property or serious disruption of railroad operations such as:

- Derailments.
- Collisions.
- Storms.
- Washouts.
- Fires.
- Track obstructions.

or

- Emergency brake applications.

In addition, emergency calls must be made for the following:

- Overrunning limits of authority.

or

- Overrunning Stop indications.

Emergency calls must contain as much complete information on the incident as possible.

All employees must give absolute priority to an emergency communication. Unless they are answering or aiding the emergency call, employees must not transmit until they are certain no interference will result.

2.11 Prohibited Transmissions

Employees must not transmit a false emergency, or an unnecessary or unidentified communication.

Employees must not use indecent language over the radio. Employees must not reveal the existence, contents, or meaning of any communication (except emergency communications) to persons other than those it is intended for or those whose duties may require knowing about it.

2.12 Fixed Signal Information

Employees must not use the radio to give information to a train or engine crew about the name, position, aspect, or indication displayed by a fixed signal, unless the information is given between members of the same crew or the information is needed to warn of an emergency.

2.13 Not Used

2.14 Transmission of Mandatory Directives

When transmitted by radio, mandatory directives must conform to applicable operating rules and the following:

- The train dispatcher must state which mandatory directive will be transmitted.
- The employee must inform the train dispatcher when ready to copy stating the employee’s occupation (ex. conductor, engineer, foreman, maintainer), name and location on the main track or where the main track will be entered. An employee operating the controls of a moving engine may not copy mandatory directives. In addition, mandatory directives must not be transmitted to the crew of a moving train if the conductor, engineer or train dispatcher feels that the transmission could adversely affect the safe operation of the train.
- The employee receiving a mandatory directive must copy it in writing using the format outlined in the operating rules.
- Before a mandatory directive is acted upon, the conductor and engineer must each have a written copy and each crew member must read and understand it.

2.14.1 Verbally Transmitting and Repeating Mandatory Directives

When transmitting and repeating mandatory directives:

- State and spell single digit numbers by number and digit.
- State multiple digit numbers by number and digit.
- Identify decimal points as “point”, “dot”, or “decimal”.
- State and spell directions.

2.15 Phonetic Alphabet

If necessary, a phonetic alphabet (Alpha, Bravo, Charlie, etc.) will be used to pronounce clearly any letter used as an initial, except initial letters of railroads.

2.16 Assigned Frequencies

The railroad must authorize any radio transmitters used in railroad service. Radio transmitters must operate on frequencies the Federal Communications Commission assigns the railroad. Employees are prohibited from using other transmitters or railroad frequencies not assigned to that particular territory.

2.17 Radio Testing

Test radios to be used as soon as possible before beginning of work assignment.

The radio test must include an exchange of voice transmissions with another radio. The test must confirm the quality of the radio’s transmission.

2.18 Malfunctioning Radio

Malfunctioning radios must not be used. As soon as possible, notify each crew member and the train dispatcher or other affected employees that the radio is not working.

If a radio fails on the controlling locomotive enroute, the train may continue until the earlier of:

- The next calendar day inspection.
- or
- The nearest forward point where the radio can be repaired or replaced.

2.19 Blasting Operations

Employees must not operate radio transmitters located less than 250 feet from blasting operations.

2.20 Internal Adjustments

Employees are prohibited from making internal adjustments to a railroad radio unless they are specifically authorized by the FCC or hold a current Certified Technicians Certificate. Employees authorized to make adjustments must carry their FCC operator license, Certified Technicians Certificate, or verification card while on duty.

2.21 Electronic Devices

This rule outlines the requirements for use of electronic devices. As used in this rule, the following definitions apply:

Electronic Device. An electronic or electrical device used to conduct oral, written, or visual communication; place or receive a telephone call; send or read an electronic mail message or text message; look at pictures; read a book or other written material; play a game; navigate the Internet; navigate the physical world; play, view, or listen to a video; play, view or listen to a television broadcast; play or listen to music; execute a computational function; or, perform any other function that is not necessary for the health or safety of the person and that entails the risk of distracting the employee or another employee from a safety related task.

Railroad Operating Employee. An individual who is:

- Engaged in or connected with the movement of a train including a hostler,
- A train employee providing commuter or intercity rail passenger transportation,
or
- Subject to hours of service governing train service employees.

The use of any electronic device is prohibited if that use would interfere with an employee's performance of safety-related duties.

A. Personal or Railroad Supplied Electronic Devices

Personal or railroad supplied electronic devices may be used as necessary:

- To respond to an emergency situation involving the operation of the railroad,
- To respond to an emergency encountered while on duty,
- As a communication device in the event of radio malfunction.

B. Personal Electronic Devices

Except when deadheading in other than a controlling locomotive, railroad operating employees on duty (includes supervisors) must have each electronic device turned off and stowed out of sight with any earpiece removed from the ear when:

- On moving rolling equipment or on-track equipment.
- Any member of the crew is on the ground performing safety related duties.
or
- Any employee is assisting in preparation of the train, engine(s) or on-track equipment.

A railroad operating employee may use a personal cell phone only for voice communication when:

- Rolling and on-track equipment is stopped,
- A safety briefing is conducted with all crew members to confirm that it will not interfere with any safety related or required duty,
- No member of crew will foul any track.

Cell phone must be turned off when call has been completed.

Railroad operating employees may use a digital storage and display function of an electronic device to refer to a railroad rule, special instruction, timetable, or other directive provided train is stopped and use does not interfere with any employee's performance of safety related duties and all other crew members have been briefed on its limited use. When not in use it must be turned off and stowed.

A personal stand-alone camera may be used to take a photograph of a safety hazard or a violation of a rail safety law, regulation, order, or standard, provided that:

- A job briefing is conducted among all crew members and any other individuals in the controlling cab of moving equipment,
- It is turned off immediately after the photograph has been made;
- It is not used by an employee at the controls of moving equipment.

A personal stand-alone calculator, digital watch whose only purpose is as a timepiece and medical devices that are consistent with the railroad's standards may be used as necessary in the performance of duties.

C. Railroad Supplied Electronic Devices

Railroad operating employees may use railroad supplied electronic devices to send or receive work related information with:

- Railroad supervisors.
- Railroad customers.
- Railroad dispatchers.
- Railroad customer service employees.

or

- Other railroad employees as necessary in the performance of their duties.

Railroad operating employees must not use a railroad supplied electronic device for purposes other than which it was intended or while:

- Operating the controls of a moving locomotive.
- On the ground within 4 feet of any track.
- On the ground and engaged in an active switching operation.
- Riding rolling equipment during a switching operation.
- At the controls of the locomotive and any other employee is assisting in the preparation of the train, engine(s), or on-track equipment, including testing of railroad equipment or brakes.
- Inside the controlling cab of a locomotive, train or on-track equipment, unless there has been a safety briefing and all crew members agree that it is safe to do so.
- Verbally obtaining or releasing mandatory directives when railroad radio communication is available.

Railroad authorized electronic devices may be used in the body of a business car or passenger train for railroad business when it will not interfere with an employee's performance of safety related duties.

3.0 Section Reserved

This page left blank intentionally.

4.0 Timetables

4.1 New Timetable

The moment a new timetable goes into effect, it will replace the previous one.

4.1.1 Notice of New Timetable

At least 24 hours before a new timetable goes into effect, notification will be made by general order. A track bulletin will also be issued at least 24 hours before the new timetable goes into effect and continue for 6 days after the effective date.

4.2 Special Instructions

Special instructions will replace any rule or regulation with which they conflict.

4.3 Timetable Characters

Timetable characters are letters and symbols located in the timetable station column. These letters and symbols indicate the special conditions at specific locations (such as yard limits and manual interlockings). A timetable station column may also include information on the method of operation (such as TWC, ABS, CTC, or DTC). Explanation of characters will be shown in the timetable or special instructions.

This page left blank intentionally.

5.0 Signals and Their Use

5.1 Signal Equipment

Employees who give or display signals must have the proper appliances. Appliances must be in good condition and ready to use.

5.2 Receiving and Giving Signals

5.2.1 Looking for Signals

To recognize and follow signals correctly, employees must:

- Always be on the lookout for signals.
- Comply with the intent of the signal.
- Not act on any signal that they do not understand or that may be intended for other trains or engines.

5.2.2 Signals Used by Employees

To give clear signals during the day and at night, employees must:

A. During the Day

1. Use the correct color of flags or lights.
2. Use day signals from sunrise to sunset.
3. Flagmen providing protection as outlined in Rule 6.19 (Flag Protection) must have a red flag and six red fuses.

B. At Night



1. Use the correct color of reflectorized flags or lights.
2. Use night signals from sunset to sunrise or when day signals cannot be seen clearly.
3. Flagmen providing protection as outlined in Rule 6.19 (Flag Protection) must have a white light and six red fuses.

Flags may be made from cloth, metal, or other suitable material.

5.3 Hand and Radio Signals

5.3.1 Hand Signals

The following diagram illustrates the hand signals for a train or engine to stop, proceed, or back up.

Description of Signal	Indication	Movement
1. Swung at a right angle to the track	STOP	
2. Raised and lowered vertically	PROCEED	
3. Swung slowly in a circle at a right angle to the track	BACK UP	

[Diagram A.]

Employees may use other hand signals only if all crew members understand the signals. When employees are not giving hand signals, they must not make any gestures or movements that may resemble a hand signal.

5.3.2 Giving Signals

Employees who give signals must:

- Make sure signals can be plainly seen.
- Give signals clearly so they can be understood.
- Give signals on the engineer's side of the track when practical.

5.3.3 Signal Disappearance

If a person disappears who is giving the signal to back or shove a train, engine, or car, or the light being used disappears, employees must stop movement unless employee on leading car controls the air brakes.

5.3.4 Signal to Stop

Any object waved violently by any person on or near the track is a signal to stop.

5.3.5 Acknowledge Stop Signal

Except when switching, acknowledge hand signal to stop a train. When flagged, the engineer must obtain a thorough explanation from the flagman before proceeding.

5.3.6 Radio and Voice Communication

Employees may use radio and other means of voice communication to give information when using hand signals is not practical. Employees must make sure crew members:

- Know which moves will be made by radio communication.
- Understand that while using the radio, the engineer will not accept any hand signals, unless they are Stop signals.

5.3.7 Radio Response

When radio communication is used to make movements, crew members must respond to specific instructions given for each movement. Radio communications for shoving movements must specify the direction and distance and must be acknowledged when distance specified is more than four cars.

Movement must stop within half the distance specified unless additional instructions are received.

5.4 Flags for Temporary Track Conditions

5.4.1 Temporary Restrictions

Track bulletins, track warrants, or general orders may restrict or stop train movements because of track conditions, structures or men or equipment. Yellow flags are used to indicate temporary speed restrictions. Yellow-red flags are used to indicate when a train may be required to stop. When flags are not displayed, that information will be included in the track bulletin, track warrant, or general order.

When a restriction spans adjoining subdivisions, separate temporary restrictions may be issued on each subdivision. Only one set of flags may be displayed in advance of the entire restriction in each direction.

5.4.2 Display of Yellow Flag

A. Restriction Is In Effect

Two Miles Ahead of Restricted Area. Yellow flags warn trains to restrict movement because of track conditions or structures. To make sure train movement is restricted at the right location, employees must display a yellow flag 2 miles before the restricted area.

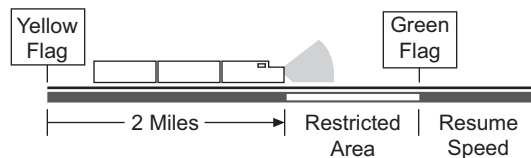

[Diagram A.]

Less than Two Miles Ahead of Restricted Area. When the restricted area is close to a terminal, junction, or another area, employees will display the yellow flag less than 2 miles before the restricted area. This information will also be included in the track bulletin, track warrant, or general order.

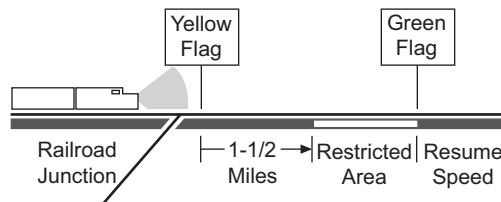

[Diagram B.]

Once the Train Reaches the Restricted Area. The speed specified by track warrant, track bulletin, general order, or radio speed restriction must not be exceeded until the rear of the train clears the restricted area.

B. Restriction Is Not In Effect

When a yellow flag is displayed and no restriction is in effect as specified by a track bulletin, track warrant, or general order, once the train is 2 miles beyond the yellow flag, crew members must:

1. Continue moving the train but at a speed not exceeding 10 MPH.
2. Resume speed only after the rear of the train has:
 - a. Passed a green flag.
 - or
 - b. Traveled 4 miles beyond the yellow flag and the train dispatcher has verified that no track bulletin or track warrant specifying a temporary speed restriction is in effect at that location.

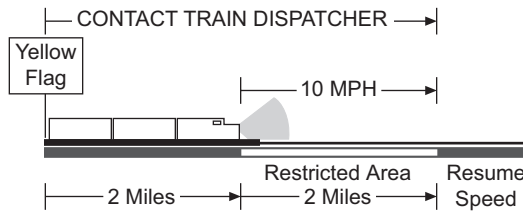

[Diagram C.]

5.4.3 Display of Yellow-Red Flag

Employees may display yellow-red flags from one hour before to one hour after a track bulletin Form B is in effect. During that time the employee in charge may provide a train instructions to proceed without restriction, specifying the Track Bulletin number (specifying line number when necessary) and advising no red flag displayed.

The display of yellow-red flags as described does not extend the authorized working time beyond the times listed on the track bulletin Form B.

A. Restriction Is In Effect

Two Miles Ahead of Restricted Area. Yellow-red flags warn a train to be prepared to stop because of men or equipment. To make sure the train is prepared to stop at the right location, employees must display a yellow-red flag 2 miles before the restricted area.

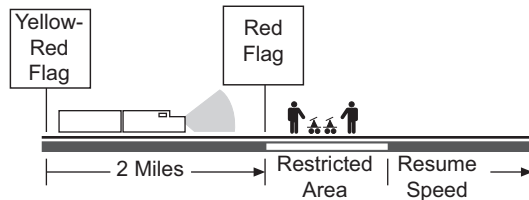

[Diagram A.]

Less Than Two Miles Ahead of Restricted Area. When the restricted area is close to a terminal, junction, or another area, employees will display the yellow-red flag less than 2 miles before the restricted area. This information will also be included in the track bulletin, track warrant, or general order.

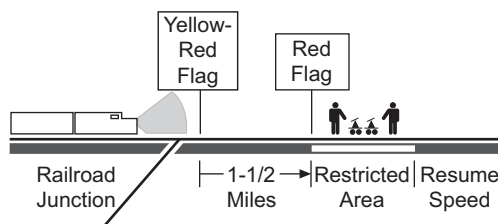

[Diagram B.]

B. Restriction Is Not In Effect

When a yellow-red flag is displayed and no restriction is in effect as specified by a track bulletin, track warrant, or general order, a crew member must attempt to contact the employee in charge of the yellow-red flag. Crew members must be prepared to stop short of a red flag 2 miles beyond the yellow-red flag. If a red flag is displayed, proceed as outlined in Rule 5.4.7 (Display of Red Flag). If no red flag is displayed and no instructions have been provided by the employee in charge of the yellow-red flag:

1. Move at restricted speed.
2. Increase speed only after:
 - a. A crew member has received instructions from the employee in charge.
or
 - b. The leading wheels of movement are 4 miles beyond the yellow-red flag, and the train dispatcher has verified that no track bulletin or track warrant protecting men or equipment is in effect at that location.

5.4.4 Authorized Protection by Yellow or Yellow-Red Flag

On subdivisions where maximum speed does not exceed 40 MPH, and it is authorized by special instructions, yellow or yellow-red flags may be displayed without the use of track bulletins, track warrants, or flagmen. Yellow or yellow-red flags must be displayed 2 miles before the restricted area. Protection will begin at a point 2 miles beyond the yellow or yellow-red flag and continue for 2 more miles, as outlined in Rule 5.4.2 (Display of Yellow Flag) and Rule 5.4.3 (Display of Yellow-Red Flag).

Note: Crew members do not need to receive verification from the train dispatcher when this rule is in effect.

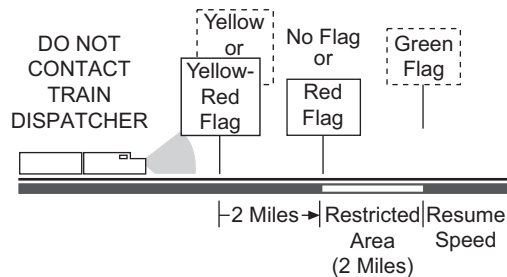

[Diagram A.]

5.4.5 Display of Green Flag

A green flag indicates the end of a temporary speed restriction. If a series of locations requires reduced speeds, the green flags could overlap yellow flags. When this is the case, employees must:

- Place a yellow flag before each speed restriction.
- Place a green flag at the end of the last speed restriction.

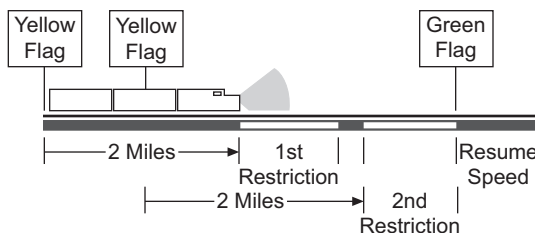

[Diagram A.]

5.4.6 Display of Flags Within Current of Traffic

A. Yellow and Green Flags

Flags for temporary speed restrictions will only be placed for trains moving with the current of traffic.

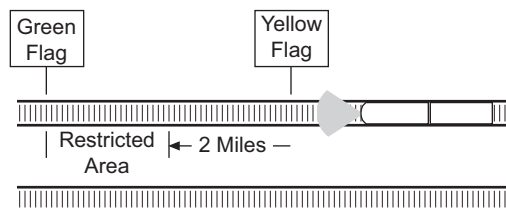

[Diagram A.]

B. Yellow-Red Flags

Flags protecting men or equipment must be placed in both directions on each track affected.

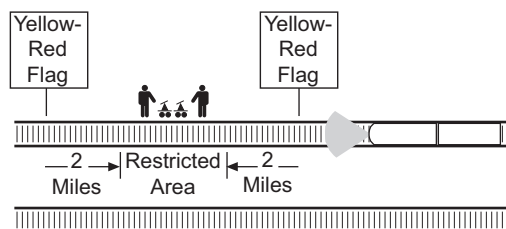

[Diagram B.]

5.4.7 Display of Red Flag

A red flag is displayed where trains must stop. When approaching a red flag the train must stop short of the red flag and not proceed unless the employee in charge gives instructions, including the milepost location of the red flag. A crew member must attempt to contact the employee in charge to avoid delay, giving the location of the red flag and the track being used. If instructions to proceed are received before the train stops, the train may pass the red flag without stopping.

If track bulletin Form B is not in effect, instructions must include speed and distance. This speed must not be exceeded until the rear of the train has passed the specified distance from the red flag, unless otherwise instructed by the employee in charge.

Displayed Between Rails. When a red flag is displayed between the rails of a track, the train must stop and not proceed until the flag has been removed by an employee of the class that placed it.

5.4.8 Flag Location

Flags will be displayed only on the track affected. However, when yellow, yellow-red, or red flags are used for protection without a track bulletin, track warrant, or general order, these flags must be placed to protect all possible access to the restricted area.

Flags must be displayed to the right of the track as viewed from an approaching train. In multiple main track territory or where sidings are adjacent to main track(s), they will be placed on the field side of outside tracks. Red flags may be displayed between the rails as outlined in Rule 5.4.7 (Display of Red Flag). Flags will be placed in this manner unless otherwise specified by track bulletin, track warrant, special instructions, or general order.

When flags are displayed beyond the first rail of an adjacent track, the flags will not apply to the track on which the train is moving.

5.5 Permanent Speed Signs

Permanent speed restriction signs will be placed in advance of permanent speed restrictions. Numbers on the face of these signs indicate the highest speed permitted over the limits of the restriction.

Two Sets of Numbers

When two sets of numbers are shown, the greater number governs trains consisting entirely of passenger equipment. The lesser number governs all other trains.

Resume Speed Signs

A permanent resume speed sign or a speed sign showing a higher speed will be placed at the end of each restriction.

Crew members must not exceed the speed shown on each permanent speed restriction sign until the rear of the train:

- Has passed a permanent resume speed sign or a sign showing a higher speed.
- or
- Has cleared the limits of the restriction.

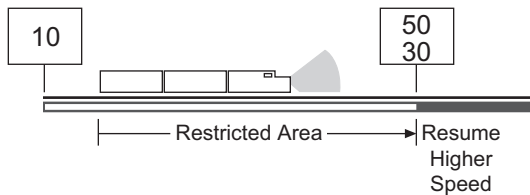

[Diagram A.]

5.6 Unattended Fusee

If a train approaches an unattended fusee burning on or near its track, the train must stop consistent with good train handling.

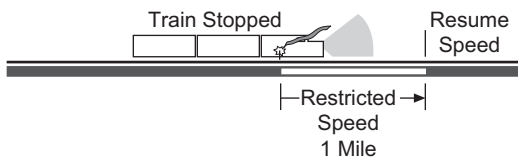

[Diagram A.]

A train moving at restricted speed must stop before passing the fusee.

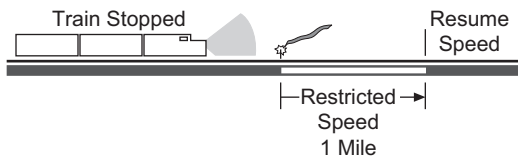

[Diagram B.]

After stopping, the train must proceed at restricted speed for 1 mile beyond the fusee.

If the unattended burning fusee is beyond the first rail of an adjacent track, the fusee does not apply to the track on which the train is moving.

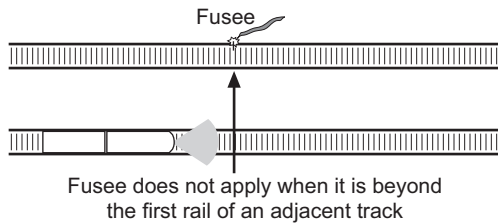

[Diagram C.]

Do not place fusees where they may cause fires.

5.7 Not Used

5.8 Bell and Whistle Signals

5.8.1 Ringing Engine Bell

Ring the engine bell under any of the following conditions:

- Before moving, except when making momentary stop and start switching movements.
- As a warning signal anytime it is necessary.
- When approaching men or equipment on or near the track.
- Approaching public crossings at grade with the engine in front start signal at the crossing sign. If no sign, or if movement begins between sign and crossing, start signal soon enough before crossing to provide warning. Continue ringing bell until the crossing is occupied.

5.8.2 Sounding Whistle

The whistle may be used at anytime as a warning regardless of any whistle prohibitions.

When other employees are working in the immediate area, sound the required whistle signal before moving.

Other forms of communications may be used in place of whistle signals, except signals (1), (7), and (8). See following chart.

The required whistle signals are illustrated by “o” for short sounds and “—” for longer sounds:

<u>Sound</u>		<u>Indication</u>
(1)	Succession of short sounds	Use when persons or livestock are on the track at other than road crossings at grade. In addition, use to warn railroad employees when an emergency exists, such as a derailment. When crews on other trains hear this signal, they must stop until it is safe to proceed.
(2)	—	When stopped: air brakes are applied, pressure equalized.
(3)	— —	Release brakes. Proceed.
(4)	o o	Acknowledgment of any signal not otherwise provided for.
(5)	o o o	When stopped: back up. Acknowledgment of hand signal to back up.
(6)	o o o o	Request for signal to be given or repeated if not understood.
(7)	— — o —	When approaching public crossings at grade with the engine in front, sound signal as follows: A. At speeds in excess of 45 MPH, start signal at or about the crossing sign but not more than 1/4 mile before the crossing. B. At speeds of 45 MPH or less, start signal at least 15 seconds, but not more than 20 seconds, before entering the crossing. C. If no crossing sign start signal at least 15 seconds, but not more than 20 seconds before entering crossing but not more than 1/4 mile before the crossing. D. If movement starts less than 1/4 mile from a crossing, signal may be sounded less than 15 seconds before the crossing when it is clearly seen traffic is not approaching the crossing, traffic is not stopped at the crossing or when crossing gates are fully lowered. Prolong or repeat signal until the engine completely occupies the crossing(s).
(8)	— o	Approaching men or equipment on or near the track, regardless of any whistle prohibitions. After this initial warning, sound whistle signal (4) intermittently until the head end of train has passed the men or equipment.

5.8.3 Whistle Failure

If the whistle fails to operate and no other unit can be used as the lead unit, continue movement with the bell ringing continuously. Stop the train before each public crossing, so a crew member on the ground can provide warning until the crossing is occupied, unless:

- Crossing gates are in the fully lowered position.
- or
- No traffic is approaching or stopped at the crossing.

5.8.4 Whistle Quiet Zone

Within designated whistle quiet zones, whistle signal (7) must not be sounded approaching public crossings at grade except when:

- Necessary to provide warning in an emergency.
- Notified automatic warning devices are malfunctioning.
- Notified automatic warning devices are out of service.
- or
- The whistle quiet zone is not in effect during specified hours.

5.8.5 Silenced Whistle

Whistle signal (7) is not required when approaching a public crossing at grade when:

- Permanent maximum authorized track speed is 15 MPH or less,
- Active grade crossing warning devices, if equipped, are operating as intended, and
- Crew member is on the ground at the crossing to provide warning until crossing is occupied.

5.9 Headlight Display

Turn the headlight on bright to the front of every train, except when the light must be dimmed as outlined in Rule 5.9.1 (Dimming Headlight) or turned off as outlined in Rule 5.9.2 (Headlight Off).

5.9.1 Dimming Headlight

Approaching public crossings at grade with engine in front, the headlight must be on bright at the crossing sign. If no sign, or if movement begins between sign and crossing, the headlight must be on bright soon enough before the crossing to provide warning. Except when the engine is approaching and passing over a public crossing at grade, dim the headlight during any of the following conditions:

1. At stations and yards where switching is being done.

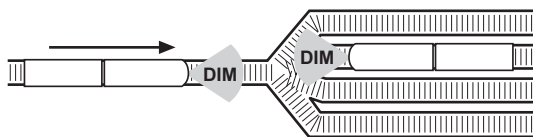

[Diagram A.]

2. When stopped close behind a train.



[Diagram B.]

3. When stopped on the main track waiting for an approaching train. However, when stopped in block system limits, turn the headlight off at the radio request of the crew of an approaching train, until the head end of the train passes.

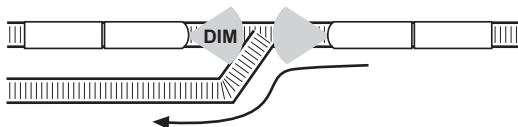

[Diagram C.]

4. When approaching and passing the head end of a train at night.

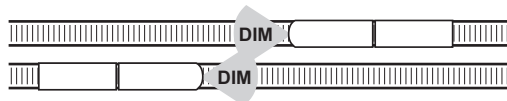

[Diagram D.]

- At other times to permit passing of hand signals or when the safety of employees requires.

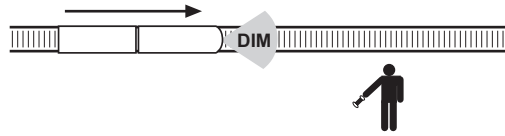

[Diagram E.]

- When left unattended on a main track in non-sigaled territory.

5.9.2 Headlight Off

Turn the headlight off under either of the following conditions:

- The train is stopped clear of the main track.

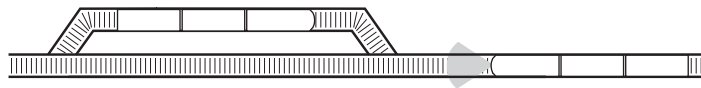

[Diagram A.]

- The train is left unattended on the main track in block system limit.

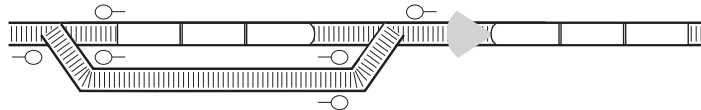

[Diagram B.]

5.9.3 Headlight Failure

If the headlight on the train fails, ditch lights must be on, when so equipped. Headlight failure must be reported to the train dispatcher.

At night, if headlight and ditch lights fail to operate and no other unit can be used as the lead unit, continue movement with a white light displayed on the lead unit. Stop the train before each public crossing, so a crew member on the ground can provide warning until the crossing is occupied, unless:

- Crossing gates are in the fully lowered position.
- or
- No traffic is approaching or stopped at the crossing.

5.9.4 Displaying Headlights Front and Rear

When engines are moving, crew members must turn on the headlight to the front and rear, but may dim or extinguish it on the end coupled to cars.

5.9.5 Displaying Ditch Lights

Display ditch lights, if equipped, to the front of the train when moving over public crossings and anytime the headlight is required to be on bright.

Locomotives must not be operated as the lead unit out of a train's initial terminal unless both ditch lights are operating. However, if no units are equipped with ditch lights, do not exceed 20 MPH over public crossings until occupied.

If one ditch light fails enroute, the train may proceed, but repairs must be made by the next daily inspection. If two ditch lights fail enroute, the train may proceed, but not exceeding 20 MPH over public crossings until occupied, but must not travel beyond the first point where repairs may be made or until the next daily inspection, whichever occurs first.

5.9.6 Displaying Oscillating White Headlight

If the leading engine is equipped with an oscillating white headlight, turn the light on when the engine is moving. However, turn the light off when meeting trains, passing trains, or during switching operations, unless movement involves public crossings at grade.

5.9.7 Displaying Oscillating or Flashing Red Light

If the leading engine is equipped with an oscillating or flashing red light, turn the light on under any of the following conditions:

- Train is stopped suddenly where adjacent tracks may be fouled.
- Head-end protection is required.

or

- Condition exists that endangers movement.

The red light signals an approaching train on the same or adjacent track to stop at once and to proceed only after the track is safe for train passage. Extinguish red flashing lights when they are no longer needed.

Displaying these lights does not modify the requirements of Rule 6.19 (Flag Protection) or Rule 6.23 (Emergency Stop or Severe Slack Action).

5.10 Markers

A marker of the prescribed type must be displayed on the trailing end of the rear car to indicate the rear of the train.

5.10.1 Highly Visible Markers

Display a highly visible marker at the rear of every train as follows:

- From 1 hour before sunset to 1 hour after sunrise.
- When weather conditions restrict visibility to less than 1/2 mile.

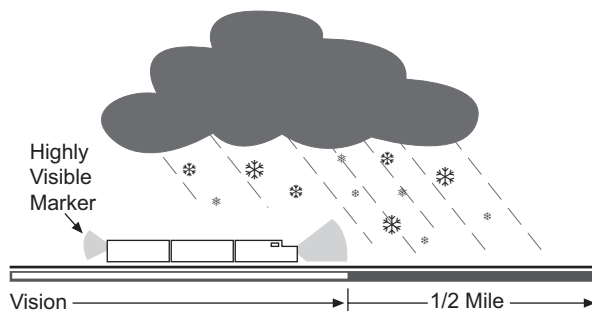

[Diagram A.]

A marker equipped with a functioning photoelectric cell will automatically illuminate at the appropriate time.

When an engine is operating without cars or is at the rear of the train, the trailing headlight illuminated on dim may be used as a marker.

Inspection of Marker

When a highly visible marker is required, a qualified employee must inspect it at the initial terminal and at each crew change point. To determine if the marker is functioning properly, the employee will inspect it by observation or by telemetry display in the cab of the engine. The engineer must be informed of the results of the inspection.

5.10.2 Alternative Markers

Display a reflector, red flag, or light fixture at the rear of the train as the marker when any of the following conditions exists:

- A highly visible marker is not required.
 - A defective car must be placed at the rear for movement to a repair point.
 - The rear portion of the train is disabled and cannot be moved, and a highly visible marker cannot be displayed on the rear of the portion to be moved.
- or
- The highly visible marker becomes inoperative enroute. If this occurs, notify the train dispatcher and move the train to the next forward location where the highly visible marker can be repaired or replaced.

5.11 Engine Identifying Number

Trains will be identified by initials and engine number, adding the direction when required. When an engine consists of more than one unit or when two or more engines are coupled, the number of one unit only will be illuminated as the identifying number. When practical, use the leading unit.

5.12 Protection of Occupied Outfit Cars

This rule outlines the requirements for protecting occupied outfit cars. As used in this rule, the following definitions apply:

Outfit Car. Any on-track vehicle, including outfit, camp, or bunk car or modular home mounted on a flat car to house railroad employees. Such equipment is not considered an outfit car when placed in a wreck train.

Effective Locking Device. When used in relation to a manually operated switch or a derail, a lock that can be locked or unlocked only by the craft or group of workmen applying the lock.

Rolling Equipment. Engines, cars, and one or more engines coupled to one or more cars.

Switch Providing Direct Access. A switch that if used by rolling equipment could permit the rolling equipment to couple to the equipment being protected.

Warning Signal. A white sign that reads "OCCUPIED CAMP CAR" in black lettering. At night, an illuminated white light must also be used.

When occupied outfit cars are placed on a track, the employee in charge of the outfit car occupants (or a designated representative) must provide or request protection using one of the following methods:

A. On a Main Track

One of these two methods or a combination of these methods must be provided:

1. Each manually operated switch that provides direct access to that portion of the main track where occupied outfit cars are located must be lined against movement to that track, secured with an effective locking device, and spiked or clamped. Warning signals must be displayed at or near each switch.

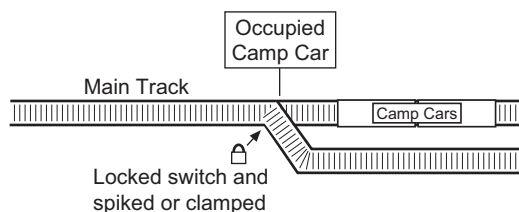

[Diagram A.]

2. If remote control switches provide direct access to the main track where occupied outfit cars are located, the control operator will line the switch against movement to that track and apply blocking devices to the control machine to prevent movement onto that track. The control operator must complete the above tasks before informing the employee requesting protection that protection is provided.

Blocking devices must not be removed until the employee in charge of the outfit car occupants (or a designated representative) informs the control operator that protection is no longer required.

- a. Warning signals must be displayed at or near each remote control switch.
- b. In addition, a derail capable of restricting access to the portion of main track where occupied outfit cars are located must be placed at least 150 feet from the end of the occupied outfit cars. The derail must be locked in derailing position with an effective locking device. Warning signals must be displayed at each derail.
- c. The control operator must maintain for 15 days a written record of each notification. The record must contain the following information:
 - Name and craft of employee requesting protection.
 - Identification of track protected.
 - Date and time employee in charge of outfit car occupants is notified that protection was provided.
 - Date, time, name, and craft of employee authorizing removal of protection.

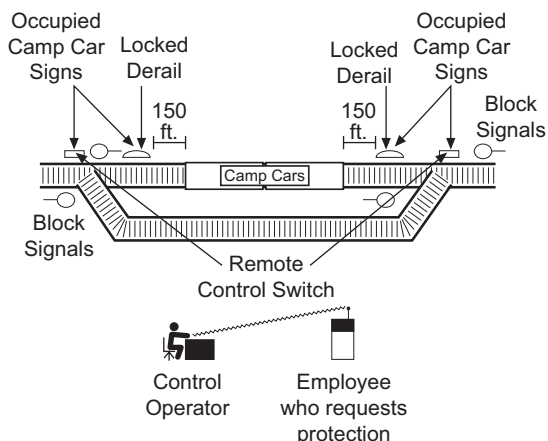

[Diagram B.]

B. On Other Than a Main Track

One of these three methods of protection or a combination of these methods must be provided:

1. Each manually operated switch that provides direct access to the track where occupied outfit cars are located must be lined against movement to that track and secured with an effective locking device. Warning signals must be displayed at or near each switch.

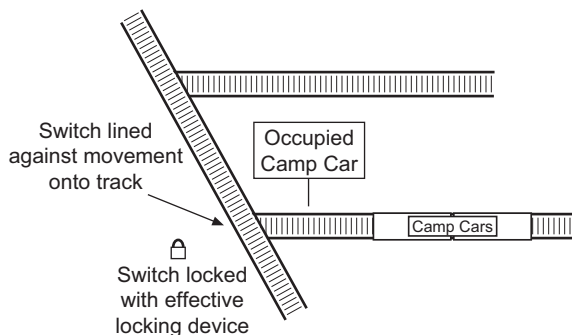

[Diagram C.]

2. If remote control switches provide direct access to the track where occupied outfit cars are located, the control operator will line the switch against movement to that track and apply blocking devices to the control machine to prevent movement onto that track. The control operator must complete the above tasks before informing the employee requesting protection that protection is provided.

Blocking devices must not be removed until the employee in charge of the outfit car occupants (or a designated representative) informs the control operator that protection is no longer required.

- a. Warning signals must be displayed at or near each remote control switch.

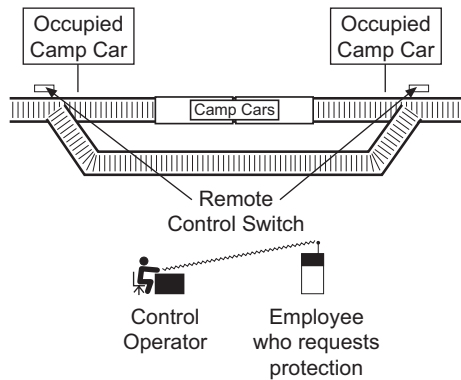

[Diagram D.]

- b. The control operator must maintain for 15 days a written record of each notification. The record must contain the following information:
 - Name and craft of employee requesting protection.
 - Identification of track protected.
 - Date and time employee in charge of outfit car occupants is notified that protection was provided.
 - Date, time, name, and craft of employee authorizing removal of protection.
3. A derail capable of restricting access to that portion of the track where occupied outfit cars are located will fulfill the requirements of protection when the derail is:
 - a. Positioned at least 150 feet from the end of the occupied outfit cars.
 - or
 - b. Positioned at least 50 feet from the end of the occupied outfit cars where the maximum speed on that track is 5 MPH.

Warning signals must be displayed at each derail.

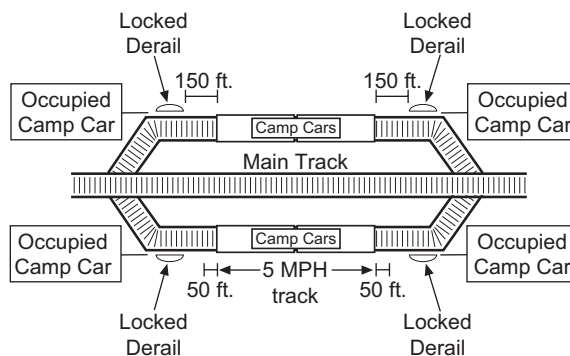

[Diagram E.]

C. Warning Signals

When a warning signal is displayed to protect occupied outfit cars:

1. Occupied outfit cars must not be coupled to or moved.
2. Rolling equipment must not pass the warning signal.
3. Rolling equipment must not be placed on the same track in a manner that would block or reduce the crew's view of the warning signal.

5.13 Blue Signal Protection of Workmen

This rule outlines the requirements for protecting railroad workmen who are inspecting, testing, repairing, and servicing rolling equipment. In particular, because these tasks require the workmen to work on, under, or between rolling equipment, workmen are exposed to potential injury from moving equipment.

As used in this rule, the following definitions apply:

Workmen. Railroad employees assigned to inspect, test, repair, or service railroad rolling equipment or components, including brake systems. Train and yard crews are excluded, except when they perform the above work on rolling equipment not part of the train or yard movement they are handling or will handle.

- “Servicing” does not include supplying cabooses, engines, or passenger cars with items such as ice, drinking water, tools, sanitary supplies, stationery, or flagging equipment.
- “Testing” does not include an employee making visual observations while on or along side a caboose, engine, or passenger car. Also, testing does not include repositioning the activation switch or covering the photoelectric cell of the marker when the rear of the train is on the main track. The employee inspecting the marker must contact the employee controlling the engine to confirm that the train will remain secure against movement until the inspection is complete.

Group of Workmen. Two or more workmen of the same or different crafts who work as a unit under a common authority and communicate with each other while working.

Rolling Equipment. Engines, cars, and one or more engines coupled to one or more cars.

Blue Signal. During the day, a clearly distinguishable blue flag or light, and at night, a blue light. The blue light may be steady or flashing.

The blue signal does not need to be lighted when it is attached to the operating controls of an engine and the inside of the engine cab area is lighted enough to make the blue signal clearly distinguishable.

Effective Locking Device. When used in relation to a manually operated switch or a derail, a lock that can be locked or unlocked only by the craft or group of workmen applying the lock.

Car Shop Repair Area. One or more tracks within an area where rolling equipment testing, servicing, repairing, inspecting, or rebuilding is controlled exclusively by mechanical department personnel.

Engine Servicing Area. One or more tracks within an area where engine testing, servicing, repairing, inspecting, or rebuilding is controlled exclusively by mechanical department personnel.

Switch Providing Direct Access. A switch that if used by rolling equipment could permit the rolling equipment to couple to the equipment being protected.

A. What a Blue Signal Signifies

A blue signal signifies that workmen are on, under, or between rolling equipment and requires that:

1. Rolling equipment must not be coupled to or moved, except as provided in “**Movement in Engine Servicing Area**” and “**Movement in Car Shop Repair Area**” of this rule.
2. Rolling equipment must not pass a blue signal on a track protected by the signal.
3. Other rolling equipment must not be placed on the same track so as to block or reduce the view of the blue signal.
 - a. However, rolling equipment may be placed on the same track when it is placed on designated engine servicing area tracks or car shop repair area tracks, or when a derail divides a track into separate working areas.

4. Rolling equipment must not enter a track when a blue signal is displayed at the entrance to the track.
5. Controls or devices on rolling equipment that could affect equipment movement (for example, MU cables/hoses, hand brakes, angle cocks, etc.) must not be changed or operated unless directed by individuals who placed the blue signals or by the employee in charge of workmen.

Blue signals or remote control blue signals must be displayed for each craft or group of workmen who will work on, under, or between rolling equipment.

Protection Removed. Blue signals may be removed only by the craft or group who placed them. Remote control display may be discontinued when directed by the craft or group that requested the protection. When blue signal protection has been removed from one entrance of a double-ended track or from either end of rolling equipment on a main track, that track is no longer under blue signal protection.

B. How to Provide Protection

When workmen are on, under, or between rolling equipment and exposed to potential injury, protection must be provided as follows:

On a Main Track. A blue signal must be displayed at each end of the rolling equipment.

On Other than a Main Track. One of these three methods of protection or a combination of these methods must be provided:

1. Each manually operated switch, including any facing point crossover switch that provides direct access must be lined against movement onto the track and secured by an effective locking device. A blue signal must be placed at or near each such switch.

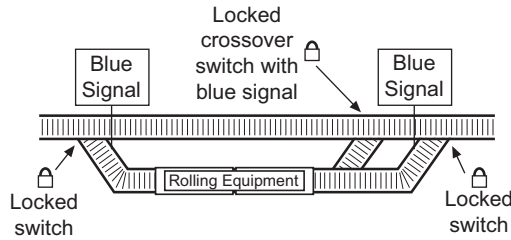

[Diagram A.]

2. A derail capable of restricting access to the track where work will occur must be locked in derailing position with an effective locking device and positioned at least:
 - a. 150 feet from the rolling equipment to be protected.
 - or
 - b. 50 feet from the end of rolling equipment on a designated engine servicing track or car shop repair track where speed is limited to not more than 5 MPH.

A blue signal must be displayed at each derail.

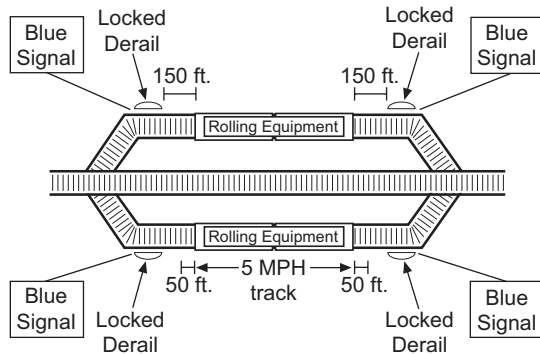

[Diagram B.]

3. Where remote control switches provide direct access, the employee in charge of the workmen must tell the switch operator what work will be done. The switch operator must then:
 - a. Inform the employee in charge of the workmen that the switches have been lined against movement onto the track and devices controlling the switches have been secured.
 - b. Not remove the locking devices unless the employee in charge of the workmen says it is safe to do so.
 - c. Maintain for 15 days a written record of each notification that includes:
 - Name and craft of the employee in charge of the workmen requesting protection.
 - Identification of track involved.
 - Date and time the employee in charge of workmen is notified that protection was provided.
 - Date, time, name, and craft of the employee in charge of workmen who authorized removal of the protection.

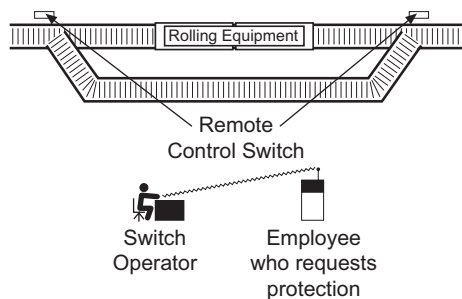

[Diagram C.]

C. Blue Signal Readily Visible to Engineer

In addition to providing protection as required in “**On a Main Track**” and “**On Other than a Main Track,**” when workmen are on, under, or between an engine or rolling equipment coupled to an engine:

1. A blue signal must be attached to the controlling engine and be visible to the engineer or employee controlling the engine.
2. Engines equipped for remote control operations must be in manual.
3. The engine must not be moved.

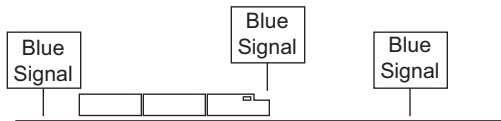

[Diagram D.]

4. Engine controls, brakes, circuit breakers and electrical switches (except cab lights) must not be operated unless directed by individuals who placed the blue signals or by the employee in charge of workmen.

D. Protection for Workmen Inspecting Markers

Blue signal protection must be provided for workmen when they are:

1. Replacing, repositioning, or repairing a marker, and the rear of the train is on any track.
- or
2. Inspecting a marker by repositioning the activation switch or covering the photoelectric cell, and the rear of the train is on other than a main track.

E. Protection for Emergency Repair Work on a Main Track

If a blue signal is not available for employees performing emergency repairs on, under, or between an engine or rolling equipment coupled to an engine on a main track, the employee controlling the engine must be notified and appropriate measures taken to provide protection for the employees.

F. Movement in Engine Servicing Area

An engine must not enter a designated engine servicing area until the blue signal protection is removed from the entrance. The engine must stop short of coupling to another engine.

An engine must not leave a designated engine servicing area unless the blue signal is removed from the engine and the track in the direction of movement.

Blue signal protection removed to let engines enter or leave the engine servicing area must be restored immediately after the engine enters or clears the area.

An engine protected by blue signals may be moved on a designated engine servicing area track when:

1. An authorized employee operates the engine under the direction of the employee in charge of workmen.
2. The blue signal has been removed from the controlling engine to be repositioned.
3. Workmen have been warned of the movement.

G. Movement in Car Shop Repair Area

When rolling equipment on car shop repair tracks is protected by blue signals, a car mover may reposition the equipment if:

1. Workmen have been warned of the movement.
2. An authorized employee operates the car mover under the direction of the employee in charge of workmen.

5.13.1 Utility Employees

This rule outlines the requirements for allowing utility employees to work without blue signal protection. As used in this rule, a Utility Employee is a railroad employee assigned as a temporary member of a train or yard crew.

A. Requirements to Start Work

A utility employee may work as a member of only one train or yard crew at a time.

No more than three utility employees may work with one train or yard crew at the same time.

A utility employee may become a member of a train or yard crew under the following conditions:

- The utility employee communicates with the designated crew member of the train or yard crew before starting work. Communication may be conducted verbally or by radio.
- The designated crew member identifies the utility employee to each member of the crew and each crew member acknowledges the utility employee's presence.
- The designated crew member authorizes the utility employee to work as a temporary member of the crew.

B. Requirements While Working On, Under, or Between

Before a utility employee may work on, under, or between rolling equipment, the following applies:

- All members of the crew must communicate with each other to understand the work to be done.
- The engineer must be in the cab of the assigned controlling locomotive. However, another member of the same crew may replace the engineer when the locomotive is stationary.

C. Requirements When Work Ends

A utility employee is released from a train or yard crew when:

- The utility employee notifies the designated crew member that the work is completed.
- The designated crew member notifies each crew member that the utility employee is being released.
- The designated crew member releases the utility employee from the train or yard crew, after each crew member acknowledges this notice.

5.14 Signs Protecting Equipment

When a sign reading:

STOP—TANK CAR CONNECTED

STOP—MEN WORKING

EMPLOYEES WORKING

SERVICE CONNECTIONS

or a similar warning is displayed on a track or car, the car must not be coupled to or moved. Other equipment must not be placed on the same track in a manner that would block or reduce the view of the sign.

5.15 Improperly Displayed Signals

If a signal is improperly displayed, or a signal, flag, or sign is absent from the place it is usually shown, regard the signal as displaying the most restrictive indication it can give. However, if a semaphore arm is visible, it will govern.

Promptly report improperly displayed signals or absent fixed signals, flags, or signs to the train dispatcher.

6.0 Movement of Trains and Engines

6.1 Repeat Instructions

An employee who verbally receives instructions or information about train or engine movements must repeat them.

6.2 Initiating Movement

Before initiating movement on a main track or controlled siding, a crew member must:

- Receive track bulletins affecting their movement.
- or
- Determine from the train dispatcher or yardmaster if any track bulletins are needed.

6.2.1 Train Location

Trains or maintenance of way employees who receive authority to occupy the main track after the arrival of a train or to follow a train must ascertain the train's location by one of the following methods:

- Visual identification of the train.
- Direct communication with a crew member of the train.
- or
- Receiving information about the train from the train dispatcher or control operator.

6.3 Main Track Authorization

Do not occupy main tracks unless authorized by one of the following:

- Rule 6.13 (Yard Limits).
- Rule 6.14 (Restricted Limits).
- Rule 6.15 (Block Register Territory).
- Rule 9.14 (Movement with the Current of Traffic).
- Rule 9.15 (Track Permits).
- Rule 10.1 (Authority to Enter CTC Limits).
- Rule 14.1 (Authority to Enter TWC Limits).
- Rule 14.6 (Movement Against the Current of Traffic).
- Rule 15.3 (Authorizing Movement Against the Current of Traffic).
- Rule 15.4 (Protection When Tracks Removed from Service).
- Rule 16.1 (Authority to Enter DTC Limits).
- At manual interlockings, verbal authority from the control operator or a controlled signal that indicates proceed.
- Special instructions or general order.

When unable to obtain authority and it is necessary to foul or occupy a main track in ABS, protection must be provided in both directions as outlined under Rule 9.17.1 (Signal Protection in ABS by Lining Switch).

Written authorities that are no longer in effect must be retained until the end of tour of duty, unless otherwise instructed by the train dispatcher.

Joint Authority

When a train or employee receives authority joint with employee(s), the train or employee must not occupy the overlapping limits until:

- Working limits are described and permission is received to enter the overlapping limits from the employee(s) listed on the authority.

or

- Advice is received from the train dispatcher or control operator that the employee(s) have reported clear of the limits.

6.3.1 Train Coordination

Train Coordination provides for men or equipment to use a train's authority to establish working limits. The employee must contact the train's engineer to request use of Train Coordination. To establish working limits:

- The train must be in view and stopped.
- The employee in charge of working limits will communicate with the engineer who will notify other crew members that working limits are to be established.
- The engineer will make movements only as permitted by the employee in charge until the working limits have been released to the engineer.
- The train will not release its authority within the limits until those working limits have been released by the employee in charge.

Establish Working Limits

Working limits may be established within a train's authority limits as follows:

A. DTC or TWC Territory

1. With a train having authority to move in either direction that is not joint.
or
2. With a train having authority to move in one direction only, working limits must not be established:
 - Behind the train.
 - More than one block in advance of the train or beyond any location that a train or engine could enter the track between the employee in charge of the working limits and the train.

B. Rule 9.15 (Track Permit)

With a train having the only track permit authority within the limits.

C. Rule 9.14 (Current of Traffic)

With a train having authority to move with the current of traffic, working limits must not be established:

- Behind the train.
- More than one block in advance of the train or beyond any location that a train or engine could enter the track between the employee in charge of the working limits and the train.

D. CTC Territory

1. With a train having track and time authority that is not joint.

or

2. With a train having authority to move in one direction only, working limits must not be established:
 - Behind the train.
 - More than one block in advance of the train or beyond any location that a train or engine could enter the track between the employee in charge of the working limits and the train.

6.4 Reverse Movements

Make reverse movements on any main track, controlled siding, or on any track where a block system is in effect at restricted speed and only within the limits a train has authority to occupy the track.

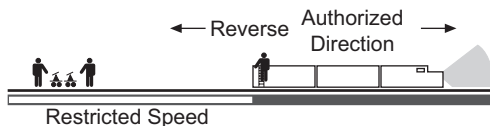

[Diagram A.]

6.4.1 Permission for Reverse Movements

Obtain permission from the train dispatcher or control operator before making a reverse movement, unless the movement is within the same signaled block.

When a train or engine is advised that working limits have been established behind their train, obtain permission from the employee in charge to make any reverse movements, including within the same signaled block.

6.4.2 Movements Within Control Points or Interlockings**A. Control Points or Manual Interlockings**

Except within track and time limits, if movement stops while the trailing end is between the outer opposing absolute signals of a control point or manual interlocking, the movement must not change direction without permission from the control operator.

B. Automatic Interlockings

At an automatic interlocking, the movement may change direction within the limits of the interlocking if it continuously occupies at least one car length of the limits.

6.5 Shoving Movements

Equipment must not be shoved until the engineer and the employee protecting the movement have completed a job briefing concerning how protection will be provided. Employee must be in position, provide visual protection of the equipment being shoved and must not engage in unrelated tasks while providing protection.

Equipment must not be shoved until it is visually determined that:

- Portion of track to be used is clear of equipment or conflicting movements.
- The track will remain clear to the location where movement will be stopped.
- Switches and derails are properly lined.

Employees may be relieved from providing visual protection when:

- Local instructions specify tracks involved and how shoving movement will be protected, such as shove light or monitored cameras.
 - A track has been pulled and an equivalent amount or less of cars or equipment will be immediately shoved back into that track and that track has remained clear to the location where the movement will be stopped.
 - Immediately before shoving, a movement is made on the adjacent track providing the employee the ability to visually determine the track to be shoved is clear and route is properly lined.
 - Authority on main track or controlled siding allows for movement in direction of shove, provided route is properly lined, road crossings will not be fouled and movement at restricted speed is not required.
- or
- Making back up movements in accordance with Rule 6.6 (Back Up Movements).

Shoving movements over road crossings must be made in accordance with Rule 6.32.1 (Providing Warning Over Road Crossings).

Speeds when Shoving

When cars are shoved on a main track or controlled siding in the direction authorized, movement must not exceed:

- 20 MPH for freight trains.
- 30 MPH for passenger trains.
- Maximum timetable speed for snow service unless the employee in charge authorizes a higher speed.

6.5.1 Remote Control Movements

Remote control movements are considered shoving movements, except when the remote control operator controlling the movement is riding the leading engine in the direction of movement. Before initiating movement, the remote control operator or a crew member must be in position to visually observe the direction the equipment moves.

When Remote Control Zone is equipped with pull back / stop protection (PSP), the operator must verify that PSP is operational. Pull back and stop protection must again be verified if PSP is overridden.

Relief of Providing Protection

The remote control operator is relieved from providing protection and the requirement to stop within half the range of vision for movements with engine on leading end when:

1. The remote control zone has been activated.
2. Switches/derails are known to be properly lined.
3. Track(s) within the zone are known to be clear of other trains, engines, railroad cars, and men or equipment fouling track.

Note: These steps must be repeated each time the remote control zone is activated.

6.6 Back Up Movements

After obtaining permission from the train dispatcher, a train may back up on any main track or on any track where CTC is in effect under the following conditions:

1. The train dispatcher must verify the following within the same or overlapping limits:
 - a. Another authority is not in effect unless conflicting movements are protected.
 - b. A track bulletin Form B is not in effect.
 - c. A main track is not removed from service by a track bulletin.
 - d. Permission to leave a switch in the reverse position has not been granted.
2. The crew ensures movement will not:
 - a. Exceed the limit of the train's authority.
 - b. Exceed the train's length.
 - c. Enter or foul a private or public crossing except as provided by Rule 6.32.1 (Providing Warning Over Road Crossings).
 - d. Be made into or within yard limits, restricted limits, interlocking limits, drawbridges, railroad crossings at grade, or track bulletin Form B limits.

When movement is made under these conditions, restricted speed does not apply. Trains backing up under the provisions of this rule may pass signals indicating Stop and Proceed, without stopping.

6.7 Remote Control Zone

A. Entering Remote Control Zone

Before entering a remote control zone, all employees that are not part of the remote control crew must determine whether the zone is activated. Employees may receive this information from the remote control operator, other authorized employee, or special instructions.

When the remote control zone is activated, track(s) within the zone must not be fouled with equipment, occupied, or switches operated until the remote control zone has been deactivated or permission is granted by the remote control operator to enter the remote control zone.

Protection must be provided while other employees are in the remote control zone. The remote control operator must know the track is clear and switches are properly lined after other employees are clear of the remote control zone.

B. Transfer of an Active Remote Control Zone

An active remote control zone may be transferred to other remote control operators. A job briefing must be conducted each time the zone is transferred between remote control operators and, if applicable, other authorized employee.

C. Deactivating Remote Control Zone

When the remote control operator ends the tour of duty, the remote control zone must be deactivated except the remote control zone may remain active if:

- Transferred.
- or
- Special instructions specify the hours the remote control zone is active.

6.8 Stopping Clear for Meeting or Passing

A train that may be met or passed must stop at least 400 feet from the signal or clearance point of the facing point switch the other train will pass over, if length of train permits.

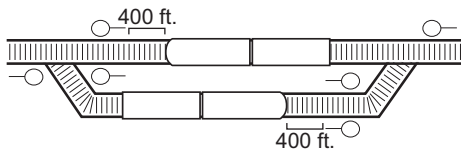

[Diagram A.]

6.9 Meeting or Passing Precautions

A train required to take siding must stop clear of the switch, unless the switch is properly lined to leave the main track.

A train standing on the main track to meet an opposing train must, if possible, line the switch for the opposing train to leave the main track. However, within ABS, do not line the switch until the opposing train has entered the block in advance.

6.10 Instructions to Clear a Following Train

If the train dispatcher instructs a train within block system limits to clear a following train, the train must be in the clear before the following train could receive a restrictive signal indication.

Determine the location of the following train by radio or other means of communication.

6.11 Mandatory Directive

Mandatory directives are written, printed, or displayed authorities or speed restrictions issued by the train dispatcher or control operator. Mandatory directives are:

- Track warrants.
- Track bulletins.
- DTC authority.
- Track and time.
- Track permits.
- Radio speed restrictions.

A mandatory directive restricting a train's movement will not be issued near a point where the restriction applies until the engineer or conductor confirms that the train can comply with the restriction.

Indicate "VOID" on mandatory directive form when:

- Employee reports clear of authority limits,
or
- Mandatory directive is made void

Crew must retain mandatory directives for continuous tour of duty.

6.12 FRA Excepted Track

On a track designated as "FRA Excepted Track," the following will govern:

- Maximum speed must not exceed 10 MPH.
- No occupied passenger train will be operated.
- No movement will be operated that contains more than five cars placarded according to Hazardous Material Regulations.

6.13 Yard Limits

Within yard limits, trains or engines are authorized to use the main track not protecting against other trains or engines. Engines must give way as soon as possible to trains as they approach. Engines must keep posted as to the arrival of passenger trains and must not delay them.

All movements entering or moving within yard limits must be made at restricted speed unless operating under a block signal indication that is more favorable than Approach.

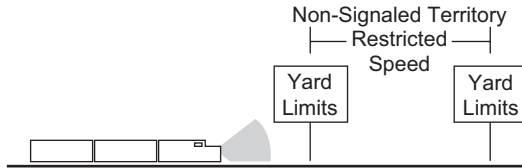

[Diagram A.]

Upon observing or having advance knowledge that a block signal may require restricted speed due to yard limits, if entering or within yard limits, the movement must be at restricted speed at that block signal, or as soon as possible thereafter, consistent with good train handling.

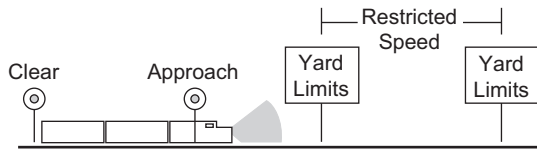

[Diagram B.]

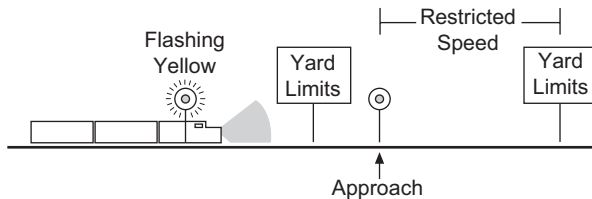

[Diagram C.]

Yard limits remain in effect continuously unless otherwise specified by special instructions or track bulletin.

Against the Current of Traffic

Movements against the current of traffic must not be made unless authorized or protected by track warrant, track bulletin, yardmaster, or other authorized employee.

In CTC Territory

Where yard limits are in effect in CTC territory, the control operator must authorize any movement on the main track. Reverse movements within the same block may be made as outlined in Rule 6.4.1 (Permission for Reverse Movements).

In Track Permit Territory

Where yard limits are in effect in Rule 9.15 (Track Permit) territory, all movements must receive permission from the control operator to enter the main track or to cross over from one main track to another as follows:

- A controlled signal displays a proceed indication.
 - A track permit is issued.
- or
- Verbal permission is granted if no track permit is in effect. Rule 9.17 (Entering Main Track at Hand-Operated or Spring Switch) applies.

6.14 Restricted Limits

Within restricted limits, trains or engines are authorized to use the main track not protecting against other trains or engines. All movements must be made at restricted speed.

Movements against the current of traffic must not be made unless authorized or protected by track warrant, track bulletin, yardmaster, or other authorized employee.

6.15 Block Register Territory (BRT)

Block register territory will be designated in the special instructions. A register labeled “Block Register Territory” will apply only on that designated territory. A train or employee in charge of men or equipment is authorized to occupy block register territory under the following conditions:

- The following information is in the register on first blank line:

Train, gang, or equipment identification	Conductor or employee in charge of men or equipment	Date	Time territory occupied	Time territory cleared
A	B	C	D	E

Column	Required Entry
A	Enter the train, gang, or equipment identification.
B	Enter last name of conductor or employee in charge of men or equipment.
C	Enter current date.
D	Enter time entry is made in register.
E	Enter time the territory was cleared. Then, draw a line through the entire entry. The required exit entry may be completed by any authorized employee.

- If the register indicates the territory is occupied, entry cannot be made on the register until the employee in charge or engineer of each preceding entry has been contacted. When the territory is jointly occupied, movements must be made at restricted speed.

6.16 Approaching Railroad Crossings, Drawbridges, and End of Multiple Main Track

Trains and engines must be prepared to stop when they approach railroad crossings at grade, drawbridges, and the end of multiple main track, unless these areas are protected by block or interlocking signals.

Protected by Stop Signs

If stop signs protect these areas, the train must stop before any part of the train or engine passes the stop sign. The train cannot proceed until the route is clear or drawbridge position permits movement.



[Diagram A.]

Protected by Gate

If a gate is lined against the intended route, trains and engines must stop and remain at least 50 feet from fouling the track on the conflicting route until the gate is changed to the stop position on the conflicting route. Where required, restore gate to its normal position after movement is complete.

Obscured View of Conflicting Route

If a train must stop before entering a railroad crossing at grade and the view on the conflicting route is obscured, a crew member must go ahead of the train and signal from the crossing when it is safe to proceed.

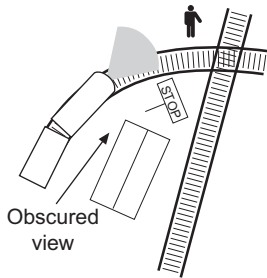

[Diagram B.]

6.17 Switches at Junctions

The normal position for a junction switch is for through movement on the main track where the junction is an intermediate station.

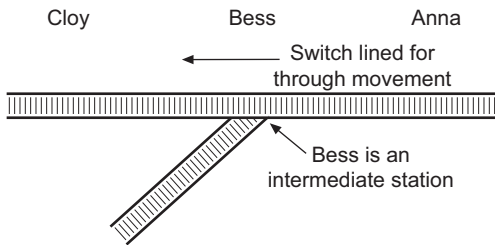

[Diagram A.]

6.18 Stopping Clear of Crossings and Junctions

At a railroad crossing or junction, a train or engine must not stop, if possible, where it could interfere with train movement on the other track.

6.19 Flag Protection

A. Flag Protection Not Required

Flag protection is not required against following trains on the same track if:

1. Train is within ABS limits and the rear of the train is protected by at least two block signals or one block signal and one distant signal.
 2. Rear of the train is within BRT, CTC, DTC, TWC or interlocking limits.
- or
3. General order or special instructions specify that flag protection is not required.

B. Flag Protection is Required

When flag protection is required against following trains:

1. More Than Half the Maximum Timetable Speed

When a train is moving on a main track at or more than half the maximum authorized timetable speed for any train at that location, and the train may be overtaken by a following train, a flagman must decide whether to drop lighted fuses by considering the following:

- Grade of the track.
- Curvature of the track.
- Weather conditions.
- Sight distance.
- Speed of the train relative to a following train.

2. Less than Half the Maximum Timetable Speed

When a train is moving on a main track at less than half the maximum authorized timetable speed for any train at that location, a flagman must provide flag protection against following trains on the same track. The flagman must drop off single lighted fuses at close enough intervals to ensure full protection and not exceed the burning time of the fusee.

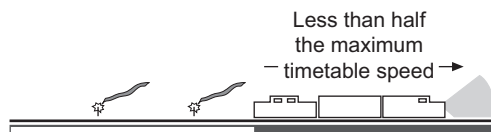

[Diagram A.]

3. Stopped on a Main Track

When a train stops on a main track, a flagman must immediately go back at least 1 mile. Flagman must remain there until stopping a following train or until recalled.

If the flagman is recalled and safety will permit, the flagman must leave a lighted fusee and return to the train. If recalled before reaching the prescribed distance, the flagman must leave a lighted fusee. While returning to the train, the flagman must also place single lighted fusees at intervals shorter than the burning time of the fusee.

When the train departs, a crew member must leave one lighted fusee. In addition, until the train is moving at least half the maximum authorized timetable speed for any train at that location, a crew member must drop off single lighted fusees at intervals shorter than the burning time of the fusee.

6.20 Equipment Left on Main Track

A. Portion of Train Left on Main Track

When necessary to leave a portion of a train temporarily on the main track, follow this procedure:

- Set a sufficient number of hand brakes to keep the detached portion from moving.
- Provide protection against movements that may enter the main track between the detached portion and the returning front portion unless:
 - The train dispatcher verbally relieves the protection.
 - or
 - The return movement is otherwise authorized.
- Make return movement at restricted speed. However, an engine without cars may return at a higher speed when governed by block signal indication.

B. Other Equipment Left on Main Track

Crews that leave equipment on the main track do not need to provide protection for the equipment if the train dispatcher gives verbal relief.

The train dispatcher may request a crew to report clear of their authority and leave equipment on a main track. Crews that leave equipment on a main track do not need to provide protection for the equipment if the train dispatcher provides relief. The train dispatcher must provide protection for the equipment.

All crews that use the main track at that point must be notified of the equipment location and must move at restricted speed when approaching that location.

6.21 Precautions Against Unusual Conditions

Protect trains and engines against any known condition that may interfere with their safety.

When conditions restrict visibility, regulate speed to ensure that crew members can observe and comply with signal indications.

In unusually heavy rain, storm, or high water, trains and engines must approach bridges, culverts, and other potentially hazardous points prepared to stop. If they cannot proceed safely, they must stop until it is safe to resume movement.

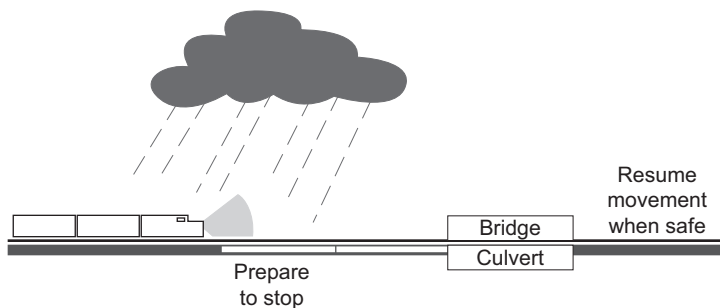

[Diagram A.]

Advise the train dispatcher of such conditions by the first available means of communication.

6.21.1 Protection Against Defects

If any defect or condition that might cause an accident is discovered on tracks, bridges, or culverts, or if any crew member believes that the train or engine has passed over a dangerous defect, the crew member must immediately notify the train dispatcher and provide protection if necessary.

6.21.2 Water Above Rail

Do not operate trains and engines over tracks submerged in water until the track has been inspected and verified as safe.

Operate engines at 5 MPH or less when water is above the top of the rail. If water is more than 3 inches above the top of the rail, a mechanical department supervisor must authorize the movement.

6.21.3 Track Obstruction / Unusual Conditions

When a train is advised in the words, "Between (location) and (location) be governed by Rule 6.21.3", within the specified limits train must move as directed in the special instructions.

6.22 Maintaining Control of Train or Engine

Crew members must consider train or engine speed, grade conditions, and air gauge indications to determine that the train or engine is being handled safely and is under control. If necessary, take immediate action to bring the train or engine under control.

6.23 Emergency Stop or Severe Slack Action

When a train or engine is stopped by an emergency application of the brakes or severe slack action occurs while stopping, take the following actions:

Obstruction of Main Track or Controlled Siding

If an adjacent main track or controlled siding may be obstructed, immediately:

- Warn other trains by radio, stating the exact location and status of the train and repeat as necessary.
- Place lighted fuseses on adjacent tracks.
- Notify the train dispatcher or control operator and, when possible, foreign line railroads if necessary.

Warning to other movements is no longer necessary when:

- It is known adjacent tracks are not obstructed.

or

- The train dispatcher or control operator advises the crew that protection is provided on adjacent tracks.

Inspection of Cars and Units

- All cars, units, equipment, and track must be inspected as outlined in the:
 - Special Instructions.
 - Air Brake and Train Handling Rules.

Train on Adjacent Track

A train on an adjacent track that receives radio notification must pass the location specified at restricted speed and stop short of any portion of the stopped train fouling their track. When advised that the track is clear and it is safe to proceed, this restriction no longer applies.

6.24 Movement on Double Track

On double track, trains must keep to the right unless otherwise instructed.

6.25 Movement Against the Current of Traffic

Movements against the current of traffic must be authorized by track bulletin or track warrant, except as provided by:

- Rule 6.13 (Yard Limits).
 - Rule 6.14 (Restricted Limits).
 - Rule 9.15 (Track Permits).
 - Rule 9.17.1 (Signal Protection in ABS by Lining Switch).
- or
- Rule 16.1 (Authority to Enter DTC Limits).

Movements must approach block and interlocking signals prepared to stop unless signals indicate proceed.

When a facing point movement will be made over a spring switch, comply with Rule 8.9.1 (Testing Spring Switch).

6.26 Use of Multiple Main Tracks

Multiple main tracks will be designated by name or number. When necessary, track use will be indicated in the special instructions.

6.27 Movement at Restricted Speed

When required to move at restricted speed, movement must be made at a speed that allows stopping within half the range of vision short of:

- Train.
 - Engine.
 - Railroad car.
 - Men or equipment fouling the track.
 - Stop signal.
- or
- Derail or switch lined improperly.

When a train or engine is required to move at restricted speed, the crew must keep a lookout for broken rail and not exceed 20 MPH.

Comply with these requirements until the leading wheels reach a point where movement at restricted speed is no longer required.

6.28 Movement on Other than Main Track

Except when moving on a main track or on a track where a block system is in effect, trains or engines must move at a speed that allows them to stop within half the range of vision short of:

- Train.
 - Engine.
 - Railroad car.
 - Men or equipment fouling the track.
 - Stop signal.
- or
- Derail or switch lined improperly.

6.28.1 Sidings of Assigned Direction

Do not use sidings of an assigned direction in the opposite direction unless authorized by the train dispatcher.

6.28.2 Stopping Clear in Siding

When possible, a train entering a siding must not stop until the entire train is clear of the main track.

6.28.3 Cars or Equipment Left on Siding

Avoid leaving cars or equipment on sidings unless authorized by the train dispatcher, except in an emergency. In this case, notify the train dispatcher immediately.

6.29 Inspecting Trains

6.29.1 Inspecting Passing Trains

Employees must inspect passing trains. If they detect any of the following conditions, they must notify crew members on the passing train by any available means:

- Overheated journals.
- Sticking brakes.
- Sliding wheels.
- Wheels not properly positioned on the rail.
- Dragging equipment.
- Insecure contents.
- Signs of smoke or fire.
- Headlight or marker improperly displayed.
- Any other dangerous condition.

When possible, employees inspecting the passing train must advise crew members of the condition of their train.

When possible, a crew member on the engine of the train being inspected must notify a crew member on the rear of the train when the train is being inspected by other employees.

Ground Inspections

When a train is stopped and is met or passed by another train, crew members must inspect the passing train. The trainman's inspection must be made from the ground if there is a safe location. If safe to do so, a trainman must cross the track and inspect the side of the passing train opposite the stopped train.

Trackside Warning Detectors and Inspections

Crew members must be aware of trackside warning detectors and signals from persons inspecting their train. Stop the train immediately for an inspection when any of the following conditions exist:

- A crew member receives a stop signal.
- A trackside warning detector indicates a train defect.
- or
- A crew member is notified of a dangerous condition.

Movement must not proceed until it is safe.

6.29.2 Train Inspections by Crew Members

When a walking inspection of the train is required, and physical characteristics prevent a complete train inspection, inspect as much of the train as possible. The train may then be moved, but may not exceed 5 MPH for the distance necessary to complete the inspection.

While their train is moving, crew members must inspect it frequently and look for indications of defects in the train, especially when rounding curves.

When inspecting their train, crew members must observe the train closely for any of the following:

- Overheated journals.
- Sticking brakes.
- Sliding wheels.
- Wheels not properly positioned on the rail.
- Dragging equipment.
- Insecure contents.
- Signs of smoke or fire.
- Any other dangerous condition.

Crew members who discover defects while the train is moving must stop the train promptly and correct any defects, if possible. If the defective car must be set out, they must not attempt to move the car to the setout point unless it is safe to do so.

When a car is set out because of an overheated journal, any fire must be completely extinguished and precautions taken to prevent further ignition.

6.30 Receiving or Discharging Passengers

A. Passenger Crew Responsibilities

When approaching a station to receive or discharge passengers, determine if the train is routed on the track nearest the station platform. If other trains could pass on a main track or controlled siding between the passenger train and the station platform:

- Communicate with the train dispatcher to determine whether any trains are approaching between the train and the station platform.
- Do not make the station stop until assured that trains will not pass between the train and the station platform.

If unable to communicate with the train dispatcher, the station stop may be made after the crew determines that no trains are approaching on the track between the train and the station platform. Before making the station stop, the conductor must assign crew member responsibilities to ensure passenger safety. If during the station stop a train is seen or heard approaching, crew members must take immediate action to keep passengers from fouling the affected track.

B. Responsibilities of Approaching Movements

When notified that a passenger train will be at a station, do not pass between station platform and a passenger train until assured that all passengers and employees have cleared the track between the passenger train and the station platform. Movement may then pass when preceded by an employee walking ahead of the movement.

C. Other than Main Track Movements

A movement must not pass between a passenger train and the station platform being used unless safeguards are provided.

6.31 Maximum Authorized Speed

All crew members are responsible for knowing and not exceeding the maximum authorized speed for their train. Passenger speed is applicable only to trains consisting entirely of passenger equipment.

When possible, a crew member must promptly notify the train dispatcher of any condition that will delay or prevent the train from making usual speed.

6.31.1 Permanent Speed Restrictions

Permanent speed restrictions must not be exceeded until the rear of the train clears the limits of the restriction, unless otherwise specified.

6.32 Road Crossings

6.32.1 Providing Warning Over Road Crossings

When cars are shoved, kicked or a gravity switch move is made over road crossings at grade, an employee must be on the ground at the crossing to provide warning until crossing is occupied. Make any movement over the crossing only on the employee's signal.

Warning is not required when crossing is equipped with:

- Gates that are in the fully lowered position.
- or
- Flashing lights or passive warning devices when it is clearly seen that no traffic is stopped at the crossing or is approaching the crossing. Leading end of shoving movements must not exceed 15 MPH over crossings.

6.32.2 Automatic Warning Devices

Under any of the following conditions, a movement must not foul a crossing equipped with automatic warning devices until the device has been operating long enough to provide warning and the crossing gates, if equipped, are fully lowered:

- Movement has stopped within 3,000 feet of the crossing.
- Movement is within 3,000 feet of the crossing and speed has increased by more than 5 MPH.
- Movement is closely following another movement.
- Movement is on other than the main track or siding.
- or
- Movement enters a main track or siding within 3,000 feet of the crossing.

Employees must observe all automatic warning devices and report any that are malfunctioning to the train dispatcher or proper authority by the first available means of communication. Notify all affected trains as soon as possible.

A. Automatic Warning Devices Malfunctioning

Use the following table to properly complete movement over the crossing:

Movement When Notified that Automatic Warning Devices have an Activation Failure, are Disabled or Malfunctioning	
If ...	Then ...
The crew is notified that the crossing warning system has an activation failure or that the crossing warning system has been disabled and an equipped flagger is not at the crossing to provide warning.	Stop before occupying crossing. After a crew member is on the ground at the crossing to warn highway traffic, proceed over the crossing as directed by that crew member. Then proceed at normal speed.
The crew is notified that the crossing warning system is malfunctioning, and an equipped flagger is not at the crossing to provide warning.	Stop before occupying crossing. After a crew member is on the ground at the crossing to warn highway traffic, proceed over the crossing as directed by that crew member, or If devices are seen to be working or when instructed by the train dispatcher or proper authority, proceed with caution over the crossing at 15 MPH without stopping until the head end of the train completely occupies the crossing. Then proceed at normal speed.
The crew communicates with a flagger before fouling the crossing and receives confirmation that warning is being provided by at least one equipped flagger who is unable to provide warning in all directions of approaching traffic.	Proceed over the crossing at 15 MPH without stopping until the head end of the train completely occupies the crossing. Then proceed at normal speed.
The crew communicates with a flagger before fouling the crossing and receives confirmation that warning is being provided by one or more equipped flaggers who are able to provide warning in all directions of approaching traffic.	Proceed over the crossing at normal speed without stopping.
NOTE: An equipped flagger is a person other than a crew member who is equipped with an orange vest, orange shirt or orange jacket. At night, the vest, shirt or jacket must be fluorescent. The flagger must have a red flag or stop paddle by day and a light at night.	

When advised by the train dispatcher or proper authority that the automatic warning devices are repaired or returned to service, these restrictions no longer apply.

B. Whistle for Crossing

When notified that automatic warning devices are malfunctioning, sound whistle signal 5.8.2(7) regardless of any prohibition.

6.32.3 Providing Warning for Adjacent Tracks

When practical, position an employee on the ground to warn traffic against movements approaching on adjacent tracks, under either of the following conditions:

- A train or cut of cars is parted closer than 250 feet from a road crossing.
- The head end of a train is stopped closer than 250 feet from a road crossing.

6.32.4 Clear of Crossings and Signal Circuits

Leave cars, engines, or equipment clear of road crossings and crossing signal circuits.

When practical, avoid leaving cars, engines, or equipment standing closer than 250 feet from the road crossing when there is an adjacent track.

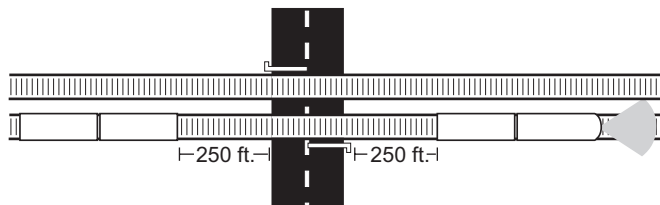

[Diagram A.]

6.32.5 Actuating Automatic Warning Devices Unnecessarily

Avoid actuating automatic warning devices unnecessarily by leaving switches open or permitting equipment to stand within the controlling circuit. If this cannot be avoided and if the signals are equipped for manual operation, a crew member must manually operate the signal for movement of traffic. A crew member must restore signals to automatic operation before a train or engine occupies the crossing or before it leaves the crossing.

6.32.6 Blocking Public Crossings

When practical, a standing train or switching movement must avoid blocking a public crossing longer than 10 minutes.

7.0 Switching

7.1 Switching Safely and Efficiently

While switching, employees must work safely and efficiently and avoid damage to contents of cars, equipment, structures, or other property.

Do not leave equipment standing where it will foul equipment on adjacent tracks or cause injury to employees riding on the side of a car or engine.

On tracks where clearance point is indicated, leave equipment beyond the clearance point.

If the clearance point is not indicated or visible, determine the clearance point by standing outside the rail of adjacent track and extend arm towards the equipment. When unable to touch the equipment, leave equipment at least an additional 50 feet into the track to ensure equipment is beyond the clearance point.

Equipment may be left on a:

- Main track, fouling a siding switch, when the switch is lined for the main track.
 - Siding, fouling a main track switch, when the switch is lined for the siding.
 - Yard switching lead, fouling a yard track switch, when the switch is lined for the yard switching lead.
- or
- Industry track, beyond the clearance point of the switch leading to the industry.

7.2 Communication Between Crews Switching

To avoid injury or damage where engines may be working at both ends of a track or tracks, crews switching must have a clear understanding of movements to be made.

7.3 Additional Switching Precautions

The following equipment must not be unnecessarily switched or couplings made so as to damage the equipment or load:

- Passenger or outfit cars.
- Intermodal or TOFC cars.
- Cabooses.
- Multi-level loads.
- Cars containing livestock.
- Open top loads subject to shifting.

The following equipment must not be cut off in motion or struck by any car moving under its own momentum:

- Passenger cars.
- Outfit cars.
- High-value loads.
- Engines.
- Loaded depressed-center flat cars.
- Cars loaded with modular housing units.
- Articulated and solid drawbar-connected cars with more than two car bodies. However, when empty, these cars may be kicked but not humped.
- Scale test cars.
- Roadway equipment.

7.4 Precautions for Coupling or Moving Cars or Engines

Before coupling to or moving cars or engines, verify that the cars or engines are properly secured and can be coupled and moved safely.

Make couplings at a speed of not more than 4 MPH. Stretch the slack to ensure that all couplings are made.

7.5 Testing Hand Brakes

Employees must know how to operate the type of brakes they are using. When hand brakes must control or prevent car movement, test the brakes to ensure that they are operating properly before using them.

7.6 Securing Cars or Engines

Do not depend on air brakes to hold a train, engine, or cars in place when left unattended. Apply a sufficient number of hand brakes to prevent movement. If hand brakes are not adequate, block the wheels.

When the engine is coupled to a train or cars standing on a grade, do not release the hand brakes until the air brake system is fully charged.

When cars are moved from any track, apply enough hand brakes to prevent any remaining cars from moving.

7.7 Kicking or Dropping Cars

Kicking or dropping cars is permitted only when it will not endanger employees, equipment, or contents of cars.

Dropping cars is permitted only at locations where specifically indicated by special instructions.

Before dropping cars, crew members must fully understand the intended movement. They must verify that the track is sufficiently clear and that switches and hand brakes are in working order. If possible, the engine must run on straight track. Cars must not be dropped over spring switches or dual control switches.

7.7.1 Gravity Switch Moves

Unless otherwise restricted, a gravity switch move may be utilized where cars must be repositioned on the opposite end of the engine. Not more than five cars may be handled at one time.

When making a gravity switch move:

- Hand brakes must be tested to ensure proper operation.
- Sufficient hand brakes must be manned by crew members to ensure that the movement can be controlled and stopped.
- Using the hand brake on cars with shiftable loads must be avoided when practical.
- Cars must not be allowed to couple to other equipment.

7.8 Coupling or Moving Cars on Tracks Where Cars are Being Loaded or Unloaded

Before coupling to or moving cars on tracks where cars are being loaded or unloaded, crew members must be sure that all of the following have been removed or cleared:

- Persons in, on, or about cars.
- Platforms.
- Boards.
- Tank car couplings and connections.
- Conveyors.
- Loading or unloading spouts and similar appliances or connections.
- Vehicles.
- Other obstructions.

In addition:

- Be careful to avoid damage to freight of partly loaded cars.
- Do not handle cars that are improperly or unevenly loaded if load could shift or fall from the car, or if the car could derail or overturn.
- Return any car placed for loading or unloading to the location it was found if it has not been released for movement.
- Do not pull empty cars from an unloading facility until any major accumulation of debris is removed.
- Ensure that plug-type and swinging doors on cars are properly closed or secured. However, crew members must not attempt to close those doors. If plug door is found open enroute, car may continue in the train to the next location where mechanical forces are available to close door.

7.9 Switching Passenger or Occupied Outfit Cars

Before switching passenger equipment or occupied outfit cars:

- Couple the air hoses.
- Fully charge the brake system.
- Use the automatic brake valve when switching.

When coupling passenger or outfit cars:

- Stop the movement approximately 50 feet before the coupling is made.
- Have an employee on the ground direct the coupling.
- Ensure couplers are fully compressed and stretched to ensure that knuckles are locked before making:
 - Air connections.
 - Steam connections.
 - Electrical connections.

7.10 Movement Through Gates or Doorways

Before moving engines, cars, or other equipment through gates, doorways, or similar openings, stop to ensure that the gates, doorways, or openings are completely open and secure. When overhead or side clearances are close, make sure movement is safe. Do not ride on side of a car, engine, or other equipment when moving through gates, doorways, or similar openings.

7.11 Charging Necessary Air Brakes

Do not handle cars without charging the air brake system, unless the cars can be handled safely and stopped within the required distance. If necessary, couple the air hoses and charge the brake systems on a sufficient number of cars to control movement.

7.12 Movements Into Spur Tracks

When shoving cars into a spur track, control movement to prevent damage at the end of the track, and do the following:

- Stop movement 150 feet from the end of the track.
- Apply hand brakes, when necessary, to control slack.
- Have a crew member precede any further movement when it can be done safely.
- Move only on the crew member's signal.

7.13 Protection of Employees in Bowl Tracks

During humping operations, before a train or yard crew member goes between engines or cars on a bowl track to couple air hoses or adjust coupling devices, or before an employee performs maintenance on a bowl track, protection must be provided against cars released from the hump into the track as follows:

- The employee requesting protection must notify the employee controlling the switches that provide access from the hump to the track where the work will occur.
- After being notified, the switch controller must line any remote control switch against movement to the affected bowl track and apply a locking or blocking device to the control for that switch.
- The switch controller must then notify the employee that protection is provided. Protection will be maintained until the switch controller is advised that work is complete and protection is no longer required.

8.0 Switches

8.1 Hand Operation of Switches

Spring or dual control switches operated by hand are considered hand-operated switches, and all rules governing hand-operated switches apply.

8.2 Position of Switches

The employee operating the switch or derail is responsible for the position of the switch or derail in use. Movement must not foul an adjacent track until the hand-operated switch is properly lined.

Do not operate switch that is tagged. If the switch is spiked, do not remove the spike unless authorized by the same craft or group that placed it.

Employees operating switches and derails must make sure:

- The switches and derails are properly lined for the intended route.
- The points fit properly and the target, if so equipped, corresponds with the switch's position.
- When the operating lever is equipped with a latch, they do not step on the latch to release the lever except when operating the switch.
- After locking a switch or derail, they test the lock to ensure it is secured.
- The switch is not operated while equipment is fouling, standing on, or moving over the switch.
- When equipment has entered a track, the switch to that track is not lined away until the equipment has passed the clearance point of the track.

When possible, crew members on the engine must see that the switches and derails near the engine are properly lined.

8.3 Main Track Switches

The normal position of a main track switch is for main track movement, and it must be lined and locked in that position. At points where double track begins, the normal position of a spring switch is for movement with the current of traffic.

However, the main track switch may be left open:

- In CTC territory within track and time limits.
 - When attended by a crew member or switch tender.
 - During switching operations when it is certain that no other train or engine will pass over the switch.
 - For another train or engine when the switch is attended by a member of that crew.
 - Within ABS limits when instructed by the train dispatcher at:
 - The entering switch of a siding in Rule 9.14 (Movement with the Current of Traffic) territory.
 - Either switch of a siding in Rule 16.1 (Authority to Enter DTC Limits) territory.
 - Within TWC territory when authorized by track warrant. Track warrant protection must be provided for this condition. The switch must not be considered restored to normal position until the train dispatcher is notified by an employee or train at that location.
- or
- Within ABS-TWC, ABS-DTC, or Rule 9.14 (Movement with the Current of Traffic) territory at the entering switch of a siding after the following has been done:
 1. Communication has been established between crews of trains meeting or passing.
 2. An understanding has been reached that the train on the main track will stop and restore the switch to the normal position. A crew member must not report clear of the limits until it is known the switch is lined and locked in the normal position.

On main track switches (if equipped), the target will be red if the switch is lined in other than its normal position.

Before leaving the location where a hand-operated main track switch was operated:

- Crew members must confirm the position of the switch with each other.
- Engineering Department employees granted authority to enter working limits must confirm the position of the switch with the employee in charge or a designated employee who will notify the employee in charge.

8.4 Lining Main Track Switch

When an employee lines the switch to let a train enter or leave the main track, the employee must then go to the opposite side of the main track and not return to the switch stand until movement is complete. If unable to go to the opposite side of the track, the employee must stand at least 20 feet from the switch stand.

8.5 Not Used

8.6 Restoring Switch to Normal Position

An employee getting off moving equipment to return the main track switch to normal position must, when possible, get off the equipment on the opposite side from the switch stand.

8.7 Clear of Main Track Switches

Except in switching movements, when a train or engine is approaching or passing on a main track, employees must not go nearer than 20 feet to any main track switch.

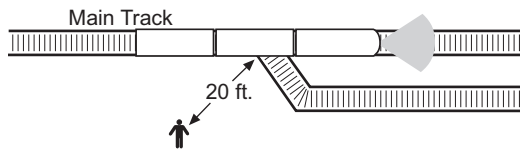

[Diagram A.]

When a train or engine that will be met or passed is on a siding or other track, the employee attending the switch must be in a safe location. The employee must not be nearer than 150 feet, if possible, from the switch when the train is closely approaching and passing.

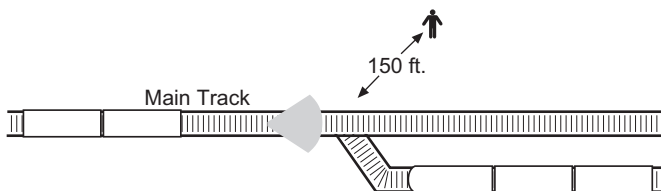

[Diagram B.]

Inspecting Hand-Operated Switches in Non-Signaled Territory

In non-signaled territory, if the expected train is not closely approaching, a crew member will inspect facing point, hand-operated switches the train will pass over to determine that the:

- Switches are lined for the intended route.
- Switch points fit properly.
- Switch lever is secured.

8.8 Switches Equipped with Locks, Hooks or Latches

When not in use, switches must be locked, hooked, or latched if so equipped. Before making movements in either direction over these switches, make sure the switch is latched or secured by placing the lock or hook in the hasp. However, when making train movements in facing point direction, lock the switches equipped with a lock.

Replace any missing or defective switch locks. If they cannot be replaced, report the condition at once to the train dispatcher, yardmaster, or supervisor in charge, and spike the switch if possible.

8.9 Movement Over Spring Switches

Spring switches are identified by the letters S or SS, special targets, signs, and/or lights.

8.9.1 Testing Spring Switch

A crew member tests the switch by lining the switch over and back by hand and examining the switch points to see that they fit properly.

Before a train or engine makes a facing point movement over a spring switch, the switch must be tested when any of the following conditions exist:

1. A block signal governing movement over the switch indicates:
 - Stop.
 - Stop and Proceed.
 or
 - Restricted Proceed.

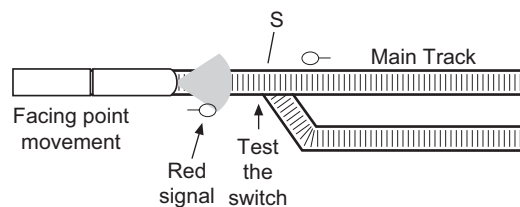

[Diagram A.]

2. A switch point indicator protecting the switch indicates Stop and Inspect Switch.
- or
3. The switch is not protected by a block signal or switch point indicator.

The switch does not need to be tested if it has been lined for the diverging route or written instructions advise the crew that the spring switch has been spiked.

8.9.2 Trailing Through and Stopping on a Spring Switch

A train or engine trailing through and stopping on a spring switch must control the slack. A crew member must line the switch by hand before the train or engine can change direction or take slack.

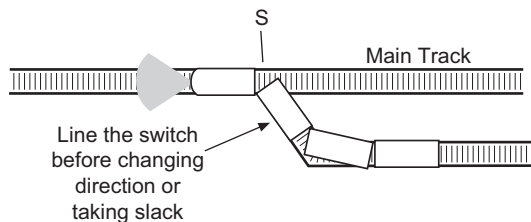

[Diagram A.]

8.9.3 Hand Operating a Spring Switch Before Making a Trailing Movement

A. With Facing Point Lock

When a train is stopped by a signal governing trailing movement through a spring switch and the switch is equipped with a facing point lock, operate the switch by hand. Do not return the switch to normal position until after movement is complete.

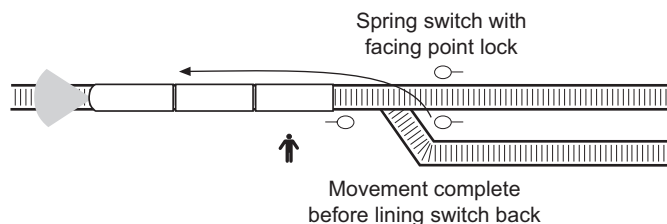

[Diagram A.]

B. Without Facing Point Lock

Before a train makes a trailing movement through a spring switch not equipped with a facing point lock, and only hand operation can establish block signal protection, line the switch for the intended route. Return the switch to normal position after leading wheels have passed both insulated joints.

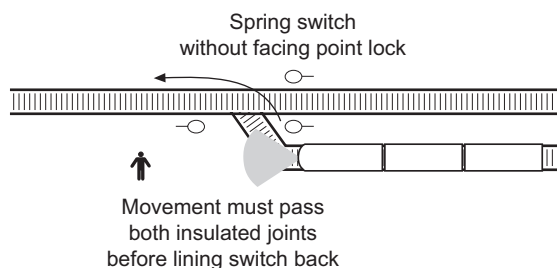

[Diagram B.]

8.9.4 During Snow or Ice Storms

During snow storms, ice storms, or other conditions that may prevent a spring switch from functioning properly, avoid making a trailing movement through the spring switch until the switch has been lined by hand for the movement.

8.9.5 Spiking Spring Switch

A spring switch that is spiked must be protected.

8.9.6 Approaching a Spring Switch in Non-Signaled Territory

A train in non-signaled territory must approach the facing points of a spring switch prepared to stop until:

- A switch point indicator shows that the switch is properly lined.
- or
- A distant signal displays clear.

8.10 Switch Point Indicator

Aspect	Indication
Green	Switch points fit properly in normal position.
Yellow	Switch points fit properly in reverse position.
Red or Dark	Stop and inspect switch.

8.11 Switches in Sidings

The normal position of switches connecting any track, except the main track, to a siding is lined and locked or secured for movement on the siding.

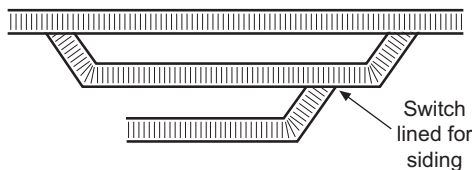

[Diagram A.]

8.12 Hand-Operated Crossover Switches

The normal position of crossover switches is for other than crossover movement. The crossover switches must be left lined in normal position, except when they are in use for crossover movements. Both switches of a crossover shall be properly lined before equipment begins a crossover movement. A crossover movement shall be completed before either switch is restored to normal position, except when one crew is using both tracks connected by the crossover during continuous switching operations.

In Rule 6.14 (Restricted Limits), Rule 6.28 (Movement on Other than Main Track) or non-signaled Rule 6.13 (Yard Limits) territory, crossover switches may be left out of correspondence while providing blue signal or inaccessible track protection. When protection is no longer required the crossover switches connected to a main track or siding must be left lined for other than crossover movement. Crossover switches not connected to a main track or siding must be left in a corresponding position.

In signaled territory, crossover switches may be out of correspondence while performing maintenance, testing or inspection.

8.13 Scale Track Switches

When scales are not in use, line switches for dead rails where provided.

8.14 Conflicting Movements Approaching Switch

When conflicting movement is closely approaching a switch, the track must not be fouled or the switch operated. Except at a spring switch, trains must not foul a main track or signaled track or pass beyond an insulated joint at the clearance point until the switch connected with the movement is properly lined.

Crossover switches must not be unlocked or lined for crossover movement when another movement is approaching or passing over either switch.

8.15 Switches Run Through

Do not run through switches, other than spring switches or variable switches. If a rigid type switch is run through, it is unsafe and must be protected by spiking the switch, unless a trackman or other employee takes charge.

An engine or car that partially runs through a switch must continue movement over the switch. The engine or car must not change direction over a damaged switch until it has been spiked or repaired.

8.16 Damaged or Defective Switches

Report a switch that is damaged or defective to the train dispatcher, yardmaster, or supervisor in charge. Tag the switch, spike it if necessary, unless trackman or other employee takes charge. If the switch cannot be made safe, provide protection at once.

8.17 Avoid Sanding Over Moveable Parts

When possible, avoid using sand over moveable parts of an interlocking, retarders, spring switches, variable switches, or power-operated switches.

8.18 Variable Switches

Trailing point movements may be made over a variable switch from either track, regardless of the position of the switch points.

When making a trailing point movement and the switch is not lined for such movement, make sure all wheels of the leading car or unit clear the switch points before changing direction.

During snow storms, ice storms, or other conditions that may prevent a variable switch from functioning properly, avoid making a trailing point movement through a variable switch until it has been lined by hand for movement.

8.19 Automatic Switches

The location of automatic switches will be designated in the timetable. When movement authority requires a train to stop at an Automatic Switch location, stop must be made before any part of a train passes the signal governing movement over the Automatic Switch. To operate an automatic switch to enter the siding, a crew member must do the following:

- Stop the leading end of movement within 200 feet of the absolute signal that governs movement over the switch.
- Operate the push button on the signal mast.

After 40 seconds, the signal will display a restricting indication when the switch is lined for movement into the siding.

When the signal that governs movement over an automatic switch displays a Stop indication, the switch must be operated by hand before proceeding.

Operating an Automatic Switch by Hand

To operate an automatic switch by hand, the crew member must stop the train for the signal that governs movement over the switch and then do the following:

- Unlock the switch lock.
- Place the selector lever in the HAND position.
- Operate the hand throw lever until the switch points move when the lever is moved.
- Line the switch for the intended route.
- Do not return the selector lever to the POWER position until at least one unit or car has passed over the switch.

After switch is placed in hand position, signal governing movement over the switch will display Stop indication and movements will be governed by hand signals.

When the switch is returned to the POWER position and movement over the switch is complete, the switch will automatically return to its normal position.

Entering Main Track. A train that is about to enter the main track and is authorized to proceed must move past the overlap sign. Further movement must not be made until the signal governing movement over the switch displays a proceed indication. If the signal does not display a proceed indication within 5 minutes, a crew member must operate the switch by hand as specified in Rule 9.17 (Entering Main Track at Hand-Operated or Spring Switch), waiting an additional 5 minutes, if necessary.

When automatic switches are operated by hand, all rules governing hand-operated switches apply, except cars must not be dropped over the switches.

8.19.1 Radio Controlled Switches

The location of radio controlled switches and operating instructions will be designated in the timetable and special instructions.

8.20 Derail Location and Position

Employees in train, engine, and yard service must know the location of all fixed derails. A train or engine moving on or entering tracks where fixed derails are located, must stop at least 100 feet from derail in derailing position. Movement must not continue until the derail is placed in the non-derailing position. However, the distance restriction will not apply in engine servicing areas.

Do not make a movement over a derail in derailing position.

Sidings having hand-thrown derails will have derail locked in non-derailing position, except when engines or cars are left unattended on siding. On auxiliary tracks other than siding, except when derails are placed in non-derailing position to permit movement, make sure they are always in derailing position regardless of whether cars are on the track they are protecting. Lock all derails equipped with a lock.

Derails that are used in conjunction with Rule 5.12 (Protection of Occupied Outfit Cars), Rule 5.13 (Blue Signal Protection of Workmen), or roadway worker protection must be in the derailing position only when their use is required for such protection. When their use is not required for protection:

- Remove portable derails.
- or
- Lock fixed derails in non-derailing position with an effective locking device.

9.0 Block System Rules

9.1 Signal Aspects and Indications

Distant, block, and interlocking signal aspects and indications are shown in the special instructions.

Signal aspects are identified by the position of semaphore arms, color of lights, flashing of lights, position of lights, or any combination. Aspects may be qualified by marker plate, number plate, letter plate, or marker light.

Signals may display color light aspects or semaphore arms and color lights.

9.2 Location of Signals

When viewed from the train, block and interlocking signals are generally to the right of the track. However, they may be located to the left or above the track. To display indications for two tracks, two bracketed signals may be located on a supporting mast. The signal to the right governs the track to the right, and the signal to the left governs the track to the left.

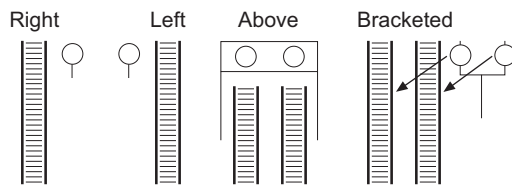

[Diagram A.]

9.3 What Signals Govern

Block signals, cab signals, or both govern the use of blocks.

Interlocking signals govern the use of interlocking routes. Where a track is signaled beyond the interlocking limits in the direction of movement, the interlocking signal is also a block signal.

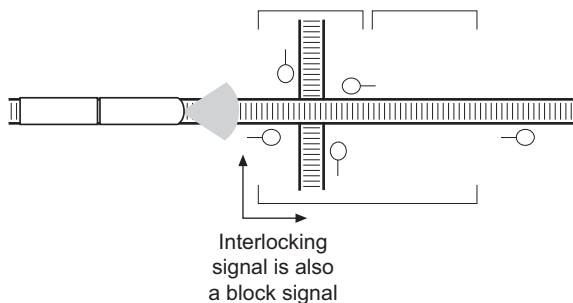

[Diagram A.]

All other rules, where required, remain in effect when complying with the indication of block and interlocking signals.

9.4 Improperly Displayed Signals or Absent Lights

Except as shown in block, cab, and interlocking signal aspects in the special instructions, if a light is absent, a white light is displayed where a colored or lunar light should be, or additional colored or lunar lights are displayed, regard a block or interlocking signal as displaying the most restrictive indication it can give. However, when the semaphore arm position is plainly seen, that aspect will govern.

9.5 Where Stop Must Be Made

When movement is being made beyond a block signal requiring a train to be prepared to stop at the next signal, the stop must be made before any part of a train passes the block signal requiring the train to stop.

If a train overruns any block signal that requires it to stop, the crew must:

- Warn other trains at once by radio.
- Stop the train immediately.
- Report it to the train dispatcher.

9.5.1 Changing Established Route

Except to avoid an accident, after a controlled signal has been cleared for a closely approaching train, the control operator must not change the signal before the approaching train's engineer has assured the control operator that he can comply with the signal change. Do not establish or authorize a conflicting route until communicating with the approaching train's crew and ensuring that the train has stopped clear of the conflicting route.

The control operator must not establish a conflicting route into an occupied block or interlocking limits, or authorize a conflicting movement, unless it is safe to do so.

The control operator must avoid operating the device controlling a switch, derail, movable point frog, or lock when any portion of a train is on or closely approaching the equipment.

9.5.2 Protection if Signal Appliance or Track is Damaged

If a signal or signal appliance functions improperly or the track is damaged, signals that govern movements on affected routes must display a Stop indication. No movements on such routes may be permitted until track and signal appliances are examined and movement can occur safely.

9.5.3 Protection During Repairs

Within CTC limits or within manual interlocking limits (unless track bulletin Form B is in effect), when a switch, movable point frog, derail, or signal is under repair or is disconnected, or when the track is obstructed or removed from service, display Stop indications for all affected routes. In addition, block or mark any controls to prevent their operation.

Maintenance forces must contact the control operator before beginning repairs, disconnecting equipment, obstructing the track, or removing the track from service. Switches, movable point frogs, and derails must be spiked or secured in the required position if any movement over them occurs before repairs are complete.

9.5.4 Authority to Proceed

Except when a signal is used to provide protection within CTC limits or at manual interlockings, control operators must not give hand signals or verbally authorize movement beyond a Stop indication when a proceed indication can be displayed for the movement.

At manual interlockings, control operators must give hand signals so that crew members can understand the signals and know which train they are intended for.

9.5.5 Reporting Delays

When a controlled signal displays a proceed indication, notify the control operator immediately if movement cannot occur promptly.

9.5.6 Track Occupancy Indicator

Where track occupancy indicators are located, employees must observe the indication before fouling a circuit or changing the derail or a main track switch.

When an occupied indication is displayed, trains or equipment must not foul the main track unless movement is properly protected.

Track occupancy indications do not authorize movement or relieve employees from protecting movements as required by the rules.

9.6 Change of Signal Indication

If a signal displaying a proceed indication changes to an indication requiring a train to stop, the train must stop at once. Report such a signal change to the train dispatcher.

9.7 Failure to Display Most Restrictive Indication

When a block is occupied, or when a switch protected by a signal is changed from its normal position and that signal fails to display its most restrictive indication, regard the signal as displaying Stop. The train must stop immediately, and employees must warn others by radio of the exact location and status of the train. Contact the train dispatcher or control operator and do not move the train without permission.

9.8 Next Governing Signal

A train may comply with the next signal's indication when its aspect can be clearly seen and the signal governs the track where movement is occurring or will be made. This does not apply when a rule or previous signal indication requires movement at restricted speed.

9.9 Train Delayed Within a Block

If a train has entered a block on a proceed indication that does not require restricted speed, and the train stops or its speed is reduced below 10 MPH, the train must:

A. ABS

Proceed at restricted speed. The train must maintain this speed until the next signal is visible, that signal displays a proceed indication, and the track to that signal is clear.

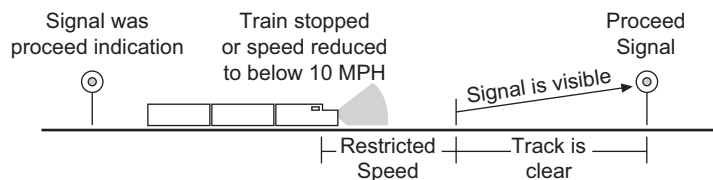

[Diagram A.]

B. CTC or Manual Interlocking Limits

Proceed prepared to stop at the next signal until the next signal is visible and that signal displays a proceed indication.

C. ACS

Operate according to cab signal indication.

9.9.1 Approach to Automatic Interlocking

A train must proceed prepared to stop at the interlocking signal when:

- Moving below 25 MPH and passing a signal that governs the approach to an automatic interlocking.
- or
- Speed is reduced below 25 MPH after passing a signal that governs the approach to an automatic interlocking.

The train must continue to move prepared to stop at the interlocking signal until the train reaches a point approximately 1,000 feet from that signal. If the interlocking signal then indicates proceed, the train may resume speed.

9.10 Initiating Movement Between Signals

When one of the following occurs, move at restricted speed until the leading wheels have passed the next governing signal or the end of the block system:

- The train enters a block with no governing signal.

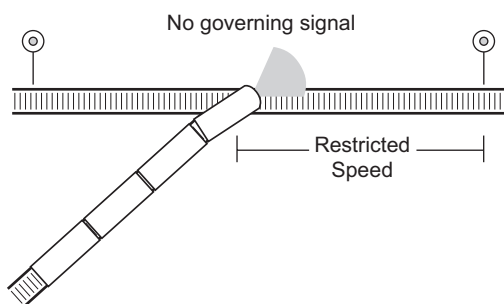

[Diagram A.]

- The previous signal indication is unknown.
- Movement is in opposite direction from which the block was entered.

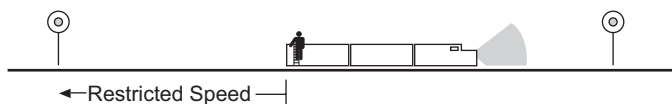

[Diagram B.]

Exception

If a train is within ACS or ATC territory with operative cab signals, the train may operate according to the cab signal indication.

9.11 Movement from Signal Requiring Restricted Speed

When a train passes a signal requiring movement at restricted speed, the train must move at restricted speed until its leading wheels have passed the next governing signal or the end of the block system.

9.12 Stop Indications

9.12.1 CTC Territory

At a signal displaying a Stop indication, if no conflicting movement is evident, the train will be governed as follows:

- A crew member must immediately contact the control operator, unless the train is:
 - Within track and time limits
 - or
 - Entering track and time limits from any point other than either end of track and time limits.
- Before authorizing the train to proceed, the control operator must know that the route is properly lined and no conflicting movement is occupying or authorized to enter the track between that signal and the next absolute signal governing movement or the end of CTC where applicable.
- When the train receives these instructions, “After stopping, (train) at (location) has authority to pass signal displaying Stop indication,” specifying the route where applicable. The train must move at restricted speed.
- If the signal governs movement over a drawbridge, a crew member must verify that the bridge is in the proper position for the train to pass.

Exception

Conflicting Movement. When the control operator has stopped a conflicting movement, he may then authorize another train to proceed in the same limits, advising both crews of movement to be made. If the stopped movement is later permitted to proceed, that train must move at restricted speed until its leading wheels have passed the next governing signal or the end of the block system.

9.12.2 Manual Interlockings

At a signal displaying a Stop indication, if no conflicting movement is evident, the train will be governed as follows:

- A crew member must immediately contact the control operator.
- Before authorizing the train to proceed, the control operator must know that the route is properly lined and no conflicting movement is occupying or authorized to enter the track between that signal and the next absolute signal governing movement or the end of interlocking limits where applicable.
- The control operator may authorize the train to proceed using hand signals or the following instructions, “After stopping, (train) at (location) has authority to pass signal displaying Stop indication,” specifying the route where applicable. The train must move at restricted speed.
- If the signal governs movement over a drawbridge, a crew member must verify that the bridge is in the proper position for the train to pass.

Before proceeding into or continuing in CTC territory, the manual interlocking control operator must be sure that the CTC control operator has given authority to proceed.

Exception

Conflicting Movement. When the control operator has stopped a conflicting movement, he may then authorize another train to proceed, advising both crews of movements to be made. If the stopped movement is later permitted to proceed, that train must move at restricted speed until its leading wheels have passed the next governing signal or the end of the block system.

9.12.3 Automatic Interlockings

At a signal displaying a Stop indication, the crew will be governed by instructions in the release box, special instructions, or other instructions. After complying with the instructions that allow the train to proceed, if signal continues to display a Stop indication, the train must move at restricted speed. However, if there is a conflicting movement, the train must not proceed until the movement has passed or stopped, and both crews agree on the next movement.

9.12.4 ABS Territory

At a signal displaying a Stop indication outside interlocking limits, the train will be governed as follows:

A. Main Track

On a main track, except where Rule 9.14 (Movement with the Current of Traffic) is in effect, after stopping, a train authorized beyond the signal may proceed at restricted speed under any of the following conditions:

1. Authority beyond the signal is joint with other trains or employees.
2. To permit an engine, with or without cars, to couple to its train or to a standing cut of cars, if the track between the engine and cars is clear.
3. A crew member has contacted the train dispatcher and obtained permission to pass the Stop indication. However, if the train dispatcher cannot be contacted, move 100 feet past the signal, wait 5 minutes, then proceed at restricted speed.

B. Movement with the Current of Traffic

On a main track where Rule 9.14 (Movement with the Current of Traffic) is in effect, after stopping, a crew member must contact the train dispatcher or control operator and obtain permission to pass the Stop indication, then proceed at restricted speed. However, if the signal governs movement to a single main track, comply with Rule 9.17 (Entering Main Track at Hand-Operated or Spring Switch), then proceed at restricted speed.

C. Siding or Other Track

If the signal governs movements from a siding or other track to the main track, comply with Rule 9.17 (Entering Main Track at Hand-Operated or Spring Switch), then proceed at restricted speed.

9.13 When Instructed to Operate Dual Control Switches by Hand

If the control operator cannot line the dual control switch to the desired position, or the control machine does not indicate that the switch is lined and locked, the control operator must authorize movement past the Stop indication and instruct the employee to operate the switch by hand. Movement may then proceed to that switch.

Before passing over the switch, the train must stop and the employee must operate the switch by hand as outlined in Rule 9.13.1 (Hand Operation of Dual Control Switches). After at least one unit or car has passed over the switch points, the employee must return the switch to power unless otherwise instructed by the control operator.

9.13.1 Hand Operation of Dual Control Switches

An employee must get permission from the control operator to operate a dual control switch by hand. Operate the switch as follows:

- Unlock the switch lock.
- Place the selector lever in the HAND position or remove the hand crank from the holder.
- Operate the hand throw lever until the switch points are seen to move when the lever is operated, even if the switch is lined for the intended route.
- Line the switch for the intended route, or insert the crank on the shaft and turn the crank as far as it will turn until the switch is in the desired position. Remove the crank from the shaft, but do not return it to the crank holder.
- Return the switch to power by restoring the selector lever to the POWER or MOTOR position and lock. Or, return the crank to the holder and secure it with the switch lock. Notify the control operator after power to the switch is restored.

When the selector lever is in the HAND position or the crank has been removed from the holder, signals governing movements over the switch will display Stop indication, and movements will be governed by the employee operating the switch. Notify the engineer, if possible, when the switch is in hand operation and when it has been restored to power operation.

For other types of switch machines, follow the above procedure using the instructions for operation posted at the switch or by special instructions.

9.14 Movement with the Current of Traffic

On tracks designated in the timetable, trains will run with the current of traffic, if the train dispatcher or control operator gives authorization or a controlled signal indicates proceed.

9.14.1 Reporting Clear of a Track Having a Current of Traffic

A train without a crew member on the rear and operating on a track having a current of traffic may report clear of the limits or report having passed a specific location only when it is known the train is complete. This must be determined by one of the following ways:

- The rear of the train has a rear-end telemetry device, and air pressure on the head-end device indicates brake pipe continuity.
- An employee verifies the marker is on the rear of the train.
- A crew member can observe the rear car of the train on which the marker is placed.
- The train is stopped and an inspection verifies that the marker is on the rear car of the train.
- A trackside warning detector transmits an axle count for the train, and axle count duplicates the axle count transmitted by the previous trackside warning detector.

In addition, a train clearing in a siding or other track must comply with requirements outlined in Rule 8.3 (Main Track Switches) before reporting clear of the limits.

9.15 Track Permits

On tracks designated in the timetable, a track permit will authorize a train, track car, machine, or employee to occupy the main track or tracks between specific points. The track permit must be issued by a designated control operator under the direction of the train dispatcher. Within these limits, movements may be made in either direction according to signal indication.

Limits designated by a switch extend only to the signal governing movement over the switch, unless otherwise designated.

A train must obtain authority to pass a controlled signal displaying Stop indication to enter track permit limits. Within track permit limits a train, after stopping, may pass a signal displaying Stop indication at restricted speed without further authority, except when signal governs movement at an interlocking.

9.15.1 Issuing Track Permits

The track permit may only be issued when:

- Limits are clear.
 - Limits are occupied by the train, track car, machine, or employee who will receive the track permit.
 - Limits are occupied by a train, track car, machine, or employee holding a track permit.
- or
- All trains moving on signal indication without a track permit have passed the location where the track will be fouled.

The track permit limits must be protected by controlled signals. The designated control operator must know the following before issuing a track permit:

- Each controlled signal protecting the limits displays a Stop indication.
- Marking or blocking devices prevent displaying signals for movement into the limits.
- The designated control operator and each control operator who controls signals to protect the limits understand the limits, have provided protection, and have recorded the track permit on the prescribed form.

Track Permit Acknowledgment

Track permit authority must be recorded and repeated to the control operator. Acknowledgment must be received before being acted upon.

The control operator must maintain a record of the authority granted.

More than One Track Permit

If more than one track permit is in effect at any time within the same limits, all affected trains or employees must be notified.

Trains must move at restricted speed within these limits.

9.15.2 Clearing Track Permits

Marking or blocking devices must not be changed or removed until the limits have been released to the control operator.

Track permit limits must be cleared and reported clear to the control operator before time expires. If the track permit is released before time expires, all equipment must be clear of the limits and reported clear to the designated control operator. However, if no other track permit has been granted within the same limits, the train may request release of the track permit. Signal indications will then govern the train if the control operator verbally authorizes the release, specifying direction of movement if required.

When necessary to modify the expiration time, an employee and the control operator must communicate before the time expires to adjust the time granted. If the employee cannot contact the control operator and the time limit expires, authority is extended until the control operator is contacted.

Employees reporting clear of track permit authority must state:

- Their name or other identification.
- Track permit number being released.
- Limits being released.

Releasing Portion of Limits

When a crew member informs the control operator that the authority is released between two specific points, the authority is considered void between those points. This track release must begin at the outer limit of the authority.

9.16 Stop and Proceed Indication

At a signal displaying a Stop and Proceed indication, the train will be governed as follows:

1. The train must stop, then proceed at restricted speed.
or
2. The train may pass the signal at restricted speed without stopping to do any of the following:
 - a. Leave the main track when the switch is lined for movement and the track is clear from the signal to the clearance point.

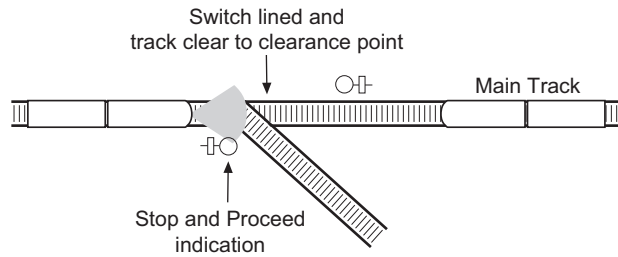

[Diagram A.]

- b. Continue on the main track when meeting or passing a train, and the main track is clear to the opposite end of the siding where a train is fouling the main track.

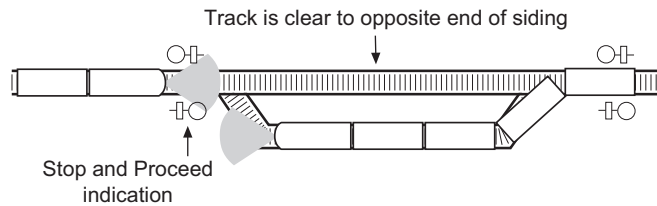

[Diagram B.]

- c. Permit an engine, with or without cars, to couple to its train or to a standing cut of cars, if the track between the engine and cars is clear.

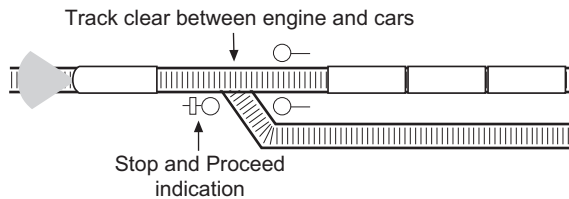

[Diagram C.]

- d. Enter a switch that is less than 1,000 feet beyond the signal, and the employee in charge of the switch has granted permission for movement.

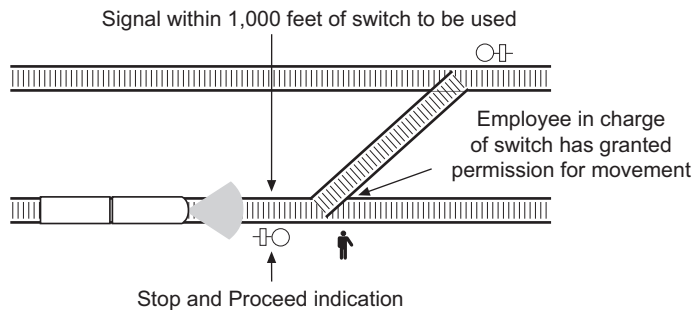

[Diagram D.]

- e. Continue on the main track when proceeding at restricted speed due to rule or previous signal indication.
- f. Move within track and time, work and time, work between, track permit, or track out of service limits.

9.17 Entering Signaled Track at Hand-Operated or Spring Switch

Within CTC territory and manual interlocking limits, the control operator must authorize the train to enter the track at a hand-operated or spring switch where no governing signal exists. The control operator must verify that there are no conflicting movements before giving the authority.

In ABS territory, when authorized to enter the signaled track, a crew member or switch tender must open the switch and wait 5 minutes at the switch to establish block signal protection. If at the end of 5 minutes the employee does not hear or see movement approaching, the train may enter the signaled track. At a crossover, line the switch in the track the train is on, wait the 5 minutes, then line the other switch of the crossover.

A. When Hand Operation of a Spring Switch or 5-Minute Wait is Not Required

Waiting 5 minutes or operating the spring switch by hand is not required [unless prescribed by Rule 8.9 (Movement over Spring Switches)] under any of the following conditions:

1. Switch is equipped with an electric lock.
2. Track occupancy indicator indicates track is clear.
3. Block signal governing movement to signaled track indicates proceed.
4. Block signals governing movements on the signaled track indicate that no train is approaching from either direction.

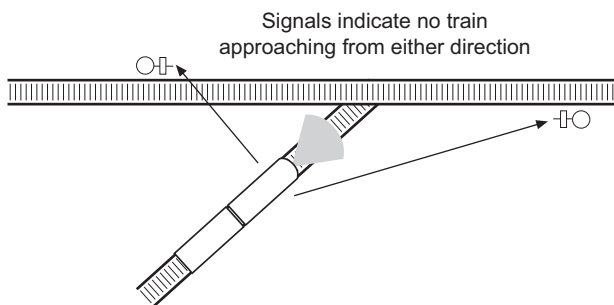

[Diagram A.]

5. Block to be entered is occupied by a train, engine, or car that is standing or moving away from the switch to be used.

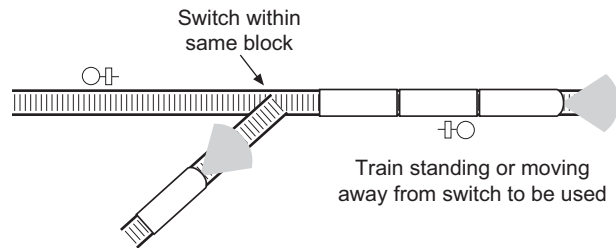

[Diagram B.]

6. Main track between siding switches is occupied by a train that has been met or a standing train that will be passed.

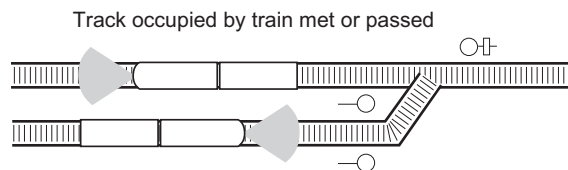

[Diagram C.]

7. Train is entering a main track outside of yard limits for authorized movement against the current of traffic.
 8. Rule 6.14 (Restricted Limits) is in effect, provided movement does not occur beyond restricted limits for 5 minutes after the main track circuit is fouled, unless a block signal displays a proceed indication.
 9. Work and time authority is granted within DTC.
 10. Track permit authorizes movement.
- or
11. Track warrant outside yard limits authorizes "WORK BETWEEN" two specific points.

9.17.1 Signal Protection in ABS by Lining Switch

When a train or engine is within ABS limits and requires action as necessary to stop other trains, this may be provided by lining and locking a main track switch against movement at or beyond the point where the train or engine will stop movement or clear the main track.

If the switch is located within a block other than the one occupied, do not make movements until 5 minutes after the switch has been lined. Also, make sure no train or engine is between the switch and the train or engine being protected or is within or closely approaching the block where the switch is located.

Except where Rule 6.13 (Yard Limits) or Rule 6.14 (Restricted Limits) is in effect, a train must receive permission from the train dispatcher before crossing over to or obstructing another main track signaled for movement in one or both directions.

Train dispatcher must ensure that no other movements against the current of traffic have been or will be authorized. Crew members must notify the train dispatcher when their movement is clear of the other main track.

In addition, before crossing over or fouling a main track, trains must comply with the following:

- a. Do not move until 5 minutes after lining the switch.
- b. Locate the block signal that protects the switch against trains moving with the current of traffic. To move against the current of traffic past that signal, pull the leading engine or car 100 feet beyond the signal. Wait 10 minutes before moving any further against the current of traffic. Then proceed at restricted speed.
- c. To move against the current of traffic beyond any further signals, obtain authority as outlined in Rule 14.6 (Movement Against the Current of Traffic) or Rule 15.3 (Authorizing Movement Against the Current of Traffic).

9.18 Electrically Locked Switches and Derails

Special instructions or instructions posted near the switch will govern the operation of switches and derails equipped with electric locks.

To enter a track within manual interlocking or CTC limits, employees must not open the case door or unlock an electrically locked switch or derail without track and time or authority from the control operator.

Emergency Release

If the electric lock includes an emergency release, do not break the seal on the release or operate the release without permission from the control operator or train dispatcher. However, when communication has failed, the seal may be broken and/or the release operated:

- To permit a train to leave the main track.
- or
- To permit a train that has authority to enter the main track. Train must not enter the main track until 5 minutes after the seal is broken and/or the release operated.

Notify the control operator or train dispatcher when the seal has been broken and/or the emergency release operated.

9.19 Leaving Equipment in Signal Systems

Engines, cars, or equipment must not be detached and left standing entirely between the opposing interlocking signals that govern movements at a railroad crossing at grade.

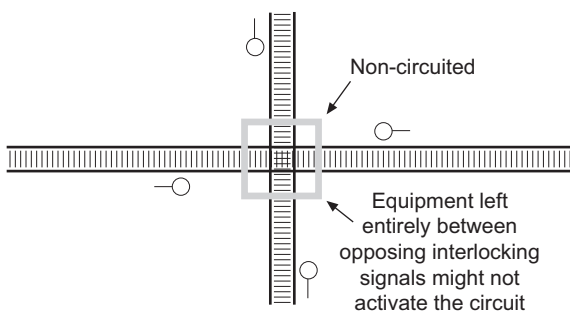

[Diagram A.]

Do not depend upon track equipment, other than engines or cars to actuate block signals, interlocking signals, or highway crossing signals or to be under the protection of such signals.

9.20 Clear Track Circuits

A train, engine, car, or equipment left standing on sidings or other tracks must be clear of insulated joints at clearance points.

9.21 Overlap Circuits

Overlaps may be identified by overlap signs. A train on the main track at a meeting point must not pass an overlap sign location or open a switch within the overlap until the opposing train has entered the block.

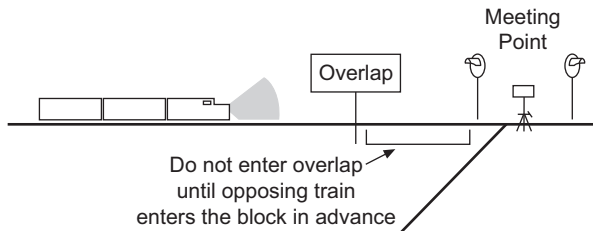

[Diagram A.]

A preceding train must clear the overlap as soon as possible to avoid delaying a following train.

Unless otherwise instructed by the train dispatcher, a train on a siding at a meeting or passing point must not pass an overlap sign location until authorized to leave the siding.

9.22 Standing on Sanded Rail

Do not allow an engine with less than three cars, or cuts of four cars or less, to stand on a sanded rail.

9.23 Suspension of Block System

When authorized, a track bulletin may suspend the block system or sections of it.

Do not suspend the block system or sections of it until all trains and control operators in the affected territory have been notified by track bulletin specifying the limits of the suspension.

Track bulletins issued to suspend the block system must not be delivered to trains entering the affected territory until the affected limits are clear of trains, or until the track bulletin has been transmitted or delivered to all trains within the limits.

9.23.1 Guidelines While Block System is Suspended

When the block system or sections of it are suspended, the following guidelines govern:

- Employees must follow rules that apply to non-signaled territory.
- Trains must receive a track bulletin prescribing speed restrictions that do not exceed 59 MPH for passenger trains or 49 MPH for other trains.
- Trains will disregard extinguished or illuminated block and interlocking signals except where:
 - Signals govern movements over railroad crossings at grade or drawbridges.
 - or
 - Signals are connected with trackside warning detectors.

Trains must approach the block and interlocking signals excepted above and each end of the suspended limits prepared to stop. Trains that leave the limits and move into block system territory must move at restricted speed until they reach the first signal in service beyond the limits. Signals that govern movement over railroad crossings at grade and drawbridges must be regarded as displaying a Stop indication, regardless of the aspect displayed, unless the track bulletin specifies that the signals are in service.

If the crew does not know that signals governing movement over railroad crossings at grade are in service, the crew must provide flag protection in each direction on conflicting routes before proceeding over the crossing. Crew members must not rely on time release or key controller operation as adequate protection while moving over the crossing, unless they are instructed otherwise.

- On multiple main tracks, a track bulletin will designate the track or tracks the block system is suspended on. A track bulletin that specifies the track to be used will be issued to each train.
- Where automatic crossing warning devices have been affected, action to be taken will be stated in the track bulletin.
- Dual control switches on the main track will be lined and locked for main track movement. Switches equipped with selector levers will be locked in the HAND position. All other dual control switches will be spiked. All concerned will be notified. Until informed by the train dispatcher, trains must stop and inspect dual control switches, foul the circuit, and make sure the switch is properly lined before passing over it.

A track bulletin must be issued that specifies which position dual control switches at the end of double track or multiple main tracks are to be left lined.

If a crew member receives notification from the train dispatcher of the position of dual control switches, leave those switches in that position after use.

- Spring switches that will be removed from service must be spiked and those concerned notified. If spring switches are left in service, trains making facing point movements must be prepared to stop, unless it is known that the switch is properly lined.
- When the block system has been returned to normal operation, a track bulletin must notify all trains within the affected territory before any train can enter the limits and be governed by the block system.

9.24 Call Lights

When a call light is on, any employee who sees it, unless the employee is on a moving train, must contact the control operator immediately.

10.0 Rules Applicable Only in Centralized Traffic Control (CTC)

10.1 Authority to Enter CTC Limits

CTC limits are designated in the timetable. Sidings within CTC limits are controlled sidings and are governed by CTC rules. A train must not enter or occupy any track where CTC is in effect unless a controlled signal displays a proceed indication or the control operator authorizes:

- Movement past a Stop indication under Rule 9.12.1 (CTC Territory).
 - A train to enter track between block signals as follows: “(Train) at (location) has authority to enter (track) and proceed (direction).” After entering the track, the train is authorized to move only in the direction specified.
- or
- Track and Time under Rule 10.3 (Track and Time).

Signal Governing Movement Over a Hand-Operated Switch

If a signal governs movement over a hand-operated switch that is not electrically locked, the control operator must authorize the train to enter or occupy any track where CTC is in effect before the switch is opened. After the switch is opened, if the signal does not display a proceed indication, a crew member must wait 10 minutes at the switch. After the 10 minute wait if the signal does not display a proceed indication, move the train at restricted speed and notify the control operator.

However, if the block to be entered is occupied by its own standing train or when the hand-operated switch remains open, the movement may, after stopping, pass an absolute signal displaying a Stop indication without waiting 10 minutes and without contacting the control operator.

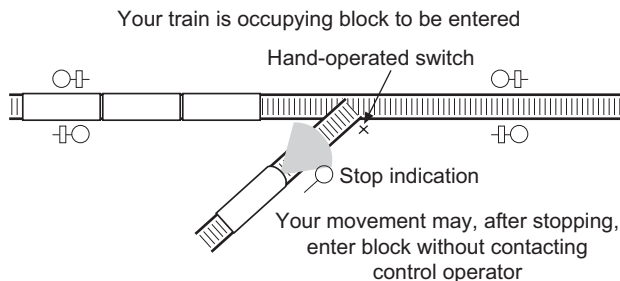

[Diagram A.]

10.2 Clearing Through Hand-Operated Switches

Where CTC is in effect, a train must not clear in any track at a hand-operated switch not equipped with an electric switch lock, except under one of the following conditions:

- Where the permanent maximum authorized speed does not exceed 20 MPH on the main track or controlled siding.

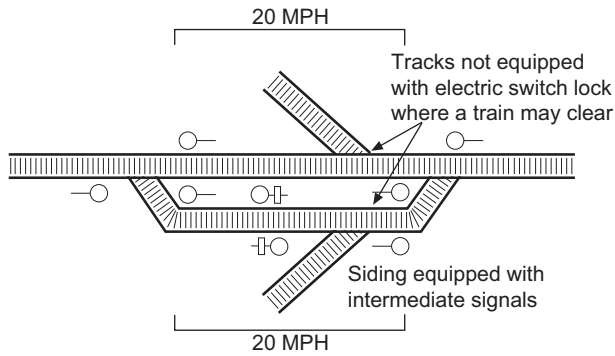

[Diagram A.]

- Where the permanent maximum authorized speed does not exceed 30 MPH on a controlled siding not equipped with an intermediate signal.

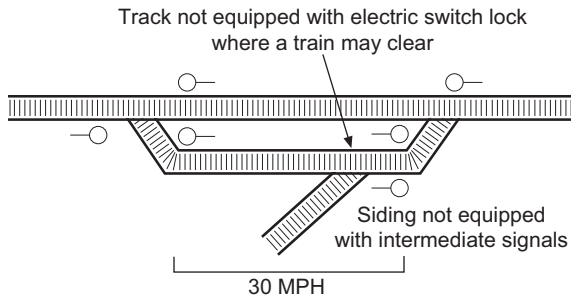

[Diagram B.]

- Where a signal governs movement to a track where CTC is in effect.

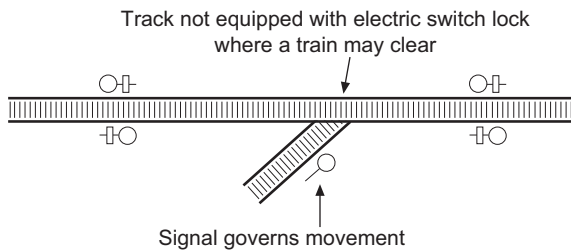

[Diagram C.]

- When the hand-operated switch is kept open.

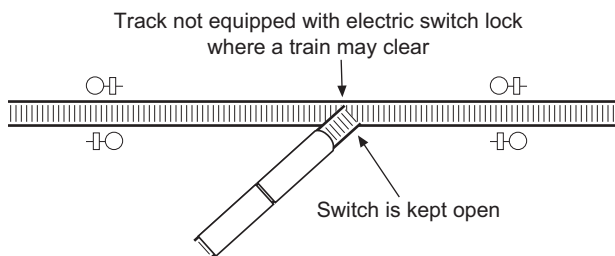

[Diagram D.]

10.3 Track and Time

The control operator may authorize a train to occupy a track or tracks within specified limits for a certain time period. Authority must include track designation, track limits, and either a time limit or the words “until released”. The train may use the track in either direction within the specified limits according to signal indication until the limits are verbally released.

Limits designated by a switch extend only to the signal governing movement over the switch unless otherwise designated.

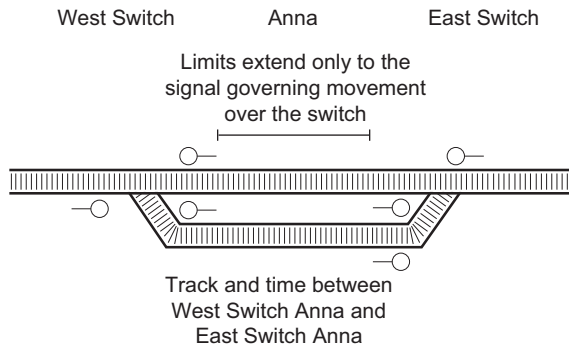

[Diagram A.]

Track and time does not authorize trains to occupy the track(s) within interlocking limits.

A. Passing Signal Displaying Stop or Stop and Proceed Indication

Except at interlockings, trains granted track and time:

1. After stopping at a signal displaying a Stop indication, must be granted verbal authority to enter the limits at either end. Verbal authority is not required after stopping within the limits or when entering the limits at any other location. Train must move at restricted speed.
2. Must observe the requirements for inspection of spring switches.
3. May pass a signal within the limits displaying Stop and Proceed indication without stopping.

B. Time Limits

Trains must release track and time before the time granted expires. When necessary to modify the expiration time, an employee and the control operator must communicate before time expires to adjust the time granted. If the employee cannot contact the control operator and the time limit expires, authority is extended until the control operator is contacted.

C. Releasing When Within the Limits

Employees releasing track and time must state:

- Their name or other identification.
- The track and time limits being released, including number, if applicable.

If no other employee has received track and time within the same limits, a train within the limits may release its track and time to move in a specified direction. Signal indications will then govern the train, if the control operator verbally authorizes the release specifying direction of movement.

D. Releasing Portion of Limits

When a crew member informs the control operator that the authority is released between two specific points, the authority is considered void between those points. This track release must begin at the outer limit of the authority.

10.3.1 Protection of Limits

Before granting track and time, the control operator must apply blocking or marking devices to the control machine to prevent movement into the limits. The control operator may only grant track and time:

1. If the limits are clear.
2. If the limits are occupied by a train with track and time or that will receive track and time.
3. For an engine to switch a train standing within the limits. Crew members on the engine must provide protection against possible movement of the standing train, if necessary.
or
4. After all trains moving within the limits that do not have track and time have passed the location where the track will be occupied and the employee has been notified that authority is granted behind such trains.

Blocking or marking devices must not be changed or removed until limits have been released to the control operator.

10.3.2 Protection of Machines, Track Cars, or Employees

Machines, track cars, or employees will receive track and time in the same manner as trains.

Machines, track cars, or employees must be clear of the limits before the employee granted track and time releases the authority.

10.3.3 Joint Track and Time

Before track and time is granted where limits will be jointly occupied, the control operator must issue joint track and time to all trains, machines, track cars, or employees within the same limits or that will enter the limits. Trains must move at restricted speed within joint track and time limits.

10.3.4 Track and Time Acknowledgment

Track and time authority must be recorded and repeated to the control operator. Acknowledgment must be received before being acted upon.

The control operator must maintain a record of the authority granted.

11.0 Rules Applicable in ACS, ATC and ATS Territories

11.1 Establishing Absolute Block

Absolute block may be established in advance of a train. The train dispatcher can establish it verbally or by issuing a track bulletin addressed only to the train affected by stating, "Absolute block is established in advance of your train between _____ and _____."

11.2 Signal Indications with Absolute Block

When absolute block is established in advance of a train, the train must not pass a signal indicating Stop, Stop and Proceed, Restricted Proceed, or Restricting unless verbally authorized by the train dispatcher. However, the train may leave the main track through a switch that is immediately after a signal indicating Stop and Proceed, Restricted Proceed or Restricting.

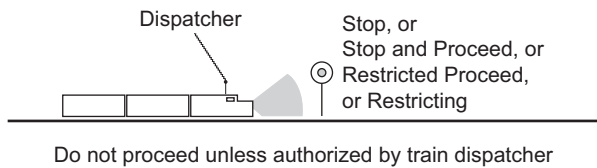

[Diagram A.]

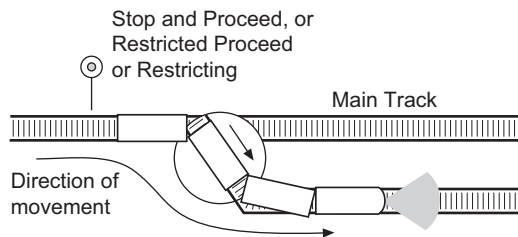

[Diagram B.]

When absolute block is established in advance of a train, the train dispatcher must not authorize the train to pass a signal indicating Stop, Stop and Proceed, Restricted Proceed, or Restricting until the block governed by that signal is clear of trains.

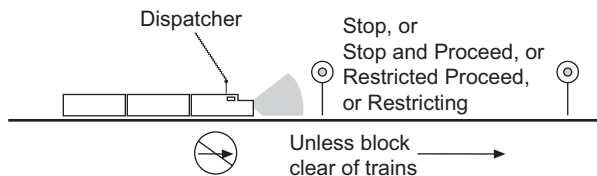

[Diagram C.]

If authorized to pass the signal, the train must proceed at restricted speed until it reaches the next governing signal.

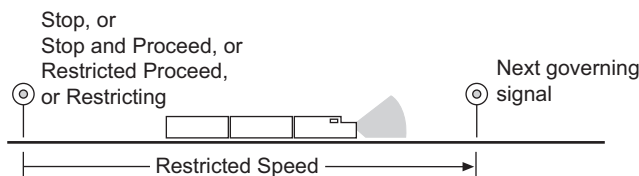

[Diagram D.]

11.3 Broken or Missing Seals

Do not break the seal on the cutout cock or cut out ACS or ATS devices unless they do not operate properly. Report ACS or ATS failures, interruptions, and removal of or missing seals to the train dispatcher immediately.

12.0 Rules Applicable Only in Automatic Train Stop System (ATS) Territory

12.1 Required Equipment

Except as provided in Rule 12.2 (ATS Device Cut Out, Not Equipped, or Not Working), an engine controlling the air brakes of a passenger train within ATS limits must be equipped with an operative ATS device.

12.1.1 ATS Seals and Keys

When operating in ATS territory, the ATS must be sealed or locked.

12.2 ATS Device Cut Out, Not Equipped, or Not Working

Within ATS limits, if the ATS device on an engine controlling the train's air brakes fails or is cut out enroute, or if the engine on a train being detoured is not equipped with a working ATS device, the following will apply:

- The train dispatcher must be notified promptly by radio or telephone.
- The train may proceed according to signal indication, but cannot exceed 40 MPH until an absolute block is established in advance of the train.
- If an absolute block is established in advance of the train as provided in Rule 11.1 (Establishing Absolute Block), the train may proceed according to signal indication, but cannot exceed 79 MPH.

12.3 Unusual Conditions

12.3.1 ATS Penalty Brake Application

When two successive ATS penalty brake applications have occurred while passing over inductors at signals displaying Proceed, engineer must acknowledge at each succeeding inductor thereafter, regardless of signal indications and report to the train dispatcher.

12.3.2 ATS Inoperative

The ATS system is considered inoperative when:

- Acknowledging at subsequent inductors at signals when required by Rule 12.3.1 (ATS Penalty Brake Applications), or at two successive inert inductors, does not prevent penalty stops.
- The acknowledgment alarm fails to sound or light fails to illuminate when acknowledgment is required at an inductor at a wayside signal indicating other than Proceed.
- Brakes do not apply upon failure to acknowledge a signal indicating other than Proceed.
or
- Absence of, or damage to, an ATS receiver is noted.

12.3.3 Damaged Inductor

Employees noting the absence of or damage to a wayside inductor in approach to a signal must notify the train dispatcher. The train dispatcher must immediately call the signal maintainer who must cause the signal to display its most restrictive indication until inductor is replaced or repaired.

12.4 ATS Testing

12.4.1 Test Inductor Locations

1. Move engine at 3 MPH or more over first inductor while holding the acknowledging device in full position (not over 15 seconds) to determine that brake application does not occur.
2. Move engine at 3 MPH or more over second inductor and do not acknowledge. A brake application should occur. Operate reset device to full position and release brakes.
3. Report as prescribed in Rule 17.4.1.

12.4.2 No Test Inductors

At locations where there are no test inductors:

1. Pass a test bar under the ATS receiver while holding the acknowledging device in full position (not over 15 seconds) to determine that brake application does not occur.
2. Pass a test bar under the ATS receiver and do not acknowledge device. A brake application should occur. Operate reset device to full position and release brakes.
3. Report as prescribed in Rule 17.4.1.

13.0 Rules Applicable Only in Automatic Cab Signal System (ACS) Territory

13.1 General Information

13.1.1 Observance of Signals

The Automatic Cab Signal (ACS) system is used in addition to block signals to govern the use of blocks. However, employees must continue to observe rules that govern the use of block signals as well as other rules, except as outlined in Rules 13.2.1 (Restrictive to More Favorable) and 13.2.2 (Favorable to More Restrictive).

13.1.2 Conforming with Block Signals

The cab signal and block signal systems are interconnected so that the cab signal agrees with the block signal indication within 8 seconds after the engine passes the block signal that governs entrance into a block.

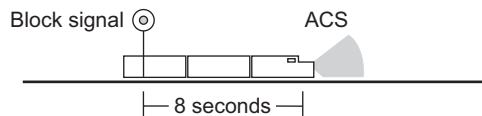

[Diagram A.]

Exception

The ACS system is to be considered inoperative through turnouts and crossovers. Block signal indications and speeds specified in the special instructions for each turnout govern movements through turnouts and crossovers.

13.1.3 Does Not Indicate Conditions Ahead

Cab signals will not indicate conditions ahead when the engine is:

- Moving against the current of traffic.
 - Shoving cars.
- or
- Moving backward and not equipped for backward operation.

13.1.4 Cab Signals Cut In and Out

The cab signal on the lead unit must be cut in before entering and while operating within ACS territory and placed in partial cutout after leaving ACS territory.



[Diagram A.]

The cab signal must be placed in partial cutout on all trailing units in ACS territory.

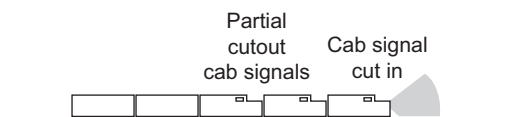

[Diagram B.]

Before taking charge of an engine in or approaching ACS territory, the engineer must know that the cab signal devices are cut in and operative and that the ACS cutout is properly sealed. If the device was cutout or seal is missing upon taking charge of a locomotive, the ACS equipment must be retested. If device was previously tested and fails to function properly upon entering, or while operating in ACS territory, the train dispatcher must be notified and the train must be operated under an absolute block. If the device was not tested previously, the engineer must make a departure test before entering ACS territory.

Do not cut out cab signal devices while the train is in ACS territory, unless authorized to do so.

13.2 Normal Operation

13.2.1 Restrictive to More Favorable

Cab signal indications do not supersede the indication displayed on block and interlocking signals. However, when a cab signal changes to a more favorable indication after having passed the block or interlocking signal, the train may immediately comply with the indication.

13.2.2 Favorable to More Restrictive

When a cab signal changes to a more restrictive indication, the engineer must comply promptly with the indication received.

Acknowledging Restrictive Indication

When a cab signal changes to a more restrictive indication, the engineer must acknowledge the change with the acknowledging device. On engines not equipped with the Coded Cab Signal-Safety Control (CCS-SC) System, another member of the crew must immediately find out from the engineer why the warning whistle sounded longer than 6 seconds. When conditions require, the crew member must stop the train immediately.

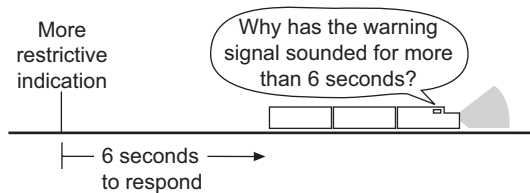

[Diagram A.]

On engines equipped with CCS-SC, the engineer must acknowledge the change within 6 seconds of receiving it to avoid a penalty brake application.

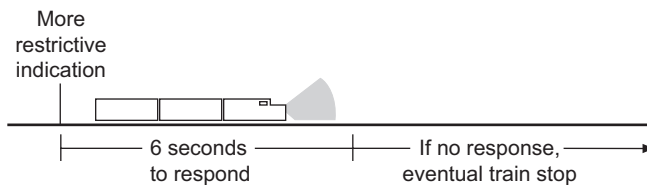

[Diagram B.]

Penalty Brake Application Occurs

On engines equipped with CCS-SC, if the engineer does not acknowledge the more restrictive indication, a full service penalty brake application will occur automatically within 6 to 8 seconds. When this occurs, the engineer must do the following:

- Place the automatic brake valve handle in suppression position and leave it there until the train stops.
- Place the throttle in idle position.
- Acknowledge the signal change with the acknowledging device.
- After the train has stopped and the P.C. light goes out, place the automatic brake valve handle in release position.

13.2.3 Elimination of Audible Indicator

To keep the audible indicator from sounding while the train is stopped in a cab signal test loop, place the reverser handle in either the neutral or reverse position. This will change the cab signal to its most restrictive aspect. After acknowledging the signal change, no more signal changes will be received.

Place the reverser handle in the forward position to automatically restore the equipment to normal operation.

Since the reverser handle in trailing units is in neutral position, the audible indicator is automatically silenced on trailing units.

13.3 Unusual Conditions

13.3.1 Cab Signal and Block Signal Do Not Agree

If the cab signal does not display the proper ACS aspect shown in the Block and Interlocking Signal Rules:

- The most restrictive block or cab signal indication must be complied with. A crew member must promptly notify the train dispatcher of the location, signal number, and track where the signals did not agree.
- At control point locations with only an absolute signal(s), when authorized by the train dispatcher to pass the Stop indication, the cab signal may change to a more favorable indication at the signal. The train may comply with the cab signal indication. This is normal due to track circuitry and would not be considered an improper display of the cab signal.

Exception

When the train dispatcher's instructions require the train to proceed at restricted speed, the train must comply with the train dispatcher's instructions regardless of cab signal indication.

13.3.2 Inoperative Cab Signal Device

The ACS system is to be considered inoperative when:

- The audible indicator does not sound when the cab signal changes to a more restrictive indication.
- The audible indicator continues to sound when the cab signal change is acknowledged.
- The cab signal does not conform at two consecutive block or interlocking signal locations.
or
- Any part of the cab signal device is damaged.

Known in Advance

When it is known in advance that the ACS system is inoperative in a specific area, crew members will be notified with a track bulletin.

13.3.3 Movement with an Inoperative Cab Signal Device

When it is determined the cab signal device is inoperative, the train may proceed according to block signal indications. However, the train must not exceed 40 MPH until it reaches a point where a crew member can report the defect to the train dispatcher.

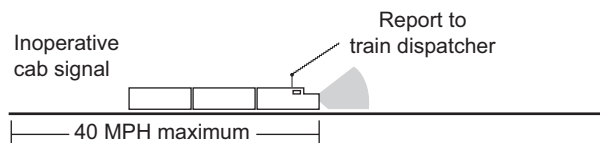

[Diagram A.]

The train dispatcher will:

- Instruct the crew to cut out the cab signal device.
- Establish an absolute block in advance of the train.

When the cab signal device has been cut out, the train must:

- Proceed according to block signal indications, not exceeding 79 MPH.
- Comply with Rule 11.2 (Signal Indications with Absolute Block).

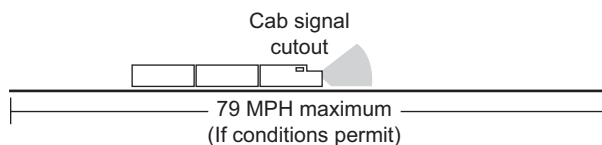

[Diagram B.]

When it is determined the cab signal device is inoperative due to a power outage, a crew member will position the acknowledging lever in the Partial Cutout position.

14.0 Rules Applicable Only Within Track Warrant Control (TWC) Limits

TRACK WARRANT
(Suggested Form)

NO: _____
TO: _____

1. TRACK WARRANT NO. _____ IS VOID.
2. PROCEED FROM _____ TO _____ ON _____ TRACK.
3. PROCEED FROM _____ TO _____ ON _____ TRACK.
4. WORK BETWEEN _____ AND _____ ON _____ TRACK.
5. NOT IN EFFECT UNTIL _____.
6. THIS AUTHORITY EXPIRES AT _____.
7. NOT IN EFFECT UNTIL AFTER ARRIVAL OF _____ AT _____.
8. HOLD MAIN TRACK AT LAST NAMED POINT.
9. DO NOT FOUL LIMITS AHEAD OF _____.
10. CLEAR MAIN TRACK AT LAST NAMED POINT.
11. BETWEEN _____ AND _____ MAKE ALL MOVEMENTS AT RESTRICTED SPEED. LIMITS OCCUPIED BY TRAIN.
12. BETWEEN _____ AND _____ MAKE ALL MOVEMENTS AT RESTRICTED SPEED. LIMITS OCCUPIED BY MEN OR EQUIPMENT.
13. DO NOT EXCEED _____ MPH BETWEEN _____ AND _____.
14. DO NOT EXCEED _____ MPH BETWEEN _____ AND _____.
15. FLAG PROTECTION NOT REQUIRED AGAINST FOLLOWING TRAINS ON THE SAME TRACK.
16. TRACK BULLETINS IN EFFECT _____, _____, _____, _____, _____, _____, _____, _____.
17. OTHER SPECIFIC INSTRUCTIONS: _____

OK _____ (TIME) DISPATCHER _____

LIMITS REPORTED CLEAR AT _____

(Mark the box for each item instructed.)

[Diagram A.]

14.1 Authority to Enter TWC Limits

Where designated by the timetable, a track warrant will authorize main track use under the direction of the train dispatcher or as prescribed by Rule 6.13 (Yard Limits) or Rule 6.14 (Restricted Limits). Track warrant instructions must be followed where yard limits or restricted limits are in effect.

14.2 Designated Limits

Track warrant limits must be designated by specifying track, where required, and specific locations such as switches, mile posts, or railroad identifiable points. However, station names may be used as follows:

A. First Named Point

When a station name designates the first named point, authority extends from and includes the last siding switch. Authority extends from the station sign if no siding exists.

B. Last Named Point

When a station name designates the last named point, authority extends to and includes the first siding switch. Authority extends to the station sign if no siding exists.

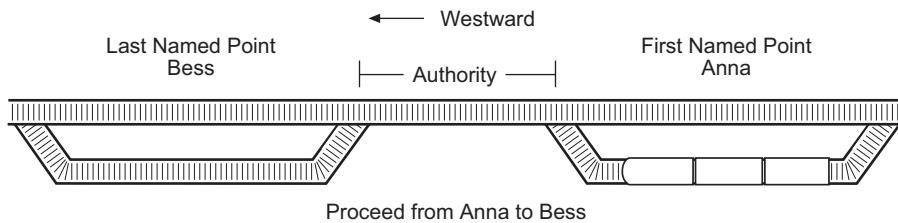

[Diagram A.]

At the last named point, authority extends to but does not include the last siding switch when the track warrant states, “Hold main track at last named point.”

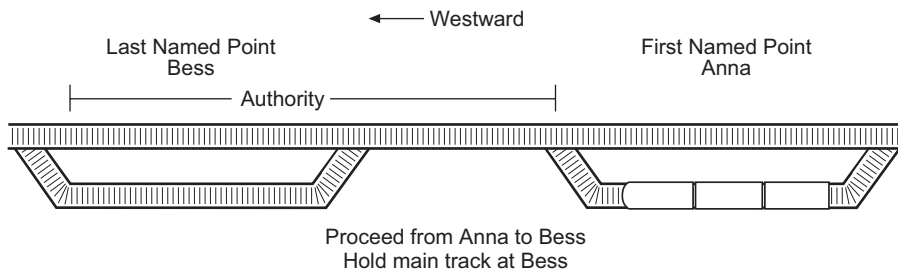

[Diagram B.]

14.3 Operating with Track Warrants

A track warrant authorizes a train or engine to occupy the main track within designated limits. However, the train or engine must not foul a switch at either end of the limits where an opposing train may use the same switch to clear the main track.

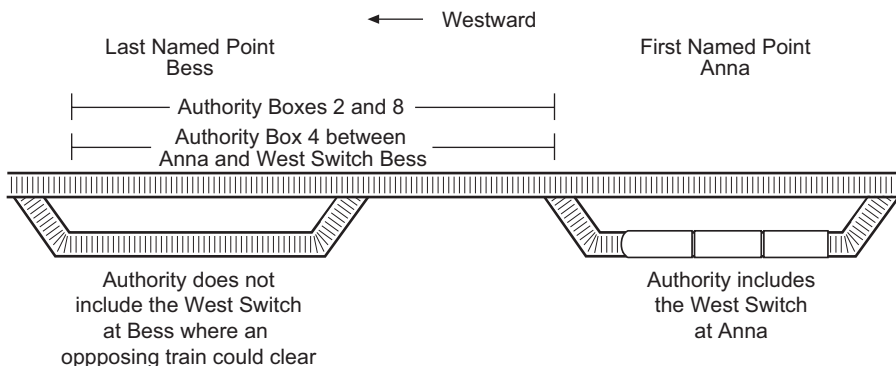

[Diagram A.]

The train or engine must move as follows:

1. Proceed from one point to another in the direction the track warrant specifies. When a crew member informs the train dispatcher that the entire train has passed a specific point, track warrant authority is considered void up to that point.
or
2. If authorized to “WORK BETWEEN” two specific points, the train or engine may move in either direction between those points. When a crew member informs the train dispatcher that the authority is released between two specific points, the authority is considered void between those points. This track release must begin at the outer limit of the authority.

14.3.1 Leaving the Main Track

A train authorized to proceed in one direction must inform the train dispatcher when it leaves the main track before reaching the last named point, unless a crew member is left to prevent a following movement from passing.

14.4 Occupying Same Track Warrant Limits

A track warrant must not be issued to a train within the same or overlapping limits with another train unless:

1. In signaled territory, all trains are authorized to proceed in the same direction.
2. In non-signaled territory, all trains are authorized to proceed in the same direction and are instructed to move at restricted speed.
3. Two or more trains are authorized to “WORK BETWEEN” two specific points at restricted speed within the overlapping limits.
4. Trains are authorized to proceed through the limits of another train authorized to “WORK BETWEEN” two specific points, and track warrants instruct all trains to move at restricted speed within the overlapping limits. When station name(s) designate the overlapping limits, refer to Rule 14.2 (Designated Limits) for limits where trains are required to move at restricted speed.
or
5. Radio Blocking is authorized as outlined by Rule 14.4.1 (Radio Blocking).

Where track warrant authority includes yard limits or restricted limits, the terms of Rule 6.13 (Yard Limits) or Rule 6.14 (Restricted Limits) apply, but track warrant instructions must be followed.

14.4.1 Radio Blocking

Where designated by special instructions, in non-signaled territory, more than one train may be authorized to proceed in the same direction within the same or overlapping limits, provided the following train:

- Is notified on the track authority of the identity of the preceding train.
- Does not occupy the limits ahead of the preceding train.
- Notifies the crew of the preceding train that radio blocking has been authorized stating the limits.
- Is notified by the preceding train that the entire train has passed a specific location. Location specified must not be beyond limits indicated. The following words must be used: “(Train) clear of (location)”.
- Does not proceed beyond the last location the preceding train has reported to have passed.

All instructions between the trains must be written, repeated, and acknowledged with “THAT IS CORRECT” before being acted on. These written instructions between the trains must be retained until the end of tour of duty.

Notify the train dispatcher if communication cannot be established between the two trains. If necessary, radio blocking information may be relayed only by the train dispatcher.

The last named point of the following train’s authority must not extend beyond the last named point of the preceding train’s authority.

In the application of Rule 6.4 (Reverse Movements) and Rule 6.6 (Back Up Movements), the movement must not go beyond the last specific location reported to the following train.

Written Instructions Between Trains			
(Suggested Form)			
(<i>Following Train ID</i>) is authorized Radio Blocking from _____ to _____ behind (<i>Preceding Train ID</i>).			
	<u>LOCATION</u>	<u>TIME</u>	<u>CREW MEMBER</u>
(<i>Preceding Train ID</i>) clear of	_____ at	_____	reported by _____
	_____ at	_____	reported by _____
	_____ at	_____	reported by _____
	_____ at	_____	reported by _____
	_____ at	_____	reported by _____

14.5 Protecting Men or Equipment

Men or equipment may receive a track warrant in the same manner as trains to occupy or perform maintenance on the main track without other protection.

A track warrant must not be issued to protect men or equipment within the same or overlapping limits with a train unless:

1. All trains are authorized to proceed in one direction only, and the track warrant specifies that men or equipment do not occupy limits ahead of these trains.
or
2. All trains authorized are notified of the men or equipment and have been instructed by track warrants to move at restricted speed within overlapping limits. When station name(s) designate the overlapping limits, refer to Rule 14.2 (Designated Limits) for limits where trains are required to move at restricted speed. Also, a track warrant must inform the employee in charge of men or equipment about the trains. If the track is not safe for trains to move at restricted speed, the employee must protect the track with red flags according to Rule 5.4.7 (Display of Red Flag).

14.6 Movement Against the Current of Traffic

When a track warrant authorizes a train to move against the current of traffic, the train must use only the track designated within the specified limits. This train must not allow a train following on the same track to pass, unless the train dispatcher instructs it to pass.

14.7 Reporting Clear of Limits

A train without a crew member on the rear and operating in non-signaled or double track territory may report clear of the limits, report having passed a specific location, or release the track between two specific locations only when it is known the train is complete. This must be determined by one of the following ways:

1. The rear of the train has a rear-end telemetry device, and air pressure on the head-end device indicates brake pipe continuity.
2. An employee verifies the marker is on the rear of the train.
3. A crew member can observe the rear car of the train on which the marker is placed.
4. The train is stopped, and an inspection verifies that the marker is on the rear car of the train.
5. A trackside warning detector transmits an axle count for the train, and the axle count duplicates the axle count transmitted by the previous trackside warning detector.

In addition, a train using a hand-operated switch to clear the main track must comply with requirements outlined in Rule 8.3 (Main Track Switches) before reporting clear of the limits.

When a hand-operated switch is used to clear the main track, except where Rule 6.13 (Yard Limits) or Rule 6.14 (Restricted Limits) are in effect, advise the train dispatcher of the position of the switch and that the switch is locked when reporting clear of track warrant limits. Train dispatcher shall repeat the reported switch position and employee releasing the limits shall confirm to the train dispatcher this information is correct.

14.8 Track Warrant Requests

An employee who requests a track warrant must inform the train dispatcher what movements will be made and, when necessary, which tracks will be used and how much time is required.

14.9 Copying Track Warrants

The conductor and the engineer must each have a copy of the track warrant issued to their train, and each crew member must read and understand it. The copy must show the date. The following must occur when transmitted verbally:

A. Transmitting Track Warrants

1. An employee will enter all of the information and instructions on the track warrant.
2. The employee will repeat the preprinted and written information transmitted by the train dispatcher.
3. The train dispatcher will check it and, if correct, will say "OK" and give the time and his initials.
4. The employee will enter the "OK" time and the train dispatcher's initials on the track warrant and repeat them to the train dispatcher.

B. In Effect

1. The track warrant is not in effect until the "OK" time is shown on it.
2. If the track warrant restricts movement or previously granted authority, it cannot be considered in effect by the train dispatcher until acknowledgment of the "OK" has been received.

Employees may relay track warrants.

14.9.1 Duplicating Track Warrants

Employees who reproduce track warrants with a duplicating machine do not need to repeat them to the train dispatcher.

Duplicated track warrants must not be delivered or used until they are checked and verified as:

- Legible.
- Duplicated in their entirety.

14.10 Track Warrant in Effect

A track warrant is in effect until a crew member reports the train has cleared the limits, or the track warrant is made void. The crew member must inform the train dispatcher when the train has cleared the limits.

Employees reporting clear of track warrant limits must state:

- Their name or other identification.
- Track warrant number being released.
- Limits being released.

Time Limit Shown

If the track warrant shows a time limit, the train must clear the limits by the time specified, unless another track warrant is obtained. If an employee cannot contact the train dispatcher and the time limit expires, authority is extended until the train dispatcher is contacted.

14.11 Changing Track Warrants

Employees must not add to or alter a track warrant in any manner, except as specified by Rule 15.1.1 (Changing Address of Track Warrants or Track Bulletins).

When the limits or instructions of a track warrant must be changed, a new track warrant must be issued voiding the track warrant(s) to be changed.

14.12 Not Used

14.13 Mechanical Transmission of Track Warrants

Repetition is not required when track warrants are transmitted mechanically. The “OK” time will be given when the track warrant is issued.

Track warrants that restrict the authority or movement of a train must not be transmitted mechanically, unless the train being restricted will not leave the point without receiving the track warrant.

15.0 Track Bulletin Rules

(Suggested Form)
Track Bulletin Form A

No. _____ On _____ SUBDIV _____
To _____

Between points shown in lines 1 through 10 below, do not exceed speed given:
(Use last two columns when displayed less than distance prescribed by Rule 5.4.2 to indicate location and direction.)

Line Void	Line No.	Between/At Location & Location		Speed MPH		Track(s)	Flags At MP	For Direction
				PSGR	FRT			
	1.							
	2.							
	3.							
	4.							
	5.							
	6.							
	7.							
	8.							
	9.							
	10.							
	11.	Other Conditions _____						
		OK _____ Dispatcher _____						

[Diagram A.]

(Suggested Form)
Track Bulletin Form B

No. _____ On _____ SUBDIV _____
To _____

On (Date) _____ **Be governed by Rules 15.2 and 15.2.1 within the following limits:**
(Use last two columns when displayed less than distance prescribed by 5.4.3 to indicate location and direction.)

Line Void	Line No.	Between Location & Location		From	Until	Track(s)	Foreman and/or Gang No.	Y/R Flag at MP	For Direction
	1.								
	2.								
	3.								
	4.								
	5.								
	6.								
	7.								
	8.								
	9.								
	10.								
		OK _____ Dispatcher _____							

[Diagram B.]

15.1 Track Bulletins

Track bulletins must not be changed unless specified by Rules 15.1.1 (Changing Address of Track Warrants or Track Bulletins) or Rule 15.13 (Voiding Track Bulletins). The train dispatcher will issue track bulletins as required. Track bulletins will contain information on all conditions that affect safe train or engine movement. Forms other than track bulletin Forms A and B may be used when necessary.

Receipt and Comparison of Track Bulletins

At their initial station, unless otherwise instructed by the train dispatcher, the conductor and engineer must receive track bulletins affecting their train's movement:

- By a track warrant, unless the track warrant shows "NONE" or "NO."

or

- In a manner designated by special instructions. All rules that apply to track bulletins also apply.

The conductor and engineer must have copies of all track bulletins and other instructions required. Each crew member must read and understand them.

All crew members are responsible for complying with the requirements of track bulletins and reminding each other of those requirements.

At the initial station, when outbound crew members receive track warrants and track bulletins from inbound crew members, the conductor and engineer must compare the track warrants and track bulletins with each other and with the train dispatcher before proceeding.

At locations where track bulletins are delivered electronically crew members must verify that route description, if provided, covers the intended route of their train. If it does not, contact the train dispatcher and determine if the track bulletins are valid. Crew members must check the date and "OK" or issue time and if over 4 hours old when received, contact the train dispatcher and determine if additional track bulletins are needed.

Any rule referencing track warrants is also applicable to DTC authority.

15.1.1 Changing Address of Track Warrants or Track Bulletins

If the address must be changed on a track warrant used to deliver track bulletins only or a track bulletin that does not grant authority according to Rule 15.3 (Authorizing Movement Against the Current of Traffic), the train dispatcher may verbally change the train symbol, engine identification, direction, or date.

15.2 Protection by Track Bulletin Form B

Display track flags as specified in Rule 5.4.3 (Display of Yellow-Red Flag) and Rule 5.4.7 (Display of Red Flag).

A train must not enter the limits unless instructed by the employee in charge. A train within the limits at the time the track bulletin Form B takes effect must not make further movement until instructed by the employee in charge.

A crew member must attempt to contact the employee in charge to avoid delay, giving the train's location and track being used. The employee in charge will use the following format to establish communication with the train:

Employee in charge of Track Bulletin No. ____ (specifying line number when necessary) between MP ____ and MP ____ (specifying subdivision when necessary).

Trains within the limits, unless otherwise restricted, must move at the speed(s) specified by the employee in charge as stated in Item A (Instructions).

A. Instructions

After communication with the train has been established, the employee in charge will use the following format to grant a train permission to proceed through the Form B limits:

- (Train ID) may enter limits (and pass the red flag) at MP ____ and proceed at (one of the following), specifying route:
 - “Maximum Authorized Speed”
 - “Restricted Speed”
 - A speed specified by the employee in charge

Two additional speeds may be given to restrict a train’s movement through a portion of the limits, by adding the following:

- Do not exceed ____ MPH between/at MP ____ and MP ____ (or other location).

To require a train to stop at a designated location within the limits, add the following:

- Stop at MP ____ (or other location) until additional instructions are received.

When men or equipment foul adjacent track(s), add the following:

- Men or equipment fouling (specify track).

B. Repeat Instructions

A crew member must repeat the above instructions, and the employee giving the instructions must acknowledge them before they can be followed.

Once instructions are received from employee in charge, if the track route changes from previous instructions received, contact employee in charge to determine that original instructions received are valid on new track route before proceeding on the new route. The movement must not change direction without permission from the employee in charge.

15.2.1 Protection for On-Track Equipment

Track bulletin Form B may be used to protect on-track equipment, such as rail detector cars, without using yellow-red flags. Identify protected equipment in the track bulletin.

While trains, engines, and protected equipment are in track bulletin limits, they will otherwise be governed by Rule 15.2 (Protection by Track Bulletin Form B). The same track bulletin must not protect other gangs and equipment.

15.3 Authorizing Movement Against the Current of Traffic

Where Rule 9.14 (Movement with the Current of Traffic) is in effect, a track bulletin may authorize movement against the current of traffic as follows:

1. “(Train) will use ____ track against the current of traffic (point) to (point).”

The train must use only the track specified between these points. Opposing trains must not leave the last point until the train arrives. The train dispatcher must not authorize a following train to move against the current of traffic until the previous train has cleared the last point.

The example may be modified as follows:

- a. “After (opposing train) arrives at (point), (train) will use _____ track against the current of traffic (point) to (point).”

The train that will move against the current of traffic must not leave the first point until the opposing train arrives.

Trains directly affected in both directions must receive this track bulletin and must not:

- Clear the main track.
 - Allow a following train to pass.
- or
- Pass a preceding train, unless authorized by the train dispatcher.

2. “(Time) until (time) (date), all trains use _____ track between (point) and (point). All trains must stop before fouling _____ track between these points unless directed to proceed by employee in charge of switches or by train dispatcher.”

This bulletin may also contain information on public crossing protection, switches spiked, intermediate flagman, and so forth.

Following Movement. A train may not follow another train against the current of traffic until the previous train has cleared the limits, passed a designated location, or passed a flagman located at the next intermediate point. Flag protection is not required against following trains.

Flagman Provided. When flagmen are provided, the example will be modified by adding:

- “Intermediate flagman located at (point). Trains moving against the current of traffic must stop short of flagman unless directed to proceed.”

Extending Time. Time may be extended by issuing another track bulletin as follows:

- “Track bulletin No. _____ is extended until (time).”

This bulletin will be used when one or more tracks will be removed from service, and all trains in both directions must use the remaining track as directed by the train dispatcher or an employee in charge of switches at each end of the designated limits.

The train dispatcher will authorize movement between the designated points and issue the track bulletin and necessary instructions to the employee in charge of switches. This employee may verbally direct movement or use hand signals. Also, the train dispatcher may use a controlled signal indication to authorize movement.

All affected trains must receive a copy of the track bulletin.

15.4 Protection When Tracks Removed from Service

Before a track is removed from service it must be protected.

A track bulletin may protect tracks removed from service by designating the track and naming the points at each end of the track. Trains must not use this track, unless the track bulletin states the name or title of an employee who may authorize use, and this person directs all movement. Movements must be made at restricted speed.

Proper authority must also be received to pass an absolute signal displaying a Stop indication to enter the out of service track. Except at interlockings, after stopping, movements may pass Stop indications within the out of service limits. Movements within the out of service limits may pass Stop and Proceed indications without stopping.

When required, the train dispatcher must advise crews of alternate routes and switch positions.

15.5 Protection When Tracks Blocked with Equipment

Notify the train dispatcher when main tracks, sidings, or other tracks that are normally clear are blocked with equipment and cannot be cleared.

When the main track is blocked, provide protection as specified by Rule 6.20 (Equipment Left on Main Track).

15.6 Change of a General Order, Special Instruction, or Rule

When authorized by the designated manager, a track bulletin may be used to issue, change, or cancel general orders, special instructions, or rules.

General orders or special instructions canceled by track bulletins must not be reinstated. The track bulletin must remain in effect until the general order that contains the change is posted.

15.7 Copying Track Bulletins

The conductor and the engineer must each have a copy of the track bulletins issued to their train, and each crew member must read and understand them. The copy must show the date. The following must occur when track bulletins are transmitted verbally:

1. An employee will enter all of the information on the track bulletin.
2. The employee will repeat the information to the train dispatcher.
3. The train dispatcher will check it and, if correct, will say “OK” and give the time and his initials.
4. The employee will enter the “OK” time and the train dispatcher’s initials on the track bulletin and repeat them to the train dispatcher.

Employees may relay track bulletins.

15.8 Duplicating Track Bulletins

Employees who reproduce track bulletins with a duplicating machine do not need to repeat them to the train dispatcher.

Duplicated track bulletins must not be delivered or used until they are checked and verified as:

- Legible.
- Duplicated in their entirety.

15.9 Mechanical Transmission of Track Bulletins

Repetition is not required when track bulletins are transmitted mechanically. The “OK” time will be given when the track bulletin is issued.

15.10 Retaining Track Bulletins

Employees must keep and comply with track bulletins on all trips during the tour of duty when track bulletins were received.

When directed by the train dispatcher, track bulletins may be retained for use during the next tour of duty. Before initiating movement on the main track on the next tour of duty, a crew member must verify from the train dispatcher that no additional track bulletins are needed.

15.11 Not Used

15.12 Relief of Engineer or Conductor During Trip

When a conductor, engineer, or both are relieved before a trip is finished, they must contact the train dispatcher and comply with instructions concerning the handling of their track warrants, track bulletins, and other instructions.

When crew members are called to relieve a train at other than the initial station, crew members must contact the train dispatcher before leaving the initial station and determine if any track warrants, track bulletins, or other instructions must be obtained.

Comparison of Information

The relieving conductor and engineer must compare track warrants, track bulletins, instructions, and pertinent information with each other and with the train dispatcher before proceeding.

15.13 Voiding Track Bulletins

To void a numbered line on a track bulletin, a part of a track bulletin, or an entire track bulletin, the train dispatcher may do one of the following:

A. Voiding Track Bulletins Verbally

Void the track bulletin by verbally using one of the following examples:

1. "Line (number) of track bulletin No. ____ reading (quote the line to be voided) is void."
2. "That part of track bulletin No. ____ reading (quote the part to be voided) is void."
3. "Track bulletin No. ____ is void."

Employee must repeat the information to the train dispatcher. If correct, the word "VOID" will be entered to indicate that portion is no longer in effect.

B. Issue Track Bulletin or a Track Warrant to Void a Track Bulletin

Issue a track bulletin or use the line designated "OTHER SPECIFIC INSTRUCTIONS" on a track warrant using one of the following examples:

1. "Line (number) of track bulletin No. ____ is void."
2. "That part of track bulletin No. ____ reading (quote the part to be voided) is void."
3. "Track bulletin No. ____ is void."

Where paper copies are used, employee will keep a copy of the track warrant or track bulletin that made it void and the word "VOID" will be entered to indicate that portion is no longer in effect.

The track bulletin or the part of the track bulletin indicated will no longer be in effect.

15.14 Delivering Track Bulletins

Employees who copy track bulletins for delivery must deliver copies to all those addressed, unless the track bulletin is voided or transferred to a relieving employee. When employees have delivered copies to all addressed, they must keep a copy on file.

16.0 Rules Applicable Only in Direct Traffic Control (DTC) Limits

16.1 Authority to Enter DTC Limits

The timetable will designate DTC limits. A train may enter DTC limits only after receiving authority from the train dispatcher. Men or equipment may be issued DTC authority in the same manner as trains. DTC territory will not include territory where Rule 6.13 (Yard Limits) or Rule 6.14 (Restricted Limits) is in effect.

16.1.1 Switches Between DTC Blocks

Switches between DTC blocks may be occupied only when authority includes at least one block on each side of the switch; however, men or equipment may be authorized to occupy a switch located between DTC blocks without authority on each side of the switch when the DTC authority includes the name of the switch and the instructions "Switch Yes." DTC authority must not be released until the rear of the movement has completely entered the adjoining block.

16.2 DTC Authority

The train dispatcher will issue DTC authority to a crew member on the head end of the train when possible. An employee operating the controls of a moving engine or on-track equipment may not copy DTC authority.

A. Recorded in Writing

When transmitted verbally, the employee who receives or releases DTC authority must record it in writing and include the following:

1. Name of first and last DTC block where authority is issued.
2. Time that work and time expires.
3. Train identity when DTC authority is issued behind a train or radio blocking behind a preceding train is in effect.
4. Time DTC authority is released to the train dispatcher.

DTC authority must not be transferred to a relieving crew, unless authorized to do so by the train dispatcher.

When verbal authority is received from the train dispatcher to leave equipment in a DTC block, the train dispatcher may instruct a crew member to void the DTC authority.

Employees cannot act upon DTC authority until the train dispatcher says, "That is correct."

B. Multiple Authorities

Not more than one DTC authority may be issued in the same DTC block except:

1. In ABS territory, as provided by Rule 16.3 (Movement in a Specified Direction), authority may be issued to more than one train in the same direction.
2. As provided by Rule 16.4 (Work and Time).
or
3. Where radio blocking is designated by special instructions, in non-signaled territory, more than one train may be authorized to proceed in the same direction within the same or overlapping limits, provided the following train:
 - Is notified on DTC authority of the identity of the preceding train.
 - Notifies the crew of the preceding train that radio blocking has been authorized stating the limits.
 - Does not occupy the block limits ahead of the preceding train.
 - Is notified by the preceding train that the entire train has cleared a specific block. Location specified must not be beyond block limits of the following train. The following words must be used: “(Train) clear of (block).”
 - Does not proceed beyond the last block the preceding train has reported to have cleared.

All instructions between trains must be written, repeated, and acknowledged with “That is correct” before being acted on. These written instructions between the trains must be retained until the end of tour of duty.

Written Instructions Between Trains:

“(Preceding Train ID) has cleared (Block) at (Time).” When all available lines on DTC form have been filled in, new DTC authority must be obtained.

Notify the train dispatcher if communication cannot be established between the two trains. If necessary, radio blocking information may be relayed only by the train dispatcher.

The last named point of the following train’s authority must not extend beyond the authority of the preceding train.

In the application of Rule 6.4 (Reverse Movements) and Rule 6.6 (Back Up Movements), the movement must not enter the last block reported cleared to the following train.

16.3 Movement in a Specified Direction

Issue Format

One or Two Blocks. The train dispatcher will issue authority and an employee will acknowledge it using the following sample format:

Train Dispatcher:	“RR 4321 East, with Engineer Jones, you are authorized to proceed Eastward in one block, Anna.”
Crew Member:	“RR 4321 East, with Engineer Jones, I am authorized to proceed Eastward in one block, Anna.”
Train Dispatcher:	“RR 4321 East, that is correct.”

More than Two Blocks. The train dispatcher will issue authority in more than two blocks using the following sample format:

Train Dispatcher:	“RR 4321 East, with Engineer Jones, you are authorized to proceed Eastward in three blocks, Anna through Cloy.”
--------------------------	---

16.3.1 Leaving the Main Track

A train authorized to proceed in one direction must inform the train dispatcher when it leaves the main track before reaching the last named point, unless a crew member is left to prevent a following movement from passing.

16.4 Work and Time

A. Issue Requirements

1. Work and time authority may be issued to an employee in charge of on-track equipment when:
 - The DTC block is clear.
 - The DTC block is occupied by a train and/or employee in charge of on-track equipment that has already been issued work and time. Before joint work and time may be issued, the train dispatcher must first notify the engineer of train or employee in charge of on-track equipment affected that the DTC block will be jointly occupied. All movements must be made at restricted speed within joint work and time limits.or
 - All trains issued Rule 16.3 (Movement in a Specified Direction) have passed the location where the track will be occupied and the employee receiving the DTC authority is notified that work and time is granted behind such trains.
2. Work and time authority may be issued to a train when:
 - The DTC block is clear.
 - The DTC block is occupied by a train and/or employee in charge of on-track equipment that has already been issued work and time. Before joint work and time may be issued, the train dispatcher must first notify the engineer of train or employee in charge of on-track equipment affected that the DTC block will be jointly occupied. All movements must be made at restricted speed within joint work and time limits.or
 - All trains issued Rule 16.3 (Movement in a Specified Direction) have passed the location where the track will be occupied and the employee receiving the DTC authority must be notified that work and time is granted behind such trains as prescribed by Rule 16.2 (DTC Authority).

A train or on-track equipment issued work and time may occupy the designated block and move in either direction.

An employee in charge of on-track equipment granted work and time behind a train must not pass train(s) specified.

B. Issue Format

One or Two Blocks. The train dispatcher will issue work and time and an employee will acknowledge it using the following sample format:

Train Dispatcher:	“RR 4321 East, with Engineer Jones, I am granting you work and time in one block, Anna, until 10:10 AM.”
Crew Member:	“RR 4321 East, with Engineer Jones, I am granted work and time in one block, Anna, until 10:10 AM.”
Train Dispatcher:	“RR 4321 East, that is correct.”

More than Two Blocks. The train dispatcher will issue authority in more than two blocks using the following sample format:

Train Dispatcher:	“RR 4321 East, with Engineer Jones, I am granting you work and time in 3 blocks, Anna through Cloy, until 10:10 AM.”
Crew Member:	“RR 4321 East, with Engineer Jones, I am granted work and time in three blocks, Anna through Cloy, until 10:10 AM.”

Unless the train and/or employee in charge of on-track equipment receives a time extension, they must clear the block and report “Released” before the time limit expires. The train dispatcher may issue an unspecified time limit by using the words “until released.”

A train dispatcher must not authorize a train to enter a DTC block under Rule 16.3 (Movement in a Specified Direction) until work and time in that block is released.

C. Additional Time

Trains or the employee in charge of on-track equipment must release work and time before the time granted expires. If the train or employee in charge requires additional time, the authority must be obtained from the train dispatcher before time expires. If a train crew member or employee in charge is unable to contact the train dispatcher, and the time limit expires, authority is extended until the train dispatcher is contacted.

16.5 Changing DTC Authority

When it becomes necessary to change the authority previously granted to a train, a new authority will be issued in accordance with Rule 16.3 (Movement in a Specified Direction) or Rule 16.4 (Work and Time). After the “(_____), that is correct” response is received from the train dispatcher, the authority previously granted becomes void.

The train dispatcher must notify the engineer before withdrawing previously issued DTC authority.

16.6 Releasing DTC Authority

Unless the train dispatcher specifies otherwise, when a train with directional authority clears a DTC block, an employee will immediately release it to the train dispatcher. The train must not re-enter the DTC block it has been released from.

Before a DTC block is released, engineer and conductor must communicate with each other and confirm that their train is clear of DTC block(s) to be released.

A. Release Format

One or Two Blocks. An employee will release a DTC block and the train dispatcher will acknowledge it using the following sample format:

Crew Member:	“RR 4321 East, with Engineer Jones, I am releasing one block, Anna.”
Train Dispatcher:	“RR 4321 East, with Engineer Jones, you are releasing one block, Anna.”
Crew Member:	“Train dispatcher, that is correct.”

More than Two Blocks. An employee will release more than two blocks using the following sample format:

Crew Member:	“RR 4321 East, with Engineer Jones, I am releasing three blocks, Anna through Cloy.”
---------------------	--

A DTC block is not released until the employee releasing the block reports, “Train dispatcher, that is correct.”

B. Operating in Non-Signaled or Double Track Territory

In non-signaled or double track territory, a train without a crew member on the rear of the train may release a DTC block only when the complete train is clear of the limits, which is determined by one of the following:

1. The rear of the train has an operating rear-end telemetry device, and the air pressure on the head-end device indicates brake pipe continuity.
2. An employee verifies that a marker is on the rear of the train.
3. A crew member can observe the rear car of the train on which the marker has been placed.
4. A trackside warning detector transmits an axle count for the train, and the axle count duplicates the axle count transmitted by the previous trackside warning detector.

In addition, a train clearing in a siding or other track must comply with requirements outlined in Rule 8.3 (Main Track Switches) before reporting clear of the limits.

16.7 Communication Failure

If communication fails, a third party may relay the authority to enter and/or release a DTC block as follows:

- The train dispatcher must transmit the DTC authority to the third party.
- The third party must repeat it back to the train dispatcher.
- If correct, the train dispatcher will respond, “(Third Party Identification), that is correct for relay,” which authorizes the third party to transmit the DTC authority to a crew member.
- The crew member receiving the DTC authority must repeat it back to the third party.
- If correct, the third party will respond, “(_____), that is correct” and inform the train dispatcher that DTC authority has been relayed correctly.

This page left blank intentionally.

17.0 Rules Applicable Only in Automatic Train Control (ATC) Territory

17.1 Automatic Train Control Territory

ATC territory is specified in special instructions. An engine must not be operated in ATC territory if it is not equipped with an operable ATC system unless otherwise authorized by special instructions or the train dispatcher.

17.2 Taking Charge

When taking charge of an engine equipped with ATC in ATC territory or entering such territory, engineers must know that:

1. The ATC system is cut in and sealed or locked on engines equipped.
2. The following devices are sealed (on engines equipped) with a mechanical seal:
 - Speed indicator case.
 - Speed indicator cables.
 - High speed whistle cutout cock.

17.3 Cut In and Cut Out Requirements

The ATC system, in part or in its entirety, must not be cut out in ATC territory unless:

- Train dispatcher grants permission.
- or
- Failure of the ATC system prevents train movement at restricted speed (unable to recover the air) and crew is unable to immediately contact the train dispatcher. The train dispatcher must be notified as soon as practical. Notification must include if cab signals are operative.

The train dispatcher may grant permission to a crew member to cut out the ATC system when:

- It has failed. Before granting permission to the crew to cut out the ATC the train dispatcher must determine if the cab signals are operative.
- or
- Required for movements against the current of traffic at speeds above restricted speed.

A. Cutting In ATC

To cut in ATC:

1. Turn on the ATC system.
2. Acknowledge when the acknowledging horn sounds.
3. Cut in the ATC actuator and seal or lock.

B. Cutting Out ATC

To cut out ATC:

1. Break the seal or unlock and cut out the ATC actuator.
2. Turn off the power to the ATC system.

If ATC is cut out due to failure enroute, at the next stop the engineer must cut in the ATC to determine if it is again operable. Train dispatcher must be notified if ATC is again operative or continues to fail and if cab signals are operative if previously cut out.

17.4 Departure Test Requirements

A departure test is required:

- Before entering ATC territory.
- or
- When the ATC is cut in after being cut out enroute within ATC territory.

A. Energized Test Loop

While the engine is standing on energized test loop:

1. The cab signal should display a Clear aspect.
2. When the test loop is de-energized or when the engine is moved off of the test loop, the aspect will change to a Restricting and the acknowledging horn will sound. Do not acknowledge the horn and do not move the brake valve handle.
3. A penalty brake application should occur within 8 seconds.
4. Recover the air.
5. When the horn sounds again, acknowledge to prevent a penalty brake application.

Note: To recover the air after an ATC penalty brake application, acknowledge the horn or alarm and move the brake valve handle to SUPPRESSION until the PCS light has gone out. The brakes may then be released.

Receivers on Both Ends: When an engine has ATC receivers on both ends and is standing on energized track, the cab signal should display Clear.

1. Place the reverser in Reverse position. The cab signal will change to Restricting and the acknowledging horn will sound.
2. Do not acknowledge the horn and do not move the brake valve handle. A penalty brake application should occur within 8 seconds.
3. Recover the air.
4. When the horn sounds again, acknowledge to prevent brake application.

B. De-energized Track

When engine is standing on de-energized track:

1. Release the brakes, but do not acknowledge the acknowledging horn.
2. A penalty brake application should occur within 8 seconds.
3. Recover the air.
4. When the horn sounds again, acknowledge to prevent a penalty brake application.

17.4.1 Departure Test Reporting

Records of ATC and ATS tests:

- Must be retained for 92 days.
 - Must be placed in the engine cab.
1. When Mechanical Department employees perform the test:
 - One part of the form must be retained at the test location for 92 days.
 - The other must be placed in the inspection holder in the engine cab.
 2. At points where engineers are required to perform ATC or ATS departure tests, engineers must complete the form, place it in the inspection holder of the engine, and notify the train dispatcher. Crew members are not to remove this form unless specifically instructed to do so.
 3. The train dispatcher, unless instructed otherwise, must record the date, time, location, engine number and name of the engineer.

17.5 High Speed Setting

When a cab signal displays a Clear aspect and the train speed exceeds the high-speed setting, a high speed whistle will sound continuously. This will require a SUPPRESSION brake application within 6 seconds to prevent a penalty brake application.

17.5.1 Over 40 MPH

The high-speed whistle will sound when the speed is more than 40 MPH when the cab signal changes to a Restricting aspect.

1. Move the brake valve handle to SUPPRESSION within 6 seconds to prevent a penalty brake application.
2. When speed is reduced to less than 40 MPH, the high-speed whistle will stop and the acknowledging horn will sound.
3. Acknowledge this horn. If the cab signal continues to display Restricting, speed must immediately be reduced to restricted speed.

If restricted speed is not reached within 70 seconds after the acknowledging horn was acknowledged, a penalty brake application will occur unless the brake valve handle is in SUPPRESSION.

17.5.2 Under 40 MPH

The acknowledging horn will sound if the cab signal changes from Clear to Restricting when the speed is under 40 MPH.

1. Acknowledge the horn within 6 seconds to prevent a penalty brake application.
2. If the cab signal continues to display Restricting, train speed must immediately be reduced to restricted speed.

If restricted speed is not reached within 70 seconds after the acknowledging horn was acknowledged, a penalty brake application will occur unless the brake valve handle is in SUPPRESSION.

17.5.3 Restricting Cab Signal

When cab signal changes from a Clear to a Restricting aspect, trains exceeding restricted speed must immediately reduce to restricted speed. While the cab signal continuously displays a Restricting aspect, the acknowledging horn will sound to alert the crew members of the restriction. When the speed is approaching the restricting over speed setting, the low speed alarm will sound to alert crew members that speed must be reduced.

17.6 Conforming with Block Signals

Cab signal indications do not supersede the indication displayed on block and interlocking signals. The most restrictive block or cab signal indication must be complied with. However, when the cab signal changes from Restricting to Clear after having passed the block or interlocking signal, the train may immediately comply with the cab signal indication.

Except where cab signals are capable of displaying diverging route aspects, when initiating movement or when the cab signal changes from Restricting to Clear after the engine passes a signal that governs the approach to a diverging route, the train must approach the next signal at the speed prescribed for the most restrictive route at that location until the next signal is visible.

Note: When the cab signal cycles from Clear to Restricting and immediately back to Clear, the train may continue at normal speed.

17.6.1 Approaching Diverging Route

When the cab signal changes from Restricting to Clear after the engine passes a signal displaying an Approach or a more restricting indication and the next signal can display an indication for a diverging route, the train must approach the next signal at the speed prescribed for the most restrictive route at that location. However, if the signal is seen to display an indication for a more favorable route, the speed for that route governs.

17.7 ATC Failure/Cut Out Enroute

When any part of the ATC system is cut out enroute:

1. Before an absolute block is established in advance of the train:
 - If cab signals are operative or movement will be entirely in continuous block signal territory, proceed not exceeding 40 MPH.
 - or
 - If cab signals are not operative and movement is outside continuous block signal territory, proceed at restricted speed.
2. After an absolute block is established in advance of a train:
 - If cab signals are operative or movement will be entirely in continuous block signal territory, proceed in accordance with signal indications not exceeding 79 MPH.
 - If cab signals are not operative and movement is outside continuous block signal territory:
 - Passenger trains may proceed not exceeding 59 MPH.
 - Freight trains may proceed not exceeding 49 MPH.
3. Before an absolute block in advance of movement is established in ATC territory the train dispatcher must determine if:
 - The cab signals are operative.
 - The absolute block in advance of movement will be entirely in territory with continuous fixed block signals.
 - a. If the cab signals are operative or the absolute block in advance of movement will be entirely in continuous block signal territory, the train dispatcher may establish an absolute block in advance of movement as provided by Rule 11.1 (Establishing an Absolute Block). Rule 11.2 (Signal Indications with Absolute Block) applies. If the cab signal changes to Restricting, the train must stop.
 - b. If the cab signals are inoperative and any part of the absolute block in advance of movement will be outside continuous block signal territory, the train dispatcher must not establish an absolute block in advance of movement until it is determined that no trains or engines:
 - Occupy the limits ahead of the train being given the absolute block in advance of movement.
 - Will occupy the limits ahead of the train being given the absolute block in advance of movement.
 - c. Rule 9.15 (Track Permit) or Rule 10.3 (Track and Time) establishes an absolute block when not issued joint.

17.7.1 Speed Indicator in ATC

An inoperative or inaccurate speed indicator, as prescribed by Rule 1.39 (Accuracy of Speed Indicator) is considered an ATC failure. Rule 17.7 (ATC Failure/Cut Out Enroute) applies.

17.7.2 ATC Motion Light

If the motion light is not on when the speed is 6 MPH or above, proceed in accordance with the cab signal indication but not to exceed 40 MPH. Rule 17.7 (ATC Failure/Cut Out Enroute) applies.

17.7.3 Audible Indicator

If the audible indicator does not sound when the cab signal changes to a more restrictive indication or continues to sound when the cab signal change is acknowledged, it is considered an ATC failure. Rule 17.7 (ATC Failure/Cut Out Enroute) applies.

17.8 Improper Display

If a cab signal displays Clear when it should display Restricting due to an open switch, occupied block, or other condition, the train must:

- Stop and warn other trains by radio of exact location and status of train.
- Contact the train dispatcher and be governed by his instructions. If the train dispatcher gives permission to proceed, the train must proceed at restricted speed until the train dispatcher establishes an absolute block in advance of movement.

18.0 Section Reserved

19.0 Section Reserved

Glossary

Abbreviations

Use only the following abbreviations:

ABS Automatic Block Signal System
 ACS Automatic Cab Signal System
 AMTK..... Amtrak
 ATC..... Automatic Train Control
 ATS..... Automatic Train Stop
 AUTH..... Authority
 BO Bad Order
 BRN Branch
 BRT Block Register Territory
 C Center
 C & E Conductor and Engineer
 COFC Container on Flat Car
 CONDR Conductor
 CP..... Control Point
 CTC Centralized Traffic Control
 DCS Dual Control Switch
 DISPR..... Dispatcher
 DIST District
 DIV..... Division
 DT..... Double Track
 DTC Direct Traffic Control
 E East
 ENG..... Engine
 ENGR Engineer
 ESS East Siding Switch
 EWD Eastward
 FRT..... Freight
 HER..... Head End Restriction
 IM..... Intermodal
 JCT..... Junction
 MAX..... Maximum
 MMT Multiple Main Track
 MP Mile Post
 MPH..... Miles Per Hour
 MT Main Track
 MW Maintenance of Way
 N North
 NO Number
 NSS North Siding Switch
 NWD Northward
 OK Correct
 OOS..... Out of Service
 OPR..... Operator
 ORIG Originating
 PSGR Passenger
 RC Radio Channel
 RCO..... Remote Control Operator
 RCZ Remote Control Zone
 RECD Received
 RE..... Region
 S South

SDG..... Siding
 SSS South Siding Switch
 SUB Subdivision
 SUBDIV Subdivision
 SUPT Superintendent
 SW..... Switch
 SWD Southward
 TOFC..... Trailer on Flat Car
 TRK Track
 TRN Train
 TWC Track Warrant Control
 W West
 WSS West Siding Switch
 WWD Westward
 XO Crossover
 YD..... Yard
 YL Yard Limits
 YM Yardmaster

Use the normal abbreviations for names of months.

ABS

See Automatic Block Signal System.

Absolute Block

A length of track that no train is permitted to enter while the track is occupied by another train.

Absolute Signal

A block or interlocking signal without a number plate, or designated by an A marker.

ACS

See Automatic Cab Signal System.

Articulated

Permanently connected multiple unit cars that share a common truck.

ATC Actuator

An ATC brake applying apparatus.

ATS

See Automatic Train Stop System.

Automatic Block Signal System (ABS)

A series of consecutive blocks governed by block signals, cab signals, or both. The signals are activated by a train or by certain conditions that affect the block use.

Automatic Cab Signal System (ACS)

A system that allows cab signals and the cab warning whistle to operate automatically.

Automatic Train Control (ATC)

A system to enforce compliance with cab and wayside signal indications. If the train exceeds a predetermined speed for a given signal indication and speed is not reduced at a sufficient rate, brakes are automatically applied.

Automatic Train Stop System (ATS)

A system activated by wayside inductors positioned to apply the brakes automatically until the train stops.

Block

A length of track:

- between consecutive block signals.
 - between a block signal and the end of block system limits.
- or
- in ATC limits the use of which is governed by cab signals and/or block signals.

Block Register Territory (BRT)

A method of operation in non-signaled territory where trains, men, and equipment are authorized to occupy the main track in limits designated by the timetable.

Block Signal

A fixed signal at the entrance of a block that governs trains entering and using that block.

Block System

A block or series of consecutive blocks within ABS, ACS, CTC, or interlocking limits.

BRT

See Block Register Territory.

Cab Signal

A signal in the engineer's compartment or cab that indicates a condition affecting train movement. Cab signals are used with interlocking or block signals or without block signals.

Cars

Railroad cars.

Centralized Traffic Control (CTC)

A block system that uses block signal indications to authorize train movements.

Clearance Point

The location closest to a switch where it is safe for equipment, and a person riding the side of equipment unless prohibited, to pass equipment on an adjacent track.

Conductor

Crew member in charge of train or yard crew.

Control Operator

Employee assigned to operate a CTC or interlocking control machine or authorized to grant track permits.

Control Point

The location of absolute signals controlled by a control operator.

Controlled Siding

A siding within CTC or interlocking limits where a signal indication authorizes the siding's use.

Controlled Signal

An absolute signal controlled by a control operator.

Crew Member

Conductors, assistant conductors, brakemen, engineers, remote control operators, yard engine foremen, switchmen, and yard helpers.

Crossings at Grade

Crossings that intersect at the same level.

Crossover

A track connection between two adjacent tracks, consisting of two switches, which is intended to be used primarily for the purpose of crossing over from one track to the other.

CTC

See Centralized Traffic Control.

Current of Traffic

The movement of trains in one direction on a main track, as specified by the rules.

Direct Traffic Control (DTC)

A DTC block or a series of DTC blocks where the train dispatcher authorizes track occupancy.

Distant Signal

A fixed signal outside a block system that governs the approach to a block signal, interlocking signal, or switch point indicator. A distant signal does not indicate conditions that affect track use between the distant signal and block or interlocking signals or between the distant signal and switch point indicator. A distant signal is identified by a D.

Double Track

Two main tracks where the current of traffic on one track is in a specified direction and in the opposite direction on the other.

DTC

See Direct Traffic Control.

DTC Block

A length of main track specified by name. DTC block name and limits are identified by wayside signs reading, Begin (name) Block and End (name) Block and by mile post location in the timetable.

Dual Control Switch

A power-operated switch, moveable point frog, or derail that can also be operated by hand.

Electric Switch Lock

An electrically controlled lock that restricts the use of a hand-operated switch or derail.

Engine

A unit propelled by any form of energy or more than one of these units operated from a single control. Engines are used in train or yard service. Rules that apply to engines also apply to cab control cars.

Engineer

Also includes student engineers, firemen, hostlers, and remote control operators.

Equipment

Railroad equipment.

Equipment Fouling a Track

The end of rolling equipment or on-track maintenance of way equipment left between the clearance point and the switch points leading to the track on which the equipment is standing.

Fixed Signal

A signal that is fixed to a location permanently and that indicates a condition affecting train movement.

Flagman

Any employee providing flag protection as outlined in Rule 6.19 (Flag Protection) and for other purposes as outlined in the rules.

Foreman

Employee in charge of work.

Interlocking

Signal appliances that are interconnected so that each of their movements follows the other in a proper sequence. Interlockings may be operated manually or automatically.

Interlocking Limits

The tracks between outer opposing absolute signals of an interlocking.

Interlocking Signals

The fixed signals of an interlocking that govern trains using interlocking limits.

Main Track

A track extending through yards and between stations that must not be occupied without authority or protection.

Men or Equipment

A term referring to Engineering Department employees and their related equipment.

Multiple Main Tracks

Two or more main tracks that are used according to the timetable.

Pilot

An employee assigned to a train to assist an engineer or conductor who is unfamiliar with the rules or the portion of railroad the train will operate on.

Proceed Indication

Any block signal indication that allows a train to proceed without stopping.

Radio

As used in these rules it also applies to wireless communication devices when used in railroad operation.

Radio Blocking

A method to establish an absolute block for a following train in non-signaled territory by direct communication with a preceding train.

RCO

See Remote Control Operator

RCZ

See Remote Control Zone

Remote Control Operator (RCO)

An employee who may operate an engine with or without cars by means of a remote control transmitter.

Remote Control Transmitter

A device that gives the remote control operator control of a remote control engine.

Remote Control Zone (RCZ)

A portion of track(s) within definite limits designated in the timetable special instructions.

Restricted Limits

A portion of main track designated by restricted limits signs and timetable special instructions or a track bulletin.

Reverse Movement

A movement opposite the authorized direction.

Siding

A track connected to the main track and used for meeting or passing trains. Location of sidings are shown in the timetable.

Signal Aspect

The appearance of a fixed or cab signal.

Signal Indication

The action required by the signal aspect.

Single Track

A main track where trains are operated in both directions.

Special Instructions

Instructions contained in the timetable or other publication.

Spring Switch

A switch with a spring mechanism that returns the switch points to the original position after they are trailed through.

Station

A place designated by name in the timetable station column.

Switch Point Indicator

A light type indicator used during movement over certain switches to show that switch points fit properly.

Timetable

A publication with instructions on train, engine, or equipment movement. It also contains other essential information.

Track Bulletin

A notice of conditions affecting train movement. It may also authorize movement against the current of traffic where Rule 9.14 (Movement with the Current of Traffic) is in effect.

Track Occupancy Indicator

An indicator that tells whether a length of track is occupied or not.

Trackside Warning Detector

A device that indicates conditions such as overheated journals, dragging equipment, excess dimensions, shifted loads, high water, or slides.

Track Warrant Control (TWC)

A method to authorize train movements or protect men or machines on a main track within specified limits in a territory designated by the timetable.

Train

One or more engines coupled, with or without cars, displaying a marker, and authorized to operate on a main track. A term that when used in connection with speed restrictions, flag protection, and the observance of all signals and signal rules also applies to engines.

Train Coordination

Working limits established by a roadway worker through the use of a train's authority on a main track or other track where specific authority is required from a control operator or train dispatcher.

TWC

See Track Warrant Control.

Variable Switch

A switch identified by a V or a bowl painted yellow. When trailed through, the switch points remain lined in the position they were forced.

Whistle Quiet Zone

A designated portion of track, that includes road crossing(s) at grade where whistle signal (7) is not regularly sounded.

Working Limits

A segment of track within definite boundaries on which movements may be made only as permitted by the employee in charge. Boundaries may be established using mile posts, station signs, timetable locations, or clearly identifiable points.

Yard

A system of tracks, other than main tracks and sidings, used for making up trains, storing cars, and other purposes.

Yard Limits

A portion of main track designated by yard limit signs and timetable special instructions or a track bulletin.

Index

Absence from Duty

- 1.15.....Duty—Reporting or Absence
- 1.16.....Subject to Call

Accidents

- 1.1.3.....Accidents, Injuries, and Defects
- 1.2.3.....Equipment Inspection
- 1.2.4.....Mechanical Inspection
- 1.2.6.....Statements
- 1.2.7.....Furnishing Information
- 2.10.....Emergency Calls

ACS

See Automatic Cab Signal System

Against the Current of Traffic

See Movements Against the Current of Traffic

Air Brake

- 1.3.1.....Rules, Regulations, and Instructions
- 1.14.....Employee Jurisdiction
- 4.2.....Special Instructions
- 6.23.....Emergency Stop or Severe Slack Action
- 7.6.....Securing Cars or Engines
- 7.11.....Charging Necessary Air Brakes
- 15.6.....Change of General Order, Special Instruction or Rule

Alcohol

- 1.5.....Drugs and Alcohol

Altercations

- 1.7.....Altercations

Altering Equipment

- 1.23.....Altering Equipment

Appearance

- 1.8.....Appearance

ATC

See Automatic Train Control

ATS

See Automatic Train Stop System

Authority

See Main Track

Automatic Cab Signal System (ACS)

- 9.10.....Initiating Movement Between Signals
- 11.1.....Establishing Absolute Block
- 11.2.....Signal Indications with Absolute Block
- 11.3.....Broken or Missing Seals
- 13.1.1.....Observations of Signals
- 13.1.2.....Conforming with Block Signals
- 13.1.3.....Does Not Indicate Conditions Ahead
- 13.1.4.....Cab Signals Cut In and Out
- 13.2.1.....Restrictive to More Favorable
- 13.2.2.....Favorable to More Restrictive
- 13.2.3.....Elimination of Audible Indicator
- 13.3.1.....Cab Signal and Block Signal Do Not Agree
- 13.3.2.....Inoperative Cab Signal Device
- 13.3.3.....Movement with an Inoperative Cab Signal Device

Automatic Interlocking

- 6.4.2.....Movements Within Control Points or Interlockings
- 6.16.....Approaching Railroad Crossings, Drawbridges, and End of Multiple Main Track
- 9.3.....What Signals Govern
- 9.9.1.....Approach to Automatic Interlocking
- 9.12.3.....Automatic Interlockings
- 9.19.....Leaving Equipment in Signal Systems
- 10.3.....Track and Time

Automatic Switches

- 8.19.....Automatic Switches

Automatic Train Control (ATC)

- 9.10.....Initiating Movement Between Signals
- 11.1.....Establishing Absolute Block
- 11.2.....Signal Indications with Absolute Block
- 11.3.....Broken or Missing Seals
- 17.1.....Automatic Train Control Territory
- 17.2.....Taking Charge
- 17.3.....Cut In and Cut Out Requirements
- 17.4.....Departure Test Requirements
- 17.4.1.....Departure Test Reporting
- 17.5.....High Speed Setting
- 17.5.1.....Over 40 MPH
- 17.5.2.....Under 40 MPH
- 17.5.3.....Restricting Cab Signal
- 17.6.....Conforming with Block Signals
- 17.6.1.....Approaching Diverging Route
- 17.7.....ATC Failure/Cut Out Enroute
- 17.7.1.....Speed Indicator in ATC
- 17.7.2.....ATC Motion Light
- 17.7.3.....Audible Indicator
- 17.8.....Improper Display

Automatic Train Stop (ATS)

- 11.1.....Establishing Absolute Block
- 11.2.....Signal Indications with Absolute Block
- 11.3.....Broken or Missing Seals
- 12.1.....Required Equipment
- 12.2.....ATS Device Cut Out, Not Equipped, or Not Working
- 12.3.1.....ATS Penalty Brake Application
- 12.3.2.....ATS Inoperative
- 12.3.3.....Damaged Inductor
- 12.4.1..... Test Inductor Locations
- 12.4.2.....No Test Inductors

Automatic Warning Devices

- 5.8.4.....Whistle Quiet Zone
- 5.8.5.....Silenced Whistle
- 6.32.1.....Providing Warning Over Road Crossings
- 6.32.2.....Automatic Warning Devices
- 6.32.4.....Clear of Crossings and Signal Circuits
- 6.32.5.....Actuating Automatic Warning Devices Unnecessarily
- 9.23.1.....Guidelines While Block System is Suspended

Back Up Movements

- 6.5.....Shoving Movements
- 6.6.....Back Up Movements
- 14.4.1.....Radio Blocking
- 16.2.....DTC Authority

Bell

- 1.2.2.....Witnesses
- 5.8.1.....Ringing Engine Bell
- 5.8.3.....Whistle Failure

Block Register Territory

- 6.15.....Block Register Territory (BRT)

Block Signals

- See Signals
- 1.47.....Duties of Crew Members
 - 2.12.....Fixed Signal Information
 - 5.15.....Improperly Displayed Signals
 - 6.19.....Flag Protection
 - 9.1.....Signal Aspects and Indications
 - 9.3.....What Signals Govern
 - 9.5.....Where Stop Must Be Made
 - 9.7.....Failure to Display Most Restrictive Indication
 - 9.9.....Train Delayed Within a Block
 - 9.9.1.....Approach to Automatic Interlocking
 - 9.10.....Initiating Movement Between Signals
 - 13.1.2.....Conforming with Block Signals
 - 17.6.....Conforming with Block Signals

Blue Signal

- 5.13.....Blue Signal Protection of Workman
- 5.13.1.....Utility Employees
- 8.12.....Hand-Operated Crossover Switches
- 8.20.....Derail Location and Position

Bowl Tracks

- 7.13.....Protection of Employees in Bowl Tracks

Cab Signals

- See Automatic Cab Signal System
- 9.10.....Initiating Movement Between Signals
 - 17.5.3.....Restricting Cab Signal

Call Lights

- 9.24.....Call Lights

Careless

- 1.6.....Conduct

Cars

- 1.2.4.....Mechanical Inspection
- 1.20.....Alert to Train Movement
- 1.21.....Occupying Roof
- 1.23.....Altering Equipment
- 1.31.....Repairs to Foreign Cars
- 1.32.....Overheated Wheels
- 1.33.....Inspection of Freight Cars
- 1.34.....Flat Spot
- 1.35.....Dump Doors
- 1.36.....Excessive Dimension Loads
- 1.37.....Open Top Loads
- 1.38.....Shipments Susceptible to Damage
- 1.41.....Engines Coupled to Occupied Passenger Cars
- 5.12.....Protection of Occupied Outfit Cars
- 6.5.....Shoving Movements
- 6.20.....Equipment Left on Main Track
- 6.28.3.....Cars or Equipment Left on Siding
- 6.32.4.....Clear of Crossings and Signal Circuits
- 7.4.....Precautions for Coupling or Moving Cars or Engines
- 9.19.....Leaving Equipment in Signal Systems
- 9.20.....Clear Track Circuits
- 9.22.....Standing on Sanded Rail
- 15.5.....Protection When Tracks Blocked with Equipment

Centralized Traffic Control (CTC)

See Track and Time

- 6.3.1..... Train Coordination
- 6.4.2..... Movements Within Control Points or Interlockings
- 6.13..... Yard Limits
- 9.5.2..... Protection If Signal Appliance or Track is Damaged
- 9.5.3..... Protection During Repairs
- 9.5.4..... Authority to Proceed
- 9.5.5..... Reporting Delays
- 9.9..... Trains Delayed Within a Block
- 9.12.1..... CTC Territory
- 9.13..... When Instructed to Operate Dual Control Switches by Hand
- 9.13.1..... Hand Operation of Dual Control Switches
- 9.18..... Electrically Locked Switches and Derails
- 10.1..... Authority to Enter CTC Limits
- 10.2..... Clearing Through Hand-Operated Switches

Change of Direction

- 6.4.2..... Movement Within Control Points or Interlockings
- 8.9.2..... Trailing Through and Stopping on a Spring Switch
- 8.15..... Switches Run Through

Circulars

- 1.3.3..... Circulars, Instructions, and Notices

Conduct

- 1.6..... Conduct

Conductor

- 1.6.1..... Motor Vehicle Driving Records
- 1.47..... Duties of Crew Members

Continued Employment

- 1.1..... Safety

Controlled Siding

- 6.2..... Initiating Movement
- 6.4..... Reverse Movements
- 6.5..... Shoving Movements
- 6.6..... Back Up Movements
- 6.23..... Emergency Stop or Severe Slack Action
- 6.30..... Receiving or Discharging Passengers
- 10.1..... Authority to Enter CTC Limits
- 10.2..... Clearing Through Hand-Operated Switches

Control Point

- 6.4.2..... Movement Within Control Points or Interlockings

Control Operators

- 1.3.1..... Rules, Regulations, and Instructions
- 1.45..... Duties of Control Operators and Operators

Credit

- 1.25..... Credit or Property

Crew Members

- 1.47..... Duties of Crew Members

Crossings

- See Public Crossing
- See Railroad Crossing

Crossover Switches

- 8.3..... Main Track Switches
- 8.12..... Hand-Operated Crossover Switches
- 8.14..... Conflicting Movements Approaching Switch

CTC

- See Centralized Traffic Control
- 9.5.1..... Changing Established Route

Current of Traffic

- 5.4.6..... Display of Flags Within Current of Traffic
- 6.3..... Main Track Authorization
- 6.3.1..... Train Coordination
- 6.13..... Yard Limits
- 6.14..... Restricted Limits
- 6.24..... Movement on Double Track
- 6.25..... Movement Against the Current of Traffic
- 8.3..... Main Track Switches
- 9.12.4..... ABS Territory
- 9.14..... Movement with the Current of Traffic
- 9.14.1..... Reporting Clear of a Track Having a Current of Traffic
- 9.17..... Entering Signaled Track at Hand-Operated or Spring Switch
- 9.17.1..... Signal Protection in ABS by Lining Switch
- 14.6..... Movement Against the Current of Traffic
- 15.3..... Authorizing Movement Against the Current of Traffic

Damage to Property

- See Railroad Property

Defects

- 1.1.3..... Accidents, Injuries, and Defects
- 1.2.3..... Equipment Inspection
- 1.40..... Reporting Engine Defects
- 6.21.1..... Protection Against Defects

Delayed Within a Block

- 9.9..... Train Delayed Within a Block
- 9.9.1..... Approach to Automatic Interlocking

Derails

- See Hand-Operated Switches
- 5.12.....Protection of Occupied Outfit Cars
- 6.27.....Movement at Restricted Speed
- 6.28.....Movement on Other than Main Track
- 8.2.....Position of Switches
- 8.8.....Switches Equipped with Locks, Hooks or Latches
- 8.20.....Derail Location and Position
- 9.5.1.....Changing Established Route
- 9.5.6.....Track Occupancy Indicator
- 9.18.....Electrically Locked Switches and Derails

Detoured Trains

- 1.42.....Trains Detoured

Direct Traffic Control (DTC)

- 6.3.1.....Train Coordination
- 6.25.....Movement Against the Current of Traffic
- 9.12.4.....ABS Territory
- 16.1.....Authority to Enter DTC Limits
- 16.2.....DTC Authority
- 16.3.....Movement in a Specified Direction
- 16.4.....Work and Time
- 16.5.....Changing DTC Authority
- 16.6.....Releasing DTC Authority
- 16.7.....Communication Failure

Discourteous

- 1.6.....Conduct

Dishonest

- 1.6.....Conduct

Distant Signals

- 8.9.6.....Approaching a Spring Switch in Non-Signaled Territory
- 9.1.....Signal Aspects and Indications

Ditch Lights

- 5.9.5.....Displaying Ditch Lights

Double Track

- 5.4.6.....Display of Flags Within Current of Traffic
- 6.16.....Approaching Railroad Crossings, Drawbridges, and End of Multiple Main Track
- 6.24.....Movement on Double Track
- 6.25.....Movement Against the Current of Traffic
- 6.26.....Use of Multiple Main Track
- 8.3.....Main Track Switches
- 9.12.4.....ABS Territory
- 9.14.....Movement with the Current of Traffic
- 9.14.1.....Reporting Clear of a Track Having a Current of Traffic
- 15.3.....Authorizing Movement Against the Current of Traffic

Drawbridge

- 6.6.....Back Up Movements
- 6.16.....Approaching Railroad Crossings, Drawbridges, and End of Multiple Main Track
- 9.12.1.....CTC Territory
- 9.12.2.....Manual Interlockings

Driving Record

- 1.6.1.....Motor Vehicle Driving Records

Dropped Cars

- 6.32.1.....Providing Warning Over Road Crossings
- 7.1.....Switching Safely and Efficiently
- 7.7.....Kicking or Dropping Cars
- 7.7.1.....Gravity Switch Moves

Dual Control Switches

- 8.1.....Hand Operation of Switches
- 8.8.....Switches Equipped with Locks, Hooks or Latches
- 8.17.....Avoid Sanding Over Moveable Parts
- 8.19.....Automatic Switches
- 9.13.....When Instructed to Operate Dual Control Switches by Hand
- 9.13.1.....Hand Operation of Dual Control Switches

Drugs

- 1.5.....Drugs and Alcohol

DTC

See Direct Traffic Control

Dump Doors

- 1.35.....Dump Doors

Electrically Locked Switches

- 9.18.....Electrically Locked Switches and Derails

Electronic Devices

- 1.10.....Games, Reading, or Other Media
- 2.21.....Electronic Devices

Emergency

- 2.10.....Emergency Calls

Emergency Stop

- 6.23.....Emergency Stop or Severe Slack Action

Employees Working Sign

- 5.14.....Signs Protecting Equipment

Employment

- 1.18.....Unauthorized Employment

Engineer

- 1.6.1.....Motor Vehicle Driving Records
- 1.47.....Duties of Crew Members

Engine Number

5.11.....Engine Identifying Number

Engines

1.2.4.....Mechanical Inspection
 1.20.....Alert to Train Movement
 1.21.....Occupying Roof
 1.23.....Altering Equipment
 1.29.....Avoiding Delays
 1.30.....Riding Engine
 1.34.....Flat Spots
 1.39.....Accuracy of Speed Indicator
 1.40.....Reporting Engine Defects
 1.41.....Engines Coupled to Occupied Passenger Cars
 5.9.4.....Displaying Headlights Front and Rear
 5.9.5.....Displaying Ditch Lights
 5.9.6.....Displaying Oscillating White Headlight
 5.9.7.....Displaying Oscillating or Flashing Red Light
 5.11.....Engine Identifying Number
 7.4.....Precautions for Coupling or Moving Cars or Engines
 9.20.....Clear Track Circuits
 9.22.....Standing on Sanded Rail

Equipment

See Cars

See Engines

1.1.4.....Condition of Equipment and Tools
 1.2.3.....Equipment Inspection
 1.2.4.....Mechanical Inspection
 1.20.....Alert to Train Movement
 1.22.....Unauthorized Persons on Equipment
 1.23.....Altering Equipment
 15.5.....Protection When Tracks Blocked with Equipment

Examinations

1.3.1.....Rules, Regulations, and Instructions

Excepted Track

6.12.....FRA Excepted Track

Fire

1.28.....Fire

Fixed Signal

2.12.....Fixed Signal Information
 5.15.....Improperly Displayed Signals

Flagmen

5.2.2.....Signals Used by Employees

Flag Protection

6.19.....Flag Protection

Flags

See Green Flags

See Yellow Flags

See Yellow-Red Flags

See Red Flags

FRA Excepted Track

6.12.....FRA Excepted Track

Fusee

5.6.....Unattended Fusee

Games

1.10.....Games, Reading, or Other Media
 2.21.....Electronic Devices

General Order

1.3.1.....Rules, Regulations, and Instructions
 1.3.2.....General Orders
 4.1.1.....Notice of New Timetable
 15.6.....Change of General Order, Special Instruction or Rule

Good Faith Challenge

1.4.1.....Good Faith Challenge

Gratuities

1.26.....Gratuities

Green Flags

5.4.2.....Display of Yellow Flag
 5.4.5.....Display of Green Flag
 5.4.6.....Display of Flags Within Current of Traffic
 5.15.....Improperly Displayed Signals

Hand Brakes

7.4.....Precautions for Coupling or Moving Cars or Engines
 7.5.....Testing Hand Brakes
 7.6.....Securing Cars or Engines

Hand-Operated Switches

See Main Track Switches

See Spring Switches

8.1.....Hand Operation of Switches
 8.2.....Position of Switches
 8.8.....Switches Equipped with Locks, Hooks or Latches
 8.11.....Switches in Sidings
 8.12.....Hand-Operated Crossover Switches
 8.14.....Conflicting Movements Approaching Switch
 8.15.....Switches Run Through
 8.16.....Damaged or Defective Switches
 9.13.....When Instructed to Operate Dual Control Switches by Hand
 9.13.1.....Hand Operation of Dual Control Switches
 9.18.....Electrically Locked Switches and Derails

Hand Signals

- 5.1.....Signal Equipment
- 5.2.....Receiving and Giving Signals
 - 5.2.1.....Looking for Signals
 - 5.2.2.....Signals Used by Employees
- 5.3.1.....Hand Signals
- 5.3.2.....Giving Signals
- 5.3.3.....Signal Disappearance
- 5.3.4.....Signal to Stop
- 5.3.5.....Acknowledge Stop Signal
- 5.3.6.....Radio and Voice Communication
- 5.9.1.....Dimming Headlight

Hazardous Material

- 1.3.1.....Rules, Regulations, and Instructions
- 1.14.....Employee Jurisdiction
- 1.33.....Inspection of Freight Cars
- 6.12.....FRA Excepted Track

Headlight

- 5.9.....Headlight Display
 - 5.9.1.....Dimming Headlight
 - 5.9.2.....Headlight Off
 - 5.9.3.....Headlight Failure
 - 5.9.4.....Displaying Headlights Front and Rear
 - 5.9.6.....Displaying Oscillating White Headlight

Hours of Service

- 1.17.....Hours of Service Law
- 15.12.....Relief of Engineer or Conductor During Trip

Hump Yard

- 7.13.....Protection of Employees in Bowl Tracks

Immoral

- 1.6.....Conduct

Injuries

- 1.1.2.....Alert and Attentive
- 1.1.3.....Accidents, Injuries, and Defects
- 1.2.1.....Care for Injured
- 1.2.2.....Witnesses
- 1.2.3.....Equipment Inspection
- 1.2.4.....Mechanical Inspection
- 1.2.5.....Reporting
- 1.2.6.....Statements
- 1.2.7.....Furnishing Information
- 2.10.....Emergency Calls

Information

- 1.27.....Divulging Information

Initiating Movement

- 6.2.....Initiating Movement
- 15.10.....Retaining Track Bulletins

Inspection

- 1.2.4.....Mechanical Inspection
- 1.33.....Inspection of Freight Cars
- 6.29.1.....Inspecting Passing Trains
- 6.29.2.....Train Inspections by Crew Members

Instructions

- 1.3.1.....Rules, Regulations, and Instructions
- 1.3.3.....Circulars, Instructions, and Notices
- 1.13.....Reporting and Complying with Instructions
- 6.1.....Repeat Instructions

Insubordinate

- 1.6.....Conduct
- 1.13.....Reporting and Complying with Instructions

Interlocking

- See Manual Interlocking
- See Automatic Interlocking

Junctions

- 5.4.2.....Display of Yellow Flag
- 5.4.3.....Display of Yellow-Red Flag
- 6.17.....Switches at Junctions
- 6.18.....Stopping Clear of Crossings and Junctions

Jurisdiction

- 1.14.....Employee Jurisdiction

Kicked Cars

- 6.32.1.....Providing Warning Over Road Crossings
- 7.1.....Switching Safely and Efficiently
- 7.7.....Kicking or Dropping Cars
 - 7.7.1.....Gravity Switch Moves

Main Track

- See Main Track Authority
- 2.14.....Transmission of Mandatory Directives
- 6.2.....Initiating Movement
 - 6.2.1.....Train Location
 - 6.3.1.....Train Coordination
 - 6.4.1.....Permission for Reverse Movements
 - 6.11.....Mandatory Directive
 - 6.20.....Equipment Left on Main Track
 - 6.23.....Emergency Stop or Severe Slack Action
 - 9.14.1.....Reporting Clear of a Track Having a Current of Traffic
 - 15.5.....Protection When Tracks Blocked with Equipment

Main Track Authority

- 6.3..... Main Track Authorization
- 6.13..... Yard Limits
- 6.15..... Block Register Territory (BRT)
- 9.14..... Movement with the Current of Traffic
- 9.15..... Track Permits
- 10.1..... Authority to Enter CTC Limits
- 10.3..... Track and Time
- 14.1..... Authority to Enter TWC Limits
- 16.1..... Authority to Enter DTC Limits
- 16.4..... Work and Time

Main Track Switches

See Spring Switches

See Dual Control Switches

- 8.3..... Main Track Switches
- 8.4..... Lining Main Track Switch
- 8.6..... Restoring Switch to Normal Position
- 8.7..... Clearing of Main Track Switches
- 8.8..... Switches Equipped with Locks, Hooks or Latches
- 8.12..... Hand-Operated Crossover Switches
- 9.14.1..... Reporting Clear of a Track Having a Current of Traffic
- 9.17..... Entering Signaled Track at Hand-Operated or Spring Switch
- 10.1..... Authority to Enter CTC Limits
- 10.2..... Clearing Through Hand-Operated Switches
- 14.3.1..... Leaving the Main Track
- 14.7..... Reporting Clear of Limits

Mandatory Directive

- 2.14..... Transmission of Mandatory Directives
- 2.14.1..... Verbally Transmitting and Repeating Mandatory Directives
- 6.11..... Mandatory Directive

Manual Interlocking

- 6.3..... Main Track Authorization
- 6.4.1..... Permission for Reverse Movements
- 6.4.2..... Movement Within Control Points or Interlockings
- 6.16..... Approaching Railroad Crossings, Drawbridges, and End of Multiple Main Track
- 8.17..... Avoid Sanding Over Moveable Parts
- 9.5.1..... Changing Established Route
- 9.5.2..... Protection If Signal Appliance or Track is Damaged
- 9.5.3..... Protection During Repairs
- 9.5.4..... Authority to Proceed
- 9.5.5..... Reporting Delays
- 9.9..... Train Delayed Within a Block
- 9.12.2..... Manual Interlockings
- 9.13..... When Instructed to Operate Dual Control Switches by Hand
- 9.13.1..... Hand Operation of Dual Control Switches
- 9.17..... Entering Signaled Track at Hand-Operated or Spring Switch
- 9.18..... Electrically Locked Switches and Derails
- 9.19..... Leaving Equipment in Signal Systems
- 10.3..... Track and Time

Maximum Speed

- 5.8.5..... Silenced Whistle
- 6.5..... Shoving Movements
- 6.12..... FRA Excepted Track
- 6.19..... Flag Protection
- 6.31..... Maximum Authorized Speed
- 9.23.1..... Guidelines While Block System is Suspended
- 10.2..... Clearing Through Hand-Operated Switches
- 15.2..... Protection by Track Bulletin Form B

Marker

- 5.10..... Marker
- 5.10.1..... Highly Visible Marker
- 5.10.2..... Alternative Markers

Men Working Sign

- 5.14..... Signs Protecting Equipment

Meets

- 6.8..... Stopping Clear for Meeting or Passing
- 6.9..... Meeting or Passing Precautions

Misconduct

- 1.4..... Carrying Out Rules and Reporting Violations
- 1.6..... Conduct

Motor Vehicle Driving Records

- 1.6.1..... Motor Vehicle Driving Records

Movements Against the Current of Traffic

- 6.13..... Yard Limits
- 6.25..... Movement Against the Current of Traffic
- 14.6..... Movement Against the Current of Traffic
- 15.3..... Authorizing Movement Against the Current of Traffic

Multiple Main Track

- 5.4.8..... Flag Location
- 6.16..... Approaching Railroad Crossings, Drawbridges, and End of Multiple Main Track
- 6.26..... Use of Multiple Main Tracks

Napping

- 1.11..... Sleeping
- 1.11.1..... Napping

Negligence

- 1.4..... Carrying Out Rules and Reporting Violations
- 1.6..... Conduct

Notices

- 1.3.3..... Circulars, Instructions, and Notices

Obedying the Rules

- 1.1..... Safety
- 1.3.1..... Rules, Regulations, and Instructions
- 1.4..... Carrying Out Rules and Reporting Violations

Open Top Loads

- 1.37..... Open Top Loads
- 1.38..... Shipments Susceptible to Damage
- 7.3..... Additional Switching Precautions

Operating Rules

- 1.3.1..... Rules, Regulations, and Instructions
- 1.3.2..... General Orders
- 4.2..... Special Instructions
- 15.6..... Change of a General Order, Special Instruction, or Rule

Oscillating or Flashing Red Light

- 5.9.7..... Displaying Oscillating or Flashing Red Light

Oscillating White Headlight

- 5.9.6..... Displaying Oscillating White Headlight

Other Than Main Track

- 6.28..... Movement on Other Than Main Track
- 6.30..... Receiving or Discharging Passengers
- 8.12..... Hand-Operated Crossover Switches
- 9.20..... Clear Track Circuits

Outfit Cars

- 5.12..... Protection of Occupied Outfit Cars
- 7.9..... Switching Passenger or Occupied Outfit Cars

Overlap Circuits

- 9.21..... Overlap Circuits

Passenger Trains & Cars

- 1.41..... Engines Coupled to Occupied Passenger Cars
- 1.43..... Stopped in Tunnels
- 5.5..... Permanent Speed Signs
- 6.5..... Shoving Movements
- 6.12..... FRA Excepted Track
- 6.13..... Yard Limits
- 6.30..... Receiving or Discharging Passengers
- 6.31..... Maximum Authorized Speed
- 7.3..... Additional Switching Precautions
- 7.9..... Switching Passenger or Occupied Outfit Cars
- 9.23.1..... Guidelines While Block System is Suspended

Passengers

- 1.2.1..... Care for Injured
- 1.4..... Carrying Out Rules and Reporting Violations

Passing

- 6.8..... Stopping Clear for Meeting or Passing
- 6.9..... Meeting or Passing Precautions

Permanent Speed Signs

- 5.5..... Permanent Speed Signs

Personal Injuries

See Injuries

Power-Operated Switch

See Dual Control Switches

Practical Jokes

- 1.7..... Altercations

Property

See Railroad Property

Public Crossings

- 5.8.1..... Ringing Engine Bell
- 5.8.2..... Sounding Whistle
- 5.8.3..... Whistle Failure
- 5.8.4..... Whistle Quiet Zone
- 5.8.5..... Silenced Whistle
- 5.9.1..... Dimming Headlight
- 5.9.3..... Headlight Failure
- 5.9.5..... Displaying Ditch Lights
- 5.9.6..... Displaying Oscillating White Headlight
- 6.5..... Shoving Movements
- 6.6..... Back Up Movements
- 6.32.1..... Providing Warning Over Road Crossings
- 6.32.2..... Automatic Warning Devices
- 6.32.3..... Providing Warning for Adjacent Tracks
- 6.32.4..... Clear of Crossings and Signal Circuits
- 6.32.5..... Actuating Automatic Warning Devices Unnecessarily
- 6.32.6..... Blocking Public Crossings

Quarrelsome

1.6..... Conduct

Quiet Zone

See Whistle

Radio

2.1..... Transmitting
 2.2..... Required Identification
 2.3..... Repetition
 2.4..... Ending Transmission
 2.5..... Communication Redundancy
 2.6..... Communication Not Understood or Incomplete
 2.7..... Monitoring Radio Transmissions
 2.8..... Acknowledgment
 2.9..... Misuse of Radio Communications
 2.10..... Emergency Calls
 2.11..... Prohibited Transmissions
 2.12..... Fixed Signal Information
 2.14..... Transmission of Mandatory Directives
 2.14.1..... Verbally Transmitting and Repeating
 Mandatory Directives
 2.15..... Phonetic Alphabet
 2.16..... Assigned Frequencies
 2.17..... Radio Testing
 2.18..... Malfunctioning Radio
 2.19..... Blasting Operations
 2.20..... Internal Adjustments
 5.3.6..... Radio and Voice Communication
 5.3.7..... Radio Response

Railroad Crossings

6.6..... Back Up Movements
 6.16..... Approaching Railroad Crossings, Drawbridges,
 and End of Multiple Main Track
 6.18..... Stopping Clear of Crossings and Junctions
 9.9.1..... Approach to Automatic Interlocking
 9.19..... Leaving Equipment in Signal Systems
 9.23.1..... Guidelines While Block System is Suspended

Railroad Property

1.2.2..... Witnesses
 1.19..... Care of Property
 1.23..... Altering Equipment
 1.24..... Clean Property
 1.25..... Credit or Property

Reading

1.10..... Games, Reading, or Other Media

Red Flags

5.4.3..... Display of Yellow-Red Flag
 5.4.7..... Display of Red Flag
 5.4.8..... Flag Location
 5.15..... Improperly Displayed Signals
 14.5..... Protecting Men or Equipment
 15.2..... Protection by Track Bulletin Form B

Regulations

1.3.1..... Rules, Regulations, and Instructions
 1.3.2..... General Orders

Remote Control

5.12..... Protection of Occupied Outfit Cars
 5.13..... Blue Signal Protection of Workmen
 6.5.1..... Remote Control Movements
 6.7..... Remote Control Zone
 7.13..... Protection of Employees in Bowl Tracks

Repeat of Instructions

6.1..... Repeat Instructions

Reporting for Duty

1.15..... Duty—Reporting or Absence

Respect of Railroad Company

1.9..... Respect of Railroad Company

Restricted Limits

6.3..... Main Track Authorization
 6.6..... Back Up Movements
 6.14..... Restricted Limits
 6.25..... Movement Against the Current of Traffic
 8.12..... Hand-Operated Crossover Switches
 9.12.4..... ABS Territory
 9.17..... Entering Signaled Track at Hand-Operated or
 Spring Switch
 9.17.1..... Signal Protection in ABS by Lining Switch
 14.1..... Authority to Enter TWC Limits
 14.4..... Occupying Same Track Warrant Limits

Restricted Speed

- 5.4.3..... Display of Yellow-Red Flag
- 5.6..... Unattended Fusee
- 6.4..... Reverse Movements
- 6.5..... Shoving Movements
- 6.6..... Back Up Movements
- 6.13..... Yard Limits
- 6.14..... Restricted Limits
- 6.20..... Equipment Left on Main Track
- 6.23..... Emergency Stop or Severe Slack Action
- 6.27..... Movement at Restricted Speed
- 9.9..... Train Delayed Within a Block
- 9.10..... Initiating Movement Between Signals
- 9.11..... Movement from Signal Requiring Restricted Speed
- 9.12.1..... CTC Territory
- 9.12.2..... Manual Interlockings
- 9.12.3..... Automatic Interlockings
- 9.12.4..... ABS Territory
- 9.15..... Track Permits
- 9.15.1..... Issuing Track Permits
- 9.16..... Stop and Proceed Indication
- 9.17.1..... Signal Protection in ABS by Lining Switch
- 10.1..... Authority to Enter CTC Limits
- 10.3..... Track and Time
- 10.3.3..... Joint Track and Time
- 14.4..... Occupying Same Track Warrant Limits
- 14.5..... Protecting Men and Equipment

Restrictions

- 1.47..... Duties of Crew Members

Retarders

- 8.17..... Avoid Sanding Over Moveable Parts

Reverse Movements

- 6.4..... Reverse Movements
- 6.4.1..... Permission for Reverse Movements
- 6.6..... Back Up Movements

Road Crossing

See Public Crossing

Rule 9.14 (Current of Traffic)

- 6.3..... Main Track Authorization
- 6.3.1..... Train Coordination
- 9.12.4..... ABS Territory

Rules

- 1.3.1..... Rules, Regulations, and Instructions
- 15.6..... Change of General Order, Special Instruction or Rule

Rule Violation

- 1.2.7..... Furnishing Information

Safety

- 1.1..... Safety
- 1.1.1..... Maintaining a Safe Course
- 1.1.2..... Alert and Attentive
- 1.1.4..... Condition of Equipment and Tools
- 1.3.1..... Rules, Regulations, and Instructions
- 1.4..... Carrying Out Rules and Reporting Violations
- 1.6..... Conduct
- 1.20..... Alert to Train Movement
- 2.6..... Communication Not Understood or Incomplete
- 5.13..... Blue Signal Protection of Workmen

Safety Rules

- 1.14..... Employee Jurisdiction
- 4.2..... Special Instructions

Sanded Rail

- 9.22..... Standing on Sanded Rail

Scale Track Switches

- 8.13..... Scale Track Switches

Securing Cars or Engines

See Hand Brakes

Service Connection Sign

- 5.14..... Signs Protecting Equipment

Shoving Cars

- 6.5..... Shoving Movements
- 6.32.1..... Providing Warning Over Road Crossings

Siding

- 5.4.8..... Flag Location
- 6.2..... Initiating Movement
- 6.5..... Shoving Movements
- 6.8..... Stopping Clear for Meeting or Passing
- 6.9..... Meeting or Passing Precautions
- 6.10..... Instructions to Clear a Following Train
- 6.23..... Emergency Stop or Severe Slack Action
- 6.28..... Movement on Other than Main Track
- 6.28.1..... Sidings of Assigned Direction
- 6.28.2..... Stopping Clear in Siding
- 6.28.3..... Cars or Equipment Left on Siding
- 6.30..... Receiving or Discharging Passengers
- 6.32.2..... Automatic Warning Devices
- 8.3..... Main Track Switches
- 8.7..... Clear of Main Track Switches
- 8.11..... Switches in Sidings
- 8.20..... Derail Location and Position
- 9.20..... Clear Track Circuits
- 10.1..... Authority to Enter CTC Limits
- 10.2..... Clearing Through Hand-Operated Switches
- 14.2..... Designated Limits
- 15.5..... Protection When Tracks Blocked with Equipment

Signals

- See Fixed Signals
- See Distant Signals
- See Block Signals
- See Cab Signals
- See Hand Signals
- See Signal Indication
- 1.47.....Duties of Crew Members
- 9.1.....Signal Aspects and Indications
- 9.2.....Location of Signals
- 9.3.....What Signals Govern
- 9.4.....Improperly Displayed Signals or Absent Lights
- 9.5.....Where Stop Must Be Made
- 9.9.....Train Delayed Within a Block
- 9.10.....Initiating Movement Between Signals
- 9.11.....Movement from Signal Requiring Restricted Speed

Signal Indication

- 9.1.....Signal Aspects and Indications
- 9.6.....Change of Signal Indication
- 9.7.....Failure to Display Most Restrictive Indication
- 9.8.....Next Governing Signal
- 9.11.....Movement from Signal Requiring Restricted Speed
- 9.12.1.....CTC Territory
- 9.12.2.....Manual Interlockings
- 9.12.3.....Automatic Interlockings
- 9.12.4.....ABS Territory
- 9.16.....Stop and Proceed Indication

Signs

- 5.14.....Signs Protecting Equipment
- 5.15.....Improperly Displayed Signals

Sleeping

- 1.11.....Sleeping
- 1.11.1.....Napping

Special Instructions

- 1.3.1.....Rules, Regulations, and Instructions
- 1.3.2.....General Orders
- 1.14.....Employee Jurisdiction
- 4.2.....Special Instructions
- 4.3.....Timetable Characters
- 15.6.....Change of a General Order, Special Instruction, or Rule

Speed Indicator

- 1.39.....Accuracy of Speed Indicator

Speed Restrictions

- 2.14.....Transmission of Mandatory Directives
- 5.4.1.....Temporary Restrictions
- 5.4.2.....Display of Yellow Flag
- 5.4.5.....Display of Green Flag
- 5.4.6.....Display of Flags Within Current of Traffic
- 5.5.....Permanent Speed Signs
- 6.11.....Mandatory Directive
- 6.31.1.....Permanent Speed Restrictions

Speed Signs

- 5.5.....Permanent Speed Signs

Spring Switches

- 8.1.....Hand Operation of Switches
- 8.3.....Main Track Switches
- 8.8.....Switches Equipped with Locks, Hooks or Latches
- 8.9.....Movement Over Spring Switches
- 8.9.1.....Testing Spring Switch
- 8.9.2.....Trailing Through and Stopping on a Spring Switch
- 8.9.3.....Hand Operating a Spring Switch Before Making a Trailing Movement
- 8.9.4.....During Snow or Ice Storms
- 8.9.5.....Spiking Spring Switch
- 8.9.6.....Approaching a Spring Switch in Non-Signaled Territory
- 8.10.....Switch Point Indicator
- 8.17.....Avoid Sanding Over Moveable Parts
- 9.17.....Entering Signaled Track at Hand-Operated or Spring Switch

Statements

- 1.2.6.....Statements

Spur Track

- 7.12.....Movement Into Spur Tracks

Stop Sign

- 6.16.....Approaching Railroad Crossings, Drawbridges, and End of Multiple Main Track

Stop and Proceed Indication

- 9.16.....Stop and Proceed Indication
- 10.3.....Track and Time

Stop Signal

- 5.3.4.....Signal to Stop
- 5.3.5.....Acknowledge Stop Signal
- 5.4.7.....Display of Red Flag
- 5.6.....Unattended Fusee
- 9.5.....Where Stop Must Be Made
- 9.6.....Change of Signal Indication
- 9.12.1.....CTC Territory
- 9.12.2.....Manual Interlockings
- 9.12.3.....Automatic Interlockings
- 9.12.4.....ABS Territory
- 9.16.....Stop and Proceed Indication
- 10.1.....Authority to Enter CTC Limits
- 10.3.....Track and Time

Subject to Call

- 1.16.....Subject to Call

Suspension of Block System

- 9.23.....Suspension of Block System
- 9.23.1.....Guidelines While Block System is Suspended

Switches

- See Crossover Switches
- See Hand-Operated Switches
- See Spring Switches
- See Dual Control Switches
- See Derails
- See Main Track Switches
- See Scale Track Switches
- See Variable Switches
- See Automatic Switches

Switching

- See Hand Signals
- 2.2.....Required Identification
- 2.3.....Repetition
- 5.3.6.....Radio and Voice Communication
- 5.3.7.....Radio Response
- 5.9.1.....Dimming Headlight
- 7.1.....Switching Safely and Efficiently
- 7.2.....Communication Between Crews Switching
- 7.3.....Additional Switching Precautions
- 7.4.....Precautions for Coupling or Moving Cars or Engines
- 7.7.....Kicking or Dropping Cars
- 7.7.1.....Gravity Switch Moves
- 7.8.....Coupling or Moving Cars on Tracks Where Cars are Being Loaded or Unloaded
- 7.9.....Switching Passenger or Occupied Outfit Cars
- 7.10.....Movement Through Gates or Doorways
- 7.11.....Charging Necessary Air Brakes
- 7.12.....Movement Into Spur Tracks

Switch Point Indicator

- 8.9.6.....Approaching a Spring Switch in Non-Signaled Territory
- 8.10.....Switch Point Indicator

Tank Car Connected Sign

- 5.14.....Signs Protecting Equipment

Timetable

- 1.3.1.....Rules, Regulations, and Instructions
- 1.14.....Employee Jurisdiction
- 4.1.....New Timetable
- 4.1.1.....Notice of New Timetable
- 4.3.....Timetable Characters
- 15.6.....Change of a General Order, Special Instruction, and Rule

Time

- 1.48.....Time

Tools

- 1.1.4.....Condition of Equipment and Tools
- 1.2.3.....Equipment Inspection

Track and Time

- 2.14.....Transmission of Mandatory Directives
- 6.3.1.....Train Coordination
- 6.11.....Mandatory Directive
- 8.3.....Main Track Switches
- 9.12.1.....CTC Territory
- 9.16.....Stop and Proceed Indication
- 10.1.....Authority to Enter CTC Limits
- 10.3.....Track and Time
- 10.3.1.....Protection of Limits
- 10.3.2.....Protection of Machines, Track Cars, or Employees
- 10.3.3.....Joint Track and Time
- 10.3.4.....Track and Time Acknowledgment

Track Bulletin

- 1.3.1.....Rules, Regulations, and Instructions
- 1.47.....Duties of Crew Members
- 2.14.....Transmission of Mandatory Directives
- 4.1.1.....Notice of New Timetable
- 6.11.....Mandatory Directive
- 15.1.....Track Bulletins
- 15.1.1.....Changing Address of Track Warrants or Track Bulletins
- 15.2.....Protection by Track Bulletin Form B
- 15.3.....Authorizing Movement Against the Current of Traffic
- 15.4.....Protection When Tracks Removed from Service
- 15.5.....Protection When Tracks Blocked with Equipment
- 15.6.....Change of a General Order, Special Instruction, or Rule
- 15.7.....Copying Track Bulletins
- 15.8.....Duplicating Track Bulletins
- 15.9.....Mechanical Transmission of Track Bulletins
- 15.10.....Retaining Track Bulletins
- 15.12.....Relief of Engineer or Conductor During Trip
- 15.13.....Voiding Track Bulletins
- 15.14.....Delivering Track Bulletins

Track Occupancy Indicator

- 9.5.6.....Track Occupancy Indicator

Track Permits

- 2.14.....Transmission of Mandatory Directives
- 6.11.....Mandatory Directive
- 6.3.1.....Train Coordination
- 6.13.....Yard Limits
- 6.25.....Movement Against the Current of Traffic
- 9.15.....Track Permits
- 9.15.1.....Issuing Track Permits
- 9.15.2.....Clearing Track Permits

Track Warrant

- See Track Warrant Control
- 1.47.....Duties of Crew Members
- 2.14.....Transmission of Mandatory Directives
- 6.11.....Mandatory Directive
- 8.3.....Main Track Switches
- 14.2.....Designated Limits
- 14.9.....Copying Track Warrants
- 15.12.....Relief of Engineer or Conductor During Trip

Track Warrant Control (TWC)

- See Track Warrant
- 9.12.4.....ABS Territory
- 14.1.....Authority to Enter TWC Limits
- 14.2.....Designated Limits
- 14.3.....Operating with Track Warrants
- 14.3.1.....Leaving the Main Track
- 14.4.....Occupying Same Track Warrant Limits
- 14.5.....Protecting Men or Equipment
- 14.6.....Movement Against the Current of Traffic
- 14.7.....Reporting Clear of Limits
- 14.8.....Track Warrant Requests
- 14.9.....Copying Track Warrants
- 14.9.1.....Duplicating Track Warrants
- 14.10.....Track Warrant in Effect
- 14.11.....Changing Track Warrants
- 14.13.....Mechanical Transmission of Track Warrants

Train

- 1.20.....Alert to Train Movement
- 1.29.....Avoiding Delays
- 1.30.....Riding Engine
- 1.32.....Overheated Wheels
- 1.42.....Trains Detoured
- 1.43.....Stopped in Tunnels
- 2.5.....Communication Redundancy
- 5.10.....Markers
- 5.10.1.....Highly Visible Markers
- 5.10.2.....Alternative Markers
- 5.11.....Engine Identifying Number
- 6.2.1.....Train Location
- 6.10.....Instructions to Clear a Following Train
- 6.21.....Precautions Against Unusual Conditions
- 6.21.1.....Protection Against Defects
- 6.22.....Maintaining Control of Train or Engine
- 6.29.1.....Inspecting Passing Trains
- 6.29.2.....Train Inspections by Crew Members
- 15.7.....Copying Track Bulletins

Train Coordination

- 6.3.1.....Train Coordination

Train Inspection

- See Inspection

Train Dispatchers

- 1.3.1.....Rules, Regulations, and Instructions
- 1.44.....Duties of Train Dispatchers
- 1.45.....Duties of Control Operators and Operators

Tunnels

- 1.43.....Stopped in Tunnels

TWC

- See Track Warrant Control

Unauthorized Employment

1.18..... Unauthorized Employment

Unusual Conditions

1.1.3..... Accidents, Injuries, and Defects
1.2.7..... Furnishing Information
6.21..... Precautions Against Unusual Conditions
6.21.1..... Protection Against Defects
6.21.2..... Water Above Rail
6.21.3..... Track Obstruction / Unusual Conditions

Utility Employee

5.13.1..... Utility Employees

Variable Switches

8.10..... Switch Point Indicator
8.17..... Avoid Sanding Over Moveable Parts
8.18..... Variable Switches

Voiding Track Bulletins

15.13..... Voiding Track Bulletins

Violations

1.4..... Carrying Out Rules and Reporting Violations

Water Above Rail

6.21.2..... Water Above Rail

Weapons

1.12..... Weapons

Whistle

1.2.2..... Witnesses
5.8.2..... Sounding Whistle
5.8.3..... Whistle Failure
5.8.4..... Whistle Quiet Zone
5.8.5..... Silenced Whistle

Witness

1.2.2..... Witnesses

Working Limits

6.3..... Main Track Authorization
6.3.1..... Train Coordination
6.4.1..... Permission for Reverse Movements

Wrestle

1.7..... Altercations

Written Main Track Authorities

6.3..... Main Track Authorization
6.11..... Mandatory Directive

Yardmasters

1.46..... Duties of Yardmasters

Yard Limits

6.3..... Main Track Authorization
6.6..... Back Up Movements
6.13..... Yard Limits
6.25..... Movement Against the Current of Traffic
8.12..... Hand-Operated Crossover Switches
9.12.4..... ABS Territory
14.1..... Authority to Enter TWC Limits
14.4..... Occupying Same Track Warrant Limits
14.7..... Reporting Clear of Limits

Yellow Flags

5.4.1..... Temporary Restrictions
5.4.2..... Display of Yellow Flag
5.4.4..... Authorized Protection by Yellow or
Yellow-Red Flag
5.4.5..... Display of Green Flag
5.4.6..... Display of Flags Within Current of Traffic
5.4.8..... Flag Location
5.15..... Improperly Displayed Signals

Yellow-Red Flags

5.4.1..... Temporary Restrictions
5.4.3..... Display of Yellow-Red Flag
5.4.4..... Authorized Protection by Yellow or
Yellow-Red Flag
5.4.6..... Display of Flags Within Current of Traffic
5.4.8..... Flag Location
5.15..... Improperly Displayed Signals
15.2..... Protection by Track Bulletin Form B