

Beechcraft®

Bonanza®

36 *and* A36

(Serials E-1 thru E-926)

Pilot's Operating Handbook *and* FAA Approved Airplane Flight Manual

FAA Approved in Utility Category based on CAR 3. This document must be carried in the airplane at all times and be kept within reach of the pilot during all flight operations.

This handbook includes the material required to be furnished to the pilot by CAR 3.

Airplane Serial Number: _____

Airplane Registration Number: _____

FAA Approved: _____

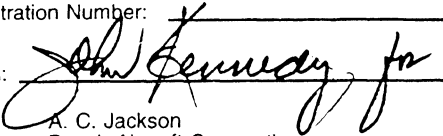
A. C. Jackson
Beech Aircraft Corporation
DOA CE-2

This handbook supersedes all BEECH published owner's manuals, flight manuals, and check lists issued for this airplane with the exception of FAA Approved Airplane Flight Manual Supplements.

COPYRIGHT © BEECH 1994

P/N 36-590002-19C
Reissued: August, 1982

P/N 36-590002-19C3
Revised: July, 1994

Published By
RAYTHEON AIRCRAFT COMPANY
P.O. Box 85
Wichita, Kansas 67201
U.S.A.

NOTE

Where Beech Aircraft Corporation or Beechcraft is referred to in this publication, it will be taken to read Raytheon Aircraft Company.

Raytheon Aircraft

Beech

Hawker



Member of GAMA
General Aviation
GAMA Manufacturers Association

Raytheon Aircraft

Bonanza 36, A36
Log of Temporary Changes
to the
Pilot's Operating Handbook
and
FAA Approved Airplane Flight Manual
P/N 36-590002-19C

Changes to this Pilot's Operating Handbook and FAA Approved Airplane Flight Manual must be in the airplane for all flight operations.

Part Number	Subject	Date
36-590002-19CTC1	Fuel Selector Placard Installation	8/26/97

Note: This page should be filed in the front of the *Pilot's Operating Handbook and FAA Approved Airplane Flight Manual* immediately following the *Title* page. This page replaces any *Log of Temporary Changes* page dated prior to the date in the lower right corner of this page.

**BONANZA 36 AND A36
(E-1 THRU E-926)
PILOT'S OPERATING HANDBOOK
AND
FAA APPROVED AIRPLANE FLIGHT MANUAL**

C3 Revision July, 1994

LOG OF REVISIONS

Page	Description
Title Page	Updated
Page A (C3)	New
10-1 thru 10-48	Revised Section X, Safety Information (May, 1994)

C3

**BONANZA 36 AND A36
(E-1 THRU E-926)
PILOT'S OPERATING HANDBOOK
AND
FAA APPROVED AIRPLANE FLIGHT MANUAL**

C2 Revision October, 1990

LOG OF REVISIONS

Page	Description
Title Page	Updated
Page A (C2)	New
10-1 thru 10-48	Revised Section X, Safety Information (October, 1990)

C2

Bonanza 36 and A36 (E-1 thru E-926)
Pilot's Operating Handbook
and
FAA Approved Airplane Flight Manual

C1 March 1983

LOG OF REVISIONS

PAGES	DESCRIPTION
Title Page	Update
Page A (C1)	New
a & b	Add "Warning"
2-20	Revise "Emergency Exit" Placard
3-2	Update Table of Contents
3-12	Revise "Emergency Exits"
7-2	Update Table of Contents
7-26 & 7-26A	Revise "Openable Cabin Windows" and Add "Emergency Exits"
8-28, 8-29 & 8-30	Revise "Cleaning - Exterior Painted Surfaces"
8-48 & 8-49	Revise "Consumable Materials"
	C1

Bonanza 36, A36

PILOT'S OPERATING HANDBOOK

and

FAA APPROVED AIRPLANE FLIGHT MANUAL

LOG OF REVISIONS

ORIGINAL (A) FEBRUARY 1978
REISSUE (B) FEBRUARY 1980
REISSUE (C) AUGUST 1982

PAGE	DESCRIPTION OF REVISION
Title page Logo page A page a thru b 1-1 thru 1-20 2-1 thru 2-32 3-1 thru 3-14 4-1 thru 4-20 5-1 thru 5-32 6-1 thru 6-18 7-1 thru 7-46 8-1 thru 8-58 Section 9 10-1 thru 10-67	See Log of Supplements March 1981
	C

BEECHCRAFT Bonanza 36, A36
E-1 thru E-926

INTRODUCTION

This Pilot's Operating Handbook and FAA Approved Airplane Flight Manual is in the format and contains data recommended in the GAMA (General Aviation Manufacturers Association) Handbook Specification Number 1. Use of this specification by all manufacturers will provide the pilot the same type data in the same place in all of the handbooks.

In recent years, BEECHCRAFT handbooks contained most of the data now provided, however, the new handbooks contain more detailed data and some entirely new data.

For example, attention is called to Section X SAFETY INFORMATION. BEECHCRAFT feels it is highly important to have SAFETY INFORMATION in a condensed form in the hands of the pilots. The SAFETY INFORMATION should be read and studied. Periodic review will serve as a reminder of good piloting techniques.

WARNING

Use only genuine BEECHCRAFT or BEECHCRAFT approved parts obtained from BEECHCRAFT approved sources, in connection with the maintenance and repair of Beech airplanes.

Genuine BEECHCRAFT parts are produced and inspected under rigorous procedures to ensure airworthiness and suitability for use in Beech airplane applications. Parts purchased from sources other than BEECHCRAFT, even though outwardly identical in appearance, may not have had the required tests and inspections performed, may be different in fabrication techniques and materials, and may be dangerous when installed in an airplane.

Bonanza 36, A36

Salvaged airplane parts, reworked parts obtained from non-BEECHCRAFT approved sources, or parts, components, or structural assemblies, the service history of which is unknown or cannot be authenticated, may have been subjected to unacceptable stresses or temperatures or have other hidden damage, not discernible through routine visual or usual nondestructive testing techniques. This may render the part, component or structural assembly, even though originally manufactured by BEECHCRAFT, unsuitable and unsafe for airplane use.

BEECHCRAFT expressly disclaims any responsibility for malfunctions, failures, damage or injury caused by use of non-BEECHCRAFT approved parts.

TABLE OF CONTENTS

SECTION I	General
SECTION II	Limitations
SECTION III	Emergency Procedures
SECTION IV	Normal Procedures
SECTION V	Performance
SECTION VI	Weight and Balance/Equipment List
SECTION VII	Systems Description
SECTION VIII	Handling, Servicing and Maintenance
SECTION IX	Supplements
SECTION X	Safety Information

SECTION I

GENERAL

TABLE OF CONTENTS

<i>SUBJECT</i>	<i>PAGE</i>
Important Notice	1-3
Use of the Handbook	1-4
Revising the Handbook	1-7
Airplane Flight Manual Supplements	
Revision Record	1-8
Vendor-Issued STC Supplements	1-8
Airplane Three View	1-9
Ground Turning Clearance	1-10
Descriptive Data	1-11
Engine	1-11
Propeller	1-11
Fuel	1-11
Oil Capacity	1-12
Weights	1-12
Cabin And Entry Dimensions	1-12
Baggage Space and Entry Dimensions	1-12
Specific Loadings	1-12
General Airspeed Terminology and Symbols	1-13
Meteorological Terminology	1-15
Power Terminology	1-16
Engine Controls and Instruments	1-16
Airplane Performance and Flight	
Planning Terminology	1-17
Weight and Balance Terminology	1-18

INTENTIONALLY LEFT BLANK

THANK YOU . . . for displaying confidence in us by selecting a BEECHCRAFT airplane. Our design engineers, assemblers and inspectors have utilized their skills and years of experience to ensure that the BEECHCRAFT Bonanza meets the high standards of quality and performance for which BEECHCRAFT airplanes have become famous throughout the world.

IMPORTANT NOTICE

This handbook must be read carefully by the owner and operator in order to become familiar with the operation of the BEECHCRAFT Bonanza. The handbook presents suggestions and recommendations to help obtain safe and maximum performance without sacrificing economy. The BEECHCRAFT Bonanza must be operated according to the Pilot's Operating Handbook and FAA Approved Airplane Flight Manual, and/or placards located in the airplane.

As a further reminder, the owner and operator of this airplane should also be familiar with the applicable Federal Aviation Regulations concerning operation and maintenance of the airplane and FAR Part 91 General Operating and Flight Rules. Likewise this airplane must be operated and maintained in accordance with FAA Airworthiness Directives which may be issued against it.

The Federal Aviation Regulations place the responsibility for the maintenance of this airplane on the owner and the operator who must ensure that all maintenance is done by qualified mechanics in conformity with all airworthiness requirements established for this airplane.

All limits, procedures, safety practices, time limits, servicing, and maintenance requirements contained in this handbook are considered mandatory for the continued airworthiness of this airplane, in a condition equal to that of its original manufacture.

Authorized BEEHCRAFT Aero or Aviation Centers or International Distributors or Dealers can provide recommended modification, service, and operating procedures issued by both FAA and Beech Aircraft Corporation, designed to get maximum utility and safety from this airplane.

USE OF THE HANDBOOK

The Pilot's Operating Handbook is designed to facilitate maintaining documents necessary for the safe and efficient operation of the BEEHCRAFT Bonanza. The handbook has been prepared in loose leaf form for ease in maintenance and in a convenient size for storage. The handbook has been arranged with quick reference tabs imprinted with the title of each section and contains ten basic divisions:

- Section 1 General
- Section 2 Limitations
- Section 3 Emergency Procedures
- Section 4 Normal Procedures
- Section 5 Performance
- Section 6 Weight and Balance/Equipment List
- Section 7 Systems Description
- Section 8 Handling, Servicing and Maintenance
- Section 9 Supplements
- Section 10 Safety Information

NOTE

Except as noted, all airspeeds quoted in this handbook are Indicated Airspeeds (IAS) and assume zero instrument error.

In an effort to provide as complete coverage as possible, applicable to any configuration of the airplane, some optional equipment has been included in the scope of the handbook. However, due to the variety of airplane appointments and arrangements available, optional equipment described and depicted herein may not be designated as such in every case.

The following information may be provided to the holder of this manual automatically:

1. Original issues and revisions of Class I and Class II Service Instructions
2. Original issues and revisions of FAA Approved Airplane Flight Manual Supplements
3. Reissues and revisions of FAA Approved Airplane Flight Manuals, Flight Handbooks, Owner's Manuals, Pilot's Operating Manuals, and Pilot's Operating Handbooks

This service is free and will be provided only to holders of this handbook who are listed on the FAA Aircraft Registration Branch List or the BEECHCRAFT International Owners Notification Service List, and then only if you are listed by airplane serial number for the model

for which this handbook is applicable. For detailed information on how to obtain "Revision Service" applicable to this handbook or other BEECHCRAFT Service Publications consult a BEECHCRAFT Aero or Aviation Center or International Distributor or Dealer, or refer to the latest revision of BEECHCRAFT Service Instructions No. 0250-010.

BEECH AIRCRAFT CORPORATION EXPRESSLY RESERVES THE RIGHT TO SUPERSEDE, CANCEL, AND/OR DECLARE OBSOLETE, WITHOUT PRIOR NOTICE, ANY PART, PART NUMBER, KIT OR PUBLICATION REFERENCED IN THIS HANDBOOK.

The owner/operator should always refer to all supplements, whether STC Supplements or Beech Supplements, for possible placards, limitations, normal, emergency and other operational procedures for proper operation of the airplane with optional equipment installed.

REVISING THE HANDBOOK

Immediately following the title page is the "Log of Revisions" page(s). The Log of Revisions pages are used for maintaining a listing of all effective pages in the handbook (except the SUPPLEMENTS section), and as a record of revisions to these pages. In the lower right corner of the outlined portion of the Log of Revisions is a box containing a capital letter which denotes the issue or reissue of the handbook. This letter may be suffixed by a number which indicates the numerical revision. When a revision to any information in the handbook is made, a new Log of Revisions will be issued. All Logs of Revisions must be retained in the handbook to provide a current record of material status until a reissue is made.

WARNING

When this handbook is used for airplane operational purposes it is the pilot's responsibility to maintain it in current status.

AIRPLANE FLIGHT MANUAL SUPPLEMENTS REVISION RECORD

Section IX contains the FAA Approved Airplane Flight Manual Supplements headed by a Log of Supplements page. On the "Log" page is a listing of the FAA Approved Supplemental Equipment available for installation on the airplane. When new supplements are received or existing supplements are revised, a new "Log" page will replace the previous one, since it contains a listing of all previous approvals, plus the new approval. The supplemental material will be added to the grouping in accordance with the descriptive listing.

NOTE

Upon receipt of a new or revised supplement, compare the "Log" page just received with the existing "Log" page in the manual. Retain the "Log" page with the latest date on the bottom of the page and discard the other log.

VENDOR-ISSUED STC SUPPLEMENTS

When a new airplane is delivered from the factory, the handbook delivered with it contains either an STC (Supplemental Type Certificate) Supplement or a Beech Flight Manual Supplement for every installed item requiring a supplement. If a new handbook for operation of the airplane is obtained at a later date, it is the responsibility of the owner/operator to ensure that all required STC Supplements (as well as weight and balance and other pertinent data) are transferred into the new handbook.

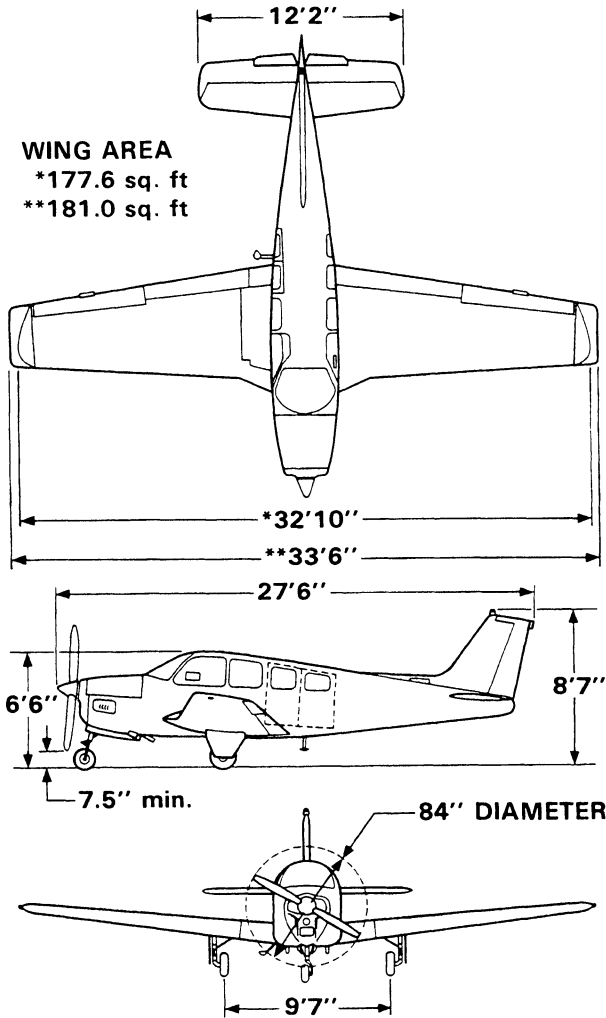

*36 prior to E-185

**A36, E-185 thru E-926

AIRPLANE THREE-VIEW

GROUND TURNING CLEARANCE

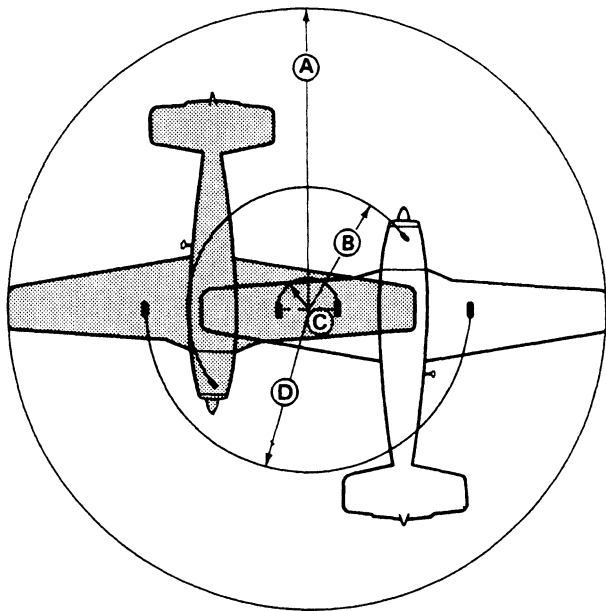

- | | |
|--|---------------|
| (A) Radius for Wing Tip | 27 ft. 7 in. |
| (B) Radius for Nose Wheel | 13 ft. 8 in. |
| (C) Radius for Inside Gear | 6 ft. 3 in. |
| (D) Radius for Outside Gear | 15 ft. 10 in. |

TURNING RADII ARE CALCULATED USING FULL STEERING,
ONE BRAKE AND PARTIAL POWER.

DESCRIPTIVE DATA

ENGINE

One Teledyne Continental Motors Corporation engine model IO-520-B, IO-520-BA or IO-520-BB. It is a fuel-injected, direct-drive, air-cooled, horizontally-opposed, 6-cylinder, 520-cubic inch-displacement, 285-horsepower-rated engine.

PROPELLER

McCauley constant speed, two blade, 84 inch diameter propeller using a McCauley 2A36C23 hub with 84B-0 blades.

or

McCauley constant speed, three blade, 80 inch diameter propeller using a McCauley 3A32C76 hub with 82NB-2 blades.

NOTE

Other propellers may be approved but not installed as original equipment. These are listed in the FAA Aircraft Specification 3A15 or approved by Supplemental Type Certificate.

FUEL

Aviation Gasoline 100LL (blue) or 100 (green) minimum grade.

STANDARD SYSTEM

Total Capacity	50 gal.
Total Usable	44 gal.

OPTIONAL SYSTEM

Total Capacity	80 gal.
Total Usable	74 gal.

OIL CAPACITY

The oil capacity is 12 quarts.

WEIGHTS

Maximum Ramp Weight	3612 lbs
Maximum Take-Off Weight	3600 lbs
Maximum Landing Weight	3600 lbs
Maximum Zero Fuel Weight	No Structural Limit
Maximum Weight in Baggage Compartment	400 lbs.

CABIN AND ENTRY DIMENSIONS

Length	10 ft 11 in.
Height	4 ft 2 in.
Width	3 ft 6 in.
Cabin Door	37 in. wide by 36 in. high

BAGGAGE SPACE AND ENTRY DIMENSIONS

Compartment Volume	40 cu ft
Hat Shelf Volume	1.7 cu ft
Door Width (Minimum)	45 in.
Door Height (Minimum)	35 in.

SPECIFIC LOADINGS (Maximum Take-Off Weight)

Wing Loading (36)	20.3 lbs/sq ft
Wing Loading (A36)	19.9 lbs/sq ft
Power Loading	12.6 lbs/hp

**GENERAL AIRSPEED TERMINOLOGY
AND SYMBOLS**

- CAS** Calibrated Airspeed is the indicated speed of an airplane, corrected for position and instrument error. Calibrated airspeed is equal to true airspeed in standard atmosphere at sea level.
- GS** Ground Speed is the speed of an airplane relative to the ground.
- IAS** Indicated Airspeed is the speed of an airplane as shown on the airspeed indicator when corrected for instrument error. IAS values published in this handbook assume zero instrument error.
- KCAS** Calibrated Airspeed expressed in "knots".
- KIAS** Indicated Airspeed expressed in "knots".
- TAS** True Airspeed is the airspeed of an airplane relative to undisturbed air which is the CAS corrected for altitude, temperature, and compressibility.
- V_A** Maneuvering Speed is the maximum speed at which application of full available aerodynamic control will not overstress the airplane.
- V_{FE}** Maximum Flap Extended Speed is the highest speed permissible with wing flaps in a prescribed extended position.

- V_{LE} Maximum Landing Gear Extended Speed is the maximum speed at which an airplane can be safely flown with the landing gear extended.
- V_{LO} Maximum Landing Gear Operating Speed is the maximum speed at which the landing gear can be safely extended or retracted.
- V_{NE} Never Exceed Speed is the speed limit that may not be exceeded at any time.
- V_{NO} or V_C Maximum Structural Cruising Speed is the speed that should not be exceeded except in smooth air and then only with caution.
- V_S Stalling Speed or the minimum steady flight speed at which the airplane is controllable.
- V_{SO} Stalling Speed or the minimum steady flight speed at which the airplane is controllable in the landing configuration.
- V_X Best Angle-of-Climb Speed is the airspeed which delivers the greatest gain of altitude in the shortest possible horizontal distance.
- V_Y Best Rate-of-Climb Speed is the airspeed which delivers the greatest gain in altitude in the shortest possible time.

METEOROLOGICAL TERMINOLOGY

ISA	International Standard Atmosphere in which <ol style="list-style-type: none">(1) The air is a dry perfect gas;(2) The temperature at sea level is 15° Celsius (59° Fahrenheit);(3) The pressure at sea level is 29.92 in Hg. (1013.2 millibars);(4) The temperature gradient from sea level to the altitude at which the temperature is -56.5° C (-69.7° F) is -0.00198° C (-0.003566° F) per foot and zero above that altitude.
OAT	Outside Air Temperature is the free air static temperature, obtained either from inflight temperature indications adjusted for instrument error and compressibility effects, or ground meteorological sources.
Indicated Pressure Altitude	The number actually read from an altimeter when the barometric sub-scale has been set to 29.92 in Hg. (1013.2 millibars).
Pressure Altitude	Altitude measured from standard sea-level pressure (29.92 in. Hg) by a pressure or barometric altimeter. It is the indicated pressure altitude corrected for position and instrument error. In this Handbook, altimeter instrument errors are assumed to be zero. Position errors may be obtained from the Altimeter Correction Graph.

Section I
General

BEECHCRAFT Bonanza 36, A36
E-1 thru E-926

Station Pressure	Actual atmospheric pressure at field elevation.
Wind	The wind velocities recorded as variables on the charts of this handbook are to be understood as the headwind or tailwind components of the reported winds.

POWER TERMINOLOGY

Take off and Maximum Continuous	Highest power rating not limited by time.
Cruise Climb	Power recommended for cruise climb.

ENGINE CONTROLS AND INSTRUMENTS

Throttle Control	Used to control power by introducing fuel-air mixture into the intake passages of the engine. Settings are reflected by readings on the manifold pressure gage.
Propeller Control	This control requests the propeller governor to maintain engine/propeller rpm at a selected value by controlling propeller blade angle.
Mixture Control	This control is used to set fuel flow in all modes of operation and cuts off fuel completely for engine shut down.

EGT (Exhaust Gas Temperature Indicator)	This indicator is used to identify the lean and best power fuel flow for various power settings.
Tachometer	Indicates the rpm of the engine/propeller.
Propeller Governor	Regulates the rpm of the engine/propeller by increasing or decreasing the propeller pitch through a pitch change mechanism in the propeller hub.

AIRPLANE PERFORMANCE AND FLIGHT PLANNING TERMINOLOGY

Climb Gradient	The ratio of the change in height during a portion of a climb, to the horizontal distance traversed in the same time interval.
Demonstrated Crosswind Velocity	The maximum 90° crosswind component for which adequate control of the airplane during takeoff and landing was actually demonstrated during certification tests.
MEA	Minimum enroute IFR altitude.
Route Segment	A part of a route. Each end of that part is identified by: (1) a geographical location; or (2) a point at which a definite radio fix can be established.

GPH	U.S. Gallons per hour.
PPH	Pounds per hour.

WEIGHT AND BALANCE TERMINOLOGY

Reference Datum	An imaginary vertical plane from which all horizontal distances are measured for balance purposes.
Station	A location along the airplane fuselage usually given in terms of distance from the reference datum.
Arm	The horizontal distance from the reference datum to the center of gravity (C.G.) of an item.
Moment	The product of the weight of an item multiplied by its arm. (Moment divided by a constant is used to simplify balance calculations by reducing the number of digits.)
Airplane Center of Gravity (C.G.)	The point at which an airplane would balance if suspended. Its distance from the reference datum is found by dividing the total moment by the total weight of the airplane.
C.G. Arm	The arm obtained by adding the airplane's individual moments and dividing the sum by the total weight.

C.G. Limits	The extreme center of gravity locations within which the airplane must be operated at a given weight.
Usable Fuel	Fuel available for flight planning.
Unusable Fuel	Fuel remaining after a runout test has been completed in accordance with governmental regulations.
Standard Empty Weight	Weight of a standard airplane including unusable fuel, full operating fluids and full oil.
Basic Empty Weight	Standard empty weight plus optional equipment.
Payload	Weight of occupants, cargo and baggage.
Useful Load	Difference between take-off weight, or ramp weight if applicable, and basic empty weight.
Maximum Ramp Weight	Maximum weight approved for ground maneuvering. (It includes weight of start, taxi, and run-up fuel).
Maximum Take-off Weight	Maximum weight approved for the start of the take-off run.
Maximum Landing Weight	Maximum weight approved for the landing touchdown.

**Section I
General**

**BEECHCRAFT Bonanza 36, A36
E-1 thru E-926**

Zero Fuel Weight	Weight exclusive of usable fuel.
Tare	The weight of chocks, blocks, stands, etc., used on the scales when weighing an airplane.
Leveling Points	Those points which are used during the weighing process to level the airplane.
Jack Points	Points on the airplane identified by the manufacturer as suitable for supporting the airplane for weighing or other purposes.

SECTION II

LIMITATIONS

TABLE OF CONTENTS

<i>SUBJECT</i>	<i>PAGE</i>
Airspeed Limitations	2-3
Airspeed Indicator Markings	2-4
Power Plant Limitations	2-5
Engine	2-5
Operating Limitations	2-5
Fuel Grades	2-5
Oil Specifications	2-5
Propeller Specifications	2-6
Power Plant Instrument Markings	
(Round Type)	2-7
Miscellaneous Instrument Markings	
(Round Type)	2-8
Power Plant Instrument Markings	
(Vertical Electrically Operated Type)	2-8
Miscellaneous Instrument Markings	
(Vertical Electrically Operated Type)	2-9
Weight Limits	2-9
Center of Gravity Limits (Gear Down)	2-10
Maneuver Limits	2-10
Approved Maneuvers	2-10
Flight Load Factors	2-11
Minimum Flight Crew	2-11
Kinds of Operation Limits	2-11
Fuel	2-12
Seating	2-12
August 1982	2-1

TABLE OF CONTENTS (Continued)

<i>SUBJECT</i>	<i>PAGE</i>
Placards	2-13
Required Equipment for Various Conditions of Flight	2-24

The limitations included in this section have been approved by the Federal Aviation Administration.

The following limitations must be observed in the operation of this airplane.

AIRSPEED LIMITATIONS

SPEED	CAS		IAS		REMARKS
	KNOTS	MPH	KNOTS	MPH	
Never Exceed V_{NE}	203	234	204	235	Do not exceed this speed in any operation
Maximum Structural Cruising V_{NO} or V_C	165	190	166	191	Do not exceed this speed except in smooth air and then only with caution
Maneuvering V_A	139	160	140	161	Do not make full or abrupt control movements above this speed
Maximum Flap Extended V_{FE}	122	140	123	142	Do not operate with flaps extended above this speed
Maximum Flap Extension E-1 thru E-105 E-106 thru E-926	113 122	130 140	117 123	135 142	Do not extend flaps above this speed
Maximum Landing Gear Operating/ Extended V_{LO} and V_{LE}	152	175	153	176	Do not extend, retract or operate with landing gear extended above this speed except in emergency

***AIRSPEED INDICATOR MARKINGS**

MARKING	CAS		IAS		SIGNIFICANCE
	KNOTS	MPH	KNOTS	MPH	
White Arc	56-113	64-130	56-117	63-135	Full Flap Operating Range
	**56-122	64-140	56-123	63-142	
Green Arc	65-165	75-190	62-166	71-191	Normal Operating Range
Yellow Arc	165-203	190-234	166-204	191-235	Operate with caution only in smooth air
Red Line	203	234	204	235	Maximum speed for ALL operations

*The Airspeed Indicator is marked in CAS values

**Effective E-106 and After

POWER PLANT LIMITATIONS

ENGINE

One Teledyne Continental Motors Corporation model IO-520-B, IO-520-BA or IO-520-BB engine

OPERATING LIMITATIONS

Engine Speed	2700 rpm
Cylinder Head Temperature	460°F/238°C
Oil Temperature	240°F/116°C
Oil Pressure	
Minimum	30 psi
Maximum	100 psi
Fuel Pressure	
Minimum	1.5 psi
Maximum	17.5 psi
Mixture - Set per leaning instructions on performance charts.	

FUEL GRADES

Aviation Gasoline 100LL (blue) or 100 (green) minimum grade.

OIL SPECIFICATIONS

Ashless dispersant oils must meet Teledyne Continental Motors Corporation Specification MHS-24B. Refer to APPROVED ENGINE OILS in the Handling, Servicing, and Maintenance section

PROPELLER SPECIFICATIONS

McCauley constant speed, two blade propeller

Hub: 2A36C23

Blades: 84B-0

Diameter: Maximum 84 in., Minimum 82 in.

Pitch settings at 30 in. sta.:

Low - 13.3°

High - not under 29.2°

or

McCauley constant speed, three bladed propeller

Hub: 3A32C76

Blades: 82NB-2

Diameter: Maximum 80 in., Minimum 78.5 in.

Pitch settings at 30 in. sta.:

Low - $13.3^{\circ} \pm 0.2^{\circ}$

High - not under $29.0^{\circ} \pm 0.5^{\circ}$

NOTE

Other propellers may be approved but not installed as original equipment. These are listed in the FAA Aircraft Specification 3A15 or approved by Supplemental Type Certificate.

POWER PLANT INSTRUMENT MARKINGS

(ROUND TYPE)

OIL TEMPERATURE

Caution (Yellow Radial) 100°F/38°C
Operating Range
(Green Arc) 100° to 240°F/38° to 116°C
Maximum (Red Radial) 240°F/116°C

OIL PRESSURE

Minimum Pressure (Red Radial) 30 psi
Operating Range (Green Arc) 30 to 60 psi
Maximum Pressure (Red Radial) 100 psi

FUEL FLOW

Minimum (Red Radial) 1.5 psi
Operating Range (Green Arc) 6.9 to 24.3 gph
or 41.4 to 145.8 pph
Maximum (Red Radial) 17.5 psi

TACHOMETER

Operating Range (Green Arc) ... 1800 to 2700 rpm
Maximum RPM (Red Radial) 2700 rpm

CYLINDER HEAD TEMPERATURE

Operating Range
(Green Arc) 200° to 460°F/93° to 238°C
Maximum Temperature
(Red Radial) 460°F/238°C

MANIFOLD PRESSURE

Operating Range
(Green Arc) 15 to 29.6 in. Hg
Maximum (Red Radial) 29.6 in. Hg

**MISCELLANEOUS INSTRUMENT MARKINGS
(ROUND TYPE)**

INSTRUMENT PRESSURE

Minimum (Red Radial) 3.5 in. Hg
Operating Range (Green Arc) 3.5 to 5.5 in. Hg
Maximum (Red Radial) 5.5 in. Hg

or

Operating Range (Green Arc) 4.3 to 5.9 in. Hg

FUEL QUANTITY

Yellow Band (44-gallon system) E to 1/2 full
Yellow Band (74-gallon system) E to 3/8 full

**POWER PLANT INSTRUMENT MARKINGS
(VERTICAL ELECTRICALLY OPERATED TYPE)**

OIL TEMPERATURE

Caution (Yellow Line) 100°F/38°C
Operating Range
(Green Band) 100° to 240°F/38° to 116°C
Maximum (Red Line) 240°F/116°C

OIL PRESSURE

Minimum Pressure (Red Line) 30 psi
Operating Range (Green Band) 30 to 60 psi
Maximum Pressure (Red Line) 100 psi

FUEL FLOW

Minimum (Red Line) 1.5 psi
Operating Range (Green Band) 41.4 to 145.8 pph
Maximum (Red Line) 17.5 psi

TACHOMETER

Operating Range (Green Band) 1800 to 2700 rpm
Maximum RPM (Red Line) 2700 rpm

CYLINDER HEAD TEMPERATURE

Operating Range
(Green Band) 200° to 460°F/93° to 238°C
Maximum Temperature
(Red Line) 460°F/238°C

MANIFOLD PRESSURE

Operating Range
(Green Band) 15 to 29.6 in. Hg
Maximum (Red Line) 29.6 in. Hg

**MISCELLANEOUS INSTRUMENT MARKINGS
(VERTICAL ELECTRICALLY OPERATED TYPE)**

INSTRUMENT PRESSURE

Minimum (Red Radial) 3.5 in. Hg
Operating Range (Green Arc) 3.5 to 5.5 in. Hg
Maximum (Red Radial) 5.5 in. Hg

or

Operating Range (Green Arc) 4.3 to 5.9 in. Hg

FUEL QUANTITY

Yellow Band (22-gal Main Tank) 0 to 80 lbs.
Yellow Band (37-gal Main Tank) 0 to 80 lbs.

WEIGHT LIMITS

Maximum Ramp Weight 3612 lbs
Maximum Take-off
and Landing Weight 3600 lbs
Zero Fuel Weight No Structural Limitation
Maximum Baggage Compartment Load 400 lbs

CENTER OF GRAVITY LIMITS (Gear Down)

Forward: 74.0 inches aft of datum to 3100 lbs with straight line variation to 81.0 inches at 3600 lbs.

Aft: 87.7 inches aft of datum at all weights.

REFERENCE DATUM

Datum is 83.1 inches forward of center line through forward jack points.

MAC leading edge is 66.7 inches aft of datum.
MAC length is 65.3 inches.

MANEUVER LIMITS

This is a utility category airplane. Spins are prohibited. No acrobatic maneuvers are approved except those listed below. Maximum slip duration is 30 seconds for airplanes with baffled main fuel cells in both wings and 20 seconds for airplanes with unbaffled main fuel cells in either wing.

APPROVED MANEUVERS (3600 POUNDS)

MANEUVER	ENTRY SPEED (CAS)
Chandelle	132 kts/152 mph
Steep Turn	132 kts/152 mph
Lazy Eight	132 kts/152 mph
Stall (Except Whip)	Use slow deceleration

Minimum fuel for above maneuvers - 10 gallons each main tank.

Spins are prohibited.

FLIGHT LOAD FACTORS (3600 POUNDS)

Positive Maneuvering Load Factors

Flaps Up	4.4G
Flaps Down	3.0G

MINIMUM FLIGHT CREW

One (1) Pilot

KINDS OF OPERATION LIMITS

This airplane is approved for the following type operations when the required equipment is installed and operational as defined herein:

1. VFR day and night
2. IFR day and night
3. FAR 91 operations when all pertinent limitations and performance considerations are complied with.

WARNING

FLIGHT IN ICING CONDITIONS IS PROHIBITED.

NOTE

Refer to "REQUIRED EQUIPMENT FOR VARIOUS CONDITIONS OF FLIGHT" at the end of this Section.

FUEL

STANDARD SYSTEM

Total Capacity	50 gal.
Total Usable	44 gal.

OPTIONAL SYSTEM

Total Capacity	80 gal.
Total Usable	74 gal.

FUEL MANAGEMENT

Take off on main tank that is more nearly full.

When operating fuel selector, feel for detent position.

Do not take off when Fuel Quantity Gages indicate in Yellow Band or with less than 13 gallons in each main tank.

Maximum slip duration:

30 seconds for airplanes with baffled main fuel cells in both wings.

20 seconds for airplanes with unbaffled main fuel cells in either wing.

SEATING

All seats must be in the upright position for take-off and landing.

**Temporary Change
to the
Pilot's Operating Handbook
and
FAA Approved Airplane Flight Manual
P/N 36-590002-19CTC1**

Publication Affected	36, A36 Pilot's Operating Handbook and FAA Approved Airplane Flight Manual (P/N 36-590002-19C, Reissued August, 1982 or Subsequent)
Airplane Serial Numbers Affected	E-1 thru E-926
Description of Change	The addition of a placard to the fuel selector to warn of the no-flow condition that exists between the fuel selector detents.
Filing Instructions	Insert this temporary change into the 36, A36 Pilot's Operating Handbook and FAA Approved Airplane Flight Manual immediately following page 2-12 (Section II, LIMITATIONS) and retain until rescinded or replaced.

LIMITATIONS

PLACARDS

Located On The Face Of The Fuel Selector Valve, For Those Airplanes In Compliance With S.B. 2670:

WARNING - POSITION SELECTOR IN DETENTS ONLY - NO FUEL FLOW TO ENGINE BETWEEN DETENTS

Approved:



A.C. Jackson
Raytheon Aircraft Company
DOA CE-2

PLACARDS

On Fuel Selector Valve:

Standard 44 Gallon (Usable) System:

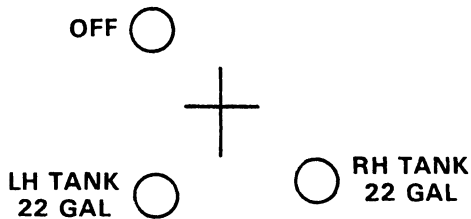

Optional 74 Gallon (Usable) System:

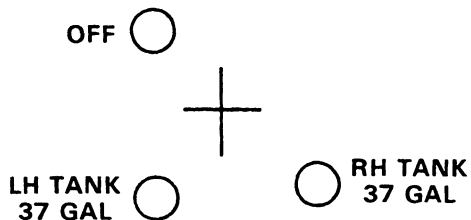

On Fuel Selector Panel:

**DO NOT TAKE OFF IF FUEL QUANTITY GAGES
INDICATE IN YELLOW BAND OR WITH LESS
THAN 13 GALLONS IN EACH MAIN TANK**

PLACARDS (Cont'd)

*On Left Side Panel (Airspeed values are CAS):
(E-1 thru E-363 except E-357, 358, 361)*

UTILITY CATEGORY AIRPLANE
THIS AIRPLANE MUST BE OPERATED IN COMPLIANCE WITH THE OPERATING LIMITATIONS STATED IN THE FORM OF PLACARDS, MARKINGS AND MANUALS. MAXIMUM WEIGHT 3600 LB. REFER TO WEIGHT AND BALANCE DATA FOR LOADING INSTRUCTIONS. OCCUPIED SEATS MUST BE IN UPRIGHT POSITION DURING TAKEOFF AND LANDING. ALTITUDE LOST IN STALL RECOVERY 300 FEET. FLIGHT MANEUVER LOAD FACTOR: FLAPS UP 4.4 G; FLAPS DOWN 3.0 G NO AEROBATIC MANEUVERS APPROVED EXCEPT THOSE LISTED BELOW:
MANEUVER
CHANDELLES 160 MPH (139 KNOTS)
LAZY EIGHTS 160 MPH (139 KNOTS)
STEEP TURNS 160 MPH (139 KNOTS)
STALLS (EXCEPT WHIP STALLS) SLOW DECELERATION
NOTE: INTENTIONAL SPINS PROHIBITED
AIRSPEED LIMITATION
MAXIMUM LANDING GEAR EXTENDED SPEED 175 MPH (152 KNOTS)
MAXIMUM DESIGN MANEUVER SPEED 160 MPH (139 KNOTS)

*On Left Side Panel (Airspeed Values are CAS):
(E-357, 358, 361 and E-364 thru E-926)*



*In Full View of Pilot: (E-1 thru E-184) unless baffled main
fuel cells are installed in both wings.*

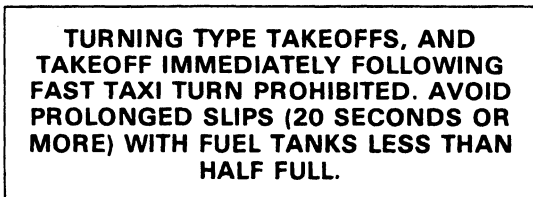

*On Left Side Panel Below Instrument Subpanel
When Emergency Static Air System is Installed:*

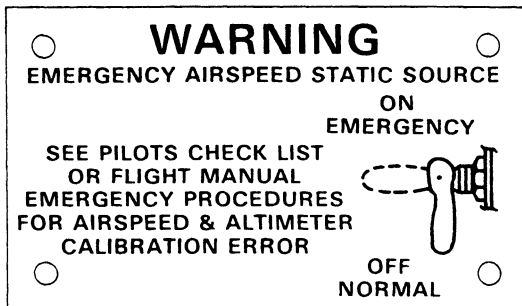

PLACARDS (Cont'd)

On Left Side Panel Near Firewall Air Controls:

(36)

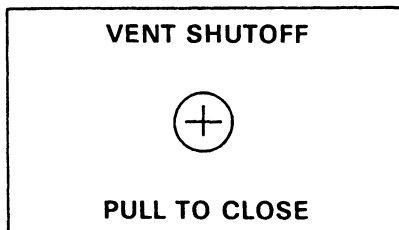

(A36 Only)

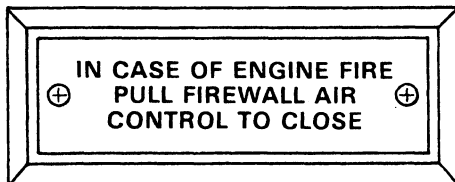

*On Left-Hand Side of Nose Wheel Well Bulkhead
Below Generator Circuit Breaker:
(E-1 thru E-476 except E-391)*

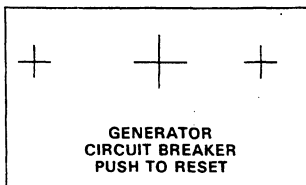

*Under Left Subpanel:
(E-391 and E-477 thru E-762 except E-710)*

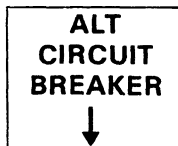

On Control Console:

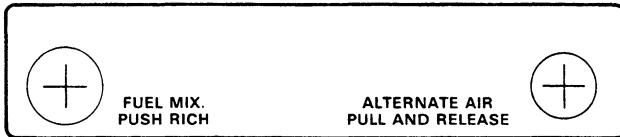
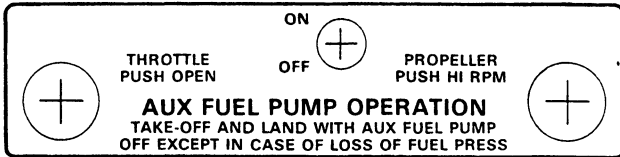

On Oxygen Console:

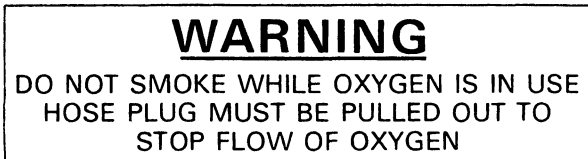

Around Each Oxygen Outlet:

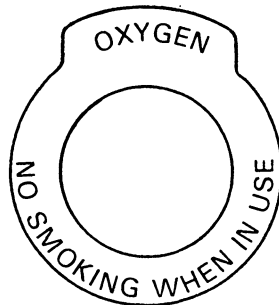

PLACARDS (Cont'd)

*On Top of Front Spar Carry-Thru Structure Between
Front Seats:*

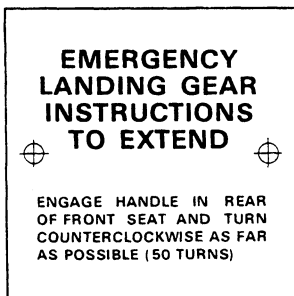

On Emergency Crank Access Cover: (E-477 and after)

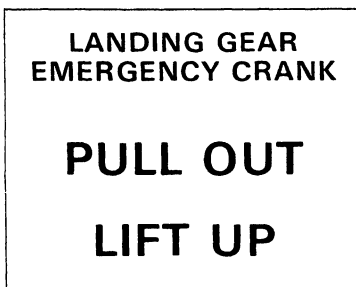

Below Controls on Control Console:

NOTICE

**REMOVE WINTER
BAFFLES WHEN
OAT EXCEEDS 70° F**

The notice is centered and enclosed in a large, thin-lined square frame. The text is in bold, uppercase letters.

*On Left Side Window When Shoulder
Harness is Installed: (Prior to E-825)*

**WHEN SHOULDER HARNESS
IS IN USE, SNUG LAP BELT
WITH BUCKLE CENTERED IN
FRONT OF OCCUPANT WITH
SEAT BACK UPRIGHT**

*On Windows Adjacent to Pilot's and
Copilot's Seats: (E-825 and after)*

**SHOULDER HARNESS
MUST BE WORN AT
ALL TIMES WHILE AT
PILOT POSITIONS**

*On Windows Adjacent to 3rd, 4th,
5th & 6th Seats: (E-825 and after)*

**SHOULDER HARNESS
MUST BE WORN DURING
TAKE-OFF AND LANDING
WITH SEAT BACK UPRIGHT**

*On Windows Adjacent to 3rd & 4th Aft Facing Club Seats:
(E-825 and after)*

**SHOULDER HARNESS
MUST BE WORN DURING
TAKE-OFF AND LANDING
WITH SEAT BACK UPRIGHT
AND AFT FACING SEATS
MUST HAVE HEADREST
FULLY EXTENDED**

PLACARDS (Cont'd)

On Left Cabin Sidewall (Prior to E-825):

**ALL AFT FACING SEATS MUST HAVE
BACK UPRIGHT AND HEADREST FULLY
RAISED DURING TAKEOFF AND LANDING**

On Storm Window (36 only) (CAS):

CAUTION

**DO NOT OPEN ABOVE
145 MPH (126 KNOTS)**

*Below Left and Right Openable Windows After Compliance
with BEECHCRAFT Service Instructions 1241:*

**EMERGENCY EXIT
LIFT LATCH - PULL PIN
PUSH WINDOW OUT**

On Openable Windows:

**DO NOT OPEN
IN FLIGHT**

**LATCH WINDOW
BEFORE TAKE-OFF**

*On Inboard Side of Seat Back for 3rd & 4th Seats:
(E-825 and after)*

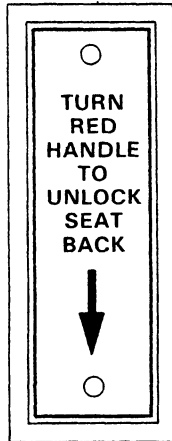

*On Instrument Panel when Anti-collision Lights are
not Installed:*

**THIS AIRCRAFT NOT FULLY
EQUIPPED FOR NIGHT FLIGHT**

On Instrument Panel:

**WHEN UTILITY DOORS
ARE REMOVED - AIR
SPEED IS NOT TO
EXCEED 190 MPH (165
KNOTS) CAS**

PLACARDS (Cont'd)

On Baggage Straps Aft Side of Front Seat Backs:

**BAGGAGE STOWAGE
MAXIMUM LOADING
50 LBS**

On Left Cabin Sidewall:

**BAGGAGE AND CARGO COMPARTMENT
LOAD IN ACCORDANCE WITH
WEIGHT AND BALANCE DATA**

⊕ **MAXIMUM STRUCTURAL CAPACITY—400 POUNDS** ⊕

**WHEN UTILITY DOORS ARE REMOVED THE FOLLOWING
RESTRICTIONS APPLY TO CABIN AREA:**

1. NO SMOKING
2. ALL LOOSE OBJECTS MUST BE SECURED
3. PERSONNEL NOT SECURED IN SEATS BY SAFETY BELTS MUST WEAR PARACHUTES

In Lieu of LH Cabin Sidewall Placard (if required by CAR 3.74, due to optional equipment configuration):

**BAGGAGE AND CARGO COMPARTMENT
LOAD IN ACCORDANCE WITH
WEIGHT AND BALANCE DATA**

MAXIMUM STRUCTURAL CAPACITY—400 POUNDS

⊕ **MAXIMUM 5TH AND 6TH SEAT CAPACITY _____ POUNDS** ⊕

**WHEN UTILITY DOORS ARE REMOVED THE FOLLOWING
RESTRICTIONS APPLY TO CABIN AREA:**

1. NO SMOKING
2. ALL LOOSE OBJECTS MUST BE SECURED
3. PERSONNEL NOT SECURED IN SEATS BY SAFETY BELTS MUST WEAR PARACHUTES

On Hat Shelf:

HAT SHELF
NO HEAVY OBJECTS

Above Inside Door Handle:
(E-1 thru E-476)

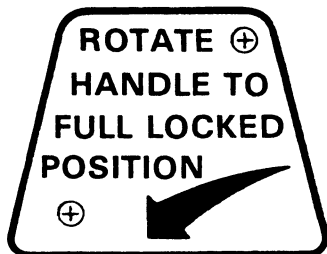

(E-477 and after)

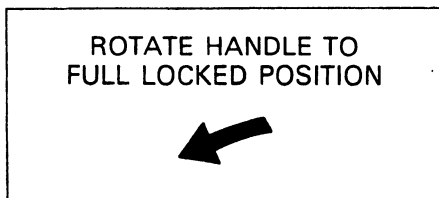

REQUIRED EQUIPMENT FOR VARIOUS CONDITIONS OF FLIGHT

Part 91 of the Federal Aviation Regulations specifies the minimum numbers and types of airplane instruments and equipment which must be installed and operable for various kinds of flight conditions. This includes VFR day, VFR night, IFR day, and IFR night.

Regulations also require that all airplanes be certificated by the manufacturer for operations under various flight conditions. At certification, all required equipment must be in operating condition and should be maintained to assure continued airworthiness. If deviations from the installed equipment were not permitted, or if the operating rules did not provide for various flight conditions, the airplane could not be flown unless all equipment was operable. With appropriate limitations, the operation of every system or component installed in the airplane is not necessary, when the remaining operative instruments and equipment provide for continued safe operation. Operation in accordance with limitations established to maintain airworthiness, can permit continued or uninterrupted operation of the airplane temporarily.

For the sake of brevity, the Required Equipment Listing does not include obviously required items such as wings, rudders, flaps, engine, landing gear, etc. Also the list does not include items which do not affect the airworthiness of the airplane such as entertainment systems, passenger convenience items, etc. However, it is important to note that **ALL ITEMS WHICH ARE RELATED TO THE AIRWORTHINESS OF THE AIRPLANE AND NOT INCLUDED ON THE LIST ARE AUTOMATICALLY REQUIRED TO BE OPERATIVE.**

To enable the pilot to rapidly determine the FAA equipment requirements necessary for a flight into specific conditions, the following equipment requirements and exceptions are presented. It is the final responsibility of the pilot to determine whether the lack of, or inoperative status of a piece of equipment on his airplane, will limit the conditions under which he may operate the airplane.

LEGEND

Numbers refer to quantities required to be operative for a specified condition.

- (-) Indicates that the item may be inoperative for the specified condition.
- (*) Refer to the REMARKS AND/OR EXCEPTIONS column for explicit information or reference.

**Section II
Limitations**

**BEECHCRAFT Bonanza 36, A36
E-1 thru E-926**

SYSTEM and/or COMPONENT	VFR Day				Remarks and/or Exceptions	
	VFR Day	VFR Night	IFR Day	IFR Night		
	GENERAL					
	Overwater flight	*	*	*		- *Per FAR 91
ATA 100 CHAPTER 23 COMMUNICATIONS						
VHF communications system	*	*	*	- *Per FAR 91		
ATA 100 CHAPTER 24 ELECTRICAL POWER						
Battery	1	1	1	1		
DC alternator	1	1	1	1		
DC alternator out indicator light	1	1	1	1		
Standby generator	*	*	*	*	- *Optional	

ATA 100 CHAPTER 25 EQUIPMENT AND FURNISHING									
Seat belts	1	1	1	1	1				- Per Person or Per FAR 91
Shoulder harness	*	*	*	*	*				- *Pilot and copilot if installed
Emergency locator transmitter	1	1	1	1	1				- Per FAR 91
ATA 100 CHAPTER 26 FIRE PROTECTION									
Portable fire extinguisher	*	*	*	*	*				- *Optional
ATA 100 CHAPTER 27 FLIGHT CONTROLS									
Elevator trim tab indicator	1	1	1	1	1				-
Flap position indicator	1	1	1	1	1				-
Stall warning	1	1	1	1	1				

**Section II
Limitations**

**BEECHCRAFT Bonanza 36, A36
E-1 thru E-926**

SYSTEM and/or COMPONENT	VFR Day				Remarks and/or Exceptions
	VFR Night		IFR Day		
ATA 100 CHAPTER 28 FUEL EQUIPMENT					
Auxiliary fuel pump	1	1	1	1	
Engine driven fuel pump	1	1	1	1	
Fuel quantity indicator	2	2	2	2	
Fuel flow indicator	1	1	1	1	
ATA 100 CHAPTER 30 ICE AND RAIN PROTECTION					
Emergency static air source	*	*	*	*	*Optional
Pitot heater	*	*	1	1	*Optional

ATA 100 CHAPTER 32 LANDING GEAR Landing gear motor Landing gear position lights Landing gear warning horn	1	1	1	1	1	2 on model 36
	4	1	4	4	4	
	1	4	1	1	1	
	1	1	1	1	1	
ATA 100 CHAPTER 33 LIGHTS Cockpit and instrument lights Taxi light Landing light Rotating beacon Position light Utility door ajar light	-	*	-	*	*	*Lights must be operative.
	-	-	-	-	-	
	-	*	-	*	*	*Per FAR 91
	*	1	*	1	1	-*Optional
	-	3	-	3	3	
	1	1	1	1	1	

**Section II
Limitations**

**BEECHCRAFT Bonanza 36, A36
E-1 thru E-926**

SYSTEM and/or COMPONENT	VFR Day				Remarks and/or Exceptions
	VFR Day	IFR Day	IFR Night	IFR Night	
	VFR Night	IFR Day	IFR Night	IFR Night	
ATA 100 CHAPTER 34 NAVIGATION INSTRUMENTS					
Altimeter	1	1	1	1	
Airspeed indicator	1	1	1	1	
Vertical speed	-	*	*	*	-*Per FAR 135
Magnetic compass	1	1	1	1	
Attitude indicator	-	1	1	1	
Turn Coordinator	-	1	1	1	
Directional gyro	-	1	1	1	
Clock	-	1	1	1	
Transponder	*	*	*	*	-*Per FAR 91
Navigation equipment	-	*	*	*	-*Per FAR 91

<p>ATA 100 CHAPTER 35 OXYGEN</p> <p>Oxygen system</p>	*	*	*	*	-	-	-	-	-	-	-	-	-
<p>ATA 100 CHAPTER 36 PNEUMATIC</p> <p>Pressure system for instrument air</p> <p>Pressure gage</p>	-	-	-	-	-	-	-	-	-	-	-	-	-
<p>ATA 100 CHAPTER 77 ENGINE INDICATING INSTRUMENTS</p> <p>Engine tachometer indicator</p> <p>Exhaust gas temperature indicator</p> <p>Manifold pressure indicator</p>	1	1	1	1	1	1	1	1	1	1	1	1	1

-*Per FAR 91

-*Optional

**Section II
Limitations**

**BEECHCRAFT Bonanza 36, A36
E-1 thru E-926**

SYSTEM and/or COMPONENT	VFR Day		VFR Night		IFR Day		IFR Night		Remarks and/or Exceptions
ATA 100 CHAPTER 79 ENGINE OIL INSTRUMENTS									
Oil pressure indicator	1		1		1		1		
Oil temperature indicator	1		1		1		1		

SECTION III

EMERGENCY PROCEDURES

TABLE OF CONTENTS

<i>SUBJECT</i>	<i>PAGE</i>
Emergency Airspeeds	3-3
Engine Failure	3-4
During Take-Off Ground Roll	3-4
After Liftoff and in Flight	3-4
Engine Discrepancy Checks	3-5
Rough Running Engine	3-5
Loss of Engine Power	3-5
Air Start Procedure	3-5
Engine Fire	3-6
In Flight	3-6
On The Ground	3-6
Maximum Glide Configuration	3-6
Emergency Descent	3-7
Landing Emergencies	3-7
Landing Without Power	3-7
Landing Gear Retracted - With Power	3-7
Systems Emergencies	3-8
Propeller Overspeed	3-8
Alternator-Out Procedure	3-8
Alternator Overvoltage	3-9
Engine Instrument Malfunction	3-9
Landing Gear Manual Extension	3-10
Landing Gear Retraction After Practice Manual Extension	3-11

TABLE OF CONTENTS (Continued)

<i>SUBJECT</i>	<i>PAGE</i>
Induction System Blockage	3-11
Emergency Static Air Source System	3-11
Emergency Exits	3-12
Unlatched Door in Flight	3-13
Spins	3-13
Emergency Speed Reduction	3-13

EMERGENCY AIRSPEEDS

Emergency Descent	153 kts/176 mph
Glide	110 kts/127 mph
Emergency Landing Approach	81 kts/93 mph

CAUTION

The approach airspeed is higher than normal to assure the availability of control during flare without power.

All airspeeds quoted in this section are indicated airspeeds (IAS).

The following information is presented to enable the pilot to form, in advance, a definite plan of action for coping with the most probable emergency situations which could occur in the operation of the airplane. Where practicable, the emergencies requiring immediate corrective action are treated in check list form for easy reference and familiarization. Other situations, in which more time is usually permitted to decide on and execute a plan of action, are discussed at some length.

ENGINE FAILURE

DURING TAKE-OFF GROUND ROLL

1. Throttle - CLOSED
2. Braking - MAXIMUM
3. Fuel Selector Valve - OFF
4. Battery and Alternator Switches - OFF

AFTER LIFTOFF AND IN FLIGHT

Landing straight ahead is usually advisable. If sufficient altitude is available for maneuvering, accomplish the following:

1. Fuel Selector Valve - SELECT OTHER TANK (Check to feel detent)
2. Auxiliary Fuel Pump - ON
3. Mixture - FULL RICH, then LEAN as required
4. Magnetos - CHECK LEFT and RIGHT, then BOTH
5. Alternate Air T-handle - PULL AND RELEASE

NOTE

The most probable cause of engine failure would be loss of fuel flow, improper functioning of the ignition system or blockage of the induction system.

If No Restart

1. Select most favorable landing site.
2. See EMERGENCY LANDING procedure.
3. The use of landing gear is dependent on the terrain where landing must be made.

ENGINE DISCREPANCY CHECKS

CONDITION: ROUGH RUNNING ENGINE

1. Mixture - FULL RICH, then LEAN as required
2. Magneto/Start Switch - CHECK LEFT and RIGHT, then BOTH
3. Alternate Air T-handle - PULL AND RELEASE

CONDITION: LOSS OF ENGINE POWER

1. Fuel Flow Gage - CHECK

If fuel flow is abnormally low:

- a. Mixture - FULL RICH
 - b. Auxiliary Fuel Pump - ON (Lean as required)
 - c. Auxiliary Fuel Pump - OFF if performance does not improve in a few moments
2. Fuel Quantity Indicator - CHECK for fuel supply in tank being used
 3. Alternate Air T-handle - PULL AND RELEASE

If tank being used is empty:

Fuel Tank Selector Valve - SELECT OTHER FUEL TANK
(feel for detent and check visually)

AIR START PROCEDURE

1. Fuel Selector Valve - SELECT TANK MORE NEARLY FULL (check to feel detent)
2. Throttle - RETARD
3. Mixture - FULL RICH
4. Auxiliary Fuel Pump - ON until power is regained, then OFF. (Leave on if engine driven fuel pump is inoperative.)
5. Throttle - ADVANCE to desired power
6. Mixture - LEAN as required

ENGINE FIRE

IN FLIGHT

The red Vent Shutoff (36) FIREWALL AIR (A36) control on the outboard side of the left subpanel is used to close off all heating system outlets so that smoke and fumes will not enter the cabin. In the event of engine fire, shut down the engine as follows and make a landing:

1. Vent Shutoff/Firewall Air Control - PULL TO CLOSE
2. Mixture - IDLE CUT-OFF
3. Fuel Selector Valve - OFF
4. Battery and Alternator Switches - OFF (Extending the landing gear can be accomplished manually if desired.)
5. Do not attempt to restart engine.

ON THE GROUND

1. Mixture - IDLE CUT-OFF
2. Fuel Selector Valve - OFF
3. Battery, Alternator and Magneto/Start Switches - OFF
4. Extinguish with Fire Extinguisher.

MAXIMUM GLIDE CONFIGURATION

1. Landing Gear - UP
2. Flaps - UP
3. Cowl Flaps - CLOSED
4. Propeller - PULL for LOW RPM
5. Airspeed - 110 kts/127 mph

Glide distance is approximately 1.7 nautical miles (2 statute miles) per 1000 feet of altitude above the terrain.

EMERGENCY DESCENT

1. Power - IDLE
2. Propeller - HIGH RPM
3. Landing Gear - DOWN
4. Airspeed - ESTABLISH 153 kts/176 mph

LANDING EMERGENCIES

LANDING WITHOUT POWER

The approach speed is higher than normal to assure the availability of control during flare without power. When assured of reaching the landing site selected, and on final approach:

1. Airspeed - 81 kts/93 mph
2. Fuel Selector Valve - OFF
3. Mixture - IDLE CUT-OFF
4. Magneto/Start Switch - OFF
5. Flaps - AS REQUIRED
6. Landing Gear - DOWN OR UP, DEPENDING ON TERRAIN
7. Battery and Alternator Switches - OFF

LANDING GEAR RETRACTED - WITH POWER

If possible, choose firm sod or foamed runway. Make a normal approach, using flaps as necessary. When you are sure of making the selected landing spot:

1. Throttle - CLOSED
2. Mixture - IDLE CUT-OFF
3. Battery and Alternator Switches - OFF
4. Fuel Selector Valve - OFF
5. Keep wings level during touchdown.
6. Get clear of the airplane as soon as possible after it stops.

SYSTEMS EMERGENCIES

PROPELLER OVERSPEED

1. Throttle - RETARD TO RPM RED LINE
2. Airspeed - REDUCE
3. Oil Pressure - CHECK

WARNING

If loss of oil pressure was the cause of overspeed, the engine will seize after a short period of operation.

4. Land - SELECT NEAREST SUITABLE SITE and follow LANDING EMERGENCIES procedure.

ALTERNATOR OUT PROCEDURE

An inoperative alternator will place the entire electrical operation of the airplane on the battery. Alternator malfunction will be indicated by the illumination of the alternator warning light, located on the instrument panel below the flight instruments. When this condition occurs in flight, all non-essential electrical loads should be discontinued to conserve the battery.

ALTERNATOR OVERVOLTAGE

If an alternator overvoltage condition occurs in flight:

1. Battery Switch and Alternator Switch - OFF MOMENTARILY, THEN ON (this resets overvoltage relay)

If overvoltage condition does not recur, continue to use the alternator.

If overvoltage condition persists:

2. Alternator Switch - OFF
3. Nonessential Electrical Equipment - OFF to conserve battery power.

ENGINE INSTRUMENT MALFUNCTION

In event of engine instrument malfunction, maintain the last known rpm and manifold pressure setting and proceed to the nearest suitable airfield and land. If a higher power setting is required, select maximum rpm and enrichen mixture appropriately.

CAUTION

At high altitudes and low power settings, full rich mixtures may result in poor engine operation. Adjust the mixture for smooth engine operation upon power reduction.

LANDING GEAR MANUAL EXTENSION

Manual extension of the landing gear can be facilitated by first reducing airspeed. Then proceed as follows:

1. LDG GEAR Circuit Breaker - OFF (PULL OUT)
2. Landing Gear Switch Handle - DOWN position
3. Handcrank Handle Cover (at rear of front seats) - REMOVE
4. Handcrank - ENGAGE and TURN COUNTERCLOCK-WISE AS FAR AS POSSIBLE (approximately 50 turns)

CAUTION

The manual extension system is designed to lower the landing gear only. DO NOT ATTEMPT TO RETRACT THE GEAR MANUALLY.

5. If electrical system is operative, check landing gear position lights and warning horn (check LDG GEAR circuit breakers engaged).
6. Check mechanical landing gear indicator - DOWN (36 only)
7. Handcrank - DISENGAGE. Always keep it stowed when not in use.

WARNING

Do not operate the landing gear electrically with the handcrank engaged, as damage to the mechanism could occur. After emergency landing gear extension, do not move any landing gear controls or reset any switches or circuit breakers until airplane is on jacks as failure may have been in the gear up circuit and gear might retract on the ground.

LANDING GEAR RETRACTION AFTER PRACTICE MANUAL EXTENSION

After practice manual extension of the landing gear, the gear may be retracted electrically, as follows:

1. Handcrank - CHECK, STOWED
2. Landing Gear Motor Circuit Breaker - IN
3. Landing Gear - RETRACT

INDUCTION SYSTEM BLOCKAGE

An alternate induction air door, spring-loaded to the closed position, is located downstream from the induction air filter. If the induction air filter becomes blocked (e.g., ice, etc.), the differential air pressure normally opens the alternate induction air door to provide induction air from the bottom of the engine compartment. If the alternate induction air door becomes stuck in the closed position, it can be opened by pulling and releasing the T-handle located directly below the propeller control knob. This T-handle is placarded ALTERNATE AIR PULL AND RELEASE.

EMERGENCY STATIC AIR SOURCE SYSTEM

THE EMERGENCY STATIC AIR SOURCE SHOULD BE USED FOR CONDITIONS WHERE THE NORMAL STATIC SOURCE HAS BEEN OBSTRUCTED. When the airplane has been exposed to moisture and/or icing conditions (especially on the ground), the possibility of obstructed static ports should be considered. Partial obstructions will result in the rate of climb indication being sluggish during a climb or descent. Verification of suspected obstruction is possible by switching to the emergency system and noting a sudden sustained change in rate of climb. This may be accompanied by abnormal indicated airspeed and altitude changes beyond normal calibration differences.

Whenever any obstruction exists in the Normal Static Air System or the Emergency Static Air System is desired for use:

1. Pilot's Emergency Static Air Source - Switch to ON EMERGENCY.
2. For Airspeed Calibration and Altimeter Correction, refer to PERFORMANCE section.

CAUTION

Be certain the emergency static air valve is in the NORMAL position when system is not needed.

EMERGENCY EXITS

Emergency exits, provided by the openable window on each side of the cabin, may be used for egress in addition to the cabin door and the utility door. An emergency exit placard is installed below the left and right openable windows.

To open each emergency exit:

1. Lift the latch.
2. Pull out the emergency release pin and push the window out.

NOTE

On E-825 and after, for access past the 3rd and/or 4th seats, rotate the red handle, located on the lower inboard side of the seat back, and fold the seat back over.

UNLATCHED DOOR IN FLIGHT

If the cabin door is not locked it may come unlatched in flight. This may occur during or just after take-off. The door will trail in a position approximately 3 inches open, but the flight characteristics of the airplane will not be affected, except that rate of climb will be reduced. Return to the field in a normal manner. If practicable, during the landing flare-out have a passenger hold the door to prevent it from swinging open.

SPINS

Spins are prohibited. If a spin is entered inadvertently:

Immediately move the control column full forward and simultaneously apply full rudder opposite to the direction of the spin; continue to hold this control position until rotation stops and then neutralize all controls and execute a smooth pullout. Ailerons should be neutral and throttle in idle position at all times during recovery.

EMERGENCY SPEED REDUCTION

In an emergency, the landing gear may be used to create additional drag. Should disorientation occur under instrument conditions, the lowering of the landing gear will reduce the tendency for excessive speed build-up. This procedure would also be appropriate for a non-instrument rated pilot who unavoidably encounters instrument conditions or in other emergencies such as severe turbulence.

Should the landing gear be used at speeds higher than the maximum extension speed, a special inspection of the gear doors in accordance with shop manual procedures is required, with repair as necessary.

INTENTIONALLY LEFT BLANK

SECTION IV

NORMAL PROCEDURES

TABLE OF CONTENTS

<i>SUBJECT</i>	<i>PAGE</i>
Airspeeds for Safe Operation	4-3
Preflight Inspection	4-4
Before Starting	4-7
External Power	4-7
Starting Engine Using Auxiliary Power Unit	4-8
Starting	4-8
After Starting and Taxi	4-9
Before Take-Off	4-10
Take-Off	4-11
Climb	4-11
Cruise	4-11
Leaning Using the Exhaust Gas Temperature Indicator (EGT)	4-12
Descent	4-13
Before Landing	4-13
Balked Landing	4-13
After Landing	4-14
Shutdown	4-14
Environmental Systems	4-14
Oxygen System	4-14
Preflight	4-14
Oxygen Duration	4-15
In Flight	4-16
After Using	4-16
Heating and Ventilation	4-17

TABLE OF CONTENTS (Continued)

<i>SUBJECT</i>	<i>PAGE</i>
Cold Weather Operation	4-17
Icing Conditions	4-19
Engine Break-in Information	4-19

All airspeeds quoted in this section are indicated airspeeds (IAS)

AIRSPEEDS FOR SAFE OPERATION

Take-off	
Lift-off	70 kts/81 mph
50 Ft.	78 kts/90 mph
Maximum Climb	
Best Rate (V_y)	96 kts/110 mph
Best Angle (V_x)	78 kts/90 mph
Cruise Climb	109 kts/125 mph
Maximum Turbulent Air Penetration	140 kts/161 mph
Balked Landing	76 kts/87 mph
Landing Approach	76 kts/87 mph
Maximum Demonstrated Crosswind	17 kts/20 mph

PREFLIGHT INSPECTION

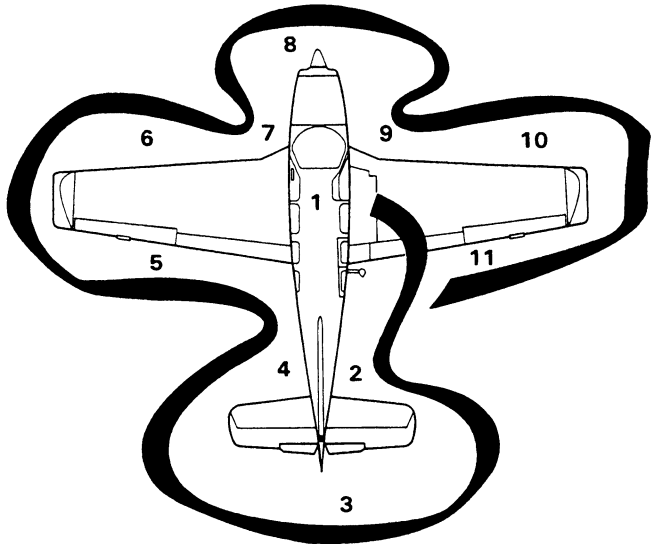

Emergency Locator Transmitter - ARMED
Location may vary with individual airplanes

1. CABIN:

- a. Parking Brake - SET
- b. Control Lock - REMOVE
- c. All Switches - OFF

2. RIGHT FUSELAGE:

- a. Utility Doors - SECURE
- b. Static Pressure Button - UNOBSTRUCTED

3. EMPENNAGE:

- a. Control Surfaces - CHECK
- b. Tie Down - REMOVE
- c. Position Light - CHECK
- d. Cabin Air Intake - CHECK

4. LEFT FUSELAGE:

- a. Static Pressure Button - UNOBSTRUCTED
- b. All Antennas - CHECK

5. LEFT WING TRAILING EDGE:

- a. Flap - CHECK
- b. Aileron - CHECK
- c. Wing Tip - CHECK
- d. Position Light - CHECK

6. LEFT WING LEADING EDGE:

- a. Stall Warning - CHECK
- b. Pitot Tube - CHECK (Remove Cover)
- c. Fuel Tank - CHECK QUANTITY; Filler Cap SECURE.
- d. Cabin Air Intake - CHECK
- e. Tie Down and Chocks - REMOVE

7. LEFT LANDING GEAR:

- a. Wheel Well Door, Tire and Strut - CHECK
- b. Fuel Vent - CHECK
- c. Fuel Sump - DRAIN
- d. Fuel Selector Valve Sump - DRAIN; Cover SECURE

8. NOSE SECTION:

- a. Left Cowl Flap - CHECK
- b. Engine Oil - CHECK (See Servicing, Section 8) Cap and Dipstick - SECURE
- c. Left Cowl - SECURE
- d. Propeller - CHECK, General Condition, Nicks, etc.
- e. Wheel Well Doors, Tire and Strut - CHECK
- f. Induction Air Intake - CLEAR
- g. Landing Light (s) - CHECK
- h. Engine - CHECK GENERAL CONDITION
- i. Right Cowl - SECURE
- j. Right Cowl Flap - CHECK
- k. Chocks - REMOVE

9. RIGHT LANDING GEAR:

- a. Fuel Vent - CHECK
- b. Fuel Sump - DRAIN
- c. Wheel Well Door, Tire and Strut - CHECK

10. RIGHT WING LEADING EDGE:

- a. Cabin Air Intake - CHECK
- b. Tie Down and Chocks - REMOVE
- c. Fuel Tank - CHECK QUANTITY; Filler Cap - SECURE

11. RIGHT WING TRAILING EDGE:

- a. Position Light - CHECK
- b. Wing Tip - CHECK
- c. Aileron - CHECK
- d. Flap - CHECK

CAUTION

NEVER TAXI IF ANY STRUT IS FLAT.

BEFORE STARTING

1. Seats - POSITION AND LOCK; Seat Backs - UPRIGHT
2. Seat Belts and Shoulder Harnesses - FASTEN
3. Parking Brake - SET
4. All Avionics - OFF
5. Circuit Breakers - IN
6. Landing Gear Handle - DOWN; Safety System - CHECK (If installed)
7. Flaps - UP
8. Cowl Flaps - OPEN
9. Light Switches - As required
10. Fuel Selector Valve - CHECK OPERATION; SELECT TANK MORE NEARLY FULL
11. Battery and Alternator Switches - ON (If external power is used, turn Alternator Switch - OFF) (See Section 7)
12. Fuel Quantity Indicators - CHECK QUANTITY

WARNING

Do not take off if gages indicate in yellow arc or with less than 13 gallons in each main tank.

EXTERNAL POWER

When using external power, it is very important that the following precautions be observed:

1. The airplane has a negative ground system. Exercise care to avoid reversed polarity. Be sure to connect the positive lead of the external power unit to the positive terminal of the airplane's external power receptacle and the negative lead to the negative terminal of the external power receptacle. A positive voltage must also be applied to the small guide pin.

2. To prevent arcing, make certain no power is being supplied when the connection is made.
3. Make certain that the battery switch is ON, all avionics and electrical switches OFF, and a battery is in the system before connecting an external power unit. This protects the voltage regulators and associated electrical equipment from voltage transients (power fluctuations).

STARTING ENGINE USING AUXILIARY POWER UNIT

1. Alternator, Electrical, and Avionics Equipment - OFF
2. Auxiliary Power Unit - CONNECT
3. Auxiliary Power Unit - SET OUTPUT (13.5 to 14.25 volts)
4. Auxiliary Power Unit - ON
5. Engine - START using normal procedures
6. Auxiliary Power Unit - OFF (after engine has been started)
7. Auxiliary Power Unit - DISCONNECT
8. Alternator Switch - ON

STARTING

CAUTION

Vernier-type engine controls should not be rotated clockwise after being advanced to the full forward position.

1. Mixture - FULL RICH
2. Propeller - HIGH RPM
3. Throttle - FULL OPEN
4. Auxiliary Fuel Pump - On until fuel flow peaks then OFF
5. Throttle - Approximately 1/4 inch open.
6. Magneto/Start Switch - START position; release to BOTH position when engine fires

CAUTION

Do not engage starter for more than 30 seconds in any 4-minute time period.

7. In Event of Overprime Condition:
 - a. Mixture - IDLE CUT-OFF
 - b. Throttle - OPEN
 - c. Magneto/Start Switch - START position
 - d. As engine fires, reduce throttle to IDLE and advance the mixture control to FULL RICH

NOTE

During hot starts, the Auxiliary Fuel Pump is turned on momentarily after starting to purge system, then turned off.

8. Throttle - 1000 to 1200 RPM
9. Oil Pressure - CHECK
10. External Power (if used) - DISCONNECT
11. Alternator Switch - ON; CHECK FOR CHARGING
12. All Engine Indicators - CHECK

CAUTION

The ammeter indication should be less than 25% of full charge at 1000 to 1200 rpm within two minutes, with no additional electrical equipment on. If not, turn off the battery and alternator switches, and do not take off.

AFTER STARTING, AND TAXI

1. Brakes - RELEASE AND CHECK
2. Avionics Equipment - ON, AS REQUIRED
3. Lights - AS REQUIRED

CAUTION

Do not operate engine above 1200 RPM until oil temperature reaches 75°F (24°C).

BEFORE TAKEOFF

1. Seat Belts and Shoulder Harnesses - CHECK

NOTE

All reclining seats must be in the upright position during take-off.

2. Parking Brake - SET
3. Radios - CHECK
4. Engine Instruments - CHECK
5. Flight Instruments - CHECK AND SET
6. Ammeter - CHECK - for stabilized indication between 0 and 25% of full charge at 1000 to 1200 rpm
7. Auxiliary Fuel Pump - CHECK OFF
8. Throttle - 1700 RPM
9. Propeller - EXERCISE to obtain approximately 300 to 400 rpm drop; return to high rpm
10. Magnetos - CHECK at 1700 rpm (variance between individual magnetos should not exceed 50 rpm, maximum drop not to exceed 150 rpm.)
11. Trim - SET
 - a. Aileron - NEUTRAL
 - b. Elevator - 3° (6° nose up if only front seats are occupied)
12. Flaps - UP
13. Door and Windows - SECURE
14. Controls - CHECK PROPER DIRECTION AND FREEDOM OF MOVEMENT
15. Mixture - FULL RICH (or as required by field elevation)
16. Brakes - RELEASED
17. Instruments - CHECK (Make final check of manifold pressure, fuel flow, and rpm at the start of the take-off run.)

TAKE-OFF

Take-Off Power Full Throttle, 2700 rpm

1. Power - SET TAKE-OFF POWER (Mixture - SET as required by field elevation)
2. Brakes - RELEASE THEN ACCELERATE to recommended speeds
3. Landing Gear - RETRACT (when positive rate of climb is established and insufficient runway remains for landing)
4. Airspeed - ESTABLISH DESIRED CLIMB SPEED (when clear of obstacles)

CLIMB

Maximum Continuous Full Throttle, 2700 rpm
Cruise Climb 25 in. Hg (or full throttle) 2500 rpm

1. Engine Temperatures - MONITOR
2. Power - SET AS DESIRED.
3. Mixture - SET FUEL FLOW

CRUISE

See Cruise Charts in PERFORMANCE Section.

1. Cowl Flaps - CLOSED
2. Power - SET
3. Mixture - SET FUEL FLOW

LEANING USING THE EXHAUST GAS TEMPERATURE INDICATOR (EGT)

A thermocouple-type exhaust gas temperature (EGT) probe is mounted in the exhaust system. This probe is connected to an indicator on the instrument panel. The indicator is calibrated in degrees Fahrenheit. Use EGT system to lean the fuel/air mixture when cruising at 75% power or less in the following manner:

1. Lean the mixture and note the point on the indicator that the temperature peaks and starts to fall.
 - a. CRUISE (LEAN) MIXTURE - Increases the mixture until the EGT shows a drop of 25°F below peak on the rich side of peak.
 - b. BEST POWER MIXTURE - Increase the mixture until the EGT shows a drop of 100°F below peak on the rich side of peak.

CAUTION

Do not continue to lean mixture beyond that necessary to establish peak temperature.

2. Continuous operation is recommended at 25°F or more below peak EGT only on the rich side of peak.
3. Changes in altitude and power settings require the peak EGT to be rechecked and the mixture reset.

DESCENT

1. Altimeter - SET
2. Cowl Flaps - CLOSED
3. Power - AS REQUIRED (avoid prolonged idle settings and low cylinder head temperatures)
4. Mixture - ENRICH AS REQUIRED

BEFORE LANDING

1. Seat Belts and Shoulder Harnesses - SECURE

NOTE

All reclining seats must be in the upright position during landing.

2. Fuel Selector Valve - SELECT TANK MORE NEARLY FULL
3. Cowl Flaps - AS REQUIRED
4. Mixture - FULL RICH (or as required by field elevation)
5. Landing Gear - DOWN and CHECK. (Observe maximum extension speed)
6. Landing and Taxi Lights - AS REQUIRED
7. Flaps - DOWN (Observe maximum extension speed)
8. Airspeed - ESTABLISH LANDING APPROACH SPEED.
9. Propeller - HIGH RPM

BALKED LANDING

1. Power - FULL THROTTLE, 2700 RPM
2. Airspeed - 76 kts/87 mph until clear of obstacles, then trim to normal climb speed
3. Flaps - UP
4. Landing Gear - UP
5. Cowl Flaps - OPEN

AFTER LANDING

1. Landing and Taxi Lights - AS REQUIRED
2. Flaps - UP
3. Trim Tab - SET TO 0°
4. Cowl Flaps - OPEN

SHUTDOWN

1. Brakes - SET
2. Electrical and Radio Equipment - OFF
3. Throttle - CLOSE
4. Mixture - IDLE CUT-OFF
5. Magneto/Start Switch - OFF, after engine stops
6. Battery and Alternator Switches - OFF
7. Control Lock - INSTALL, if conditions warrant.
8. Install wheel chocks and release brakes if the airplane is to be left unattended.

ENVIRONMENTAL SYSTEMS

OXYGEN SYSTEM

PREFLIGHT

1. Check Oxygen Pressure Gage for pressure reading.
2. Determine percent of full system.
3. Multiply oxygen duration in minutes by percent of full bottle.

EXAMPLE:

People	5
Gage Pressure	1500 psig
Oxygen Available (from chart)	80%
Cylinder Capacity (full)	49 cu ft
Altitude (planned flight)	15,000 ft
Full Bottle Duration (from chart)	149 min
Duration (80% full)	119 min

**OXYGEN AVAILABLE WITH
PARTIALLY FULL BOTTLE**

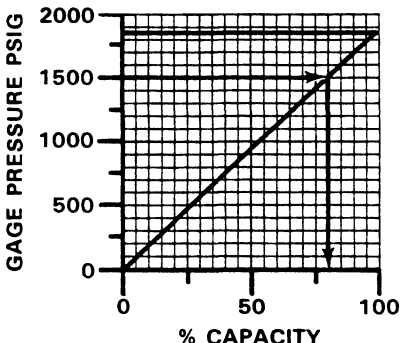

OXYGEN DURATION

The recommended masks are provided with the system. They are designed to be adjustable to fit the average person, with minimum leakage of oxygen.

CAUTION

Since 90% of the system efficiency is determined by the fit of the oxygen mask, make certain the masks fit properly and are in good condition.

OXYGEN DURATION CHART (Full Bottle)

Duration in minutes at the following altitudes:

Bottle Capacity	Persons Using	12,500 FT	15,000 FT	20,000 FT
49 cu ft	1	1014	746	507
	2	507	373	253
	3	338	248	169
	4	253	186	126
	5	202	149	101
	6	169	124	84

NOTE

To calculate duration times for bottle capacities other than 49 cu. ft. use 77% (38 cu. ft.) or 230% (114 cu. ft.) of chart values.

WARNING

NO SMOKING when using oxygen.

IN FLIGHT

The use of oxygen is recommended to be in accordance with current FAR operating rules.

1. Oxygen Control Valve - OPEN SLOWLY
2. Mask - INSERT FITTING, DON MASK (adjust mask for proper fit)
3. Oxygen - CHECK INDICATOR FOR FLOW

AFTER USING

1. Discontinue use by unplugging mask from outlet.

NOTE

Closing the control valve while in flight is not necessary due to automatic sealing of the outlet when the mask is unplugged. However, it is desirable to shut off supply when not in use.

2. Oxygen Control Valve - CLOSED (may be accomplished during shut-down)

HEATING AND VENTILATION

Refer to the SYSTEMS DESCRIPTION Section for operation of heating and ventilation controls.

COLD WEATHER OPERATION

PREFLIGHT INSPECTION

All accumulations of ice, snow and frost must be removed from the wings, tail, control surfaces and hinges, propeller, windshield, fuel cell filler caps, crankcase vents, and fuel vents. If such accumulations are not removed completely, the airplane shall not be flown. The deposits will not blow off in flight. While an adverse weight factor is clearly involved in the case of heavy deposits, it is less obvious that even slight accumulations will disturb or completely destroy the designed aerodynamic properties of the airfoils.

The normal preflight procedures should then be completed, with particular attention given to check of flight controls for complete freedom of movement.

ENGINE

Use engine oil in accordance with Consumable Materials in the HANDLING, SERVICING AND MAINTENANCE Section. Always pull the propeller through by hand, opposite the direction of rotation, several times to clear the engine and "limber up" the cold, heavy oil before using the starter. This will also lessen the load on the battery if external power is not used.

Under very cold conditions, it may be necessary to preheat the engine prior to a start. Particular attention should be given to the oil cooler, engine sump and propeller hub to ensure proper preheat. A start with congealed oil in the system may produce an indication of normal pressure immediately after the start, but then the oil pressure may decrease when residual oil in the engine is pumped back with the congealed oil in the sump. If an engine heater capable of heating both the engine sump and cooler is not available, the oil should be drained while the engine is hot and stored in a warm area until the next flight.

If there is no oil pressure within the first 30 seconds of running, or if oil pressure drops after a few minutes of ground operation, shut down and check for broken oil lines, oil cooler leaks or the possibility of congealed oil.

NOTE

It is advisable to use external power for starting in cold weather.

During warm-up, monitor engine temperatures closely, since it is quite possible to exceed the cylinder head temperature limit in trying to bring up the oil temperature.

Exercise the propeller several times to remove cold oil from the pitch change mechanism. The propeller should also be cycled occasionally in flight.

During letdown and landing, give special attention to engine temperatures, since the engine will have a tendency toward overcooling.

ICING CONDITIONS

Flight in Icing Conditions Is Prohibited.

ENGINE BREAK-IN INFORMATION

See Systems Description section

INTENTIONALLY LEFT BLANK

SECTION V

PERFORMANCE

TABLE OF CONTENTS

<i>SUBJECT</i>	<i>PAGE</i>
Introduction to Performance and	
Flight Planning	5-3
Conditions	5-3
Comments Pertinent to the Use of	
Performance Graphs	5-9
Airspeed Calibration - Normal System	5-10
Airspeed Calibration - Emergency System	5-11
Altimeter Correction - Normal System	5-12
Altimeter Correction - Emergency System	5-13
Fahrenheit to Celsius Temperature Conversion ...	5-14
ISA Conversion	5-15
Stall Speeds - Power Idle	5-16
Wind Components	5-17
Take-Off Distance	5-18
Climb	5-19
Time, Fuel and Distance to Climb	5-20
Cruise Power Settings	
75% MCP (Or Full Throttle)	5-21
65% MCP (Or Full Throttle)	5-22
55% MCP (Or Full Throttle)	5-23
45% MCP (Or Full Throttle)	5-24
Cruise Speeds	5-25
Manifold Pressure vs RPM	5-26
Fuel Flow vs Brake Horsepower	5-27

TABLE OF CONTENTS (Continued)

<i>SUBJECT</i>	<i>PAGE</i>
Range Profile - 74 Gallons	5-28
Range Profile - 44 Gallons	5-29
Endurance Profile - 74 Gallons	5-30
Endurance Profile - 44 Gallons	5-31
Landing Distance	5-32

**INTRODUCTION TO PERFORMANCE AND FLIGHT
PLANNING**

The graphs and tables in this section present performance information for flight planning at various parameters of weight, power, altitude and temperature. Examples have been presented on all performance graphs. In addition, the calculations for flight time, block speed and fuel required for a proposed flight are detailed below. All examples and calculations utilize the following conditions:

CONDITIONS

At Denver:

Outside Air Temperature 15°C (59°F)
Field Elevation 5330 ft
Altimeter Setting 29.60 in. Hg
Wind 270° at 10 kts
Runway 26L length 10,010 ft

Route of Trip

*DEN-V81-AMA

For VFR Cruise at 11,500 feet

ROUTE SEGMENT	MAGNETIC COURSE	DIST NM	WIND 11500 FEET DIR/KTS	OAT 11500 FEET °C	ALT SETTING IN.HG
DEN-COS	161°	55	010/30	-5	29.60
COS-PUB	153°	40	010/30	-5	29.60
PUB-TBE	134°	74	100/20	0	29.56
TBE-DHT	132°	87	200/20	9	29.56
DHT-AMA	125°	65	200/20	10	29.56

*REFERENCE: Enroute Low Altitude Chart L-6

Section V
Performance

BEEHCRAFT Bonanza 36, A36
E-1 thru E-926

At Amarillo:

Outside Air Temperature	25°C (77°F)
Field Elevation	3605 ft
Altimeter Setting	29.56 in. Hg
Wind	180° at 10 kts
Runway 21 Length	13500 ft

To determine pressure altitude at origin and destination airports, add 100 feet to field elevation for each .1 in. Hg below 29.92, and subtract 100 feet from field elevation for each .1 in. Hg above 29.92.

Pressure Altitude at DEN:

$$29.92 - 29.60 = .32 \text{ in. Hg}$$

The pressure altitude at DEN is 320 feet above the field elevation.

$$5330 + 320 = 5650 \text{ ft}$$

Pressure Altitude at AMA:

$$29.92 - 29.56 = .36 \text{ in. Hg}$$

The pressure altitude at AMA is 360 feet above the field elevation.

$$3605 + 360 = 3965 \text{ ft}$$

NOTE

For flight planning, the difference between cruise altitude and cruise pressure altitude has been ignored.

Calculations for flight time, block speed and fuel requirement:

Cruise Climb:

Enter the graph for TIME, FUEL AND DISTANCE TO CLIMB at 15°C to 5650 ft and to 3600 lbs. Enter at -5°C to 11,500 ft and to 3600 lbs. Read:

$$\text{Time to Climb} = (27.5 - 9.5) = 18 \text{ min}$$

$$\text{Fuel Used to Climb} = (7.8 - 3.1) = 4.7 \text{ gal}$$

$$\text{Distance Traveled} = (55 - 18) = 37 \text{ NM}$$

The cruise power setting is assumed to be at 2500 rpm. Since cruise at 11,500 feet requires full throttle, the manifold pressure and fuel flow may be read from the cruise power setting table for 75 percent maximum continuous power.

The temperatures for cruise are presented for a standard day (ISA); 20°C (36°F) above a standard day (ISA + 20°C); and 20°C (36°F) below a standard day (ISA - 20°C). These should be used for flight planning. The IOAT values are true temperature values which have been adjusted for the compressibility effects. IOAT should be used for setting cruise power while enroute.

Enter the graph for ISA conversion at 11,500 feet and the temperature for the route segment:

DEN-PUB	OAT	=	-5°C
	ISA Condition	=	ISA + 3°C
PUB-TBE	OAT	=	0°C
	ISA Condition	=	ISA + 8°C
TBE-DHT	OAT	=	9°C
	ISA Condition	=	ISA + 17°C
DHT-AMA	OAT	=	10°C
	ISA Condition	=	ISA + 18°C

**Section V
Performance**

**BEECHCRAFT Bonanza 36, A36
E-1 thru E-926**

Enter the Cruise Power Settings table for 75 percent maximum continuous power (or full throttle) at 11,000 ft, 12,000 ft, ISA and ISA + 20°C.

	TEMPERATURE					
	ISA			ISA + 20°C		
ALTI- TUDE FEET	MAN. PRESS. IN. HG	FUEL FLOW GPH	TAS KNOTS	MAN. PRESS. IN. HG	FUEL FLOW GPH	TAS KNOTS
11000	19.2	13.1	162	19.2	12.7	161
12000	18.3	12.7	161	18.3	12.3	160

Interpolate for 11,500 feet and the temperature for the appropriate route segment. Results of the interpolations are:

ROUTE SEGMENT	MAN. PRESS. IN. HG	FUEL FLOW GPH	TAS KNOTS
DEN-PUB	18.8	12.8	161
PUB-TBE	18.8	12.7	161
TBE-DHT	18.8	12.6	161
DHT-AMA	18.8	12.5	161

NOTE

The above are exact values for the assumed conditions.

Time and fuel used were calculated as follows:

$$\text{Time} = \frac{\text{Distance}}{\text{Ground Speed}}$$

$$\text{Fuel Used} = (\text{Time}) (\text{Fuel Flow})$$

Results are:

ROUTE SEGMENT	DISTANCE NM	EST GROUND SPEED KNOTS	TIME AT CRUISE ALTITUDE HRS: MIN	FUEL USED FOR CRUISE GAL
DEN-COS	*18	190	0:06	1.3
COS-PUB	40	188	0:13	2.8
PUB-TBE	74	147	0:30	6.4
TBE-DHT	87	149	0:35	7.4
DHT-AMA	65	150	0:26	5.4

*Distance required to climb has been subtracted from segment distance.

TIME - FUEL - DISTANCE

ITEM	TIME HRS: MINS	FUEL GAL	DISTANCE NM
Start, Runup, Taxi and Take-off acceleration	0:00	2.0	0
Climb	0:18	4.7	37
Cruise	1:50	23.3	284
Total	2:08	30.0	321

**Section V
Performance**

**BEEHCRAFT Bonanza 36, A36
E-1 thru E-926**

Total Flight Time: 2 hours, 8 minutes

Block Speed: $321 \text{ NM} \div 2 \text{ hours, 8 minutes} = 150 \text{ knots}$

Reserve Fuel (45 minutes at 45 percent maximum continuous power)

Enter the Cruise Power Settings table for 45 percent MCP (or full throttle). The fuel flow for 45 percent MCP is 9.6 gallons per hour.

Reserve fuel = $(45 \text{ min}) (9.6 \text{ GPH}) = 7.2 \text{ gallons}$

Total Fuel = $30.0 + 7.2 = 37.2 \text{ gallons}$

The estimated landing weight is determined by subtracting the fuel required for the trip from the ramp weight:

Assumed ramp weight = 3612 lbs

Estimated fuel from DEN to AMA = $(30.0 \text{ gal}) (6 \text{ lbs/gal})$
= 180 lbs

Estimated landing weight = $3612 - 180 = 3432 \text{ lbs}$

Examples have been provided on the performance graphs. The above conditions have been used throughout. Rate of climb was determined for the initial cruise altitude conditions.

**COMMENTS PERTINENT TO THE USE OF
PERFORMANCE GRAPHS**

1. The example, in addition to presenting an answer for a particular set of conditions, also presents the order in which the graphs should normally be used, i.e., if the first item in the example is OAT, then enter the graph at the known OAT.
2. The reference lines indicate where to begin following guide lines. Always project to the reference line first, then follow the guide lines to the next known item.
3. Indicated airspeeds (IAS) were obtained by using the AIRSPEED CALIBRATION NORMAL SYSTEM Graph.
4. The associated conditions define the specific conditions from which performance parameters have been determined. They are not intended to be used as instructions, however, performance values determined from charts can only be achieved if specified conditions exist.
5. The full amount of usable fuel is available for all approved flight conditions.

Section V
Performance

BEECHCRAFT Bonanza 36, A36
E-1 thru E-926

AIRSPEED CALIBRATION - NORMAL SYSTEM

EXAMPLE
IAS
FLAPS
CAS
90 KTS (104 MPH)
DOWN
88 KTS (101 MPH)

NOTE: INDICATED AIRSPEED ASSUMES ZERO INSTRUMENT ERROR

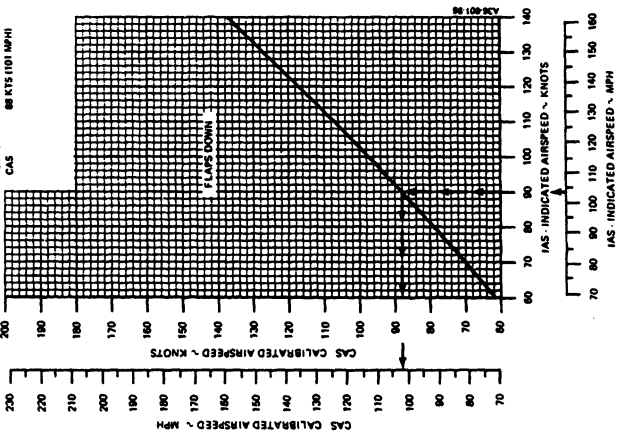
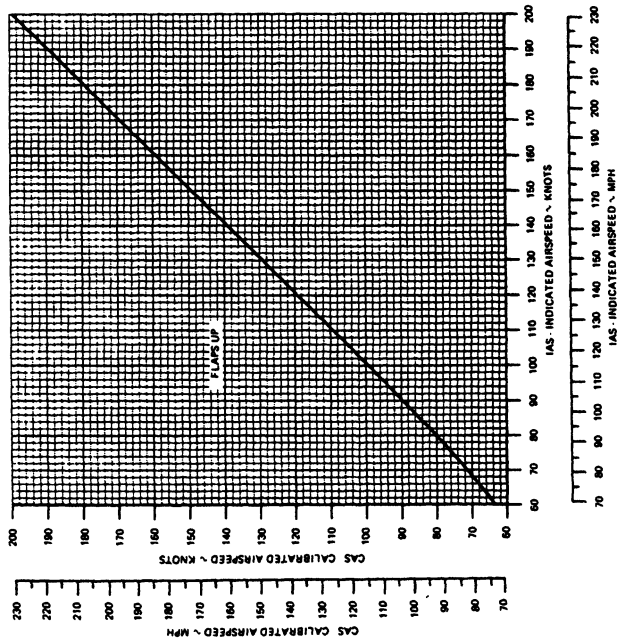

AIRSPEED CALIBRATION — EMERGENCY SYSTEM

NOTE: INDICATED AIRSPEED ASSUMES ZERO INSTRUMENT ERROR

EXAMPLE:

- IAS 100 KTS (115 MPH)
- STORM WINDOW OPEN
- GEAR UP
- FLAPS UP
- CAS 98 KTS (110 MPH)

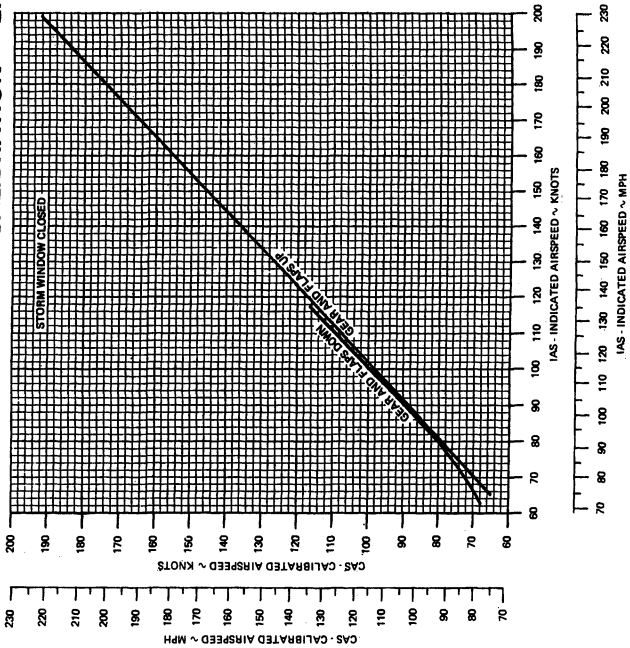

Section V
Performance

BEECHCRAFT Bonanza 36, A36
E-1 thru E-926

ALTIMETER CORRECTION - NORMAL SYSTEM

NOTE: INDICATED AIRSPEED AND INDICATED ALTITUDE ASSUME ZERO INSTRUMENT ERROR

EXAMPLE: IAS 85 KTS (88 MPH)
 FLAPS DOWN
 INDICATED PRESSURE ALTITUDE 4500 FT
 ALTITUDE CORRECTION -13 FT
 ACTUAL PRESSURE ALTITUDE 4500 - 13 = 4487 FT

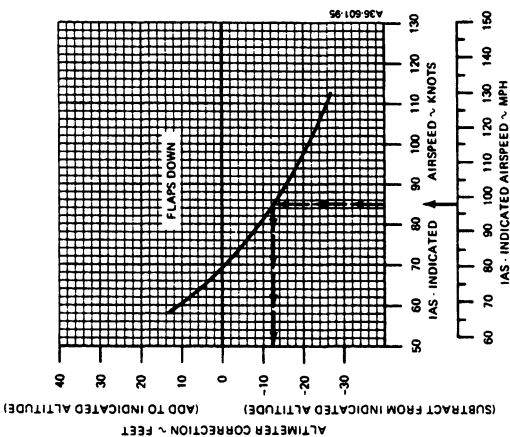
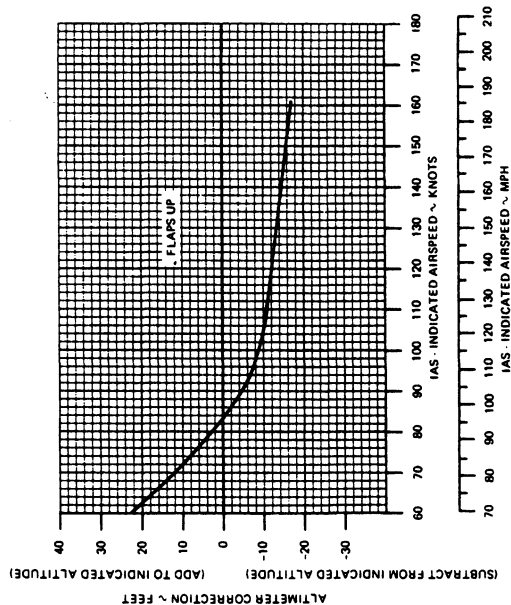

BEECHCRAFT Bonanza 36, A36 E-1 thru E-926

Section V Performance

EXAMPLE

IAS WINDOW 70 KTS (81 MPH)
 OPEN UP
 LANDING GEAR UP
 FLAPS UP

INDICATED PRESSURE ALTITUDE - 5000 FT
 ALTITUDE CORRECTION - 12 FT
 ACTUAL PRESSURE ALTITUDE - 5000 12 = 4988 FT

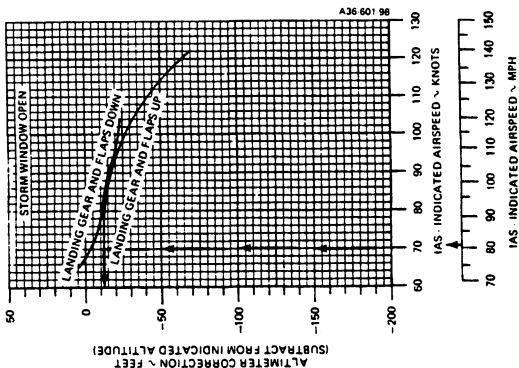

ALTIMETER CORRECTION - EMERGENCY SYSTEM

NOTE: INDICATED AIRSPEED AND INDICATED ALTITUDE ASSUME ZERO INSTRUMENT ERROR

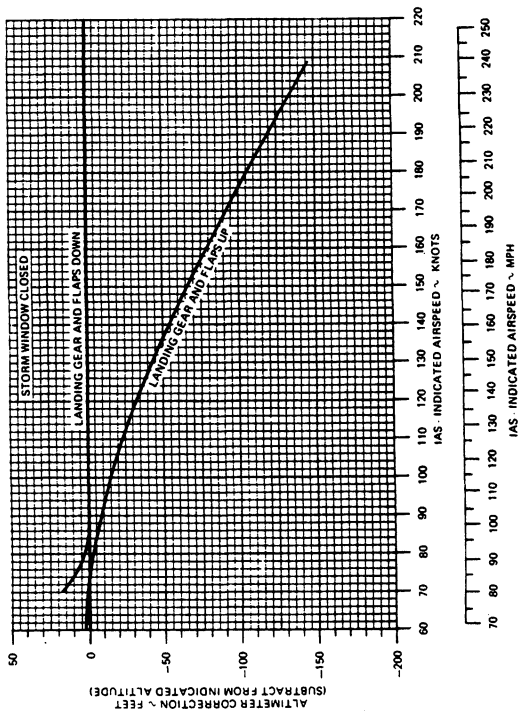

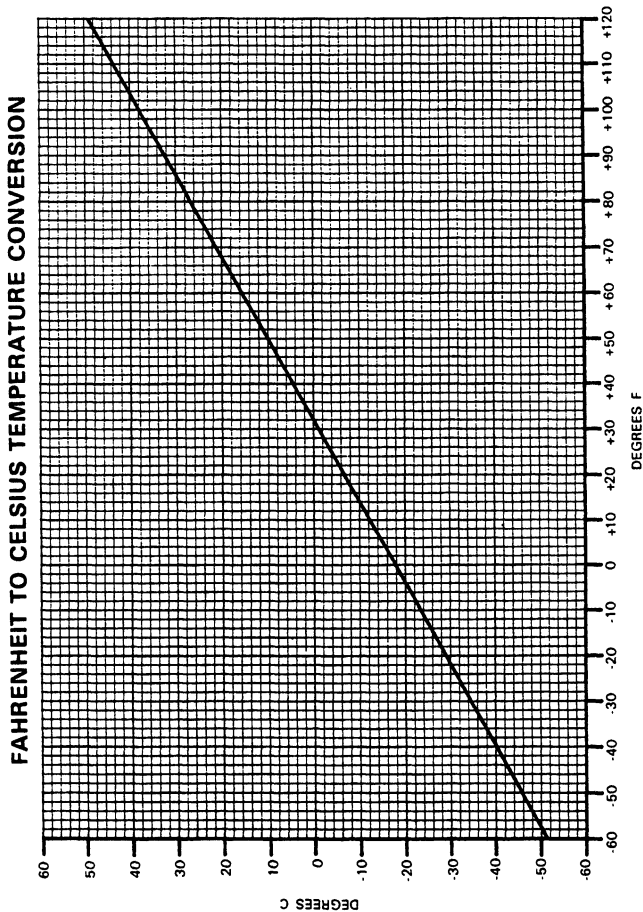

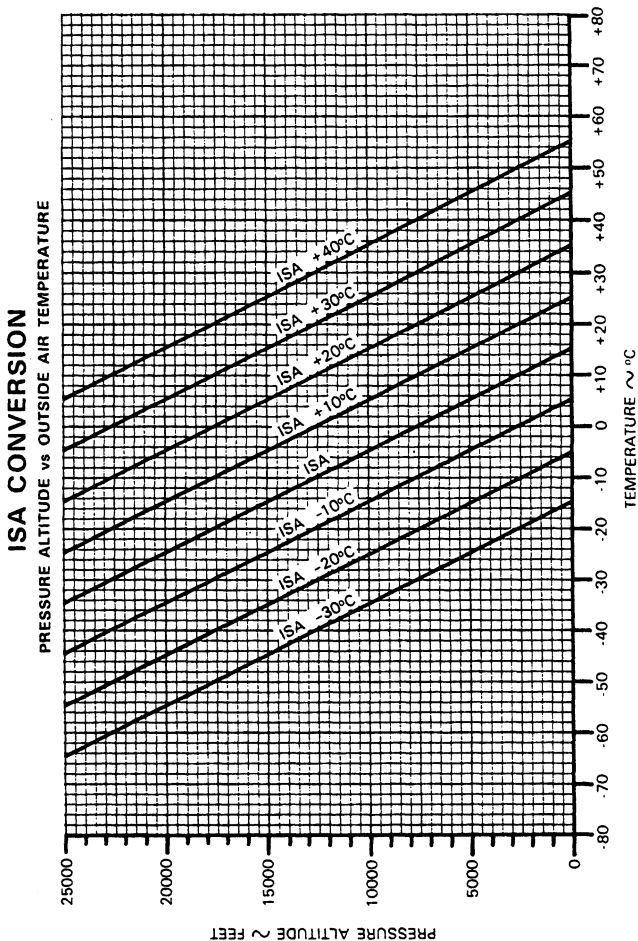

STALL SPEEDS - POWER IDLE

EXAMPLE
WEIGHT 3500 LBS
FLAPS UP
ANGLE OF BANK 30°
STALL SPEED CAS 68 KTS (79 MPH)
IAS 66 KTS (76 MPH)

- NOTES
1. THE MAXIMUM ALTITUDE LOSS EXPERIENCED WHILE CONDUCTING STALLS IN ACCORDANCE WITH CAM 3.120 WAS 200 FEET.
 2. THESE STALL SPEEDS WERE MEASURED AT THE MOST FORWARD CENTER OF GRAVITY POSITION. THE MAXIMUM ALTITUDE LOSS STOP WAS REACHED PRIOR TO A FULL STALL CONDITION.

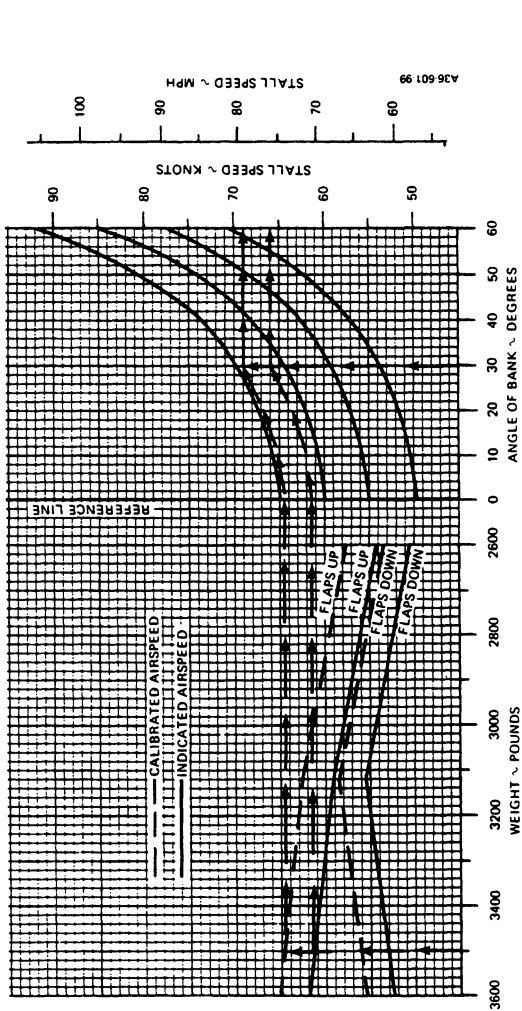

WIND COMPONENTS

Demonstrated Crosswind Component is 17 kts

EXAMPLE:

WIND SPEED	20 KTS
ANGLE BETWEEN WIND DIRECTION AND FLIGHT PATH	50°
<hr/>	
HEADWIND COMPONENT	13 KTS
CROSSWIND COMPONENT	15 KTS

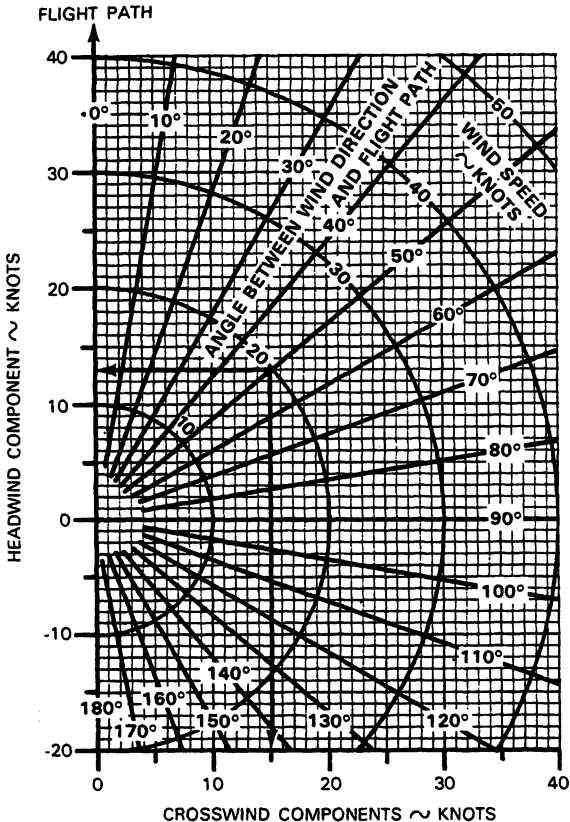

Section V
Performance

BEECHCRAFT Bonanza 36, A36
E-1 thru E-926

TAKE-OFF DISTANCE

ASSOCIATED CONDITIONS:

- POWER FULL THROTTLE - 2700 RPM
- MIXTURE LEAN TO APPROPRIATE FUEL FLOW
- FLAPS UP
- LANDING GEAR RETRACT AFTER POSITIVE CLIMB ESTABLISHED
- COWL FLAPS OPEN
- RUNWAY PAVED, LEVEL, DRY SURFACE

EXAMPLE:

- OAT 15°C (59°F)
- PRESSURE ALTITUDE 5650 FT
- TAKE-OFF WEIGHT 3600 LBS
- HEADWIND COMPONENT 9.5 KTS

- GROUND ROLL 1750 FT
- TOTAL DISTANCE OVER A 50 FT OBSTACLE 3250 FT
- TAKE-OFF SPEED AT LIFT OFF 70 KTS (81 MPH)
- 50 FT 78 KTS (90 MPH)

WEIGHT ~ POUNDS	TAKE-OFF SPEED	
	LIFT OFF	50 FT
	KNOTS	MPH
3600	70	81
3400	69	79
3200	67	77
3000	66	76
2800	63	73

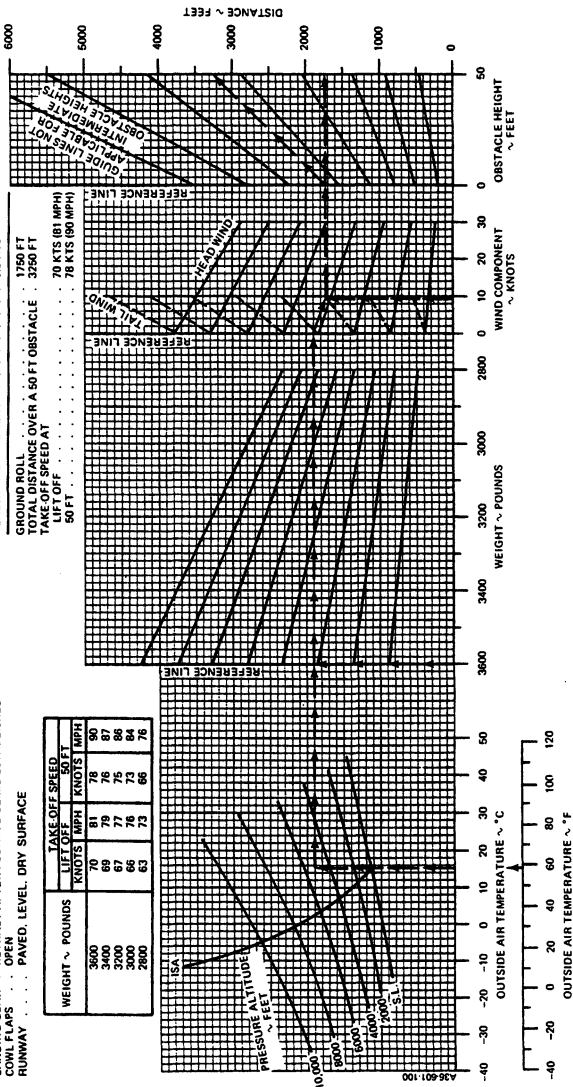

BEECHCRAFT Bonanza 36, A36 E-1 thru E-926

Section V Performance

CLIMB

ASSOCIATED CONDITIONS:

- POWER FULL THROTTLE AT 2700 RPM
- MIXTURE LEAN TO APPROPRIATE FUEL FLOW
- FLAPS UP
- LANDING GEAR UP
- COWL FLAPS AS REQUIRED

CLIMB SPEED 96 KNOTS (110 MPH) ALL WEIGHTS

- EXAMPLE:
- ALT 810 (MPL)
 - PRESSURE ALTITUDE 11,500 FT
 - WEIGHT 3200 LBS
 - RATE OF CLIMB 500 FT/MIN
 - CLIMB GRADIENT 4.3 %
 - CLIMB SPEED 96 KTS (110 MPH)

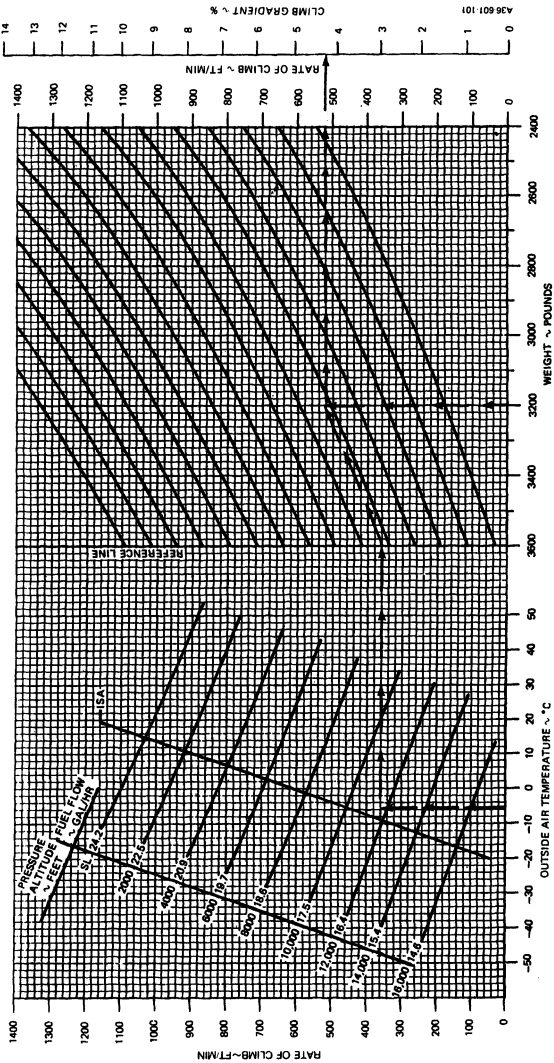

TIME, FUEL, AND DISTANCE TO CLIMB

ASSOCIATED CONDITIONS:

- 24 IN. HGR OR FULL THROTTLE 2500 RPM
- POWER 85%
- AIR DENSITY LEAN TO APPROPRIATE FUEL FLOW
- MIXTURE CLOSED
- COOL FLAPS CLOSED 125 MPH SEA LEVEL TO 12,000 FT
- CLIMB SPEED 100 KTS 1115 MPH ABOVE 12,000 FT

- EXAMPLE
- DAY AT TAKEOFF 15°C
 - DAY AT CRUISE 5°C
 - DAY AT CLIMB 5°C
 - AIRPORT PRESSURE ALTITUDE 15,000 FT
 - INITIAL CLIMB ALTITUDE 10,000 FT
 - INITIAL CLIMB WEIGHT 3600 LB
 - TIME TO CLIMB - 127.5 - 9.9 18.0 MIN
 - FUEL TO CLIMB - 17.8 - 3.1 4.7 GAL
 - DISTANCE IN CLIMB - 155 - 181 31 NAUT MI

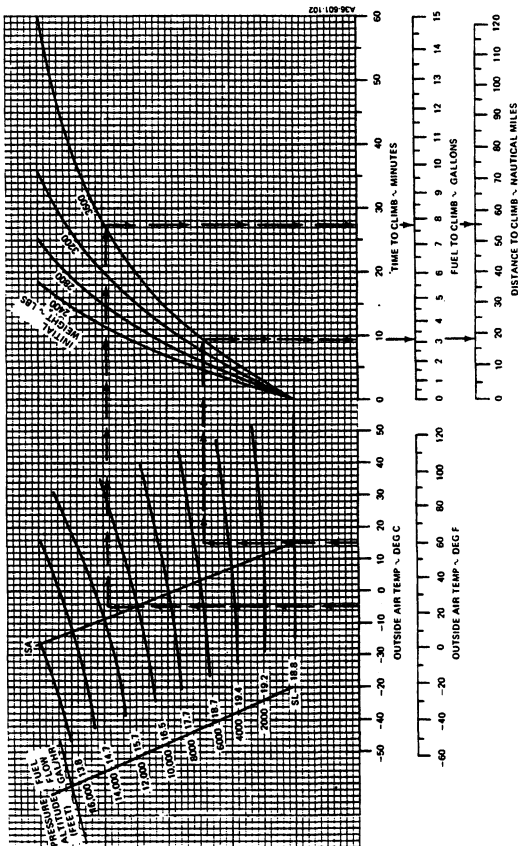

CRUISE POWER SETTINGS
75% MAXIMUM CONTINUOUS POWER (OR FULL THROTTLE) 2500 RPM
3400 POUNDS

PRESS ALT.	ISA -36°F (-20°C)						STANDARD DAY (ISA)						ISA +30°F (+20°C)						
	IOAT		MAN. PRESS.		FUEL FLOW		IOAT		MAN. PRESS.		FUEL FLOW		IOAT		MAN. PRESS.		FUEL FLOW		
	°F	°C	IN HG	PPH	GPH	KTS	°F	°C	IN HG	PPH	GPH	KTS	°F	°C	IN HG	PPH	GPH	KTS	
SL	27	-3	23.9	91.4	15.2	156	63	17	24.6	91.4	15.2	160	99	37	25.1	91.4	15.2	163	157
1000	24	-5	23.6	91.4	15.2	156	60	15	24.3	91.4	15.2	161	96	36	24.8	91.4	15.2	164	156
2000	20	-7	23.4	91.4	15.2	159	56	13	24.1	91.4	15.2	162	92	34	24.6	91.4	15.2	165	155
3000	17	-9	23.1	91.4	15.2	160	53	12	23.8	91.4	15.2	164	89	32	24.3	91.4	15.2	167	154
4000	13	-11	22.8	91.4	15.2	162	49	10	23.5	91.4	15.2	166	85	30	24.0	91.4	15.2	168	153
5000	10	-12	22.5	91.4	15.2	163	46	8	23.2	91.4	15.2	166	82	28	23.7	90.5	15.1	169	151
6000	6	-14	22.2	91.4	15.2	164	42	6	23.0	91.4	15.2	168	78	26	23.6	89.7	15.0	169	150
7000	3	-16	22.0	91.4	15.2	166	38	4	22.6	89.7	14.9	169	75	24	23.6	89.7	14.4	166	146
8000	-1	-18	21.7	89.8	15.0	166	35	2	21.7	89.9	14.5	169	71	22	21.7	84.0	14.0	166	143
9000	-5	-20	20.8	86.9	14.4	164	31	0	20.8	84.1	14.0	165	67	20	20.8	81.3	13.6	165	139
10,000	-8	-22	20.0	83.7	13.9	163	28	-2	20.0	81.0	13.6	163	64	18	20.0	78.3	13.0	163	136
11,000	-12	-24	19.2	81.4	13.2	162	24	-4	19.2	78.8	13.1	162	60	16	19.2	76.2	12.7	161	132
12,000	-16	-26	18.3	79.1	12.1	161	21	-6	18.3	76.6	12.7	161	56	14	18.3	74.0	12.3	160	128
13,000	-19	-28	17.6	76.0	12.0	160	19	-8	17.6	73.9	12.3	159	53	12	17.6	71.1	11.9	157	124
14,000	-23	-31	16.8	72.9	12.1	156	13	-11	16.8	70.8	11.8	155	48	9	16.8	68.3	11.4	153	119
15,000	-27	-33	16.1	70.4	11.7	153	9	-13	16.1	68.2	11.4	152	45	7	16.1	66.0	11.0	149	114
16,000	-30	-35	15.4	68.0	11.3	151	6	-15	15.4	65.8	11.0	149	41	5	15.4	63.8	10.6	145	109

- NOTES:
1. Full throttle manifold pressure settings are approximate.
 2. Shaded area represents operation with full throttle.

Section V
Performance

BEECHCRAFT Bonanza 36, A36
E-1 thru E-926

CRUISE POWER SETTINGS
65% MAXIMUM CONTINUOUS POWER (OR FULL THROTTLE) 2300 RPM
3400 POUNDS

PRESS ALT.	ISA - 36°F (-20°C)										STANDARD DAY (ISA)										ISA + 36°F (+20°C)									
	IOAT		MAN. PRESS.	FUEL FLOW		TAS	CAS	IOAT	MAN. PRESS.	FUEL FLOW		TAS	CAS	IOAT	MAN. PRESS.	FUEL FLOW		TAS	CAS											
	°F	°C		PPH	GPH					PPH	GPH					PPH	GPH			PPH	GPH	PPH	GPH	PPH	GPH	PPH	GPH			
SL	27	-3	23.3	80.0	13.3	147	152	63	17	23.9	80.0	13.3	150	150	99	37	24.5	80.0	13.3	152	147									
1000	23	-5	23.1	80.0	13.3	148	151	59	15	23.6	80.0	13.3	151	149	95	35	24.2	80.0	13.3	153	146									
2000	20	-7	22.8	80.0	13.3	149	150	56	13	23.4	80.0	13.3	152	148	92	33	24.0	80.0	13.3	155	145									
3000	16	-9	22.5	80.0	13.3	150	149	52	11	23.1	80.0	13.3	153	147	88	31	23.7	80.0	13.3	156	144									
4000	13	-11	22.3	80.0	13.3	152	148	49	9	22.9	80.0	13.3	154	145	85	29	23.5	80.0	13.3	157	143									
5000	9	-13	22.0	80.0	13.3	153	147	45	7	22.6	80.0	13.3	155	144	81	27	23.2	80.0	13.3	158	142									
6000	6	-15	21.8	80.0	13.3	154	146	42	5	22.4	80.0	13.3	157	143	78	25	23.0	80.0	13.3	159	140									
7000	2	-17	21.5	80.0	13.3	155	145	38	3	22.1	80.0	13.3	157	142	74	23	22.8	80.0	13.2	159	138									
8000	-2	-19	21.3	80.0	13.3	156	144	35	1	21.7	79.4	13.2	158	140	71	21	21.7	76.7	12.8	157	135									
9000	-5	-21	20.9	78.7	13.1	156	142	31	-1	20.9	76.2	12.7	156	136	67	19	20.9	73.7	12.3	155	130									
10,000	-9	-23	20.0	76.2	12.7	154	138	27	-3	20.0	73.8	12.3	154	132	63	17	20.0	71.4	11.9	152	127									
11,000	-12	-25	19.2	73.8	12.3	153	134	24	-6	19.2	71.4	11.9	152	129	60	15	19.2	69.0	11.5	150	123									
12,000	-16	-27	18.4	71.3	11.9	151	131	20	-7	18.4	69.0	11.5	150	125	56	13	18.4	66.7	11.1	147	118									
13,000	-20	-29	17.6	68.8	11.5	148	127	16	-9	17.6	66.7	11.1	147	120	52	11	17.6	64.6	10.8	143	113									
14,000	-23	-31	16.9	66.3	11.1	145	122	13	-11	16.9	64.3	10.7	143	116	48	9	16.9	62.4	10.4	138	108									
15,000	-27	-33	16.1	64.0	10.7	142	118	9	-13	16.1	62.1	10.3	138	110	44	7	16.1	60.2	10.0	131	100									
16,000	-31	-35	15.5	62.4	10.4	139	113	5	-15	15.5	60.6	10.1	134	105									

- NOTES:
1. Full throttle manifold pressure settings are approximate.
2. Shaded area represents operation with full throttle.

CRUISE POWER SETTINGS

55% MAXIMUM CONTINUOUS POWER (OR FULL THROTTLE) 2100 RPM
3400 POUNDS

PRESS ALT.	ISA -36°F (-20°C)						STANDARD DAY (ISA)						ISA +36°F (+20°C)																																																																																																																																																																																																																																																																																																																																																			
	IOAT		MAN. PRESS.		FUEL FLOW		IOAT		MAN. PRESS.		FUEL FLOW		IOAT		MAN. PRESS.		FUEL FLOW																																																																																																																																																																																																																																																																																																																																															
	°F	°C	IN HG	PPH	GPH	TAS	CAS	KTS	°F	°C	IN HG	PPH	GPH	TAS	CAS	KTS	°F	°C	IN HG	PPH	GPH	TAS	CAS	KTS																																																																																																																																																																																																																																																																																																																																								
SL	26	-3	23.0	68.8	11.5	136	141	62	17	23.6	69.8	11.5	138	138	98	37	24.2	68.8	11.5	140	136	10000	23	-5	22.8	68.8	11.5	137	140	59	15	23.3	68.8	11.5	139	137	95	35	24.0	68.8	11.5	141	134	20000	19	-7	22.5	68.8	11.5	138	139	55	13	23.1	68.8	11.5	140	136	91	33	23.7	68.8	11.5	142	133	30000	15	-9	22.3	68.8	11.5	139	138	52	11	22.9	68.8	11.5	141	135	88	31	23.5	68.8	11.5	143	130	40000	12	-11	22.1	68.8	11.5	139	136	48	9	22.6	68.8	11.5	141	133	84	29	23.2	68.8	11.5	143	130	50000	8	-13	21.8	68.8	11.5	140	135	45	7	22.4	68.8	11.5	142	132	81	27	23.0	68.8	11.5	143	129	60000	5	-15	21.6	68.8	11.5	141	134	41	5	22.1	68.8	11.5	143	131	77	25	22.5	68.8	11.5	144	127	70000	1	-17	21.3	68.8	11.5	142	133	37	3	21.9	68.8	11.5	143	129	74	23	22.7	68.8	11.5	145	126	80000	-2	-19	21.1	68.8	11.5	142	131	34	1	21.6	68.8	11.5	144	128	70	21	21.9	67.5	11.3	143	122	90000	-6	-21	20.9	68.8	11.5	143	130	30	-1	21.0	67.8	11.3	143	125	66	19	21.0	65.6	10.9	140	118	10,000	-9	-23	20.1	66.0	11.3	142	127	27	-3	20.2	66.8	11.0	141	121	63	17	20.1	63.8	10.8	137	114	11,000	-13	-25	19.3	66.0	11.0	140	124	23	-5	19.3	63.9	10.7	138	117	59	15	19.3	62.0	10.3	133	109	12,000	-17	-27	18.5	63.9	10.7	136	119	19	-7	18.5	62.1	10.3	134	112	55	13	18.5	60.2	10.0	129	102	13,000	-20	-29	17.7	61.8	10.3	134	115	16	-9	17.7	60	10.0	129	106	14,000	-24	-31	16.9	59.7	10.0	129	109	11	-11	16.9	57.9	9.6	120	97	15,000	-28	-33	16.2	57.6	9.6	123	102	11	-11	16.9	57.9	9.6	120	97	16,000	-32	-36	15.6	55.8	9.3	112	92	11	-11	16.9	57.9	9.6	120	97	11	-11	16.9	57.9	9.6	120	97

1. Full throttle manifold pressure settings are approximate.

2. Shaded area represents operation with full throttle.

NOTES:

CRUISE SPEEDS

ASSOCIATED CONDITIONS:

AVERAGE CRUISE WT. 3400 LBS
TEMPERATURE STD DAY (ISA)

EXAMPLE:

PRESSURE ALT 11,500 FT
PWR SETTING FULL THROTTLE, 2450 RPM
TRUE AIRSPEED 161 KTS

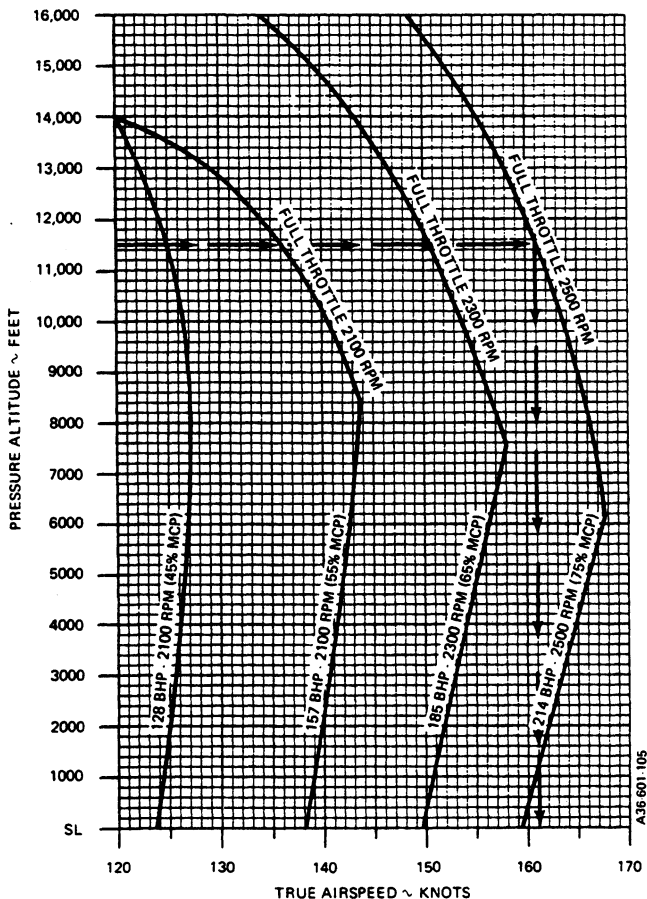

MANIFOLD PRESSURE vs RPM

EXAMPLE:

ENGINE SPEED 2450 RPM
MANIFOLD PRESSURE 24.5 IN. HG

WITHIN RECOMMENDED LIMITS

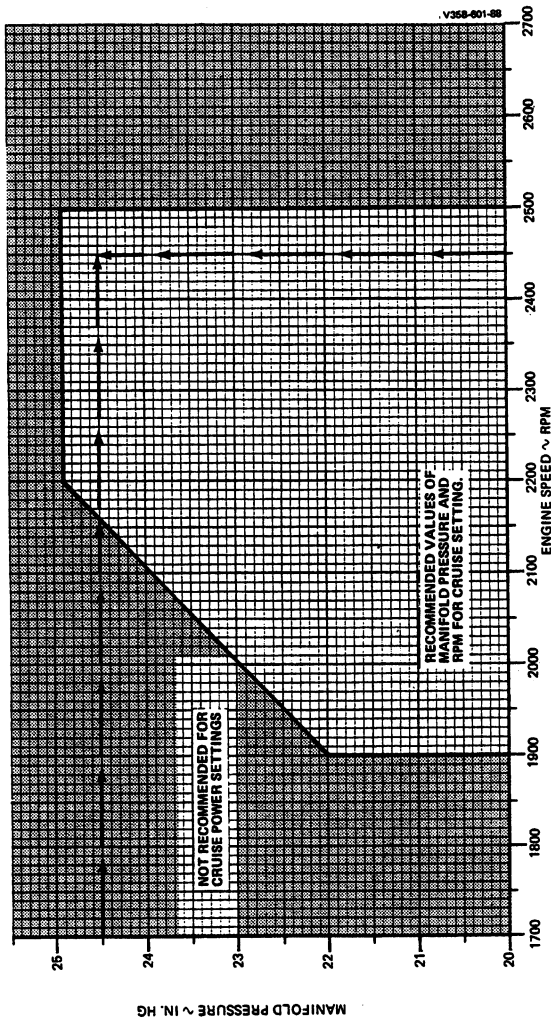

FUEL FLOW vs BRAKE HORSEPOWER

EXAMPLE:

① BRAKE HORSEPOWER	213.75
CONDITION	75% MCP LEVEL FLIGHT CRUISE
FUEL FLOW	15.25 GAL/HR
② FUEL FLOW	14.6 GAL/HR
CONDITION	LEVEL FLIGHT CRUISE
BRAKE HORSEPOWER	204

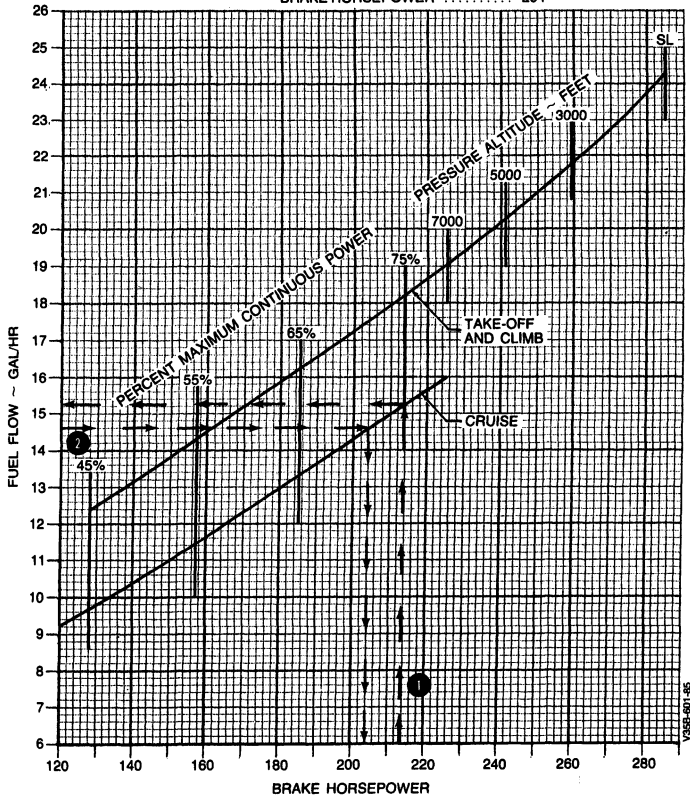

RANGE PROFILE - 74 GALLONS STANDARD DAY (ISA)

ASSOCIATED CONDITIONS:

WEIGHT 3612 LBS BEFORE ENGINE START
 FUEL AVIATION GASOLINE
 FUEL DENSITY 6.0 LBS/GAL
 INITIAL FUEL LOADING 74 U.S. GAL (444 LBS)
 TAKE-OFF ALTITUDE SL

EXAMPLE:

CRUISE ALTITUDE 11,500 FT
 POWER SETTING FULL THROTTLE, 2500 RPM
 RANGE 763 NM

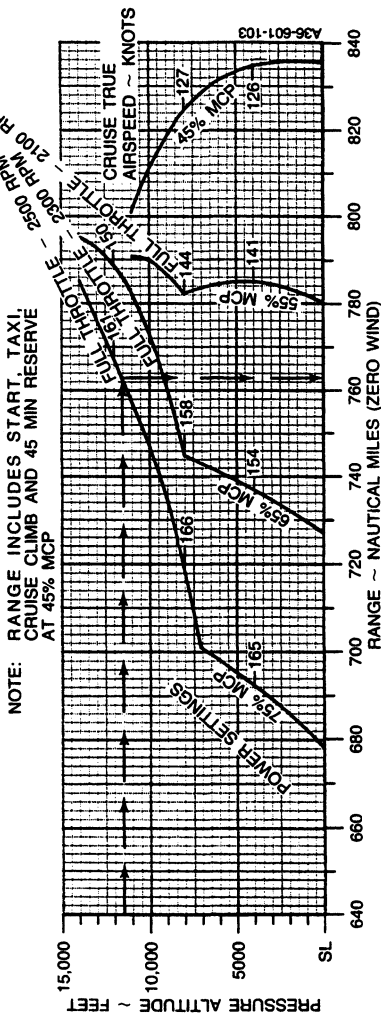

RANGE PROFILE - 44 GALLONS STANDARD DAY (ISA)

ASSOCIATED CONDITIONS:

WEIGHT 3612 LBS BEFORE ENGINE START
 FUEL AVIATION GASOLINE
 FUEL DENSITY 6.0 LBS/GAL
 INITIAL FUEL LOADING 44 U.S. GAL (184 LBS)
 TAKE-OFF ALTITUDE SL

EXAMPLE:

CRUISE ALTITUDE 11,500 FT
 POWER SETTING F.T. - 2500 RPM
 RANGE 388 NM

NOTE: RANGE INCLUDES START, TAXI,
 CRUISE CLIMB AND 45 MIN RESERVE
 AT 45% MCP.

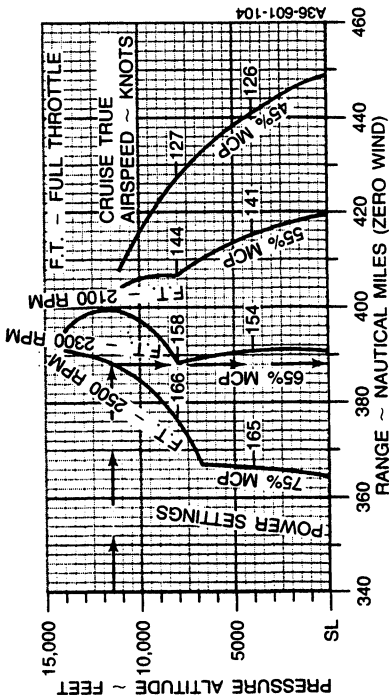

ENDURANCE PROFILE — 74 GALLONS

STANDARD DAY (ISA)

ASSOCIATED CONDITIONS:

WEIGHT 3612 LBS BEFORE ENGINE START
 FUEL AVIATION GASOLINE
 FUEL DENSITY 6.0 LBS/GAL
 INITIAL FUEL LOADING 74 U.S. GAL (444 LBS)
 TAKE-OFF ALTITUDE SL

EXAMPLE:

CRUISE ALTITUDE 11,500 FT
 POWER SETTING FULL THROTTLE — 2500 RPM
 ENDURANCE 4.9 HRS
 (4 HRS, 54 MIN)

NOTE: ENDURANCE INCLUDES START, TAXI, CRUISE CLIMB, AND 45 MIN RESERVE FUEL AT 45% M.C.P.

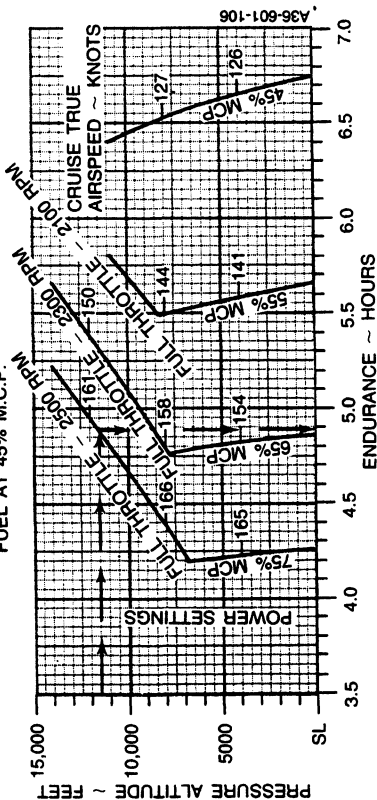

ENDURANCE PROFILE — 44 GALLONS

STANDARD DAY (ISA)

ASSOCIATED CONDITIONS:

WEIGHT 3612 LBS BEFORE
ENGINE START
AVIATION GASOLINE
FUEL DENSITY 6.0 LBS/GAL
INITIAL FUEL LOADING 44 U.S. GAL (164 LBS)
TAKE-OFF ALTITUDE SL

EXAMPLE:

CRUISE ALTITUDE 11,500 FT
POWER SETTING FULL THROTTLE —
2500 RPM
ENDURANCE 2.55 HRS
(2 HRS, 33 MIN)

NOTE: ENDURANCE INCLUDES START, TAXI,
CRUISE CLIMB, AND 45 MIN RESERVE
AT 45% MCP.

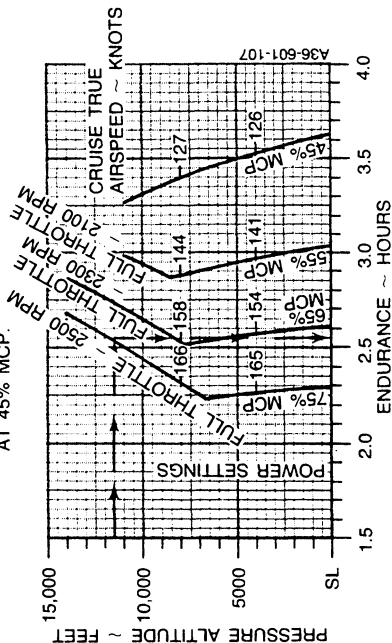

LANDING DISTANCE

EXAMPLE:

OAT 25°C (77°F)
 PRESSURE ALTITUDE 3965 FT
 WEIGHT 3433 LBS
 HEADWIND COMPONENT 9 KTS
 GROUND ROLL 925 FT
 TOTAL OVER 50 FT OBSTACLE 1700 FT
 APPROACH SPEED 74 KTS (85 MPH)

WEIGHT ~ POUNDS	SPEED AT 50 FT	
	KNOTS	MPH
3600	72	83
3400	74	85
3200	76	87
3000	75	86
2800	73	84

ASSOCIATED CONDITIONS:

- POWER RETARDED TO MAINTAIN 900 FT/MIN
- FLAPS FINAL APPROACH
- LANDING GEAR DOWN
- RUNWAY PAVED, LEVEL, DRY SURFACE
- APPROACH SPEED AS TABULATED
- BRAKING MAXIMUM

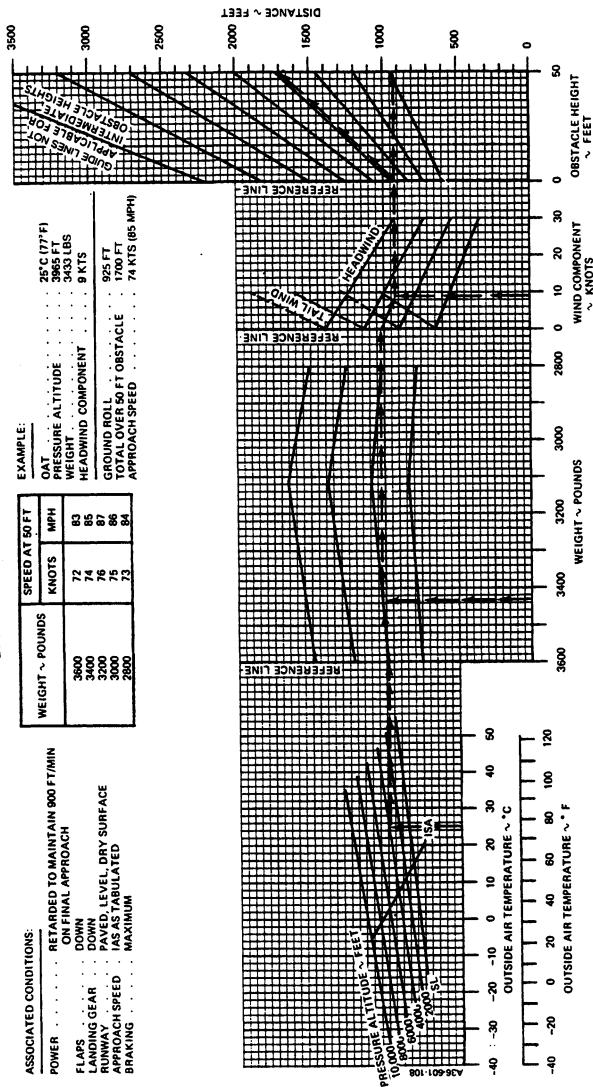

SECTION VI

WEIGHT AND BALANCE/ EQUIPMENT LIST

TABLE OF CONTENTS

<i>SUBJECT</i>	<i>PAGE</i>
Weighing Instructions	6-3
Basic Empty Weight and Balance Form	6-6
Weight and Balance Record	6-7
Loading Instructions	6-9
Seating, Baggage and Equipment Arrangements (E-1 thru E-631)	6-9
Seating, Baggage and Equipment Arrangements (E-632 thru E-926)	6-10
Moment Limits vs Weight Table	6-11
Computing Procedure	6-12
Sample Weight and Balance Loading Form	6-13
Weight and Balance Loading Form	6-14
Useful Load Weights and Moments	6-15
Occupants (E-1 thru E-631)	6-15
Occupants (E-632 thru E-926)	6-16
Baggage and Cargo	6-17
Usable Fuel	6-18
Oil	6-18
Equipment List	Provided for each airplane

INTENTIONALLY LEFT BLANK

WEIGHING INSTRUCTIONS

Periodic weighing of the airplane may be required to keep the Basic Empty Weight current. All changes to the airplane affecting weight and balance are the responsibility of the airplane's operator.

1. Three jack points are provided for weighing: two on the wing front spar at Fuselage Station 83.1 and one on the aft fuselage at Fuselage Station 271.0.
2. Fuel should be drained preparatory to weighing. Tanks are drained from the regular drain ports with the airplane in static ground attitude. When tanks are drained, 1.5 pounds of undrainable fuel remain in the airplane at Fuselage Station 76.0. The remainder of the unusable fuel to be added to a drained system is 34.5 pounds at Fuselage Station 79.1.
3. Engine oil must be at the full level or completely drained. Total engine oil when full is 26 pounds at Fuselage Station 14.5 (Includes 3 pounds undrainable oil.)
4. To determine airplane configuration at time of weighing, installed equipment is checked against the airplane equipment list or superseding forms. All installed equipment must be in its proper place during weighing.

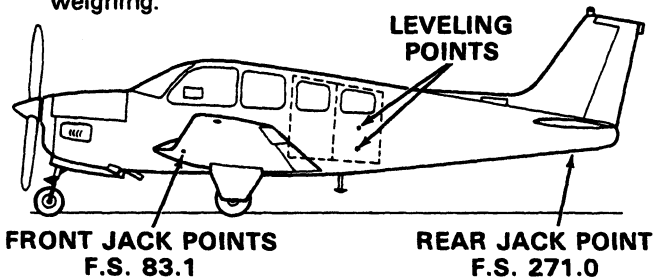

5. At the time of weighing, the airplane must be level both longitudinally and laterally, and the landing gear must be fully extended. Leveling screws are located on the left side of the fuselage at approximately Fuselage Station 152.25. Longitudinally level attitude is determined with a plumb bob. Laterally level attitude is obtained when the vertical distance from each wing tip to the floor is equal.

6. Measurement of the reaction arms for a wheel weighing is made using a steel measuring tape. Measurements are taken, with the airplane level on the scales, from the reference (a plumb bob dropped from the center of either main jack point) to the axle center line of the main gear and then to the nose wheel axle center line. The main wheel axle center line is best located by stretching a string across from one main wheel to the other. All measurements are to be taken with the tape level with the hangar floor and parallel to the fuselage center line. The locations of the wheel reactions will be approximately at Fuselage Station 96.7 for main wheels and Fuselage Station 2.7 for the nose wheel.

7. Jack point weighings are accomplished by placing scales at the jack points specified in step 1 above. Since the center of gravity of the airplane is forward of Fuselage Station 83.1, the tail reaction of the airplane will be in an up direction. This can be measured on regular scales by placing ballast of approximately 200 pounds on the scales and attached to the aft weighing point by cable of adjustable length. The up reaction will then be total ballast weight minus the scale reading and is entered in the weighing form as a negative quantity.

8. Weighing should always be made in an enclosed area which is free from air currents. The scales used should be properly calibrated and certified.

NOTE

Each new airplane is delivered with a completed sample loading, empty weight and center of gravity, and equipment list, all pertinent to that specific airplane. It is the owner's responsibility to ensure that changes in equipment are reflected in a new weight and balance and in an addendum to the equipment list. There are many ways of doing this; it is suggested that a running tally of equipment changes and their effect on empty weight and c.g. is a suitable means for meeting both requirements.

The current equipment list and empty weight and c.g. information must be retained with the airplane when it changes ownership. Beech Aircraft Corporation cannot maintain this information; the current status is known only to the owner. If these papers become lost, the FAA will require that the airplane be re-weighed to establish the empty weight and c.g. and that an inventory of installed equipment be conducted to create a new equipment list.

Section VI
Wt and Bal/Equip List

BEECHCRAFT Bonanza 36, A36
E-1 thru E-926

BONANZA A36 SER. NO. _____ REG. NO. _____ DATE _____
 STRUT POSITION - NOSE MAIN JACK POINT LOCATION PREPARED BY
 EXTENDED 1.8 96 FORWARD 83.1 Company _____
 COMPRESSED 3.1 97 AFT 271.0 Signature _____

REACTION WHEEL - JACK POINTS	SCALE READING	TARE	NET WEIGHT	ARM	MOMENT
LEFT MAIN					
RIGHT MAIN					
NOSE OR TAIL					
TOTAL (AS WEIGHED)					
<i>Space below provided for additions and subtractions to as - weighed condition</i>					
EMPTY WEIGHT					
ENGINE OIL			26	-	378
UNUSABLE FUEL			36	79	2844
BASIC EMPTY WEIGHT					

BASIC EMPTY WEIGHT AND BALANCE

LOADING INSTRUCTIONS

It is the responsibility of the airplane operator to ensure that the airplane is properly loaded. At the time of delivery, Beech Aircraft Corporation provides the necessary weight and balance data to compute individual loadings. All subsequent changes in airplane weight and balance are the responsibility of the airplane owner and/or operator.

The basic empty weight and moment of the airplane at the time of delivery are shown on the airplane Basic Empty Weight and Balance form. Useful load items which may be loaded into the airplane are shown on the Useful Load Weight and Moment tables. The minimum and maximum moments are indicated on the Moment Limits vs Weight graph. These moments correspond to the forward and aft center of gravity flight limits for a particular weight. All moments are divided by 100 to simplify computations.

**SEATING, BAGGAGE AND EQUIPMENT
ARRANGEMENTS**

(E-1 thru E-631)

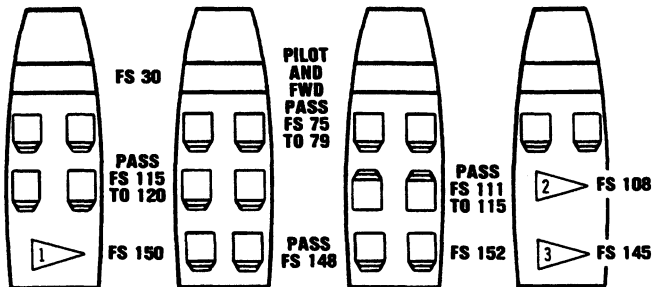

**SEATING, BAGGAGE AND EQUIPMENT
ARRANGEMENTS (Continued)**

(E-632 thru E-926)

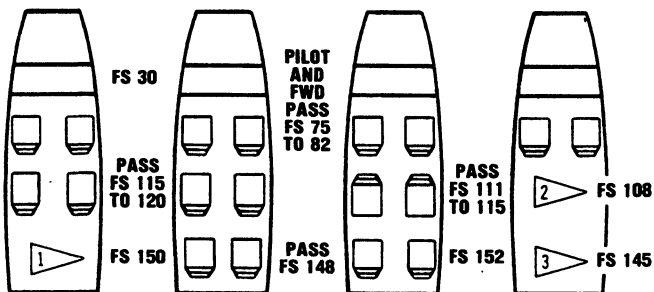

1. MAXIMUM WEIGHT 400 POUNDS INCLUDING EQUIPMENT AND BAGGAGE.
2. MAXIMUM WEIGHT 200 POUNDS FORWARD OF REAR SPAR INCLUDING EQUIPMENT AND CARGO WITH 3rd and 4th SEATS REMOVED.
3. MAXIMUM WEIGHT 400 POUNDS AFT OF REAR SPAR INCLUDING EQUIPMENT AND CARGO WITH 3rd, 4th, 5th and 6th SEATS REMOVED.

NOTE

The floor structure load limit is 100 pounds per square foot, except for the area between the front and rear spars, where the floor structure load limit is 50 pounds per square foot.

NOTE

All baggage/cargo must be secured with an approved cargo net.

MOMENT LIMITS VS WEIGHT

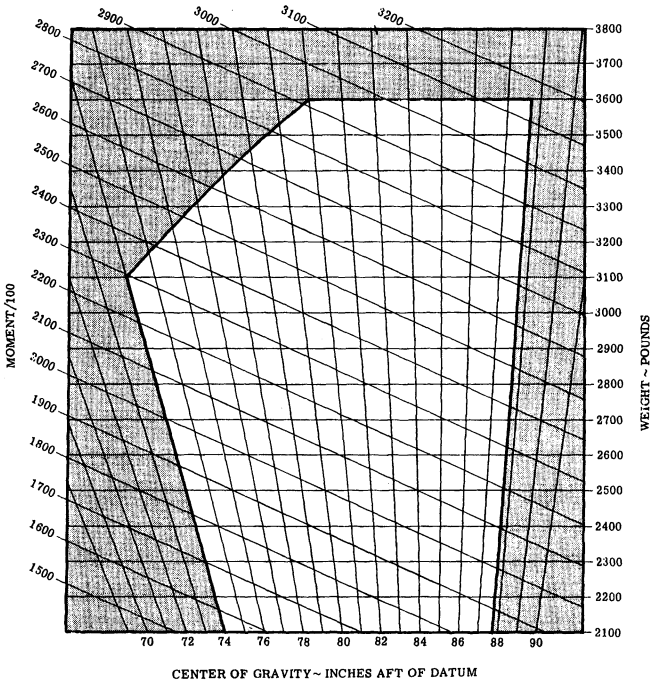

Envelope Based On The Following Weight And
 Center Of Gravity Limit Data (Landing Gear Down)

<u>Weight Condition</u>	<u>Forward C. G. Limit</u>	<u>Aft C. G. Limit</u>
3600 Lb. (Max. Take-Off or Landing)	81.0	87.7
3100 Lb. or Less	74.0	87.7

A36 601 40

COMPUTING PROCEDURE

1. Record the *Basic Empty Weight and Moment from the Basic Empty Weight and Balance form (or from the latest superseding form) under the Basic Empty Condition block. The moment must be divided by 100 to correspond to Useful Load Weights and Moments tables.
 2. Record the weight and corresponding moment from the appropriate table of each of the useful load items (except fuel) to be carried in the airplane.
 3. Total the weight column and moment column. The SUB-TOTAL is the Zero Fuel Condition.
 4. Determine the weight and corresponding moment for the fuel loading to be used. This fuel loading includes fuel for the flight, plus that required for start, taxi, and take-off. Add the Fuel to Zero Fuel Condition to obtain the SUB-TOTAL Ramp Condition.
 5. Subtract the fuel to be used for start, taxi, and take-off to arrive at the SUB-TOTAL Take-off Condition.
 6. Subtract the weight and moment of the fuel in the incremental sequence in which it is to be used from the take-off weight and moment. The Zero Fuel Condition, the Take-Off Condition, and the Landing Condition moment must be within the minimum and maximum moments shown on the Moment Limit vs Weight graph for that weight. If the total moment is less than the minimum moment allowed, useful load items must be shifted aft or forward load items reduced. If the total moment is greater than the maximum moment allowed, useful load items must be shifted forward or aft load items reduced. If the
- * *The Certificated Empty Weight for the airplane may be converted to Basic Empty Weight by adding the weight and moment for full oil (23 lbs. and 339 lb. in.).*

quantity or location of load items is changed, the calculations must be revised and the moments rechecked.

The following Sample Loading chart is presented to depict the sample method of computing a load. Weights used DO NOT reflect an actual airplane loading.

WEIGHT AND BALANCE LOADING FORM

BONANZA _____ **DATE** _____

SERIAL NO. E-XXXX **REG NO.** NXXX

ITEM	WEIGHT	MOM/100
1. BASIC EMPTY CONDITION	2231	1712
2. FRONT SEAT OCCUPANTS	340	256
3. 3rd and 4th SEAT OCCUPANTS	340	376
4. 5th and 6th SEAT OCCUPANTS	170	258
5. BAGGAGE	87	131
6. CARGO	-	-
7. SUB TOTAL ZERO FUEL CONDITION	3168	2733
8. FUEL LOADING (74 GAL)	444	333
9. SUB TOTAL RAMP CONDITION	3612	3066
10. *LESS FUEL FOR START, TAXI, AND TAKE-OFF	-12	-9
11. SUB TOTAL TAKE-OFF CONDITION	3600	3057
12. LESS FUEL TO DESTINATION (58 GAL)	-348	-261
13. LANDING CONDITION	3252	2796

SAMPLE

*Fuel for start, taxi and take-off is normally 12 lbs at an average mom/100 of 9.

WEIGHT AND BALANCE LOADING FORM

BONANZA _____ DATE _____

SERIAL NO. _____ REG NO. NXXX _____

ITEM	WEIGHT	MOM/100
1. BASIC EMPTY CONDITION		
2. FRONT SEAT OCCUPANTS		
3. 3rd and 4th SEAT OCCUPANTS		
4. 5th and 6th SEAT OCCUPANTS		
5. BAGGAGE		
6. CARGO		
7. SUB TOTAL ZERO FUEL CONDITION		
8. FUEL LOADING		
9. SUB TOTAL RAMP CONDITION		
10. *LESS FUEL FOR START, TAXI, AND TAKE-OFF		
11. SUB TOTAL TAKE-OFF CONDITION		
12. LESS FUEL TO DESTINATION		
13. LANDING CONDITION		

*Fuel for start, taxi and take-off is normally 12 lbs at an average mom/100 of 9.

USEFUL LOAD WEIGHTS AND MOMENTS
E-1 thru E-631
OCCUPANTS

WEIGHT	FRONT SEATS		STANDARD SEATING		CLUB SEATING			
	3RD & 4TH SEATS		5TH & 6TH SEATS		3RD & 4TH SEATS			
	FWD. POS. ARM 75	AFT POS. ARM 79	FWD FACING	SEATS	AFT FACING	5TH & 6TH SEATS		
	FWD. POS. ARM 115	AFT POS. ARM 120	FWD. POS. ARM 115	ARM 120	ARM 148	FWD. POS. ARM 111	AFT POS. ARM 115	ARM 152
	MOMENT/100							
100	75	79	115	120	148	111	115	152
110	82	87	126	132	163	122	126	167
120	90	95	138	144	178	133	138	182
130	98	103	150	156	192	144	150	198
140	105	111	161	168	207	155	161	212
150	112	118	172	180	222	166	172	228
160	120	126	184	192	237	178	184	243
170	128	134	196	204	252	188	196	258
180	135	142	207	216	266	200	207	274
190	142	150	218	228	281	210	218	288
200	150	158	230	240	296	222	230	304

NOTE: Occupant Positions for Adjustable Seats are shown at their extreme positions. Intermediate Positions will require interpolation of the Moment/100 Values.

USEFUL LOAD WEIGHT AND MOMENTS
E-632 thru E-926
OCCUPANTS

WEIGHT	FRONT SEATS		STANDARD SEATING		CLUB SEATING					
			3RD & 4TH SEATS		5TH & 6TH SEATS		3RD & 4TH SEATS		5TH & 6TH SEATS	
	FWD. POS. ARM 75	AFT POS. ARM 82	FWD FACING	FWD. POS. AFT POS. ARM 115 ARM 120	FWD FACING	FWD. POS. AFT POS. ARM 148	AFT FACING	FWD. POS. AFT POS. ARM 111 ARM 115	AFT FACING	FWD. POS. AFT POS. ARM 115 ARM 152
100	75	82		115	120	148		111	115	152
110	82	90		126	132	163		122	126	167
120	90	98		138	144	178		133	138	182
130	98	106		150	156	192		144	150	198
140	105	114		161	168	207		155	161	212
150	112	123		172	180	222		166	172	228
160	120	131		184	192	237		178	184	243
170	128	139		196	204	252		188	196	258
180	135	148		207	216	266		200	207	274
190	142	156		218	228	281		210	218	288
200	150	164		230	240	296		222	230	304

MOMENT/100

NOTE: Occupant Positions for Adjustable Seats are shown at their extreme positions. Intermediate Positions will require interpolation of the Moment/100 Values.

USEFUL LOAD WEIGHTS AND MOMENTS

WT.	BAGGAGE			CARGO	
	SECURED TO BACK OF FRONT SEATS ARM 91	BEHIND CENTER SEATS ARM 150	BEHIND AFT SEATS ARM 164	FORWARD OF SPAR (CENTER SEATS REMOVED) ARM 108	AFT OF SPAR (CENTER & AFT SEATS REMOVED) ARM 145
	MOMENT/100				
10	9	15	16	11	15
20	18	30	33	22	29
30	27	45	49	32	44
40	36	60	66	43	58
50	46	75	82	54	73
60	55	90	98	65	87
70	64	105	115	76	102
80	73	120	131	86	116
90	82	135	148	97	131
100	91	150	164	108	145
110		165		119	160
120		180		130	174
130		195		140	189
140		210		151	203
150		225		162	218
160		240		173	232
170		255		184	247
180		270		194	261
190		285		205	276
200		300		216	290
220		330			319
240		360			348
260		390			377
280		420			406
300		450			435
320		480			464
340		510			493
360		540			522
380		570			551
400		600			580

USEFUL LOAD WEIGHTS AND MOMENTS

USABLE FUEL

LEADING EDGE TANKS ARM 75		
Gallons	Weight	<u>Moment</u> 100
5	30	23
10	60	45
15	90	68
20	120	90
25	150	113
30	180	135
35	210	158
40	240	180
44	264	198
50	300	225
55	330	248
60	360	270
65	390	293
70	420	315
74	444	333

***OIL**

Quarts	Weight	<u>Moment</u> 100
12	23	6

*Included in Basic Empty Weight (E-364 thru E-926)

SECTION VII

SYSTEMS DESCRIPTION

TABLE OF CONTENTS

<i>SUBJECT</i>	<i>PAGE</i>
Airframe	7-5
Seating Arrangements	7-5
Flight Controls	7-5
Control Surfaces	7-5
Control Column	7-5
Rubber Pedals	7-6
Trim Controls	7-6
Instrument Panel	7-6
Flight Instruments	7-7
Power Plant Instruments	7-7
Manifold Pressure and Fuel Flow Indicator (Round Type)	7-8
Multiple Readout Type Instrument (Round Type)	7-9
Electrically Operated Vertical Instruments	7-9
Fuel Flow Indicator	7-9
Cluster Arrangement	7-11
Cluster Type Power Plant Instruments	7-11
Typical Round Type Engine Instruments	7-12, 7-13
Typical Vertical Type Engine Instruments	7-14

TABLE OF CONTENTS (Continued)

<i>SUBJECT</i>	<i>PAGE</i>
Avionics Panel	7-15
Switches	7-15
Annunciator System	7-15
Warning Light	7-15
Ground Control	7-16
Wing Flaps	7-17
Landing Gear System	7-19
Control Switch	7-19
Position Indicators	7-19
Circuit Breaker	7-20
Safety Switch	7-20
Warning Horn	7-21
Brakes	7-21
Manual Extension	7-21
Baggage/Cargo Compartment	7-22
Seats, Seat Belts and Shoulder Harnesses	7-22
Seat Adjustments	7-22
Shoulder Harness Installation (Prior to E-825)	7-23
Shoulder Harness Installation (E-825 thru E-926)	7-23
Doors, Windows and Exits	7-24
Forward Cabin Door	7-24
Aft Utility Door	7-25
Operation with Aft Utility Door Removed	7-26
Openable Cabin Windows	7-26
Emergency Exits	7-26A
Control Column Lock Pin	7-27
Power Plant	7-27
Engine Controls	7-27
Throttle, Propeller, and Mixture	7-27
Cowling	7-28
Cowl Flaps	7-28

TABLE OF CONTENTS (Continued)

<i>SUBJECT</i>	<i>PAGE</i>
Induction System Icing	7-28
Lubrication System	7-29
Starter	7-29
Propeller	7-29
Fuel System	7-30
Fuel Cells	7-30
Fuel System Schematic	7-31
Fuel Quantity Indication System	7-32
Auxiliary Fuel Pump	7-32
Fuel Tank Selection	7-32
Fuel Required for Flight	7-33
Electrical System	7-33
Battery	7-34
Alternator	7-34
External Power Receptacle	7-35
Lighting System	7-35
Interior Lighting	7-35
Exterior Lighting	7-36
Environmental Systems	7-37
Cabin Heating	7-37
Heating and Ventilation System Schematic	7-38
Heater and Defroster Operation	7-41
Cabin Ventilation	7-41
Cabin Fresh Air Outlets	7-41
Exhaust Vents	7-42
Oxygen System	7-43
Pitot and Static Systems	7-43
Pitot System	7-43
Pitot Heat	7-43
Normal Static Air System	7-43
Emergency Static Air System	7-44
Instrument Pressure System	7-44
Stall Warning	7-44
Engine Break-in Information	7-45

INTENTIONALLY LEFT BLANK

AIRFRAME

The BEECHCRAFT 36 and A36 Bonanzas are all-metal, low-wing, single-engine airplanes with retractable tricycle landing gear and conventional horizontal and vertical stabilizers.

SEATING ARRANGEMENTS

The 36 and A36 Bonanzas are four- to six-place airplanes. In the standard configuration four forward facing seats are installed. Fifth and sixth seats are optional.

In the optional club seating configuration, the third and fourth seats are aft facing.

FLIGHT CONTROLS

CONTROL SURFACES

Control surfaces are operated through push-pull rods and conventional cable systems terminating in bellcranks.

CONTROL COLUMN

The throw-over type control column for elevator and aileron control can be placed in front of either front seat. Pull the T-handle latch at the back of the control arm and position the control wheel as desired. The aileron trimmer on the control column hub should be held until the column is repositioned. Check for full freedom of movement after repositioning the control.

The optional dual control column is required for flight instruction.

RUDDER PEDALS

To adjust the rudder pedals, press the spring-loaded lever on each pedal arm and move the pedal forward or aft. The adjustment lever can also be used to place the right set of rudder pedals against the floor when not in use.

TRIM CONTROLS

Elevator trim is controlled by a handwheel located to the left of the throttle. An elevator tab indicator dial is located above and to the left of the trim control handwheel.

The aileron trimmer on the control column hub displaces the ailerons; displacement is maintained by cable loads imposed by the trimmer.

INSTRUMENT PANEL

The standard instrument panel of the Bonanza 36 consists of the floating instrument panel on the upper left portion, the engine instrument cluster on the left subpanel, a radio grouping to the right of the control wheel assembly and subpanels which provide a compact circuit breaker group across the base of the instrument panel.

The standard instrument panel of the Bonanza A36 consists of the floating instrument panel on the upper left portion, the engine instruments on a surrounding fixed panel, a radio grouping to the right of the engine instruments, and a subpanel which provides for a compact circuit breaker group on the right side and switching panel on the left.

FLIGHT INSTRUMENTS

The floating instrument panel contains all flight instruments except the magnetic compass. On this panel are the airspeed indicator, gyro horizon, altimeter, turn coordinator, directional gyro, and vertical speed indicator, with provisions for an ADF indicator and a clock. Additional navigation equipment, such as dual omni indicators, can be mounted in the panel directly below the flight instrument grouping.

POWER PLANT INSTRUMENTS

The engine instruments include: cylinder head temperature, oil temperature, oil pressure indicators, tachometer, manifold pressure, fuel flow, and fuel quantity indicators, and an ammeter.

The cylinder head temperature sensor is installed in the engine cylinder which, because of location in the compartment, has the highest temperature reading. Monitor cylinder head temperature after power setting adjustments are made, to assure that the engine operating temperature remains in the desired range.

The oil pressure normal operating range is 30 to 60 psi. The oil pressure should be checked when starting the engine and with extra attention when starting during cold weather. The oil temperature operating range is 100°F to 240°F. Monitor the oil temperature after starting to assure temperature is above minimum before advancing the throttle above warm-up rpm and on descent with power reduced to avoid overcooling.

The tachometer is driven by a flexible shaft from the engine accessory section. Incorporated in the tachometer is an engine hour meter which automatically records the total engine operating time.

**MANIFOLD PRESSURE AND FUEL FLOW INDICATOR
(Round Type)**

The manifold pressure portion of this instrument indicates the pressure of the fuel-air mixture entering the engine cylinders and is calibrated in inches of mercury. By observing the manifold pressure indications and adjusting the propeller and throttle controls, the power output of the engine can be regulated. To avoid excessive cylinder pressures during cruise operations, observe the maximum recommended rpm and manifold pressure as indicated on the Manifold Pressure vs RPM graph in the PERFORMANCE Section.

The fuel flow portion of the indicator is calibrated in gallons per hour, the green arc indicating fuel flow for normal operating limits. Red radials are placed at the minimum and maximum allowable fuel pressures.

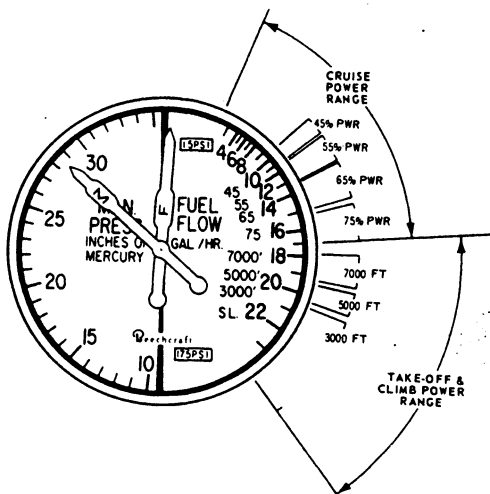

In the cruise power range, the green sectors cover the fuel flow required from 45% to 75% power. The lowest value of a given sector is the cruise-lean setting, and the highest value of the sector is the best-power setting for that particular power range.

The take-off and climb range is covered by green sectors for full power at various altitudes. The high side of each green sector represents the fuel flow setting required to achieve maximum power at the specified altitude when operating full throttle at 2700 rpm. These values should correspond to the fuel flow values on the Climb graph in the PERFORMANCE Section.

***MULTIPLE READOUT TYPE INSTRUMENT (A36)
(Round Type)***

A multiple readout type instrument, on early aircraft with round type instruments, is located on the lower left instrument panel and gives indications of cylinder head temperature calibrated in degrees Fahrenheit, oil temperature and oil pressure.

***ELECTRICALLY OPERATED VERTICAL
INSTRUMENTS (A36)***

Electrically operated vertical readout instruments are installed in the upper center of the instrument panel. They include manifold pressure, tachometer, fuel flow meter calibrated in pounds per hour, cylinder head temperature and oil temperature indicator both calibrated in degrees centigrade, oil pressure indicator, ammeter, and left and right fuel quantity indicators calibrated in pounds.

FUEL FLOW INDICATOR (Vertical Type)

The fuel flow indicator is calibrated in pounds per hour. The normal operating range of 41.4 pph to 145.8 pph is

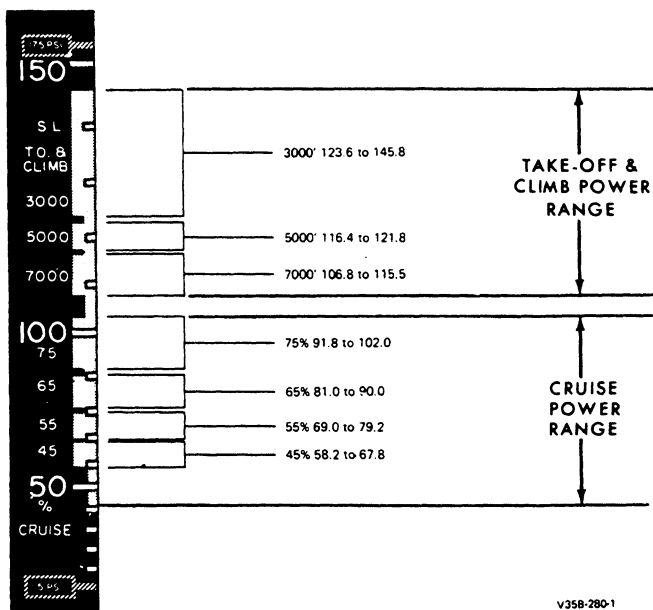

FUEL FLOW PPH

indicated on the instrument by the green band. Red markings indicate the minimum and maximum fuel pressure.

In the illustration the lower portion of the scale (58.2 pph to 102.0 pph) is the fuel flow required for cruise power settings between 45% and 75%. The upper portion indicates fuel flow for take-off and climb at various altitudes. The lower fuel flow figure is the normal lean setting while the higher flow is the best power setting for that percentage of power. The high side of each green sector represents the fuel flow setting required to achieve maximum power of the specified altitude when operating full throttle at 2700 rpm. These values should correspond to the fuel flow values on the Climb graph in the PERFORMANCE section.

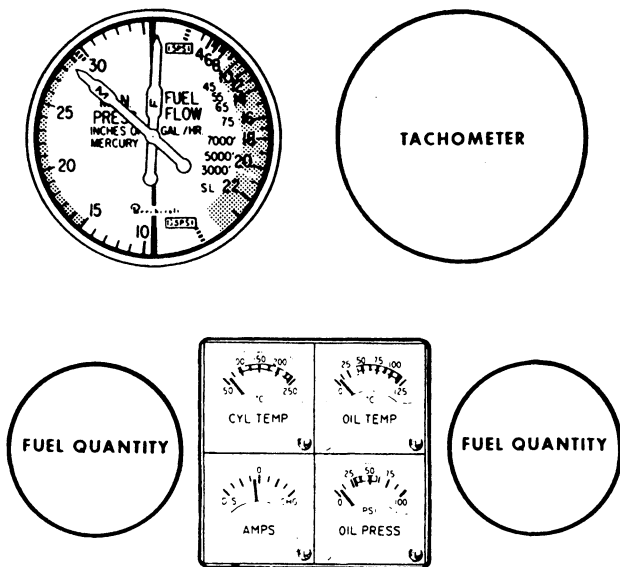

CLUSTER ARRANGEMENT

CLUSTER TYPE POWER PLANT INSTRUMENTS

The cluster type instruments, as shown in accompanying illustration, are located in the center of the panel just below the manifold pressure/fuel flow and tachometer. Included in the square cluster are the cylinder head temperature and oil temperature, both calibrated in degrees Centigrade, ammeter, and oil pressure. A fuel quantity indicator is located on each side of the cluster, the left indicator for the left wing fuel and the right indicator for the right wing fuel.

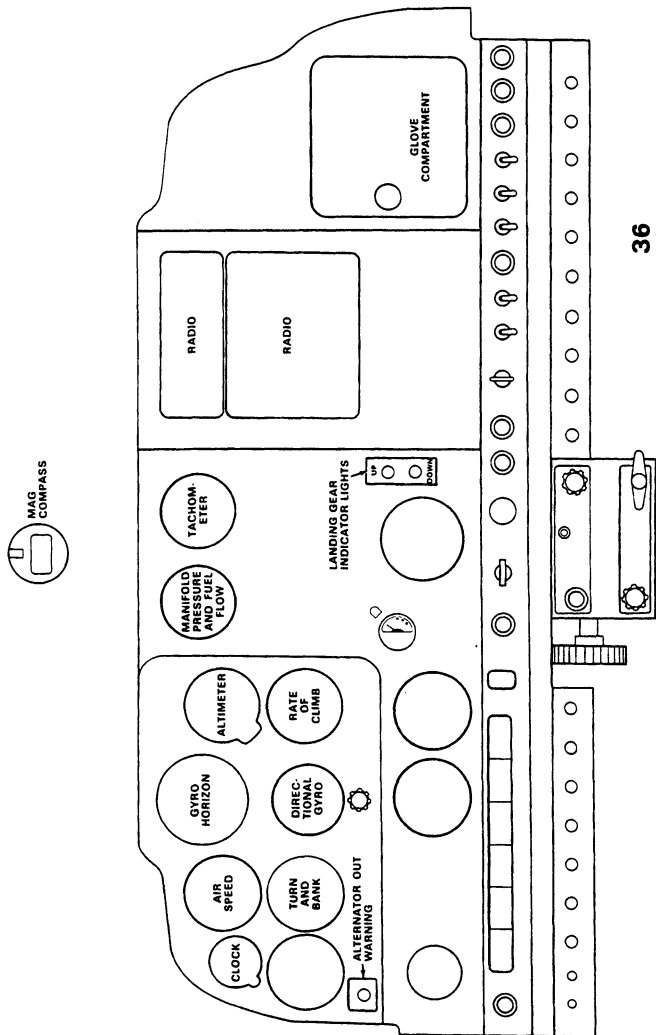

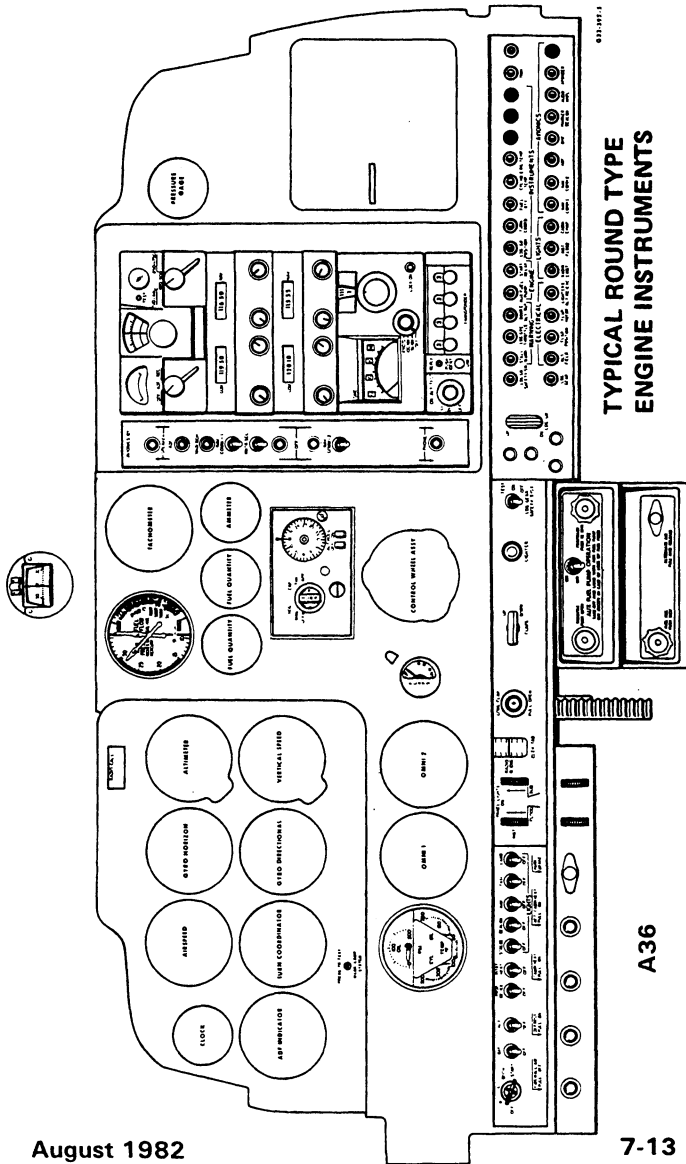

Section VII
Systems Description

BEECHCRAFT Bonanza 36, A36
E-1 thru E-926

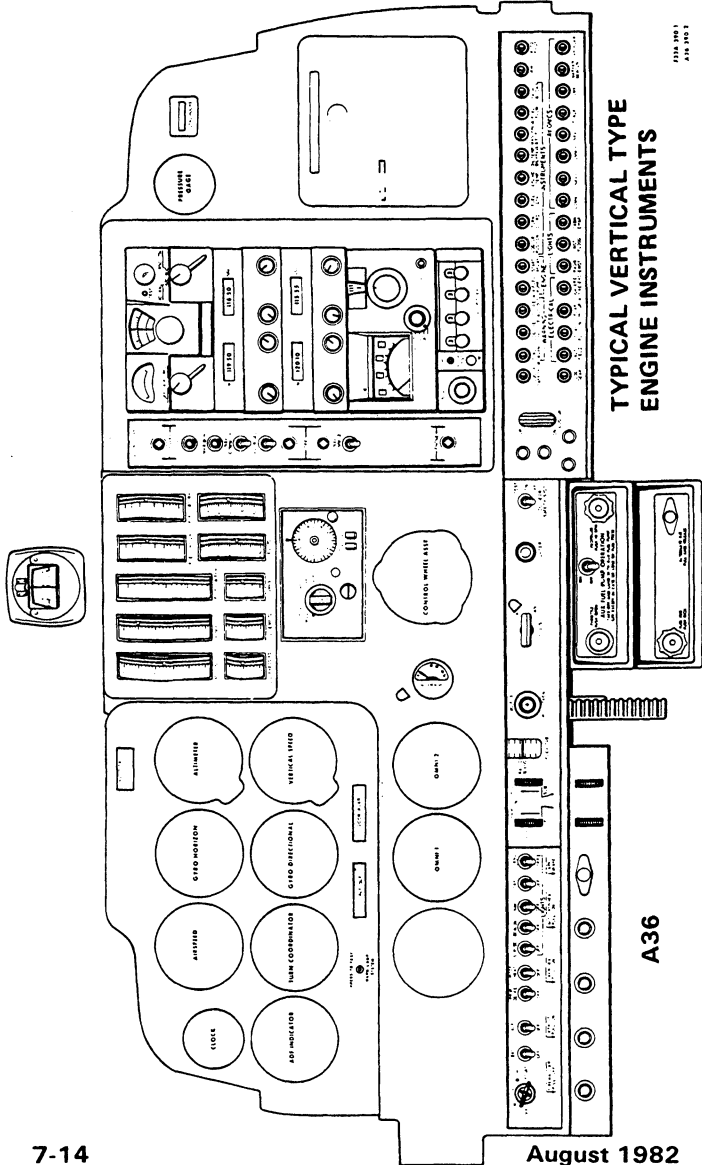

AVIONICS PANEL

Tuning and selecting equipment for the radios, to the right of the center panel, is mounted in block form with switching on the left edge of the block and radio heads and tuning on the right.

SWITCHES

The battery master switch, alternator switch and key-operated magneto/start switch are grouped together at the left of the instrument panel. An escutcheon assembly contains the switches on the Bonanza 36 models; the A36 models have them located on the upper left subpanel.

The landing gear switch, the flap switch and the auxiliary fuel pump switch are located near the center console power plant controls. Interior and exterior lighting switches are located on either the right (36) or left (A36) subpanel.

ANNUNCIATOR SYSTEM

WARNING LIGHT

Alternator-Out Warning Light (36)

A press-to-test alternator-out warning light on the instrument panel will come on, should the alternator be disconnected from the airplane bus by the overvoltage relay.

NOTE

To reset the overvoltage relay, refer to the Emergency Procedures section.

Alternator-Out Warning Light (A36)

A warning light placarded ALT-OUT is located on the pilot's floating instrument panel. It will illuminate if an alternator malfunction occurs. Located near the warning light is a switch placarded PRESS TO TEST - WARN LAMP SYSTEM. When the switch is pressed, the ALT-OUT light and the landing gear position indicator lights will illuminate if none of the lamps require replacement.

NOTE

To reset the overvoltage relay, refer to the EMERGENCY PROCEDURES section.

Utility Door Warning Light

A warning light for the utility door located on the pilot's floating instrument panel will illuminate if the door is not securely closed.

GROUND CONTROL

Steering is accomplished by use of the rudder pedals through a linkage arrangement which connects the nose strut to the rudder pedal shaft. Nose wheel straightening is accomplished by engagement of a roller with a track as the nose wheel is retracted. The steering link attaches to the steering mechanism on the nose strut with a swivel connection which permits the mechanism to disengage when the nose gear is retracted and operation of the rudder pedals will have no tendency to turn the nose wheel with the gear retracted.

The minimum wing tip turning radius, using full steering, one brake and partial power, is 27 feet 7 inches.

WING FLAPS

The wing flaps are controlled by a three-position switch, UP, OFF, and DOWN, located in the subpanel, above the power quadrant. The switch must be pulled out of detent before it can be repositioned. A dial type indicator has markings for UP, 10°, 20°, and DN. The indicator is located to the left of the control column.

Limit switches automatically turn off the electric motor when the flaps reach the extremes of travel. Intermediate flap positions can be obtained by placing the switch in the OFF position as the flaps reach the desired position during flap extension or retraction.

INTENTIONALLY LEFT BLANK

LANDING GEAR SYSTEM

CAUTION

Never taxi with a flat strut.

The landing gears are operated through adjustable linkage connected to an actuator assembly mounted beneath the front seats. The actuator assembly is driven by an electric motor. The landing gears may be electrically retracted and extended, and in an emergency may be extended manually.

CONTROL SWITCH

The landing gear is controlled by a two-position switch on the right side of the subpanel. The switch handle must be pulled out of the safety detent before it can be moved to the opposite position.

CAUTION

Do not change the position of the control switch to reverse the direction of the landing gear while the gear is in transit, as this could cause damage to the retract mechanism.

POSITION INDICATORS (36)

Landing gear position indicator lights on the right side of the control console show red when the gear is up, or green when it is down, illuminating only when the actuator assembly reaches either extreme. In addition, a mechanical indicator on the floorboard beneath the control console shows the position of the nose gear. Its pointer is linked by a cable to the actuating mechanism and moves

simultaneously with it. Limit switches and a dynamic brake automatically stop the retract mechanism when the gear reaches its full up or full down position.

POSITION INDICATORS (A36)

The landing gear position indicator lights are located adjacent to the landing gear switch handle. Three green lights, one for each gear, are illuminated whenever the landing gear are down and locked. The red light illuminates any time one or all of the landing gear are in transit or in any intermediate position. All of the lights will be out when the gear are up.

Testing of the landing gear position indicator lights is accomplished by pressing the warning light test button on the floating instrument panel. The intensity of the lamps is automatically lowered for night flights when the navigation lights are turned on.

CIRCUIT BREAKER

The landing gear circuit breaker is located on the left sub-panel of Bonanza 36 models and on the right subpanel of Bonanza A36 models. It is a pull-and-reset type breaker. The breaker will pop out under overload conditions.

SAFETY SWITCH

To prevent inadvertent retraction of the landing gear on the ground, a main strut safety switch opens the control circuit when the strut is compressed.

WARNING

Never rely on the safety switch to keep the gear down during taxi or on take-off, landing roll, or in a static position. Always make certain that the landing gear switch is in the down position during these operations.

WARNING HORN

With the landing gear retracted, if the throttle is retarded below approximately 12 in. Hg manifold pressure, a warning horn will sound intermittently.

BRAKES

The brakes on the main landing gear wheels are operated by applying toe pressure to the rudder pedals.

CAUTION

Continuous brake application of either the pilot's or copilot's brake pedals in conjunction with an overriding pumping action from the opposite brake pedals could result in the loss of braking action on the side which continuous pressure is being applied.

The parking brake push-pull control is located on the sub-panel (right - Bonanza 36; left - Bonanza A36). To set the parking brakes, pull control out and depress both toe pedals until firm. Push the control in to release the brakes.

CAUTION

The parking brake should be left off and wheel chocks installed if the airplane is to be left unattended. Changes in ambient temperature can cause brakes to release or to exert excessive pressures.

MANUAL EXTENSION

The landing gear can be manually extended by operating a handcrank at the rear of the front seats. This procedure is described in the EMERGENCY PROCEDURES section.

BAGGAGE/CARGO COMPARTMENT

The baggage/cargo compartment is accessible through the utility door on the right side of the fuselage. This area extends aft of the pilot and copilot seats to the rear bulkhead. Because of structural limitations, this area is divided into sub-compartments, each having a different weight limitation. Loading within the baggage/cargo compartment must be in accordance with the data in the WEIGHT AND BALANCE Section. All baggage/cargo must be secured.

WARNING

Do not carry hazardous material anywhere in the airplane.

Do not carry children in the baggage/cargo compartment unless secured in a seat.

SEATS, SEAT BELTS, AND SHOULDER HARNESSSES

SEAT ADJUSTMENTS

To adjust any of the four standard seats forward or aft, pull up on the release bar below the seat and slide the seat to the desired position. The seat backs of all standard seats can be placed in any of four positions by operating a release lever on the inboard side of each seat. An option is available that provides for the seat backs on the copilot, 3rd and 4th place seats to be placed in any position from vertical to fully reclined.

Outboard armrests for all standard seats are built into the cabin sidewalls. Center armrests can be elevated or positioned flush with the seat cushions. On E-825 and after,

the 3rd- and 4th-place chairs are equipped with a locking back to accommodate the shoulder harness, and the seat back can be folded over for access by rotating the red handle located on the lower inboard side of the seat back. The optional fifth and sixth seats can be folded up to provide additional floor space.

Club seating is available. When occupied, aft facing chairs in the club seating arrangement must have the headrests in the fully raised position during takeoff and landing. Aft facing club seats may be converted to the forward facing configuration. Maintenance personnel must refer to the shop manual before making the conversion in order to assure proper installation.

SHOULDER HARNESS INSTALLATION (Prior to E-825)

The shoulder harness installation is available for the pilot seats only. The belt is in the "Y" configuration with the single strap being contained in an inertia reel attached to the overhead canopy structure of the cockpit. The two straps are worn with one strap over each shoulder and fastened by metal loops into the seat belt buckle. The harness should be used with the seats in the upright position. The spring loading at the inertia reel keeps the harness snug but will allow normal movement required during flight operations. The inertia reel is designed with a locking device that will secure the harness in the event of sudden forward movement or an impact action.

SHOULDER HARNESS INSTALLATION (E-825 thru E-926)

The shoulder harness is a standard installation for all seats and should be used with the seats in the upright position. The spring loading at the inertia reel keeps the harness

snug but will allow normal movement during flight operations. The inertia reel is designed with a locking device that will secure the harness in the event of sudden forward movement or an impact action.

The strap is worn over the shoulder and down across the body, where it is fastened by a metal loop into the seat belt buckle. For the pilot seats, the harness strap is contained in an inertia reel attached to the side canopy structure of the cockpit. The inertia reel is covered with an escutcheon and the strap runs up from the reel location to a looped fitting attached to the window frame just aft of the pilot seats. For the third and fourth passenger seats, the inertia reel is attached into the seat back structure and is covered with the seat back upholstery. The strap runs up the seat back and over the outboard corner of the seat back. For the fifth and sixth passenger seats, the strap is contained in an inertia reel attached to the upper fuselage side structure, just aft of the seat back and is covered with an escutcheon.

NOTE

The seat belt is independent of the shoulder harness, but the outboard seat belt and the shoulder harness must be connected for stowage when the seat is not occupied.

DOORS, WINDOWS AND EXITS

FORWARD CABIN DOOR

The airplane has a conventional cabin door on the forward right side of the fuselage and when closed, the outside cabin door handle is spring loaded to fit into a recess in the door to create a flat aerodynamically clean surface. The door may be locked with a key. To open the door from the outside, lift the handle from its recess and pull until the door opens.

To close the cabin door from the inside, observe that the door handle is in the unlocked position. In this position, the latch handle is free to move approximately one inch in either direction before engagement of the locking mechanism. Then grasp the door and firmly pull the door closed. Rotate the door handle fully counterclockwise into the locked position. When the door is properly locked, the door latch handle is free to move approximately one inch in either direction.

NOTE

When checking the door latch handle, do not move it far enough to engage the door latch release mechanism.

Press firmly outward at the top rear corner of the door. If any movement of the door is detected, completely open the door and close again following the above instructions.

To open the door from the inside, depress the lock button and rotate the handle clockwise.

AFT UTILITY DOOR

A utility door aft of the cabin door is provided for loading bulky cargo or to accommodate passengers. The utility door is a double door with each half hinged at the forward and aft edge of the door opening. The rear half of the door must be closed first. A latch on the forward edge of the door moves downward to a locked position to secure the hooks at the top and bottom of the door to the door frame. The front half of the door cannot be fully closed until the latch of the aft door is latched and flush with the edge of the door. After the forward half of the door is closed, it can be latched from the outside by rotating the half-moon shaped handle to the CLOSED position. A conventional handle on the inside of this door provides for opening or closing from the inside.

OPERATION WITH AFT UTILITY DOOR REMOVED

This Bonanza is approved for operation with the aft utility door removed. The factory installed placards pertaining to airspeed and other operating restrictions when the utility door is removed are reproduced in the LIMITATIONS section. With the doors removed, assure that all registration numbers are visible on the side of the airplane.

NOTE

It is the responsibility of the owner and operator to contact the nearest FAA General Aviation District Office (GADO) for authorization to use the airplane for the specific operation with the door removed.

OPENABLE CABIN WINDOWS

To Open Window For Ventilation (Only On Ground):

Release latch front of bar, pull bar at the bottom of the window out and upward. Window will open approximately two inches.

To Close Window:

Pull inward and down on the bar at the bottom of the window. Resistance will be felt as the bar moves downward. Continue moving bar downward to its lowest position. Check that bar is locked by the latch.

NOTE

Window is to be closed before and during flight. While closing window, ascertain that the emergency release pin (which allows the window to open fully for emergency exit) is securely in place.

EMERGENCY EXITS

To open the emergency exit provided by the openable window on each side of the cabin:

1. Lift the latch.
2. Pull out the emergency release pin and push the window out.

The above procedure is described on a placard installed below the left and right openable windows.

INTENTIONALLY LEFT BLANK

CONTROL COLUMN LOCK PIN

1. Rotate control wheel and move column so the hole in the bracket and the column align to accept pin.
2. Push the control column lock pin through the hole provided in the control column hanger and into the hole in the control column tube assembly.
3. Ensure positive retention of the lock pin by positioning the attached red plate on top of the throttle and propeller controls.

WARNING

Before starting engine, remove the lock reversing the above procedure.

POWER PLANT

One Teledyne Continental Motors Corporation engine model IO-520-B, IO-520-BA or IO-520-BB. It is a fuel-injected, direct-drive, air-cooled, horizontally-opposed, 6-cylinder, 520-cubic inch-displacement, 285-horsepower-rated engine.

ENGINE CONTROLS

THROTTLE, PROPELLER, AND MIXTURE

The push-pull throttle, propeller and mixture controls are located on the control console. Each control is released for repositioning by pushing a button on the knob. With the button extended, fine adjustments are accomplished by rotating the knob, clockwise to increase and counter-clockwise to decrease. Do not rotate clockwise with control fully advanced.

COWLING

The Bonanza is equipped with Hartwell latch mechanisms on the right and left upper engine cowling for quick and easy access to the engine compartments without the aid of tools. Each cowl latch is locked and released by a single recessed handle located in the lower cowling panel on each side of the engine. To close the cowling requires only to lower the cowling to the closed position with the handle in the prelatch position. The handle has three positions: flush with the fuselage - latched; held fully forward - unlatched (open cowling); approximately 90° to the fuselage - prelatch (ready to close cowl). An audible click denotes the bayonet fittings, located forward and aft on the upper cowl, sliding into the latch safety catch. The cowl is locked by moving the latch handle to the full recessed position. The security of the forward latches can be checked by pulling out on the check tab attached to the lower forward edge of the upper cowling. If the cowling can be moved after latching, open the cowling, check the latch alignment and re-latch.

COWL FLAPS

The push-pull cowl flap control is located above and to the left of the control console on the subpanel. Except in extremely low temperatures, the cowl flaps should be open during ground operation, take-off, and as required in flight.

INDUCTION SYSTEM ICING

The possibility of induction system icing is reduced by the non-icing characteristics of the Bonanza's fuel injected engine and the automatic alternate air source. Under certain conditions, however, impact ice can form at several points in the induction system. If the air intake or filter

becomes clogged with ice, a spring-loaded door in the air intake duct will open automatically and the induction system will operate on alternate air. If the alternate air source door becomes frozen in the closed position, a pull-and-release T-handle is provided to force the door open.

LUBRICATION SYSTEM

The engine oil system is the full pressure, wet sump type and has a 12-quart capacity. Oil operating temperatures are controlled by an automatic thermostat bypass control. The bypass control will limit oil flow through the oil cooler when operating temperatures are below normal and will permit the oil to bypass the cooler if it should become blocked.

STARTER

The starter is relay-controlled and is actuated by a rotary type, momentary-on switch incorporated in the magneto/start switch. To energize the starter circuit, rotate the magneto/start switch beyond the BOTH position to START. After starting, release the switch to the BOTH position.

PROPELLER

Installed as standard equipment is a constant speed, variable pitch, 84-inch diameter propeller with two aluminum alloy blades. The pitch setting at 30 inch station is 13.3° low and 29.2° high pitch.

An optional 80-inch diameter, three-blade propeller is also available. The pitch setting at the 30-inch station is 13.3° low and 29.0° high pitch.

Propeller rpm is controlled by a governor which regulates hydraulic oil pressure to the blades. A push-pull knob on the control console allows the pilot to select the governor's rpm range.

If governor oil pressure is lost, the propeller will go to the full high rpm position. This is because propeller low rpm is obtained by governor boosted engine oil pressure working against the centrifugal twisting moment of the blades.

FUEL SYSTEM

The airplane is designed for operation on grade 100LL (blue) or 100 (green) aviation gasoline.

CAUTION

Before refueling, make certain the airplane and fuel dispensing unit are properly grounded. Failure to do so creates a fire hazard.

FUEL CELLS

Either the 44-gallon usable (50-gallon capacity) standard fuel system or the 74-gallon usable (80-gallon capacity) optional fuel system is available. The fuel system consists of a rubber fuel cell in each wing leading edge with a flush type filler cap. A visual measuring tab is attached to the filler neck of the optional system. The bottom of the tab indicates 27 gallons of usable fuel and the detent on the tab indicates 32 gallons of usable fuel in the tank provided the wings are level.

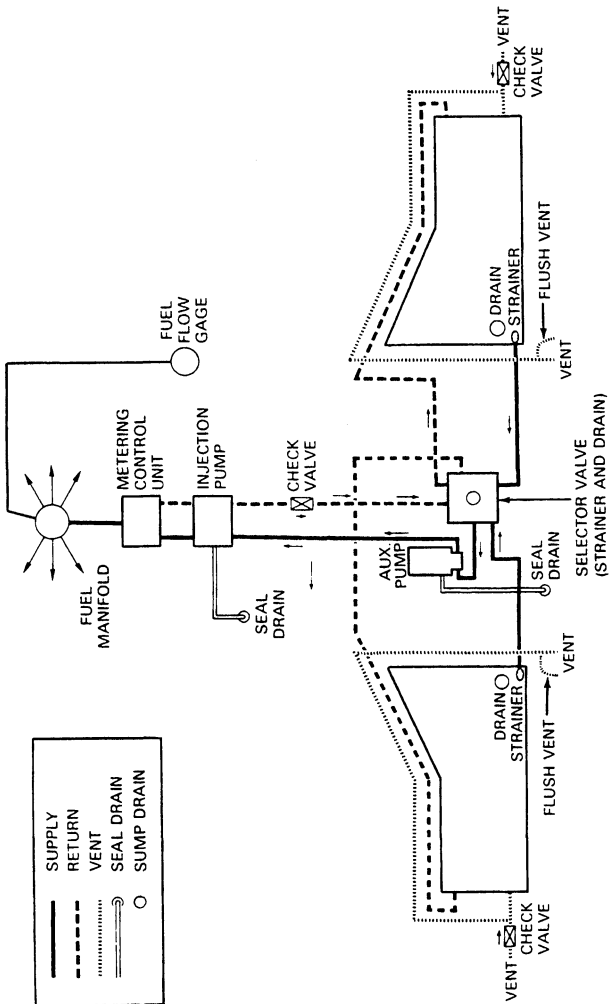

FUEL SYSTEM SCHEMATIC

The engine driven fuel injector pump delivers approximately 10 gallons of excess fuel per hour, which bypasses the fuel control and returns to the tank being used. Three fuel drains are provided, one in each fuel sump on the underside of each wing and one in the fuel selector valve inboard of the left wing root. These points should be drained daily before the first flight.

FUEL QUANTITY INDICATION SYSTEM

Fuel quantity is measured by float operated sensors, located in each wing tank system. These transmit electrical signals to the individual indicators that indicate fuel remaining in the tank. There are sensors in each wing tank system connected to the individual wing tank indicator.

AUXILIARY FUEL PUMP

The electric auxiliary fuel pump is controlled by an ON-OFF toggle switch on the control console. It provides pressure for starting and emergency operation. Immediately after starting, the auxiliary fuel pump can be used to purge the system of vapor caused by an extremely high ambient temperature or a start with the engine hot. The auxiliary fuel pump provides for near maximum engine performance should the engine driven pump fail.

FUEL TANK SELECTION

The fuel selector valve handle is located forward and to the left of the pilot's seat. Take-offs and landings should be made using the tank that is more nearly full.

If the engine stops because of insufficient fuel, refer to the EMERGENCY PROCEDURES Section for the Air Start procedures.

FUEL REQUIRED FOR FLIGHT

It is the pilot's responsibility to ascertain that the fuel quantity indicators are functioning and maintaining a reasonable degree of accuracy, and be certain of ample fuel for a flight. Takeoff is prohibited if the fuel quantity indicators do not indicate above the yellow arc. An inaccurate indicator could give an erroneous indication of fuel quantity. A minimum of 13 gallons of fuel is required in each tank before takeoff.

The filler caps should be removed and fuel quantity checked to give the pilot an indication of fuel on board. The airplane must be approximately level for visual inspection of the tank. If the pilot is not sure that at least 13 gallons are in each tank, add necessary fuel so that the amount of fuel will be not less than 13 gallons per tank at takeoff. Plan for an ample margin of fuel for any flight.

ELECTRICAL SYSTEM

The system circuitry is the single-wire, ground-return type, in which the airplane structure itself is used as the ground return.

The battery ON-OFF switch, the alternator ON-OFF switch, and the magneto/start switch are located on either an escutcheon at the left of the instrument panel (36) or the left subpanel (A36).

The various circuits in the system are protected by toggle switch, push-to-reset or push-pull type circuit breakers. Most of the circuit breakers are located on their individual subpanel.

BATTERY

A 35 ampere-hour, 12-volt battery is located on the right forward side of the firewall. Battery servicing procedures are described in the **HANDLING, SERVICING AND MAINTENANCE** section.

ALTERNATOR

A 70-ampere, 12-volt, gear-driven alternator is standard equipment. The alternator is designed to maintain approximately 70-ampere output at 1700 rpm, and supply approximately 20 amperes at engine idle speed.

A transistorized voltage regulator adjusts alternator output to the required electrical load, including battery recharging. Charge or discharge of the battery is indicated by the ammeter. A zero reading, which is normal for cruising flight, indicates that the battery is fully charged and that alternator output has been adjusted by the voltage regulator to balance the load of the electrical equipment in use.

The alternator field circuit breaker is located on the right sub-panel and the alternator output circuit breaker is installed on the left side of the nose wheel well cover. The alternator-out warning light can be tested on the A36 by the warning test switch on the instrument panel and by the press-to-test feature on the Bonanza 36. If a malfunction occurs the light will illuminate. See the **EMERGENCY PROCEDURES** section.

Refer to the **HANDLING, SERVICING AND MAINTENANCE** Section for minor maintenance of the alternator.

EXTERNAL POWER RECEPTACLE

The external power receptacle accepts a standard AN type plug. Before connecting an external power unit turn alternator switch and avionic equipment OFF.

CAUTION

A negative ground external power source is required. Check polarity before using external power.

If the external power unit does not have a standard AN type plug, connect the positive lead from the external power source to the positive battery terminal and the negative lead to the negative battery terminal.

LIGHTING SYSTEM

INTERIOR LIGHTING

(36)

Lighting for the instrument panel is furnished by a light in the cabin ceiling. It is controlled by the FLOOD LIGHTS rheostat control located below and to the right of the control column.

A RADIO and POST LIGHTS control rheostat is located to the left of the flood light rheostat. It controls the internal lights in the radio installation and individual instrument post lights.

The cabin dome light is operated by an ON-OFF switch next to the light. Switches for the two optional individual reading lights above the standard rear seats are located adjacent to the lights.

(A36)

Lighting for the instrument panel is controlled by thumb-rotated, disc-type rheostats, located on the pilot's sub-

panel to the left of the control column. The first rheostat is labeled RADIO and ENG and controls the lighting of the avionics panel and the multiple readout engine instrument. The second rheostat labeled INST is optional and controls the lighting for the flight instruments, the omni indicators, and the instrument pressure gage.

On the lower subpanel are two more lighting rheostats, the first labeled SUB which controls the intensity of the complete subpanel lighting. The second rheostat is labeled FLOOD and controls the glareshield lighting which illuminates the full upper panel.

The cabin dome light is operated by an ON-OFF switch adjacent to the light. The optional reading lights above the rear seats have individual switches at the light. The optional map light has a press type switch on the wheel. The OAT, map, and compass lights are controlled by a PUSH-ON, PUSH-OFF switch located adjacent to the OAT or on the control wheel.

EXTERIOR LIGHTING

The switches for all of the exterior lights are located on the pilot's subpanel. Each switch is a circuit-breaker-type which will open the switch if it becomes overloaded or shorted.

The exterior lights consist of navigation lights on the wing tips and tail cone, a landing light in the fuselage nose section, and a taxi light attached to the nose strut. The landing light can be used for approach and taxiing. The taxi light should only be used for taxiing. For longer battery and lamp life, use the landing light and taxi light sparingly; avoid prolonged operation which could cause overheating during ground maneuvering.

NOTE

Particularly at night, reflections from anti-collision lights on clouds, dense haze or dust can produce optical illusions and intense vertigo. Such lights, when installed, should be turned off before entering an overcast; their use may not be advisable under instrument or limited VFR conditions.

ENVIRONMENTAL SYSTEMS

CABIN HEATING

A heater muffler on the right engine exhaust stack provides for heated air to five outlets in forward and aft areas of the cabin. Two forward outlets are located above and forward of each set of rudder pedals. One aft outlet is installed behind the right front seat and a second one under the right rear seat. The fifth outlet provides heated air for windshield defrosting.

On the Bonanza 36, fresh ram air is picked up through an intake on the rear engine baffle, passes through the heater muffler, then into a mixer valve on the forward side of the firewall. In the mixer valve, the heated air is combined with a controlled quantity of unheated ram air which enters an intake on the right side of the nose. Air of the desired temperature is then ducted from the mixer valve to the outlets in the cabin.

On the Bonanza A36, fresh ram air enters an intake on the right side of the nose, passes through the heater muffler, then into a mixer valve on the forward side of the firewall. In the mixer valve, the heated air is combined with a controlled quantity of unheated ram air picked up at an intake at the rear engine baffle. Air of the desired temperature is then ducted from the mixer valve to the outlets in the cabin.

Section VII
Systems Description

BEECHCRAFT Bonanza 36, A36
E-1 thru E-926

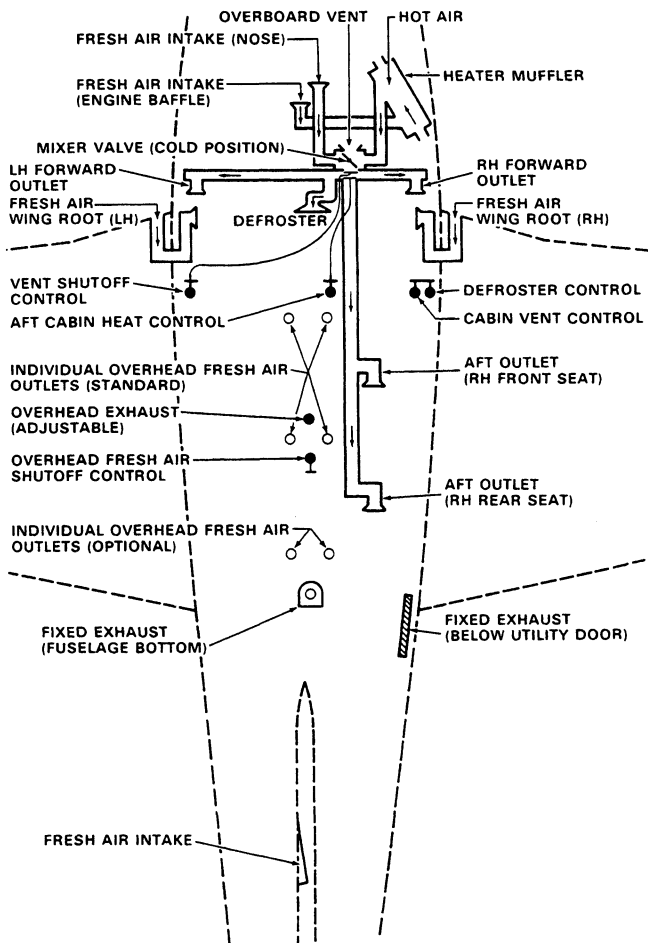

HEATING AND VENTILATION SYSTEM SCHEMATIC
36 (E-1 thru E-105)

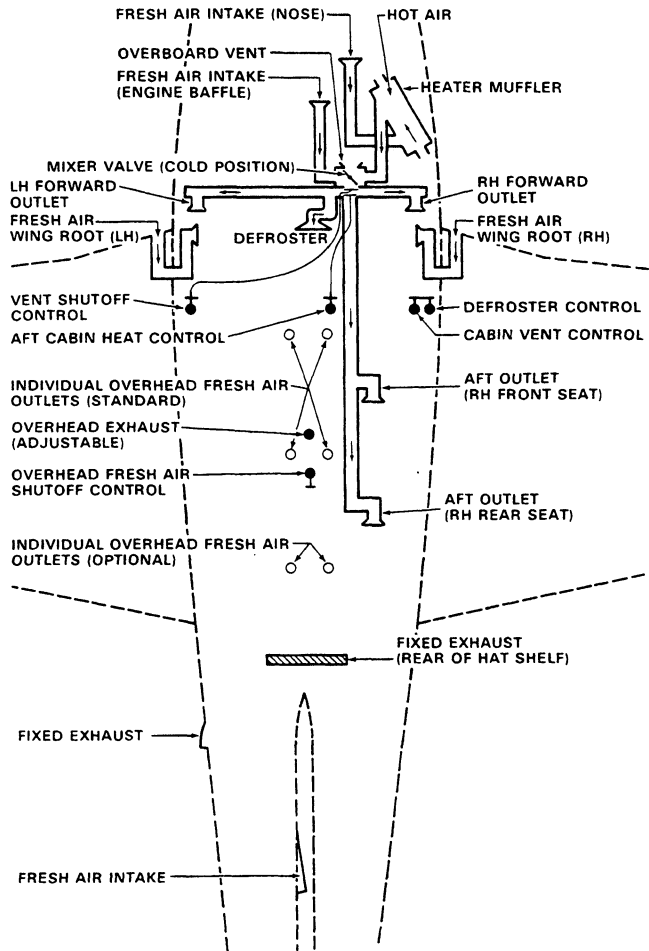

**HEATING AND VENTILATION SYSTEM SCHEMATIC
36 (E-106 thru E-184)**

Section VII
Systems Description

BEECHCRAFT Bonanza 36, A36
E-1 thru E-926

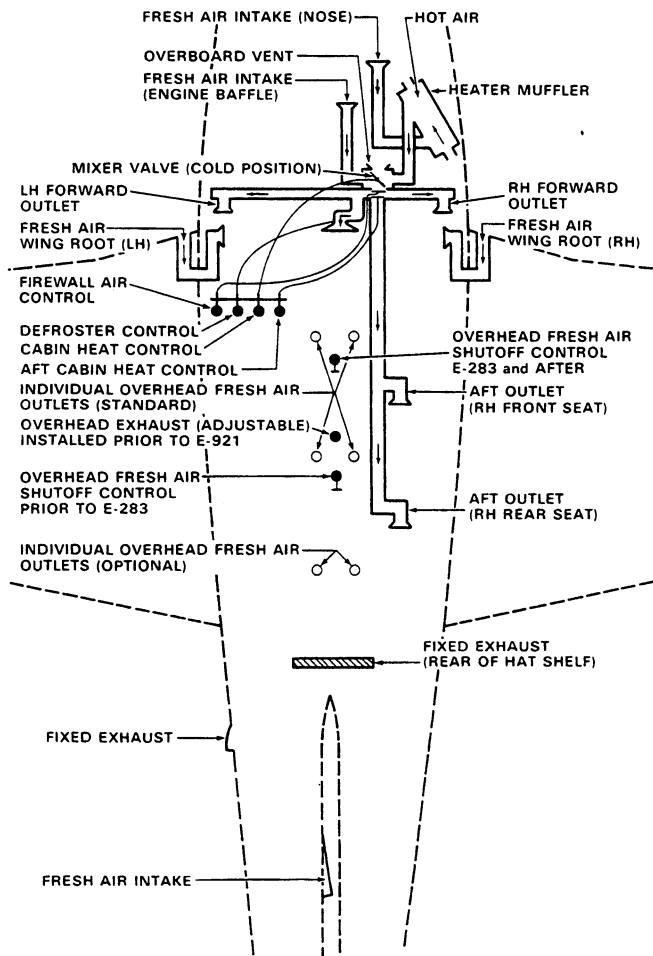

HEATING AND VENTILATION SYSTEM SCHEMATIC

A36 (E-185 thru E-926)

HEATER AND DEFROSTER OPERATION

The cabin heat control is located on the upper right sub-panel in the Bonanza 36 models and on the lower left sub-panel in the Bonanza A36. To provide heated air to the cabin outlets, pull the CABIN HEAT control. The control regulates the amount of cold air that is mixed with the air from the heater muff. When the control is pulled fully out, the cold air is shut off and only heated air enters the cabin.

To deliver heated air to the aft seat outlets, either push (36) or pull (A36) the AFT CABIN HEAT control. For maximum heat, the control is moved to full open position. To obtain heated air for defrosting the windshield pull the DEFROST control out. It may be necessary to vary or close the AFT CABIN HEAT control to obtain maximum air flow for defrosting. To close off all air from the heater system, pull the red control located at the extreme left of the pilots' lower subpanel. It is placarded either VENT SHUTOFF (36) or FIREWALL AIR (A36).

CABIN VENTILATION

In moderate temperatures, ventilation air can be obtained from the same outlets used for heating, by pushing the CABIN HEAT control full forward. However, in extremely high temperatures, it may be desirable to pull the VENT SHUTOFF (FIREWALL AIR) control and use only the fresh air outlets described in the following paragraphs.

CABIN FRESH AIR OUTLETS

A duct in each wing root is connected directly to an adjustable outlet in the upholstery panel forward of each front seat. Airflow from the right outlet is controlled by a

center knob. The volume of air from the left outlet is regulated by a center knob, and the direction of airflow is controlled by rotating the louvered cover with the small knob on the rim.

Individual Overhead Fresh Air Outlets

Fresh ram air from the air intake on the upper side of the aft fuselage is ducted to individual outlets above each seat. Each outlet can be positioned to direct the flow of air as desired. The volume of incoming air can be regulated by rotating the outlet. A system shutoff valve is installed in the duct between the overhead fresh air scoop and the individual fresh air outlets. The valve is operated by a push-pull control or by turning a knob in the overhead panel.

EXHAUST VENTS

(E-1 thru E-105)

A manually controlled cabin air exhaust vent is located aft of the radio speaker in the overhead panel. In addition, a fixed exhaust in the upholstery panel below the utility door is vented through an opening in the fuselage below the baggage compartment.

(E-106 thru E-920)

A manually controlled cabin air exhaust vent is located aft of the radio speaker in the overhead panel. In addition, a fixed exhaust is vented through the hat shelf.

On E-921 and after, only one exhaust (a fixed exhaust vent located in the aft cabin) is installed.

OXYGEN SYSTEM

The oxygen cylinder is located beneath the cover under the front seats. The system is available with either four, five or six outlets and with either a 38, 49 or 114 cu ft oxygen cylinder. Supply of oxygen to the system is controlled by a shut-off valve on the oxygen console. The pressure gage indicates the supply of oxygen available (1850 psig is nominal pressure for a full supply in the cylinder).

The system regulator is altitude compensated to provide a varying flow of oxygen with altitude. Flow is varied automatically from 0.5 liters per minute at 5,000 feet to 3.5 liters per minute at 30,000 feet. The use oxygen is recommended to be in accordance with current FAR operating rules.

PITOT AND STATIC SYSTEMS

PITOT SYSTEM

The pitot systems provides a source of impact air for operation of the airspeed indicator. The pitot mast is located on the leading edge of the left wing.

PITOT HEAT (Optional)

The pitot mast is provided with an electric heating element which is turned on and off with a switch on the instrument panel. The switch should be ON when flying in visible moisture. It is not advisable to operate the pitot heating element on the ground except for testing or for short intervals of time to remove ice or snow.

NORMAL STATIC AIR SYSTEM

The normal static system provides a source of static air to the flight instruments through a flush static fitting on each side of the airplane fuselage. Aft of the rear closure bulk-

head (rear seat panel) is a drain plug, located at the low point of the normal static system. It is provided in order to drain moisture accumulations from the system. The closure bulkhead is held in place with Velcro and may be removed by pulling forward. The drain plug should be removed and the moisture drained from the clear plastic line every 100 hours and after exposure to visible moisture, either in the air or on the ground.

EMERGENCY STATIC AIR SYSTEM

An emergency static air source, if installed, provides air for instrument operation should the static ports become blocked. Refer to the EMERGENCY PROCEDURES Section for procedures describing how and when to use this system.

INSTRUMENT PRESSURE SYSTEM

Instrument pressure is supplied by an engine driven pressure pump. Pressure is controlled by an adjustable pressure regulator on the forward side of the firewall.

A gage located on either the lower left subpanel (36) or upper right corner (A36) of the instrument panel indicates the system pressure in inches of mercury. The pressure should be maintained within the green arc for proper operation of the pressure operated instruments.

STALL WARNING

A stall warning horn on the forward side of the instrument panel sounds a warning signal as the airplane approaches a stall condition. The horn is triggered by a sensing vane on the leading edge of the left wing and is effective at all flight attitudes. Irregular and intermittent at first, the warning signal will become steady as the airplane approaches a complete stall.

ENGINE BREAK-IN INFORMATION

Use a straight mineral oil as recommended by the engine manufacturer throughout the break-in period. Drain the initial oil at 20 to 30 hours, replace with new mineral oil which is to be used until oil consumption stabilizes, usually a total of about 50 hours.

Drain and replace the engine oil as recommended in **HANDLING, SERVICING AND MAINTENANCE**. If operating conditions are unusually dusty or dirty, more frequent oil changes may be necessary. Oil changes are more critical during the break-in period than at any other time.

Use full throttle at recommended rpm for every take-off and maintain until at least 400 feet AGL, then reduce as necessary for cruise climb or cruise. Maintain the highest power recommended for cruise operations during the break-in period, avoiding altitudes above 8000 feet. Interrupt cruise power every 30 minutes or so by smoothly advancing to take-off power settings for about 30 seconds, then returning to cruise power settings.

Avoid long power-off descents especially during the break-in period. Maintain sufficient power during descent to permit cylinder head temperatures to remain in the green arc.

Minimize ground operation time, especially during warm weather. During the break-in period, avoid engine idling in excess of 15 minutes, especially in high ambient temperatures.

INTENTIONALLY LEFT BLANK

SECTION VIII

HANDLING, SERVICING AND MAINTENANCE

TABLE OF CONTENTS

<i>SUBJECT</i>	<i>PAGE</i>
Introduction	8-5
Publications	8-6
Airplane Inspection Periods	8-7
Preventative Maintenance That May Be Accomplished By A Certificated Pilot	8-9
Alterations or Repairs to Airplane	8-9
Ground Handling	8-10
Towing	8-10
Parking	8-11
Tie-Down	8-11
Main Wheel Jacking	8-12
Prolonged Out of Service Care	8-12
Flyable Storage - 7 to 30 Days	8-12
Mooring	8-12
Engine Preparation For Storage	8-13
Fuel Cells	8-13
Flight Control Surfaces	8-13
Grounding	8-13
Pitot Tube	8-13
Windshield and Windows	8-13
During Flyable Storage	8-14
Preparation For Service	8-14
External Power	8-15
Checking Electrical Equipment	8-15

TABLE OF CONTENTS (Continued)

<i>SUBJECT</i>	<i>PAGE</i>
Servicing	8-16
Fuel System	8-16
Fuel Cells	8-16
Fuel Drains	8-16
Fuel Strainers	8-17
Oil System	8-17
Oil Change Procedure	8-18
Battery	8-18
Tires	8-20
Shock Struts	8-20
To Inflate Struts	8-20
To Replenish Strut Hydraulic Fluid	8-21
Shock Strut Shimmy Damper	8-22
Brakes	8-23
Induction Air Filter	8-23
To Remove and Clean the Filter	8-23
Instrument Pressure System	8-23
Propeller Blades	8-24
Oxygen System	8-24
Oxygen Cylinder Retesting	8-26
Minor Maintenance	8-26
Rubber Seals	8-26
Alternator	8-26
Magnetos	8-27
Cleaning	8-28
Exterior Painted Surfaces	8-28
Windshield and Windows	8-31
Interior	8-31
Engine	8-32
Bulb Replacement Guide	8-33
Recommended Servicing Schedule	8-34
Lubrication Points	8-40
Consumable Materials	8-46

TABLE OF CONTENTS (Continued)

<i>SUBJECT</i>	<i>PAGE</i>
Approved Engine Oils	8-50
Overhaul or Replacement Schedule	8-52
Special Conditions Cautionary Notice	8-52
Landing Gear	8-53
Power Plant	8-53
Fuel System	8-54
Instruments	8-55
Electrical System	8-55
Flaps and Flight Controls	8-56
Miscellaneous	8-56

INTENTIONALLY LEFT BLANK

INTRODUCTION

The purpose of this section is to outline the requirements for maintaining the airplane in a condition equal to that of its original manufacture. This information sets the time frequency intervals at which the airplane should be taken to a BEEHCRAFT Aero or Aviation Center or International Distributor or Dealer for periodic servicing or preventive maintenance.

The Federal Aviation Regulations place the responsibility for the maintenance of this airplane on the owner and operator of the airplane who must ensure that all maintenance is done by qualified mechanics in conformity with all airworthiness requirements established for this airplane.

All limits, procedures, safety practices, time limits, servicing and maintenance requirements contained in this handbook are considered mandatory.

Authorized BEEHCRAFT Aero or Aviation Centers and International Distributors or Dealers will have recommended modification, service, and operating procedures issued by both FAA and Beech Aircraft Corporation, designed to get maximum utility and safety from the airplane.

If there is a question concerning the care of the airplane, it is important to include the airplane serial number in any correspondence. The serial number appears on the model designation placard attached to the right side of the fuselage under the utility door.

PUBLICATIONS

The following publications are available through BEEHCRAFT Aero or Aviation Centers and International Distributors or Dealers:

1. Shop Manual
2. Parts Catalog
3. Service Instructions
4. Various Inspection Forms

NOTICE

The following information may be provided to the holder of this manual automatically:

1. Original issues and revisions of Class I and Class II Service Instructions
2. Original issues and revisions of FAA Approved Airplane Flight Manual Supplements
3. Reissues and revisions of FAA Approved Airplane Flight Manuals, Flight Handbooks, Owner's Manuals, Pilot's Operating Manuals, and Pilot's Operating Handbooks

This service is free and will be provided only to holders of this handbook who are listed on the FAA Aircraft Registration Branch List or the BEEHCRAFT International Owners Notification Service List, and then only if you are listed by airplane serial number for the model for which this handbook is applicable. For detailed information on how to obtain "Revision Service" applicable to this handbook or other BEEHCRAFT Service Publications consult a BEEHCRAFT Aero or Aviation Center or International Distributor or Dealer, or refer to the latest revision of BEEHCRAFT Service Instructions No. 0250-010.

AIRPLANE INSPECTION PERIODS

1. FAA Required Annual Inspections.
2. BEEHCRAFT Recommended Inspection Guide.
3. Continuing Care Inspection Guide.
4. See "Recommended Servicing Schedule" and Overhaul or Replacement Schedule" for further inspection schedules.

NOTE

In event of emergency gear or flap extension at speeds above the respective normal extension speeds and before the next flight, inspect gear retract rods, gear doors and flaps for damage or distortion.

INTENTIONALLY LEFT BLANK

**PREVENTATIVE MAINTENANCE THAT MAY
BE ACCOMPLISHED BY A CERTIFICATED PILOT**

1. A certificated pilot may perform limited maintenance. Refer to FAR Part 43 for the items which may be accomplished.

To ensure proper procedures are followed, obtain a BEEHCRAFT Shop Manual for performing preventative maintenance.

2. All other maintenance must be performed by licensed personnel.

NOTE

Pilots operating airplanes of other than U.S. registry should refer to the regulations of the registering authority for information concerning preventative maintenance that may be performed by pilots.

ALTERATIONS OR REPAIRS TO AIRPLANE

The FAA should be contacted prior to any alterations on the airplane to ensure the airworthiness of the airplane is not violated.

NOTE

Alterations and repairs to the airplane must be made by properly licensed personnel.

GROUND HANDLING

The three-view drawing in Section 1 shows the minimum hangar clearances for a standard airplane. Allowances must be made for any special radio antennas.

CAUTION

To ensure adequate propeller clearance, always observe recommended shock strut servicing procedures and tire inflation pressures.

TOWING

One man can move the airplane on a smooth and level surface using a hand tow bar. Attach the tow bar to the tow lugs on the nose gear lower torque knee.

Where movement is restricted, two men can pivot the airplane on the main wheels. One man should push on the wing leading edge or hold the wing tip, while the other operates the tow bar.

CAUTION

Do not exert force on the propeller or control surfaces. Do not place weight on the stabilizers to raise the nose wheel. When towing with a tug, limit turns to prevent damage to the nose gear. Do not attempt to tow airplane backward by the tail tie down ring.

Care should be used when removing the tow bar to prevent damage to the lubrication fittings on the landing gear.

PARKING

The parking brake push-pull control is located on the sub-panel. To set the parking brakes, pull control out and depress both toe pedals until firm. Push the control in to release the brakes.

CAUTION

The parking brake should be left off and wheel chocks installed if the airplane is to be left unattended. Changes in ambient temperature can cause the brakes to release or to exert excessive pressures.

TIE-DOWN

It is advisable to nose the airplane into the wind. Three tie-down lugs are provided: one on the lower side of each wing and a third at the rear of the fuselage.

1. Install the control column lock pin.
2. Chock the main wheels, fore and aft.
3. Using nylon line or chain of sufficient strength, secure the airplane at the three points provided. **DO NOT OVER TIGHTEN**; if the line at the rear of the fuselage is excessively tight, the nose may rise and produce lift due to the angle of attack of the wings.
4. Release the parking brake.

If high winds are anticipated, a vertical tail post should be installed at the rear tie-down lug, and a tie-down line attached to the nose gear.

MAIN WHEEL JACKING

1. Check the shock strut for proper inflation to prevent damage to the landing gear door by the jack adapter and to facilitate installation of the adapter.

CAUTION

Persons should not be in or on the airplane while it is on a main wheel jack.

2. Insert the main wheel jack adapter into the main wheel axle.
3. A scissors-type jack is recommended for raising and lowering the wheel.

PROLONGED OUT OF SERVICE CARE

Storage procedures are intended to protect the airplane from deterioration while it is not in use. The primary objectives of these measures are to prevent corrosion and damage from exposure to the elements.

Flyable Storage (7-30 days) has been considered here. For more extended storage periods, consult the Beech Airplane Shop Manual and Continental Service Bulletin M 81-3 or later issue.

FLYABLE STORAGE - 7 TO 30 DAYS

MOORING

If airplane cannot be placed in a hangar, tie down securely at the three points provided. Do not use hemp or manila rope. It is recommended a tail support be used to compress the nose strut and reduce the angle of attack of the wings. Attach a line to the nose gear.

ENGINE PREPARATION FOR STORAGE

Engines in airplanes that are flown only occasionally tend to exhibit cylinder wall corrosion much more than engines that are flown frequently.

Run engine at least five minutes at 1200 to 1500 rpm with oil and cylinder head temperatures in the normal operating range.

Check for correct oil level and add oil if necessary to bring level to full mark.

FUEL CELLS

Fill to capacity to minimize fuel vapor and protect cell inner liners.

FLIGHT CONTROL SURFACES

Lock with internal and external locks.

GROUNDING

Static ground airplane securely and effectively.

PITOT TUBE

Install cover.

WINDSHIELD AND WINDOWS

Close all windows and window vents. It is recommended that covers be installed over windshield and windows.

DURING FLYABLE STORAGE

Each seven days during flyable storage, the propeller shall be rotated by hand. After rotating the engine six revolutions, stop the propeller 60° or 120° from the position it was in.

WARNING

Before rotation of propeller blades, ascertain magneto/start switch is OFF, throttle in CLOSED position, and mixture control is in the IDLE CUT-OFF position. Always stand in the clear while turning propeller.

If at the end of 30 days airplane will not be removed from storage, the engine shall be started and run. The preferred method will be to fly the airplane for 30 minutes, and up to, but not exceeding normal oil and cylinder temperatures.

PREPARATION FOR SERVICE

Remove all covers and tape, clean the airplane and give it a thorough inspection, particularly wheel wells, flaps, and control openings.

Preflight the airplane.

EXTERNAL POWER

When using external power, it is very important that the following precautions be observed:

1. The airplane has a negative ground system. Exercise care to avoid reversed polarity. Be sure to connect the positive lead of the external power unit to the positive terminal of the airplane's external power receptacle and the negative lead to the negative terminal of the external power receptacle. A positive voltage must also be applied to the small guide pin.
2. To prevent arcing, make certain no power is being supplied when the connection is made.
3. Make certain that the battery switch is ON, all avionics and electrical switches OFF, and a battery is in the system before connecting an external power unit. This protects the voltage regulators and associated electrical equipment from voltage transients (power fluctuations).

CHECKING ELECTRICAL EQUIPMENT

Connect an auxiliary power unit as outlined above. Ensure that the current is stabilized prior to making any electrical equipment or avionics check.

CAUTION

If the auxiliary power unit has poor voltage regulation or produces voltage transients the equipment connected to the unit may be damaged.

SERVICING

FUEL SYSTEM

FUEL CELLS

See Consumable Materials for recommended fuel grades.

CAUTION

Never leave the fuel cells completely empty for more than a few days, as the cell inner liners may dry out and crack, permitting fuel to diffuse through the walls of the cell after refueling. If the cells are to be left empty for a week or more, a thin coating of light engine oil should be sprayed or flushed onto the inner liner of the cells.

The standard fuel cell installation consists of a 25-gallon capacity fuel cell (22-gallon usable) and filler cap in each wing leading edge. In the optional installation a 40-gallon capacity fuel cell (37-gallon usable) replaces the smaller capacity cell. The filler neck in this installation contains a visual measuring tab to permit partial filling of the tank. Filling the tank until the fuel touches the bottom of the tab indicates 27 gallons of usable fuel, and filling to the slot in the tab indicates 32 gallons of usable fuel. The airplane must be level for the tabs to indicate accurately.

FUEL DRAINS

Open the three snap-type fuel drains daily to purge any water from the system. Each fuel cell drain is located on the bottom of the wing just outboard of the fuselage. The system low spot drain is at the bottom of the fuel selector valve. The drain is accessible through a door in the fuselage adjacent to the left wing.

FUEL STRAINERS

At each 50 hour inspection the strainer plug should be removed from the fuel injection control valve and the fuel injection control valve screen washed in fresh cleaning solvent. After the strainer plug has been reinstalled and safetied, the installation should be checked for leakage. The strainer at the bottom of the fuel selector valve should also be removed and cleaned with solvent every 100 hours. To reduce the possibility of contaminated fuel, always cap any disconnected fuel lines or fittings.

Ordinarily the finger strainers in the fuel cell outlets should not require cleaning unless there is a definite indication of solid foreign material in the cells or the airplane has been stored for an extended period.

OIL SYSTEM

CAUTION

During break-in periods on new engines, oil consumption tends to be higher, therefore, maximum range flights should be avoided and oil level brought to full after each flight during this period.

The engine oil filler cap and dipstick is accessible by raising the left cowl door. The sump capacity is 12 quarts. Normal operating level should be 10 to 12 quarts.

The oil and filter element should be changed every 100 hours under normal operating conditions. To assure complete drainage, the engine should be at operating temperature.

OIL CHANGE PROCEDURE

1. Remove the access plate from the engine cowl on the lower right side.
2. Locate the oil sump drain plug at the low point of the engine sump.
3. Remove the plug button below the sump drain and insert the oil drain duct.
4. Remove the oil sump drain plug.
5. Remove the oil filter and replace with a new unit. A torque of 18 to 20 ft lbs should be applied to the oil filter (Canister type). Apply 15 to 18 ft lbs when the oil filter is attached with a center stud assembly.
6. Replace the oil sump drain plug and fill the engine with oil.

See Consumable Materials and Approved Engine Oils for specified oils.

The engine manufacturer recommends ashless dispersant oils. In order to promote faster ring seating and oil control, a straight mineral oil should be used for the first oil change period or until oil consumption stabilizes. Oils must meet Teledyne Continental Motors Specification MHS-24B. Refer to APPROVED ENGINE OILS.

BATTERY

The battery is accessible by opening the right engine cowling. Check the electrolyte level after each 25 hours of operation and add distilled water as necessary. Do not overfill the battery.

Excessive water consumption may be an indication that the voltage regulator requires resetting. The specific gravity of the electrolyte should be checked periodically and maintained within the limits placarded on the battery.

The battery box is vented overboard to dispose of electrolyte and hydrogen gas fumes discharged during the normal charging operation. To ensure disposal of these fumes the vent tube should be checked frequently for obstructions and should be kept open.

TIRES

An inflation pressure of 33 to 40 psi should be maintained on the 7.00 x 6 main wheel tires. The 5.00 x 5 nose wheel tire should be inflated to 40 psi. Maintaining proper tire inflation will minimize tread wear and aid in preventing tire failure caused from running over sharp stones. When inflating tires, visually inspect them for cracks and breaks.

CAUTION

Beech Aircraft Corporation cannot recommend the use of recapped tires. Recapped tires have a tendency to swell as a result of the increased temperature generated during takeoff. Increased tire size can jeopardize proper function of the landing gear retract system, with the possibility of damage to the landing gear doors and retract mechanism.

SHOCK STRUTS

The following procedures may be used for servicing both the main and the nose gear shock struts.

TO INFLATE STRUTS:

1. Check to see that the airplane is empty except for full fuel and oil.
2. While rocking the airplane gently to prevent possible binding of the piston in the barrel, inflate the shock strut until the main gear piston is extended 3 inches (3-1/2 or 5 inches as indicated on the nose gear shock strut servicing placard).

CAUTION

If a compressed air bottle containing air under extremely high pressure is used, exercise care to avoid over-inflating the shock strut.

WARNING

NEVER FILL SHOCK STRUTS WITH OXYGEN.

3. Remove all foreign material from the exposed piston with a soft cloth moistened with hydraulic fluid.

TO REPLENISH STRUT HYDRAULIC FLUID:

1. Support the airplane on jacks at the wing jack points.
2. Remove the air valve cap, depress the valve core, and allow the strut to fully deflate.
3. Raise and block the strut 1/4 inch from the compressed position.

WARNING

Do not remove the valve body assembly until all air pressure has been released or it may blow off, causing injury to personnel or damage to equipment.

4. Carefully remove the valve body assembly.
5. Fill the strut to the level of the valve body assembly with hydraulic fluid (see Consumable Materials).
6. Slowly extend the strut from the blocked position and replace the valve body assembly.

7. Depress the valve core and completely compress the strut to release excess air and oil.
8. Remove airplane from jacks and inflate the strut as described in the preceding inflation procedure.

SHOCK STRUT SHIMMY DAMPER

The shimmy damper has a reservoir of fluid carried in the piston rod. Two coil springs installed in the piston rod keep fluid in the shimmy damper under pressure. As fluid is lost through leakage it is automatically replenished from the reservoir until the reservoir supply is exhausted.

To check the fluid level in the shimmy damper, insert a wire, approximately 1/32 inch in diameter, through the hole in the disc at the aft end of the piston rod until it touches the bottom of the hole in the floating piston. Mark the wire, remove it, and measure the depth of the insertion. When the shimmy damper is full, insertion depth is 2-3/16 inches, when empty, 3-1/16 inches.

NOTE

The measuring wire should be inserted in the hole in the floating piston rather than against the piston face to give a more accurate reading. To determine if the wire is inserted in the hole in the floating piston, insert the wire several times, noting insertion depth each time. When the wire is inserted in the hole, the depth will be about 1/4 inch greater than when it rests against the piston face.

When the shimmy damper is found empty or nearly empty, it should be refilled. See Shop Manual.

BRAKES

The brake hydraulic fluid reservoir is located on the firewall in the engine compartment. A dipstick is attached to the reservoir cap. Refer to Consumable Materials for hydraulic fluid specification.

The brakes require no adjustments since the pistons move to compensate for lining wear.

INDUCTION AIR FILTER

This filter should be inspected for foreign matter at least once during each 50-hour operating period. In adverse climatic conditions, or if the airplane is stored, preflight inspection is recommended.

TO REMOVE AND CLEAN THE FILTER:

1. Remove the fuselage nose section grill.
2. Remove the wing nuts securing the filter and remove the filter.
3. Clean as described in the manufacturer's instructions on the filter.

INSTRUMENT PRESSURE SYSTEM

The pressure system incorporates two filters; a pump intake filter and an in-line filter. The pump intake filter is mounted on the rear engine baffle. The foam rubber suction screen should be washed with soap and water every 100 hours of normal operation. The dry type filter should be replaced every 300 to 500 hours. If the aircraft is operated in dusty conditions the filter should be cleaned more frequently. The in-line filter is located between the pressure regulator and the instruments. This filter should be changed every 300 hours of operation.

PROPELLER BLADES

The daily preflight inspection should include a careful examination of the propeller blades for nicks and scratches.

Each blade leading edge should receive particular attention. It is very important that all nicks and scratches be smoothed out and polished. The BEEHCRAFT Aero or Aviation Center and International Distributors or Dealers will be glad to answer any questions concerning propeller blade repair.

WARNING

When servicing a propeller, always make certain the ignition switch is off and that the engine has cooled completely. **WHEN MOVING A PROPELLER, STAND IN THE CLEAR;** there is always some danger of a cylinder firing when a propeller is moved.

OXYGEN SYSTEM

To service the oxygen system, use the following procedures:

WARNING

Keep hands, tools, clothing, and oxygen equipment clean and free from grease and oil. **KEEP FIRE AND SPARKS AWAY FROM OXYGEN.** Use only recommended leak testing soaps.

1. Read the pressure gage on the oxygen console panel just forward and to the left of the pilot's seat.

2. The gage will not indicate pressure unless the shut-off valve on the oxygen cylinder is open. When the 38 or 49 cu. ft. cylinder is installed, the shut-off valve is located under the pilot's seat. When the 114 cu. ft. cylinder is installed, it is located under the copilot's seat.

CAUTION

Open the cylinder shutoff valve slowly to prevent damage to the system.

3. Close the cylinder shutoff valve and the console panel shutoff valve.
4. Slide the pilot's or copilot's seat aft until the filler valve is clear, then remove the cap from the filler valve and attach the recharging outlet. Open valve on supply bottle slowly.
5. Open the cylinder shutoff valve and slowly fill the cylinder to 1850 ± 50 psi at a temperature of 70°F . This pressure may be increased an additional 3.5 psi for each degree of increase in temperature. Similarly, for each degree of drop in temperature, reduce the cylinder pressure 3.5 psi.
6. Close the cylinder shutoff valve, close the supply bottle valve, remove the recharging outlet, and replace the filler valve cap.
7. Slowly open the cylinder shutoff valve to prepare the system for use.
8. Reinstall the access panel and slide the pilot's seat forward to its original position.
9. The console panel shutoff valve should remain closed until the system is used.

OXYGEN CYLINDER RETESTING

The oxygen cylinders, (light weight cylinders, stamped "3HT" on the plate on the side) must be hydrostatically tested every three years and the test data stamped on the cylinder. This cylinder has a service life of 4380 pressurizations or twenty-four years, whichever occurs first, and then must be discarded.

The oxygen cylinders stamped 3A or 3AA must be hydrostatically tested every five years. The cylinder life is not limited on these cylinders.

MINOR MAINTENANCE

RUBBER SEALS

To prevent sticking of the rubber seals around the windows, doors, and engine cowling, the seals should be coated with Oakite 6 compound. The compound is noninjurious to paint and can be removed by employing normal cleaning methods.

ALTERNATOR

Since the alternator and voltage regulator are designed for use on only one polarity system, the following precautionary measures must be observed when working on the charging circuit, or serious damage to the electrical equipment will result:

1. When installing a battery, make certain that the ground polarity of the battery and the ground polarity of the alternator are the same.
2. When connecting a booster battery, be sure to connect the negative battery terminals together and the positive battery terminals together.

3. When using a battery charger, connect the positive lead of the charger to the positive battery terminal and the negative lead of the charger to the negative battery terminal.
4. Do not operate an alternator on open circuit. Be sure all circuit connections are secure.
5. Do not short across or ground any of the terminals on the alternator or voltage regulator.
6. Do not attempt to polarize an alternator.

MAGNETOS

Ordinarily, the magnetos will require only occasional adjustment, lubrication, and breaker point replacement. This work should be done by a BEEHCRAFT Aero or Aviation Center or International Distributor or Dealer.

WARNING

To be safe, treat the magnetos as hot whenever a switch lead is disconnected at any point; they do not have an internal automatic grounding device. The magnetos can be grounded by replacing the switch lead at the noise filter capacitor with a wire which is grounded to the engine case. Otherwise, all spark plug leads should be disconnected or the cable outlet plate on the rear of the magneto should be removed.

CLEANING

EXTERIOR PAINTED SURFACES

WARNING

Do not expose control surface trim tab hinge lines and their pushrod systems to the direct stream or spray of high-pressure, soap-and-water washing equipment. Fluid dispensed at high pressure could remove the protective lubricant, allowing moisture from heavy or prolonged rain to collect at hinge lines, and then to freeze at low temperatures. After high-pressure or hand washing, and at each periodic inspection, lubricate trim tab hinge lines and trim tab pushrod end fittings (Brayco 300 per Federal Specification VV-L-800 preferred). See Consumable Materials.

CAUTION

When cleaning landing gear areas with solvent, especially if high-pressure equipment is used, exercise care to avoid washing away grease from landing gear components. After washing the landing gear areas with solvent, lubricate all lubrication points, or premature wear may result.

Do not apply wax, polish, rubbing compound, or abrasive cleaner to any uncured painted surface. Use of such items can permanently damage the surface finish. Also, waxes and polishes seal the paint from the air and prevent curing.

CAUTION

Alkyd enamel (sometimes called "automotive

enamel"), acrylic enamel, lacquer, and dope finishes require a curing period of approximately 90 days; Acrylic urethane, polyester urethane, and epoxy finishes undergo a curing process for a period of 30 days after application. Wash uncured painted surfaces with a mild non-detergent soap (MILD detergents can be used on urethane finishes) and cold or lukewarm water only. Use soft cloths, keeping them free of dirt and grime. Any rubbing of the surface should be done gently and held to a minimum to avoid damaging the paint film. Rinse thoroughly with clear water. Stubborn oil or soot deposits may be removed with automotive tar removers.

Prior to cleaning, cover the wheels, making certain the brake discs are covered. Attach the pitot cover securely, and plug or mask off all other openings. Be particularly careful to mask off all static air buttons before washing or waxing. Use special care to avoid removing lubricant from lubricated areas.

When using high-pressure washing equipment, keep the spray or stream clear of wheel bearings, propeller hub bearings, etc., and openings such as pitot tubes, static air buttons, and battery and avionics equipment cooling ducts, which should be securely covered or masked off. Avoid directing high-pressure sprays toward the fuselage, wings, and empennage from the rear, where moisture and chemicals might more easily enter the structure, causing corrosion damage to structural members and moving parts.

Hand washing may be accomplished by flushing away loose dirt with clean water, then washing with a mild soap and water, using soft cleaning cloths or a chamois. Avoid harsh, abrasive, or alkaline soaps or detergents which could cause

corrosion or scratches. Thorough clear-water rinsing prevents buildup of cleaning agent residue, which can dull the paint's appearance. To remove oily residue or exhaust soot, use a cloth dampened with an automotive tar remover. Wax or polish the affected area, if necessary.

There is some variation in the procedures required for proper care of the several types of exterior paint. During the curing period, do not make prolonged flights in heavy rain or sleet, and avoid all operating conditions which might cause abrasion or premature finish deterioration. Alkyd enamel, lacquer, and dope finishes must be polished and waxed periodically to maintain luster, and to assure protection from the weather. Acrylic enamel should be waxed, and may be polished, if desired. Acrylic urethane may be waxed for protection from the elements, but should not be polished unless polishing or buffing is required to restore a damaged area. Waxing of polyester urethane finishes, although not required, is permitted; however, never use abrasive cleaner type waxes, polishes, or rubbing compounds, as these products cause eventual deterioration of the characteristic urethane gloss. Epoxy finishes should be waxed on a regular basis, and may be polished and buffed to restore appearance should "chalking" occur. For waxing, select a high quality automotive or aircraft waxing product. Do not use a wax containing silicones, as silicone polishes are difficult to remove from surfaces. A buildup of wax on any exterior paint finish will yellow with age; therefore, wax should be removed periodically. Generally, aliphatic naphtha (see Consumable Materials) is adequate and safe for this purpose.

NOTE

Before returning the airplane to service, remove all maskings and coverings, and re-lubricate as necessary.

WINDSHIELD AND WINDOWS

The windshield and plastic windows should be kept clean and waxed at all times. To prevent scratches, wash the windows carefully with plenty of soap and water, using the palm of the hand to feel and dislodge dirt and mud. A soft cloth, chamois or sponge may be used, but only to carry water to the surface. Rinse thoroughly, then dry with a clean, moist chamois. Rubbing the surface of the plastic with a dry cloth builds up an electrostatic charge which attracts dust particles in the air.

Remove oil and grease with a cloth moistened with isopropyl alcohol. Never use gasoline, benzine, alcohol, acetone, carbon tetrachloride, fire extinguisher fluid, anti-ice fluid, lacquer thinner or glass cleaner. These materials will soften the plastic and may cause it to craze.

After thoroughly cleaning, the surface should be waxed with a good grade of commercial wax. The wax will fill in minor scratches and help prevent further scratching. Apply a thin, even coat of wax and bring it to a high polish by rubbing lightly with a clean, dry, soft flannel cloth. Do not use a power buffer; the heat generated by the buffing pad may soften the plastic.

INTERIOR

To remove dust and loose dirt from the upholstery, headliner, and carpet, clean the interior regularly with a vacuum cleaner.

Blot up any spilled liquid promptly with cleansing tissue or rags. Do not pat the spot; press the blotting material firmly and hold it for several seconds. Continue blotting until no more liquid is taken up. Scrape off sticky materials with a dull knife, then spot-clean the area.

Oily spots may be cleaned with household spot removers, used sparingly. Before using any solvent, read the instructions on the container and test it on an obscure place on the fabric to be cleaned. Never saturate the fabric with a volatile solvent; it may damage the padding and backing materials.

Soiled upholstery and carpet may be cleaned with foam-type detergent used according to the manufacturer's instructions. To minimize wetting the fabric, keep the foam as dry as possible and remove it with a vacuum cleaner.

The plastic trim, instrument panel, and control knobs need only be wiped with a damp cloth. Oil and grease on the control wheel and control knobs can be removed with a cloth moistened with isopropyl alcohol. Volatile solvents, such as mentioned in the article on care of plastic windows should never be used since they soften and craze the plastic.

ENGINE

Clean the engine with neutral solvent. Spray or brush the fluid over the engine, then wash off with water and allow to dry.

CAUTION

Do not use solutions which may attack rubber or plastic. Protect engine switches, controls, and seals; fluid applied at high pressure can unseat seals, resulting in contamination of the sealed systems.

BULB REPLACEMENT GUIDE

LOCATION	NUMBER
Cabin Overhead Lights (E-283 and after)	1816
Compass Light	330
Dome Light (E-1 thru E-282)	89
Door Ajar Warning Light	330
Engine Instruments	1819R
Edgelighted Panel	330
Fuel Selector Placard	53
Glareshield	1815
Instrument Light, Flood	89
Instrument Light, Post	330
Landing Gear Indicator	330
Landing Gear Visual	53
Landing Light, Nose Section	4313
Landing Light, Nose Shock Strut	4313
Light Tray Assembly	266
Map	1816
Navigation Light, Tail Cone	93
Navigation Light, Wing	1512
OAT	330
Reading	
(E-1 thru E-282)	1816
(E-283 and after)	89
Rotating Beacon	A-7079-12
Strobe Light Lamp, Tail (Grimes)	633
Strobe Light Flashtube, Tail (Grimes)	31-2440-1
Strobe Light Flashtube, Wing (Grimes)	31-1840-1
Strobe Light (Bullock)	82219
Sub Panel Post	330
Trim Tab Indicator	1813

RECOMMENDED SERVICING SCHEDULE

INTERVAL	ITEM	LOCATION (Letters refer to Lubrication Points Diagram)	LUBRICANT (Number refers to item on Consumable Materials)
Pre-flight	Check engine oil level Drain fuel cell drains Drain fuel system low spot drain Service fuel cells	Upper left side of engine Bottom of wing near wing root Bottom of fuselage, left side Top of wings, leading edge	5 - - 6
25 Hrs.	Check battery electrolyte	Under right cowling door	See Shop Manual
50 Hrs.	Clean fuel injection control valve screen Clean induction air filter Drain static air lines	Lower engine compartment Behind nose section grill Behind aft cabin bulkhead	7 - -

50 Hrs. (Cont.)	Lubricate landing gear retract mechanism and uplock rollers	Wheel wells (K) (E-1 thru E-283 unless BEECHCRAFT S.I.0448-211 has been compiled with)	4
100 Hrs. †	<p>Change engine oil Install oil filter Clean fuel selector valve strainer Inspect, replace the pressure pump intake filter as necessary Lubricate aileron control linkage Lubricate cabin door mechanism Lubricate control column linkage Lubricate utility door mechanism Lubricate cowl flap hinges</p>	<p>Lower right side of engine Upper left side of engine Left side belly Engine compartment Each wing (J) Aft edge of cabin door (E) Forward of instrument panel (C) Utility door (P) Bottom of cowl (N)</p>	<p>5 - 7 7 4, 10 4 4 4 4</p>

RECOMMENDED SERVICING SCHEDULE

INTERVAL	ITEM	LOCATION (Letters refer to Lubrication Points Diagram)	LUBRICANT (Number refers to item on Consumable Materials)
100 Hrs. (Cont.)	Lubricate elevator and rudder control mechanism Lubricate elevator tab chain Lubricate landing gear door hinges Lubricate landing gear retract mechanism and uplock rollers Lubricate nose wheel steering mechanism Lubricate rudder pedals Lubricate trim tab control Lubricate wheel bearings and felt seals	Forward of tail bulk- head (H) In each horizontal stabilizer (I) Edge of wheel well (L) (O) Wheel wells (A) (K) (E-284 and After and prior airplanes after compliance with BEECH- CRAFT S.I. 0448-211) Nose wheel well (B) Cockpit (M) Control pedestal (D) Nose and main wheels (A, K)	4 4 4 3, 10 3 4 4 1, 4

††

300 Hrs.	Flap motor (brushes) Service landing gear actuator gear box Change pressure system in-line filter	Under front seats in cabin (G)	-
		Under front seats in cabin (F) Forward of instrument panel	8 Airborne Mfg. 1J4-7
600 Hrs.	Service landing gear motor-reduction gears Service flap motor gear box	Under front seats in cabin (F)	3
		Under front seats in cabin (G)	10
900 Hrs.	Lubricate flap actuators Lubricate flap flex driveshafts *Lubricate elevator tab actuators	Inside wing aft of wheel well (G)	9, 10
		Inside each horizontal stabilizer (I)	10
As Req.	Clean spark plugs Service main and nose shock struts Service shimmy damper	Engine compartment Landing gear	- 2
		Nose gear	2

* Lubricate every 900 hours or 5 years whichever comes first.

RECOMMENDED SERVICING SCHEDULE

INTERVAL	ITEM	LOCATION (Letters refer to Lubrication Points Diagram)	LUBRICANT (Number refers to item on Consumable Materials)
As Req. (Cont.)	Drain static air lines Remove cap drain with 1 1/16" wrench and permit the system to drain.	Behind aft cabin bulkhead	
NOTE			
The static air line should be drained frequently during periods of high humidity. Also drain the line each time the airplane is flown through heavy rain or is washed down.			
Note 3	Replace emergency locator transmitter battery	At emergency locator	

NOTES:

1. Anytime the control surfaces are altered, repaired, or repainted, they must be re-balanced per the Shop Manual.
2. Check the wing bolts for proper torque at the first 100-hour inspection and at the first 100-hour inspection after each reinstallation of the wing attach bolts.
3. Rechargeable Batteries: Recharge after one cumulative hour of use or after 50% of the useful charge life.

Non-rechargeable Batteries: Replace after one cumulative hour of use or after 50% of the useful charge life.

† Lubricate aileron control rod ends in place using SAE 20 or SAE 10W30 or remove aileron control rod assembly, clean and relubricate control rod ends using MIL-G-23827 grease. Rotate rod end bearings to assure adequate lubricant coverage. Check aileron rigging after re-installation of rod end assembly.

†† Lightly saturate felt seals with 10W30 oil (remove excess by pressing slightly) also coat the sides and outer diameter with the same type of grease used on the bearings.

LUBRICATION POINTS

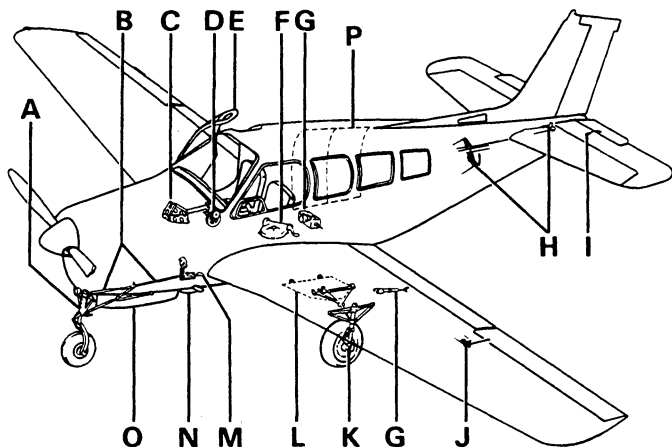

A

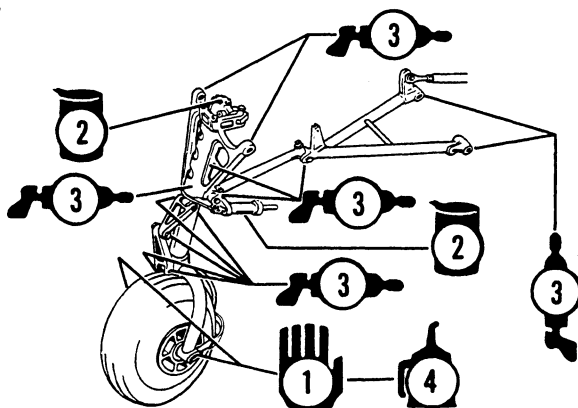

NOSE GEAR RETRACT

B

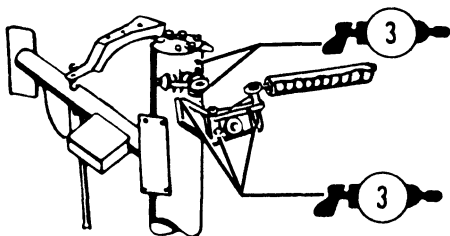

NOSE WHEEL STEERING

C

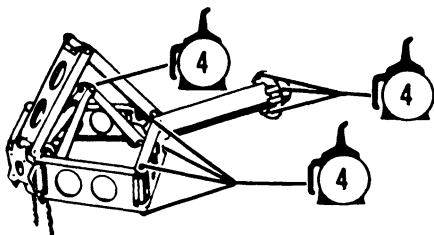

CONTROL COLUMN LINKAGE

D

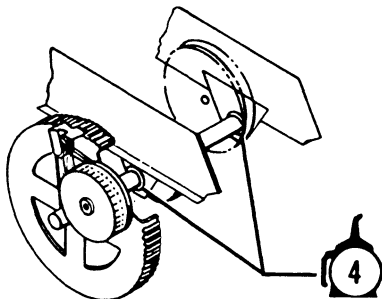

ELEVATOR TRIM CONTROL

E

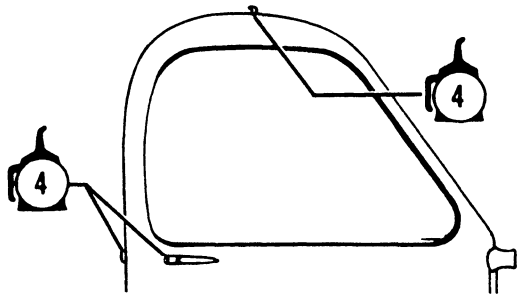

CABIN DOOR

F

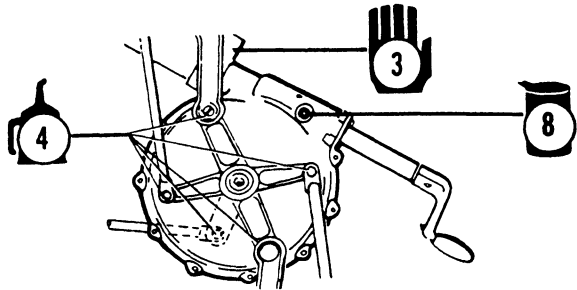

LANDING GEAR ACTUATOR GEAR BOX

G

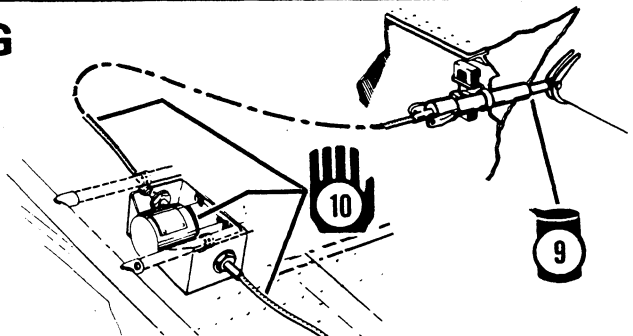

FLAP MOTOR AND ACTUATOR

H

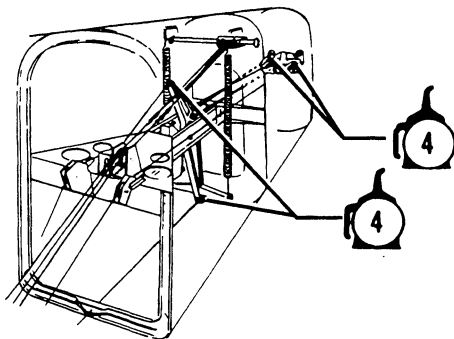

ELEVATORS AND RUDDER CONTROL MECHANISM

I

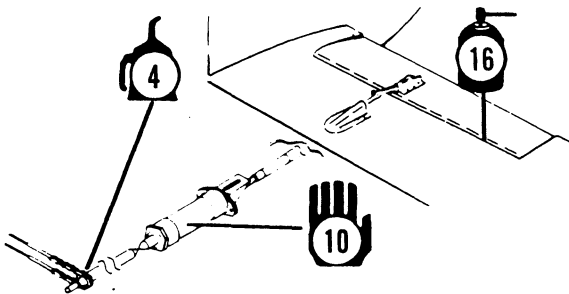

ELEVATOR TAB MECHANISM

J

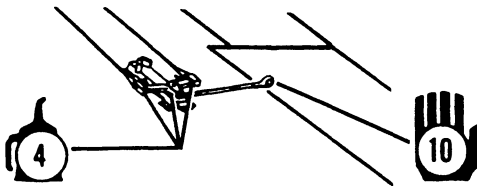

AILERON BELL CRANKS

K

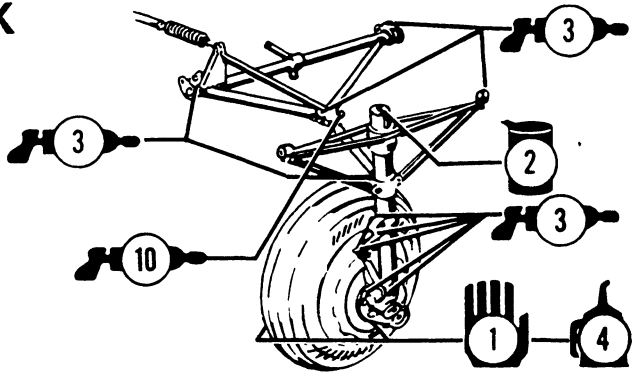

MAIN GEAR RETRACT

L

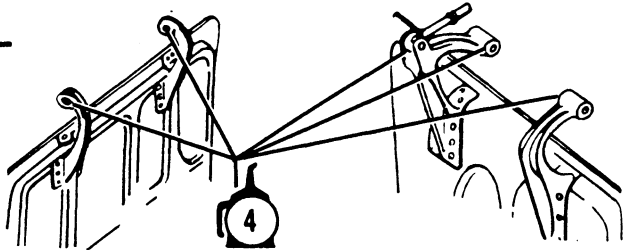

MAIN GEAR DOOR HINGES

M

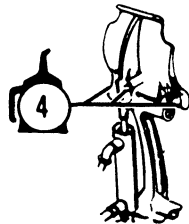

RUDDER PEDALS

N

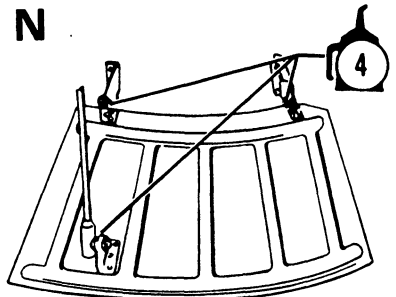

COWL FLAP HINGES

O

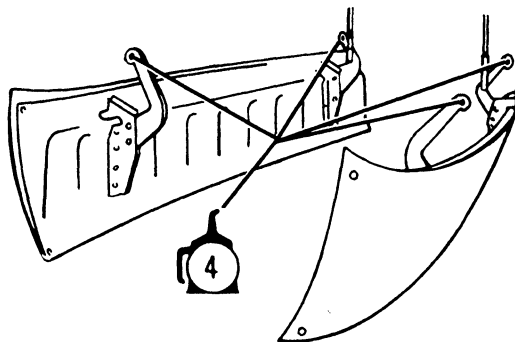

NOSE GEAR DOOR HINGES

P

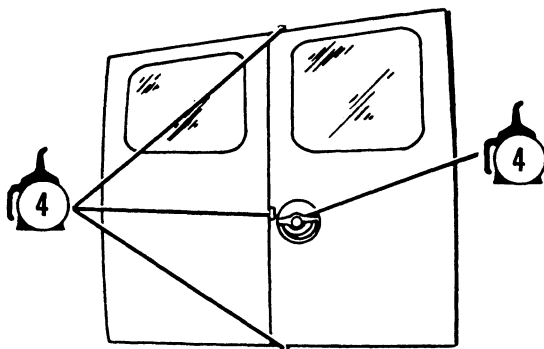

UTILITY DOOR



HAND OR PACK



ZERK FITTING



FLUID CONTAINER



SQUIRT CAN

NOTE: Letters are keyed to the Service Schedule; Numbers refer to items in the Consumable Materials Chart.

CONSUMABLE MATERIALS

Only the basic number of each Military Specification is included in the Consumable Materials Chart. No attempt has been made to update the basic number with the letter suffix that designates the current issues of the various specifications.

Vendors listed as meeting Federal and Military Specifications are provided as reference only and are not specifically recommended by Beech Aircraft Corporation; consequently, any product conforming to the specification listed may be used. The products listed below have been tested and approved for aviation usage by Beech Aircraft Corporation, by the vendor, or by compliance with the applicable specifications. Other products that are locally procurable which conform to the requirements of the applicable Military Specification may be used even though not specifically included herein.

It is the responsibility of the operator/user to determine the current revision of the applicable Military Specification prior to usage of that item. This determination may be made by contacting the vendor of a specific item.

CONSUMABLE MATERIALS

ITEM	MATERIAL	SPECIFICATION
1.	Lubricating Grease Wheel Bearing	Aeroshell No. 5 or MIL-G-81322

CAUTION

Do not mix Aeroshell No. 5 with MIL-G-81322.
Thoroughly clean grease from bearings and
bearing area before changing grease.

2.	Hydraulic Fluid	MIL-H-5606
*3.	Lubricating Grease, General Purpose, Wide Temperature	MIL-G-81322
4.	Lubricating Oil	SAE No. 20 or SAE10W-30
**5.	Engine Oil	SAE No. 30 (Below 40°F) SAE No. 50 (Above 40°F) Approved Multiviscosity Oils
***6.	Engine Fuel	100LL (Blue)
7.	Solvent	Federal Specification, PD680
8.	Lubricant	Mobil Compound GG or Mobil 636
9.	Lubricating Oil, Gear	MIL-L-10324 or MIL-L-2105C, Grade 75W

Section VIII
Handling, Serv - Maint

BEEHCRAFT Bonanza 36, A36
E-1 thru E-926

ITEM	MATERIAL	SPECIFICATION
10.	Grease, Aircraft and Instrument	MIL-G-23827
†11.	Lubricant, Rubber Seal	Oakite 6 Compound
12.	Naptha, Aliphatic	Federal Specification, TT-N-95
††13.	Tape, Anti-Seize, Tetrafluorethylene	MIL-T-27730
14.	Leak Test Compound, Oxygen Systems	MIL-L-25567
15.	Oxygen, Aviators Breathing	MIL-O-27210
16.	Lubricating Oil, General Purpose, Preservative (Water-Displacing, Low Temperature)	●Brayco 300 per Federal Specification VV-L-800 (Preferred)

Alternates for Brayco 300:

Lubricant

- CRC 3-36
- LPS No. 1
- WD-40

- * In extremely cold climates use MIL-G-23827 grease in place of MIL-G-81322. (These greases harmful to paint.)
- ** Ashless dispersant oil (latest revision of Teledyne Continental Motors Corp. Spec. MHS-24) recommended; straight mineral oils recommended during break-in period. See servicing data.
- *** 100LL (Blue) preferred, or 100 (Green).
- † Product of Oakite Products, Inc., 50 Valley Road, Berkley Heights, N.J. 07922.
- †† For sealing tapered threads on high pressure oxygen lines.
 - Product of Bray Oil Co.,
1925 North Marianna
Los Angeles, Calif. 90032
 - Product of CRC Chemicals, Inc.,
Warminster, Pa. 18974
 - Product of LPS Research Laboratories, Inc.,
2050 Cotner Ave,
W. Los Angeles, Calif. 90025
 - Product of WD-40 Company,
1061 Cudahy Place,
San Diego, Calif. 92110

APPROVED ENGINE OILS

COMPANY	BRAND AND WEIGHT
BP Oil Corporation	B/P Aero Oil D65/80
Castrol Limited (Australia)	Grade 40, Castrolaero AD, Type III Grade 50, Castrolaero AD, Type II
Continental Oil Co.	Conoco Aero S
Delta Petroleum Co.	Delta Avoil - Grades 30, 40 - 50
Gulf Oil Corporation	Gulfpride Aviation AD
Humble Oil & Refining Company	Esso Aviation Oil Enco Aviation Oil
Pennzoil Company	Pennzoil Aircraft Engine Oil, Heavy Duty Dispersant, Grades 30, 40, 50
Phillips Petroleum Co.	Phillips 66 Aviation Oil Type A (Replaced HD Aviation Oil)
Quaker State Oil Refining Corp.	Quaker State AD Aviation Engine Oil Grades 20W/30, 40 - 50

COMPANY	BRAND AND WEIGHT
Shell Oil Company	Aeroshell Oil W Aeroshell Oil W (in 4 grades) Grade 120 (Nominal SAE 60) - Military Grade 1120 Grade 100 (Nominal SAE 50) - Military Grade 1100 Grade 80 (Nominal SAE 40) - Military Grade 1080 Grade 65 (Nominal SAE 20 or 30) - Military Grade 1065
Sinclair Refining Co.	Sinclair Avoil 20W-40
Socony-Mobil	Mobil (Aero Oil 65) (Ashless Mobil (Aero Oil 80) Dispersant Mobil (Aero Oil 100) Aviation Mobil (Aero Oil 120) Engine Oil)
Texaco, Inc.	Texaco Aircraft Engine Oil - Premium AD, Grades 65, 80, 100
Union Oil Co. of California	Union Aircraft Engine Oil HD Grades 80 - 100

NOTE

This chart lists all oils which were certified as meeting the requirements of Teledyne Continental Motors Specification MHS-24B at the time this handbook was published. Any other oil which conforms to this specification may be used.

OVERHAUL OR REPLACEMENT SCHEDULE

The first overhaul or replacement should be performed not later than the required period. The condition of the item at the end of the first period can be used as a criterion for determining subsequent periods applicable to the individual airplane or fleet operation, providing the operator has an approved monitoring system.

The time periods for inspection noted in this handbook are based on average usage and average environmental conditions.

SPECIAL CONDITIONS CAUTIONARY NOTICE

Airplanes operated for Air Taxi or other than normal operation and airplanes operated in humid tropics or cold and damp climates, etc., may need more frequent inspections for wear, corrosion and/or lack of lubrication. In these areas periodic inspections should be performed until the operator can set his own inspection periods based on experience.

NOTE

The required periods do not constitute a guarantee that the item will reach the period without malfunction, as the aforementioned factors cannot be controlled by the manufacturer.

COMPONENT	OVERHAUL OR REPLACE
Alternator	On condition
Oil cooler	On condition (replace when contaminated)
Propeller (Hartzell)	**1500 hours or 4 years.
Propeller (McCauley)	***1500 hours or 5 years.
Propeller controls	On condition
Propeller governor	At engine overhaul but not to exceed 1500 hours or 3 years
Fuel pressure pump	Every 1500 hours
Cabin heat muff	Inspect every 100 hours

FUEL SYSTEM

Fuel cells	On condition
Wing fuel quantity transmitters	On condition
Fuel cell drain valve	On condition
Fuel system check valves	On condition
Fuel selector valve	Inspect every 600 hours Overhaul every 1200 hours
Auxiliary fuel pump	Every 1200 hours
All hose	Hose carrying flammable liquids at engine overhaul or every 5 years. All other hose on condition.

COMPONENT OVERHAUL OR REPLACE

INSTRUMENTS

Turn coordinator	On condition
Altimeter	Every 24 months per FAA Directive (Inspect and Calibrate)
Directional gyro	On condition
Gyro horizon	On condition
Gyro pressure	On condition
Engine indicator units	On condition
Airspeed indicator	On condition
Rate-of-climb	On condition
Fuel quantity indicator	On condition
Fuel flow indicator	On condition
Manifold pressure indicator	On condition
Tachometer	On condition
Flap position indicator	On condition
Free air temperature indicator	On condition
All hose	On condition
Pressure system filter	Every 300 hours
Air pressure regulator valve	On condition

ELECTRICAL SYSTEM

Battery master relay	On condition
All other relays	On condition
Voltage regulator	On condition
Starter relay	On condition
Standby generator	Inspect every 100 hours/overhaul every 1500 hours

*Reference Teledyne Continental Motors Corporation Service Bulletin M81-22, dated November 2, 1981 or later issue.

With particular attention to throttle response, smooth power and oil consumption, a qualified certificated mechanic must determine that the engine is operating normally at the time of each periodic inspection.

** Refer to Hartzell Propeller, Inc. Service Letter No. 61F, dated August 31, 1979, or later issue.

*** Applies only to propellers with hub serial number 71XXXX and higher; all other propellers; 1200 hours or 5 years.

INTENTIONALLY LEFT BLANK

SECTION IX

SUPPLEMENTS

NOTE

The supplemental data contained in this section is for equipment that was delivered on the airplane including standard optional equipment that was available, whether it was installed or not. Supplements or Flight Manuals for equipment for which the vendor obtained a Supplemental Type Certificate were included as loose equipment with the airplane at the time of delivery. If a new handbook is obtained for official use, the vendor Flight Manual Supplements must be checked for conformity to the airplane's optional equipment. These and other Supplements or Flight Manuals for other equipment that was installed after the airplane was delivered new from the factory should be placed in this SUPPLEMENTS Section of this Pilot's Operating Handbook and FAA Approved Airplane Flight Manual.

NOTE

Supplements applicable to equipment other than that installed may, at the discretion of the owner/operator, be removed from the manual.

PILOT'S OPERATING HANDBOOK
and
FAA APPROVED AIRPLANE FLIGHT MANUAL
P/N 36-590002-19C
LOG OF SUPPLEMENTS

<i>FAA Supplement must be in the airplane for flight operation when subject equipment is installed</i>			
Part Number	Subject	Rev No.	Date
35-590110-13	Landing Gear Safety System	5	4/81
35-590118-13	King KN-74 Area Navigation System	3	12/78
35-590118-19	Standby Generator Power System	4	9/78
130694	Electrothermal Propeller Deice (2 and 3 Blade)	1	10/77
35-590118-35	Air Conditioning System	1	11/77
36-590002-21	Operation of United Kingdom Registered Aircraft E-185 thru E-926	1	2/80
SA785CE	Hartzell Propellers	2	2/26/80
36-590002-39	Fuel Selector Valve Stop Installation		3/83
58-590000-49	Inside Cabin Door Handle With Open/Closed Placard		12/90

Supplements applicable to equipment other than that installed may, at the discretion of the owner/operator, be removed from the manual.

**BEECHCRAFT 35-C33, 35-C33A, E33, E33A, E33C,
F33, F33A, F33C, G33, S35, V35, V35A, V35B, 36,
A36, AND A36TC LANDPLANES**

**PILOT'S OPERATING HANDBOOK AND
FAA APPROVED AIRPLANE FLIGHT MANUAL
SUPPLEMENT
for the
LANDING GEAR SAFETY SYSTEM**

GENERAL

This document is to be attached to the Pilot's Operating Handbook and FAA Approved Airplane Flight Manual when the airplane is equipped with the Landing Gear Safety System which has been installed in accordance with BEECHCRAFT FAA approved data.

This document supersedes or adds to the Pilot's Operating Handbook and FAA Approved Airplane Flight Manual only where covered in the items contained herein.

LIMITATIONS

The landing gear safety system is designed to help prevent "gear-up" landings and premature or inadvertent operation of the landing gear mechanism. The system is to be used as safety backup device only; normal usage of the landing gear position switch is mandatory.

EMERGENCY PROCEDURES

In the event of an emergency, automatic extension of the landing gear may be prevented by placing the landing gear safety system switch in the OFF position, thus inactivating the safety system.

NORMAL PROCEDURES

PREFLIGHT CHECK:

1. Throttle - CLOSED OR RETARDED.
2. Battery master switch - ON
3. Landing gear circuit breaker - either IN or OUT.
4. (Airplanes incorporating the on-off and test function in one switch.)
Place the ON-OFF-TEST switch in the TEST position. Proper functioning of the automatic landing gear extension portion of the system is indicated by the noise or movement of the solenoid in the landing gear position switch. The ON-OFF-TEST switch returns normally to the ON position unless the pilot places the switch in the OFF position.
5. (Airplanes equipped with on-off and press-to-test switches.)
Place the ON-OFF switch in the "ON" position and push the PRESS-TO-TEST. Proper functioning of the automatic landing gear extension portion of the system is indicated by the noise or movement of the solenoid in the landing gear position switch. The PRESS-TO-TEST switch will not operate the solenoid unless the on-off switch is in the "ON" position.
6. Landing gear circuit breaker - IN before takeoff.

OPERATION

1. Landing Gear Extension - With the landing gear safety system switch in the ON position the landing gear will be automatically extended when: (1) the airspeed is below approximately 104 kts/120 mph IAS and (2) the engine is

operating at a throttle position corresponding to approximately 18 to 20 inches or less of manifold pressure depending on setting.

2. Landing Gear Retraction - With the landing gear safety system switch in the ON position, the landing gear will not retract unless: (1) the landing gear position switch is in the UP position (2) the airspeed is above approximately 78 kts/90 mph IAS and (3) the engine is operating at a throttle position corresponding to approximately 18 to 20 inches or more of manifold pressure depending on setting.

NOTE

If landing gear retraction is desired before the indicated airspeed reaches approximately 78 kts/90 mph, the landing gear safety system must be inactivated by placing the switch in the OFF position, preferably before placing the landing gear position switch in the UP position.

PERFORMANCE

No change

Approved:



W. H. Schultz
Beech Aircraft Corporation
DOA CE-2

**BEEHCRAFT F33A, F33C, G33, V35B, A36,
and A36TC LANDPLANES**

**PILOT'S OPERATING HANDBOOK AND
FAA APPROVED AIRPLANE FLIGHT MANUAL
SUPPLEMENT
for the
KING KN-74 AREA NAVIGATION SYSTEM**

GENERAL

The information in this supplement is FAA approved material and must be attached to the Pilot's Operating Handbook and FAA Approved Airplane Flight Manual when the airplane is equipped with a King KN-74 Area Navigation System which has been installed in accordance with BEEHCRAFT FAA approved data.

The information in this supplement supersedes or adds to the basic Pilot's Operating Handbook and FAA Approved Airplane Flight Manual only as set forth below.

LIMITATIONS

1. This system shall not be used as a primary system under IFR conditions except on approved approach procedures, approved area navigation airways, and random area navigation routes when approved by Air Traffic Control.
2. This system is to be used only with collocated facilities (VOR and DME signals originate from the same geographic location).

EMERGENCY PROCEDURES

CAUTION

DME may unlock due to loss of signal with certain combinations of distance from station, altitude, and angle of bank.

1. VOR or Distance flag appears while in RNAV mode:
 - a. Selected Frequency - CHECK FOR CORRECT FREQUENCY
 - b. VOR or Distance flag intermittent or lost - UTILIZE OTHER NAVIGATION EQUIPMENT AS REQUIRED.

2. VOR or Distance flag appears while in APPR mode:

If flag appears while on an approach, execute a missed approach and utilize another approved facility.

NORMAL PROCEDURES

1. VHF NAV - ON
2. DME - ON
3. Mode Selector - SELECT VOR/DME, RNAV, or APPR
4. NAV Frequency - SET
5. DME Frequency - SET
6. Waypoint Bearing - SET WAYPOINT RADIAL FROM VORTAC
7. Waypoint Distance - SET WAYPOINT DISTANCE FROM VORTAC
8. OBS Control - DESIRED MAGNETIC COURSE
9. Self-Test - ACTUATE (must have VOR reception)

PERFORMANCE

No change.

Approved:



for

W. H. Schultz
Beech Aircraft Corporation
DOA CE-2

**BEECHCRAFT H35, J35, K35, M35, N35, P35,
S35, V35, V35A, V35B, 33, A33, B33, C33,
E33, F33, F33A, F33C, G33, and A36
LANDPLANES**

**PILOT'S OPERATING HANDBOOK AND
FAA APPROVED AIRPLANE FLIGHT MANUAL
SUPPLEMENT
for the
STANDBY GENERATOR POWER SYSTEM
(14-VOLT ELECTRICAL SYSTEM)**

GENERAL

The information in this supplement is FAA approved material and must be attached to the Pilot's Operating Handbook and FAA Approved Airplane Flight Manual when the airplane is equipped with a factory installed Standby Generator Power System in accordance with BEECHCRAFT FAA approved data, or if the system is installed by kit, in accordance with BEECH KIT 35-3012

The information in this supplement supersedes or adds to the basic Pilot's Operating Handbook and FAA Approved Airplane Flight Manual only as set forth below

LIMITATIONS

1. The system is to be used only in the event of an alternator failure.
2. Maintain a minimum of 2300 RPM during system operation.

EMERGENCY PROCEDURES

1. With a loss of electrical power from the alternator, turn the Battery and Alternator Switches - OFF
2. Turn Standby Generator System - ON
3. If RNAV is installed - Select NAV COMM II position.
4. The factory installed standby Generator Power System will operate ONLY the following items.
 - a. Engine Instruments and Fuel Gages
 - b. Electric Turn Coordinator
 - c. Transponder (if installed)
 - d. Audio Amplifier (if installed)
 - e. If RNAV is not installed: NAV COMM I or NAV COMM II (only one at a time)
 - f. If RNAV is installed: COMM I or NAV COMM II (only one at a time)

NOTE

If an electric compass system is installed and the standby generator system is in operation, no directional gyro indication will be available unless a second air driven directional gyro is installed.

5. The kit installed Standby Generator Power System will operate ONLY the following items, Marked X.

- Engine Instruments and Fuel Gages
- Electric Turn Coordinator
- Transponder (if installed)
- Audio Amplifier (If installed)
- If RNAV is not installed. NAV COMM I or NAV COMM II (only one at a time)
- If RNAV is installed. COMM I or NAV COMM II (only one at a time)

NOTE

If an electric compass system is installed and the standby generator system is in operation, no directional gyro indication will be available unless a second air driven directional gyro is installed.

6. Failure of a NAV/COMM, all other instruments operable.
 - a. If RNAV is not installed: select other NAV/COMM (if installed)
 - b. If RNAV is installed: select COMM I.
7. Failure of any one instrument indicates a malfunction in that system only.
8. Failure of all instruments indicates a malfunction of the Standby Generator System.
 - a. Standby Generator Switch - OFF
 - b. Reduce Electrical Load
 - c. Battery Switch - ON (If available)

9. When the Standby Generator System is in use, the Landing Gear must be extended manually.

NORMAL PROCEDURES

In the Before Take-Off Check List the Standby Generator TEST procedure follows the Magneto Check.

1. Throttle - 1700 RPM
2. Battery and Alternator Switches OFF

NOTE

If either the BAT-GEN lights fail to illuminate, it indicates a malfunction in that part of the system. Check operation of components listed under step "5" of EMERGENCY PROCEDURES to ensure system is functioning properly.

3. Standby Generator Power ON-OFF-TEST Switch TEST (Hold Momentarily in Test Position. BAT-GEN lights will illuminate.)
4. Standby Generator Power ON-OFF-TEST Switch-OFF
5. Battery and Alternator Switches ON

PERFORMANCE - No Change

Approved:



For Chester A. Rembleske
Beech Aircraft Corporation
DOA CE-2

BEECHCRAFT LANDPLANE
E33, F33, 35-C33A, E33A,
E33C, F33A, F33C, 36 and A36

PILOT'S OPERATING HANDBOOK AND
FAA APPROVED AIRPLANE FLIGHT MANUAL
SUPPLEMENT

for the

ELECTROTHERMAL PROPELLER DEICE
(2 and 3 Bladed Propeller)

GENERAL

The information in this supplement is FAA approved material and must be attached to the Pilot's Operating Handbook and FAA Approved Airplane Flight Manual when the airplane is equipped with an Electrothermal Propeller Deice System that has been installed in accordance with BEECHCRAFT FAA approved data, or if the system is installed by kit, in accordance with Beech Kit 35-9001, 35-9003, or 35-9005.

This document supersedes or adds to the Pilot's Operating Handbook and FAA Approved Airplane Flight Manual only where covered in the items contained herein.

LIMITATIONS

Do not operate the system unless engine is operating.

EMERGENCY PROCEDURES

1. Loss of Alternator
 - a. Propeller Deice Switch - Off

2. Abnormal Reading on Propeller Deice Ammeter

a. Zero Amps

Check propeller deice switch. If the circuit breaker in the switch has tripped, a wait of approximately 30 seconds is necessary before resetting the switch to the ON position. If ammeter reads 0 and switch has not tripped or if ammeter still reads 0 after the switch has been reset, turn the switch off and consider the propeller deice system inoperative.

b. Zero to 20 Amps (2 Blade) Zero to 30 Amps (3 Blade)

If propeller deice system ammeter occasionally or regularly indicates less than 20 amps (2 blade), 30 amps (3 blade), operation of the propeller deice system can continue unless serious propeller imbalance results from irregular ice throw-offs.

c. More than 24 Amps (2 Blade) More than 34 Amps (3 Blade)

If the propeller deice system ammeter occasionally or regularly indicates more than 24 amps (2 blade), 34 amps (3 blade), the system should not be operated unless the need for propeller deice is urgent.

NORMAL PROCEDURES

PREFLIGHT

1. With engine operating, place propeller deice switch in the ON position.

2. Check propeller deice system ammeter for reading of 20 to 24 amperes (2 blade) 30 to 34 amperes (3 blade).
3. Watch ammeter closely for at least two minutes. A small momentary deflection of the needle may be noticed approximately every 30 seconds: This is due to the switching action of the timer and is an indication of normal operation of the system.

IN FLIGHT

1. To place the system in operation, move propeller deice switch to the ON position. The system will function automatically until the switch is turned off.

CAUTION

The system is not to be operated continuously due to its electrical load.

2. Propeller imbalance may be relieved by varying rpm. Increase rpm briefly and return to desired setting, repeating if necessary.
3. The use of propeller deice is acceptable only if the electrical load is monitored so that the ammeter does not show a discharge.

PERFORMANCE - No change

Approved:

for 
Chester A. Rembleske
Beech Aircraft Corporation
DOA CE-2

FAA Approved
Revised: October 1977
P/N 130694

**BEECHCRAFT F33A, V35B,
AND A36 LAND PLANES**

**PILOT'S OPERATING HANDBOOK AND
FAA APPROVED AIRPLANE FLIGHT MANUAL
SUPPLEMENT**

**for the
AIR CONDITIONING SYSTEM**

GENERAL

The information in this supplement is FAA approved material and must be attached to the Pilot's Operating Handbook and FAA Approved Airplane Flight Manual when the airplane is equipped with an Air Conditioning System, which has been installed in accordance with BEECHCRAFT FAA approved data.

The information in this supplement supersedes or adds to the basic Pilot's Operating Handbook and FAA Approved Airplane Flight Manual only as set forth below.

LIMITATIONS

The air conditioning system must be off during takeoff. The AIR COND. CONDENSER EXT. warning light must be extinguished (condenser retracted) before takeoff.

The air conditioning system must be off when using magnetic compass.

PLACARDS

On Glareshield:



**FAA Approved
Revised: November, 1977
P/N 35-590118-35**

On Control Console:

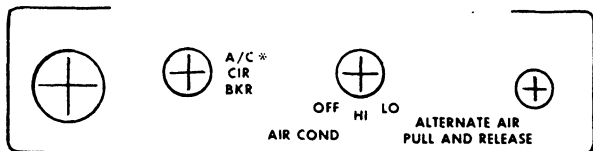

* Located on copilot's subpanel in airplanes with 28-volt electrical system

*On Lower Edge of
Floating Panel:*

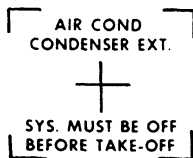

EMERGENCY PROCEDURES

AIR START PROCEDURE

Air conditioning system must be turned off before attempting air start procedures.

AIR CONDITIONING SYSTEM MALFUNCTION

Turn off air conditioning system.

If air conditioning system circuit breaker trips, do not reset until the cause of the malfunction has been determined and corrected.

NORMAL PROCEDURES

PREFLIGHT INSPECTION

NOSE SECTION

Air Conditioner Condenser - CHECK SECURITY AND ATTACHMENT.

STARTING

Air conditioner may be on as desired after engine start for cabin cooling before takeoff.

BEFORE TAKEOFF

WARNING

Air conditioner condenser extended warning light, located on the lower edge of the floating panel, must be off before takeoff.

Air conditioning system must be turned off before takeoff. After landing gear is retracted and airplane is clear of all obstacles, air conditioning system may be turned on as desired.

SHUTDOWN

Turn off air conditioner before engine shutdown.

PERFORMANCE

CRUISE PERFORMANCE

NOTE

Using the power settings given in the PERFORMANCE section, with the air conditioner in operation, Range and airspeed will decrease by approximately 5% due to the extension of the condenser to the flight extension position. This is to be taken into consideration during flight planning.

SYSTEMS DESCRIPTION

Cabin cooling is provided by a 12,000 Btu, 30-cfm, refrigerative type air conditioning system. The principal components of the air conditioning system are the compressor and clutch unit (belt-driven from a drive pulley on the engine), the retractable condenser on the center line of the fuselage bottom skin, the dehydrator beneath the right front seat, the evaporator module beneath the left front seat, the air conditioner condenser-extended warning light on the lower edge of the floating panel, the various retractable condenser limit switches, the system controls on the control console, and the circuit breaker. The circuit breaker is located on the control console in airplanes with the 14-volt system and on the right subpanel on airplanes with the 28-volt system.

The three-position retractable condenser is operated by an electric motor and jackscrew actuator, and controlled by two internal stops in the motor, two limit switches on the condenser, the landing gear safety switch, and a throttle limit switch. The three retractable condenser positions are ground extension, flight extension, and retracted.

When the airplane is on the ground and the air conditioner is turned on, the condenser extends to the ground extension (lowest) position below the fuselage bottom to facilitate condenser cooling by ambient air from the propeller slipstream. More effective cooling on the ground can be accomplished by maintaining a propeller setting of at least 1200 rpm with the airplane nosed into the wind. With the condenser in the ground extension position, the air conditioner condenser-extended warning light on the lower edge of the floating panel is illuminated.

When the airplane is in flight with the landing gear retracted and the air conditioner is turned on, the condenser extends only to the flight extension position. The flight extension position produces less drag than the ground extension

FAA Approved

Revised: November, 1977

P/N 35-590118-35

position, but provides adequate condenser cooling from the airstream. The air conditioner condenser-extended warning light is not illuminated in the flight extension position.

When the air conditioner is turned off, the condenser returns to the retracted position, the position which produces minimum drag.

For cooling, cabin air is drawn into the evaporator module plenum below the forward edge of the left front seat. When cabin ambient air at a temperature of approximately 90° F passes over the evaporator coils the temperature of the air is reduced to approximately 56°F, then the evaporator module electric blower forces the cooled air through outlet ducting to adjustable louvers below the control console. The cabin air continues to circulate as described until the air conditioner is turned off.

After engine start the air conditioner may be turned on by actuating a three-way toggle switch on the control console below the center of the upper subpanel. Either a high or a low blower speed may be selected, and the airflow can be distributed by moving the adjustable louvers up and down and from side to side.

Before takeoff make certain that the air conditioner is off and that the air conditioner condenser-extended warning light is extinguished. Pressing the warning light test button on the instrument panel will verify that the bulb is functioning.

After takeoff with the landing gear retracted and the airplane clear of all obstacles, the air conditioner may be turned on if desired.

The air conditioner should be turned off before engine shutdown.

The throttle limit switch is a safety device designed to operate only at full throttle with the landing gear extended, and is installed on the engine throttle body. When the air conditioner is on during landing approach with the landing gear extended and partial throttle, the condenser is in the flight extension position. However, should a go-around be necessary, the application of full throttle will cause the throttle limit switch to shut down the compressor for maximum engine power and retract the condenser to the retracted position to minimize drag. When the landing gear is retracted and/or the throttle is retarded, the compressor will resume operation and the condenser will return to the flight extension position.

Approved:

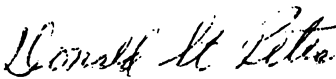
for 
Chester A. Rembleske
Beech Aircraft Corporation
DOA CE-2

**BEECHCRAFT BONANZA A36 LANDPLANES
(SERIALS E-185 THROUGH E-926)**

**PILOT'S OPERATING HANDBOOK SUPPLEMENT
for
OPERATION OF UNITED KINGDOM
REGISTERED AIRCRAFT**

GENERAL

This document must be attached to the Pilot's Operating Handbook when operating on the United Kingdom Register. The contents are in addition to, or override, the contents of the Pilot's Operating Handbook and FAA Approved Airplane Flight Manual.

LIMITATIONS

CERTIFICATION CATEGORY

The BEECHCRAFT Bonanza A36 is eligible for certification in the United Kingdom in the Transport Category (Passenger). This particular aeroplane may, however, be restricted to another category and a particular use, and this will be stated in the Certificate of Airworthiness.

PERFORMANCE

When certified in the Transport Category (Passenger), the aeroplane is classified in Performance Group E. For the purpose of establishing compliance with the Air Navigation Performance Group E Regulations, the Performance Data in the Pilot's Operating Handbook, Beech Part No. 36-590002-19, except as modified by this supplement is to be used.

CRUISE

For the purpose of compliance with legislation governing flight over water, the true airspeed to be assumed is 150 knots.

TAKEOFF AND LANDING

When the aeroplane is flown in the Transport Category (Passenger), the "Obstacle" take-off and landing performance in the Pilot's Operating Handbook must not be used for compliance with the Air Navigation Performance Group E Regulations.

CREW AND OCCUPANTS

The minimum crew is one pilot.

The total number of persons carried shall not exceed six, nor exceed the number for which seating accommodations approved for use during takeoff and landing is provided. Children under the age of three years who are carried in the arms of passengers may be left out of account for this purpose.

AIR TEMPERATURE

The maximum air temperature for scheduled operation is ISA + 23° C. No minimum temperature has been established.

TYPE OF OPERATION

The aeroplane shall not be flown at night or in IFR conditions unless the required equipment is carried, and it is permitted by the Air Navigation Legislation.

All flights in icing conditions are prohibited.

AUTOMATIC PILOT

Minimum permissible altitudes with Bendix FCS-810 Automatic Pilot engaged are:

Cruise 1000 feet above terrain

Coupled to ILS

Glideslope and Localizer 350 feet above terrain

EMERGENCY PROCEDURES - No Change

NORMAL PROCEDURES

FLAPLESS LANDING

Manoeuvre to final approach, maintaining 10 knots above the Approach Speed appropriate to the weight shown on the Normal Landing Distance graph. Extend landing gear. Maintain this speed down to the 50-foot height point.

GO-AROUND

A go-around may be executed when it appears that this is the only way to avoid a possible accident. Early recognition of the need to go around is essential.

1. Apply take-off power (full throttle - 2700 rpm).
2. Raise landing gear after a positive rate of climb has been established.
3. Raise flaps cautiously.
4. Retrim for best rate-of-climb speed (100 knots IAS at 3600 lbs).

PERFORMANCE

TAKEOFF

The total distance over a 50-foot obstacle shown on the Normal Take-Off Distance graph should be increased 18% for operation on short dry grass with a firm subsoil.

LANDING

The total distance over a 50-foot obstacle shown on the Normal Landing Distance graph should be increased 18% for operation on short dry grass with a firm subsoil.

AIRSPEED AND ALTIMETER

Airspeed Calibration and Altimeter Correction are presented for both normal and emergency systems. Notes and examples are presented directly on the graphs.

CLIMB

Rate of climb is shown for varying air temperatures, pressure altitudes, and weights. The associated conditions, climb speed, example, and notes are presented directly on the graph.

AIRSPEED CALIBRATION - NORMAL SYSTEM

EXAMPLE:

90 KTS (104 MPH)
IAS
FLAPS
DOWN
88 KTS (101 MPH)
CAS

NOTE: INDICATED AIRSPEED ASSUMES ZERO INSTRUMENT ERROR

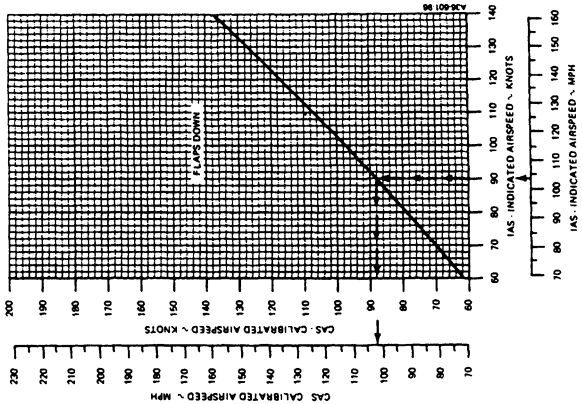
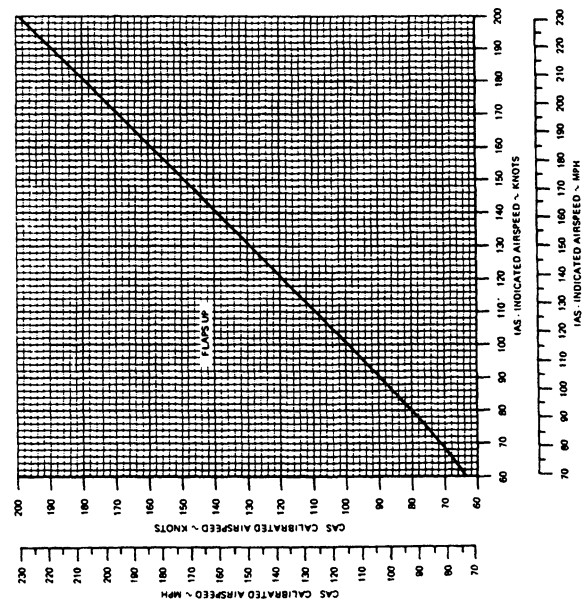

AIRSPEED CALIBRATION — EMERGENCY SYSTEM

EXAMPLE:

CAS 100 KTS (115 MPH)
 STORM WINDOW OPEN
 GEAR UP
 FLAPS UP
 CAS 96 KTS (110 MPH)

NOTE: INDICATED AIRSPEED ASSUMES ZERO INSTRUMENT ERROR

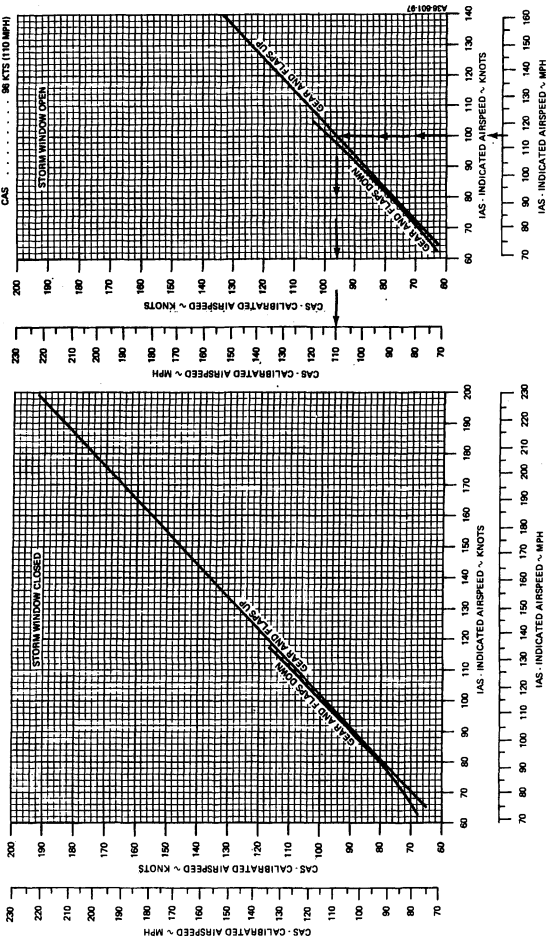

ALTIMETER CORRECTION—NORMAL SYSTEM

EXAMPLE:

IAS 85 KTS (98 MPH)
 FLAPS DOWN
 INDICATED PRESSURE ALTITUDE 4500 FT
 ALTITUDE CORRECTION -13 FT
 ACTUAL PRESSURE ALTITUDE 4500 - 13 = 4487 FT

NOTE: INDICATED AIRSPEED AND INDICATED ALTITUDE ASSUME ZERO INSTRUMENT ERROR

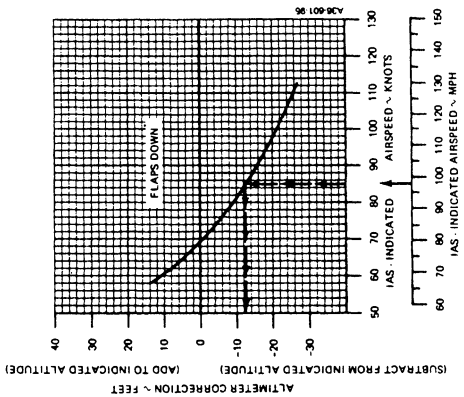
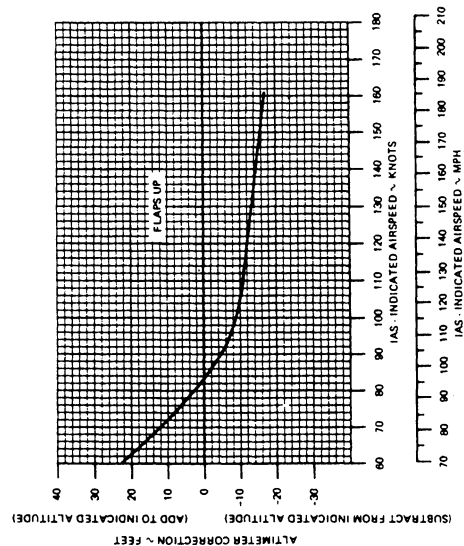

ALTIMETER CORRECTION—EMERGENCY SYSTEM

EXAMPLE

IAS 70 KTS (81 MPH)
 STORM WINDOW OPEN
 LANDING GEAR UP
 FLAPS UP
 INDICATED PRESSURE ALTITUDE 5000 FT

ALTIMETER CORRECTION -12 FT
 ACTUAL PRESSURE ALTITUDE = 5000 - 12 = 4988 FT

NOTE: INDICATED AIRSPEED AND INDICATED ALTITUDE ASSUME ZERO INSTRUMENT ERROR

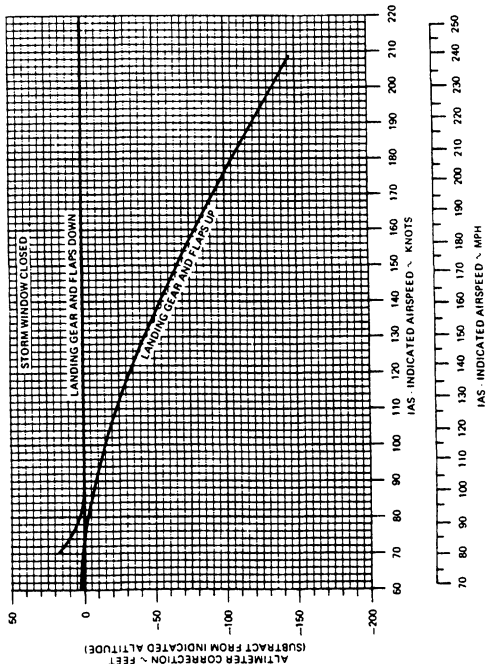

A36 601 98

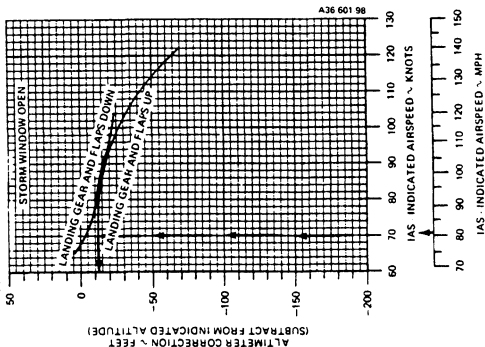

ASSOCIATED CONDITIONS:
 POWER FULL THROTTLE AT 2700 RPM
 MIXTURE LEAN TO APPROPRIATE FUEL FLOW
 FLAPS UP
 LANDING GEAR UP
 COWL FLAPS AS REQUIRED

CLIMB

CLIMB SPEED 96 KNOTS (110 MPH) ALL WEIGHTS

EXAMPLE:
 OAT -5°C (23°F)
 PRESSURE ALTITUDE 11,500 FT
 WEIGHT 3200 LBS
 RATE OF CLIMB 500 FT/MIN
 CLIMB GRADIENT 4.3%
 CLIMB SPEED 96 KTS (110 MPH)

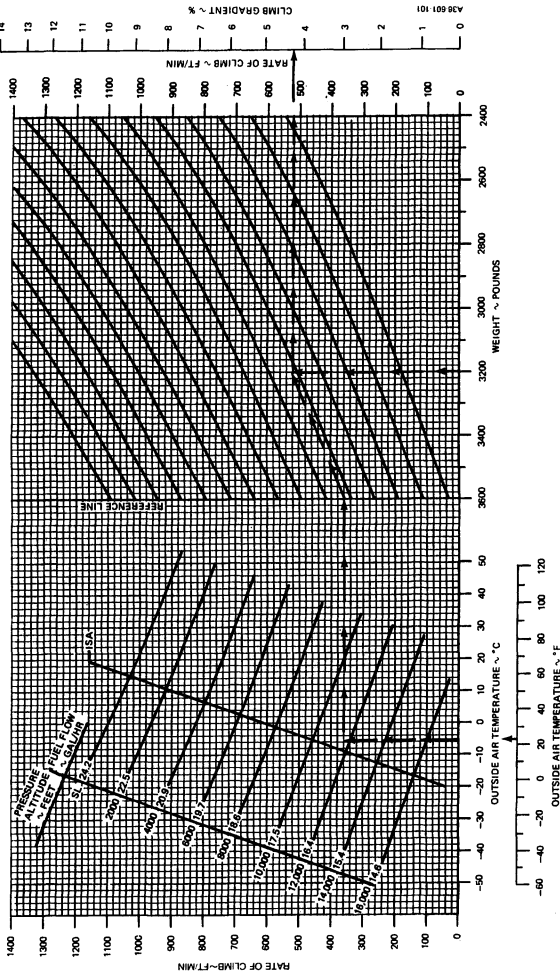

Page 1 of 1
FAA APPROVED
DATE 12/10/71
REVISED 12/18/73
REVISED 2/26/80

HARTZELL PROPELLER, INC.
350 WASHINGTON AVE.
PIQUA, OHIO
FAA APPROVED AIRPLANE FLIGHT MANUAL
FOR
BEECH MODELS 35-C33A, E33C, F33A, F33C, 36 AND
A36 LANDPLANES
WITH
HARTZELL PROPELLERS
PER STC SA785CE

REG. NO. _____

SER. NO. _____

THIS DOCUMENT MUST BE KEPT IN THE AIRPLANE AT ALL TIMES WHEN HARTZELL PROPELLERS ARE INSTALLED PER STC SA785CE. INFORMATION CONTAINED HEREIN SUPPLEMENTS OR SUPERSEDES CORRESPONDING INFORMATION IN PLACARDS, AIRCRAFT SPECIFICATIONS, OR BASIC AIRPLANE FLIGHT MANUAL (IF APPLICABLE).

I. LIMITATIONS

A. PROPELLERS:

1. Hartzell constant-speed, three-bladed propeller (75 lbs. @ Station +1; Models 36 and A36 @ Station -9)
Hubs: HHC-C3YF-1R or HHC-C3YF-1RF
Blades: 8468-6R, 8468A-6R, or F8468A-6R
Spinner: A-2295-1 (5 lbs. @ Station +1; Models 36 and A36 @ Station -9)
Governor: C120452 or D210680
Pitch Settings at 30 inch station: Low 12.0° - High 32.0° Min.
Diameter: Not over 80 inches, not under 78 inches
Engine: Continental IO-520-B, IO-520-BA, and IO-520-BB

OR

2. Hartzell constant-speed, two-bladed propeller (51 lbs. @ Station +1; Models 36 and A36 @ Station -9)
Hubs: HHC-C2YF-1B or HHC-C2YF-1BF
Blades: 8468AR or F8468AR
Spinner: A-2295 (5 pounds @ Station +1; Models 36 and A36 @ Station -9)
Governor: C120452 or D210680
Pitch Settings at 30 inch station: Low 13.0° - High 29.0° Min.
Diameter: Not over 80 inches, not under 78 inches
Engine: Continental IO-520-BA and IO-520-BB

II. PERFORMANCE

No Change.

FAA APPROVED

W. F. Horn, Jr.
W. F. Horn, Inc., Acting Chief
Engineering & Manufacturing
Great Lakes Region
Dearborn, Michigan

**BEEHCRAFT Debonair/Bonanza
35-B33, 35-C33, E33, F33, and G33
(Serials CD-388 thru CD-1304);
35-C33A, E33A, and F33A
(Serials CE-1 thru CE-1013);
Bonanza E33C and F33C
(Serials CJ-1 thru CJ-155);
P35, S35, V35, V35TC, V35A, V35A-TC, V35B, and
V35B-TC
(Serials D-6874 thru D-10403);
36 and A36
(Serials E-1 thru E-2061);
and A36TC
(Serials EA-1 thru EA-272 except EA-242)
LANDPLANES**

**PILOT'S OPERATING HANDBOOK AND
FAA APPROVED AIRPLANE FLIGHT MANUAL
SUPPLEMENT
for the
FUEL SELECTOR VALVE
STOP INSTALLATION
(BEEHCRAFT SERVICE INSTRUCTIONS NO. 1248)**

GENERAL

This document is to be attached to the Pilot's Operating Handbook and FAA Approved Airplane Flight Manual when the airplane is equipped with the Fuel Selector Valve Stop Installation which has been installed in accordance with BEEHCRAFT Service Instructions No. 1248.

This document supersedes or adds to the Pilot's Operating Handbook and FAA Approved Airplane Flight Manual only where covered in the items contained herein.

**FAA Approved
Issued: March, 1983
P/N 36-590002-39**

NOTE

This installation is not applicable to airplanes equipped with the Brittain wing tip fuel system.

LIMITATIONS

PLACARDS

On Fuel Selector Panel:

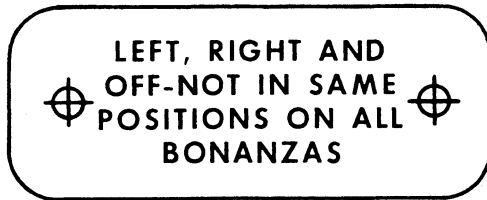

and;



EMERGENCY PROCEDURES

No Change

NORMAL PROCEDURES

No Change

PERFORMANCE

No Change

WEIGHT AND BALANCE

No Change

SYSTEMS DESCRIPTION

FUEL SYSTEM

FUEL TANK SELECTION

The fuel selector valve handle is located forward and to the left of the pilot's seat. Takeoffs and landings should be made using the tank that is more nearly full.

On airplanes equipped with the fuel selector valve stop installation (BEECHCRAFT Service Instructions No. 1248), the pilot is cautioned to observe that the short, pointed end of the handle aligns with the fuel tank position being selected. The tank positions are located on the aft side of the valve. The OFF position is forward and to the left. An OFF position lock-out feature has been added to prevent

inadvertant selection of the OFF position. To select OFF, depress the lock-out stop and rotate the handle to the full clockwise position. Depression of the lock-out stop is not required when moving the handle counterclockwise from OFF to LEFT MAIN or RIGHT MAIN. When selecting the LEFT MAIN or RIGHT MAIN fuel tanks, position handle by sight and by feeling for detent.

If the engine stops because of insufficient fuel, refer to the EMERGENCY PROCEDURES Section for the Air Start procedures.

Approved: *Donald St. Peter*

for

W. H. Schultz
Beech Aircraft Corporation
DOA CE-2

BEEHCRAFT SERIES 33,35,36,55,58

**PILOT'S OPERATING HANDBOOK AND FAA
APPROVED AIRPLANE FLIGHT MANUAL
SUPPLEMENT**

FOR

**INSIDE CABIN DOOR HANDLE WITH OPEN/
CLOSED PLACARD**

**THIS SUPPLEMENT IS APPLICABLE TO PILOT'S
OPERATING HANDBOOKS AND FAA APPROVED
AIRPLANE FLIGHT MANUALS:**

(SEE NEXT PAGE FOR APPLICABILITY)

Airplane Serial Number: _____

Airplane Registration Number: _____

FAA Approved:



W. H. Schultz
Beech Aircraft Corporation
DOA CE-2

COPYRIGHT © BEECH 1990

This supplement applies to the following Pilot's Operating Handbooks and FAA Approved Airplane Flight Manuals:

MODEL	PART NUMBER	A/C SERIALS
35-B33	33-590000-17B	All
35-C33, E33, F33	33-590002-9B	All
35-C33A, E33A, E33C	33-590003-7B	All
F33A, F33C	33-590009-13	CE-674 & after, CJ-129 & after
F33A, F33C	33-590009-15	CE-290 thru CE- 673, CJ-26 thru CJ-128
G33	33-590027-3	All
F35	35-590071-13	All
G35	35-590072-9	All
H35	35-590073-15	All
N35, P35	35-590094-7	All
S35-TC	35-590110-3	All
S35	35-590110-11B	All
V35-TC	35-590113-3	All
V35A-TC	35-590116-3	All
V35B-TC	35-590118-23	D-9069 thru D- 9947
V35B	35-590118-29	D-9948 & after
V35, V35A, V35B	35-590118-31B	D-7977 thru D- 9947
A36	36-590002-17	E-927 thru E-2110 except E-1946 & E-2104
36, A36	36-590002-19C	E-1 thru E-926
A36	36-590002-37	E-1946, E-2104, E- 2111 & after
A36-TC	36-590003-3	EA-1 thru EA-272 except EA-242

MODEL	PART NUMBER	A/C SERIALS
B36-TC	36-590006-3	EA-242, EA-273 thru EA-388
B36-TC	36-590006-19	except EA-326 EA-326, EA-389 & after
95-B55B	55-590000-49	All
95-55, 95-A55	55-590000-65B	TC-1 thru TC-501 except TC-350 & TC-371
58, 58A	58-590000-21	TH-773 thru TH- 1395 except TH- 1389
58, 58A	58-590000-31B	TH-1 thru TH-772
58, 58A	58-590000-35	TH-1389, TH-1396 thru TH-1471, TH- 1476, TH-1487, TH- 1489, TH-1498
58, 58A	58-590000-39	TH-1472 & after, except TH-1476, TH-1487, TH-1489, TH-1498
E55, E55A	96-590010-17	TE-1084 & after
95-C55, 95-C55A, D55, D55A, E55, E55A	96-590010-29B	TC-350, TE-1 thru TE-942, except TE-938
E55, E55A	96-590010-31	TE-938, TE-943 thru TE-1083
E55, E55A	96-590010-37	TE-1197 only
95-B55, 95-B55A	96-590011-17	TC-2003 & after
95-B55, 95-B55A	96-590011-23	TC-1608 thru TC- 2002
95-B55, 95-B55A	96-590011-25	TC-371, TC-502 thru TC-1607
58TC	106-590000-5	TK-1 thru TK-84
58TC, 58TCA	106-590000-19	TK-85 thru TK-150, except TK-147

MODEL	PART NUMBER	A/C SERIALS
58TC, 58TCA	106-590000-21	TK-147, TK-151 & after

CONTENTS

GENERAL	Page 5
LIMITATIONS	Page 5
EMERGENCY PROCEDURES	Page 6
NORMAL PROCEDURES	Page 6
PERFORMANCE	Page 6
WEIGHT & BALANCE	Page 6
SYSTEMS DESCRIPTION	Page 6
HANDLING, SERVICING & MAINTENANCE ...	Page 7

GENERAL

The information in this supplement is FAA-approved material and must be attached to the Pilot's Operating Handbook and FAA Approved Airplane Flight Manual when the airplane has been modified by installation of the Inside Cabin Door Handle With Open/Closed Placard in accordance with Beech Kit 35-5050.

The information in this supplement supersedes or adds to the basic Pilot's Operating Handbook and FAA Approved Airplane Flight Manual only as set forth below. Users of the manual are advised to always refer to the supplement for possibly superseding information and placarding applicable to operation of the airplane.

LIMITATIONS

PLACARDS

On inside of Cabin Door Adjacent to Door Handle:

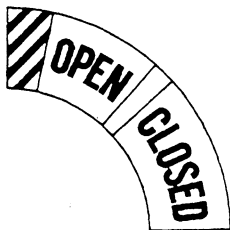

EMERGENCY PROCEDURES

No change.

NORMAL PROCEDURES

BEFORE TAKEOFF

All procedures specified in the Pilot's Operating Handbook and FAA Approved Airplane Flight Manual for the particular airplane shall be completed. In addition, accomplish the following:

- Doors and Windows - SECURE (Check cabin door lock indicator - CLOSED)

PERFORMANCE

No change.

WEIGHT AND BALANCE

No change.

SYSTEMS DESCRIPTION

DOORS, WINDOWS AND EXITS

CABIN DOOR

The airplane has a conventional cabin door on the forward right side of the fuselage and when closed, the outside cabin door handle is spring loaded to fit into a recess in the door to create a flat aerodynamically clean surface. The door may be locked with a key. To open the door from the outside, lift the handle from its recess and pull until the door opens.

To close the cabin door from the inside, observe that the door handle is in the open position. In this position, the latch handle is free to move approximately one inch in either direction before engagement of the locking mechanism. Then grasp the door and firmly pull the door closed. Rotate the door handle fully counterclockwise into the locked position. Observe that the door handle indicator is in the CLOSED position. When the door is properly locked, the door latch handle is free to move approximately one inch in either direction.

NOTE

When checking the door latch handle, do not move it far enough to engage the door latch release mechanism.

Press firmly outward at the top rear corner of the door. If any movement of the door is detected, completely open the door and close again following the above instructions.

To open the door from the inside, depress the lock button and rotate the handle clockwise.

HANDLING, SERVICING, AND MAINTENANCE

No change.

SECTION X
SAFETY INFORMATION
TABLE OF CONTENTS

<i>SUBJECT</i>	<i>PAGE</i>
Introduction	10-3
General	10-5
Do's	10-5
Don'ts	10-6
Sources of Information	10-7
Pilot's Operating Handbook and FAA Approved Airplane Flight Manual	10-7
BEECHCRAFT Service Publications	10-8
Federal Aviation Regulations	10-10
Airworthiness Directives	10-10
Airman's Information Manual	10-10
Advisory Information	10-11
FAA Advisory Circulars	10-12
FAA General Aviation News	10-15
FAA Accident Prevention Program	10-15
Additional Information	10-16
General Information on Specific Topics	10-17
Maintenance	10-17
Hazards of Unapproved Modifications	10-19
Flight Planning	10-20
Passenger Information Cards	10-20
Stowage of Articles	10-21
Flight Operations	10-21
General	10-21
Preflight Inspection	10-21
Weight and Balance	10-22
Autopilots and Electric Trim Systems	10-23
Flutter	10-26
Turbulent Weather	10-27
Wind Shear	10-30
Weather Radar	10-30
Mountain Flying	10-32
VFR - Low Ceilings	10-33
VFR at Night	10-33
Vertigo - Disorientation	10-34
May, 1994	10-1

SECTION X
SAFETY INFORMATION
TABLE OF CONTENTS (Continued)

<i>SUBJECT</i>	<i>PAGE</i>
Stalls, Slow Flight and Training	10-36
Spins	10-36
Descent	10-38
Vortices - Wake Turbulence	10-39
Takeoff and Landing Conditions	10-40
Medical Facts for Pilots	10-40
General	10-40
Fatigue	10-41
Hypoxia	10-41
Hyperventilation	10-43
Alcohol	10-43
Drugs	10-45
Scuba Diving	10-45
Carbon Monoxide and Night Vision	10-45
Decompression Sickness	10-46
A Final Word	10-47

INTRODUCTION

Beech Aircraft Corporation has developed this special summary publication of safety information to refresh pilots' and owners' knowledge of safety related subjects. Topics in this publication are dealt with in more detail in FAA Advisory Circulars and other publications pertaining to the subject of safe flying.

The skilled pilot recognizes that safety consciousness is an integral - and never-ending - part of his or her job. Be thoroughly familiar with your airplane. Know its limitations and your own. Maintain your currency, or fly with a qualified instructor until you are current and proficient. Practice emergency procedures at safe altitudes and airspeeds, preferably with a qualified instructor pilot, until the required action can be accomplished without reference to the manual. Periodically review this safety information as part of your recurring training regimen.

BEECHCRAFT airplanes are designed and built to provide you with many years of safe and efficient transportation. By maintaining your BEECHCRAFT properly and flying it prudently you will realize its full potential.

..... Beech Aircraft Corporation

WARNING

Because your airplane is a high performance, high speed transportation vehicle, designed for operation in a three-dimensional environment, special safety precautions must be observed to reduce the risk of fatal or serious injuries to the pilot(s) and occupant(s).

It is mandatory that you fully understand the contents of this publication and the other operating and maintenance manuals which accompany the airplane; that FAA requirements for ratings, certifications and review be scrupulously complied with; and that you allow only persons who are properly licensed and rated, and thoroughly familiar with the contents of the Pilot's Operating Handbook and FAA Approved Airplane Flight Manual to operate the airplane.

IMPROPER OPERATION OR MAINTENANCE OF AN AIRPLANE, NO MATTER HOW WELL BUILT INITIALLY, CAN RESULT IN CONSIDERABLE DAMAGE OR TOTAL DESTRUCTION OF THE AIRPLANE, ALONG WITH SERIOUS OR FATAL INJURIES TO ALL OCCUPANTS.

GENERAL

As a pilot, you are responsible to yourself and to those who fly with you, to other pilots and their passengers and to people on the ground, to fly wisely and safely.

The following material in this Safety Information publication covers several subjects in limited detail. Here are some condensed Do's and Don'ts.

DO'S

Be thoroughly familiar with your airplane, know its limitations and your own.

Be current in your airplane, or fly with a qualified instructor until you are current. Practice until you are proficient.

Preplan all aspects of your flight - including a proper weather briefing and adequate fuel reserves.

Use services available - weather briefing, inflight weather and Flight Service Station.

Carefully preflight your airplane.

Use the approved checklist.

Have more than enough fuel for takeoff, plus the trip, and an adequate reserve.

Be sure your weight and C.G. are within limits.

Use seatbelts and shoulder harnesses at all times.

Be sure all loose articles and baggage are secured.

Check freedom and proper direction of operation of all controls during preflight inspection.

Maintain the prescribed airspeeds in takeoff, climb, descent, and landing.

Section X
Safety Information

Beechcraft
Single Engine (Piston)

Avoid wake turbulence (Vortices).

Preplan fuel and fuel tank management before the actual flight. Utilize auxiliary tanks only in level cruise flight. Take off and land on the fullest main tank, NEVER use auxiliary tanks for takeoff or landing.

Practice emergency procedures at safe altitudes and air-speeds, preferably with a qualified instructor pilot, until the required action can be accomplished without reference to the manual.

Keep your airplane in good mechanical condition.

Stay informed and alert; fly in a sensible manner.

DON'TS

Don't take off with frost, ice or snow on the airplane.

Don't take off with less than minimum recommended fuel, plus adequate reserves, and don't run the tank dry before switching.

Don't fly in a reckless, show-off, or careless manner.

Don't fly into thunderstorms or severe weather.

Don't fly in possible icing conditions.

Don't fly close to mountainous terrain.

Don't apply controls abruptly or with high forces that could exceed design loads of the airplane.

Don't fly into weather conditions that are beyond your ratings or current proficiency.

Don't fly when physically or mentally exhausted or below par.

Don't trust to luck.

SOURCES OF INFORMATION

There is a wealth of information available to the pilot created for the sole purpose of making your flying safer, easier and more efficient. Take advantage of this knowledge and be prepared for an emergency in the event that one should occur.

PILOT'S OPERATING HANDBOOK AND FAA APPROVED AIRPLANE FLIGHT MANUAL

You must be thoroughly familiar with the contents of your operating manuals, placards, and check lists to ensure safe utilization of your airplane. When the airplane was manufactured, it was equipped with one or more of the following: placards, Owner's Manual, FAA Approved Airplane Flight Manual, FAA Approved Airplane Flight Manual Supplements, Pilot's Operating Handbook and FAA Approved Airplane Flight Manual. Beech has revised and reissued many of the early manuals for certain models of airplanes in GAMA Standard Format as Pilot's Operating Handbooks and FAA Approved Airplane Flight Manuals. For simplicity and convenience, all official manuals in various models are referred to as the Pilot's Operating Handbook and FAA Approved Airplane Flight Manual. If the airplane has changed ownership, the Pilot's Operating Handbook and FAA Approved Airplane Flight Manual may have been misplaced or may not be current. Replacement handbooks may be obtained from any BEECHCRAFT Authorized Outlet.

BEECHCRAFT SERVICE PUBLICATIONS

Beech Aircraft Corporation publishes a wide variety of manuals, service letters, service instructions, service bulletins, safety communiques and other publications for the various models of BEECHCRAFT airplanes. Information on how to obtain publications relating to your airplane is contained in BEECHCRAFT Service Bulletin number 2001, entitled "General - BEECHCRAFT Service Publications - What is Available and How to Obtain It."

Beech Aircraft Corporation automatically mails original issues and revisions of BEECHCRAFT Service Bulletins (Mandatory, Recommended and Optional), FAA Approved Airplane Flight Manual Supplements, reissues and revisions of FAA Approved Airplane Flight Manuals, Flight Handbooks, Owners Manuals, Pilot's Operating Manuals and Pilot's Operating Handbooks, and original issues and revisions of BEECHCRAFT Safety Communiques to BEECHCRAFT Owner addresses as listed by the FAA Aircraft Registration Branch List and the BEECHCRAFT International Owner Notification Service List. While this information is distributed by Beech Aircraft Corporation, Beech can not make changes in the name or address furnished by the FAA. The owner must contact the FAA regarding any changes to name or address. Their address is: FAA Aircraft Registration Branch (AAC250) P.O. Box 25082, Oklahoma City, OK 73125, Phone (405) 680-2131.

It is the responsibility of the FAA owner of record to ensure that any mailings from Beech are forwarded to the proper persons. Often the FAA registered owner is a bank or financing company or an individual not in possession of the airplane. Also, when an airplane is sold, there is a lag in processing the change in registration with the FAA. If you are a new owner, contact your BEECHCRAFT Authorized Outlet and ensure your manuals are up to date.

Beech Aircraft Corporation provides a subscription service which provides for direct factory mailing of BEECHCRAFT

publications applicable to a specific serial number airplane. Details concerning the fees and ordering information for this owner subscription service are contained in Service Bulletin number 2001.

For owners who choose not to apply for a Publications Revision Subscription Service, Beech provides a free Owner Notification Service by which owners are notified by post card of BEEHCRAFT manual reissues, revisions and supplements which are being issued applicable to the airplane owned. On receipt of such notification, the owner may obtain the publication through a BEEHCRAFT Authorized Outlet. This notification service is available when requested by the owner. This request may be made by using the owner notification request card furnished with the loose equipment of each airplane at the time of delivery, or by a letter requesting this service, referencing the specific airplane serial number owned. Write to:

Supervisor, Special Services
Dept. 52
Beech Aircraft Corporation
P.O. Box 85
Wichita, Kansas 67201-0085

From time to time Beech Aircraft Corporation issues BEEHCRAFT Safety Communiques dealing with the safe operation of a specific series of airplanes, or airplanes in general. It is recommended that each owner/operator maintain a current file of these publications. Back issues of BEEHCRAFT Safety Communiques may be obtained without charge by sending a request, including airplane model and serial number, to the Supervisor, Special Services, at the address listed above.

Airworthiness Directives (AD's) are not issued by the manufacturer. They are issued and available from the FAA.

FEDERAL AVIATION REGULATIONS

FAR Part 91, General Operating and Flight Rules, is a document of law governing operation of airplanes and the owner's and pilot's responsibilities. Some of the subjects covered are:

Responsibilities and authority of the pilot-in-command

Certificates required

Liquor and drugs

Flight plans

Preflight action

Fuel requirements

Flight rules

Maintenance, preventive maintenance, alterations, inspection and maintenance records

You, as a pilot, have responsibilities under government regulations. The regulations are designed for your protection and the protection of your passengers and the public. Compliance is mandatory.

AIRWORTHINESS DIRECTIVES

FAR Part 39 specifies that no person may operate a product to which an Airworthiness Directive issued by the FAA applies, except in accordance with the requirements of that Airworthiness Directive.

AIRMAN'S INFORMATION MANUAL

The Airman's Information Manual (AIM) is designed to provide airmen with basic flight information and ATC procedures for use in the national airspace system of the United States. It also contains items of interest to pilots concerning health and medical facts, factors affecting flight safety, a pilot/controller glossary of terms in the Air Traffic Control

system, information on safety, and accident/hazard reporting. It is revised at six-month intervals and can be purchased from the Superintendent of Documents, U.S. Government Printing Office, Washington, D.C. 20402.

This document contains a wealth of pilot information. Among the subjects are:

Controlled Airspace
Emergency Procedures
Services Available to Pilots
Weather and Icing
Radio Phraseology and Technique
Mountain Flying
Airport Operations
Wake Turbulence - Vortices
Clearances and Separations
Medical Facts for Pilots
Preflight
Bird Hazards
Departures - IFR
Good Operating Practices
En route - IFR
Airport Location Directory
Arrival - IFR

All pilots must be thoroughly familiar with and use the information in the AIM.

ADVISORY INFORMATION

NOTAMS (Notices to Airmen) are documents that have information of a time-critical nature that would affect a pilot's decision to make a flight; for example, an airport closed, terminal radar out of service, or enroute navigational aids out of service.

FAA ADVISORY CIRCULARS

The FAA issues Advisory Circulars to inform the aviation public in a systematic way of nonregulatory material of interest. Advisory Circulars contain a wealth of information with which the prudent pilot should be familiar. A complete list of current FAA Advisory Circulars is published in AC 00-2, which lists Advisory Circulars that are for sale, as well as those distributed free of charge by the FAA, and provides ordering information. Many Advisory Circulars which are for sale can be purchased locally in aviation bookstores or at FBO's. These documents are subject to periodic revision. Be certain the Advisory Circular you are using is the latest revision available. Some of the Advisory Circulars of interest to pilots are:

*00-6	Aviation Weather
00-24	Thunderstorms
00-30	Rules of Thumb for Avoiding or Minimizing Encounters with Clear Air Turbulence
*00-45	Aviation Weather Services
00-46	Aviation Safety Reporting Program
20-5	Plane Sense
20-32	Carbon Monoxide (CO) Contamination in Aircraft - Detection and Prevention
20-35	Tie-Down Sense
20-43	Aircraft Fuel Control
20-105	Engine Power-Loss Accident Prevention
20-113	Pilot Precautions and Procedures to be Taken in Preventing Aircraft Reciprocating Engine Induction System & Fuel System Icing Problems
20-125	Water in Aviation Fuel
10-12	

- 21-4** Special Flight Permits for Operation of Overweight Aircraft
- 43-9** Maintenance Records: General Aviation Aircraft
- 43-12** Preventive Maintenance
- 60-4** Pilot's Spatial Disorientation
- 60-6** Airplane Flight Manuals (AFM), Approved Manual Materials, Markings and Placards - Airplanes
- 60-12** Availability of Industry-Developed Guidelines for the Conduct of the Biennial Flight Review
- 60-13** The Accident Prevention Counselor Program
- *61-9** Pilot Transition Courses for Complex Single-Engine and Light Twin-Engine Airplanes
- *61-21** Flight Training Handbook
- *61-23** Pilot's Handbook of Aeronautical Knowledge
- *61-27** Instrument Flying Handbook
- 61-67** Hazards Associated with Spins in Airplanes Prohibited from Intentional Spinning.
- 61-84** Role of Preflight Preparation
- *67-2** Medical Handbook for Pilots
- 90-23** Aircraft Wake Turbulence
- 90-42** Traffic Advisory Practices at Nontower Airports

Section X
Safety Information

Deerecraft
Single Engine (Piston)

- 90-48** Pilot's Role in Collision Avoidance
- 90-66** Recommended Standard Traffic Patterns for Airplane Operations at Uncontrolled Airports
- 90-85** Severe Weather Avoidance Plan (SWAP)
- 91-6** Water, Slush and Snow on the Runway
- 91-13** Cold Weather Operation of Aircraft
- *91-23** Pilot's Weight and Balance Handbook
- 91-26** Maintenance and Handling of Air Driven Gyroscopic Instruments
- 91-33** Use of Alternate Grades of Aviation Gasoline for Grade 80/87 and Use of Automotive Gasoline
- 91-35** Noise, Hearing Damage, and Fatigue in General Aviation Pilots
- 91-43** Unreliable Airspeed Indications
- 91-44** Operational and Maintenance Practices for Emergency Locator Transmitters and Receivers
- 91-46** Gyroscopic Instruments - Good Operating Practices
- 91-50** Importance of Transponder Operations and Altitude Reporting
- 91-51** Airplane Deice and Anti-ice Systems
- 91-59** Inspection and Care of General Aviation Aircraft Exhaust Systems
- 91-65** Use of Shoulder Harness in Passenger Seats

103-4 Hazards Associated with Sublimation of Solid Carbon Dioxide (Dry Ice) Aboard Aircraft

210-5A Military Flying Activities

* For Sale

FAA GENERAL AVIATION NEWS

FAA General Aviation News is published by the FAA in the interest of flight safety. The magazine is designed to promote safety in the air by calling the attention of general aviation airmen to current technical, regulatory and procedural matters affecting the safe operation of airplanes. FAA General Aviation News is sold on subscription by the Superintendent of Documents, Government Printing Office, Washington D.C., 20402.

FAA ACCIDENT PREVENTION PROGRAM

The FAA assigns accident prevention specialists to each Flight Standards and General Aviation District Office to organize accident prevention program activities. In addition, there are over 3,000 volunteer airmen serving as accident prevention counselors, sharing their technical expertise and professional knowledge with the general aviation community. The FAA conducts seminars and workshops, and distributes invaluable safety information under this program.

Usually the airport manager, the FAA Flight Service Station (FSS), or Fixed Base Operator (FBO), will have a list of accident prevention counselors and their phone numbers available. All Flight Standards and General Aviation District Offices have a list of the counselors serving the District.

Before flying over unfamiliar territory, such as mountainous terrain or desert areas, it is advisable for transient pilots to consult with local counselors. They will be familiar with the

more desirable routes, the wind and weather conditions, and the service and emergency landing areas that are available along the way. They can also offer advice on the type of emergency equipment you should be carrying.

ADDITIONAL INFORMATION

The National Transportation Safety Board and the Federal Aviation Administration periodically issue, in greater detail, general aviation pamphlets concerning aviation safety. FAA Regional Offices also publish material under the FAA General Aviation Accident Prevention Program. These can be obtained at FAA Offices, Weather Stations, Flight Service Stations or Airport Facilities. Some of these are titled:

12 Golden Rules for Pilots
Weather or Not
Disorientation
Plane Sense
Weather Info Guide for Pilots
Wake Turbulence
Don't Trust to Luck, Trust to Safety
Rain, Fog, Snow
Thunderstorm - TRW
Icing
Pilot's Weather Briefing Guide
Thunderstorms Don't Flirt ... Skirt 'em
IFR-VFR - Either Way Disorientation Can Be Fatal
IFR Pilot Exam-O-Grams
VFR Pilot Exam-O-Grams
Tips on Engine Operation in Small General Aviation Aircraft
Estimating Inflight Visibility
Is the Aircraft Ready for Flight
Tips on Mountain Flying
Tips on Desert Flying
Always Leave Yourself An Out

Safety Guide for Private Aircraft Owners
Tips on How to Use the Flight Planner
Tips on the Use of Ailerons and Rudder
Some Hard Facts About Soft Landings
Propeller Operation and Care
Torque "What it Means to the Pilot"
Weight and Balance. An Important Safety Consideration for Pilots

GENERAL INFORMATION ON SPECIFIC TOPICS

MAINTENANCE

Safety of flight begins with a well maintained airplane. Make it a habit to keep your airplane and all its equipment in air-worthy condition. Keep a "squawk list" on board, and see that all discrepancies, however minor, are noted and promptly corrected.

Schedule your maintenance regularly, and have your airplane serviced by a reputable organization. Be suspicious of bargain prices for maintenance, repair and inspections.

It is the responsibility of the owner and the operator to assure that the airplane is maintained in an airworthy condition and that proper maintenance records are kept.

Use only genuine BEECHCRAFT or BEECHCRAFT approved parts obtained from BEECHCRAFT approved sources, in connection with the maintenance and repair of Beech airplanes.

Genuine BEECHCRAFT parts are produced and inspected under rigorous procedures to insure airworthiness and suitability for use in Beech airplane applications. Parts purchased from sources other than BEECHCRAFT, even though outwardly identical in appearance, may not have had

the required tests and inspections performed, may be different in fabrication techniques and materials, and may be dangerous when installed in an airplane.

Salvaged airplane parts, reworked parts obtained from non-BEECHCRAFT approved sources or parts, components, or structural assemblies, the service history of which is unknown or cannot be authenticated, may have been subjected to unacceptable stresses or temperatures or have other hidden damage not discernible through routine visual or usual nondestructive testing techniques. This may render the part, component, or structural assembly, even though originally manufactured by BEECHCRAFT, unsuitable and unsafe for airplane use.

BEECHCRAFT expressly disclaims any responsibility for malfunctions, failures, damage or injury caused by use of non-BEECHCRAFT parts.

Airplanes operated for Air Taxi or other than normal operation, and airplanes operated in humid tropics, or cold and damp climates, etc., may need more frequent inspections for wear, corrosion and/or lack of lubrication. In these areas, periodic inspections should be performed until the operator can set his own inspection periods based on experience.

NOTE

The required periods do not constitute a guarantee that the item will reach the period without malfunction, as the aforementioned factors cannot be controlled by the manufacturer.

Corrosion and its effects must be treated at the earliest possible opportunity. A clean, dry surface is virtually immune to corrosion. Make sure that all drain holes remain unobstructed. Protective films and sealants help to keep corrosive agents from contacting metallic surfaces. Corrosion

inspections should be made most frequently under high-corrosion-risk operating conditions, such as in areas of excessive airborne salt concentrations (e.g., near the sea) and in high-humidity areas (e.g., tropical regions).

If you have purchased a used airplane, have your mechanic inspect the airplane registration records, logbooks and maintenance records carefully. An unexplained period of time for which the airplane has been out of service, or unexplained significant repairs may well indicate the airplane has been seriously damaged in a prior accident. Have your mechanics inspect a used airplane carefully. Take the time to ensure that you really know what you are buying when you buy a used airplane.

HAZARDS OF UNAPPROVED MODIFICATIONS

Many airplane modifications are approved under Supplemental Type Certificates (STC's). Before installing an STC on your airplane, check to make sure that the STC does not conflict with other STC's that have already been installed. Because approval of an STC is obtained by the individual STC holder based upon modification of the original type design, it is possible for STC's to interfere with each other when both are installed. Never install an unapproved modification of any type, however innocent the apparent modification may seem. Always obtain proper FAA approval.

Airplane owners and maintenance personnel are particularly cautioned not to make attachments to, or otherwise modify, seats from original certification without approval from the FAA Engineering and Manufacturing District Office having original certification responsibility for that make and model.

Any unapproved attachment or modification to seat structure may increase load factors and metal stress which could cause failure of seat structure at a lesser "G" force than exhibited for original certification.

Examples of unauthorized attachments found are drilling holes in seat tubing to attach fire extinguishers and drilling holes to attach approach plate book bins to seats.

FLIGHT PLANNING

FAR Part 91 requires that each pilot in command, before beginning a flight, familiarize himself with all available information concerning that flight.

Obtain a current and complete preflight briefing. This should consist of local, enroute and destination weather and enroute navaid information. Enroute terrain and obstructions, alternate airports, airport runways active, length of runways, and takeoff and landing distances for the airplane for conditions expected should be known.

The prudent pilot will review his planned enroute track and stations and make a list for quick reference. It is strongly recommended a flight plan be filed with Flight Service Stations, even though the flight may be VFR. Also, advise Flight Service Stations of changes or delays of one hour or more and remember to close the flight plan at destination.

The pilot must be completely familiar with the performance of the airplane and performance data in the Pilot's Operating Handbook and FAA Approved Airplane Flight Manual. The resultant effect of temperature and pressure altitude must be taken into account in performance if not accounted for on the charts. An applicable FAA Approved Airplane Flight Manual must be aboard the airplane at all times and include the weight and balance forms and equipment list.

PASSENGER INFORMATION CARDS

Beech has available, for most current production airplanes, passenger information cards which contain important information on the proper use of restraint systems, oxygen

masks, emergency exits and emergency bracing procedures. Passenger information cards may be obtained at any BEECHCRAFT Authorized Outlet. A pilot should not only be familiar with the information contained in the cards, but should always, prior to flight, inform the passengers of the information contained in the information cards. The pilot should orally brief the passengers on the proper use of restraint systems, doors and emergency exits, and other emergency procedures, as required by Part 91 of the FAR's.

STOWAGE OF ARTICLES

The space between the seat pan and the floor is utilized to provide space for seat displacement. If hard, solid objects are stored beneath seats, the energy absorbing feature is lost and severe spinal injuries can occur to occupants.

Prior to flight, pilots should insure that articles are not stowed beneath seats that would restrict seat pan energy absorption or penetrate the seat in event of a high vertical velocity accident.

FLIGHT OPERATIONS

GENERAL

The pilot **MUST** be thoroughly familiar with ALL INFORMATION published by the manufacturer concerning the airplane, and is required by law to operate the airplane in accordance with the FAA Approved Airplane Flight Manual and placards installed.

PREFLIGHT INSPECTION

In addition to maintenance inspections and preflight information required by FAR Part 91, a complete, careful preflight inspection is imperative.

Each airplane has a checklist for the preflight inspection which must be followed. **USE THE CHECKLIST.**

WEIGHT AND BALANCE

Maintaining center of gravity within the approved envelope throughout the planned flight is an important safety consideration.

The airplane must be loaded so as not to exceed the weight and center of gravity (C.G.) limitations. Airplanes that are loaded above the maximum takeoff or landing weight limitations will have an overall lower level of performance compared to that shown in the Performance section of the Pilot's Operating Handbook and FAA Approved Airplane Flight Manual. If loaded above maximum takeoff weight, takeoff distance and the landing distance will be longer than that shown in the Performance section; the stalling speed will be higher, rate of climb, the cruising speed, and the range of the airplane at any level of fuel will all be lower than shown in the Performance section.

If an airplane is loaded so that the C.G. is forward of the forward limit, it will require additional control movements for maneuvering the airplane with correspondingly higher control forces. The pilot may have difficulty during takeoff and landing because of the elevator control limits.

If an airplane is loaded aft of the aft C.G. limitation, the pilot will experience a lower level of stability. Airplane characteristics that indicate a lower stability level are; lower control forces, difficulty in trimming the airplane, lower control forces for maneuvering with attendant danger of structural overload, decayed stall characteristics, and a lower level of lateral-directional damping.

Ensure that all cargo and baggage is properly secured before takeoff. A sudden shift in balance at rotation can cause controllability problems.

AUTOPILOTS AND ELECTRIC TRIM SYSTEMS

Because there are several different models of autopilots and electric trim systems installed in Beech airplanes and different installations and switch positions are possible from airplane to airplane, it is essential that every owner/operator review his Airplane Flight Manual (AFM) Supplements and ensure that the supplements properly describe the autopilot and trim installations on his specific airplane. Each pilot, prior to flight, must be fully aware of the proper procedures for operation, and particularly disengagement, for the system as installed.

In addition to ensuring compliance with the autopilot manufacturer's maintenance requirements, all owners/operators should thoroughly familiarize themselves with the operation, function and procedures described in the Airplane Flight Manual Supplements. Ensure a full understanding of the methods of engagement and disengagement of the autopilot and trim systems.

Compare the descriptions and procedures contained in the Supplements to the actual installation in the airplane to ensure that the supplement accurately describes your installation. Test that all buttons, switches and circuit breakers function as described in the Supplements. If they do not function as described, have the system repaired by a qualified service agency. If field service advice or assistance is necessary, contact Beech Aircraft Corporation, Customer Support Department.

As stated in all AFM Supplements for autopilot systems and trim systems installed on Beech airplanes, the preflight check must be conducted before every flight. The preflight check assures not only that the systems and all of their features are operating properly, but also that the pilot, before flight, is familiar with the proper means of engagement and disengagement of the autopilot and trim system.

Autopilot Airplane Flight Manual Supplements caution against trying to override the autopilot system during flight without disengaging the autopilot because the autopilot will continue to trim the airplane and oppose the pilot's actions. This could result in a severely out of trim condition. This is a basic feature of all autopilots with electric trim follow-up.

Do not try to manually override the autopilot during flight.

IN CASE OF EMERGENCY, YOU CAN OVERPOWER THE AUTOPILOT TO CORRECT THE ATTITUDE, BUT THE AUTOPILOT AND ELECTRIC TRIM MUST THEN IMMEDIATELY BE DISENGAGED.

It is often difficult to distinguish an autopilot malfunction from an electric trim system malfunction. The safest course is to deactivate both. Do not re-engage either system until after you have safely landed. Then have the systems checked by a qualified service facility prior to further flight.

Depending upon the installation on your airplane, the following additional methods may be available to disengage the autopilot or electric trim in the event that the autopilot or electric trim does not disengage utilizing the disengage methods specified in the Supplements.



Transient control forces may occur when the autopilot is disengaged.

1. Turn off the autopilot master switch, if installed.
2. Pull the autopilot and trim circuit breaker(s) or turn off the autopilot switch breaker, if installed.
3. Turn off the RADIO MASTER SWITCH, if installed, and if the autopilot system and the trim system are wired through this switch.

CAUTION

Radios, including VHF COMM are also disconnected when the radio master switch is off.

4. Turn off the ELECTRIC MASTER SWITCH.

WARNING

Almost all electrically powered systems will be inoperative. Consult the AFM for further information.

5. Push the GA switch on throttle grip, if installed (depending upon the autopilot system).
6. Push TEST EACH FLT switch on the autopilot controller, if installed.

NOTE

After the autopilot is positively disengaged, it may be necessary to restore other electrical functions. Be sure when the master switches are turned on that the autopilot does not re-engage.

The above ways may or may not be available on your autopilot. It is essential that you read your airplane's AFM SUPPLEMENT for your autopilot system and check each function and operation on your system.

The engagement of the autopilot must be done in accordance with the instructions and procedures contained in the AFM SUPPLEMENT.

Particular attention must be paid to the autopilot settings prior to engagement. If you attempt to engage the autopilot when the airplane is out of trim, a large attitude change may occur.

IT IS ESSENTIAL THAT THE PROCEDURES SET FORTH IN THE APPROVED AFM SUPPLEMENTS FOR YOUR SPECIFIC INSTALLATION BE FOLLOWED BEFORE ENGAGING THE AUTOPILOT.

FLUTTER

Flutter is a phenomenon that can occur when an aerodynamic surface begins vibrating. The energy to sustain the vibration is derived from airflow over the surface. The amplitude of the vibration can (1) decrease, if airspeed is reduced; (2) remain constant, if airspeed is held constant and no failures occur; or (3) increase to the point of self-destruction, especially if airspeed is high and/or is allowed to increase. Flutter can lead to an in-flight break up of the airplane. Airplanes are designed so that flutter will not occur in the normal operating envelope of the airplane as long as the airplane is properly maintained. In the case of any airplane, decreasing the damping and stiffness of the structure or increasing the trailing edge weight of control surfaces will tend to cause flutter. If a combination of those factors is sufficient, flutter can occur within the normal operating envelope.

Owners and operators of airplanes have the primary responsibility for maintaining their airplanes. To fulfill that responsibility, it is imperative that all airplanes receive a thorough preflight inspection. Improper tension on the control cables or any other loose condition in the flight control system can also cause or contribute to flutter. Pilot's should pay particular attention to control surface attachment hardware including tab pushrod attachment during preflight inspection. Looseness of fixed surfaces or movement of control surfaces other than in the normal direction of travel should be

rectified before flight. Further, owners should take their airplanes to mechanics who have access to current technical publications and prior experience in properly maintaining that make and model of airplane. The owner should make certain that control cable tension inspections are performed as outlined in the applicable Beech Inspection Guide. Worn control surface attachment hardware must be replaced. Any repainting or repair of a moveable control surface will require a verification of the control surface balance before the airplane is returned to service. Control surface drain holes must be open to prevent freezing of accumulated moisture, which could create an increased trailing-edge-heavy control surface and flutter.

If an excessive vibration, particularly in the control column and rudder pedals, is encountered in flight, this may be the onset of flutter and the procedure to follow is:

1. IMMEDIATELY REDUCE AIRSPEED (lower the landing gear if necessary).
2. RESTRAIN THE CONTROLS OF THE AIRPLANE UNTIL THE VIBRATION CEASES.
3. FLY AT THE REDUCED AIRSPEED AND LAND AT THE NEAREST SUITABLE AIRPORT.
4. HAVE THE AIRPLANE INSPECTED FOR AIRFRAME DAMAGE, CONTROL SURFACE ATTACHING HARDWARE CONDITION/SECURITY, TRIM TAB FREE PLAY, PROPER CONTROL CABLE TENSION, AND CONTROL SURFACE BALANCE BY ANOTHER MECHANIC WHO IS FULLY QUALIFIED.

TURBULENT WEATHER

A complete and current weather briefing is a requirement for a safe trip.

Updating of weather information enroute is also essential. The wise pilot knows that weather conditions can change

quickly, and treats weather forecasting as professional advice, rather than an absolute fact. He obtains all the advice he can, but stays alert to any sign or report of changing conditions.

Plan the flight to avoid areas of reported severe turbulence. It is not always possible to detect individual storm areas or find the in-between clear areas.

The National Weather Service classifies turbulence as follows:

Class of Turbulence	Effect
Extreme	Airplane is violently tossed about and is practically impossible to control. May cause structural damage.
Severe	Airplane may be momentarily out of control. Occupants are thrown violently against the belts and back into the seat. Unsecured objects are tossed about.
Moderate	Occupants require seat belts and occasionally are thrown against the belt. Unsecured objects move about.
Light	Occupants may be required to use seat belts, but objects in the airplane remain at rest.

Thunderstorms, squall lines and violent turbulence should be regarded as extremely dangerous and must be avoided. Hail and tornadic wind velocities can be encountered in thunderstorms that can destroy any airplane, just as tornadoes destroy nearly everything in their path on the ground.

Thunderstorms also pose the possibility of a lightning strike on an airplane. Any structure or equipment which shows evidence of a lightning strike, or of being subjected to a high

current flow due to a strike, or is a suspected part of a lightning strike path through the airplane should be thoroughly inspected and any damage repaired prior to additional flight.

A roll cloud ahead of a squall line or thunderstorm is visible evidence of extreme turbulence; however, the absence of a roll cloud should not be interpreted as denoting that severe turbulence is not present.

Even though flight in severe turbulence must be avoided, flight in turbulent air may be encountered unexpectedly under certain conditions.

The following recommendations should be observed for airplane operation in turbulent air:

Flying through turbulent air presents two basic problems, the answer to both of which is proper airspeed. On one hand, if you maintain an excessive airspeed, you run the risk of structural damage or failure; on the other hand, if your airspeed is too low, you may stall.

If turbulence is encountered, reduce speed to the turbulent air penetration speed, if given, or to the maneuvering speed, which is listed in the Limitations section of the Pilot's Operating Handbook and FAA Approved Airplane Flight Manual. These speeds give the best assurance of avoiding excessive stress loads, and at the same time provide the proper margin against inadvertent stalls due to gusts.

Beware of overcontrolling in an attempt to correct for changes in attitude; applying control pressure abruptly will build up G-forces rapidly and could cause structural damage or even failure. You should watch particularly your angle of bank, making turns as wide and shallow as possible. Be equally cautious in applying forward or back pressure to keep the airplane level. Maintain straight and level attitude in either up or down drafts. Use trim sparingly to avoid being

grossly out of trim as the vertical air columns change velocity and direction. If necessary to avoid excessive airspeeds, lower the landing gear.

WIND SHEAR

Wind shears are rapid, localized changes in wind direction, which can occur vertically as well as horizontally. Wind shear can be very dangerous to all airplanes, large and small, particularly on approach to landing when airspeeds are slow.

A horizontal wind shear is a sudden change in wind direction or speed that can, for example, transform a headwind into a tailwind, producing a sudden decrease in indicated airspeed because of the inertia of the airplane. A vertical wind shear, is a sudden updraft or downdraft. Microbursts are intense, highly localized severe downdrafts.

The prediction of wind shears is far from an exact science. Monitor your airspeed carefully when flying near storms, particularly on approach. Be mentally prepared to add power and go around at the first indication that a wind shear is being encountered.

WEATHER RADAR

Airborne weather avoidance radar is, as its name implies, for avoiding severe weather--not for penetrating it. Whether to fly into an area of radar echoes depends on echo intensity, spacing between the echoes, and the capabilities of you and your airplane. Remember that weather radar detects only precipitation drops; it does not detect turbulence. Therefore, the radar scope provides no assurance of avoiding turbulence. The radar scope also does not provide assurance of avoiding instrument weather due to clouds and fog. Your scope may be clear between intense echoes; this clear area does not necessarily mean you can fly between the storms and maintain visual sighting of them.

Thunderstorms build and dissipate rapidly. Therefore, do not attempt to plan a course between echoes using ground based radar. The best use of ground radar information is to isolate general areas and coverage of echoes. You must avoid individual storms from in-flight observations either by visual sighting or by airborne radar. It is better to avoid the whole thunderstorm area than to detour around individual storms unless they are scattered.

Remember that while hail always gives a radar echo, it may fall several miles from the nearest visible cloud and hazardous turbulence may extend to as much as 20 miles from the echo edge. Avoid intense or extreme level echoes by at least 20 miles; that is, such echoes should be separated by at least 40 miles before you fly between them. With weaker echoes you can reduce the distance by which you avoid them.

Above all, remember this: never regard any thunderstorm lightly. Even when radar observers report the echoes are of light intensity, avoiding thunderstorms is the best policy. The following are some do's and don'ts of thunderstorm avoidance:

1. Don't land or take off in the face of an approaching thunderstorm. A sudden gust front of low level turbulence could cause loss of control.
2. Don't attempt to fly under a thunderstorm even if you can see through to the other side. Turbulence and wind shear under the storm could be disastrous.
3. Don't fly without airborne radar into a cloud mass containing scattered embedded thunderstorms. Embedded thunderstorms usually can not be visually circumnavigated.
4. Don't trust visual appearance to be a reliable indicator of the turbulence inside a thunderstorm.

5. Do avoid by at least 20 miles any thunderstorm identified as severe or giving an intense radar echo. This is especially true under the anvil of a large cumulonimbus.
6. Do circumnavigate the entire area if the area has 6/10 or greater thunderstorm coverage.
7. Do remember that vivid and frequent lightning indicates the probability of a severe thunderstorm.
8. Do regard as extremely hazardous any thunderstorm with tops 35,000 feet or higher, whether the top is visually sighted or determined by radar.

If you cannot avoid penetrating a thunderstorm, the following are some do's BEFORE entering the storm:

9. Tighten your safety belt, put on your shoulder harness, and secure all loose objects.
10. Plan and hold your course to take you through the storm in minimum time.
11. To avoid the most critical icing, establish a penetration altitude below the freezing level or above the level of -15°C .
12. Verify that pitot heat is on and turn on carburetor heat or engine anti-ice. Icing can be rapid at any altitude and cause almost instantaneous power failure and/or loss of airspeed indication.

MOUNTAIN FLYING

Pilots flying in mountainous areas should inform themselves of all aspects of mountain flying, including the effects of topographic features on weather conditions. Many good articles have been published, and a synopsis of mountain flying operations is included in the FAA Airman's Information Manual, Part 1.

Avoid flight at low altitudes over mountainous terrain, particularly near the lee slopes. If the wind velocity near the

level of the ridge is in excess of 25 knots and approximately perpendicular to the ridge, mountain wave conditions are likely over and near the lee slopes. If the wind velocity at the level of the ridge exceeds 50 knots, a strong mountain wave is probable with extreme up and down drafts and severe turbulence. The worst turbulence will be encountered in and below the rotor zone, which is usually 8 to 10 miles downwind from the ridge. This zone is sometimes characterized by the presence of "roll clouds" if sufficient moisture is present; altocumulus standing lenticular clouds are also visible signs that a mountain wave exists, but their presence is likewise dependent on moisture. Mountain wave turbulence can, of course, occur in dry air and the absence of such clouds should not be taken as assurance that mountain wave turbulence will not be encountered. A mountain wave downdraft may exceed the climb capability of your airplane. Avoid mountain wave downdrafts.

VFR - LOW CEILINGS

If you are not instrument rated, do not attempt "VFR on Top" or "Special VFR" flight or clearances. Being caught above a solid cloud layer when an emergency descent is required (or at destination) is an extremely hazardous position for the VFR pilot. Accepting a clearance out of airport control zones with no minimum ceiling and one-mile visibility as permitted with "Special VFR" is a foolish practice for the VFR pilot.

Avoid areas of low ceilings and restricted visibility unless you are instrument rated and proficient and have an instrument equipped airplane. Then proceed with caution and with planned alternates.

VFR AT NIGHT

When flying VFR at night, in addition to the altitude appropriate for the direction of flight, pilots should maintain a safe minimum altitude as dictated by terrain, obstacles such as

TV towers, or communities in the area flown. This is especially true in mountainous terrain, where there is usually very little ground reference. Minimum clearance is 2,000 feet above the highest obstacle enroute. Do not depend on your ability to see obstacles in time to miss them. Flight on dark nights over sparsely populated country can be the same as IFR, and must be avoided by inexperienced or non-IFR rated pilots.

VERTIGO - DISORIENTATION

Disorientation can occur in a variety of ways. During flight, inner ear balancing mechanisms are subjected to varied forces not normally experienced on the ground. This, combined with loss of outside visual reference, can cause vertigo. False interpretations (illusions) result, and may confuse the pilot's conception of the attitude and position of his airplane.

Under VFR conditions, the visual sense, using the horizon as a reference, can override the illusions. Under low visibility conditions (night, fog, clouds, haze, etc.) the illusions predominate. Only through awareness of these illusions, and proficiency in instrument flight procedures, can an airplane be operated safely in a low visibility environment.

Flying in fog, dense haze or dust, cloud banks, or very low visibility, with strobe lights or rotating beacons turned on can contribute to vertigo. They should be turned off in these conditions, particularly at night.

All pilots should check the weather and use good judgment in planning flights. The VFR pilot should use extra caution in avoiding low visibility conditions.

Motion sickness often precedes or accompanies disorientation and may further jeopardize the flight.

Disorientation in low visibility conditions is not limited to VFR pilots. Although IFR pilots are trained to look at their instruments to gain an artificial visual reference as a replacement for the loss of a visual horizon, they do not always do so. This can happen when the pilot's physical condition will not permit him to concentrate on his instruments; when the pilot is not proficient in flying instrument conditions in the airplane he is flying; or, when the pilot's work load of flying by reference to his instruments is augmented by such factors as turbulence. Even an instrument rated pilot encountering instrument conditions, intentional or unintentional, should ask himself whether or not he is sufficiently alert and proficient in the airplane he is flying, to fly under low visibility conditions and in the turbulence anticipated or encountered.

If any doubt exists, the flight should not be made or it should be discontinued as soon as possible.

The result of vertigo is loss of control of the airplane. If the loss of control is sustained, it will result in an excessive speed accident. Excessive speed accidents occur in one of two manners, either as an inflight airframe separation or as a high speed ground impact; and they are fatal accidents in either case. All airplanes are subject to this form of accident.

For years, Beech Pilot's Operating Handbooks and FAA Approved Airplane Flight Manuals have contained instructions that the landing gear should be extended in any circumstance in which the pilot encounters IFR conditions which approach the limits of his capability or his ratings. Lowering the gear in IFR conditions or flight into heavy or severe turbulence, tends to stabilize the airplane, assists in maintaining proper airspeed, and will substantially reduce the possibility of reaching excessive airspeeds with catastrophic consequences, even where loss of control is experienced.

Excessive speed accidents occur at airspeeds greatly in excess of two operating limitations which are specified in the

manuals: Maximum maneuvering speed and the "red line" or "never exceed" speed. Such speed limits are set to protect the structure of an airplane. For example, flight controls are designed to be used to their fullest extent only below the airplane's maximum maneuvering speed. As a result, the control surfaces should never be suddenly or fully deflected above maximum maneuvering speed. Turbulence penetration should not be performed above that speed. The accidents we are discussing here occur at airspeeds greatly in excess of these limitations. No airplane should ever be flown beyond its FAA approved operating limitations.

STALLS, SLOW FLIGHT AND TRAINING

The stall warning system must be kept operational at all times and must not be deactivated by interruption of circuits, circuit breakers, or fuses. Compliance with this requirement is especially important in all high performance single engine airplanes during simulated engine-out practice or stall demonstrations, because the stall speed is critical in all low-speed operation of airplanes.

Training should be accomplished under the supervision of a qualified instructor-pilot, with careful reference to the applicable sections of the FAA Practical Test Standards and FAA Pilot Transition Courses for Complex Single Engine and Light Twin Engine Airplanes (AC 61-9). In particular, observe carefully the warnings in the Practical Test Standards.

SPINS

A major cause of fatal accidents in general aviation airplanes is a spin. Stall demonstrations and practice are a means for a pilot to acquire the skills to recognize when a stall is about to occur and to recover as soon as the first signs of a stall are evident.

If a stall does not occur - A spin cannot occur.

It is important to remember, however, that a stall can occur in any flight attitude, at any airspeed, if controls are misused.

Unless your airplane has been specifically certificated in the aerobatic category and specifically tested for spin recovery characteristics, it is placarded against intentional spins.

The pilot of an airplane placarded against intentional spins should assume that the airplane may become uncontrollable in a spin, since its performance characteristics beyond certain limits specified in the FAA regulations may not have been tested and are unknown. This is why airplanes are placarded against intentional spins, and this is why stall avoidance is your protection against an inadvertent spin.

Pilots are taught that intentional spins are entered by deliberately inducing a yawing moment with the controls as the airplane is stalled. Inadvertent spins result from the same combination - stall plus yaw. That is why it is important to use coordinated controls and to recover at the first indication of a stall when practicing stalls.

Always remember that extra alertness and pilot techniques are required for slow flight maneuvers, including the practice or demonstration of stalls. In addition to the foregoing mandatory procedure, always:

- Be certain that the center of gravity of the airplane is as far forward as possible. Forward C.G. aids stall recovery, spin avoidance and spin recovery. An aft C.G. can create a tendency for a spin to stabilize, which delays recovery.
- Whenever a student pilot will be required to practice slow flight, be certain that the qualified instructor pilot has a full set of operable controls available. FAA regulations prohibit flight instruction without full dual controls.

Section X Safety Information

Dechcraft Single Engine (Piston)

- Conduct any maneuvers which could possibly result in a spin at altitudes in excess of five thousand (5,000) feet above ground level in clear air only.
- Remember that an airplane, at or near traffic pattern and approach altitudes, cannot recover from a spin, or perhaps even a stall, before impact with the ground. On final approach maintain at least the airspeed shown in the flight manual.
- Remember that if an airplane flown under instrument conditions is permitted to stall or enter a spin, the pilot, without reference to the horizon, is certain to become disoriented. He may be unable to recognize a stall, spin entry, or the spin condition and he may be unable to determine even the direction of the rotation.
- Finally, never forget that stall avoidance is your best protection against an inadvertent spin. **MAINTAIN YOUR AIRSPEED.**

In airplanes not certificated for aerobatics, spins are prohibited. If a spin is entered inadvertently:

Immediately move the control column full forward and simultaneously apply full rudder opposite to the direction of the spin; continue to hold this position until rotation stops and then neutralize all controls and execute a smooth pullout. Ailerons should be neutral and the throttle in idle position at all times during recovery.

DESCENT

In single engine piston-powered airplanes, supercharged or normally aspirated, it is necessary to avoid prolonged descents with low power, as this produces two problems: (1) excessively cool cylinder head temperatures which cause premature engine wear, and (2) excessively rich mixtures due to idle enrichment (and altitude) which causes soot and lead deposits on the spark plugs (fouling). The second of these is the more serious consideration; the engine may not

respond to the throttle when it is desired to discontinue the descent. Both problems are amenable to one solution: maintain adequate power to keep cylinder head temperature in the "green" range during descent, and lean to best power mixture (that is, progressively enrich the mixture from cruise only slightly as altitude decreases). This procedure will lengthen the descent, of course, and requires some advance planning. If it is necessary to make a prolonged descent at or near idle, as in practicing forced landings, at least avoid the problem of fouled spark plugs by frequently advancing the throttle until the engine runs smoothly, and maintain an appropriate mixture setting with altitude. (Refer to pre-landing check list.)

VORTICES - WAKE TURBULENCE

Every airplane generates wakes of turbulence while in flight. Part of this is from the propeller or jet engine, and part from the wing tip vortices. The larger and heavier the airplane, the more pronounced and turbulent the wakes will be. Wing tip vortices from large, heavy airplanes are very severe at close range, degenerating with time, wind and distance. These are rolling in nature, from each wing tip. In tests, vortex velocities of 133 knots have been recorded. Encountering the rolling effect of wing tip vortices within two minutes after passage of large airplanes is most hazardous to light airplanes. This roll effect can exceed the maximum counter-roll obtainable in a light airplane. The turbulent areas may remain for as long as three minutes or more, depending on wind conditions, and may extend several miles behind the airplane. Plan to fly slightly above and to the windward side of other airplanes. Because of the wide variety of conditions that can be encountered, there is no set rule to follow to avoid wake turbulence in all situations. However, the Airman's Information Manual, and to a greater extent Advisory Circular 90-23, Aircraft Wake Turbulence, provide a thorough discussion of the factors you should be aware of when wake turbulence may be encountered.

TAKEOFF AND LANDING CONDITIONS

When taking off on runways covered with water or freezing slush, the landing gear should remain extended for approximately ten seconds longer than normal, allowing the wheels to spin and dissipate the freezing moisture. The landing gear should then be cycled up, then down, wait approximately five seconds and then retracted again. Caution must be exercised to insure that the entire operation is performed below Maximum Landing Gear Operating Airspeed.

Use caution when landing on runways that are covered by water or slush which cause hydroplaning (aquaplaning), a phenomenon that renders braking and steering ineffective because of the lack of sufficient surface friction. Snow and ice covered runways are also hazardous. The pilot should also be alert to the possibility of the brakes freezing.

Use caution when taking off or landing during gusty wind conditions. Also be aware of the special wind conditions caused by buildings or other obstructions located near the runway.

MEDICAL FACTS FOR PILOTS

GENERAL

When the pilot enters the airplane, he becomes an integral part of the man-machine system. He is just as essential to a successful flight as the control surfaces. To ignore the pilot in preflight planning would be as senseless as failing to inspect the integrity of the control surfaces or any other vital part of the machine. The pilot has the responsibility for determining his reliability prior to entering the airplane for flight. When piloting an airplane, an individual should be free of conditions which are harmful to alertness, ability to make correct decisions, and rapid reaction time.

FATIGUE

Fatigue generally slows reaction time and causes errors due to inattention. In addition to the most common cause of fatigue; insufficient rest and loss of sleep, the pressures of business, financial worries, and family problems can be important contributing factors. If you are tired, don't fly.

HYPOXIA

Hypoxia, in simple terms, is a lack of sufficient oxygen to keep the brain and other body tissues functioning properly. There is a wide individual variation in susceptibility to hypoxia. In addition to progressively insufficient oxygen at higher altitudes, anything interfering with the blood's ability to carry oxygen can contribute to hypoxia (anemias, carbon monoxide, and certain drugs). Also, alcohol and various drugs decrease the brain's tolerance to hypoxia.

Your body has no built-in alarm system to let you know when you are not getting enough oxygen. It is impossible to predict when or where hypoxia will occur during a given flight, or how it will manifest itself. Some of the common symptoms of hypoxia are increased breathing rate, a light-headed or dizzy sensation, tingling or warm sensation, sweating, reduced visual field, sleepiness, blue coloring of skin, fingernails, and lips, and behavior changes. A particularly dangerous feature of hypoxia is an increased sense of well-being, called euphoria. It obscures a person's ability and desire to be critical of himself, slows reaction time, and impairs thinking ability. Consequently, a hypoxic individual commonly believes things are getting progressively better while he nears total collapse.

The symptoms are slow but progressive, insidious in onset, and are most marked at altitudes starting above ten thousand feet. Night vision, however, can be impaired starting at an altitude of 5,000 feet. Persons who have recently overindulged in alcohol, who are moderate to heavy smokers, or

Section X Safety Information

Deechcraft Single Engine (Piston)

who take certain drugs, may be more susceptible to hypoxia. Susceptibility may also vary in the same individual from day to day or even morning to evening. Use oxygen on flights above 10,000 feet and at any time when symptoms appear.

Depending upon altitude, a hypoxic individual has a limited time to make decisions and perform useful acts, even though he may remain conscious for a longer period. The time of useful consciousness is approximately 3-5 minutes at 25,000 feet of altitude and diminishes markedly as altitude increases.

Should symptoms occur that cannot definitely be identified as either hypoxia or hyperventilation, try three or four deep breaths of oxygen. The symptoms should improve markedly if the condition was hypoxia (recovery from hypoxia is rapid).

Pilots who fly to altitudes that require or may require the use of supplemental oxygen should be thoroughly familiar with the operation of the airplane oxygen systems. A preflight inspection of the system should be performed, including proper fit of the mask. The passengers should be briefed on the proper use of their oxygen system before flight.

Pilots who wear beards should be careful to ensure that their beard is carefully trimmed so that it will not interfere with proper sealing of the oxygen masks. If you wear a beard or moustache, test the fit of your oxygen mask on the ground for proper sealing. Studies conducted by the military and oxygen equipment manufacturers conclude that oxygen masks do not seal over beards or heavy facial hair.

Federal Aviation Regulations related to the use of supplemental oxygen by flight crew and passengers must be adhered to if flight at higher altitudes is to be accomplished safely. Passengers with significant circulatory or lung disease may need to use supplemental oxygen at lower altitudes than specified by these regulations.

HYPERVENTILATION

Hyperventilation, or overbreathing, is a disturbance of respiration that may occur in individuals as a result of emotional tension or anxiety. Under conditions of emotional stress, fright, or pain, breathing rate may increase, causing increased lung ventilation, although the carbon dioxide output of the body cells does not increase. As a result, carbon dioxide is "washed out" of the blood. The most common symptoms of hyperventilation are: dizziness, nausea, sleepiness, and finally, unconsciousness. If the symptoms persist, discontinue use of oxygen and consciously slow your breathing rate until symptoms clear, and then resume normal breathing rate. Normal breathing can be aided by talking aloud.

ALCOHOL

Common sense and scientific evidence dictate that you must not fly as a crew member while under the influence of alcohol. Alcohol, even in small amounts, produces (among other things):

- A dulling of critical judgement.
- A decreased sense of responsibility.
- Diminished skill reactions and coordination.
- Decreased speed and strength of muscular reflexes (even after one ounce of alcohol).
- Decreases in efficiency of eye movements during reading (after one ounce of alcohol).
- Increased frequency of errors (after one ounce of alcohol).
- Constriction of visual fields.
- Decreased ability to see under dim illuminations.
- Loss of efficiency of sense of touch.
- Decrease of memory and reasoning ability.

Section X
Safety Information

Dechcraft
Single Engine (Piston)

- Increased susceptibility to fatigue and decreased attention span.
- Decreased relevance of response.
- Increased self confidence with decreased insight into immediate capabilities.

Tests have shown that pilots commit major errors of judgment and procedure at blood alcohol levels substantially less than the minimum legal levels of intoxication for most states. These tests further show a continuation of impairment from alcohol up to as many as 14 hours after consumption, with no appreciable diminution of impairment. The body metabolizes ingested alcohol at a rate of about one-third of an ounce per hour. Even after the body completely destroys a moderate amount of alcohol, a pilot can still be severely impaired for many hours by hangover. The effects of alcohol on the body are magnified at altitudes, as 2 oz. of alcohol at 18,000 feet produce the same adverse effects as 6 oz. at sea level.

Federal Aviation Regulations have been amended to reflect the FAA's growing concern with the effects of alcohol impairment. FAR 91 states:

"Alcohol or drugs.

(a) No person may act or attempt to act as a crew-member of a civil aircraft -

- (1) Within 8 hours after the consumption of any alcoholic beverage;
- (2) While under the influence of alcohol;
- (3) While using any drug that affects the person's faculties in any way contrary to safety; or
- (4) While having .04 percent by weight or more alcohol in the blood.

(b) Except in an emergency, no pilot of a civil aircraft may allow a person who appears to be intoxicated or who demonstrates by manner or physical indications that the individual is under the influence of drugs (except a medical patient under proper care) to be carried in that aircraft."

Because of the slow destruction of alcohol by the body, a pilot may still be under influence eight hours after drinking a moderate amount of alcohol. Therefore, an excellent rule is to allow at least 12 to 24 hours between "bottle and throttle," depending on the amount of alcoholic beverage consumed.

DRUGS

Self-medication or taking medicine in any form when you are flying can be extremely hazardous. Even simple home or over-the-counter remedies and drugs such as aspirin, anti-histamines, cold tablets, cough mixtures, laxatives, tranquilizers, and appetite suppressors, may seriously impair the judgment and coordination needed while flying. The safest rule is to take no medicine before or while flying, except after consultation with your Aviation Medical Examiner.

SCUBA DIVING

Flying shortly after any prolonged scuba diving could be dangerous. Under the increased pressure of the water, excess nitrogen is absorbed into your system. If sufficient time has not elapsed prior to takeoff for your system to rid itself of this excess gas, you may experience the bends at altitudes even under 10,000 feet, where most light planes fly.

CARBON MONOXIDE AND NIGHT VISION

The presence of carbon monoxide results in hypoxia which will affect night vision in the same manner and extent as hypoxia from high altitudes. Even small levels of carbon

monoxide have the same effect as an altitude increase of 8,000 to 10,000 feet. Smoking several cigarettes can result in a carbon monoxide saturation sufficient to affect visual sensitivity equal to an increase of 8,000 feet altitude.

DECOMPRESSION SICKNESS

Pilots flying unpressurized airplanes at altitudes in excess of 10,000 feet should be alert for the symptoms of 'decompression sickness'. This phenomenon, while rare, can impair the pilot's ability to perform and in extreme cases, can result in the victim being rendered unconscious. Decompression sickness, also known as dysbarism and aviators "bends", is caused by nitrogen bubble formation in body tissue as the ambient air pressure is reduced by climbing to higher altitudes. The symptoms are pain in the joints, abdominal cramps, burning sensations in the skin, visual impairment and numbness. Some of these symptoms are similar to hypoxia. The only known remedy for decompression sickness is recompression, which can only be accomplished in an unpressurized airplane by descending. The pilot should immediately descend if it is suspected that this condition exists, since the effects will only worsen with continued exposure to the reduced pressure environment at altitude and could result, if uncorrected, in complete incapacitation. The possibility of decompression sickness can be greatly reduced by pre-breathing oxygen prior to flight and by commencing oxygen breathing well below the altitudes where it is legally mandatory.

A FINAL WORD

Airplanes are truly remarkable machines. They enable us to shrink distance and time, and to expand our business and personal horizons in ways that, not too many years ago, were virtually inconceivable. For many businesses, the general aviation airplane has become the indispensable tool of efficiency.

Advances in the mechanical reliability of the airplanes we fly have been equally impressive, as attested by the steadily declining statistics of accidents attributed to mechanical causes, at a time when the airframe, systems and power plants have grown infinitely more complex. The explosion in capability of avionics systems is even more remarkable. Radar, RNAV, LORAN, sophisticated autopilots and other devices which, just a few years ago, were too large and prohibitively expensive for general aviation size airplanes, are becoming increasingly commonplace in even the smallest airplanes.

It is thus that this Safety Information is directed to the pilot, for it is in the area of the skill and proficiency of you, the pilot, that the greatest gains in safe flying are to be made over the years to come. Intimate knowledge of your airplane, its capabilities and its limitations, and disciplined adherence to the procedures for your airplane's operation, will enable you to transform potential tragedy into an interesting hangar story when - as it inevitably will - the abnormal situation is presented.

Know your airplane's limitations, and your own. Never exceed either.

Safe flying,

BEECH AIRCRAFT CORPORATION

THIS PAGE INTENTIONALLY LEFT BLANK