

Modification and preservation of environmental signals in speleothems

Fairchild, Ian; Smith, Claire; Baker, Andrew; Fuller, Lisa; Spotl, C; Matthey, D; McDermott, F

DOI:

[10.1016/j.earscirev.2005.08.003](https://doi.org/10.1016/j.earscirev.2005.08.003)

Citation for published version (Harvard):

Fairchild, I, Smith, C, Baker, A, Fuller, L, Spotl, C, Matthey, D & McDermott, F 2006, 'Modification and preservation of environmental signals in speleothems', *Earth Science Reviews*, vol. 75, pp. 105-153. <https://doi.org/10.1016/j.earscirev.2005.08.003>

[Link to publication on Research at Birmingham portal](#)

General rights

Unless a licence is specified above, all rights (including copyright and moral rights) in this document are retained by the authors and/or the copyright holders. The express permission of the copyright holder must be obtained for any use of this material other than for purposes permitted by law.

- Users may freely distribute the URL that is used to identify this publication.
- Users may download and/or print one copy of the publication from the University of Birmingham research portal for the purpose of private study or non-commercial research.
- User may use extracts from the document in line with the concept of 'fair dealing' under the Copyright, Designs and Patents Act 1988 (?)
- Users may not further distribute the material nor use it for the purposes of commercial gain.

Where a licence is displayed above, please note the terms and conditions of the licence govern your use of this document.

When citing, please reference the published version.

Take down policy

While the University of Birmingham exercises care and attention in making items available there are rare occasions when an item has been uploaded in error or has been deemed to be commercially or otherwise sensitive.

If you believe that this is the case for this document, please contact UBIRA@lists.bham.ac.uk providing details and we will remove access to the work immediately and investigate.

Modification and preservation of environmental signals in speleothems

Ian J. Fairchild^{1,2}, Claire L. Smith², Andy Baker², Lisa Fuller², Christoph Spötl³, Dave Matthey⁴, Frank McDermott⁵ and E.I.M.F.⁶

²*School of Geography, Earth and Environmental Sciences, University of Birmingham, Edgbaston, Birmingham B15 2TT, UK*

³*Institut für Geologie und Paläontologie, Leopold-Franzens-Universität Innsbruck, Innrain 52, 6020 Innsbruck, Austria*

⁴*Department of Geology, Royal Holloway University of London, Egham, Surrey TW20 0EX, UK*

⁵*Department of Geology, University College Dublin, Belfield, Dublin 4, Ireland*

⁶*Edinburgh Ion Microprobe Facility, Institute of Earth Science, School of Geosciences, University of Edinburgh EH9 3JW, UK*

Abstract

Speleothems are primarily studied in order to generate archives of climatic change and results have led to significant advances in identifying and dating major shifts in the climate system. However, the climatological meaning of many speleothem records cannot be interpreted unequivocally; this is particularly so for more subtle shifts and shorter time periods, but the use of multiple proxies and improving understanding of formation mechanisms offers a clear way forward.

An explicit description of speleothem records as time series draws attention to the nature and importance of the signal filtering processes by which the weather, the seasons and longer-term climatic and other environmental fluctuations become encoded in speleothems. We distinguish five sources of variation that influence speleothem geochemistry: atmospheric, vegetation/soil, karstic aquifer, primary speleothem crystal growth and secondary alteration and give specific examples of their influence. The direct role of climate diminishes progressively through these five factors.

We identify and review a number of processes identified in recent and current work that bear significantly on the conventional interpretation of speleothem records, for example:

1) speleothem geochemistry can vary seasonally and hence a research need is to establish the proportion of growth attributable to different seasons and whether this varies over time.

2) whereas there has traditionally been a focus on monthly mean $\delta^{18}\text{O}$ data of atmospheric moisture, current work emphasizes the importance of understanding the synoptic processes that lead to characteristic isotope signals, since changing relative abundance of different weather types might

control their variation on the longer-term.

3) the ecosystem and soil zone overlying the cave fundamentally imprint the carbon and trace element signals and can show characteristic variations with time.

4) new modelling on aquifer plumbing allows quantification of the effects of aquifer mixing.

5) recent work has emphasized the importance and seasonal variability of CO_2 -degassing leading to calcite precipitation upflow of a depositional site on carbon isotope and trace element composition of speleothems.

6) Although much is known about the chemical partitioning between water and stalagmites, variability in relation to crystal growth mechanisms and kinetics is a research frontier.

7) Aragonite is susceptible to conversion to calcite with major loss of chemical information, but the controls on the rate of this process are obscure.

Analytical factors are critical to generate high-resolution speleothem records. A variety of methods of trace element analysis are available, but standardization is a common problem with the most rapid methods. New stable isotope data on Irish stalagmite CC3 compares rapid laser-ablation techniques with the conventional analysis of micromilled powders and ion microprobe methods. A high degree of comparability between techniques for $\delta^{18}\text{O}$ is found on the mm-cm scale, but a previously described high-amplitude oxygen isotope excursion around 8.3 ka is identified as an analytical artefact related to fractionation of the laser-analysis associated with sample cracking. High-frequency variability of not less than 0.5‰ may be an inherent feature of speleothem $\delta^{18}\text{O}$ records.

Keywords: speleothems, stable isotopes, trace elements, palaeoclimate, time series analysis, karst

1. Introduction

Calcareous speleothems (cave precipitates) have proved attractive to palaeoclimatologists for a number of reasons. For example, they can grow continuously for 10^3 – 10^5 years and be precisely and accurately dated by U-series methods. They capture the cave's response to the external environment (cave temperature is around the mean annual external temperature and dripwater discharge reflects the amount of infiltration), and generally show little secondary alteration. This article focuses on the preservation of environmental and climatic signals in such speleothems, with emphasis on geochemical parameters. We pay particular attention to the degree of preservation of time-varying signals from the external environment in speleothem records (Fig 1a) and explain how the karstic system modifies the signals. This way of synthesizing the interpretation of speleothem records is new and is designed to complement and build on several excellent recent reviews, including those of Darling (2004) and Darling et al. (2005) on water isotopes, McDermott (2004) and McDermott et al. (2005) on stable isotopes in speleothems, Richards and Dorale (2003) and Dorale et al. (2004) on uranium-series dating of speleothems, Harmon et al. (2004) on modern calibrations, McGarry and Baker (2000) and McGarry and Caseldine (2004) on organic components, and Lauritzen (2003) and White (2004) on the approaches to the generation of speleothem palaeoclimate records. A companion article (Fairchild et al., 2006) emphasizes the geomorphological context of

¹Corresponding author, fax +44(0)1214145528, E-mail: i.j.fairchild@bham.ac.uk

speleothems, and discusses their physical fabrics and lamination in relation to their geochemistry, but does not deal with time series issues.

outline general approaches to time series in general and examine the ways in which time series are generated from speleothems, with new examples of the use of comparative techniques and spatial scales of sampling to illustrate the

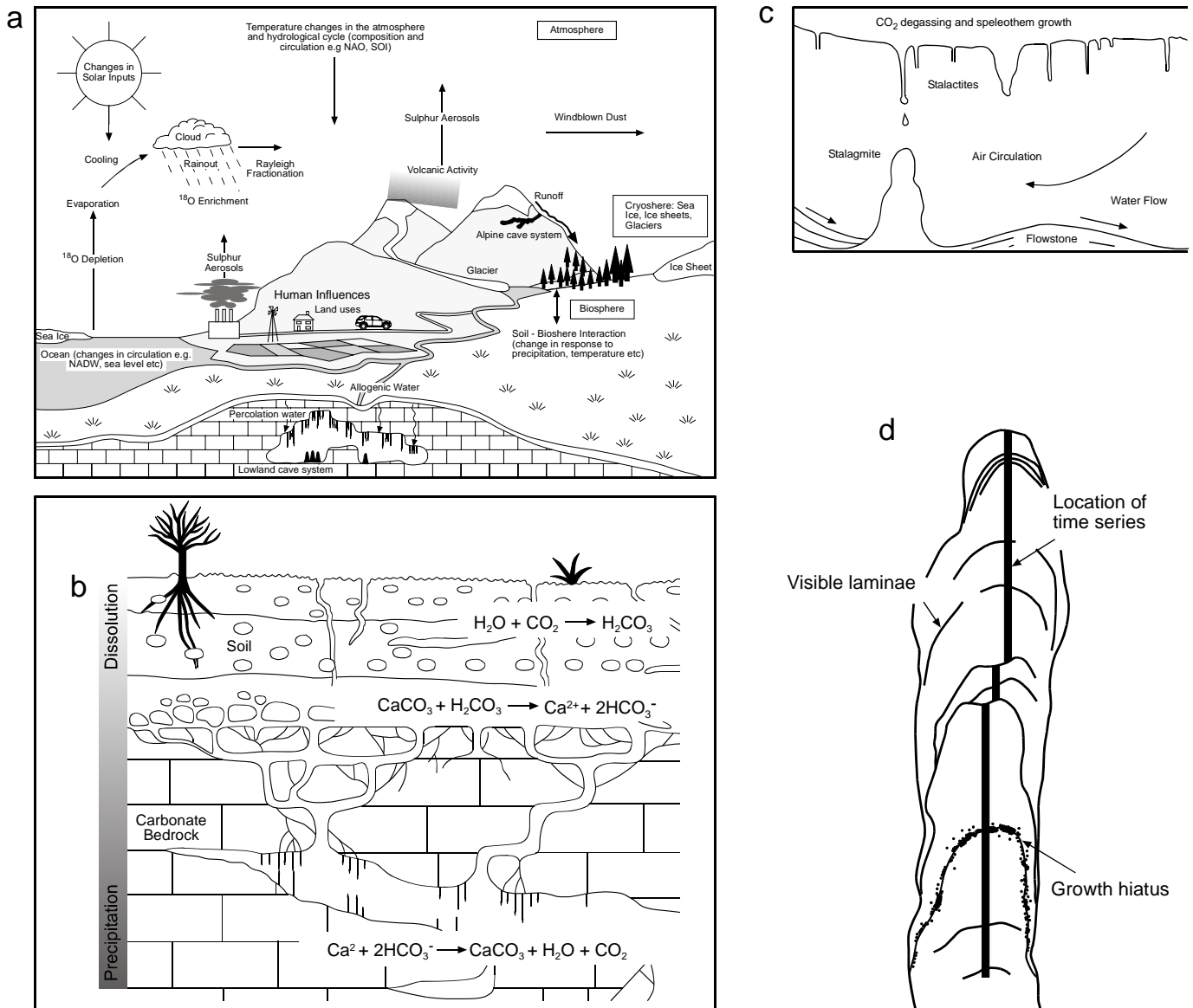

Figure 1. The setting of speleothems and their derived geochemical time series. **a.** Relationships of speleothems to external climate-drivers (adapted from Houghton et al., 2001). **b.** the dissolutional and precipitational regimes of the karstic system (adapted from Tooth, 2000), **c.** Processes in the cave environment, **d.** A slabbed stalagmite illustrating the relationship of growth features to the location of the time series. Stalagmites are normally studied in polished slabs perpendicular to the direction of their maximum growth, but transverse sections of stalactites have also been used. Often a reference half of the specimen is retained and the remaining quarters are each used for sub-sampling, with a focus on the parts closest to the centre of the structure where laminae are sub-horizontal, and where any evaporation effects are minimized.

principles. In the remainder of the paper, we systematically examine how atmospheric/climatic/external environmental time series become modified and preserved. Section 3 focuses on the external forcing series and highlights instances where they are the dominant component of the resulting speleothem records. Section 4 shows the effects of the soil zone coupled with the adjacent top of the karstic aquifer in modifying the external signal and generating new types of proxy record. Section 5 deals with the signal modifications introduced by the movements of water and air through the karstic aquifer, including amplifications of the annual signal. Section 6 shows how the signal carried by the dripwater in the cave is further modified by precipitation of CaCO₃. Section 7 illustrates those circumstances where secondary (diagenetic) changes influence speleothem composition, and section 8 together with Table 4 provide a summary of the outcomes of the review.

The structure of this paper is as follows. The remainder of section 1 outlines the nature of speleothems and issues related to the historical development of their study. In section 2, we

1.1 The environment and nature of speleothems

The context of speleothems is a cave environment in a karstified carbonate aquifer; that is a rock mass in which cavity development is so extensive that there is little or no surface drainage of water. Soil in such an environment overlies a highly fissured zone, termed the *epikarst* or *subcutaneous zone*. The epikarst functions as a perched aquifer which feeds both major conduits, and lower transmissivity fissures which in turn tend to feed zones of dripwater in caves. Figure 1b makes a fundamental distinction between two regions with different geochemical functioning. The *dissolution region* of the soil and upper epikarst is dominated by the process of carbonate dissolution in contact with waters of relatively high PCO_2 derived from plant respiration and organic matter decay. In contrast, the *precipitation region* refers to the location of carbonate supersaturation and speleothem precipitation induced by degassing of CO_2 from descending waters into cave and fissure 'air'. Even though temperature may vary little in cave interiors, the pattern of the external seasons can be marked by changes in quantity and chemistry of dripping water and by varying CO_2 concentration of the cave atmosphere, sometimes associated with differing patterns of air circulation (Figure 1c). This leads to seasonal variations in the rate of carbonate precipitation.

Three principal types of speleothems have been used for palaeoenvironmental studies. Flowstone is a generic term for laminated deposits on the floor or walls of caves that form from sheets of flowing water derived from relatively strong water flows from fissures or conduits. Although they have the useful property of being laterally extensive, which allows for repeated sampling by coring (e.g. Hellstrom et al., 1998), the internal stratigraphy of flowstones is commonly complex because of non-uniform calcite growth rates across the flowstone surface (Baker and Smart, 1995) and flow-switching behaviour. They tend to have high impurity contents; in such cases they can be difficult to date by U-series methods (Richards and Dorale, 2003).

Hollow cylindrical *soda-straw* stalactites are often associated with seepage zones on cave ceilings, but they are very delicate and typically only record the youngest few decades of a cave record (Moore, 1962; Huang et al., 2001). Massive stalactites are conical growths from cave ceilings which display an internal growth layering parallel to the surface. Stalactites, sliced parallel to or perpendicular to their length have been used in the highly successful palaeoclimate work at Soreq and other Israeli caves (e.g. Bar-Matthews et al., 2003), and their use is favoured for conservation reasons, since they are more commonly found fallen by natural processes.

Most workers favour the use of stalagmites growing upwards from the cave floor, particularly cylindrical types, because of their relatively simple growth geometry. The shape and diameter of a stalagmite depends on water flow rate (narrower for low flows), water supersaturation (more supersaturated waters may tend to precipitate more irregularly), and drop fall height (diameter increases with fall height). Modelling studies have been used to suggest that variations in growth conditions could be deduced from speleothem shape (Kaufmann and Dreybrodt, 2004), but in practice changes in the overlying

regolith (Fairchild et al., 2006) and the feeding system of drips could occur, particularly on the longer-term. Real stalagmites often show growth hiatuses, evidence for changing drip location and long-term evolutionary development (Figure 1d). The effects specifically of climate on morphology can be difficult to disentangle.

Speleothems vary from compact to porous, and contain from zero to tens of percent impurities (typically clay minerals with some organic matter). Calcitic examples tend to develop relative large crystal units, elongated parallel to growth and typically with a large number of component crystallites varying in their degree of optical continuity (Kendall and Broughton, 1978; Frisia et al., 2000), whereas most aragonitic examples show fibrous crystals parallel to the growth direction (Hill and Forti, 1997). Stalactites and stalagmites are covered by a water film typically only 50–100 μm in thickness (Dreybrodt, 1988; Baker et al., 1998) and have surface growth irregularities on the <1–10 μm scale, particularly between crystallites. Consequently fluid inclusions, both of air and water are found within speleothems. They are often elongate parallel to the growth direction and typically make up 0.05 to 0.5 wt % of the speleothem (McDermott et al., 2005). Most speleothems show variations in crystal texture or impurities giving rise to fine lamination or large-scale banding, which reveals the history of the growth surface, and hence aids the construction of geochemical time series (Figure 1d).

Comparison of observed Ca contents of cave waters with theoretical models of stalagmite growth (Dreybrodt, 1988; Genty et al., 2001a) leads to predicted maximal growth (extension) rates of around 70–100 $\mu\text{m}/\text{yr}$ at 6°C to 800 μm at 13°C (Fairchild et al., in press a), but rates are commonly much slower because of high cave PCO_2 or low drip rate. In practice, typical cool temperate stalagmites grow at 10–100 $\mu\text{m}/\text{yr}$ compared with 300–500 $\mu\text{m}/\text{yr}$ (rarely 1 mm/yr) in sub-tropical climates.

1.2 The progress of speleothem studies and the future agenda

Historically, geochemical studies of speleothems have had two prominent strands: the measurement of disequilibrium in uranium series isotopes to determine the timing of speleothem formation (e.g. Atkinson et al., 1978), and the generation of oxygen isotope time series in an attempt to elucidate palaeotemperatures (Gascoyne, 1992). In the latter case, the attraction was the useful property of cave interiors to be close to the mean annual external temperature. Speleothem studies followed in the wake of the revolution to our understanding of Quaternary climates wrought by oxygen isotope measurements of foraminifera in deep sea sediment cores (Emiliani, 1955; 1972; Shackleton and Opdyke, 1967) and water isotopes in ice cores (Johnsen et al., 1972). However, the early promise of generation of palaeotemperature records from oxygen isotopes in speleothem carbonates and hydrogen and oxygen isotopes from their fluid inclusions (e.g. Hendy and Wilson, 1968; Duplessy et al., 1970; Thompson et al., 1974; Harmon et al., 1979; Gascoyne et al., 1980; Schwarcz, 1986) proved difficult to fulfil during the 1980s to early 1990s. Similarly, the earlier hopes of a long-term temperature control on Mg abundance (Gascoyne, 1983) have proved to be over-simplified, whereas

carbon isotopes were already known to have multiple controls (Wigley et al., 1978; Schwarcz, 1986).

Three factors that hindered progress are identified here. Firstly, the difficulties associated with reproducible extraction and analysis of fluid inclusion water prevented a simple solution to the palaeotemperature equation for oxygen isotopes in speleothem carbonate. As a response to this, strategies were developed to calibrate the relationship of $\delta^{18}\text{O}$ in atmospheric moisture (and hence also in speleothems) to temperature in the longer term, a particularly elegant example being that of Lauritzen and Lundberg (1999), a pattern also followed by Mangini et al. (2005). Secondly, the nature and relative importance of complicating processes in the karst and cave system had been insufficiently researched. There is much site-specific behaviour, and indeed some unique geochemical characteristics of individual drips that, combined with logistical difficulties in accessing cave environments, proved a significant obstacle. Thirdly, there was an over-simplified view of the controls on meteoric water isotope composition and its relationship to temperature. We now should be cautious about treating isotope values as palaeothermometers, even in ice cores (e.g. Noone and Simmonds, 1998; Alley and Cuffey, 2001; Krinner and Werner, 2003; Masson-Delmotte et al., 2005), because of the limitations of calibrations under modern conditions to different climate regimes.

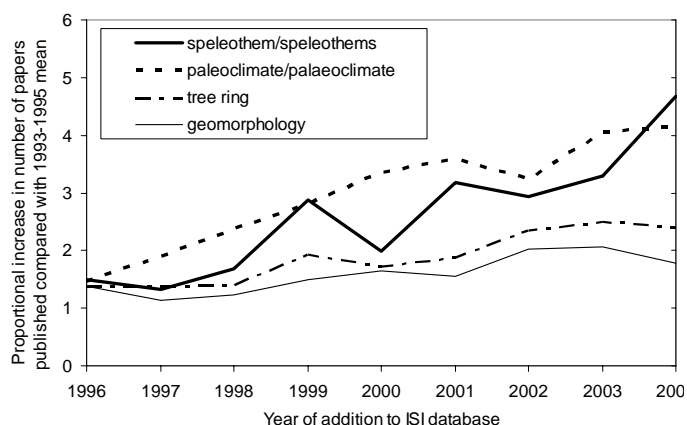

Figure 2. Plot of the increase in number of published papers on the ISI's Web of Science® database which use particular words in the title, keywords, or abstract. Geomorphology is used to illustrate the trend for a mature subject area where the increase includes a factor (c. 1.6 to 2002–2004, see text) related to wider coverage of journals by the database. The increase in speleothem literature is much higher than that on tree rings, but this is only comparable with that of palaeoclimate studies as a whole. Data for 2004 hint at a further relative rise in speleothem studies.

The rate of publication of articles in international journals (using the ISI Web of Science® database) provides insight into the progress of the science. Searching for *speleothem* or *speleothems* in the title (abstracts only became generally available around 1993) shows relatively constant figures of 13, 9 and 11 published papers for the 3 year periods of 1981–83, 1984–86 and 1987–89 respectively, increasing to 19 and 18 for 1990–92 and 1993–95 respectively. Figure 2 presents a comparison of data over the past 9 years with the mean of the

years 1993–1995. Over this period, the journal coverage of the database and the global rate of publication has expanded, as can be judged quantitatively by the proportional increase by a factor of 1.6 ± 0.2 ($n = 4$) of papers containing generic words like ('result', 'reviewed', 'process/processes' and 'introduction' were used). There has been a somewhat greater rate of increase of the use of terms characterizing mature sub-disciplines in the geosciences and environmental sciences such as 'geomorphology' (1.97) and 'tree ring' (2.42), whereas there has been a more radical growth in the use of the terms 'palaeoclimate'/paleoclimate' (3.82) and 'speleothem'/speleothems' (3.64).

A key reason for the recent rapidly increasing impact of speleothem studies is the application of thermal ionization mass spectrometric methods of U-series dating (Edwards et al., 1987), which offered much smaller sample size, and hence better time-resolution, than the original alpha spectrometric counting methods (Goldstein and Stirling, 2003; Richards and Dorale, 2003). This enabled the inherent advantages of speleothems as palaeoenvironmental proxies to be opened up: speleothems can usually be precisely dated, they contain a number of physical and chemical proxy variables, and can be studied on a wide variety of timescales from sub-annual to hundreds of thousands of years.

Most attention has been paid to speleothem records on the long (10^4 – 10^5 year) timescale, with particular emphasis on oxygen isotope studies. For example, the pioneering studies in Soreq cave, Israel, clearly established the land-sea linkage of climate in the eastern Mediterranean on glacial-interglacial timescales (Bar-Matthews et al., 1999, 2003) and speleothems in Alpine and monsoonal climates have not only demonstrated the preservation of reorganizations of the climate system in speleothems during the last glacial period, but also significantly improved their dating (e.g. Wang et al., 2001; Spötl and Mangini, 2002). Speleothems in sensitive climate zones are also providing important insights into Holocene climate (see section 2.3). Overall, there is an increased acceptance of their power in, for example, dating significant climatic thresholds and demonstrating changes in palaeohydrology (Bradley, 1999; Jones and Mann, 2004). Speleothem insights on the major long-term evolution of the climate system will become increasingly important, but speleothems also contain much high-resolution information which is now also starting to be unlocked.

The key for the understanding of more subtle variations in speleothem properties, and those on shorter timescales, is an understanding of formation processes, coupled with parallel studies on the climate system on comparable timescales. Many speleothem studies contain interpretations of palaeoclimate conditions from geochemical proxies that are equivocal, or even speculative, because of insufficient understanding of the meaning of the proxy. They can only be tested by evaluating further, more detailed, proxy records. A great deal of work over the past 15 years has laid the foundation of a better process understanding of speleothem formation (sections 3 to 6). Now that instrumental developments permit high-resolution multi-proxy records to be obtained (section 2.4), we are on the brink of an explosion of new work that will realize the potential of the enormous temporal dynamic range of speleothem records.

In this review we examine both spatial and temporal variables. Geographic variations in climatic factors are crucial variables that control the delivery and isotope composition of atmospheric moisture, and constrain the limits (dry, cold, terrestrial) of speleothem growth. Geochemical results are typically plotted against time or distance as *time series* (Weedon, 2003). The relationship between the speleothem series and the forcing series has not previously been systematically reviewed, and we do so here in a process context.

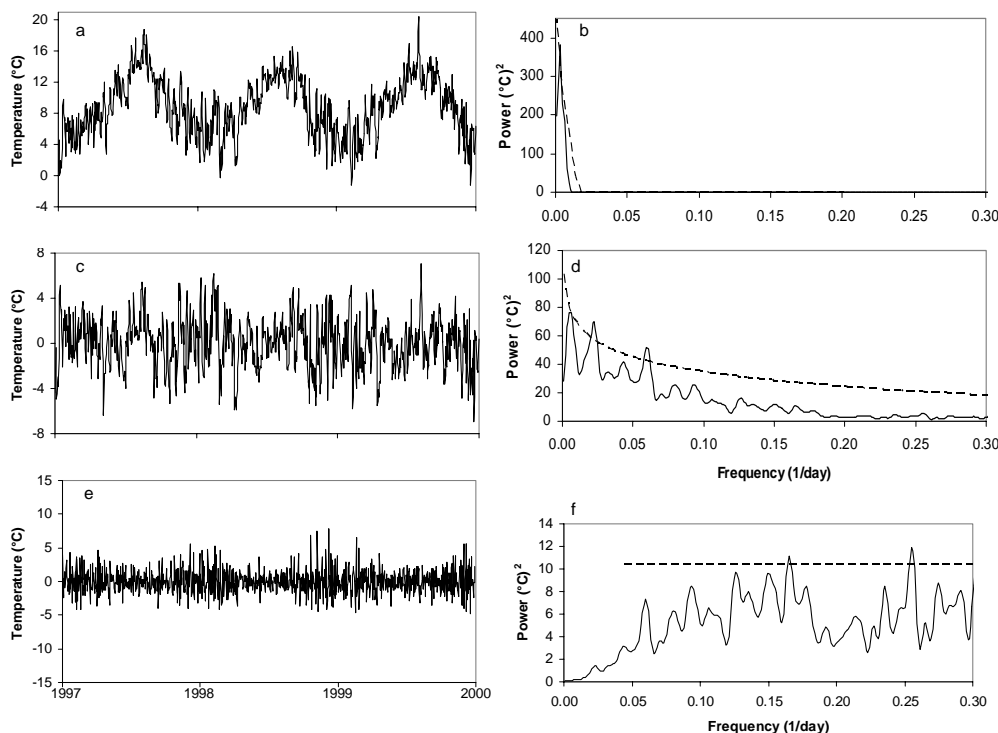

*Figure 3. Illustration of some properties of time series using three years of daily temperature data from Stornoway, western Scotland as an example. The power spectra (b, d, f) illustrate the variation of the square of the temperature (power) with frequency of variation. Spectral analysis was performed with SPECTRUM software (Schulz and Statterger, 1997). Dashed lines in power spectra denote 95% confidence limit of significant spectral power (using approximately eight Hanning windows depending on resolution and length of series). a. raw data with a modelled annual cycle superimposed. b. most of the time series power is on the annual cycle (peak frequency 1/365). c. signal remaining when the annual cycle, modelled by a sine wave, is removed. Autocorrelation is still present, and can be attributed to the occurrence of synoptic weather conditions. d. Autocorrelated features show much low-frequency power (red noise pattern with some peaks, especially at frequencies of <0.1 , i.e. >10 days, corresponding to blocking weather patterns). e. Removal of the autocorrelation ('pre-whitening') leaves residual noise. The noise has higher amplitude in the winter. The procedure used was such that each pre-whitened temperature value at time $t(T_p)_t = T_t - T_{t-1} * \rho_1$ where T_t is the unwhitened value and ρ_1 is the coefficient of autocorrelation of the series with itself at a lag of one value. f. The remaining power spectrum has the characteristics of white noise. An effect of pre-processing is to enhance the significance level of very minor features of the raw data.*

Hence there are two apparently significant peaks; synthetic noise can also show such peaks, whereas a real peak should be present in power spectra constructed using different parts of the dataset.

2. Signal capture by speleothems

In this section, we examine some of the important characteristics of time series in general, and summarize the production of speleothem time series. We then discuss the need

for better understanding of high-resolution issues (synoptic-scale isotope variations and the controls of seasonality on caves and speleothems) in order to understand their impact on longer-term variations. Our ability to recover records at high resolution depends fundamentally on our analytical capability and this is discussed both for trace elements and stable isotopes. New isotope data demonstrate inherent variability at the highest spatial resolution and indicate that a previously described large isotope anomaly at 8.3 ka BP in a speleothem from Crag Cave is not real.

2.1 Time series concepts

Given the increasing use of time-series in speleothem studies, we review some important general concepts in this section, in order to facilitate understanding of later sections. If common structures are found by time series analysis within both climatic and proxy variable records, these observations can help determine how much of the variability within the proxy series can be explained by climate forcing. Climate time series are generally comprised of stochastic noise plus regular cyclic components and also exhibit a tendency for values to persist, the property of autocorrelation, that is the degree to which a value depends on previous values in the series (Figure 3). It is the deterministic, periodic component which has attracted most attention from researchers guided by the possible predictability of climate, but a broader focus on all aspects that can yield process information will arguably prove most useful.

Spectral analysis is commonly used to extract the frequency, phase and amplitude of cycles within a proxy time series (Figure 3). However, the effects of smoothing and aliasing (section 2.4.3), and the short duration of most series, limit the extent to which spectral analyses alone are capable of reliably distinguishing climate phenomena within the proxy series (Burroughs, 1992), and as such, should be interpreted with caution. Moreover, it is important to recognise that 'significant' spectral peaks often account for a comparatively low proportion of overall record variability (Wunsch, 2004). For example, Mills (2004) modelled that a deterministic component explains only 15% of the North Atlantic Oscillation series. At the low-

frequency end of the spectrum, the necessarily small sample size makes periodicities difficult to distinguish from stochastic processes (Wunsch, 2004) because there may be few or no cycle repetitions contained within the series.

The power spectrum provides a visually potent means by which periodic structure above a certain confidence threshold can be identified (Figure 3b). White noise can be defined in this context as the situation where a time series shows equal power across a range of frequencies (Figure 3f) and is wholly non-deterministic. Conversely, where energy monotonically decreases as the frequency increases, this is described as red noise. 'Reddening' of the spectrum will arise from autocorrelation (Figure 3d). There has generally been less interest in autocorrelation phenomena than in periodicity in proxy climate time series, an exception being the removal of the memory of the previous year's climatic conditions in the properties of a tree ring in a given year (Cook, 1992). Figures 3c,d illustrates the encoding of process information (in this case presumably the presence of blocking synoptic weather systems) in the autocorrelated variation that remains when the annual cycle is removed from a temperature dataset. The removal of periodic and autocorrelative components from a time series leaves residual white noise (Figure 3f).

A time series is said to be stationary if the power spectrum is the same for any subset of the series. Wavelet analysis offers a useful tool for examining the stationarity of a climate signal over time. Many shorter term periodicities display significant non-stationarity (e.g. Torrence and Compo, 1998), but stationarity of longer period cycles is more difficult to determine due to the limited number of repeat events occurring in a record of restricted length. In this paper we focus primarily on stationary parts of time series, but see Proctor et al. (2002), Holmgren et al. (2003) and Lachniet et al. (2004) for examples of wavelet analysis of speleothem data.

2.2 Speleothem time series

Geochemical time series of speleothems are constructed by transformation of the time series from the distance domain (Figure 1d) to the time domain via an age-model. Normally U-series methods provide basis of the age model, but individual dates are subject to errors that rarely fall below 0.5% (two sigma) of the age, and can be as high as several % where the U content is low, or where there is contamination by detritus (section 2.4.3). U-series dating is expensive and construction of a well-constrained age-model consumes much of the resources in long-term palaeoclimate studies. Certain methodological issues have not been standardized, for example how to interpolate between dates. Linear interpolation has the advantage of simplicity, but in a statistical simulation study of the construction of radiocarbon age models, Telford et al. (2004) found that interpolation using a cubic spline function offered the most accurate representation. Although long-term speleothem growth rates can be quasi-linear (e.g. Cruz et al., 2005a; Wang et al., 2005), there are many exceptions (e.g. Linge et al., 2001a; Plagnes et al., 2002); such varying growth rate increases age uncertainties of time series. The aim should be to provide robust error estimates of the age model, but this is currently limited by insufficient understanding of the change in growth rates over time.

Studies of thickness variation of annual laminae (e.g. Proctor et al., 2000; 2002; Polyak and Asmerom, 2001; Burns et al., 2002; Frisia et al., 2003; Tan et al., 2003; Fleitmann et al., 2004) demonstrate that growth rate itself has a climate sensitivity, as expected from theoretical considerations (Dreybrodt, 1988; Kaufman, 2003; Kaufmann and Dreybrodt, 2004). Ideally, the characteristic sensitivity of growth rate to forcing factors should be determined as part of any speleothem palaeoclimate study that seeks to study the preservation of characteristic atmospheric forcing variability. This is made more feasible because annual variation in speleothems can be expressed by lamina couplets (e.g. Railsback et al., 1994; Genty and Quinif, 1996), or by event laminae which may be visible in ultraviolet fluorescence (Baker et al., 1993; Shopov et al., 1994) or transmitted light (Fairchild et al., 2001; in press a). Additionally, trace element fluctuations commonly define annual variation (Roberts et al., 1998; Huang et al., 2001; Fairchild et al., 2001; Finch et al., 2001; Treble et al., 2003) and can be used to define the duration of climatically significant periods (Baldini et al., 2002, but see section 2.5.2; McMillan et al., 2005). Since these methods too are time-consuming, much work remains to be done. In summary, the additional (often unquantified) uncertainties associated with transforming from distance to time must be borne in mind.

2.3 Relationships between short-term and long-term speleothem geochemical variability

Viles and Goudie (2003) have reviewed the complex issues relating modes of climate variability to their geomorphic products and speleothems are a good example of such a product. As will be discussed in section 3, speleothems exhibit patterns of variability in over a range of four orders of magnitude, from seasonal to tens of thousands of years. In suitably sensitive settings, specific external drivers can be identified by characteristic periodicities. The timing of change (lead or lag) in relation to other climate proxies also provides important information. The interpretation of the processes that link drivers to speleothem patterns is however dependent on understanding the basic building blocks of variation on the shorter timescales.

Figure 4a illustrates three types of change of a driving or response parameter resulting in the same shift in mean parameter values. The simplest type - a shift in the entire signal pattern without change in its shape - is perhaps the least likely. For example, global warming over the last three decades has differentially affected the seasons and the diurnal cycle of temperature (Houghton et al., 2001). However, Figure 4b illustrates that shifts in the entire signal pattern can occur in speleothem geochemical series (e.g. around the 7 mm mark in the figure).

The second type displays a loss of part of the original signal because of some threshold being exceeded. For example, rainfall variation in Africa is characterized by the multi-decadal persistence of anomalies (Nicholson, 2000) which, in particular locations may see the temporary loss of precipitation in a particular season. A speleothem case is the seasonal cessation of growth either because the feeding drip ceases to flow in a dry season, or because flows in the wet season become very strong, and the water is no longer supersaturated for CaCO₃. On the

long timescale, Baker et al. (1995) showed an example from England where flowstone growth was restricted to periods of high summer insolation within the period 40–130 ka.

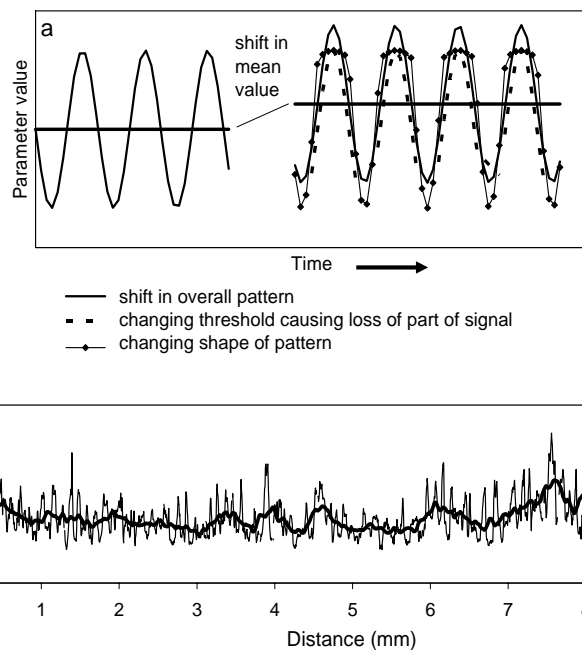

Figure 4. a. Different modes of change of the mean value of a forcing parameter or measured speleothem property (see text for discussion). b. Example of ion probe analysis of mg in 10 mm 20th-century segment of stalagmite(Obi 84, Obir cave, SE Austria). Raw data at 5 μ m intervals compared with 50-point moving average. The high-frequency variation is on the annual scale (around 77 years are represented); longer-term variations locally reflect a shift in all values, but more generally mainly reflect the annual maximum.

The third type – a change in the shape of the pattern of the parameter – is the most generally applicable and there are numerous climatological examples such as changes in synoptic weather patterns coinciding with recent warming in the North Atlantic (Hurrell, 1995) and changes in the seasonality of precipitation over Greenland during glacials (Denton et al., 2005). Much of the speleothem data from Figure 4b exhibit this type of behaviour. The data are drawn from a speleothem in the Austrian Obir cave which is strongly influenced by strong degassing by enhanced airflow in the winter (Spötl et al., 2005) that would be expected to lead to seasonally enhanced $\delta^{13}\text{C}$ and Mg values. The main factor causing long-term variation is the annual maximum value of Mg reached, which is consistent with the knowledge of prior precipitation processes (section 5.4) at the site.

In section 3 we review evidence of large variations in the oxygen isotope composition of precipitation on synoptic and seasonal timescales. Day-to-day variations are much more dramatic than the differences between monthly values, and monthly variation is often stronger than the long-term change in annual mean values. In sections 4 and 5, we illustrate how the seasonality of cave conditions is imprinted on speleothems in terms of strongly varying seasonal composition. Such variations can be larger than the shifts in mean composition over much longer timescales. This accounts for our emphasis

on the research needs to understand the processes responsible for high-frequency variation in order to understand their potential impact on longer timescales.

2.4 Recovery of the signal: analytical issues

The last 10–15 years has seen rapid advances both in the range of proxies recovered from speleothems that are arguably of palaeoenvironmental significance, and of instruments capable of carrying out precise analyses of geochemical proxies using ever-smaller sample sizes. This allows scientific problems associated with shorter timescales and more slowly-growing stalagmites to be tackled. Investigation of new proxies is still an important frontier area, but there is also a crucial need for wise multi-proxy investigations making best use of the limited material, since speleothems yielding long-term records are a non-renewable resource.

2.4.1 Trace element analysis

Up to AD 2000, most published trace element analyses had been produced from sample powders individually drilled from stalagmite slabs. Powders of several mg were dissolved in dilute acid and solutes typically analyzed by conventional instrumental techniques: atomic absorption spectrometry (AAS) or inductively-coupled atomic-emission spectrometry (ICP-AES). Table 1 illustrates that there are now available a wide variety of in situ micro-analytical techniques, including laser-ablation instrumentation with the capacity of variable micro- to macro-sampling capability. We do not review technical details here (see references in Table1), but focus on those most widely used and the trade-offs that determine analytical technique, taking for granted that issues of time-efficiency and expense will also feature strongly.

The first issue we discuss is that of spatial (and hence temporal) scale. Resolution of sub-annual variation can be accomplished by electron probe only for minor rather than true trace elements. The ion probe can accomplish this on all but the slowest-growing stalagmites (Fairchild et al., 2001), but at the expense of analytical speed. Micro X-ray fluorescence spectrometry (Kuczumow et al., 2001; 2003) is also slow, but it is capable of very sensitive analysis of a huge range of elements including species such as trace S that had not previously been analyzed by other techniques (Frisia et al., 2005). Laser-ablation inductively coupled plasma mass spectrometry (LA-ICP-MS) can rapidly construct annual time series on moderate to fast-growing samples and is being used extensively on marine carbonate organisms (e.g. Sinclair et al., 1998; Rosenheim et al., 2004). Treble et al. (2003) took advantage of this productivity to stack of a number of parallel traverses to increase the robustness of time series.

Table 1: summary of inorganic elemental analytical techniques on speleothems including their spatial resolution.

Instrument	Typical detection limit	Elements detected	Typical spatial resolution/ sample size	Issues	Key references
Electron microprobe (analysis of X-rays stimulated by electron beam)	100 ppm	Mg and sometimes other divalent ions	1 μm spot (3 μm excited diameter)	Widely available with well-known correction procedures. Automated chain analyses.	Reed (1996), Potts (2003)
Secondary ionization mass spectrometer (SIMS), i.e. ion microprobe (primary negative oxygen ion beam causes sputtering of secondary ions)	0.01–10 ppm (primary Cs^+ beam optimal for electronegative elements)	H, F, Na, Mg, Si, P, Ca, Fe, Mn, Pb, Sr, Y, Ba, U and potentially others (e.g. REE)	1.8 to 10 μm spot (2–3 μm depth), with automated line scan	precision of ratios to Ca is 1–2% over long term (excepting local sample artefacts), but accuracy limited by available carbonate standards.	Hinton (1995) Fairchild et al. (2001); Finch et al. (2003); McMillan et al. (2005) Our unpublished data
Scanning proton microprobe (analysis of X-rays stimulated by primary proton beam)	5 ppm	Divalent ions, K and U in carbonates	1–5 μm spot, with automated line scan	Expensive facility and complex correction issues	Wogelius et al. (1997); Ortega et al. (2003)
Micro X-ray fluorescence spectrometer using synchrotron radiation	0.1–1 ppm	Most elements (light elements less easily detected)	2 μm	Expensive facility; requires standardization, but precise. Penetrates into sample, so thin wafers (e.g. 200 μm) used, ideally with lamination perpendicular to wafer	Fenter et al. (2002) Kuczumow et al (2003); Frisia et al. (2005)
Laser-ablation inductively-coupled plasma mass spectrometer (ICP-MS)	ppm-level for single collector	In principle, most elements, but if spot size is large, some elements may be compromised by analysis of non-carbonate inclusions	20–1000 μm diameter ablated spot (potentially down to 1 μm) ; depth of pit c. 1–5 μm (Excimer laser) or c. 60–80 μm (Nd-YAG laser).	Rapid and precise analysis, but standardization and within-run precision are issues. Depth of excavation limits spatial resolution for Nd-YAG lasers. Deeper pits may be sites of redeposition of material.	Vadillo et al. (1998); Sinclair et al. (1998); Roberts et al., (1999); Sylvester (2001); Treble et al. (2003); Eggins et al. (2003) Rosenheim et al. (2004)
ICP-MS with sample dissolved in dilute acid dissolution from drilled sample powders	ppt-ppb in solution, (e.g. ppb to ppm in CaCO_3)	Most elements, limited mainly by specific interferences	100–5000 μg powder	Excellent precision and accuracy; slow sample preparation; can be paired with isotope samples	Jarvis (1997)
AA (atomic absorption spectrometer) or ICP-AES (inductively-coupled plasma atomic emission spectrometer)	ppb to 100 ppb in solution (ppm to 100 ppm in carbonates)	Na, Mg, Ca, Sr, Ba	as above	as above	Walsh (1997), Rowland (1997); Potts (2003)

Table 2: summary of inorganic isotope analytical techniques on speleothems including their spatial resolution. *Sample size required in terms of sample powder may be higher than when expressed in terms of mass analyte needed by the instrument because of sample preparation and handling issues

Ratio	Instrument	External Precision (1 σ)	Typical spatial resolution/sample size*	Issues	Key references
$\delta^{18}\text{O}$ and $\delta^{13}\text{C}$	Isotope-ratio mass spectrometer (IRMS) (dual-inlet or continuous flow)	$\pm 0.05\text{--}0.10$ ($\delta^{13}\text{C}$) $\pm 0.05\text{--}0.10$ ($\delta^{18}\text{O}$)	mm-scale down to (0.02)–0.05–0.2 mm by micromilling	Conventional technique; mature technology	Frappier et al. (2002)
$\delta^{18}\text{O}$ and $\delta^{13}\text{C}$	Continuous-flow IRMS with gas generated from source by laser ablation	± 0.1 ($\delta^{13}\text{C}$) ± 0.2 ($\delta^{18}\text{O}$)	100 μm spot; spacing 250–300 μm by doubling back analyses	Generates additional fractionation requiring correction and more prone to drift than conventional analysis. Excursions require validation by conventional analyses	Matthey (1997); McDermott et al. (2001, 2005)
$\delta^{18}\text{O}$ (and $\delta^{13}\text{C}$ in this article)	Multicollector secondary ionization mass spectrometer (SIMS), i.e. ion microprobe, using a primary Cs^+ ion beam	± 0.2 to 0.3 ($\delta^{18}\text{O}$) ± 0.5 ($\delta^{13}\text{C}$)	20–30 μm spot size (with similar depth)	Highly sensitive to instrument set-up leading to issues of drift and standardization. Avoidance of surface charging is a major concern.	Kolodny et al. (2003); Treble et al. (2005a); this article and our unpublished data
$\delta^{18}\text{O}$ and δD from fluid inclusion water	IRMS with water syringed from large inclusions	$\pm 0.5\text{--}1$ per mil δD	3 μl water per syringe extraction for deuterium analysis	Large inclusions are very rare	Genty et al. (2002)
δD from fluid inclusion water	IRMS with water derived by thermal decrepitation	± 10 per mil δD	0.3–1 μl water (from 150 mg samples from Israel caves)	Water is isotopically light and requires correction of 22–30‰ to bring results into line with source waters	Mathews et al. (2000) McGarry et al. (2004) McDermott et al. (2005)
$\delta^{18}\text{O}$ and δD from fluid inclusion water	IRMS with water derived by crushing and heating to 150°C	$\pm 0.4\text{‰}$ $\delta^{18}\text{O}$ and $\pm 3\text{‰}$ δD	1 μl water, potentially 0.1 μl (<100 mg)	Oxygen more problematic than hydrogen. Future work should utilize on-line crushing for more reproducible values at smallest sample sizes	Dennis et al. (2001); Fleitmann et al. (2003b) McDermott et al. (2005)
$^{87}\text{Sr}/^{86}\text{Sr}$	Thermal ionization mass spectrometry (TIMS) or MC-ICPMS	± 0.00001 to ± 0.00003	Sensitivity improved to allow analysis of 50–200 ng Sr (x mg powder at 100 mg Sr/kg CaCO_3)	Time-consuming preparation	Goede et al. (1998); Verheyden et al. (2000); Banner (2004)
$^{87}\text{Sr}/^{86}\text{Sr}$	MC-ICPMS with laser source	± 0.00009 in high-Sr samples	100–300 μm spot, or 10 μm wide slit; a few ng Sr per analysis (high-Sr samples)	Developing rapidly; correction of interferences vital. Applications limited by Sr content and precision.	Woodhead et al. (2005)
$\delta^{26}\text{Mg}$	Multi-collector (MC)-ICPMS from separated Mg in solution	0.06‰ (2 σ)	Not attempted (potentially sub-mm)	Still at pioneering stage	Galy et al. (2002) Johnson et al. (2004)
^{238}U , ^{234}U , ^{232}Th ^{230}Th (U-Th dating)	TIMS or MC-ICPMS	0.5–5% 2 σ precision on ages depending on U content	Approximately μg (analyte)- 10 μg (in sample powder) amounts of U required – typically 100–1000 mg sample for calcite. Errors can be less than sampling temporal precision of several-mm thick sample used for analysis.	MC-ICPMS has higher ionization efficiency for Th than TIMS allowing a several-fold smaller sample size in principle, and analysis is also more rapid. TIMS has higher stability which is important if precision is crucial.	Edwards et al. (1987) Richards and Dorale (2003); Dorale et al. (2004)
U-Th dating as above	Excimer laser coupled to MC-ICP-MS	12% on high-U samples	Ablation of 70 μg carbonate (containing 2 ng U) in a layer parallel scan (mm long by 120 μm wide), Potter et al. (2005)	Precision compared to that of alpha spectrometry in high-U samples (10s ppm – some calcites, but especially aragonite)	Stirling et al. (2000); Hellstrom (2003); Potter et al. (2005); Eggins et al. (2005)
^{235}Pa - ^{235}U (Protactinium dating)	TIMS	Approaching the above	As above	Complex preparation, but can be used to confirm U-Th dates and to test concordancy..	Edwards et al. (1997); Richards and Dorale (2003)

A second issue is that of comparability with other analyses. The traditional methods of macroscopically drilling sample powders allows the same materials to be analyzed both for trace elements and stable isotopes, which offers great advantages for construction of multiproxy time series. With care however, multiproxy series can be generated by combining different techniques or sampling regimes.

A third issue is that of the location of elements within the speleothem: lattice substitutions (restricted to divalent ions substituting for Ca^{2+} or CO_3^{2-} in their lattice positions), interstitial substitution of ions or molecules at defect sites in the lattice, or in non- CaCO_3 phases. Ideally, analysis should be *selective*, that is distinguishing between elements present in different phases; otherwise it can be very difficult to interpret the data (Fairchild et al., 1988). Both lattice and interstitially-substituted ions are best analyzed by dilute acid dissolution of carbonates on a macro-scale, or fine-scale microanalysis in which non-carbonate phases can be analyzed separately. On the other hand, elements present in non-carbonate phases are also analyzed by laser-ablation. Silica content can be used as an example to explain the importance of this issue. If present as an adsorbed and coprecipitated species within CaCO_3 , high Si values in dripwater and CaCO_3 would be expected to be associated with low rainfall when this corresponds to enhanced leaching of fresh aeolian dust (Hu et al., 2005). On the other hand, if Si is present primarily as detrital particles, it is likely to covary positively with rainfall events associated with high water infiltration rates bringing such particles onto the speleothem surface (e.g. the Irish Ballynamintra speleothem described in Fairchild et al., 2001).

2.4.2 Isotope analysis (Table 2)

The spot-sampling methodology for sample powders for carbon and oxygen isotope analysis of speleothems has historically been a pragmatic solution to the generation of expensive time series of relatively large speleothems. However reductions in required sample size and increased automation of modern mass spectrometers permit large sample throughputs which leads to a choice arising as to sampling protocol, as is discussed in the next section (2.4.3). The two alternatives to conventional sample preparation (by dissolution of CaCO_3 in orthophosphoric acid) are laser-ablation analysis, and ion microprobe, which are discussed in section 2.5.

Most other isotope techniques require significantly larger sample sizes than carbon and oxygen. Sr isotope analysis, at least in high-Sr (normally aragonitic) samples is fast becoming an exception to this with the advent of sensitive protocols for laser-ablation multi-collector (MC-) ICP-MS (Woodhead et al., 2005). Balancing sample allocation to different techniques can be a tricky task because of uncertainties prior to analysis in the required sample size. U-series dating is critically dependent on U content, which is best determined initially by dissolution of a small aliquot, but also on sample age, which in reconnaissance dating can be difficult to estimate in advance. Both U-series analysis and conventional Sr isotope analysis involve complex chemical separations and so it is practical to take rather more than the minimum sample size to allow for duplicate analyses, although Sr- and U-series isotopes could be determined on the same

aliquot by column-elution of Sr prior to Th and U. Dorale et al. (2004) give an admirably clear summary of analytical issues affecting the production of precise U-series of speleothems. Laser-ablation methods are now also available for high-U samples (Eggins et al., 2005; Potter et al., 2005).

Fluid inclusion analysis of $\delta^{18}\text{O}$ and δD has proved particularly difficult (McDermott et al., 2005). Hand-specimen colour (milky/frosty versus clear) may provide some guidance on concentration of inclusions, but again there is generally a need to sample more than a minimum size to be sure of generating sufficient liquid. The extraction protocols for thermal decrepitation (Matthews et al., 2000; McGarry et al., 2004) and cold-crushing (Dennis et al., 2001; Fleitmann et al., 2003a) techniques are also very difficult to set up and maintain, although there is currently much effort at designing on-line continuous-flow applications. An interesting development is the recognition by H. Schwarz of a dispersed water phase, only released by thermal decrepitation and which does not freeze (McDermott et al., 2005). This *nano-water* represents either nano-inclusions or molecular scale water. Since nano-water is typically approximately equal in importance to water in macro-inclusions its composition and nature are of much interest. Presumably this nano-water is equivalent to the hydrogen determined by ion microprobe analysis at continuous levels of hundreds to thousands of ppm, and which commonly defines annual laminae (Fairchild et al., 2001). Finally, it should be mentioned that, despite the successes of Dennis et al. (2001) and Genty et al. (2002), the oxygen isotope analysis of fluid inclusions is still fraught with uncertainty as to the circumstances in which oxygen may exchange between liquid and solid CaCO_3 .

2.4.3 Optimizing the sampling protocol

Ablation microanalytical methods require analysis of a spot, although where the material is not damaged by the analysis, spots can be joined into a line scan without gaps. In most cases the sample is excavated only a few microns at most. Where samples are mechanically drilled from a surface, there is a choice of how to excavate the sample volume and a growth-layer-parallel 'trench' is commonly used in order to maximize sample recovery over a minimal age range. Such a geometry was also used for isolated ablation pits in Sr isotope analysis by Woodhead et al. (2005) and in U-series dating by Potter et al. (2005).

In a stratigraphic time series context, Weedon (2003) drew attention to the difference between point sampling, where only certain points within the material are analysed (often at a constant spacing) and trench sampling, where the whole of the material is removed in a representative manner for each successive sample, with no gaps. Point sampling is compromised if there are important modes of variation at higher frequency (shorter distances than the sampling interval). Perhaps the most obvious example of this is the annual frequency of variation. Spot samples consisting of much less than around 2 years growth in material exhibiting seasonal variations in composition are prone to the phenomenon of *aliasing*, that is the incorrect recording of high-frequency variation (Weedon, 2003). Figure 5 illustrates an approximately stationary ion probe time series of a 10-year

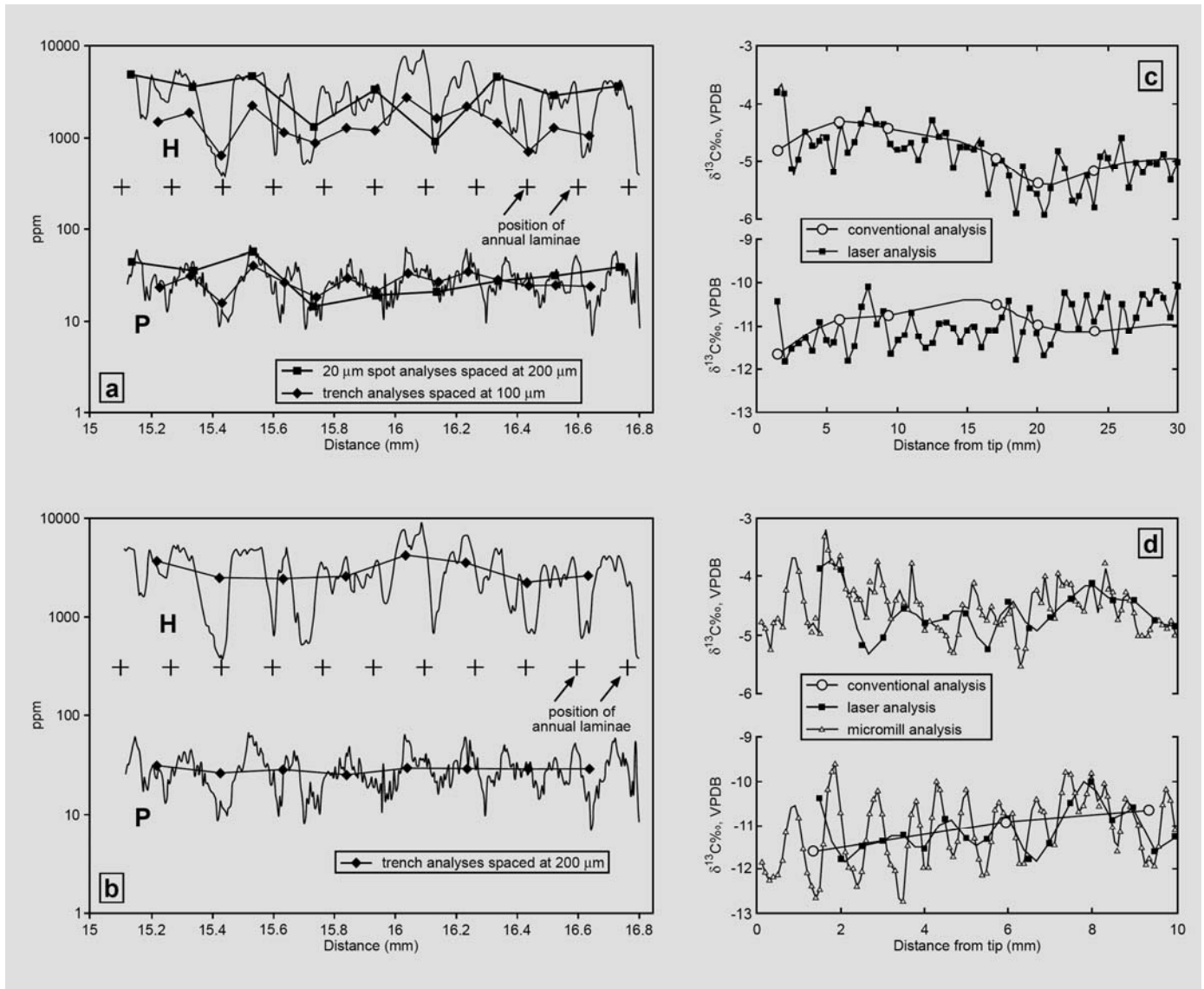

interval for H and P. Figure 5a illustrates that trench analyses at around the annual growth spacing produces analyses with little point-to-point variation. In contrast Figure 5b shows how 10% spot sampling at intervals around the annual frequency gives rise to aliasing, expressed as point-to-point variation that is unrepresentative of the full time series. Trench sampling is not immune however as the Figure 5b also illustrates a similar phenomenon in the case where trench sampling has an approximately biannual frequency.

Figure 5. Time series illustrating annual resolution and aliasing effects. a, b. Ion microprobe trace element data on hydrogen and phosphorus obtained by methods similar to Fairchild et al. (2001) in an interval 110–120 years before 2002 in speleothem Obi84 from Obir Cave, SE Austria. Location of thin annual (autumnal infiltration) laminae are shown by crosses. The diagrams show synthetic averaging and aliasing effects that would be produced by different sampling methods at lower resolution. Diagram a illustrates the irregular and unrepresentative variation (aliasing) produced by spot sampling at 20 μm every 200 μm, or trench sampling at 100 μm intervals. In contrast, diagram b illustrates the smoothing of the data that would be produced by a ‘trench’ sampling method, averaging at 200 μm intervals, similar to the length of annual cycles.

c, d. Stable isotope data, produced by three different sampling protocols, of the top of a speleothem with annual laminae 500–1000 μm thick from Gibraltar. c. Top 30 mm of sample illustrating conventional drill analyses at 5 mm intervals which display smooth trends, and laser spot-sampling (250 μm diameter) at 500 μm intervals. The laser samples reveal high-frequency variation, but are strongly aliased. d. The top 10 mm of the sample comparing the laser data with analyses of trenched powders produced by micromilling at 100 μm resolution. The temporal resolution of the micromill data is 1–2 monthly and resolves the seasonal signal.

Figures 5c and 5d compare three methods of stable isotope sampling, using the top of a stalagmite sample from Gibraltar. Without knowledge of the annual growth rates, the 0.5 mm sampling interval of the laser samples in Figure 5c might be interpreted as reflecting annual variability, whereas in fact the analyses are aliased. Figure 5d demonstrates the true magnitude and spacing of annual oxygen isotope variations, over the topmost 10 mm, by analysis at 100 μm resolution.

The above considerations suggest that where the analytical instrumentation gives a choice, trench sampling is to be preferred. Figure 6 indicates a pragmatic solution to the general sampling issue. Since the first-order variation of speleothem

composition will be along the growth direction, individual samples can be taken at higher temporal resolution if their volume is dominantly along laminae. Figure 6 illustrates a suggested sample volume as an obloid with dimensions 20:2:1 drilled from a polished surface approximately perpendicular to the speleothem growth laminae. A shorter obloid would be optimal if growth laminae were more irregular.

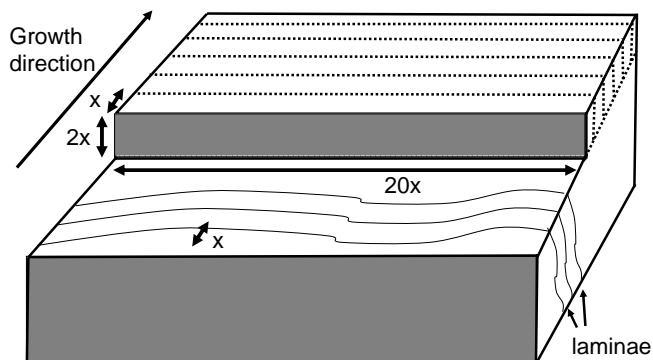

Figure 6. Recommended sampling protocol for trench sampling in order to maximize both the sample mass and the time-resolution of samples. The recommended prismatic (obloid) sampling shape is 20x by 2x by x in the case where irregularity of lamination shape is of the order of $x:20x$. See also table 4 and Figure 7. The ratio 20:1 was derived from preliminary analysis of speleothem shape at the mm-scale from eight sites indicating that the curvature of growth relief is often around 20:1. Given such growth irregularity the obloid will contain about 50% material from laminae immediately above and below the target lamina; that is the actual spatial resolution will be reduced by an (acceptable) factor of around 2 compared with the nominal resolution given by distance x . A significant minority of speleothems however exhibit growth relief on a scale of 1:10 on the mm-scale, sometimes up to 1:5, and ratios up to 1:2 can characterize 20–100 μm domains where individual crystallites have relief on growth surfaces. Where the relief is greater, the long axis of the obloid should be made shorter since no further spatial resolution is gained otherwise. The other dimension of the obloid illustrated in Figure 6 (2x) is the depth of removal of material from the sample. Deeper sampling would only be recommended if the side face of Figure 6 were also to be polished to reveal the shape of laminae below the surface.

Table 3: relationships between sample dimensions and mass of CaCO_3 and trace species

Parameter of sampled volume	Units	Examples of different sample sizes							
Distance in growth direction (x), obloid	mm	0.05	0.1	0.2	0.5	1	2	5	
Length of trench (20x), obloid	mm	1	2	4	10	20	40	100	
Depth into specimen (2x), obloid	mm	0.1	0.2	0.4	1	2	4	10	
Side of equivalent sample cube	mm	0.17	0.34	0.68	1.7	3.4	6.8	17	
Volume of sample CaCO_3	mm^3	0.005	0.04	0.32	5	40	320	5000	
Mass of sample CaCO_3	mg	0.0125	0.1	0.8	12.5	100	800	12500	
Mass of trace species at concentration 1ppm ($\mu\text{g/g}$)	μg	0.0000125	0.0001	0.0008	0.0125	0.1	0.8	12.5	
Mass of trace species at 10 ppm	μg	0.000125	0.001	0.008	0.125	1	8	125	
Mass of trace species at 100 ppm	μg	0.00125	0.01	0.08	1.25	10	80	1250	
Mass of trace species at 1000 ppm	μg	0.0125	0.1	0.8	12.5	100	800	12500	

Figure 7 and Table 3 illustrate the constraints on sample size imposed by growth rate and analytical techniques. Figure 7 illustrates that trace element analysis can readily be undertaken with sub-annual resolution. However, time constraints may dictate a lower sampling resolution, in which case care needs to be taken to avoid sample aliasing. The same issues arise with respect to carbon and oxygen stable isotope analysis. Computer-controlled micromills are capable of removal of trench samples at as little as 20 μm growth intervals (Dettman et al., 1995; Frappier et al., 2002), but a resolution on this scale could only be possible with samples exhibiting exceptionally low growth relief. Given a more typical situation illustrated in Figure 6, if resolution (= distance x) is 100 μm and a typical speleothem density of 2.5 mg/mm^3 , 100 μg of sample would be produced (Table 3), a convenient volume for analysis using isotope-ratio mass spectrometry.

Techniques for analysis of fluid inclusions, ultra-trace elements in solution, U-series dating samples, or other isotope samples are likely to need of the order of 1 to 100 mg sample. Time resolution is improved by a factor of 3.4 by excavating an obloid as illustrated in Figure 6, rather than a cubic shape (Table 3). The choice of stratigraphic resolution in taking samples for U-series dating will also be determined by the sample age. The varying abundances of the parent and daughter isotopes result in the best precisions for samples of intermediate age. This is illustrated by Dorale et al. (2004) for a 100 mg sample with 1 ppm U, where current analytical techniques would allow precisions of 1.2% (6 years) for a 500 year old sample, 0.4% (40 years) at 10 ka, 0.36% (180 years) at 50 ka, 0.6% (500 years) at 120 k, rising to 3.3% (15 ka) at 500 ka. A worse situation will exist where significant detrital sources of Th exist, particularly in young samples. Otherwise, in older samples, the absolute age errors (being percentages) will always exceed the age range of the material sampled (being fairly constant), but in young samples, dating errors could be the lesser. As pointed out by Lauritzen (2003) and Richards and Dorale (2003) it is best to equalize the precision of the U-series analysis and the range of ages within the sample represented by distance x , since the final result is limited by whichever is larger. It is not generally possible to do this precisely because the U content increases proportionally to mass whereas counting statistics improve more slowly. If the U

content is doubled by doubling sample size, counting statistics only lead to a $\sqrt{2}$ factor of improvement. Hence for a given U content, temporal and U-series dating precision can only be equal for a sample of one specific growth rate. For a faster growth-rate sample with the same U content, the precision for sampling improves more quickly than for dating.

Nevertheless, the high precisions and small sample requirements of modern instrumentation do make approximate equalization possible.

2.5 High-resolution stable isotope measurements and an invalid 8.3 ka oxygen isotope anomaly

2.5.1. Analytical techniques for C and O stable isotope analysis at high resolution

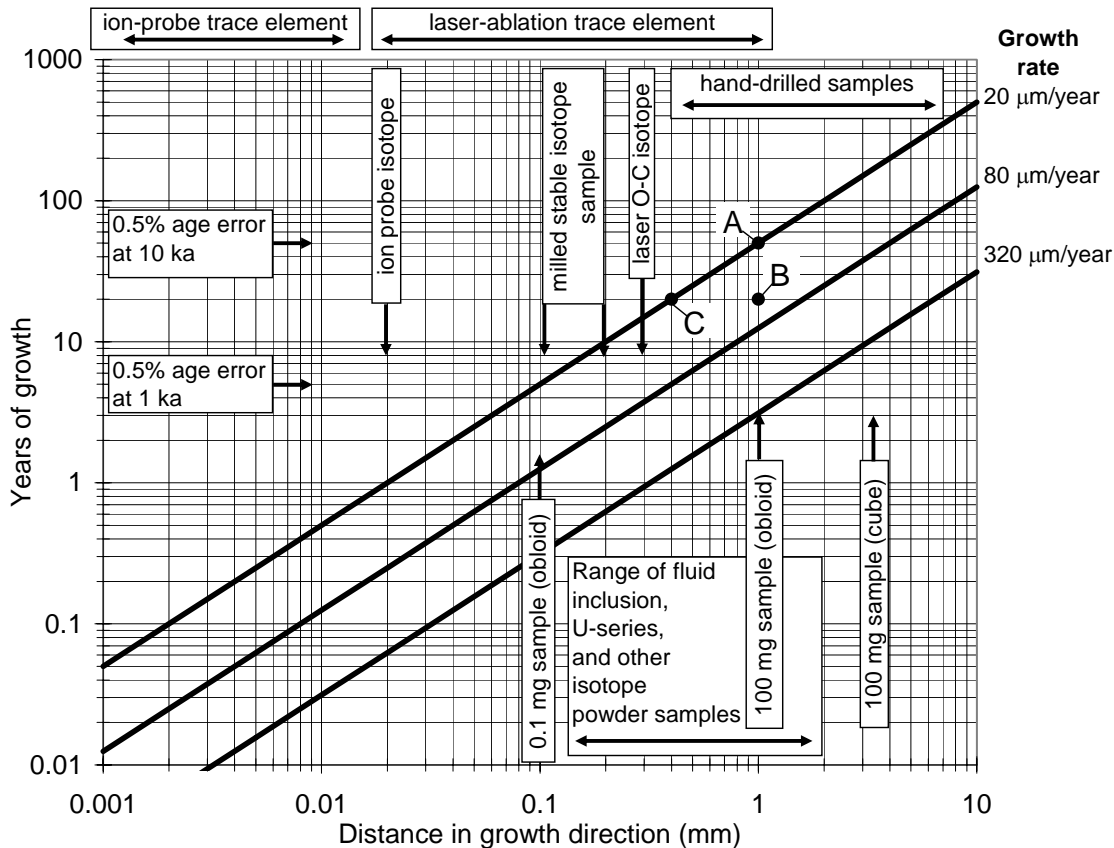

Figure 7. Nomogram plot of time versus distance to illustrate sampling issues in relation to temporal and spatial variation. Diagonal lines indicate a range of growth rates inclusive of most speleothems. Table 4 gives the unit length of the “ideal” sampling obloid (with sides 20:2:1, Fig. 6) corresponding to different sample masses. Unit lengths corresponding to 0.1 mg and 100 mg obloid samples are shown on the figure in comparison with a cubic volume of mass 100 mg which requires a unit length 3.4 times larger. The spatial resolution of different techniques is indicated, ranging from ion-probe trace element spots of 0.001 to 0.01 mm to hand-drilled sample powders at resolution of ≥ 0.5 mm. Adjacent to the y-axis, the boxes indicate the resolution limits of a 0.5% age error (e.g. 50 years for a 10 ka sample). As an example of comparing the errors associated with U-series dating and with sampling, if the sample size required to obtain sufficient U for dating in a particular sample was 100 mg, the corresponds to a sampling obloid 1 mm high in the growth direction. If growth rate was at 20 $\mu\text{m}/\text{year}$, then the spatial resolution error (1 mm – 50 years) is equivalent to a 0.5% age error for sample 10 ka old (point A). In order to achieve 0.5% dating errors in a younger sample, either a faster growth (e.g. point B), or a higher U content and hence smaller required sample size (e.g. point C) would be needed.

Obtaining high spatial resolution has long been a goal of stable isotope study of petrographically complex materials, and *in situ* laser-ablation sampling provides an attractive route. Early instrumentation (e.g. Smalley et al., 1989) demonstrated the potential of the method, which later subsequently benefited from the evolution of continuous-flow methodology. In the continuous-flow technique, CO_2 is carried into the mass spectrometer by a carrier gas (He) providing rapid analysis and minimising isotope fractionation (Sharp and Cerling, 1996, Matthey, 2002, Spötl and Matthey, 2006). Laser heating induces decarbonation to yield

CO_2 from pits around 150 μm in diameter surrounded by a thermal aureole that limits linear spatial resolution to around 500 μm . Spatial resolution can be doubled to 250 μm or better by combining data from offset parallel tracks (e.g. McDermott et al., 2001). Measured $\delta^{13}\text{C}$ values are intrinsically accurate but $\delta^{18}\text{O}$ values are subject to fractionation which in the Royal Holloway (University of London) laboratory is monitored using a Carrara marble standard also analysed *in situ*. One-sigma precision of the technique is typically better than 0.1‰ for $\delta^{13}\text{C}$ and 0.2‰ for $\delta^{18}\text{O}$ and the technique provides a means of obtaining isotope profiles at moderately high resolution along long sections of material which would otherwise be too time-consuming to be analysed by conventional techniques. A disadvantage of laser sampling is that fragile samples are prone to damage, and spallation of the sample can induce spurious results requiring careful monitoring of CO_2 yields and sample integrity.

The advent of computer-controlled micromills (Dettman and Lohmann, 1995) provides a means of implementation of the sampling strategy illustrated in Figure 6 with a typical stratigraphic resolution of 70–100 μm (but slightly degraded by lamina irregularities). Isotope data are obtained using conventional analysis by phosphoric acid dissolution of milled sample powders and the method provides data at high spatial resolution and at the highest attainable accuracy and precision, but at a relatively slow sample throughput. Where growth rates are high (>300–400 $\mu\text{m}/\text{yr}$), as in sub-tropical and moist

Mediterranean sites annual resolution can be effectively resolved as shown by the data in Figure 5c and 5d.

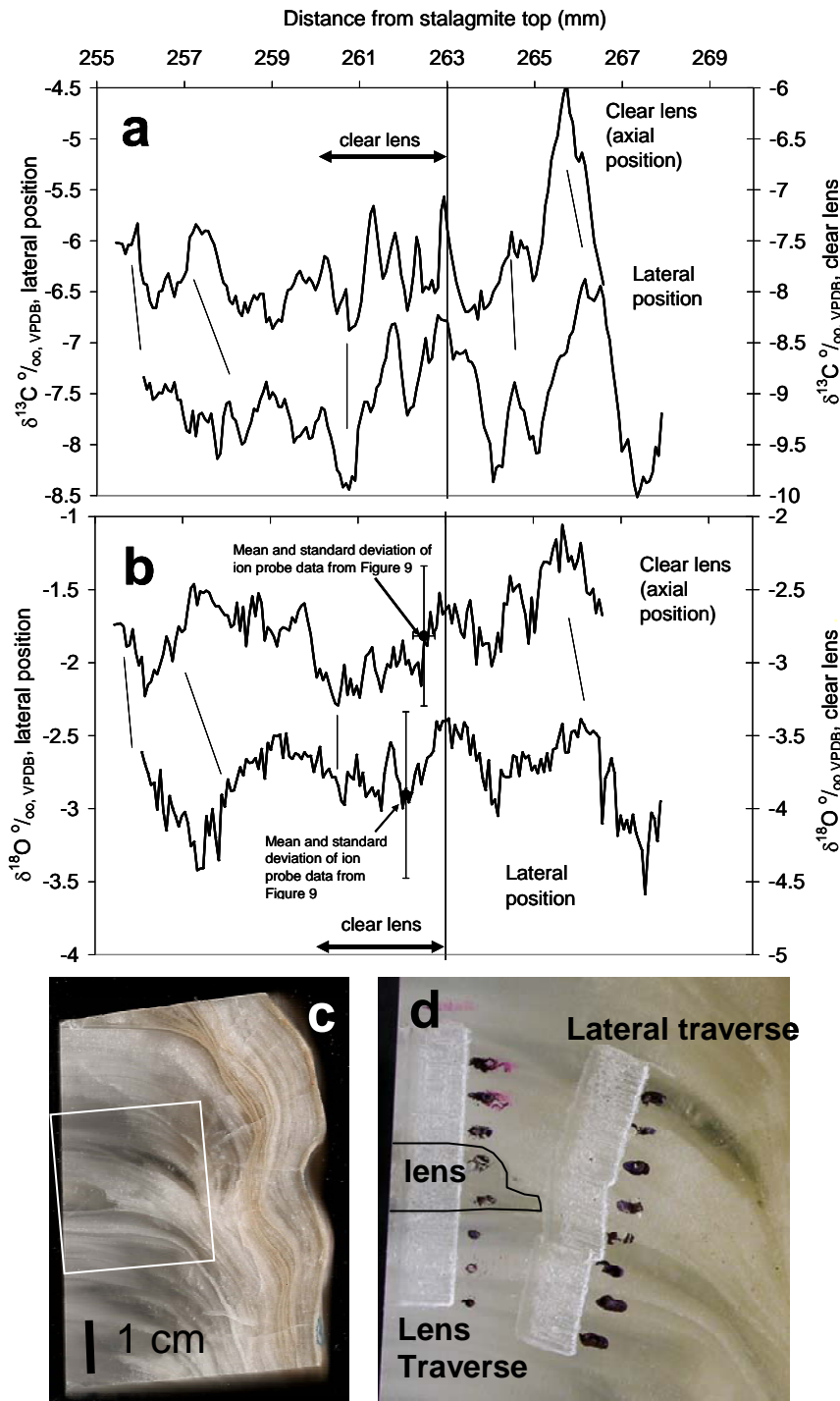

Figure 8. **a.** carbon and **b.** oxygen isotopes in stalagmite CC3 around 8.3 ka comparing an axial position, including a clear calcite lens (= position of the light isotope anomaly of McDermott et al., 2001), and a lateral position. **c.** Image showing the polished sample slab prior to micromilling with white square indicating area enlarged in **d.** : view of the slab after micromilling with the lens outlined (black spots are ink marks).

The instrument that offers the highest spatial resolution (20 to 30 μm diameter spots) is the ion microprobe (Table 2). Analysis on single ion-collector instruments (e.g. Reeder et al.,

1997) only allow for collection of few data, and precision is much poorer than other techniques. The Cameca IMS-1270 allows simultaneous collection of heavier and lighter isotopes, but there are few instruments world-wide, the set-up is extremely complex, and it has proved difficult to produce reliable data since changing instrumental conditions can degrade accuracy. Nevertheless, two previous speleothem studies are available (Kolodny et al., 2003; Treble et al., 2005b), and further data are presented later in this paper. It is the only technique capable of producing sub-annual resolution in speleothems from cooler climates.

2.5.2 The 8 ka event from stalagmite CC3, Crag Cave, Ireland

A cool, dry climatic anomaly at around 8200 years BP was recognized as the most extreme transient climatic change in Holocene ice core records from Greenland by Alley et al. (1997) and referred to as the '8k event' by Alley and Ágústsdóttir (2005). The laser-ablation system at Royal Holloway, developed by one of us (DM), was used to provide a high-resolution study of a Holocene stalagmite (McDermott et al., 2001). A major negative oxygen isotope anomaly of 8‰, with values down to -12‰, was found at around 8.3 ka and correlated with this event. The main focus of the paper by McDermott et al. (2001) was the overall structure of a new high-resolution laser-ablation Holocene isotope record at 250 μm resolution as described above. Most isotope fluctuations were corroborated by conventional analyses (McDermott et al., 1999), although no such analyses were available within the inferred 8 ka event. Subsequently, Baldini et al. (2002) counted annual trace element layers in order to estimate the duration of the assumed climatic anomaly which coincided stratigraphically both with a trace-element anomaly and clear calcite lens in the axial part of the sample (Figure 8). In order to learn more of the structure of this event, we investigated this interval in more detail using high-resolution techniques.

Initial ion microprobe investigations in April 2004 (summarized in EIMF report of Fairchild, 2005) on the section used by Baldini et al. (2002) could not reproduce the very negative values at 8.3 ka, but appeared to show a small negative oxygen isotope anomaly. These data are now thought not to have been standardized correctly. Nevertheless, the standard deviation of the 2004 analyses is comparable over the entire lens thickness to the later ion probe data presented below over a shorter interval.

Micromill analyses at the University of Innsbruck, are shown in Figure 8. Analyses are at 70 μm resolution from the 'axial' and 'lateral' positions, from the same slab from which the thin section of Baldini et al. (2002) had been taken. No isotope

anomaly is apparent. Subsequent ion probe analyses on the thin section in 2005, using an improved technique (Figure 9), produced mean values identical to the micromilled data.

sample points alternated with blocks of 10 analyses of standard UWC (University of Wisconsin calcite, which has a composition of $-7.40 \pm 0.06\text{‰}_{\text{VPDB}}$ determined by multiple analyses of sample powders by J.W. Valley). The particular crystal of UWC used was mounted and polished on the same thin section as the sample CC3. No systematic difference with other crystals of UWC mounted in a separate standard block was observed.

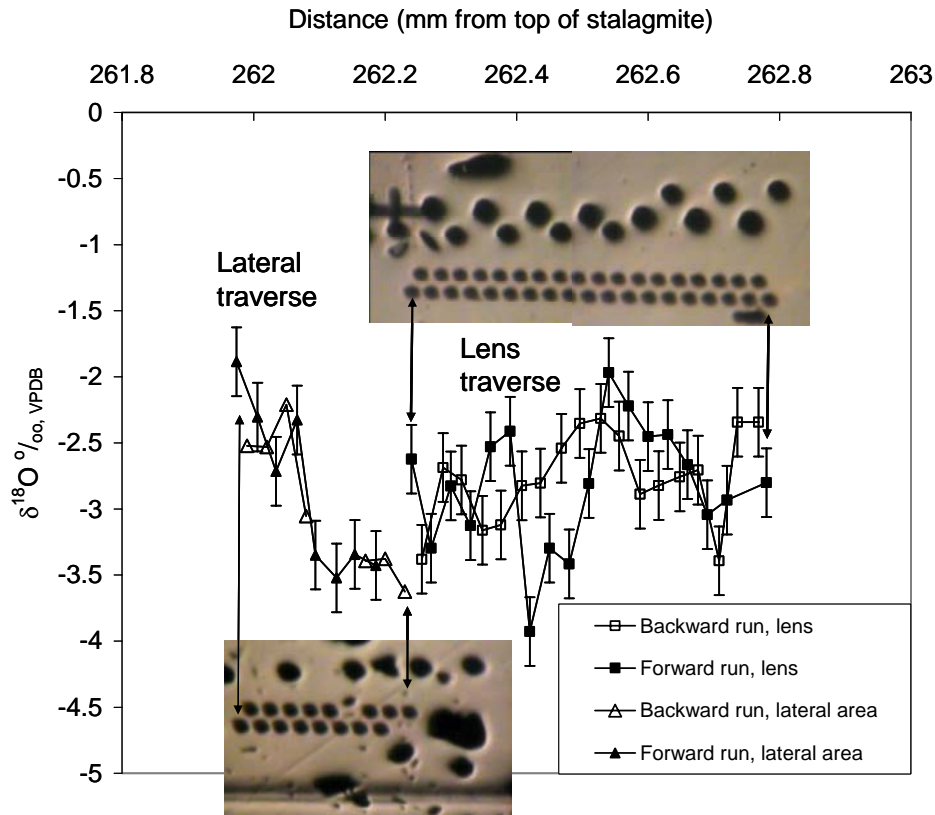

Figure 9. Ion microprobe data from speleothem CC3. Data from both the axial lens and the lateral area in a similar stratigraphic position showed mean values virtually identical to the micromill data of Figure 8. The left-hand image and datapoints from the lateral area illustrate a 1.5‰ shift over a distance in the growth direction of $250\ \mu\text{m}$ in the lateral area which was verified by a return traverse. Analytical spots form the array in the image and in the image lie below larger ion probe spots from previous analyses and above a linear trace element track. Other holes are natural inclusions. In the lens traverse (right), 1.5‰ variability is found, but the spatial positions are not reproduced. The image (right) shows the array of $25\ \mu\text{m}$ ion probe sputter pits, with larger pits from previous analysis in the upper part of the view.

Details of methods.

The analytical method is similar to that of Treble et al. (2005b). Oxygen isotope analyses were carried out on a Cameca IMS-1270 ion microprobe on polished, gold-coated samples. The section was sputtered with Cs^+ primary ions with a beam current of $3\text{--}6\ \text{nA}$ (constant for a given session) to yield an analytical spot size of between 25 and $40\ \mu\text{m}$. Secondary oxygen ions of masses 18 and 16 were collected using multiple Faraday cups at a mass resolution of 2400. In order to ensure consistent secondary ion optical alignment, the secondary ion beam was scanned across and centred within a small field aperture followed by a scan of the entrance slits across the contrast aperture plane. Each location was pre-sputtered for 50 seconds during which time the backgrounds of the Faraday cups were measured. Each analysis consisted of 10 blocks of 4 seconds measurement time. Analysis of a group of 10–25

Initial data was collected in April 2004 with a $35\text{--}40\ \mu\text{m}$ beam diameter and are summarized below from Fairchild (2005). There were issues of instrumental drift which compromised most of the analyses, although an apparently more stable period also yielded results that were consistently lighter than obtained in April 2005 or by micromill. The April 2004 values averaged -4.6‰ through the full thickness of the lens ($\sigma = 0.51$, $n = 45$) and -6.0‰ in inclusion-rich calcite ($\sigma = 0.22$, $n = 15$) 5mm away laterally. The low mean values are attributed to inaccurate standardization with respect to the calcite standard (variability of analyses, $\sigma = 0.64$, $n = 45$), although the specific reason for this is unknown. Standardization is a difficult issue with ion probe isotope analyses, such that other authors have standardized to bulk analyses (Kolodny et al., 2003; Treble et al. 2005b).

Data in Figure 9 were collected in April 2005 using revised experimental conditions to reduce geometrical effects that may have degraded analytical precision (see also Treble et al., 2005a). Rather than using a focused primary beam, Köhler illumination conditions were used whereby beam size is determined by a final aperture resulting in a relatively small spot size of $25\ \mu\text{m}$ and a beam current kept stable at $4\ \text{nA}$. The instrument was aligned so as to maximize secondary ion count rates, which has the effect of reducing the influence of the uncertainty of the Faraday cup background; adjustment of the Faraday Cups obtained a flat-topped peak of the ratio of masses 16 and 18. Typical counts per second on ^{18}O were $5\text{--}6 \times 10^6$ and on ^{16}O were $2.6\text{--}3 \times 10^9$. The 1-sigma precision of determination of standard $^{18}\text{O}/^{16}\text{O}$ ratios bracketing the analyses in the figure was 0.26‰ ($n = 30$).

The laser data of McDermott et al. (2001) had been obtained from a 'pencil' 40mm long and 7 mm wide (Figure 10), axial in position (and thus containing the clear lens, here around 4 mm thick), but about 5 mm laterally away from the axial part of the slab illustrated in Figure 8. Scrutiny of this 'pencil' indicated that it had suffered severe ablation and has also fractured along the calcite lens. The pencil was repaired and micromill analyses at $100\ \mu\text{m}$ resolution were made along its length as presented in Figure 10. They confirm the absence of a stratigraphic $\delta^{18}\text{O}$ anomaly. Re-analysis of the original CC3 pencil by laser ablation reproduces an anomaly related to a crack caused by laser-fracture at the time of the original analysis (Figure 10). Apart from discrete cracks, the improved standardisation gives a close match with the micromill data. The original large anomaly from laser-ablation analysis is now

regarded as an analytical artefact produced by unusual fractionations associated with the onset of fracturing of the sample.

found in the 2005 laser data in two places (red arrows in lower photograph) where fractures occur. Otherwise the new laser analyses reproduce micromill analyses very closely (slight lateral peak offsets are due to uncertainties in sample registration).

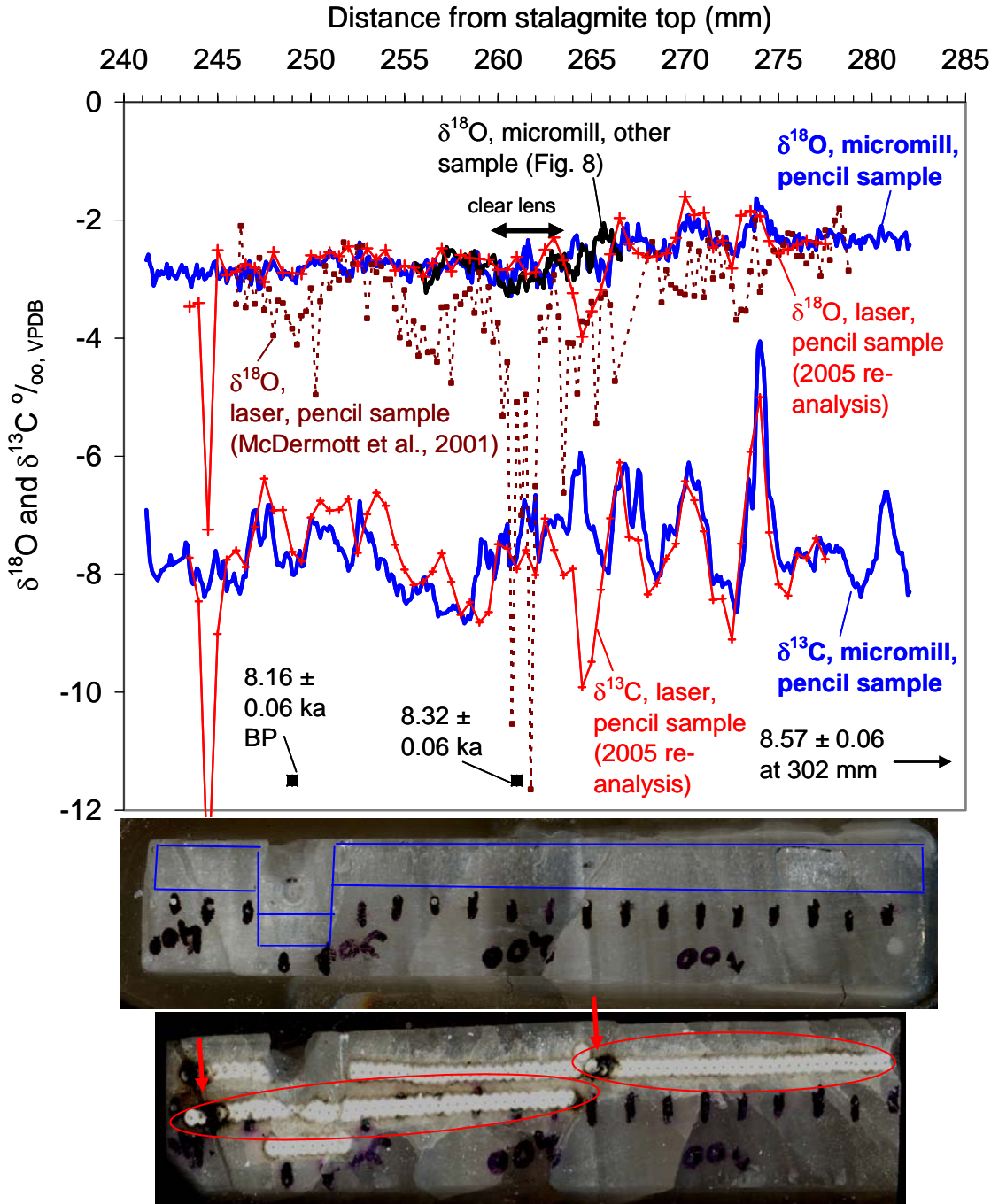

Figure 10. Comparison of the laser-ablation oxygen isotope data of McDermott et al. (2001) and new micromill (blue) and laser-ablation (red) data for $\delta^{13}\text{C}$ and $\delta^{18}\text{O}$ through a pencil-shaped section of stalagmite CC3, laterally equivalent to the piece of sample shown in Figure 8. Axial lens oxygen isotope micromill data from figure 8 (black) are also shown; they lie within 0.5‰ of the $\delta^{18}\text{O}$ data from the pencil sample. The photograph with blue box illustrates the location of the micromill samples prior to laser re-analysis and likewise the bottom photograph shows the final condition of the pencil with red ellipses surrounding the chain of laser-ablation analyses. The large negative isotope anomaly of the 2001 laser data is not reproduced in the new analyses, but negative spikes are

By comparison with the constraints of the U-series dates (Figure 10), the major variations of the pencil oxygen and carbon isotopic profiles occur on a multi-decadal scale and there is a weak covariation of $\delta^{13}\text{C}$ and $\delta^{18}\text{O}$ ($r^2 = 0.27$, $n = 396$), with $\delta^{18}\text{O}$ magnitude of around 0.5‰ , and carbon variations showing variable magnitude (<1 to 4‰). Within the interval around 8.2 ka, there are no distinctive $\delta^{18}\text{O}$ anomalies and the trend of $\delta^{18}\text{O}$ in Figure 10 is quasi-linear (cf. Rohling and Pälike, 2005). Given a drier climate during the 8 ka event (Alley and Ágústsdóttir, 2005), heavier $\delta^{13}\text{C}$ compositions might be anticipated, by one of several mechanisms (sections 3 and 4). However, there is no unique candidate for the event in the data of Figure 10. There is also no clear evidence (irregular surface with impurities) of a growth hiatus. Modelling implies a fall in $\delta^{18}\text{O}$ of atmospheric moisture of up to 1‰ on the Atlantic seaboard during the 8 ka event (G. Schmidt, pers comm., 2005). If the modelling is valid, the absence of a clear $\delta^{18}\text{O}$

anomaly implies either a significant decrease in cave (and external mean annual) temperature to counteract the slightly more negative modelled isotope composition of precipitation, or at least a multi-decadal smoothing of atmospheric changes in this record.

2.5.3 Isotope variability at the highest resolution in speleothems

It is implicit in the study of isotope time series from speleothems that the profile is representative of changing conditions through time. Ideally multiple time series from the

same or different caves are needed to test the robustness of the signals, but the small-scale variability is normally only characterized by a few analyses along laminae. The data of figure 8 represents an unusually detailed test of lateral variability (see the ‘Hendy test’, section 6.2). Encouragingly, a number of fluctuations of magnitude 0.5‰ or greater in both $\delta^{13}\text{C}$ and $\delta^{18}\text{O}$ can be correlated between transects. Although peaks and troughs may vary by up to 0.2‰ in $\delta^{18}\text{O}$, and 0.5‰ in $\delta^{13}\text{C}$, there is no systematic difference between the profiles. The ‘pencil’ profile, around 1 cm laterally away from the slab of figure 8 cannot be correlated so exactly because of a lack of continuity of laminae, but also appears to match within 0.2‰ in $\delta^{18}\text{O}$ and 0.5‰ in $\delta^{13}\text{C}$.

A mean growth rate within the calcite lens of 84 $\mu\text{m}/\text{year}$ (with an uncertainty of around 10%) can be calculated from the data of Baldini et al. (2002) comparable with rates of the order of 100 $\mu\text{m}/\text{yr}$ by differences in U-series dates in the interval represented by the pencil. The micromill data is thus roughly at annual resolution and so could be subject to aliasing if seasonal variations in isotope abundances occur. The ion probe data of figure 9 do not display clear annual scale variation, unlike the SW Australian data of Treble et al. (2005a) and unlike our unpublished data on samples from other locations collected in the same analytical session as that of the data of Figure 9. The axial profile displays inconsistent variation, whilst the lateral profile displays a trend over 250 μm . Ninety-five per cent of the data fall within 1.5‰ and the $\pm 0.25‰$ uncertainty of each measurements implies that the real range of values is likely to be within 1‰. If interpreted as genuine features of the sample rather than an artefact of technique, the consistent variation over 250 μm implies a multi-year full cycle, whereas the inconsistent variation implies local 50 μm scale differences (of up to 1‰ as argued above) in fractionation during deposition. If such stochastic variation occurred it would average out to within the analytical uncertainties on the scale of the micromill analyses. Hence, the 0.1–0.2‰ scale point-to-point variability of the micromill data at 100 μm scale is consistent with a somewhat larger and irregular variation on a finer spatial scale, whereas if regular annual 0.5–1‰ isotope banding were present larger variations of the micromill data would be expected (cf. Figure 6). An implication of this study, consistent with data from modern caves by Mickler et al. (2004) cited in section 6.2, is that stochastic variation in speleothem stable isotopes may pose a problem in interpretation at the highest spatial resolutions.

3. Signals of external forcing

Here, we examine the nature of the external inputs to the karstic system and give examples of speleothems whose time series, particularly in $\delta^{18}\text{O}$, appear to be a simple and direct reflection of the changing state of the climate system. In other cases, external signals are more strongly modified by the processes to be described in sections 4 to 7, and the reader has the option to read these sections first if they wish first to be aware of the factors that can disturb the signal. However, generally it is more logical to consider the external signal first before consideration of how it is modified.

Extra-terrestrial and planetary influences lead to characteristic features of long-term (10^3 – 10^5 year) time series (as well as on the daily and annual timescales); at other time scales we have the Earth system response via meteorology and climate (Table 4). An important conclusion of this section is that the emphasis of study of monthly records of meteoric precipitation has masked synoptic meteorological processes that could be influential for both short-term variations and in determining long-term mean values, for example of $\delta^{18}\text{O}$.

3.1 Orbital, geomagnetic and solar forcing

The best known long-term subterranean terrestrial carbonate record is from sample DH-11, collected from a slow-growing subaqueous deposit from laterally flowing groundwater flow in a tectonic fracture (Devil’s Hole) from the SW USA (Ludwig et al., 1992; Winograd et al., 1997). Within the period of 60 ka to ~560 ka, this reproduces the major features of the major glacial-interglacial variability known from ice cores and marine records, but the timing of some glacial terminations differ from that of the orbitally-tuned SPECMAP chronology (Winograd et al., 1992). Since the ages have been precisely determined by two separate U-series methods, they have been used to challenge the dominant view (Imbrie and Imbrie, 1979) that Milankovitch cycles are the pacemaker of ice ages. However, as with all complex continental proxies, it can be argued that the timing of events in DH-11 is likely to reflect primarily the regional response to global drivers and this viewpoint is added weight by speleothem and marine evidence of the variation in timing (130–140 ka) of significant warming associated with glacial Termination II (e.g. Henderson and Slowey, 2000; Bard et al., 2002; Spötl et al., 2002a; Yuan et al., 2004).

We now describe examples of longer-term records from conventional speleothems where each record refers to atmospheric and ground surface conditions at a specific site. This site may be representative of a region, but is not in itself integrated through a region as is the DH-11 sample which formed from regional groundwater flow. In many cases there is a striking parallelism of potential forcing parameters (or the state of the climate system as reflected in more straightforward climate proxy records such as $\delta^{18}\text{O}$ in ice cores) with speleothem oxygen (or carbon) isotopic records. In most cases the parallelism reflects the sensitivity of $\delta^{18}\text{O}$ in atmospheric precipitation in particular regions (e.g. monsoonally-influenced areas, Burns et al., 2001) to climate system parameters (see section 3.2), although Drysdale et al. (2004) described a case from Italy where temperature appears to be the control on the glacial-interglacial timescale. In Figure 11, we re-present some of the speleothem results matched in a common format with likely forcing parameters (or other proxy data), together with associated power spectra. In figure 11, we have adopted a conservative approach to the treatment of series, with only simple processing to remove the long-period variation, on the principle that the main features of interest ought to be discernable in raw data.

Table 4: summary of main factors influencing inorganic geochemical time series of Quaternary speleothems

	Oxygen isotopes	Carbon isotopes	Trace elements
Atmosphere	Variably strong climatic function Key control on composition of atmospheric moisture which over time could vary as a function of the partially correlated variables of changing atmospheric circulation patterns, temperature and amount of precipitation	None Changing composition of $\delta^{13}\text{C}$ in atmosphere likely will have negligible effect due to dominance of soil and bedrock-derived carbon.	Irregular variation A major control on variability of sulphur in stalagmites; can make up significant proportion of some other trace species and isotopes introduced to karst system.
Soil and upper epikarst (dissolution region)	May shift signal; both dampens high frequencies in general, but accentuates contribution of water from major precipitation events Total evaporation of light rains; partial evaporation of near-surface water in some climates leads to slightly heavier isotopes. Variability of atmospheric precipitation events greatly reduced by mixing, although heaviest events infiltrate macropores with only minor mixing.	Initiates signal with indirect and complex links to temperature and rainfall Carbon isotopic composition set by: 1) C_3 versus C_4 vegetation 2) closed versus open system dissolution 3) bedrock composition (if closed system) 4) kinetics of generation and loss of CO_2 from soil and/or entrainment of atmospheric CO_2 These factors may in part be linked to rainfall.	Main initiation of signal with indirect and complex links to rainfall Trace element composition determined by geometry of regolith and CaCO_3 composition, modified by addition of other ions from slower dolomite dissolution, incongruent dissolution effects in frost-affected soil, seasonal salt accumulation, bioaccumulation and breakdown of organic species; seasonal flushing events convey trace species into karst fracture systems
Lower epikarst and cave	May dampen high frequency signal Variable mixing of fast-infiltrating fractured waters and slowly seeping waters	Variable shift to heavier values, control by seasons or longer-term dry conditions ^{13}C enrichment by CO_2 -degassing at equilibrium, but kinetically enhanced in actively ventilated caves; process is seasonally variable in relation to hydrological and/or ventilation factors	Variable mixing and shift to higher values, control by seasons or longer-term aridity 1) Mixing of different aquifer compartments can lead to seasonal or long-term variations caused by dry conditions 2) Trace element enrichment by prior calcite precipitation along flowline from waters made supersaturated by CO_2 -degassing; process is seasonally variable in relation to hydrological and/or ventilation factors.
Calcite precipitation	Adds high-frequency noise; may shift signal Variable kinetic effects even in the absence of evaporation; severe effects can be recognized by lateral change in speleothem composition (Hendy test)	Adds high frequency noise; variable shift to higher values Additional degassing can be associated with landing of drips; additional kinetic effects associated with lack of equilibration of carbon species; severe effects can be recognized by lateral change in speleothem composition	Greatly enhances annual signal and introduces high and low-frequency noise Growth kinetics (rate and especially mechanisms of growth) strongly influence uptake of non-divalent ions with variable effect on divalent ions. Seasonally variable in relation to hydrological and/or ventilation factors.
Post-depositional change	Usually none Shift if aragonite \rightarrow calcite Fluid inclusion water most susceptible to any water rock interaction	Usually none Minor shift if aragonite \rightarrow calcite	Usually none Possibly major shift if aragonite \rightarrow calcite

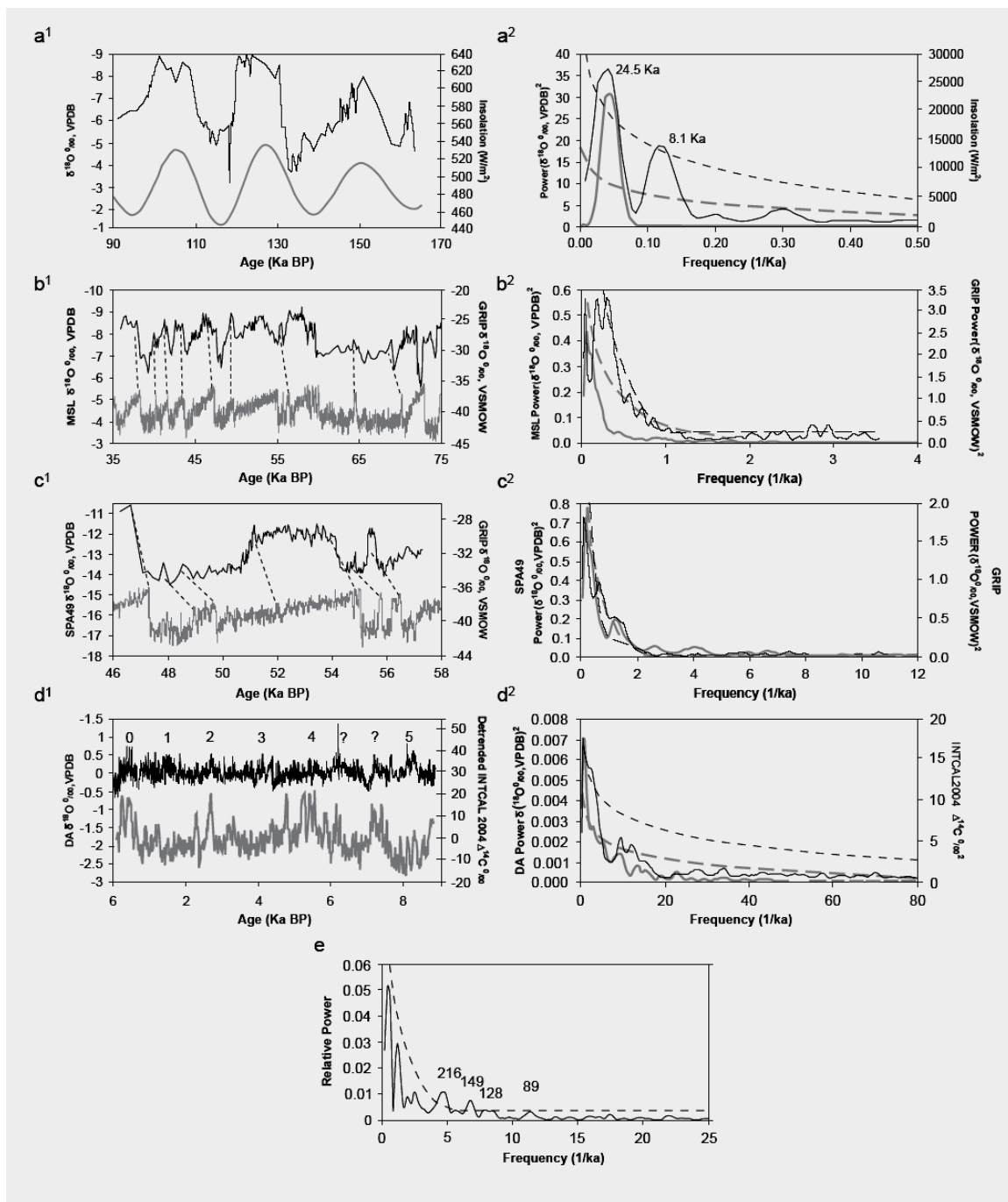

Figure 11: Time series (left) and accompanying power spectra (right) using methods as in Figure 3. In each case the black line refers to the speleothem data and the grey line refers to the forcing or comparative data series. Dashed lines in power spectra denote 95% confidence limit of significant spectral power. **a¹ and a²**. $\delta^{18}\text{O}$ values of Dongge cave stalagmite D3, southern China (Yuan et al, 2004) compared with June mid-month insolation at 30°N (Berger & Loutre, 1991). **b¹ and b²**. $\delta^{18}\text{O}$ values for stalagmite MSL, Hulu cave, eastern China (Wang et al, 2001) compared with twenty-year smoothed values of $\delta^{18}\text{O}$ in GRIP ice core (central Greenland, Johnsen et al., 2001, <http://www.glaciology.gfy.ku.dk/data/grip-ss09sea-cl-20yr.stp>). **c¹ and c²**. $\delta^{18}\text{O}$ values for stalagmite SPA49, Austria (Spötl and Mangini, 2002) compared with GRIP ice core data as above. **d¹ and d²**. $\delta^{18}\text{O}$ values for Dongge cave stalagmite DA, southern China (Wang et al., 2005) after removal of long-term linear trend compared with $\Delta^{14}\text{C}$ from the INTCAL2004 radiocarbon calibration (Reimer et al., 2004) detrended using

the function $f(x) = 81.99 + 1.276 \cdot \cos(-2.82x) - 10.55 \cdot \sin(-2.82x)$. Numbers '0.5' and '?' on d¹ indicate correlations of high $\delta^{18}\text{O}$ (and usually higher $\Delta^{14}\text{C}$) with North Atlantic ice-rafted events of Bond et al. (2001) e. Cross-spectral analysis (using Spectrum program) between the two series shown in d¹ revealing the existence of spectral coherence at several frequencies (numbers shown are equivalent time periods in years).

On the longest time-scales, Figure 11a¹ and a² illustrate evidence for an orbital precession signal in the oxygen isotope record of a stalagmite from Dongge cave in south-central China (Yuan et al., 2004). Although only three 20 ka cycles are represented, the phase parallelism of peak summer insolation at 30°N with minimum $\delta^{18}\text{O}$ values provides additional supporting evidence in that it illustrates a potential amplifying mechanism on climate via the intensity of summer monsoon circulation. The precessional signal at a frequency of 0.05 1/ka (= 20 ka period) makes up

much of the significant variance in the speleothem record, but the spectrum also reveals a peak at frequency 0.12 (8.5 ka), that can be confidently interpreted as a harmonic of the precessional signal related to the difference in shape between the speleothem record and a pure sine wave (Weedon, 2003). The importance of such non-linear responses is emphasized by the observation that in younger speleothems from central China, the precessional signal is much weaker (Wang et al., 2001). However, Cruz et al. (2005a) have illustrated five clear precessional cycles in a 116 ka record from an atmospherically sensitive region in subtropical Brazil.

The influence of insolation variations on atmospheric circulation has also been argued to be felt in other records, too short to be supported by spectral analysis. For example, a speleothem record from Qunf cave in Oman (Fleitmann et al., 2003b) demonstrates a strong parallelism of increasing $\delta^{18}\text{O}$

and reducing mid-Holocene insolation; also a series of similarities to Greenland ice core $\delta^{18}\text{O}$ variations in the early Holocene are indicative of sensitivity to hemispheric aspects of climate (similar features characterize Holocene speleothems from Dongge cave in south-central China, Dykoski et al., 2005, Wang et al., 2005).

Speleothem records from Israel have been demonstrated to illustrate a variety of information representative of climate system changes on a regional to hemispheric scale over the past 250 ka (Bar-Matthews et al., 1999; 2003). The parallelism of records from planktonic foraminifera and speleothems from two caves in both north (Peqin) and central (Soreq) Israel is caused primarily by similar temperature changes on land and sea surfaces with associated effects on rainfall amount (Bar-Matthews et al., 2003). Another factor is the change in seawater $\delta^{18}\text{O}$ composition associated with changes in global ice volume; this also has a recognizable impact on other speleothem records (e.g. Lauritzen and Lundberg, 1999; Williams et al., 2004).

Glacial climates contain evidence for bundles of millennial scale climate fluctuations. These Dansgaard-Oeschger (D-O) oscillations, recognized originally from Greenland ice cores, can often form a group (a Bond 'cycle') which culminates in a major ice rafting (Heinrich) event in the North Atlantic region and which influenced certain proxies over a much wider geographical area (Broecker and Hemming, 2001). A number of speleothem records have documented such patterns of variation and have led to improved knowledge of the timing of these events (Wang et al., 2001; Spötl and Mangini, 2002; Genty et al., 2003; Burns et al., 2003; Shackleton et al., 2004; Serefiddin et al., 2004). Figure 11b¹ and b² illustrate such phenomena in the Hulu cave of central eastern China (Wang et al., 2001), which displays parallel records with that at Dongge Cave (Yuan et al., 2004). The high Alpine Kleegruben and Spannagel Caves in Austria (Spötl et al., 2004) are also climatically sensitive (Spötl and Mangini, 2002; Figure 11c¹ and c²), which is now thought to relate to the change in intensity of winter cold temperatures (Spötl et al., in press). The correlations favour the GRIP2001 timescale (Johnsen et al., 2001) over previous Greenland ice core chronologies, and both the GRIP and speleothem $\delta^{18}\text{O}$ data in this interval (Figure 11b²) both show a strongly red spectrum. Finally, carbon isotopes can also be sensitive to the overall long-term state of the climate system. Genty et al. (2003) described from the Villars site in southern France a response of $\delta^{13}\text{C}$ in association with D-O events through changes in the relative proportions of organic and bedrock-derived carbon (see section 4.2).

The last of the major fluctuations, the Younger Dryas interval and the preceding Antarctic Cold Reversal of south polar regions are intriguingly captured in hybrid form in south island of New Zealand by $\delta^{18}\text{O}$ records (Williams et al., 2005). Here, the $\delta^{18}\text{O}$ appears to be a composite proxy of temperature and rainfall. Millennial-scale periodicity is also known from suitably sensitive Holocene records, such as the North Atlantic record of ice-rafting (Bond et al., 1997) and similarities to smoothed and detrended ice core ^{10}Be and tree ring $\Delta^{14}\text{C}$ records have been shown (Bond et al., 2001). The ^{10}Be production variation on timescales of >100 years is thought to reflect primarily the modulation of cosmic ray input by earth's

geomagnetic field, whereas an influence by varying solar input is believed to be mainly responsible for short-term variations. Most features of the $\Delta^{14}\text{C}$ record are similar to ^{10}Be production records and solar forcing has been argued (Stuiver et al., 1993), but it is also strongly influenced by CO_2 -exchange between atmosphere and oceans, and hence by the overall behaviour of the climate system. Neff et al. (2001) illustrated an extraordinary similarity between the early Holocene INTCAL98 atmospheric $\Delta^{14}\text{C}$ series (detrended) and a tuned oxygen isotope record from Hoti cave in Oman (another monsoonally-influenced location). The tuning process involves peak-matching within the limits of the age errors of the dates. Fleitmann et al., (2003b) showed similar features on a longer Holocene record from the same region and Niggemann et al. (2003a) made similar arguments, and also found a significant 1450 year period peak, in relation to a Holocene speleothem record from Atta cave in Sauerland, Germany. Although the previously published results appear impressive, the tuned age model requires repeated several-fold changes in growth rate within an interval in which U-series dates suggest a linear trend (Neff et al., 2001). Ideally, these relationships need to be demonstrated from annually-laminated deposits where errors in the age-model can be best minimized. This would not only allow verification of the solar control, but also allow leads and lags in the climate system to be determined (McDermott et al., 2005).

Wang et al. (2005) have come close to the ideal just stated, not by the use of annually laminated speleothems, but by finding and intensively dating a stalagmite (named DA) with a nearly linear growth rate through the Holocene, and which can be tuned to peaks in the $\Delta^{14}\text{C}$ record with little disturbance to the age model. The detrended data are shown in Figure 11e¹ by comparison with the updated INTCAL04 $\Delta^{14}\text{C}$ records (Reimer et al., 2004). Wang et al. (2005) found that most of the brief excursions to higher isotopic values marked on Figure 11e¹ coincided with the ages of the increased ice-rafting events of Bond et al. (2001), which in turn showed strong similarities with $\Delta^{14}\text{C}$ and ^{10}Be records. The direct relationship between detrended and tuned DA and detrended INTCAL98 $\Delta^{14}\text{C}$ curves is a Pearson correlation coefficient of 0.30, whilst correlations with Greenland ice core $\delta^{18}\text{O}$ are higher, particularly ($r = 0.57$) if a 150-year lag of the Greenland NGRIP chronology from DA is used. Wang et al. (2005) showed that further processing of the time series led to a number of significant peaks whilst cross-spectral analysis with the INTCAL98 $\Delta^{14}\text{C}$ record likewise displayed a number of peaks in the range 29 to 232 years. The more parsimonious approach of Figure 11 also illustrates that cross-spectral analysis enhances the significance of a number of periods of variation (cf. Figures 11d² and 11e). Notably, the two peaks at 89 and 216 years are both in common with those revealed in the analysis of Wang et al. (2005, their figure S1), but also correspond to two well-known frequencies attributed to solar variation and which are also found in a further Holocene stalagmite from Dongge cave (Dykoski et al., 2005).

More generally, there has been considerable interest in the presence of short-term solar-forcing on climate records (Burroughs, 1992). Since the primary variation of insolation is small, an amplification mechanism must operate in the climate system. The double sunspot (22 year) cycle is most commonly

recorded, and others include the Gleissberg (90 year) and single sunspot (Schwabe) 11-year mean cycle (range 7.5 to 16 years). However, the dynamics of the climate system itself can generate multidecadal periodicities (e.g. Delworth and Mann, 2000) in addition to shorter-term climate modes (Burroughs, 1992) and so this is an area where caution is needed. Periodicities in the sub-decadal to centennial-scale have been found to a varying extent in growth rate records of annually-laminated speleothems (e.g. Genty and Quinif, 1996; Frisia et al., 2003) and in $\delta^{18}\text{O}$ records (e.g. Neff et al., 2001; Niggemann et al., 2003a, b; Paulsen et al., 2003; Dykoski et al., 2005; Wang et al., 2005). The existing data are promising, but what is needed are more high-resolution analyses and detailed tests of both the presence and stationarity of periodic features in the series to provide a firm foundation for these studies.

In summary, the longer-term features of speleothem climate records in sensitive areas match those found from marine and ice core records, with the same problems of causality. Speleothem records are also revealing shorter-term periodicities, but in general it is difficult to distinguish extra-terrestrial forcing from internal dynamics of the climate system, from noise (e.g. Soubiès et al., 2005). There is a need for many more high-resolution records, particularly where annual variation can be recognized, and the stationarity or otherwise of time series needs more extensive investigation in order to be more confident about the meaning of spectral peaks. A good example is the work of Holmgren et al. (2003), who established the consistent presence (but variable frequency) of frequencies in the range 2.5–4 ka and around 1 ka by wavelet analysis of South African speleothems.

3.2 Atmospheric circulation (meteorology and short-term climate)

Oxygen isotope records have again provided the main focus to date in this context. The primary database used to construct the behaviour of the modern atmospheric system are the monthly collections at various locations coordinated and archived by the International Atomic Energy Agency (IAEA) and the World Meteorological Organization (Araguas-Araguas et al., 2000), whereas daily or event-scale data are much more scarce (Darling, 2004).

Fractionation of a given parcel of atmospheric moisture is controlled by the Rayleigh fractionation process of condensation and removal of precipitation. Since precipitation is isotopically heavier than the residual vapour, the effect is that of progressively larger total fractionations at lower temperatures (Gat, 1996; Alley and Cuffey, 2001). The amount effect, which dominates in tropical areas (Figure 12b), can in part be explained by the condensation of water vapour at low temperatures within intense low pressure systems associated with high rainfall events, and also in part by partial evaporation of light rains.

Lawrence and White (1991) presciently used modern rainfall data to search for geographic settings in which $\delta^{18}\text{O}$ was sensitive to rainfall amount or temperature, as a guide for palaeoclimate workers. Hoffmann et al. (1998) used a combination of model and observational data to provide a more complete representation of the geographic distribution of such

sites (Figure 12). Speleothem workers are now making effective use of an understanding of the modern amount effect in palaeoclimatic interpretations of rainfall (e.g. Ayalon et al., 1998; Bar-Matthews et al., 1998; 2003; Fleitmann et al., 2004). Southern China is an interesting region in that it shows a strong amount effect related to the summer monsoon intensity, but observational and tree ring data further north show a transition to a relationship of $\delta^{18}\text{O}$ with temperature instead (Johnson and Ingram, 2004; Liu et al., 2004). The speleothem data e.g. in southern and eastern China, Oman and India (Wang et al., 2001; Fleitmann et al., 2004; Yadava et al., 2004) have helped to demonstrate the sensitivity of monsoonal delivery of rainfall to subtle external drivers, as well as to the amplification by large-scale reorganization of the climate system that accompanied glacial-interglacial fluctuations. More generally, in tropical to sub-tropical areas, the long-term migration of the inter-tropical convergence zone (ITCZ) can be sensitively recorded by episodes of speleothem growth (e.g. near the limit of influence of the ITCZ in NE Brazil, Wang et al., 2004) or by $\delta^{18}\text{O}$ where the relative importance of different moisture sources changes over time (Hellstrom et al., 1998; Cruz et al., 2005a).

The NAO (North Atlantic Oscillation) and ENSO (El Niño-Southern Oscillation) are two of the main climate modes identifiable in regions where speleothems accumulate, and they are known to affect ice core oxygen isotope compositions (Werner and Heimann, 2002), but their multi-year variability is far from being deterministic. Winter NAO variability is associated with inverse changes in rainfall amount in NW and SW Europe and was associated with changes in lamina thickness records at the Tartair cave in Scotland in the studies by Proctor et al. (2000; 2002). However, Pauling et al. (2003), in a multiproxy study, show that beyond the instrumental period, the relationships change and that it is more appropriate to think of the stalagmite records in terms of their response to temperature and precipitation rather than to the NAO *per se*. Rainfall changes related to the NAO are particularly strong in Iberia (Xoplaki et al., 2004) where there are associated changes in $\delta^{18}\text{O}$ of precipitation (Andreo et al., 2004), but no high-resolution records are currently available. There is an indication that there is a correlation between $\delta^{18}\text{O}$ of precipitation and the NAO index in central Europe (e.g. the analysis of Vienna data by Kaiser et al., 2002), and Onac et al. (2002) argued that such a relationship contributes to the trends in a $\delta^{18}\text{O}$ Holocene record from Ursilor Cave, Romania.

Historical ENSO records are well recorded by sea-surface temperature proxies in corals (Tudhope et al., 2001) and ought also to be recorded in speleothems since ENSO is associated with strong 2–7 year variability (Cane, 2005) which can be expressed in quantity of rainfall in geographic areas where there is a clear amount effect. A recent 1500-year speleothem $\delta^{18}\text{O}$ record from Chilibrillo Cave in ENSO-influenced Panama (Lachniet et al., 2004) does display (weak) evidence of sub-decadal periodicity, but is dominated by a linear trend and low-frequency variation. The full width of the ENSO frequency range is beyond the sampling resolution of much of this record. Dykoski et al. (2005) found some evidence of ENSO frequencies in a high-resolution portion of a stalagmite $\delta^{18}\text{O}$ record from Dongge Cave. Brook et al. (1999) demonstrated a correlation with ENSO in growth rates of stalagmites from

Anjohibe Cave, Madagascar and indications that cave processes can lead to trace element ENSO records are given by McDonald et al. (2004) - see also section 5.4.

clouds (Gat, 2000). This leads to the well-known correlations between isotope composition of precipitation and latitude, altitude and continentality (Rozanski et al., 1993). A constant gradient of isotope composition versus within-event

temperature of $0.55\text{‰}/\text{°C}$ has been demonstrated by Kohn and Welker (2005) for sites in the USA, whereas based on monthly temperature data much more widely varying gradients have been used to date. For example, for Europe there is a present day spatial gradient of $0.58\text{‰}/\text{°C}$, a seasonal gradient of $0.32\text{‰}/\text{°C}$ and a long-term gradient of $0.63\text{‰}/\text{°C}$ (Darling et al., 2005). When such a gradient is added to the temperature effect associated with calcite precipitation from water ($-0.24\text{‰}/\text{°C}$), this provides an estimate of the (usually positive, sometimes negative) temperature sensitivity of speleothems in a given region, at least for modern period (McDermott et al., 1999; McDermott, 2004). Mangini et al. (2005) have recently provided a five-point calibration for an apparent atmospheric gradient of $-0.22\text{‰}/\text{°C}$ over the past 300 years in a stalagmite record from the high-altitude Spannagel Cave (Austria) and discuss the implications of extending this calibration to their entire 2000-year record. An implication in this case would be a significant difference in regional temperature between the Mediaeval Warm Period and Little Ice Age, somewhat larger than in the northern hemisphere reconstructions of Cook et al. (2004) and Moberg et al. (2005), and much larger than that of the IPCC 2001 assessment (Houghton et al., 2001).

There are however caveats to this approach. One is that high-resolution variation on the sub-decadal scale (e.g. Figure 9) is probably on a shorter-timescale than the thermal inertia of the cave and so may well reflect changes in

rainfall composition on the annual to decadal scale. There is also much evidence pointing to the role of varying source areas and/or moisture histories in controlling isotope composition (Darling et al., 2005, Mangini et al., 2005). For example, rainfall in temperate areas can vary enormously in composition on daily timescales (Darling and Talbot, 2003). In SE Iceland, variations in daily summer rainfall of 12‰ (Robinson, 2003) show no correlation with temperature or rainfall amount. Lawrence and White (1991) showed that Mohonk Lake in New York State displayed multi-year fluctuations in the annual rolling average of δD of 15‰ (equivalent to 1.5‰ variations in $\delta^{18}\text{O}$), correlating inversely with rainfall amount, related to changing patterns of synoptic weather systems. Celle-Jeanton et al. (2001) used event data to demonstrate characteristic differences in the isotope composition of precipitation in the

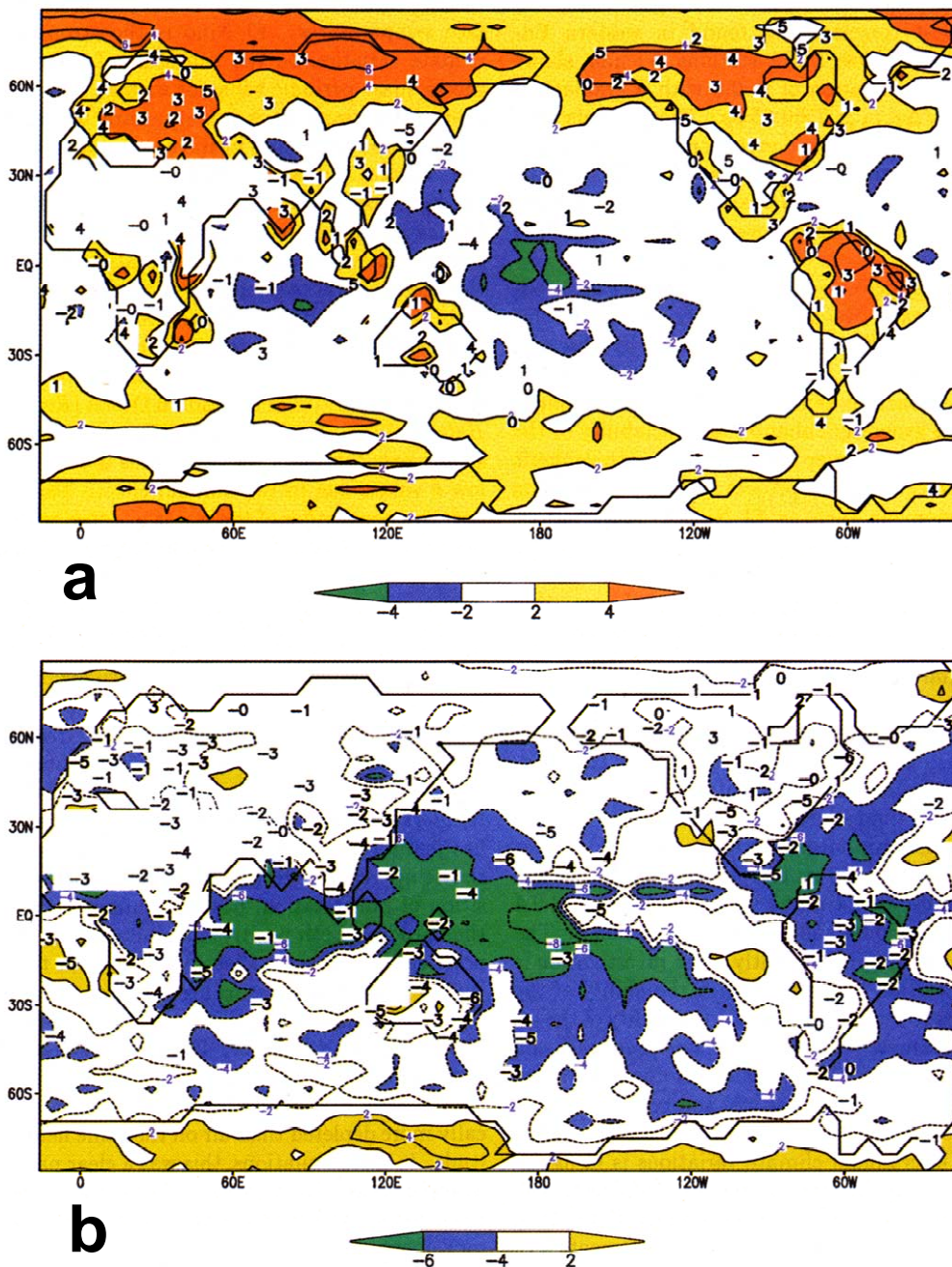

Figure 12. Geographic variation of correlation coefficients between $\delta^{18}\text{O}$ of atmospheric precipitation and monthly **a)** mean temperature and **b)** rainfall amount (Hoffmann et al., 1998). Oxygen isotopes are from a 10-year simulation of the ECHAM Atmospheric Circulation Model together with IAEA stations. Correlations are all multiplied by 10; the bold numbers denote the calculated correlations with at least three seasonal cycles. This diagram is reproduced by permission of the copyright holders, the American Geophysical Union.

In cooler geographic areas, there is frequently a correlation of temperature at the cloud base (and the ground surface) with the isotope composition of precipitation (Figure 12a). This arises because of the primary fractionation associated with cooling, but also because also of re-equilibration processes within

Mediterranean coastal region of France. Clearly, more research of this kind is needed on the distinctive isotope compositions of different types of synoptic weather systems since small changes in the proportion of different synoptic types of widely differing composition can lead to significant changes in mean composition of precipitation and hence speleothems. On the longer term within the Holocene, changes in the relationship between $\delta^{18}\text{O}$ and temperature in Scandinavia deduced from carbonate lake sediments have been related to changing oceanicity (Hammarlund et al., 2002); such changing relationships can be tested by isotope-enabled General Circulation Models (e.g. Jouzel et al., 2000).

A vivid example of the dangers of relying on monthly precipitational compositions is provided by Treble et al. (2005b) on the basis of a 6 year long daily record of Tasmanian precipitation. She shows that although on a monthly basis there is a correlation between temperature and isotope composition, individual events are dominated by a strong amount effect, apparently related to proximity of major low pressure systems. Here then, the apparent link to temperature has no predictive power since it incorrectly identifies the responsible mechanisms.

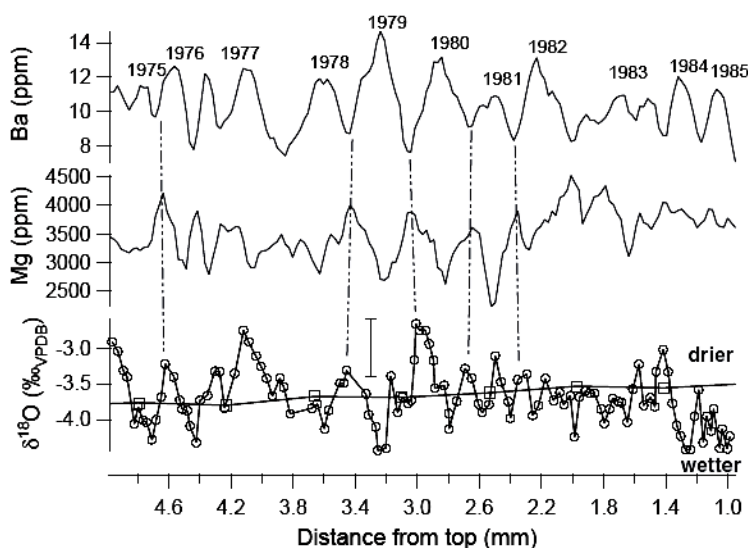

Figure 13 (from Treble et al., 2005b). Stalagmite MND-S1 from Moondyne cave, SW Australia. Comparison of an ion microprobe $\delta^{18}\text{O}$ transect (circles), conventional $\delta^{18}\text{O}$ analyses of powdered sample (squares) and annual cycles of Ba and Mg measured by laser ablation ICP-MS. Where prominent annual cycles are present, $\delta^{18}\text{O}$ peaks corresponds to Ba troughs and Mg peaks. Bar indicates 2σ internal analytical uncertainty for ion probe (here argued to be a minimum as it was obtained on a glass standard).

Most geographic locations display seasonal variations in the isotope composition of precipitation, but because of soil and cave-filtering effects, it does not necessarily follow that this will be registered in cave waters (sections 4.1 and 5.1). New data in Figure 5c, d, together with the ion microprobe work of Treble et al. (2005a) in Figure 13 are the first results to demonstrate seasonal variations in oxygen isotopes in speleothems. Although dripwater data are not available for the SW Australian Moondyne Cave site studied by Treble et al.

(2005a), the range of 0.7–1.5‰ in the speleothem are comparable to the 2‰ difference between isotopically lighter winter rains and heavier summer rains. A number of other studies demonstrating seasonal variations are in progress.

There is now a realization that proportions of winter and summer growth can shift markedly during major climate changes (Jouzel et al., 2000; Denton et al., 2005). More subtle change can also result in major shifts in seasonality of precipitation as evidenced by the patterns of change of tree ring isotopes at the northern tree-line in Eurasia (Saurer et al., 2002). Variations in the seasonality of rainfall (or moisture sources within a season, Lee-Thorp et al., 2001) have been recognized by speleothem workers as a potentially important control on changing $\delta^{18}\text{O}$ over time (e.g. Denniston et al., 1999; Wang et al., 2001), but sub-annual studies and inter-comparison with models are required to provide the proof.

3.3 Climatic, volcanic and anthropogenic forcing of atmospheric solute inputs

A relatively small part of the dissolved load of karstic waters originates from the atmosphere. Nevertheless, corrections to water chemistry by removing the marine aerosol component, for example by scaling elements to their marine abundance of chloride, lead to major changes in for example Mg and Sr concentrations, where their total concentrations are low (e.g. Fairchild et al., 2000; Baker et al., 2000). The sea-salt component can vary temporally. For example, precipitation from stronger winter circulation would be expected to have a higher sea-salt component, although this can be counteracted by increased summer evaporation in the soil zone above a cave (Tooth, 2000; Tooth and Fairchild, 2003). In NW Europe, strong westerly circulation associated with positive values of the North Atlantic Oscillation (NAO) lead to enhanced transport of sea-salt inland (Hindar et al., 2004). A challenge is to find an aspect of preserved speleothem chemistry that can be used as a proxy for such circulation and we are currently investigating the sulphur system. Sulphur is also one of the characteristic species associated with both volcanism and pollution and signals arguably of both discrete volcanic eruptions and 20th century anthropogenic pollution have now been detected in speleothems (Frisia et al., 2005), although the extent of modification to the signal by ecosystem storage of S is a current topic of investigation. It is important also to understand the effects of current atmospheric change on modern calibration studies. In tree ring studies, this is a current concern since it has been shown that at high northern latitudes there is currently a reduced sensitivity (of unknown origin) of tree-ring growth to temperature (Briffa et al., 1998).

Short-lived isotope species can also be characteristic of atmospheric processes, and detectable at high sensitivity. An example is ^{210}Pb , which is derived by decay of ^{222}Rn via short-lived intermediates; its half-life of 22 years makes it useful for dating lake sediments. Paulsen et al. (2003) used measurements of excess ^{210}Pb in a stalagmite top to determine growth rate as a check on annual layer-counting.

4. Modifications mediated by ecosystem, soil and upper epikarst

In this section we review the role of the vegetation type and properties of the soil and upper epikarst (that is within the *dissolution region* of section 1.1) in controlling the amount of recharge and its geochemical properties. This surficial zone is vital for setting a baseline to carbon isotope and trace element characteristics (Table 4).

4.1 Oxygen isotopes and water infiltration through soils

Surface precipitation infiltrates soil to form soil water, whose literature is mainly on non-karstic environments. The first-order controls on soil water are the surface climate and the soil physical properties, which control soil water movement, storage and evaporation (Shurbaji and Phillips, 1995). Isotope analyses of soil water demonstrate a typical depth profile where soil surface evaporation causes deuterium and ^{18}O enrichment near the soil surface, which decreases with depth (Zimmerman et al., 1967). Soil water isotope variability is also often smoothed with depth (depending on water movement mechanisms), and both seasonal and interannual variations in the extent of surface soil water isotope enrichment are observed (Tang and Feng, 2001). The amount of surface isotope enrichment has been shown to vary with the amount of evaporation: for example Hsieh et al (1998) show surface water enrichment of $\sim 6.5\text{‰}$ at a potential evapotranspiration rate of 4 mm/day and $\sim 2.0\text{‰}$ at 1 mm/day in a Hawaiian transect. Transpiration has been shown not to fractionate soil water, except in hydrogen isotopes during uptake by some halophytes. Noone et al (2002) and Yoshimura (2004) coupled isotope GCMs with land surface models to examine spatial and temporal patterns of simulated water pools including soil water, and obtain a similar range of surface soil water isotope enrichment (a range from 0 to 10‰ enrichment depending on evaporation amount) as in the field experiments.

Soil water may eventually become transported into the underlying groundwater, depending on the moisture state of the soil, the type of precipitation events and the soil structure. Isotope composition of soil water provides information about mixing and residence time in soil (Gazis and Feng, 2004), demonstrating that soil water comprises both stationary and mobile fractions. Water movement in solids can be by preferential (macropore) flow, which would allow mobile event water to pass old stationary water, fingered flow due to wetting front instability, or piston flow, which would result in movement of an isotope front of relatively stationary water within the soil. At depth, there is a higher proportion of water replenished from storm events or snowmelt. Variations in soil structure can lead to significant spatial isotope variability; Gazis and Feng (2004) show two soil water profiles within 200 m differ by 1.5 to 3‰ at the same depth, purely due to topographic differences.

In karstic settings, the signal-smoothing effects of soil water cannot easily be separated from the mixing processes also taking place in the soil aquifer. Spatial variations in soil water isotope composition due to spatial variability in soil structure can potentially lead to spatial differences in $\delta^{18}\text{O}$ in contemporaneously deposited stalagmites. The extent to which the isotopically enriched surface soil water is transported to the

groundwater will depend on both the soil type and the surface climate regime, in particular the relative timing and extent of periods of actual evaporation and periods of significant precipitation. Conditions ideal for transporting surface isotopically-enriched water would be climates with sufficient summer heat to induce evaporation but not to an extent where all mobile water is evaporated, followed by a rapid increase in precipitation to transport a mixture of surface enriched water and event water. Snowmelt is a particularly effective mechanism of rewetting soils, and changes in snowmelt through time will significantly affect the soil water isotope signal.

4.2 Changes to solute chemistry

4.2.1 Carbon isotopes

The most significant impact on ionic chemistry in the water arises from the dissolution of carbonate minerals, in contact with a fluid with a PCO_2 higher than that of the atmosphere, in the *dissolution region* of the soil and upper epikarst. Typically, this will be most important around the soil-bedrock contact where the highest carbonate mineral surface area will be encountered. In most cases carbonate is dissolved to saturation at the PCO_2 of the soil environment, or further dissolution may occur if a higher PCO_2 is encountered by further organic decay in an epikarstic reservoir of ‘ground air’ (Atkinson, 1977). This is described as an *open system* (Garrels and Christ, 1965) when modelling carbon sources (Clark and Fritz, 1997). Organically-derived carbon is in excess with typically 80–95% of the ^{14}C activity of modern carbon in waters and speleothems (Genty et al., 2001a). Conversely, where soils are carbonate-free and there are no epikarstic sources of CO_2 , carbonate dissolution occurs in a *closed system* and total dissolved Ca and dissolved inorganic carbon are much lower than in the open system.

The conditions of dissolution have an important bearing on the $\delta^{13}\text{C}$ of cave waters, and hence that of speleothem calcite. The common emphasis is on the differences between closed and open system dissolution with the higher proportion of isotopically light organically-derived carbon leading in the open system resulting in isotopically lighter precipitates. However, Baker et al. (1997) pointed out that seasonal changes in soil $\delta^{13}\text{C}$ within the year and the potential variability in the nature of the soil-epikarst cover could affect $\delta^{13}\text{C}$ in dissolved inorganic carbon (sections 5.4 and 6.2).

The isotope composition of soil organic carbon can also be a function of vegetation type since dryland grasses utilizing the C4 photosynthetic pathway display much heavier compositions (typically around -12‰) compared with the otherwise dominant C3 vegetation with composition closer to -25‰ . The associated speleothems typically have compositions of -6 to $+2\text{‰}$ and -14 to -6‰ respectively (McDermott, 2004), although other processes can cause values to be heavier than expected. A series of studies around the prairie belt of the central United States clearly showed the relationship between the photosynthesis mechanism and the carbon isotopic composition of the speleothems within the last glacial period (25–75 ka) and the Holocene (Dorale et al., 1992; 1998; Denniston et al., 2000; R.G. Baker et al., 2002), matching independent pollen and macrofossil evidence. Slow speleothem growth implies complete degassing, whereas variation in the

amount of degassing might otherwise have an influence on $\delta^{13}\text{C}$ (Schwarcz, 1986; Bar-Matthews et al., 1996). C_4/C_3 variations were also thought to control Holocene $\delta^{13}\text{C}$ variations in NE South Africa (Talma and Vogel, 1992; Lee-Thorp et al., 2001). In other cases, the vegetation amount has been hypothesized to control speleothem $\delta^{13}\text{C}$ composition. Examples are the heavy values in New Zealand from late glacial to early Holocene times (Hellstrom et al., 1998) and the observation of modern heavy values that can relate to deforestation (e.g. Zhang et al., 2004). Heavier $\delta^{13}\text{C}$ values associate with sparse vegetation and hence a lower proportion of light carbon in the dissolution zone. However, in a study from Rana cave in northern Norway, Linge et al. (2001b) demonstrated that different speleothems at the same site can display consistently different $\delta^{13}\text{C}$ signals, indicating the local importance in the aquifer of specific fluid pathways.

As mentioned earlier, speleothems at Villars cave in southern France show a $\delta^{13}\text{C}$ sensitivity to Dansgaard-Oeschger events during the last glacial period (Genty et al., 2003). The mechanisms involved were introduced by Genty et al. (2001a) in terms of passing a threshold within a geographic region susceptible to climate shifts from semi-arid through Mediterranean to temperate. Above a rainfall threshold, increased soil biogenic CO_2 production via plant respiration and microbial activity leads to more negative $\delta^{13}\text{C}$ values.

There are few studies to date which examine $\delta^{13}\text{C}$ at high resolution, but in this case, there are possible lag effects, depending on the mechanism causing change. Whereas a change in $\delta^{13}\text{C}$ driven by the amount of degassing in the cave can act immediately, system modification involving cycling through the soil is longer. Genty and Massault (1997; 1999) and Genty et al. (1998) have developed models of soil carbon cycling based on ^{14}C analyses at the tops of modern speleothems indicating for example that the bomb-carbon peak is both attenuated and delayed typically by 5–15 years in cave dripwaters and speleothems compared with the atmosphere. Where the ecosystem biomass or photosynthetic pathway is involved, much more gradual changes may be expected.

4.2.1 Trace elements

The two most important ion sources in karst waters are calcite (CaCO_3) and dolomite (approximately $\text{CaMg}(\text{CO}_3)_2$), but dolomite dissolves much more slowly than calcite (Morse and Arvidson, 2002) leading to aqueous Mg/Ca ratios of less than one. Raised ratios of Mg/Ca and Sr/Ca compared with bulk carbonate, referred to as incongruent dissolution by Fairchild et al. (2000), is now thought to be due to preferential leaching of Mg and Sr from newly created calcite surfaces (McGillen and Fairchild, 2006). Such surfaces can be generated by winter freezing in soils and selective leaching can also arise where there is storage during a dry season as sulphate or chloride salts, where there is a fresh supply of clay minerals with other exchangeable ions, or where there are other more soluble phases present such as aragonite, which is invariably rich in Sr .

Changes in ion ratios in infiltrating waters could occur on a seasonal basis if salts are alternately precipitated and leached from a soil. In some speleothems, there is an association of certain trace species appear with evidence of flushing from the soil during seasonally high flows (autumnal in western Europe). Species such as P , Y and organic colloids are present at higher concentrations, and a visible and/or fluorescent lamina is characteristic (Baker et al., 1993; Huang et al., 2001; Fairchild et al., 2001), although identification of this flush ideally requires the use of precise techniques at the highest spatial resolution (Borsato et al., 2006). A good example is the discovery by Richter et al. (2004) of cathodoluminescent bands in early Holocene speleothems in Germany stimulated by increased rare earth element and Mn^{2+} concentrations related to high infiltration events.

On the longer timescale modifications to the nature of reactive materials close to the ground surface can be recognized in speleothems. For example, Sr isotope data can demonstrate changes in aeolian sediment or marine aerosol supply to the soil, or variations in leaching intensity from the soil over extended periods (Banner et al., 1996; Goede et al., 1998; Ayalon et al., 1999; Bar-Matthews et al., 1999; Frumkin and Stein, 2004; Li et al., 2005). Uranium isotope variations also are likely responsive to hydrological conditions (Ayalon et al., 1999; Frumkin and Stein, 2004). Another example capitalizes on the discovery by Klein and Walter (1995) that silica adsorbed onto calcareous surfaces according to its ratio to Ca . Hu et al. (2005) showed that adsorbed Si varies over millennial periods at Heshang Cave in central China and suggested it could be used as an index of palaeorainfall, the argument being that Si leaching from soils would be at a maximum under drier climates with a higher rate of supply of fresh aeolian dust.

A distinct body of work on fluorescing organic species has led to interpretations of the relationships between hydrologically effective precipitation, flushing of fluorescent organic matter into caves (van Beynen et al., 2002; Tatár et al., 2004), and its capture in speleothems (Baker et al., 1993). For example Baker et al. (1999a) found that both intensity and duration of infiltration was important in the efficiency of transfer to caves. The luminescent intensity in speleothem laminae can reflect surface climate parameters with some smoothing by the karst system (Baker et al., 1999b), and in a 1000 year climate record from Tartair cave in Scotland additional snowmelt flushes in cold years were found (Baker et al., 2002).

5. Modifications by the karst aquifer and cave environment

Here we summarize the influences of the karst aquifer and the cave environment in mixing, storing, and delivering water to the site of speleothem formation. Site-specific variation in carbon isotopes and trace element composition is particularly important (González and Lohmann, 1988), but temporal patterns can still be related to seasonality (Table 4).

5.1 Karst aquifer and water flow behaviour

Karst aquifers display complex flow phenomena since the porosity occurs in three forms as conduits, fractures and pervasive matrix, the detailed geometry of which is not

accessible to observation. Transit times are variable, or multimodal, as demonstrated by dye-tracing tests, but a simplifying factor is that infiltration to caves is sub-vertical (e.g. Bottrell and Atkinson, 1992). Aquifer rocks vary considerably in their matrix porosity and degree of fracturing, although a significant water capacity in the epikarst zone is normal (Williams, 1983; Perrin et al., 2003). In some cases, dripwaters may show the effects of piston flow behaviour whereby distinct parcels of water, representing a series of infiltration events, successively reach the drip, but as discussed in Fairchild et al. (in press a) most of the claims for such a process are based on non-conservative tracers.

A pervasive phenomenon is mixing of water derived from different aquifer compartments, as is demonstrated for example by oxygen isotope data (e.g. Perrin et al., 2003; Long et al., 2004). Smart and Friederich (1986) distinguished the behaviour of drips by plotting the mean discharge of drips against their coefficient of variation and Tooth and Fairchild (2003) developed their concept of aquifer plumbing elements which combined to produce these different behaviours. This led to a quantitative model of drip hydrology and hydrogeochemistry by Fairchild et al. (in press b) who combined constant flow in a seepage reservoir with exponentially declining flow in a macropore-fracture reservoir to model drip behaviour at a disused mine site. Drips varied from <20% to more than 250% in their variation in discharge about the mean and Figure 14 illustrates the behaviour of a particularly variable drip, but one that was nevertheless depositing a stalagmite. Calculated weekly precipitation minus infiltration leads to the identification of sporadic recharge events that matched increases in discharge from the drip (Figure 14a); closer matches are found with daily data compared with continuous drip-logging (Figure 14b). Although a linear systems model was able to combine water flows to model variation of discharge of drips at the site, the hydrogeochemical data indicated greater complexity (Fairchild et al., in press b) and more generally, drip hydrology also displays non-linear responses to driving parameters (Genty and Deflandre, 1998; Baker and Brunson, 2003).

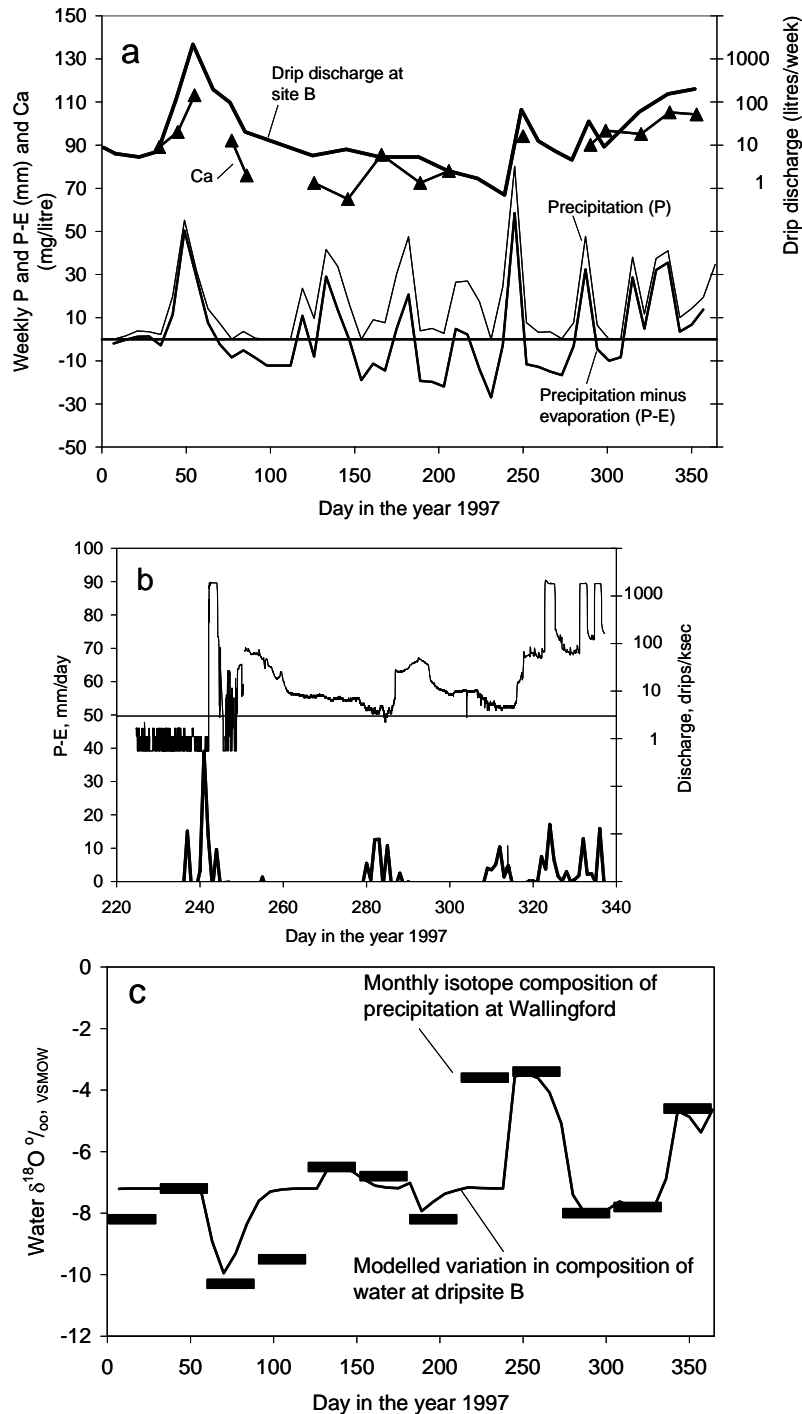

Figure 14. Observations and models related to drip site B during the calendar year 1997 at Brown's Folly Mine, SW England (data replotted from Fairchild et al., in press b). **a.** Discharge from observations at 10–20 day intervals exhibits correlation with Ca content; this is attributed to prior calcite precipitation at lower flows. Increases in discharge correspond to periods of hydrologically effective precipitation as expressed as P-E (Baker et al., 1999b). **b.** Daily P-E values related to a period of operation of datalogged discharge. The flat-topped peak discharge events presumably relate to conduit flow; lower flows can be modelled by a combination of seepage and fracture flow (Fairchild et al., 2005). **c.** Comparison of monthly compositions of precipitation at the nearest IAEA site (Wallingford) with the isotope composition of dripwater at site B as predicted from a discharge model.

5.2 Cave air

Carbonate speleothems arise primarily because of the creation of supersaturated waters by CO_2 -degassing (Holland et al., 1964) and the extent of speleothem growth relates to the difference between soil PCO_2 , higher in warmer, moist climates (Brook et al., 1983) and cave air PCO_2 . There has been a relative neglect of the process of air circulation in caves an essential part of their physiology (Carrasco et al., 1995; Fairchild et al., in press a), which allows CO_2 to be removed and hence CaCO_3 to be precipitated. Such circulation can be a rate-determining step in speleothem growth by controlling the PCO_2 of cave air, complementing the important baseline

control of the Ca content of incoming dripwater (Dreybrodt, 1988). There is growing recognition that dripwaters often derive from an epikarstic reservoir of year-round constant PCO_2 (Atkinson, 1977; Fairchild et al., 2000; Spötl et al., 2005), but that cave air shows seasonal changes in PCO_2 (Figure 15). These changes are likely to be caused by combinations of enhanced winter air circulation (as indicated for example by radon studies, Hakl et al., 1997), seasonal changes in PCO_2 of inflowing stream water (Troester and White, 1984), or a seasonal filling of air fissures by water, cutting off the CO_2 supply. These issues are discussed further in Fairchild et al. (in press a).

5.3 Spatial setting of speleothems

Three important variables in terms of speleothem setting are position with respect to cave entrances, depth below the surface, and position with respect to the flowline of water within the cave. The temperature distribution and ventilation properties of cave systems are highly variable, but in general sections of cave passage close to the cave exterior are more prone to seasonal variations in temperature (e.g. Spötl et al., 2005), and tend to have lower humidity. Other factors being equal, the deeper a cave passage is below the surface, the less responsive the hydrological system is likely to be to infiltration events, although a deep cave in vertical strata may be more responsive than many shallower sites. Sites less than 10–15 m below the surface are particularly likely to show responsive dripsites, whatever the geology. Nevertheless the feeding drip for an individual stalagmite could still be almost entirely fed from seepage flow. The third point is that the studied speleothem may be some distance downflow of the point at which seeping water encounters cave air, degasses and becomes supersaturated. Downflow speleothems have a more ‘evolved’ composition, as illustrated by terminal pool water compositions in the Italian Ernesto cave described by Huang et al. (2001).

5.4 Hydrochemical patterns

5.4.1. Dripwater oxygen isotopes

The spatial and temporal pattern of oxygen (and hydrogen) isotopes in cave dripwaters reflect a combination of the evaporation and mixing processes in the soil zone, selective recharge of heavier rains and the hydrological behaviour of the karstic aquifer. In regions where evaporation is high, and consistent with the soil literature, there is evidence of enrichment of $\delta^{18}\text{O}$ in cave dripwaters compared with weighted mean precipitation. For example, in Israel, an approximate 1‰ enrichment is typical (Ayalon et al., 1998). In contrast, cave dripwaters in Barbados are closer to the lighter end of the monthly rainfall values because of limited recharge in drier months when the isotopically heavier precipitation occurs (Jones et al., 2000; Mickler et al., 2004); this is the pattern expected also in arid climates (Gat, 1996). In temperate climates little deviation from mean compositions of precipitation is usual (Yonge et al., 1985; Williams et al., 2004).

Several published examples exist demonstrating an absence of significant isotope shifts in slow drips through at least a

hydrological year (Yonge et al., 1995; Caballero et al., 1996; Williams et al., 2004). This is consistent with a dominance of seepage-fed flow, where the seepage reservoir and/or the overlying soil and epikarst has a structure that permits thorough mixing. On the other hand, where there is significant fracture-fed flow, a more heterogeneous pattern would be expected (this can also be demonstrated by the use of dissolved organic carbon tracers, Baker et al., 1999b; Cruz et al., 2005b). Ayalon et al. (1998) studied the Soreq cave in Israel and found a fracture-fed drip which closely followed the seasonally variable rainfall with an annual range of the dripwater of up to 5‰ , in contrast to most other fast drips, deeper in the cave, where seasonal variation was no more than $0.5\text{--}1\text{‰}$. Evidence of entrainment of an evaporated seepage component for the latter is that they were 0.3 to 1‰ heavier than weighted mean rainfall composition. Slow drips showed a seasonal variation of $0.5\text{--}1\text{‰}$ (attributed to varying contributions from more ^{18}O -depleted and partly evaporated ^{18}O -enriched end-members) and were slightly more enriched than the mean of fast drips. The Brown’s Folly Mine drip data is used to illustrate the mixing phenomena in principle, using the flashy site B. Figure 14b illustrates that if the hydrological model for drip site B at Brown’s Folly Mine is driven by the monthly stable isotope data from the Wallingford site in southern England, significant deviation in dripwater composition occurs whenever precipitation of distinctive composition strong enough to cause significant infiltration. It is this kind of pattern that is required to produce speleothems exhibiting annual $\delta^{18}\text{O}$ fluctuations as in Figure 13.

5.4.2. Degassing and prior calcite precipitation

The carbon dioxide degassed from cave waters is around 10‰ lighter in $\delta^{13}\text{C}$ than the host solution and so creates strong Rayleigh fractionation effects. This is one reason that $\delta^{13}\text{C}$ in different modern speleothems can display significant variation (Baker et al., 1997). Once the solution is supersaturated there is a tendency also for CaCO_3 to precipitate. Where these processes are slow, as in the Soreq cave, isotopic equilibrium prevails (Bar-Matthews et al., 1996). Spötl et al. (2005) have shown that in a more dynamically ventilated system where PCO_2 falls strongly in winter, the equilibrium enhancement of $\delta^{13}\text{C}$ values in cave water is more than doubled by kinetic effects, leading to strong seasonal variations in $\delta^{13}\text{C}$ (Figure 15) and maximum rates of CaCO_3 precipitation in the winter. Conversely summer maxima in supersaturations can arise by seasonal dryness (Fairchild et al., 2000). Figure 14, shows the correlation of Ca content with discharge at Brown’s Folly Mine, interpreted as being due to prior calcite precipitation effects at lower flows. Because the distribution coefficients for Mg and Sr are much less than 1, CaCO_3 precipitation upflow leads to enhanced Mg/Ca and Sr/Ca downflow and a correlation with $\delta^{13}\text{C}$ (Verheyden et al., 2000; McDermott et al., 2005). Since Galy et al. (2002) estimate that calcite is around 2.7 lower in $\delta^{26}\text{Mg}$ values than the precipitating solution, Mg isotope data could also be used in future to establish the extent of occurrence of prior calcite precipitation.

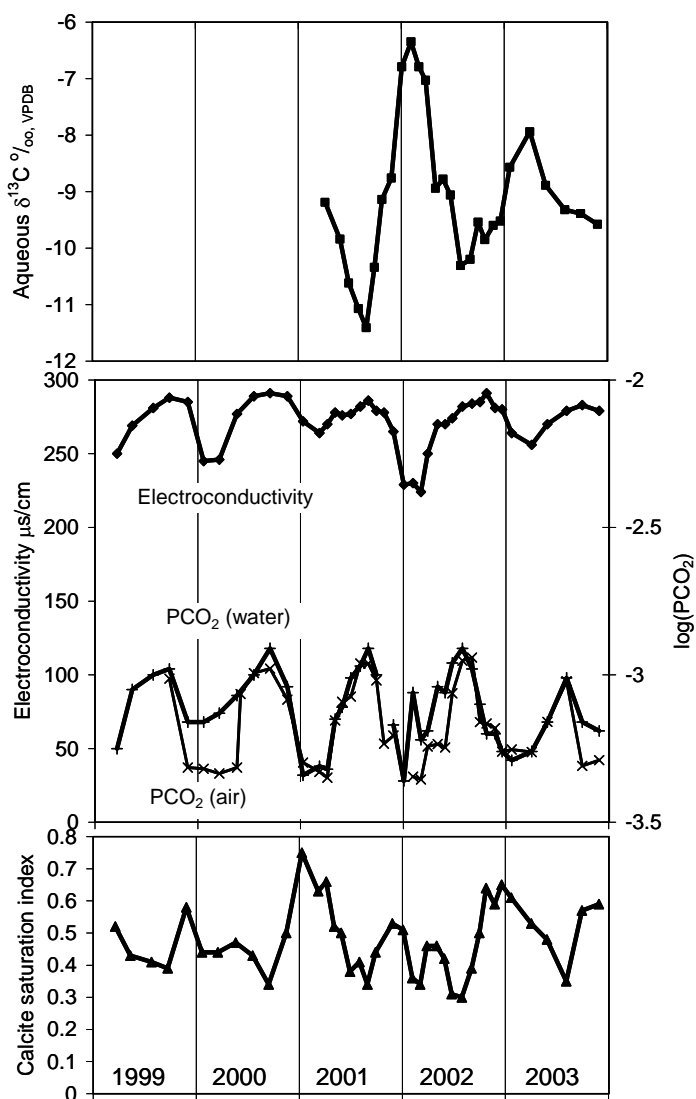

Figure 15. Carbonate system data from Obir Cave (based on the published data in Spötl et al., 2005). Conductivity (surrogate for Ca and alkalinity), $\delta^{13}\text{C}$ and calculated PCO_2 and calcite saturation index of dripwater from Haifischmaul chamber and measured PCO_2 of air in nearby chamber Stollenabzweigung. Annual cycles of cave ventilation drive increased degassing of CO_2 from water, increased supersaturation and $\delta^{13}\text{C}$ of cave waters and cause increased rates of CaCO_3 precipitation resulting in lowered solution electroconductivity.

The preferential dissolution of calcite over dolomite leads to lower Mg/Ca ratios than would be expected from the bulk aquifer rock composition as modelled by Fairchild et al. (2000). It has been tempting to interpret temporal changes in Mg/Ca in terms of a residence time model which predicts that if water has a higher residence time (slower water flow, drier conditions) this will lead to higher Mg/Ca ratios by enhanced dolomite dissolution (Roberts et al., 1998; Fairchild et al., 2000; Tooth and Fairchild, 2003; Musgrove and Banner, 2004). However, since this mechanism requires dolomite dissolution into solutions already saturated for calcite, the process of measurably enhancing Mg contents is very slow and is likely to require residence times of months to years. Specifically, Musgrove and Banner (2004) illustrated an association between low discharge, high Mg/Ca and Sr/Ca and low $^{87}\text{Sr}/^{86}\text{Sr}$ in

dripwaters at the Cretaceous Edwards aquifer, Texas, and interpreted data using a geochemical model originally designed for progressive limestone recrystallization processes and which had been applied successfully to the Pleistocene carbonate aquifer of Barbados (Banner et al., 1994). Such multiproxy data are valuable, but less water-rock interaction over short timescales might apply in many aquifers. More straightforward is a hydrological routing model for which there is strong evidence in Mesozoic aquifers. Here the residence time effect is related to an enhanced contribution of Mg-rich waters from low-permeability parts of the aquifer at low flow. Hence Mg and/or Sr enrichments during annual low flows in dripwaters in Mesozoic aquifers can be related to higher contents of dolomite (for Mg) or aragonite (for Sr) associated with clay (Baker et al., 2000; Fairchild et al., in press b). A change in mean hydrological routing in relation to rainfall was also inferred to control long-term variations in $^{87}\text{Sr}/^{86}\text{Sr}$ ratios in Holocene speleothems from Barbados by Banner et al. (1996).

Prior calcite precipitation leading to increasing Mg/Ca and Sr/Ca in cave waters was first explicitly modelled in principle by Holland et al. (1964). Examples of sub-annual to annual increases in these ratios in response to prior precipitation during dry weather conditions are illustrated in dripwater data by Tooth and Fairchild (2003) and with a clear seasonal pattern linked to ENSO by McDonald et al. (2004). Where large seasonal changes in Mg/Ca and/or Sr/Ca occur, they would be expected to dominate the speleothem geochemistry. McMillan et al. (2005) have found an excellent example of this pattern in the Clamouse cave of southern France which is impacted by seasonal reduction in drip rates accompanied by prior calcite precipitation. Covarying trace element patterns are close to those expected by prior calcite precipitation with a minor kinetic enhancement of Sr at seasonally-high Sr/Ca ratios. The robust nature of the trace element patterns allowed the long-term variation in Sr and Mg in speleothem calcite to be used as an aridity index. Other examples of equivalent annual enrichments in Mg and Sr are found in our unpublished data, and also illustrated by White (2004) from Butler Cave, Virginia. In the case of aragonite, Finch et al. (2001) established annual cycles in Sr and Ba data, probably related to seasonal dryness, and used spectral analysis to demonstrate the coherence of these relationships; McMillan et al. (2005) also found probably annual U cycles in aragonite. This mechanism may be responsible for the observations that on longer timescale Sr and Ba correlated positively with rainfall in aragonite from Cold Air Cave, South Africa (Finch et al., 2003).

5.4.3. Mechanisms for changes at longer timescales

Long-term changes in $\delta^{18}\text{O}$ might reflect differential changes in winter and summer growth (McDermott, 2004; Treble et al., 2005a). This will only apply where the dripwater itself changes in isotope composition seasonally. Only recently has sufficient dripwater data been available to estimate the proportions of winter and summer growth at a number of cave sites (Genty et al., 2001b), but there is currently insufficient information to judge how climate change will affect growth rates: quantitative modelling of cave systems are needed to achieve this. In a given speleothem however, if the shape of the seasonal trace

element profile changes, this may be an indication of such a mechanism.

On longer time scales, establishing whether changes in speleothem $\delta^{13}\text{C}$ and trace element composition reflect aquifer processes is more difficult to establish. Hellstrom and McCulloch (2000) argued for a residence time effect on Mg and a vegetation effect on $\delta^{13}\text{C}$ causing variations in a 30 ka record from a flowstone of Nettlebed Cave, New Zealand, in part because of an absence of a similar composition with Ba and Sr which would result from prior calcite precipitation effects. Composite process models are probably needed to account for the positive covariation of P and U with rainfall and negative variation of Mg with rainfall over time at Moondyne cave in SW Australia (Treble et al., 2003). On centennial to millennial timescales, changes in aquifer flow routing must occur to account for the switching of speleothem growth sites.

6. The Crystallization Filter

Here we examine the transformation of water chemistry into that of the stalagmite. Hence the time series signal passes through a *crystallization filter*. This is highly variable in its impact on the time series of different components (Table 4).

6.1 Mineralogy and crystal morphology of speleothems

Cave mineralogy is reviewed exhaustively by Hill and Forti (1997) and the form of crystal aggregates is reviewed by Self and Hill (2003). The most common mineral in calcareous speleothems is calcite, although aragonite is known from a number of caves in dolomitic host rocks, and a variety of rarer carbonates also occur (Hill and Forti, 1997). Annual interlayering of calcite and aragonite is known from seasonally dry caves (Railsback et al., 1994).

Although the unit rhombohedral crystallographic form of calcite is the normal one displayed in speleothem tips, a variety of different crystallographic forms are known in hydrothermal environments in particular (Onac, 1997). There are also reports of length-slow calcite in subaqueous speleothems (Kolesar and Riggs, 2004), perhaps indicative of a different crystallographic form (Dickson, 1993). Different crystallographic forms typically exhibit differing trace element contents (Reeder and Grams, 1987), although the majority view is that isotope compositions should not be affected (Klein and Lohmann, 1995; Reeder et al. 1997; versus Dickson, 1997). A pervasive form of variation in calcite is the degree to which 1–10 μm scale crystallites define larger crystal units. Frisia et al. (2000) discussed the development of columnar, ‘microcrystalline’ and dendritic fabrics as representative of increasingly rough crystal surfaces with more variation in orientation of large composite crystal units representing growth further from equilibrium. Dendritic crystals in particular were regarded as unlikely to exhibit equilibrium isotope and trace element fractionations. Frisia et al. (2000) also demonstrated that different morphologies could alternate seasonally in response to variations in saturation state.

Aragonite typically occurs as aggregates of crystal needles, and more rarely as stouter ray crystals (Finch et al., 2001; Frisia et

al., 2002; Spötl et al., 2002b; McMillan et al., 2005). Aragonite is a metastable mineral at earth surface conditions and is prone to alteration to calcite, but in speleothems largely unaltered aragonite can persist for periods of thousands to millions of years.

Lamination, representing variations in crystal size, fluid inclusion or impurity content on sub-annual to millennial-scale is found in most speleothems, although a specifically annual lamination is the most common and distinctive type when annual climate forcing dominates (Baker and Genty, 2003). Fairchild et al. (in press a) distinguish between *couplets*, for example the alternating inclusion-rich and inclusion-poor crystals of Genty and Quinif (1996), and *infiltration laminae*, where a thin annual lamina typically enriched in many trace elements occurs (e.g. Huang et al., 2001; Frisia et al., 2003). Infiltration laminae are often fluorescent under ultra-violet light, reflecting transport and incorporation of soil-derived humic and fulvic acid colloidal molecules. Although both types of laminae can be preserved simultaneously (Genty et al., 1997), light-scattering from inclusions can hinder the preservation of the luminescent signal. Couplets probably reflect seasonal variations in cave water chemistry, and specifically saturation state, which could reflect changes in cave air composition, or seasonal reduction in water infiltration. Infiltration laminae are more typical of year-round wet caves, where the lamina appears to mark a critical degree of aquifer filling in the wet season.

6.2 Stable Isotopes

Much effort has been devoted to determining the isotope fractionation factors that relate the oxygen isotopic composition of water and the carbon isotopic composition of dissolved inorganic carbon species to the $\delta^{18}\text{O}$ and $\delta^{13}\text{C}$ composition of speleothem (and other low-temperature) CaCO_3 (Kim and O’Neil, 1997; Zhou and Zheng, 2003; Jiménez-López et al., 2004; McDermott, 2004; McDermott et al., 2005). Since the early studies of Duplessy et al. (1969), Fantidis and Ehhalt (1970) and Hendy (1971) there has been concern about possible disequilibrium processes occurring in relation to degassing and evaporation processes on the speleothem surface. Field observations by Mickler et al. (2004) on calcareous precipitates forming on glass plates under drips are consistent with the occurrence of a kinetic fractionation associated with CO_2 -loss and enrichment in ^{13}C in the remaining solution by a Rayleigh fractionation process. This is associated with ^{18}O -enrichment by lack of equilibration with H_2O (Hendy, 1971) either because of lack of fractionation between oxygen in aqueous bicarbonate and solid CaCO_3 during fast precipitation, or by this process augmented by the Rayleigh fractionation reaction that affects the $\delta^{13}\text{C}$ pattern. Also, recent experimental research at the University of Heidelberg indicates that a distinction should be made between evaporative effects, which affect $\delta^{18}\text{O}$ more than $\delta^{13}\text{C}$, and kinetic effects during rapid degassing where the ratio of increase of $\delta^{18}\text{O}$ to $\delta^{13}\text{C}$ was determined to be 0.7 (Wiedner, 2004). In the latter case, loss of CO_2 depleted in heavier isotopes of both carbon and oxygen is accompanied by precipitation of isotopically heavy carbonate before re-equilibration is complete.

Hendy (1971) indicated that the kinetic effects would lead to a progressive enrichment in ^{18}O and ^{13}C as the fluid moved over a stalagmite surface from the point of impact of the drip (consistent with the spatial patterns mentioned in Mickler et al., 2004) and advocated testing for an absence of covariance of the isotopes along laminae, or over time as a test for equilibrium deposition. This advice has been followed in numerous publications, but it is actually very difficult to carry out the lateral 'Hendy test' in a reproducible manner because of the difficulty in following the same lamina (cf. Figure 8). However, as attention has changed from the determination of precise palaeotemperatures to the documentation of climatic trends, there has been a greater willingness to interpret data from speleothems displaying covariation. A number of authors (e.g. Hellstrom et al., 1998; Plagnes et al., 2002; Genty et al., 2003; Fleitmann et al., 2004; Yadava et al., 2004; Lachniet et al., 2004) have also drawn attention to climatic controls of covariation of the isotope species over time. For example, in regions where the amount effect is strong, reduced rainfall leads to heavier $\delta^{18}\text{O}$ values which may be further enhanced by evaporation within the cave in correlation with $\delta^{13}\text{C}$ (Fleitmann et al., 2004). The converse, unusually low $\delta^{18}\text{O}$ and $\delta^{13}\text{C}$ characterized pluvial periods in Israel in the interval 178–152 ka (Ayalon et al., 2002).

The occurrence of isotopic equilibrium in real cave environments has often been tested for in speleothem studies, although typically by comparing waters with speleothem carbonate representing a few years, or a few decades growth. Mickler et al. (2004) presented a careful study of incremental precipitates and illustrated $\delta^{13}\text{C}$ variations of up to 1.3‰ in a humid cave passage where kinetic effects were not anticipated. McDermott et al. (2005) compare published data from several caves and conclude that although there is a good correlation between the calculated isotopic fractionation factor (α) and cave temperature, equivalent values for $\delta^{18}\text{O}_{\text{calcite}}$ are enriched by typically 0.5–1.5‰ compared with the least fractionated experimental calcite crystals of Kim and O'Neil (1997). Zhou and Zheng (2003) considered that heavier calcite crystals of Kim and O'Neil (1997) might have inherited excess ^{18}O from an initial aragonite precipitate. Whatever its origin, this apparent kinetic effect (and its variation in the careful study of Mickler et al., 2004) introduces a small shift and additional noise to the calcite signal compared with the water (cf. Figure 9). Higher resolution analyses will allow in the future testing of whether changes in the magnitude of small-scale kinetic variations, which may or may not coincide with fabric changes (McDermott et al., 1999) can be interpreted in climatic terms. One other factor is introduced by Beck et al. (2005) who indicate that there is a measurable pH effect arising from different oxygen isotopic fractionations of bicarbonate and carbonate ions with respect to water. The effect results in isotopically lighter compositions at higher pH (lower cave air PCO_2) and hence could enhance variation related to isotopically lighter winter rainfall. Finally, a microbial origin of carbon isotopic variations can be posited. The observations of Cacchio et al. (2004) in Cervo Cave (Italy), were that some variations in $\delta^{13}\text{C}$ in micro-spherulitic precipitates were created by colonization by different strains of bacteria.

6.3 Trace elements and other impurities

The most common interpretational paradigm of trace elements is that of the partition or distribution coefficient (Morse and Bender, 1990; Rimstidt et al., 1998). Many trace elements (Tr), show a relationship to a carrier species (Cr = Ca or CO_3 in our case) in speleothem carbonate and water as follows:

$$(\text{Tr}/\text{Cr})_{\text{CaCO}_3} = K_d (\text{Tr}/\text{Cr})_{\text{solution}} \quad (1)$$

where K_d is the distribution coefficient. Although the theoretical basis for such a relationship is more straightforward for divalent ions, Rimstidt et al. (1998) show that, for example, trivalent rare earth elements also show systematic relationships. In practice there are often important variations of K_d with temperature (e.g. Mg^{2+}), growth kinetics (e.g. Sr^{2+} , Ba^{2+}), or solution composition. We now know that many polyvalent (single or triply-charged) ions are present in speleothem carbonates, probably facilitated both by adsorption at defect sites (e.g. PO_4^{3-}) and coupled substitution to maintain charge balance (Huang et al., 2001; Fairchild et al., 2001). Such species are important in that they often clearly define annual chemical laminae.

Trace element incorporation depends on the crystallographic form, but to the extent that the unit rhombohedron dominates calcite speleothem morphology, this factor may not be of first-order importance. Reeder and colleagues (e.g. Paquette and Reeder, 1995; Reeder et al., 2001) have demonstrated the crucial importance of differential ion incorporation at complementary growth sites around growth hillocks on rhombohedral surfaces. This factor was argued to account for scatter in partition coefficients experimentally determined at microscopic scale by Huang and Fairchild (2001), but data so far indicates that any heterogeneity of these growth sites appears to occur on a spatial scale smaller than that of the analytical points (Fairchild et al., 2001; Treble et al., 2006). In aragonite, combinations of forms are invariably present and are likely to differ in trace element composition. Only if crystal morphology is constant is the situation likely to be sufficiently simple for interpretation. Also, high-resolution time series will inevitably be compromised if the growth surface has a complex shape (e.g. dendritic morphology (Frisia et al., 2000), or lensing layers (e.g. Treble et al., 2006). Some degree of lateral change in concentration of trace species appears to be normal (Treble et al., 2003; 2006; Frisia et al., 2005).

Since significant fluctuations of trace elements occur on an annual scale, there is potential for unravelling cause and effect, a potential which is now partially realized. One striking feature is the differing types of behaviour of specific ions, e.g. Sr and Mg can display antipathetic, sympathetic, or no covariation, and these patterns can change within a time series. At the present time only some of these features can be interpreted. Here we present three basic idealized interpretive annual patterns which are relevant to the transmission of climatic signals and discuss how they might be recognized.

The first is termed the *fluid-dominated pattern* where distinctive changes in fluid composition occur and the equivalent signal is recorded in the speleothem. Various examples have been listed in sections 4 and 5. Particularly

distinctive features are the Sr-Mg covariance (McMillan et al., 2005) indicative of prior calcite precipitation, high-magnitude increases in Sr and/or Mg at low flows (Baker et al., 2000; Fairchild et al., in press b) and chemical changes within infiltration laminae.

The second phenomenon we refer to as the *crystal-dominated pattern*. Typically a group of trace elements (e.g. P, Na, H, F and sometimes Mg) show sinusoidal variations within annual laminae often, but not invariably displaying a broad peak antipathetic to Sr, and sometimes Ba. Most of the patterns illustrated by Fairchild et al. (2001) are of this kind. Treble et al. (2003) described sympathetic variations in U, Na, Sr and Ba (opposed to a more irregular seasonal changes in Mg) and interpreted them in relation to changing growth rate. In principle, where the partition coefficient is less than 1, there will be a growth rate threshold to higher incorporation of ions, perhaps related to the kinetics of ion diffusion in relation to a chemically-distinct surface layer of the lattice which differs from its bulk composition (Watson, 2004). However, it is not yet clear that speleothems grow fast enough to reach a general threshold since in a number of samples we have not observed correlations of trace element concentration with annual lamina thickness (although Treble et al., 2003, did observe a relationship between trace element annual wavelength and Ba and Na concentrations). Accordingly, we use the wider term *growth kinetics*, instead of growth rate, to refer to changes in crystal morphology and/or growth mechanism, usually associated with changes in growth rate. An interpretation of this pattern as *crystal-dominated* can stem from several types of observation. If H variation is interpreted as H₂O, its abundance clearly does not vary in solution and so where annual variations in H occur and are matched by other elements, this suggests a crystallographic cause. Another observation made at the Ernesto cave is that little change in aqueous Na or Sr/Ca at these cave sites although there are changes in stalagmites (Fairchild et al., 2000, 2001). Additionally, Huang et al. (2001) found experimentally that Na incorporation in calcite did not necessarily increase if aqueous Na was increased, pointing to the dominance of kinetic factors. Seasonal changes in aqueous supersaturation, related to hydrological or cave ventilation factors can lead to crystal morphological changes (Frisia et al., 2000) reflecting changes in growth mechanism. Increased defect density will then permit increased adsorption of species such as PO₄³⁻, which in turn facilitates incorporation of other polyvalent species to maintain charge balance. Since a portion of Sr may also be in interstitial lattice positions (Pingitore and Eastman, 1986), a reduction in Sr may in part reflect competition with these other species. Finch et al. (2003) also consider the role of kinetic factors in aragonite trace element patterns.

The *temperature-controlled pattern* is the expected situation where significant temperature changes occur during the year since the Mg partition coefficient is temperature-dependent. Roberts et al. (1998) discussed the possible contribution of temperature variations to annual Mg cycles in a stalagmite from Tartair cave in NW Scotland. Our monitoring in 2004 (Fuller et al., 2004) has shown that this cave currently displays a 4.5 °C annual range (4.75–9.45 °C) which would be predicted to be associated with around 20% change in Mg compositions, other factors being equal (Huang and Fairchild, 2001). This would

be sufficient to account for the observed annual range of Mg (Roberts et al., 1998), although a modern speleothem from this site does not display such prominent Mg cycles (Fairchild et al., 2001). Variable along-layer behaviour of Mg has been found in elemental mapping studies of the upper part of the Australian Moondyne cave speleothem (Treble et al., 2006) and tentatively attributed to variable adsorption behaviour. This is a warning that Mg behaviour is not always as complacent as concluded from experimental studies (Huang and Fairchild, 2001).

More generally, the behaviour of trace elements can be influenced by different proportions of the three *fluid, crystal and temperature-control* effects than is the case on the annual timescale. For example, Treble et al. (2003) and Finch et al. (2003) provide examples of elemental trends that reflect decadal and longer trends in 20th century rainfall, and which differ in part from the behaviour of elements on the subannual scale. A change in mean annual temperature will be buffered by karst processes, but little modelling of rates of change has been done (cf. Luetscher and Jeannin, 2004).

7. Post-depositional change (Table 4)

Diagenetic change primarily affects originally metastable carbonate precipitates, of which aragonite is the prime example as discussed below. Calcite with a high magnesium content (>c. 1–3 mole % MgCO₃) would also be susceptible to loss of Mg, but without change in macroscopic texture. No examples of the diagenetic alteration of such high-Mg calcites in late Quaternary speleothems has been described and indeed Bar-Matthews et al. (1991) observed preserved interlamination of calcites of highly variable Mg composition and dolomite. Highly unstable phases such as hydromagnesite, that can accompany aragonite precipitates in high Mg/Ca waters tend to form more irregular precipitates than the compact speleothems used for palaeoclimate work.

Low-magnesium calcite is known to be a highly stable phase in which samples hundreds of millions of years old that have escaped metamorphism can display sharp primary chemical growth zones, as imaged for example by cathodoluminescence (Dickson, 1993). Although there is evidence of ion migration at fresh calcite surfaces (Stipp et al., 1998), these effects are probably on too small a scale to be a problem in palaeoclimate work. Absence of chemical change is also neatly shown by absence of U-series age-reversals, once appropriate corrections for primary Th have been made (Beck et al., 2001; Richards and Dorale, 2003).

Frisia (1996) considered a variety of possible secondary changes to speleothems and drew attention to possible cementation effects in relation to primary porosity; this seems particularly applicable to speleothems which have cavernous porosity related to seasonal undersaturation, and to Pleistocene speleothems that can be leached (Bar-Matthews et al., 1991) and develop a weathering patina. In addition, Frisia (1996) illustrated equant calcites interrupting organic-rich laminae in a flowstone and interpreted them as porosity fills related to organic matter oxidation and also discussed possible enlargement of crystals by ripening over time. Although such phenomena may be more typical of more porous and impurity-

rich flowstones (and of Mg-rich carbonates, Bar-Matthews et al., 1991), it illustrates the advisability of petrographic study.

In more compact speleothems, the most logical place to expect to see modification is at the contact with fluid inclusions since in other minerals secondary changes in inclusion shape by dissolution and reprecipitation are commonly observed (Roedder, 1990). Some of the initial growth may occur just behind the crystal terminations as crystallites merge together leaving isolated inclusions (Kendall and Broughton, 1978), but this is a subtle effect. Observations by P. Rowe, P. Dennis and A. Kendall, reported in McDermott et al. (2005) indicate that diffusive exchange should be negligible at earth surface temperatures, and that there is no petrographic evidence of modification of primary inclusion shape by dissolution/precipitation reactions. The most sensitive component to any re-equilibration effects will be the $\delta^{18}\text{O}$ composition of fluid inclusion water, but a larger problem may be the 100% recovery of water during analysis since adsorbed water layers show evidence of fractionation compared with bulk water (Dennis et al., 2001).

Aragonite will tend to transform to calcite, but in carbonate aquifers primary aragonite shows wide variation in rates of transformation (Morse and McKenzie, 1990). An important difference for isolated speleothems is that there is no physical driving force for water migration within the structure, unlike carbonate aquifers; this favours aragonite retention. Frisia et al. (2002) present evidence that aragonite-to-calcite conversion can occur within 10^3 years, but the trigger for it to start is unclear. Where aragonite is replaced by calcite, it is unlikely that original chemical time series can be recovered (e.g. Railsback et al., 2002) because of the variable loss of species such as ^{13}C , ^{18}O , U, Sr and Ba, gain of Mg, and variable retention of aragonite inclusions within calcite. U-series systematics are also likely to be significantly disturbed by aragonite replacement (Dorale et al., 2004). X-ray diffraction or electron backscatter diffraction evidence (McMillan et al., 2005) of a lack of calcite is desirable to demonstrate the preservation of aragonitic records.

8. Conclusion: unscrambling the signal

Speleothem time series contain evidence of the changing climate system and sometimes of specific forcing factors. The records are inherently more complex than ice cores, although even these have complexities in their recording of atmospheric processes. However, the quality of dating of speleothem records is a strength of this type of proxy in comparison with most proxy records from non-glacial continental regions. The discovery of the climate sensitivity of speleothem records in many geographic areas is complemented by the process studies that help unravel the complicating factors that distort climate signals (Table 4). Together, they have led to a rapid development of speleothem studies and range of geochemical proxies, and a steadily increasing ability to understand their limitations and decode their geochemical time series.

We are now on the brink of a further explosion in the acquisition of data, including many studies at the high-resolution that we herein have argued are needed to understand many of the more subtle and short-term variations in

geochemical patterns, i.e. precisely those applicable over human lifetimes. There will be increasing use of multiproxy studies involving combinations of isotopes, trace elements and fabrics. The gap in studies integrated with parallel proxy materials from the same region (e.g. tree rings, peat bogs, and lake sediments) will be filled. Multiproxy studies have enormous potential in identifying process controls and fulfilling the potential of speleothems in palaeoenvironmental analysis. Stalagmites – upwards and onwards!

9. Acknowledgements

We acknowledge much helpful discussion with a wide range of collaborators and other colleagues, but even so we apologize to the speleothem community for our inevitable biases and omissions. We are currently supported by the UK's Natural Environment Research Council's (NERC) RAPID climate change programme, a Philip Leverhulme Prize (to AB), Austrian Science Funds (Y122-GEO), and NERC facilities funding. EIMF staff most closely concerned with this work are John Craven, Richard Hinton, Simone Kasemann and Nicola Kayzer. Thanks to Melanie Leng for the opportunity to present on this topic at the ISOPAL2 meeting at Keyworth and for her support in preparation of this paper. Comments on the manuscript by Graham Weedon and three journal reviewers (including Pauline Treble) are much appreciated.

10. References

- Alley, R.B., Ágústsdóttir, A.M., 2005. The 8k event: cause and consequences of a major Holocene abrupt climate change. *Quaternary Science Reviews* 24, 1123–1149.
- Alley, R.B., Cuffey, K.M., 2001. Oxygen- and hydrogen-isotopic ratios of water in precipitation: Beyond paleothermometry. In: Valley, J.W., Cole, Dr. (Eds.) *Stable Isotope Geochemistry, Reviews in Mineralogy and Geochemistry (Mineralogical Society of America, Washington D.C.)* 43, 527–553.
- Alley, R.B., Mayewski, P.A., Sowers, T., Stuiver, M., Taylor, K.C., Clark, P.U., 1997. Holocene climatic instability: a prominent, widespread event 8200 years ago. *Geology* 25, 483–486.
- Andreo, B., Liñan, C., Carrasco, F., Jiménez de Cisneros, C., Caballero, F., Mudry, J., 2004. Influence of rainfall quantity on the isotopic composition (^{18}O and ^2H) of water in mountainous areas. Application for groundwater research in the Yunquera-Nieves karst aquifers (S Spain). *Applied Geochemistry* 19, 561–574.
- Araguas-Araguas, L., Froehlich, K., Rozanski, K., 2000. Deuterium and oxygen-18 isotope composition of precipitation and atmospheric moisture. *Hydrological Processes* 14, 1341–1355.
- Atkinson, T.C., 1977. Carbon dioxide in the atmosphere of the unsaturated zone: an important control of groundwater hardness in limestones. *Journal of Hydrology* 35, 111–123.
- Atkinson, T.C., Smart, P.L., Harmon, R., Waltham, A.C., 1978. Paleoclimatic and geomorphic implications of $^{230}\text{Th}/^{234}\text{U}$ dated speleothems from Britain. *Nature* 272, 24–28.
- Ayalon, A., Bar-Matthews, M., Sass, E., 1998. Rainfall-recharge relationships within a karstic terrain in the Eastern Mediterranean semi-arid region, Israel: $\delta^{18}\text{O}$ and δD characteristics. *Journal of Hydrology* 207, 18–31.
- Ayalon, A., Bar-Matthews, M., Kaufman, A., 1999. Petrography, strontium, barium and uranium concentrations, and strontium and uranium isotope ratios in speleothems as

- palaeoclimatic proxies: Soreq Cave, Israel. *The Holocene* 9, 715–722.
- Ayalon, A., Bar-Matthews, M., Kaufman, A., 2002. Climatic conditions during marine oxygen isotope stage 6 in the eastern Mediterranean region from the isotopic composition of speleothems of Soreq Cave, Israel. *Geology* 30, 303–306.
- Baker, A., Smart, P.L., 1995. Recent flowstone growth rates: Field measurements in comparison to theoretical predictions. *Chemical Geology* 122, 121–128.
- Baker, A., Genty, D., 2003. Comment on “A test of annual resolution in stalagmites using tree rings”. *Quaternary Research* 59, 476–478.
- Baker, A., Brunsdon, C., 2003. Non-linearities in drip water hydrology: an example from Stump Cross Caverns, Yorkshire. *Journal of Hydrology* 277, 151–163.
- Baker, A., Smart, P., Edwards, R., Richards, D., 1993. Annual growth banding in a cave stalagmite. *Nature* 364, 518–520.
- Baker, A., Smart, P.L., Edwards, R.L., 1995. Paleoclimate implications of mass spectrometric dating of a British flowstone. *Geology* 23, 309–312.
- Baker, A., Ito, E., Smart, P.L., McEwan, R.F., 1997. Elevated and variable values of ^{13}C in speleothems in a British cave system. *Chemical Geology* 136, 263–270.
- Baker, A., Genty, D., Dreybrodt, W., Barnes, W.L., Mockler, N.J., Grapes, J., 1998. Testing theoretically predicted stalagmite growth rate with Recent annually laminated samples: Implications for past stalagmite deposition. *Geochimica et Cosmochimica Acta* 62, 393–404.
- Baker, A., Proctor, C.J., Barnes, W.L., 1999a. Variations in stalagmite luminescence laminae structure at Poole’s Cavern, England, AD 1910–1996: calibration of a palaeoprecipitation proxy. *The Holocene* 9, 683–688.
- Baker, A., Mockler, N.J., Barnes, W.L., 1999b. Fluorescence intensity variations of speleothem-forming groundwaters: Implications for paleoclimate reconstruction. *Water Resources Research* 35, 407–413.
- Baker, A., Genty, D., Fairchild, I.J., 2000. Hydrological characterisation of stalagmite drip waters at Grotte de Villars, Dordogne, by the analysis of inorganic species and luminescent organic matter. *Hydrology and Earth System Sciences* 4, 439–449.
- Baker, A., Proctor, C., Barnes, W.L., 2002. Stalagmite lamina doublets: a 1000 year proxy record of severe winters in northwest Scotland. *International Journal of Climatology* 22, 1339–1345.
- Baker, R.G., Bettis, E.A., Denniston, R.F., Gonzalez, L.A., Strickland, L.E., Krieg, J.R., 2002. Holocene palaeoenvironments in southeastern Minnesota - chasing the prairie-forest ecotone. *Palaeogeography, Palaeoclimatology, Palaeoecology* 177, 103–122.
- Baldini, J. U. L., McDermott, F., Fairchild, I. J., 2002. Structure of the 8200-year cold event revealed by a speleothem trace element record. *Science* 296, 2203–2206.
- Banner, J.L., 2004. Radiogenic isotopes: systematics and applications to earth surface processes and chemical stratigraphy. *Earth-Science Reviews* 65, 141–194.
- Banner, J.L., Musgrove, M.L., Capo, R.C., 1994. Tracing groundwater evolution in a limestone aquifer using Sr isotopes: Effects of multiple sources of dissolved ions and mineral-solution reactions. *Geology* 22, 687–690.
- Banner, J.L., Musgrove, M.L., Asmerom, Y., Edwards, R.L., Hoff, J.A., 1996. High-resolution temporal record of Holocene ground-water chemistry: tracing links between climate and hydrology. *Geology* 24, 1049–1053.
- Bard, E., Antonioli, F., Silenzi, S., 2002. Sea-level during the penultimate interglacial period based on a submerged stalagmite from Argentarola Cave (Italy). *Earth and Planetary Science Letters* 196, 135–146.
- Bar-Matthews, M., Matthews, A., Ayalon, A., 1991. Environmental controls of speleothem mineralogy in a karstic dolomitic terrain (Soreq Cave, Israel). *Journal of Geology* 99, 189–207.
- Bar-Matthews, M., Ayalon, A., Matthews, A., Sass, E., Halicz, L., 1996. Carbon and oxygen isotope study of the active water-carbonate system in a karstic Mediterranean cave: Implications for palaeoclimate research in semiarid regions. *Geochimica et Cosmochimica Acta* 60, 337–347.
- Bar-Matthews, M., Ayalon, A., Kaufman, A., 1998. Middle to late Holocene (6500 Yr. period) palaeoclimate in the Eastern Mediterranean regions form stable isotope composition of speleothems from Soreq Cave, Israel. In Isaac, A.S., Brown, N. (Eds.), *Water, Climate and Society in Time of Climate Change*, Kluwer, pp. 203–214.
- Bar-Matthews, M., Ayalon, A., Kaufman, A., Wasserburg, G.J., 1999. The Eastern Mediterranean palaeoclimate as a reflection of regional events: Soreq cave, Israel. *Earth and Planetary Science Letters* 166, 85–95.
- Bar-Matthews, M., Ayalon, A., Gilmour, M., Matthews, A., Hawkesworth, C.J., 2003. Sea-land oxygen isotopic relationships from planktonic foraminifera and speleothems in the Eastern Mediterranean region and their implication for paleorainfall during interglacial intervals. *Geochimica Cosmochimica Acta* 67, 3181–3199.
- Beck, J.W., Richards, D.A., Edwards, L.A., Silverman, B.W., Smart, P.L., Donahue, D.J., Hererra-Osterheld, S., Burr, G.S., Calsoyas, L., Jull, A.J.T., Biddulph, D., 2001. Extremely large variations of atmospheric ^{14}C concentration during the last glacial period. *Science* 292, 2453–2458.
- Beck, W.C., Grossman, E.L., Morse, J.W., 2005. Experimental studies of oxygen isotope fractionation in the carbonic acid system at 15°, 25°, and 40°C. *Geochimica et Cosmochimica Acta*, 69, 3493–3503.
- Berger, A., Loutre, M.F., 1991. Insolation values for the climate of the last 10 million years. *Quaternary Science Reviews* 10, 297–317.
- Bond, G., Showers, W., Cheseby, M., Lotti, R., Almasi, P., deMenocal, P., Priore, P., Cullen, H., Hajdas, I., Bonani, G., 1997. A pervasive millennial-scale cycle in North Atlantic Holocene and glacial climates. *Science* 278, 1257–1266.
- Bond, G., Kromer, B., Beer, J., Muscheler, R., Evans, M.N., Showers, W., Hoffmann, S., Lotti-Bond, R., Hajdas, I., Bonani, G., 2001. Persistent solar influence on North Atlantic climate during the Holocene. *Science* 294, 2130–2136.
- Bottrell, S.H., Atkinson, T.C., 1992. Tracer study of flow and storage in the unsaturated zone of a karstic limestone aquifer. In: Hötzel, H. and Werner, A. (Eds.), *Tracer Hydrology*. Rotterdam: Balkema, pp. 207–211.
- Bradley, R.S., 1999. *Paleoclimatology*. Academic Press, London.
- Briffa, K.R., Schweingruber, F.H., Jones, P.D., Osborn, T.J., Shiyatov, S.G., Vaganov, E.A., 1998. Reduced sensitivity of recent tree-growth to temperature at high northern latitudes. *Nature* 391, 678–682.
- Broecker, W.S., Hemming, S., 2001. Climate swings come into focus. *Science* 294, 2308–2309.
- Brook, G.A., Folkoff, M.E., Box, E.O., 1983. A world model of soil carbon dioxide. *Earth Surface Processes and Landforms* 8, 79–88.
- Brook, G.A., Rafter, M.A., Railsback, L.B., Shee, S.-W., Lundberg, J., 1999. A high-resolution proxy record of rainfall and ENSO since AS 1550 from layering in stalagmites from Anjohibe Cave, Madagascar. *The Holocene* 9, 695–705.
- Burns, S.J., Fleitmann, D., Matter, A., Neff, U., Mangini, A., 2001. Speleothem evidence from Oman for continental pluvial events during interglacial periods. *Geology* 29, 623–626.
- Burns, S. J., Fleitmann, D., Mudelsee, M., Neff, U., Matter, A., Mangini, A., 2002. A 780-year annually resolved record of Indian Ocean Monsoon precipitation from a speleothem from south Oman. *Journal of Geophysical Research* 107, 4434–4442.

- Burns, S.J., Fleitmann, D., Matter, A., Kramers, J., Al-Subary, A.A., 2003. Indian Ocean climate and an absolute chronology over Dansgaard/Oeschger Events 9 to 13. *Science* 301, 1365–1369 (and erratum).
- Burroughs, W. J., 1992. *Weather cycles real or imaginary?* Cambridge University Press, Cambridge.
- Caballero, E., Jiménez de Cisneros, C., Reyes, E., 1996. A stable isotope study of cave seepage waters. *Applied Geochemistry* 11, 583–587.
- Cacchio, P., Contento, R., Ercole, C., Cappuccio, G., Martinez, M.P., Lepidi, A., 2004. Involvement of microorganisms in the formation of carbonate speleothems in the Cervo Cave (L'Aquila- Italy). *Geomicrobiology Journal* 21, 497–509.
- Cane, M.A., 2005. The evolution of El Niño, past and future. *Earth and Planetary Science Letters* 230, 227–240.
- Carrasco, F., Andreo, B., Benavente, J., Vadillo, I., 1995. Chemistry of the water in the Nerja Cave System (Andalusia, Spain). *Cave and Karst Science* 21, 27–32.
- Celle-Jeanton, H., Travi, Y., Blavoux, B., 2001. Isotopic typology of the precipitation in the Western Mediterranean region at three different time scales. *Geophysical Research Letters* 28, 1215–1218.
- Clark, I., Fritz, P., 1997. *Environmental Isotopes in Hydrogeology*. Lewis, NY.
- Cook, E. R., 1992. Using tree rings to study past El Niño/Southern Oscillation influences on climate. In: Diaz, H. F., Markgraf, V. (Eds.) *El Niño: Historical and Paleoclimatic Aspects of the Southern Oscillation*. Cambridge University Press, Cambridge, pp. 204–214.
- Cook, E.R., Esper, J., D'Arrigo, R.D., 2004. Extra-tropical Northern Hemisphere land temperature variability over the past 1000 years. *Quaternary Science Reviews*, 23, 2063-2074.
- Cruz, F.W., Burns, S.J., Karmann, I., Sharp, W.D., Vuille, M., Cardoso, A.O., Ferrari, J.A., Silva Dias, P.L., Viania, O., 2005a. Insolation-driven changes in atmospheric circulation over the past 116,000 years in subtropical Brazil. *Nature* 434, 63–66.
- Cruz, F.W., Karmann, I., Magdaleno, G.B., Coichev, N., Viana, O., 2005b. Influence of hydrological and climatic parameters on spatial-temporal variability of fluorescence intensity and DOC of karst percolation waters in the Santana Cave System, Southeastern Brazil. *Journal of Hydrology* 302, 1–12.
- Darling, W.G. 2004. Hydrological factors in the interpretation of stable isotopic proxy data present and past: a European perspective. *Quaternary Science Reviews* 23, 743–770.
- Darling, W.G., Talbot, J.C., 2003. The O and H stable isotopic composition of fresh waters in the British Isles. 1. Rainfall. *Hydrology and Earth System Sciences* 7, 163–181.
- Darling, W.G., Bath, A.H., Gibson, J.J., Rozanski, K., 2005. 1. Isotopes in water. In: Leng, M.J. (Ed.) *Isotopes in Palaeoenvironmental Research*. Springer, Dordrecht, The Netherlands, pp. xxx–xxx (in press).
- Delworth, T.L., Mann, M.E., 2000. Observed and simulated multidecadal variability in the Northern Hemisphere. *Climate Dynamics* 16, 661–676.
- Dennis, P.F., Rowe, P.J., Atkinson, T.C., 2001. The recovery and isotopic measurement of water from fluid inclusions in speleothems. *Geochimica et Cosmochimica Acta* 65, 871–884.
- Denniston, F.R., González, L.A., Asmerom, Y., Baker, R.G., Reagan, M.K., Bettis, E.A. 1999. Evidence for increased cool season moisture during the middle Holocene. *Geology* 27, 815–818.
- Denniston, R.F., González, L.A., Asmerom, Y., Reagan, M.K., Recelli-Snyder, H., 2000. Speleothem carbon isotopic records of Holocene environments in the Ozark Highlands, USA. *Quaternary International* 67, 21–27.
- Dettman, D.L., Lohmann, K.C., 1995. Microsampling carbonates for stable isotope and minor element analysis: physical separation of samples on a 20 micrometer scale. *Journal of Sedimentary Research* A65, 566–569.
- Denton, G.H., Alley, R.B., Comer, G.C., Broecker, W.S., 2005. The role of seasonality in abrupt climate change. *Quaternary Science Reviews* 24, 1159–1182.
- Dickson, J.A.D., 1993. Crystal-growth diagrams as an aid to interpreting the fabrics of calcite aggregates. *Journal of Sedimentary Petrology* 63, 1–17.
- Dickson, J.A.D., 1997. Synchronous intracrystalline $\delta^{13}\text{C}$ and $\delta^{18}\text{O}$ differences in natural calcite crystals. *Mineralogical Magazine* 61, 243–248.
- Dorale, J. A., González, L. A., Reagan, M. K., Pickett, D. A., Murrell, M. T., Baker, R. G., 1992. A high-resolution record of Holocene climate change in speleothem calcite from Cold Water Cave, Northeast Iowa. *Science* 258, 1626–1630.
- Dorale, J. A., Edwards, R. L., Ito, E., González, L. A., 1998. Climate and vegetation history of the Midcontinent from 75 to 25 ka: A speleothem record from Crevice Cave, Missouri, USA. *Science* 282, 1871–1874.
- Dorale, J.A., Edwards, R.L., Alexander, E.C., Shen, C.-C., Richards, D.A., Cheng, H., 2004. Uranium-series dating of speleothems: current techniques, limits and applications. In: Sasowsky, I.D., Mylroie, J. (Eds), *Studies of Cave Sediments. Physical and Chemical Records of Palaeoclimate*. Kluwer Academic, New York, pp. 177–197.
- Dreybrodt, W., 1988. *Processes in karst systems*. Springer-Verlag, Berlin.
- Drysdale, R.N., Zanchetta, G., Hellstrom, J.C., Fallick, A.E., Zhao, J.-X., Isola, I., Bruschi, G., 2004. Palaeoclimatic implications of the growth history and stable isotope ($\delta^{18}\text{O}$ and $\delta^{13}\text{C}$) geochemistry of a Middle to Late Pleistocene stalagmite from central-western Italy. *Earth and Planetary Science Letters* 227, 215–229.
- Duplessy, J.C., Lalou, C., De Azevedo, A.E.G., 1969. Concretioning conditions in cave studies with stable isotopes of oxygen and carbon. *Comptes Rendus Academie de Science, Paris* 268, 2327–2330.
- Duplessy, J.C., Labeyrie, J., Lalou, C., Nguyen, H.V., 1970. Continental climatic variations between 130,000 and 90,000 years BP. *Nature*, 226 631–633.
- Dykoski, C.A., Edwards, R.L., Cheng, H., Yuan, D., Cai, Y., Zhnag, M., Lin, Y., Qing, J., An, Z., Revenauh, J., 2005. A high-resolution, absolute-dated Holocene and deglacial Asian monsoon record from Dongge Cave, China. *Earth and Planetary Science Letters*, 233, 71-86.
- Edwards, R.L., Chen, J.H., Wasserburg, G.J., 1987. ^{238}U - ^{234}U - ^{230}Th - ^{232}Th systematics and the precise measurement of time over the past 500,000 y. *Earth and Planetary Science Letters* 81, 175–192.
- Edwards, R.L. Cheng, H., Murrell, M.T., Goldstein, S.J., 1997. Protactinium-231 dating of carbonates by thermal ionization mass spectrometry: Implications for Quaternary climate change. *Science* 276, 782–786.
- Eggins, S., Grün, Pike, A.W.G., Shelley, M., Taylor, L., 2003. ^{238}U , ^{232}Th profiling and U-series isotope analysis of fossil teeth by laser-ablation-ICPMS. *Quaternary Science Reviews* 22, 1373–1382.
- Eggins, S.M., Grün, R., McCulloch, M., Pike, A.W.G., Chappell, J., Kinsley, L., Mortimer, G., Shelley, M., Murray-Wallace, C., Spötl, C., Taylor, L., in press. In situ U-series dating by laser-ablation multi-collector ICPMS: new prospects for Quaternary geochronology. *Quaternary Science Reviews* (in press)
- Emiliani, C., 1955. Pleistocene temperatures. *Journal of Geology* 63, 138–178.
- Emiliani, C., 1972. Quaternary palaeotemperatures and the duration of the high temperature intervals. *Science* 178, 398–401.
- Fairchild, I.J., 2005. High resolution stable isotope characterization of speleothem calcite. Report to Edinburgh Ion Microprobe

- Facility. Available at:
<http://www/geos.ed.ac.uk/facilities/ionprobe/>
- Fairchild, I.J., Quest, M., Tucker, M.E., Hendry, G.L., 1988. Chemical analysis of sedimentary rocks. In: Tucker, M.E. (Ed.) *Techniques in Sedimentology*, Blackwells, Oxford, pp. 274–354.
- Fairchild, I.J., Borsato, A., Tooth, A.F., Frisia, S., Hawkesworth, C.J., Huang, Y., McDermott, F., Spiro, B., 2000. Controls on trace element (Sr-Mg) compositions of carbonate cave waters: implications for speleothem climatic records. *Chemical Geology* 166, 255–269.
- Fairchild, I.J., Baker, A., Borsato, A., Frisia, S., Hinton, R.W., McDermott, F., Tooth, A.F., 2001. High-resolution, multiple-trace-element variation in speleothems. *Journal of the Geological Society, London* 158, 831–841.
- Fairchild, I.J., Frisia, S., Borsato, A., Tooth, A.F., in press a. Speleothems in their geomorphic, hydrological and climatological context. In: Nash, D.J., McLaren, S.J. (Eds), *Geochemical Sediments and Landscapes*. Blackwell, Oxford, pp. xxx–xxx.
- Fairchild, I.J., Tuckwell, G.W., Baker, A., Tooth, A.F., in press b. Modelling of dripwater hydrology and hydrogeochemistry in a weakly karstified aquifer (Bath, UK): implications for climate change studies. *Journal of Hydrology*.
- Fantidis, J., Ehlig, D.H., 1970. Variations of the carbon and oxygen isotopic composition in stalagmites and stalactites: Evidence of non-equilibrium isotopic fractionation. *Earth and Planetary Science Letters* 10, 136–144.
- Fenter, P.A., Rivers, M., Sturchio, N.C., Sutton, S.R. (Eds), 2002. Applications of synchrotron radiation in low-temperature geochemistry and environmental sciences. *Reviews in Mineralogy and Geochemistry*, 49. Mineralogical Society of America, Washington D.C.
- Finch, A. A., Shaw, P. A., Weedon, G. P., Holmgren, K., 2001. Trace element variation in speleothem aragonite: potential for paleoenvironmental reconstruction. *Earth and Planetary Science Letters* 186, 255–267.
- Finch, A.A., Shaw, P.A., Holmgren, K., Lee-Thorp, J. 2003. Corroborated rainfall records from aragonitic stalagmites. *Earth and Planetary Science Letters* 215, 265–273.
- Fleitmann, D., Burns, S.J., Neff, U., Mangini, A., Matter, A., 2003a. Changing moisture sources over the last 330,000 years in Northern Oman from fluid-inclusion evidence in speleothems. *Quaternary Research* 60, 223–232.
- Fleitmann, D., Burns, S.J., Mudelsee, M., 2003b. Holocene forcing of the Indian monsoon recorded in a stalagmite from Southern Oman. *Science* 300, 1737–1739.
- Fleitmann, D., Burns, S.J., Neff, U., Mudelsee, M., Mangini, A., Matter, A., 2004. Palaeoclimatic interpretation of high-resolution oxygen isotope profiles derived from annually laminated speleothems from Southern Oman. *Quaternary Science Reviews*, 23 935–945.
- Frappier, A., Sahagian, D., González, L.A., Carpenter, S.J., 2002. El Niño events recorded by stalagmite carbon isotopes, *Science* 298, 565.
- Frisia, S., 1996. Petrographic evidences of diagenesis in speleothems: some examples. *Speleochronos* 7, 21–30.
- Frisia, S., Borsato, A., Fairchild, I.J., McDermott, F., 2000. Calcite fabrics, growth mechanisms, and environment of formation in speleothems from the Italian Alps and southwestern Ireland. *Journal of Sedimentary Research* 70, 1183–1196.
- Frisia, S., Borsato, A., Fairchild, I.J., McDermott, F., Selmo, E.M., 2002. Aragonite-calcite relationships in speleothems (Grotte de Clamouse, France): environment, fabrics, and carbonate geochemistry. *Journal of Sedimentary Research* 72, 687–699.
- Frisia, S., Borsato, A., Preto, N., McDermott, F., 2003. Late Holocene annual growth in three Alpine stalagmites records the influence of solar activity and the North Atlantic Oscillation on winter climate, *Earth and Planetary Science Letters* 216, 411–424.
- Frisia, S., Borsato, A., Fairchild, I.J., Susini, J., 2005. Variations in atmospheric sulphate recorded in stalagmites by synchrotron micro-XRF and XANES analyses. *Earth and Planetary Science Letters*, 235, 729–740.
- Frumkin, A., Stein, M., 2004. The Sahara-East Mediterranean dust and climate connection revealed by strontium and uranium isotopes in a Jerusalem speleothem. *Earth and Planetary Science Letters* 217, 451–464.
- Fuller, L., Baker, A., Fairchild, I. J., Matthey, D., Rowe, P. J., Spötl, C., 2004. A High-Resolution Climate Record for the Last Millennium From a Scottish Stalagmite, *Eos*, 85(47), Fall Meeting Supplement, (abstract) PP43A-0609
- Galy, A., Bar-Matthew, M., Halicz, L., O’Nions, R.K., 2002. Mg isotopic composition of carbonate: insight from speleothem formation. *Earth and Planetary Science Letters* 201, 105–115.
- Garrels, R.M., Christ, C.L., 1965. *Solutions, Minerals and Equilibria*. Harper & Row, N.Y.
- Gascoyne, M. 1983. Trace-element partition coefficients in the calcite-water system and their paleoclimatic significance in cave studies. *Journal of Hydrology* 61, 213–222.
- Gascoyne, M., 1992. Palaeoclimate determination from cave deposits. *Quaternary Science Reviews* 11, 609–632.
- Gascoyne, M., Schwarcz, H.P., Ford, D., 1980. A palaeotemperature record for the mid-Wisconsin in Vancouver Island. *Nature* 285, 474–476.
- Gat, J.R., 1996. Oxygen and hydrogen isotopes in the hydrological cycle. *Annual Review of Earth and Planetary Sciences* 24, 225–262.
- Gat, J.R., 2000. Atmospheric water balance - the isotopic perspective. *Hydrological Processes* 14, 1357–1369.
- Gaziz, C., Feng, X., 2004. A stable isotope study of soil water: evidence for mixing and preferential flow paths. *Geoderma* 119, 97–111.
- Genty, D., Quinif, Y., 1996. Annually laminated sequences in the internal structure of some Belgian stalagmites-importance for paleoclimatology. *Journal of Sedimentary Research* 66, 275–288.
- Genty, D., Massault, M., 1997. Bomb ^{14}C recorded in laminated speleothems: dead carbon proportion calculation. *Radiocarbon* 39, 33–48.
- Genty, D., Deflandre, G., 1998. Drip flow variations under a stalactite of the Père Noël cave (Belgium). Evidence of seasonal variations and air pressure constraints. *Journal of Hydrology* 211, 208–232.
- Genty, D., Massault, M., 1999. Carbon transfer dynamics from bomb- ^{14}C and $\delta^{13}\text{C}$ time series of a laminated stalagmite from SW-France – Modelling and comparison with other stalagmite. *Geochimica et Cosmochimica Acta* 63, 1537–1548.
- Genty, D., Baker, A., Barnes, W., 1997. Comparaison entre les lamines luminescentes et les lamines visibles annuelles de stalagmites. *Comptes Rendus Academie Sciences, Paris* 325, 193–200.
- Genty, D., Vokal, B., Obelic, B., Massault, M. 1998. Bomb ^{14}C time history recorded in two modern stalagmites – importance for soil organic matter dynamics and bomb ^{14}C distribution over continents. *Earth and Planetary Science Letters* 160, 795–809.
- Genty, D., Baker, A., Massault, M., Proctor, C., Gilmour, M., Pons-Branchu, E., Hamelin, B., 2001a. Dead carbon is stalagmites: Carbonate bedrock palaeodissolution vs. ageing of soil organic matter. Implications for ^{13}C variations in speleothems. *Geochimica Cosmochimica Acta* 65, 3443–3457.
- Genty, D., Baker, A., Vokal, B., 2001b. Intra- and inter-annual growth rate of modern stalagmites. *Chemical Geology* 176, 191–212.

- Genty, D., Plagnes, V., Causse, C., Cattani, O., Stievenard, M., Falourd, S., Blamart, D., Ouahdi, R., Van-Exter, S., 2002. Fossil water in large stalagmite voids as a tool for paleoprecipitation stable isotope composition reconstitution and paleotemperature calculation. *Chemical Geology* 184, 83–95.
- Genty, D., Blamart, D., Ouahdi, R., Gilmour, M., Baker, A., Jouzel, J., Van-Exter, S., 2003. Precise dating of Dansgaard-Oeschger climate oscillations in western Europe from stalagmite data. *Nature* 421, 833–838.
- Goede, A., McCulloch, M., McDermott, F., Hawkesworth, C., 1998. Aeolian contribution to strontium and strontium isotope variations in a Tasmanian speleothem. *Chemical Geology* 149, 37–50.
- Goldstein, S.J., Stirling, C.H., 2003. Techniques for measuring Uranium-series nuclides: 1992–2002. In: Bourdon B., Henderson G.M., Lundstrom C.C. and Turner S.P. (Eds), Uranium-series geochemistry. *Reviews in Mineralogy and Geochemistry* 52, 23–57.
- González, L.A., Lohmann, K.C. 1988. Controls on mineralogy and composition of spelean carbonates: Carlsbad Caverns, New Mexico. In James, N.P., Choquette, P.W. (Eds), *Paleokarst*, Springer-Verlag, New York, pp. 81–101.
- Hakl, J., Hunyadi, I., Csige, I., Gécky, G., Lénart, K.L., Várhegyi, A., 1997. Radon transport phenomena studied in karst caves - international experiences on radon levels and exposures. *Radiation Measurement*, 28, 675–684.
- Hammarlund, D., Barnekow, L., Birks, H.J.B., Buchardt, B., Edwards, T.W.D., 2002. Holocene changes in atmospheric circulation recorded in the oxygen-isotope stratigraphy of lacustrine carbonates from northern Sweden. *Holocene* 12, 339–351.
- Harmon, R.S., Schwarcz, H.P., O'Neil, J.R. 1979. D/H ratios in speleothem fluid inclusions: a guide to variations in the isotopic composition of meteoric precipitation? *Earth and Planetary Science Letters* 42, 254–266.
- Harmon, R.S., Schwarcz, H.P., Gascoyne, M., Hess, J.W., Ford, D.C. 2004. Paleoclimate information from speleothems: the present as a guide to the past. In: Sasowsky, I.D., Mylroie, J. (Eds), *Studies of Cave Sediments. Physical and Chemical Records of Palaeoclimate*. Kluwer Academic, New York, pp. 199–226.
- Hellstrom, J., 2003. Rapid and accurate uranium-series dating by MC-ICP-MS, using microdrilling and laser ablation. *Geochimica et Cosmochimica Acta* 67, A144.
- Hellstrom, J.C., McCulloch, M.T., 2000. Multi-proxy constraints on the climatic significance of trace element records from a New Zealand speleothem. *Earth and Planetary Science Letters* 179, 287–297.
- Hellstrom, J., McCulloch, M., Stone, J., 1998. A detailed 31,000-year record of climate and vegetation change, from the isotope geochemistry of two New Zealand speleothems. *Quaternary Research* 50, 167–178.
- Henderson, G.M., Slowey, N.C., 2000. Evidence from U-Th dating against Northern Hemisphere forcing of the penultimate deglaciation. *Nature* 404, 61–66.
- Hendy, C.H., 1971. The isotopic geochemistry of speleothems - I. The calculation of the effects of different modes of formation on the isotopic composition of speleothems and their applicability as palaeoclimatic indicators. *Geochimica Cosmochimica Acta* 35, 801–824.
- Hendy, C.H., Wilson, A.T., 1968. Palaeoclimate data from speleothems. *Nature* 219, 48–51.
- Hill, C., Forti, P., 1997. *Cave Minerals of the World*. 2nd edition. National Speleological Society, Huntsville, Alabama.
- Hindar, A., Torseth, K., Henirksen, A., Orsolini, Y. 2004. The significance of the North Atlantic Oscillation for sea-salt episodes and acidification effects in Norwegian rivers. *Environmental Science and Technology* 38, 26–33.
- Hinton, R.W., 1995. Ion microprobe analysis in geology. In: Potts, P.J., Bowles, J.F.W., Reed, S.J.B., Cave, M.R. (Eds.), *Microprobe Techniques in the Earth Sciences*, Chapman and Hall, London, pp. 235–289.
- Hoffmann, G., Werner, M., Heimann, M., 1998. Water isotope module of the ECHAM atmospheric general circulation model: A study of timescales from days to several years. *Journal of Geophysical Research* 103, 16871–16896.
- Holland, H.D., Kirsipu, T.V., Huebner, J.S., Oxburgh, U.M., 1964. On some aspects of the chemical evolution of cave water. *Journal of Geology* 72, 36–67.
- Holmgren, K., Lee-Thorp, J.A., Cooper, G.R.J., Lundblad, K., Partridge, T.C., Scott, L., Sithaldeen, R., Talma, A.S., Tyson, P.D., 2003. Persistent millennial-scale climatic variability over the past 25,000 years in Southern Africa. *Quaternary Science Reviews* 22, 2311–2326.
- Houghton, J.T., Ding, Y., Griggs, D.J., Noguer, M., van der Linden, P.J., Xiaosu, D. (Eds), 2001. *Climate Change 2001: the Scientific Basis. Contribution of Working Group I to the Third Assessment Report of the Intergovernmental Panel on Climate Change*. CUP, Cambridge.
- Hsieh, J.C.C., Chadwick, O.A., Kelly, E.F., Savin, S.M., 1998. Oxygen isotopic composition of soil water: quantifying evaporation and transpiration. *Geoderma* 82, 269–293.
- Hu, C., Huang, J., Fang, N., Xie, S., Henderson, G.M., Cai, Y., 2005. Adsorbed silica in stalagmite carbonate and its relationship to past rainfall. *Geochimica et Cosmochimica Acta* 69, 2285–2292.
- Huang, Y., Fairchild, I.J., 2001. Partitioning of Sr²⁺ and Mg²⁺ into calcite under karst-analogue experimental conditions. *Geochimica et Cosmochimica Acta* 65, 47–62.
- Huang, H. M., Fairchild, I. J., Borsato, A., Frisia, S., Cassidy, N. J., McDermott, F., Hawkesworth, C. J., 2001. Seasonal variations in Sr, Mg and P in modern speleothems (Grotta di Ernesto, Italy). *Chemical Geology* 175, 429–448.
- Hurrell, J.W., 1995. Decadal trends in the North Atlantic Oscillation: Regional temperatures and precipitation. *Science* 269, 676–679.
- Imbrie, J., Imbrie, K.P., 1979. *Ice Ages: Solving the Mystery*. London: Macmillan.
- Jarvis, K.E., 1997. Inductively-coupled plasma mass spectrometry (ICP-AES). In: Gill, R. (Ed.), *Modern Analytical Geochemistry*, Longman, Harlow, Essex, pp. 171–187.
- Jiménez-López, C., Romanek, C.S., Huertas, F.J., Ohmoto, H., Caballero, E., 2004. Oxygen isotope fractionation in synthetic magnesian calcite. *Geochimica et Cosmochimica Acta* 68, 3367–3377.
- Johnsen, S.J., Dansgaard, W., Clausen, H.B., Langway, C.C., 1972. Oxygen isotope profiles through the Antarctic and Greenland ice sheets. *Nature* 235, 429–434.
- Johnsen, S.J., Dahl-Jensen, D., Gundestrup, N., Steffensen, J.P., Clausen, H.B., Miller, H., Masson-Delmotte, V., Sveinbjörnsdóttir, A.E., White, J., 2001. Oxygen isotope and palaeotemperature records from six Greenland ice-core stations: Camp Century, Dye-3, GISP2, Renland and NorthGRIP. *Journal of Quaternary Science* 16, 299–307.
- Johnson, C.M., Beard, B.L., Albarede, F., 2004. Geochemistry of non-traditional stable isotopes. Review in *Mineralogy and Geochemistry*, 55, Mineralogical Society of America, Washington D.C.
- Johnson, K.R., Ingram, B.L., 2004. Spatial and temporal variability in the stable isotope systematics of modern precipitation in China: implications for paleoclimate reconstructions. *Earth and Planetary Science Letters* 220, 365–377.
- Jones, I.C., Banner, J.L., Humphrey, J.D., 2000. Estimating recharge in a tropical karst aquifer. *Water Resources Research* 36, 1289–1299.
- Jones, P.D., Mann, M.E., 2004. Climate over past millennia. *Reviews of Geophysics*, 42, RG2002, doi:10.1029/2003RG000143.
- Jouzel, J., Hoffmann, G., Koster, R.D., Masson, V., 2000. Water isotopes in precipitation: data/model comparison for present-

- day and past climates. *Quaternary Science Reviews* 19, 363–379.
- Kaiser, A., Scheifinger, H., Kralik, M., Papesch, W., Rank, D., Stichler, W., 2002. Links between meteorological conditions and spatial/temporal variations in long-term isotope records from the Austrian precipitation network. In: *Study of Environmental Change using Isotope Techniques*, Vienna (International Atomic Energy Agency), 67–76.
- Kaufmann, G., 2003. Stalagmite growth and palaeo-climate: the numerical perspective. *Earth and Planetary Science Letters* 214, 251–266.
- Kaufmann, G., Dreybrodt, W., 2004. Stalagmite growth and palaeo-climate: an inverse approach. *Earth and Planetary Science Letters* 224, 529–545.
- Kendall, A.C., Broughton, P.L., 1978. Origin of fabric in speleothems of columnar calcite crystals. *Journal of Sedimentary Petrology* 48, 550–552.
- Kim, S.T., O'Neil, J.R., 1997. Equilibrium and nonequilibrium oxygen isotope effects in synthetic carbonates. *Geochimica Cosmochimica Acta* 61, 3461–3475.
- Klein, R.T., Lohmann, K.C., 1995. Isotopic homogeneity among non-equivalent sectors of calcite. *Geology* 23, 633–636.
- Klein, R.T., Walter, L.M., 1995. Interaction between dissolved silica and carbonate minerals: An experimental study at 25–50°C. *Chemical Geology* 125, 29–43.
- Kohn, M.J., Welker, J.M., 2005. On the temperature correlation of $\delta^{18}\text{O}$ in modern precipitation. *Earth and Planetary Science Letters* 231, 87–96.
- Kolesar, P.T., Riggs, A.C., 2004. Influence of depositional environment on Devils Hole calcite morphology and petrology. In: Sasowsky, I.D., Mylroie, J. (Eds), *Studies of Cave Sediments. Physical and Chemical Records of Palaeoclimate*. Kluwer Academic, New York, pp. 227–241.
- Kolodny, Y., Bar-Matthews, M., Ayalon, A., McKeegan, K.D., 2003. A high spatial resolution delta O-18 profile of a speleothem using an ion-microprobe. *Chemical Geology* 197, 21–28.
- Krinner, G., Werner, M., 2003. Impact of precipitation seasonality changes on isotopic signals in polar ice cores: a multi-model analysis. *Earth and Planetary Science Letters* 216 525–538.
- Kuczumow, A., B. Vekemans, B., Schalm Wajnberg, P., Van Grieken, R., 2001. Analysis of speleothems by electron and X-ray microprobes. *Journal of Analytical Atomic Spectrometry* 16, 90–95.
- Kuczumow, A., Genty, D., Chevallier, P., Nowak, J., Ro, C.-U., 2003. Annual resolution analysis of a SW-France stalagmite by X-ray synchrotron microprobe analysis. *Spectrochimica Acta Part B* 58, 851–865.
- Lachniet, M.S., Burns, S.J., Piperno, D.R., Asmerom, Y., Polyak, V.J., Moy, C.M., Christenson, K., 2004. A 1500-year El Niño/Southern Oscillation and rainfall history for the Isthmus of Panama from speleothem calcite. *Journal of Geophysical Research* 109, D20117, doi:10.1029/2004JD004694.
- Lauritzen, S.-E., Lundberg, J., 1999. Calibration of the speleothem delta function: an absolute temperature record for the Holocene in northern Norway. *The Holocene* 9, 659–669.
- Lauritzen, S.-E., 2003. Reconstructing Holocene climate records from speleothems. In: Mackay, A., Battarbee, R., Birks, J., Oldfield, F. (Eds), *Global Change in the Holocene*. Hodder Arnold, London, pp. 242–263.
- Lawrence, J.R., White, J.W.C., 1991. The elusive climate signal in the isotopic composition of precipitation. In: Taylor, H.P., O'Neil, J.R., Kaplan, I.R. (Eds), *Stable Isotope Geochemistry: A Tribute to Samuel Epstein*. Geochemical Society Special Publication 3, pp. 169–185.
- Lee-Thorp, J.A., Holmgren, K., Lauritzen, S.-E., Linge, H., Moberg, A., Partridge, T.C., Stevenson, C., Tyson, P.D., 2001. Rapid climate shifts in the southern African interior throughout the mid to late Holocene. *Geophysical Research Letters* 28, 4507–4510.
- Li, H.-C., Ku, T.-H., You, C.-F., Cheng, H., Edwards, R.L., Ma, Z.-B., Tsai, W.-S., Li, M.-D., 2005. $^{87}\text{Sr}/^{86}\text{Sr}$ and Sr/Ca in speleothems for paleoclimate reconstruction in Central China between 70 and 280 kyr ago. *Geochimica et Cosmochimica Acta*, 69, 3933–3947.
- Linge, H., Lauritzen, S.-E., Lundberg, J., 2001a. Stable isotope stratigraphy of a Late Last Interglacial speleothem from Rana, Northern Norway. *Quaternary Research* 56, 155–164.
- Linge, H., Lauritzen, S.-E., Lundberg, J., Berstad, I.M., 2001b. Stable isotope stratigraphy of Holocene speleothems: examples from a cave system in Rana, northern Norway. *Palaeogeography, Palaeoclimatology, Palaeoecology* 167, 209–224.
- Liu, W.G., Feng, X.H., Liu, Y., Zhang, Q.G., An, Z.S., 2004. Delta O-18 values of tree rings as a proxy of monsoon precipitation in arid Northwest China. *Chemical Geology* 206, 73–80.
- Long, A.J., Putnam, L.D., 2004. Linear model describing three components of flow in karst aquifers using ^{18}O data. *Journal of Hydrology* 296 254–270.
- Ludwig, K.R., Simmons, K.R., Szabo, B.J., Winograd, I.J., Landwehr, J.M., Riggs, A. C., Hoffman, R.J., 1992. Mass-spectrometric ^{230}Th - ^{234}U - ^{238}U dating of the Devils Hole calcite vein. *Science* 258, 284–287.
- Luetscher, M., Jeannin, P.-Y., 2004. Temperature distribution in karst systems: the role of air and water fluxes. *Terra Nova* 16, 344–350.
- Masson-Delmotte, V., Jouzel, J., Landais, A., Stievenard, M., Johnsen, S.J., White, J.W.C., Werner, M., Sveiunbjornsdottir, A., Fuhrer, K., 2005. GRIP deuterium excess reveals rapid and orbital-scale changes in Greenland moisture origin. *Science* 306, 118–121.
- Mattey, D.P., 1997. Gas-source mass spectrometry: isotopic composition of lighter elements. In: Gill, R. (Ed), *Modern Analytical Geochemistry*, Longman, Harlow, Essex, pp. 154–170.
- Mattey, D.P., 2002. Carbonates revisited: high resolution stable isotope profiling using He flow techniques (abstract) <http://www.gl.rhul.ac.uk/News/Conferences/MatteyIsocon.doc.pdf>
- Matthews, A., Ayalon, A., Bar-Matthews, M., 2000. D/H ratios of fluid inclusions of Soreq cave (Israel) speleothems as a guide to the Eastern Mediterranean Meteoric Line relationships in the last 120 ky. *Chemical Geology* 166, 183–191.
- McDermott, F., 2004. Palaeo-climate reconstruction from stable isotope variations in speleothems: a review. *Quaternary Science Reviews* 23, 901–918.
- McDermott, F., Frisia, S., Huang, Y., Longinelli, A., Spiro, B., Heaton, T.H.E., Hawkesworth, C.J., Borsato, A., Keppens, E., Fairchild, I.J., van der Borg, K., Verheyden, S., Selmo, E., 1999. Holocene climate variability in Europe: evidence from $\delta^{18}\text{O}$ and textural variations in speleothems. *Quaternary Science Reviews* 18, 1021–1038.
- McDermott, F., Mattey, D.P., Hawkesworth C., 2001. Centennial-scale Holocene climate variability revealed by a high-resolution speleothem delta O-18 record from SW Ireland. *Science* 294, 1328–1331.
- McDermott, F., Schwarcz, H.P., Rowe, P.J., 2005. 6. Isotopes in speleothems. In: Leng, M.J. (Ed.) *Isotopes in Palaeoenvironmental Research*. Springer, Dordrecht, The Netherlands, pp. xxx–xxx (in press)
- McDonald, J., Drysdale, R., Hill, D., 2004. The 2002–2003 El Niño recorded in Australian cave drip waters: Implications for reconstructing rainfall histories using stalagmites. *Geophysical Research Letters* 31, L22202, doi:10.1029/2004GL020859.
- McGarry, S., Baker, A., 2000. Organic acid fluorescence: applications to speleothem palaeoenvironmental reconstruction. *Quaternary Science Reviews* 19, 1087–1101.

- McGarry, S.F., Caseldine, C. 2004. Speleothem palynology: an undervalued tool in Quaternary studies. *Quaternary Science Reviews* 23, 2389–2404.
- McGarry, S.F., Bar-Matthews, M., Matthew, A., Vaks, A., Schilman, B., Ayalon, A. 2004. Constraints on hydrological and palaeotemperature variations in the Eastern Mediterranean region in the last 140 ka given by the δD values of speleothem fluid inclusions. *Quaternary Science Reviews* 23, 919–934.
- McMillan, E., Fairchild, I.J., Frisia, S., Borsato, A., McDermott, F. 2005. Annual trace element cycles in calcite-aragonite speleothems: evidence of drought in the western Mediterranean 1200–1100 yr BP. *Journal of Quaternary Science* 20, 423–433.
- McGillen, M., Fairchild, I.J., in press. An experimental study of the controls on incongruent dissolution of $CaCO_3$ under analogue glacial conditions. *Journal of Glaciology*.
- Mangini, A., Spötl, C., Verdes, P., 2005. Reconstruction of temperature in the Central Alps during the past 2000 yr from a $\delta^{18}O$ stalagmite record. *Earth and Planetary Science Letters*, 235, 741–751.
- Mickler, P.J., Banner, J.L., Stern, L., Asmerom, Y., Edwards, R.L., Ito, E., 2004. Stable isotope variations in modern tropical speleothems: evaluating equilibrium vs. kinetic effects. *Geochimica Cosmochimica Acta* 68, 4381–4393.
- Mills, T.C., 2004. Is the North Atlantic Oscillation a random walk? A comment with further results. *International Journal of Climatology* 24, 377–383.
- Moberg, A., Sonechkin, D.M., Holmgren, K., Datsenko, N.M., Karlen, K., 2005. Highly variable Northern Hemisphere temperatures reconstructed from low- and high-resolution proxy data. *Nature*, 433, 613–617.
- Morse, J.W., Mackenzie, F.T., 1990. *Geochemistry of Sedimentary Carbonates*. Elsevier, Amsterdam.
- Morse, J.W., Arvidson, R.S., 2002. The dissolution kinetics of major sedimentary carbonate minerals. *Earth-Science Reviews* 58, 51–84.
- Moore, G.W., 1962. The growth of stalactites. *National Speleological Society Bulletin* 24, 95–105.
- Morse J.W., Bender M.L., 1990. Partition coefficients in calcite: Examination of factors influencing the validity of experimental results and their application to natural systems. *Chemical Geology* 82, 265–277.
- Musgrove, M., Banner, J.L., 2004. Controls on the spatial and temporal variability of vadose dripwater geochemistry: Edwards Aquifer, central Texas. *Geochimica et Cosmochimica Acta* 68, 1007–1020.
- Neff, U., Burns, S. J., Mangini, A., Mudelsee, M., Fleitmann, D., Matter, A., 2001. Strong coherence between solar variability and the monsoon in Oman between 9 and 6 kyr ago. *Nature* 411, 290–293.
- Nicholson, S.E., 2000. The nature of rainfall variability over Africa on timescales of decades to millennia. *Global and Planetary Change* 26, 137–158.
- Niggemann, S., Mangini, A., Mudelsee, M., Richter, D.K., Wurth, G., 2003a. Milankovitch climatic cycles in Holocene stalagmites from Sauerland, Germany. *Earth and Planetary Science Letters* 216, 539–547.
- Niggemann, S.M., Mangini, A., Richter, D.K., Wurth, G., 2003b. A paleoclimate record of the last 17,600 years in stalagmites from the B7 cave, Sauerland, Germany. *Quaternary Science Reviews* 22, 555–567.
- Noone, D., Simmonds, I., 1998. Implications for the interpretation of ice-core isotope data from analysis of modelled Antarctic precipitation. *Annals of Glaciology* 27, 398–402.
- Noone, D., Still, C., Riley, W., 2002. A global biophysical model of ^{18}O in terrestrial water and CO_2 fluxes. In Ritchie, H. (ed.) *Research Activities in Atmospheric and Oceanic Modelling*, Report No. 32, World Meteorological Organization 4.19–4.20.
- Onac, B.P., 1997. Crystallography of speleothems. In: Hill, C.A. and Forti, P. (Eds.), *Cave Minerals of the World*, 2nd edition. National Speleological Society, Huntsville, Alabama.
- Onac, B.P., Constantin, S., Lundberg, J., Lauritzen, S.E., 2002. Isotopic climate record in a Holocene stalagmite from Ursilor Cave (Romania). *Journal of Quaternary Science* 17, 319–327.
- Ortega, R., Devès, G., Maire, R., 2003. Nuclear microprobe analysis of uranium-rich speleothems: methodological aspects. *Nuclear Instruments and Methods in Physics Research B* 210, 455–458.
- Paquette, J., Reeder, R.J., 1995. Relationship between surface structure, growth mechanism, and trace element incorporation in calcite. *Geochimica et Cosmochimica Acta* 59, 735–749.
- Pauling, A., Luterbacher, J., Wanner, H., 2003. Evaluation of proxies for European and North Atlantic temperature field reconstructions. *Geophysical Research Letters* 30 (15), art no 1787, doi:10.1029/2003GL017589.
- Paulsen, D.E., Li, H.-C., Ku, T.-L., 2003. Climate variability in central China over the last 1270 years revealed by high-resolution stalagmite records. *Quaternary Science Reviews* 22, 691–701.
- Perrin, J., Jeannin, P.-V., Zwahlen, F., 2003. Epikarst storage in a karst aquifer: a conceptual model based on isotopic data, Milandre test site, Switzerland. *Journal of Hydrology* 279, 106–124.
- Pingitore, N.E., Eastman, M.P., 1986. The coprecipitation of Sr^{2+} with calcite at 25 °C and 1 atmosphere. *Geochimica et Cosmochimica Acta* 50, 2195–2203.
- Plagnes, V., Causee, C., Genty, D., Paterne, M., Blamart, D., 2002. A discontinuous climatic record from 187 to 74 ka from a speleothem of the Clamouse Cave (south of France). *Earth and Planetary Science Letters* 201, 87–103.
- Polyak, V. J., Asmerom, Y., 2001. Late Holocene climate and cultural changes in the southwestern United States. *Science* 294, 148–151.
- Potter, E.-K., Stirling, C.H., Wiechert, U.H., Halliday, A.N., Spötl, C., 2005. Uranium-series dating of corals in situ using laser-ablation MC-ICPMS. *International Journal of Mass Spectrometry* 240, 27–35.
- Potts, P.J., 2003. *Handbook of Rock Analysis*. Viridian Publishing, Woking, UK.
- Proctor, C. J., Baker, A., Barnes, W. L., Gilmour, M. A., 2000. A thousand year speleothem proxy record of North Atlantic climate from Scotland. *Climate Dynamics* 16, 815–820.
- Proctor, C. J., Baker, A., Barnes, W. L., 2002. A three thousand year record of North Atlantic climate. *Climate Dynamics* 19, 449–454.
- Railsback, L. B., Brook, G. A., Chen, J., Kalin, R., Fleisher, C. J., 1994. Environmental controls on the petrology of a late Holocene speleothem from Botswana with annual layers of aragonite and calcite. *Journal of Sedimentary Research A64*, 147–155.
- Railsback, L.B., Dabous, A.A., Osmond, J.K., Fleischer, C.J., 2002. Petrographic and geochemical screening of speleothems for U-series dating: an example from recrystallized speleothems from Wadi Sannur Cavern, Egypt. *Journal of Cave and Karst Studies* 64, 108–116.
- Reed, S.J.B., 1996. *Electron Microprobe Analysis and Scanning Electron Microscopy in Geology*, Cambridge Univ. Press. Cambridge.
- Reeder, R.J., Grams, J.C., 1987. Sector zoning in calcite cement crystals: Implications for trace element distributions in carbonates. *Geochimica et Cosmochimica Acta* 51, 187–194.
- Reeder, R.J., Valley, J.W., Graham, C.M., Eiler, J.M., 1997. Ion microprobe study of oxygen isotopic compositions of structurally non-equivalent growth surfaces on synthetic calcite. *Geochimica et Cosmochimica Acta* 61, 5057–5063.
- Reeder, R.J., Nugent, M., Tait, C.D., Morris, D.E., Heald, S.M., Beck, K.M., Hess, W.P., Lanzirrotti, A., 2001. Coprecipitation of

- uranium(VI) with calcite: XAFS, micro-XAS, and luminescence characterization. *Geochimica et Cosmochimica Acta* 65, 3491–3503.
- Reimer, P.J., Baillie, M.G.L., Bard, E., Bayliss, A., Beck, J.W., Bertrand, C.J.H., Blackwell, P.G., Buck, C.E., Burr, G.S., Cutler, K.B., Damon, P.E., Edwards, R.L., Fairbanks, R.G., Friedrich, M., Guilderson, T.P., Gogg, A.G., Hughen, K.A., Kromer, B., McCormac, G., Manning, S., Ramsey, C.B., Rimere, R.W., Remmele, S., Southon, J.R., Stuiver, M., Talamo, S., Taylor, F.W., van der Plicht, J., Weyhenmeyer, C.E., 2004. INTCAL04 terrestrial radiocarbon age calibration, 0–26 kyr BP. *Radiocarbon*, 46, 1029–1058.
- Richards, D.A., Dorale, J.A., 2003. Uranium-series chronology and environmental applications of speleothems. *Reviews in Mineralogy and Geochemistry* 52, 407–460.
- Richter, D.K., Götze, T., Niggemann, S., Wurth, G., 2004. REE³⁺ and Mn²⁺ activated cathodoluminescence in lateglacial and Holocene stalagmites of central Europe: evidence for climatic processes? *The Holocene* 14, 759–767.
- Rimstidt, J.D., Balog, A., Webb, J., 1998. Distribution of trace elements between carbonate minerals and aqueous solutions. *Geochimica et Cosmochimica Acta* 62, 1851–1863.
- Roberts, M. S., Smart, P., Baker, A., 1998. Annual trace element variations in a Holocene speleothem. *Earth and Planetary Science Letters* 154, 237–246.
- Roberts, M.S., Smart, P.L., Hawkesworth, C.J., Perkins, W.T., Pearce, N.J.G., 1999. Trace element variations in coeval Holocene speleothems from GB cave, southwest England. *The Holocene* 9, 717–713.
- Robinson, Z.P., 2003. The geochemistry and behaviour of shallow groundwater in an Icelandic sandur. PhD thesis, Keele University, UK.
- Roedder, E., 1990. Fluid inclusion analysis – prologue and epilogue. *Geochimica et Cosmochimica Acta*, 54, 495–507.
- Rohling, E.J., Pälike, H., 2005. Centennial-scale climate cooling with a sudden cold event around 8,200 years ago. *Nature* 434, 975–979.
- Rosenheim, B., E., Swaet, P.K., Thorrold, S.R., Willenz, P., Berry, L., Latkoczy, C., 2004. High-resolution Sr/Ca records in sclerosponges calibrated to temperature in situ. *Geology* 32, 145–148.
- Rowland, A.P., 1997. Atomic absorption spectrometry and other solution methods. In: Gill, R. (Ed.) *Modern Analytical Geochemistry*, Longman, Harlow, Essex, pp. 67–86.
- Rozanski, K., Araguas-Araguas, L., Gonfiantini, R., 1993. Isotopic patterns in modern global precipitation. In: Swart P.K. et al., (Eds), *Climate Change in Continental Isotopic Record*. American Geophysical Union Monograph 78, 1–36.
- Saurer, M., Schweingruber, F., Vaganov, E.A., Shiyatov, S.G., Siegwolf, R., 2002. Spatial and temporal oxygen isotope trends at the northern tree-line in Eurasia. *Geophysical Research Letters* 29, 9, 1296, 10.1029/2001GL013739.
- Schulz, M., Statterger, K., 1997. SPECTRUM: Spectral analysis of unevenly spaced paleoclimatic time series. *Computers and Geosciences* 23, 929–945.
- Schwarcz, H.P., 1986. Geochronology and isotopic geochemistry of carbonates in the weathering zone. In: Fritz, P., Fontes, J. Ch. (Eds), *Handbook of Environmental Isotope Geochemistry*, Vol. 2, The Terrestrial Environment, B. Elsevier, Amsterdam, pp. 271–300.
- Self, C.A., Hill, C.A. 2003. How speleothems grow: an introduction to the ontogeny of cave minerals. *Journal of Cave and Karst Studies* 65, 130–151.
- Sereffiddin, F., Schwarcz, H.P., Ford, D.C., Baldwin, S., 2004. Late Pleistocene paleoclimate in the Black Hills of South Dakota from isotope records in speleothems. *Palaeogeography, Palaeoclimatology, Palaeoecology* 203, 1–17.
- Shackleton, N.J., Opdyke, N.D., 1967. Oxygen isotope and paleomagnetic stratigraphy of equatorial Pacific core V28-238: oxygen isotope temperatures and ice volumes on a 10⁵ and 10⁶ year scale. *Quaternary Research* 3, 39–55.
- Shackleton, N.J., Fairbanks, R.G., Chiu, T.-C., Parrenin, F., 2004. Absolute calibration of the Greenland time scales and for $\Delta^{14}\text{C}$. *Quaternary Science Reviews* 23, 1513–1522.
- Sharp, Z.D., Cerling, T.E., 1996. A laser-GC-IRMS technique for in situ stable isotope analysis of carbonates and phosphates. *Geochimica et Cosmochimica Acta* 60, 2909–2916.
- Shopov, Y.Y., Ford, D.C., Schwarcz, H.P., 1994. Luminescent microbanding in speleothems: High-resolution chronology and palaeoclimate. *Geology* 22, 407–410.
- Shurbaji, A.R.M., Phillips F., 1995. A numerical model for the movement of H₂O, H-2, O-18, and (HHO)-H-2 in the unsaturated zone. *Journal of Hydrology* 171, 125–142.
- Sinclair, D.J., Kinsley, L.P.J., McCulloch, M.T. 1998. High resolution analysis of trace elements in corals by laser ablation ICP-MS. *Geochimica Cosmochimica Acta* 62, 1889–1901.
- Smalley, P.C., Stijfhoorn, D.E., Råheim, A., Johansen, H., Dickson, J.A.D., 1989. The laser microprobe and its application to the study of C and O isotopes in calcite and aragonite. *Sedimentary Geology* 65, 211–221.
- Smart, P.L., Friederich, H., 1986. Water movement and storage in the unsaturated zone of a maturely karstified aquifer, Mendip Hills, England. *Proceedings of the Conference on Environmental Problems in Karst Terrains and their Solutions*, October 28–30 1986, Bowling Green, Kentucky, National Water Wells Association, pp. 57–87.
- Soubiès, F., Seidel, A., Mangin, A., Genty, D., Ronchail, J., Plagnes, V., Hirooka, S., Santos, R., 2005. A fifty-year climatic signal in three Holocene stalagmite records from Mato Grosso, Brazil. *Quaternary International* 135, 115–129.
- Spötl, C., Mangini, A., 2002. Stalagmite from the Austrian Alps reveals Dansgaard-Oeschger events during isotope stage 3: Implications for the absolute chronology of Greenland ice cores. *Earth and Planetary Science Letters* 203, 507–518.
- Spötl, C., Mathey, D.P., in press. Stable isotope microsampling of speleothems: a comparison of manual drill, micromill and laser ablation techniques.
- Spötl, C., Mangini, A., Frank, N., Eichstädter, R., Burns, S.J., 2002a. Start of the last interglacial period at 135 ka: Evidence from a high Alpine speleothem. *Geology* 30, 815–818.
- Spötl, C., Unterwurzacher, M., Mangini, A., Longstaffe, F., 2002b. Carbonate speleothems and tufas in the dry, inneralpine Vinschgau valley, northernmost Italy: Witnesses of changes in hydrology and climate since the Late Glacial Maximum. *Journal of Sedimentary Research* 72, 793–808.
- Spötl, C., Mangini, A., Burns, S.J., Frank, N., Pavuza, R., 2004. Speleothems from the high-alpine Spannagel cave, Zillertal Alps (Austria). In Sasowsky, I.D. and Mylroie, J. (eds.) *Studies of Cave Sediments. Physical and Chemical Records of Palaeoclimate*, Kluwer Academic, New York, p. 243–256.
- Spötl, C., Fairchild, I.J., Tooth, A.F., 2005. Cave air control on dripwater geochemistry, Obir Caves (Austria): Implications for speleothem deposition in dynamically ventilated caves. *Geochimica et Cosmochimica Acta*, 69, 2451–2468.
- Spötl, C., Holzkämper, S., Mangini, A., in press. The Last and the Penultimate Interglacial as recorded by speleothems from a climatically sensitive high-elevation cave site in the Alps. In Sirocko, F., Litt, T., Claussen, M., Sánchez-Goni, M.F. (Eds.), *The Climate of Past Interglacials. Developments in Quaternary Science Series*, Elsevier, Amsterdam.
- Stipp, S.L.S., Konnerup-Madsen, J.K., Franzreb, K., Kulik, A., Mathieu, H.J., 1998. Spontaneous movement of ions through calcite at standard temperature and pressure. *Nature* 396, 356–359.
- Stirling, C.H., Lee, D.C., Christensen, J.N., Halliday A.N., 2000. High-precision in situ U-238-U-234-Th-230 isotopic analysis using laser ablation multiple-collector ICPMS. *Geochimica et Cosmochimica Acta* 64, 3737–3750.

- Stuiver, M., Braziunas, T.F., Sun, T.F., 1993. Sun, ocean climate and atmospheric $^{14}\text{CO}_2$: an evaluation of causal and spectral relationships. *Holocene* 3, 289–305.
- Sylvester, P., 2001. Laser-ablation ICPMS in the Earth Sciences. Mineralogical Association of Canada (Victoria, B.C.), Short course Series volume 29.
- Talma, A.S., Vogel, J.C., 1992. Late Quaternary palaeotemperatures derived from a speleothem from Cango Caves, Cape Province, South Africa. *Quaternary Research* 37, 203–213.
- Tan, M., Liu, T., Hou, J., Qin, X., Zhang, H., Li, T. 2003. Cyclic rapid warming on centennial-scale revealed by a 2650-year stalagmite record of warm season temperature. *Geophysical Research Letters* 30, 1617–1620.
- Tang, K., Feng, X., 2001. The effect of soil hydrology on oxygen and hydrogen isotopic compositions of plants' source water. *Earth and Planetary Science Letters* 185, 355–367.
- Tatár, E., Mihucz, V.G., Zámbo, L., Gasparics, T., Zárny, G., 2004. Seasonal changes of fulvic acid, Ca and Mg concentrations of water samples collected above and in the Béke Cave of the Aggtelek karst system (Hungary). *Applied Geochemistry* 19, 1727–1733.
- Telford, R. J., Heegaard, E., Birks, H. J. B., 2004. All age-depth models are wrong: but how badly? *Quaternary Science Reviews* 23, 1–5.
- Thompson, P., Schwarcz, H.P., Ford, D.C., 1974. Continental Pleistocene climatic variations from speleothem age and isotopic data. *Science* 184, 893–895.
- Tooth, A.F., 2000. Controls on the geochemistry of speleothem-forming karstic drip waters. PhD thesis, Keele University, UK.
- Tooth, A.F., Fairchild, I.J., 2003. Soil and karst aquifer hydrological controls on the geochemical evolution of speleothem-forming drip waters, Crag Cave, southwest Ireland. *Journal of Hydrology* 273, 51–68.
- Torrence, C., Compo, G. P., 1998. A practical guide to wavelet analysis. *Bulletin of the American Meteorological Society* 79, 61–78.
- Treble, P., Shelley, J.M.G., Chappell, J., 2003. Comparison of high resolution sub-annual records of trace elements in a modern (1911–1992) speleothem with instrumental climate data from southwest Australia. *Earth and Planetary Science Letters* 216, 141–153.
- Treble, P., Chappell, J., Gagan, M.K., McKeegan, K.D., Harrison, T.M., 2005a. *In situ* measurement of seasonal $\delta^{18}\text{O}$ variations and isotopic trends in a modern speleothem from southwest Australia. *Earth and Planetary Science Letters* 233, 17–32.
- Treble, P., Budd, W.F., Hope, P.K., Rustomji, P.K., 2005b. Synoptic-scale climate patterns associated with rainfall delta O-18 in southern Australia. *Journal of Hydrology* 302, 270–282.
- Treble, P., Chappell, J., Shelley, J.M.G., in press. Complex speleothem growth processes revealed by trace element mapping and scanning electron microscopy of annual layers. *Geochimica et Cosmochimica Acta*, xx, xxx–xxx.
- Troester, J.W., White, W.B., 1984. Seasonal fluctuations in the carbon dioxide partial pressure in a cave atmosphere. *Water Resources Research*, 20, 153–156.
- Tudhope, A.W., Cillcott, C.P., McCulloch, M.T., Cook, E.R., Chappell, J., Ellam, R.M., Lea, D.W., Lough, J.M., Shimmield, G.B., 2001. Variability in the El Niño-Southern Oscillation through a glacial-interglacial cycle. *Science* 291, 1511–1517.
- Vadillo, J.M., Vadillo, I., Carrasco, F., Laserna, J.J. 1998. Spatial distribution profiles of magnesium and strontium in speleothems using laser-induced breakdown spectrometry, *Fresenius Journal of Analytical Chemistry* 361, 119–123.
- van Beynen, P.E., Schwarcz, H.P., Ford, D.C., Timmins, G.T., 2002. Organic substances in cave drip waters: studies from Marengo Cave, Indiana. *Canadian Journal of Earth Sciences* 39, 279–284.
- Verheyden, S., Keppens, E., Fairchild, I.J., McDermott, F., Weis, D., 2000. Mg, Sr and Sr isotope geochemistry of a Belgian Holocene speleothem: implications for paleoclimate reconstructions. *Chemical Geology* 169, 131–144.
- Viles, H.A., Goudie, A.S., 2003. Interannual, decadal and multidecadal scale climatic variability and geomorphology. *Earth-Science Reviews* 61, 105–131.
- Walsh, J.N., 1997. Inductively-coupled plasma-atomic emission spectrometry (ICP-AES). In: Gill, R. (Ed.) *Modern Analytical Geochemistry*, Longman, Harlow, Essex, pp. 41–66.
- Wang, Y., Cheng, H., Edwards, R. L., An, Z. S., Wu, J. Y., Shen, C.-C., Dorale, J. A., 2001. A high-resolution absolute dated late Pleistocene monsoon record from Hulu cave, China. *Science* 294, 2345–2348.
- Wang, Y., Cheng, H., Edwards, R.L., He, Y., Kong, X., An, Z., Wu, J., Kelly, M.J., Dykoski, C.A., Li, X., 2005. The Holocene Asian Monsoon: links to solar changes and North Atlantic climate. *Science*, 308, 854–857.
- Wang, X., Auler, A.S., Edwards, R.L., Cheng, H., Cristall, P.S., Smart, P.L., Richards, D.A., Shen, C.-C., 2004. Wet periods in northeastern Brazil over the past 210 kyr linked to distant climate anomalies. *Nature* 432, 740–743.
- Watson, E.B., 2004. A conceptual model for near-surface kinetic controls on the trace-element and stable isotope composition of abiogenic crystals. *Geochimica et Cosmochimica Acta* 68, 1473–1478.
- Weedon, G.P., 2003. *Time-Series Analysis and Cyclostratigraphy*. CUP, Cambridge.
- Werner, M., Heimann, M., 2002. Modeling interannual variability of water isotopes in Greenland and Antarctica. *Journal of Geophysical Research* 107, D1, 10.1029/2001JD900253.
- White, W.B., 2004. Palaeoclimate records from speleothems in limestone caves. In: Sasowsky, I.D., Mylroie, J. (Eds.) *Studies of Cave Sediments. Physical and Chemical Records of Palaeoclimate*. Kluwer Academic, New York, pp. 135–175.
- Wiedner, E.A., 2004. Laborexperimente zur kinetischen Fraktionierung stabiler Isotope bei der Sinterbildung. PhD thesis. University of Heidelberg, Germany.
- Wigley, T.M.L., Plummer, L.N., Pearson, F.J., 1978. Mass transfer and carbon isotope evolution in natural water systems. *Geochimica et Cosmochimica Acta* 42, 1117–1140.
- Williams, P., 1983. The role of the subcutaneous zone in karst hydrology. *Journal of Hydrology* 61, 45–67.
- Williams, P.W., King, D.N.T., Zhao, J.-X., Collerson, K.D., 2004. Speleothem master chronologies: combined Holocene ^{18}O and ^{13}C records from the North Island of New Zealand and their palaeoenvironmental interpretation. *Holocene* 14, 194–208.
- Williams, P.W., King, D.N.T., Zhao, J.-X., Collerson, K.D., 2005. Late Pleistocene to Holocene composite speleothem ^{18}O and ^{13}C chronologies from South Island, New Zealand – did a global Younger Dryas really exist? *Earth and Planetary Science Letters* 230, 301–317.
- Winograd, I.J., Coplen, T.B., Landwehr, J.M., Riggs, A.C., Ludwig, K.R., Szabo, B., Kolesar, P.T., Revesz, K.M., 1992. Continuous 500,000 year climate record from vein calcite in Devils Hole, Nevada. *Science* 258, 255–260.
- Winograd, I.J., Landwehr, J.M., Ludwig, K.R., Coplen, T.B., Riggs, A.C., 1997. Duration and structure of the past four interglaciations. *Quaternary Research* 48, 141–154.
- Wogelius, R.A., Fraser, D.G., Wall, G.R.T., Grime, G.W., 1997. Trace element and isotopic zonation in vein calcite from the Mendip Hills, UK, with spatial-process correlation analysis. *Geochimica et Cosmochimica Acta* 61, 2037–2051.
- Woodhead, J., Swearer S., Hergta J., Maasa R., 2005. *In situ* Sr-isotope analysis of carbonates by LA-MC-ICP-MS: interference corrections, high spatial resolution and an

- example from otolith studies. *Journal of Analytical Atomic Spectrometry* 20, 22–27.
- Wunsch, C., 2004. Quantitative estimate of the Milankovitch-forced contribution to observed Quaternary climate change. *Quaternary Science Reviews* 23, 1001–1012.
- Xoplaki, E., González-Rouco, J.F., Luterbacher, J., Wanner, H., 2004. Wet season Mediterranean precipitation variability: influence of large-scale dynamics and trends. *Climate Dynamics* 23, 63–78.
- Yadava, M.G., Ramesh, R., Pant, G.B., 2004. Past monsoon rainfall variations in peninsular India recorded in a 331-year-old speleothem. *Holocene* 14, 517–524.
- Yoshimura, K., 2004. Effect of land surface processes on precipitation isotopes, In *Proceedings of the 6th International Study Conference on GEWEX in Asia and GAME*, Kyoto, Japan, 3-5, December, 2004.
- Yonge, C., Ford, D.C., Gray, J., Schwarcz, H.P., 1985. Stable isotope studies of cave seepage water. *Chemical Geology* 58, 97–105.
- Yuan, D., Cheng, H., Edwards, R. L., Dyoski, C. A., Kelly, M. J., Zhang, M., Qing, J., Lin, Y., Wang, Y., Wu, J., Dorale, J., A., An, Z., Cai, Y., 2004. Timing, duration and transitions of the last interglacial Asian monsoon. *Science* 304, 575–578.
- Zhang, M., Yuan, D., Lin, Y., Qin, J., Bin, L., Cheng, H., Edwards, R.L., 2004. A 6000-year high-resolution climatic record from a stalagmite in Xiangshui Cave, Guilin, China. *Holocene* 14, 697–702.
- Zhou, G.-T., Zheng, Y.-F., 2003. An experimental study of oxygen isotope fractionation between inorganically precipitated aragonite and water and low temperatures. *Geochimica et Cosmochimica Acta* 67, 387–399.
- Zimmerman, U., Ehhalt, D., Münnich, K.O., 1967. Soil water movement and evapotranspiration: Changes in the isotopic composition of the water, *Proceedings of the Isotope Hydrology Symposium*, 14–18, International Atomic Energy Authority, Vienna, pp. 567–584.