

Э. Хокинс, Д. Эйвон

Фотография. Техника и искусство

Издательство «Мир»



ФОТОКИНОТЕХНИКА
в книгах издательства «Мир»

Л. Гонт

Экспозиция в фотографии

Р. Рёссинг

Увеличение фотоснимка

Э. Хокинс, Д. Эйвон

Фотография. Техника и искусство

К. Престон-Мэфем

Фотографирование живой природы

• , •
•

Photography
The guide to technique
Andrew Hawkins and Dennis Avon
Blandford Press Poole
1980





Москва «Мир» 1986

,

,

.

.

,

,

,

.

,

,

,

.

,

-

.

,

-

.

,

.

,

,

,

.

,

,

.

,

.

,

,

,

.

—



) 10 (10^{-10} (10^{-10})¹.
 ($(4,3 \cdot 10^{-7}) \cdot 10^{14}$)
 ()
 XVI).
 $30 \cdot 10^{10}$ / .
 80% , — 2—3%.
 ()
)

1.

1,5,

2,4).

(

1,3,

0.5

125

3

. 2.

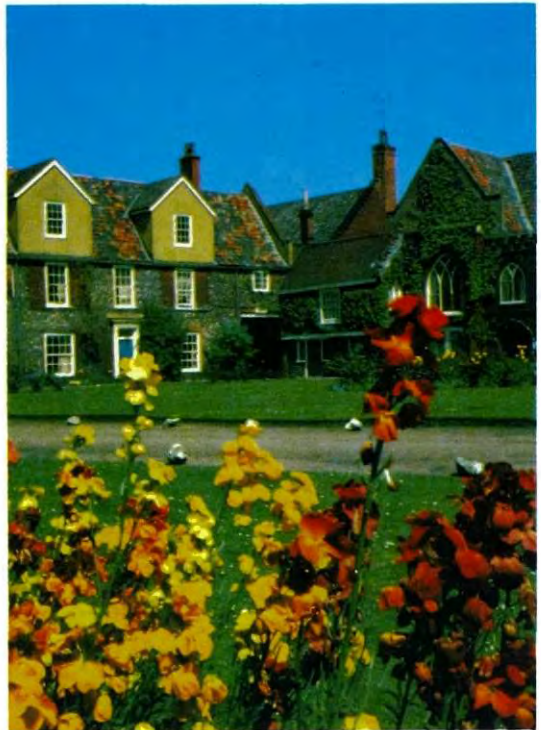
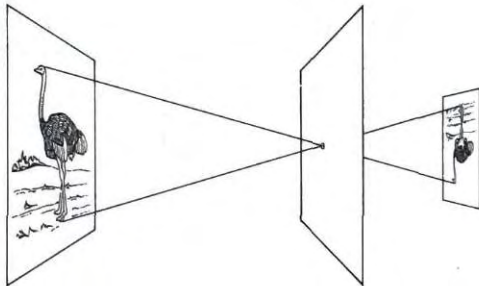

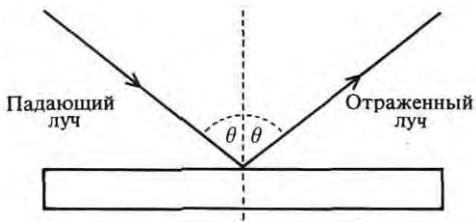

. 3.

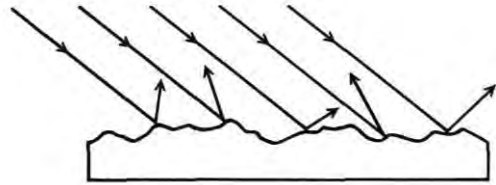

. 4.

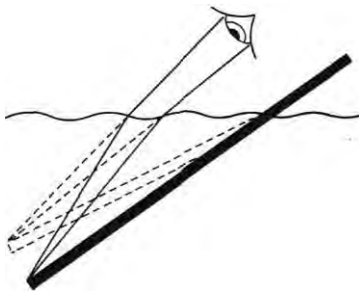

. 5

. 6.

())

()) —

(),

;

(б),

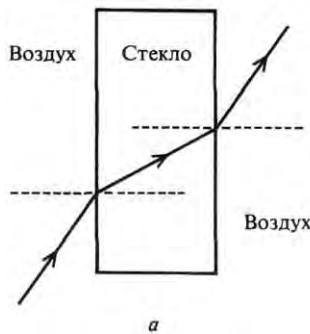

а

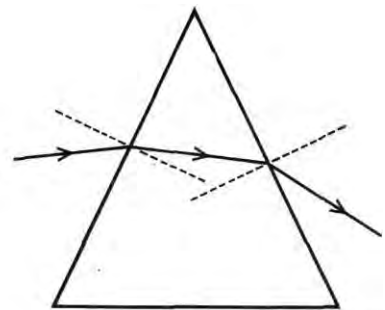

б

.7.

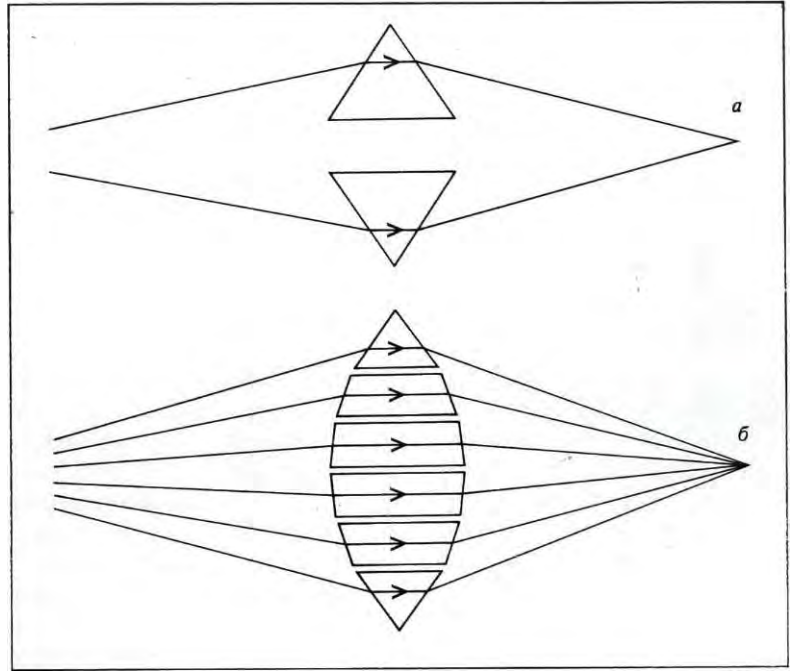

.8.

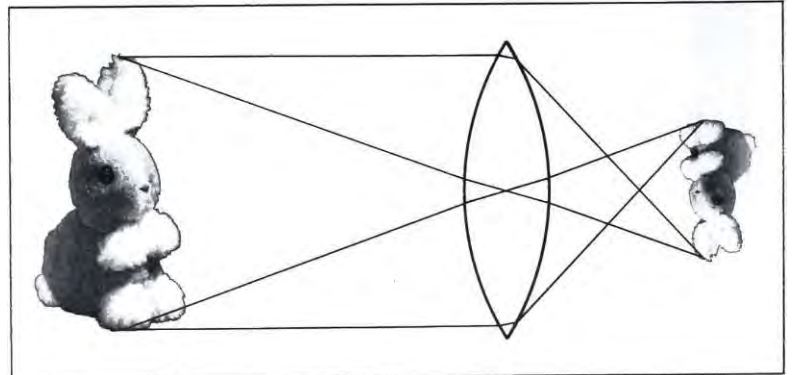



2.

()

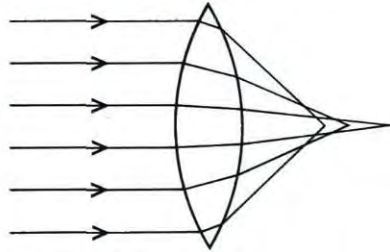
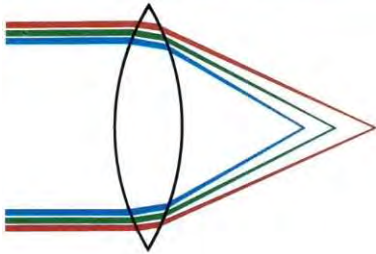

.9.



3.

()

()

()

()



a

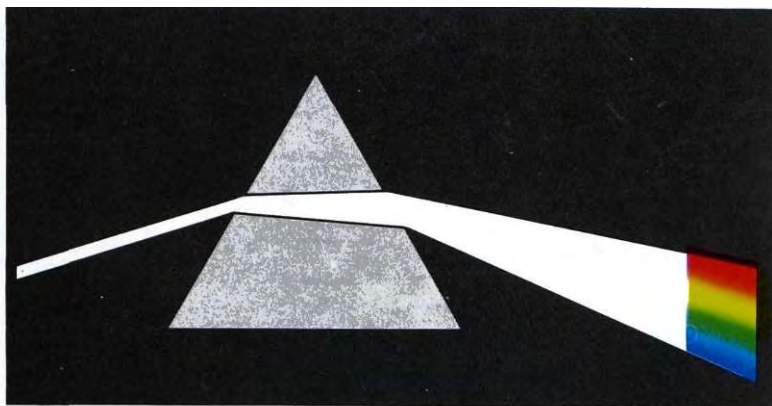

б

. 10.

— (; —

. 11.

— « » ; б —

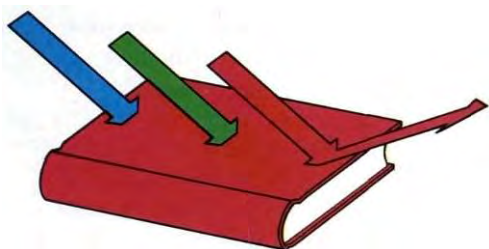

a

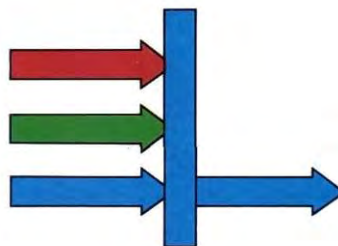

б

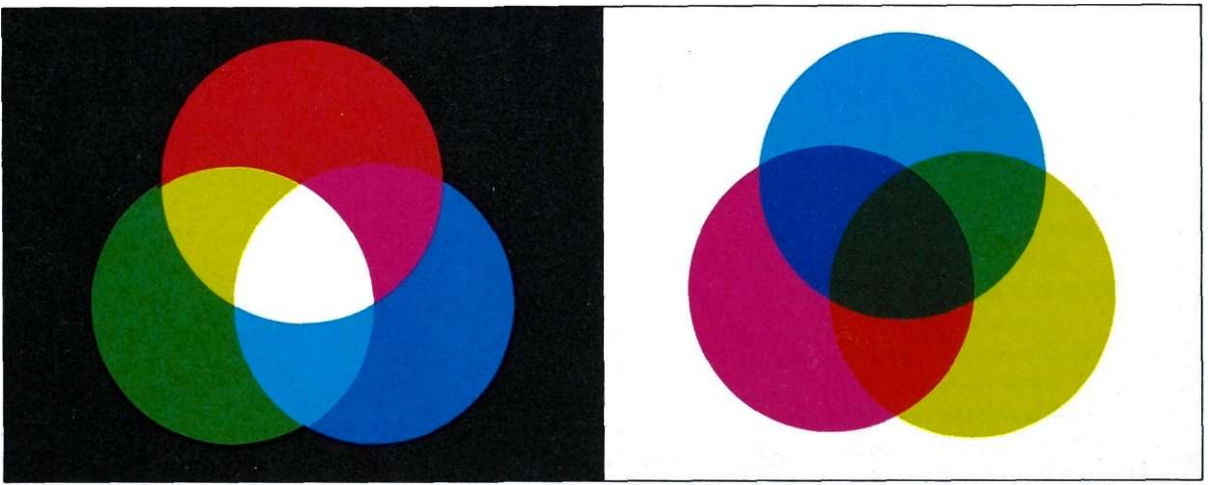

. 12.

. 13.

, . . . , , .
 , . . . , , .
 (,) .
 , , .
 , .
 :
 .
 — () .
 ;
 , .

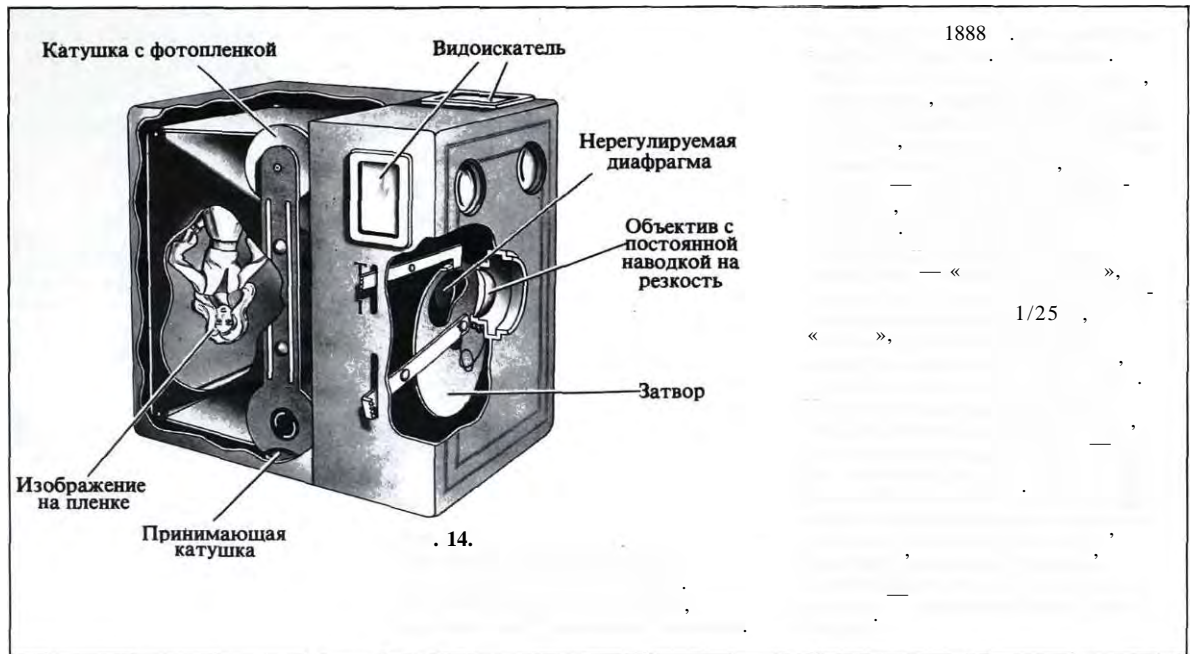

() ,

, , , ,

() ,

,

.

, ,

() .

,

« » ,

,

() .

()

,

()

(,

() ,) .

—

() ,

, , , ,

, , -

,
 .
 ,
 .
 .
 ()
 ,
 ,
 .
 ,
 ;
 ,
 .

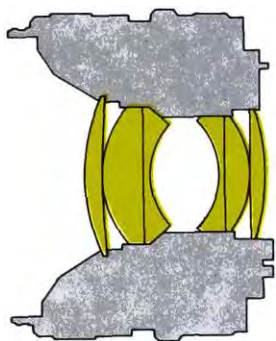

. 15.

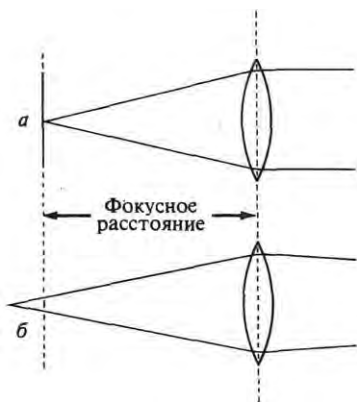

. 16.

. 17.

()

(6),



a

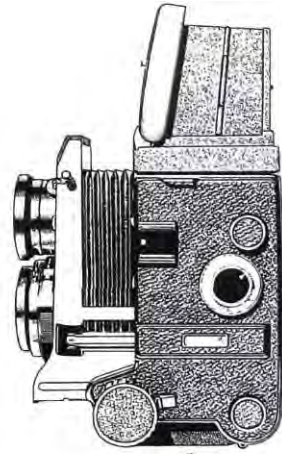

b

1:1.

qrt(2).

f:1

4.





. 18.

(1 = 30)

5
1:16.

2.5

. 19.

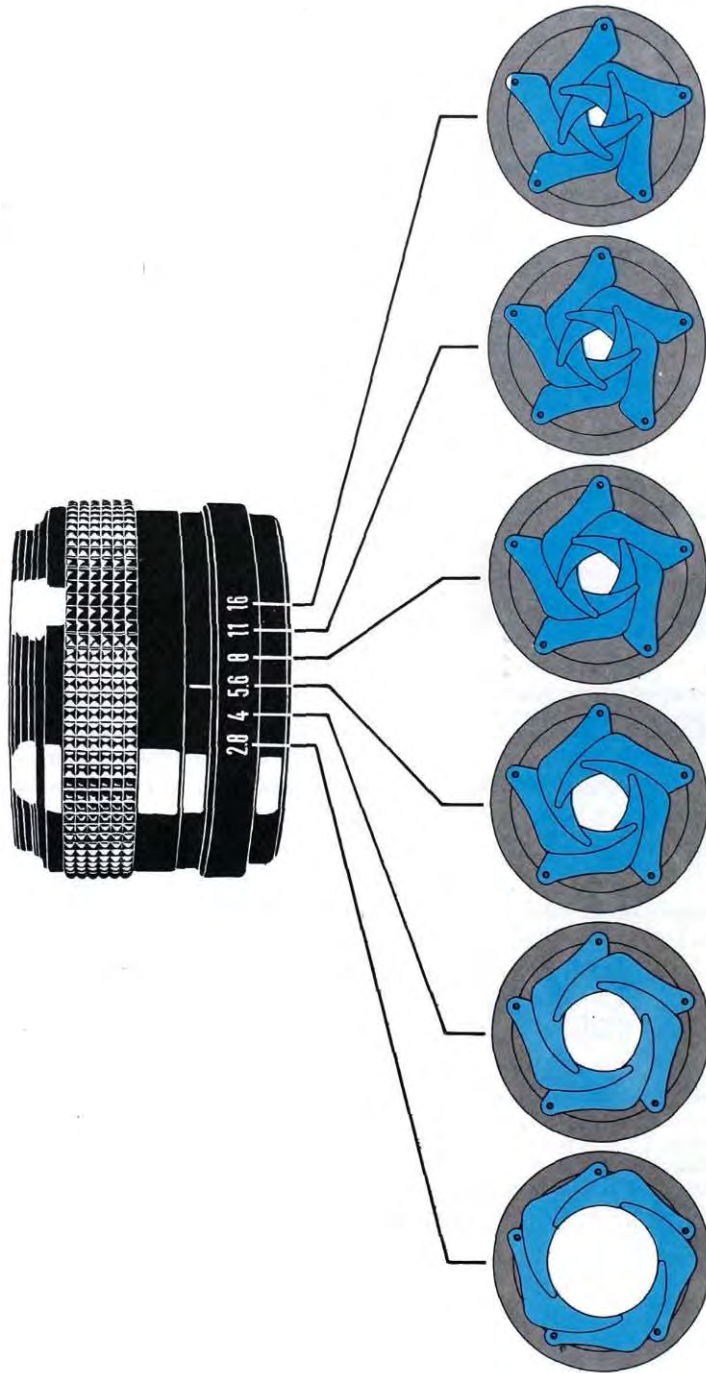

qrt(2), f: 1,414.

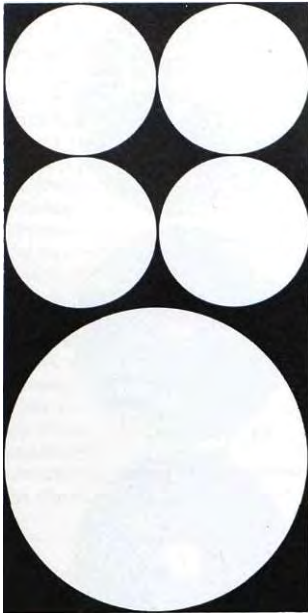

. 20.

f:2 (1:2).

, . . f: qrt(4),
: 1,0 1,4 2 2,8 4 5,6 8 11 16 22 32 45 64

()
()

1:1.

1:2,8;

()

1:1,4

1:1,2.

;

1:1,2 1:1,8.

35-
1:16 1:22,

1:32

1:45.

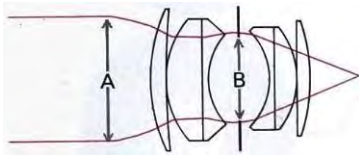

. 21.

5.

1:1,4;

1:22.



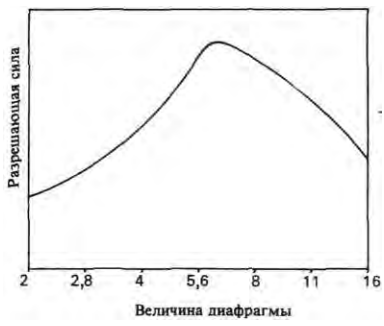

. 22.

1:5,6 1:11, . . .

()

6.

()



7.



5%

(),

() ()

$\frac{1}{4}$

.)

d,

—), (d= /4. — 2%
.
,
,
.

(— Multi-Coating),
0,2%

,
.
,
.
,
.

. 23.

())

), (—

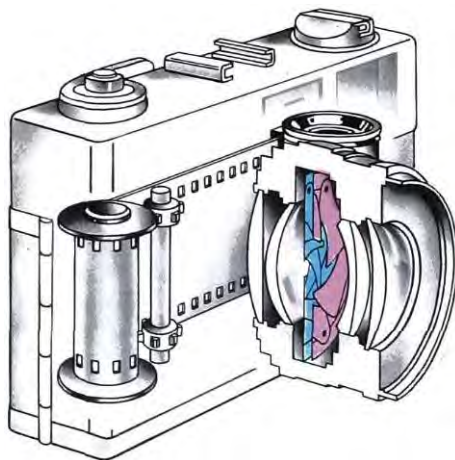

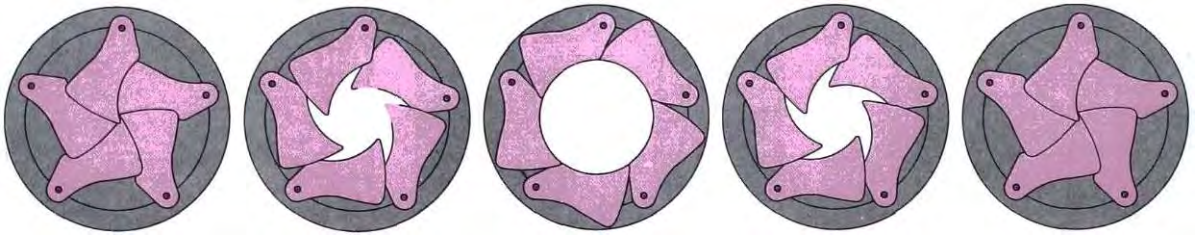

. 24.

1/500

), 1/500

1/500 1

: 1/500, 1/250, 1/125, 1/60, 1/30,
1/15, 1/8, 1/4, 1/2 1

30

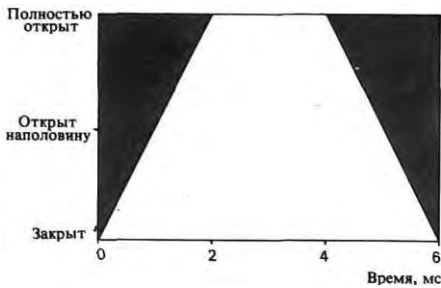

. 25.

(10—15)

1/500

1/250

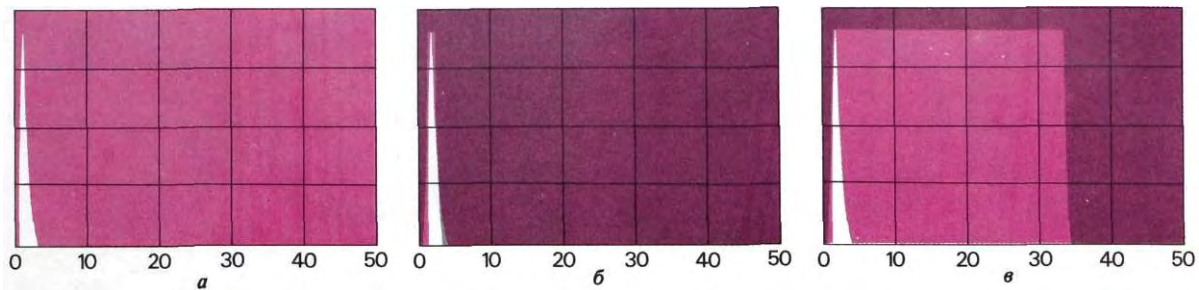

. 26.

($\frac{1}{500}$)
 1—2 ;
 6 —
 1/500 X- 1.
 ; X
 1/30 1/800
 2 ($\frac{1}{500}$)
 16
 40 (1/25)
 12
 2.
 1 X « » (Xenon) —
 2

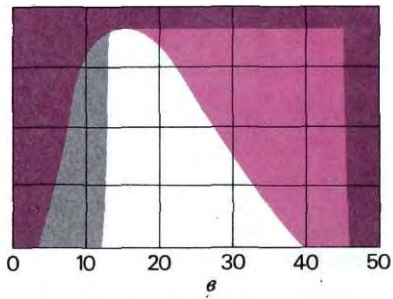
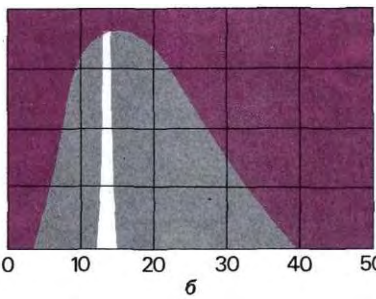
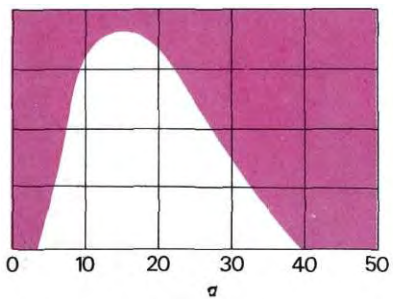

. 27.

(0),

« »

16

; 6 —

1/500

110 126),

; — 1/30

1 — 2

().

()

(

),

()

« »

()

35-

10

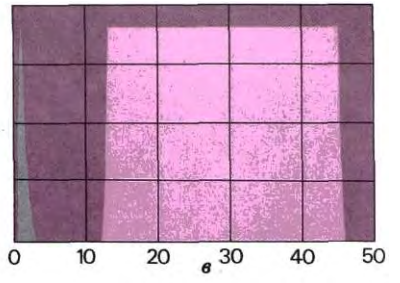
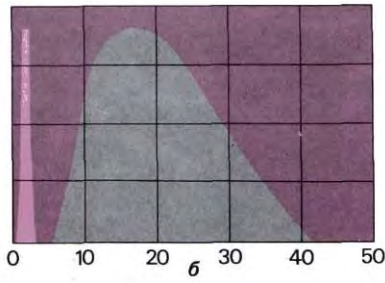
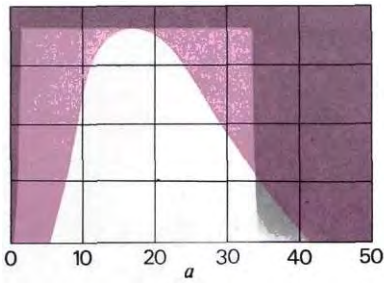

. 28.

1/60

1/30

; 6 —

1/500

1/2000

. 29.

(

(,) ,

).

(,).

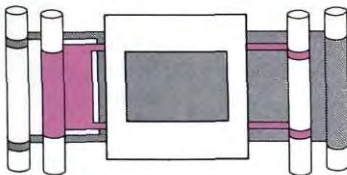
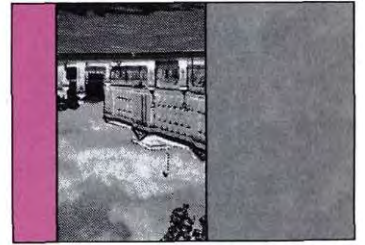
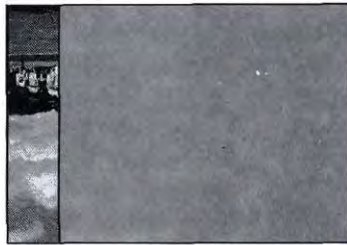

a

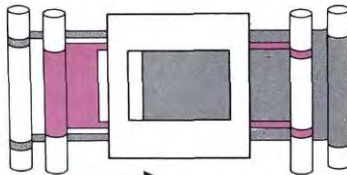

б

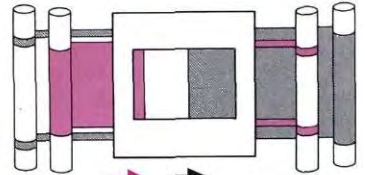

в

1/ 125

1/ 60

FP-

16

FP-

FP-

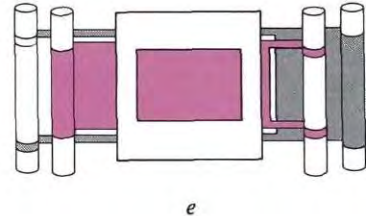
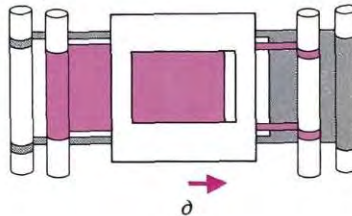
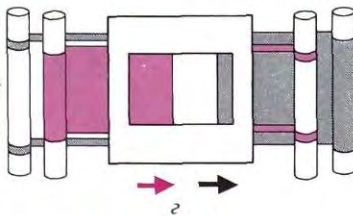
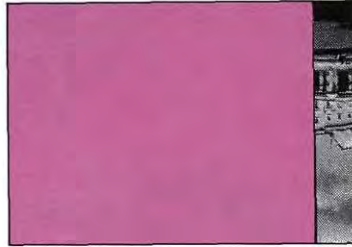
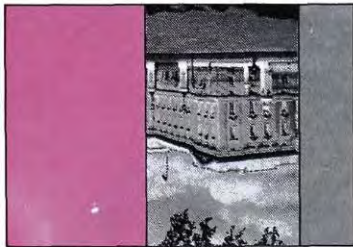

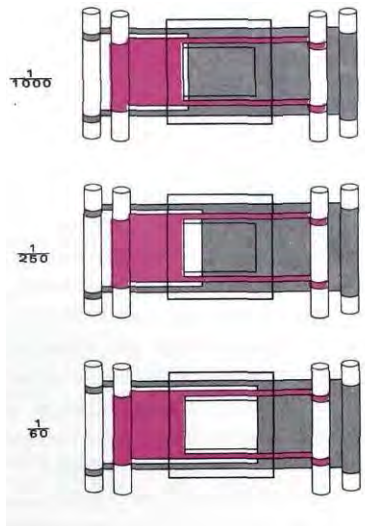

. 30.

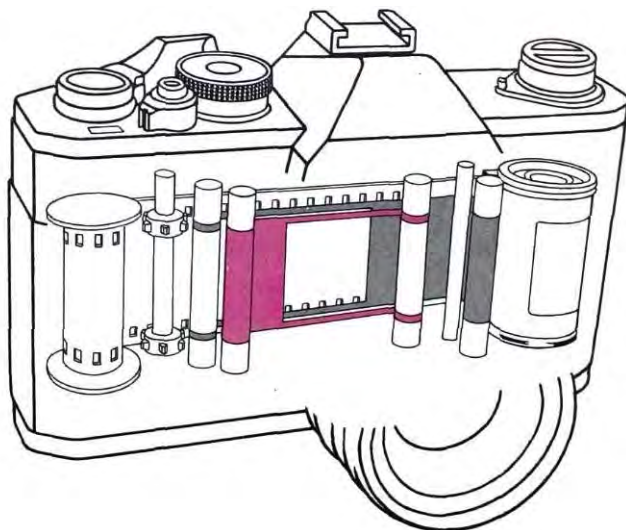

. 31.

1/60

. 32.

Synchro-Compur,

Promor-Press,



Alfred Gautheir GMBH,
Wildbad, Black Forest,





. 33.

35-



. 34.

110.



.35.

. 34.

110.

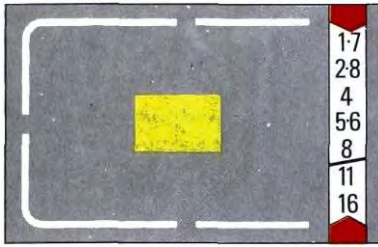

. 37.

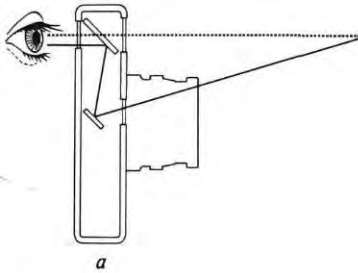
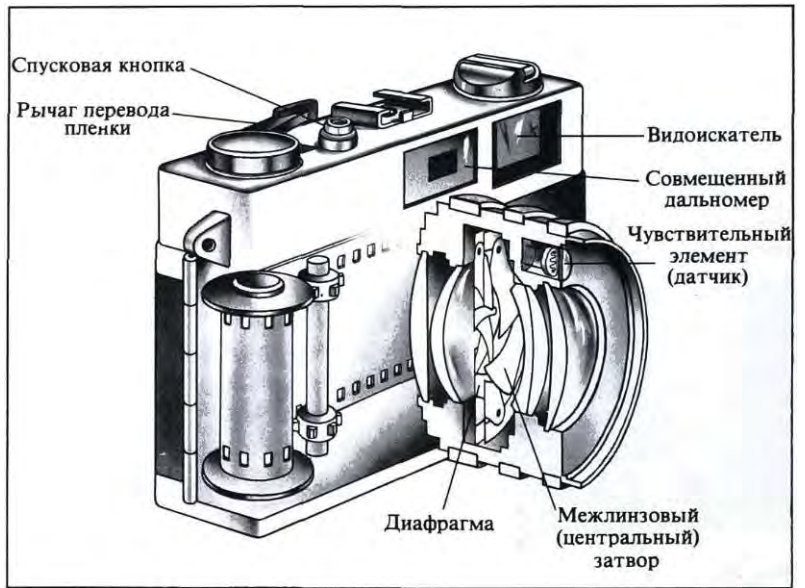

. 38.

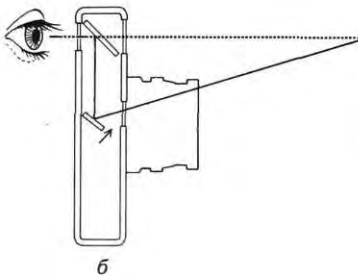

(.)

(.)



. 39.

« »

(. 38);

()

)

()

().

45°

(),

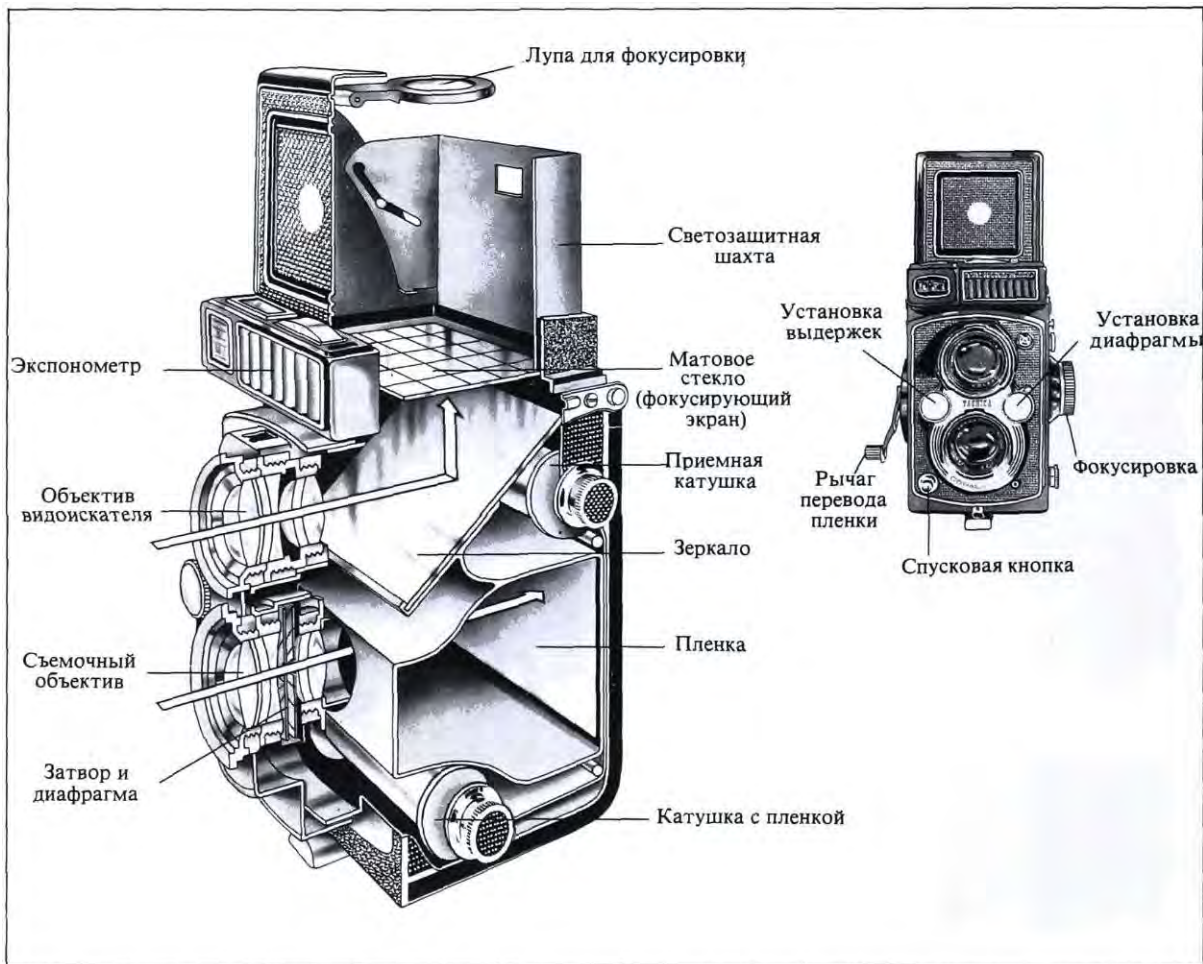

. 40.

() ,

« »

«

» —

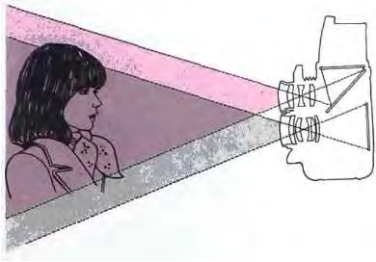

. 41.

« »

()

120 220

12

6X6

;

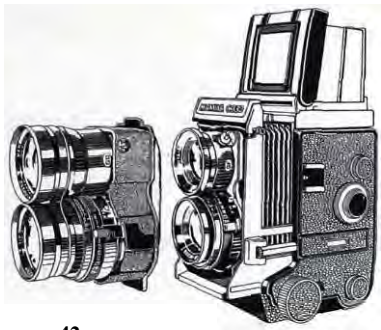

. 42.

()

(),

« »

1

45°

()



5 / .

() ,

i

35-

90°.

() ,

(TTL).

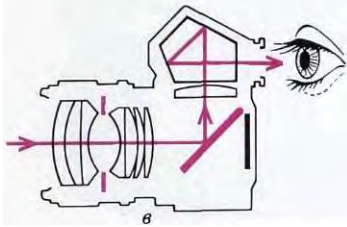
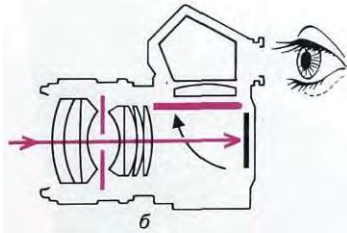
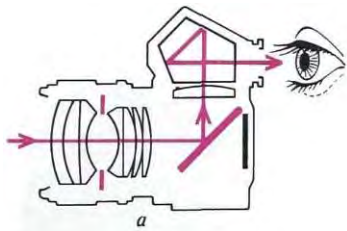

. 44.

(« ») , —
« »

(« »)

35-

24X 36
4,5 X 6, 6 6 9 ,

6 —

120.



. 46.
 « () « »
 ()
 « »
 ()

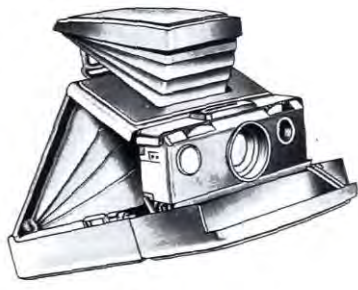
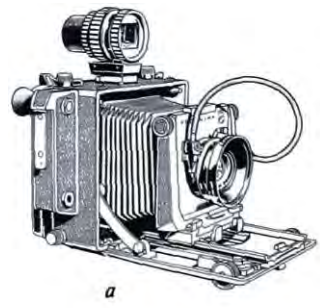

. 45.
 — Hasselblad —

120 6X6
 220.

() ,

; — Polaroid SX-70 —



б

. 47.

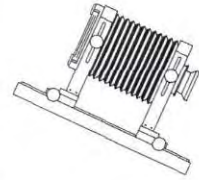
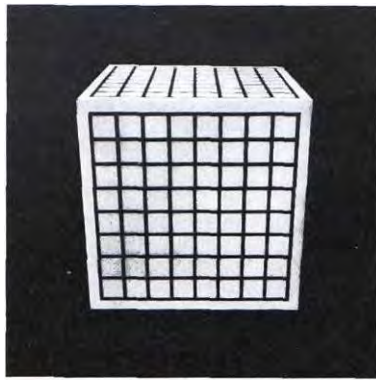

(()),

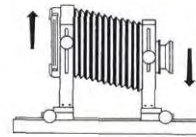
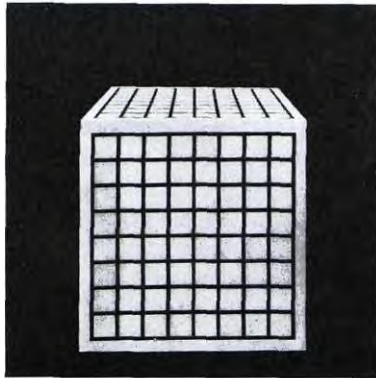

. 48.

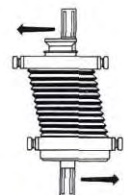
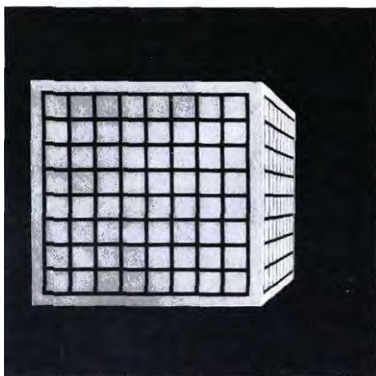
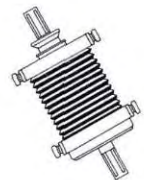
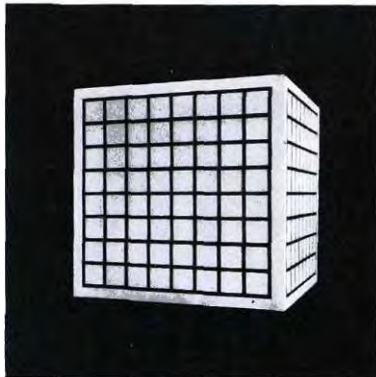

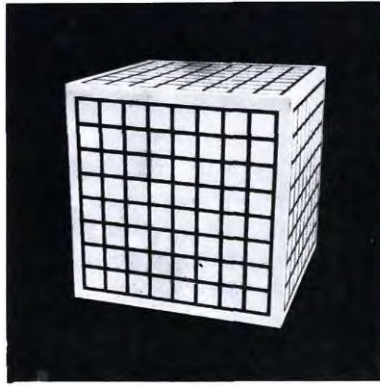

a

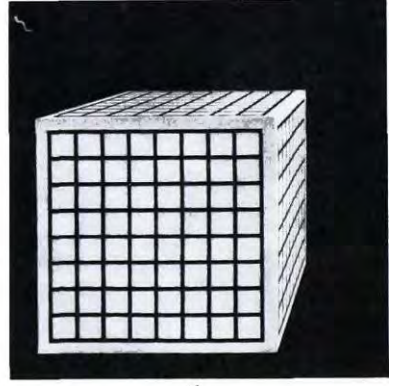

б

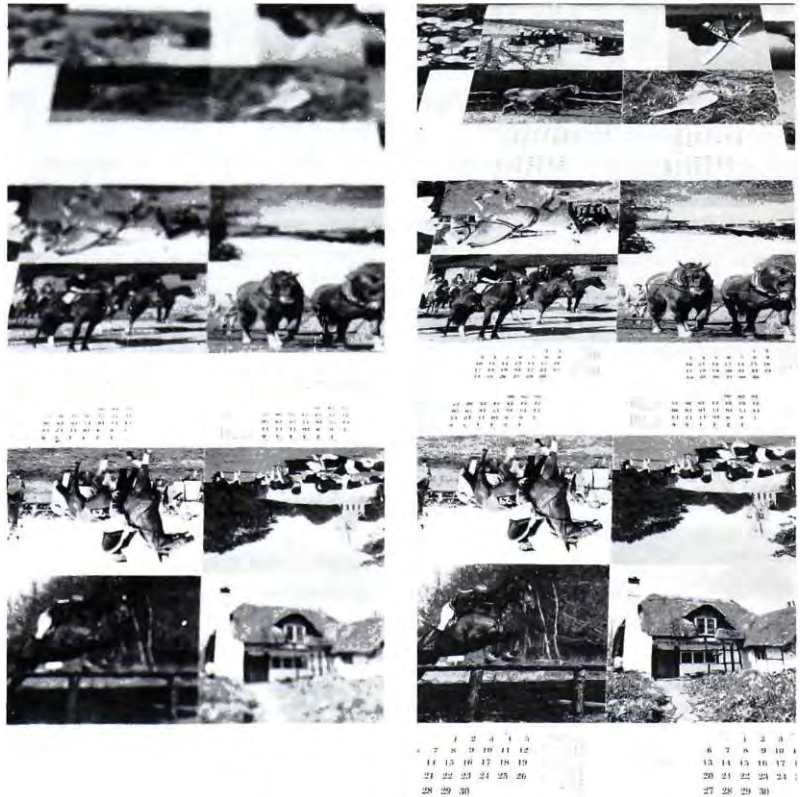

()

()

» («

»),

«

() ,

,

,

-

-

,

—

—

,

,

,

-

()

1.

-

() .

-

-

-

-

,

,

,

25	15
32	16
40	17
50	18
64	19
80	20
100	21
125	22
160	23
200	24
240	25
320	26
400	27
500	28

(American Standards Association),
(Deutsche Industrie-Normen).

3

;

50

(18),

25

(15

),

100

(21

).

25

(15

)

400

(27

).

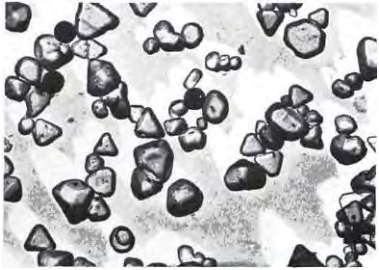

9.

(Kodak Tri-X).

4000 X.

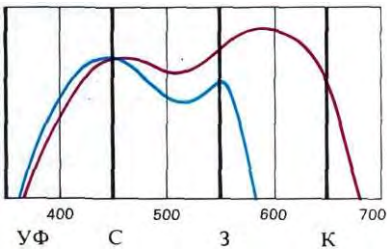

. 50.

()

(0,12—0,17)

()

() ;

()

(125)

(200—400)

(25—50)

() . « »

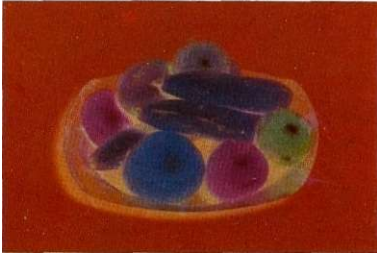

10.

() ()

« »

« »

Kodachrome

Kodachrome

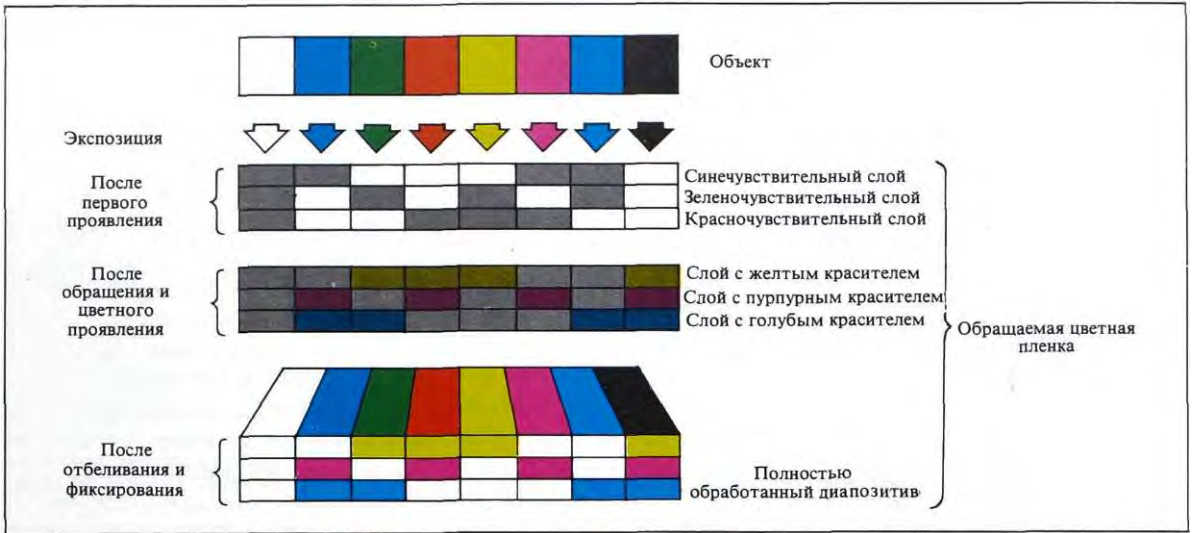

. 51.

11.

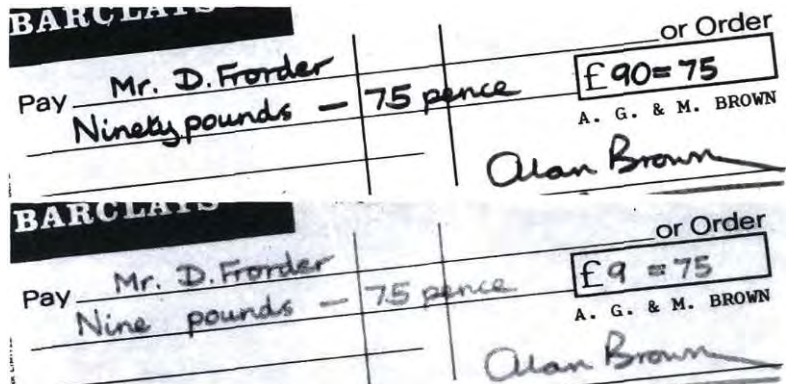

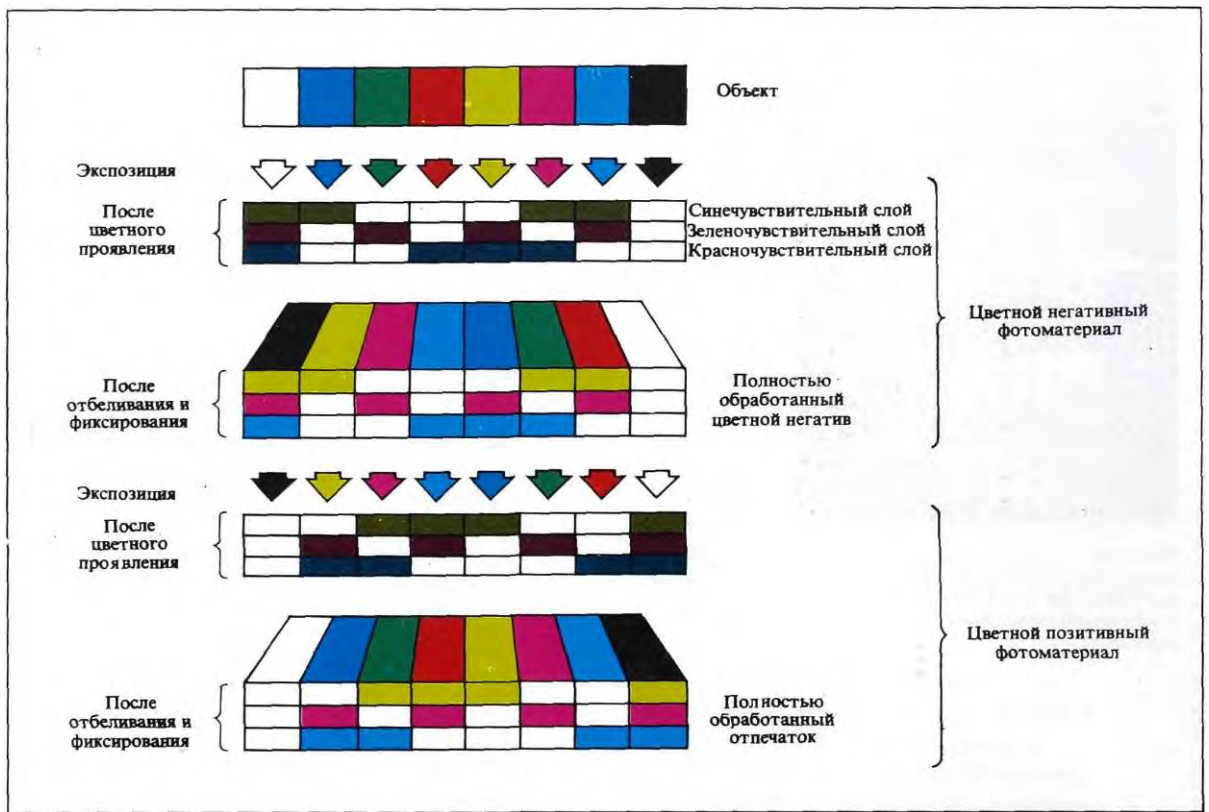

. 52.



12.

()

2.

()

	-	-

53.

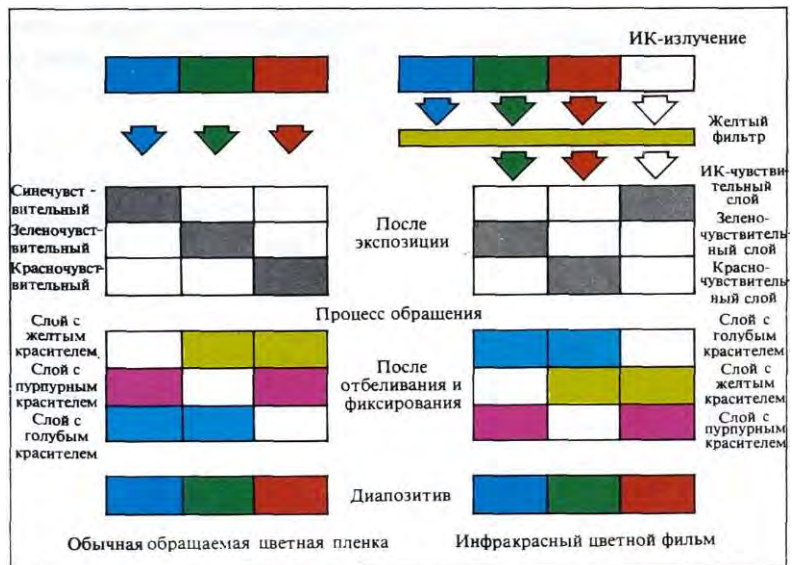



13.



. 54.

()

« » ().

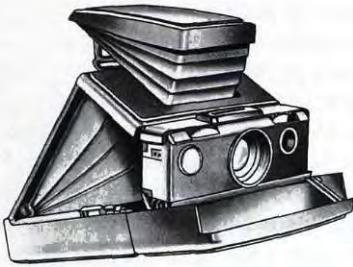

. 55.

« »
« » ()
) ()
)

5—8

	110 —			
20	,	13X 17	.	12
				-
	126 —			12
20	,	28 X 28	.	
35-	—			-
		20	36 (12
24)			24 X 36 (
18 X 24)				

. 56.

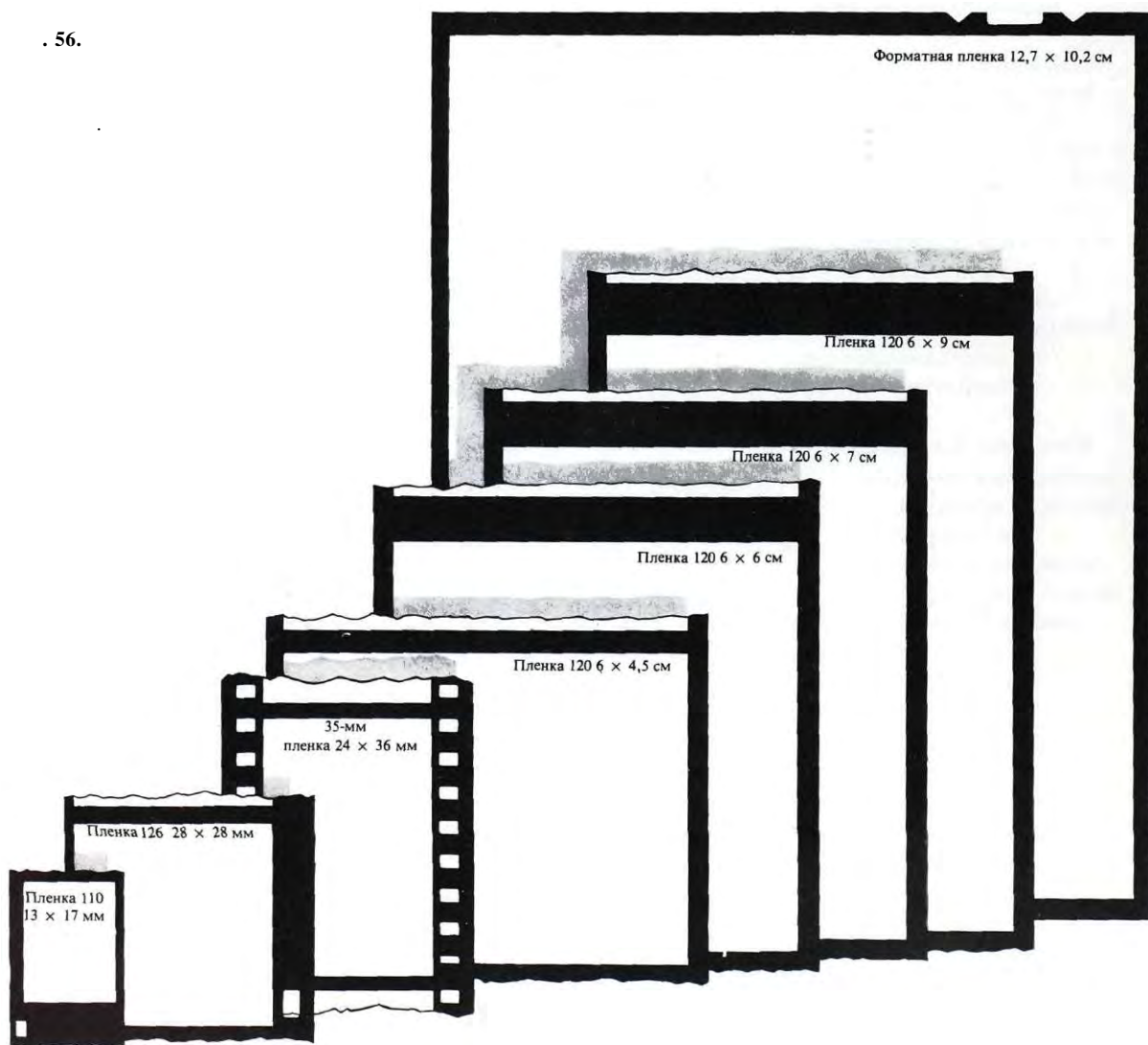

. 57.

—
 6 — 35-
 24X 36 ; —
 () ;
 6x4,5 ; —
 6x6 ; —
 6x7 ; —
 —
 10x13(5x4)

110;
 126;

6x9 ;

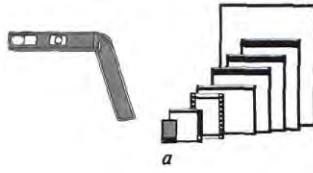

a

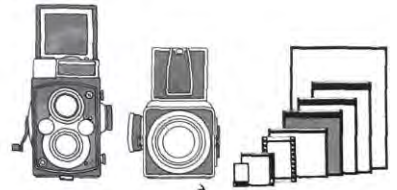

d



b

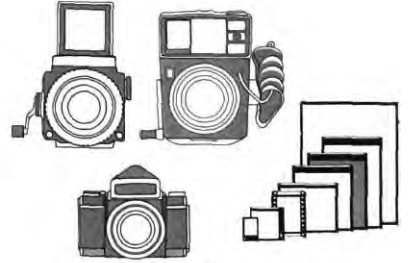

e



g

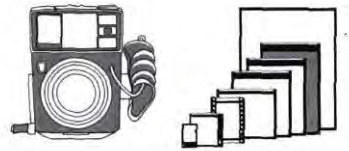

ж

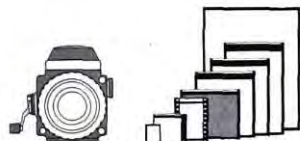

z

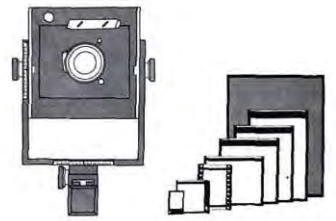

3

120 —
 ,
 6 4,5 , 12
 , 10
 6 7 8
 6 9 .

6X6 ,

6 9

120,

(),

220 —

120.

220

120,

120.

() —

5 4 20 X 16

— 12,7 X 10,2 50,8 X 40,8 ()

()

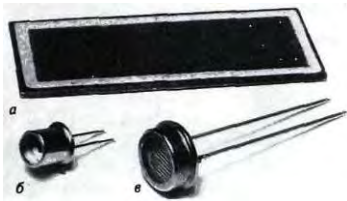

. 58.

: ()
 ()

— , . . .
 ,
 .
 ,
 ,
 .
) (. .
)
 .
 ,
 .
 ,
 .
 ,
 .
 ()
 () —
 ,
 .
 ,
 .
 .
 ,
 .
 ()
 . . .

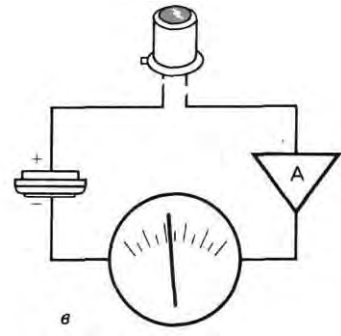
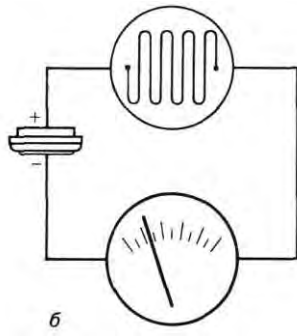
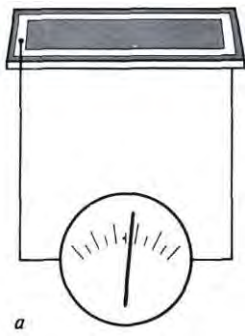

. 59.

; 6 —

() —

; —

« » —

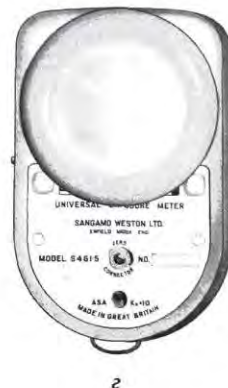
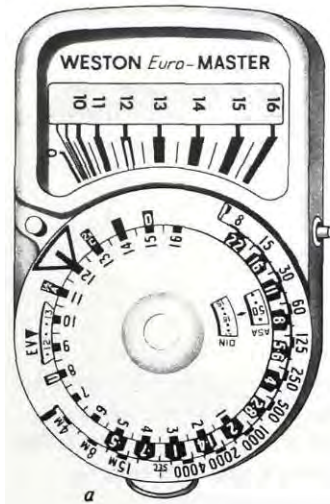

. 60.

().

().

()

().

()

(

),

«

».

(),

().

. 61.

()

()

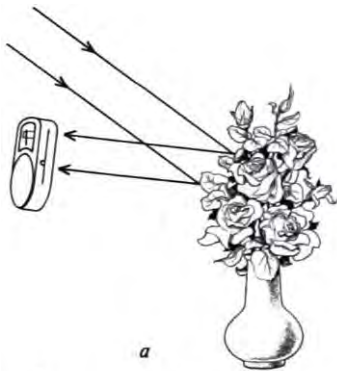

a

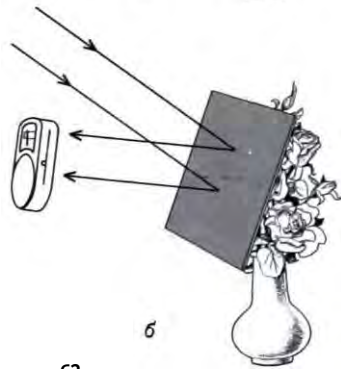

b



a

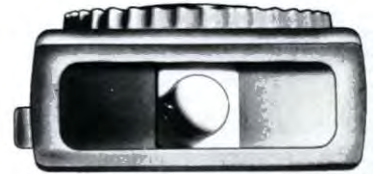

b

. 62.

(« »)

6 —

« »

« »

90%

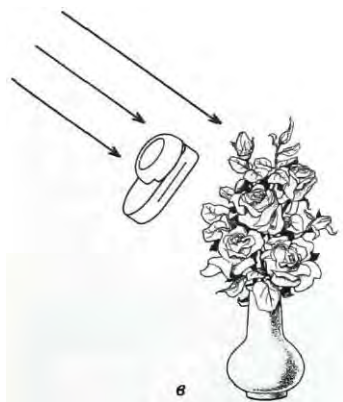

(), ()

« »

14.

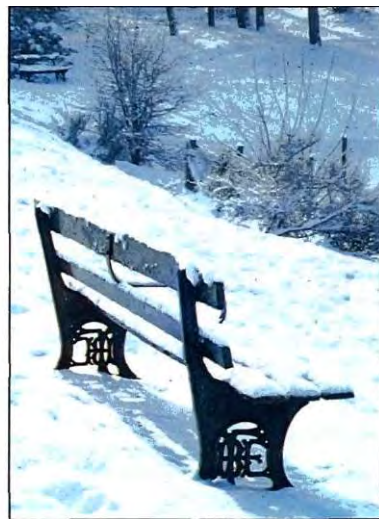

15.



()

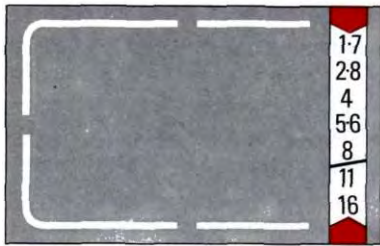

. 63.

< >

()

16.

(TTL)



)

(

TTL.

« »

TTL

(,),

TTL

),

(« »).

(

)

»

(

)

17.



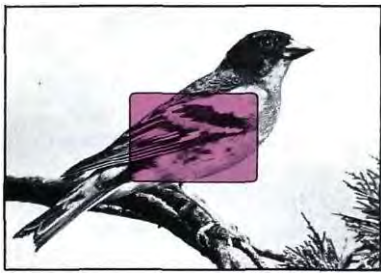

18.

« ».

TTL

TTL,

« TTL ».

TTL

()

« »

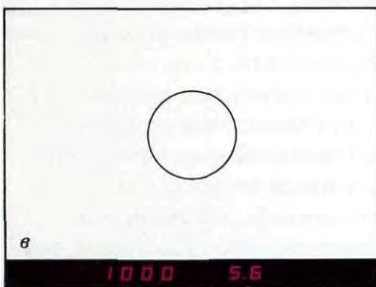
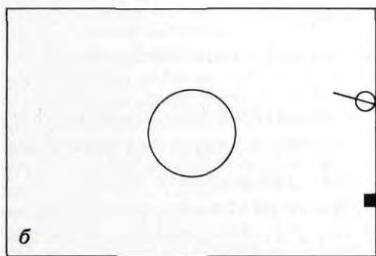
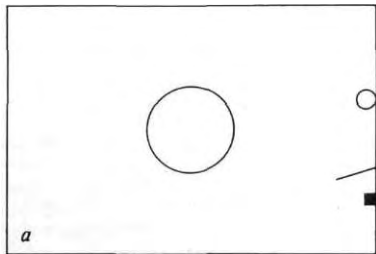

. 64.



a



b

()

« »

(),

« »

%

« »

(),

« »

« »

2:1.

1:5,6.

$\frac{1}{125}$

1:4

$\frac{1}{30}$

1:8, . . .

1:5,6,
1:4.

1:5,6. 1:4

1:5,6.
 $\frac{1}{125}$.
1:5,6

1:8

$\frac{1}{30}$.
(

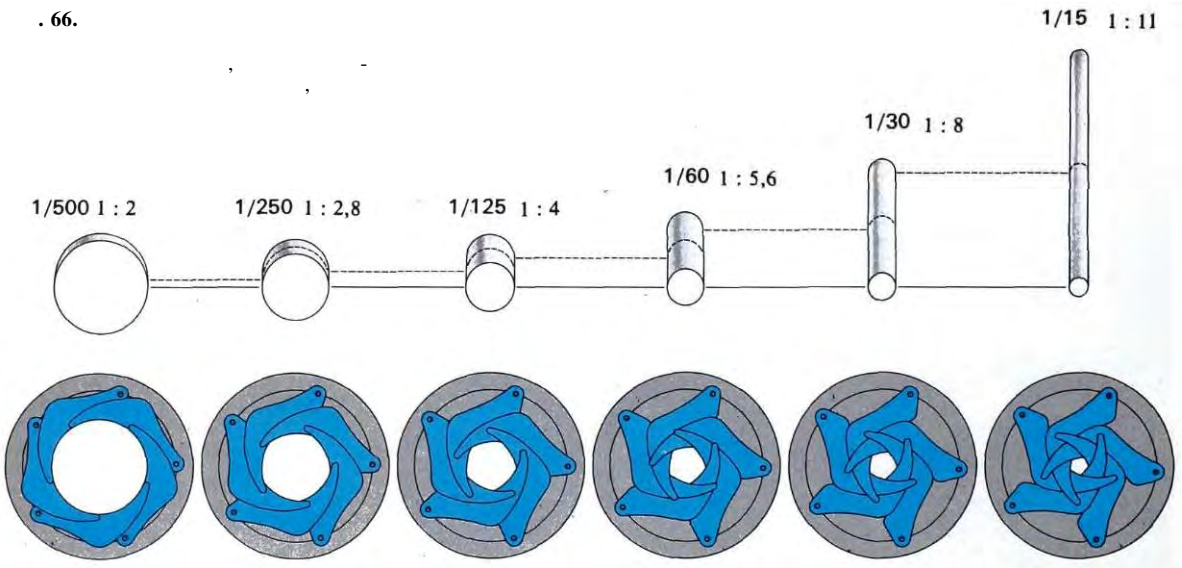

) (,) ()

« »

()

() ,

()

1:2 1:16

$\frac{1}{60}$) 1:5,6

$\frac{1}{500}$ 1:2 $\frac{1}{8}$ 1:16,

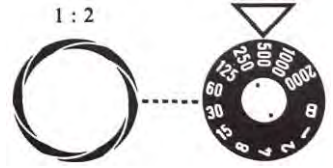

19.

1/500
1:2.

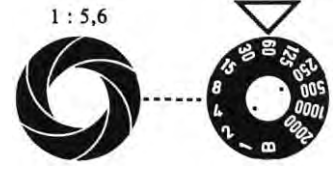

« » ()
;
1/60
1:5.6.
»

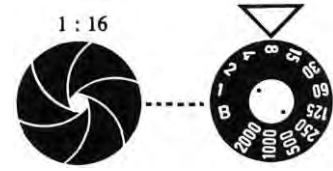

1:16.
1/8

100 /
 $\frac{1}{30}$.

1 ,
.

$\frac{1}{500}$,
5 ,
.

« »

« »

,

.

,

,

,

.

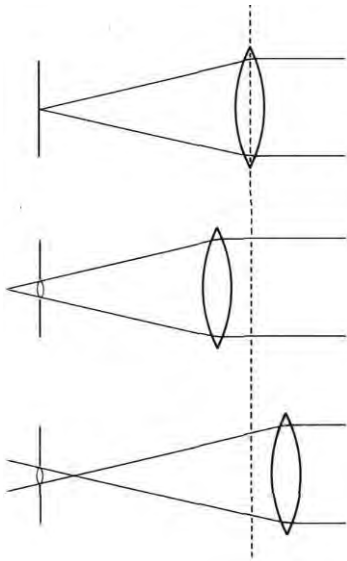

.67.

(),

. 68.

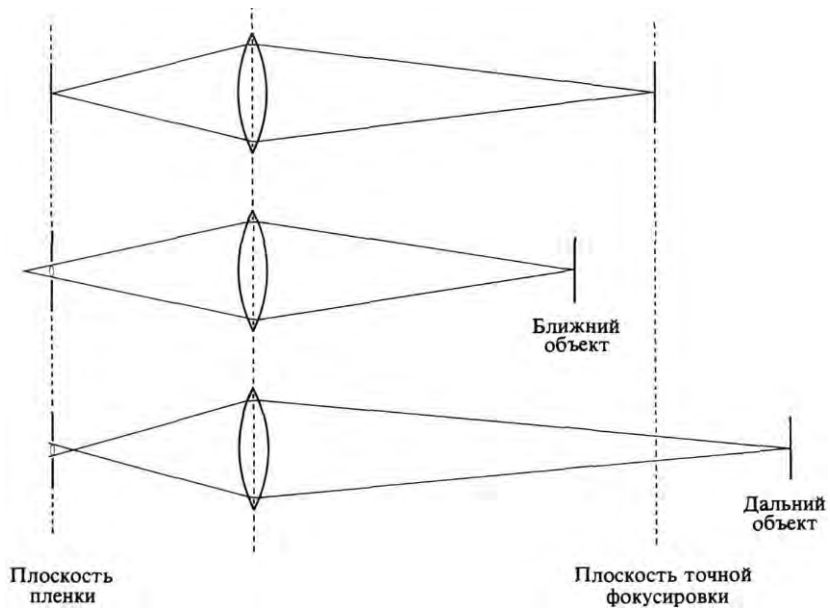

(. 71).

20.

1:1,4

1:22

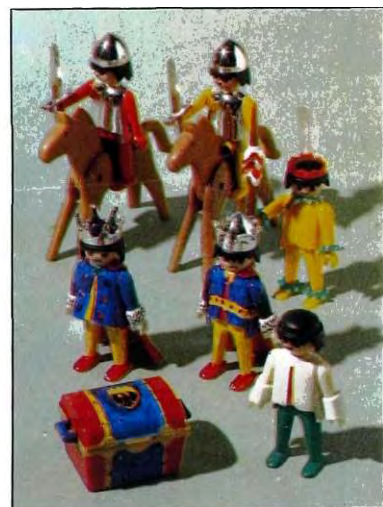



. 69.

5

1:16,

2,5

F —

, f —

$$= \frac{Fu(F+cf)}{F^2+ucf},$$

$$= \frac{Fu(F-cf)}{F^2+ucf},$$

, 1:8 1:5,6.

. 70.

$2\frac{1}{4}$

0,166

30) (100

1:8.

25

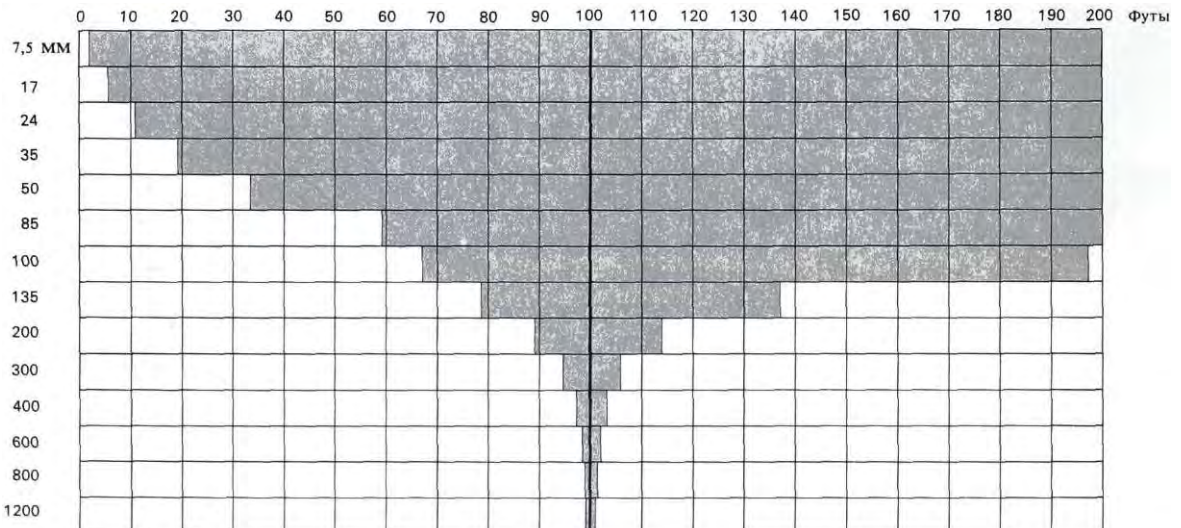

0,166

20 X 25

20 X 25

6X9

0,055

35-

0,021 . (

40 X 45

F —

, f —

. 71.

«

»,

/2,
/5

/3,

/4,

30,
30, 15, 10, 7,5, 6, 5
30

15

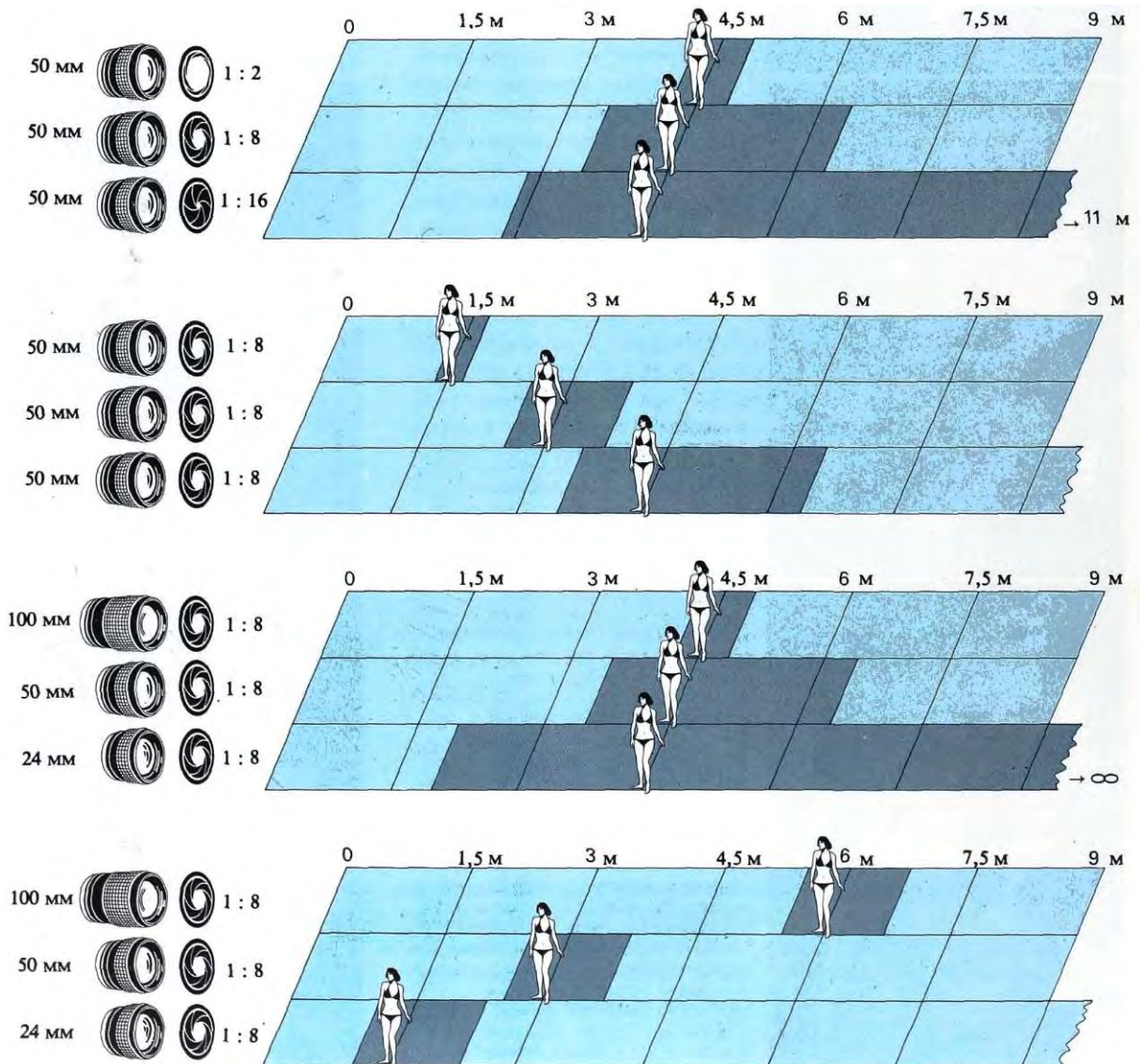



21.

. Canon
FTb, 50-
1, 1/500 , 1:2,8,
Kodachrome 25. —

. Canon FTb, 50-
1, 1/60 ,
1:8, Kodachrome 25. —

Canon FTb, 50-
1, 1/15 ,
1:16, Kodachrome 25.

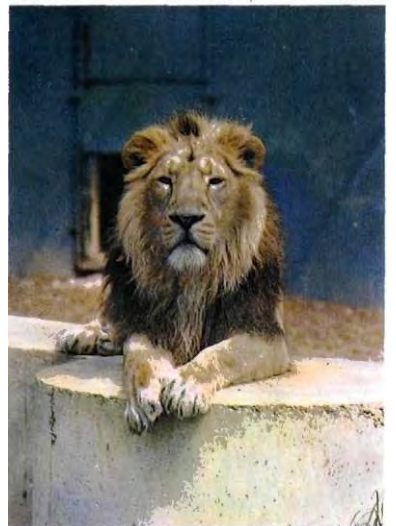
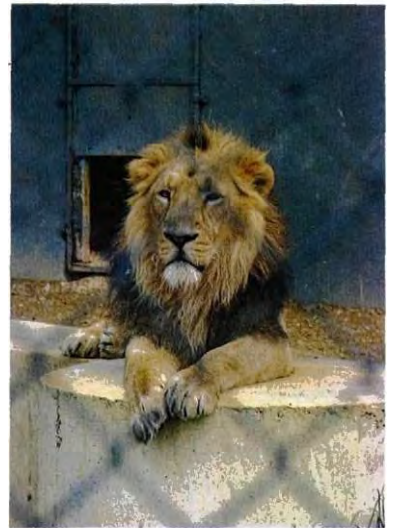
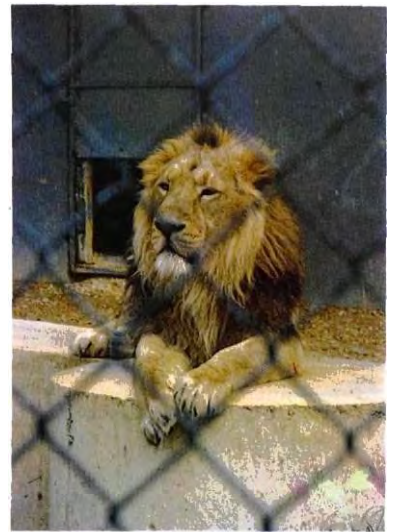

22.

. Nikkormat, 135-
1/30 ; 1:16,
Kodachrome 64. —

1 ,
1:11.
. Nikkormat, 135-
1/60 , 1:11,
Kodachrome 64. —
1:5.6.

.
Nikkormat, 135-
1/250 . 1:5.6. Kodachrome 64.

10 30 15 ,

,

,

,

,

,

,

,

50
0,02

1:16

8

25 4,1

1:16

4

0,01

2

50

, . . . 1:32.

(, . . .),

,

,

.

() , -

, , .
 , , .
 . , .
 , , .
 , , « »

6 6
85
35-

(). , ,
 , ,
 50 ,

; -
 , 45, 40
 .

, , .
 , , .
 , , .
 , , .

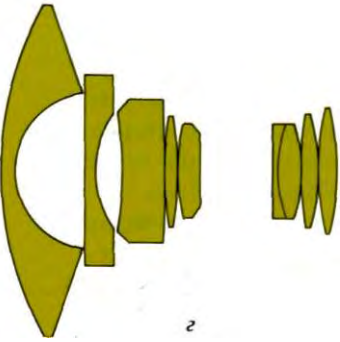
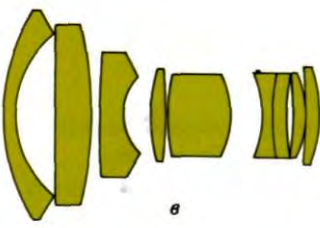
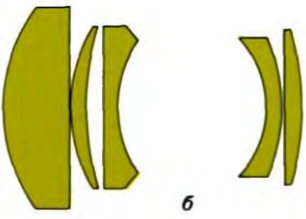
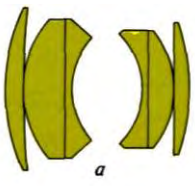

()

« »

100

35-

1

. 72.

« » ; —

200

; —

24

« »; —

« » 15

1

« » . —

. 73.

6 —

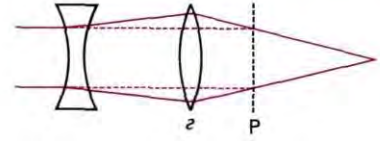
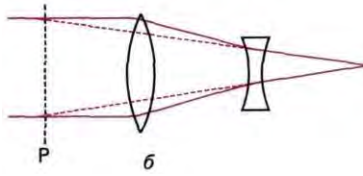
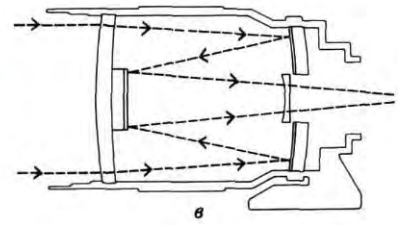
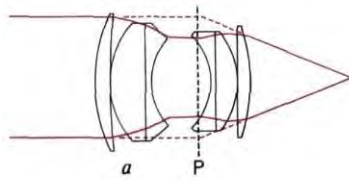

500 ; —

(. 73,),

1. (

.)

(' 1:8),

«

».

35-

17

35-

)

(

17

17

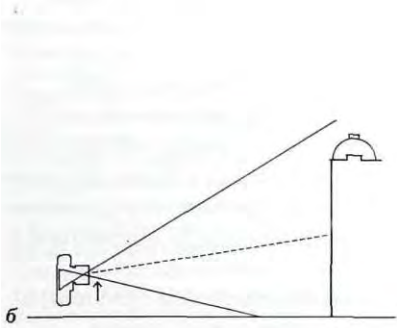
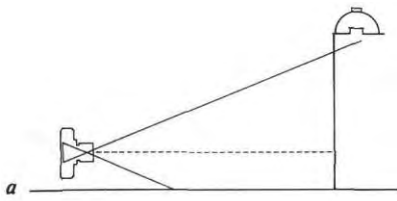

. 74.



23.

« »

— « ».

« ».

« »

« ».

360°.



24.

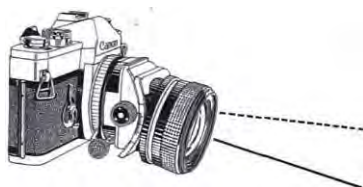

. 75.

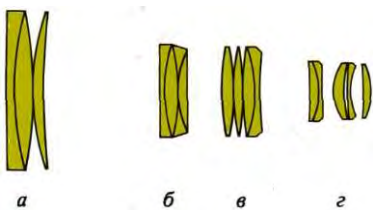

. 76.

(« - »).

2:1)

« »,

(1:2).

« »

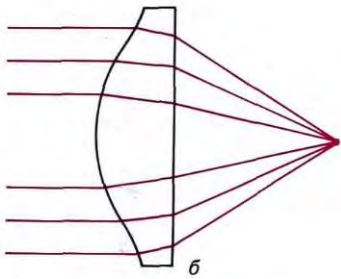
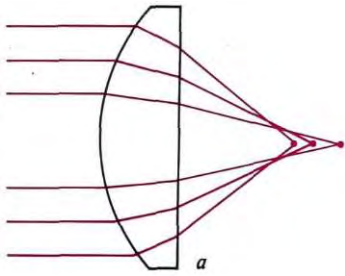

. 77.

« (1:1,4) »

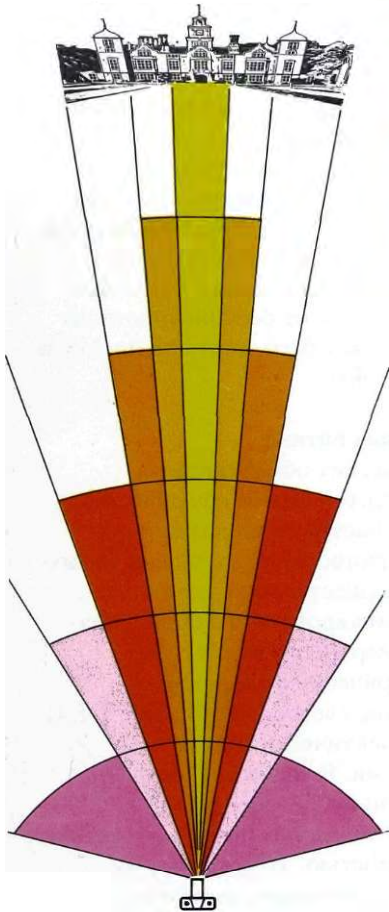

Объектив «рыбий глаз» — горизонтальный угол зрения 150°

28 мм	— 65°
50 мм	— 40°
100 мм	— 20°
200 мм	— 10°
500 мм	— 4°



25.

35-
 (24X 36)
 « »
 Trust.) (National

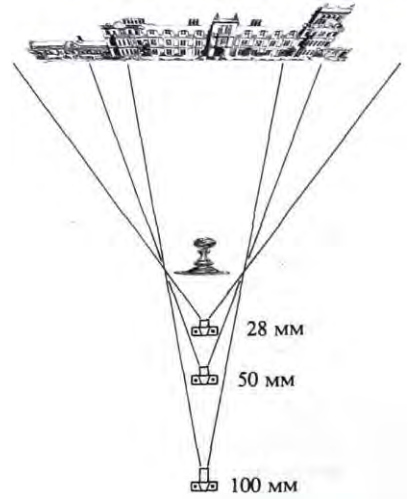

26.

35-
24 X 36

28-

50

100-

100-

()

1. The first step in the process of identifying a problem is to define the problem. This involves identifying the symptoms and the underlying causes of the problem. Once the problem has been defined, the next step is to identify the stakeholders who are affected by the problem. This is important because it helps to determine who has a stake in the solution and who is responsible for implementing it. The third step is to gather information about the problem. This involves conducting research and consulting with experts in the field. The fourth step is to analyze the information and identify the most effective solutions. This involves weighing the pros and cons of each solution and determining which one is most likely to be successful. The fifth step is to implement the solution. This involves putting the solution into action and monitoring its progress. The final step is to evaluate the results of the solution. This involves determining whether the solution has been successful and whether it has had the desired impact.



27.

35-



28.

. 78.



. 79.

2,25 ; —

« »

« »,



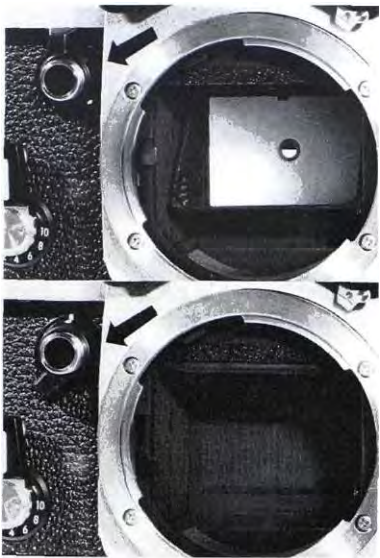

. 80.



29.

35-
135

1/1000



30.

« »

1/125



31.

« »

(« »)

1/8



32.

« »
 . Canon FTb, 100
 1/30 , 1:16, Kodachrome 64.
 — « »

« »
 . Canon FTb,
 100 , 1/500 , 1:4,
 Ektachrome 64.



33.

- Practika LTL,
135 , 1/250 , 1:8, Agfa 18.

(' ')

« »



TTL

Wratten 80 ,

. Canon FTb,
3200
85-

Agfa 18. , 1/500 , 80 ,

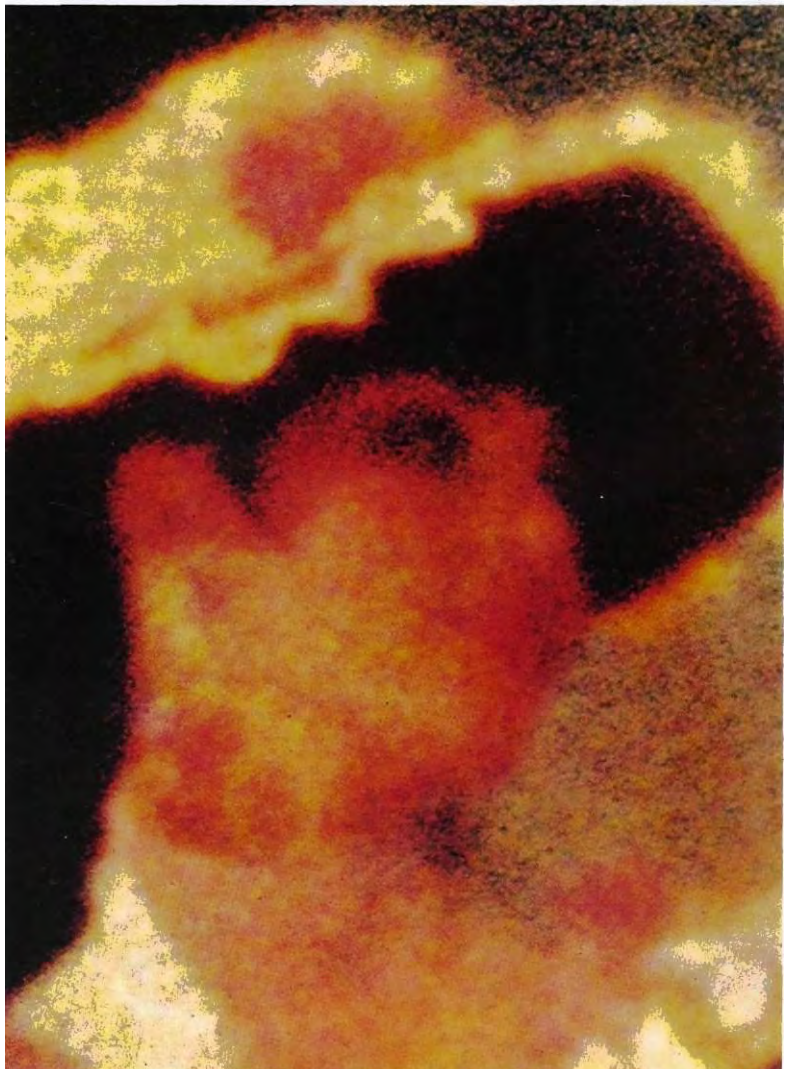

35.



()

1000:1.

1/ 1000

0,2)

3,0 3,4)

(

1.

300:1.

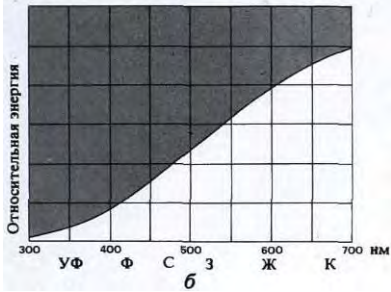
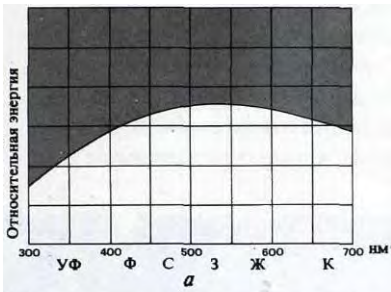

. 81.

3200).

100

5500)
(

37.

(
). 1 , 1:5,6, Kodachrome 25.

1:5,6, Kodachrome 25.



38.

« »
Vericolor S. . 1/4 , 1:3,5,



, (

);

, ...

(),

()

: 1 = 1000000/ , .

'(,) (,)

,

()

- 1.

. 82.

() () ,

() ,

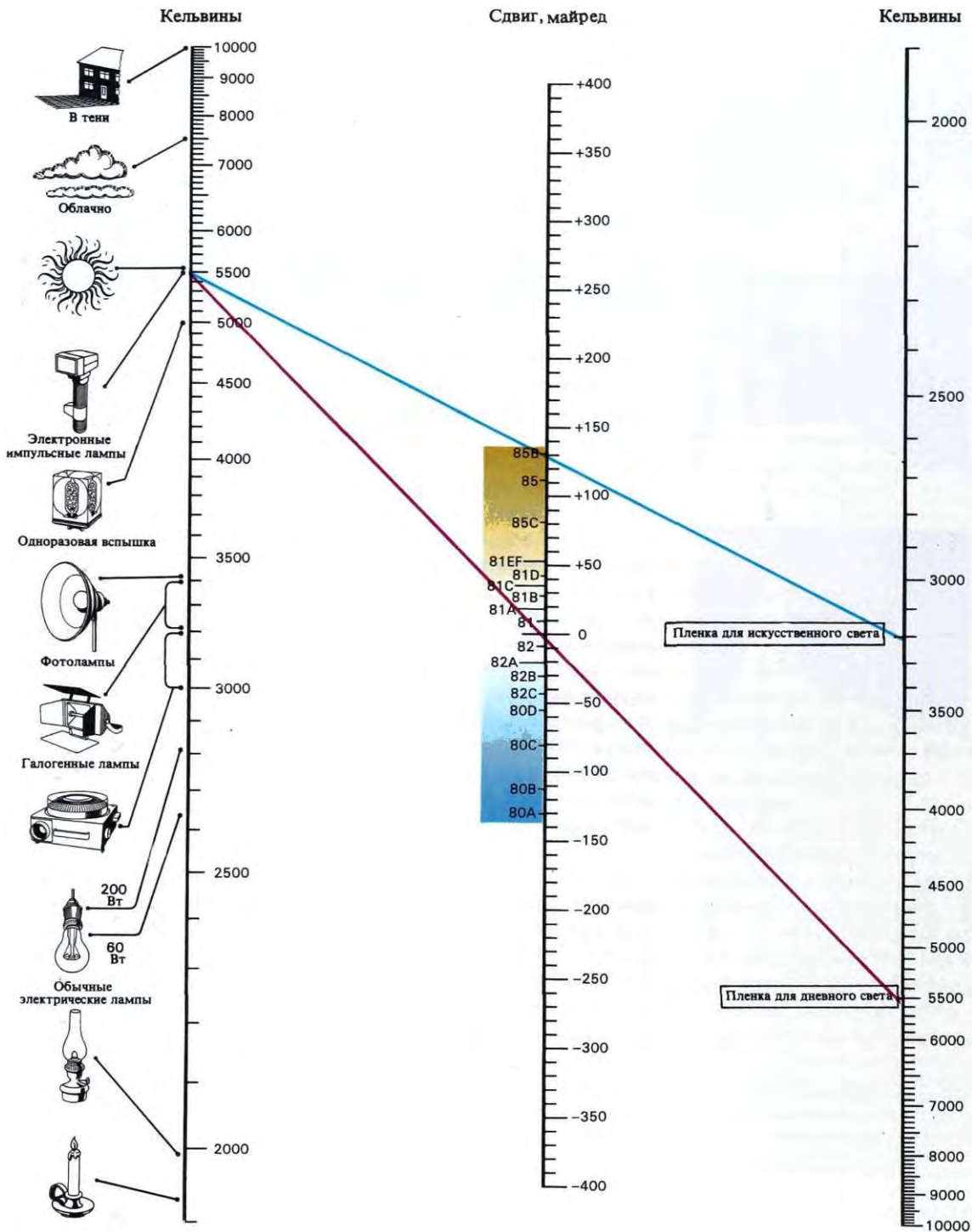

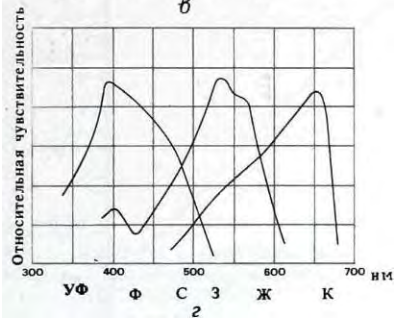
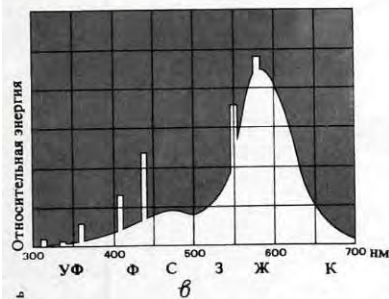
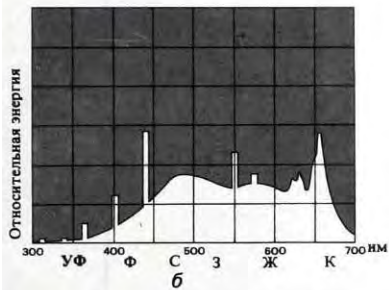
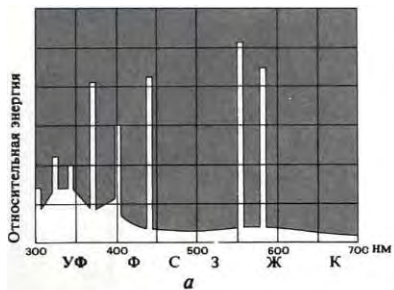

. 83.

б — «
 »;
 « »



39.

()

1. "Warm White", Kodachrome 64.
2. "Colour Matching", Kodachrome 64.
3. Philips "Colour 32", Kodachrome 64.
4. Philips "Colour 34", Kodachrome 64.
5. Philips "Colour 34", Agfa CT18.

4 5



. 84.

(Gentian)

(Moming-Glory):

()



40. — «

», —

41. —



1/ 1000

42.

— «
».

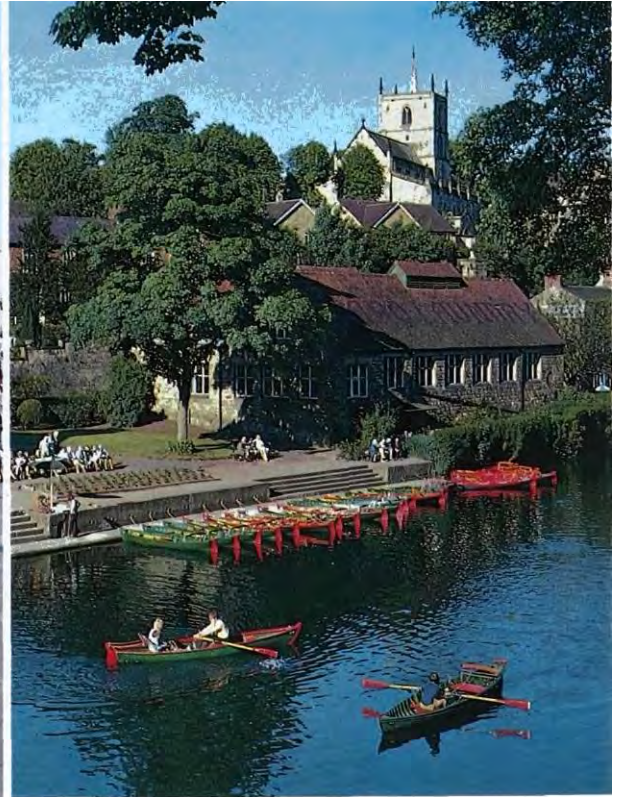

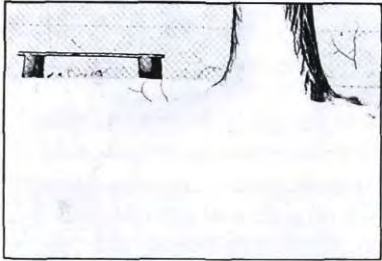
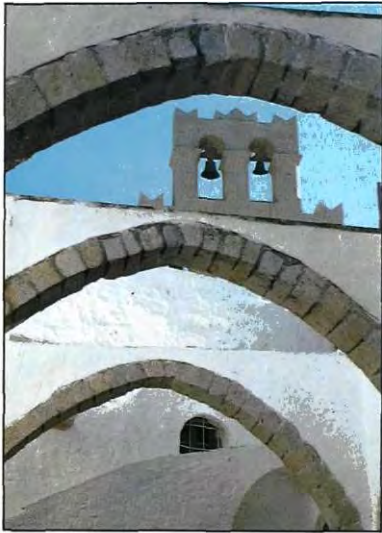

43.



(44, 45).

« »

(,

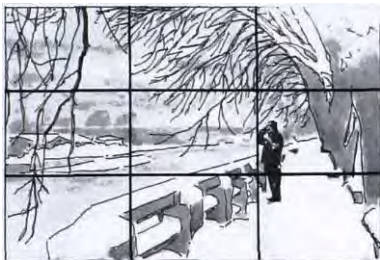

44.

(:)

« »



46.

« »



47.

« »

« » (53).

?

« »,

:



48.

() ,
() .
() .

49.

()
() .





50.

()

« »

51.





52.

(

),

«

»

«

»

(1:5,6). (

.)

1

* * *



53.

() —
:

« »

. Canon FTb,
1/125 , 1:6,3, Kodachrome 25.





54.

S-



55.

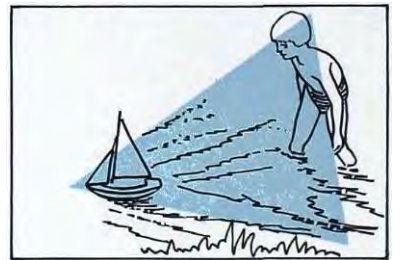

56.



57.

« »



58.



59.

60.



61.

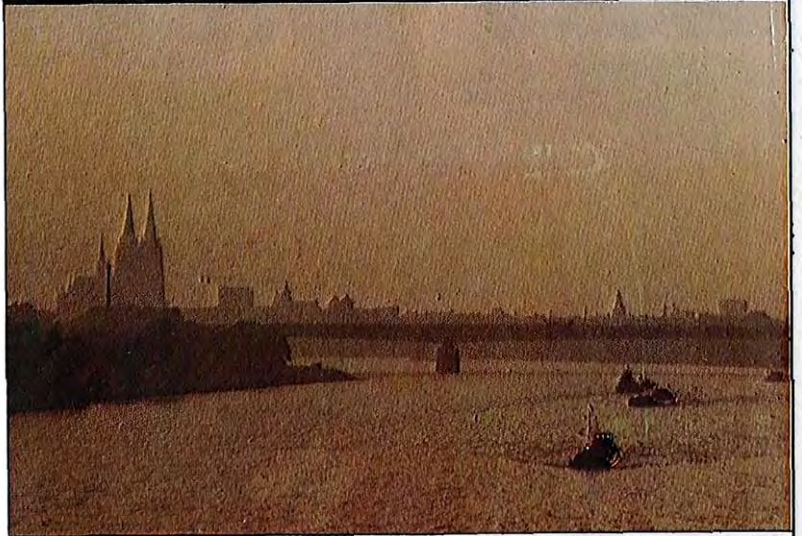

62.

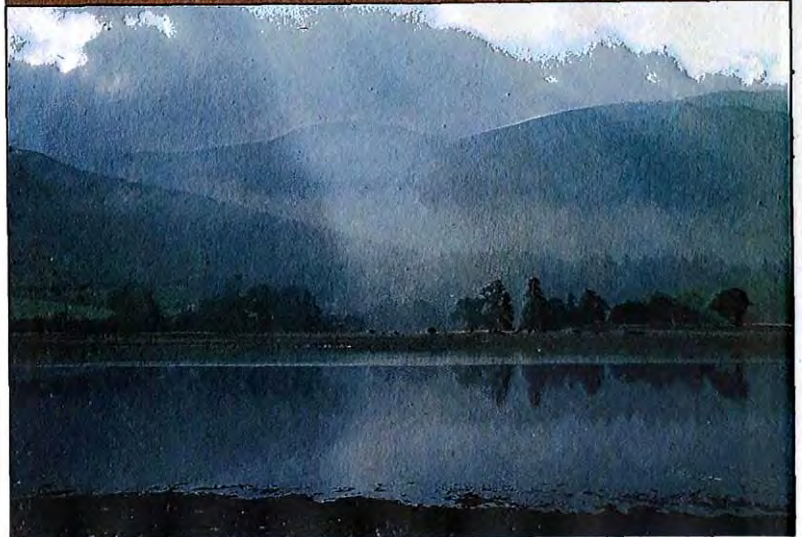

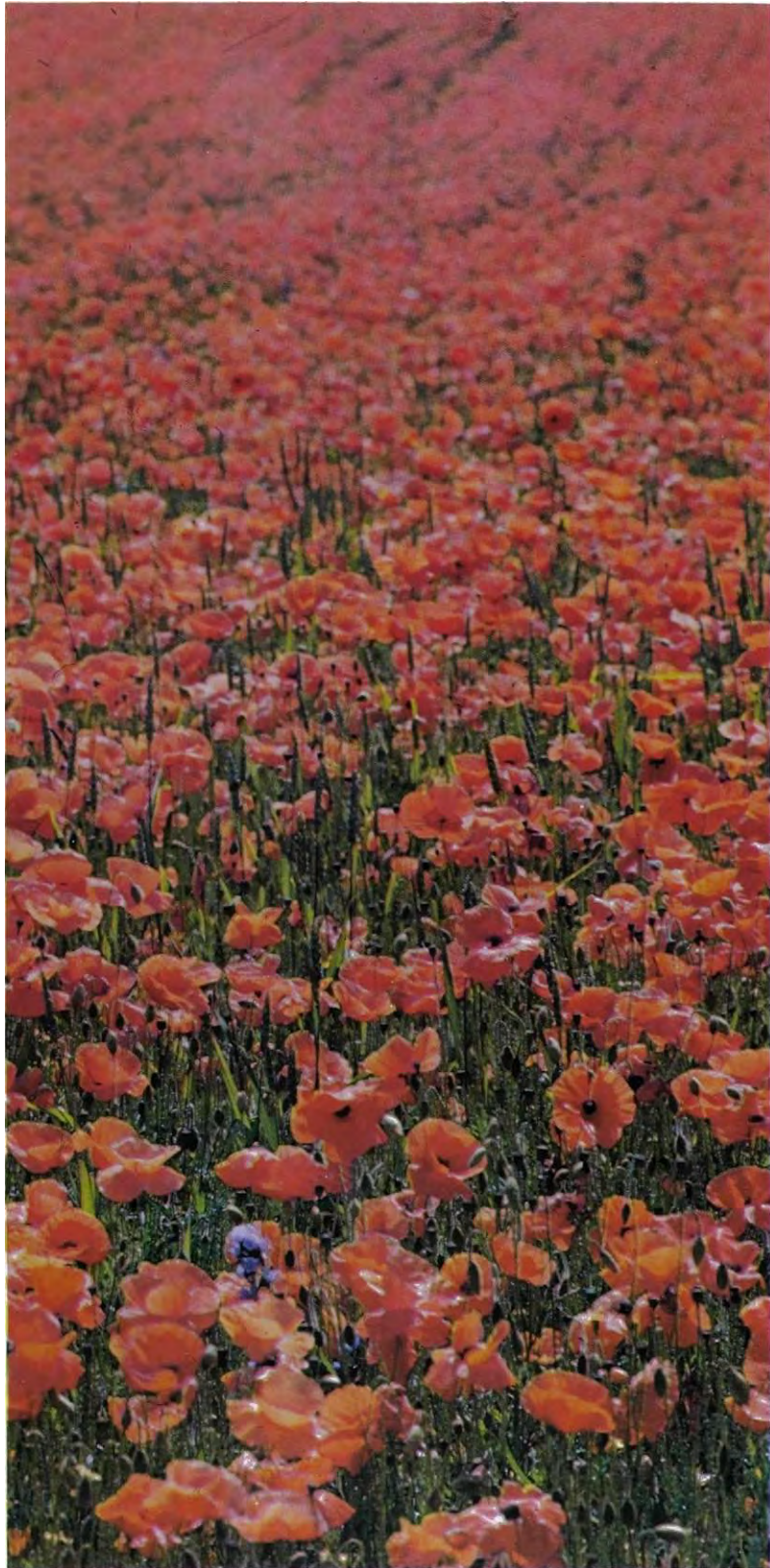

63.

« »

300-

. Canon FTb, 135-
, 1/125 , 1:8, —
Ektachrome 64. — 500-

1:8

4 .

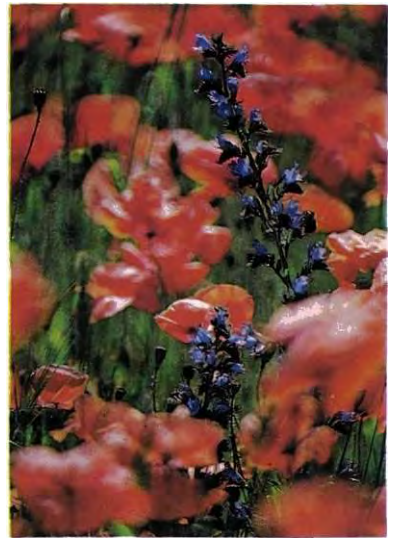

. Nikon F 2,500-
Nikkor,
1/125 , Ektachrome 64.

64.

(), ()



65.



66.



67.

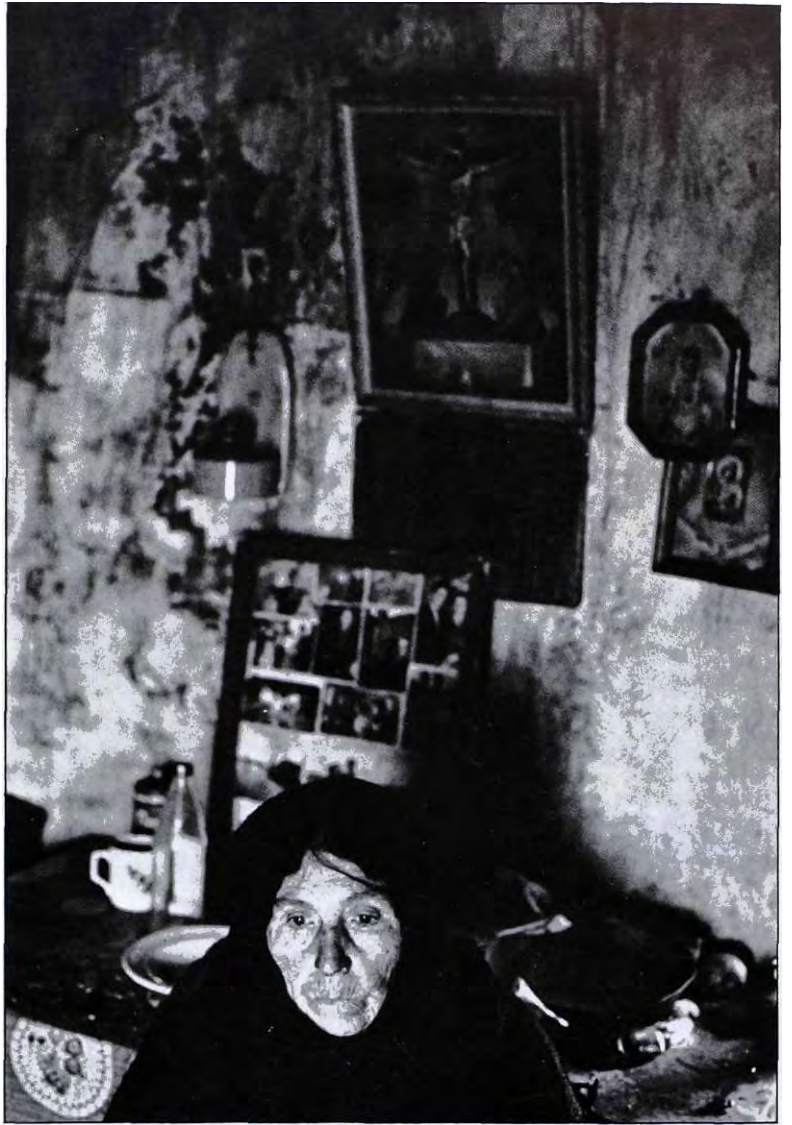

68.



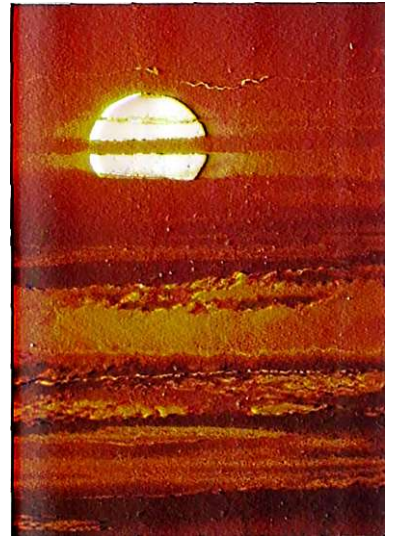
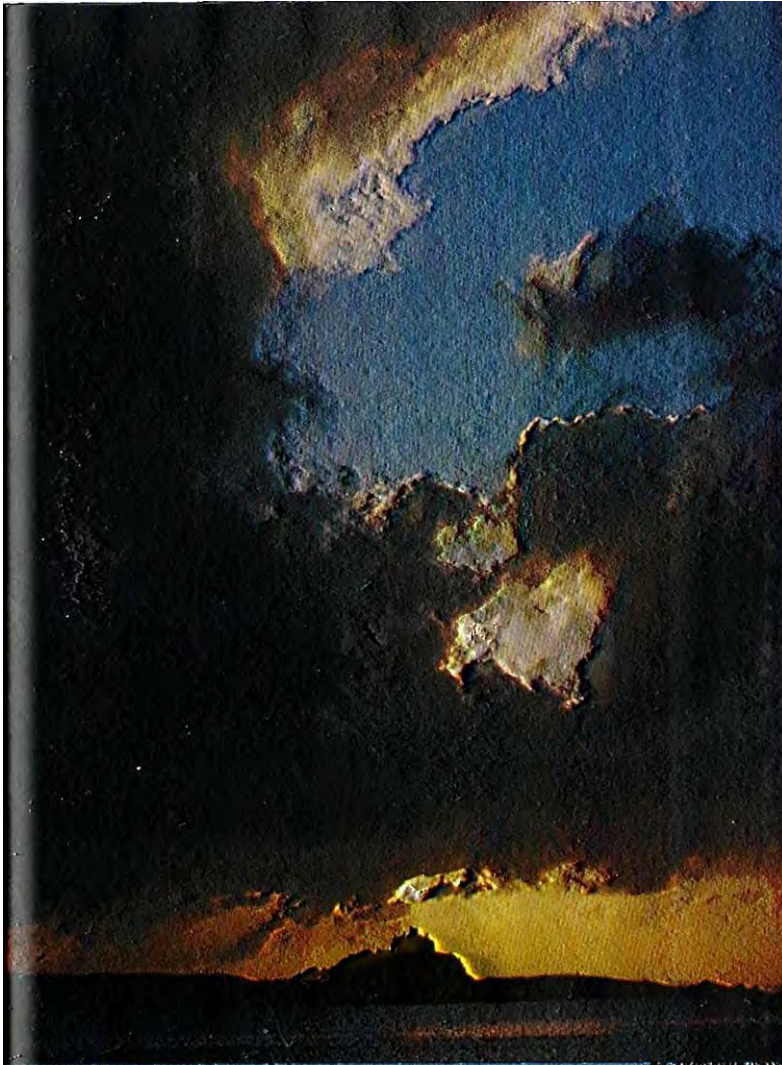

69.

« »,
« »,
500- (, 1/125 ,
1:8, Kodak Ektachrome 64.

70.

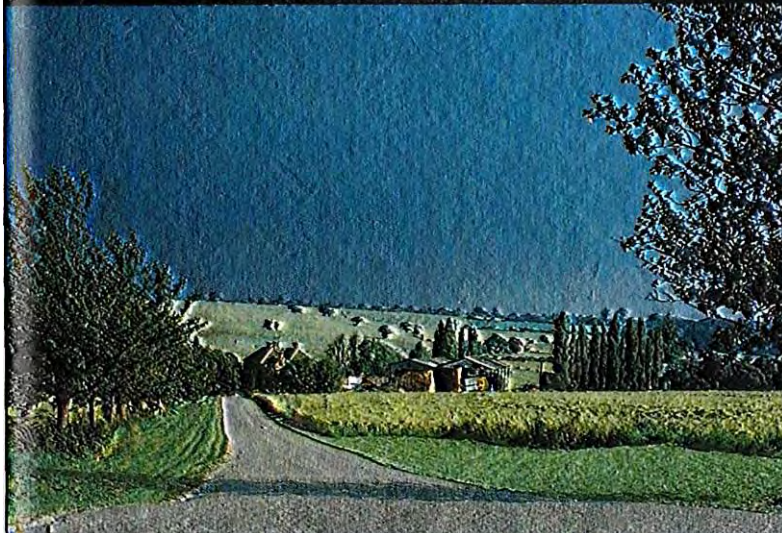

71.

« ».

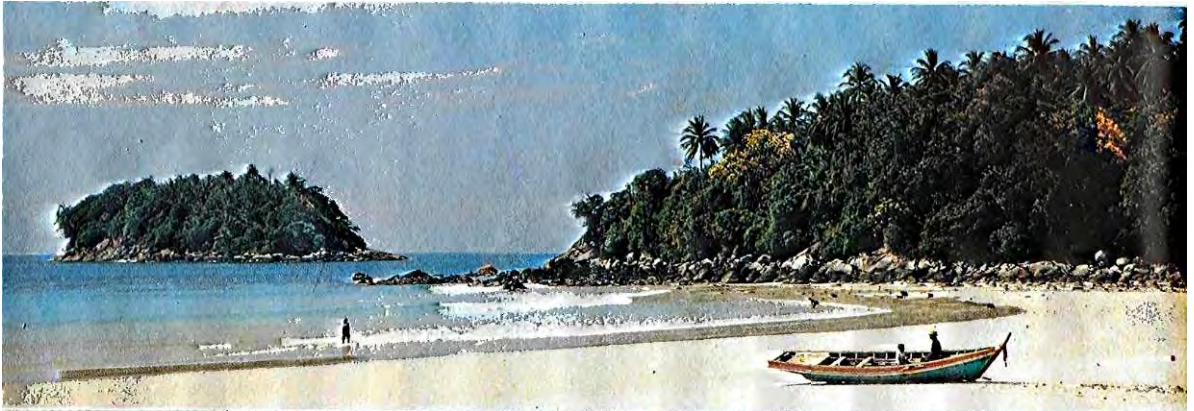

Kodak:

1/4

50

72.

1/60 , 1:8, Ektachrome.

73.

1/30 , 1:8, Ektachrome.

1970

1977

74.

1/30 , 1:11, Ektachrome.

FSIA.

», —

(«

Kodak,

Kodak

Blue Peter,

28

10

, 8

«

», 5

5

8

- , . , ,

3

- , , - .

50

, , , , ,

(

13 X18

5

?

!)

, . , (,). ,

5

, - , : , ,

!)

(, : « - - !» •

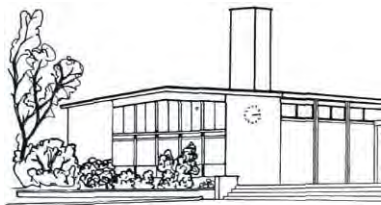

a



b

. 85.

75.

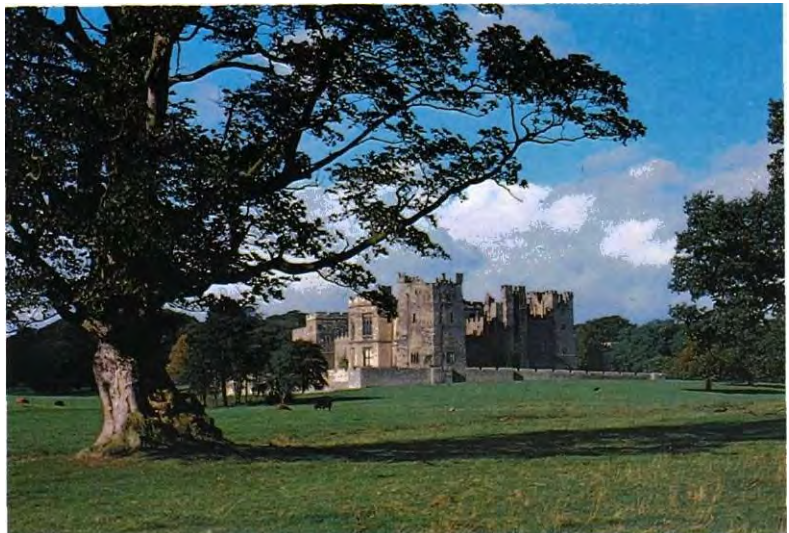

76.

«
»
—
(

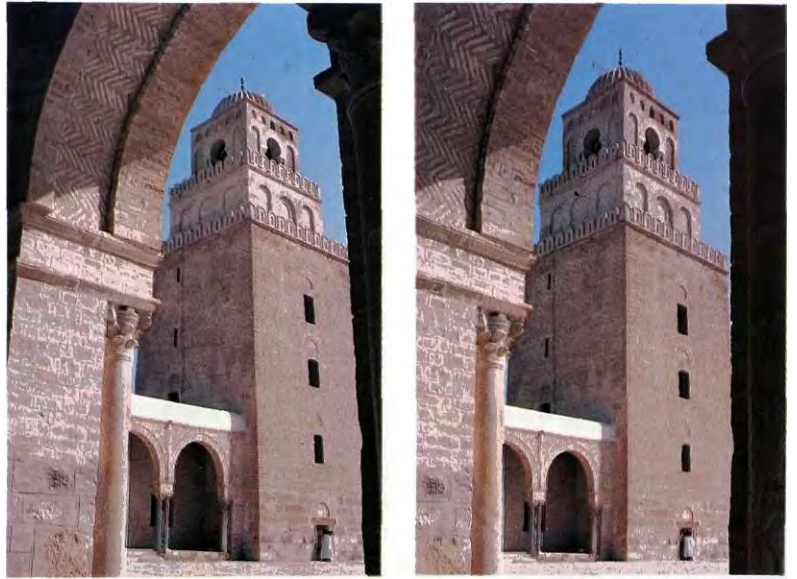

77.

() ,

()

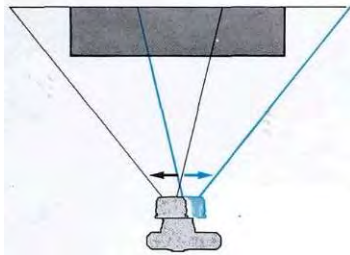
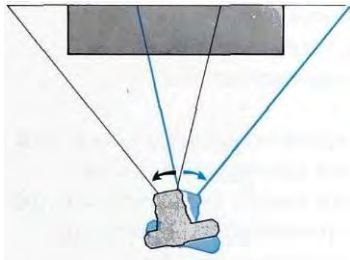

(«

»),



78.



79.

()
135-

(),
50

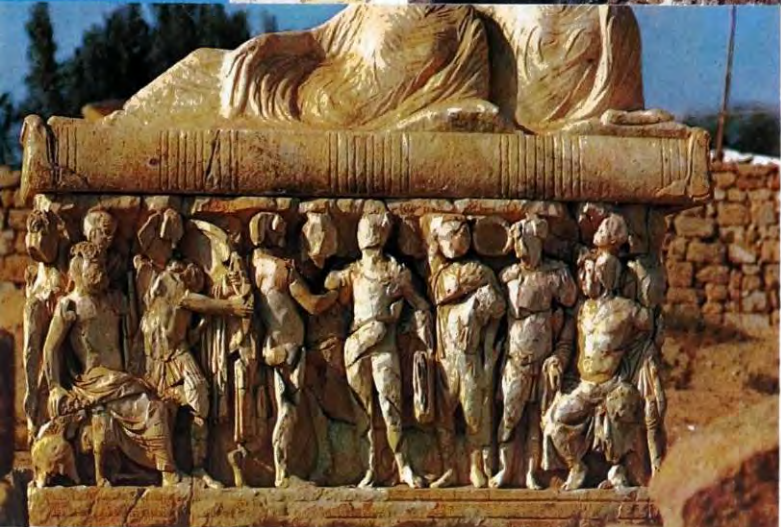

80.



81.

, ,
, , - (,)
, , (-),
, , ,
, , ,
, , , () ,
30
, -
, ,

82.

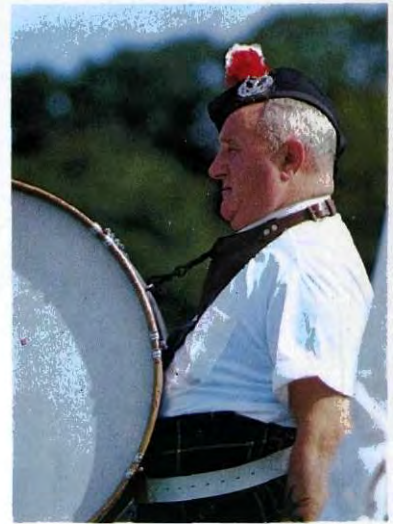
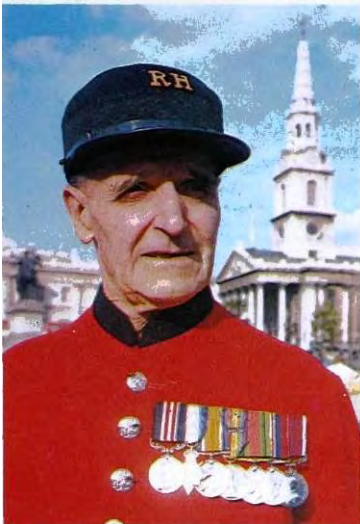

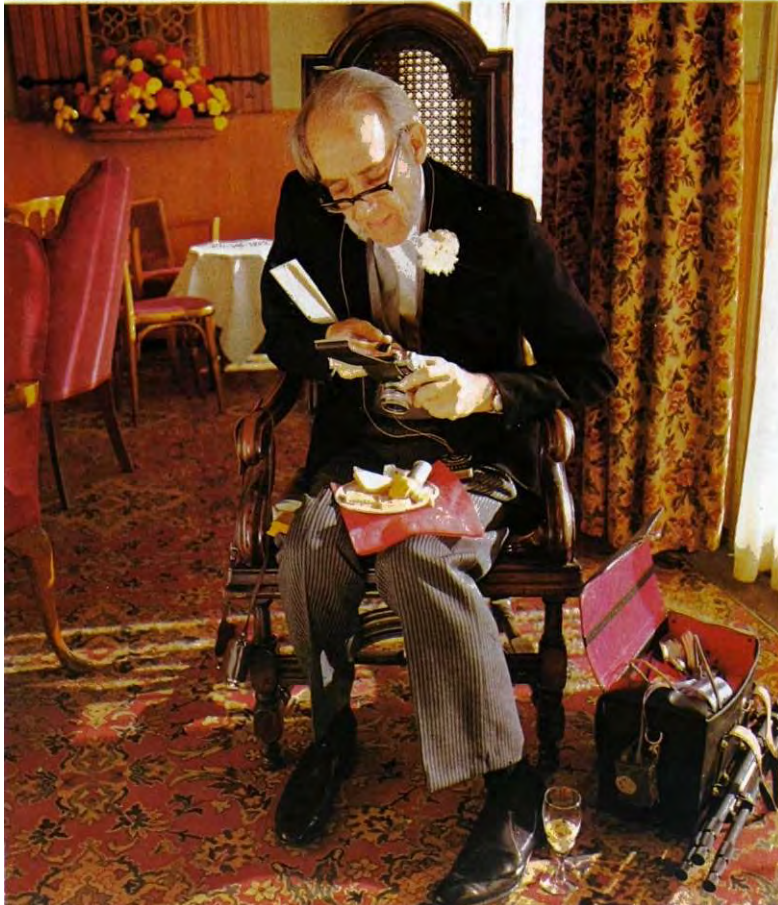
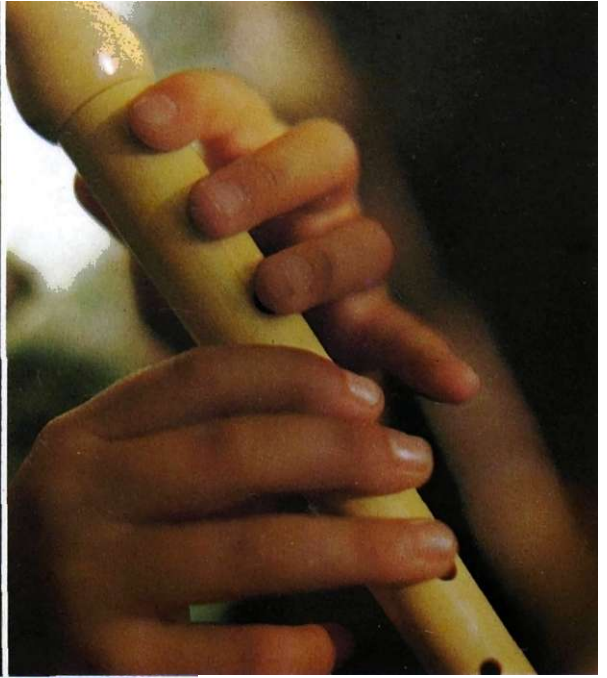

83.

« ».

1/125 , 1:11, Ektachrome 200.

« »
1/125 « », 1:8, Ektachrome 200.

84.

1/30 , 1:11, Ektachrome 64.

85.

« »

86.

« »

87.

88.

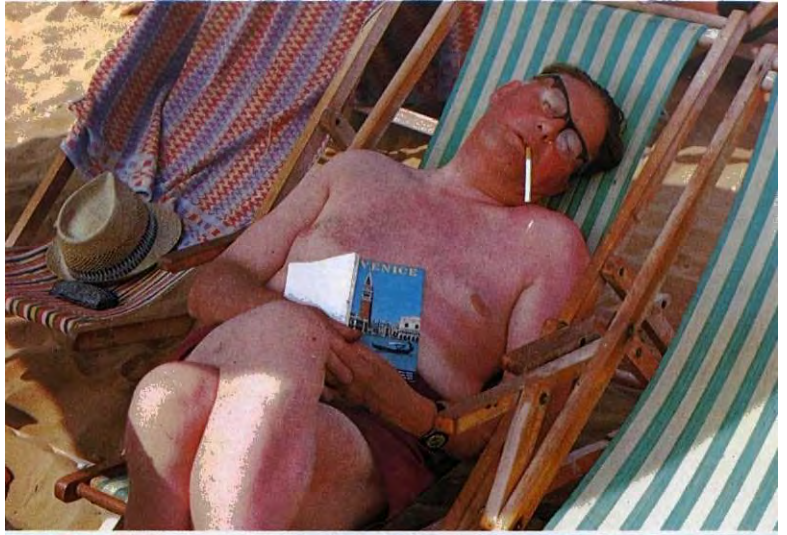

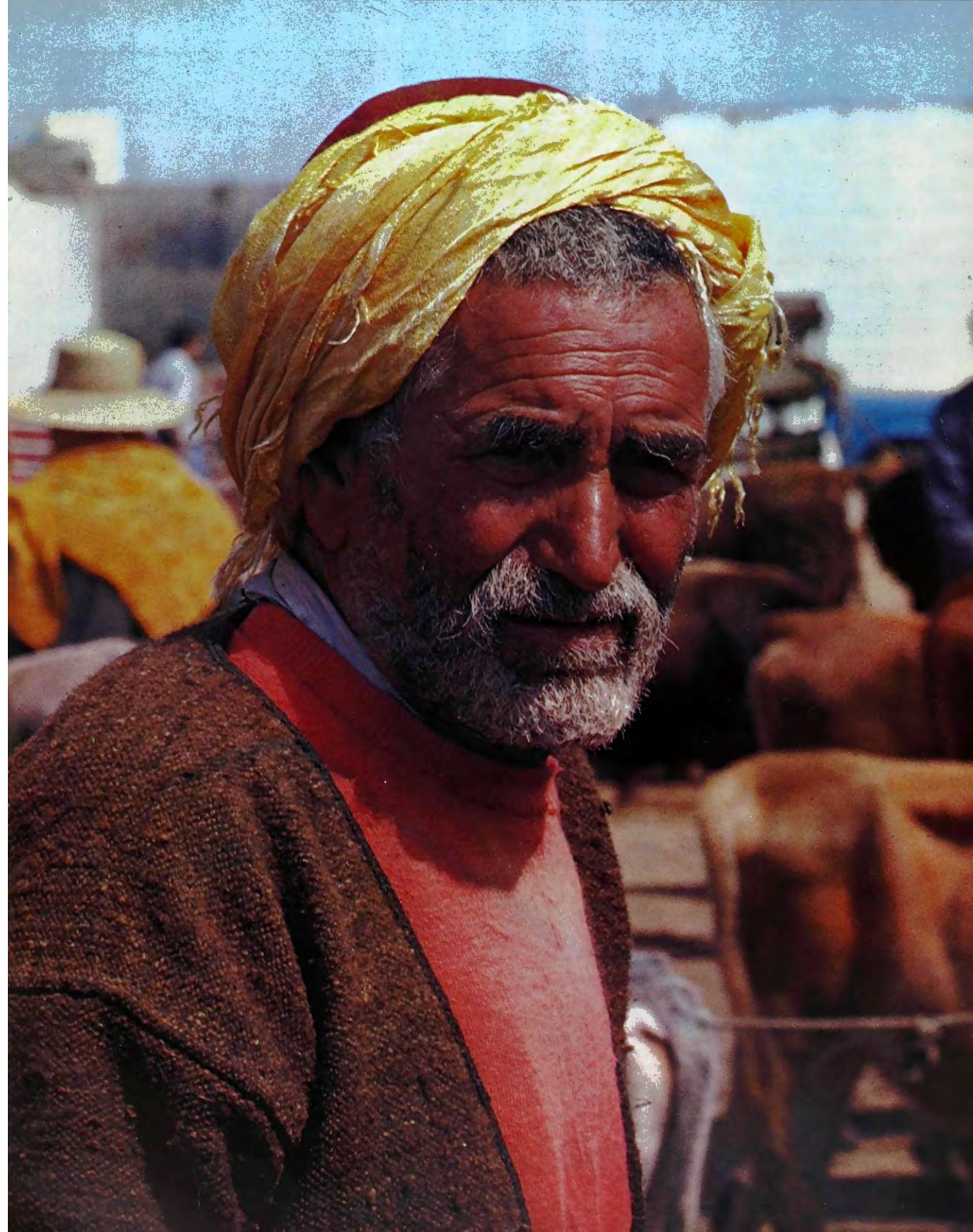

89.

« - »
(), Wratten IA.

« »,

1:8, Wratten 1 . 1/60 ,
Ektachrome 64.



90.

1/ 125 , 1:8, Ektachrome 64.



91.

()

1/30 , *1:5,6*,
Ektachrome 200.
92.

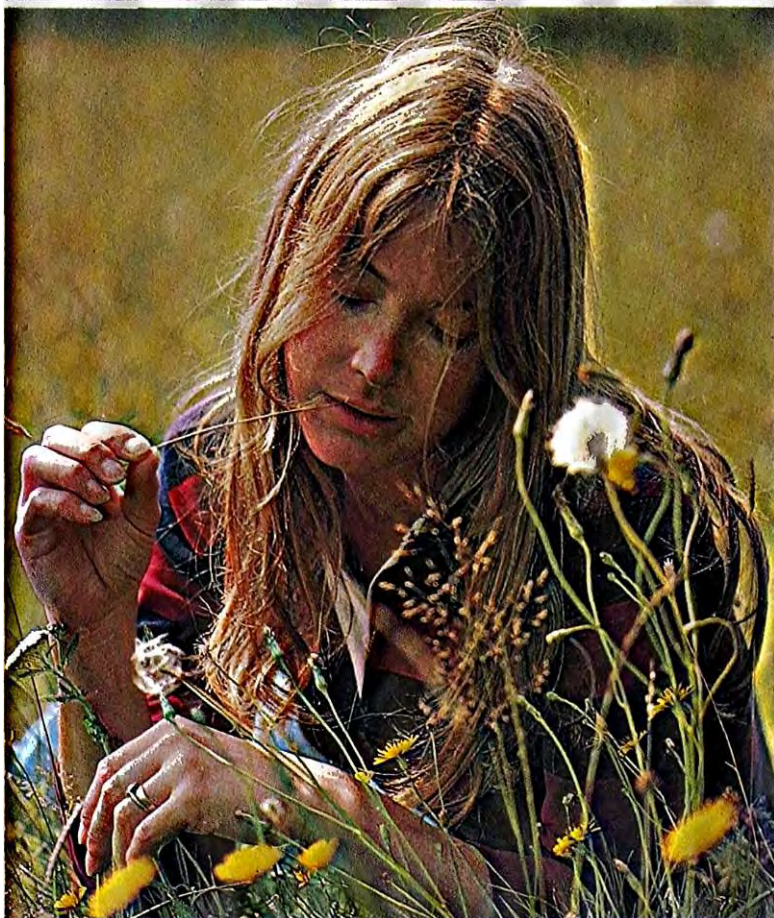

1/30 , *1:4*, *Ektachrome* 64.
93.



94.



1/ 125 , 1:8, Ektachrome 64.
95.

1:32, Ektachrome 64.
96.

« ».
1/15 , 1:8,
Ektachrome 64.

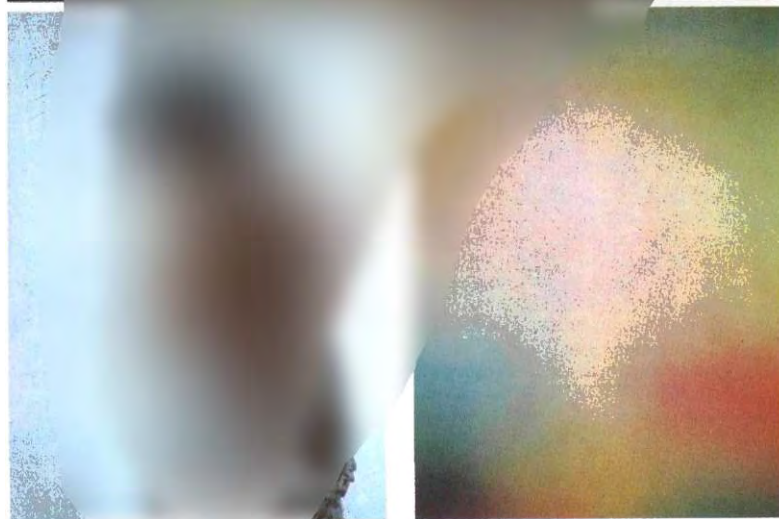
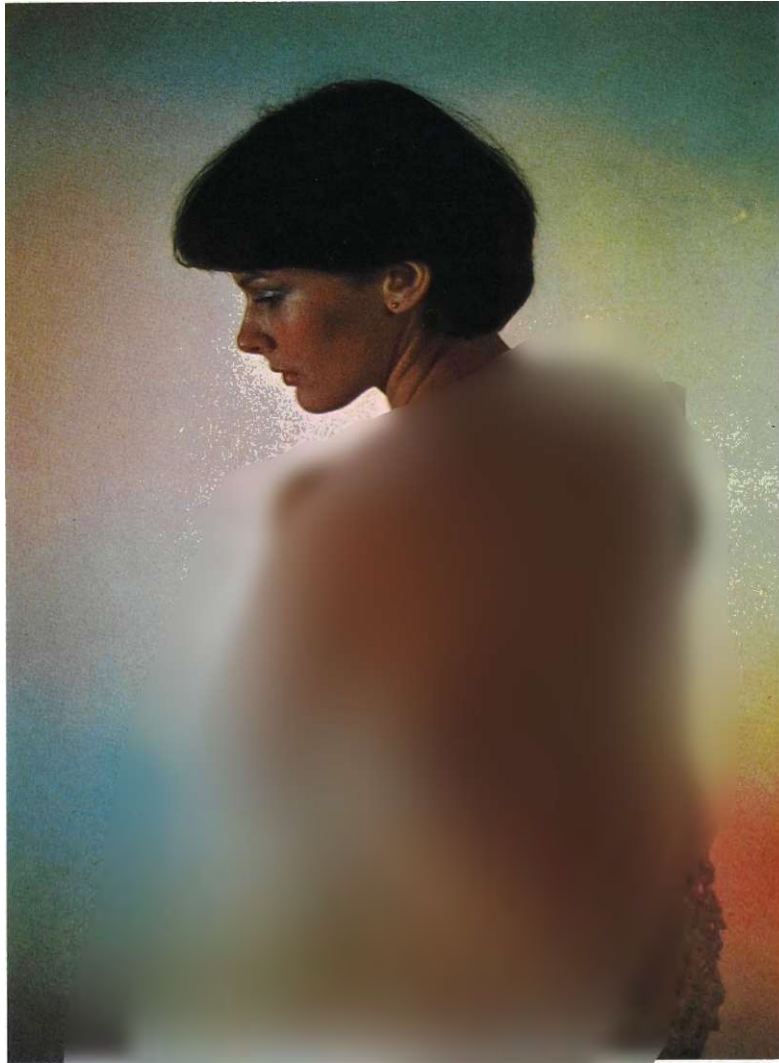

97.

:
(,)
15
(,).

98.

35-





Рис. 86.

Портрет человека в профиль и в 3/4 фронтальной и 3/4 задней точки зрения. — Стенд для портрета; 2 — осветительный прибор; 3 — осветительный прибор; 4 — осветительный прибор; 5 — осветительный прибор; 6 — осветительный прибор.

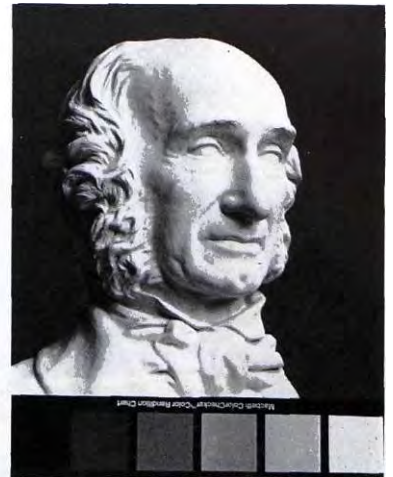
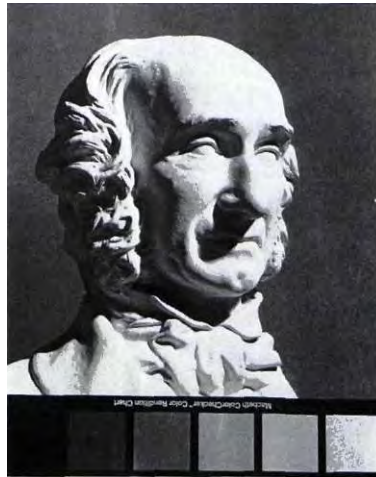
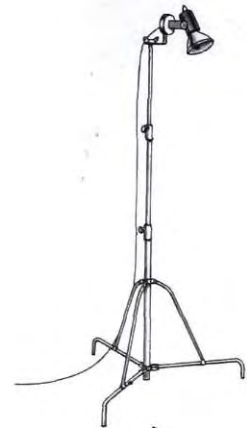
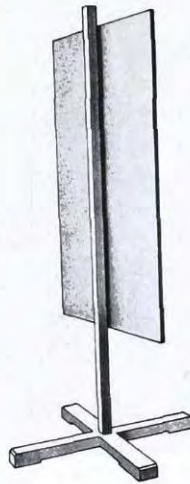

б

г

д



100.



. 87.

101.

—
Ektachrome 64. 1/1000, 1:4, 135-

102.

(
« »,
.)

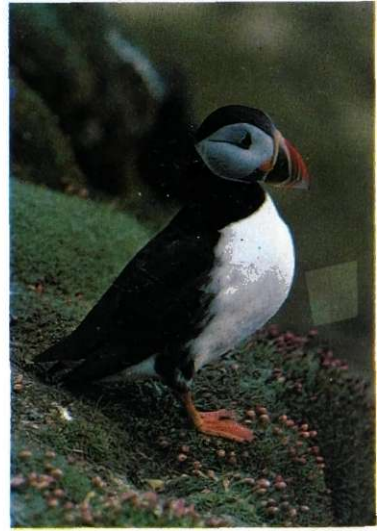

103.

35-

135-



104.



105.

500-
Nikon F,
Nikkor, 1/250, Kodak
Ektachrome 64.



106.

Canon F1, 300-
1/250, 1:6.3, Kodak
Ektachrome 64.



107.

135-

35-



«

».

(
).

()

().

!

().

108.

173000

1/60

. Canon F1, 135-
+ 9-

, Sunk Auto
Zoom 4000, 1:11, Kodak Ektachrome
64.



109.

35-

100-

20 ().





110.

()

()

. 88.

(. 88).

12-

() —

111.

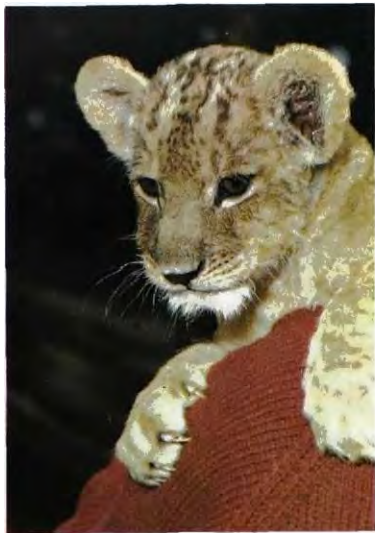

112.



113.



114.



115.



116.



117.



118.

100-

35-

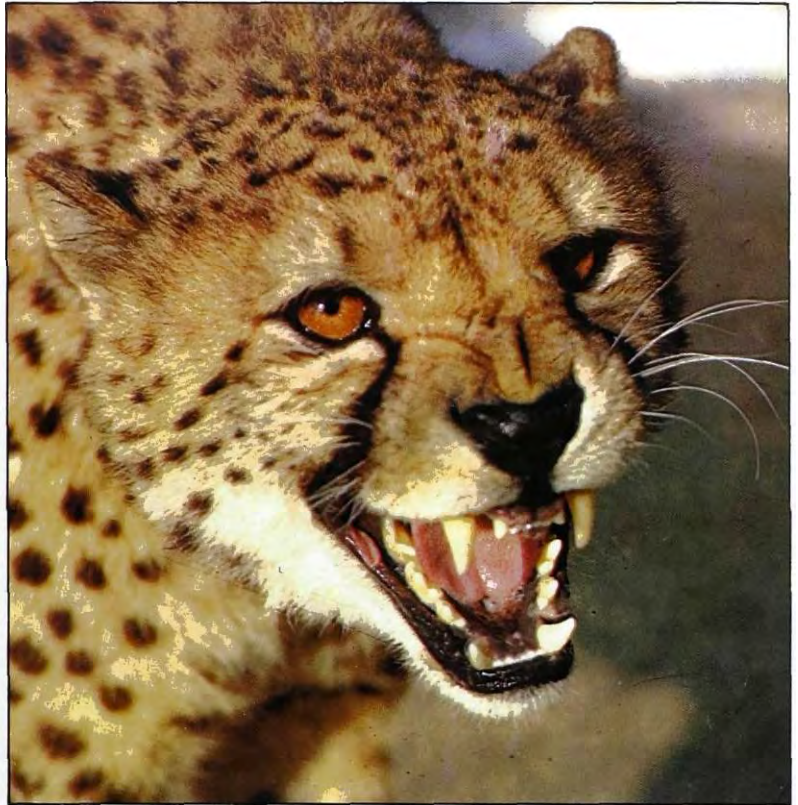
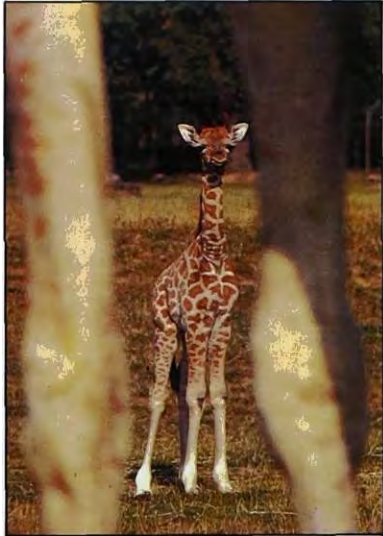

119.

, « »

120.

Amanita muscaria.

Pentax, 55-

, 1/30, 1:8,
Kodachrome 25.



121.



122.



123.

() ,

() .





124.

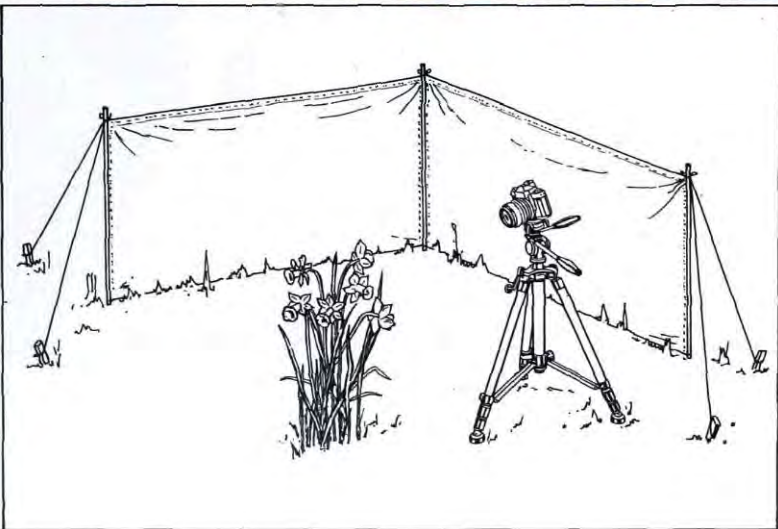

. 89.

« »



(), ,
 ,
 (. .
), - - . ,
 - .
 :
 . ,
 ,
 ().

90.
 2,25 ,
 CC20R
 1,5 —
 CC30R,
) (

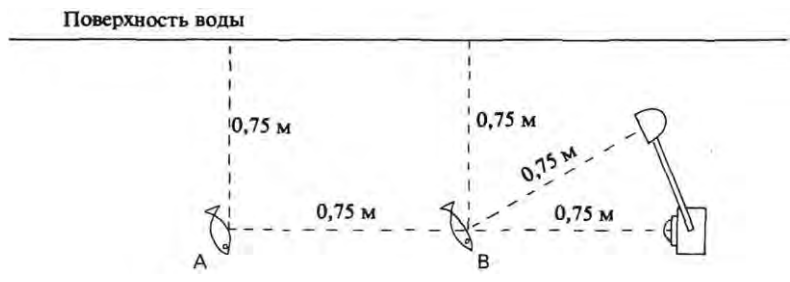

125.

Mamiya RB67,
1:22, High Speed
Ektachrome.

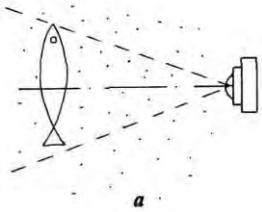

a

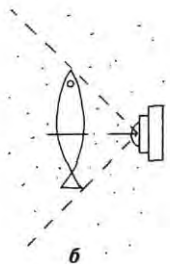

b

. 91.

(.)

(.)

, ,
(,),

(1 30)
- -

! , 10

- ,

- ;

- -

« » (1 / 1000) ,

,

,

,

,

Nikonos), (,

Ikelite Polaroid SX70. Nikonos, Nikon.

Nikonos

« » ,

(),



126.

Nikonos

(—)

. 92. Nikonos



127.

. Mamiya RB67,
1:22, High Speed
Ektachrome.

. 93.

Nikon F2 Canon,



. 94.

(.)

(.)

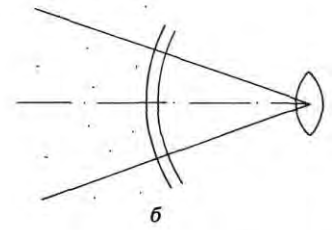
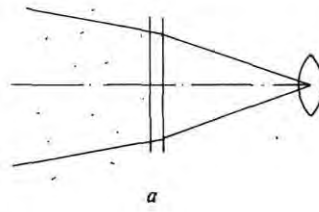

. 95.

(.)

(.)

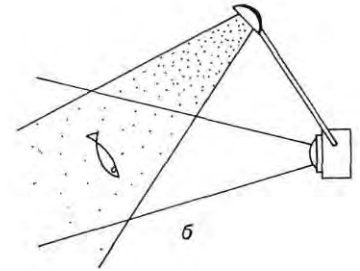
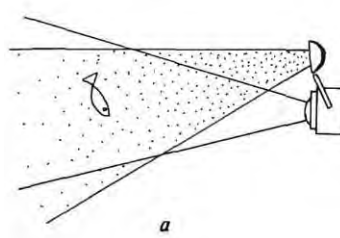

(

)

Nikon Canon



128.

Nikonos

129.

Mamiya RB67, 50-

1/60 , 1:5.6, Tri-XPan.

30



130.

(

).

();
Nikonos

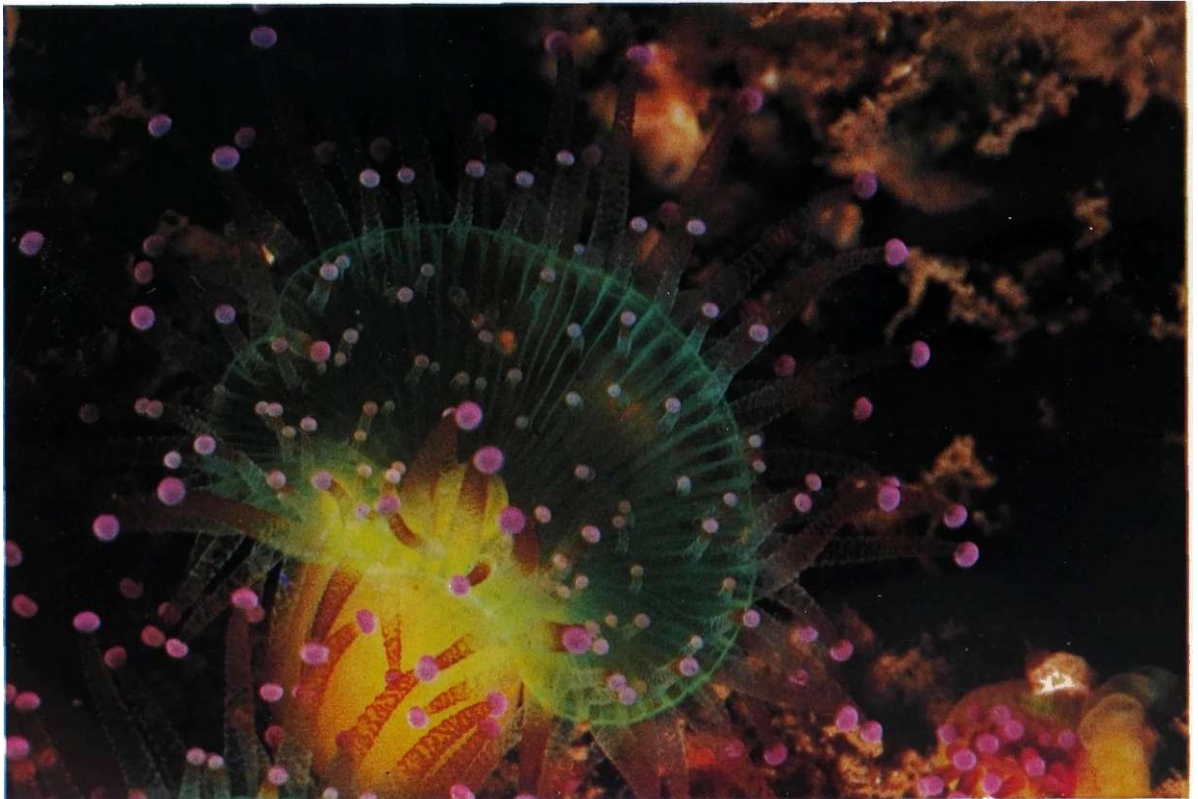

Products, Oceanic See and Sea. Philips Oceanic

(90°)

Sekonic)

(Sekonic).

Weston;

()

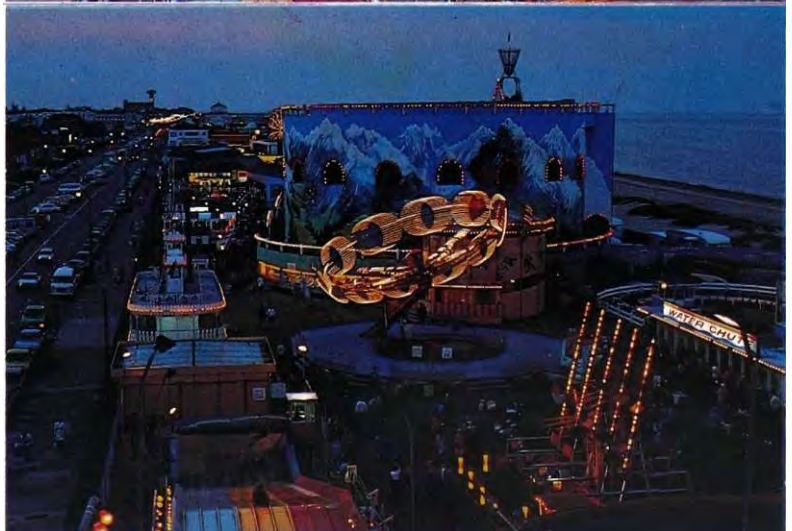

131.

1/250 ; — , 1:5,6,
1:4, 1/4 , . . .
100 .

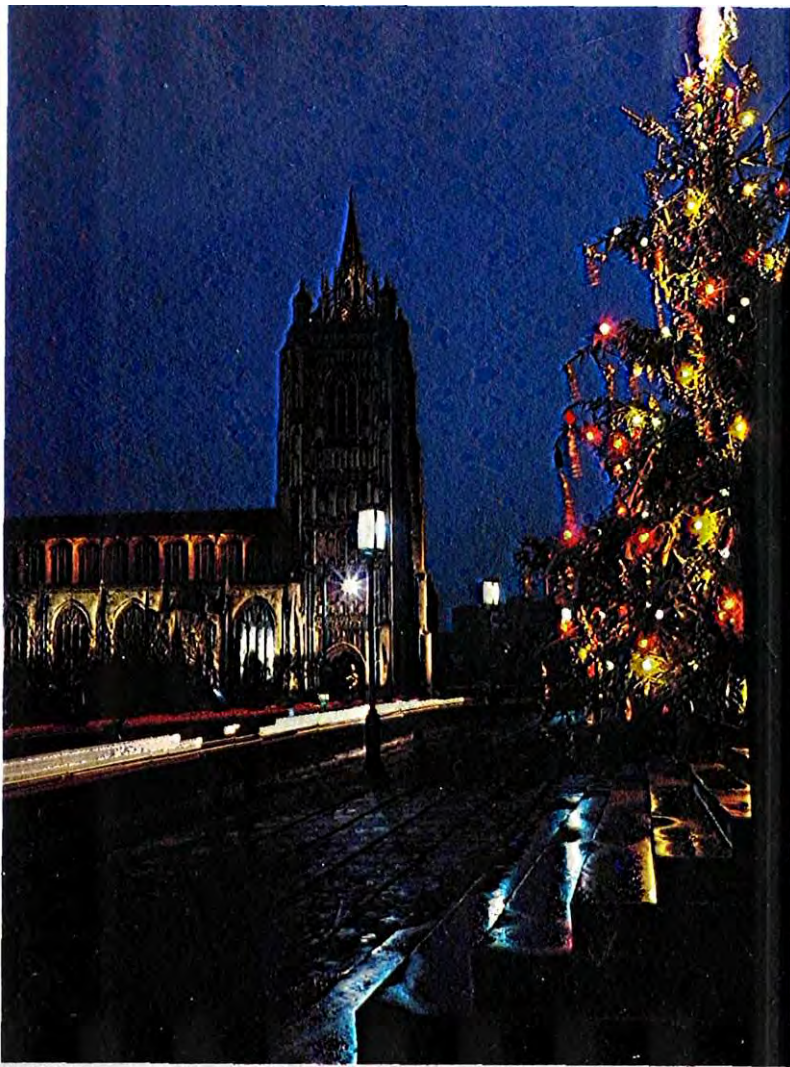

132.

() .

Nikkormat, 8 , 1:5,6, Kodachrome II.

133.

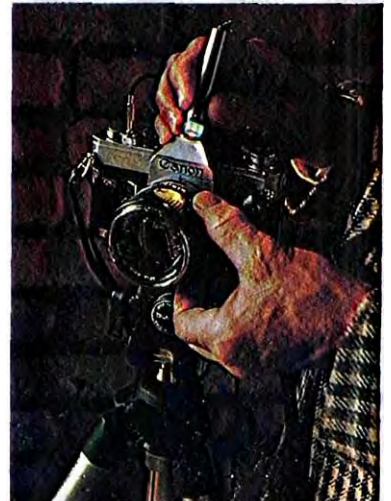
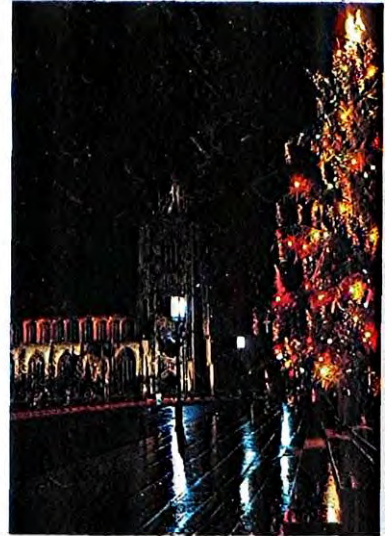

134.

« » ,

1/15 ,
1:5,6 Ektachrome 64.



135.

« » —

« »

64

1:8.

(1/60) .

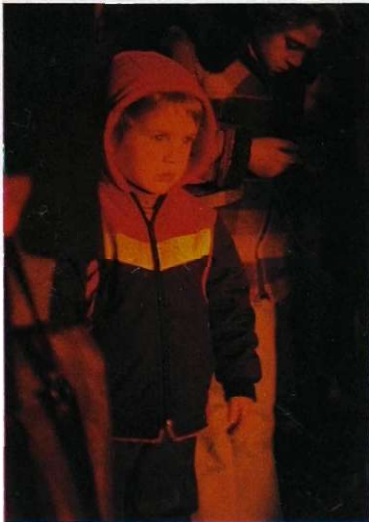

136.

1/15 , 1:1,4, Ektachrome 200.



137.

« »
Wratten 80 ;
80 Wratten
« »





139.

Nikkormat, 85-
 1/125, 1:2, Kodak
 Ektachrome 160.

140.

Nikkormat, 85-
 1/125, 1:2, Kodak Ektachrome
 160.

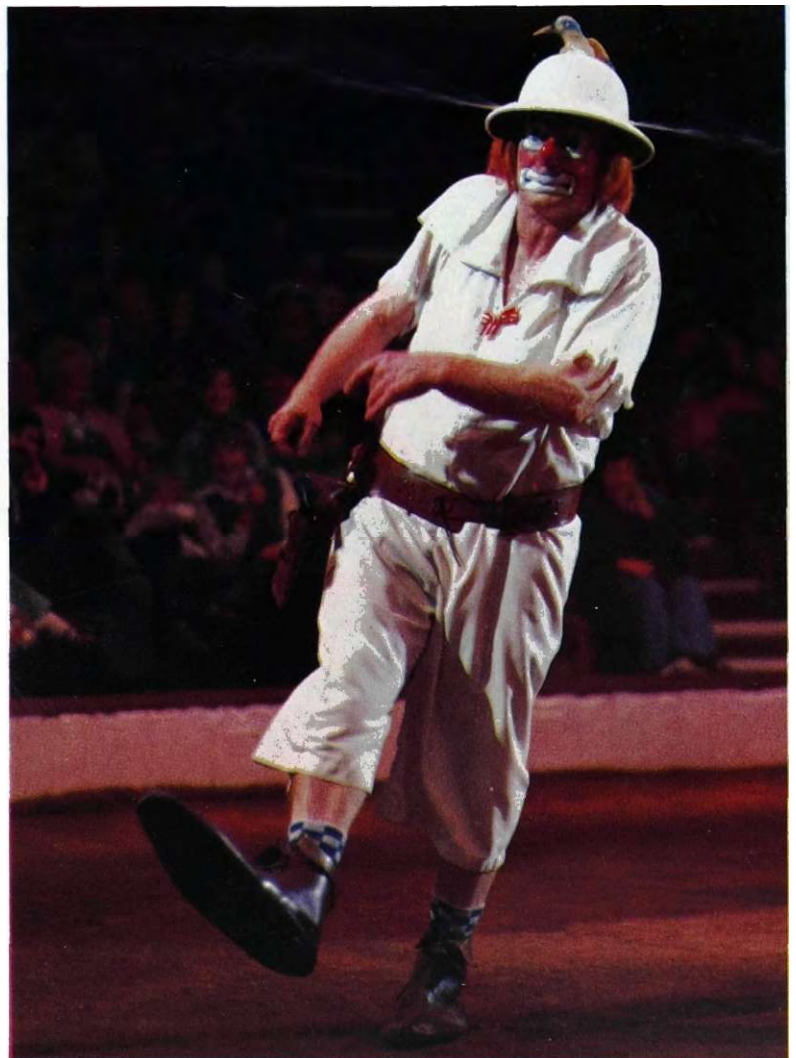

138.

() .

1:5,6

1/125 .

1:8

1/8 . (

Robin Smith Photography
 Limited.)

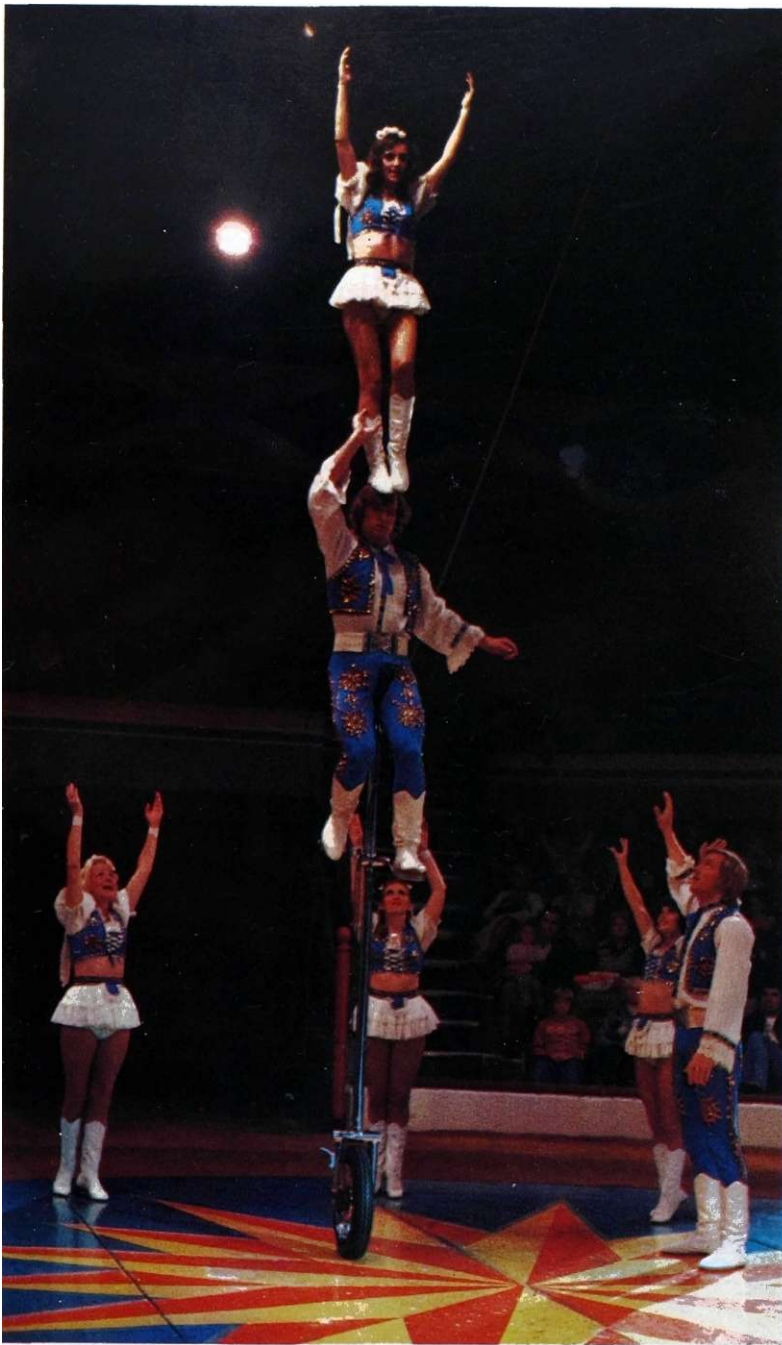

141.

160

320

Canon FTb, 50-
1/250, 1:8;
1:8.

: 1/125 ,
:

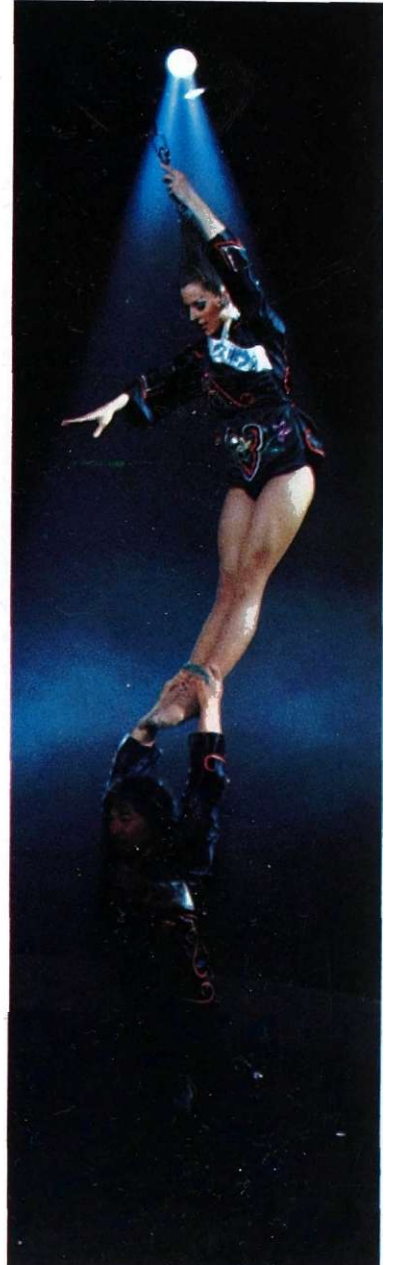

3.

	64
:	1/15 , 1:2 1/4 , 1:3,5 1/2 , 1:2,8 1/30 . 1:2 1/30 , 1:2,8 1/30 , 1:2.8 4 , 1:5,6 1/15 , 1:2 1/30 . 1:2,8 1/30 . 1:4 1/30 . 1:2.8 1/30 . 1:2.8 1:8, - - -
10	
:	1/30 . 1:2 1/60 , 1:2.8

• , , ,
• ,
• ,
• ,

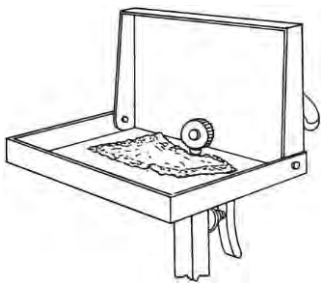

. 96.

30- (),

« » ()



142.

», -

«

30-

(().
) , (() .
-« » ,

-« »

250—350 .

()

“ ”



. 99.

10

100—200

()

100

1/2000

1/ 500...



. 100.

12 14 ,
(3).

. 101.

(300)

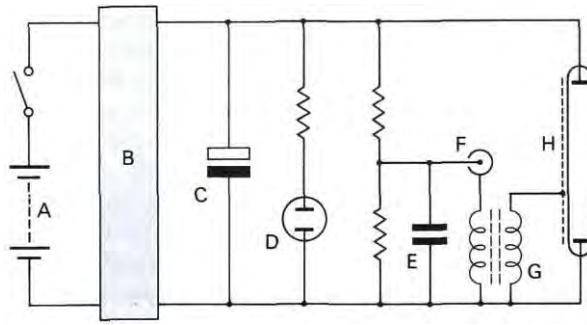

D,

(150) F

G.

()

()

10%

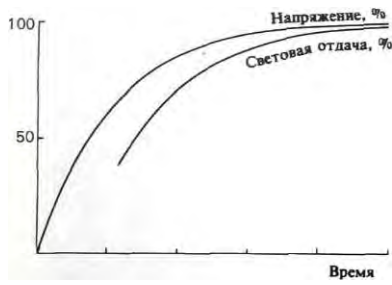

. 102.

60%;
80%
90%.

80—90%

85 100%

(100).

X.

1/25—1/30 ,

X.

().

(

X



. 103.

$$1/30 - 1/125$$

$$1/25 - 1/30$$

$$\frac{28}{10} = 1:2,8.$$

$$\frac{28}{10} = 2,8$$

()

$$2^2 = 4$$

$$20 \left(\dots \right) 10$$

$$\frac{1:2,8}{10} = 20$$

$$1:1,4$$

$$28 -$$

$$\frac{28}{130} = 20, \quad 32 \cdot 65 - 28 \setminus = 14,$$



. 104.

1

« »



. 105.

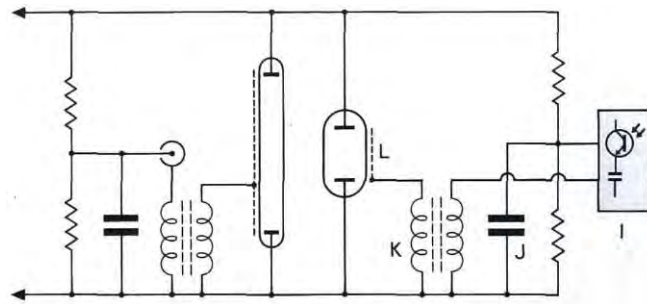

I

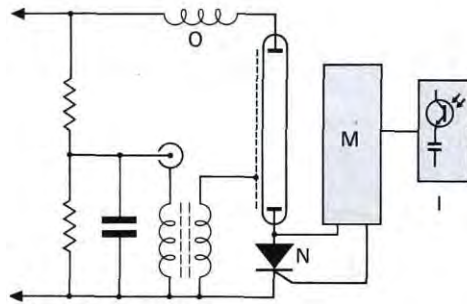

J

1/50000

1000

0,25

L,

1/400

9

60

(
)
 «
 »,
 I

(
),

«
 »

()



. 107.

50

1:5,6,

1:5,6,

1:8,

1:5,6 1:8.

(1:11),

1/128

: 1:16

1:22.

« »

0,3 (

lg2)

()

0,3.

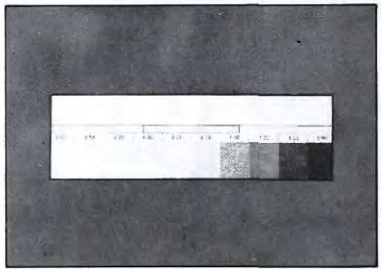
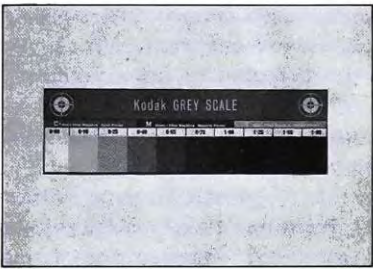
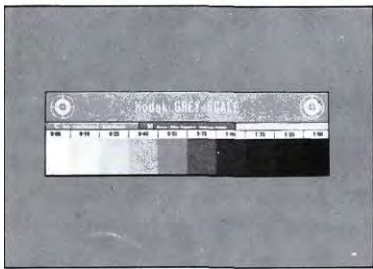
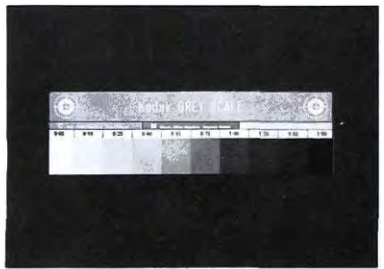
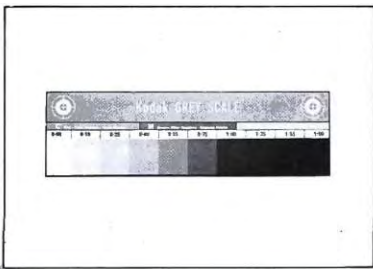
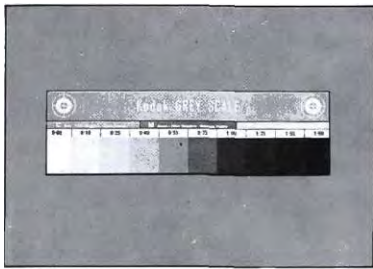

. 108.

« »

()

0,4

()

()



143.

18%

()

$$\frac{1}{400} \quad \frac{1}{128}$$

$$\frac{1}{50}$$

144.



« » — , —

145.





146.

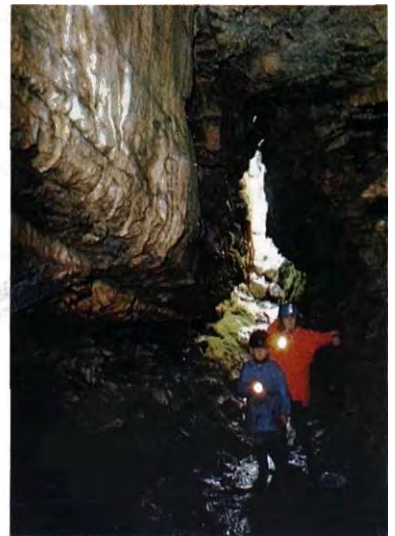
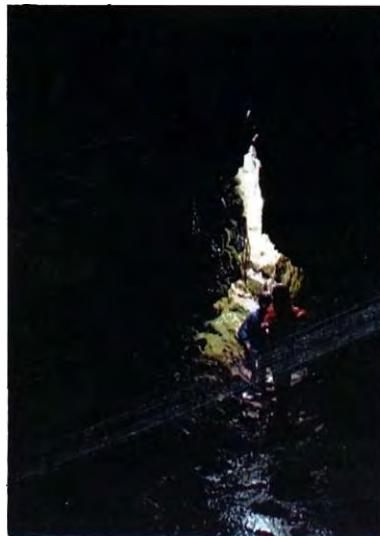

147.

(,)

1:8, 30
1/30 1:4,
1:4 1:8, . . .

(),

(. . .),



148.

40,

5

1:8.

: 1:11.

1/ 125

1/60

190



151.

(:) —
 (—)) —
 ())

) (

, 1/8 , 1:11,

Ektachrome 64.



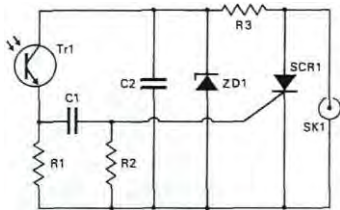

109.

R1 R2,

SCR1.

SK1.

R3

ZD1

2

SK1.

TIL78,

R2 = 10 ; R1 = 56 ;
 1 = 0,02 ; R3 = 5,6 ;
 ; 2 = 0,1 ; 1 —
 TIL78
 ; ZD1 —
 20 , 400 ; SCR1 —
 C106D - SK1 —
 3 ()

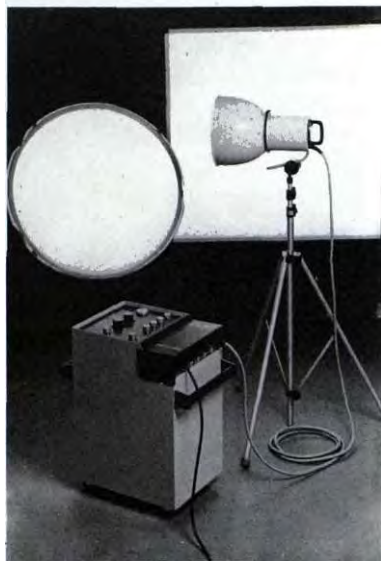

. 110.

Elektronik AG.)



. 111.

Wratten 88 ,



152.

()



153.

). (



154.

155.

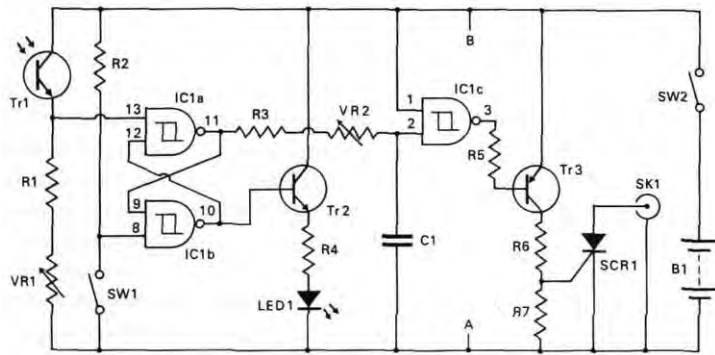

1/6400

112.

SW2 —

LED1

VR1

IC1 —
CMOS,

SK1

SW1;

VR2

VR2, R3 1
11 200 1

R1= 4,7 ;
R2= 100 ; R3=5,6 ;
R4= 2,2 ; R5= 22 ;
R6= 1 ; R7= 1 ; VR1 —
47 ; VR2 —
100 ; 1 —
(, 2,2 ;
TIL78)
109 ; TR2 — ; TR3 —
479 ;
; SCR1 — C106D
; LED1 —
TIL209 ; IC1 —
; SW1 — CD4093B
; SW2 —
SPST; SK1 —
0 3 ; 1 —

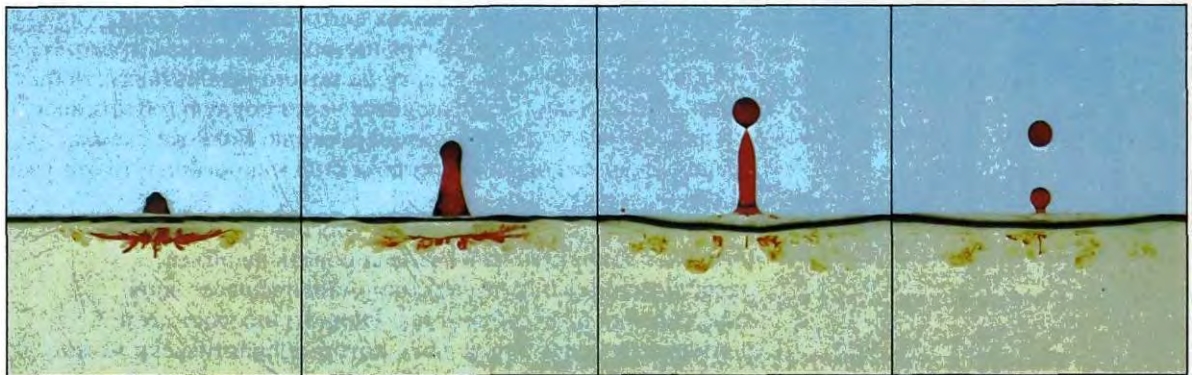
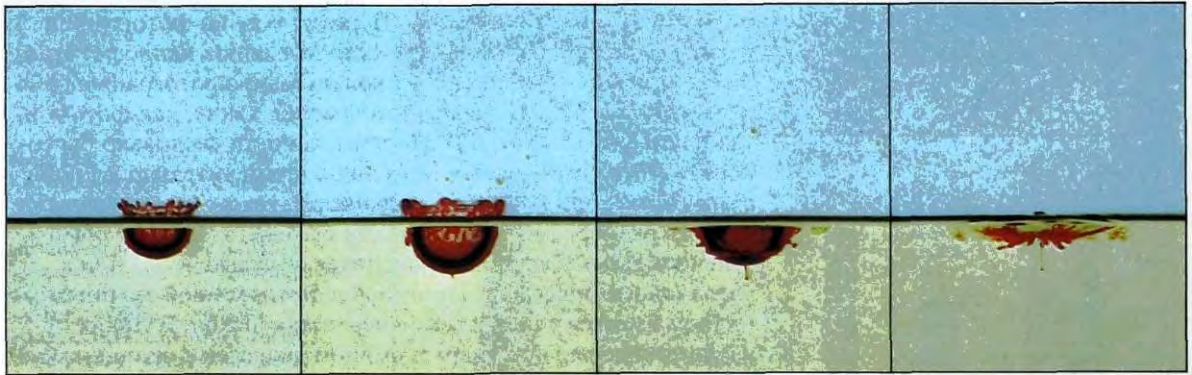
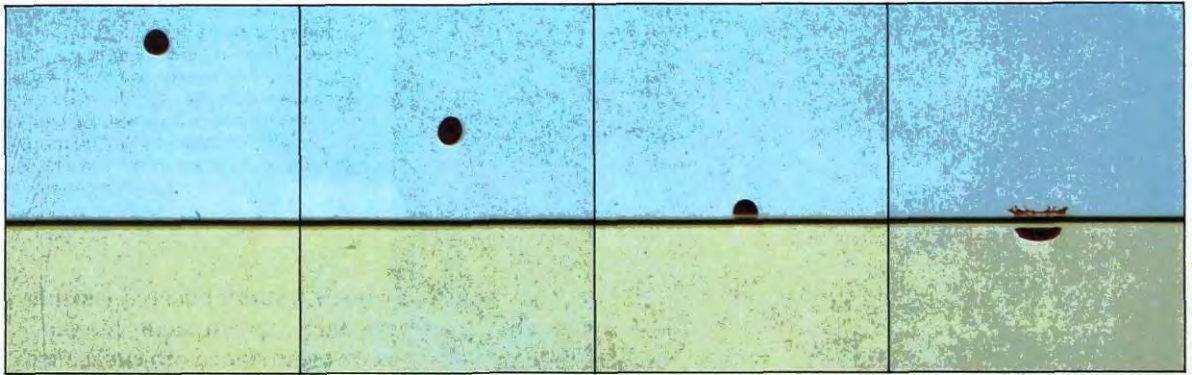

156.

5

112.

30

Sunpak Auto Zoom 5000;
1/32

« » . « - 10

1/12 500

« »

« »

30

150

() ,

,

.

,

,

1X .

1:1

,

,

)

(

,

,

,

,

,

,

,

,

,

157.

4-3

(1:16)



158.

+1



3 1.

1, 2

1

, = 1/

1

+3 —

+2

0,3

1 ;
0,5

1

—

«+»
«-»

159.

(1,5) 35-

8-

135-

()

(1:2,8),



1 , , . 4,

4.

	+ 1	+ 2	+ 3	+ 4(1+3)	+5 (2 + 3)
<i>∞</i>	100	50	33,3	25	20
10	91	47,6	32,3	24,4	19,6
5	83,3	45,5	31,3	23,8	19,2
3	75	42,9	30	23,1	18,8
2	66,7	40	28,6	22,2	18,2
1,5	60	37,5	27,3	21,4	17,6
1,2	54,5	35,3	26,1	20,7	17,1
1	50	33,3	25	20	16,7
0.8	44,4	30,8	23,5	19	16
0,7	41,2	29,2	22,6	18,4	15,5
0,6	37,5	27,3	21,4	17,6	15

1 ,

160.

10 X 15

+ 3



+ 3

« »

yxvqmei



. 113.

, (,)

,

,

.

,

35-

12 , 20 36 .

»

«

TTL.

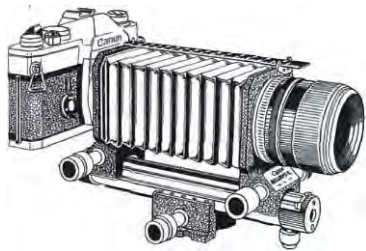

. 114.

150 .

()

2 ; IX ,

0,5 X .

$$\left(\begin{array}{c} 1:1 \\ 0,5- \end{array} \right) \quad 2:1, \quad - 1:2.$$

« ».

,

,

,

« »,

« »

,

,

,

,

,

«V».

$$m = (V - F) / F, \quad F -$$

$$V = F.$$

V

$$: = v - F \left(\frac{V}{F} \right).$$

$$: = / F.$$

50

25

$$= 25/50 = 0,5, \dots$$

$$m = (x + \dots) / F.$$

. 5.

() .

$$+ = m * F.$$

50

$$= 0,25.$$

$$+ = 0,25 \times 50 = 12,5$$

10

$$- 12,5 - 10 = 2,5$$

. 5

5.

	24	28	35	50	85	100	135
	0	0	0	0	0	0	0
10	0,06	0,08	0,12	0,25	0,73	1,01	1,85
5	0,12	0,16	0,25	0,51	1,47	2,04	3,75
3	0,19	0,26	0,41	0,85	2,48	3,45	6,36
2	0,29	0,40	0,62	1,28	3,78	5,26	9,77
1,5	0,39	0,53	0,84	1,72	5,11	7,14	13,35
1,2	0,49	0,67	1,05	2,17	6,48	9,09	17,11
1	0,59	0,81	1,27	2,63	7,90	11,11	21,07
0,8	0,74	1,02	1,60	3,33	10,10	14,29	27,41
0,7	0,85	1,17	1,84	3,85	11,75	16,67	32,26
0,6	1	1,37	2,17	4,55	14,03	20	39,19
0,5	1,21	1,66	2,63	5,56	17,41	25	49,93

()

1 .

(. . . , ())

(,)

100 135 35-

25—40 .

25—40 ,

« »

50-

24-

6-

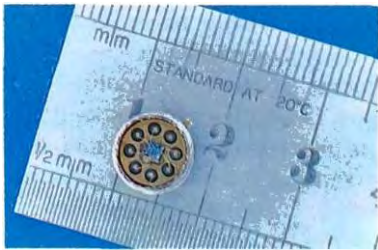
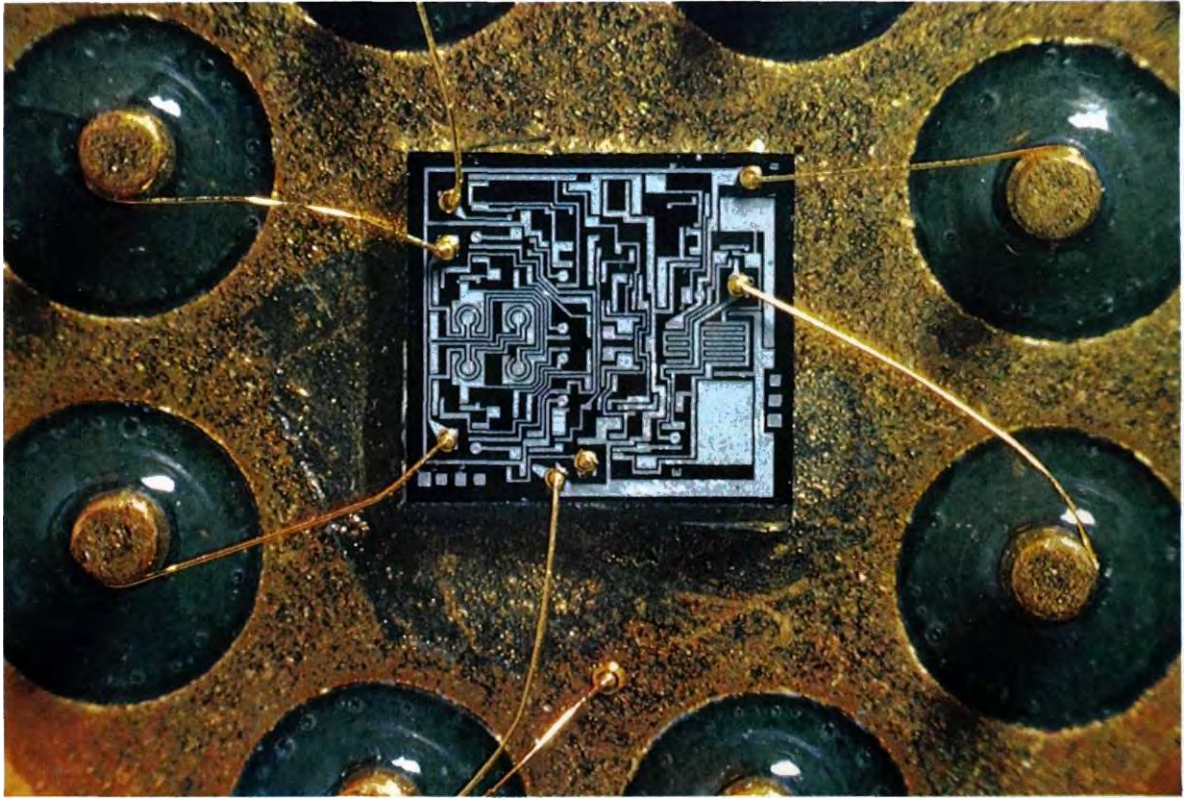

161. , 28X .

25-

. Canon FTb,
 , Kodachrome 64.

. 115.

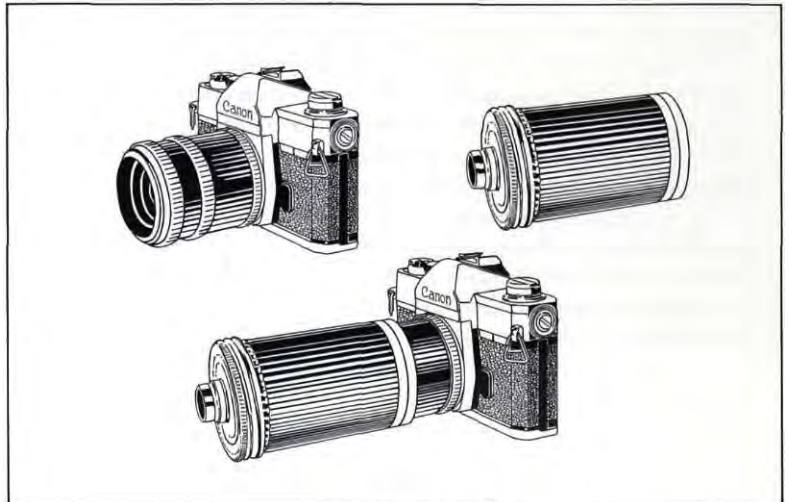

(. . m < 1).
(. . m = 1),

(. . > 1),

m

$$m = e/F,$$

()

TTL

m

=

(+ 1).

IX

1:16
16 (+ 1) = 1:32.

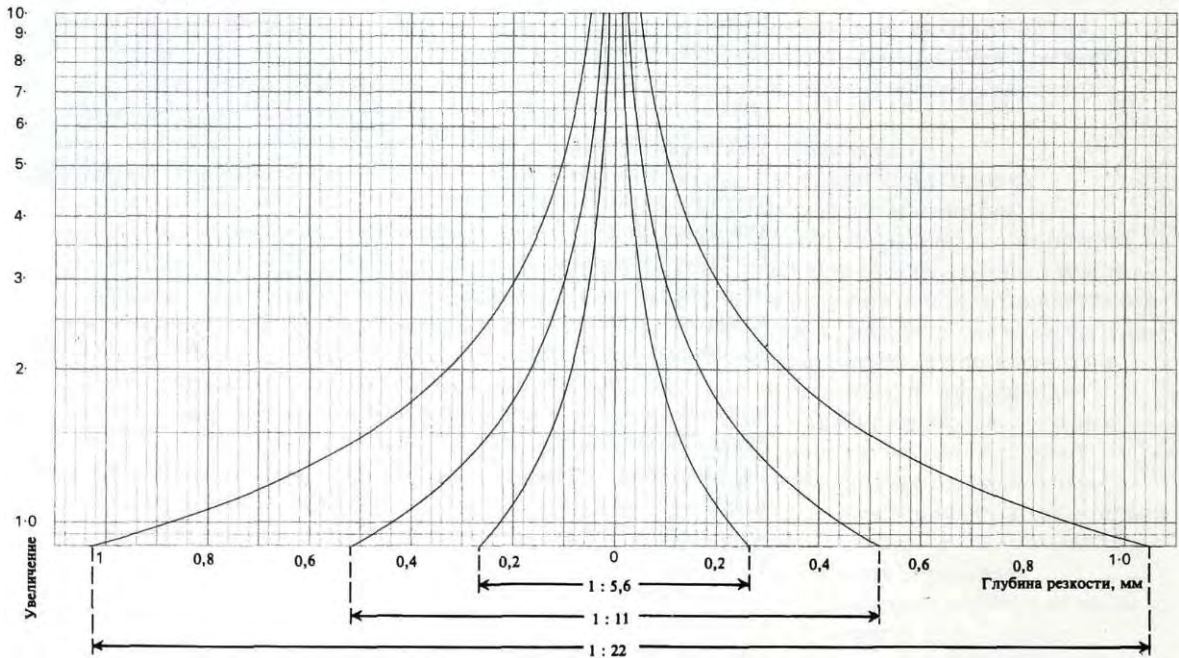
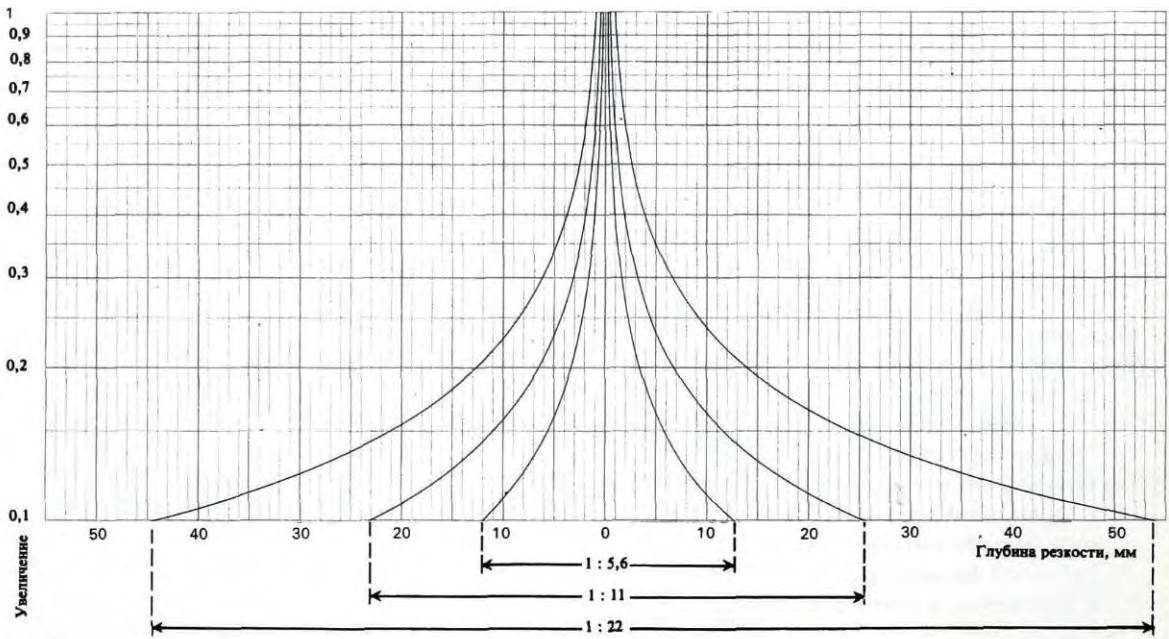

. 116.

0,02 35-

20X 24

()

X 10

0,02

. 73.

$$u = [(1/m) + 1]F.$$



162.

(. . = 60, — , 60 X
).

250

()

(. 117).

250

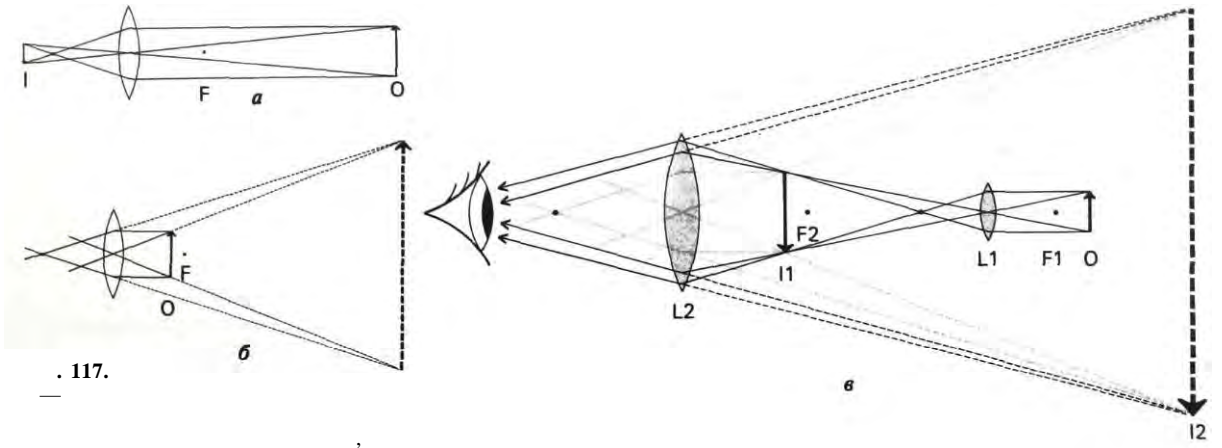

. 117.

б

б

12

I

250

20 1000 X.

(

).

L1

II (

L2,

12

(

).

4 100 X .

5 20 X

25 X .

200 X. 20 X -

10 X -

. 117

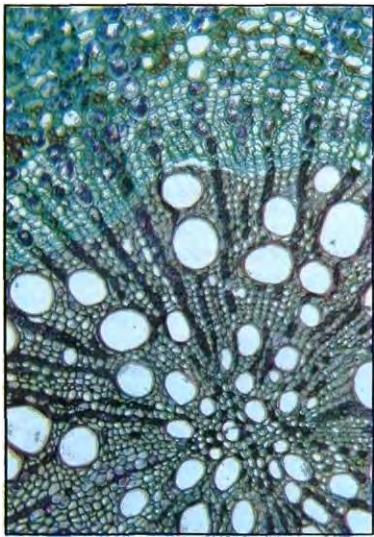

163.

), (= 90.



164.

165,

162—168,

165.

1—2

= 20.
« »



$$= (F / 250), \quad F = m$$

(. 118).

. 118.

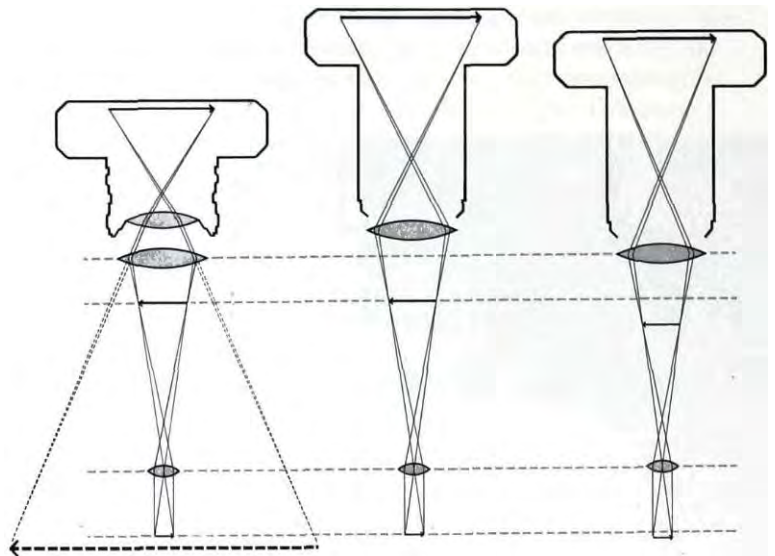

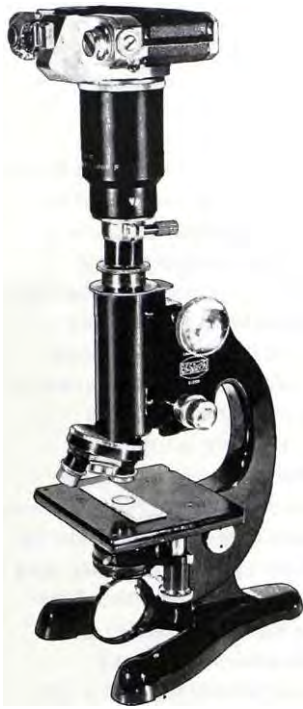

. 119.

(/ 250), — =

125 ,

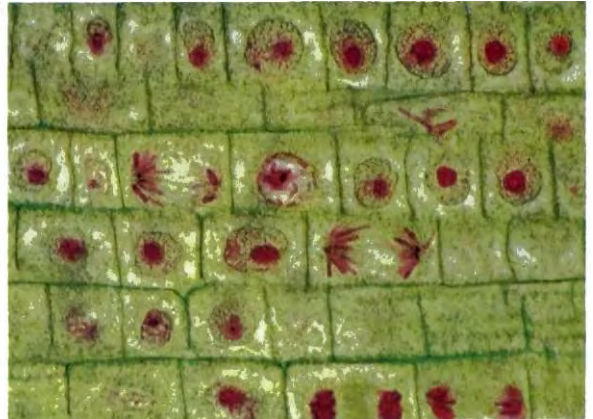
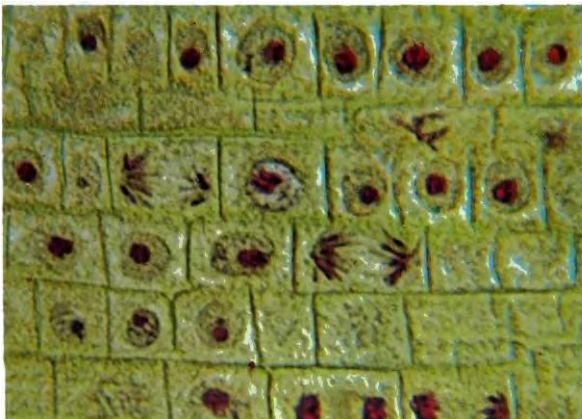

« »

,

« »,

,

,

,

,

,

»,

,

,

0,1,

4-

10-

0,25,

40-

— 0,65.

100X

,

,

100X ,

.

,

(),

1,5, . . .

,

,

-

,

.

, «

-

166.

»

,

, = 500. —

,

,

,

:

,

—

:

=

1000.

(, .)

40-
0,65,
0,65- 1000= 650.
10-

()
40- 10= 400, . .

—
—
40' 10- 250/250= 400, . .
;

—
400- 2= 800,
« », « », ;
—

167.

= 120.

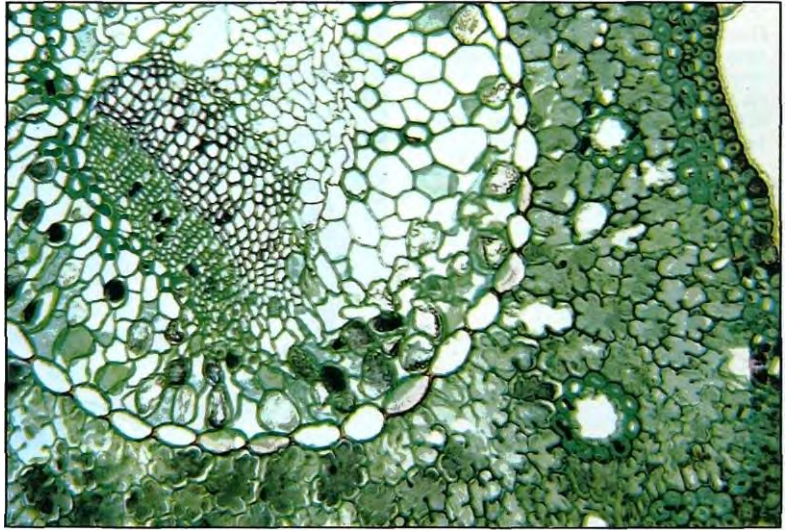

168.

Fucus.

= 60.

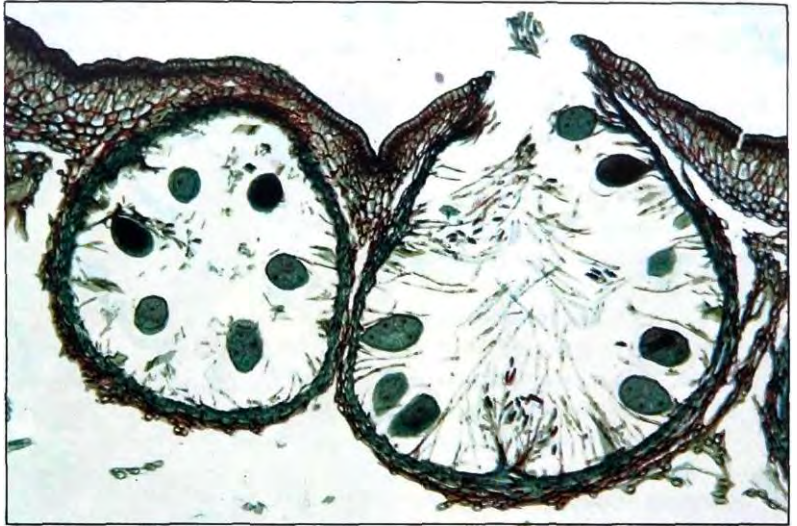

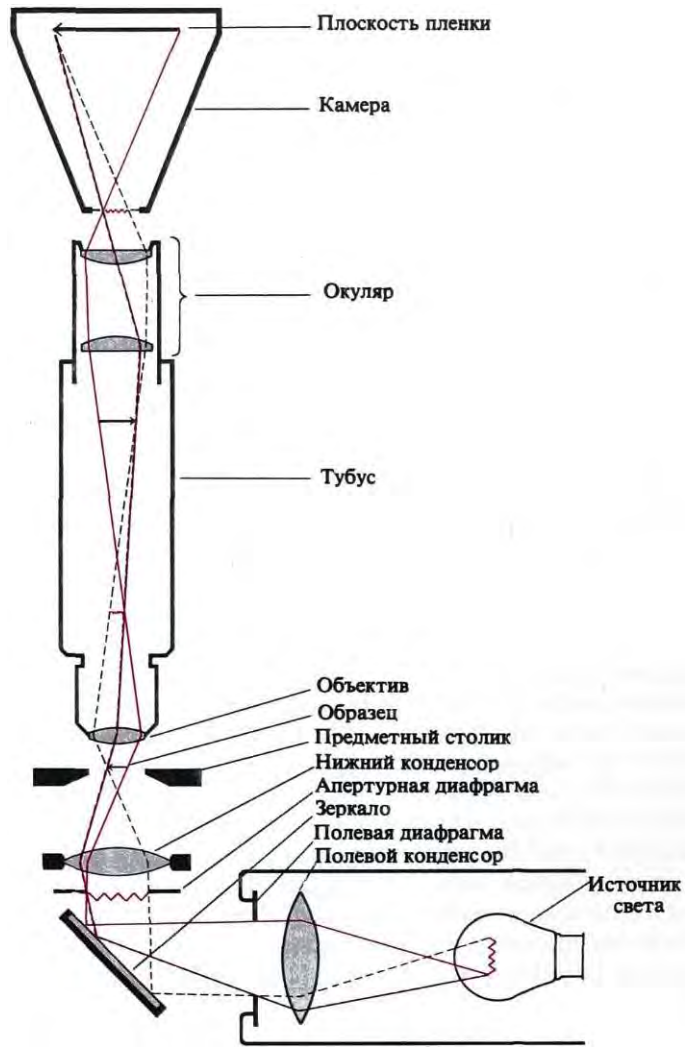

« »

100-
40 X

162—168,

1.

()

2.

(2)

(

.)

3.

4.

5.

6.

(

)

7.

7 ()

TTL

»:

=

$$\times \left(\frac{\text{Стандартная числовая апертура}}{\text{Новая числовая апертура}} \right)^2 \times \left(\frac{\text{Новое увеличение}}{\text{Стандартное увеличение}} \right)^2$$

1.

TTL,

1/4

TTL

1/30

1/60

1/8

(Wratten 85 ,
).

$$(1 = 1/1000^3).$$

1000,

), ()

, , ()

, « », ,

« », « » (, . . .)¹.

1

169.

(. 121),





. 121.

170—173 . 123—125.

« »

. 122.

176;

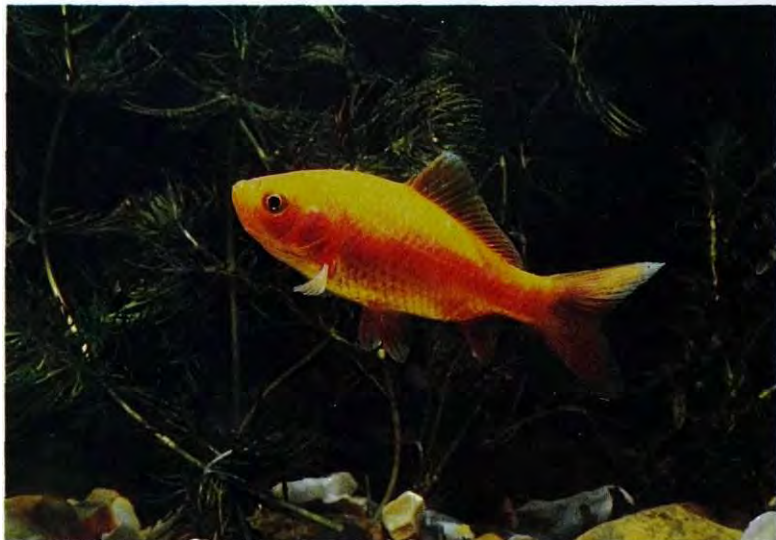
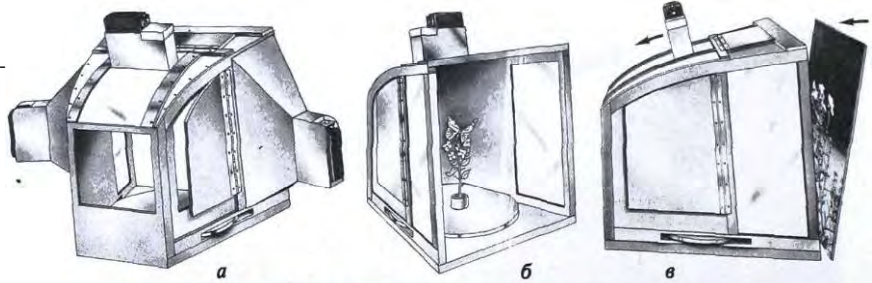

170.

123.



123.

(171).

124.

123.

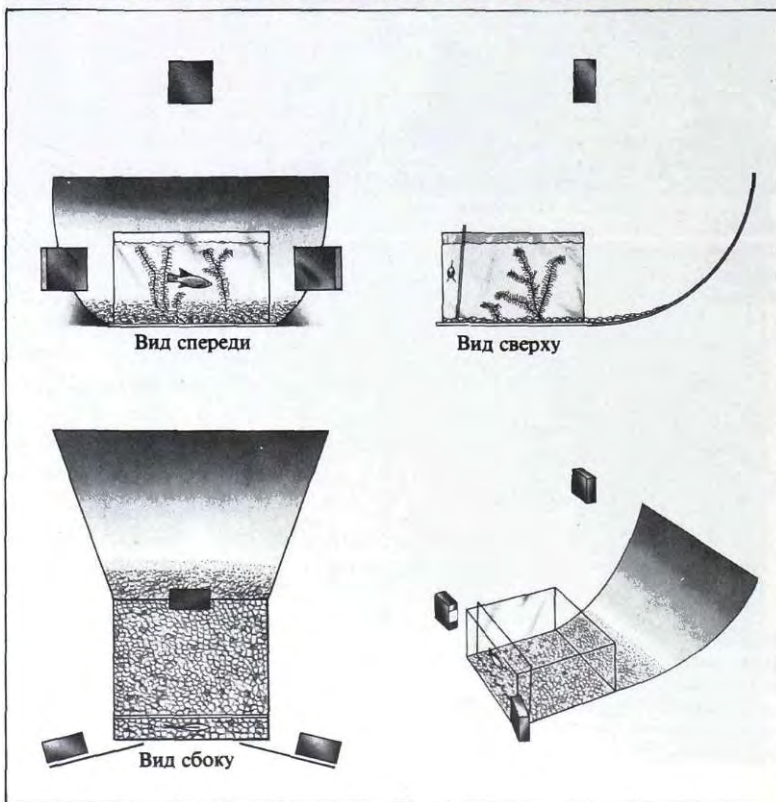



171.

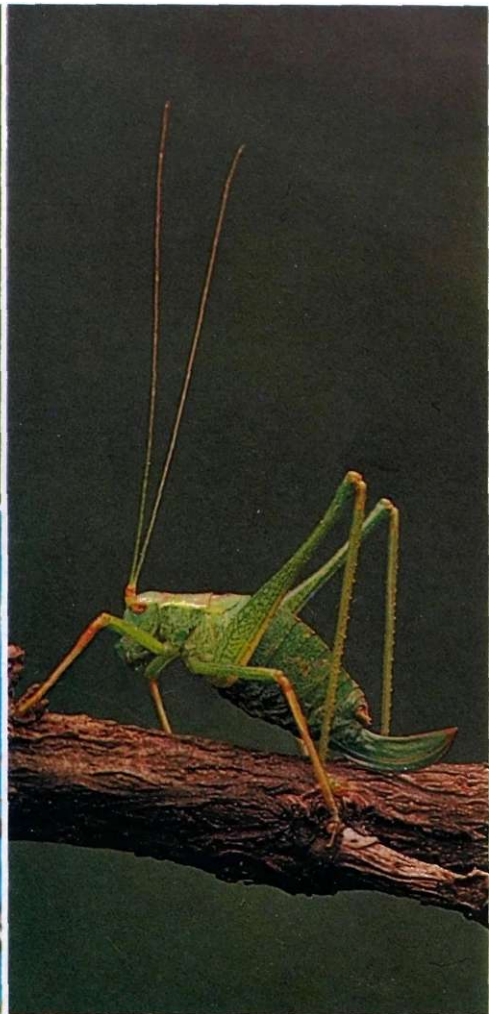

122.

45°

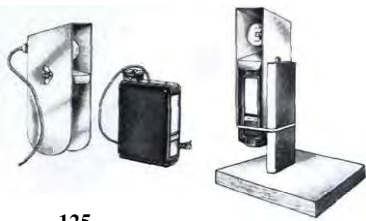

125.

(: ()
(,) . ()

), (:
) (()
) . ()

, , -
, , -

—

, , -
, , -

, , -
, , -

—
—

, , -
, , -

, , -
, , -

—
—

, , -
, , -

, , -
, , -

—
—

, , -
, , -

, , -
, , -





173. — *Coenagrion*, 4X.



Culex, 6 X .



(7,5 ²),

U-

Canon F1, 50-
Kodachrome 25. , 1:22,

— *Canon F1*, 50-
3,1 , 1:16,
Kodachrome 64. —

Carton F1, 50-
8,3 , 1:16,
Kodachrome 64. — *Gerris*,

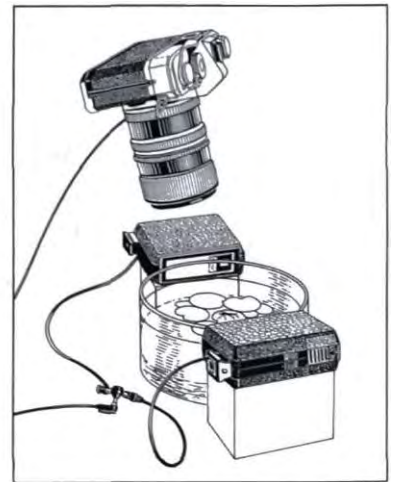
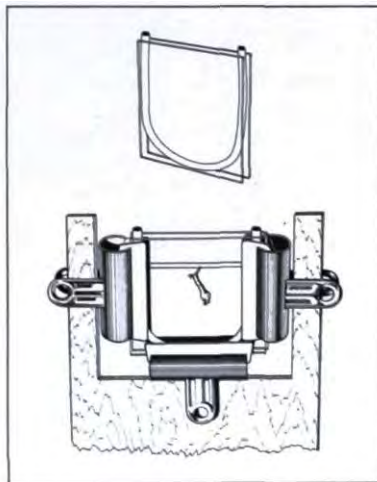
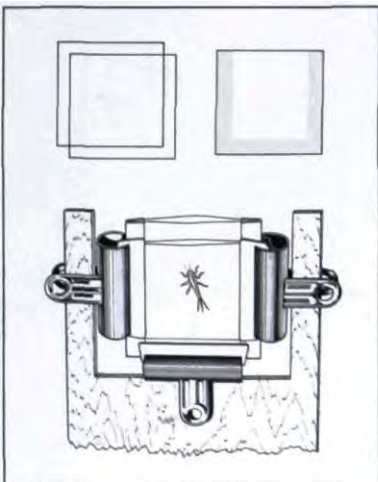



(TTL),

. 126.

(177)

177,

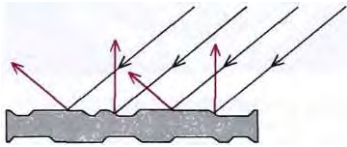

. 127.

(174).

174.

175.





176.

30

30

TTL.

« ».

. 128.

176:

().

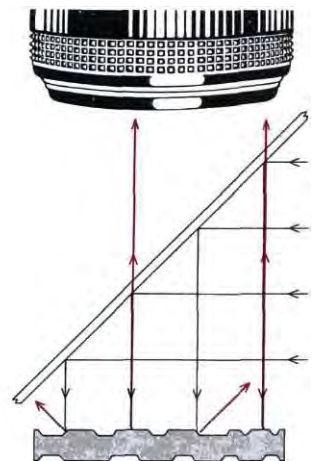
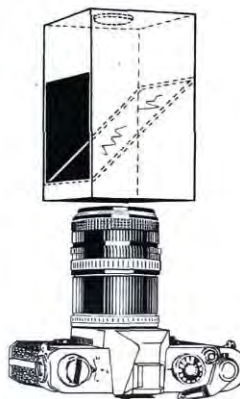

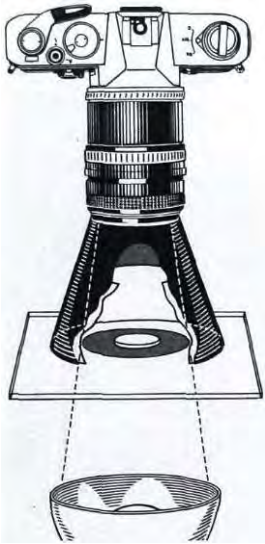

. 129.

177.

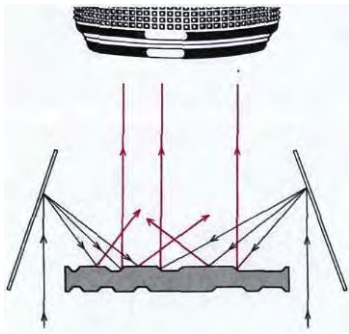

. 130.

() .

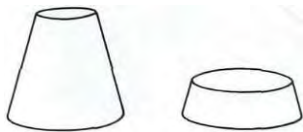

.131.

177.

« 180 181 »

177.

()
()



178.

« »

Wratten 2 .
16 , 1:22, Kodachrome 64,
Blacklight
Blue 8 Bt 15

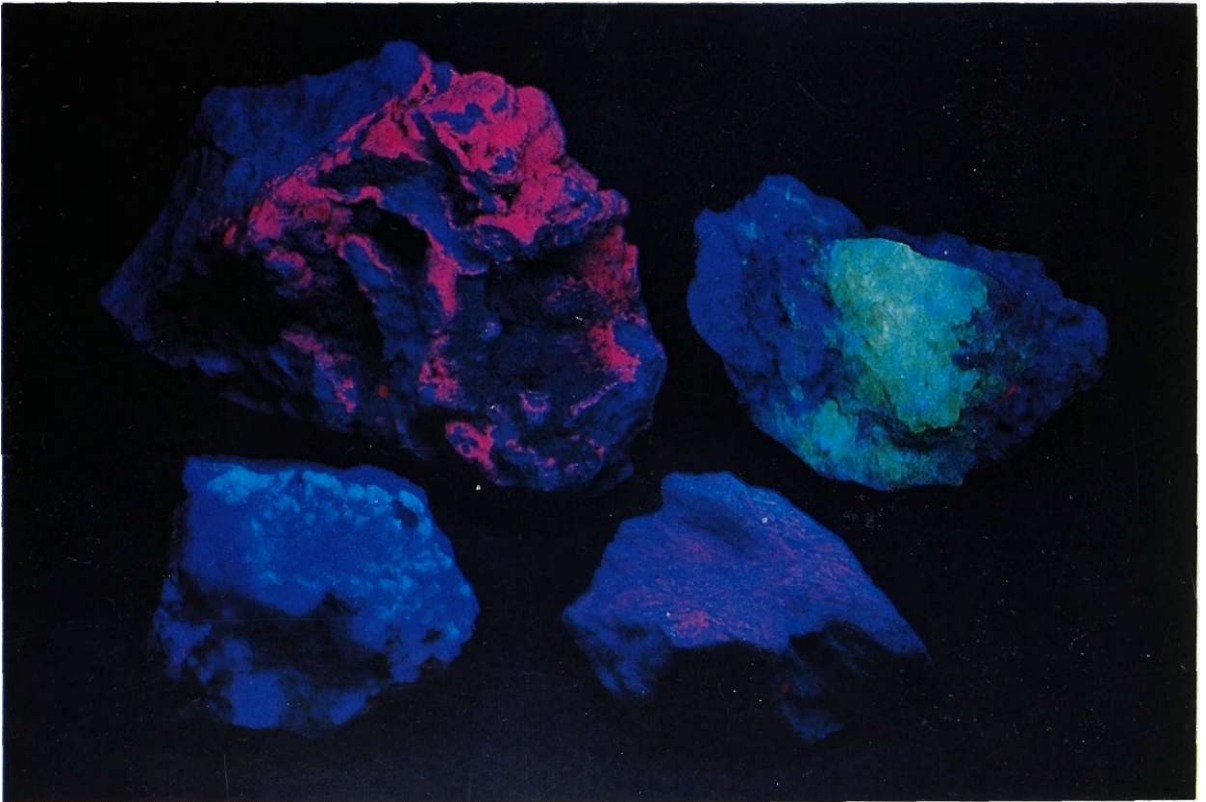

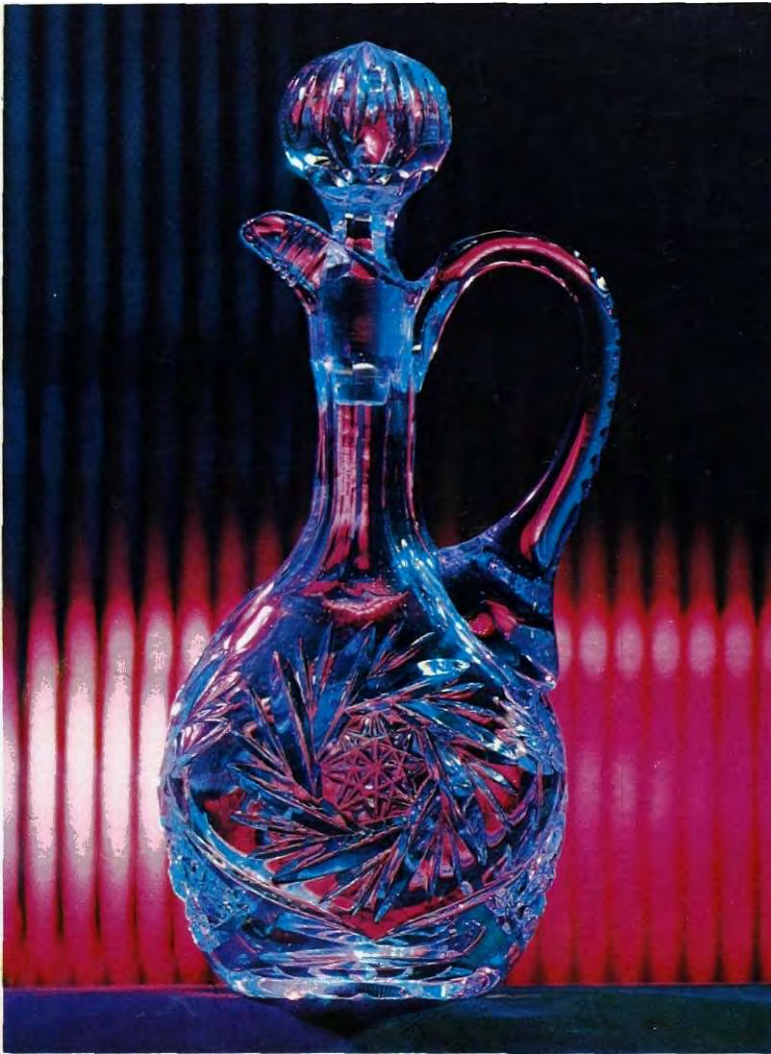

179.

25. , 1/15 , 1:8, Kodachrome
25'

« »
. Canon FTb, 1/8 , 1:11,
Ektachrome 50.

182 183

« »

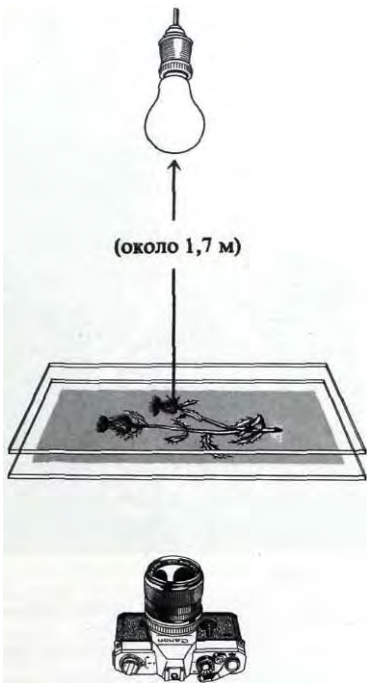

. 132.

181. 180

1,7 (1
Photoflood)

180.

. 132.

« » ,
« », « »
« »
35-
« »
« »
182 183
35-
6





Фото 181.

Фотосъемка производилась
способом, схематически
изображенным на рис. 132.

Papaver rhoeas



182.

. 133.



. 133.

« »
« » .« »

(. 134).

183.

133,



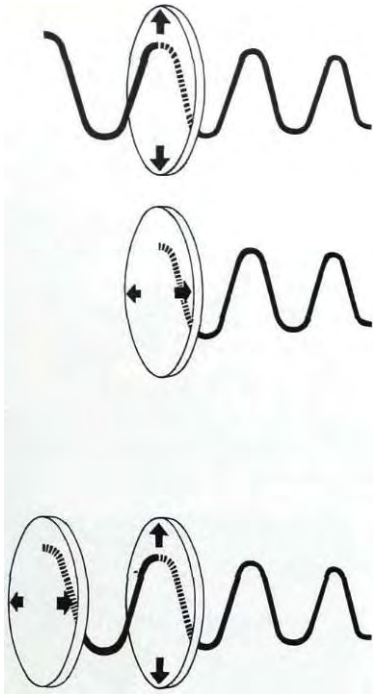

. 134.



184.

45°
90°
TTL
« »



186.

—
4
, 4 ; —
7
, 10 X .

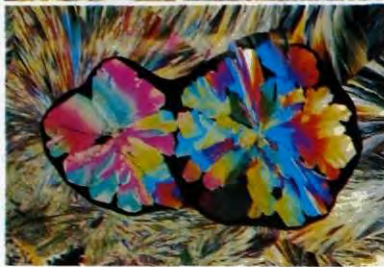
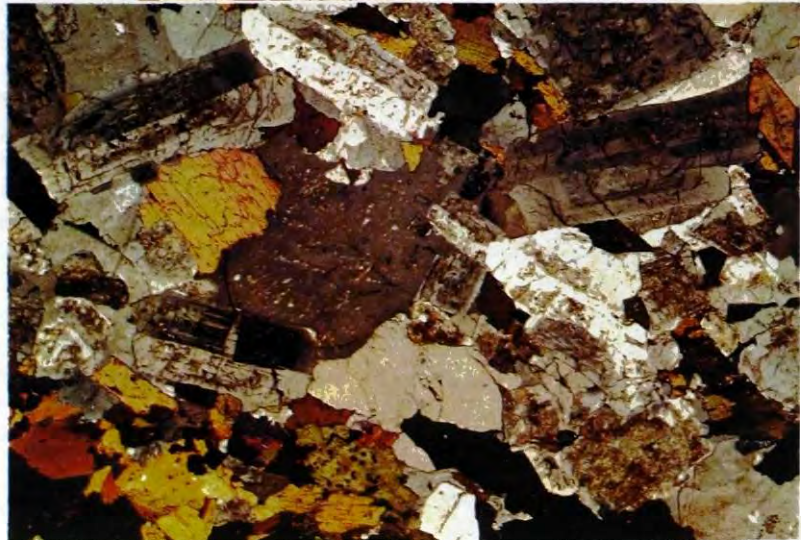
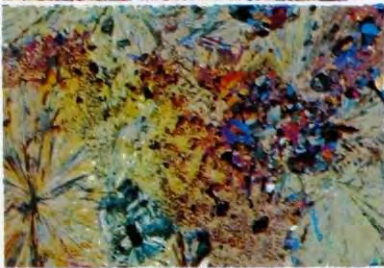
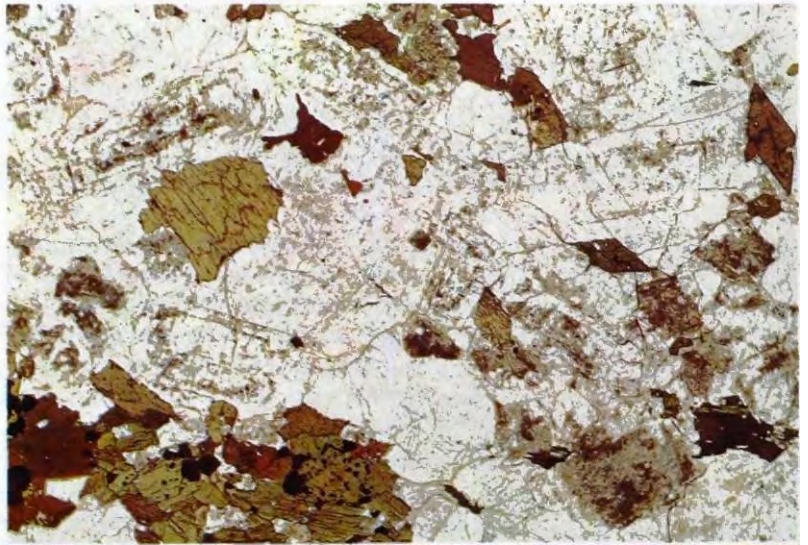
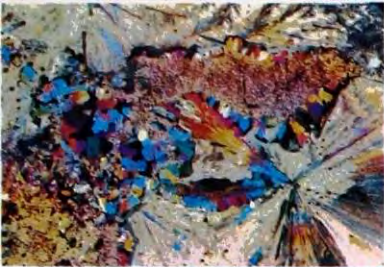

185.

187.

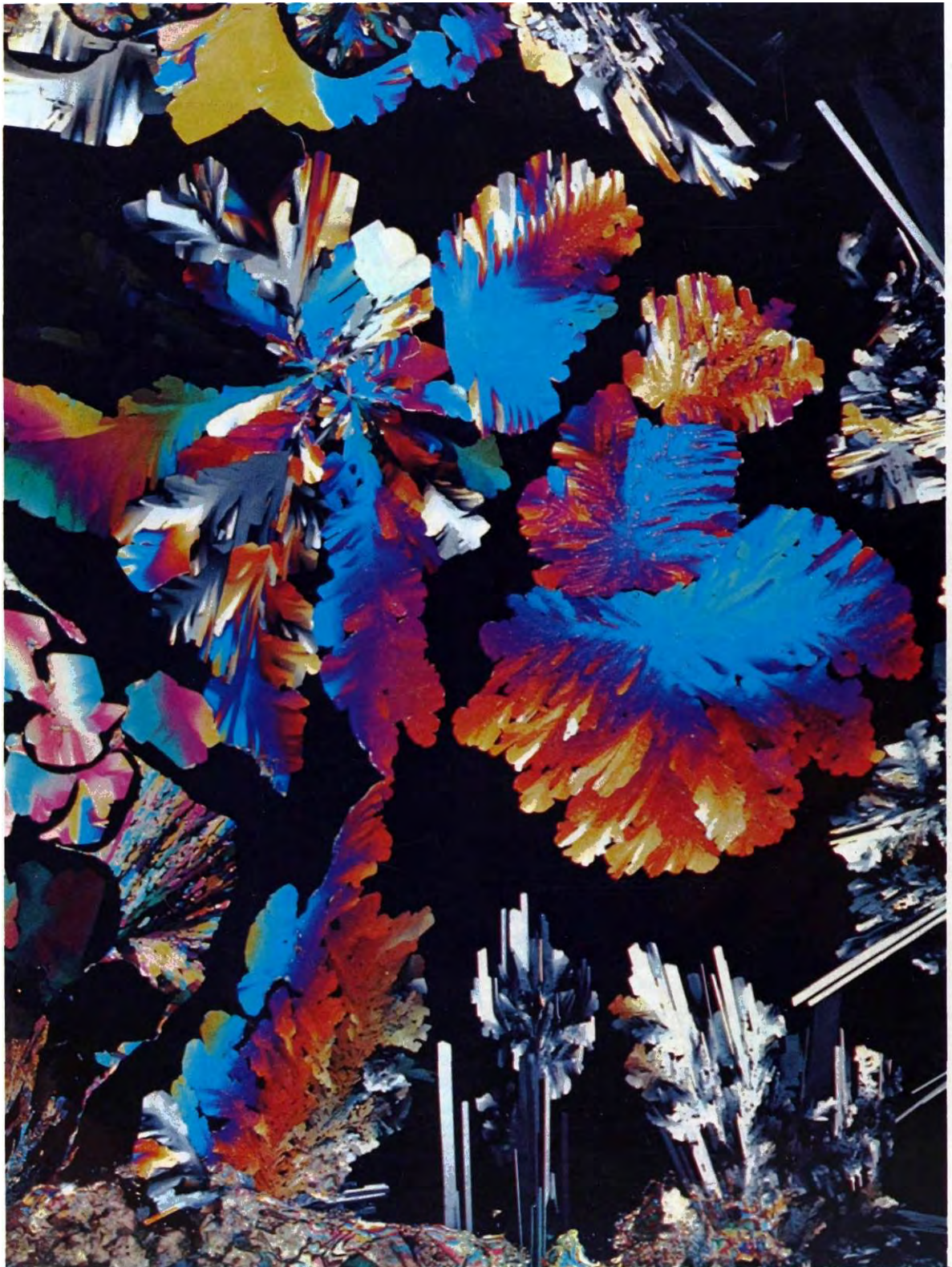

188.

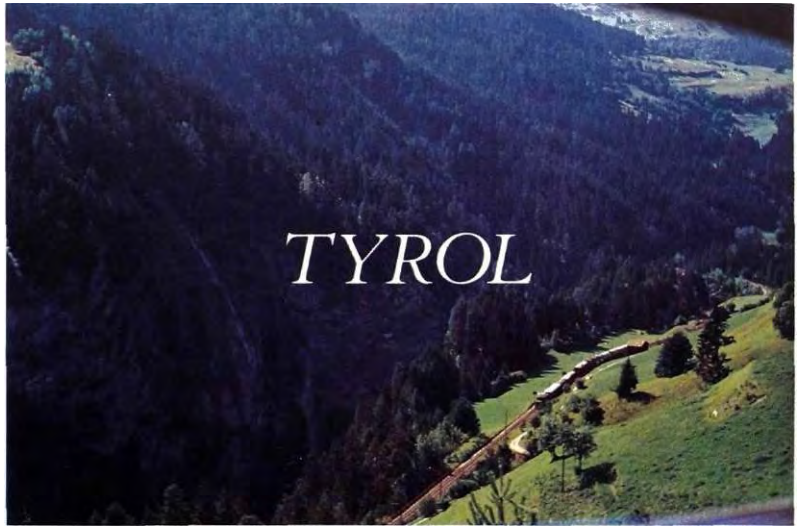

189.

Close-up lens data

Close-Up Lens	Focus Setting in Feet	Lens-to-Subject Distance in Inches	Approximate Field Size for Picture Area in 2 x 2-inch Slide	
			44 to 46mm Lens	50mm Lens
1+	Inf	39	21 × 30	18 × 26½
	15	32½	17½ × 24½	14½ × 22
	3½	20½	10½ × 15	9 × 13½
2+	Inf	19½	10½ × 15	9 × 13½
	15	17½	9½ × 13½	8 × 12
	3½	13½	6½ × 9½	6½ × 9
3+	Inf	13	6½ × 10	6 × 8½
	15	12½	6½ × 9½	5½ × 8½
	3½	9½	4½ × 7½	4½ × 6½
3+ plus 3+	Inf	6½	3½ × 5½	3½ × 4½
	15	6½	3½ × 4½	2½ × 4½
	3½	5½	2½ × 4½	2½ × 3½

Close-up lens data (50mm lens set for 3½ feet)

Close-up lens	Lens-subject (inches)	Field size (inches)
1+	20½	9 × 13¼
2+	13⅛	6⅛ × 9
3+	9¾	4½ × 6¾
3+ Plus 3+	5¾	2⅝ × 3⅙

190.

()

1/8

16

2

191.

1 / 50

1/25

()

25

— 1,5

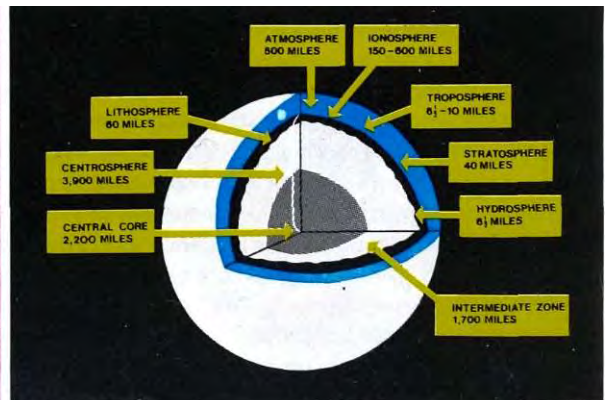
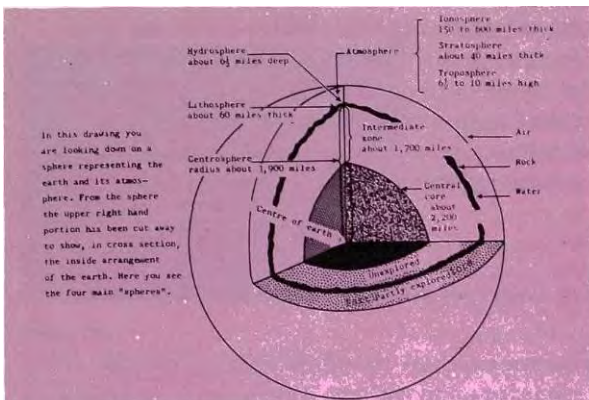

Letraset.

«1/25»,

Если напечатанный текст сфотографировать так, чтобы
окаймляющая его рамка полностью заполнила весь
35-мм кадр, то текст будет легко читаемым для всей
аудитории.

15 X 22,5

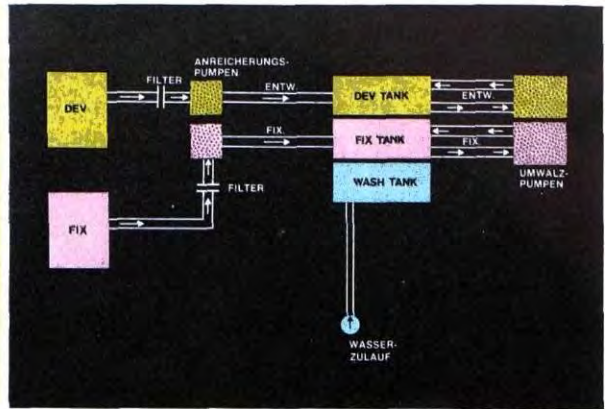
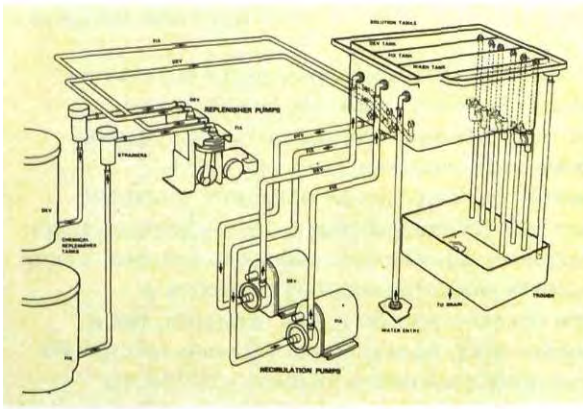

192.

(),

().

(),

(

).

193.

POPULATION RESOURCES COMPARED

Year	Western Europe (millions)	USSR (millions)	USA (millions)
1850	175	90	40
1950	300	180	110
1960	305	200	120
1970	310	205	125

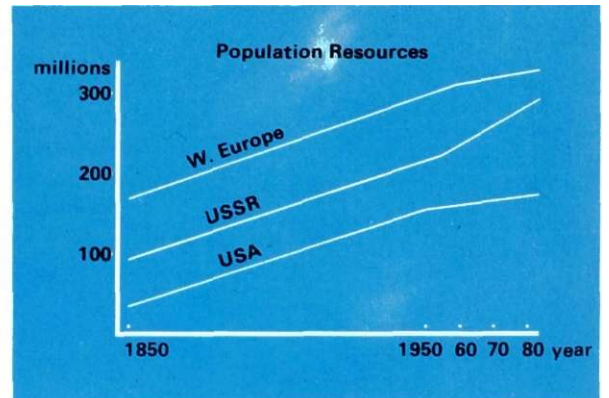

194.

()

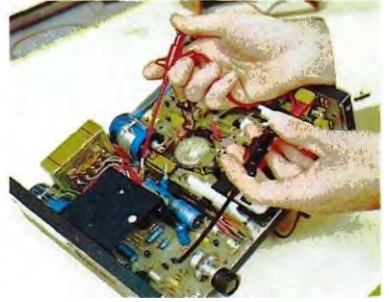

()

Wratten 47

47

Acknowledgements

Unless otherwise indicated below, the text and captions for this book were written and researched by Andrew Hawkins, and the diagrams and artwork were drawn by Dennis Avon.

Natural History: section dealing with the photography of wild birds and animals — text and diagrams by **Tony Tilford**.

Underwater Photography: text and diagrams by **Peter Scoones**.

Photographs by Andrew Hawkins and Dennis Avon with the exception of the following:

photo 178, **Michael Allman**; photo 84, 95, **Jennifer Carter**; photo 61, 62, **Keith Chant**; photo 115—117, by courtesy of **The Chipperfield Organisation**; photo 154, **A.E. and Sons Limited**; photo 38, 88, **Colour Center**; photo 36, 64—66, **Mike Cox**; photo 43 top, 54—56, 06, **Roger Gamble**; photo 33, **Bill Goodchild**; photo 43 bottom, 60, **Susan Hind**; photo 2, 34 top, 42 right, 48, 49, 75, 81, 103, 122, 124, 157, 160, **Jarrold, Norwich**; photo 43 center (2 pictures), 52 top, 67, 68, **Neil Jinkerson**; photo 9, 40, 189—193, by courtesy of **Kodak Limited**; photo 72—74, 83 **Jack Oakley**; photo 58, **Andrew T. Paton**; photo 71, **Ted Rule**; photo 125—130, **Peter Scoones/Seaphot**; photo 89, 91, 96, **Ian Shaw**; photo 138, **Robin Smith Photography Limited**; photo 69, **Richard Tilbrook**; photo 159 **Tony Tilford**; photo 97, **Geoffrey Unwin**; photo 31, 91, **Patrick Walmsley**; photo 44, 90, 94, **John Ward**.

Grateful thanks are also due to:

Canon Incorporated, for the illustration of the Canon A-1 appearing on page 39;

Jean Churchyard, for her artistic arrangement of the flowers for the photographs 183;

George Elliott and Sons Limited, The United Kingdom importers of Compur and Prontor shutters, for the photographs of the Prontor Electronic shutter on page 32;

Norwich Camera Centre, for allowing us on numerous occasions to photograph cameras and other equipment from their stock;

Trevor Weinle of Exposure Camera Service, Norwich, for his frequent advice and help on the technicalities of camera mechanisms;

Dougal Dixon, for editing the text.

And last, but not least, thanks to our wives **Margaret** and **May**, for their forbearance and understanding over the two-year period during which we were preparing the contents of this book.

(DIN,
Industrie-Norm —

Deutsche
).

18 = 50 , 21 = 100

— dyop,

(1 ;)

+ 2

0,5

(1,5).

().

(, ,) . ,
 ,
 . ,
 ,
 . , ,
 , ,
 () -
 , ,)
 ,
 (« »),
 ,
 -
 ,
 — ,
 , , ,
 ,
 2 , . . .
 ,
 ,
 , , —
 ,
 (,),
 ,
 , ,
 ,
 , . . . ,
 ,
 ,

1/500 .

()

()

5 / .

(-) ,
(-)

(-

),

-

,

,

;

, 1. - ,

2. ,

;

()

« »
(180°).

18%,

« »

TTL,

(),

(),

« - » (),

1°.

45—65° ,
75°
30°

5—32

()

400—10

f f.

()

()

()

5500

; ().

60°.

(),

(),

().

(),

—	11, 16	.	106	-	11	172	70	-
—		-	9	-				215
—	11	-				371		34
						207		38, 39
			64		202		156	-
	179							-
	27				31		156	-
				62		213		-
	13				—			156
	215		9			213		-
	12						198	10
								-
	127							-
						(-
85				59)		96
					18			71
				60			198	26
	17		214					
— «	»	37	214				9	
			214					
111					19		—	9
	66		244		78		—	10
				1,15	—		80	10
					—		—	
			15		78			16
(—	78		45
)	102		15		—			29
						80		253
	74				—		—	253
		(29		80		23
				9			80	9
)	67,71,212,230		17		—	80	78	—
					—			9
	73		108		—	78		9
	72				—			105
—	72		110		—			109
				(83		-
)				-
	17		98			81		104
—					«			-
	35				»			-
	12, 16, 18,					69		13
66			26		«			-
—	16			28	»	193		11
				28				-
20								-

	«			—	45	—	(-
	»	243		34	45)	14
«		»	64	-	45			-
TTL-	39		16	—	-	45,	102	
				-	46			100
	203			16				
—	204			-	257			
	11		17, 26	—		-		-
					196			45
202		(—		-	26, 29	
145)	17,25		-		
				-	247			
	48, 102		27	—	234			177
				—	234	—		177,210
104			27	—		-		39
	178		(-	234			56
		85)	17,29	—	241	—	64
11			45	—		-	—	
		—		-		241		57
11			48					
	55	—		45				56
	53	—		45	9, 12			-
		—		-	12			-
	34		45	—		(57
		—		-)	12	-
	38		46	—		(28
		—		45)	12	-
	36	—		50				28

5
7

9
9
12
15

16

19

26
26
29
31

34
34
36
38
40

45
45
46
51
53

56
56
57
57
58
61

66
66
67

71
72
73
74
77

277

78

78

78

81

83

84

-

85

89

89

93

96

96

98

(

)

100

106

108

110

112

112

?

127

132

142

143

149

156

156

158

163

171

-

171

173

176

179

185

188

191

193 «

»

193

193

195

198

198

278

202.
203
206
207
208
210
212

213
213
216
218
220
222
227
228
229
230

233
233

234
234
240
241
241
243
246

« »

253
253
255
257

261
275

!

129820, , -110, , 1- , 2,
« ».

5261

6.12.84

3.09.85

80 X 100¹/₁₆

8,75 25,90

. 105,64. 25,51

. 20/3464

50000 1434. 4 . 80 .

« »

129820, , -110,

1- , 2.

. 170024, .

, 5.