

# Stopwatch and Timer Calibrations



Jeff C. Gust  
Robert M. Graham  
Michael A. Lombardi

**NIST**  
National Institute of  
Standards and Technology  
Technology Administration  
U.S. Department of Commerce

Special  
Publication  
960-12



# NIST Recommended Practice Guide

Special Publication 960-12

# Stopwatch and Timer Calibrations

Jeff C. Gust  
Quametec Corporation

Robert M. Graham  
Sandia National Laboratories

Michael A. Lombardi  
National Institute of Standards and Technology

Physics Laboratory

May 2004



**U.S. Department of Commerce**

Donald L. Evans, Secretary

**Technology Administration**

Phillip J. Bond, Under Secretary for Technology

**National Institute of Standards and Technology**

Arden L. Bement, Jr., Director

Certain commercial entities, equipment, or materials may be identified in this document in order to describe an experimental procedure or concept adequately. Such identification is not intended to imply recommendation or endorsement by the National Institute of Standards and Technology, nor is it intended to imply that the entities, materials, or equipment are necessarily the best available for the purpose.

---

National Institute of Standards and Technology  
Special Publication 960-12  
Natl. Inst. Stand. Technol.  
Spec. Publ. 960-12  
57 pages (May 2004)  
CODEN: NSPUE2

U.S. GOVERNMENT PRINTING OFFICE  
WASHINGTON: 2004

For sale by the Superintendent of Documents  
U.S. Government Printing Office  
Internet: [bookstore.gpo.gov](http://bookstore.gpo.gov) Phone: (202) 512-1800 Fax: (202) 512-2250  
Mail: Stop SSOP, Washington, DC 20402-0001

## FOREWORD

Stopwatch and timer calibrations are perhaps the most common calibrations performed in the field of time and frequency metrology. Hundreds of United States laboratories calibrate many thousands of timing devices annually to meet legal and organizational metrology requirements. However, until now, no definitive text has existed on the subject. This *NIST Recommended Practice Guide* was created to fill a gap in the metrology literature. It assists the working metrologist or calibration technician by describing the types of stopwatches and timers that require calibration, the specifications and tolerances of these devices, the methods used to calibrate them, and the estimated measurement uncertainties for each calibration method. It also discusses the process of establishing measurement traceability back to national and international standards.



## **ACKNOWLEDGMENTS**

The authors thank the following individuals for their extremely useful suggestions regarding this manuscript: Georgia Harris and David Smith of NIST, Ross Andersen of the New York Bureau of Weights and Measures, Jim Jenkins of Quametec Corporation, and Warren Lewis and Dick Pettit of Sandia National Laboratories.\*

---

\* Sandia is a multiprogram laboratory operated by Sandia Corporation, a Lockheed Martin Company, for the United States Department of Energy's National Nuclear Security Administration under Contract DE-AC04-94AL85000.





**TABLE OF CONTENTS**

<i>List of Figures</i> .....	<i>ix</i>
<i>List of Tables</i> .....	<i>x</i>
<b>1. Introduction to Stopwatch and Timer Calibrations</b> .....	<b>1</b>
<b>1.A. The Units of Time Interval and Frequency</b> .....	<b>1</b>
<b>1.B. A Brief Overview of Calibrations</b> .....	<b>3</b>
<b>1.C. Traceability and Coordinated Universal Time (UTC)</b> .....	<b>5</b>
<b>2. Description of Timing Devices that Require Calibration</b> .....	<b>9</b>
<b>2.A. Stopwatches</b> .....	<b>9</b>
<b>2.A.1. Basic Theory of Operation</b> .....	<b>11</b>
<b>2.B. Timers</b> .....	<b>13</b>
<b>2.C. Commercial Timing Devices</b> .....	<b>14</b>
<b>3. Specifications and Tolerances</b> .....	<b>15</b>
<b>3.A. Interpreting Manufacturer's Specifications</b> .....	<b>15</b>
<b>3.B. Tolerances Required for Legal Metrology</b> .....	<b>19</b>
<b>4. Calibration Methods</b> .....	<b>21</b>
<b>4.A. Direct Comparison Method</b> .....	<b>21</b>
<b>4.A.1. References for Direct Comparison Method</b> .....	<b>21</b>
<b>4.A.2. Calibration Procedure for Direct Comparison Method</b> .....	<b>25</b>
<b>4.B. Totalize Method</b> .....	<b>27</b>
<b>4.C. Time Base Method</b> .....	<b>29</b>

## ◆ Stopwatch and Timer Calibrations

<b>5. Measurement Uncertainty .....</b>	<b>35</b>
<b>5.A. Uncertainties of Direct Comparison Method .....</b>	<b>35</b>
<b>5.A.1. Uncertainty of the Traceable             Time Interval Reference .....</b>	<b>35</b>
<b>5.A.2. Uncertainty Due to Human             Reaction Time .....</b>	<b>37</b>
<b>5.A.3. Device Under Test (DUT)             Resolution Uncertainty .....</b>	<b>39</b>
<b>5.A.4. Uncertainty Analysis .....</b>	<b>39</b>
<b>5.B. Uncertainties of Totalize Method .....</b>	<b>41</b>
<b>5.B.1. Uncertainty of the Frequency Input .....</b>	<b>41</b>
<b>5.B.2. Uncertainty Due to Human             Reaction Time .....</b>	<b>41</b>
<b>5.B.3. Uncertainty Due to the Counter .....</b>	<b>43</b>
<b>5.B.4. Device Under Test (DUT)             Resolution Uncertainty .....</b>	<b>44</b>
<b>5.C. Uncertainties of Time Base Method .....</b>	<b>45</b>
<b>5.D. Uncertainty Analysis of Using a Calibrated         Stopwatch to Calibrate Another Device .....</b>	<b>45</b>
<b>5.E. Adequacy of Calibration Method to         Meet the Required Uncertainty .....</b>	<b>46</b>
<b>Appendix A: Calibration Certificates .....</b>	<b>49</b>
<b>References .....</b>	<b>51</b>

**List of Figures**

Figure 1. The calibration and traceability hierarchy .....	6
Figure 2. Type I digital stopwatch .....	9
Figure 3. Type II mechanical stopwatch .....	9
Figure 4. Interior of digital (Type I) stopwatch .....	11
Figure 5. Inner workings of mechanical (Type II) stopwatch or timer .....	12
Figure 6. A collection of timers .....	13
Figure 7. Sample specifications for stopwatch (Example 1) .....	16
Figure 8. Sample specifications for stopwatch (Example 2) .....	18
Figure 9. Typical performance of quartz wristwatches using 32 768 Hz time base oscillators .....	19
Figure 10. Portable shortwave radio receiver for reception of audio time signals .....	23
Figure 11. Block diagram of the Totalize Method .....	28
Figure 12. Using the start-stop button of the stopwatch to start the counter .....	29
Figure 13. Time base measurement system for stopwatches and timers .....	30
Figure 14. Reaction time measurements (four operators, ten runs each) for the Direct Comparison Method .....	37
Figure 15. Averaging measurement results for four different operators .....	38
Figure 16. Reaction time measurements (four operators, ten runs each) for the Totalize Method .....	42
Figure 17. Mean reaction times (four operators, ten runs each) for the Totalize Method .....	43
Figure A1. Sample calibration certificate, page 1 .....	49
Figure A2. Sample calibration certificate, page 2 .....	50

## ◆ Stopwatch and Timer Calibrations

### **List of Tables**

Table 1: Prefixes (May Be Applied to All SI Units) .....	2
Table 2: Unit Values, Unit Less Values, and Percentages .....	4
Table 3: Type I and Type II Stopwatches .....	10
Table 4: Comparison of Calibration Methods .....	21
Table 5: Traceable Audio Time Signals .....	22
Table 6: The Contribution of 300 ms Variation in Reaction Time to the Measurement Uncertainty .....	26
Table 7: The Effect of Averaging Time on Stability .....	31
Table 8: Uncertainty Analysis for Direct Comparison Method (Digital DUT) Using Land Line .....	40
Table 9: Uncertainty Analysis for Direct Comparison Method (Digital DUT) Using Cell Phone .....	40
Table 10: Uncertainty Analysis for Direct Comparison Method (Analog DUT) Using Land Line .....	41
Table 11: Uncertainty Analysis for Totalize Method .....	44
Table 12: Uncertainty Analysis of Using a Calibrated Stopwatch to Calibrate Another Device .....	46

# 1. INTRODUCTION TO STOPWATCH AND TIMER CALIBRATIONS

This document is a recommended practice guide for stopwatch and timer calibrations. It discusses the types of stopwatches and timers that require calibration, the specifications and tolerances of these devices, and the methods used to calibrate them. It also discusses measurement uncertainties and the process of establishing measurement traceability back to national and international standards.

This guide is intended as a reference for the metrologist or calibration technician. It attempts to provide a complete technical discussion of stopwatch and timer calibrations by presenting practical, real world examples of how these calibrations are performed.

This guide is divided into five sections. Section 1 provides an overview, Section 2 describes the types of timing devices that require calibration, Section 3 discusses specifications and tolerances, Section 4 discusses calibration methods, and Section 5 discusses measurement uncertainties. A sample calibration report and references are provided in the appendices. We'll begin Section 1 by introducing and defining the terminology used throughout the rest of this guide.

## 1.A. The Units of Time Interval and Frequency

Stopwatches and timers are instruments used to measure *time interval*, which is defined as the elapsed time between two events. One common example of a time interval is our age, which is simply the elapsed time since our birth. Unlike a conventional clock that displays *time-of-day* as hours, minutes, and seconds from an absolute epoch or starting point (such as the beginning of the day or year), a stopwatch or timer simply measures and displays the time interval from an arbitrary starting point that began at the instant the stopwatch was started.

The standard unit of time interval is the *second* (s). Seconds can be accumulated to form longer time intervals, such as minutes, hours, and days; or they can be sliced into fractions of a second such as milliseconds ( $10^{-3}$  s, abbreviated as ms) or microseconds ( $10^{-6}$  s, abbreviated as  $\mu$ s). Table 1 lists these and other prefixes that can be used with seconds, as well as the multipliers and symbols used to represent them. The second is one of the seven base units in the International System of Units (SI). Other units (most notably the meter and the volt) have definitions that depend upon the definition of the second.

## ◆ Stopwatch and Timer Calibrations

Table 1: Prefixes (May Be Applied to All SI Units)

Multiples and Submultiples	Prefix	Symbol
1 000 000 000 000 = $10^{12}$	tera	T
1 000 000 000 = $10^9$	giga	G
1 000 000 = $10^6$	mega	M
1 000 = $10^3$	kilo	k
1 = $10^0$		
0.001 = $10^{-3}$	milli	m
0.000 001 = $10^{-6}$	micro	$\mu$
0.000 000 001 = $10^{-9}$	nano	n
0.000 000 000 001 = $10^{-12}$	pico	p
0.000 000 000 000 001 = $10^{-15}$	femto	f

The SI defines the second based on a property of the cesium atom, and for this reason, *cesium oscillators* are regarded as primary standards for both time interval and frequency. A second is defined as the time interval required for 9 192 631 770 transitions between two energy states of the cesium atom to take place. The atomic definition of the second, together with current technology, allows it to be measured with much smaller uncertainties than any other SI unit. In fact, NIST can currently measure a second with an uncertainty of about 1 part in  $10^{15}$ , or about 1 billion ( $10^9$ ) times smaller than the uncertainties required for the calibrations described in this guide!

The *resolution* of a stopwatch or timer represents the smallest time interval that the device can measure or display. Resolution is related to the number of digits on the device's display for a digital stopwatch or the smallest increment or graduation on the face of an analog stopwatch. For example, if a stopwatch display shows two digits to the right of the decimal point, it has a resolution of 0.01 s (10 ms, or 1/100 of a second). This means, for example, that it can display a value of 42.12 s or 42.13 s but that it lacks the resolution to display 42.123 s. Resolution of 10 ms is

common for digital stopwatches, but some devices might have 1 ms resolution (0.001 s), or even smaller. For analog stopwatches, a common resolution is 1/5 of a second, or 0.2 s.

Although stopwatches and timers measure time interval, they do so by using a *frequency* source. Frequency is the rate of a repetitive event, defined as the number of events or cycles per second. The standard unit of frequency ( $f$ ) is the hertz (Hz), which is not a base unit of the SI but one of the 21 derived SI units. One hertz equals 1 event per second, one kilohertz (kHz) equals  $10^3$  events per second, one megahertz (MHz) equals  $10^6$  events per second, and so on. The *period* ( $T$ ) is the reciprocal of the frequency,  $T = 1/f$ . For example, a 1 MHz sine wave would produce  $10^6$  cycles per second, or one cycle every microsecond.

A *time base* oscillator (sometimes called a clock or reference oscillator) produces the frequency signals used by the stopwatch or timer to measure intervals. In today's devices, the time base oscillator is nearly always a quartz crystal oscillator. However, older devices might use a mechanical oscillator, the AC line frequency (60 Hz in the United States), or an oscillator based on a tuned electronic circuit as their frequency source. The time base oscillator serves as the reference for all of the time and frequency functions performed by the device. The most common frequency used by quartz time base oscillators is 32 768 ( $= 2^{15}$ ) Hz. In this case, when the stopwatch or timer has counted 32 768 oscillations of its time base oscillator, it then records that 1 s has elapsed. If you want to think of this time base oscillator as a clock, it “ticks” 32 768 times per second, or once every 30.52  $\mu$ s.

Throughout this guide, we'll discuss time interval in units of seconds (or fractions of a second) and frequency in units of hertz (or multiples of a hertz). However, when we discuss measurement uncertainties, we'll typically use dimensionless values that represent a fractional percentage error. Since these dimensionless values are often very small percentages, they are often expressed in scientific notation. For example, if a stopwatch has an uncertainty of 1 s over an interval of 10 000 s, we can list the uncertainty either as a percentage (0.01 %) or as the dimensionless value of  $1 \times 10^{-4}$ . Table 2 provides more examples.

## 1.B. A Brief Overview of Calibrations

Like all calibrations, stopwatch and timer calibrations are simply comparisons between the device under test (DUT) and a measurement reference, or *standard*. When we calibrate a stopwatch or timer,

## ◆ Stopwatch and Timer Calibrations

Table 2: Unit Values, Unit Less Values, and Percentages

Time Uncertainty	Length of Test	Dimensionless Uncertainty (Literal)	Dimensionless Uncertainty (Scientific Notation)	Percentage Uncertainty
1 s	1 minute	1 part per 60	$1.67 \times 10^{-2}$	1.67 %
1 s	1 hour	1 part per 3600	$2.78 \times 10^{-4}$	0.027 8 %
1 s	1 day	1 part per 86 400	$1.16 \times 10^{-5}$	0.001 16 %
1 s	100 s	1 part per hundred	$1 \times 10^{-2}$	1 %
1 s	1000 s	1 part per thousand	$1 \times 10^{-3}$	0.1 %
1 s	10 000 s	1 part per 10 thousand	$1 \times 10^{-4}$	0.01 %
1 s	100 000 s	1 part per 100 thousand	$1 \times 10^{-5}$	0.001 %
1 ms	100 s	1 part per 100 thousand	$1 \times 10^{-5}$	0.001 %
1 ms	1000 s	1 part per million (1 ppm)	$1 \times 10^{-6}$	0.000 1 %
1 ms	10 000 s	1 part per 10 million	$1 \times 10^{-7}$	0.000 01 %
1 ms	100 000 s	1 part per 100 million	$1 \times 10^{-8}$	0.000 001 %

we can use either a time interval standard or a frequency standard as our measurement reference. If a time interval standard is used, it is compared to the DUT's display. If a frequency standard is used, it is compared to the DUT's time base oscillator. Both types of comparisons are described in detail in Section 4.

Most of the calibrations described in this guide are *laboratory calibrations*, as opposed to *field calibrations*. To understand what this means, consider an example where a stopwatch is calibrated in the laboratory against a reference, and a calibration certificate or sticker is issued. That same stopwatch or timer can then be used as a *transfer standard* to make a *field calibration*. It can be brought outside the laboratory and used to calibrate a parking meter, for example. The same basic principles that apply to laboratory calibrations apply to



field calibrations, although laboratory calibrations generally take longer and are made much more carefully because the required measurement uncertainties are smaller. Devices that are field calibrated are generally not used as a reference for other calibrations. Instead, they are working instruments used for business or legal purposes. Therefore, their calibration can be thought of as a periodic test or inspection that ensures that these devices are working properly and meeting their specifications.

Common sense tells us that the reference for any calibration (either the laboratory reference or the transfer standard brought into the field) must always outperform the devices it needs to test. A parking meter, for example, might have an acceptable uncertainty of 1 % when timing a 5 min interval ( $\pm 3$  s). A stopwatch brought into the field to test the parking meter should be certified to an uncertainty small enough so that it contributes no significant uncertainty to the parking meter calibration. In other words, we need to be able to trust our reference so that we can trust our measurement of the DUT.

When a laboratory calibration is completed, the metrologist has determined the offset<sup>1</sup> of the DUT with respect to the reference. This offset can be stated as a percentage or in units of time interval or frequency (or both) on the calibration certificate, and it should be quantified with a statement of measurement uncertainty, as discussed in Section 5. Field calibrations are generally “go/no-go” calibrations. This means that the device is tested to see whether it meets its intended or legal metrology requirements, and it either passes or fails. If it fails, it is removed from service until it can be adjusted, repaired or replaced.

### 1.C. Traceability and Coordinated Universal Time (UTC)

As previously discussed, when we calibrate a device by comparing it to a reference, the reference must be more accurate than the DUT. Otherwise, our measurement results will be false. How do we know the accuracy of our reference? The answer is we don't, unless the reference has been compared to a more accurate reference. That more accurate reference needs to be periodically compared to an *even more accurate* reference, and so on, until eventually a comparison is made against a national or international standard that represents the best physical realization of the SI unit we are trying to measure (in this case, the SI second). This measurement traceability hierarchy is sometimes

---

<sup>1</sup> The term “offset” is commonly used in the discipline of frequency and time measurement and will be used throughout this text. In terms of the *ISO Guide to the Expression of Uncertainty in Measurement*, the offset would be considered the measurand.

## ◆ Stopwatch and Timer Calibrations

illustrated with a pyramid as shown in Figure 1. The series of comparisons back to the SI unit is called the *traceability chain*. Traceability itself is defined, by international agreement, as:

*The property of a result of a measurement or the value of a standard whereby it can be related to stated references, usually national or international standards, through an unbroken chain of comparisons all having stated uncertainties.<sup>[1,2]</sup>*

The definition of traceability implies that unless the measured value is accompanied by a stated uncertainty, the traceability chain is broken. It is the responsibility of the calibration laboratory to ensure that it determines and reports the uncertainty of its measurements so that traceability is maintained.

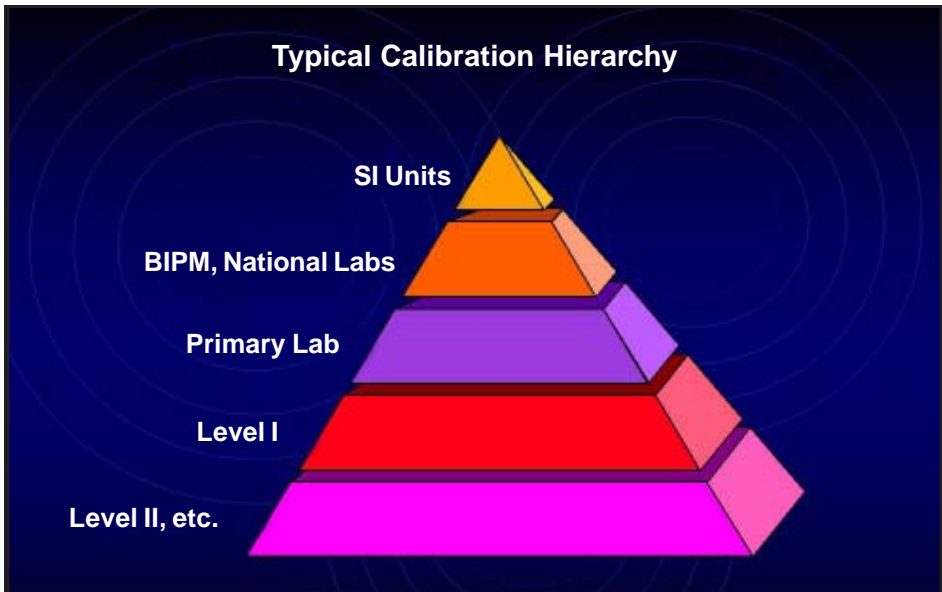

*Figure 1. The calibration and traceability hierarchy.*

The International Bureau of Weights and Measures (BIPM) located near Paris, France, is responsible for ensuring the worldwide uniformity of measurements and their traceability to the SI. The BIPM collects and averages time interval and frequency data from about 50 laboratories around the world and creates a time scale called Coordinated Universal Time (UTC) that realizes the SI second as closely as possible, and it serves as the international standard for both time interval and frequency. However, UTC is not a physical representation of the second, it's

simply a calculated average. The laboratories that provide data to the BIPM maintain the oscillators and clocks that produce the signals. These laboratories are known as national metrology institutes (NMIs), and they serve as the caretakers of the ultimate measurement references for their countries. Thus, to establish traceability to the SI for time interval and frequency calibrations, the traceability chain for a measurement must link back to an NMI that in turn periodically submits data to the BIPM.

The National Institute of Standards and Technology (NIST) is the ultimate reference point for most measurements made in the United States, and, as such, it submits time and frequency data to the BIPM. NIST provides its own real-time representation of UTC, called UTC(NIST), that it distributes to the public using a variety of radio, telephone, and internet signals. These signals are described in more detail in Section 4 and can serve as references for measurements traceable back to the SI.

The traceability chain is easy to visualize if you think of it as a series of comparisons. Every link in the chain is a comparison; comparing a device to a higher reference until eventually you make a comparison to the SI unit. Every comparison has some measurement uncertainty. At the top of the chain, the measurement uncertainties are so tiny they are insignificant to those of us who calibrate stopwatches and timers. For example, the difference between the best possible estimate of the SI second and UTC(NIST) is measured in parts in  $10^{15}$ . This represents a time offset of about 0.1 ns ( $10^{-10}$  s) over the course of a day. As we move down the chain to the actual calibration of a stopwatch or timer, the uncertainties become larger and larger. For example, if we use an audio signal from NIST's radio station, WWV (Section 4), the uncertainty of the received tones might be 1 ms. This uncertainty is still small enough for the WWV tones to be used as a stopwatch calibration reference, because the uncertainty introduced by an operator starting and stopping the watch (human reaction time) is much larger, typically tens or even hundreds of milliseconds (see Section 5). As long as each link of the chain and its uncertainty are known, traceability to the SI can be established.

Stopwatch and timer calibrations are among the least demanding of all time and frequency measurements. Relatively speaking, the instruments requiring calibration are low cost, and the acceptable measurement uncertainties can be quite large. Even so, for both legal and practical reasons, it is very important to establish traceability to the SI. If a traceability chain is established, it ensures that the working device was properly calibrated, and if correctly used, it will produce valid results.



## 2. DESCRIPTION OF TIMING DEVICES THAT REQUIRE CALIBRATION

This section describes the various types of stopwatches (Section 2.A.) and timers (Section 2.B.) that are calibrated in the laboratory. The devices described in 2.A. and 2.B. are often used as transfer standards to make field calibrations of the commercial timing devices described in section 2.C.

### 2.A. Stopwatches

Stopwatches can be classified into two categories, Type I and Type II.<sup>[3]</sup> In general, stopwatches are classified as Type I if they have a digital design employing quartz oscillators and electronic circuitry to measure time intervals (Figure 2). Type II stopwatches have an analog design and use mechanical mechanisms to measure time intervals (Figure 3). Key elements of Type I and Type II stopwatches are summarized in Table 3.



*Figure 2. Type I digital stopwatch.*



*Figure 3. Type II mechanical stopwatch.*

## ◆ Stopwatch and Timer Calibrations

Table 3: Type I and Type II Stopwatches

Description	Type I Stopwatch	Type II Stopwatch
Operating Principle	Time measured by division of time base oscillator	Time measured by mechanical movement
Time Base	<ul style="list-style-type: none"> <li>Quartz oscillator</li> </ul>	<ul style="list-style-type: none"> <li>Mechanical mainspring</li> <li>Synchronous motor, electrically driven</li> </ul>
Case	<ul style="list-style-type: none"> <li>Corrosion-resistant metal</li> <li>Impact-resistant plastic</li> </ul>	
Crystal	<ul style="list-style-type: none"> <li>Protects display</li> <li>Allows for proper viewing</li> <li>May be tinted</li> <li>May employ magnification</li> </ul>	<ul style="list-style-type: none"> <li>Protects dial/hands</li> <li>Allows for proper viewing</li> <li>Must be clear and untinted</li> </ul>
Minimum Time Interval	<ul style="list-style-type: none"> <li>48 h without replacement of battery</li> </ul>	<ul style="list-style-type: none"> <li>3 h without rewinding</li> </ul>
Start and Stop	<ul style="list-style-type: none"> <li>Single control to start/stop</li> <li>Audible signal of start/stop</li> </ul>	
Reset	<ul style="list-style-type: none"> <li>Must reset stopwatch to zero</li> </ul>	
Split Time (if equipped)	<ul style="list-style-type: none"> <li>Must indicate whether display mode is regular or split time.</li> </ul>	
Force to Operate Controls	<ul style="list-style-type: none"> <li>Must not exceed 1.8 N (0.4046 lbf)</li> </ul>	
Dial and Hands		<ul style="list-style-type: none"> <li>Face must be white</li> <li>Graduations must be black or red</li> <li>Hands must be black or red</li> </ul>
Required Markings	<ul style="list-style-type: none"> <li>Unique, nondetachable serial number</li> <li>Manufacturer's name or trademark</li> <li>Model number (Type I only)</li> </ul>	
Digital Display	<ul style="list-style-type: none"> <li>Provide delimiting character for hours, minutes, seconds (usually colon)</li> </ul>	
Minimum Increment	<ul style="list-style-type: none"> <li>0.2 s</li> </ul>	
Minimum Elapsed Time at Rollover	<ul style="list-style-type: none"> <li>1 h</li> </ul>	<ul style="list-style-type: none"> <li>30 min</li> </ul>
Physical Orientation	<ul style="list-style-type: none"> <li>Stopwatch meets tolerance regardless of physical orientation</li> </ul>	

### 2.A.1. Basic Theory of Operation

Every stopwatch is composed of four elements: a power source, a time base, a counter, and an indicator or display. The design and construction of each component depends upon the type of stopwatch.

**Digital (Type I) Stopwatches** — The power source of a type I stopwatch is usually a silver cell or alkaline battery, which powers the oscillator, counting and display circuitry. The time base is usually a quartz crystal oscillator, with a nominal frequency of 32 768 Hz ( $2^{15}$  Hz). Figure 4 shows the inside of a typical device, with the printed circuit board, quartz crystal oscillator, and battery visible. The counter circuit consists of digital dividers that count the time base oscillations for the period that is initiated by the start/stop buttons.<sup>[4,5]</sup> The display typically has seven or eight digits.

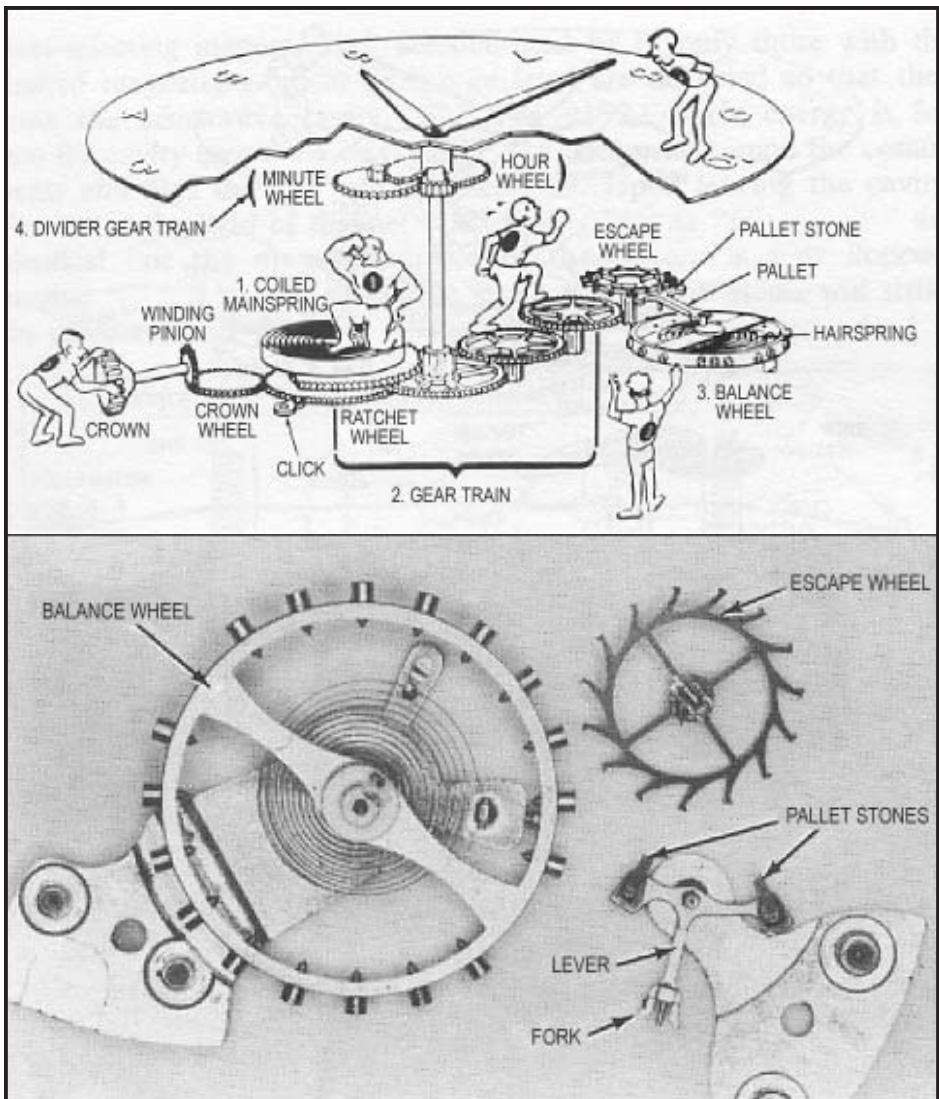

*Figure 4. Interior of digital (Type I) stopwatch.*

**Mechanical (Type II) Stopwatches** — For the traditional mechanical stopwatch, the power source is a helical coil spring, which stores energy obtained from the person winding the spring. The time base is usually a balance wheel that functions as a torsion pendulum. The rate at which the spring unwinds is governed by the balance wheel, which is designed

## ◆ Stopwatch and Timer Calibrations

to provide a consistent period of oscillation, relatively independent of factors such as friction, temperature, and orientation. In most mechanical stopwatches, the balance wheel is designed to oscillate at 2.5 periods per second, and produces five “ticks” or beats per second. The balance wheel is connected to an escapement which meters the unwinding of the coil spring and provides impulses that keep the balance wheel moving. It is this metered unwinding of the coil spring that drives the counter indicator. In this type of device, the counter is composed of



**Figure 5.** Inner workings of mechanical (Type II) stopwatch or timer:



a gear train that divides the speed of rotation of the escapement wheel to the appropriate revolution speed for the second, minute and hour hands. The time interval from the counter is displayed either on a face across which the second and minutes hands sweep, or on a series of numbered drums or discs that indicate the elapsed time (Figure 5).<sup>[4]</sup>

Another form of the Type II stopwatch uses a timer driven by a synchronous motor that also drives the hands or numbered wheels. For this device, the power source is the 60 Hz AC line voltage. The power source drives an electric motor within the timing device. The time base is derived from the controlled regulation of the 60 Hz frequency of AC electric power as supplied by the power utility company. The frequency limits for distributed AC power in the United States is 59.98 Hz to 60.02 Hz, or  $60 \text{ Hz} \pm 0.033 \%$  of the nominal value; however the actual frequency control is much more accurate than this, in order to advance or retard the grid frequency to synchronize the power distribution system.<sup>[6]</sup> The counter and display circuitry are similar to the mechanical stopwatches previously discussed.

## 2.B. Timers

Timers, unlike stopwatches, count down from a preset time period instead of counting up from zero. They can be small, battery-operated devices that are used to signal when a certain time period has elapsed, or they can be larger devices that plug into a wall outlet and control other items (Figure 6). A parking meter is an example of a countdown timer. Inserting a coin starts the internal timer counting down from an initial preset point. When the time has elapsed, the “EXPIRED” flag is raised.



*Figure 6. A collection of timers.*

## ◆ Stopwatch and Timer Calibrations

One type of timer used extensively in industry is the process control timer. As their name implies, these devices measure or control the duration of a specific process. For example, when a product is made, it may need to be heat treated for a specific length of time. In an automated manufacturing system, the process control timer determines the amount of time that the item is heated. In some applications, such as integrated circuit manufacturing, the timing process can be critical for proper operation.

Process control timers are also used in many different types of laboratory environments. Calibration laboratories use timers to calibrate units such as radiation detectors, where they regulate the amount of time the detector is exposed to the radiation source. Any uncertainty in the time of exposure directly influences the uncertainty of the detector calibration.

Timers are also used in the medical field. For example, medical laboratories use process control timers when specimen cultures are grown. Hospitals use timers to regulate the amount of medication given to patients intravenously.

### **2.C. Commercial Timing Devices**

Many types of timing devices are used every day in commercial applications. Parking meters, automatic car wash facilities, taxicab meters, and commercial parking lots are examples of entities that either charge a certain amount for a specified period or provide a certain period of service for a specified amount.

The calibration requirements and allowable tolerances are usually determined on a state-by-state basis by state law or locally by city or municipality ordinances. The allowable uncertainties are often 1 % or larger. Generic guidance is provided in Section 3.

### 3. SPECIFICATIONS AND TOLERANCES

Whether we are developing a calibration procedure, or performing an uncertainty analysis for a given calibration process, we need to be able to understand and interpret the specifications and tolerances for both the DUT and the test equipment associated with the calibration. This section reviews both manufacturer's specifications and specifications required of stopwatches and timing devices for legal metrology applications.

#### 3.A. Interpreting Manufacturer's Specifications

When reviewing specification sheets, it quickly becomes obvious that not all instrument manufacturers specify their products in the same way. This section defines and describes the most common types of specifications quoted for stopwatches and timing devices.

**Absolute Accuracy Specifications** — The absolute accuracy<sup>2</sup> of an instrument is the maximum allowable offset from nominal. Absolute accuracy is defined in either the same units or a fractional unit quantity of the measurement function for an instrument. For example, the absolute accuracy of a ruler might be specified as  $\pm 1$  mm for a scale of 0 to 15 cm.

In the case of timing devices, it isn't useful to provide an absolute accuracy specification by itself. This is because a device's time offset from nominal will increase as a function of time. If the timing device were able to measure an infinite time interval, the offset (or difference in time from nominal) of the device would also become infinitely large. Because of this, when timing devices are specified with an absolute accuracy number, it is also accompanied by a time interval for which this specification is valid. An example of this is the specifications for the stopwatch shown in Figure 7, specified with an absolute accuracy of 5 s per day.

If the stopwatch in Figure 7 were used to measure a longer time interval, we could determine a new absolute accuracy figure by simply multiplying the original specification by the desired time interval. For example, 5 s per day becomes 10 s per two days, 35 s per week, and so on.

---

<sup>2</sup> In this section, the term "accuracy" is used in order to allow the reader to correlate the concepts of this chapter directly with published manufacturer specifications. In terms of the *ISO Guide to the Expression of Uncertainty in Measurement*, the quantities associated with accuracy are understood to be uncertainties.

## ◆ Stopwatch and Timer Calibrations

- Handsome stopwatch with large display provides timing to 1/100th of a second over a range of 9 hours 59 minutes and 59.99 seconds.
- Accurate to  $\pm 5$  s/day.
- Built-in memory recalls up to ten laps.
- Clock function (12 or 24 hour) features a programmable alarm with an hourly chime plus built-in calendar displays day, month and date.
- Countdown timer function features input ranges from one minute to 9 hours, 59 minutes.
- Dimensions/Weight:  
2.5×3.2×.8 in (63×81×20 mm);  
2.8 oz.
- Water resistant housing is complete with lithium battery.



*Figure 7. Sample specifications for stopwatch (Example 1).*

While it is usually acceptable to multiply the absolute accuracy by time intervals longer than the period listed in the specifications, we must use caution when dividing the absolute accuracy specification for periods of time shorter than the period listed in the specifications. If we divide the absolute accuracy specification for shorter measurement periods, a new source of uncertainty, the resolution uncertainty of the instrument, becomes important to consider. For example, if we try to determine the accuracy of the stopwatch of Figure 7 for a period of 30 s, we can compute the absolute accuracy as follows:

$$\frac{5 \text{ s}}{\text{day}} \times 30 \text{ s} = \frac{5 \text{ s}}{\text{day}} \times \frac{1}{2880} \text{ day} = 0.0017 \text{ s}$$

However, we can see from the specifications in Figure 7 that the stopwatch has a resolution of 1/100 of a second, or 0.01 s. In this case, the computation of the absolute accuracy results in a number that is almost 10 times smaller than the smallest value the stopwatch can display. Most manufacturers of timing devices do not consider the resolution of the product in their specifications, so we will discuss resolution uncertainty further in Section 5.

**Relative Accuracy Specifications** — While absolute accuracy specifications are helpful, sometimes it is more desirable to specify accuracy relative to the measured time interval. This makes its significance easier to understand. For this purpose, we define a quantity called relative accuracy:

$$\text{Relative Accuracy} = \frac{\text{Absolute Accuracy}}{\text{Measured Time Interval}}$$

Using our previous example of the stopwatch specifications from Figure 7, the stopwatch has an accuracy specification of 5 s per day, so the relative accuracy is:

$$\begin{aligned} \text{Relative Accuracy} &= \frac{5 \text{ s}}{1 \text{ day}} = \frac{5 \text{ s}}{86\,400 \text{ s}} = 0.000\,058 \\ &= 0.0058 \% = 5.8 \times 10^{-5} \end{aligned}$$

Note that since the accuracy specification and the measured time interval are both expressed in seconds, the unit cancels out, leaving us with a dimensionless number which can be expressed either as a percentage or in scientific notation. Relative accuracy specifications can also be converted back to absolute time units if necessary. For example, Figure 8 shows the manufacturer's specifications for a stopwatch accurate to 0.0003 % (although not stated, it is assumed this percentage has been stated as a percent of reading). To compute the time accuracy for a 24 h measurement, we simply multiply the relative accuracy by the measurement period:

$$0.0003 \% \times 24 \text{ h} = 0.000\,072 \text{ h} = 0.2592 \text{ s}$$

This computation shows that this stopwatch is capable of measuring a 24 h period with an accuracy of about 0.26 s. However, once again it is important to note that when measuring small time intervals, the resolution

## ◆ Stopwatch and Timer Calibrations

uncertainty of the stopwatch must be considered. For example, if the stopwatch in Figure 8 is used to measure a time interval of 5 s, the computed accuracy is much smaller than the resolution of the stopwatch:

$$0.0003\% \times 5 \text{ s} = 0.000015 \text{ s}$$

**Timer:** 9 hours, 59 minutes, 59 seconds, 99 hundredths.

**Stopwatch:** Single-action timing; time-in/time-out; continuous timing; cumulative split, interval split and eight memories. Triple display shows cumulative splits, interval splits and running time simultaneously.

**Features:** Captures and stores up to eight separate times. After timed event is complete, stopwatch displays information in its memory. Counter box shows number of split times taken. Solid-state design with an accuracy of 0.0003 %. Durable, water-resistant construction makes stopwatch suitable for field use (operates in temperatures from 1° to 59° C [33° to 138° F]). With triple-line LCD: top two lines are each 1/8 in. high (3.2 mm); third line is 1/4 in. high (6 mm).



*Figure 8. Sample specifications for stopwatch (Example 2).*

**Typical Performance** — During the NIST centennial celebration of 2001, a booth at the NIST laboratories in Boulder, Colorado allowed visitors to measure the time base of their quartz wristwatches. Over 300 wristwatches were tested. Nearly all quartz wristwatches contain a 32 768 Hz time base oscillator, the same technology employed by a Type I digital stopwatch. The results of these measurements, showing the loss or gain in seconds per day for the watches, are summarized in Figure 9, and give some idea of the typical performance of a quartz stopwatch or timer. Roughly 70 % of the watches were able to keep time to within 1 s per day or better, a relative accuracy of approximately 0.001 % ( $1 \times 10^{-5}$ ). About 12 % had a relative accuracy larger than 5 s per day, or larger than 0.005 %. It is interesting to note that nearly all of the watches in this study gained time rather than lost time; they were presumably designed that way to help prevent people from being late. This characteristic will not necessarily apply to stopwatches and timers.

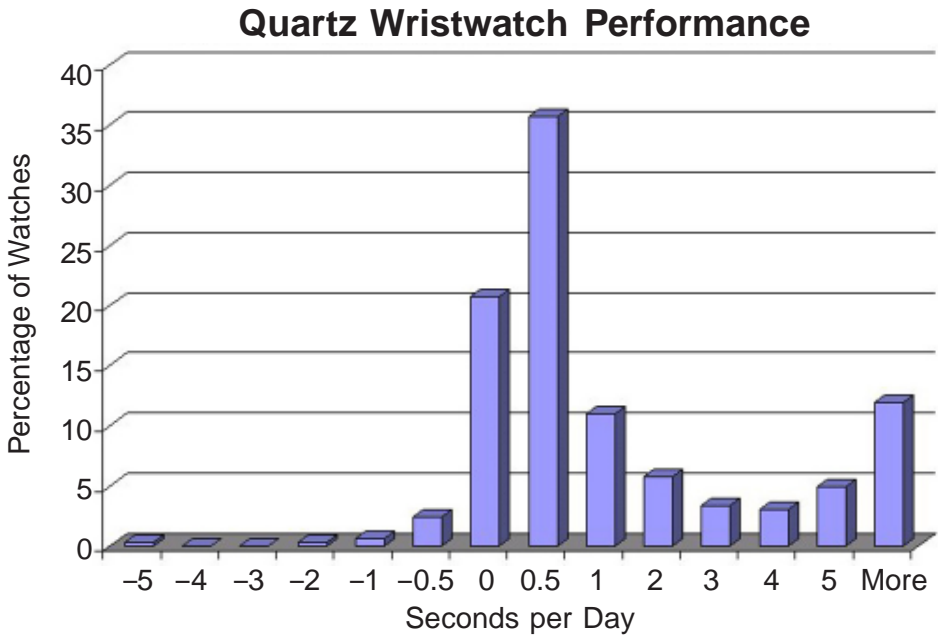

**Figure 9.** Typical performance of quartz wristwatches using 32 768 Hz time base oscillators.

### 3.B. Tolerances Required for Legal Metrology

General specifications for timing devices are provided in *NIST Handbook 44*,<sup>[7]</sup> and are summarized below. Please note that state governments and other regulatory agencies might have other specifications which are too numerous to list here and which are subject to change. Be sure to check and understand the required tolerances and regulations for the types of calibration that you are asked to perform.

*NIST Handbook 44*<sup>[7]</sup> uses the terms *overregistration* and *underregistration* when specifying accuracy of timing devices. The terms are used to describe conditions where the measurement device does not display the actual quantity. In timing devices, underregistration is the greatest concern, because an underregistration error occurs when the timing device indicates that the selected time interval has elapsed before it actually has. An example of underregistration would be paying for 10 min on a parking meter, and then having the meter indicate your time had expired, when only 9 min and 45 s had actually elapsed.

## ◆ Stopwatch and Timer Calibrations

**Time Clocks and Time Recorders** — The specification for both overregistration and underregistration is 3 s per hour, not to exceed 1 min per day.

**Parking Meters** — The specifications for parking meters have no tolerance for overregistration. Parking meters with a time capacity of 30 min or less are specified to have a maximum underregistration error of 10 s per min, but not to exceed 2 min over the 30 min period. For parking meters with a capacity of greater than 30 min, but less than 1 h, the tolerance for underregistration is 5 min, plus 4 s per min for every minute between 30 min and 60 min. Parking meters that indicate over 1 h have an underregistration tolerance of 7 min plus 2 min per hour for time intervals greater than 1 h.

All other timing devices are specified to have an overregistration tolerance of 5 s for any time interval of 1 min or more and an underregistration tolerance of 6 s per indicated minute. If the instrument is a digital indicating device, the tolerance is expanded by one-half of the least significant digit.

**Stop Watches** — *NIST Handbook 44* <sup>[7]</sup> specifies that instruments that are required to calibrate timing devices must be accurate to within 15 s per 24 h period (approximately 0.02 %). If stopwatches are used as the calibration standard, this becomes the minimum allowable tolerance for the stopwatch. Another reference, *NIST Handbook 105-5* <sup>[3]</sup> states that the tolerance for instruments used to calibrate timing devices must be three times smaller than the smallest tolerance of the device being calibrated. *Handbook 105-5* also provides a general specification for stopwatches, stating that the tolerance for stopwatches is  $\pm 0.02$  % of the time interval tested (approximately 2 s in 3 h), rounded to the nearest 0.1 s.

The uncertainties listed above were meant to be achievable with Type II (mechanical) devices, but Type I devices are certainly capable of lower uncertainties. As a result, organizations and jurisdictions that rely exclusively on digital stopwatches (Type 1) might require that devices be calibrated to a tolerance of 0.01 %, or even 0.005 %.



## 4. CALIBRATION METHODS

There are three generally accepted methods for calibrating a stopwatch or timer: the Direct Comparison Method, which compares the DUT's display to a traceable time interval standard; the Totalize Method, which requires a synthesized signal generator, a counter, and a traceable frequency standard; and the Time Base Method, which compares the frequency of the DUT's time base to a traceable frequency standard.<sup>[8]</sup> All three methods are summarized in Table 4, and discussed in detail below.

*Table 4: Comparison of Calibration Methods*

Method Area	Direct Comparison	Totalize	Time Base Measurement
Equipment Requirements	Best	Better	Better
Speed	Good	Better	Best
Uncertainty	Good	Good	Best
Applicability	Good	Best	Better

### 4.A. Direct Comparison Method

The Direct Comparison Method is the most common method used to calibrate stopwatches and timers. It requires a minimal amount of equipment, but has larger measurement uncertainties than the other methods. This section describes the references used for this type of calibration and the calibration procedure.

#### 4.A.1. References for Direct Comparison Method

The Direct Comparison Method requires a traceable time-interval reference. This reference is usually an audio time signal, but in some cases, a traceable time display can be used. The audio time signals are usually obtained with a shortwave radio or a telephone. Since time interval is being measured and not absolute time, the fixed signal delay from the source to the user is not important as long as it remains relatively constant during the calibration process. A list of traceable audio time sources is provided in Table 5.

## ◆ Stopwatch and Timer Calibrations

Table 5: Traceable Audio Time Signals

National Metrology Institute (NMI)	Location	Telephone Numbers	Radio Call Letters	Broadcast Frequencies
National Institute of Standards and Technology (NIST)	Fort Collins, Colorado, United States	(303) 499-7111*	WWV	2.5, 5, 10, 15, 20 MHz
National Institute of Standards and Technology (NIST)	Kauai, Hawaii, United States	(808) 335-4363*	WWVH	2.5, 5, 10, 15 MHz
United States Naval Observatory (USNO)	Washington, DC, United States	(202) 762-1401* (202) 762-1069*	—	—
United States Naval Observatory (USNO)	Colorado Springs, Colorado, United States	(719) 567-6742*		
National Research Council (NRC)	Ottawa, Ontario, Canada	(613) 745-1576** (English language) (613) 745-9426** (French language)	CHU	3.33, 7.335, 14.67 MHz
Centro Nacional de Metrología (CENAM)	Querétaro, México	(442) 215-39-02* (442) 211-05-06† (442) 211-05-07†† (442) 211-05-08‡	—	—

Time announcements are in Spanish, a country code must be dialed to access these numbers from the United States, see [www.cenem.mx](http://www.cenem.mx) for more information.

\* Coordinated Universal Time (UTC)

\*\* Eastern Time

† Central Time

†† Mountain Time

‡ Pacific Time

Please note that the local “time and temperature” telephone services are not considered traceable and **should not be used**. In all cases, use only sources that originate from a national metrology institute, such as those listed in Table 5 for the United States, Canada, and Mexico. The following sections briefly describe the various radio and telephone time signals and provide information about the types of clock displays that can and cannot be used.

**Audio Time Signals Obtained by Radio** — The radio signals listed in Table 5 include a voice announcement of UTC and audio ticks that indicate individual seconds. WWV, the most widely used station, features a voice announcement of UTC occurring about 7.5 s before the start of each minute. The beginning of the minute is indicated by a 1500 Hz tone that lasts for 800 ms. Each second is indicated by 1000 Hz tones that last for 5 ms. The best way to use these broadcasts is to start and stop the stopwatch when the beginning of the minute tone is heard.

The reception of WWV, WWVH, and CHU requires a *shortwave* receiver. A typical general coverage shortwave receiver provides continuous coverage of the spectrum from about 150 kHz, which is below the commercial AM broadcast band, to 30 MHz. These receivers allow the reception of WWV, WWVH, and CHU on all



*Figure 10.* Portable shortwave radio receiver for reception of audio time signals.

## ◆ Stopwatch and Timer Calibrations

available frequencies. The best shortwave receivers are designed to work with large outdoor antennas, with quarter-wavelength or half-wavelength dipole antennas often providing the best results. However, in the United States, adequate reception of at least one station can usually be obtained with a portable receiver with a whip antenna, such as the one shown in Figure 10. This type of receiver typically costs a few hundred dollars or less.

The reason that WWV, WWVH, and CHU broadcast on multiple frequencies is due to changing atmospheric conditions, not all of the frequencies will be available at all times. In many cases, only one frequency will be receivable, so you might have to tune the receiver to several different frequencies before finding a usable signal. In the case of WWV, 10 MHz and 15 MHz are probably the best choices for daytime reception, unless you are within 1000 km of the Fort Collins, Colorado station, in which case 2.5 MHz might also suffice. Unless your receiver is near the station, the 5 MHz signal will probably be easiest to receive at night.<sup>[9]</sup>

**Audio Time Signals Obtained by Telephone** — The telephone time signals for NIST radio stations WWV and WWVH are simulcasts of the radio broadcasts, and time announcements are made in UTC once per minute. The length of the phone call is typically limited to 3 min. The format of the other broadcasts varies. The USNO phone numbers broadcast UTC at 5 s or 10 s intervals. The NRC phone number broadcasts Eastern Time at 10 s intervals, and CENAM offers separate phone numbers for UTC and the local time zones of Mexico.

**Time Displays** — It might be tempting to use a time display from a radio controlled clock or a web site as a reference for stopwatch or timer calibration. As a general rule, however, these displays are not acceptable for establishing traceability. The reason is that the displays are only synchronized periodically, and in between synchronizations, they use a free running local oscillator whose frequency offset is usually unknown. An unknown uncertainty during any comparison breaks the traceability chain. For example, a low-cost, radio-controlled clock that receives a 60 kHz signal from NIST radio station WWVB is usually synchronized only once per day. In between synchronizations, each “tick” of the clock originates from a local quartz oscillator whose uncertainty is unknown and is probably of similar or lesser quality than the oscillator inside the device under test. The NIST web clock located at <http://nist.time.gov> presents similar problems. It synchronizes to

UTC(NIST) every 10 min if the web browser is left open. However, between synchronizations it keeps time using the computer's clock, which is usually of very poor quality, and whose uncertainty is generally not known. In contrast, each "tick" of an audio broadcast from WWV originates from NIST and is synchronized to UTC. Therefore, WWV audio keeps the traceability chain intact.

There are a few instances where a time display can be used to establish traceability. One example would be a display updated each second by a 1 Hz signal, such as a WWVB receiver or a pulse from a Global Positioning System (GPS) satellite receiver. In this case, if the traceable input signal were not available, the display would stop updating. Therefore, if the display is updating, then it is clear that each "tick" is originating from a traceable source. However, nearly all receivers have the capability to "coast" and keep updating their display even when no GPS signal is available. There must be an indicator on the unit to tell whether it is locked to the GPS signal or is in "coast" mode. If the receiver is in "coast" mode, it should not be used as a calibration reference.

Another example of a usable time display would be a digital time signal obtained from a telephone line, such as signals from the NIST Automated Computer Time Service (ACTS).<sup>[9]</sup> With an analog modem and simple terminal software (configured for 9600 baud, 8 data bits, 1 stop bit, and no parity), you can view time codes on a computer screen by dialing (303) 494-4774, and you can use these codes as a reference in the same way that you would use an audio time announcement from WWV. However, the length of a single telephone call is limited to just 48 s. In theory, Internet time codes could be used the same way, although the transmission delays through the network can vary by many milliseconds from second to second. For this reason, the currently available Internet signals should not be used as measurement references.

#### **4.A.2. Calibration Procedure for Direct Comparison Method**

Near the top of the hour, dial the phone number (or listen to the radio broadcast) of a traceable source of precise time. Start the stopwatch at the signal denoting the hour, and write down the exact time. After a suitable time period (depending on the accuracy of the stopwatch), listen to the time signal again, stop the stopwatch at the sound of the tone, and write down the exact stopping time. Subtract the start

## ◆ Stopwatch and Timer Calibrations

time from the stop time to get the time interval, and compare this time interval to the time interval displayed by the stopwatch. The two time intervals must agree to within the uncertainty specifications of the stopwatch for a successful calibration. Otherwise, the stopwatch needs to be adjusted or rejected.

**Advantages of the Direct Comparison Method** — This method is relatively easy to perform and, if a telephone is used, does not require any special test equipment or standards. It can be used to calibrate all types of stopwatches and many types of timers, both electronic and mechanical.

**Disadvantages of the Direct Comparison Method** — The operator's start/stop reaction time is a significant part of the total uncertainty, especially for short time intervals. Table 6 shows the contribution of a 300 ms variation in human reaction time to the overall measurement uncertainty, for measurement periods ranging from 10 s to 1 day.

*Table 6: The Contribution of 300 ms Variation in Reaction Time to the Measurement Uncertainty*

Hours	Minutes	Seconds	Uncertainty (%)
		10	3
	1	60	0.5
	10	600	0.05
	30	1800	0.005 6
1	60	3600	0.001 67
2	120	7200	0.004 2
6	360	21 600	0.001 4
12	720	43 200	0.000 69
24	1440	86 400	0.000 35

As Table 6 illustrates, the longer the time interval measured, the less impact the operator's start/stop uncertainty has on the total uncertainty of the measurement. Therefore, it is better to measure for as long a time period as practical to reduce the uncertainty introduced by the operator and to meet the overall measurement requirement.

To get a better understanding of the numbers in Table 6, consider a typical stopwatch calibration where the acceptable measurement uncertainty is 0.02 % ( $2 \times 10^{-4}$ ). If the variation in human reaction time is known to be 300 ms for the Direct Comparison Method, a time interval of at least 1500 s is needed to reduce the uncertainty contributed by human reaction time to 0.02 %. However, if a 1500 s interval were used, we would be measuring the variation in human reaction time, and nothing else. Our goal is to measure the performance of the DUT, and to make human reaction time an insignificant part of the measurement. Therefore, at the very least, we should extend the time interval by at least a factor of 10, to 15 000 s. To be "safe," *NIST Handbook 105-5*<sup>[3]</sup> and other references refer to an acceptable time offset of 2 s in 3 h (10 800 s) for a stopwatch to be declared within tolerance. This is a long enough time interval to exceed the 0.02 % requirement, and to ensure that the uncertainty of human reaction time is insignificant. Keep in mind that the actual length of the time interval can vary according to each laboratory's procedures. However, it must be long enough to meet the uncertainty requirements for the device being tested. If your uncertainty requirement is 0.01 % or lower, the Direct Comparison Method might not be practical.

#### 4.B. Totalize Method

The Totalize Method partially eliminates the measurement uncertainty from human reaction time, but it requires a calibrated signal generator and a universal counter. The counter is set to TOTALIZE, with a manual gate. A signal from a calibrated synthesized signal generator is connected to the counter's input, and the laboratory's primary frequency standard is used as the external time base for the synthesizer (Figure 11). An external reference is not needed for the counter because the operator is controlling the counter's gate time. The frequency should have a period at least one order of magnitude smaller than the resolution of the stopwatch. For example, if the stopwatch has a resolution of 0.01 s (10 ms), use a 1 kHz frequency (1 ms period). This provides the counter with one more digit of resolution than the stopwatch.

## ◆ Stopwatch and Timer Calibrations

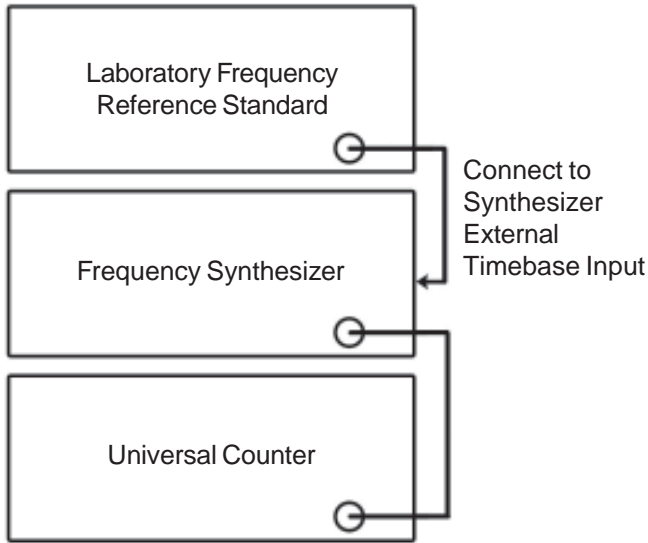

*Figure 11. Block diagram of the Totalize Method.*

To begin the measurement, start the stopwatch and manually open the gate of the counter at the same time. One way to do this is by rapidly pressing the start-stop button of the stopwatch against the start button on the counter (Figure 12). Another method is to press the start/stop button of the stopwatch with one hand and simultaneously press the start/stop button of the counter. After a suitable period of time (determined by the calibration requirements of the stopwatch or timer being calibrated), use the same method to stop the stopwatch, and simultaneously close the gate of the counter.

Once the counter and stopwatch are stopped, compare the two readings. Use the equation  $\Delta t/T$  to get the results, where  $\Delta t$  is the difference between the counter and stopwatch displays, and  $T$  is the length of the measurement run. For example, if  $\Delta t = 100$  ms and  $T = 1$  h, the time uncertainty is  $0.1$  s/3600 s or roughly  $2.8 \times 10^{-5}$  (0.0028 %).

**Advantages of the Totalize Method** — When using the stopwatch's start/stop button to open and close the counter's gate, this method partially eliminates human reaction time, and, therefore, has a lower measurement uncertainty than the direct comparison method.

**Disadvantages of the Totalize Method** — This method requires more equipment than the direct comparison method, including a calibrated signal generator and counter.





*Figure 12. Using the start-stop button of the stopwatch to start the counter.*

#### 4.C. Time Base Method

The Time Base Method is the preferred measurement method for stopwatch and timer calibrations, since it introduces the least amount of measurement uncertainty. Because the DUT's time base is measured directly, the calibrating technician's response time is not a factor.

The exact method of measuring the stopwatch's time base depends upon the type of stopwatch or timer being calibrated. If the unit has a quartz crystal time base, an inductive or acoustic pickup is used to monitor the stopwatch's 32 768 Hz time base frequency on a calibrated frequency counter (the pickup is fed into an amplifier to boost the signal strength). If the unit is an older LED-type stopwatch, the frequency is usually 4.19 MHz. An inductive pickup can even be used to sense the stepping motor frequency of analog mechanical stopwatches, or the "blink rate" of a digital stopwatch display. Or an acoustic pickup can be used to measure the "tick" of a mechanical stopwatch.

**References for the Time Base Method** — The reference for a time base calibration is the time base oscillator of the measuring instrument.

## ◆ Stopwatch and Timer Calibrations

For example, if a frequency counter is used, the measurement reference is the time base oscillator of the frequency counter. In order to establish traceability, the frequency counter time base must have been recently calibrated and certified. However, a better solution is to have the laboratory maintain a traceable 5 MHz or 10 MHz signal that can be used as an external time base for the frequency counter and all other test equipment. If an external time base is used and its measurement uncertainty is known, it is unnecessary to calibrate the internal time base oscillator.

**Calibration Procedure for the Time Base Method** — Two methods of calibrating a stopwatch time base are described below. One uses a commercially available measurement system; the other uses a frequency counter with an acoustic pickup. Note that neither calibration method requires opening the case of the stopwatch or timer. Keep in mind that you should never disassemble a stopwatch or timer and attempt to measure the time base frequency by making a direct electrical connection. The crystal oscillators in these units are very small, low-power devices. Their frequency can dramatically change if they are disturbed or loaded down by the impedance of a frequency counter, and, in some cases, they can even be destroyed by incorrect electrical connections.

### 1) Using a Commercial Time Base Measurement System —

One example of a commercially available time base measurement system (Figure 13) is described here for the purposes of illustration. This unit measures the frequency offset of the time base oscillator, and displays seconds per day, or seconds per month. This same function could be performed with a sensor (acoustic or inductive pickup), a frequency counter, and the conversion formula described in the next section.



*Figure 13. Time base measurement system for stopwatches and timers.*

The commercial unit uses a 4.32 MHz time base oscillator as a measurement reference. In a 2 s measurement period (the shortest period used by the instrument), the oscillator produces 8 640 000 cycles, a number equal to the number of 0.01 s intervals in one day. Therefore, the instrument resolution is 0.01 s per day. The time base oscillator feeds a programmable divider chain that allows increasing the measurement period to intervals as long as 960 s. However, since the time base frequency is divided to support longer intervals, the number of cycles per interval remains the same, and the resolution is still limited to 0.01 s.

The time base measurement system shown in Figure 13 has several different averaging times available, from 2 s up to 960 s. It is important to select an averaging time long enough to get an accurate, stable reading. When testing a 32 768 Hz quartz-crystal stopwatch, a 10 s to 12 s averaging time is normally sufficient to obtain a reading stable to  $\pm 1$  count. Table 7 shows the effect averaging time has on the stability of the stopwatch calibrator’s readings. When testing an older mechanical (Type II) stopwatch, a longer averaging time of 120 s or more may be required.

Table 7: **The Effect of Averaging Time on Stability**

<b>Variations Due to Averaging Time, 25 Readings</b>				
<b>Averaging Time</b>	<b>2 s</b>	<b>10 s</b>	<b>12 s</b>	<b>20 s</b>
Mean	-0.03	-0.06	-0.06	-0.06
Standard Deviation of the Mean	0.0050	0.0012	0.0011	0.0006
Maximum	0.00	-0.05	-0.05	-0.06
Minimum	-0.09	-0.07	-0.07	-0.07
Range	0.09	0.02	0.02	0.01

To support 0.01 s resolution, the instrument’s 4.32 MHz time base oscillator must be calibrated to within  $1.16 \times 10^{-7}$ . If the instrument is calibrated to within specifications, the display uncertainty is  $\pm 0.05$  s per day (maximum time base frequency offset of about  $6 \times 10^{-7}$ ). In all cases, the uncertainty of the time base oscillator relative to UTC must be known in order to establish traceability.

## ◆ Stopwatch and Timer Calibrations

The device under test can be a Type 1 stopwatch (both 32 768 Hz and 4.19 MHz devices can be measured), or a Type 2 mechanical stopwatch. The 32 768 Hz signal is picked up acoustically with an ultrasonic sensor, amplified, and then compared to the time base oscillator. A 1 Hz offset in the 32 768 Hz signal translates to a time offset of about 2.6 s per day. A capacitive sensor is used to detect the 4.19 MHz frequency of quartz time base oscillators, an acoustic or inductive pickup is used to sense the stepping motor frequency of analog mechanical stopwatches, and an inductive pickup is used to sense the “blink rate” of digital stopwatches.

Front panel switches allow the operator to select the type of device being tested, the measurement interval, and whether the time offset should be displayed as seconds per day or seconds per month. Once these parameters have been chosen, the device is measured by simply positioning it on top of the sensor until a usable signal is obtained, waiting for the measurement interval to be completed, and then recording the number from the display. It is always a good idea to allow the stopwatch calibrator to complete at least two complete measurement cycles before recording a reading.

**2) Using a Frequency Counter and an Acoustic Pickup** — If an acoustic pickup and amplifier are available, you can measure the frequency of a stopwatch time base directly with a frequency counter. The reading on the counter display can be used to calculate the frequency offset using this equation:

$$f(\text{offset}) = \frac{f_{\text{measured}} - f_{\text{nominal}}}{f_{\text{nominal}}}$$

where  $f_{\text{measured}}$  is the reading displayed by the frequency counter, and  $f_{\text{nominal}}$  is the frequency labeled on the oscillator (the nominal frequency it is supposed to produce).

If  $f_{\text{nominal}}$  is 32 768 Hz, and  $f_{\text{measured}}$  is 32 767.5 Hz, the frequency offset is  $-0.5 / 32\,768$  or  $-1.5 \times 10^{-5}$  or  $-0.0015\%$ . To get time offset in seconds per day, multiply the number of seconds per day (86 400) by the frequency offset:

$$86\,400 \times (-1.5 \times 10^{-5}) = -1.3 \text{ s per day}$$

which means the stopwatch can be expected to lose 1.3 s per day. You might find it easier to note that a 1 Hz error in a 32 768 Hz device equates to a time offset of about 2.64 s, since  $86\,400 / 32\,768 = 2.64$ . Therefore, a 2 Hz offset is about 5.3 s/day, a 3 Hz offset is about 7.9 s/day, and so on. If the acceptable tolerance is 10 s/day, then you'll know that 3 Hz is well within tolerance.

As you can see from these results, even a low cost 8-digit frequency counter will provide more measurement resolution than necessary when measuring 32 768 Hz devices. The last digit on an 8-digit counter will represent .001 Hz (1 mHz), and a 1 mHz frequency offset represents a time offset of just 2.6 ms per day. Very few stopwatches or timers can perform at this level.

**Advantages of the Time Base Method** — The Time Base Method completely eliminates the uncertainty introduced by human reaction time. The measurement uncertainty can be reduced by at least two orders of magnitude when compared to the Direct Comparison Method, to  $1 \times 10^{-6}$  or less. This method is also much faster. The measurement can often be performed in a few seconds, as opposed to the several hours often required for the Direct Comparison Method.

**Disadvantages of the Time Base Method** — This method requires more equipment than the Direct Comparison Method, and it does not easily work on some electrical, mechanical, or electro-mechanical units. It also does not test the functionality of the stopwatch or timer, only the time base. Function tests need to be performed separately by starting the unit, letting it run for a while (a few minutes to a few hours, depending on how the unit is used), and stopping the unit. If the unit appears to be counting correctly, the displayed time interval will be accurate.



## 5. MEASUREMENT UNCERTAINTY

This chapter describes and estimates the uncertainty of measurement associated with the three calibration methods described in Section 4. The resulting expanded uncertainty of measurement is presented with a coverage factor that represents an approximate 95 % level of confidence. The methods used to estimate the uncertainty of measurement are described in the *ISO Guide to the Expression of Uncertainty in Measurement (GUM)*.<sup>[10]</sup> This guide does not attempt to summarize the GUM, but it does strive to produce estimates of uncertainty that are consistent with the GUM. The calculations and terminology used in this section are derived from the GUM.

### 5.A. Uncertainties of Direct Comparison Method

As discussed in Section 4, the Direct Comparison Method involves a calibration technician who uses a traceable time interval reference as a signal to physically start and stop the stopwatch. The stopwatch display is then compared to the elapsed time interval from the traceable time interval reference. The three potentially significant sources of uncertainty to consider are the uncertainty of the reference, the reaction time of the calibration technician, and the resolution of the DUT.

#### 5.A.1. Uncertainty of the Traceable Time Interval Reference

If the reference signal is one of the telephone services listed in Table 5, two phone calls are usually made. The first call is made to obtain the signal to start the stopwatch, and the second call is made to obtain the signal to stop the stopwatch. If both calls are made to the same service and routed through the same phone circuit, the delay through the circuit should be nearly the same for both calls. Of course, the delays will not be exactly the same, and the difference between the two delays represents the uncertainty of the time interval reference. In most cases, this uncertainty will be insignificant for our purposes, a few milliseconds or less. For example, callers in the continental United States using “land lines” or ordinary telephone service can expect signal delays of less than 30 ms when dialing NIST at (303) 499-7111, and these delays should be very repeatable from phone call to phone call. Even in a theoretical case where the initial call had no delay and the final call had a 30 ms delay, the magnitude of the uncertainty would be limited to 30 ms.

However, if a landline is not used, the uncertainties associated with telephone time signals might be significant. Cellular phone networks, for example, sometimes introduce delays that are larger and more

## ◆ Stopwatch and Timer Calibrations

subject to variation from phone call to phone call than wired land networks. Therefore, cell phones should not be used for stopwatch calibrations. Calls made from outside the continental United States are sometimes routed through a communications satellite, introducing delays of about 250 ms. If the first call went through a satellite, and the second call didn't (or vice versa), a significant uncertainty would be introduced. Therefore, common sense tells us that a laboratory in Illinois (for example) shouldn't start a calibration by calling the NIST service in Colorado, and then stop the calibration by calling the NIST service in Hawaii. The call to Hawaii might be routed through a satellite, and even if it isn't, the delays might be significantly different.

During a single phone call, the uncertainty is essentially equal to the stability of a telephone line (the variations in the delay) during the call. A NIST study involving the Automated Computer Time Service (ACTS), a service that sends a digital time code over telephone lines, showed phone line stability at an averaging time of 1 s to be better than 0.1 ms over both a local phone network and a long distance network between Boulder, Colorado and WWVH in Kauai, Hawaii.<sup>[11]</sup> While it is not possible to guarantee this stability during all phone calls, it is probably safe to say that the stability should be much less than 1 ms during typical calls, which are limited to about 3 min in length. This uncertainty is so small it can be ignored for our purposes.

If the radio signals listed in Table 5 are used as a reference instead of a telephone signal, the arrival time of the signal will vary slightly from second to second as the length of the radio signal path changes but not enough to influence the results of a stopwatch or timer calibration. Shortwave signals that travel over a long distance rely on skywave propagation, which means that they bounce off the ionosphere and back to Earth. A trip from Earth to the ionosphere is often called a hop, and a hop might add a few tenths of a millisecond or, in an extreme case, even a full millisecond to the path delay. Normally, propagation conditions will remain the same during the course of a calibration, and the variation in the radio signal will be negligible, less than 0.01 ms. If an extra hop is added into the radio path during the calibration (for example, if a 1 hop path becomes a 2 hop path), the received uncertainty of the radio signal is still typically less than 1 ms.<sup>[9]</sup>

If a traceable time display is used instead of a radio signal or telephone signal, it can be assumed that the uncertainty of the display is less than 1 ms because instruments that are constantly steered by GPS or WWVB update and synchronize every second. In order for this uncertainty estimate to be valid, the time display needs meet the requirements for traceability as discussed in Chapter 4.



### 5.A.2. Uncertainty Due to Human Reaction Time

To understand the effect of human reaction time on stopwatch and timer calibration uncertainties, a small study was conducted. Four individuals were selected, and asked to calibrate a standard stopwatch using the Direct Comparison Method. Two separate experiments were conducted. In the first experiment, the operators were asked to use a traceable audio time signal, and in the second experiment, the operators were asked to use a traceable time display. The time base of the stopwatch was measured before and after each test (using the Time Base Method), and its offset from nominal was found to be small enough that it would not influence the test. Therefore, differences in readings between the stopwatch being tested and the standard would only be due to the operator's reaction time.

Each operator was asked to repeat the measurement process ten times, and the resulting difference between the standard and the stopwatch were recorded and plotted (Figure 14).

As shown in Figure 14, the average reaction time was usually less than  $\pm 100$  ms, with a worst-case reaction time exceeding 700 ms.

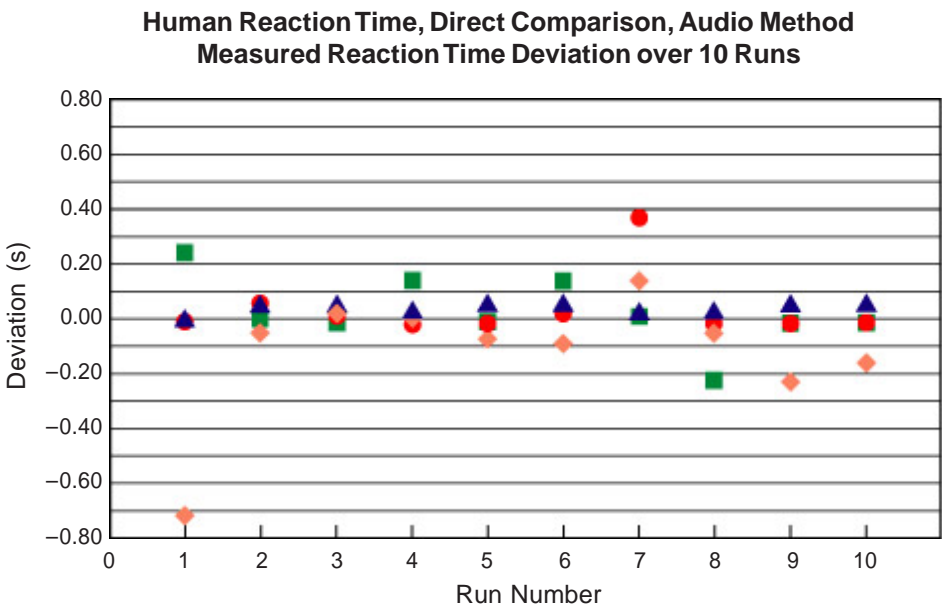

**Figure 14.** Reaction time measurements (four operators, ten runs each) for the Direct Comparison Method.

## ◆ Stopwatch and Timer Calibrations

The mean and standard deviation for each operator was computed and graphed in Figure 15. This graph indicates that the average (mean) reaction time of the operator can be either negative (anticipating the audible tone) or positive (reacting after the audible tone). Figure 15 also shows that in addition to the average reaction time having a bias, the data is somewhat dispersed, so both elements of uncertainty will need to be accounted for in a complete uncertainty budget. For this experiment, the worst case mean reaction time was 120 ms and the worst case standard deviation was 230 ms. It should be noted that in the measurements recorded in Figure 15, Operators 1 and 2 had no previous experience calibrating stopwatches. Based on these results, it is recommended that each calibration laboratory perform tests to determine their operator reaction time uncertainty value.

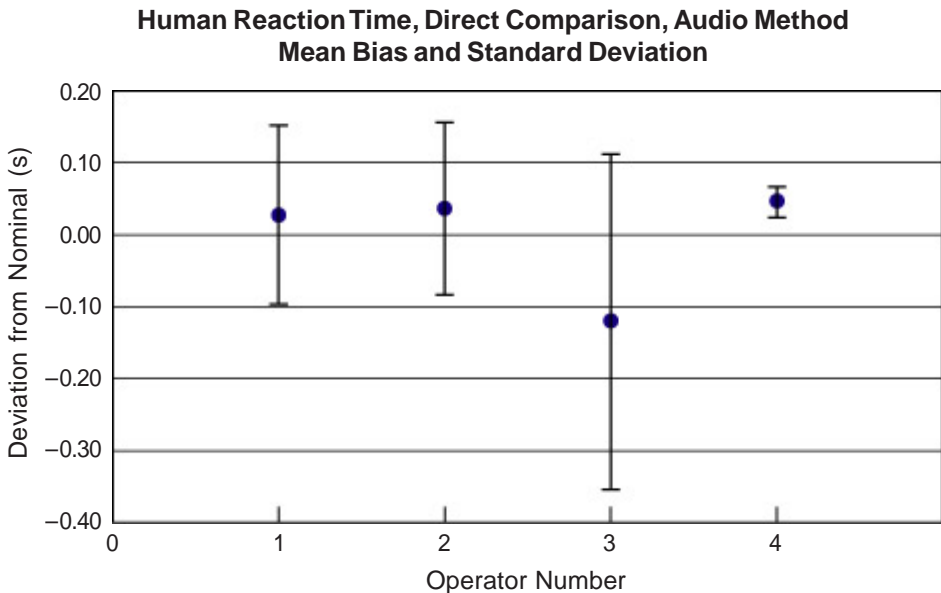

**Figure 15.** Averaging measurement results for four different operators.

When a traceable time display was used, the uncertainty due to human reaction time was found to be approximately the same as the human reaction time for an audible tone. Keep in mind that the data presented here is presented to illustrate the nature of uncertainty due to human reaction time and to provide a very rough estimate of its magnitude. We strongly encourage each person performing stopwatch and timer calibrations to perform repeatability and reproducibility experiments to determine the uncertainty due to human reaction time for the specific calibration method used by the laboratory.

### 5.A.3. Device Under Test (DUT) Resolution Uncertainty

Since the Direct Comparison Method requires observing data from the DUT display, the resolution of the DUT must also be considered. For digital indicating devices, resolution uncertainty is understood to be half of the least significant digit, with an assumed rectangular probability distribution. For an analog watch, the same method of determining resolution uncertainty may be made because the watch moves in discrete steps from one fraction of a second to the next.

### 5.A.4. Uncertainty Analysis

This section provides an example of how data collected using the Direct Comparison Method can be used to perform an uncertainty analysis. For this estimate of uncertainty, we will include the mean bias as an estimate of uncertainty rather than correcting for it since the mean bias can be either negative or positive, and it may vary from time-to-time for the same user.<sup>[12]</sup> In this calibration process, the mean bias can be considered a measurement of reproducibility, and the standard deviation a measure of repeatability.

**Uncertainty Distributions** — Due to the lack of knowledge regarding distributions of the mean bias and delay deviation between telephone calls, both components of uncertainty are treated as rectangular distributions. Since the resolutions of digital and analog stopwatches have known, discrete quantities, their distribution is also rectangular.<sup>[10]</sup> All other data are considered to be normally distributed.

**Method of Evaluation** — Even though the data provided in previous sections was treated statistically, it was collected through previous measurements and not during the actual stopwatch calibration. Because the metrologist does not have statistical data based on a series of observations to support these uncertainties, they are identified as Type B.

**Combination of Uncertainties** — All components of uncertainty for this example are considered to be uncorrelated, so the uncertainty is combined by method of root sum of squares (RSS).

In the following examples, the uncertainty budgets were developed for a calibration using traceable land lines (Tables 8 and 10), and for a calibration using a cellular phone or satellite signal (Table 9) based upon the data previously provided. The human reaction time was based on the worst case data presented in Section 5.A.2.

## ◆ Stopwatch and Timer Calibrations

**Table 8: Uncertainty Analysis for Direct Comparison Method (Digital DUT) Using Land Line**

Source of Uncertainty	Magnitude	Method of Evaluation	Distribution	Sensitivity Coefficient	Standard Uncertainty
Human reaction time bias	120 ms	Type B	Rectangular	1	69 ms
Human reaction time standard deviation	230 ms	Type B	Normal (k = 1)	1	230 ms
Telephone delay deviation	30 ms	Type B	Rectangular	1	17 ms
½ DUT resolution	5 ms	Type B	Rectangular	1	2.9 ms
Combined uncertainty					240 ms
Expanded uncertainty (k = 2, representing approximately a 95 % level of confidence)					480 ms

**Table 9: Uncertainty Analysis for Direct Comparison Method (Digital DUT) Using Cell Phone**

Source of Uncertainty	Magnitude	Method of Evaluation	Distribution	Sensitivity Coefficient	Standard Uncertainty
Human reaction time bias	120 ms	Type B	Rectangular	1	69 ms
Human reaction time standard deviation	230 ms	Type B	Normal (k = 1)	1	230 ms
Telephone delay deviation	250 ms	Type B	Rectangular	1	144 ms
½ DUT resolution	5 ms	Type B	Rectangular	1	2.9 ms
Combined uncertainty					280 ms
Expanded uncertainty (k = 2, representing approximately a 95 % level of confidence)					560 ms

*Table 10: Uncertainty Analysis for Direct Comparison Method (Analog DUT) Using Land Line*

Source of Uncertainty	Magnitude	Method of Evaluation	Distribution	Sensitivity Coefficient	Standard Uncertainty
Human reaction time bias	120 ms	Type B	Rectangular	1	69 ms
Human reaction time standard deviation	230 ms	Type B	Normal ( $k = 1$ )	1	230 ms
Telephone delay deviation	30 ms	Type B	Rectangular	1	17 ms
½ DUT resolution	100 ms	Type B	Rectangular	1	58 ms
Combined uncertainty					247 ms
Expanded uncertainty ( $k = 2$ , representing approximately a 95 % level of confidence)					495 ms

## 5.B. Uncertainties of Totalize Method

As previously discussed, this calibration method involves using a calibrated signal generator to input a signal into a universal counter configured to operate in totalize mode. The counter counts oscillations of the input frequency during a time period that is started and stopped by the operator. The factors that contribute to the measurement uncertainty of this method are discussed below.

### 5.B.1. Uncertainty of the Frequency Input

A synthesized signal generator that was recently calibrated typically has a frequency uncertainty ranging from  $1 \times 10^{-6}$  to  $1 \times 10^{-9}$ . If the signal generator time base is externally locked to a laboratory frequency standard such as a cesium oscillator or a GPS disciplined oscillator, the frequency uncertainty can be much smaller, parts in  $10^{12}$  or less.

### 5.B.2. Uncertainty Due to Human Reaction Time

This source of uncertainty is due to any difference between the starting of both the stopwatch and counter, and the stopping of both

## ◆ Stopwatch and Timer Calibrations

the stopwatch and counter. In order to estimate this source of uncertainty, a study was conducted at Sandia National Laboratories. Four individuals were selected and asked to calibrate a standard stopwatch using the Totalize Method, using one hand to start and stop the stopwatch, and one hand to start and stop the frequency counter. The time base of the stopwatch was measured before and after each test (using the Time Base Method), and its offset from nominal was found to be small enough so that it would not influence the test. Therefore differences in readings between the stopwatch being tested and the standard would only be due to the operator's reaction time.

Each operator was asked to repeat the measurement process ten times, and the resulting difference between the standard and the stopwatch were recorded.

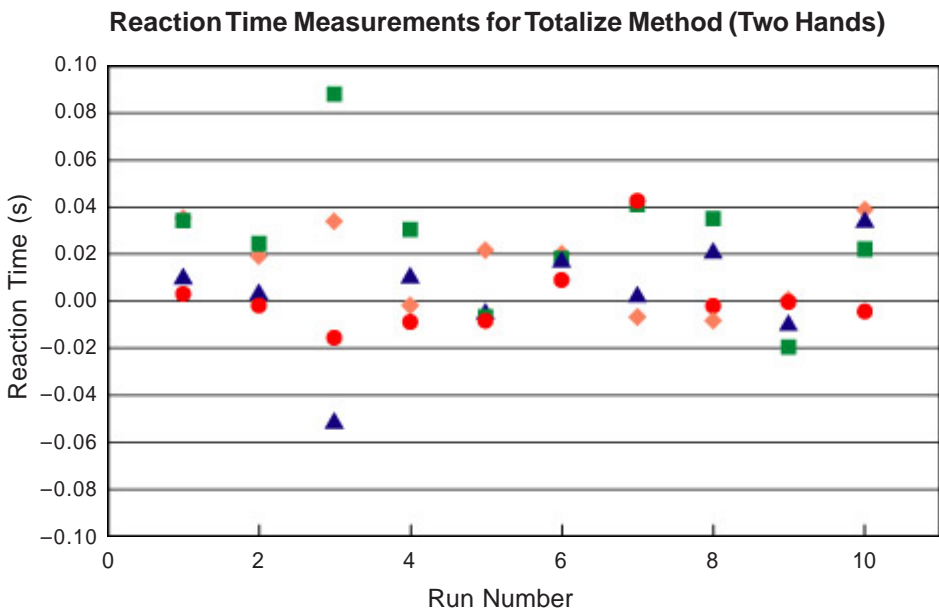

**Figure 16.** Reaction time measurements (four operators, ten runs each) for the Totalize Method.

As shown in Figure 16, the average reaction time was usually less than 40 ms. The largest deviation was about 90 ms. The mean and standard deviations for each operator were computed and graphed in Figure 17. The data demonstrates that the worst case mean reaction time was

27 ms, and the worst case standard deviation was 10 ms, which is a significant improvement over the Direct Comparison Method. Subsequent measurements of human reaction time were made by placing the start/stop button of the stopwatch directly against the start/stop button of the frequency counter (as shown in Figure 12) so that both buttons were pushed at the same time. The experimental data showed that this method provided no significant advantage over using one hand to start the stopwatch and the other hand to start the frequency counter.

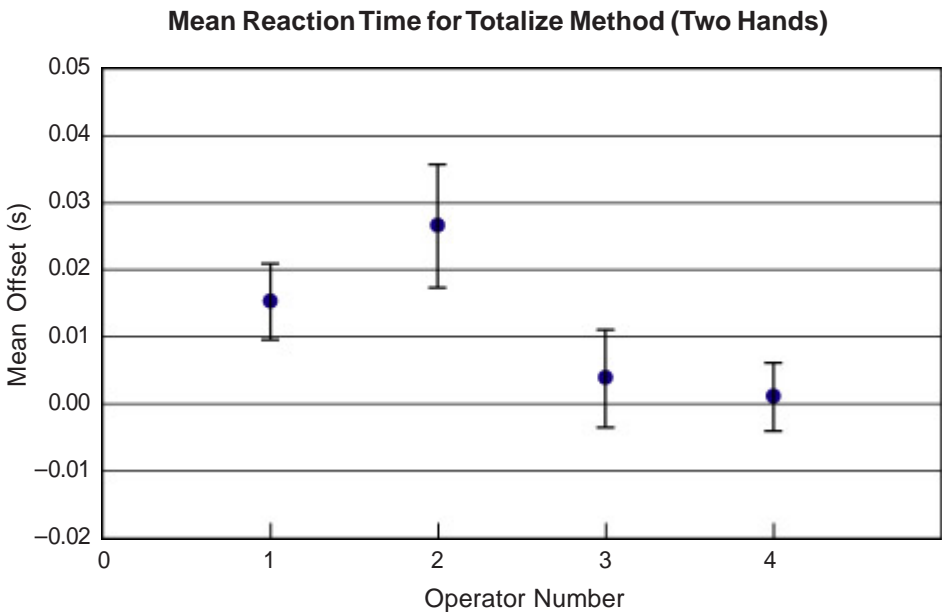

**Figure 17.** Mean reaction times (four operators, ten runs each) for the Totalize Method.

### 5.B.3. Uncertainty Due to the Counter

For this method, the uncertainty of the counter is related to the counter resolution. The internal time base of the counter is not used because the gate time is controlled by the manual start/stop function. This method does not use the counter gate or trigger, so the uncertainties associated with these functions are also eliminated. The counter is simply used as an event counting device, and the uncertainty is equivalent to  $\pm 1$  least significant digit on the display.

### 5.B.4 Device Under Test (DUT) Resolution Uncertainty

Since the Totalize Method involves observing data from the DUT, the resolution of the DUT must also be considered. For digital indicating devices, resolution uncertainty is understood to be half of the least significant digit, with a rectangular distribution. A rectangular distribution is also used for analog timers, since these devices move in discrete steps from one fraction of a second to the next.

**Method of Evaluation** — Since the sources of uncertainty in this calibration are different types, such as the absolute accuracy specification for reaction time, relative accuracy specification for the frequency source, and an absolute specification of  $\pm 1$  count for the counter, it is necessary to define the calibration conditions, and convert all specifications to a common format.

The uncertainty example in Table 11 assumes that the synthesized signal generator frequency uncertainty is  $1 \times 10^{-9}$  and is set to generate a 1 kHz signal. The time period during which the stopwatch is compared to the counter is 3 h (10 800 s). The stopwatch is started and stopped with one hand, and the counter is started and stopped with the other.

Table 11: Uncertainty Analysis for Totalize Method

Source of Uncertainty	Magnitude	Method of Evaluation	Distribution	Sensitivity Coefficient	Standard Uncertainty
Human reaction time bias	27 ms	Type B	Rectangular	1	15.6 ms
Human reaction time standard deviation	10 ms	Type B	Normal (k=1)	1	10 ms
Synthesizer accuracy	0.0108 ms	Type B	Rectangular	1	0.00623 ms
Totalize counter resolution	1 ms	Type B	Rectangular	1	0.58 ms
½ DUT resolution	5 ms	Type B	Rectangular	1	2.9 ms
Combined uncertainty					18.8 ms
Expanded uncertainty (k = 2, representing approximately a 95 % level of confidence)					37.6 ms



The stopwatch is digital and the resolution is 0.01 s. As in the previous uncertainty example, all sources of uncertainty are combined by root sum of squares.

### 5.C. Uncertainties of Time Base Method

This method utilizes either a time base measurement system or a frequency counter with an acoustic or inductive pickup to measure the frequency of the device's internal time base oscillator. If we use the time base measurement system shown in Figure 13 as an example, and take into account its specified accuracy is  $\pm 0.05$  s/day and its resolution of 0.01 s, then the measurement uncertainty equals 0.05 s/day (50 ms/day). There is no uncertainty contributed by human reaction time, and the resolution uncertainty of the stopwatch calibrator is insignificant compared to its accuracy specification. Resolution uncertainty does not need to be considered since data is not observed from the DUT's display. Since there is only one uncertainty component, we did not include an uncertainty analysis table.

If a frequency counter is used, an uncertainty analysis may be performed in the same fashion used for common frequency measurements.

### 5.D. Uncertainty Analysis of Using a Calibrated Stopwatch to Calibrate Another Device

A calibrated stopwatch is often used to calibrate a timing device, such as an industrial timer. In this example, we are calibrating an industrial timer with 1 second resolution. We are calibrating the industrial timer with a stopwatch that has a specified accuracy of 5 s per day (about 208 ms per hour), 0.01 s resolution, and a calibration uncertainty of 0.2 s per day. As previously discussed in section 5.A.2, the Human Reaction time bias is 120 ms, and the Human Reaction time standard deviation is 230 ms. The measurement time for the calibration is 1 h (3600 s).

It is important to include the specified accuracy of the stopwatch, which takes into account long-term sources of error during the calibration interval that may not have been noticeable during the time of calibration. It is also important to consider the uncertainty of the stopwatch calibration as part of the budget when using a stopwatch as a reference because it may be relatively large when compared to the other sources of uncertainty in the measurement process.

## ◆ Stopwatch and Timer Calibrations

**Table 12: Uncertainty Analysis of Using a Calibrated Stopwatch to Calibrate Another Device**

Source of Uncertainty	Magnitude	Method of Evaluation	Distribution	Sensitivity Coefficient	Standard Uncertainty
Unit under test resolution ½ digit	500 ms	Type B	Rectangular	1	290 ms
Human reaction time bias	120 ms	Type B	Rectangular	1	69 ms
Human reaction time standard deviation	230 ms	Type B	Normal (k = 1)	1	230 ms
Stopwatch accuracy	208 ms	Type B	Rectangular	1	120 ms
Stopwatch resolution ½ digit	5 ms	Type B	Rectangular	1	2.9 ms
Stopwatch calibration uncertainty	8.3 ms	Type B	Normal (k=2)	1	4.15 ms
Combined uncertainty					340 ms
Expanded uncertainty (k = 2, representing approximately a 95 % level of confidence)					680 ms

The relative uncertainty of calibration for this calibration of the parking meter for measuring a 1 h time period is 0.018 %.

### 5.E. Adequacy of Calibration Method to Meet the Required Uncertainty

The preceding sections have provided estimates of expanded measurement uncertainty associated with various types of stopwatch calibrations. It is important to ensure that the achievable measurement uncertainty is relatively small when compared to the stopwatch tolerance

we are attempting to verify. For example, if we were using the Direct Comparison Method to calibrate a stopwatch that has an accuracy of 5 s per day (0.01 s resolution), and we decided to use a calibration period of 5 min, the accuracy of the stopwatch over the 5 min interval would be about 17 ms. The first problem arises in that the resolution of the stopwatch is 0.01 s, and cannot display 0.017 s, making the specification impossible to verify for this time period. Furthermore, the measurement uncertainty for the calibration process is 480 ms, approximately 28 times larger than the uncertainty that we are trying to verify! Clearly a 5 min calibration period for this stopwatch and calibration method is not adequate. A 1 h calibration is still inadequate, because the quantity required to be measured, now about 208 ms, is still less than half of the measurement uncertainty.

As stated in ISO/IEC 17025,<sup>[2]</sup> when a statement of compliance to a metrological specification is made (for example, is the DUT “in tolerance” or “out of tolerance” based on the manufacturers specifications), the laboratory must take the measurement uncertainty into account. It is the responsibility of the calibration laboratory to decide whether the measurement uncertainty associated with the calibration method is small enough to comply with the metrological requirement. Calibration laboratories generally use some sort of decision rule for determining whether the uncertainty associated with the calibration method is adequate. Examples of such rules are the N:1 decision rule (where the tolerance of the instrument to be tested is N times larger than the calibration uncertainty and is most commonly stated as 4:1 or 3:1), or some form of guardbanding (where the calibration uncertainty or some fraction of it is subtracted from the DUT accuracy specification and the calibration results are acceptable only if the measured offset was within the guardband limit). Whatever the case, it is important to compare the calibration measurement uncertainty to the tolerance that you are testing for in order to ensure that the calibration process is valid.

To illustrate this, assume that a laboratory employs a 4:1 rule for acceptable uncertainty. This means that the expanded measurement uncertainty of the calibration must be four times smaller than the acceptable tolerance of the DUT in order to declare the unit in or out of tolerance. The laboratory is calibrating a digital stopwatch to a tolerance of 0.02 %, using the Direct Comparison Method via a telephone landline (Table 8). The estimated expanded measurement uncertainty for this method was 480 ms. In order for 480 ms to be one quarter of the

## ◆ Stopwatch and Timer Calibrations

tolerance of the DUT, the tolerance must be 1920 ms. The amount of time required to elapse on the stopwatch during the calibration would be at least:

$$\frac{1.92 \text{ s}}{X \text{ s}} = 0.02 \% = 9600 \text{ s} = 2 \text{ h } 40 \text{ min}$$

For the same scenario, if we were trying to verify the stopwatch in Figure 8 to the manufacturer's specification of 0.0003 %, the stopwatch would have to run for at least 177 h, 46 min, 40 s (which may cause the laboratory to consider the Time Base Method as a much faster, more appropriate method).

## APPENDIX A: CALIBRATION CERTIFICATES

If a calibration certificate is issued for a stopwatch or timer, it should contain the information listed in Section 5.10 of ISO/IEC 17025.<sup>[2]</sup> Some of the necessary elements are the name and address of the laboratory, the name and address of the client, the identification of the method used, and a description of the item being calibrated. A sample calibration certificate that is compliant with ISO/IEC 17025 is shown in Figure A1.

<b>XXX CALIBRATION LABORATORY</b> XXX Calibration Laboratory, City, State, Zip		<b>CERTIFICATE</b>
		CALIBRATION File: 47821
Instrument:	TIMER-CLOCK	
Manufacturer:	Fisher Scientific	
Model Number:	14-648-1	
Serial Number:	1234566	
Submitted by:	Timing Test Labs 123 Test Lab Lane Anytown, USA	
As Found Condition:	In Tolerance	
As Left Condition:	Left As Found	
Certified:	November 18, 2002	
<p>This unit was tested using the Laboratory's Stopwatch/Timer Calibration Station, MMS # 9410, utilizing procedure # LAB 9812. The calibration data indicates a deviation from the reference standard in seconds per day (+/-), tolerance of the Device Under Test, and Expanded Uncertainty of Measurement (k=2, representing approximately 95% confidence).</p>		
<b>Calibration Data</b>		
<u>Measured Value</u>	<u>Tolerance</u>	<u>Expanded Uncertainty</u>
+0.29s/d	8.64 s/d	0.0864 s/d
Calibration Procedure:	Stopwatch/Timer Version 1,03/11/1999	
Laboratory Temperature:	23.0 °C ± 2.0 °C	
Laboratory Humidity:	40.0% ± 5.0%	
Certificate Number:	146316	
Metrologist: Calibration M. Technician	Approved by: L.M. Boss	
Example Cal Cert	Page 1 of 2	

Figure A1. Sample calibration certificate, page 1.

## ◆ Stopwatch and Timer Calibrations

**XXX Calibration Laboratory**  
City, State

File: 47821  
Date: November 18, 2002

**General Traceability Statement:** Values and the associated uncertainties supplied by the XXX Calibration Laboratory are traceable to one or more of the following:

1. The values of the units (either base or derived) maintained and disseminated by the National Institute of Standards and Technology (United States of America) or, in special cases and where appropriate, to the National Standards Laboratory of another nation;
2. The accepted value(s) of fundamental physical phenomena (intrinsic standards);
3. Ratio(s) or other non-maintained standards established by either a self-calibration and/or a direct calibration technique;
4. Standards maintained and disseminated by the XXX Calibration Laboratory in special cases and where warranted;
5. Values and uncertainties arising from participation in a National Measurement System.

Because of inherent complexity in the calibration process and the uncertainty contribution by both standards and calibrating instruments traceability always requires evaluation of a “traceability tree.” A “traceability tree” analysis can be assembled for a specific calibration and valid for a particular and specific point in time. The “traceability tree” will include copies of relevant certificates and reports, excerpted as appropriate for brevity. However, the cost of preparation of the “traceability tree” will be charged to the requester.

**Note 1:** This certificate or report shall not be reproduced except in full without the advance written approval of the XXX Calibration Laboratory.

**Note 2:** The as received condition of the standard, set of standards, or measurement equipment described herein was as expected, unless otherwise noted in the body of the certificate or report.

Example Cal Cert Page 2 of 2

*Figure A2. Sample calibration certificate, page 2.*

**REFERENCES**

- [1] International Organization for Standardization (ISO). *International Vocabulary of Basic and General Terms in Metrology (VIM)*, 1993.
- [2] ISO/IEC 17025, *General Requirements for the Competence of Testing and Calibration Laboratories*. International Organization for Standardization (ISO), 2000.
- [3] Anderson, R.J., and G.L. Harris. “Specifications and Tolerances for Field Standard Stopwatches.” *Natl. Inst. Stand. Technol. Handbook 105-5*, October 1997.
- [4] Robbins, Michael. “Electronic Clocks and Watches.” Indianapolis: Howard W. Sams Co., 1975.
- [5] Vig, J.R. “Introduction to quartz frequency standards.” *Army Research and Development Technical Report*, SLCET-TR-92-1, October 1992.
- [6] North American Electric Reliability Council Operating Manual, Policy 1. “Generation, Control, and Performance,” Version 2. (Retrieved December 2003 from <http://www.nerc.com/~oc/pds.html>.)
- [7] Butcher, T.G., T.L. Grimes, and J.S. Williams. “Specifications, Tolerances, and other Technical Requirements for Weighing and Measuring Devices.” *Natl. Inst. Stand. Technol. Handbook 44*, 2003 (updated annually).
- [8] Graham, R.M. “Calibration Techniques for Stopwatches and Timers.” *Proc. 2003 National Conference of Standards Laboratories (NCSLI)*, 6 pages, August 2003.
- [9] Lombardi, M.A. “NIST Time and Frequency Services.” *Natl. Inst. Stand. Technol. Spec. Publ. 432*, 71 pages, January 2002 (available online at <http://tf.nist.gov/general/publications.htm>.)
- [10] BIPM/IEC/IFCC/ISO/IUPAC/IUPAP/OIML. *Guide to the Expression of Uncertainty in Measurement*, 1995.
- [11] Allan, D.W., D.D. Davis, J. Levine, M.A. Weiss, N. Hironaka, and D. Okayama. “New Inexpensive Frequency Calibration Service from NIST.” *Proc. 1990 IEEE Freq. Cont. Symp.*, pp. 107–116, May 1990.
- [12] Phillips, S.D., and K.R. Eberhardt. “Guidelines for Expressing the Uncertainty of Measurement Results Containing Uncorrected Bias.” *Natl. Inst. Stand. Technol. J. Res.*, pp. 577–585, Vol. 102, No. 5, September–October 1997.