



# REFERENCE GUIDE FOR OPTICAL MEDIA

Terence O'Kelly

## Content Links

1. Frequently Asked Questions ([FAQs](#))
  - a. [Digital audio](#)
  - b. [CD-R recording](#)
  - c. [CD-RW](#)
  - d. [DVD and Recordable DVD](#)
2. Introduction to the Reference Guide
  - A. [Memorex](#) history
  - A. Differences between [analogue and digital](#) recordings
  - B. [Binary](#) number system
  - C. [Digital audio](#)
3. [Compact Disc](#) and how it works
  - A. [Book Standards](#)
  - B. [Error](#) correction—CIRC
4. [CD-R](#)
  - A. Recording [dyes](#)
  - B. [Music CD-R](#)
  - C. [Reflective surface](#)
  - D. [Capacity](#)
  - E. [Speed ratings](#)
    - a. [CLV and Z-CLV](#)
    - b. [CAV and P-CAV](#)
    - c. [Comparison of speeds vs. time savings](#)
5. [CD-RW](#)
  - A. [Stability](#)
  - B. [Speed ratings](#)
6. [Mini-Disc](#)
  - A. [Magneto-optical recording](#)
  - C. [ATRAC](#) compression
  - D. [Hi-MD](#)
7. [DVD](#)
  - A. [DVD Numbering](#)
  - B. [Recordable DVD](#)
  - C. [DVD Capacities](#)
8. [Recordable DVD Formats](#)
  - A. [DVD-R](#)
    - a. [Data addresses](#)
    - b. [Land Pre-pits](#)
  - B. [DVD-RW](#)
  - C. [DVD-RAM](#)

- a. [Data addresses](#)
    - b. [Cartridge types](#)
  - D. [DVD+R](#)
    - a. [Data addresses](#)
    - b. [ADIP](#)
  - E. [DVD+RW](#)
- 9. Recording onto DVD discs
  - A. [VR Recording onto DVD](#)---+VR and -VR
  - B. [CPRM](#)
  - C. [Capacities of recordable DVD discs](#)
    - a. Capacities in [terms of time](#)
    - b. Set-top recorder [time chart](#)
  - D. [Double-Layer Discs](#)
  - E. [Recording Speeds](#)
- 10. [Blue Laser Recording](#)
  - A. High Definition Video
  - B. [Blu-ray](#) versus HD DVD
  - C. [Laser wavelengths](#)
    - a. [Numerical aperture](#)
    - b. Comparison of [High Definition Proposals](#)
- 11. [Life-time Expectations](#) of Optical Media
- 12. [Care and Handling](#) of Optical Media

## FAQs about Optical Media

There is a great deal of misinformation, hype, and misunderstanding in the field of optical media. Memorex wants to help customers make educated choices about the media and formats they choose; so we have assembled a list of Frequently Asked Questions and the Memorex Reference Guide for Optical Media covering the subject in detail. Click on the blue text to get to the answer to any question. Some answers will include additional links to the Memorex Reference Guide for Optical Media for even more information.

### Digital Audio

- 1) There's "analogue" and there's "digital." [What's the difference?](#)
- 2) What's the difference between a ["bit" and a "byte"](#)?
- 3) How can a computer count using just 2 numbers? [\(The binary counting system\)](#)
- 4) [How much data](#) can I fit on a disc?
- 5) How can a computer [store and play music](#)?
- 6) Some people say analogue is better than digital. Others say the opposite. [Which is correct?](#)
- 7) What's the difference between a ["medium" and a "media"](#)?
- 8) [How do CDs work?](#)
- 9) A scratched CD can still work most of the time. How does a player [correct those errors](#)?
- 10) What do people mean by a [Red Book](#) specification?
- 11) Are [CDs and CD-ROMs the same](#)? Why is there a "Yellow Book" for CD-ROMs?
- 12) My computer drive won't play CDs. [Why not?](#)
- 13) There are a lot of abbreviations used in talking about CDs. What do these mean?
  - a. [ATIP](#)
  - b. [BLER](#)
  - c. [CAV](#)
  - d. [CIRC](#)
  - e. [CLV](#)
  - f. [E11](#)
  - g. [EFM](#)
  - h. [HDTV](#)
  - i. [MPEG](#)
  - j. [MP3](#)
  - k. [OPC](#)

### CD-R Recording

- 14) CD-Rs are recordable CDs. How can [they record](#) information?
- 15) I've heard greenish CD's are the best. [Is that true](#) or is there a better color?
- 16) CD-Rs used to be gold; now they're silver like CD's. [What's the difference](#)?
- 17) [How much](#) can a CD-R hold?
- 18) Are 80-minute CD-Rs [better or worse](#) than 74-minute discs?
- 19) What about [90-minute discs](#)?
- 20) Why won't some CD-Rs work in my [stereo CD-R recorder](#)?
- 21) My CD-Rs won't play. Are they defective?
- 22) CD-Rs are called 12X, 16X, 24X, 32X, 40, 48, and even 52X. What's [the difference](#)?
- 23) Are faster rated discs [better than slower](#) discs?

- 24) Is it better to record at [slow speeds or fast](#) speeds?
- 25) I have an [older drive](#) that records CD-Rs at 4X. I can only get discs now rated at 40X or more but they sound terrible. Are the discs worse now than before or is something wrong with my drive?
- 26) I'm very careful about protecting the bottom of my CD-Rs, but someone told me the [top is more fragile](#). Is that true?
- 27) [How long](#) will CD-Rs last?
- 28) I've heard that the [colored discs](#) are different from plain discs. Aren't they just painted CD-Rs?
- 29) How can a laser read through a [black disc](#)?
- 30) What's the best way to [label](#) CD-Rs and CD-RWs?
- 31) What's the best way to [store](#) CD-Rs and CD-RWs?
- 32) I upgraded from a 4X drive to a 24X drive. Why doesn't the new drive record [6 times faster](#)?
- 33) My recordings fail due to "[buffer underrun](#)." What does that mean?
- 34) I have a 32X recording drive, but I can only record at 24X on Memorex discs that are labeled as 48X. Are these discs [defective or mislabeled](#)?

### CD-RW

- 35) Now some CDs are [erasable](#). How can they get erased?
- 36) What do the numbers [32/12/40](#) on CD drives mean?
- 37) I bought a 32X CD-R drive before I realized drives could [go to 52X](#). Should I upgrade to take advantage of the time savings with the faster drive...or do I run the risk of disks blowing up in my drive?
- 38) I bought some 8-24X [CD-RW discs](#) that won't work with my high-speed drive. The drive can record CD-RWs rated 4-12X. What's wrong?
- 39) I can't [format](#) Memorex 1-4X CD-RW discs, but other brands work. That means these discs are crummy, right?
- 40) Will "[high-speed](#)" [CD-RW drives](#) work with any CD-RW?
- 41) I bought [700MB CD-RWs](#), but I can't put more than half a gigabyte on them. Are they defective?
- 42) I have [a whole spindle](#) of defective CD-RWs. Every disc fails to format. How can every disc be bad?
- 43) What's the difference between "[ripping](#)" and "[burning](#)"? Or are they the same?

### DVD and Recordable DVD

- 44) How can [DVDs hold more](#) if they're the same size as CDs?
- 45) What's the difference in a DVD 5 versus a DVD 9? [How many versions](#) are there?
- 46) What's the [storage capacity](#) of a DVD?
- 47) My DVD player won't play CD-Rs but it [plays music recorded on a CD-RWs!](#) How can that be?
- 48) Now people can record on DVD, but there are [3 different types](#)? Why?
- 49) [What's the difference](#) between the types?
- 50) I've heard that my home [video cassettes will deteriorate](#) in a few years. Which format should I pick to transfer them?
- 51) What's [DVD-R](#)?
- 52) Can I [copy rented DVDs](#) onto DVD recordable discs to build my own library?
- 53) What's [DVD-RW](#)? How is it different from DVD-R?
- 54) My set-top video recorder can record [DVD-RW version 1.1](#) discs but not version 1.2 discs. What does this mean? What's the difference?
- 55) What's [DVD-RAM](#)?
- 56) What's [DVD+RW](#)? There's a DVD+R, too. Does the plus mean it's better than the minus?
- 57) Will any of these recordable DVDs [play in my DVD](#) player?
- 58) I have a 52X CD-R recorder. What [speeds are there for DVD recorders](#)?

- 59) I've heard that if I use the wrong speed disc in my DVD drive, it [can be destroyed](#)? Is that true?
- 60) I tried to record a [4.5GB file](#) onto a 4.7GB DVD+RW but it wouldn't fit. How come?
- 61) My DVD drive [won't record on Memorex DVDs](#). Is the quality that bad?
- 62) I have a choice of [CBR or VBR](#) in my video capture. What are they?
- 63) What are [VR formats](#)?
- 64) I captured my tapes at the [highest "MPEG-2 quality."](#) Why can't I make a DVD?
- 65) What is the [best bit rate](#) to choose when I capture video?
- 66) My DVDs don't look [as good as the VHS tapes](#) they came from. Aren't DVDs supposed to be better quality than VHS tape?
- 67) Once I've made DVD copies of my camcorder footage, [can I throw away the tapes](#)?
- 68) I tried to [copy my VHS movies](#) onto DVD, but they look terrible. Do I need better quality discs?
- 69) How many [minutes of video](#) can I record on a DVD recorder?
- 70) What [do I need to record video](#) onto DVDs?
- 71) Which of these [formats should I buy](#)?
- 72) Which is the [best format](#)?
- 73) I have a video DVD recorder that can record at [24X](#), but a friend says the fastest speed is 16X. Is he right?
- 74) I tried [to format a DVD-RW](#), but I got an error. Now I can't erase the disc because my drive tells me it isn't even there! What did I do wrong?
- 75) What are the numbers that appear on a disc? Which one is the [MID code](#)?

### High Definition Video

- 76) What is [high definition](#) video?
- 77) How do I get high definition [programs](#)?
- 78) I've heard that [blue lasers](#) are coming. What does that mean?
- 79) Why are there [two different high definition](#) discs?
- 80) [Which disc is better](#), HD DVD or Blu-ray?
- 81) Can I play [high definition DVDs in my DVD player](#)?
- 82) Will the new high definition DVD players be able to play my [old DVDs and CDs](#)?
- 83) Will Blu-ray and HD DVD be [compatible with each other](#)?

**The answers to the questions follow below. Click on the link to the Memorex Optical Media Guide to get more detailed information, including pictures and charts. If you have a question not listed in our FAQs, E-mail the question to us; and we will add answers to the most frequently asked questions.**

### Digital Audio

- 1) See the Reference Guide for Optical Media section ["Analogue vs. Digital."](#)
- 2) A "bit" is a **binary digit**; a "byte" is a digital word of eight bits. ([Reference Guide](#))
- 3) The computer uses a binary counting system instead of our usual decimal system. ([Reference Guide](#))
- 4) Reference Guide, [Figure 1](#).
- 5) Reference Guide, ["Digital Audio."](#)
- 6) Digital audio sound is not perfect. Nothing is. But the distortion, noise, and mechanical concerns of CDs, for example, are far less than that of other popular media. For example:
  - a. Distortion is many orders lower on a CD than on an LP or a tape.
    - i. An LP has "low" distortion at only 2 points with regular tone arm geometry.
    - ii. 3% Harmonic distortion or saturation defines a tape's highest record levels.
  - b. Dynamic range for a CD is above 90 decibels and uniform across the disc.
    - i. LP S/N ratio is low and worsens toward the end of a record.
    - ii. Tape needs assistance from noise reduction circuits to overcome hiss.

- c. Noise
  - i. The LP has pops, clicks from debris or damage in the groove.
  - ii. Phonograph tables suffer from rumble noise.
  - iii. Tape has bias noise, modulation noise, DC noise.
- d. Mechanical alignment problems and alignment issues.
  - i. Wow and flutter for both LPs and tape
  - ii. LP stylus height, overhang, anti-skate, tracking force, resistance/capacitance
  - iii. Tape head height, zenith, and azimuth alignments and torque adjustments
- e. Wear
  - i. The stylus wears the groove in the LP; the stylus itself suffers from wear.
  - ii. Tape heads wear; there are magnetostrictive effects on some tape formulations that reduce high frequencies; rub-off of oxide/binder

The CD is not a perfect medium, but it will sound more like the original recording in a far wider variety of playback systems than either a vinyl LP or a tape cassette possibly could.

- 7) A “medium” is the carrier **in the middle** between a source of information and its intended audience. TV is a medium. A CD-R is a medium. The word is single. More than one medium are “media,” the plural of medium. TV is one news **medium**; TV, newspapers, and the radio are news **media**. Almost no one in any media business, whether news or discs, ever uses the words correctly.
- 8) Reference Guide, “[How a CD Works.](#)”
- 9) Circuits to identify and correct expected errors are built into CD players and drives. See the highlighted [Reference Guide section](#) for a detailed, but not too technical explanation.
- 10) The [Red Book](#) is the book published by Philips defining digital audio discs.
- 11) Although they look the same, the information on audio CDs and CD-ROMS is arranged differently. See [Reference Guide section](#) discussion.
- 12) The CD drive in the computer probably has no audio software to identify and support the playback of audio CDs. It only recognizes CD-ROMs with data. It may be necessary to add audio software and even a sound card to the computer to get it to play music.
- 13) Abbreviations:
  - a. [ATIP](#) Absolute Time in Pre-groove
  - b. [BLER](#) Block Error Rate
  - c. [CAV](#) Constant Angular Velocity
  - d. [CLV](#) Constant Linear Velocity
  - e. [CIRC](#) Cross interleaved Reed Solomon Code
  - f. [E11](#) an Error with 1 bad byte corrected at C1 stage
  - g. [EFM](#) Eight to Fourteen Modulation
  - h. HDTV High Definition Television
  - i. [MPEG](#) Moving Picture Experts Group
  - j. [MP3](#) Motion Picture experts group layer 3
  - k. [OPC](#) Optical Power Calibration

### CD-R Recording

- 14) See Reference Guide, “[How a CD Works.](#)”
- 15) The color of the CD-R is a combination of the dye used and the reflective mirror layer behind it. Different dyes have different characteristics, but there are many more important factors that determine the quality of a disc than the dye and its color. See Reference Guide, “[CD-R Dyes.](#)”
- 16) The reflective layer of a CD is aluminum. That metal would not work with the corrosive dyes of CD-Rs, so manufacturers used gold at first and then generally switched to silver or silver alloy to reduce costs. See Reference Guide, “[CD-R Reflective Surfaces.](#)”
- 17) The maximum safe level is 80 minutes of audio or 700 MB of data (before formatting). Reference Guide, “[CD-R Capacities.](#)”
- 18) The question is not whether one is better than the other, but whether or not the discs are more or less interchangeable with players and drives and the data are retrievable. 80-minute

- discs push the limit of the specifications, but that is not a problem with modern players and drives. Older CD players, car players, and older drives are more likely to have trouble with 80-minute discs than with 74-minute discs. See [Reference Guide](#), p. 13 for more details.
- 19) 90-minute discs can be recorded and played in very few drives. There is little software support for this capacity, and it can actually pose a danger to drives not designed for “overburning,” that is, going up to the outer edge of a CD-R. Increasing the capacity requires violating the specifications for track pitch and pit size and writing in areas intended for other information. Even if a drive could manage fitting 90 minutes of audio on a CD-R, there is no guarantee that all CD players would be able to recognize or play it.
  - 20) Stand-alone stereo CD-R players are called “digital audio disc recorders.” They require CD-Rs that have a special code in the [ATIP section](#) that identifies them as DA or “digital audio” discs that can only be recorded in these types of recorders. Computer drives can use either standard or DA media, but DA recorders can only record on DA discs. Once recorded, the DA discs will play no differently from any regular CD-R. Only the recording process is restricted, not playback.
  - 21) If the CD-Rs won't play in the drive that burned them, there is something wrong with the medium, the drive, or the recording software. If the discs do play in that drive but not in another player, the reason could be an incompatibility with the reading laser and the disc. Although there are tight specifications for media, there are very few specifications for drives. Older CD players sometimes have trouble reading CD-Rs for a variety of reasons including reflectivity, pit geometry, or groove shape on the disc or tracking problems in the drive. Newer players and drives have far fewer problems with compatibility.
  - 22) The number rating of discs is a measure of how fast they can be recorded in a drive rated to be capable of that speed. A 16X disc can be recorded at 16 times normal speed (“Normal” is the playback speed of a music CD, or “1X.”) in a drive rated at 16X, but at only 8X in a drive rated only for 8X maximum. A 24X drive, however, might try—and succeed—to write to a 16X disc at 24X; but if it has trouble, it will drop down to a 16X speed. See [Reference Guide](#) for some interesting details on what the speed ratings really mean.
  - 23) Faster discs have thinner dyes that react faster to the laser light and the greater laser power used. There is no quality difference in this regard, although discs rated at the highest speeds have to have excellent balance, concentricity, and uniformity so that they do not cause problems for high speed drives. These are lesser concerns at slower speeds.
  - 24) There are many opinions from experts who claim they can hear differences in discs recorded at 1X and those recorded at faster speeds. That is unlikely, but any measurable differences would be due to the design of the drive and the condition of the laser and their compatibility with whatever medium is being recorded. The facts are: a) recording lasers pulse at slower rates at slow speeds but act more uniformly at higher rates of speed; b) more power is required at faster speeds, but the increase in required power is not proportional to the increase in speed; there may actually be less drift in laser power at the faster 4X-12X speeds and beyond; c) lasers in drives operated at the maximum speeds all the time will age faster than if they were used at a lower power levels; d) slower speeds will cause vibrations at lower frequencies which may interfere with the transfer of data: faster speeds create vibrations at higher frequencies that may pose less of a problem; e) tests measuring error rates find little difference in results at slow speeds or high speeds, but higher speeds often show a very slight advantage.
  - 25) The latest discs available today are designed to be recorded at speeds of 48X to 52X. Older drives that record at slower speeds work best on CD-Rs with slow acting dyes. Unfortunately, just as computer operating systems and peripherals are always being updated in favor of the newest and fastest products, the same is true of CD-Rs. Fast reacting, high-speed CD-Rs do not work as well with the old, slow CD-R recorders. The poor sound quality is due to the drive overburning the fast acting dye and distorting the pits. Although there is nothing wrong with either your drive or the new discs, they are no longer compatible. One either has to find old CD-Rs or upgrade to a faster drive that can handle the new discs.

- 26) The laser looks through the bottom of the disc, a solid piece of clear polycarbonate plastic. That plastic is sturdy but should not be scratched or soiled in a way to interfere with the passage of the laser's light beam. The top of the disc, however, is only a coating of lacquer covering a thin deposit of reflective metal. It is very delicate. Never write in the top of a disc unless one is using special pens designed for CD-R writing. The wrong type of pen (a ballpoint pen, for example) can either damage the surface and the data below or use inks containing acids that will damage the lacquer protection.
- 27) The lifetime of a CD-R is estimated by environmental tests that try to simulate the accumulation of damage from light, heat, humidity, and exposure to the normal chemicals in the air. The "death" of a CD-R is defined as the point at which the number of errors accumulates to such a degree that simple error correction can no longer retrieve the data on the disc. Different dyes as well as different manufacturing skill and techniques have produced discs estimated to last from 70 years to over 100 years, far longer than the playback technology will last—or even the lives of the owners. The assumption is that the discs are properly handled and stored away in the dark over that time period. Real-life conditions suggest that careless handling and heedless exposure to sunlight can ruin a disc in a month or less for poor quality discs.
- 28) Colored discs are very often just silk-screened with ink in various shades, but Memorex's "Cool" discs are actually colored clear through. There is no difference in performance with these discs because although we humans see the full spectrum of visible colors on the discs, the laser has a much narrower vision restricted to 780 nanometers of wavelength. The only color that poses a problem for a laser is green because green can absorb the red laser light. (Experiment: put a green mark on a piece of paper and shine a red light on the paper. The paper looks green, but the mark appears black. It absorbed all the red light.)
- 29) Same answer as above. To human eyes the black disc appears to absorb all "visible" light, but it will not absorb the very narrow range of the red laser light.
- 30) The best way to label CD-Rs and CD-RW's is to use special CD marking pens whose inks do not damage the lacquer surface of the disc. An alternate method is to use adhesive paper labels designed for optical discs so that they do not peel off. Misaligned paper labels cannot be pulled off a disc without damaging the surface and the reflective layer and dye below, so be sure to use a labeling kit device for best alignment. Alignment is not as critical for audio playback as it is for high-speed audio extractions ("ripping") or data recordings for which drives read at high speed. The worst way to label discs is to use a ballpoint pen.
- 31) The best way to store CD-Rs and CD-RWs is to keep them in cases that protect the surface from any physical damage and the bottom from scratches. The discs should be kept away from light and heat and transient debris such as dust.
- 32) The "speed" of a drive is its **maximum** speed, not its average. Claimed speeds of 32X up to 52X and beyond cannot be achieved over the entire disc because of the limitations in dye reaction times, data transfer rates, and laser power. These maximum speeds are achieved only if the amount of data is enough to bring the laser head to the outer half of the disc where the disc spins the fastest--the faster the maximum claimed speed, the further from the center of the disc. See [Reference Guide](#).
- 33) "Buffer underrun" occurs when the drive asks for more data to burn on a disc at a rate faster than the computer can provide. The computer's buffer memory storage can run out and interrupt the data stream. There are several ways to avoid this problem:
- Let the computer's RAM memory concentrate only on disc burning by making sure you shut down all other applications, even those running "in the background" such as anti-virus programs.
  - Defragment the hard drive so files run contiguously and the drive does not have to hunt for missing pieces.
  - Record at a slower speed.
  - Invest in a drive that has "new technology" to avoid buffer runs. (The new technology is chiefly more buffer memory in the drive and programming that automatically slows down the drive for you if it has to.)



- 34) The discs are neither mislabeled nor defective. Your drive is identifying the discs as “Memorex discs” and only allowing a maximum recording speed of 24X for them because the drive’s firmware only allowed that maximum at the time it was built. It may not recognize 48X as a legitimate speed. You may be able to update the firmware by contacting the drive manufacturer so that all discs rated 32X or greater will be able to achieve at least a 32X rate on your drive.

### CD-RW

- 35) CD-Rs and DVD-Rs use a dye to record data. The “burning” process of recording permanently alters the dye. Erasable media such as CD-RW, DVD-RW, DVD-RAM, and DVD+RW use a semi-metal alloy instead of a dye. The recording laser melts the alloy in the spots to represent pits because melting and sudden cooling dull the alloy. The laser can erase the disc by heating the alloy at lower power because heating and cooling return the alloy to its original shiny, crystalline state. See [Reference Guide](#).
- 36) The series of numbers describing drives list the **maximum** possible speeds the drive is capable of reaching during: a) recording a CD-R; b) recording a CD-RW; c) reading a CD-ROM. A 32/12/40 drive can record a CD-R at a maximum speed of 32X; can record a CD-RW at a maximum speed of 12X; and can read a CD-ROM at a maximum speed of 40X. Note that the maximum read speed may not apply to all CD-Rs or CD-RWs. If their signal to noise ratios are poor limit the drive’s read speed to lower values. See [Reference Guide](#).
- 37) Trading in a 24X drive for a 52X drive will save you about a minute, fourteen seconds per disc only if you record to the maximum capacity of an 80-minute disc. Recording any less will reduce any timesavings significantly. A disc can only “explode” in a drive if it has already experienced some severe damage already that the drive makes worse. Your 24X drive is almost as likely to explode such a disc as a 52X drive would since they both start up at approximately the same speed. See the section in the Reference Guide on [CD-R speeds for a graph](#) of timesavings and speed ratings.
- 38) There are three different types of CD-RWs: a) the regular 1X-4X version; b) the “high-speed” 4X-16X version; and an “ultra-speed” 8X-24X version. Older drives with a maximum rating of 4X for CD-RW are limited to the 1X-4X discs. High-speed drives can use record both the regular and high-speed discs, but they cannot record “ultra-speed” discs even if the speed ratings overlap between 8X and 16X. The latest ultra-speed CD-RW drive can record all speeds of CD-RWs up to the maximum speed rating of the medium. See [Reference Guide](#) for more details.
- 39) That would seem logical—if there were only two variables: good discs and bad discs. However, the variables include the drive firmware and the packet-writing software. If the drive firmware does not include the proper writing strategy for the CD-RWs, the drive will produce errors on the disc that the software interprets as disc flaws. In many cases, updating the drive firmware will solve the problem if the new drive firmware includes the discs in its settings. Updating the packet-writing software may also solve the problem.
- 40) No. They will not be able to record the latest “ultra-speed” CD-RWs even though ratings may overlap. For example, an ultra-speed 16X disc will not be able to be recorded on a high-speed CD-RW drive with a maximum speed of 16X. The 16X high-speed rating is not the same as a 16X ultra-speed rating, or even an 12X ultra-speed rating for that matter. See the answer above. “Ultra-speed” CD-RW drives are necessary to record onto 16X-24X ultra-speed CD-RW discs; but once the discs are recorded, all CD-RW drives are able to read regular, high-speed, or ultra-speed discs.
- 41) No. A 700MB CD-RW truly has a blank capacity of 700MB, but 100MB are sacrificed to formatting so that data can be filed and erased. Double-sided high-density floppy diskettes have an inherent capacity of 2MB, but everyone is used to the 1.44MB capacity that remains after they have been formatted. The same applies to CD-RW.
- 42) It is very unlikely that a whole spindle can be defective. There are two possible reasons: 1) your drive does not have the proper write strategy for the discs (see #39), or 2) the first disc you tried could actually be defective but its errors corrupted temporary memory so that the

software rejects all subsequent CD-RW discs. Rebooting will take care of the second problem, but you may have to update the drive firmware and packet-writing software to solve the first situation.

- 43) "Ripping" is the digital extraction of files from a CD to a computer hard drive. As the computer extracts the files, the software can turn them into .wav files for recording onto a CD-R as tracks that CD players will recognize or into compressed MP3 files or into a file format of the user's choice. "Burning" is the word describing the laser recording process in which a high-power laser "burns" the organic dye of CD-Rs or melts the metal alloy layer in CD-RWs.

#### **DVD and Recordable DVD**

- 44) Although the discs are the same physical size and shape, there are more tracks and smaller pit sizes on a DVD. See [Reference Guide](#).
- 45) A DVD 5 is a single-sided, single layer DVD disc holding 4.7GB of information. A DVD 9 is a single-sided, double layer disc holding almost twice as much. There are four basic versions with definitions in [Reference Guide](#).
- 46) The storage capacity can vary depending on the number of sides used and the number of layers on the disc. See [Reference Guide](#) for a complete listing.
- 47) Some newer models of DVD players follow a "multi-read" standard so that they can play most types of DVDs as well as CDs, CD-Rs, and CD-RWs. Earlier versions of DVD players were limited to DVDs, but often the circuits designed for the low reflectivity of DVDs were compatible with the low reflectivity of CD-RWs. If those types of DVD players could read CDs, they could often read CD-RWs, too. See [Reference Guide](#).
- 48) There are three different types because of a combination of different design objectives and conflicting corporate interests. [Reference Guide](#).
- 49) See Figure 22 on [Reference Guide](#).
- 50) This is a great argument for frightening people to abandon video tape and jump into DVD recording, but it's based on misinformation. As long as the chemical formulation in the binder of the video tape is sound and the tape is stored properly, there is no cause for the tape to deteriorate over time. Playing a tape over and over can reduce the signal output by 1.5 dB, but since the signal is FM modulated, that decrease makes no difference in quality. Repeated playing can actually polish a tape surface so that a new recording might even test better than the original. (As a point of reference, modern video high quality VHS tapes are able to withstand one hour of still-frame play without deterioration. That's equivalent to 108,000 passes or repeated plays.) Over time video tapes can suffer from:
- Edge damage from misaligned guides or poor heads
  - Wear from worn or damaged heads or transient debris getting between the heads and the tape surface. (Debris from the edge of the tape after slitting is a major cause of dropouts for video tape.)
  - Damage caused by excessive humidity; for example, the condensation that occurs on the tape surface if a cold tape is brought into a warm room.
  - Poor storage conditions that include heat, humidity, great fluctuations in temperature, and dust. Rewinding tapes periodically without stopping at any point in the cycle will relieve any stresses that build up in the tape packs from variations in temperature and humidity.
  - Exposure to strong magnetic fields

As long as good tape with sound chemistry is stored properly, it will not deteriorate. The real truth is the reverse: the life of optical discs is defined as the point at which slow deterioration causes the error level to reach a threshold beyond error correction. That steady deterioration can take a very long time, but it is irreversible. A fundamental difference between the two media is that the VCR contributes greatly to the physical quality of the tape as well as to its playback quality. Dirty heads and guides, worn head gaps, misaligned guides, improper take-up tensions, and many other alignment issues contribute to tape damage that often appears to be "degraded" tape. VCRs age at the same rate that tapes do, and an old, uncared-for

- VCR may be a greater contributor to poor tape playback than the aging of the tape. DVD players have no physical contact with the discs other than clamping the center hub.
- 51) A DVD-R is a recordable DVD similar in design to a CD-R. It is not erasable. [Reference Guide](#).
  - 52) No, for two reasons. First, it is wrong to take the work of others without compensating them for their efforts—and it's illegal. The second point is that there are copy protection schemes built into DVDs, drives, and software that prevent such illegal copying.
  - 53) A DVD-RW is the erasable companion to the DVD-R. Use of a semi-metal alloy instead of a permanently altered dye makes the DVD-RW erasable. [Reference Guide](#).
  - 54) Version 1.1 DVD-RW discs have a speed rating of 1X to 2X. These discs can be recorded in almost all stand-alone set-top recorders. DVD-RW discs with speed ratings of 4X or 6X are known as version 1.2 DVD-RW discs. These version 1.2 media cannot be recorded in older recorders and sometimes only play in those recorders when they are finalized.
  - 55) A DVD-RAM is a DVD designed for random access memory, for the quick and easy storage and retrieval of data. Its protective cartridge distinguishes this disc, but some versions come with a bare disc free of any cartridge. [Reference Guide](#).
  - 56) A DVD+RW is a rewritable DVD designed to work well with both video and data recording. The DVD+R is the write-once companion. The plus in their name distinguishes them from the earlier DVD-R/-RW. [Reference Guide](#).
  - 57) Whether a recorded DVD will work in a DVD player depends on the player. Multi-format DVD players will likely play all formats except the DVD-RAM cartridges. Older players may have the fewest problems with DVD-R or DVD+R if they play the discs at all. The lower reflectivity of DVD-RW and DVD+RW sometimes poses problems for older players. [Reference Guide](#).
  - 58) DVD 1X speed is already nine times faster than a CD 1X speed; so “high-speed” DVD recording is going to be limited. All present drives can record at 1X. DVD-RAM records at a maximum of 3X; DVD-R at a maximum of 4X; DVD-RW, 2X; and both DVD+R and DVD+RW at a maximum of 4X. 8X writing is next increase in DVD recording speeds, and it will come first to DVD+R, then DVD-R, and then DVD+RW. The fastest DVD writing speed possible is 16X or just slightly faster. [Reference Guide](#).
  - 59) Yes, but the whole story is not quite as dramatic. The early DVD-R/-RW drives that could write at a maximum of 2X would not recognize 4X DVD-R discs and could possibly damage their laser diodes trying in vain to identify the discs unless the user intervened and stopped the drive. Pioneer provides a firmware fix to the drives so that they will recognize 4X discs and record them at 2X. See [www.pioneerelectronics.com/hs/](http://www.pioneerelectronics.com/hs/) to download the fix for their drives. In the DVD+R/+RW camp, 4X discs in early 2.4X drives will appear to behave normally, but the write strategy will create irregular marks in the discs and the discs will fail. A firmware upgrade fix for the Memorex DVD+R/+RW drive can be downloaded from the Memorex website at [www.memorex.com](http://www.memorex.com). Memorex also provided warnings and the firmware information in all of its 4X DVD+R and DVD-R products.
  - 60) The problem is that computers and DVD drives and media count the numbers differently. The computer counts according the base two in its binary system. The DVD camp decided to count bytes in the decimal system. A 4.7GB DVD+RW actually only holds 4.377GB in computer terms minus any capacity taken up by formatting.
    - a. 1GB = 1 gigabyte = 1,073,741,824 bytes =  $2^{30}$  in computer terms
    - b. 1GB = 1 gigabyte = 1,000,000,000 bytes in DVD terms
  - 61) There are often two reasons a disc will not record in a drive: 1) the discs are the wrong format, or 2) the drive lacks the firmware to recognize the disc. In the first case, a DVD-R recorder will not be able to record on a DVD+R or DVD+RW disc unless the recorder is a “dual format” recorder that can record on both. The same is true of DVD+R/RW recorders—they will not record DVD-R/-RW discs. The second case is more common, but less obvious. Drives rushed to market with the latest speed as its chief feature often limit the testing done on various discs in order to save development time. The drives work with a limited number of discs whose ID codes are in the drive memory so that the drive selects the proper write strategy—the amount of laser power required and the timing of the light pulses—to record on

them. Discs whose codes and write instructions are not in the drive memory, its firmware, will not work or work very badly. In time the drive manufacturers develop new instructions for additional disc ID codes, and these are added to the drive's firmware by means of an update that is "flashed" to the drive's memory bank. Internet forum groups often make ignorant claims about discs or drives when the problems are due to incompatibilities, not any flaws in either the discs or the drives.

- 62) CBR stands for "constant bit rate," and VBR means "variable bit rate." The CBR means the computer assigns the same number of bits for every second of video while VBR may alter the rate depending on how complex the video is. VBR can often be more efficient and allow a little more capacity on a disc if the video is not tough to encode.
- 63) [VR stands for Video Recording](#). That's the easy part—there are two incompatible VR formats: -VR and +VR. The -VR format is used by the DVD-R/-RW camp to record video in real-time onto a DVD-R or DVD-RW disc in a set-top recorder so that TV programs can be recorded from the built-in TV tuner. Unfortunately, -VR formatted discs will play only on the type of recording device that recorded video onto them. -VR recording allows playlists and chapter markers to be added to a recording on a DVD-RW and some editing ability. The +VR mode is used by DVD+R and DVD+RW discs for the same type of real-time recording as well as some limited editing. Unlike -VR formatted discs, +VR formatted discs will also play in DVD players that play DVD+R and DVD+RW discs.
- 64) MPEG-2 encoding has a number of bit rate settings, the highest of which exceed the standard for DVD-video. A DVD cannot have a bit rate higher than 9.8 Mbps (megabits per second), including both audio and video. Some video capture/editing software allows higher rates for MPEG-2, but the higher rates will not allow DVD recording, which is what most people are trying to accomplish. Other software picks a lower rate by default. The "highest quality" for some is only 6 Mbps because it is much easier to encode and more likely to work than a higher rate. Other software limits the bit rate to 8 Mbps to offer high quality at a safer rate than the maximum of 9.8 Mbps.
- 65) The "best bit rate" is the one that offers the best balance between quality and disc capacity. Choose the highest rate possible—8 Mbps or higher—for "archival" quality, but that means only about 1 hour per disc. Choose lower rates if getting more information on a disc is more important than the highest video quality.
- 66) DVDs are capable of much better quality than that on VHS tape if: 1) the video is mastered and encoded very well, and 2) if the bit rate of encoding is sufficiently high. Capturing VHS video at too low a bit rate will produce video far worse than that on the original tape even when it is played back on a DVD player. The mastering and encoding software used by Hollywood studios costs hundreds of thousands of dollars and is far superior to anything offered to consumers today. The result is that, even at the highest bit rates, video captured from VHS tape and recorded onto DVD will not be as good as that on the original VHS tape. The best software would only be able to make it appear equal to the original, not better. The same holds true of MiniDV tape. It is encoded at a rate of 25 Mbps, but when that is transcoded to MPEG-2 video even at the maximum rate of 9.8 Mbps, the resulting video quality is less than the original if one looks very closely.
- 67) Throwing away the masters would be a very foolish thing to do for several reasons: A) the masters offer better quality than the DVDs made from them (see #60), and future software will reduce that difference if you want to remake them later; B) video tapes degrade with use, not with age (see #48) so they are safe if stored properly; C) DVDs do not degrade with use, but they do degrade over time as the number of errors increases; and, as digital media, at some point they may refuse to play altogether. It is a good rule of thumb never to throw away master copies.
- 68) The problem is probably that the capturing software did not accept a movie protected by Macrovision. Macrovision is an encoding method used to defeat copying of VHS tapes and even DVDs. Capture software will often recognize tapes protected by Macrovision and prevent the video from being seen properly.

- 69) The number of minutes of video a DVD recordable disc holds depends on the bit rate used to store the video: a high bit rate provides the best quality but requires a lot of data that use up time. A lower bit rate uses less data, but the video quality declines. The “standard practice” appears to be similar to that for video tape: the highest quality mode (“XP” or “HQ”) allows one hour of recording; SP (“standard play”) is 2 hours. At this point it becomes confusing: LP (“long play”) is 3 hours for some DVD+R/+RW recorders and 4 hours for others. For DVD-RAM, LP provides 4 hours of recording time. Extended play EP is 4 hours in some DVD+R/+RW recorders but 6 hours in others and in DVD-RAM recorders. Those DVD+R/+RW recorders that designate EP as 4 hours use “EP+” for their 6-hour mode. DVD-RAM recorders will record DVD-R discs in the same modes as the DVD-RAM, but Pioneer’s DVD-R/-RW recorders offer completely different nomenclature and settings. See the chart in the [Reference Guide](#) for the full details.
- 70) Recording video onto DVDs requires:
- a fast computer with a lot of RAM (>600MHz processing speed; >64MB of RAM)
  - a method to capture the video so that the computer can accept the video data
  - editing software to alter the program, add titles, sound tracks, etc.
  - authoring software to arrange the edited program in a DVD format with menus
  - a recording DVD drive
  - lots of time and patience [Reference Guide](#).
- 71) The factors in determining which format suits your purpose depend on:
- your reason for recording at high capacity—video or data
  - price of the drives and the media that support them
  - compatibility with other drives or DVD players
- Memorex cannot answer the question for you. Our intent is to provide enough accurate information so that buyers can make the most educated choices.
- 72) Probably the one most users choose to buy, if one defines “best” as “most suited to most users.” [Reference Guide](#).
- 73) The fastest DVD recording speed is a bit faster than 16X, a data transfer speed that can occur only at the outer edge of the disc at the end of the recording. The speed is determined by the fastest rate of data transferred to the disc divided by the regular data transfer speed of video coming from a DVD player. There are some recorder manufacturers who are misusing the standard terminology by comparing the time it takes to play back a full disc to the time it takes to record it. Since it is possible to stuff as much as 6 hours or more on a hard drive in the Extra Play EP mode by using high compression at the sacrifice of quality, transferring the 6 hours worth of video onto a DVD disc at 4X will take the same time as transferring 1 hour of highest quality of video; but one can claim that 6 hours at 4 times the standard 1-hour speed is equal to “24X.” This is misleading and incorrect. The amount of data for a 1-hour highest quality video DVD is the same as that spread over 6 hours of lowest quality video. The speed is a matter of how long it takes to transfer data, not transfer “playback time.”
- 74) You didn’t do anything wrong. When this happens, most people erroneously blame the disc or the disc quality when, in fact the real reason is most likely an incompatibility between the disc, the software, and/or the drive. If the drive or the software do not include the identification code of the particular disc so that they can set the proper write strategy for the drive (the intensity and the duration of the laser’s recording pulses), the drive can end up making recording marks on the disc that are unintelligible for it to read later. The drive may inform the user that the disc is illegal, corrupted, scratched, or not even in the drive. The drive will refuse to format or erase the disc and sometimes insist that it is not a rewritable disc. In most cases the solution is to check for firmware updates for the drive that include additional discs and software updates for the recording software that also include more discs. Updates may allow users to record to the remaining DVD-RW (or DVD+RW and CD-RW discs) in a package, but the unintelligible would have to be returned to the factory to be erased by heating methods independent of drives that can no longer identify the disc.
- 75) There are usually two visible numbers on every disc: the production code unique to each disc that appears either as an ink-jet printed number or as a number molded into the plastic. Both

appear around the inner ring of the disc. A second number appears in the silver alloy section beginning around the inner ring. This number will likely appear on all the discs in a spindle because it refers to the stamper used to mold the all the discs in a production run. The MID (Media Identification) code numbers are not visible on the disc. These numbers are in the form of digital information that is encoded into the stamper and pressed into the disc to tell recording drives what type of disc it is, its recording speed rating, and the amount of laser power to be used in recording the disc.

### High Definition Video

- 76) High Definition video generally means a video signal with either 720 or 1,080 horizontal lines of video information instead of the 525 lines our NTSC television standard uses. (Of the 525 NTSC lines, only about 480 actually display picture information. The rest are used for synchronizing signals for the TV circuitry and only appear in the black bands above and below the picture.) Some DVD players use special circuitry to repeat lines the way computer monitors do. That means that instead of showing 30 frames of picture each second, each frame composed of two fields interlaced together, these DVD players send a signal to high definition displays as both fields simultaneously composing a frame. This is referred to as “progressive scanning” instead of interlacing. Although more detail appears in a progressively scanned DVD display, it is not true high definition. True high definition signals must have 720 lines of progressively scanned video (“720p”) or 1,080 lines of lines of information either interlaced (“1080i”) or progressively scanned (1080p). DVDs using their MPEG-2 compression do not have the capacity for carrying all the data needed for HDTV. There are two ways to add high definition information to DVD discs: a) use different compression methods to pack more information on a disc, or b) use a laser with a smaller wavelength to pack more MPEG-2 data on the disc. The first method retains the standard red laser and uses new firmware in the DVD player to distinguish regular DVDs from HD DVDs. The second method uses a blue-violet laser diode capable of much smaller wavelengths. There are two different versions of the second, blue laser method that are capable of carrying true HDTV video signals in the MPEG-2 compression scheme: a “Blu-ray” version and an “HD DVD” version. See [Reference Guide](#).
- 77) There are several ways to see high definition programs: a) use a high definition tuner with a high definition monitor to receive “over-the-air” broadcasts; b) use a high definition cable box for cable reception; c) play D-VHS cassettes that have high definition programs recorded on special VHS tape (requires a D-VHS player, which is hard to find); d) or use one of the two new high definition discs that are being introduced now.
- 78) The lasers used in CD players and drives and in CD-R/-RW burners are infrared lasers that produce laser light at a wavelength of 780 nanometers (billionths of a meter). DVD players, drives, and burners all use ruby-red lasers with wavelengths tuned to 650 nanometers. In order to create DVDs capable of high definition video, engineers have had to shrink disc pit sizes below the wavelengths of red light; so to read the pits, a new laser had to be developed with a smaller wavelength. The laser is a blue-violet laser with a wavelength of 405 nm. [Reference Guide](#).
- 79) High definition programming requires far more data than DVD video. One way to increase the data would be to use a different data compression scheme to pack more information on a DVD, but developers chose to use blue lasers rather than red lasers used in DVDs. Blue lasers have smaller wavelength than red lasers (Red is at the bottom of the color spectrum and the blue lasers are closer to the upper ultra-violet—think of a rainbow!) and can read and write smaller data pits. Smaller data pits mean more information can be packed onto a disc the same size as a DVD. Unfortunately, the developers disagreed on how to use the blue lasers. One group decided to use greater data compression and fit all the HD programming on a less expensive disc much like a regular DVD. This was the HD DVD camp with its 15GB disc. A second group decided to push existing technology to its practical limits and use standard DVD compression on a totally new type of disc. Getting all the HD information at

lesser compression on a single disc required more capacity; so this group—the Blu-ray camp—designed a disc with 25GB capacity.

- 80) Both discs will play high definition programming equally well. In fact, unless one is watching on a true HD screen larger than about 32 inches, high definition will be difficult to distinguish from standard DVD. Larger screen sizes begin to show the inter-line flaws and artifacts of standard video, and that is where the improvement in high definition resolution will be noticeable. As for superiority of format, that is debatable. HD DVD discs will be less expensive to manufacture because they are so similar to regular DVDs, and the recorders/players can use a plastic lens to read/write discs. Blu-ray discs have greater data capacity; and that capacity can be used with the standard DVD compression or the same compression used for HD DVD. The choice of data compression will have a greater effect on any difference in video quality between the two than any difference in the way the discs are made. HD DVD's MPEG-4 encoding can actually produce better pictures than the older MPEG-2 compression some Blu-ray discs may use. The recording surface for Blu-ray, however, is on the bottom of the disc and more prone to scratches and physical damage. The disc will initially be more expensive to produce, and the recorders/players require a more expensive glass lens to read/write discs. The "better" format will be the one more consumers choose to adopt, and that will take time to decide.
- 81) In some cases it may be possible. The HD DVD Consortium has developed a special 'hybrid disc' that contains 2 distinct sets of information: one is the high definition information that will need a true HD DVD player to read it, and other is the standard definition information that can be played back on today's DVD players. This is relatively easy to do since both the standard DVD and the HD DVD use two pieces of plastic with the video data sandwiched between them. Blu-ray discs use a single-piece design with the data on the bottom of the disc. It is possible for such discs to have a double-layer design that includes a standard DVD program within the disc and the high definition information in its bottom position.
- 82) Yes. Read heads can include multiple read lasers or multiple lenses so that infra-red laser CDs, red laser DVDs, and blue laser high definition discs can all be read by the same device. Several leading consumer electronics companies (including Panasonic, Philips, Pioneer, Samsung, Sharp, Sony and LG) have already demonstrated products that can read/write CDs, DVDs and Blu-ray discs using a BD/DVD/CD compatible optical head; so you don't have to worry about your existing DVD collection becoming obsolete. It's up to each manufacturer to decide to make its products backwards compatible, and most see the advantage in having players that can also read older optical disc formats.
- 84) No. A Blu-ray disc will not play in an HD DVD player and vice versa. However, it appears likely that some manufacturers will manufacture 'dual format' drives, players and recorders that could accommodate both formats in the same way that some manufacturers currently offer multi-format DVD players and recorders that can accommodate both DVD+R/RW and DVD-R/RW discs.

## REFERENCE GUIDE FOR OPTICAL MEDIA

Terence O'Kelly

Memorex has long been one of the world's foremost suppliers of media for memory storage. The very name of the company is a shortened form of "**MEMORY EX**cellence" that started in 1961 with the manufacture of half-inch 9-track computer tape and progressed to audio and video cassettes, digital audio cassettes, and computer diskettes. As technology developed, Memorex expanded to optical storage media such as recordable and rewritable CDs and DVDs and has become one of the world's leading suppliers. Now, as the long-promised age of solid-state memory is beginning, Memorex is also providing a wide range of flash memory devices for computers.

Today's technology is increasingly digital. The world has quickly accepted "digital" as a distinction of advanced technology and quality, often without fully understanding what it means in everyday products. CD-Rs and CD-RWs have replaced audio cassettes and floppy disks as common recording media, but few people know how they work. Newer optical storage products such as recordable and rewritable DVD are designed for greater storage capacities to challenge video tape and computer cartridges, and these media are even more complicated because of the variety of competing designs and formats available. Memorex believes that many of our customers are curious to know more about the products they are using or will be using in the near future. In our commitment to "memory excellence," we hope to explain the technology behind the products we sell. Very technical information that may be of interest only to readers with a scientific background appears in the shaded passages

### **ANALOGUE VS. DIGITAL**

*Analogue* comes from two Greek words loosely meaning "word for word," as in a translation. The adjective is a way of describing information in one understandable way analogous to or similar to the actual way. The description is often applied to the use of a "picture for picture" instead of a "word for word" translation. For example, an analogue clock has hands that make a complete circuit in a minute or in an hour or in half a day, depending on which hand it is. The hands continually go around just as the earth turns completely around on its axis in a day. Analogue recordings "draw" an impression of sound waves in the squiggly groove in vinyl records or as variations of magnetic energy in cassette tape. The vinyl records and tape store these "pictures" of the sound patterns and allow them to be played back. The problem with this system is that the information gets mixed up with the flaws of the medium. A clock hand that does not keep up with the other hands gives inaccurate information. Dust in a record groove causes sounds and noises not meant to be heard. Tape imperfections cause hiss that was not part of the original sound.

Digital recording is a method that avoids these flaws. Digital recording does not try to draw or imitate the information that is being saved. Instead, it converts the information into a mathematical code that ignores the flaws of whatever medium is storing the data. To use an analogy, a canvas painting of a landscape records the landscape with all the "flaws" of canvass and paint texture (those "flaws" that make a painting an inaccurate but artistic impression). If oil is spilled on the painting, it is difficult to restore what was there because the oil becomes part of the record. If, however, someone recorded the landscape with a "paint-by-number" scheme in great detail, the oil would not matter. The oil stain had no numbers assigned to it; so the artist could reproduce the landscape by following the number



code exactly. The more numbers involved, the more accurate and detailed the reproduction would be—and every copy would be almost identical to the original.<sup>1</sup>

The word *digital* refers to digits or numbers. It comes from the Latin word *digitus*, or “finger,” because everyone learns to count on his or her fingers. We have ten fingers, so our common numbering system is to the base 10 and uses ten digits—0 to 9. The mathematical code used in digital recordings is very intricate and needs computer chips to encode and decode; but computers don’t have fingers. They have transistors that recognize only two states: on/off (or “0/1,” “change/no change,” “+/-,” etc.). Computer engineers use the binary numbering system for computers, a numbering system to the base 2 that needs only two numbers, 0 and 1, to construct any value. Expressing the same number 3723 in both our common decimal system (10) and the binary (2) numbering system shows the differences between the two.

**3,723**

**The decimal system uses digits 0 to 9. Each column is 10X greater than the one on its right.**

1 millions	100 thousands	10 thousands	thousands	hundreds	tens	ones	= 3,723
0	0	0	3	7	2	3	

**The binary system uses only digits 0 and 1. Each column is 2X greater than the one on its right.**

2048’s	1024’s	512’s	256’s	128’s	64’s	32’s	16’s	eights	fours	twos	ones	= 3,723
1	1	1	0	1	0	0	0	1	0	1	1	
2,048	+ 1,024	+ 512	+ 0	+ 128	+ 0	+ 0	+ 0	+ 8	+ 0	+ 2	+ 1	

In our familiar decimal system, each column of digits goes up by a factor of 10. The number 3723 is represented by 3,723 with a comma often separating each of the sections worth a thousand. In the binary system that computers understand, 3723 is represented by the number 111010001011 for which each column represents a factor of 2. Each column is twice the value of the column to its right. We count by 10’s (fingers). Computers count by 2’s (on/off transistors).

The **binary digits** that computers use are called “bits.” These bits are organized into “words” containing eight bits called, in a fit of early computer geek humor, “bytes.” It is these words that commonly describe capacities such as a kilobyte, megabyte, gigabyte, and so forth. And because these capacities are based on a binary system, there is often confusion about the true value of the numbers. A kilobyte literally means “1,000 bytes”; but because the number base is a 2, not a 10, the closest binary number to 1,000 is 2<sup>10</sup> or 1,024. A kilobyte is actually 1,024 bytes in the binary way of counting.

## STORAGE MEDIA

In the earliest days of computers kilobytes meant a lot of information. That did not last long. Technological progress has made computers faster, smaller, and less expensive and has made the storage media for them capable of greater capacity while also shrinking their size and cost. Memorex’s half-inch computer tapes gave way to 8” floppy disks, then 5 ¼” diskettes, then the 3.5” diskettes that are now being replaced by CD-Rs and CD-RWs. Figure 1 shows the enormous growth in storage capacity of modern storage media, and research continues to find ways to pack more information in smaller media that cost less per gigabyte of storage capacity. Figure 2 is an example

<sup>1</sup> This example may be part of the reasoning some people use to explain why they believe analogue recordings to be artistically “musical” and digital recordings to be lifeless and “mechanical.”

of the use of that growth in capacity. Full-color pictures, audio, and video are combining with text to make more understandable presentations than ever before. That requires more capacity.

## Growth in Data Capacities

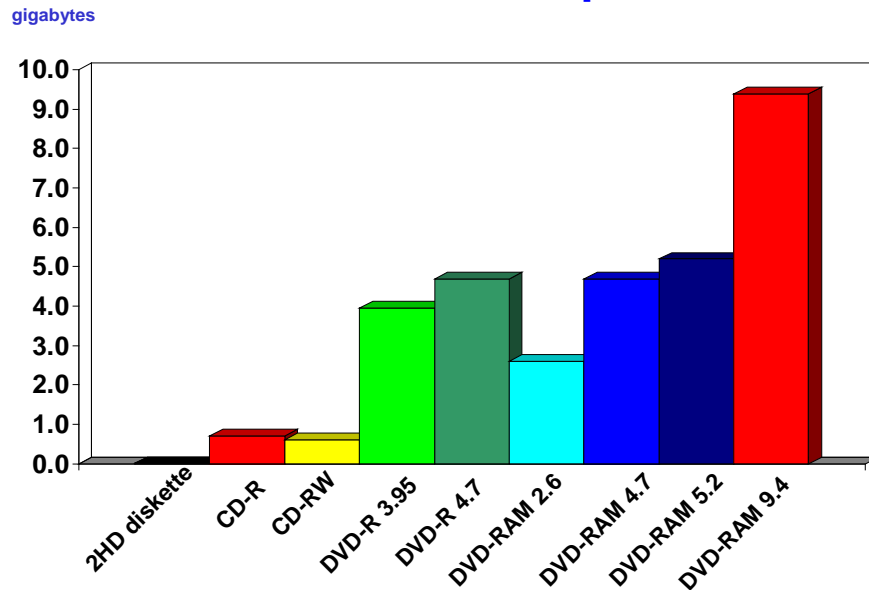

Figure 1

## Growth in Data Requirements

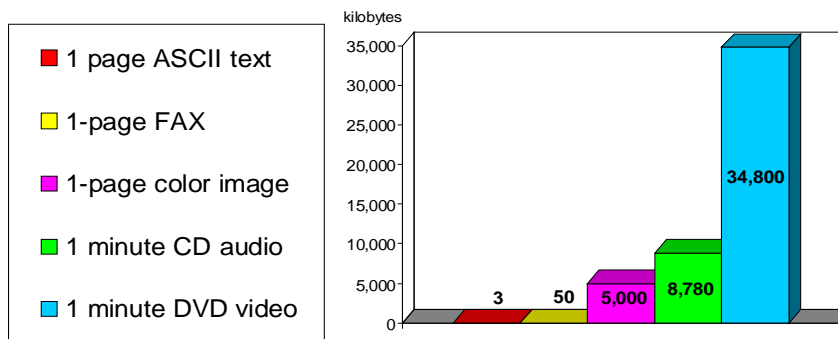

Figure 2

### DIGITAL AUDIO

Mathematicians and engineers designed computers to do calculations quickly and accurately. The success of the personal computer (PC) and its growing sophistication transformed it from a desktop calculator when software engineers began to write programs that would allow it to perform all the tricks it commonly does today. One of the first tricks was to record audio. Analogue audio recordings have a fundamental problem mentioned above: they add their own inherent flaws to the recorded program. Making analogue copies of an analogue recording doubles the flaws, and this was a problem for early multi-track recordings (but a blessing for the music industry that feared people making chains of copies of just one legitimately purchased record.) "Digitizing" audio, that is,

putting it into a mathematical code, avoids that fundamental flaw. Once the audio is in a binary code, that code can be recorded as +/- pulses on magnetic tape or magnetic discs, or as microscopic indentations on optical discs. As long as the code is accurately reproduced from copy to copy, any minor flaws in the recording medium can be ignored. Every copy is theoretically as good as the original. That assurance provided a solution for the multi-track problem (and opened up all the issues of copy protection for the music industry).

All sound is simply our ears' response to changes in air pressure. A whack on a drum first expands the air as the drum skin is pushed downward. Then it compresses the air as the skin bounces back. The skin moves back and forth at a relatively slow rate (or frequency) until it finally settles down. The low, bass sound of a drum creates changes in the air pressure at slow rates of change or low frequencies. Hitting a metal cymbal, however, causes the cymbal to vibrate very rapidly. Those vibrations make pressure changes in the air at a very high rate—high frequencies. Most of the sound we hear falls somewhere in between those rates of drums or cymbals. The range of human hearing typically runs from a rate of 20 cycles of up and down vibrations per second (called “20 Hertz”) to a rate of 20,000 cycles/second or 20 kilohertz.<sup>2</sup>

Microphones pick up the changes in sound pressure with membranes that vibrate in response to the air hitting them. The moving membranes alter an electrical voltage signal and send it to amplifiers that increase the signal and send it to speakers (boxes with much larger moving membranes that can move enough air to recreate the original pressure changes that struck the microphone). The sound can also be stored as a recording. Analogue recordings draw the vibrations in vinyl records or as changing magnetic patterns in tape. Digital recordings take the signals and encode them before storing them.

## Digital Sound

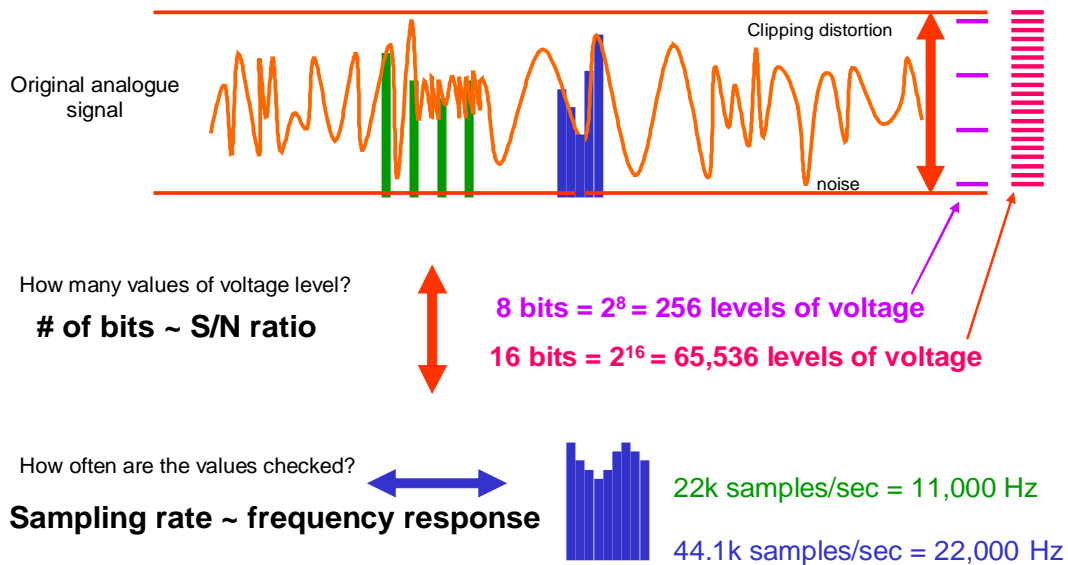

Figure 3

<sup>2</sup> Earthquakes occur at about 8 Hz, too low to hear but easily felt. That’s why sub-woofers are “special effects” speakers in sound systems—they are meant to create a feeling of low frequencies as much as a hearing of them. Dog whistles produce sounds beyond 20 kHz, too high a frequency for humans to hear. The human ear is most sensitive to sounds in the 3 kHz range. This happens to be the range for babies’ crying, which explains adults’ response depending on whether they are the parents or next-door neighbors.

## **DIGITAL AUDIO CODING**

---

The encoding process takes the changing sound waves and treats them as a series of values of changing voltage. The wavy orange line in Figure 3 represents the changes in voltage of an electrical signal caused by the changing sound pressure. A vinyl record would have a close approximation of the orange line drawn in the groove; but a digital encoder would assign number values to each point on the line based on two judgments: 1) how high or low is the signal at any point, and 2) how often should I check it? The closer the orange line can spread to the upper limit (distortion overload) and the lower limit (the noise), the louder the signal is. The fewer the up and down patterns it has, as in the area around the blue, the lower the frequency. The more frequent the changes, as those around the green area, the higher the frequency. A digital encoder works by taking millions of samples of the electrical changes and assigning values to each sample as if it were trying to code the continuous line with a line of billions of sequential dots. The more often the encoder takes its samples, the higher the frequency it can reproduce. A mathematician by the name of Nyquist theorized that at least two samples are needed for the highest frequency to be resolved. Since audio engineers originally wanted to extend the sound a bit beyond the "human hearing limit of 20,000 Hz," they chose a sampling rate of 44,100 samples/second (the blue) in order to reproduce 22,050 Hz. The green lines are examples of sampling at half that rate resolving only 11,000 Hz, and it's obvious how much more gets missed in between the lines compared to the blue sampling. The sampling rate determines the frequency response of the system.

The other measure is the number of the steps up and down the orange line makes. The more values allowed (the red steps), the greater detail in defining the shape of the orange line at any one sample. The fewer values given, the less accurate the detail will be (the purple steps). This is where the binary coding comes to play. A system using 8-bit words will allow only  $2^8$  or 256 levels of voltage to define the shape of the orange signal. A system using 16-bit words allows  $2^{16}$  or 65,536 levels of voltage changes for far more accurate reproduction. Each bit of information provides about 6 decibels of stronger signal; so a 16-bit system theoretically provides a signal-to-noise ration of 96 decibels, far better than the 64 decibels allowed by the best high bias cassettes (74 dB with Dolby noise reduction).

The developers of the compact disc decided on a specification for a sampling rate of 44.1 kHz and a resolution of 16 bits to provide the theoretical reproduction of music extending to 22,050 Hz at a S/N ratio of 96 dB. Some audio engineers believe that these specifications are insufficient for the best reproduction of music, and that is why they have introduced DVD-Audio using a sampling rate of 96 kHz and 24-bit words. The new specification means much more data has to fit on a disc, and that is why the DVD medium was chosen instead of the CD for high definition audio.

## **How A CD WORKS**

---

The compact disc is an amazing design of the old and the new. Its flat, round shape mimics the LP record albums with their quick track access advantage over tape—it's much faster and easier to find the right spot on a disc than to spool through tape. Its digital design provides high quality sound that does not deteriorate over time because it is read by laser light, not by any physical contact as with record styli or tape heads. The basic design of the players is simple even if the electronics are not.

The disc rests on a drive that spins the disc at the correct speed while a laser pickup assembly moves to the inside of the disc to start reading the contents of the disc and identify its type. Information mixed in with the digital audio code tells the player what addresses the laser is reading so that the player always knows where the laser is and is supposed to go next. The tracking drive moves the pickup assembly from the inside out as the disc is being played all the way through. The disc drive and tracking drive are controlled by servo motors (motors that are constantly adjusting themselves according to information fed back to them) that keep the disc at the correct speed and keep the laser at the correct spot. The design is not much different from that of a diskette drive except that laser light reads the information instead of a head in contact with a round magnetic sheet.

The real difference is in the CD. The disc is a thin piece of optical grade polycarbonate with billions of pits molded into it in a continuous outward spiral. The arrangement of the pits is the digital code for the audio signal as well as all the information to tell the player where to move the laser pickup. The laser shines its light up through the bottom of the disc onto the pitted spiral and follows it. The light is reflected back by a shiny layer of aluminum deposited on the disc during manufacturing. A thin coat of plastic resin protects the aluminum from oxidation and damage, and a silk-screened coated label covers the resin. The top surface of the CD is more susceptible to damage than the bottom. The bottom is solid plastic, and the laser actually sees the bottom of the pits as “bumps”

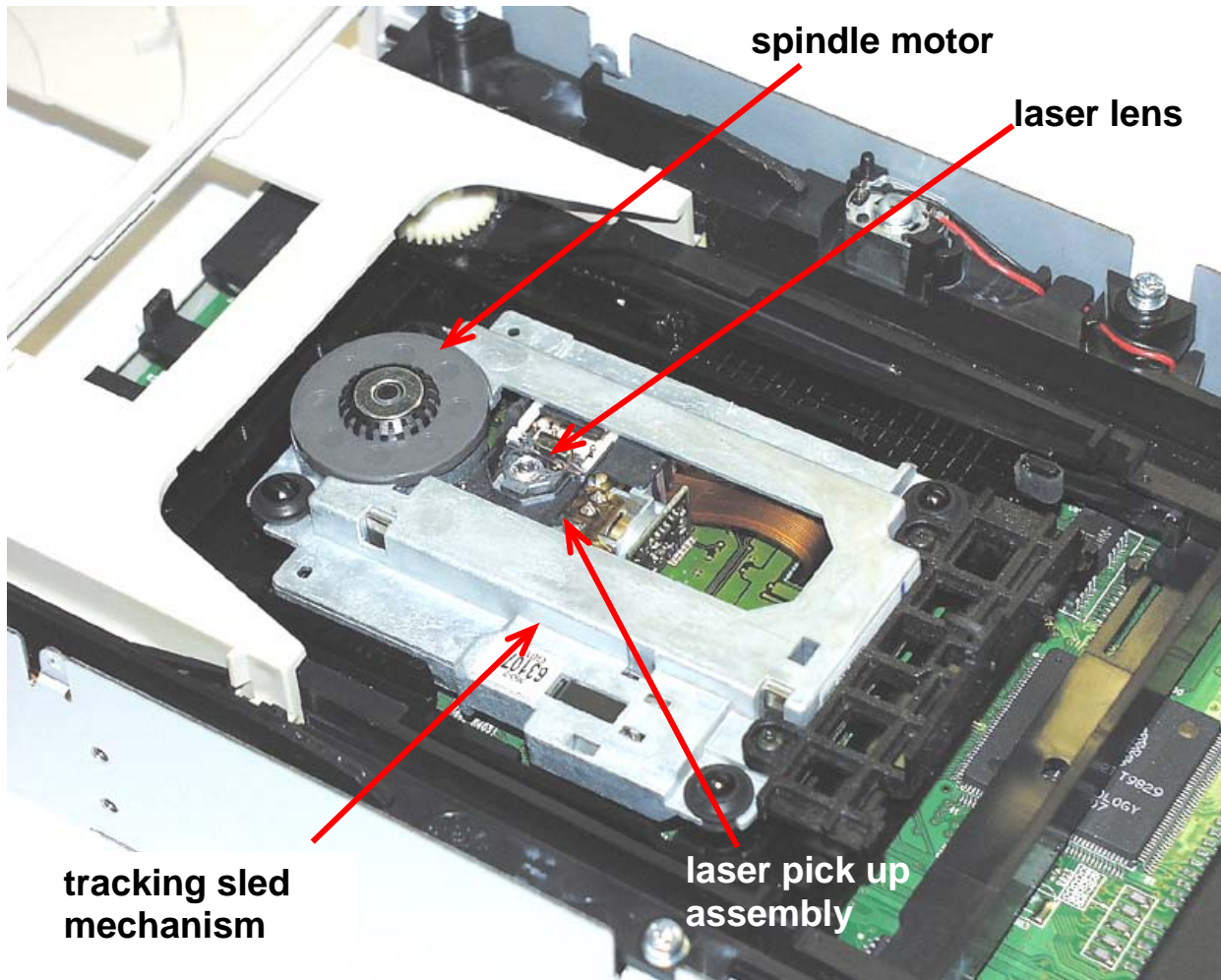

Figure 4

rather than pits. The laser focuses on the aluminum layer above the surface of the disc's bottom so that mild scratches or smudges on the bottom are not seen. The plastic helps in the focusing by acting as a lens and reducing the width of the laser from 0.8 millimeters as it enters the clear plastic to 0.001 millimeters at the aluminum layer. The laser light focused on the inner aluminum layer is reflected back to an optical sensor in the CD drive, and the sensor's electronics interpret the change in the angle of reflection as the laser moves over the bumps (pits) and flat areas (lands) as a “change/no change” binary digital code containing the audio and address information the drive needs. The designers knew that there was a great possibility of errors in the system due to manufacturing imperfections and slight damage from handling; so the information on the disc is scrambled and spread to different places so that a scratch, for example, does not wipe out an audible part of the sound. The electronics in the player find and reassemble the information and fix what might be missing or incorrect. Then the electronics send the corrected signal on to an amplifier.

The CD was designed with audio recording in mind, and the specifications for audio recording are published in the “Red Book” standards.<sup>3</sup> In 1984 Philips and Sony introduced the Yellow Book standards for using compact discs as data media. The difference is significant and explains why software for recording audio on CD-Rs is so different from recording data. All CDs, CD-Rs, and CD-RWs have errors. An audio error is often imperceptible to a listener; but a single data error can change the value of the information or even crash a system. Extra efforts go into identifying and correcting data errors for just that reason.

Audio information is divided into frames of 24 bytes of digital audio in the form of twelve 16-bit samples, and 98 of these frames fit into one block (24 bytes x 98 frames = 2,352 bytes per block or 12 samples x 98 frames=1,176 samples per block). A block in audio terminology is the same as a sector in data terminology. The blocks are only 1/75 of a second long in time intervals; so in one second the CD player sees 1,176 samples per block x75 blocks per second=88,200 samples, half of which are devoted to one of the two stereo channels. Half of 88,200 is the 44.1k sampling rate for audio. Red Book specifications also include two methods of error detection and the correction of those errors, a system known as the Cross Interleave Reed-Solomon Code (CIRC). The first method of detection adds extra information to the audio data in the form of parity bits. Almost 25% of the total capacity of an audio disc is repeated information to account for errors: for every 24 bytes of audio data, another 8 bytes of parity information are added. The second method is interleaving, that is, spreading the bytes from one block to many others so that a major defect in one spot on a disc does not wipe out a whole block or more. The 24 bytes of one data block will end up appearing in 109 other data blocks as part of the encoding. Cross interleaving makes sure the distribution of data occurs over both short and long time intervals as a further precaution. Minor damage to a disc will end up affecting small bits of many blocks instead of wiping out blocks altogether.

A CD player’s decoding system has two stages of correcting errors it finds: after audio data are reassembled in the proper order by deinterleaving (and block reconstruction using the redundant parity data, if necessary), the C1 stage corrects one or two small errors in a frame, errors such as noise in the signal. If there are three or more errors, C1 marks the whole frame as suspect and passes it back to be deinterleaved again before going on to the C2 stage. The C2 stage corrects up to 2 larger errors caused by damage to the disc or debris; but if there are 3 or more errors, the data are deinterleaved once again and passed on to the CIRC at the sector level. Test data defining errors will refer to E11 and E21 errors. That means “Errors: 1 bad byte corrected at the C1 stage” or “Errors: 2 bad bytes corrected at the C1 stage.” The C1 stage cannot correct E31 errors or more; so the C2 stage is called into play after deinterleaving that redistributes the group of bad bytes into their original blocks. The C2 stage should then find fewer bad bytes to correct. E12 and E22 errors are those that the C2 stage can correct. An E32 error is uncorrectable.

An uncorrectable audio error can still be tolerated because the error correction circuitry can “guess what the byte should have been through interpolation algorithms or, as a last resort, quickly mute the output or cause a click. Uncorrectable data errors, however, are completely intolerable. No one wants a computer “guessing” what the payroll should have been or “muting” an employee because it couldn’t read a Social Security number. CD-ROMs (that is, CDs, CD-Rs, or CD-RWs with data recorded on them) have all the audio error correction systems plus another system called Layered Error Detection Code and Error Correction Code that has additional parity information recorded and even more scrambling of data. The difference is apparent in the layout of the block/sectors of information for Red Book audio and Yellow Book data recording. It is also apparent in the fact that an 80-minute CD-R disc filled to capacity with audio programming holds 807 megabytes of information while the same kind of CD-R that is filled to the same capacity in a data format will hold only 702 megabytes. The difference between the two measurements of capacity is the extra error correction required for the data disc.

---

<sup>3</sup> \*The colors of the books represents their subject matter: Red = digital audio; yellow = CD-ROM; blue = enhanced music CD; white = video CD; orange = CD-R and CD-RW

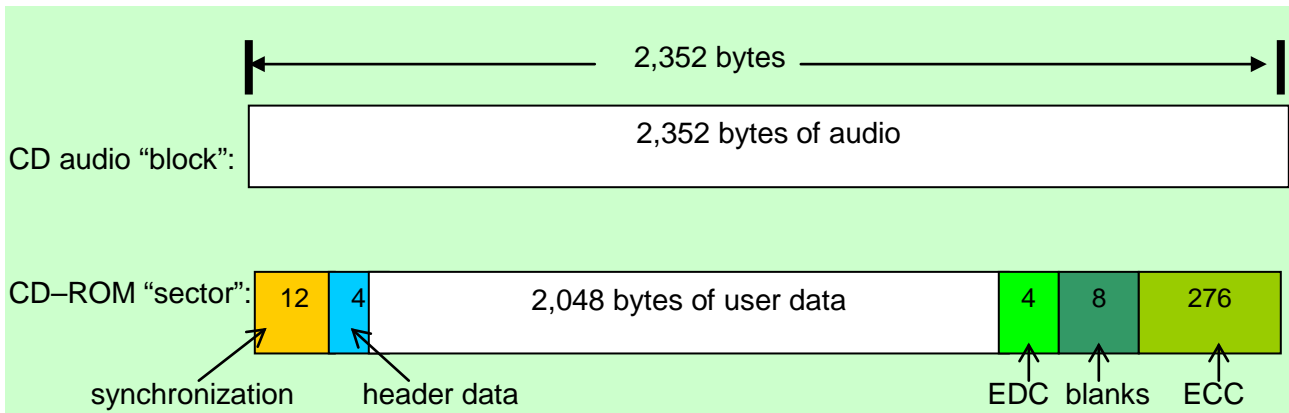

The addition of 12 bytes of synchronization data, 4 bytes of header information, and 288 bytes of additional error detection and correction on top of the CIRC protection that audio discs use increases the ability to correct errors. If a CD-ROM drive does find an uncorrectable error, it will make a certain number of retries to correct it. This process will slow down the data rate until the drive is able to correct the error or until it gives up and rejects the disc as defective.

BLER is a commonly used term describing Block Error Rate, the number of blocks or sectors per second that have bad bytes. The Red Book specification allows a BLER of up to 220 per second averaged over 10 seconds as the maximum allowable rate. Molded CDs fall well below that figure, and good, new CD-Rs are often even better than molded CDs in terms of errors. BLER is often offered as the "best figure" to determine good CD-Rs, but there are over fifty other important specifications that define true CD-R quality. BLER is only one of many quality characteristics. (Comparing BLER rates can be as misleading as rejecting a dinged up used car for "having had too many accidents" in favor of a car with just one mishap—one that put the engine in the back seat!)

### The laser sees "bumps" instead of pits.



Figure 5

The bumps and lands on the CD do not represent the digital 1's or 0's. It's actually the **change between them**, the edges, that are the 1's. The change in the angle of laser light reflection caused when the light changes depth is what makes a binary 1 in the CD code. Therein lies a big problem, though. It's impossible to have two edges next to each other, so how can two 1's follow each other in a binary number if there can't be two edges next to each other? Engineers got around this problem by coming up with another coding system called EFM, which stands for "Eight to Fourteen

Modulation.” This system makes sure that there are at least two binary 0’s between any binary 1’s so that the bumps or lands do not get too small. It also limits the number of 0’s to no more than 10 between any two 1’s.<sup>4</sup>

Figure 6 shows the RF (radio frequency) signal that the optical sensor creates from the reflected light changing between the bumps and the land. Below the graph you can see the edges of the pits where the digital “ones” appear. The flow bit information coming from the RF signal undergoes even more decoding because there are error correction codes built into the system. The designers of the CD system expected errors due to scratches or dust on the CD; so they included two ways to overcome them: 1) a check code to figure out where an error might be and what the real number is supposed to be (the “Reed-Solomon code”), and 2) spreading out the information instead of keeping it sequential. The second method, called “interleaving,” means that if there is a flaw on a disc, the flaw will not cause damage to all the music around it because the music information is spread out in different places. A wrinkle in cassette tape is very audible because the music around the wrinkle cannot be picked up. A scratch on a CD, however, may not be audible because the data under the scratch is from different bits of music. The CD player reassembles the scattered data in the right order and corrects what it believes to be errors in the code. CD players are actually a bit like mini-computers designed to interpret, sort out, and correct all of these codes.

## RF Signal Generated from the “Pits”

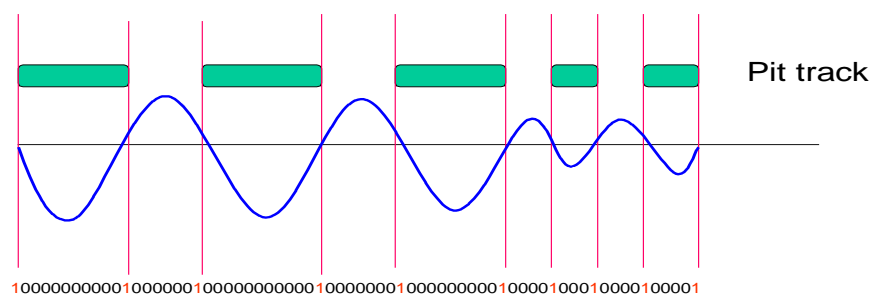

Figure 6

The radio frequency signal is decoded into analog sound.

The entire system was designed to provide the best quality sound at the time it was being developed, with no physical wear to the disc and a tremendous amount of computer coding to find, fix, or hide errors. As amazed as people were when CD’s first arrived and worked well, the second question after “How do they work?” was “When can we record on them?” That process took a longer time and involved the work of chemists in addition to mathematicians, engineers, and programmers. Together they developed the CD-R.

<sup>4</sup> This means the bumps and lands come in discrete lengths of as little as 3 bits (referred to as 3T for a 1 and two 0’s) and no more than 11 bits (11T for a 1 and ten 0’s). 3T is the smallest a pit or land can be; 11T is the longest. Test data for CD-Rs often refer to signal strength at 3T and 11T to define how accurately the media reproduce the proper signal from smallest bump or land to the longest bump or land.





## CD-Rs

The recordable CD has a structure similar to that of the CD in that it is a molded piece of optical grade polycarbonate plastic with a reflective layer and a plastic resin protective layer. The differences are that instead of a spiral of pits molded into the plastic, the spiral is a groove that is nearly 3.5 miles long. This groove has a wobble in it in the form of a sine wave at the precise frequency of 22.05 kHz (half that of the 44.1 kHz sampling rate for audio CDs). The wobble is there as a way to tell a CD-R recording drive to write at the proper speed and to follow the groove precisely. Unlike a CD, the reflective layer is not deposited directly on the plastic. There is a layer of photo-sensitive organic dye that lies between the plastic and the reflective layer and fills the groove. The reflective layer lies on top of the dye (Fig. 7). The dye would corrode aluminum, so the reflective layer is silver or a silver alloy. In some cases gold is used instead of silver.

## CD-R Writing

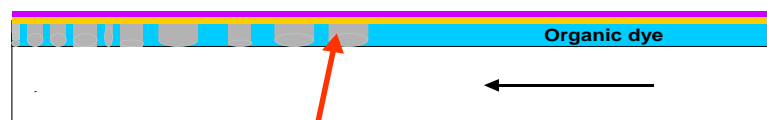

Figure 7

5.5 to 6.5 mW of burning power at 1X  
CD players use only .5 mW of power.

The protective plastic resin is coated on top of the reflective layer just as in CDs. The recording process works by using a laser with at least 10 times the power of a reading laser to “burn” the dye in a pattern resembling the 3T to 11T bumps and lands of a CD. The burning laser changes the dye so that light can no longer pass easily through these spots, and during the playback process the light of the reading laser is deflected as it crosses a burn mark in a way very similar to the deflection in a CD when the light crosses the edge of a bump. The pattern burned into the groove of the CD-R works for the playback laser just as the pattern of bumps and lands works on a CD.

## CD-R DYES

There are several different types of dyes and reflective layers used in CD-Rs. The first type of dye was a cyanine dye<sup>5</sup> that has a greenish color when visible light is reflected back from the silver or

<sup>5</sup> “Cyanine” because the dye is blue. It has nothing to do with the poison cyanide.

gold mirror layer. A second dye called phthalocyanine<sup>6</sup> later came onto the market with different characteristics. Although it would appear as yellow against a gold layer or as slightly green/yellow or even clear against a silver layer, it, too, is a slightly blue color. This dye needs slightly less laser burning power during recording; and its burn marks leave a tiny depression in the layer that has helped give this dye a reputation for excellent stability in heat and light, two of the dangers to preserving CD-R integrity. A third dye is azo-cyanine, which has a bright blue color on CD-Rs. This is a less common dye for CD-Rs than the first two.

Cyanine dyes react to laser power more slowly than phthalocyanine dyes. The laser power is applied in what is called a “long write strategy” to make the proper pulsed burns on a CD-R. For this reason cyanine dyes work well at slow writing speeds. The phthalocyanine requires a “short write strategy” that does not work as well at the slowest speeds but does perform very well at the faster speeds. Because there is a difference in the way the dyes react to laser power and there is also a difference in recording speeds drives are capable of achieving, CD-Rs have information molded into a pre-groove section to assist the drive in determining the best settings. This section is known as the ATIP (**Absolute Time In Pre-groove**) section. Absolute time is the time counted from the very beginning of the disc to the end. Additional information tells the writing drive whether the disc is a CD-R or a rewritable CD-RW, the type of the dye used and the recommended power setting for the laser to start its testing, the spiral length in blocks (which means whether the disc is 63, 74, or 80 minutes long), the maximum rated speed for recording (up to 8X), and whether or not the disc is a regular CD-R or a digital audio CD-R (“music CD-R”) that can only be recorded in drives whose purchase price includes a fee for copying. Although the disc has a recommended power setting, the drive will do its own optical power calibration (“OPC”) on a reserved area of the disc to determine the best power level. This reserved section falls within the lead-in area of a disc, an area that CD-ROM

## CD-R Dyes

### Cyanine

- “green”
- Needs 6.5mw of laser recording power
- Altered region on CD-R is not much bigger than area illuminated by the laser beam
- Long write strategy
- Excellent at slow writing speeds

### Phthalocyanine

- “yellow” or clear
- Needs 5.5 mw of laser recording power
- Altered region on CD-R is physically depressed by laser; beam affects a larger area than that illuminated by the beam
- Short write strategy
- Generally greater light and heat resistant than cyanine
- More expensive
- Excellent at high writing speeds; poor at 1X

### Azo-cyanine

- “bright blue”
- Less common than other two dyes
- The standard dye for DVD-R

Figure 8

drives and audio players do not read. There are 100 testing partitions for OPC tests so that the disc can be reinserted and retested no more than 99 times after its first test, as long as the disc is not finalized after recording. The drive starts at the recommended power and then tests at seven levels below and seven levels above that recommendation. It then checks the output of the test to see what level worked the best. Some drives will then stick to that level while more sophisticated drives may perform a “running OPC” to continually monitor output and adjust power accordingly. These test

<sup>6</sup> The ph/th is a strange combination of the Greek consonants φ and θ that should only appear together when the first is at the end of one syllable and the other at the beginning of the next syllable, as in naphtha, the Greek word for “rock oil” (as in naphthalene and Fels Naphtha soap). Sir Patrick Linstead discovered a new class of organic dyes in 1933 and coined them phthalocyanine dyes from the words “naphtha” and “cyanine.” He was a chemist, not a linguist.

steps are important because the laser's output can change as it ages, and the discs may have slight differences from the inner part of the disc to the outer edge. Once the testing is done, the drive is ready to record. The laser starts from the inside and works its way to the outside of the disc. Record players worked the opposite way, and that caused problems with vinyl discs of different diameters. The inside-out method allows recorders and players to handle discs of different sizes and dimensions without resorting to special adapters.

The official specifications for CDs are written in a book known as the "Red Book." The equivalent for CD-Rs and CD-RWs is known as the "Orange Book," first released in 1990. The Orange Book describes the various sections of a CD-R disc assigned for particular tasks. They are, in order:

- 1) The Information area
  - a) The pre-groove area (most of which is accessible only by recorders)
    - 1) speed control information
    - 2) ATIP code—Absolute Time in Pre-groove mentioned above
    - 3) MID code—Manufacturer's IDentification code to assist the drive firmware in selecting the proper laser power and pulse rate. The code also identifies the type of disc
    - 4) PCA—Power Calibration Area, a test area for determining laser writing power. This area is suitable only for speeds up to 16X. The drive may calculate the power needed for higher speeds, but the Orange Book also added a second PCA in the lead-out area to conduct true high speed power testing in a section of the disc that allows more physical room at the outer edge of the disc.
    - 5) PMA—Program Memory Area that holds track information for all sessions recorded to the disc before the final table of contents is written.
    - 6) Lead-In Area reserved for the final table of contents.
    - 7) Program Area holding all the data or music recorded on the disc. This is the largest area of the disc.
    - 8) Lead-Out Area that tells playback devices that the end of the disc is near.

There are two terms used to describe the completion of a recording session: "fixation" and "finalization." Fixating a disc means writing the table of contents (TOC) in the lead-in area and writing the lead-out areas on the CD-R disc so that the disc can be read in drives and players. CD-ROM drives and audio players look for the TOC when a disc is inserted; if it is not there, they cannot recognize the disc. If a disc is not fixated, the only drive that can handle the disc is the recording drive. That drive relies on another reserved area of the disc that lies just after the OPC area and is called the Program Memory Area or PMA. Recordings made at different times or in increments such as track-at-once or multi-session recordings store temporary TOC information in the PMA section in order to allow additional recordings to continue until the disc is full and has to be finalized. Finalizing a disc writes the final TOC and closes the disc so that no other recordings can be made to it.

Recording in the disc-at-once mode writes the lead-in with its TOC, the pre-gap, all the disc's tracks, the post-gap, and the lead-out areas in one non-stop session. It is the safer way to record CD-Rs because the recording laser operates continually and leaves no breaks in the recording that could contribute to errors. Recording in the track-at-once mode forces the laser to stop and start after each track, and the stopping and starting increase the possibility of errors. Multi-session recording also runs the risk of gaps between sessions causing errors, but modern drives seldom run into these problems today.

## **CD-R REFLECTIVE SURFACES**

The original reflective surface for CD-Rs was gold. Gold has the advantage of being immune to oxidation. It does not tarnish or rust. The disadvantage of gold, however, is its cost. Attempts to thin out the gold layer too much can cause some audio problems if the reflectivity varies enough to cause the signal output to waver and interfere with the servo motors in the drive. Thick gold layers do not

have this problem, and the silver alloys are inexpensive enough that there is less need to thin them out. Gold mirror layers are also less reflective than silver alloy layers and in some cases that can reduce the top recording speed unless steps are taken to improve light transmission through the dye. Since slower speeds often improve recording quality, and gold discs are intended for the optimum archival quality, slower speeds work to their advantage in promoting longer life. Figure 9 lists the advantages and disadvantages of the different types of reflective layers used for optical discs.

## Reflective layers

### Silver vs. Gold

	Reflective metal	Infrared reflection		advantage	disadvantage
		alone	through medium		
CD DVD CD-RW DVD-RAM DVD+/-RW	aluminum (gold/silicon for 2 <sup>nd</sup> layer)	78%	75% 18-30% 15-20%	•Cost	•Recordable dyes are corrosive to aluminum. •Oxidizes if exposed to air
CD-R DVD+/-R	thick Gold thin Gold	94% 84%	75% 65%	•Does not corrode or oxidize	•Cost •Reflects infrared and red well; less well toward blue end of spectrum
CD-R DVD+/-R	Silver	96%	77% 15-20%	•Cost •Impervious to dyes	•Oxidizes if exposed to sulfur in the air.

Figure 9

### CD-R CAPACITIES

Cost was also a factor in the design of the CD system. Exacting precision is very expensive, so the designers decided to keep the expense in the mastering equipment that made the impressions (pits or wobbled groove) in the discs. Relatively inexpensive drives just have to follow the precise guides rather than duplicate them themselves. The guides for the CD-R start in the pre-groove area with the ATIP information. One of the important bits of that information is the capacity of the disc. The original CD-Rs held 63 minutes of audio or 550 MB, and 74-minute/650 MB discs soon followed. 80-minute/700 MB discs are now the most popular capacity for home recording. Greater capacity in tape means longer lengths unless the tape speed is reduced. In CD-Rs, however, the size of the disc does not change to hold more information. What changes is the speed of the drive, the distance between the grooves (track pitch) and the size of the burn marks. 80-minute CD-Rs spin more slowly than 74-minute discs to increase capacity in a manner similar to T-120 video cassettes offering 120 minutes at standard play and 360 minutes at extended play

Figure 10 lists the different speeds of the different capacity discs, and one can see how the larger capacity discs slow down to fit more information on the disc. When the disc slows down, the burn mark sizes have to get smaller to fit more information onto the disc. The older 63-minute discs had a comfortable margin to work within, and there were fewer problems with those discs in various drives than with discs of larger capacity. Old CD players may sometimes have trouble playing 80-minute capacity discs; and Figure 10 shows why: the minimum spacing between the burn marks is almost the same as the wavelength of the laser light before the polycarbonate acts as a lens to focus the beam on the mirror layer. Customers are often quick to blame a disc for poor quality when the problem may actually lie in a drive's inflexibility to "go beyond the limits" for which it was originally designed. Computer drives generally have the most flexibility in handling higher capacity discs.

Older car and portable CD players and even some of the most expensive audiophile players are often the least flexible.

## CD-R Capacities

- Recording area on 63-, 74-, and 80-minute discs is identical
  - 22.05 kHz wobble has a range of peak-to-peak spacing at 2% of spacing between tracks
    - 63.5 microns for 63-minute discs
    - 54.4 microns for 74-minute discs
    - 50.3 microns for 80-minute discs
  - Spindle motor locks onto wobble for precise linear velocity
    - 1.4 meters/second at 1X for 63-minute discs
    - 1.2 meters/second at 1X 74-minute discs
    - 1.1 meters/second at 1X for 80-minute discs
  - Minimum spacings for optical data marks
    - .97 microns for 63 –minute discs
    - .83 microns for 74-minute discs
    - .77 microns for 80-minute discs (the laser wavelength is .78 microns.)



Figure 10

The red sine wave wobble in Figure 10 is not to scale. It is exaggerated to show what the “peak-to-peak” spacing is (the distance of the black arrow touching the orange lines). The built-in wobble tone guides the laser pick up drive in the recorder to follow the groove in the CD-R and tells the spindle drive to adjust its speed to keep the tone at 22.05 kHz for 1X speed or an exact multiple for higher speeds. Once the marks are burned in, they become the guides for a CD playback drive.

### CD-R SPEEDS

Recording a CD-R in real time is just like recording an audio or video cassette—the recording process takes just as long as the playback. A 74-minute CD would take 74 minutes to record, frustratingly slow when a computer could process information far faster. Improvements in CD-R manufacturing and CD-R drive capabilities soon sped the recording process to 2X, then 4X, 8X, 16X, and now to 52X. The first speed increases were widely welcomed, but the latest changes have led to questions about the real benefits of faster recording times. The timesavings are most meaningful if the discs are filled to capacity because the **rated** speed is really only the **maximum** speed at which the laser records at the outer half of the disc as it fills up. Recording speed refers to the rate that the **laser records**, not to the rotational speed of the disc. See Figure 11. The fastest drives will start at just below 24X recording speeds (with the disc spinning about 10,600 rpm) at the hub area of the disc because that is the fastest rotational speed the disc can handle before encountering the physical limits of balance and wobble. As the laser moves away from the hub area toward the center on its way to the outer edge, its laser recording speed increases and the rotational speed of the disc decreases. Most users do not fill their discs to maximum capacity; so they may not allow the fastest drives to reach their fastest recording speeds. Replacing a 24X drive for a more expensive 32X drive will reduce the record time on a full 80-minute disc by fewer than 90 seconds per disc—if the computer can keep the data flowing at a speed that can keep up. If the drive is faster than the data flow, one of two things happens: 1) the data buffer that stores the information before sending it to the laser control runs out of room (a “buffer underrun” that ruins the recording), or 2) the drive slows

down under the recommendation of software that prevents buffer underruns. The latest 40X, 48X, and 52X drives are more expensive because, like 16X drives, they operate at tremendous initial rotational speeds that can damage bearings of lesser drives if discs are even slightly out of balance, and they often incorporate software that slows them down if the computer cannot supply data fast enough. Most of the latest drives also incorporate greater buffer memory to reduce the problems of underruns; but unless the host computer is fairly fast, a user may find his or her expensive “super” drive smart enough to slow down to the same speed as that offered by the 12X or 16X drive it replaced.

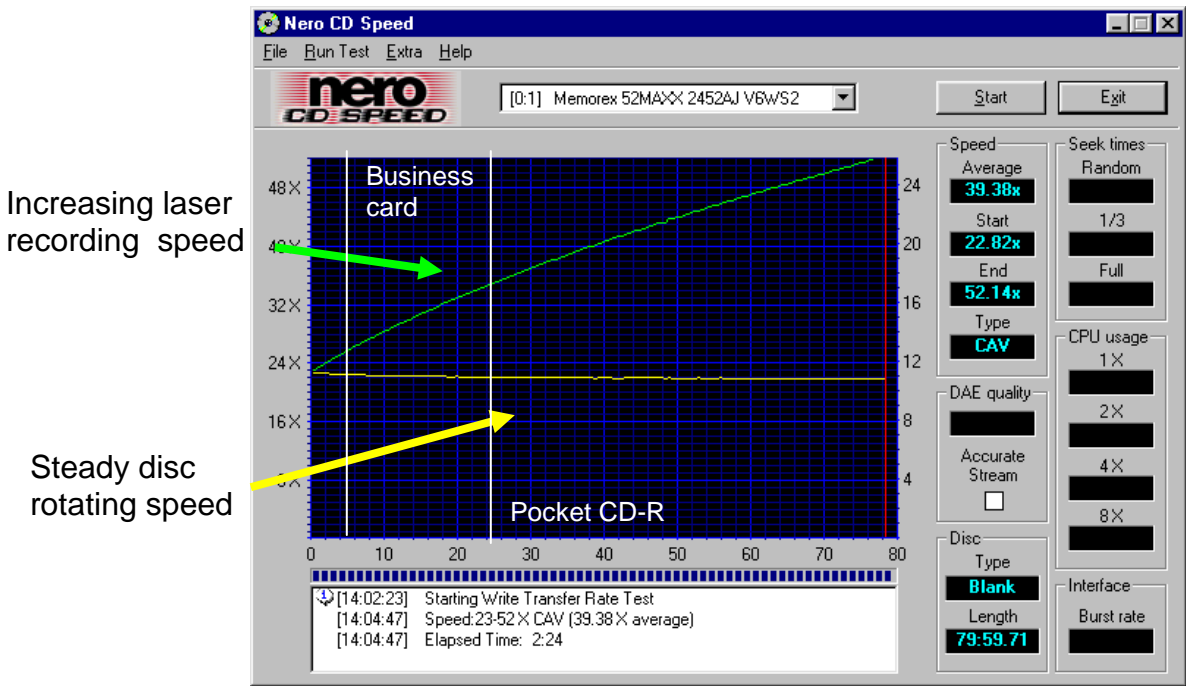

Figure 11

**52X CD-R Recording Drive**  
 Maximum Recording Speed: 52.14X  
 Starting Speed: 22.82X  
 Average Speed: 39.38X

The original design for CDs had the laser pick-up seeing the pits travel above it at a constant rate or “constant linear velocity.” That means that the disc turns at a defined rate at the beginning (about 500rpm) when the laser is reading the area closest to the hub and slows down to about 200rpm as the laser moves to the outside edge so that the music data are being transferred at a steady 150 kilobytes per second. That worked perfectly for audio CDs because there was no need to go faster than the tempo at which the music was supposed to play. When CD-ROMs with data information appeared, there was an advantage to speeding them up in order to transfer data faster to the computer or to the game console. A higher fixed speed or “constant angular velocity” became the norm for CD-ROMs. In the race to produce ever-faster CD-R drives as a way to develop market differentiation, manufacturers have developed two variants of both of these methods for high-speed recording. In order to relieve drives of the stress of high rotational velocities, the “super” drives can work their way up to their highest rated speed in two different ways: 1) Zone Constant Linear Velocity (Z-CLV) and 2) Partial Constant Angular Velocity (P-CAV). See Figure 12. The result has been a general misunderstanding of the speed ratings of CD-R drives.

A 12X/4X/32X designation describes a drive that records CD-Rs at a maximum speed of 12X; records a CD-RW at a maximum speed of 4X; and plays back a CD-ROM or extracts audio from an audio CD at a maximum of 32X. A high-speed drive labeled as 24X/10X/40X can record a CD-R at a **maximum** speed of 24X, but Figure 11 shows why “24X” does not take half the time as “12X.” The

drives have to build up to the maximum speed; and if the disc is not even half full, the burner may never reach its maximum rating. The 80mm Pocket CD-Rs and 61mm CD-R business cards will never allow a “super” drive to reach its maximum speed. Another point worth noting is that the “40X” CD-ROM rating applies to well recorded discs. Discs with lower signal-to-noise ratios or errors will prevent the drive from reading at its maximum rating. Buyers who expect to cut their recording time in half by upgrading from 12X CD-R burners to 24X burners may be surprised at how little time is actually saved. Figure 13 shows a chart with the actual maximum time savings one can expect upgrading from one speed to another; below the graph is a chart of the actual average speed of a 52X drive at different speeds and the maximum time saved

## Four Writing Speeds Compared

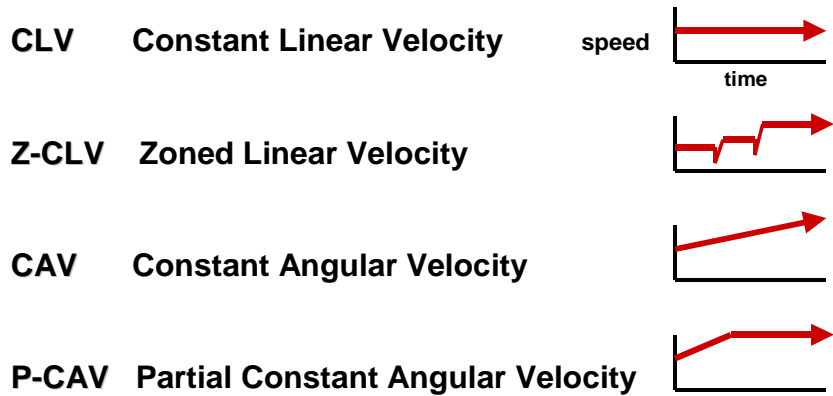

Figure 12

maximum recording speed	total time to record a full 80-minute disc	average effective speed	maximum time savings for next higher speed
4X	21:12	3.8X	
8X	10:42	7.5X	10:30
12X	7:14	11.1X	3:28
16X	5:30	14.5X	1:44
24X	3:55	20.4X	1:35
32X	3:20	24X	:35
40X	3:10	25.3X	:10
48X	2:46	28.9X	:24
52X	2:39	30.2X	:05

Figure 13

The misunderstanding of the difference between the laser writing speed and the actual drive rotational speed has promoted unnecessary concern about the integrity of CD-Rs within high-speed drives. Stories of discs “exploding” because of the high rotational forces within drives have reached the level of urban myth. Discs with damaged center hubs or badly eccentric shapes can, if improperly clamped within a drive, fracture and actually break apart. Such a situation would be due to the original disc damage increasing enough under stress to become more apparent. These “problems” existed with high-speed CD-ROM drives and even with drives rated below today’s highest

speed ratings. Figure 15 is a graph of the rotational speeds of a 52X high-speed drive (yellow line) and a 20X drive (red line). Both begin to spin the discs at speeds equivalent to approximately 20X although their actual rotational speeds may be 10,600 RPM versus 9,600 RPM.

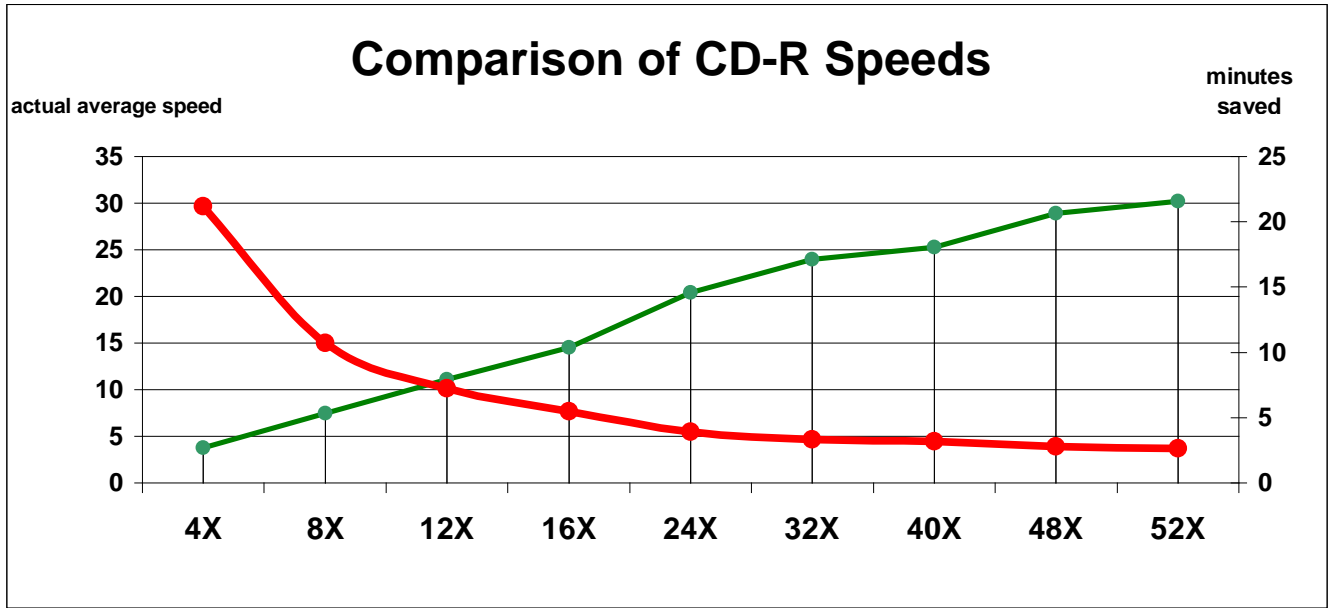

Figure 14

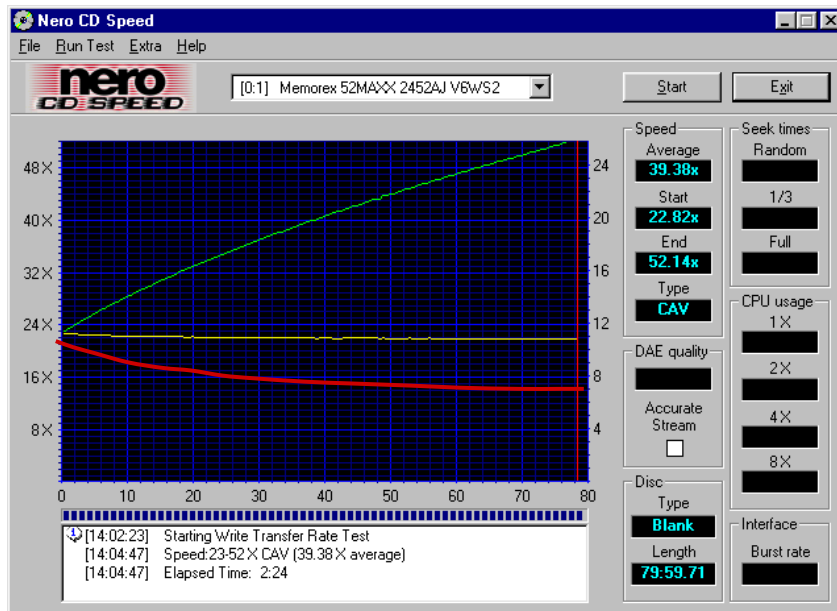

Figure 15

There is little actual rotational difference between the two, but a damaged disc that does not fracture at 9,600 RPM may not be able to keep itself together at an additional 1,000 RPM. The fault lies in the disc damage, not in “excessive” drive speeds. A badly damaged disc could also fly apart in a 20X drive. The limit of high-speed CD-R recording appears to be 52X for several reasons:



1. There are no appreciable time savings. 52X is **at best** only 5 seconds faster than 48X.
2. The flatness of a 56X would have to be perfect.
3. The mechanical problem lies in any wobble at the outer edge of a disc or in any eccentricity.
4. The cost of a 56X disc would be greater than a 52X.

These four reasons are why 52X CD-R recording speed is the limit, not a fear that discs will be exploding in users' drives.



## CD-RW

The marks burned into a CD-R dye layer are permanent. They can't be changed. For users accustomed to recording over magnetic tape and magnetic floppy discs, this can be a real handicap. Researchers looked for ways to make a disc that could be erased, and they came up with the CD-RW. Instead of an organic dye layer, this disc has layers of a semi-metal alloy vacuum deposited in between two dielectric layers that act as insulation to trap the laser's heat and to prevent it from damaging the disc. The alloy has two states: a glass crystal state and an amorphous (Greek again, for "formless") state that does not allow laser light to pass through. Heating the alloy to 200° C. (320° F.) with laser power causes it to crystallize so that it allows some light to pass through to the reflective mirror layer composed of a combination of titanium and aluminum (the dielectric layers contain sulfur that would tarnish silver.) Not much light bounces back, only 15 to 25%; so the drive needs an automatic gain circuit to boost the light reading. (DVD players have the same circuit built into them. That's why some DVD players can read CD-RWs but not CD-Rs.) Raising the laser power to 600° C. (1,112° F.), however, melts the alloy so that when it suddenly cools afterward ("quenching") the melted spot becomes dull and allows almost no light to pass through at all. This method of altering the light transmission of the disc one way or another is called "phase change" recording and is the method used not only for CD-RW but also all the versions of recordable DVDs. The entire disc can be erased by recording over it with the lower laser power to heat the alloy enough to turn it into its glassy crystalline state again. The fact that lower power "erases" the disc is a big advantage in phase change recording systems because the lower power can erase before higher power writes, and that allows direct overwriting of the medium without having to erase an entire disc prior to recording on it. The light reflection process is similar to that of CD-Rs with two exceptions: 1) CD-RWs, like floppy discs, need a file structure formatted on them, and that takes up to 23% of the disc's capacity; and 2) after time the alloy's ability to change its form has decreased enough that uncorrectable errors prevent its further use. The general rule is 1,000 erase cycles are the safe limit for CD-RW discs. The manufacturing process for CD-RWs is much trickier than that for CD-Rs because of the metal deposition processes (called "sputtering"); so it is unlikely that the two media will ever cost the same.

CD-RW discs have a reputation for being unstable that is undeserved. Phase change alloys are affected by extreme heat in order to change their physical state whereas CD-R dyes are affected both by lesser amounts of heat and ordinary sunlight. Chemical changes in the phase change layers due to ion migration or oxidation are potential problems for CD-RWs if they have not been manufactured properly. Both CD-Rs and CD-RWs use optical grade polycarbonate as a base material, and this type of plastic absorbs water. High levels of humidity can be a factor in reducing the storage life of optical discs if the humidity reacts with the mirror layers on the discs or the chemical stability of the phase change alloys. CD-Rs that use gold as a reflective layer are superior in this regard because gold does not oxidize. The reputation for instability may come from other factors such as packet-writing software problems. The original design for CD-RWs was to provide an erasable CD-R. However, the temptation to make them "optical super floppy diskettes" required a format structure written on the discs with error correction and sector addressing built in. Data would

be written in “packets” with a mechanism to link blocks so that files could be altered or deleted without interfering with existing files. Unfortunately, software companies came up with mutually incompatible format systems. The “instability” of CD-RWs is very often due to conflicts or deficiencies in packet-writing format systems, not to the disc itself. Filling a CD-RW to its capacity, for example, can stifle error correction sorting of files enough that adding files causes the disc to be unreadable. It is best to leave some extra space on all rewritable media to allow room for the error correction processes to work effectively.

CD-RWs have not avoided the pressure to develop faster recording speeds. Unfortunately, there are some significant differences in the way the phase change material in CD-RWs works and the way photo-sensitive dyes in CD-Rs work. Photosensitive dyes work over a wide range of recording speeds, but the semi-metal alloys in rewritable CD-RWs have a much narrower range of compatibility for recording speeds. The original design of CD-RWs limited the fastest recording to 4X, 4 times audio playback speed. In an attempt to increase CD-RW writing speeds to keep up with the trend in increasing CD-R speeds, engineers changed both the formatting process so that some formatting was done during recording and also changed the design of the disk and recording drives to overcome earlier restrictions that limited CD-RW recording speeds. The design changes mean that older 1X-4X drives are not able to record the faster 4X-16X “high-speed” CD-RWs. Even though the older CD-RWs rated at 1X-4X and high-speed CD-RWs rated at 4X-16X share a 4X speed, it is not the “same 4X” speed. The two versions share only the speed rating; but the “write strategy,” that is, the amount of laser power and the timing of the light pulses, is different. Only high-speed CD-RW drives can record high-speed CD-RWs. Because older 1-4X CD-RW drives do not have the proper write strategy to record high-speed CD-RWs, engineers have prevented their ability to write at all on these discs by shifting the Power Calibration Area in the ATIP on high-speed CD-RW discs. When an older drive looks for and cannot find the PCA where it expects it to be, the drive gives up and sends an “invalid” message to the user. There is nothing wrong with either the drive or the medium. They are just not designed for each other. High-speed drives do recognize and are able to use the older 1X-4X CD-RW discs at their maximum 4X speed.

Unfortunately, 4X-16X was not enough. In order to move to even greater CD-RW speeds, a new speed rating of “ultra-speed” has been introduced with a range of 16-32X. Once again there is a problem with overlapping but incompatible speeds: high-speed CD-RW drives cannot record onto ultra-speed CD-RW discs even if the speed range overlaps at 16X. Ultra-speed CD-RW drives can record any disc; but high-speed drives cannot write to ultra-speed discs no matter what the speed rating is. This is a cause of great confusion, and the small logos identifying the discs do not do much to clarify the limitations.

## CD-RW Rewritable Discs

- Quaternary crystalline metal alloy instead of dye
  - Sputtered layers of indium-silver-antimony-tellurium
  - Crystallizes at 200° C. under 4-8 milliwatts of laser power
    - Crystalline state allows a reflection of 15-20% of the laser light during read operation
  - At 600° C. (8-14 milliwatts of power, 1X speed) the alloy melts to amorphous state
    - Sudden cooling leaves the alloy dull, with little light reflected back
  - Two zinc-sulfide and silicon dioxide dielectric layers blanket the alloy to trap heat
- Alloy’s behavior deteriorates beyond 1,000 erasures; leaves uncorrectable errors

In order to offer some guidance for CD-RW users, there are three logos to distinguish the different speed ratings of CD-RW discs with barely discernable lettering on the side of the original logo. See Figure 16 below. Once any of the CD-RW discs is recorded, it can be read in all CD-RW drives that use the same packet-writing software. Reading data is not the problem. Only writing the right disc in the right drive is a concern.



## INCOMPATIBLE SPEED RANGES OF CD-RW DISCS

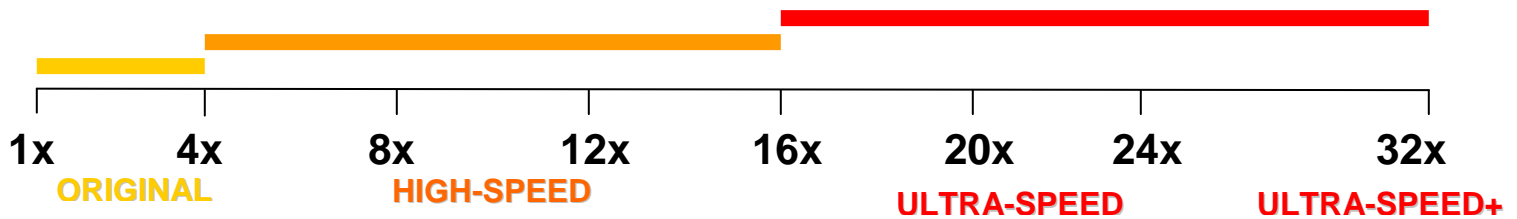

Figure 16

### MINI-DISC

Sony introduced the Mini-Disc format as a recordable optical disc well before CD-Rs were available. The Mini-Disc is in the class of magneto-optical discs, discs that work on very different principles from those used in the CD-R and CD-RW discs. The Mini-Disc was a real break-through in recording technology, but its significance was overshadowed by controversies of the time: 1) the Mini-Disc was competing for public attention with a digital audio cassette known as DCC—and the public did not seem to care much about either format; 2) the Mini-Disc used heavy audio compression to store information on the disc, long before the public became comfortable with MP3 audio compression; and 3) the disc was housed in a protective cartridge. The Mini-Disc was not a recordable equivalent of a CD, and that is what consumers expected. So despite its many technological advances, the Mini-Disc was only coolly accepted, except in Japan where it became a very popular product.

The cartridge or caddy holding the MiniDisc is square with sides of 7 centimeters (2 ¾ inches) and an opening slide that makes the cartridge resemble a floppy diskette. The disc inside the cartridge could be either a molded disc like a CD or a recordable disc. In many ways, the design of the disc itself is very similar to that of CDs. The scanning velocity is the same 1.2-1.4 meters/second, and the track pitch is identical. The sampling frequencies are the same, as is the EFM (eight to fourteen) signal modulation. The audio disc holds 160 megabytes, and the data format holds 140 MB with extra error correction. The biggest difference from the CD-R, other than the cartridge and the size of the disc, is the way the disc is recorded and the audio signal compression that is used on the disc.

Unlike CD-Rs that use a layer of photo-sensitive dye and CD-RWs that use layers of semi-metal alloys that react to the laser's heat by either melting or crystallizing, the MiniDisc used a terbium-ferrite-cobalt layer that worked in combination with both a heating laser and a magnetic head. The laser heated the recording layer to the point at which it had no specific magnetic orientation (a Curie point of 185° C or 365° F). On the other side of the disc at the same radial point is an electro-magnetic head that magnetically records information to the surface of the recording just before the surface cools and retains the magnetically printed pattern (Figure 17).

# MiniDisc Magneto-Optical Disc

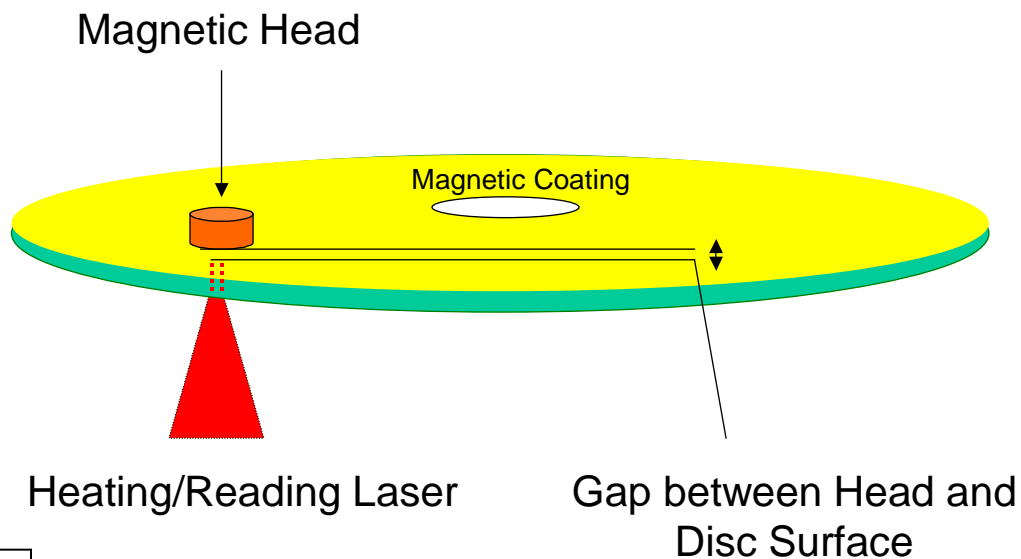

Figure 17

This type of recording format is known as Magnetic Field Modulation. Although this seems a step backwards to the days of floppy disks, the change in magnetic patterns works in combination with a reading laser according to a phenomenon known in physics as the Kerr Effect. The differing orientation patterns of the magnetic signals on the disc will change the polarization of laser light reflected back from the disc in a way that is analogous to the pits molded into a regular CD or MiniDisc. The laser is first used in a high-power mode of 6.8 milliwatts just to heat the disc from the bottom while the magnetic head does the recording on top. During playback, the laser reads the changes in reflected light through the bottom of the disc in a way similar to that of the laser in a CD player. The combined use of both a magnetic head and a laser also applied to other forms of magneto-optical recording such as M-O discs, but the MiniDisc is the most common use of this recording technology.

The diameter of the MiniDisc is only 6.4 cm (2.5 inches). The small size meant that the audio signals had to be compressed in order to store enough music to make the format attractive. Sony introduced Adaptive Transform Acoustic Coding (ATRAC), one of the earliest forms of psycho-acoustic reduction of digital audio data that was difficult to distinguish from the original uncompressed signal. ATRAC used 16-bit stereo encoding at a sampling rate of 44.1kHz, but the rate of data is reduced to one fifth that of a CD—just 292 kilobits per second instead of the CD's 1.4 megabits per second. That data rate allowed 74 minutes of audio on the tiny disc, and further developments increased the capacity to 80 minutes. This type of compression was considered heretical to audiophiles when MiniDisc was first introduced, but it paved the way for MP3 and other forms of sophisticated psycho-acoustic compression encoding that grew in popularity with the growth of the Internet and CD-R recording. A later version of the compression scheme called ATRAC3 with a bit rate of 66 kbps allows up to 5.5 hours of recording on a standard 80-minute disc and ATRAC3plus at a rate of 48 kbps allows even more recording time.

Sony never gave up on its pioneering MiniDisc format, and continuing work has led to a 1-GB version of the disc called “Hi-MD.” The Hi-MD disc competes with the miniature hard drives capable of storing 1.5 GB for use in portable audio players and digital cameras. Hi-MD recorders and playback devices are backwards compatible in that they can record and play standard 60-, 74-, and 80-minute MiniDiscs as well as the Hi-MD discs. Older MiniDisc equipment, however, will not be compatible with Hi-MD discs.



### DVD—MORE IS NEVER ENOUGH

Figure 1 showed the impressive increase of storage capacity of new media. Once the CD was well established, researchers looked for ways to store high quality video onto a disc that same size. Laser discs actually preceded CDs, but they were too big and held analogue video signals, not digital. In order to fit the massive amounts of information that digital video required onto a CD-sized disc, engineers worked to: 1) decrease the pit sizes by half from a minimum of  $0.83\ \mu\text{m}$  to  $0.4\ \mu\text{m}$ ); 2) increase the number of tracks (the number of rings the spiral on a disc can make) by reducing the pitch (the distance from the center of one track to the center of the next) to  $0.7\ \mu\text{m}$ , less than half that for CDs; and 3) decrease the amount of data required by throwing out unnecessary or repetitive information. Figure 18 shows the result of engineering efforts to fit more pits into more tracks.

Two changes had to be made to for smaller data pits: 1) the wavelength of the reading laser decreased from the 780 nanometer (billionth of a meter) wavelength used for CDs to 650 nm for DVD; and 2) the discs had to be molded in two halves to get precise pit geometry and correct focusing of the laser.<sup>7</sup> The two halves are then bonded together to equal the thickness of a CD. Engineers even figured out how to make each half of the DVD hold an inner semi-transparent layer to allow the laser to focus either on the reflective surface or the semi-reflective surface in the middle. This allowed them to produce four different types: 1 side, 1 layer; 1 side, 2 layers; 2 sides, 1 layer on each; and 2 sides, 2 layers each. Each version has a number code shown in Figure 19.

Figure 20 shows the different popular optical media and the basic manufacturing steps for each. It is obvious that DVD is the most complex medium with its two bonded halves and potential semi-transparent layers. (This form, however, offers great protection for the discs because the “top” surfaces most susceptible to physical damage are glued face to face, unlike CDs and CD-Rs.) Just as complex is the encoding of the video information. Professionals from around the world worked to determine the best ways to compress video to render a high quality picture with a minimum of data. They formed a **Moving Picture Experts’ Group** that issued a number of encoding schemes for different applications. MPEG 2 is the format for DVD, and an audio compression scheme in layer 3 became the popular MP3 encoding. The video encoding provides a much more detailed picture than VHS at a data rate that can fit a 2-hour movie on one CD-sized disc. DVD cannot provide HDTV or

<sup>7</sup> See Figure 44 for a more detailed explanation of the focusing advantages of having two halves instead of a single piece of coated polycarbonate

“high definition” TV at this point, but researchers are working on blue lasers with smaller wavelengths than the red lasers used in CDs, CD-Rs, and DVDs as part of the solution as well as developing new data compression schemes.

## CD vs. DVD Densities

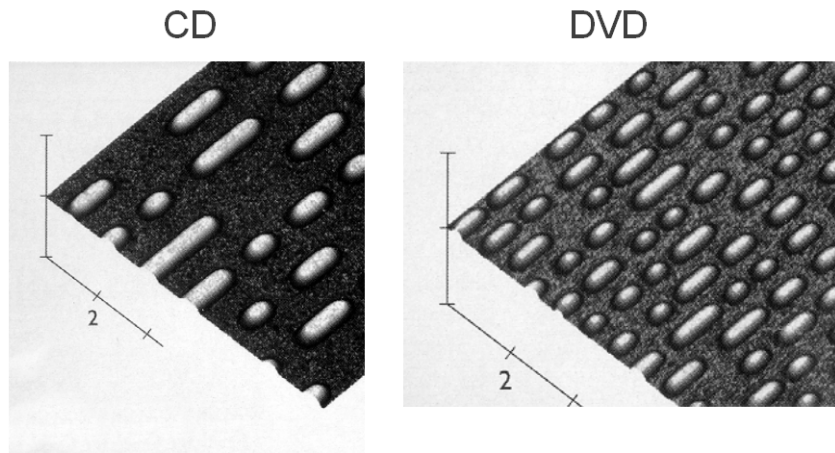

Figure 18

## DVD Numbering

- |          |         |             |              |
|----------|---------|-------------|--------------|
| • DVD 5  | 4.7 GB  | single side | single layer |
| • DVD 9  | 8.5 GB  | single side | dual layer   |
| • DVD 10 | 9.4 GB  | double side | single layer |
| • DVD 18 | 17.0 GB | double side | double layer |

Figure 19

The enormous capacity of the Digital Video Disc attracted CD-ROM users who wanted encyclopedias on one disc instead of 6 or more CD-ROMs and audiophiles who wanted higher resolution audio than CDs provided. So the DVD acronym was officially changed to mean “Digital Versatile Disc.”

# Optical Media

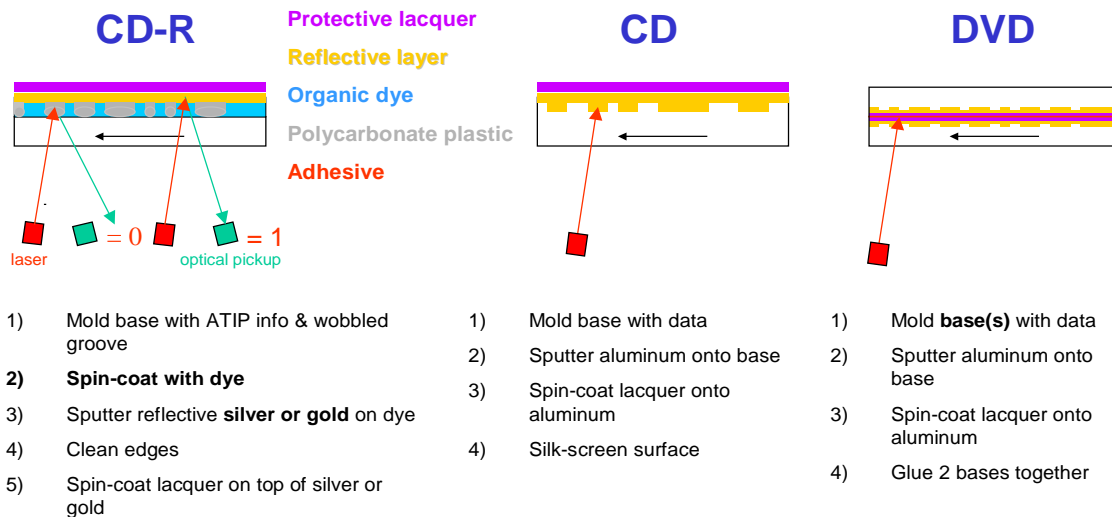

Figure 20

## DVD-RECORDABLE FORMATS—MORE THAN 1 IS TOO MANY!

The same question that followed CDs followed DVD—when can we record on them? The answer came with several competing formats offering the ability to record high-density data on a disc that may or may not be playable in a DVD player. The reasons for the competition are due to a combination of corporate pride, economics, technical arguments, and political resistance.

- Corporate pride—the developer of the “winning” format will have the reputation for ingenuity and marketing savvy. Ego drove Sony and JVC to a horrific battle over home video that JVC eventually won in the marketplace with its VHS system.
- Economics—the media industry is famous for price erosion so severe and sudden that the best chance for profit is not in manufacturing but in the royalties based on patents. Each developer is pushing for his format to provide that kind of profit protection for the future.
- Technical arguments—video generally requires a long stream of data; data storage requires fast random access. Developers of the first two systems concentrated on one requirement or the other in their designs. A third, later group was able to combine both requirements in its system.
- Political resistance—the music industry has put up a losing battle with CD-R, MP3, and copy protection. The motion picture industry has much greater firepower, and it wants to be assured that no one will be able to illegally copy and distribute movies on these new media.

At this point there is no clear answer as to which format may be the clear choice for most users or whether all the formats will continue to coexist. Each of the formats is different for one or more of the reasons above.

## Optical Disc Capacities

	Unformatted	Formatted	Audio min.	Video min.
<b>CD</b>	650 MB		76 minutes	1 hour (MPEG 1)
<b>CD-R</b>	650 MB 700 MB		74 minutes 80 minutes	1 hour (MPEG 1)
<b>CD-RW</b>	650 MB 700 MB	533 MB 572MB		
<b>DVD</b>	-5 4.7 GB* -9 8.5 GB -10 9.4 GB -18 17.0 GB			133 minutes (MPEG 2)
<b>DVD+/-R</b>	4.38 GB	4.37 GB		1-13 hours**
<b>DVD+/-RW</b>	4.38 GB	4.37 GB		1-13 hours**
<b>DVD+/-R DL</b>	7.96 GB			
<b>DVD-RAM</b>	2.6 GB 4.7GB* 5.2 GB 9.4 GB	2.32 GB 4.2 GB 4.6GB 8.4GB		1-6 hours

Figure 21

\*This figure is actually 4.377GB because the DVD Forum defined 1 GB as a billion bytes in the decimal system instead of the conventional binary system of 1,073,741,824 bytes (2<sup>30</sup>) that computers recognize.

\*\* Windows 95 will only allow a file up to a maximum of 2.0 GB; Windows 98 allows a maximum of 4.0 GB; XP has removed limits on file sizes. These numbers generally correlate with the 4.377GB capacity of a DVD disc, but inconsistencies remain in both software and operating systems.

## DVD Recordable Overview

	CD-R	DVD-R	DVD+R	DVD-RAM rewritable	DVD-RW rewritable	DVD+RW rewritable
Laser wavelength	780 nm	635/650 nm	650 nm	650 nm	650 nm	650 nm
Recording method	Organic dye	Organic dye	Organic dye	Phase change semi-metal alloy	Phase change semi-metal alloy	Phase change semi-metal alloy
Track structure	Wobbled spiral groove	Wobbled spiral groove	Wobbled groove with land pre-pits	Pre-molded pits along concentric grooves	Wobbled groove with land pre-pits	HF modulated wobbled groove
Recording area	In groove	In groove	In groove	In both groove and land	In groove	In groove
Number of erases	0	0	0	Class 0: 100,000 Class 1: 10,000	1,000	1,000
velocity	CLV/CAV	CLV	CLV/CAV	CLV/CAV	CLV	CLV/CAV
recording speed range	1x - 52x	1x - 16x	1x - 16x	Class 0: 1x-5x Class 1: 8X-16X	1x - 2x ver.1.1 1x-4x ver. 1.2	1x - 4x 3.3x-8x
Design objective	audio	video	Audio/video data	data	Video	Audio/video data

Figure 22





## DVD-R

DVD-R is very similar to the CD-R in its design and function. The original design objective was to provide a recordable disc that could hold enough video information to compete with VHS video cassettes in terms of capacity. Like CD-Rs, information is recorded in a groove filled with an organic dye; and once the laser alters the dye, the information cannot be changed. The disc rotates at different speeds so that the data pass under the laser at a constant rate. This rate is called CLV, or “constant linear velocity,” meaning that the groove travels as a steady line no matter whether it is located toward the inside of the disc or toward the outer edge. If the data are on the outer edge, the disc slows down to keep the rate of reading the data the same as the reading rate toward the center because, like a wheel, the outer edge turns faster than the inner edge around the spindle. CDs and CD-Rs also use the CLV design. Figure 23 shows a cross section of a disc groove with the laser mark fitting in the groove itself.

In order to provide copy protection for copyrighted video programs, the developers of the DVD-R offer two different versions. One is for “general” use, and it uses a 650 nm laser wavelength for recording. This wavelength is identical to that used in DVD players so consumers who record home videos can transfer them to general use DVD-Rs and play them in their DVD players. “Authoring” DVD-Rs are those used to make video masters on sophisticated hardware unencumbered with copy protection schemes that could present software conflicts during video programming. The authoring discs use a 635 nm laser wavelength to distinguish them from the general use versions. These discs can also be played on DVD players, but they cannot be recorded in general use drives. Each general use disc is actually recorded in special DVD recorders immediately after manufacturing in a process called “pre-writing.” Identification codes unique to each disc are written in the Control Data Zone reserved in the lead-in section of each disc. This special track is often visible as a 0.1mm track closest to the center hub. These codes block the direct copying of DVD discs protected with the CSS (Content Scrambling System).

The first “consumer” DVD-R drives could record at 2X for only a few DVD-R discs. All others were restricted to 1X speeds. By the time 4X drives appeared, the number of disc suitable for 4X recording had increased dramatically, but these 4X discs posed a larger problem for older drives: unless the drives’ firmware is updated, a 4X disc is likely to lock the drive in a recording cycle that could burn out the recording laser unless the user intervenes to stop it. Pioneer and suppliers of 4X discs warned users about the potential problem and offered a firmware update to resolve the problem. Shortly after 4X DVD-R discs appeared, most DVD-R drive manufacturers, including Pioneer, introduced “dual” DVD recorders that could record on both DVD-R/RW and DVD+R/RW.

The general purpose DVD-R discs offered in the U.S. (version 2.0)<sup>8</sup> have a pre-formatting address scheme in the form of “land pre-pits” between the grooves to identify data blocks, a pre-recorded control area that prevents bit-for-bit copying of CSS encrypted movies, Content Protection for Recordable Media (CPRM), and the possibility of double-sided discs. One reason for the use of the 650 nm laser is its lower cost so that “general” use drives do become more affordable. The latest version of the authoring DVD-Rs, version 2.0 /4.7GB, reserve space in their lead-in area for DDP (Disc Description Protocol) header information that is commonly used on DLT master tapes for DVD

<sup>8</sup> Version 1.0 was only 3.95GB when it first appeared in 1997. Version 1.9 in 1999 increased capacity to 4.7GB, and the next year DVD-R split into the authoring version 2.0 and the general use version 2.0 common today.

replication. This feature, known as CMF for cutting master format, allows the authoring DVD-R discs to become direct replacements for DLT masters. General-purpose discs cannot be recorded on authoring drives, and the authoring discs will not work on general-purpose drives. Once recorded, however, the discs can be played on each other's drives and on most recent DVD players or DVD-ROM drives.

## DVD-R Disc Structure

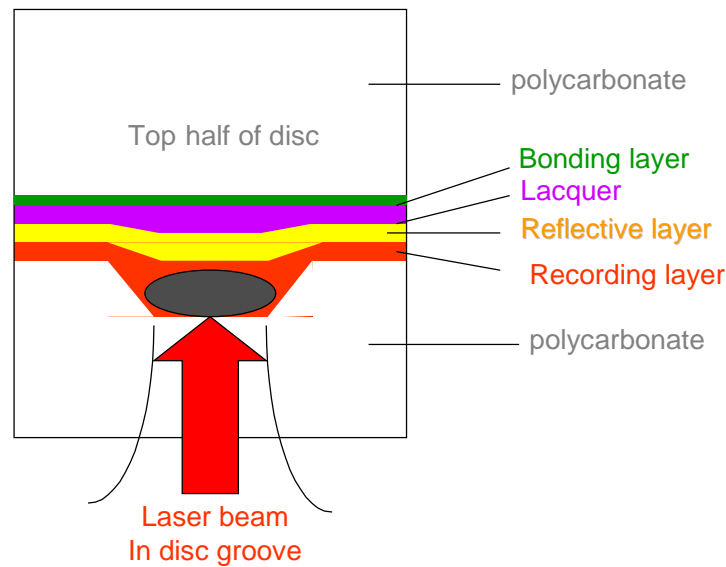

Figure 23



### DVD-RW

The erasable and rewritable DVD is similar to the CD-RW version in its basic design, and its operating parameters are directly related to the DVD-R. The marks the recording laser leaves reflect the light at a different angle from the unmarked portion so that the marked reflection misses the optical sensor just as if no light came back at all. This design is known as a “phase change” of the light, and all of the rewritable DVD systems use this method. Like CD-RW alloys, the alloy used in DVD-RW may have trouble reacting predictably to the laser power after 1,000 cycles; so that figure is used as the upper limit of record/erase times. The lower reflectivity of the DVD-RW can cause confusion in some DVD players and DVD-ROM drives that mistake the disc for a dual-layer DVD and struggle to read it. Other drives may not recognize the disc format code of the DVD-RW and refuse to play it. Drives that may accept the DVD-R may not accept the DVD-RW unless their firmware can be brought up to date. The latest DVD players are becoming more compatible with DVD-R and DVD-RW discs. The first versions of DVD-RW discs have a speed rating of 1X-2X and are known as “version 1.1.” DVD-RW discs capable of 4X or even 6X recording speeds are known as “version 1.2” and cannot be recorded on older recorders. User manuals for set-top recorders note the difference but often explain it in a way that makes it difficult to understand.

The DVD-RW was introduced as a video alternative to the rewritable DVD-RAM. Video recordings on DVD-RAM cannot be played on regular DVD players even if the discs are removed from their cartridge (see below); so DVD developers wanted an erasable DVD medium that could be reused just as video tape can be. The DVD-RW works well in that role; but when used for data, its video parentage becomes a problem. Video recordings are generally sequential: new video is added at the tail end of earlier recordings. The sequential design, however, prevents data from being erased from the DVD-RW to allow more room in their place. Deleting files from a DVD-RW will not increase the disc's capacity. The only capacity available is that at the end of the last section of recorded information. This is a handicap only for data, not for video; but some DVD developers were dissatisfied with this limitation and wanted a format that worked equally well with video and data. Their solution was the DVD+RW below.

## DVD-RW Disc Structure

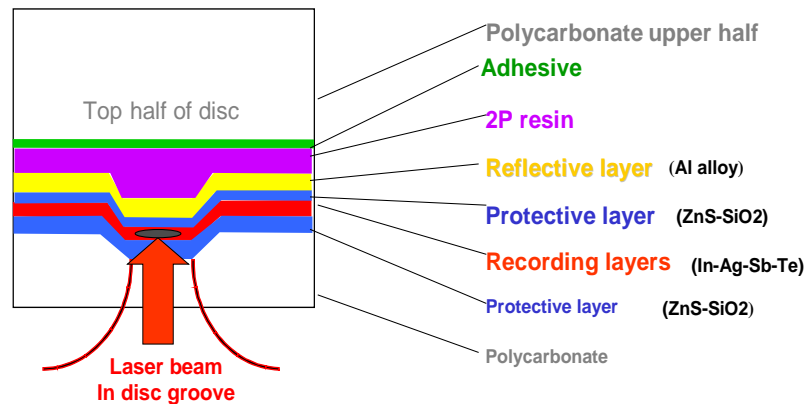

Figure 24



### DVD-RAM

This DVD is the most unusual of the recordable DVD discs. It is designed for Random Access Memory (the RAM in the name), a way to find and get data very quickly. The design offers a great deal of memory storage capacity for data files, and its original intended use as a data storage and back-up medium got around the problems associated with video copy protection although the discs can also be used to record video. In addition to concentric grooves (like data tracks on a hard drive) molded into a slice of polycarbonate that is bonded to a second slice, there are also pits used to identify sectors for address information so that a drive can locate files very quickly. These molded addresses are visible on the DVD-RAM discs as a series of small lines perpendicular to the centering hub. Additional addresses appear every 2kb just before user data so access is extremely fast. Recording is done in both the grooves and the land between the grooves so that the grooves can be a bit wider without reducing total recording capacity. The disc turns at the same rate of speed all the

time, a rate referred to as CAV for “constant angular velocity.”<sup>9</sup> This design feature also aids data access speeds because the spindle’s servo motor does not have to take time to change speeds. The most unusual aspect of the DVD-RAM is that it is often enclosed in a protective cartridge.



Safety plug/sensing hole



Write/protect lock



### DVD-RAM Types:

- Type 1: non-removable discs of all capacities
- Type 2: single-sided removable discs
- Type 3: single-sided bare discs
- Type 4: double-sided removable discs
- Type 5: double-sided bare discs
- Type 6: double-sided removable 8-cm discs
- Type 7: single-sided removable 8-cm discs
- Type 8: double-sided 8-cm bare discs
- Type 9: single-sided 8-cm bare discs

Figure 25

The Type 1 DVD-RAM versions cannot be removed from the cartridge, but Types 2 and 4 cartridges do allow the discs to be removed if the user is very careful. The cartridge prevents the use of DVD-RAM discs in DVD players; but since the original design objective was to provide a high capacity medium for data storage, not home video recording, the limitation may not be important in the medium’s intended market. The design of DVD-RAM, however, does give it a unique advantage for video: DVD-RAM drives can simultaneously write and read from DVD-RAM media. This allows a user with a set-top video recorder to watch a program while recording it, leave to answer a phone call, then return to catch up watching the portions of the program he or she missed while the recorder continues to record without a break. DVD-RAM also offers the advantage of being able to withstand

<sup>9</sup> Panasonic refers to the speed as “zoned CLV,” meaning that the drive does change speeds to some degree depending on where it expects to find data addressed in a particular zone of the disc. Because the format design is to provide fast, random access for data, there is a defect management system built into the drive to avoid using areas of a disc it finds suspect. The DVD-R, because of its design objective for video, is best at linear recording. DVD-RAM allows faster access to and retrieval of data.

100,000 record/erase cycles, a feature that is essential for a medium intended for frequent updates, high storage capacity, and random accessibility, or as a video recorder for time delayed viewing. The double interface layers in the coating allow the greater number of erasures and rerecordings compared to CD-RW, DVD-RW, and DVD+RW discs. (DVD-RAM discs rated faster at 8X or faster, however, are capable of only 10,000 cycles instead of 100,000 cycles for the slower discs.)

The DVD-RAM cartridge is somewhat similar to that of a micro floppy disc with a sliding shutter protecting the medium inside and a write/protect lock on the lower left side of the cartridge. The removable discs have cartridges with a knockout plug holding the hinged door in place. Once the plug is removed, the remaining hole becomes a sensor hole to tell a drive that the disc had been removed at one time. The drive firmware may then identify any errors as due to a dirty or damaged disc or may verify all data that are subsequently written to a disc that had been removed. DVD-RAM discs are also available without cartridges. There are two classes of bare discs: Class 0 for speeds of 1X, 3X, or 5X recording speeds and Class 1 for 6X, 8X, 12X, or 16X recording speeds. Drives compatible with Class 1 media can write and read both Class 1 and Class 0 discs, but older Class 0 drives cannot record Class 1 discs and may have some trouble reading them.

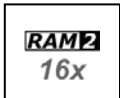

The protective cartridge, built-in sector addresses, error management, and ability for multiple erasures and rewrites make DVD-RAM an excellent medium for reliable data back-up and retrieval. These very features, unfortunately, make the format less than ideal for exchanging video recordings on DVD players.

## DVD-RAM Disc Structure

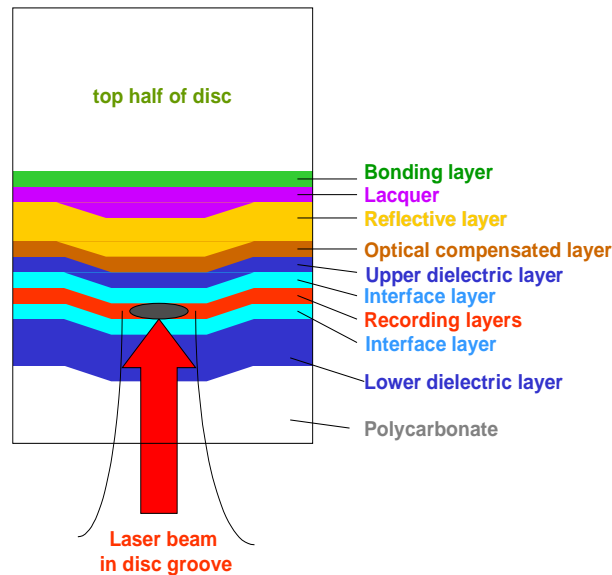

Figure 26



### DVD+RW

There is an advantage in following others—one can recognize and address any of the pitfalls discovered by those who went before. The third version of recordable DVD is called DVD+RW to

distinguish it from the DVD-RW that Pioneer introduced. This medium tries to provide all the features and advantages of both DVD-RW and DVD-RAM in a single disc format. (See Figure 22). It can operate at either CLV or CAV speeds, depending on whether or not the information is audio/video or data stored in the planned Mt. Rainier format. It can apply defect management systems when recording data or can leave them off when recording video so that DVD players can recognize the discs. Recorded discs can be played in about 80% of existing DVD-ROM drives and DVD players if the video is recorded in the DVD-Video format. The more recent the player, the more likely it will successfully recognize and play the disc.

DVD+RW has some significant advantages that are due to its formatting structure. The structure is based on an 817-kHz wobble incorporated into the groove molded into the polycarbonate base. This wobble is 37 times finer than the wobble in a CD-R, and the detailed waveform it provides makes aligning data blocks much easier and more accurate because it serves as the disc's addressing system. The fine detail in the signal allows "lossless linking," meaning that adding to or erasing information from a DVD+RW disc can put new data no more than a micron gap away from existing information because the ultra-high frequency wobble acts as an accurate marker guide for the recording laser (Figure 34). That built-in accuracy provides some very significant advantages for DVD+RW: 1) fully erasing and formatting the disc takes less than a minute compared to the 87 minutes required by DVD-RW with early software because DVD+RW allows "background formatting" (the formatting process continues as the computer moves on to other operations; formatting does not monopolize the computer as it does for DVD-RW); 2) it becomes very easy to make edits directly to a DVD+RW disc for video recorded in the VR format; and 3) the total time to record and close a disc is less.

The DVD+RW and DVD+R discs use an address system referred to as ADIP ("Address In Pre-groove") that is different from the DVD-R and DVD-RW discs' land-prepit address system. In CD-Rs the ATIP area contains the address information as well as information about the type of disc; the modulated groove provides tracking information as well as the correct read speed based on the frequency of the wobble in the groove. The DVD-R/-RW format also uses a groove modulated at a relatively low frequency of 140.6kHz for tracking and speed information; the LLP (land-prepit) data provide the addresses via data signal spikes as the laser reads the groove. DVD+R/+RW discs have a groove modulated at a much higher rate of 817.4kHz with address information provided by phase inversions in the signal. The phase inversion takes place over a longer section of the disc that is 32 times larger than the smallest land pre-pit signal (32T versus 1T), and that makes it easier for a high-speed device to detect the address information of a phase-inverted DVD+ signal than that for a small DVD- signal spike caused by a land pre-pit.



## DVD+R

DVD+R is a dye-based version of the DVD+RW that followed the introduction of the +RW by half a year. (This presented a problem for early adopters of the DVD+RW drives who expected their drives to be able to be upgraded with simple firmware changes so that they could write on DVD+R discs as well as DVD+RW discs. The final DVD+R design, however, meant completely new drives.) The similarities of DVD+/-R and DVD+/-RW are so strong that the pictures of DVD disc structures

that appear in figures 20 and 21 can apply to both DVD+R and to DVD+RW as well as to DVD-R and DVD-RW. The formats differ in terms of file structure and the design of the groove pressed into the polycarbonate substrate more than in their physical construction and materials. The dye-based DVD+R, like the dye-based DVD-R version, is more compatible with existing DVD players than their rewritable partners chiefly because the reflectivity of dye based media is much greater and similar to that of pressed DVDs. The lower reflectivity of the rewritable DVDs can confuse many DVD players into treating them as dual-layer discs and not being able to read them. Unlike DVD-R discs which must be individually recorded after assembly with a track to block DVD copying of CSS-protected material, DVD+R discs are complete after assembly.

There are claims and counter claims about whether or not DVD+R discs are more or less compatible with DVD players than DVD-R discs. Based on the number of claims, the best judgment is that there is little difference between the two in terms of compatibility. DVD-RAM recorders and players built by DVD-RAM supporters are more likely to play DVD-R discs than DVD+R discs, but there is little real difference between the two in terms of compatibility or capability. The real distinctions between the “plus” and “dash” camps lie in the rewritable DVD-RW and DVD+RW, not in the write-once discs.

## **DVD-VR AND DVD+VR**

---

These two terms do not describe new formats but “formats within a format,” or as the DVD Forum describes DVD-VR, “an application format.” They have been introduced to allow set-top DVD recorders to record video in real-time, for example, from TV broadcasts received on built-in TV tuners. The original DVD specification requires certain data to precede the writing of video information. Parameters describing file lengths and navigational information such as menus—the type of information that DVD authoring software handles—is supposed to be written first on a disc. When recording data from a TV broadcast, however, the full amount of information is not known until the recording is finished. DVD-VR and DVD+VR manipulate the data in a way that allows “streamed,” that is, real-time recording to continue so that the necessary “preliminary” data can be written afterwards when the disc is finalized. This data manipulation also allows some limited video editing, deletion of video segments, and modifications to the play lists on rewritable discs. The approach each application format takes is different and applies only to the like named DVD discs.

DVD-VR is designed for DVD-R and DVD-RW discs in set-top recorders. Its editing features are a bit more extensive than those for DVD+VR, but that advantage comes at a cost: DVD-R/-RW discs recorded in the DVD-VR format will not play in any other DVD player except the recorder itself. Some DVD players may be introduced to play these discs back, but the number of DVD-VR-capable players that exist now is so small that it is more reasonable to consider playback impossible.

DVD+VR applies to DVD+R and DVD+RW discs in set-top recorders. Its distinguishing feature is that it creates thumbnails for menus in the title page instead of the DVD-VR play lists, and the thumbnails can have titles applied to them. There are some other limited editing abilities that recorders may incorporate, but DVD+VR gives up sophisticated editing in favor of DVD video compatibility. Almost every DVD player that can play DVD+R/+RW discs will also play DVD+VR formatted discs. They are not restricted to the recorder that created them, unlike DVD-VR formatted discs.

## **CPRM (CONTENT PROTECTION FOR RECORDABLE MEDIA)**

---

CPRM is a copy protection scheme that will allow a user to make one and only one copy of an encoded analogue program. The scheme requires a recorder and disc that are both capable of interpreting the CPRM signals. CPRM-capable discs have decryption data recorded in the burst cut area including a media identification number unique to each disc. CPRM-capable recorders have device keys in their memories that combine with the CPRM disc data to allow recording of a CPRM-encoded broadcast and mark the disc as “cannot copy” once the recording is complete. No copies

can be made of the encoded disc. Discs that do not have the CPRM data on them cannot be used in CPRM recorders to record any broadcast that is encoded with the CPRM signal; only CPRM-capable discs would work for such broadcasts.

CPRM decryption data are only used on DVD-RW and DVD-RAM discs and is only used for recording in the VR mode, that is, the Video Recording mode used to record from analogue broadcast signals. CPRM is not used in either Europe or the Americas yet, but set-top recorders that can record either DVD-RW or DVD-RAM are already compliant with CPRM encoding.

In the U.S. the Federal Communications Commission has approved a system that by the year 2005 will include a broadcast "flag" in digital programs that restrict recordings at the option of the broadcaster. In anticipation of this change, Philips and HP have proposed a system somewhat similar to CPRM for DVD+R/+RW discs tentatively called "Vidi." This proposal also requires information to be in place in the ADIP section of DVD+R/+RW discs as well as compliance in the circuitry of the recorders.

DVD recordable discs come with a new set of acronyms and test parameters. Some of them are similar to those used in CD-R/-RW testing, but most are descriptive of the special characteristics of DVD recording. The following list describes the most commonly used terms.

ASYM	Asymmetry
FE	Focus Error
I3/I14	The signal from the shortest pit/land distance (3T) and the longest (I14)
LPPb	Land Pre-Pit before recording
PIE	Parity Inner Error
POE	Parity Outer Error
PIF	Parity Inner Failure
POF	Parity Outer Failure
PPb DV	Push-Pull before recording Disc Variation
PWP	Phase Wobble Pre-pit
RRO	Radial RunOut

#### **ASYM**

Asymmetry is the DC offset voltage difference between the I3 and I14 signals (the shortest and the longest signals; see below). Values are measured as both an average and as a maximum. Values <3% indicate a uniform coating of the dye layer. Changes >10% indicate coating problems that vary the I3 and I14 signals enough to cause read errors when the analogue output signal is converted to a digital signal.

#### **FE**

Focus errors are the result of sectors not being addressed properly due to buffer underruns, impurities in the coating, or uneven substrate. Focus errors produce indefinite write marks that raise jitter values and the rate of read errors. Radial 2 measures radial disturbances in a frequency range of 1.1 and 10 kHz and refer to the tracking signal of a recorded DVD. Radial 2 disturbances are beyond the ability of the servo control to correct balance and are a factor in read errors.

#### **I3/I14**

The shortest pit or land has a value of 3; the longest pit or land has a value of 14. As the light from the reading laser varies according to the length of lands and pits, the signals generated from the shortest lands/pits, I3 signals, change at the highest frequency rate while the I14 signals from the longest lands and pits have the lowest frequency of changes. All the signals from I3 to I14 create an analogue signal that is converted into a digital signal representing the information on the discs. I3 signal values should be above 0.45 for a strong output. Values below 0.3 are poor signal levels. I3 has such a short distance between pit/land/pit or land/pit/land that signal levels are low and difficult to resolve. I14 Signals above 2.0 are very good while those below 1.5 are quite poor.

#### **Jitter**



The lengths of the lands and pits should be kept as exact as possible—perfect multiples of IT signals. In reality, the lengths show variations in their actual lengths that translate into timing variations referred to as jitter. DC jitter (data-to-clock jitter) is a measure of the length of each pit and land against the precise measure of a clock pulse time signal. DC jitter is measured over the entire disc and should measure below 9.5%. Bottom jitter is the value at three different points on the disc as seen by the laser. If bottom jitter is quite different from DC jitter, that is an indication that the disc has mechanical distortions.

DC jitter is also dependent on the write strategy of the burner. If the incorrect write strategy is applied, DC jitter increases as well as PI sum 8 values and the uncorrectable POF errors.

#### **LPPb**

DVD+R/+RW discs use the 817-kHz wobble signal in the groove to address sectors, but DVD-R/-RW uses land pre-pit “bridges” at the beginning of each sector. If the signal from the pre-pits is too weak, the drive cannot identify the pre-pits; if the signal is too strong, it can disturb the data signal.

#### **PIE/POE**

DVDs have double error correction. Drives put 16 sectors (sector = 2,048 bytes of usable data + 308 bytes of error correction + 4 bytes for the sector ID + 6 bytes for copyright management = 2,366 bytes) of usable data into an ECC (Error Correction Code) matrix. The rows of the matrix are checked for accuracy according to “inner parity” while the columns are checked for “outer parity.” This two-dimensional error correction is nearly 10 times more efficient than that for CDs and can correct severe flaws caused by scratches or debris as large as 6 mm. The DVD specification requires that the sum of PIE in 8 sequential ECC sectors (PI sum 8) be less than 280.

DVD+R specifications require that after the first PI correction no more than 4 errors remain in the ECC sector for the sum of Parity Inner Failure. These should be corrected by the second error correction so that no errors remain for Parity Outer Failure. If POF is >0, the errors will be noticeable.

#### **PPb DV**

The push-pull signal from the drive assembly holds the laser in the track during burning. The difference between the strongest and weakest push-pull signals must be as small as possible to avoid problems following the track. These differences are measured as variations in the signal.

#### **PWP**

The land pre-pit signal must be -90° out of phase with the wobble signal. The pre-pit signal can deviate a maximum of +/- 10° for the Phase Wobble Pre-pit measurement.

#### **RRO**

Radial runout is the deviation of the pre-groove spiral in the substrate from the ideal distance from the center of the disc. It is a measure of the difference between the maximum and the minimum distance of a physical track from the axis of rotation measured over one revolution.

### **RECORDABLE DVD CAPACITIES**

---

The standard DVD is capable of providing 4.7 GB of storage on one side of a disc with a single layer. One would think that this enormous capacity in a single disc would satisfy anyone used to the 1.4 MB capacity of the common double-sided, double density floppy diskette. But even the name of that modest medium gives the story away: it was the successor of an original single-sided, standard density diskette that had replaced the 5.25-inch floppy that had replaced an 8-inch version. The design goal is always to provide more storage capacity in a smaller medium so that the cost per megabyte decreases. People will find a way to use all that storage space, and then ask for more.

Figure 27 is an example of how quickly data capacity gets used. Figure 28 charts the amount of data needed to store or move information. Too much is never enough!

### Expressing file sizes

Computers calculate in binary form; humans calculate in decimal form because of our 10 fingers. Even though “digital” comes from the Latin word for finger, digital data are calculated as binary amounts. The difference has led to a great deal of confusion over capacities. The numerical expressions for the large amounts of data use prefixes from Latin and Greek decimal numbers. When applied to binary numbers, these terms are not accurate because the binary numbers are always slightly greater than the decimal expressions. As the numbers grow in value, the difference becomes larger. Computers express file sizes in binary terms. Storage media such as drives, optical discs, and flash media generally use the decimal method according to the standard recommended by IBM in the 1950s. The difference in value was of little significance then, but as capacities have grown, the difference has also grown:

Common Term	Greek Prefix	Original Meaning	Literal decimal meaning	Value in Binary Terms	Difference	Suggested change for Binary Values
kilobyte	kilo	“thousand”	1,000	1,024	2%	kibibyte
megabyte	mega	“big”	1,000,000	1,048,576	5%	mebibyte
gigabyte	giga	“giant”	1,000,000,000	1,073,741,824	7%	gibibyte
terabyte	tera	“monster”	1,000,000,000,000	1,099,511,627,776	10%	tebibyte
petabyte	peta	“five”	1,000,000,000,000,000	1,125,899,906,842,620	13%	pebibyte
exabyte	exa	“six”	1,000,000,000,000,000,000	1,152,921,504,606,850,000	15%	exbibyte

The difference is most obvious when one compares the stated capacity of some storage media with the computer’s calculation of that capacity. A “10GB drive,” for example, may have 10 billion bytes of storage capacity, but the computer will divide by 1,024 to determine the number of gigabytes rather than by 1,000; so it will claim capacity to be 9.3 GB, not 10GB. A 4.7GB DVD holds almost 4.7 million bytes of data, but in binary terms that is a mere “4.37GB.” Some groups have called for new terminology to define the “kilo binary byte” as a “kibibyte” to distinguish it from a decimal “kilobyte” in order to reduce the confusion. The last column above is the proposed list of new terminology to distinguish binary values. Others, ignoring the heritage of IBM, Greece, and nature’s ten fingers, have claimed the storage industry is cheating the consumer because the computer is always right. The difference between stated capacity of a medium and what the computer claims it to be is compounded by formatting that takes up some of the capacity of rewritable media. They need to reserve some of their capacity for file addresses and error correction, and the media cannot be used unless they are formatted with that information first. The amount of capacity taken up varies according to the software used to format the medium, but it can be a significant portion of total medium capacity. This reference guide will refer to the stated capacity of storage media in order to keep things as clear as possible.

## DVD-Recordable Capacities

### 4.7 GB are equal to:

- 4,700 full-color pictures (640x480 resolution; 24-bit pixels)
- 210 minutes of compressed MPEG-2 video (at DSS-satellite quality)
- 60 minutes of theater-quality MPEG-2 video
- Nearly 9 hours of CD audio
- 400,000 plus documents (filling eight 4-drawer filing cabinets)

Figure 27

## Growth in Data Requirements

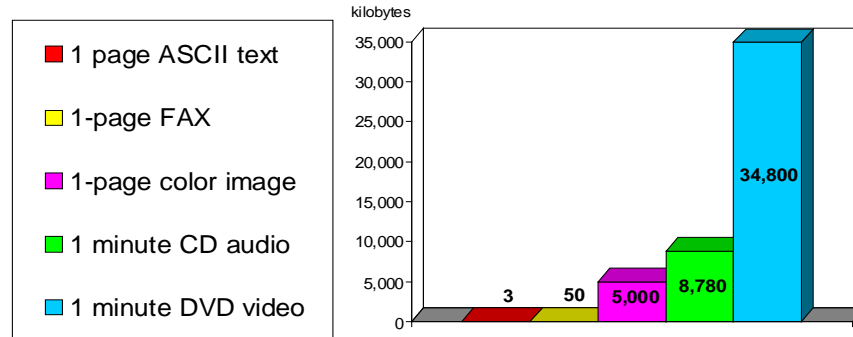

Figure 28

### CAPACITY IN TERMS OF TIME

4.7GB means nothing to most people looking to record TV programs on their DVD set-top recorders. Capacity for them is the number of minutes or hours that a disc can hold. VHS tape had three time settings: SP for standard play of 120 minutes for a T-120 or 180 minutes for an E-180 in the European PAL TV system using an almost identical cassette. LP was “long play” for 4-hour recording in North America and 6-hour recording in Europe. The EP or SLP settings (“extended play” or “super long play”) increased tape capacities to 6 hours and 9 hours, respectively. The video quality, of course, declined for the longer time settings because the amount of video signal per minute of tape decreased in order to store more video on the tape. The same holds true for digital video recording on DVD discs: the amount of video data per minute of video has to be decreased in order to fit more time on a disc. The rate of data is referred to as the “bit rate.” DVD-compliant discs can hold a maximum bit-rate of 9.8Mbps (megabits per second), for both audio and video signals. Software programs often allow users to select a bit rate from about 8mbps for “highest quality” to perhaps 4 Mbps for lower quality but increased capacity. Set-top DVD recorders do the same thing, but they refer to quality levels in terms of minutes or hours of recording time.

The good news is that the time limits are identical for the North American NTSC video system and the European PAL system. Unfortunately, the designations are not consistent from format to format or even from manufacturer to manufacturer. Figure 28 lists the different capacities for the various formats in terms used by the consumer set-top recorders.

Bit rate settings can be either a constant, unchanging rate (CBR or constant bit rate) or variable (VBR). The variable rates assign more data to complex video with lots of detail and action and less data to simpler video in order to maintain good picture quality and an efficient use of capacity.

People expect to see better quality on DVD than that from VHS tape, and that is always the case with Hollywood movie releases. Video recordings on DVDs, however, depend on the bit rate settings as well as the quality of the encoders converting video to the DVD MPEG-2 standard. Hollywood uses equipment and software that cost in the hundreds of thousands of dollars, and the quality is excellent. Home video, however, relies on far less expensive chipsets. Many people have been disappointed to see DVDs made from home VHS tapes look slightly inferior to the original tapes even when using the highest quality settings. The difference in quality is due to encoding, not to the medium. Even MiniDV digital video cassettes (encoded at 25Mbps) will look slightly inferior when converted to DVD settings of 9.8 Mbps or less. Set-top recorder settings longer than two or three

hours often display the most visible forms of picture deterioration. VHS video tape suffered from lower resolution, greater noise, and more visible dropouts at the longest EP time settings; DVDs recorded in the DVD EP mode also show lower resolution and digital artifacts such as pixelation and blocking (“stair-step” edges on diagonal lines and odd rectangular shapes in the picture). Many people find the decrease in quality of DVD EP to be worse than that of VHS EP. The solution is to use the highest bit rate possible or the shortest time setting to get the best balance between video quality and time capacity.

## Set-Top DVD Recorder Capacities (NTSC and PAL)

RECORDER	TYPE OF DISC	RECORDING FORMAT	60 MIN 1 HR	120 MIN 2 HR	180 MIN 3 HR	240 MIN 4 HR	360 MIN 6 HR	480 MIN 8 HR	600 MIN 10 HR	802 MIN 13.3 HR
<b>DVD-RAM</b>	DVD-RAM	<b>UDF 2.0</b>	<b>XP</b>	<b>SP</b>		<b>LP</b>	<b>EP</b>	<b>EP</b>		
	DVD-R	<b>DVD Video</b>	<b>XP</b>	<b>SP</b>		<b>LP</b>	<b>EP</b>	<b>EP</b>		
<b>Pioneer DVD-R</b>	DVD-R/-RW	<b>DVD Video</b>	<b>XP</b>	<b>SP</b>		<b>LP</b>	<b>EP</b>	<b>SLP</b>	<b>SEP</b>	
	DVD-RW	<b>VR format*</b>	<b>VR-SP</b>							
	DVD-RW	<b>MN-format</b>	← level 32	level 21	level 15	level 9	→ level 1			
<b>DVD+R</b>	DVD+R/+RW	<b>DVD Video</b>	<b>HQ</b>	<b>SP</b>	<b>LP</b>	<b>EP</b>	<b>EP+</b>	<b>SLP</b>		

Figure 29

Incompatible with regular DVD players; playable only in the same type of recorder.

\*VR means "Video Recording"; MN means "manual" with 32 manual rate settings from 61 to 802 min.

### DL DOUBLE-LAYER DISCS

There never seems to be enough storage capacity for our growing number of audio, video, and data files. In the battle for the next generation of optical discs, the Blu-ray camp has put most of its arsenal in its boast of extra capacity despite the complexity of its design. In the meantime, DVD disc capacities can be extended beyond the standard 4.7GB in one of two ways: double-sided DVD discs or double-layer discs. Here too, despite the fact that double-sided discs are easier to manufacture (All DVD discs have two halves; the top half is just a blank.), the emphasis has been on the more complex double-layer discs. The DVD+R DL (known as “double-layer” to avoid confusion with “dual” format drives) recordable disc was the first to appear. DVD-R DL (known as “dual-layer” just to be different) followed not long after. Just as in double-layer DVD-9 video discs, the technique uses a semi-transparent silver alloy metal mirror layer and a spacer sandwiched between two layers of organic dye. This metal reflector layer has a reflectivity of 18%, similar to the middle mirror layer in double-layer DVD-9 discs. The middle dye layer itself (L0 in Figure 30 below) has a light transmission value of 50% to allow the laser to penetrate it to the L1 dye layer above it. The L1 dye has to be much more sensitive to the laser power than the L0 dye because so much laser light is scattered and absorbed while passing through both the semi-transparent silver layer and the first dye layer below. The reflectivity of the metal layer for L1 is greater than 50%, but it ends up also at about 18% after the reflected light passes through both dye layers and the semi-reflective alloy layer. The length of the data pits increases about 10% for easier reading, and that is why the total capacity of a double-layer disc is slightly less than twice that of a 4.7GB single layer disc. Careful tuning of the dyes, metal deposition, and groove geometry has resulted in a double-layer disc with 8.55GB of storage capacity, but not without some tradeoffs.

Double-layer discs require double-layer drives in order to be recorded, and DL recording speeds are slower than those for single-layer discs. The initial double-layer drives wrote at 2.4X for DVD+R and

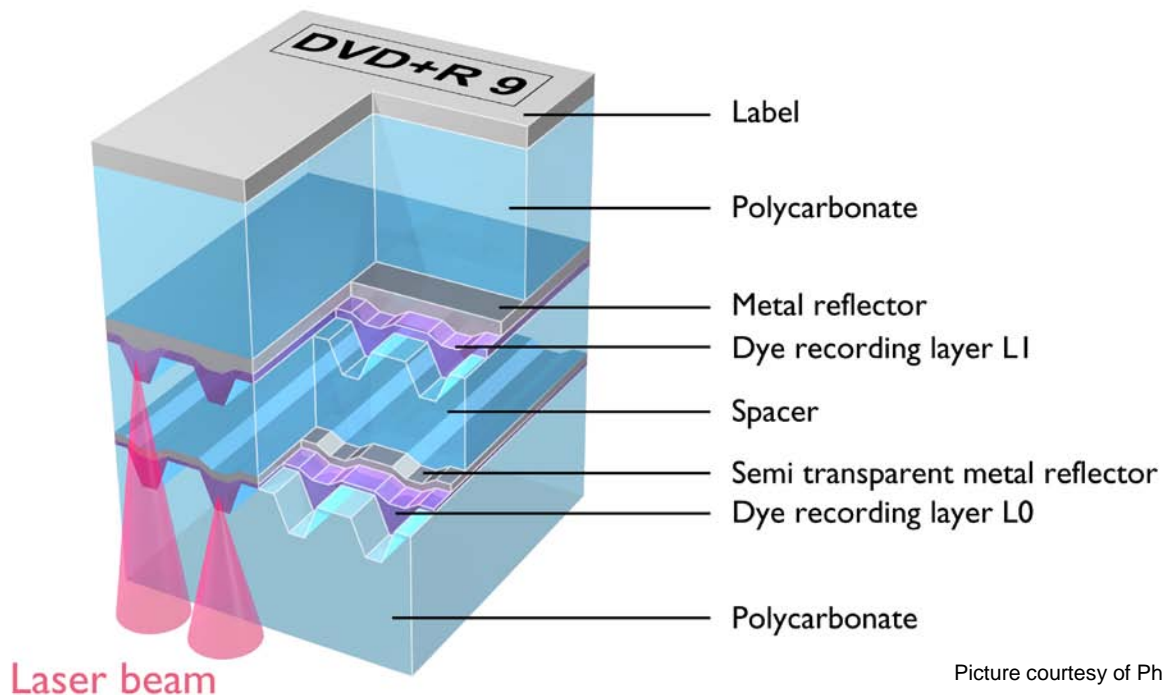

Picture courtesy of Philips

Figure 30

4X for DVD-R, but their lasers had power ratings equivalent to those for 8X discs because more power is required for the light to penetrate the semi-transparent layer and the spacer layer. 16X DL recording requires 350 milliwatts of power or more for recording.

Since a laser reading or writing a double-layer DVD starts from the inside and works outward on the “outer” layer (layer 0) to a transition point where it refocuses and switches to the “inner” layer (layer 1), both layers have to have data signals matching in their total length in order to prevent DVD players from seeing errors. Dividing fixed files into two equal sizes is not a problem for computer systems, but recording video broadcasts that are not exactly defined can pose a problem for set-top recorders using the VR mode designed for flexible recording undetermined amounts of video. In figure 31, for example, the 7-GB disc recorded in a computer drive only records half of the 7.0 GB on L0 and moves on L1 before reaching the outer edge of the disc. Recording a two and a half hour program in the VR mode on a home video recorder also uses only a portion of the disc, but the recording goes to the outer edge of the L0 layer because the recorder does not know how much is going onto the disc in the VR format. It simply maximizes the amount that can be recorded. If the disc is finalized at 2.5 hours instead of the full 4 hours in the SP mode, the recorder will have to fill the rest of the disc with dummy information to make both L0 and L1 the same size. This process takes some time, but recorders do not need to record dummy information at the same 1X speed they use to record broadcast signals. They can record dummy information at a faster speed to shorten the time it takes to finalize the disc.

The point of transition from L0 to L1 has always caused some difficulties in DVD players. There is often a slight stutter or “freeze-up” in movie playback at the point where the laser pickup stops, refocuses, and starts back on the second layer. Skilled authors will put the transition point at a scene-to-scene transition where the change is difficult to detect. For recordable DL DVDs, however, the transition point is noticeable as a momentary freeze of the picture at best or a complete lock-up of the picture at worst. Newer DVD players negotiate the transition better than older players. Some older DVD players simply cannot understand that a “double-layer” and a “recorded” disc can be one and the same. Clever hobbyists have learned how to deceive these players by using their recording

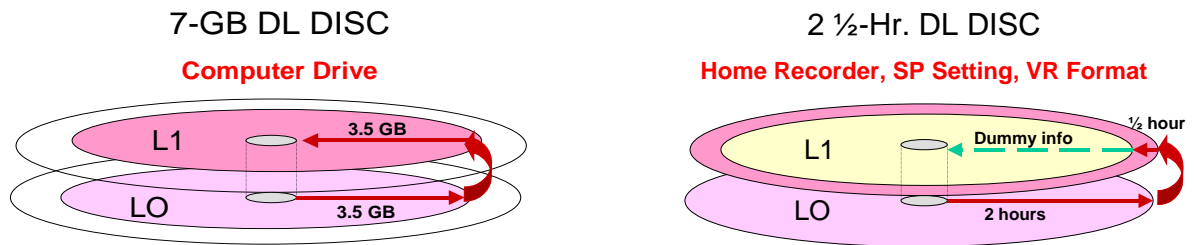

Computers easily divide total file size by two—  
half for each layer.

Figure 31

Home video recorder keeps recording until the end of the program(s)—then fills the rest of the disc with dummy information during finalization.

software to change a bit setting in their recording drives that intentionally misidentifies recorded DL discs as “DVD-ROMs” instead of recorded discs. Although this trick does improve playback compatibility, it eliminates the chance of multi-session recordings because every phony “DVD-ROM” disc needs to be finalized in order to appear as a pressed disc.<sup>10</sup>

Cost is another drawback for DL discs. Even with two layers, they do not store twice what a single DVD disc can, yet they cost far more than buying two separate DVD discs. The reason for the cost premium is the difficulty in manufacturing the discs. These discs go through multi-step processes in which each applied layer and spacer must be free from trapped air and as clean, flat, and uniform as possible in order to keep the read or write laser from going out of focus. Manufacturers have struggled to get yield rates close to half of what they are for regular DVDs.

The manufacturing process for DL discs involves many more steps than that for ordinary DVD+/-R discs. There are two different methods of manufacturing DL discs in use today: the 2P process and the inverse stack process (IS). The 2P process is far more common, but it is losing favor because of unacceptably low yield rates that at best reach 60% and because of some production waste in the process.

Figure 32 is diagram of the complicated steps involved in the 2P (Photo Polymerization) process. The first row of the diagram shows how the first steps are identical to those for regular DVD+R or DVD-R discs. The main difference is the materials used. The first dye layer is a lower sensitivity dye that has to be transparent enough to allow laser light to pass through to mark the inner dye layer. The lower reflective layer also has to allow laser light through it, too, to reach the inner layer. The second row in the diagram shows the new steps that distinguish 2P manufacturing: a malleable spacer layer is applied to the first, or outer, layer; and a plastic stamper impresses this spacer with the wobbled groove for the laser to track during recording. The spacer hardens under the curing effect of an ultra-violet light (the photo polymerization step for which the 2P process is named). The stamper is then peeled off the hardened spacer. The next step is coating an inner layer with a high sensitivity dye (L1) on top of the hard spacer. Then a very highly reflective inner layer is applied on

<sup>10</sup> Optical discs have Book Type settings recorded onto them by recording drives so that DVD players can recognize the type of disc when it is inserted into a player. In the early days of the DVD+R, some DVD player and recorder manufacturers who supported the DVD Forum’s DVD-R/-RW/-RAM formats intentionally set their equipment up to deny playback of DVD+R/+RW discs. Hackers figured a way to alter the bit settings that the drive recorded to DVD+R/+RW discs so that instead of appearing as recorded discs, they appeared as regular pressed DVDs with the DVD-ROM Book Type. This method of “cheating” made the DVD+R/+RW discs more compatible by allowing playback in both the restrictive players as well as the earliest DVD players whose firmware did not understand the Book Type settings for recordable discs. Changing the Book Type bit setting of DVD+R DL discs from “1110h” to the “0000h” setting for DVD-ROMs allows these media to be played in many older DVD players whose firmware does not understand how a recordable disc can have two layers..

top of the L1 dye layer. The rest of the manufacturing process is similar to that for regular DVDs: the recording half is bonded to the upper dummy blank to complete what is referred to as a DVD9 disc (Figure 33). The critical steps are assuring that the dye, mirror, and spacer layers are free from any debris and as flat and uniform as possible with no air bubbles trapped between them

A different method of manufacturing promises to boost yield from 60% to a range of 80-90%. The IS method (Inverse Stack) makes two separate disc halves in parallel and joins them as a last step. Although this seems an obvious way to make a two-layer disc, the approach is very different in that the upper half of the disc is made in an “inverse” process: the polycarbonate

## 2P Process—Photo Polymerization

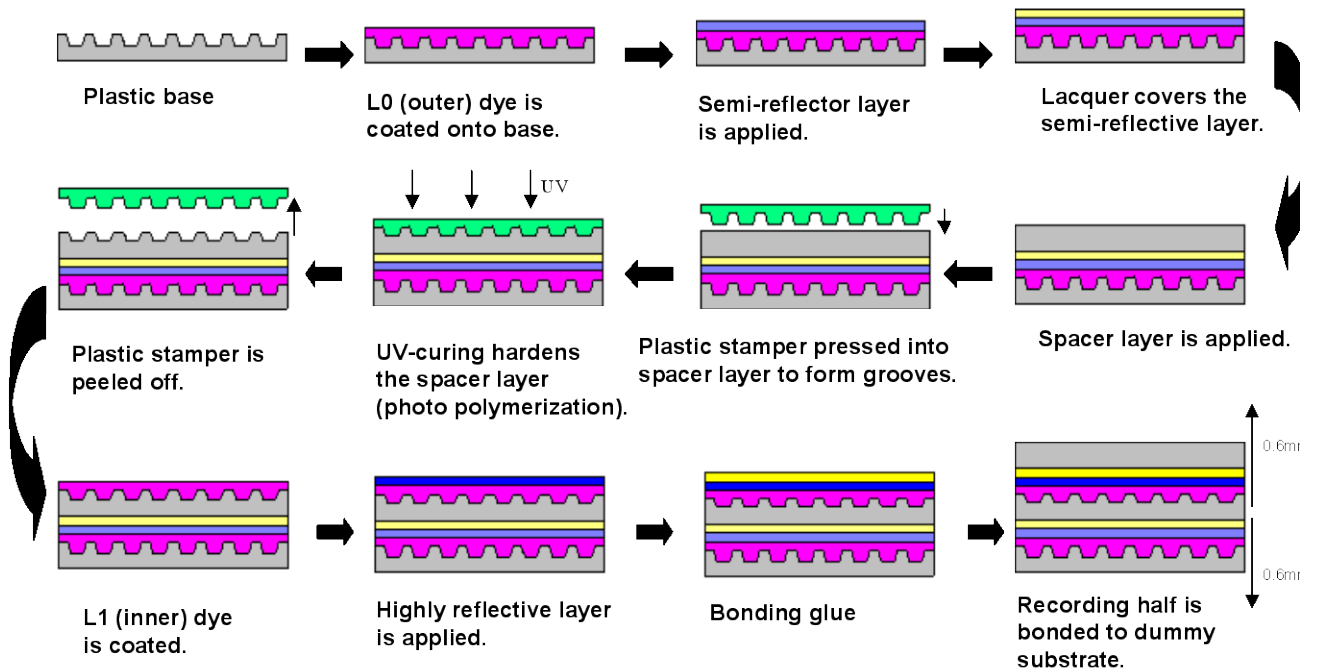
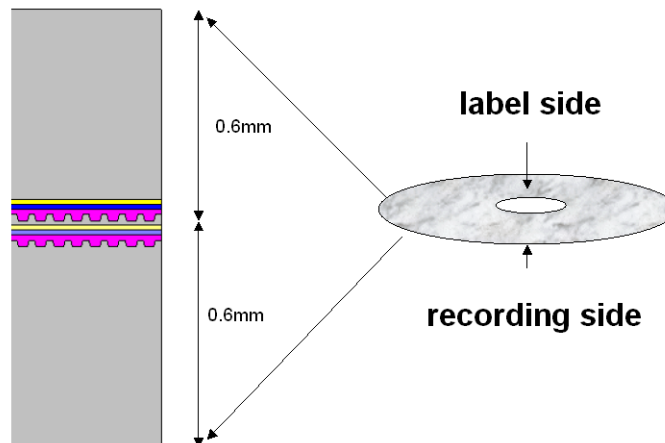

Figure 32

### Completed DL Double-Layer Disc

Figure 33



cover has the metal alloy mirror layer sputtered directly into its molded groove instead of having the photo-sensitive recording dye coated into it. This arrangement is more like a DVD or CD with aluminum in their grooves than recordable discs, all of which have the dye applied first to the polycarbonate before a silver alloy mirror layer covers the dye. The metal alloy in the groove significantly changes the cooling pattern of the disc when heat created by the recording laser is trapped within the groove walls. Engineers must strike a delicate balance in groove geometry, thickness of the mirror layer, and sensitivity of the dye in order to match the recording characteristics of discs manufactured in the standard 2P process. The attraction of better manufacturing yields, however, makes the design effort worthwhile. Figure 34 below compares the structures of DL discs made with the two different methods.

## 2P Compared to Inverse Stack

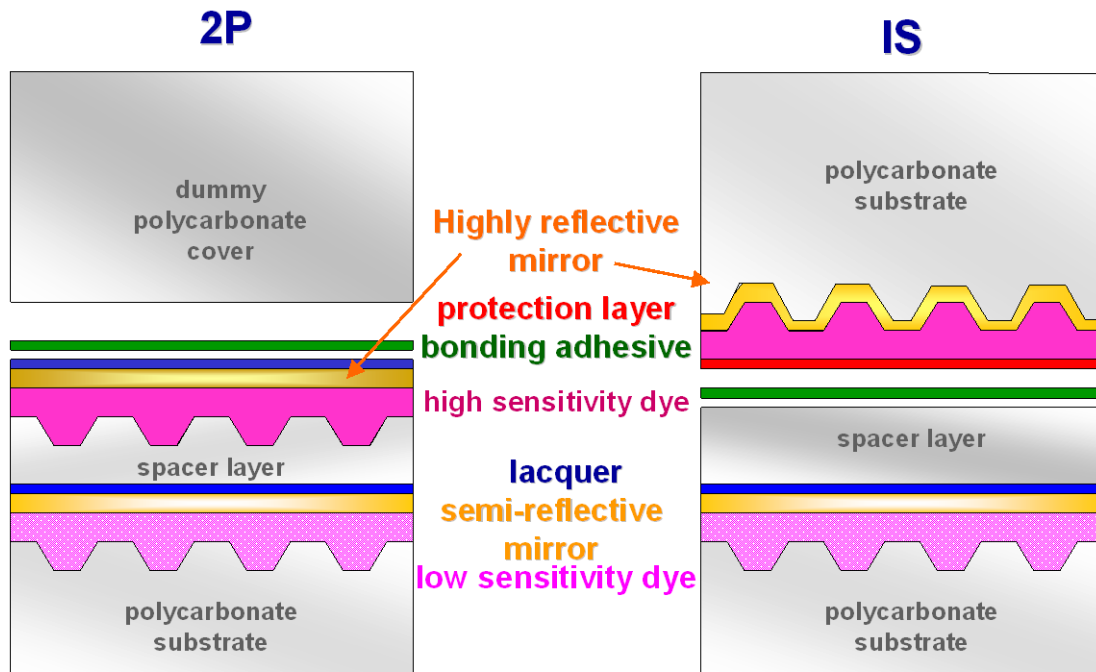

Figure 34

The fact that a single DL disc costs quite a bit more than two standard DVD+R/-R discs while offering 20% less storage capacity makes a single DL disc less attractive for data storage. Costs will decrease as yields improve, but the complexity of the design means the cost premium will remain for some time. Data storage always demands perfect integrity of the files, but the typical jump in errors at the transition stage in DL discs (Figure 35) suggests caution in storing critical data on such discs. The laser must stop, refocus, and start again at the very area of the disc that is the most sensitive to any deviation from flatness while it is spinning at the highest rotational speed. Where DL discs make the most sense is in video recording. Video encoded at the lowest compression rate for the highest levels of picture quality will only allow one hour of recording on a standard DVD disc. In home video recorders that means XP recording quality to store a one-hour broadcast or one hour of transferred home video. SP recording quality will double the amount of playback time with few compromises in quality, but there are compromises nonetheless. DL discs effectively double the amount of recording time on a single disc without forcing compromises in compression quality except for the split-second



# Layer Transition Errors

Typical spike  
in errors at  
transition

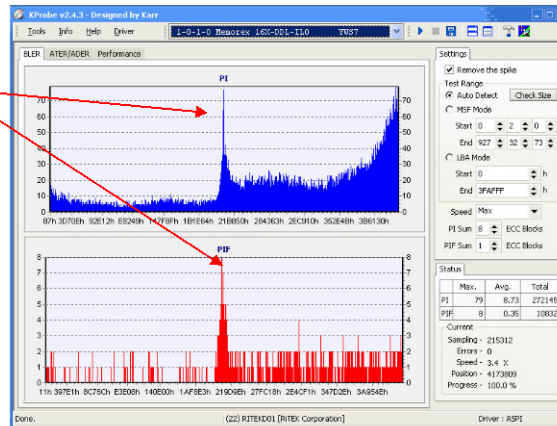

Figure 35

hiccup at the layer transition. This can be very handy for a number of recording situations:

- two-hour movie broadcasts recorded in the highest quality
- movie broadcasts that exceed two hours using SP mode without having to resort to the objectionable artifacts of LP or SLP modes
- sporting events that can exceed two hours
- multiple recordings of half-hour or 1-hour programs on a single disc
- 90-minute High Definition video recordings in Windows WMV-HD format (for computer drives only)

DL drives reached the market long before DL media were ready and available. So far DL discs have remained expensive and hard to find with questionable benefits for computer users. Home video recorders are just now incorporating DL capability, and this time it appears the discs were ahead of their most suitable application. DL discs are meant for video. Although hard drive video recorders are handy for recording multiple programs, they restrict playback to the recorder itself. DL discs allow greater flexibility in high quality, high capacity video recording with few restrictions on portability. Until now, they were a solution ahead of their time.

## DVD RECORDABLE SPEEDS

The CD-user who first burns his or her DVD may likely become frustrated at the length of time it takes to complete a project. CD-Rs hold only audio information or data. DVDs also hold data, seven times more than a CD-R; but video recordings contain both audio and complex video signals that require special processing into MPEG formats that a DVD player can recognize. That takes a lot of time and processing power. One can expect to spend four to five hours of editing, authoring, processing, and recording time for every hour of recorded MPEG-2 video on a DVD recordable disc if the user is working through a computer. Some software that encodes analogue video into MPEG-2 compressed digital video can take an hour to process a minute. Software developers are aware of the complexities and have taken steps to simplify and speed up the process, but digital video recording will always remain more involved than digital audio recording. Those who choose set-top recorders have an easier time but will lack all the editing and authoring features that can personalize the final product. The frustration that comes from the length of time involved in such projects might lead a user to blame the early drives for their slow speeds. The first CD-R recorders worked only at 1X, and the latest drives claim 52X-recording speeds; and the difference is dramatic in recording times (but it is still a real-time process loading analogue signals into a computer to edit them). DVD

recording drives are still in their infancy, but they are very sophisticated hardware when one considers that the pokey CD-R 1X speed was 150 kilobytes per second and recordable DVD 1X is 1.38 megabytes per second—nine times faster. The maximum transfer rate for a standard DVD is 10.08Mbps, 9.8Mbps of which are for video alone. Reducing the transfer rate of data allows longer recording times on a disc with a fixed capacity of 4.7GB, but the extra time comes at a reduction of video quality. (Recordable DVDs' 1.38MBps equals 11.08Mbps, a greater transfer rate than that for DVDs because extra data such as synchronization information are also being transferred during recording.) Recordable drives are already amazingly quick in handling huge amounts of data, and developments in building more powerful lasers now allow DVD recording speeds of 16X. The initial laser diodes used in DVD recording could produce 70 milliwatts of power and were restricted to a maximum of 2.4X recording speeds. More powerful 100-milliwatt lasers were used in drives capable of 4X DVD recording, and 250-milliwatt lasers are required for 16X maximum DVD recording speed. The caution about high-speed recording still remains—always recording at the maximum speed/maximum laser power shortens the laser diode's life.

The minimum acceptable laser power in milliwatts is estimated as square root of the recording speed times 50. A 4X drive requires a laser diode capable of 100 milliwatts; an 8X drive requires a minimum of 140 mW; and the final speed of 16X needs 250 milliwatts. The laser itself requires a 480 MHz clock for accuracy of the timing pulses. At 200 milliwatts the operating temperature of the laser diode case can reach a temperature of 100° Celsius.

The trick in writing at 16X DVD recording speeds is to devise a write strategy that allows the dye or phase change material to cool enough after one mark/pit is made so that the trailing edge does not affect the leading edge of the next pit/mark. There are two ways to reduce this “thermal interference: 1) increasing the thermal conductivity of the mirror layer to draw off excessive heat (generally by making the metal layer thicker) and 2) thinning the dye layer. Thinning the dye runs the risk of increasing the modulation of the burn marks; so it takes a delicate balance of dye and coating parameters to optimize the recording characteristics. The precision required to make ideal marks is less than 0.05 micrometers while the disc spins at 180 revolutions per second. That is a linear speed of 56 meters per second-- over 125 mph or 200 km per hour.

## DVD-RAM ADDRESSES

Concentric grooves act as data tracks instead of the spiraled groove in DVD+/-R. Sector addresses are molded into the substrate; formatting is added before recording. No need for “lossless linking.”

Sector addresses are like data “postal codes.”

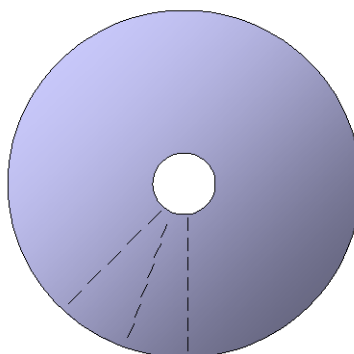

Figure 36

Recording speed has an affect only on part of the total time required writing a DVD disc. Finalization also takes a certain amount of processing time, and it differs for the three different DVD recordable disc types. Rewritable discs also vary dramatically in the time it takes to erase and format them. These differences are due to the way in which data are arranged and addressed on the discs. DVD-

RAM uses molded sectors for address information, and formatting writes the Universal Disc Format with block information for fast data erasure, storage, and retrieval. See Figure 36.

DVD-R and DVD-RW use molded “pre-pits” in the grooves for address information. Since this format was originally designed for sequential video recording, data are also added sequentially, as is formatting for the DVD-RW. This means, unfortunately, that formatting and erasing take much longer time than that for DVD-RAM or for DVD+R and DVD+RW because format information has to be written over the entire disc. A full erasure can take almost an hour and a half for a DVD-RW instead of a minute for a DVD+RW disc. New designs in software are being introduced to resolving this difference in formatting time, but it will likely always take longer to format and fully erase a DVD-RW than a DVD+RW. See Figure 37.

## DVD-R/-RW ADDRESSES

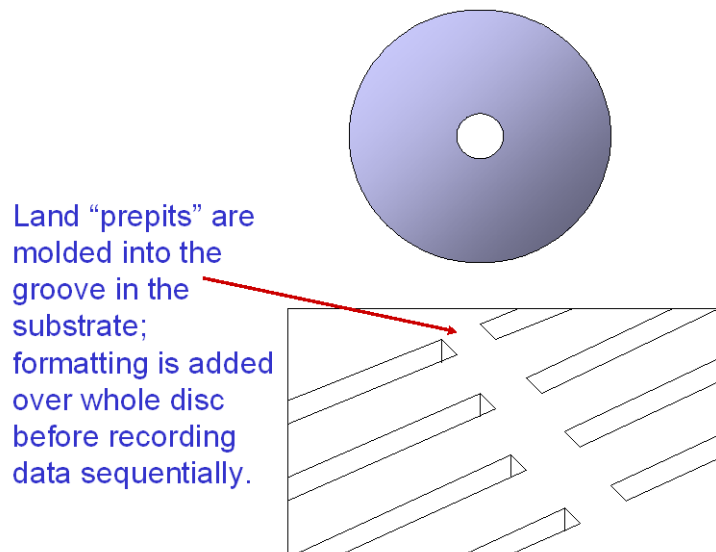

Figure 37

DVD+R and DVD+RW use the high frequency 817-kHz signal in their groove as a tool for data addressing. Instead of a CD-R ATIP, these discs contain an ADIP (ADDRESS In Pregroove) that begins the addressing information in an area of the disc not accessible to DVD players. Unlike the molded sector or pre-pit information that serve as a kind of “postal zip code” for addresses, the high frequency signal acts as a series of very closely spaced distance markers placed every “50 feet” or so. New data can be added to old data using the signal as a guide so that the difference in placement is less than 1 micron. This is the “lossless linking” that avoids the errors that would appear if the spacing of old and new data were any farther apart. This high-frequency signal method allows the DVD+RW format to offer some significant features:

- Erasing files is similar to the “drag-and-drop” method of floppy disks.
  - Data writing does not have to be sequential.
  - Erasing a file leaves the erased area open for insertion of new data
- Formatting a DVD+RW is faster than DVD-RW—just under a minute
  - Formatting actually takes longer; but it appears “in the background,” freeing up the computer to do other things while formatting continues.
  - Older software can take as long as 87 minutes for a DVD-RW but newer software allows background formatting for DVD-RW, too.
- Fully erasing a DVD+RW is faster than DVD-RW.
- Finalizing a DVD+RW is faster than DVD-RW—less than a minute after recording.
  - Some “finalizing” takes place during recording, similar to background formatting.

- DVD-RW finalizing time depends on the amount of data—more data on a disc actually reduce the time to finalize the disc.
- It is easy to edit video files straight to disc on a DVD+RW with Philips' VR format or Sonic Solutions' Open DVD architecture.

## FORMAT ADDRESSES—DVD+RW

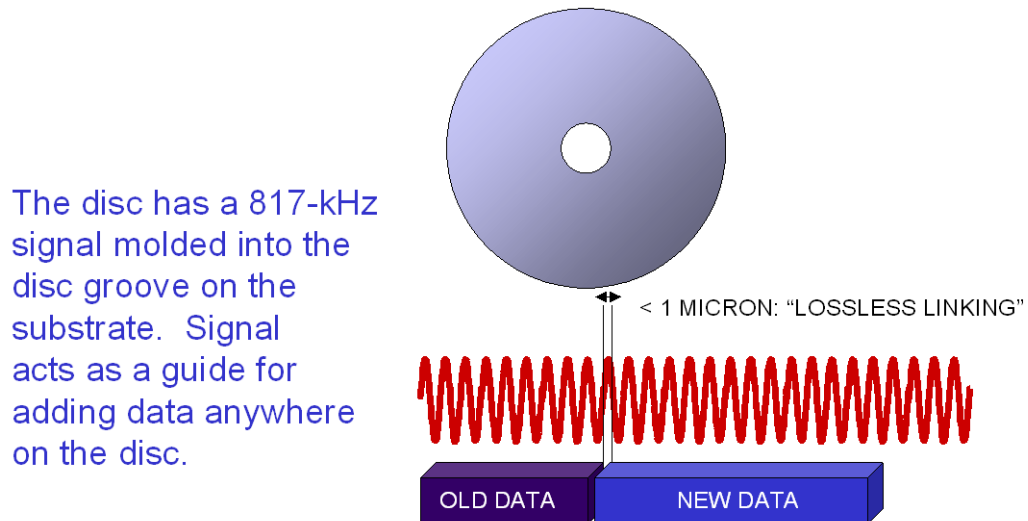

The high frequency signal acts as "mile posts every 50 ft." for addresses instead of using "postal codes."

Figure 38

## Comparative Speed of DVD Recordable Drives

FORMAT	SINGLE-SIDE CAPACITY	DATA TRANSFER AT 1X SPEED (MBps)*	million bytes/s*
DVD-Recordable	4.37 GB	1.321	1.385
CD-R	0.7 GB	0.1459	0.1536

\*MBps measures in units of 1,024 ( $2^{10}$ ) while "millions of bytes per second measures in units of 1,000.

Figure 39

The time spent for the drive to actually record a disc is only 20% or less of the time invested in an editing/authoring/recording project. What may be more frustrating is discovering that all the time invested in editing, authoring, processing, and recording a DVD is wasted because it does not play in any DVD player except the drive in which it was recorded. This is still a stumbling block in this early stage of the technology. Panasonic introduced set-top players that also play DVD-RAM discs, but in all other cases DVD-RAM's format for video prevents it from being used in the vast majority of players on the market—or already in people's homes. DVD+R and DVD-R are physically compatible (that means they have the right dimensions and shape) and are logically compatible (a term that means the DVD-Video format that can be recorded on them is recognized and correct) with DVD players, and they are much more likely to be successful in the latest players. Some older drives, however, may not be able to recognize the discs. DVD+RW and DVD-RW have the same problem

to a greater degree. Their lower reflectivity might confuse an older DVD player into thinking that they have a second layer recorded on them so that the player continues to hunt for information that is not there. Those older players or drives that check format codes may not recognize the code for the DVD-RW and refuse to play them altogether. Before investing in one format or another based on recording speed rates or data transfers, one should check to see if the player expected to play the recorded disc can actually recognize it. Compatibility with DVD players and drives is improving all the time as newer players are developed to handle new media types.

## Can DVD Players Play DVD–recordable discs?

(recorded in the DVD-Video format)

	DVD	DVD-R Either general or authoring	DVD-RW	DVD-RAM	DVD+R	DVD+RW
1 <sup>st</sup> players*	yes	many	some	no	many	some
2 <sup>nd</sup> generation players**	yes	most	many	no	most	many
Present players***	yes	yes	most	no	yes	most
Multi-read players	yes	yes	yes	no	yes	yes

Figure 40

<sup>1</sup> Of the first players introduced into the market, 95% will play the DVD-R 3.95 GB discs (the first DVD-Rs and the present authoring DVD-R, but only half are likely to play the 4.7 GB general purpose version DVD-R or the DVD+R. Few of these players may be able to play the DVD-RW.

<sup>2</sup> Almost all of the second generation players will play the 3.95 GB DVD-R discs, and roughly 95% will play the 4.7GB DVD+R and DVD-R discs. DVD+RW and DVD-RW performance improves with the number of players that recognize them, but those players are still far fewer than those that successfully play DVD+R and DVD-R.

<sup>3</sup> Almost all DVD players sold after November 1999 should play DVD+R and DVD-R discs, and most will also play DVD+RW and DVD-RW also.

### WHICH FORMAT SHOULD I CHOOSE?

The first recordable DVDs tried to match the 4.7-GB capacity of the DVD, but initial limitations restricted them to 2.6 GB in the case of DVD-RAM and 3.9 GB in the case of the DVD-R. Present versions of both media have achieved the goal of 4.7 GB, and two-sided discs double that amount to 9.4 GB before formatting. DVD+RW seemed to address most problems very well, but early adopters soon learned that their DVD+RW recording systems could not record DVD+R discs that followed six months later. All of these running changes and differences in design and application make the recordable DVD very interesting to those who follow the changes but very confusing to anyone who needs to choose a format right now. Each format has its strengths and weaknesses, just as Betamax and VHS did a quarter century ago. The market determined the winner in the video cassette war, and the market will also decide which format is the most popular for recordable DVD as well.

There is a major difference in this contest of formats from the video cassette format battle. The choice between VHS or Betamax was a critical one because the recorders and players were the same devices. Choosing the “wrong” format prevented users from exchanging tapes with anyone else who had selected the alternate format. Recordable DVD, however, does not force a critical choice. The chief issue of compatibility is with DVD players and drives, and both DVD+R/+RW and DVD-R/-RW appear to be evenly matched in that regard. DVD-RAM’s compatibility is severely limited because of its protective cartridge; but as far as the “plus camp” and the “dash camp” go, there is no “wrong” choice. The decision should be based on which format offers the user more of the features he or she needs—and plays on the DVD players and drives one expects to use.

In that regard, there is little practical difference between DVD-R and DVD+R. Both formats are nearly identical in performance. The design of the rewritable DVD-RW was for video applications, not data. The DVD Forum expected the DVD-RAM to handle data applications. The result is that DVD-RW’s sequential recording makes formatting, erasing, and rewriting more difficult and time-consuming. DVD+RW’s design is for both video and data, and it has a distinct advantage in storing and backing up data. Some drive manufacturers have tried to address the problem by building “dual” drives that will record both DVD-R/-RW and DVD+R/+RW discs, and the response from the press and consumers has been enthusiastic. What they may have failed to notice is that the ability to record both formats means a premium in the cost of the drive simply for an extra processor chip and the royalties for the additional format. Dual-format drives are an inelegant solution to the format conflict, but they do eliminate the problem of trying to guess which format to select.



### **BLUE LASERS—MORE FORMATS, MORE FORMAT BATTLES**

---

The Digital Versatile Disc is a great medium for carrying a lot of data whether those data are used for video, super high-fidelity audio, games, information, or any combination of these programs. There are, however, limitations to the format. As great as 4.7 GB of capacity per side seems, it is not enough for more than twenty minutes or so of high-definition video in the MPEG-2 compression format. DVD movies look wonderful in comparison to VHS cassette recordings, but they are merely the best our present TV standards can show. They are not HDTV, and HDTV is the new quality standard of the future.<sup>11</sup> In order to be capable of carrying high-definition video, DVDs need either more capacity or greater data compression.

The other limitation is, of course, that there are three competing, incompatible recording formats that are sometimes not playable on regular DVD players. In order to resolve both limitations at the same time, DVD developers have proposed a new, future DVD standard for both players and recorders based on a different laser diode—a blue-violet laser rather than the red lasers used for CDs, CD-Rs, DVDs, and all three recordable DVDs. The original intent was to have these new players and recorders able to play today’s DVDs, DVD-Rs, and DVD-RWs in addition to future HD DVD discs and allow a single standard to end the confusion over DVD recording and playback. A single standard was such a good idea that several other groups proposed their own competing, incompatible “single standards” to end the confusion even further!

---

<sup>11</sup> In terms of digital photography, high definition video is not so impressive. Standard TV’s 720x480 interlaced picture resolution is equivalent to 0.3 megapixels. High definition 1280x720p resolution improves to a 0.9 megapixel equivalent, and 1920x1080i is equivalent to two 1.0 megapixel interlaced fields.

Just as DVDs used smaller pits and more tracks to pack more information on a disc the same size as a CD-R, HD DVD will again shrink the pit sizes and pack more tracks on the same sized disc. The pits will have to be so small, however, that they will be smaller than the wavelength of a red laser beam; and the beam will be unable to track the disc. The laser reader/writer will have to use a smaller wavelength of light to read the edges of the pits, and a smaller wavelength means a beam of a different color.

Light is merely energy that is visible to the human eye. We first begin to see light energy as it passes from below visibility, the infrared range, to the red range. Hot coals, for example, glow “red-hot” as their heat increases to visibility. Light energy remains visible through the color spectrum until it passes beyond violet to the ultra-violet range and beyond. White light is the combination of all the visible wavelengths together. If white light passes through a prism and bounces off an interior prism wall, it spreads out according to the wavelengths of the energy components in a “rainbow” effect. In a real rainbow, sunlight passes through billions of water droplets acting as prisms to divide the light.

### Rainbow Colors Spread According to Their Wavelengths: (nanometer=1 billionth of a meter)

- Red 780-622 nm **Infrared for CD=780nm; ruby-red for DVD= 650 nm**
- Orange 622-597 nm
- Yellow 597-577 nm
- Green 577-492 nm
- Blue 492-455 nm
- Violet 455-390 nm **Blue-violet laser for DVD HD = 405 nm**



Figure 41

### Laser Beam Sizes

The higher the frequency of light, the smaller the wavelength and the beam.

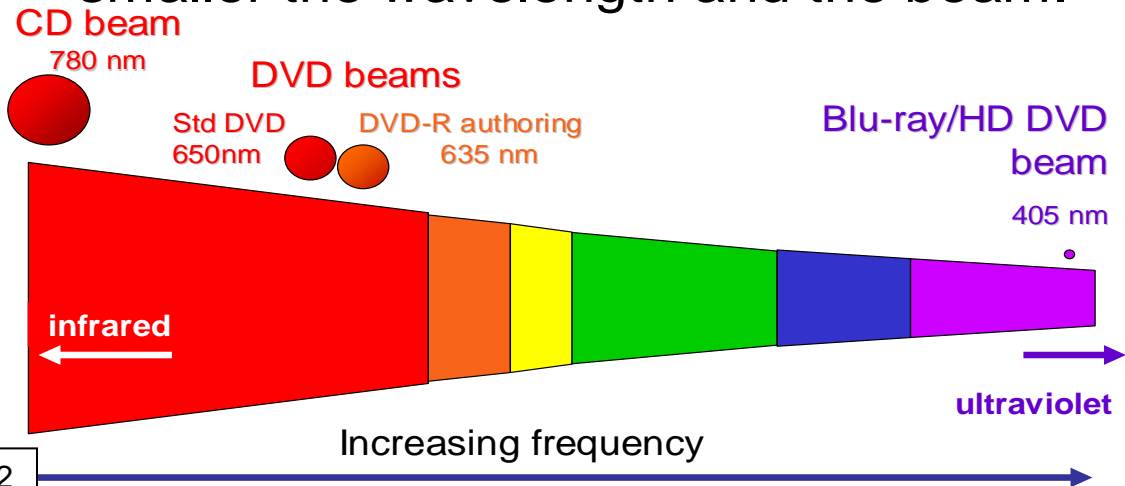

Figure 42

Figure 41 shows that the range of wavelengths for each color in the visible spectrum is different. Red has the widest range and the longest wavelengths. The laser diodes used in CD players and CD-R/RW burners are infrared lasers with a wavelength of 780 nm. A different red laser diode produces the beam needed for the smaller pit sizes of DVDs. A beam of 650 nm reads DVD information and a high-power version utilizing 70 milliwatts or more records at the same wavelength onto DVD-R, DVD-RAM, and DVD-RW discs. DVD-R authoring discs require a 635-nm burning laser.

In order to decrease pit sizes further to pack more information on a disc, engineers have to move beyond red lasers. Plans for the new high definition discs are based on blue-violet laser diodes with a wavelength of 405 nm, approaching the ultra-violet range. This wavelength is slightly more than half that of the infrared CD wavelength of 780 nm. See Figures 42 above and 43 below.

Blue-violet lasers are more expensive and difficult to build than red lasers and may have a shorter lifetime. Manufacturers, however, now feel confident that they can produce enough of them with a significantly long enough life to make them practical as a replacement for the common red laser found in CD and DVD players and drives.

**Infrared CD laser**

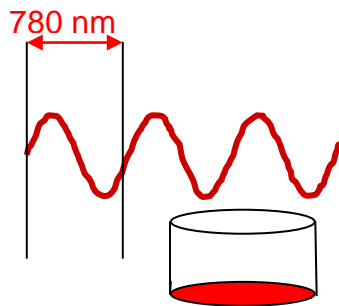

CD pit size

**Blue-violet DVD laser**

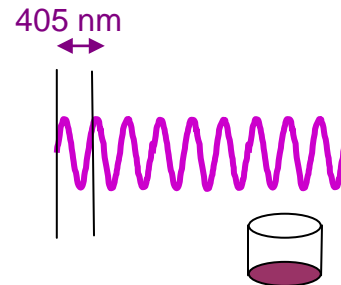

HD DVD pit size

Figure 43

CD laser spot of 1.6 microns ( $\mu\text{m}$ ) from 780-nanometer laser. Tracks are 1.6  $\mu\text{m}$  apart.

DVD laser spot of 1.1  $\mu\text{m}$  from 650-nanometer laser. Tracks are 0.74  $\mu\text{m}$  apart.

Blue laser has wavelength of 405 nanometers:  
 HD DVD spot = 0.62  $\mu\text{m}$   
 Tracks = 0.4  $\mu\text{m}$  apart  
 Blu-ray spot = 0.48  $\mu\text{m}$   
 Tracks = 0.32  $\mu\text{m}$  apart

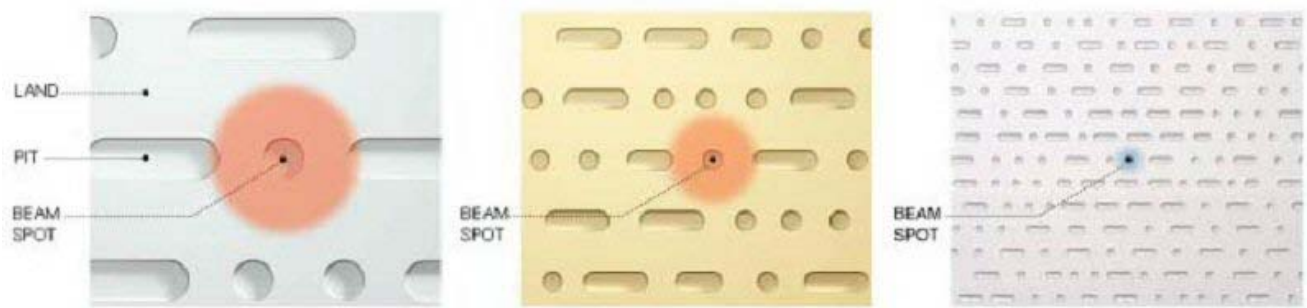

Figure 44

Courtesy of Sony and Cinram



The first blue laser system on the market is the Blu-ray format. The early Blu-ray versions use the same MPEG-2 encoding used in today's DVDs, but the disc is very different from today's two-piece DVD sandwich because it uses a single substrate with a very thin recording layer. The substrate itself does not even need to be translucent because the recording and reading lasers do not need to penetrate it. The initial versions of these discs are contained in a cartridge, but that will change in time when scratch-resistant coatings are applied to the bottom recording surface. Other changes to the format will include more advanced video encode/decode systems than MPEG-2. Specifications and comparison for the Blu-ray format appear in Figure 45.

## Specifications for Blue Laser DVD

	<b>HD DVD</b>	<b>Blu-ray DVD</b>	<b>DVD</b>	<b>CD</b>
Disc thickness:	1.2 mm	1.2 mm	1.2 mm	1.2 mm
Disc diameter:	120 mm	120 mm	120 mm	120 mm
Data capacity:				
Single layer--	15 GB/side	25 GB/side	4.7 GB/side	0.74 GB
Double layer--	30 GB	50 GB	8.5 GB	
Laser wavelength:	405 nm	405 nm	650 nm	780 nm
Laser type:	blue-violet	blue-violet	ruby-red	infrared
Track pitch:	0.4 $\mu$	0.32 $\mu$	0.74 $\mu$	1.6 $\mu$
Width of laser spot:	0.62 $\mu$	0.48 $\mu$	1.1 $\mu$	1.6 $\mu$
Minimum pit length:	0.204 $\mu$	0.15 $\mu$	0.4 $\mu$	0.83 $\mu$
Pit width:	0.25 $\mu$	0.25 $\mu$	0.35 $\mu$	0.5 $\mu$
Distance from disc surface to data surface:	0.6 $\mu$	0.1 $\mu$	0.6 $\mu$	1.1 $\mu$
Standard transfer rate	36Mbits/sec	36Mbits/sec	11.08Mbits/sec	1.38Mbits/sec

Figure 45

### **BLU-RAY**

Sony is the first manufacturer to introduce blue laser recorders and media intended for professional use. The discs themselves are quite a bit different from DVD recordable discs and DVDs in their structure. They are composed of a single polycarbonate substrate instead of two halves. The laser lens is positioned very closely the disc in a form of "near-field recording." The numerical aperture\* of the lens is 0.85 rather than the 0.65 of lenses used in regular DVDs. The complexity of the lens required that the first lenses be made of glass rather than the less expensive plastic used for all other types of optical recorders and or players, including the competing HD DVD version. (The near-ultra-violet light of blue lasers tends to break down many plastics. Research into durable plastic lenses for blue laser recorders and players continues.) See Figure 46.

# Blu-ray Disc

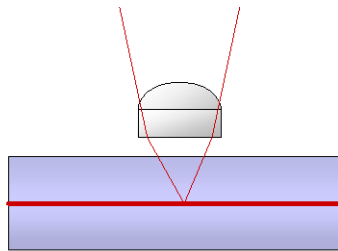

**DVD-RW/+RW**

- Requires a 650 nm. red laser
- Blank disc made of two 0.6 mm disc halves
- Total Thickness is 1.2 mm.
- Phase change recording layer in middle of disc
- Laser lens is millimeters above surface of disc.
- Capacity = 4.7 GB

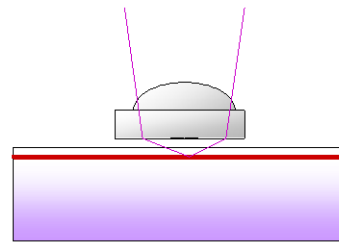

**Blu-ray DVD**

- Requires a 405 nm. blue-violet laser
- Cartridge holds disc with a 0.1 spacing layer covering a polycarbonate substrate
- Total Thickness is 1.2 mm.
- Phase change recording layer near surface of disc
- Laser lens is microns above surface of disc.
- Capacity = 25GB for a single layer; 50GB for dual layer)

Figure 46

\*The numerical aperture is a measure of a lens's ability to gather or disperse light and its ability to resolve fine detail. The expression of numerical aperture (NA) is a mathematical number derived from the sine of an angle of light passing through a lens. For example, a lens with a numerical aperture of 0.7 would form a 45° angle from the point of focus at a fixed focal length to the center of the lens.

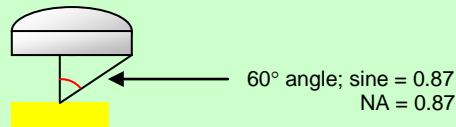
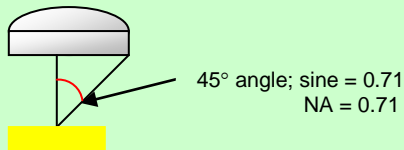

The most distinctive aspect of the Blu-ray is its application of “near-field” recording and playback. The read/write Blu-Ray laser is much closer to the data surface than it is in CDs, DVDs, or in the HD-DVD. The advantage of getting the laser closer to the data is in the reduction of deflection errors if the medium is not perfectly flat. A non-flat disc will have “tilt” errors toward its outside circumference that will deflect the reflected laser beam from its intended optical sensor. This tilt error becomes more critical as pit sizes and laser spots shrink to smaller dimensions in order to pack more data on a disc, and the whole point of moving to blue lasers is to shrink the light wavelengths and pits to the smallest practical size. The CD-R has a relatively large pit size and laser spot; so a disc's tilt would have to be severe to cause a significant deflection error.

# CD-R

recording layer at distance from laser source

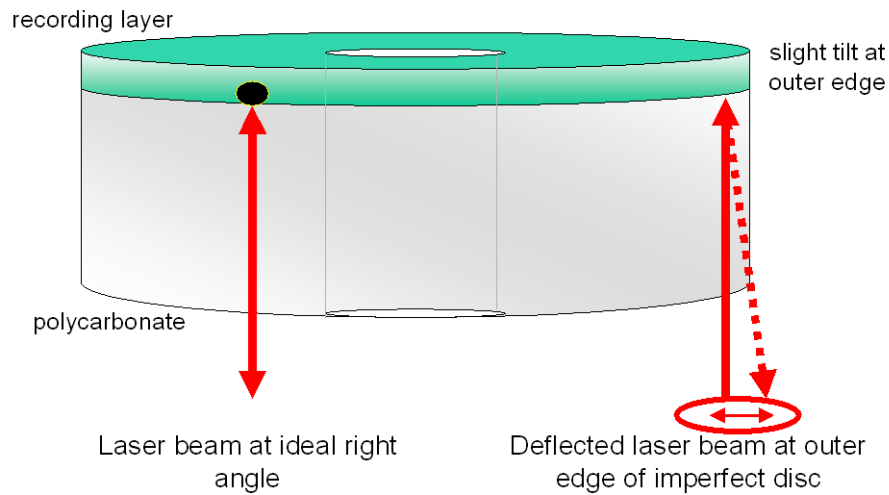

The DVD, however, packs more data on a disc the same size and thickness as a CD by using a smaller beam size as well as smaller pits and narrower tracks. In order to reduce the effect of deflection errors due to tilt of a disc, the data area is moved closer to the laser by sandwiching it between halves of a disc that are bonded together. The HD DVD uses this same design for its blue laser disc, and this approach offers HD DVD its greatest advantage: HD DVD discs can use the same manufacturing equipment as that used for DVDs and recordable DVDs because the disc design is identical. Manufacturers have gained great experience in making flatter and more uniform discs as the speed ratings of recordable bonded discs have increased from 2X to 16X. Flatness is essential to keep the recording/reading laser properly focused on at the outermost edge of a pit one-twentieth the size of the finest human hair as the disc spins at a speed of 200kph/125mph. And that DVD pit is twice as big as the one for HD DVD!

# DVD-/R (and HD DVD)

recording layer closer to laser source

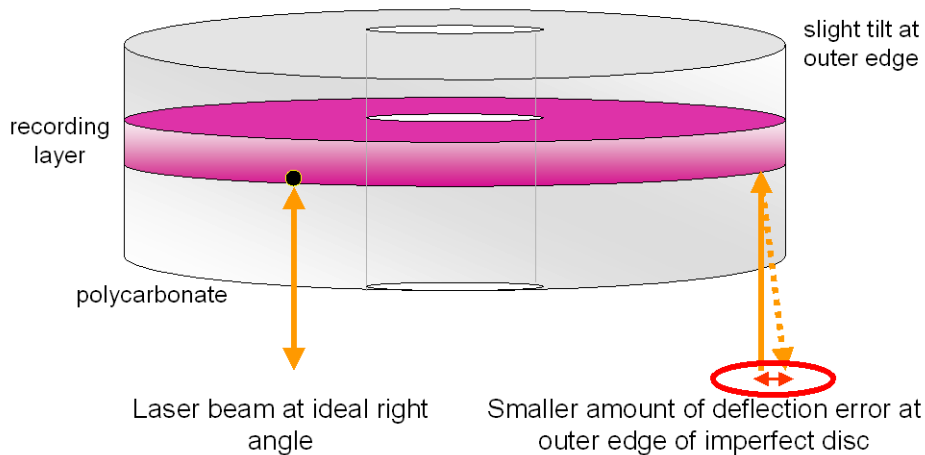

The Blu-ray engineers chose to maximize the amount of data to be recorded to a high definition disc by making pits and tracks even smaller than those for HD DVD. Over 250 Blu-ray tracks could fit across the width of a human hair (Fig. 47). The Blu-ray design has taken a “near-field” approach to



Figure 47

recording by bringing a 0.1-micron data surface as close to the read/write laser as possible. This allows a capacity of 25GB per layer with a minimum amount of tilt deflection error. A secondary advantage is that the substrate (or “superstrate” at this point) does not need to be of optical grade polycarbonate because the laser does not pass through it all. Some manufacturers have made experimental samples of Blu-ray discs made from recycled paper or other materials that are relatively durable and can be made uniformly flat. The actual write-once recording layer is a combination of aluminum/copper alloy and silicon; recording marks are spots where the laser has melted the two to form a light-blocking alloy. Organic dyes are an option for Blu-ray recording.

With every advantage comes some disadvantage, and Blu-ray discs are no exception. Because the data field is so close to the read/write laser, the surface of the disc has to be kept free as possible from scratches, damage, and fingerprints. These flaws are less critical for CDs and DVDs because the laser is focused on the data layer deeper in the disc, and many superficial flaws on the disc surface are simply too out of focus to affect the laser’s ability to resolve the pit edges. The “in-your-face” near-field design of Blu-ray discs has the laser focusing just below the disc surface with little allowance to ignore surface flaws. A cartridge for Blu-ray was the first solution to the problem, but consumers prefer discs to be free of such protection (as the DVD-RAM has learned). Manufacturers now cover the bottom of Blu-ray discs with protective coatings using a combination of micro-silica particles for hardness and scratch resistance and fluorine-loaded resins that prevent the absorption of water and oils. The laser lens for Blu-ray near-field recording is more expensive than that for DVDs or HD DVD, especially when it is combined with a red laser for reading CDs and DVDs in addition to high definition discs. Another disadvantage for Blu-ray is the same as that for any advanced technology: new production equipment to manufacture a disc quite a bit different from those that have preceded it. While HD DVD requires little investment for manufacturing beyond mastering equipment, Blu-ray requires new production lines in order to produce a disc capable of 25GB per side.

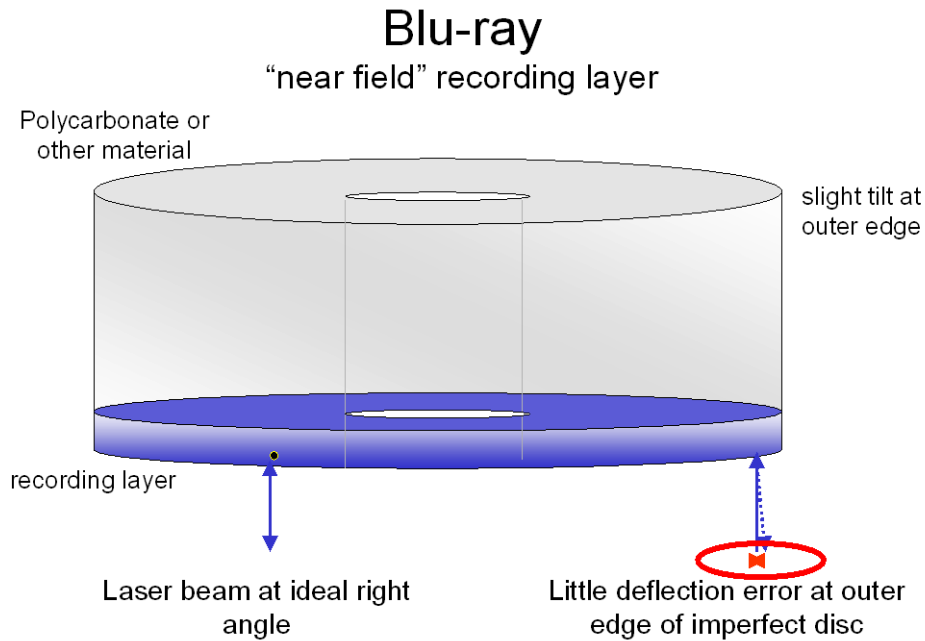

Figure 48

## HD DVD

Blu-ray is just the first of several different solutions for High Definition video. Toshiba and NEC offer their own version of a blue-laser DVD that offers a capacity of up to 30GB, enough for three hours of HD video. Instead of borrowing the MPEG-2 **DVD encoding scheme**, the Toshiba and NEC engineers borrowed the **DVD structure** and used a newer MPEG-4 encoding scheme for their HD DVD format. The capacity requirements for HD video in MPEG-2 forced Blu-ray to take extraordinary steps to maximize the amount of data on a disc. HD DVD, on the other hand, was designed from the start to use the more efficient MPEG-4 compression and use the less drastic design of today's DVD discs, which allows present DVD manufacturing equipment to be modified for production rather than have manufacturers invest in all new equipment. A single layer HD DVD version has a capacity of 15GB, and the dual-layer version holds twice that amount. A rewritable version also holds 15GB and the dual-layer version of the rewritable disc holds as much as 30GB of information. Although the HD DVD disc has received the approval of the DVD Forum, that approval is for the disc as a DVD video carrier, not necessarily as a recording medium. The rewritable version of HD DVD will use phase change alloys similar to those used in DVD rewritable discs, and the write once version will initially use an organic dye. Research continues on other methods, including the aluminum/copper and silicon recording layers used in Blu-ray discs.

## HIGH DEFINITION ALTERNATIVES

A group from Taiwan, the AOSRA (Advanced Optical Storage Research Alliance), is working on another system physically similar to the Blu-ray disc but differs from it in terms of the encoding, error correction, and file structure. AOSRA believes there are two advantages for their proposal: 1) the format is less expensive because it avoids the onerous royalty payments that are beginning to burden optical media and encoding systems, and 2) it offers more than five hours of HD video.

## High Definition Video Formats

	<b>Blu-ray</b>	<b>HD DVD</b>	<b>AOSRA</b>	<b>FVD</b>
Rec. layer:	.1 mm thick	.6 mm thick	.1 mm thick	.6 mm thick
Laser:	blue	blue	blue	Red
Wavelength	405 nm	405 nm	405 nm	650 nm
N/A:	.85	.65	.85	.65
Lens(es):	2	1	2	1
Capacity: Rewritable:	25GB 25GB single layer 50GB double layer	15GB and 30GB 15GB single layer 30GB double layer	17GB and 27GB	6 and 11GB
Encoding:	MPEG-2 to start; MPEG-4 AVC; VC-1	MPEG-4 AVC; MPEG-2; VC-1	AVC (proprietary)	WMV HD
Cartridge:	Only for earliest versions	no	no	no
Backers:	Hitachi, Matsushita, Pioneer, Sony, Philips, Sharp, Dell, Samsung, Columbia Pictures, Buena Vista	NEC, Toshiba, Warner Brothers, Paramount, New Line Cinema, HBO, Intel, Microsoft	29 Taiwanese companies	29 Taiwanese companies

There is a fourth solution called FVD (Forward Versatile Disc) offered by those who either do not want to have to upgrade all of their mastering facilities to press ever-smaller pits for a more expensive and, perhaps, shorter-lived laser diode, or who feel that the blue laser has too many shortcomings. This group uses a different compression scheme from MPEG-2 that can compress more video data without sacrificing video quality. Advances in algorithms have made such compression possible. HD-capable DVD players would retain the red laser diodes but include different circuitry to identify and decode HD signals while still being able to read today's DVD discs. The players would require only a single laser reader instead of both blue and red diodes, and prices would remain low for consumers. Prices for discs would also remain reasonable because only software upgrades would be required for the pressing facilities rather than all new mastering and test equipment and, perhaps, new molding presses. This group also argues that it is too early to introduce a new format for consumers while standard DVD is still in its growth period and has reached only half of US household penetration.

### **LIFETIME EXPECTATIONS OF OPTICAL DISCS**

Information is stored on optical discs in order to be saved for later retrieval. How long can that storage period last with comfortable assurance that the data can be retrieved? The question is often asked, "How long will a CD-R or DVD+/-R last?" but what people really want to know is "How long is my information safe?" There are two parts to that answer: 1) as long as there is equipment that can recognize the disc and retrieve digital data correctly, and 2) as long as the errors accumulating over time do not exceed a threshold at which data cannot be retrieved correctly. The first factor is one that most people forget, but it is likely to be the shorter of the two.

Media do not last forever; but as long as they outlast their intended audience they are very useful. Cave paintings at Chauvet-Pont-D'Arc in France are over 30,000 years old. The Chinese invented paper about 400 A.D., and this medium is seeing wider use every year despite futuristic claims of paperless offices. The shellac or vinyl record is a format nearly 120 years old; magnetic tape is 70 years old. Specific formats are showing shorter life cycles as technological developments bring better, smaller, and less expensive ways to store information; but the generally accepted lifetime of a successful consumer format is calculated to be about thirty years—the same as a human generation. This is no coincidence; consumers do not like to jump from one format to the next and be concerned about transferring their data and memories from one to the next. They prefer to stick to one comfortable, familiar format for most of their life and make the leap just once. The younger generations are the ones who adopt the new formats. The older generations adapt. Digital media are still relatively new, and the CD itself has only celebrated twenty years of popularity. The great advantage digital media have is that the information they store can be transferred in the digital code without apparent loss as long as all the code remains intact. That was not true of analogue media that transferred their own inherent flaws along with the stored data to another analogue medium with its own inherent flaws. The flaws accumulated, and the quality of the transfer was inferior to the original. Newer digital formats include methods of accepting transfers from older formats; and as long as the storage media can last the thirty years of the respective retrieval format's lifetime, engineers are happy.

Optical discs, both CDs and DVDs, should easily reach the thirty-year mark and beyond if they are manufactured well and are stored properly. Contrary to popular belief, these discs do degrade over time under the effects of heat, humidity, internal chemical reactions, mechanical stresses, UV light, oxidation, and accumulated scratches. The amount of degradation is measured in the accumulation of errors, and the end of life is defined as the point at which the error rate is so high that data cannot be reliably retrieved even with error correction. The fewer the initial errors, the longer the life expectancy can be.

The expected lifetimes can vary for the different types of media and the choices of materials used for each:

- CD-R--Claims have ranged from 50 years to 300 years.
  - Organic dyes—cyanine, azo-cyanine, phthalocyanine.  
Phthalocyanine shows the best resistance to UV light and to heat, but the other dyes have seen significant improvements under controlled tests. Dye type is less of a factor in determining life than it was ten years ago.
  - Mirror layer—gold or silver alloy  
Gold does not tarnish in the presence of sulfur or oxides of sulfur as silver or silver alloys would; but in a disc with a good lacquer seal, no air or sulfur should reach the metal reflective layer. There are few true gold discs available simply because gold is so expensive and silver alloys have proved more than sufficient. However, there is some evidence that discs with gold mirror layers have shown superior stability in environmental tests than those with typical silver alloys. The fact that silver alloys are more reflective than gold allows them to reach faster recording speeds than those allowed for gold. A uniformly small grain size of the deposited mirror layers should provide a longer life for the medium.
  - Structure  
CD-Rs are a single piece of polycarbonate coated with dye and covered with the metal layer and protective lacquer. It is the upper surface that is more susceptible to physical damage than the bottom of the disc. The CD-Rs have relatively large pit marks and wide tracks that can still be resolved through moderate scratches on the bottom of the disc.
- CD-RW—may last as long as CD-Rs. CD-RW discs have the reputation of being unstable, but factors such as packet-writing complexities and incompatibilities, varying

laser spot geometries from different drives, and file corruptions are more to blame for the difficulties than the design or materials of the discs.

- Recording layer—layers of indium-silver-antimony-tellurium  
The recording layers are inherently more stable than organic dyes are immune to the effects of UV light and moderate heat. The alloy crystallizes at 200° C. (420° F.), well above temperatures that would damage CD-Rs. Chemical changes due to humidity (polycarbonate plastic can absorb water.) can promote ion migration if the disc is not made well.
- Mirror layer—aluminum alloy  
Aluminum is less expensive than silver alloy but has no other advantages or disadvantages. (Silver is used in CD-Rs because the dyes would corrode aluminum.) A uniformly small grain size of the deposited layers should provide a longer life for the medium.
- Structure—same as that for CD-R
- DVD+R/-R—claims are up to 100 years
  - Organic dyes—azo-cyanine, cyanine, and metal chelate dyes are used for the write-once versions of DVD discs. These versions of dye have to react quickly to the application of the burning laser because the pit marks are very small and the disc speed is very quick.
  - Mirror layer—gold or silver alloy as in the CD-R. Environmental tests indicate that DVD recordable discs are far more sensitive to humidity than CD-Rs in terms of increases in error rates, but it is not clear yet if the humidity is affecting the dye, the mirror layer, the adhesive, or the mechanics of the polycarbonate.
  - Structure  
The fragile recording layer and mirror layer are sandwiched between two halves of a DVD disc. This offers better protection for these layers than that offered by CD-R and CD-RW disc. On the other hand, the pit sizes are much smaller and the track pitch is much narrower than that of the CD versions; so obstruction from scratches on the bottom of the disc is more likely. The bonding agent between the two halves introduces more questions about chemical stability. The hub area may or may not be bonded together, and the lack of bonding will mean more care has to be taken when inserting the discs in a protective case or a locking hub mechanism to prevent cracking. Tilt, the measure of flatness of a disc, is more critical for DVDs than for CDs.
- DVD-RW/+RW/-RAM
  - Recording layer—layers of indium-silver-antimony-tellurium  
These materials are the same as those for CD-RWs but use different formulations.
  - Mirror layer—aluminum alloy that is thicker than that for CD-RWs in order to also act as a thermal conductor.
  - Structure—same as that for DVD write-once media.



Arrhenius reasoned that the temperature had a direct influence on chemical reactions, and he proposed an equation to determine the effect heat had on activation energy. Eyring's equation examines transition states and allows another variable such as humidity:

### Arrhenius Equation

$$t = D_0 \exp\left(\frac{E_s}{kT}\right)$$

### Eyring Equation

$$t = A T^d \cdot \exp\left(\frac{E_s}{kT}\right) \cdot \exp\left\{R\left(B + \frac{C}{T}\right)\right\}$$

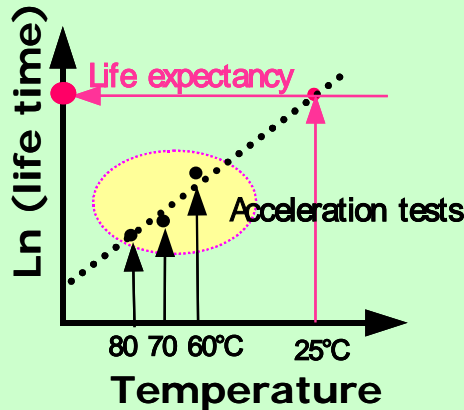

$$\ln t_1 - \ln t_2 = \frac{E_s}{k} \left( \frac{1}{T_1} - \frac{1}{T_2} \right)$$

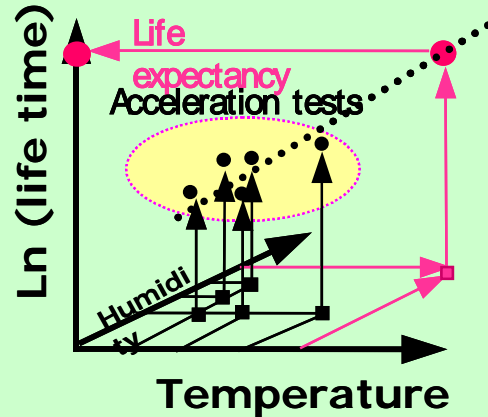

$$\ln(t_{50\%}) = \ln(A) + \left(\frac{E_s}{k}\right) \times T^{-1} + B \times R$$

t = life time	R = relative humidity (%)	T = Temperature	E <sub>s</sub> = activation energy
k = Boltzmann's constant		D, k, A, B, and C = constants	

(Data courtesy of Imation R&D group.)

Tests conducted on different dyes at differing temperatures produced the graph below (Figure 46). At a temperature of 25° C. (77° F.), the dyes will remain stable for a period of 30, 50, or 100 years, depending on the dye being used. The 100-year result is for a typical phthalocyanine dye commonly used in most of today's CD-Rs. The calculation is strictly on the heat stability of the dye itself. The life of the disc also depends on the care in manufacturing and packaging and the quality of the other materials used in the disc. Mishandling or exposure to high levels of UV light will have additional deleterious effects on life expectancy.

The estimates of life for these media depend chiefly extrapolating the increases in errors on discs subjected to heat, humidity, and light stability tests. The estimates do not take into account regular daily use and the damage done by handling the discs on a regular basis. One common estimate of heat durability is based on a formula developed by Dr. Svante Arrhenius of Sweden in 1889 to determine activation energy in chemical reactions. Engineers subject discs to different levels of heat for periods of time and measure the rates of increased errors. Using the "Arrhenius Equation," the engineers can plot the expected rate of chemical degradation over time to estimate the expected life of data on the discs. A second method of estimating expected lifetimes of optical media uses an equation developed by Henry Eyring. Unlike the Arrhenius Equation which uses heat as the stress factor and a formula based on empirical evidence, the Eyring Equation uses two stress factors—heat and humidity—and a formula based on laws of thermodynamics. This equation may be more useful for estimating lifetimes of DVD media because their error rates appear to be much more dependent

on changes in humidity than those rates for CD-Rs. Under normal conditions, today's better discs can easily outlive the format they support as long as the discs are properly made in the first place and cared for properly. Proper care includes:

1. Keeping discs out of direct sunlight and with limited exposure to light in general.
2. Keeping discs in a cool, dry environment. What is most comfortable for humans is most comfortable for discs, too.
3. Keeping the discs away from large swings in temperature and humidity.
4. Keeping discs in protective cases when they are not being used.

## Life Expectancy for Different Dyes

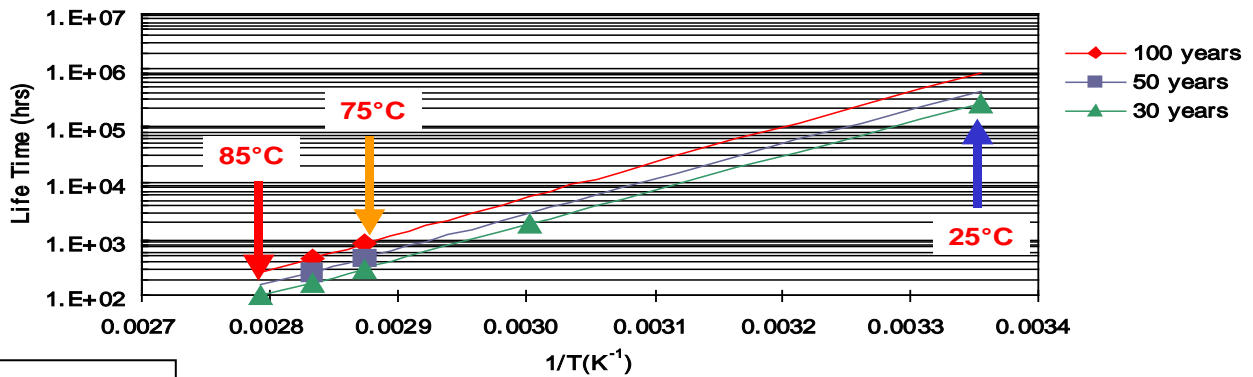

Figure 49

### CARE AND HANDLING OF OPTICAL DISCS

The estimated lifetimes of optical discs can only be reached if reasonable care is taken of them during handling and storage. Most people are familiar with handling these discs, but even a cursory glance at the bottom of discs in public libraries or from DVD rental stores indicates that the discs are subjected to far greater abuse than their designers planned. That almost all of these discs still play properly is a testament to their built-in durability, but accumulated damage will hasten the day that even good players will refuse to read them.

The most important points in their care and handling are:

- Handling
  - Hold the discs on the outer edge or through the center hole only to avoid fingerprints on the bottom of the disc.
  - Avoid flexing the discs when removing them from a player or recorder or a storage case. Flexing will distort the disc's flat design and can even damage the inner recording and mirror layers.
  - Do not put excessive pressure on the center hub when inserting the disc in its case. The center hub area, particularly on DVDs, is fragile. A crack in the hub area can lead to shattering of the disc in a high-speed drive.
  - Pick discs straight up from a flat surface; do not slide them.
    - Some discs have a special protective coating of extremely fine silicone dioxide power mixed with the lacquer that offers very good resistance to scratches.

- Labeling
  - Use only water-based or alcohol-based pens designed for optical discs.
    - The use of other solvents may damage the lacquer surface on CDs and CD-R/RW discs.
    - The pressure from a ballpoint pen on the surface of a CD or CD-R/RW will damage the lacquer, mirror, and dye layers and create errors on the disc.
  - Paper labels are not recommended for DVD discs.
    - The expansion and contraction of moisture in the paper and the accumulation of heat in a DVD drive can alter the flatness of a disc enough that it falls out of the tilt specification and may not be able to be read.<sup>12</sup>
    - Paper labels do offer extra protection for the fragile upper surface of a CD-R or CD-RW.
      - Paper CD-R labels must be aligned as precisely as possible to avoid disc imbalances.
      - A disc with a misaligned label should be discarded. Trying to peel the label off will likely damage the disc.
      - Labeling music discs should not be a problem because they are most often read at 1X, but any imbalance may reduce digital audio extraction speeds.
      - Labeling data CD-Rs is not recommended because of the risk of imbalance-induced errors because CD-ROM discs are generally read at the highest speeds.
- Cleaning
  - Any cleaning should be done radially, that is, from the center hole out to the edge rather than around the disc. This prevents any accidental scratch from lining up with a recording track. The best solution for cleaning optical discs is a solution designed for such discs or the same solution used to clean eyeglasses made from plastic.
  - Compressed air used to blow dust off a disc should be used carefully if the temperature of the air is cold enough to cause a stress fracture.
- Storage
  - Optical discs should be kept in storage cases for protection against contaminants, light, or accidental scratches.
  - Storage cases should stand on their edges so that the disc hangs from its center hub.
  - The ideal storage environment should be cool, dry, and dark.
    - 4° C (39° F) < Ideal storage range < 20° C (68° F) at 20-50% relative humidity
    - Archival: 18° C (65° F) at 35% relative humidity

Memorex has been a well-recognized and trusted supplier of high quality media for many years. We realize that the consumer will determine which medium or format to choose given enough accurate, honest information to see what fits his or her needs best. Memorex supplies, and will continue to supply, all the media types available to the market and takes pride in helping to inform the consumer so that he or she can choose what is best.

---

<sup>12</sup> John Carrier, the inventor of modern air conditioning, developed his first system as a dehumidifier for a printing plant that had trouble keeping paper in registration when the paper expanded or contracted depending on the humidity in the plant. Keeping the air dry kept the paper stable as it ran through multiple presses.