

Optical fibre field experiments in Italy: COS1, COS2 and COS3/FOSTER

S. Buzzelli, B. Catania, D. Gagliardi, F. Tosco (*)

Three field tests are at present being carried out on optical cables in Italy. The COS1, in which a 1-km long optical cable was laid in Turin in 1976, in an intercity-type trench; the COS2, in which two optical cables (a first one 4-km long containing 3 fibres, and a second one 1-km long containing 7 fibres) were laid in Turin in 1977, in urban ducts, the COS3 / FOSTER in which a 16-km long optical cable was laid in Rome in 1979-1980, to be put in regular service in 1981.

Two further field tests are planned beginning in 1981, the first one based on an aerial and the second one based on a 25-km cable containing fibres suitable for use in the 1.3 μm wavelength region. In addition, seven optical cable pilot plants are planned in the Italian public telecommunication network, to be implemented beginning in 1981.

Invited paper at the International Conference on Communications (ICC '80), Seattle, Washington, June 1980. Reprinted, with permission, from Conference Record, Vol. 3, pp. 38.9.1-5. CH 1506-5/80/0000-0182\$00.75 ©1980 IEEE; and CSELT Rapporti Tecnici - Vol. VIII - N. 3 - September 1980, p. 121-127

I. Introduction

Studies and experiments on optical fibre communications began in Italy in 1970; following a series of laboratory experiments on analog and digital transmission on optical fibres, a series of field tests was planned, to evaluate the problems concerning the introduction of optical cables and systems in the public telecommunication network.

At present, three field tests are being carried out, called COS1, COS2 and COS3/FOSTER, where COS is the Italian acronym for "Experimental Optical Cable" and the acronym FOSTER contains the initials of the exchanges at the end-stations of the cable. These experiments are described in the following, together with results obtained up to now and future developments. An overview on the experiments forecasted in the next years is finally given.

2. COS1 experiment

The COS1 experiment [1, 2] was planned immediately after the availability of the first lengths of low attenuation optical fibres, consequent to the signature (October 1973) of a development agreement between Corning Glass Works, Industrie Pirelli and CSELT.

The scope of this experiment was first to test the survivability of optical fibres during the cabling operations and the cable laying and then to verify the stability of the transmission characteristics of the optical cable, in correlation with usual environmental conditions of intercity links.

The experiment was carried out jointly by CSELT (who took care of the experiment planning, test laboratory set up, environment sensors design and routine testing), Pirelli (who constructed the cable, equipped with Corning fibres) and SIRTI (who installed the cable).

The optical cable used in the COS1 experiment has a capacity of 12 fibres, protected with loose plastic jacketing tubes and stranded around a central metallic strength member (Fig. 1 a). For cost reasons, only six fibres were actually inserted in the cable (four step-index and two graded-index fibres), with attenuation between 4.5 and 9.3 dB/km; the remaining six positions are occupied by empty jacketing tubes. The outer diameter of the cable is about 14 mm and its weight is 190 g/m.

For this first experiment, installation conditions very similar to those used in Italy for long distance coaxial cables were adopted: the cable, about 1 km long, was laid on the CSELT site in Turin, in a trench having a depth of about 70 cm, into concrete boxes with reinforced concrete cover, with both ends located in a test laboratory in the CSELT building. As the path is about 150 m long, the cable was laid in three go and return turns (Fig. 2 a). The laying

(*)Ing. Stelio Buzzelli, SIP DG, Roma; Prof. Ing. Diodato Gagliardi, ISPT, Roma; Ing. Basilio Catania, Ing. Federico Tosco, CSELT, Torino.

operations were carried out using a normal truck adapted for coaxial cable laying and did not present particular problems. Dry air pressurization was adopted, as normally used in Italy in long distance links.

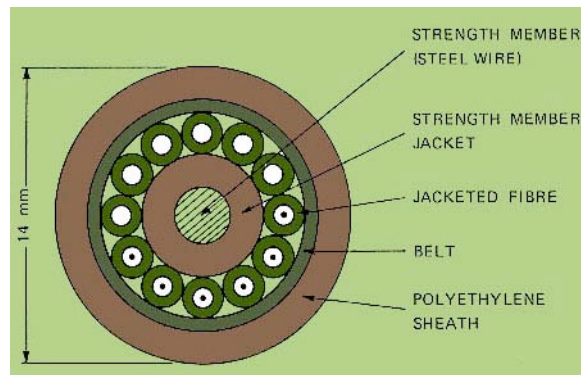

Fig. 1a COS 1 cable cross section

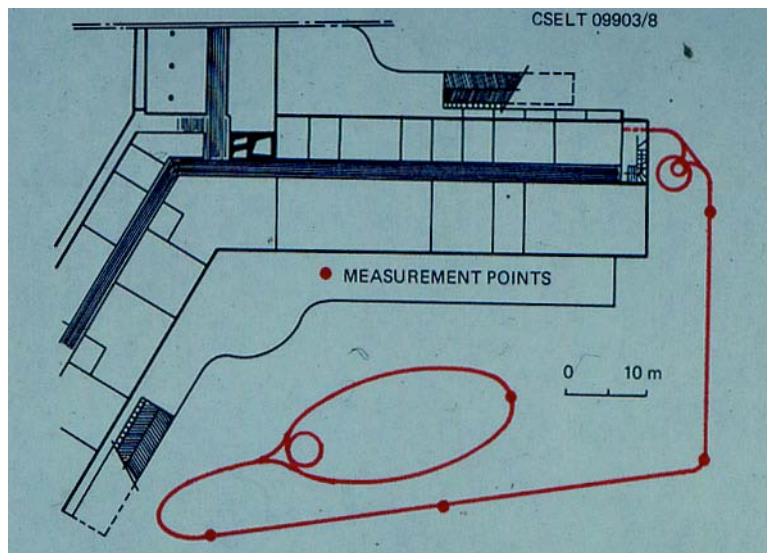

Fig. 2a – COS 1 optical cable route

An environmental monitoring system was designed and installed, to study the correlation between external environmental conditions and cable performance. The measured parameters are:

- Cable temperature, obtained through the DC resistance measurement of a copper cable laid alongside the optical cable. Fig. 3 gives the temperature recording, showing the well known quasi sinusoidal behavior, with a total yearly excursion of 20-22 °C, typical of North Italy.
- Height of the water column above the cable, measured in five locations, along the cable path, using pressure transducers. Due to the good draining properties of the soil, the measurement never indicated presence of water above the cable, even in presence of heavy and persistent rain, and was then discontinued after about two years.
- Vibrations, measured by three orthogonal inertial accelerometers, having a sensitivity of 0.01 g (g = gravity acceleration). Heavy trucks running along the cable path gave a value of 0.03 g on vertical axis and no indication on the horizontal ones; exceptionally, a 15-tons track-bulldozer produced an acceleration of 0.1 g peak on vertical axis. In no case these vibrations produced change in attenuation and/or dispersion of the fibres, as simultaneously detected during the acceleration tests.
- Characteristics of the pressurization dry air: the system has always performed correctly. Worth to be noted the unusually high pneumatic resistance of the cable.
- Before the laying of the cable the level of terrain and cosmic radiation was measured. Values obtained were such as to produce negligible influence on long-term optical attenuation of the fibres [3].

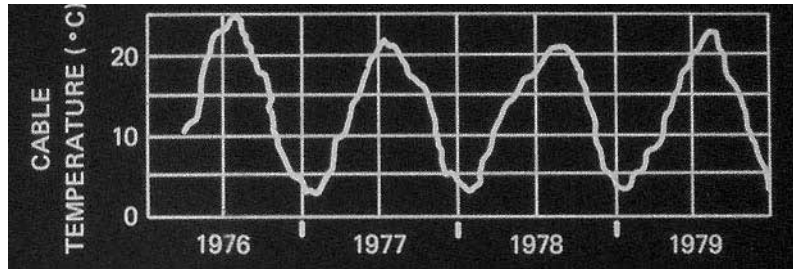

Fig. 3 – COS 1 Cable temperature vs. time

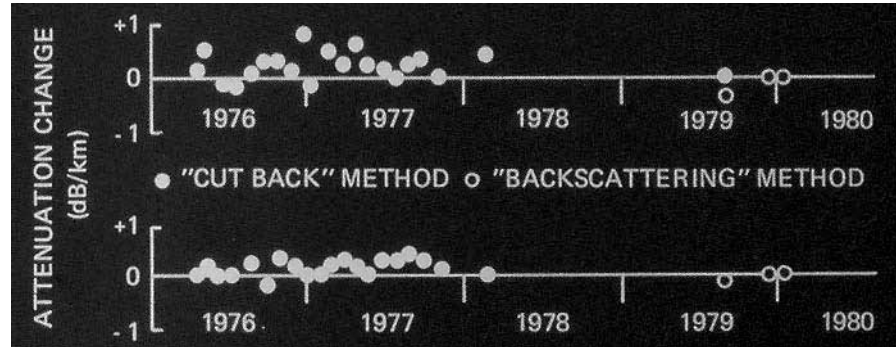

Fig. 4 – Attenuation behaviour versus time of two fibres of COS 1 cable

To verify the stability of the transmission performance of the cable, spectral attenuation (using the cutback technique) and pulse dispersion measurements were carried out after each stage of the cable construction, transport and laying and were repeated after the cable installation, every month during the first year and then every three months. The measurements were then interrupted during about one year, to avoid to completely exhaust the cable extra length present in the laboratory. The obtained results have shown that performance variations, if any, are within the range of measurement uncertainty.

In particular, Fig. 4 shows the results of attenuation measurements on two of the fibres, where seasonal variations are not detectable. The measurement uncertainty is, however, rather large. In order to improve the sensitivity and to avoid to cut about 1 m of cable whenever a measurement was made, it was recently decided to use the backscattering technique to measure the cable attenuation.

This technique, proposed at first by M. K. Barnosky et al., [4] has been deeply studied in Italy, both from the experimental point of view, introducing original provisions improving the measurement sensitivity and dynamic range [5-9] and from the theoretical point of view, improving the comprehension of the measurement results [10]. At present this technique, in addition to giving much more detailed information with respect to the cutback technique, seems also to guarantee a considerably higher repeatability of results [11]¹.

In conclusions, the COS1 cable has shown, during the four years elapsed after its laying, a satisfactory performance stability, even if the environmental variations have been relatively modest, as corresponding to an intercity type of installation with cable depth of 70 cm below the ground level.

3. COS2 experiment

Following the first encouraging results obtained by the COS1 experiment in 1976, CSELT organized a second and more advanced experiment [15], called COS2, in which two optical cables were installed, in September 1977, in normal telephone ducts of the Turin local network (Fig. 1 b): a “ main cable “, about 4 km long, connecting the Stampalia and Lucento exchanges and a “loop cable,” about 1 km long, with both ends inside the Stampalia exchange.

¹ In particular, measurements recently performed in Italy [12] on the same fibre in three laboratories (CSELT, FUB and Pirelli) using backscattering measuring sets of considerably different conceptions as regards launching, coupling and detection equipments, have given results much more satisfactory than similar campaigns carried out in Italy [13] and USA [14] using the cut-back technique.

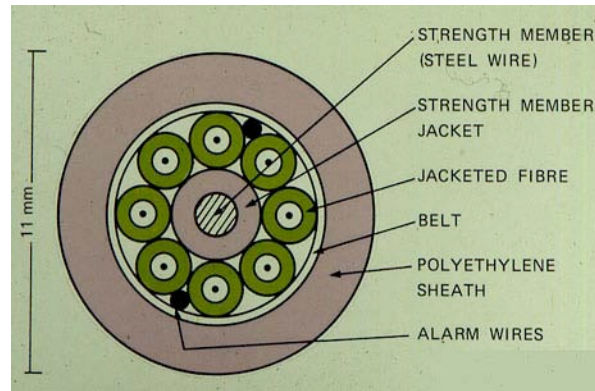

Fig. 1b COS 1 cable cross section

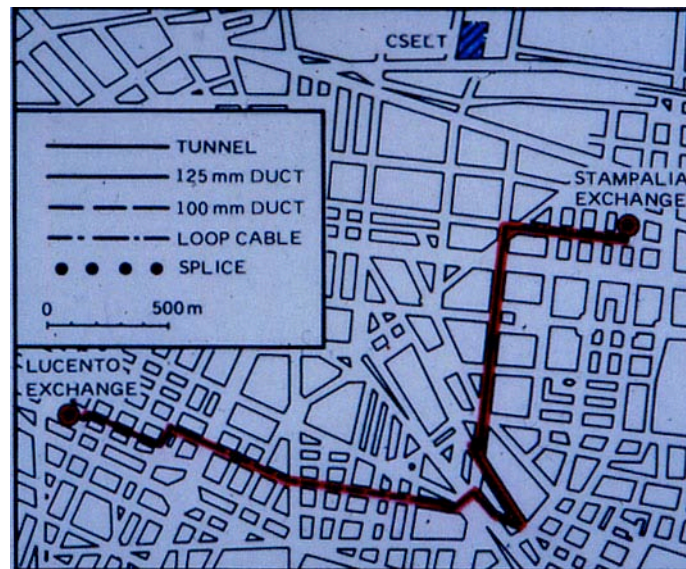

Fig. 2b – COS 2 optical cable route

This experiment was carried out in cooperation with SIP (the Italian Telephone operating company), Industrie Pirelli and SIRTI; its objectives were the following:

- to develop an optical cable that could withstand the stresses arising during the pulling of the cable through telephone ducts;
- to develop a laying technique permitting to pull in normal telephone ducts complete fabrication lengths (1 km) of the optical cable, in order to minimize the number of splices;
- to set up a splicing technique easy to use in the field;
- to field test digital transmission systems, taking advantage of the possibility of obtaining optical links of various lengths (between approximately 1 km and 19 km) as said below.

The cable used in the COS 2 experiment has a capacity of 8 fibres, inserted in loose jacketing tubes, in one layer around a central steel strength member (Fig. 2 b). The cable outer diameter is about 11 mm and the weight 100 g/m. No particular protection against water intrusion is provided, but two bare copper wires are inserted in the cable and connected to an insulation resistance measuring set, giving an alarm in case of water or moisture entrance into the cable.

For cost reasons, only three graded-index fibres, supplied by Corning, were inserted in the main cable, the remaining five positions being occupied by empty jacketing tubes. In the loop cable seven graded index fibres were inserted, four supplied by Corning and three independently made by CSELT, using the MCVD technique. Thus, taking into account the possibility of having from 1 to 3 paths, 4 km long, in the main

cable and from 1 to 7 paths, 1 km long, in the loop cable, optical links ranging from 1 to 19 km are achievable.

It was confirmed that the optical cable, constructed with the same loose-tube technique as the COS 1 cable, showed negligible attenuation change after cabling and laying operation. Typical attenuation of Corning fibres at $0.85 \mu\text{m}$ was 3.8 dB/km, and bandwidth was between 700 and 1100 MHz·km. CSELT fibres had typical attenuation of 3.9 dB/km and bandwidths of 200, 300 and 1000 MHz·km respectively.

Cable samples were submitted to mechanical tests: tension, bending, impact, crush, vibrations. Then SIRT I developed a laying technique making use of lubrication and pulleys and allowing to pull 1 km lengths with very limited tensions (maximum recorded value was 84 kg). Four polyethylene subducts were pulled into the 125 mm ducts (3 in the 100 mm ducts); in such a way 4 (or 3) optical cables can be independently pulled through the ducts and recovered, if necessary.

To splice the optical fibres, CSELT developed and patented a special technique (Springgroove® splice), based on a *groove* (given by two steel rods clamped together) for the fibres alignment and on an elastic element (*spring*), keeping the fibre ends pressed into the groove.

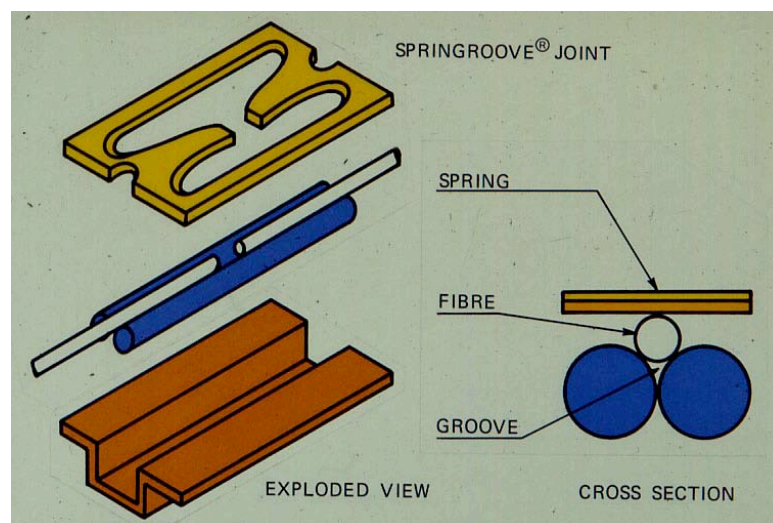

Fig. 5 - Exploded view of the Springgroove® splice.

The Springgroove® splice, schematically shown in Fig. 5, permits a quick and easy splicing, without the use of auxiliary mechanical or optical devices (such as micromanipulators and microscope) and does not require the use of instruments for either local or remote check. Laboratory tests made on 94 samples, splicing two ends of the same graded-index fibre, gave an average splice loss of 0.046 dB; the worst measured value was 0.15 dB. A cable splicing assembly, described in [15], was developed, allowing to have excess fibre to repeat the splice if necessary. The completed splices were sealed, employing normal plastic sleeves.

Measurements of attenuation and pulse dispersion were carried out during the cable installation, using a specially equipped van: no meaningful difference in transmission characteristics was found after the cable installation. Attenuation measurements have been repeated time by time after the installation, never showing appreciable performance variations. Though some manholes in occasion of heavy rains were flooded, the water alarms, set to detect an insulation resistance below 10 M Ω , have never operated. Measurements performed time by time showed a substantial stability of the insulation resistance. This indicates good water tightness of the cable sheath and of the sleeves enclosing the splices.

Vibration measurements were performed using inertial accelerometers in two manholes located at the crossing point of three heavy traffic streets and near a railway. The maximum measured values on the vertical axis were $\pm 0.03 \text{ g}$ [g being the gravity acceleration] for transit of tramcars or heavy trucks, $\pm 0.02 \text{ g}$ for transit of buses and $\pm 0.01 \text{ g}$ for transit of trains. The values measured on the horizontal axes were about 1/3 to 1/2 of those on the vertical one. The vibration frequency was in all cases around 60 Hz.

The only inconvenience recorded during the two years and a half elapsed after the cable installation was the break of one of the fibres in the main cable, that occurred about 1 month after laying, very close to a splice (few centimetres), near to the point where the jacketing was removed. This failure, very likely due to a damage produced

during the splicing operations, was easily located using the backscattering technique and was repaired.

TABLE I - CSELT systems tested on COS2 cable

Bit rate	140 Mbit/s	565 Mbit/s	34 Mbit/s
Transmitted signal	binary RZ	binary RZ	HDB3-PWM
Optical source	laser	laser	LED
Emission wavelength	842 nm	820 nm	820 nm
Photodetector	APD	APD	APD
Amplifier	voltage	voltage	transimpedance
Link length	10 km	6 km	5 km
Overall attenuation	38 dB	21.6 dB	19dB

Several digital transmission systems developed by CSELT were tested on the COS2 cable. Their characteristics are summarized in Table I; with the repeater spacing indicated in the table, an error rate of 10^{-9} was always achieved with adequate margins (4 to 6 dB). The 140 Mbit/s experimental system was the first one tested, in September 1977, with repeater spacing of 9 km, later extended to 10 km [15]. In 1978 tests were carried out on the 565 Mbit/s system with 6 km repeater spacing [17]. In 1979 a new version of the 34 Mbit/s system developed in 1976 [16] was tested, using the HDB3-PWM code [18], i.e. the code used in the interface between the multiplexer and the line terminal. This leads to a cost reduction of about 30% in line terminal, with respect to a more complex line code, like the 5B6B, while the achieved performances are quite comparable. In 1978 tests were also carried out on a 34 Mbit/s system of Italtel [19], a manufacturing company of the IRI-STET Group to which CSELT belongs; this was the first Industrial optical fibre system developed in Italy and it was later-on engineered to be extensively tested on the C053/FOSTER cable.

4. COS3/FOSTER experiment

Following the COS 1 and COS 2 experiments, ASST (the state agency operating the long distance telephone network in Italy) and SIP (the Italian telephone operating company) jointly decided to begin a new experiment, called COS 3/FOSTER, to test optical fibre systems with real traffic [20]. This experiment is based on the installation in Rome of an optical cable, about 16 km long, connecting 7 telephone exchanges (Fig. 2 c): Santa Maria in Via (SIP), Via delle Vergini (ASST), Aventino (SIP), Colombo (SIP), EUR (ASST), Via Shakespeare (SIP), Roma Sud (ASST and SIP).

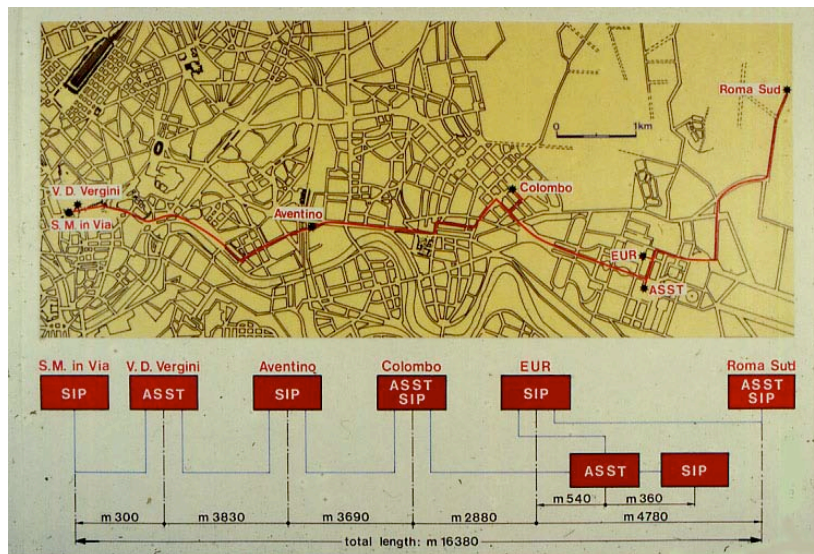

Fig. 2c – COS 3/FOSTER optical cable route

The objectives of the experiment are the following:

- to perform the first large scale experiment: COS 3/ FOSTER cable will contain 288 km of fibres, compared

- with the 19 km of fibres in the COS 2 cable and the 6 km of fibres in the COS 1 cable;
- to develop field portable measuring sets and techniques;
- to implement and test station terminations: cable fan out, distribution frame with patch cords, plug connectors, etc.;
- to field test digital transmission equipment of the Italian telecommunication industry, with the goal of putting them in service after a sufficient live experience is gained.

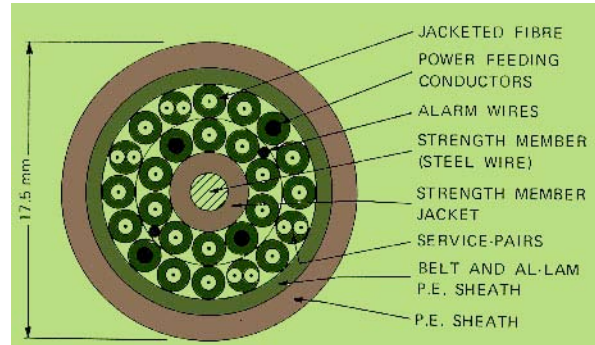

Fig. 1c) COS 3/FOSTER cable cross section

Fig. 1 c shows the cross section of the cable developed by Industrie Pirelli for the experiment: 18 fibres, protected with loose jacketing plastic tubes, are stranded in two layers (containing 8 and 10 fibres respectively) around a central plastic jacketed strength member; in addition to the fibres, the cable contains four 0.5 mm telephone pairs for service channels, four 0.9 mm copper wires for power feeding and two 0.5 mm bare copper wires for water entrance alarm, as in COS 2 cable. The cable is completed by an aluminum-laminated polyethylene water barrier and by a polyethylene sheath. The cable outer diameter is 17.5 mm and its weight 275 g/m. The fibres were supplied by Corning and are of three different types, as indicated in Table II.

TABLE II
Fibres used in COS3/FOSTER cable

Number of fibres	Attenuation (dB/km)	Bandwidth (MHz km)	Numerical Aperture
9	≤4 @ 820nm	~700	0.19
5	≤4 @ 900nm	~700	0.21
4	≤ 8 @820nm	~200	0.19

After cabling the fibres of all types and in both layers did not show any significant attenuation increase. Thanks to the studies carried out in the past by Pirelli [21] and to the experience gained with the COS 1 and COS 2 cables construction, the COS 3/FOSTER cable has a very good attenuation versus temperature performance: attenuation measurements made by SIRT I and CSELT in the temperature range between - 40 °C and + 50 °C showed maximum variations not exceeding 0.1 dB/km, i.e. practically within the measurement errors (Fig. 6). Cable samples were submitted to mechanical tests (tension, bending, impact, crush, vibrations), showing a very high cable robustness.

SIRT I performed a series of laying experiments, which confirmed for this more complex cable the techniques developed for the COS 2 cable. Also in this experiment a polyethylene subduct (outer and inner diameters 40 and 35 mm respectively) was installed in the telephone duct; in some cases a free duct was not available and the subduct was laid beside an existing conventional cable, without particular problems.

At present (February 1980), about 9 km of cable have been laid, between Santa Maria in Via and Colombo exchanges. Normally, complete 1 km lengths have been pulled, with pulling tensions not exceeding 140 kg. In the part of the path still to be completed, the direct laying in trench of some hundred meters of cable with a steel external sheath is planned, in conditions similar to those used for COS 1 cable, to experiment in a real situation also this laying condition that, in addition to being typical of long distance connections, is quite largely used also in low-density urban areas. The installation of the cable is expected to be completed by June 1980.

Portable attenuation measuring sets have been developed by CSELT and ISPT for an easy field measurement of the cable characteristics, based on the insertion loss technique and not requiring the cut of a portion of the cable at each measurement. Moreover, a backscattering portable measuring set has been developed by CSELT. These

measuring equipments were used by SIRTI to check the optical cable performance after laying, with very satisfactory results, as no appreciable variations were detected. A pulse dispersion portable measuring set is also being developed at CSELT.

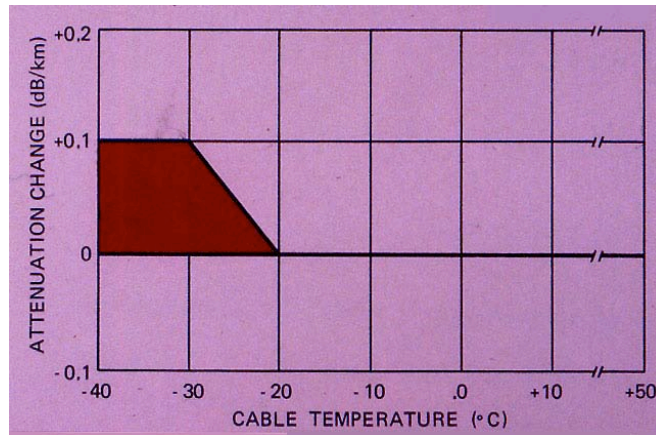

Fig. 6 - Range of attenuation variation with temperature of fibres contained in COS 3/FOSTER cable.

To perform the splicing operations in the COS 3/FOSTER cable, it was decided to adopt the Springroove® splice. As in this case it was necessary to employ some hundreds splices, SIRTI developed a new version of the Springroove® splice, more suitable for mass production and having attenuation performance equal to the laboratory version developed by CSELT and used in the C052 cable; the two versions of the Springroove® splice are shown together in Fig. 7. The attenuation of the 18 splices of the first cable joint has been measured with the backscattering portable measuring equipment using the technique described in [11] and [20], which allows a very sensitive evaluation of the splice loss; the attenuation resulted to be less than 0.1 dB for all the splices but one, for which a value of 0.15 dB was measured. Some splices have been measured also in the other cable joints, with similar results. In the part of the plant still to be implemented it is planned to utilize also the fusion splicing technique.

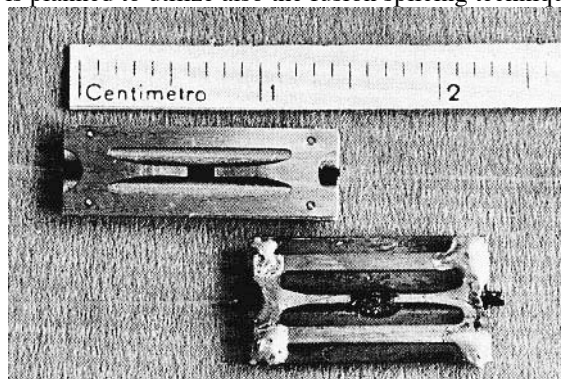

Fig. 7 - Springroove® splice. Below: CSELT laboratory version; above: SIRTI industrial version.

Since July 1979 system tests are being successfully carried out on the Aventino-Colombo cable section (about 4 km long), using the 34 Mbit/s Italtel system already tested on the C0S 2 cable [19]. In March 1980 tests will begin on the pre-series version of the same system. Tests are forecasted in the near future on other digital transmission systems of various manufacturers, at 8 Mbit/s, 34 Mbit/s, 140 Mbit/s and on a new version of the 565 Mbit/s system developed by CSELT. As soon as sufficient results on the transmission performances will be available, these systems will carry live traffic.

5. Future experiments and pilot plants

Both ASST and SIP are planning other experiments, to test optical cables in installation conditions different from

those tested till now, and pilot plants, to be inserted in the Italian telecommunication network.

A new field test which should start in 1981 is based on the aerial installation of an optical cable equipped with 2 Mbit/s and 8 Mbit/s digital transmission systems. This type of installation is very important for short and medium length connections in low telephone density areas, for which the aerial symmetric pair cables used at present give many problems, due to the short achievable repeater spacing and to surge voltages induced by electric power lines and lightning. Fundamental items of this experiment will be the test of transmission characteristics as a function of environmental conditions and mechanical stresses, which are, as known, much more severe in the aerial installation than in the buried one, and the study of suitable laying techniques.

Other experiments will concern the use in medium and long intercity links of optical cables containing fibres with attenuation around or below 1 dB/km at about 1.3 μm , in order to achieve very long repeater spacing. In particular a field test which will start in 1981 is based on the laying of a 25 km intercity cable, containing 12 optical fibres with attenuation less than 1.5 dB/km at about 1.3 μm . The main purpose of this field trial is to test 140 and 565 Mbit/s transmission systems.

In addition to these field tests, both ASST and SIP are planning pilot plants to be put in commercial service.

ASST is planning two pilot plants, to be completed in 1981-1982, for an overall length of about 40 km. These links will be equipped with 140 and 565 Mbit/s transmission systems, operating in the 0.8-0.9 μm wavelength region.

SIP is planning five pilot plants, to be implemented starting in 1981 and employing 8 and 34 Mbit/s systems supplied by Italian Industries. As among the objectives of these pilot plants is the training of the local personnel in these new transmission techniques, the plants will be implemented one in each of the five regions in which SIP is territorially divided. Both metropolitan and intercity links are planned, with locally fed intermediate repeaters. In total about 90 km of optical cables having capacities of 20-30 fibres will be installed.

REFERENCES²

- [1] CATANIA, B.; MICHETTI, L.; Tosco, F.; OCCHINI, E. and SILVESTRI, L.: *First Italian experiment with buried optical cable*, 2nd ECOC, Paris (September 27-30, 1976), pp. 315-322.
- [2] MICHETTI, L.; TOSCO, F.: *One year results on a buried experimental optical cable*, 3rd ECOC, Munich (September 14-16, 1977), pp. 56-58.
- [3] CATANIA, B.; DI LULLO, A.; LONGONI, S. and SACCHI, L.: *Applicazioni delle fibre ottiche ai collegamenti a breve distanza*, XXIII Congresso per l'elettronica, Roma (22-24 Marzo 1976), pp. 75-92.
- [4] BARNOSKY, M. K.; ROURKE, M. D., JENSEN, S. M.: *A novel technique for investigating attenuation characteristics of fiber waveguides*, 2nd ECOC, Paris (September 27-30, 1976), pp. 75-79.
- [5] COSTA, B.; SORDO, B.: *Backscattering technique for investigating attenuation characteristics of optical fibres: a new experimental approach*, CSELT Rapporti Tecnici, Vol. V (March 1977), pp. 75-77.
- [6] DAINO, B.; SETTE, D.: *The measurements of the transmission properties of optical cables*, Eurocon, Venezia (May 3-5, 1977).
- [7] COSTA, B.; SORDO, B.: *Experimental study of optical fibres attenuation by a modified backscattering technique*, 3rd ECOC, Munich (September 14-16, 1977), pp. 69-71.
- [8] COSTA, B.; DE BERNARDI, C. and SORDO, B.: *Investigation of scattering characteristics and accuracy of the backscattering technique by wavelength dependent measurements*, 4th ECOC, Genova (September 12-15, 1978), pp. 140-145.
- [9] COSTA, B.; SORDO, B. and VEZZONI, E.: *High dynamic range backscattering measurements*, Physics of Fiber Optics Conference, Chicago (April 28-30, 1980).
- [10] Di VITA, P.; ROSSI, U.: *Backscattering measurements in optical fibres: separation of power decay from imperfection contribution*, Eletttron. Lett., Vol. 15 (July 1979), pp. 467-469.
- [11] COSTA, B.: *Comparison between various fibre characterization techniques*, Invited paper to 5th ECOC, Amsterdam (September 17-19, 1979), Suppl. to Conf. Proc.
- [12] CCITT - Study Group XV - Italian delegation contribution DO to February 1980 meeting - Submitted for publication to Electron. Lett.
- [13] CCITT - Study Group XV - Italian delegation contribution DE to July 1979 meeting.
- [14] DAY, G. W.; CHAMBERLAIN, G. E.: *Results of a recent attenuation measurement comparison among U.S. optical wave-guides manufacturers*, 5th ECOC, Amsterdam (September 17-19, 1979), Suppl. to Conf. Proc.

² ECOC: European Conference on Optical Communication

- [15] COCITO, G.; COSTA, B.; LONGONI, S.; MICHETTI, L.; SILVESTRI, L.; TIBONE, D. and TOSCO, F.: *COS 2 experiment in Turin: field test on an optical cable in ducts*, IEEE Trans. Commun.. Vol. COM-26 (July 1978), pp. 1028-1036.
- [16] FAUSONE, A.; ROSSO, G. and VEGLIO, G.: *Repeater for 34 Mbit/s transmission system over optical fibre*, 2nd ECOC, Paris (September 27-30, 1976). pp. 351-356.
- [17] FAUSONE, A.; SACCHI, L.: *First 560 Mbit/s trials on COS 2 optical cable*, 4th ECOC. Genova (September 12-15, 1978), pp. 564-573.
- [18] BROSIO, A.; MONCALVO, A.; PERINO, M. and SOLINA, P.: *Transmission experiment at 34 Mbit/s on optical fibres with HDB3 line code*, 5th ECOC, Amsterdam (September 17-19, 1979), Supplement to Conference Proceedings
- [19] BRUNELLO, U.; LAURO GROTTU. U., LOVADINA, A.: *Experimental link on optical cable at 34 Mbit/s in urban area*, 4th ECOC, Genova (September 12-15, 1978). pp. 607-615.
- [20] BONAVENTURA, G.; COLAVITO, C., GAGLIARDI, D.: *Economy and planning of optical fibre systems in public telecommunication network*, 4th ECOC, Genova (September 12-15, 1978), Suppl. to Conf. Proc., pp. 31-43.
- [21] GRASSO, G.; PORTINARI, A.; PIZZORNO, M., GHERARDI, L.: *Attenuation temperature dependence of coated and cabled optical fibres*, 4th ECOC, Genova (September 12-15, 1978) Suppl. to Conf. Proc., pp. 77-84.
- [22] COSTA, B.; ESPOSTO, F.; D'ORIO, C., MORRA, P.: *Splice loss evaluation by means of the backscattering technique*, Electron. Lett., Vol. 15 (August 1979), pp. 550-551.