

What is the Comic Market?

A presentation by the Comic Market
Preparations Committee
February, 2008

Chapter One

What is the Comic Market?
What are Doujinshis?



What are Doujinshis? What are Doujinshi Marketplaces?

What are Doujinshis?

- Doujinshis are defined in Japanese dictionaries as "magazines published as a cooperative effort by a group of individuals who share a common ideology or goals with the aim of establishing a medium through which their works can be presented." Originating from the world of literature, fine arts, and academia, doujinshis experienced unprecedented growth in Japan as a medium of self-expression for various subcultures centered around manga.
- At present, *books edited and published by individuals with the aim of presenting their own material* are also considered doujinshis.
- As a norm, doujinshis are not included in the commercial publishing distribution system.
 - > The primary goal of doujinshi publishing is that of self-expression of one's own works--Ordinarily commercial profits are not the primary rationale for doujinshis endeavors.
 - > Their distribution is limited in scope.

What are Doujinshi Marketplaces?

- Social functions centered around the display and distribution of doujinshis.
- Their scale and function can vary from anywhere between small gatherings taking place in regular conference spaces where only a few dozen circles (doujinshi publishing groups) attend but can be big as the Comic Market where over 35,000 circles congregate.
- Outside of Japan, similar forums are usually attached to various manga and anime related public gatherings. In Japan, doujinshi marketplaces are almost always independent public events where the focus is on the individuals and groups that publish the doujinshis.



What is the Comic Market?

- Excluding private industry showcases such as the Tokyo Motor Show, the Comic Market is **Japan's largest indoor public gathering** operated by a single private non-governmental group.
- Main attraction: Exhibition and sales of self-published publications (doujinshis) centered around manga, anime, video games, and other related genres.
- Commercial industry booths housing over 130 corporations accommodated in a separate wing of the exhibition complex.
- The event utilizes all the facilities of the Tokyo Big Sight (an international exhibition complex in Ariake, Tokyo) for three entire days each summer and winter every year.
- Often abbreviated as the *Comiket* and *Comike*.

- *Comic Market 72*

- >August 17th ~ 19th, 2007.

- >Over 35,000 circles (publishing groups) participated.

- >Total combined attendance over three days: **Over 550,000**.

- >Total combined number of cosplay participants over three days: Over 13,000.

- *Comic Market 73*

- >December 29th ~ 31st, 2007.

- >Over 35,000 circles (publishing groups) participated.

- >Total combined attendance over three days: **Over 500,000**.

- >Total combined number of cosplay participants over three days: Over 14,000.



- *Comic Market Catalog*

- >A complete listing of all circles (publishing groups) attending.

- >Acts as a guidebook to the event itself.

- >Price, when purchased on site: 2000 yen.

- >Price, when purchased at retailers prior to event: 2400 yen.

- >B5 (approx. 8.5" x 11" letter sized,) square bound, roughly 1400 pages thick.

- >Circulation: 110,000 copies.

Chapter Two

History of the Comic Market



Chronology of General Attendees and Participating Circles statistics.

1975 / 1980 / 1985 / 1990 / 1995 / 2000 / 2005

Red - Participating Circles

Blue - General Attendees

Tokyo Big Sight Three Day Operation
Attendee Peak Number
550,000

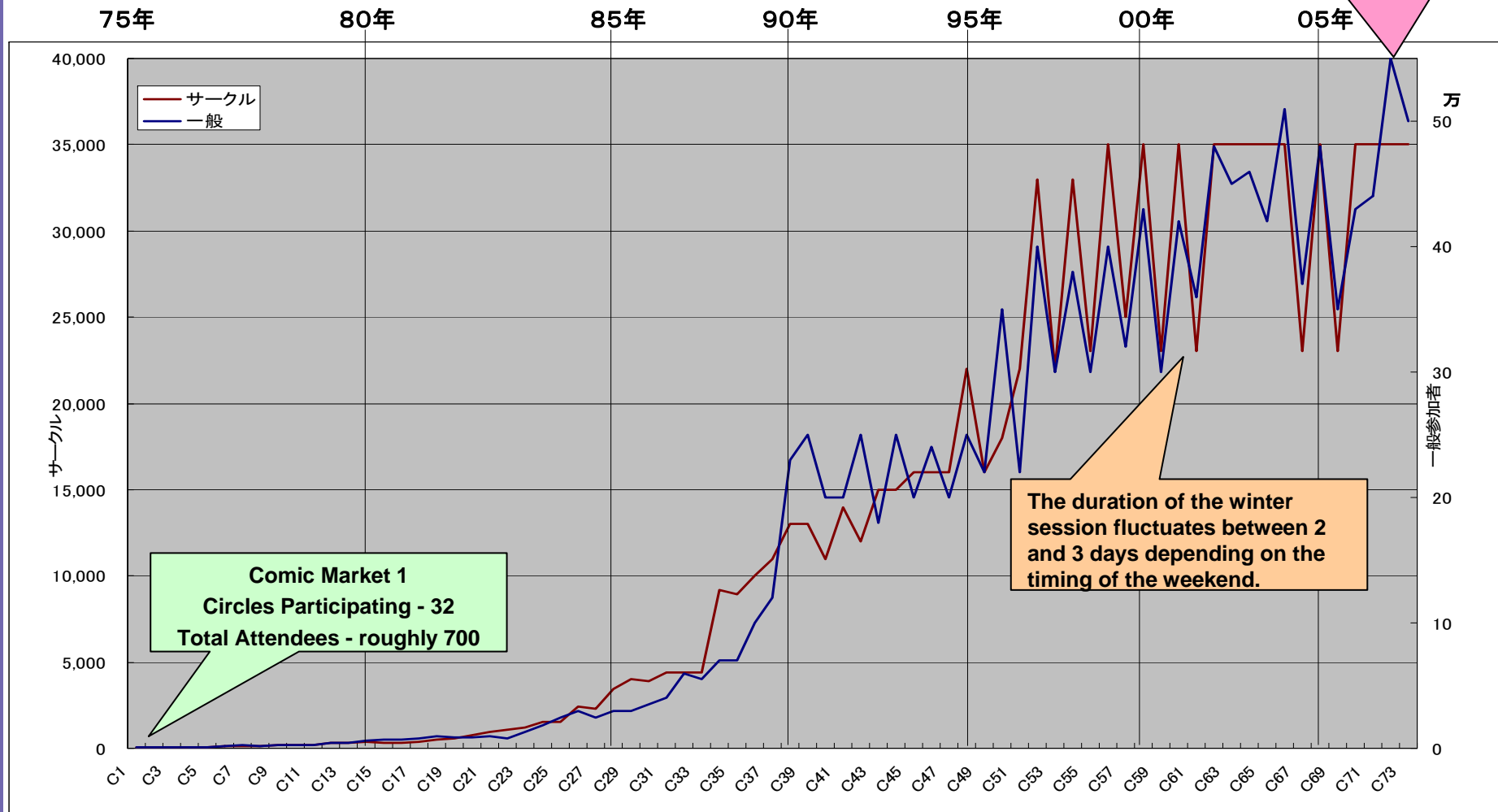

The Early Years of the Comic Market

- 1975 ~ 1981 (CM1 ~ CM18)

- Transition in attendance numbers:

- > Circles: 32 => 500
- > General attendees: 7000 => 10,000

- Comic Market was launched to counter prevailing trends in established forums over manga, etc.

- Notable trends:

- > Shōjo manga (young girl's comics) boom: Moto Hagio, Keiko Takemiya and other Year 24 Group authors embraced by women.
- > *Space Cruiser Yamato* boom takes root among both men and women (1977~.)
- > *Mobile Suit Gundam* boom among both men and women (1979~.)
- > Lolicon (comics featuring girls aimed for men) boom: Authors such as Hideo Azuma embraced by men (1980~.)

- Congestion begins to become a pressing problem from 1979. Total allotted space for circles outstripped by demand => lottery system incorporated.

- Internal strife over various incidents lead to fallout within the ranks of the CMPC (Comic Market Preparations Committee.)

- > Preparations committee division leads to new doujinshi marketplaces to come about.

- Prevailing doujinshi format

- > Offset printing still very expensive. Few printers cater to doujinshi publishing needs. Many books printed with whiteprint printing machines.
- > Membership based doujinshi circles were common. Most doujinshis were original works and parodies were not as numerous.



Ota-ku Trade Center

The 1st Harumi Era

- 1981 ~ 1986 (CM19 ~ CM30)

- Transition in attendance numbers:

- > Circles: 600 => 4000
- > General attendees: 9000 => 35,000

- Notable trends:

- > Lolicon boom continues among men, the boom is particularly pronounced from 1980 to 1984.
- > Rumiko Takahashi boom among men (1982~.)
- > *Captain Tsubasa* mega-boom among women (1985~.)

- CMPC scrambles to keep up with rapid expansion.

- > Moving to Harumi brings new operational challenges (police, fire department, security guards, clean-up concerns, etc.)
- > The publication of the catalog begins (from CM21.)
- > Shift from three times a year to two times a year scheduling.
- > The establishment of a public legal entity to support CMPC operations (1985.)

- Prevailing doujinshi format

- > Migration begins from membership doujinshi circles to small group style doujinshi circles.
- > Offset printing becomes more affordable. The number of printers catering to doujinshi publishing increases.
- > The popularity of *Captain Tsubasa* contributes to a lowering of the median age of the doujinshi creator.
- > Increasing sophistication of books (more pronounced use of color and increasing print runs,) especially among women publishers.



Fans enjoying a game of Hana Ichi Monme, a traditional children's game



The TRC, 2nd Harumi, and Makuhari Era

- 1986 ~ 1990 (CM31 ~ CM39)
- Consecutive venue changes : Tokyo Ryutsu Center => Harumi => Makuhari Messe
 - > The Japanese Bubble economy of the late 80's contributes to ever increasing number of trade shows and corporate exhibitions => Securing a venue for the Comic Market becomes increasingly difficult.
- **Transition in attendance numbers:**
 - > Circles: 4400 => 13,000
 - > General attendees: 40,000 => 250,000
- **Notable trends:**
 - > *Saint Seiya* boom among women (1987~.)
 - > *Samurai Troopers* mega-boom among women (1989~.)
 - > Bishōjo (infatuation over cute girls) boom re-ignited among men (1990~.)
- **The 1989 Serial Killer Miyazaki Incident instigates bashing against Otakus and the Hazardous Comics Controversy of 1990 highlight obscenity debate.**
 - > These incidents contribute toward increasing public exposure of the Comic Market.

Tokyo Ryutsu Center



Closing Shop at Makuhari Messe

- **Explosive growth in the size and scale of the Comic Market constantly challenges the CMPC to adapt.**
 - > In CM32, the general attendees entrance line grows to 2km in length, extends onto public roadways.
 - > The Comic Market itself is extended to become a two day event, starting from CM32.
 - > The two day setup becomes entrenched following CM34 even after returning to Harumi.
 - > Massive influx of applications by circles makes paperwork a nightmare.
 - > PC's and office automation involving databases incorporated from CM31 onwards..
 - > The categorization of doujinshi circles begins--Genre codes are established from CM31 onwards.
- **Prevailing doujinshi format**
 - > Increasing transition from small group organization based to single author based doujinshi circles.
 - > Doujinshi printers begin carrying-in printed stock directly into the CM.
 - > The advent of medium sized doujinshi marketplaces: Comic City, Comic Live, Comic Revolution, etc.
 - > The increasing size of the doujinshi marketplace makes it possible for authors to make a living off doujinshi publishing alone.



The 3rd Harumi Era

- 1991 ~ 1995 (CM40 ~ CM49) held at the Harumi Tokyo International Exhibition Center

- > Police raid bookstores selling doujinshis, obscenity charges filed March, 1991.
- > Hazardous Comic Controversy continues to rage.
- > CM venue change forced by Chiba Prefecture's intervention caused by hostile tip against the CM.
- > Makuhari Messe refuses to house the CM.
- > Harumi allows CM on condition of all books to go through contents verification checking.

- Transition in attendance numbers:

- > Circles: 11,000 => 22,000
- > General attendees: 200,000 => 250,000

- Notable trends:

- > *YūYū Hakusho* boom among women (1993~.)
- > *Slam Dunk* boom among women (1994~.)
- > *Gundam W* boom among women (1995~.)
- > *Sailor Moon* boom (1992~) notable as a work supported by both sexes after a long hiatus.
- > Men's erotic fiction genres experiences its 3rd boom: *Evangelion*, *Tokimeki Memorial*, and other works take center stage.

- CMPC struggles on accommodating overgrown Comike inside Harumi.

- > Major issues: Long lines of people attached to access of 2nd Floor of Shinkan, Overnighters (unsanctioned camping out before an event takes place,) plus maintaining orderly general attendee lines.
- > Massive expansion in the CMPC staff ranks.
- > At CM48, Comike is held three days for the first time.

- Trends within the doujinshi community.

- > Mid-sized doujinshi marketplaces propagates throughout Japan: Comic City begins holding venues in numerous locations in Japan starting roughly around 1994.
- > Doujinshi related peripheral industries begin to take root and expand starting 1994.
 - * Masquerading related activities support -- Cosplay clothing stores, cosplay dance parties organized by corporations beginning around 1994.
 - * Doujinshi bookstores selling doujinshis on consignment begin (1994~.)
 - * Used bookstores specializing in selling used doujinshis take off (1995~.)
- > Communication utilizing local dial-up BBS networks surges.



Bird's eye view of Harumi Convention facilities.



The 1st Ariake Era

- 1996 ~ 1999 (CM50 ~ CM57) moves to the new Tokyo International Exhibition Center--the Tokyo Big Sight.
- Transition in attendance numbers:
 - > Circles: 18,000 => 35,000
 - > General attendees: 350,000 => 400,000
- Notable trends:
 - > Doujinshis for women lose steam somewhat.
 - > *Galgames* (video games featuring girls aimed for men) mega-boom takes root among men (1997~.)
Examples include: *Sakura Taisen*, *Shizuku*, *Kizuato*, *Pia Carrot*, *To Heart*, etc.
- Efforts to adapt to the new exhibition facilities include:
 - > Major re-organization of CMPC departments.
 - > 3 day setup of summer session of CM becomes entrenched from CM52.
 - > CM57 marks first time winter session of Comiket being held for 3 days.
 - > Firebomb incident takes place with CM54, threatening letters against CM are repeatedly sent.
- Trends within the doujinshi community.
 - > Tax collectors begin investigating popular doujinshi circles (most of which sell books through consignment shops.)
 - > Tokimeki Memorial Video Incident of 1998, Pokemon Doujinshi Incident of 1999 underscores intellectual property issues.
 - > DTP and full digital authoring of doujinshi manuscripts becomes increasingly prevalent among male publishers starting from around 1997.



Bird's eye view of Ariake Convention (Tokyo Big Sight) facilities.

The 2nd Ariake Era

- 2000 ~ Now (CM58~) held at the Tokyo Big Sight (Tokyo International Exhibition Center)

- Transition in attendance numbers:

- > Circles: 35,000 => 35,000
- > General attendees: 430,000 => 550,000

- Notable trends:

- > The rise of *Shōnen Jump* related titles: *Naruto*, *One Piece*, *The Prince of Tennis*, *Reborn*, etc popular among women (2000~.)
- > *Gundam Seed* boom starts from 2003, *Fullmetal Alchemist* boom starts 2003 both titles popular among women.
- > The Moe (infatuation over cute girls) boom starts from 2000 among men.
Examples include: *Di Gi Charat*, *Key*, *Type Moon* titles, *Maria-sama ga Miteru*, *Lyrical Nanoha*, *The Melancholy of Haruhi Suzumiya*, etc.

- A period marked by stability overall, however--

- > Development around Ariake constantly forces changes in CMPC plans.
- > The corporate booths section of the CM becomes increasingly congested from 2001.
- > Increasing demands compels even the winter session of the Comike to run for 3 days.
- > CM71 marks first time Comike taking place on New Year's Eve.

- Trends within the doujinshi community.

- > Increasing scope of the doujinshi consignment shops, i.e. Tora no Ana and Melon Books.
- > The Otaku boom in the general Japanese society leads to influx in general attendees.
- > Increasing numbers of general attendees act like "customers at a store" within the CM, expectations and shared values shifting and eroding.
- > A surge in number of single themed doujinshi marketplaces starting from 2000.
- > Further entrenchment of DTP and full digital production of books. Both men and women increasingly become dependent of PC's for authoring both color covers and their b/w contents.
- > Increasing number of doujinshi activities intertwined with web based interaction, the rise of SNS such as Mixi related to doujinshis.



Comic Market in action--A shot of East Halls 4 ~ 6.

Chapter Three

A Profile of the Comic Market Today



The Backdrop to the Comic Market

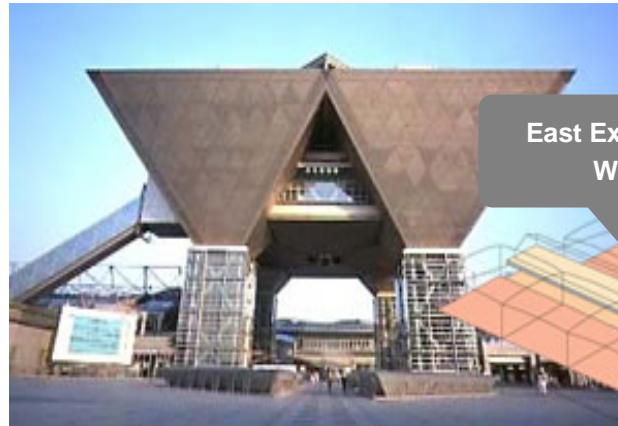

East Exhibition Wing

Conference Tower

West Exhibition Wing

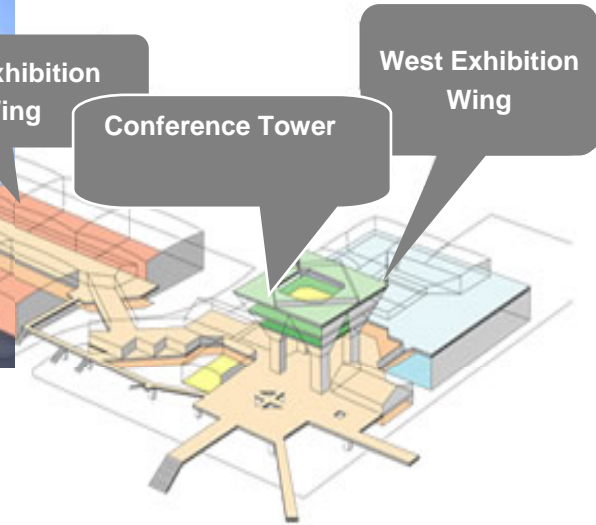
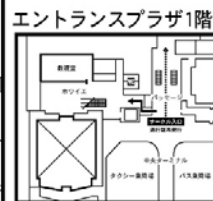
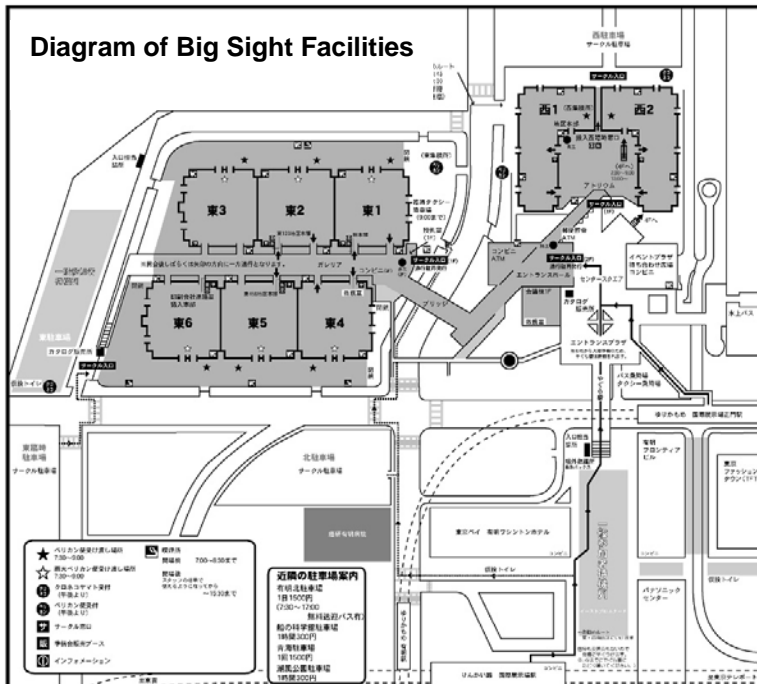
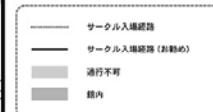

Diagram of Big Sight Facilities



※8:45以降やぐら橋と●部分の通行は出来ません。
(一般参加者が入場のため移動を開始します)



Doujinshi circles (publishing groups)

-- Housed in East Halls 1 ~ 6 and West Halls 1 ~ 2.

Cosplay and Corporate Booths

-- Housed in the 4th Floor of the West Wing.

Hours of Operation:

-- Doujinshi circles floor area open 10:00 ~ 16:00

-- Corporate Booths open 10:00 ~ 17:00
(except for last day of CM.)

A View Inside the Comic Market - Part I



A bird's eye view of the East Halls 1 ~ 3.

A View Inside of the Comic Market - Part II

General Attendees awaiting entry.



- Prior to the 10:00 a.m. opening of the Comic Market, tens of thousands of general attendees must be organized into lines and guided within nearby parking lot grounds, parks, and other open spaces.
- To help cope with the massive influx of people, nearby mass transit--such as the Yurkamome elevated train line, the Rinkaisen train line, Tokyo Metropolitan Bus lines--change their operating schedule and increase service to accommodate the crowds.
- No charge for admission (but purchasing of the catalog is strongly encouraged.)

A View Inside of the Comic Market - Part III

Doujinshi Circle Booths



- Space allotted to each circle:

- > Half a desk (90cm wide and 45cm deep -- 36" x 18")
- > 2 chairs.
- > Space for storing inventory (90cm x 70cm x 150cm -- 36" x 28" x 60")

- Cost for participating as a doujinshi circle:

- > 7500 yen (roughly \$65) per single space + 1000 yen (roughly \$8) for purchasing the application form package.

- Total number of circles applying for space.

- > 46,500 (where by a lottery is conducted and roughly 80% actually secures a space.)



A View Inside of the Comic Market - Part IV

Lines inside the Comic Market, etc.

- Long lines may form at doujinshi circles that are particularly popular.
- Any circles that are likely to have long lines form are positioned near the loading bays so the lines can be arranged to be extended out into the truck yards.
- Some circles will sell an excess of a couple 1000 copies of their books at a single session of the Comic Market.



Corporate Booths



- Located on the 4th floor of the West Wing.
- Total of 150 booths, last housing 130 corporations.
- Most of the participating corporations fall into the following categories:
 - > PC game software manufacturers, animation production studios, comic book publishers.
 - > Music content publishers and producers, TV and radio stations.
 - > Retailers specializing in novelty goods and other items.
- Some notable activities that take place.
 - > Handshaking sessions, talk shows, and autograph signings with celebrities.
 - > Rock, paper, scissors contests, present giving sessions, lotteries.
 - > Formerly special live musical acts used to be conducted but the lack of space has lead to their demise.



Cosplay



- Participants enjoy dressing up to appear like their favorite anime, manga, and/or game characters.
- A dedicated dressing room just for cosplay is setup at the 4th floor of the West Wing, separate room for the two sexes, cost -- 800 yen (roughly \$7) per person for registration, et al.
- Because of congestion, regulations regarding cosplay is more restrictive at the Comic Market compared to other events.
- Ratio of cosplay participants by gender --
Male 1 : Female 4~5.



A Profile of Comic Market Participants - Part I

- Conventional wisdom tends to portray doujinshi as male dominated.
- In fact, the Comic Market has been consistently dominated by women.

Participating circles gender breakdown:

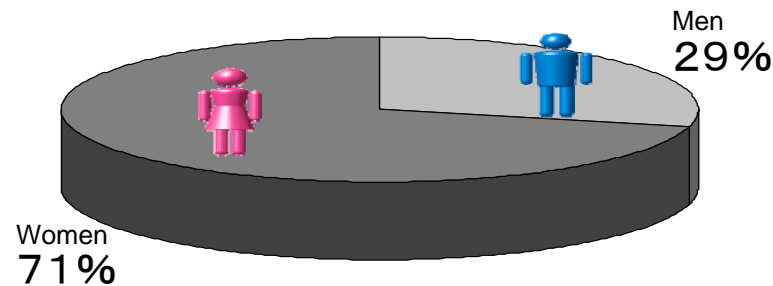

Average age of circle organizer:

Among men -- 28.6 years old
Among women -- 28.3 years old

Age demographics of circle organizer:

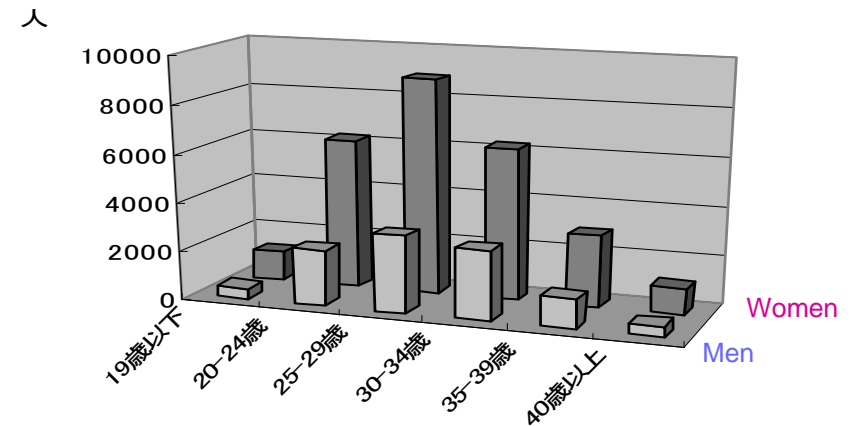

Aggregate Geographical Breakdown

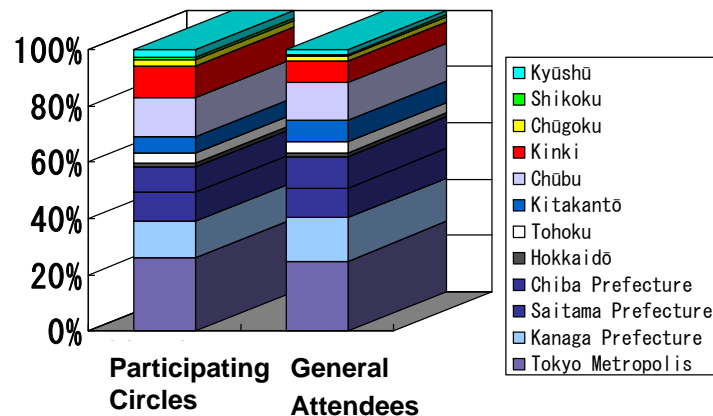

General attendees gender breakdown:

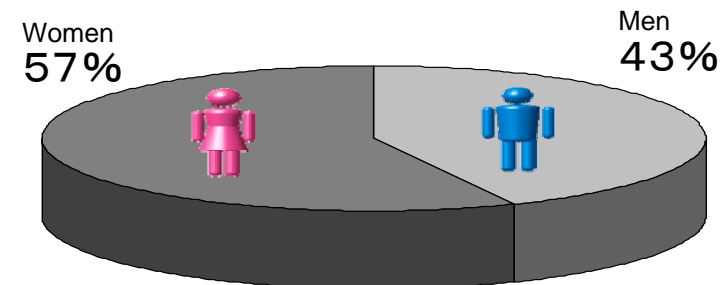

The average age of the general attendee is about 2 ~ 3 years younger than that of the participating circles.



A Profile of Comic Market Participants - Part II

While manga, anime, and games predominate, the Comic Market in fact houses a wide variety of genres.

Breakdown of circles' genres:

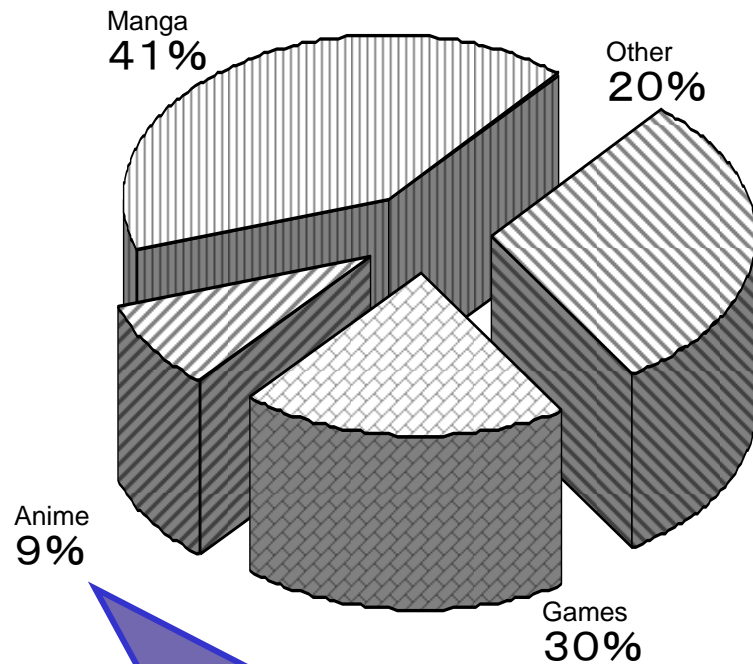

Breakdown of "Other:"

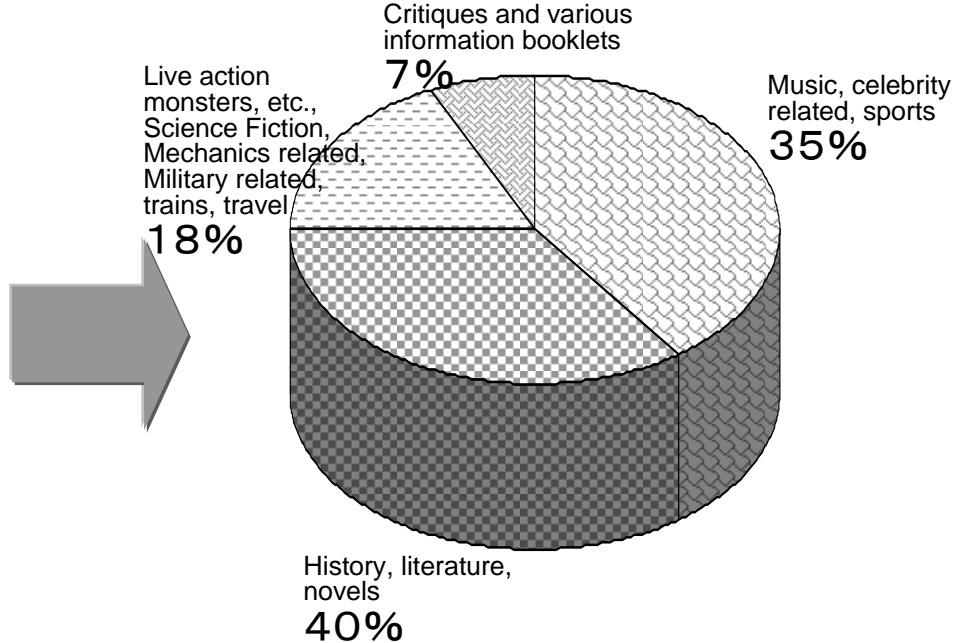

Since many manga titles only gain fame following its adaptation into the animated medium, the manga genre is actually larger.

Chapter Four

Comic Market Ideals and Its Present Shape



Comic Market Preparations Committee Organization

Total staff numbers: roughly 2400 (all volunteers.)

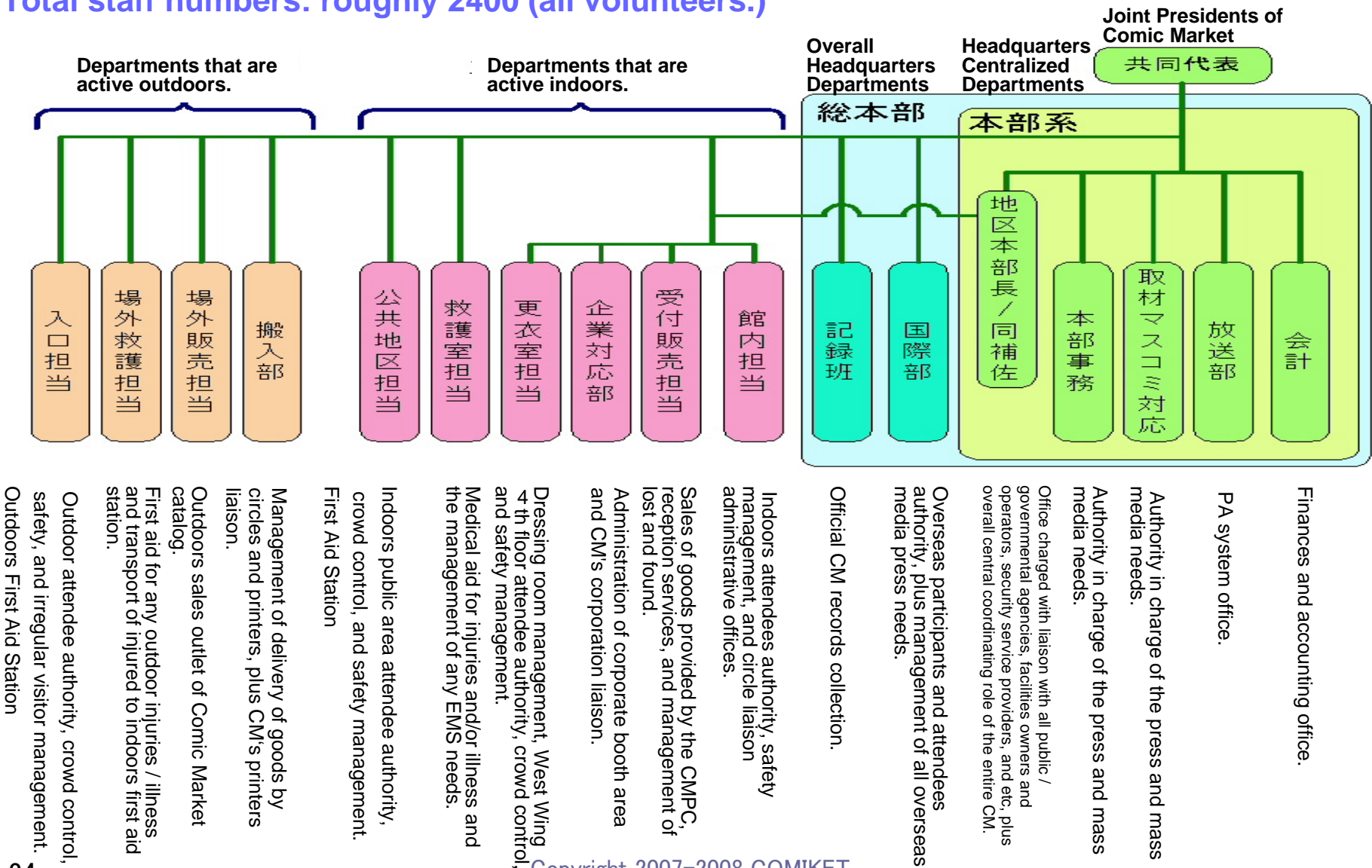

Finances and accounting office.

PA system office.

Authority in charge of the press and mass media needs.

Authority in charge of the press and mass media needs.

Office charged with liaison with all public / governmental agencies, facilities owners and operators, security service providers, and etc, plus overall central coordinating role of the entire CM.

Overseas participants and attendees authority, plus management of all overseas media press needs.

Official CM records collection.

Indoors attendees authority, safety management, and circle liaison administrative offices.

Sales of goods provided by the CMPC, reception services, and management of lost and found.

Administration of corporate booth area and CM's corporation liaison.

Dressing room management, West Wing 4th floor attendee authority, crowd control, and safety management.

Medical aid for injuries and/or illness and the management of any EMS needs.

Indoors public area attendee authority, crowd control, and safety management. First Aid Station

Management of delivery of goods by circles and printers, plus CM's printers liaison.

Outdoors sales outlet of Comic Market catalog.

First aid for any outdoor injuries / illness and transport of injured to indoors first aid station.

Outdoor attendee authority, crowd control, safety, and irregular visitor management. Outdoors First Aid Station



Comic Market Preparations Committee and Comiket Inc.

- **The Comic Market Preparations Committee is a volunteer based organization and has no legal entity status.**

- **Comiket Inc. was formed in order to manage and facilitate activities that require the presence of a legal entity, such as negotiating with public agencies, signing contracts, maintaining an administration offices, etc. Its role is solely to support the CMPC for activities it cannot conduct on its own.**
 - > Incorporated in 1985, and changed to its present form in 1996.
 - > Personal information management scheme:
 - * **Personal information administration enterprise: Comiket Inc.**
 - * **Co-user of collected information: Comic Market Preparations Committee.**
 - * **Data access control and supervision authority: CMPC co-presidents.**

 - > **Comiket Inc. also operates the subculture and cult goods shop *B-Maniacs*, and the used doujinshi bookstore *Comiket Service*.**



The Space that is the Comiket

- Comic Market's self-declared proclamation (reprinted from the Comiket Manual)

- > We conceptualize doujinshi as the medium through which creators can explore and expand the realms of manga, anime, games, novels, and other related peripheral genres. This exploration may even bear fruit in other forms, not limited to doujinshis. Our aim is to maintain a space and forum at which creators can showcase these efforts to the public.
- > To encourage creative efforts that break the mold from what is established within the realms of commercial publishing and other conventional forms of self-expression, and to support those that research and celebrate this unique brand of creative efforts, we provide a distinct space upon which enthusiasts can congregate and intermingle, and hope that the space will act as a catalyst to compel further creative achievement through interaction and discovery among their peers. The goal is maintain a social forum in the shape of a doujinshi marketplace but also acts a gathering place for manga and anime enthusiasts.
- > A space where people who seek new possibilities in self-expression can find numerous such works, as well as a space where people who seek to present such works will find a willing audience.



Since the goal is to maintain this unique space and forum, **the Comic Market is committed toward attempting to accommodate every circle and people which express an interest toward participating** as best as possible within the physical constraints that limit the scope of the event.

Everybody is a participant.

- There are no "customers" at the Comic Market.
- The Comic Market is operated, maintained, and comprised by those that are participating in the event.
- **All participants are treated equal.**
- Comic Market **must remain a space where freedom of expression is maintained.** It must expend every effort toward securing as much freedom of expression as possible.
- In order to remain a space with the greatest freedoms possible, self-reliance of the participants is integral, but the event cannot function without individual moral awareness, mindfulness of manners, and invested interests toward up-keeping this shared space.

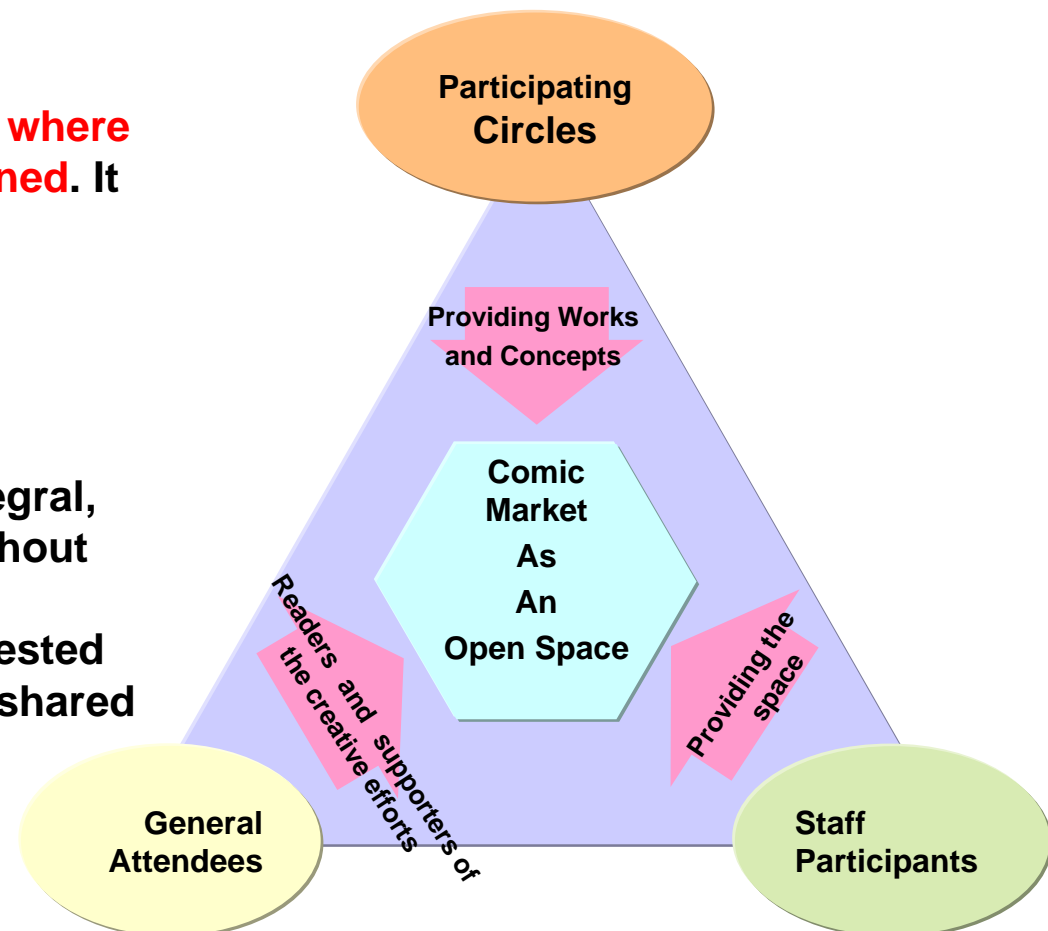



The Comic Market as a Representation of various forms of Otaku consumption

- The 2005 Nomura Research Institute study titled *Research into the Otaku Market* appears to draw heavily from the conceptualization model of the Comic Market regarding the core relationship of the market participants of the Otaku market.

➤ Nomura Research Institute's 3C Marketing Framework of the Otaku

➤ 3C is Activated with Supplementary Framework

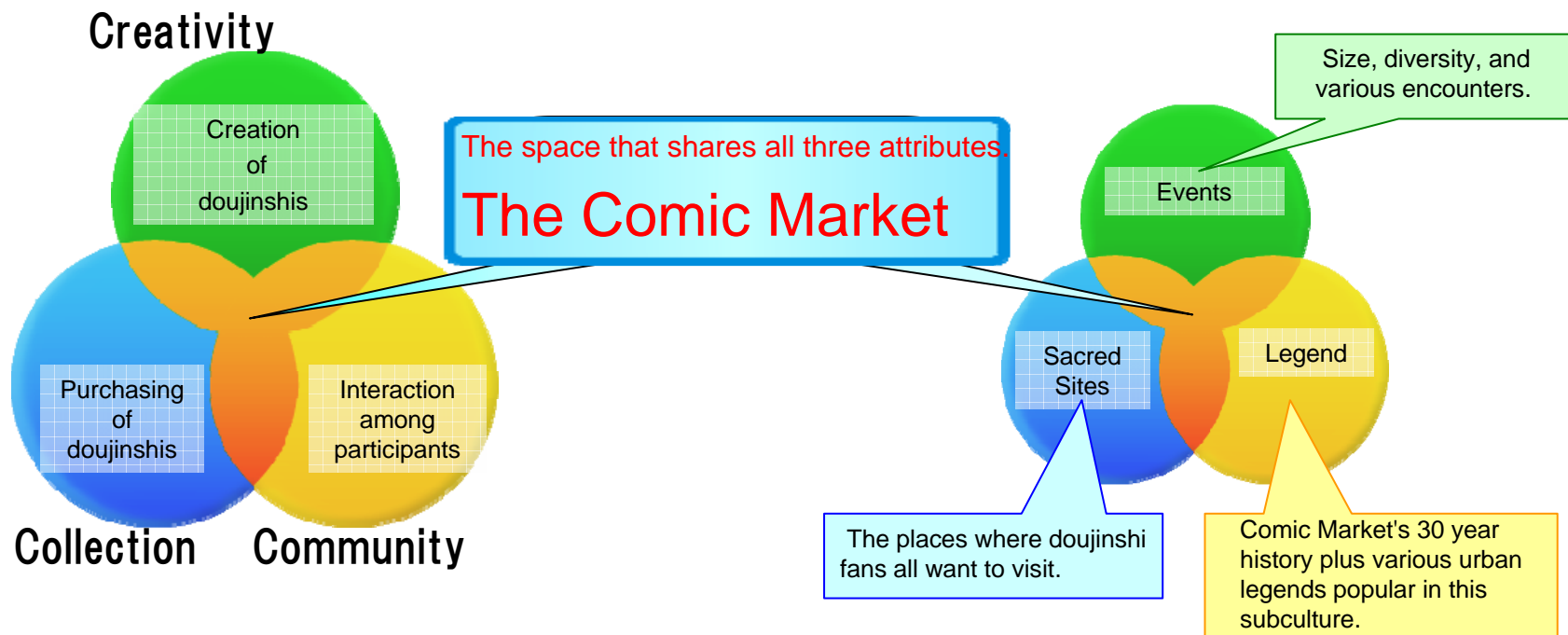



Thank you!

- This presentation includes material first presented as part of the Contents Creation Science and Industry Cooperative Education Program organized by University of Tokyo's Graduate School of Interdisciplinary Information Studies, plus additional material incorporated as part of a presentation held at the 65th Annual World Con (46th Japan Science Fiction Convention - Nippon 2007.) Further corrections and additions were added since these presentations took place.

- **Photography:**
 - > **Kaichiro Morikawa**
 - > **Comic Market Preparations Committee Records Office Group**
 - > **Kyoshin Printing Inc., and Others.**

- **English Translation :**
 - > **Dan Kanemitsu**

- **A Special Thanks to:**
 - > **Masataka Yoshida**
(Project Lecturer at University of Tokyo's Graduate School of Interdisciplinary Information Studies)
 - > **Tokyo Big Sight**