

# Landslides in the Vancouver-Fraser Valley-Whistler region

S.G. Evans<sup>1</sup> and K.W. Savigny<sup>2</sup>

*Evans, S.G. and Savigny, K.W., 1994: Landslides in the Vancouver-Fraser Valley-Whistler region; in Geology and Geological Hazards of the Vancouver Region, Southwestern British Columbia, (ed.) J.W.H. Monger; Geological Survey of Canada, Bulletin 481, p. 251-286.*

---

**Abstract:** A great diversity of landslide types occur in the Vancouver region in response to high relief, steep slopes, heavy rainfall, seismicity, and a variety of landslide-prone materials. Rockfalls and small rock avalanches (less than a million cubic metres) are a significant hazard to land use development but their biggest impact has been on the transportation network and the Fraser River fishery. The deposits of larger rock avalanches (greater than a million cubic metres) are common throughout the region and have occurred along major transportation routes in the Fraser Valley and the Squamish-Pemberton corridor in the last 10 000 years. Noncatastrophic mountain slope deformation is also widespread. Such processes form linear topographic features such as cracks and fissures. Volcanic rocks of the Garibaldi Volcanic Belt are particularly prone to massive rapid landslides, some of which have blocked major rivers and formed temporary lakes upstream. Since the late Pleistocene, major collapses have taken place on the western flanks of Mount Garibaldi and Mount Cayley volcanoes. Large landslides continue to occur in the historical period and are a major consideration in land development in the Belt. Channellized debris flows within steep mountain watersheds triggered by heavy rains occur throughout the region. Debris flow defensive structures have been constructed by provincial authorities at numerous locations to protect transportation routes and/or communities. Landslides in Pleistocene sediments are also important. In addition, a number of cases of catastrophic seepage erosion have been documented. Submarine failures (outside the Fraser Delta) occur on delta fronts in both marine and lacustrine environments. The expansion of development in the Vancouver region is increasing the vulnerability of communities, transportation routes, and the resource base to landslides.

**Résumé :** Une grande variété de glissements de terrain se produisent dans la région de Vancouver en réponse au relief prononcé, aux fortes pentes, à l'abondance des précipitations, à la sismicité et à la présence de divers matériaux susceptibles de glisser. Les écroulements et les petites avalanches de pierres (moins d'un million de mètres cubes) constituent un danger significatif pour la mise en valeur et l'exploitation des terres, mais leur plus forte incidence a eu lieu sur le réseau de transport et les pêches du fleuve Fraser. Les grandes avalanches de pierres (plus d'un million de mètres cubes) sont survenues le long des grandes voies de transport dans la vallée du Fraser et du couloir de Squamish-Pemberton au cours des 10 000 dernières années; leurs dépôts sont communs dans toute la région. Les déformations non catastrophiques de versants montagneux sont également répandues. Ces processus créent des détails topographiques linéaires tels que des fentes et des fissures. Les roches volcaniques de la ceinture volcanique de Garibaldi sont particulièrement susceptibles de glissements de terrain rapides et massifs, dont certains ont obstrué de grands cours d'eau et donné naissance à des lacs temporaires, en amont. Depuis le Pléistocène tardif, de grands effondrements se sont produits sur les flancs occidentaux des monts Garibaldi et Cayley. De grands glissements de terrain ont continué à se produire pendant la période historique et sont un important facteur à considérer en ce qui concerne l'utilisation des terres dans la ceinture volcanique de Garibaldi. Des coulées de débris, qui sont canalisées dans des bassins hydrographiques de régions montagneuses escarpées et déclenchées par des précipitations abondantes, ont lieu dans toute la région. Les autorités provinciales ont

---

<sup>1</sup> Terrain Sciences Division, Geological Survey of Canada, 601 Booth Street, Ottawa, Ontario K1A 0E8

<sup>2</sup> Department of Geological Sciences, University of British Columbia, 6339 Stores Road, Vancouver, British Columbia V6T 1Z4

construit des structures en de nombreux endroits pour protéger les voies de transport ou les collectivités contre les coulées de débris. Les glissements de terrain survenant dans les sédiments pléistocènes sont également importants. En outre, de nombreux cas d'érosion catastrophique causée par des infiltrations ont été documentés. Des effondrements sous-marins (à l'extérieur du delta du Fraser) se produisent sur des fronts deltaïques marins et lacustres. L'intensification du développement de la région de Vancouver accroît la vulnérabilité des collectivités, des voies de transport et de la base de ressources aux glissements de terrain.

## **INTRODUCTION**

The Vancouver region (Fig. 1) is situated in the southwest corner of the Canadian Cordillera where a wide variety of landslides styles and processes have been described (Eisbacher, 1979; Eisbacher and Clague, 1984; Evans, 1982, 1984, 1990a, 1992a; Cruden, 1985; Cruden et al., 1989; Evans and Gardner, 1989; Clague, 1991; Clague and Evans, 1994b; Evans and Clague, unpublished data). Evidence for landslide activity in the prehistoric past is seen in the widespread distribution of landslide deposits throughout the region, and in the historical period (taken to be 1855 to the present), in frequent landslide events as documented by Evans and Clague (unpublished data).

The interaction between high relief, steep slopes, heavy rainfall, seismicity, a complex active tectonic history, and landslide-prone materials in the region, gives rise to a great diversity of landslide types, each with particular geotechnical characteristics, geological causes, and dynamic behaviour. This presents a considerable challenge to geoscientists who face the task of assessing the hazards posed by landslides (e.g., Eisbacher, 1982; Evans and Gardner, 1989; Morgan, 1986, 1992; Morgan et al., 1992; Hungr et al., 1993; Fell, 1994), to civil engineers in their design of engineering works to mitigate landslide hazards (e.g., Hungr et al., 1984, 1987; Hungr, 1993; Martin et al., 1984; Moore et al., 1992), and to landuse planners and legislators who face the task of regulating development in response to these hazards assessments (e.g., Lister, 1980; Cave, 1992a, b; Berger, 1973; Buchanan, 1983). Geological hazards are one of the many challenges presented by the physical environment to living in or near the mountains (Spearing, 1976).

The Vancouver region has inherent strategic importance as the gateway to transcontinental transportation corridors. In the past, landslides have had important impacts on communities, transportation routes, and on valuable forestry and fishery resources. The objective of this paper is to review the diversity of landslides that occur in the region. The review will provide background for the development of hazard mitigative strategies that increasingly have to be formulated within the context of development pressures and decreasing land availability in one of Canada's most rapidly developing regions.

## **LANDSLIDE TYPES**

A lengthy discussion of landslide types and terminology is outside the scope of this paper. A number of landslide classification schemes are in use in the geotechnical/geological

literature (e.g., Varnes, 1978; Hutchinson, 1988; Skempton and Hutchinson, 1969) and reflect, to a large extent, the regional experience of the authors. No single classification scheme has found universal application to the large variety of landslides encountered in the mountains of North America; in this paper, for example, we shall encounter especial difficulty in classifying rapid flow type movements which involve a range of materials and vary in size over several orders of magnitude.

For present purposes, landslides in rock are distinguished from those involving surficial materials. In the rock grouping those involving nonvolcanic rocks are differentiated from those involving Quaternary volcanic materials. Landslides in surficial materials include debris flows originating in colluvial and/or glacial materials in steep mountain watersheds, and landslides involving Pleistocene sediments.

An informative brochure is available describing landslide types in British Columbia (British Columbia Ministry of Energy, Mines, and Petroleum Resources, 1993).

## **ROCK SLOPE MOVEMENTS IN NONVOLCANIC ROCKS**

### *Definitions*

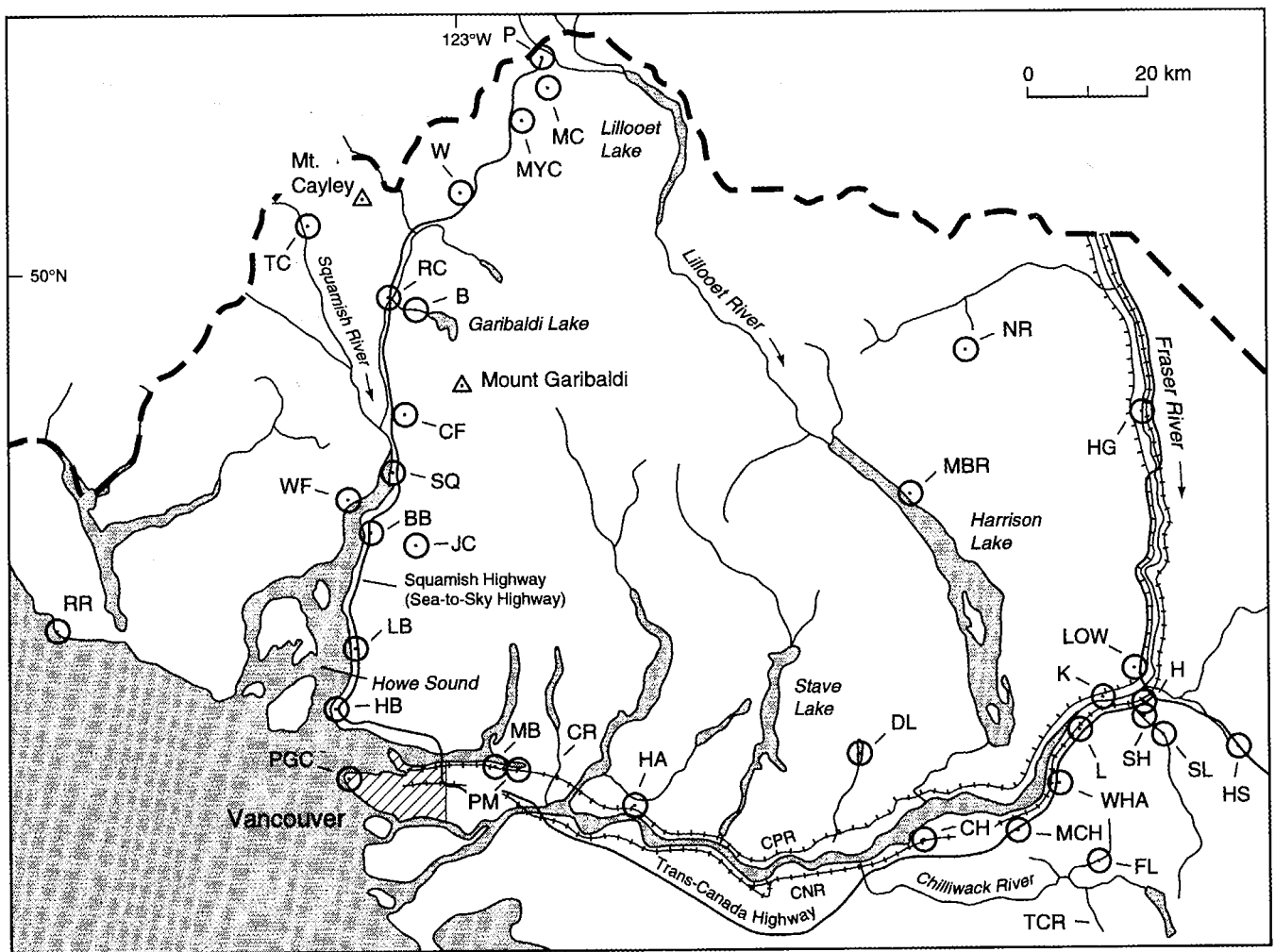
Rockfall involves the detachment of rock fragments from rock slopes and their fall and subsequent bouncing rolling, sliding, and stopping (Varnes, 1978; Hutchinson, 1988; Evans and Hungr, 1993). It may also begin by the detachment of a more or less coherent block that then disintegrates during the course of downslope movement. Rockfalls may be transitional to rock avalanches. A rock avalanche involves a very rapid downslope movement of fragments of bedrock that have become shattered and pulverized during travel which typically results from a rockfall or rockslide in mountainous terrain. It is distinguished from a rockslide by the fact that all of the debris leaves the sliding surface and travels down the valley side, generally to the valley floor, and sometimes along the valley. Rock avalanches with volumes above about one million cubic metres generally show excessive mobility and travel long distances; those with volumes below this threshold behave similarly to rockfalls (e.g., Scheidegger, 1973). Rockslides involve the movement of a rockmass on a defined shear surface or shear surfaces; most of the debris remains in contact with the sliding surface but disruption of the moved mass is considerable. Rockslides are transitional to the complex movement mechanisms associated with mountain slope deformation where discrete sliding surfaces may not be formed and the degree of disruption of the rock mass may be minimal.

## Rockfall

Rockfall is a common process in the mountainous terrain of the Vancouver region, where its continued occurrence has formed talus slopes, and it is also common on rock slopes adjacent to linear transportation facilities. Although, as described by Evans and Hungr (1993), rockfall hazards have affected land-use development at the base of talus slopes, as in the example of Silverhope (Fig. 1), the main impact of rockfall in the Vancouver region has been on transportation routes (Hungr and Evans, 1988, 1989; Peckover and Kerr, 1977; Piteau and Peckover, 1978; Theodore, 1986; VanDine, 1992) and on the fisheries resource of the Fraser River (Evans, 1986).

## Howe Sound

Rockfalls are common along the Squamish Highway (also known as the Sea-to-Sky Highway) and the adjacent B.C. Rail track along the east side of Howe Sound (Nasmith, 1972; Moore, 1983; Hungr and Skermer, 1992; Fig. 1) where they have frequently caused road and rail traffic interruptions for example, a rockfall in October 1990, near Loggers Creek (Fig. 2) involved 10 000 m<sup>3</sup> of debris and blocked the highway for 12 days thus severing the road link between the communities in the Squamish-Pemberton corridor and Vancouver. The cost of the rockfall, involving repairs and the construction of preventative structures, was approximately \$7 million (British Columbia Ministry of Energy, Mines, and Petroleum Resources, 1993). In addition, in response to this event, the



**Figure 1.** Location map of region showing localities discussed in text. Key: B = The Barrier, BB = Britannia Beach, CF = Cheekye Fan, CH = Chilliwack, CR = Coquitlam River, DL = Dickson Lake, FL = Foley Lake, H = Hope, HA = Haney, HB = Horseshoe Bay, HG = Hell's Gate, HS = Hope Slide, JC = Jane Camp (former site of), K = Katz slide(s), L = Laidlaw, LB = Lions Bay, LOW = Lake of the Woods (also known as Schkam Lake), MB = Mount Burnaby, MBR = Mount Breakenridge, MC = Mount Currie, MCH = Mount Cheam slide(s), MYC = Mystery Creek, NR = Nahatlatch River, P = Pemberton, PGC = Point Grey Cliffs, PM = Port Moody, RC = Rubble Creek, RR = Redroofs escarpment, SH = Silverhope, SL = Silver Lake, SQ = Squamish, TC = Turbid Creek, TCR = Tamih Creek, W = Whistler, WF = Woodfibre, WHA = Whaleach Power Station; dashed line represents boundary of study area.

provincial government constructed an emergency ferry terminal to be used should the highway be blocked by a similar landslide in the future.

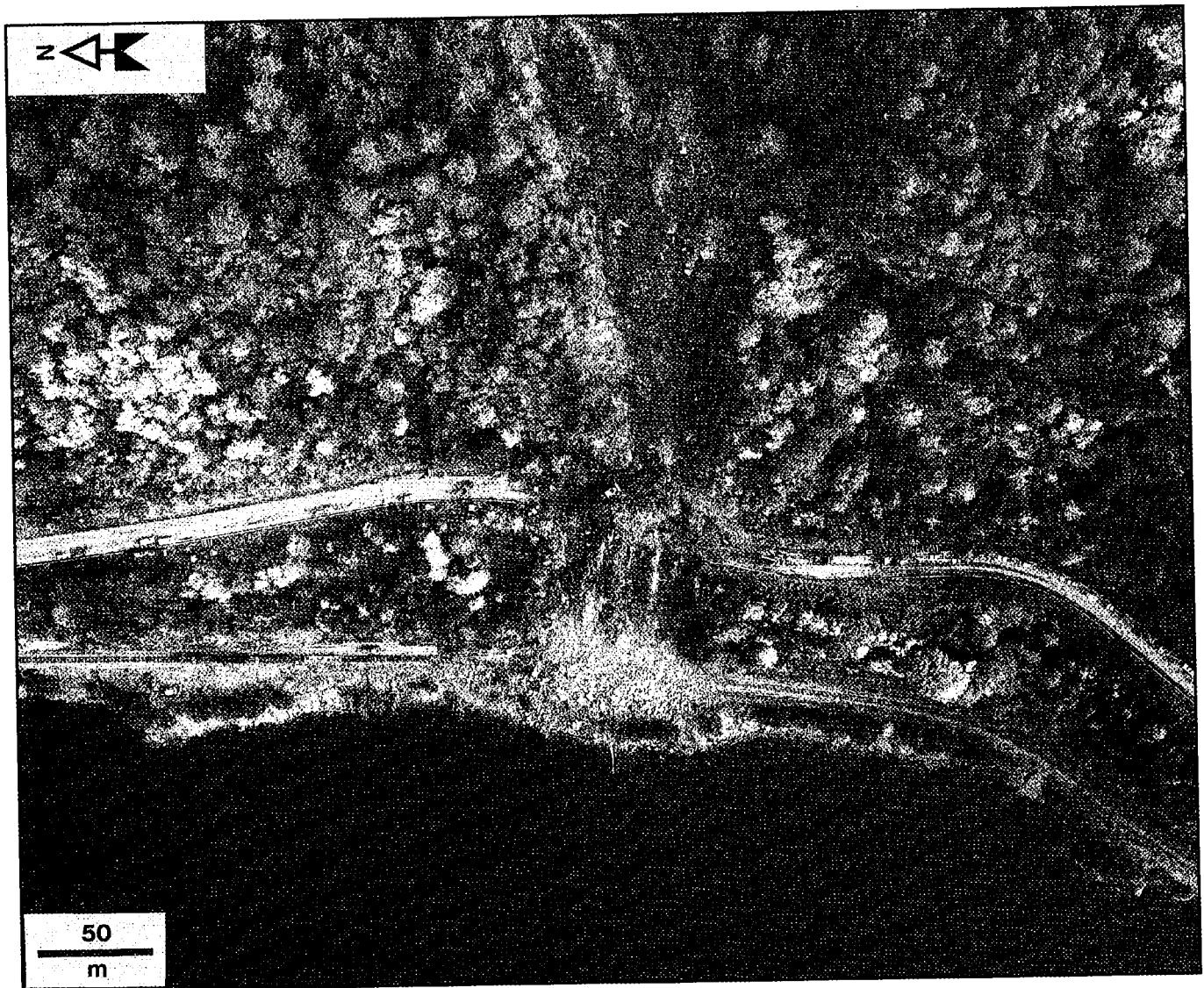
Rockfalls have resulted in the deaths of several motorists on the Squamish Highway since 1969. One such rockfall accident occurred in January 1982 when a single block fell off a rock face above the highway and killed a passenger in a car. The trajectory was analyzed (Fig. 3) by Hungr and Evans (1988) who calculated that the boulder had an impact velocity of  $28 \text{ m}\cdot\text{s}^{-1}$ .

### Fraser Canyon

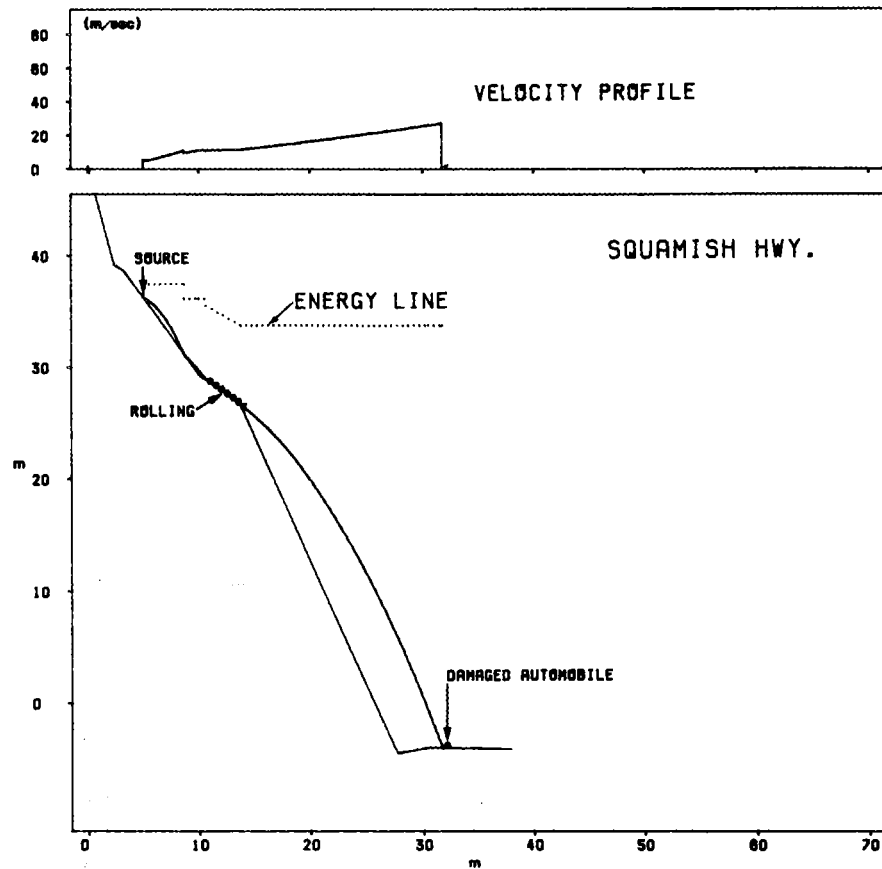
Rockfalls are also common in the Fraser Canyon (Peckover and Kerr, 1977; Piteau, 1977) and have impacted upon the Trans-Canada Highway and both intercontinental railway lines,

Canadian Pacific Railway (CPR) and Canadian National Railway (CNR) (Fig. 4, 5), causing traffic delays, derailments, and numerous deaths. Since the 1960s, the B.C. Highways Department and both railway companies have spent many millions of dollars to mitigate the rockfall hazard, either by rock slope treatment (e.g., scaling, rock bolts, shotcrete, buttresses, and drainage) or the construction of protective measures such as sheds, catch fences, meshes, ditches, and warning devices (Peckover and Kerr, 1977; Wyllie, 1991).

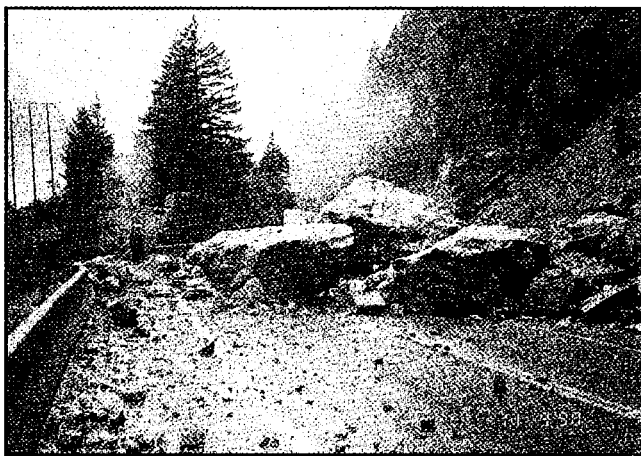
Data provided in Theodore (1986) shows that the Mountain Region of Canadian National Railways spent almost \$2 000 000 per year between 1971 and 1986 on rock slope stabilization work, mostly between Hope and Kamloops. Since the inception of a major rockfall protection program in 1971 the number of derailments has been substantially reduced despite a significant increase in traffic densities.



*Figure 2. Aerial photograph of rockfall which covered the Sea-to-Sky Highway and B.C. Rail tracks, 4 km north of Lions Bay, October 1990 (Photo courtesy of Selkirk Remote Sensing, Richmond, British Columbia; negative number SRS 4466-5).*

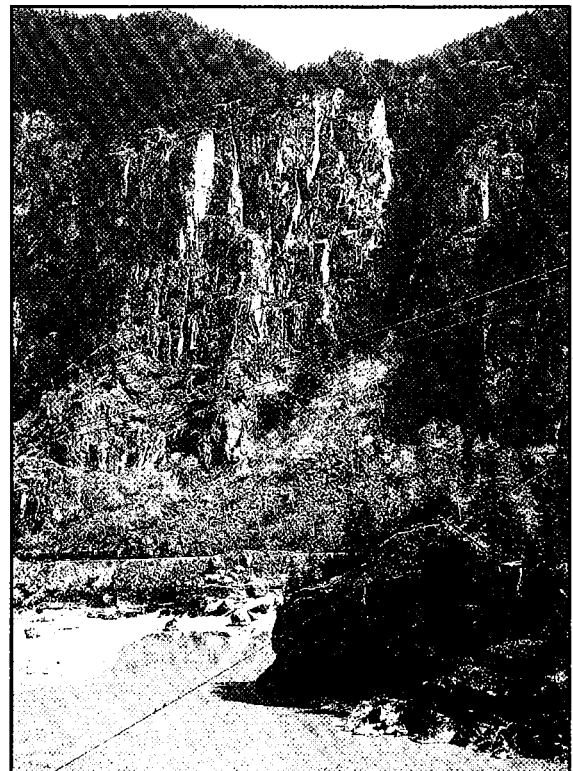


*Figure 3. Simulated trajectory of a single boulder which caused the 1982 rockfall accident on Sea-to-Sky Highway, 22 km north of Horseshoe Bay (from Hungr and Evans, 1988).*



*Figure 4. Rockfall on Trans-Canada Highway, Fraser Canyon, near Yale (courtesy of D. Wyllie).*

*Figure 5. Typical steep jointed rockslope in the Fraser Canyon, which is subject to rockfall. Canadian National Railway tracks run across the base of the slope which is located just south of Siwash Creek. GSC 1994-709A*



Rockfall frequency shows a marked correlation with the weather (Peckover and Kerr, 1977; Fig. 6). Figure 6 shows data for rockfall frequency on Canadian National Railway tracks in the Fraser Canyon. The highest frequency is found in January, February, and March, the time when freeze-thaw cycles are most frequent, thus reflecting the role of frost wedging in rockfall release. When the mean monthly temperature is above zero (March-November), the number of rockfalls per month varies more or less directly in proportion to mean monthly precipitation (Peckover and Kerr, 1977).

A rockfall (estimated volume 75 000 m<sup>3</sup>) at Hell's Gate in the Fraser Canyon (Fig. 1), caused by railway construction activity in 1914, had a major impact on the Fraser River salmon fishery from which it has not yet recovered (International Pacific Salmon Fisheries Commission, 1980; Evans, 1986). The debris greatly increased an obstruction that had been initiated by previous railway construction activity in 1913 and prevented many migrating salmon from returning to their spawning grounds in the vast Fraser watershed, covering about a quarter of the province of British Columbia, above Hell's Gate. The rockfall has had a major impact upon salmon returns in subsequent years; in 1978 dollars and landed values, the loss to sockeye fishery alone, resulting from a diminished return in 1914, amounted to \$1.7 billion between

1951 and 1978 (International Pacific Salmon Fisheries Commission, 1980). Fishways were constructed between 1944 and 1966 (Fig. 7), at a cost of \$1.36 million, to provide passage for the salmon past the obstruction in an attempt to restore the sockeye and pink salmon runs to their historical abundance.

Rockfall is not confined to steep mountain slopes in the Vancouver region. It may also occur on steep, rocky, coastal cliffs such as along the Stanley Park seawall from Prospect Point to Siwash Rock (Armstrong, 1984).

**Small rock avalanches (less than one million cubic metres)**

Rock avalanches of less than one million cubic metres are common in the Vancouver region (Fig. 8). In 1915, a rock avalanche involving about 100 000 m<sup>3</sup>, killed 56 people at Jane Camp (Fig. 9), a mining community in the Britannia Creek watershed (Evans and Clague, unpublished data). Although this event is Canada's second largest landslide disaster (after the 1903 Frank slide) little is known about the rock avalanche, except that cracks were inspected above Jane Camp several days before the landslide took place but the danger was not realized (Ramsey, 1967).

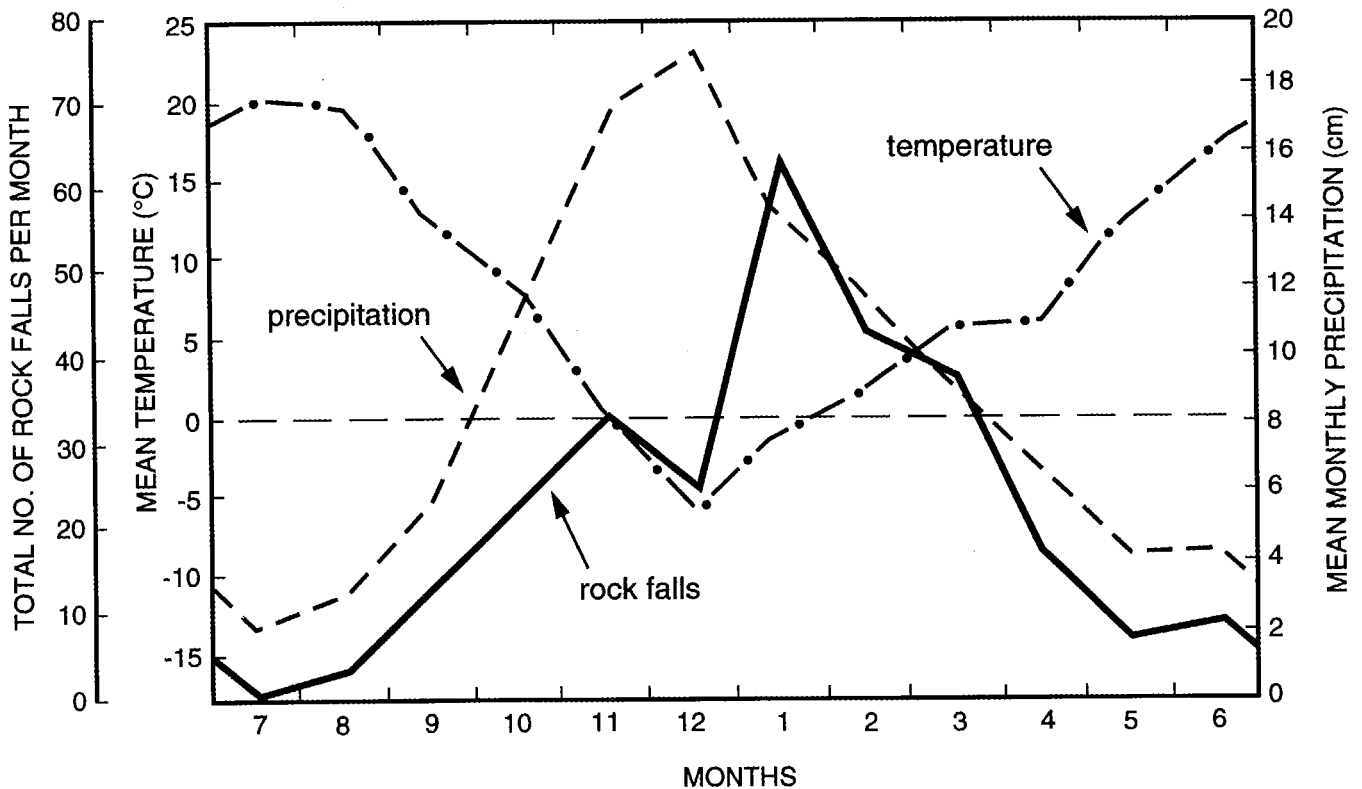


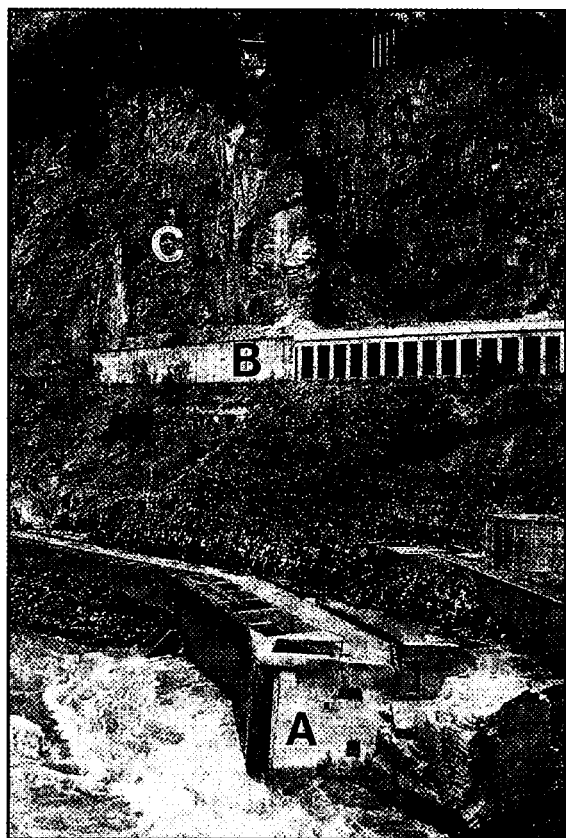
Figure 6. Rockfall frequency and weather over the period 1933-1970, Fraser Canyon, Yale subdivision, Canadian National Railway (modified from Peckover and Kerr, 1977).

**Large rock avalanches (greater than one million cubic metres)**

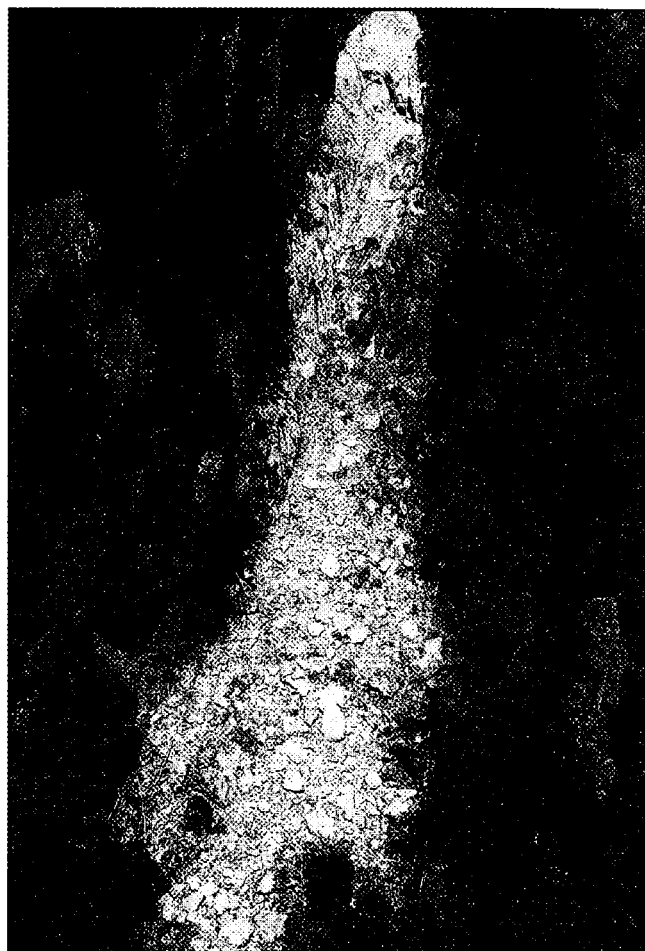
Rock avalanches are relatively common in certain geomorphic and geological environments in British Columbia (e.g., Clague and Evans, 1987; Cruden, 1985; Cruden et al., 1989; Eisbacher, 1979; Evans, 1984, 1988, 1989a, b, c, 1990a; Evans and Clague, 1988; Evans and Gardner, 1989; Evans et al., 1989).

A complex set of structural factors, detachment mechanisms, and triggers leads to the occurrence of a rock avalanche. Detachment is favoured on steep rock slopes where planar structural elements, such as joints, bedding planes, and foliation, combine to form a detachment surface that may consist of a single surface (as in rock avalanches involving dipping sedimentary rocks of the eastern part of the Cordillera) or multiple surfaces (which are typical of the rock avalanches found in the plutonic and metamorphic rocks of the Coast and Cascade Mountains) that result in more complex movement mechanisms.

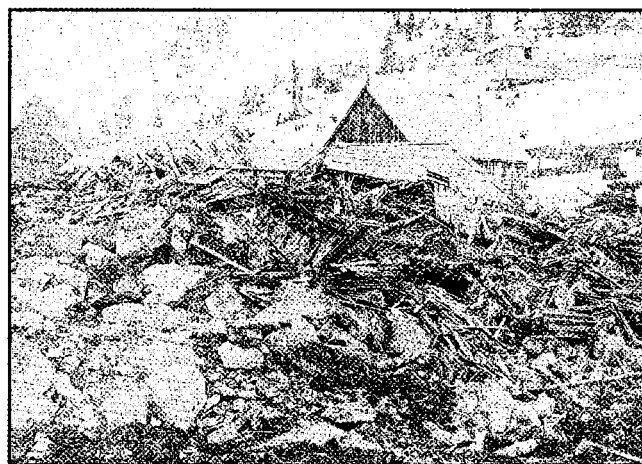
Four rock avalanches, which have occurred in major modern transportation corridors, and that are illustrative of the scale and nature of this landslide type in the Vancouver region, are described below.



**Figure 7.** View of Hell's Gate fishways, A) looking upstream from the west bank of the Fraser River in 1985. Note Canadian National Railway rockfall protection structure, B) and steep jointed rock slope of Fraser Canyon wall above C) source of 1914 rockfall. GSC 1994-709B



**Figure 8.** Typical small rock avalanche (estimated volume 20 000 m<sup>3</sup>) in jointed plutonic rock, north side of Fraser Valley, 2 km northwest of Hope. GSC 1994-492G



**Figure 9.** Destroyed buildings and rock debris at Jane Camp, Britannia mine, following the 1915 rock avalanche which resulted in 56 deaths. The Jane Camp tragedy is Canada's second largest landslide disaster, after the 1903 Frank Slide (photo by British Columbia Museum of Mining).



## Hope Slide

The 1965 Hope Slide (Fig. 1, 10) is the largest historical rock avalanche known to have occurred in Canada. It involved 48 000 000 m<sup>3</sup> of rock which descended the southwestern slope of Johnson Peak in two phases separated by about 3 hours. The landslide inundated several kilometres of the Hope-Princeton transportation corridor (Fig. 10), burying three vehicles and claiming four lives.

As noted by G.M. Dawson, the first Geological Survey of Canada geologist in the region (Dawson, 1879), Johnson Peak was the site of a prehistoric rock avalanche. A radiocarbon date obtained from organic material found beneath the debris yielded a radiocarbon age of 9680 ± 320 BP (GSC-1433) (Mathews and McTaggart, 1978), representing a minimum age for the landslide, which was of comparable size to the 1965 events. The 1965 events deepened the prehistoric slide surface and extended the headscarp almost to the top of the ridge. The rock avalanche developed mainly in greenstone belonging to the Hozameen Complex of Permian to Jurassic age. Felsite intrusions occur as sheets within the greenstone that dip toward the valley; some of these made up part of the sliding surface (Mathews and McTaggart, 1978; Von Sacken, 1991). Contacts between the felsite and the greenstone are sharp and are commonly marked by a weathered clay gouge.

As documented by Von Sacken (1991), the 1965 failure occurred on multiple discontinuity surfaces that dip toward the valley bottom at variable angles. The failure surface in the lower portion of the slope was controlled largely by felsite sheets (Fig. 11A) whereas steeply dipping intersecting joints controlled the upper portion (Fig. 11B).

The 1965 event was proposed by Mathews and McTaggart (1978) to have been triggered by two small earthquakes recorded at approximately the same time as the landslide in the pre-dawn hours of January 9. The possibility of a seismic trigger was further investigated by Wetmiller and Evans (1989) who re-examined the seismic records associated with the landslide. Their attempt to demonstrate an indisputable seismic trigger for the Hope slide was inconclusive. A re-analysis of the 1965 Hope Slide by Weichert et al. (1990, in press), in the light of the seismic signatures generated by the collapse of an open pit mine slope in the interior of British Columbia in 1990, however, suggests that the "earthquakes" associated with the landslide may have been generated by two phases of the landslide itself. Von Sacken (1991) and Von Sacken et al. (1992) found field evidence to support the two slide scenario. It is thought that the debutting of the upper slope by the first slide event, as a result of failure along felsite sheets in the lower part of the slope, led to the second event a few hours later. This scenario eliminates an obvious trigger for the Hope slide.

Analysis has shown that the prefailure slope was in a stage of limiting equilibrium before the 1965 slide (Bruce and Cruden, 1977; Wetmiller and Evans, 1989; Von Sacken, 1991) yet it had withstood substantial seismic accelerations in the past including the M = 7.4 North Cascades earthquake of 1872 (Wetmiller and Evans, 1989). It is not clear how the slope that failed in 1965 withstood such forces since, according to

slope stability analysis (Wetmiller and Evans, 1989; Von Sacken, 1991), modest seismic forces should have been high enough to result in detachment.

## Katz slides

The Katz slide is located on the north side of the Fraser Valley between Hope and Chilliwack (Fig. 1). Linear facilities occupying this section of the Fraser Valley transportation corridor include Canadian National and Canadian Pacific rail lines, the Trans-Canada Highway, trunk gas and oil pipelines owned by Trans Mountain Pipe Line Company Ltd. and Westcoast Energy Inc., respectively, the B.C. Tel fibre optics telecommunications line and several B.C. Hydro power grids; severance of these lines by a modern Katz slide would have a major impact on Vancouver and the Lower Mainland. As indicated on Figure 12, the corridor has been partially inundated by two prehistoric rock avalanche events. These have not been studied in detail. The following description is taken from preliminary accounts by Naumann (1990) and Savigny and Clague (1992).

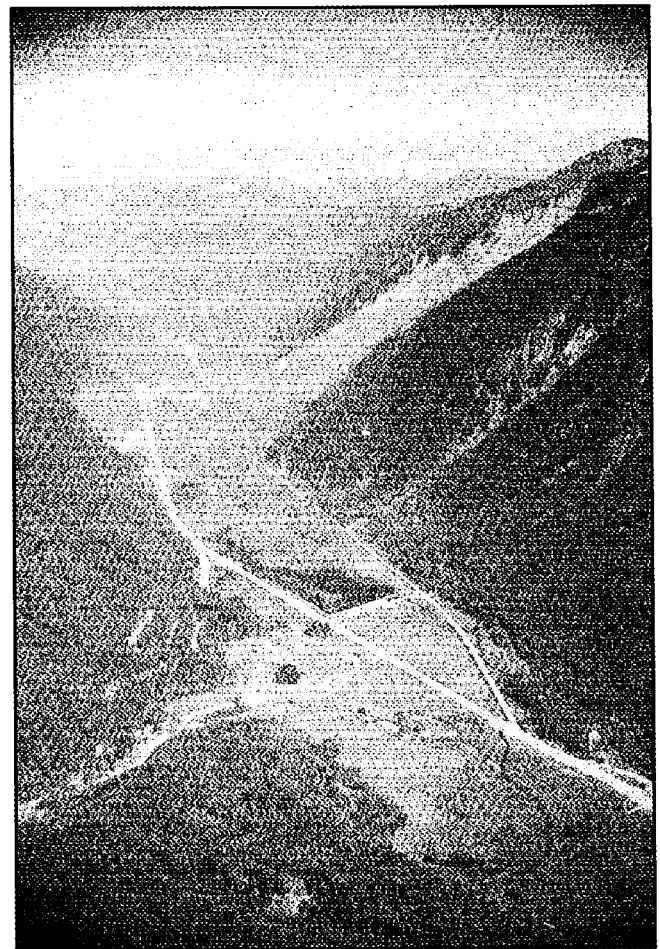


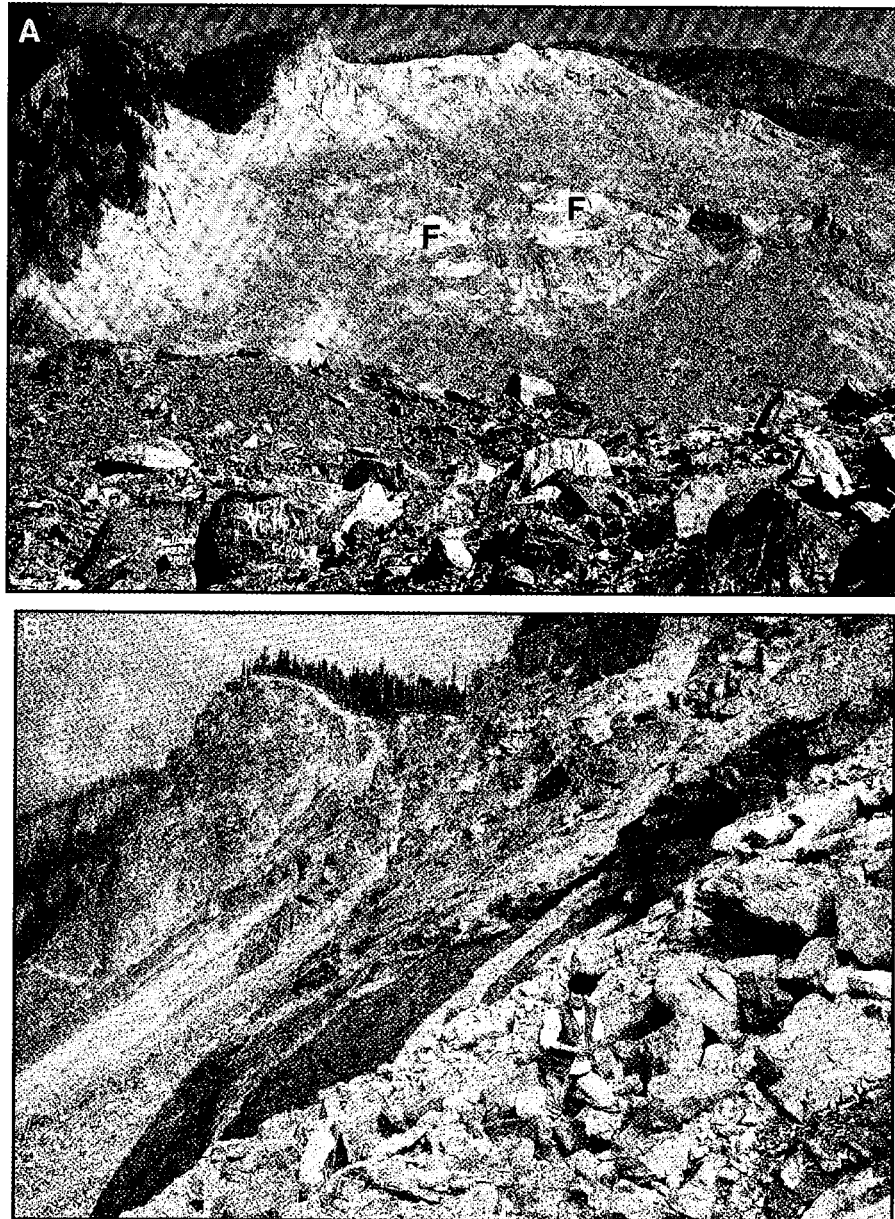
Figure 10. Oblique aerial photo of 1965 Hope Slide; view to northwest. (Photo by K.W. Savigny).



The exposed slide debris consist mainly of quartz diorite belonging to the Spuzzum Pluton. A fault, possibly an extension of the northeast-trending Vedder Fault, passes through the headscarp area. A large graben, approximately 120 m wide and at least 35 to 45 m deep, has formed along the fault trend and appears to result from slope distress on the southeast-facing flank of an unnamed mountain overlooking the Fraser River valley. The failure surface appears to be an exfoliation plane.

Katz slide is believed to have occurred as at least two rock avalanches separated by a period of hundreds to thousands of years (Savigny, in press). The first extended across the Fraser Lowland (Fig. 12 and 13) probably blocking the Fraser River,

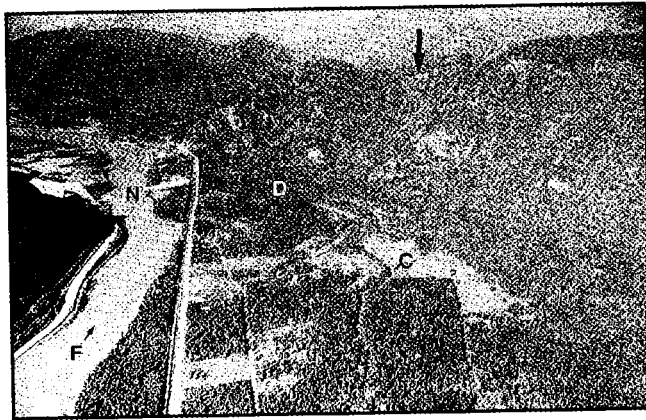
forming a landslide dam and creating a small lake. No volume estimate has been made of the debris because a fan delta quickly prograded through the lake covering all but the largest blocks of the debris. At the time of the second rock avalanche, broad, shallow channels carried flow of the Fraser River along the northwest (right) and southeast (left) sides of the valley (Fig. 12). The second event extended about half way across the valley blocking the northwest channels and diverting all flow to the southeast side (Fig. 13). Debris from the second event covers an area of 1.1 km<sup>2</sup> and has a volume of 15 000 000 m<sup>3</sup>. An organic sample from one of the abandoned northwest channel-fill sequences yielded a maximum radiocarbon age for the second rock avalanche of 3260 ± 70 BP (SFU W-02).



**Figure 11.** A) 1965 Hope Slide sliding surface and debris; felsite sheets (F) in lower part of the slope. GSC 1994-738 B) Sliding surface in upper part of the slope. Note steep irregular surfaces in greenstone. GSC 1992-114B

**Cheam slides**

Cheam slide is a prehistoric rock avalanche complex located on the southeast side of the Fraser River valley 20 km east of Chilliwack (Fig. 1 and 14). The landslide debris forms a hummocky surface which contrasts sharply with the surrounding flat Fraser Lowlands and the adjacent steep slopes of the North Cascade Mountains. The landslide was first examined by Smith (1971); the debris was mapped by Armstrong (1980) as a slope deposit. Naumann (1990) undertook a detailed assessment of both the source and deposition areas and Naumann and Savigny (1992) reported a detailed numerical analysis.

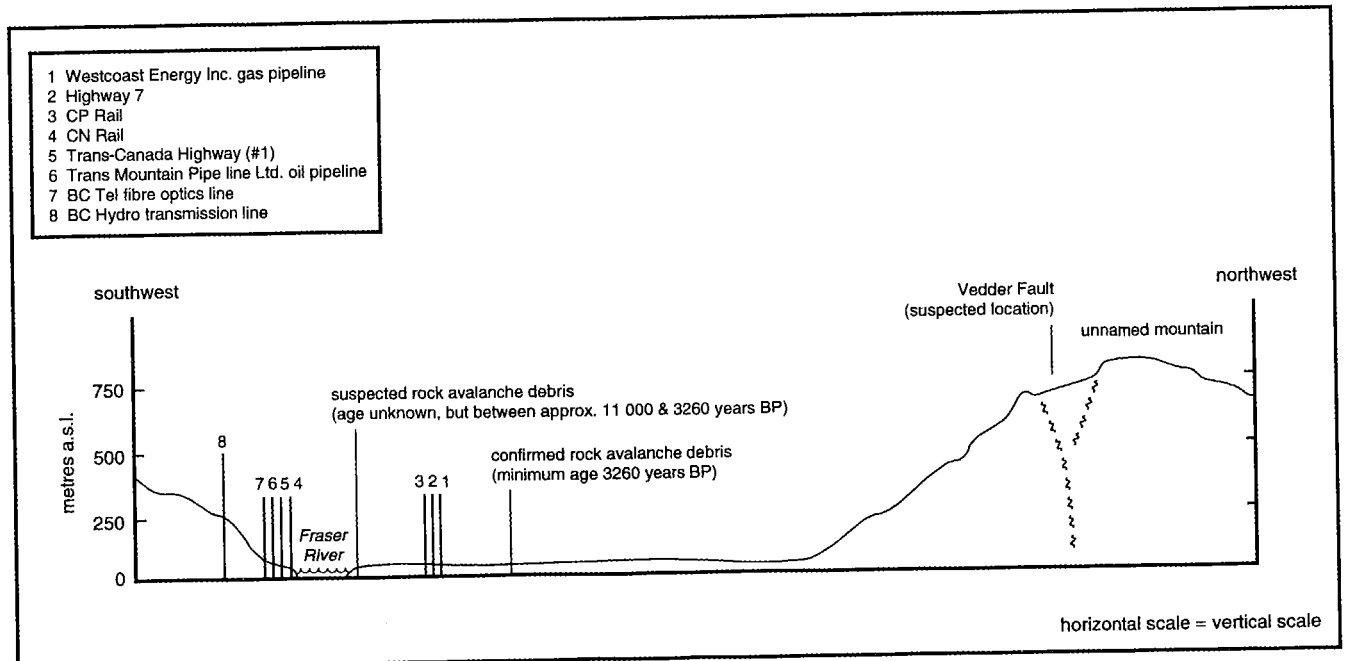


**Figure 12.** Oblique aerial view of Katz rock avalanche(s) looking southwest in the downstream direction of the Fraser River (F). The source area of the rock avalanche(s) is indicated with a vertical arrow. The debris in the Fraser Valley (D) blocked a channel of the Fraser River (C) and results in a constriction of the present Fraser River channel at point "N". (Photo by K.W. Savigny)

The rock avalanche is believed to have begun as a large asymmetric wedge on an unnamed mountain immediately southwest of Mt. Cheam; a northeast-dipping thrust fault and a steeper, southeast-trending, southwest-dipping joint set may constitute the two slide surfaces in Devonian to Permian Chilliwack Group rocks which consist of volcanic arenites, argillites, and cherty or argillaceous limestones (Naumann, 1990; Naumann and Savigny, 1992). The intersection of these surfaces outcrops in the slope approximately 400 m above the Fraser Lowlands. The source area volume is estimated to be 150 000 000 m<sup>3</sup> (Naumann, 1990). The volume of debris is barely one-third of this, a discrepancy which remains unexplained. The debris shows evidence of multiple events, possibly involving failure onto Late Wisconsinan ice. The debris contains fragments of trees; radiocarbon ages from these wood fragments range between 4350 ± 70 BP (SFU-W-04) and 5010 ± 70 BP (GSC-4004, collected by J.J. Clague) indicating a mid-Holocene age for the events.

**Mystery Creek**

The Mystery Creek rock avalanche (Fig. 1, 15; estimated volume 40 000 000 m<sup>3</sup>) is located 20 km north of Whistler and involved the failure of a portion of the east side of the Green River valley. The debris covers an area of 1.2 km<sup>2</sup> in the bottom of the Green River valley, and is traversed by a B.C. Hydro main transmission line and B.C. Highway 99. The landslide was first reported by Eisbacher (1983), and described briefly by Clague et al. (1987) and Evans (1992a). The rock avalanche involved the failure of a mountain slope consisting of foliated, hard intrusive rock of the Pemberton Dioritic Complex. Slopes adjacent to the scar of the rock avalanche show indications of mountain slope deformation (Fig. 15).



**Figure 13.** Profile of Katz rock avalanches in relation to linear infrastructural elements and the Fraser River.

A radiocarbon date from charcoal dug out from beneath a large boulder in the debris yielded a radiocarbon age of  $880 \pm 100$  BP (GSC-4237) and is thought to represent a minimum age for the landslide.

Detachment on a low angle ( $18^\circ$ ) joint surface dipping out of the slope appears to have been preceded by toppling toward the Green River valley involving flexural slip on steep foliation surfaces dipping into the slope (Evans, 1992a). Antislope scarps formed by toppling are present in displaced rock masses along the southern margin of the scar (Fig. 16). The characterization of the process by which this type of slope deformation terminates in catastrophic detachment remains a current research problem in géotechnique.

#### Other features related to rock avalanches

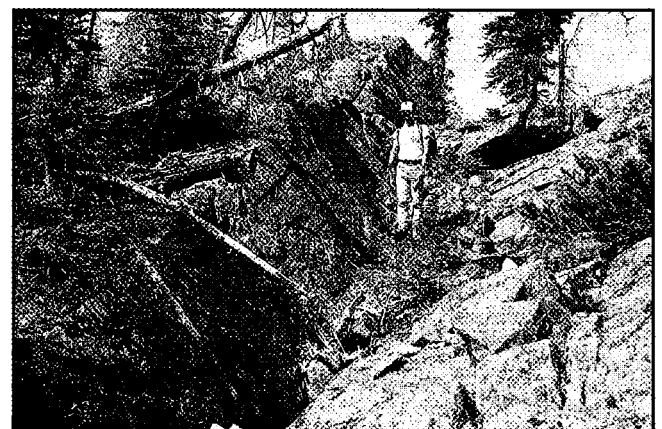
Some rock avalanches, which have occurred in similar terrain in other parts of the Coast Mountains, exhibit dramatic mobility (e.g., spectacular run-ups, marked changes in direction, and superelevation of debris in curves) and travel long



**Figure 14.** Airphoto of Cheam slide(s), Fraser Valley. Both source area (S) and extent of debris (D) have yet to be defined in detail. The debris is crossed both by the Canadian National Railway and the Trans-Canada Highway. Radiocarbon dates quoted in text were obtained from wood in debris in pit marked P. Fraser River (F) and flow direction are indicated. NAPL A27109-40



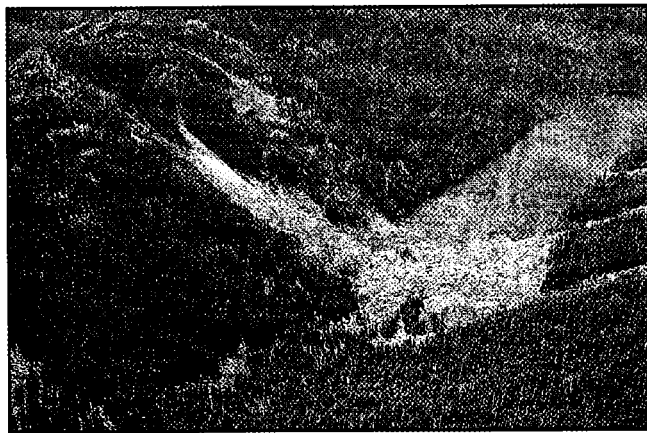
**Figure 15.** Oblique aerial view to the east of the prehistoric Mystery Creek rock avalanche, 20 km northeast of Whistler. Toppling shown in Figure 16 occurs on right hand (southern) margin of scar. GSC 204107G



**Figure 16.** Antislope scarp formed by toppling on southern margin of Mystery Creek rock avalanche. Downslope is to the left. GSC 1994-709E

distances from their source, an example being the Pandemonium Creek event (Evans et al., 1989) which occurred in 1959, 360 km northwest of Vancouver, in Tweedsmuir Provincial Park. The debris travelled up to 9 km from its source over a vertical distance of 2 km; an analysis of the event indicated that the velocity of the debris may have reached  $100 \text{ m}\cdot\text{s}^{-1}$  (Evans et al., 1989). Although this type of highly mobile rock avalanche has not been documented so far in the nonvolcanic rocks of the Vancouver region, in view of the similarity in geology and terrain, the potential for such an occurrence is thought to exist.

Rock avalanches may produce important secondary effects, including the damming of rivers and streams to form landslide dammed lakes and landslide-generated waves.



**Figure 17.** Landslide dammed lake in the Nahatlatch River watershed. The rock avalanche occurred in plutonic rocks. GSC 1992-0815

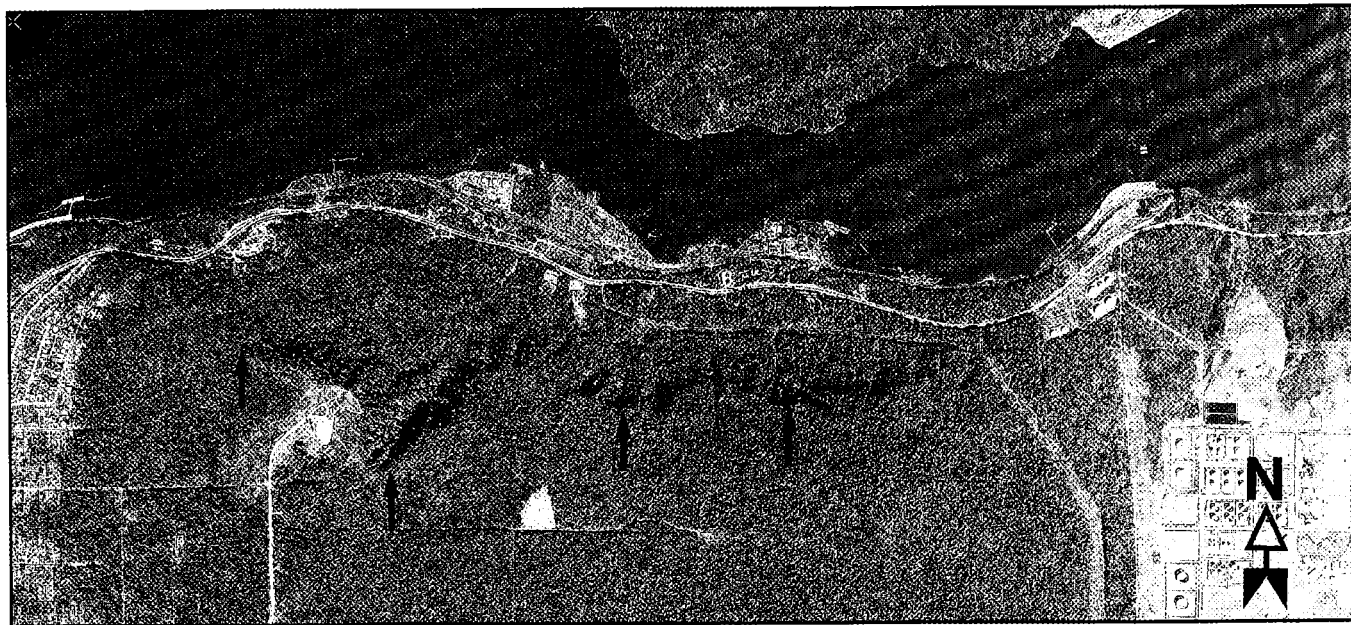
There are several lakes in the Vancouver region which are dammed by rock avalanche debris (Fig. 17; Evans, 1986; Clague and Shilts, 1993; Clague and Evans, 1994b). They include Dickson Lake, Lake of the Woods (also known as Schkam Lake), Silver Lake, and Foley Lake (Fig. 1).

Landslide-generated waves, which extend the zone of potential damage well beyond the limits of the rock avalanche debris, have not been documented in the Vancouver region but have been reported from nearby Vancouver Island (Evans, 1989b).

### ***Rockslides and mountain slope deformation***

Numerous rockslides involving noncatastrophic movement of rock masses on defined shear surfaces, and in which the debris largely remains on the sliding surface, have been mapped in the Vancouver region (e.g., Armstrong, 1984; Savigny, in press). On the north slope of Mount Burnaby for example, (Fig. 1, 18) small rockslides have developed in southerly dipping Tertiary sediments (Armstrong, 1984).

The deformation of steep mountain slopes is a common slope movement process in the Vancouver region. It is manifested in topographic features such as cracks, fissures, trenches, antislope scarps at mid- or upper slope locations, collectively known as linears, and, in some cases, bulging at lower slope locations. Frequently, these features occur without well defined headscarps, or lateral scarp or lateral shear zones suggesting that slope movement is occurring without well defined shear surfaces having been formed, unlike rockslides described above. These characteristics often lead to problems in the identification and interpretation of mountain slope deformation as the following examples illustrate.



**Figure 18.** Airphoto taken in 1959 of rockslides on north slope of Mount Burnaby. The scarps of the rockslides are indicated with arrows. NAPL A16830; 121

## Wahleach

The best documented example of mountain slope deformation in the Vancouver region is that at B.C. Hydro's Wahleach Power Station in the Fraser Valley (Moore et al., 1992; Savigny and Rinne, 1991). The Wahleach power station generates electricity by water flows from a reservoir at Wahleach Lake through a complex conduit system (Fig. 19) which consists of a 3 m diameter, 3500 m long upper tunnel, a 600 m shaft inclined at 48°, a 300 m lower tunnel, and a 485 m surface penstock to the power house located adjacent to the Trans Canada Highway. A total of 620 m of head is developed. In 1989 the steel lining of the upper tunnel was ruptured by slope movement (Fig. 19) and water was released into the slope.

The slope at Wahleach consists of hard, strong granodiorite cut by minor dykes and has total relief of approximately 920 m and an average slope of 25° (Fig. 19). The rock mass is characterized by closely spaced fractures and shear zones.

There is a gradual increase in rock quality with depth (Moore et al., 1992). Throughgoing discontinuities with downslope dips of less than 45° are absent. According to Moore et al. (1992), the Wahleach slope has undergone prehistoric movement down to average depths of 150-200 m as indicated by loosened rock down to this elevation, and the linear troughs and scarps in the upper part of the slope (For location, see D in Fig. 34); the current movement involves rock to depths of 60-120 m (Fig. 19). Between 1990 and 1992 the movements have resulted in surface displacements of 4-40 mm·a<sup>-1</sup> and, on the basis of their distribution and timing are concluded by Moore et al. (1992) to be consistent with gravitational creep which may also involve elements of sliding and block rotation. Moore et al. (1992, p. 106) concluded that, "lack of throughgoing adversely oriented discontinuities, the long history of diffuse, slow movements and the insensitivity of these movements to groundwater, indicate that the present movements will continue for considerable time and that a large rockslide is not imminent".

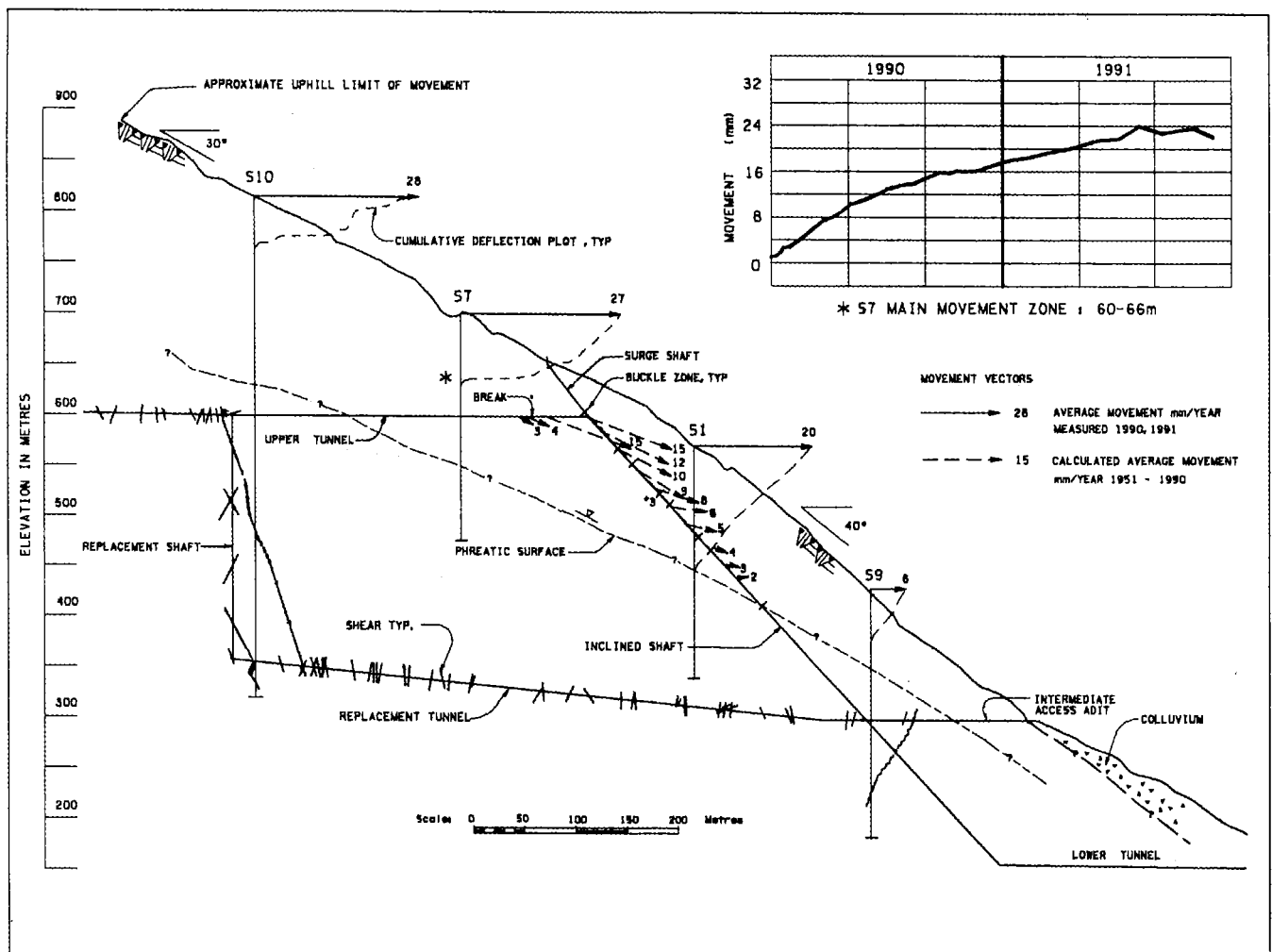
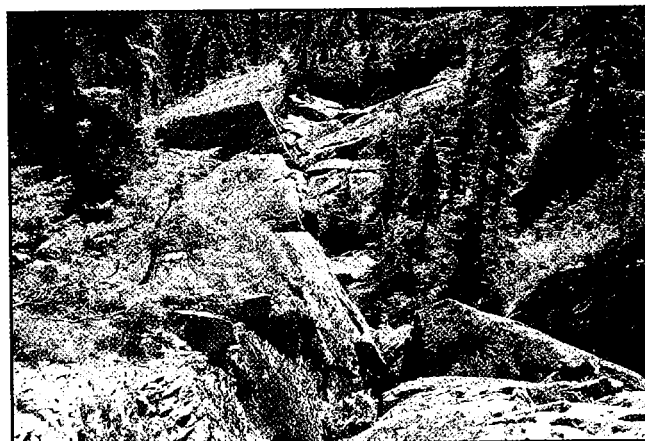


Figure 19. Mountain slope deformation at B.C. Hydro's Wahleach Power station in the Fraser Valley. Section showing movement and geology (after Moore et al., 1992).

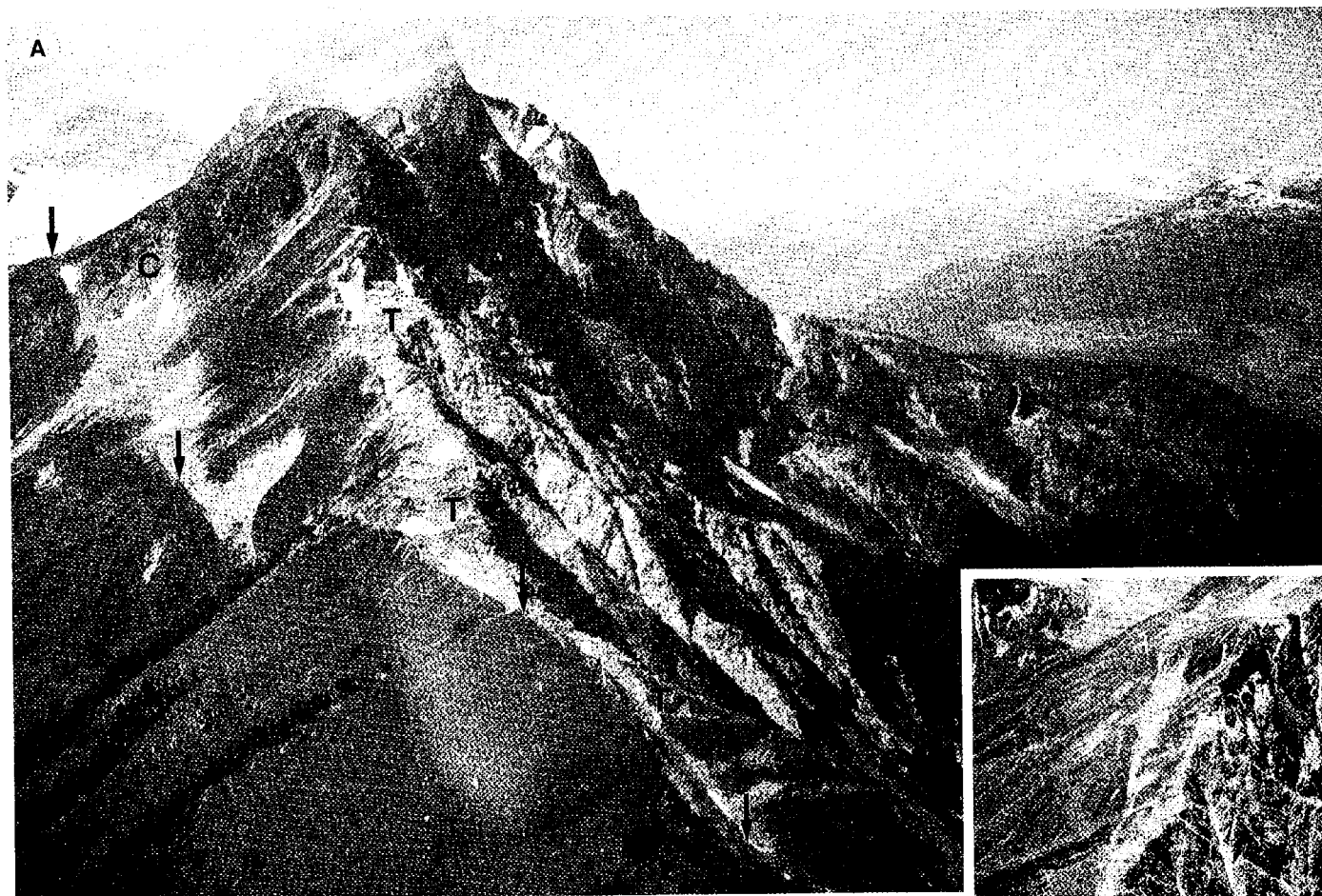




*Figure 20. View of mountain slope deformation at Mt. Breakenridge, Harrison Lake. GSC 1994-709F*



*Figure 21. Displaced rock masses resulting from mountain slope deformation, Mt. Breakenridge, Harrison Lake. GSC 1994-709G*



*Figure 22. Slope deformation at Mount Currie, near Pemberton. A) Oblique aerial photograph of the northwest face of Mount Currie. Major linear discussed in text marked with vertical arrows. Also shown are areas of toppling (T), and the location of open cracks (C). GSC 204247-V. B) Oblique view of linears on summit ridge looking south-southwest along major linear. GSC 204045-V*



### Mount Breakenridge, Harrison Lake

The geotechnical interpretation of mountain slope deformation features, particularly with respect to movement mechanism and catastrophic potential, is sometimes problematical. At Mount Breakenridge, for example, on the eastern shore of Harrison Lake (Fig. 20), a steep mountain slope has undergone considerable deformation (Fig. 21). The slope consists of metamorphic rocks of the Mesozoic Slollicum Schist; it extends from lake level to an elevation of 1445 m and runs beneath Harrison Lake to elevation -200 m, resulting in a total relief of 1645 m. The broken ground on the summit ridge of the slope consists of toppled blocks, scarps, and cracks and extends for 2.5 km along the ridge. The attitude of the foliation in displaced rock masses suggests that slope deformation has resulted from toppling. Concern was raised about the possibility of catastrophic failure at the site which could generate a displacement wave in Harrison Lake (Vancouver Sun, June 30, 1989), which in turn would impact on the tourist resort of Harrison Hot Springs at the southern end of the lake, 48 km from the site, and on the Port Douglas Indian Reserve at the head of the lake, 15 km from the site. Subsequent investigations by provincial authorities indicated that the likelihood of this scenario occurring was low. An acoustic survey of Harrison Lake by Desloges and Gilbert (1991) found no evidence of any disturbances of the lake floor sediments that could have resulted from a previous catastrophic failure of the Mount Breakenridge slope.

### Mount Currie

In some parts of the Coast Mountains, mountain linears have previously been interpreted as tectonic features rather than the result of gravitational processes (e.g., Clague and Evans, 1994a). In the Vancouver region, a problematical example of slope deformation is that which exists on the northeast ridge of Mount Currie, overlooking the town of Pemberton (Fig. 1). A 1.75 km long southwest-trending linear, obvious from the air and on aerial photographs (Fig. 22), was first described by Eisbacher (1983) who ascribed a tectonic origin to the feature. A maximum of 20-30 m vertical displacement has taken place along the linear. The northeast ridge is made up of hard gneissic rocks of the Pemberton Dioritic Complex, the structural fabric of which is dominated by a near vertical foliation (Evans, 1987). Rock mass disruption and gaping tension cracks indicate that at least some of the vertical displacement is due to gradual large scale slope movement of the summit ridge. Toppling of the gneissic foliation is also present (Evans, 1987).

### Hell's Gate

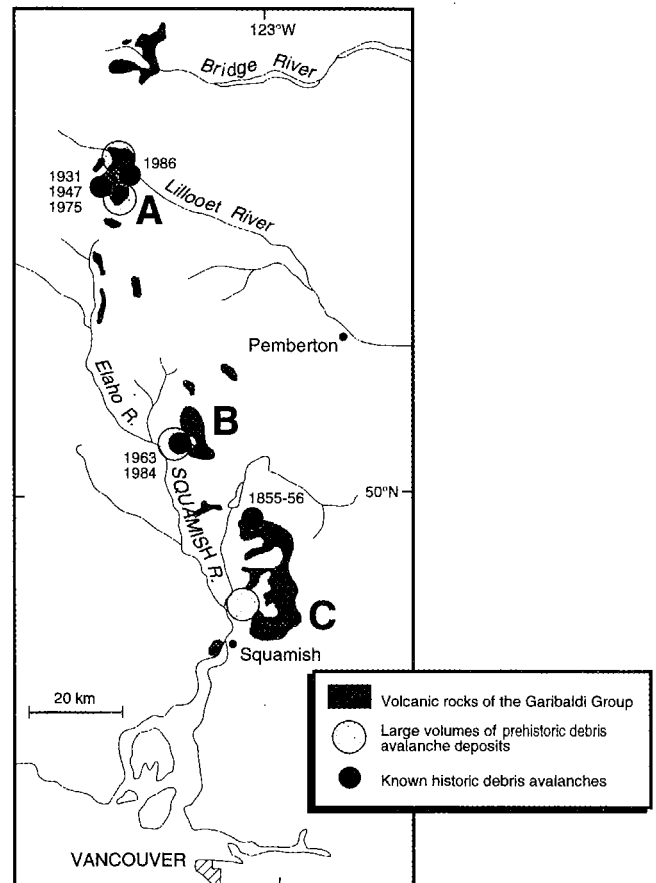
Slope deformation may also be triggered by large scale construction. During excavation of a 65 m high rock cut at Hell's Gate Bluffs during the construction of the Trans-Canada Highway in the Fraser Canyon, cracks exceeding 1 m wide in places, were discovered in hard granodiorite containing steeply dipping discontinuities. Construction was halted but movement continued. As described by Piteau et al. (1979), the cracks developed along a set of steeply dipping faults and

analysis showed that the movements consisted of the outward overturning, or toppling, of fault defined blocks (Kalkani and Piteau, 1976). Movement was found to be a direct function of precipitation. The movement was stabilized by excavation of the head of the slope and the implementation of measures to prevent infiltration.

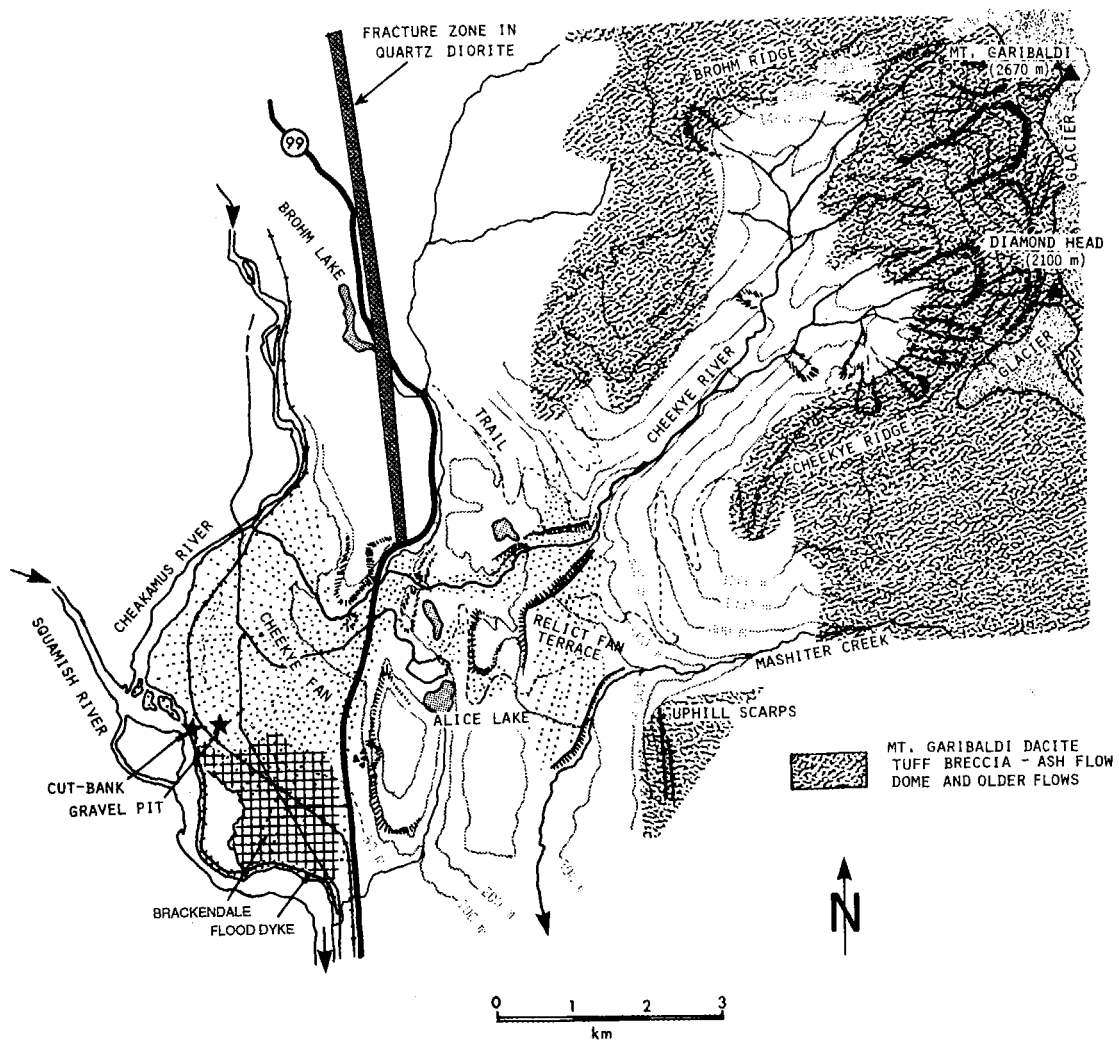
## DEBRIS AVALANCHES IN QUATERNARY VOLCANIC ROCKS, GARIBALDI VOLCANIC BELT

### Garibaldi Volcanic Belt

The Garibaldi Volcanic Belt is the northward extension of the Cascade Volcanic Belt. Quaternary volcanic rocks of the Garibaldi Group occur in three major centres, viz. Mt. Garibaldi, Mount Cayley, and Mount Meager (Fig. 23).



**Figure 23.** Map of Garibaldi Volcanic Belt, southwestern British Columbia showing main volcanic centres (A = Mount Meager, B = Mount Cayley; C = Mount Garibaldi), location of large volumes of prehistoric debris avalanche deposits, and the location and dates of known historic debris avalanches (modified from Evans and Brooks, 1991).



**Figure 24.** Sketch map of the western flank of Mount Garibaldi and the Cheekye River basin (after Eisbacher, 1983).



**Figure 25.** Oblique aerial view of Mount Garibaldi viewed from the south. The steep western face of the volcano is essentially a scarp formed by the Late Pleistocene flank collapse of the volcano. GSC 1994-709H

The most recent eruption in the Belt was at Plinth Peak, within the Mount Meager complex, at about 2350 BP (Read, 1990; Evans, 1992b) which deposited the so-called Bridge River Ash to the east (Nasmith et al., 1967).

The term "debris avalanche" is used here to describe the transformation of a volcano slope failure into what Schuster and Crandell (1984, p. 567) described as "a sudden and very rapid flowage of an incoherent, unsorted mixture of rock and soil material...Movement of the mass is characterized by flowage regardless of whether it is wet or dry..."

### ***Debris avalanches in the Mount Garibaldi Complex***

Large landslides have taken place in two types of settings within the Mount Garibaldi Complex; from the flanks of the volcanoes themselves (e.g., Mount Garibaldi) and from the high precipitous margins of lava flows at some distance from the source vent (e.g., Rubble Creek).

Major debris avalanche deposits have been documented in the Mount Garibaldi-Cheekye River area and Rubble Creek.

### **Mount Garibaldi-Cheekye River**

Debris avalanche deposits were first described in the Mount Garibaldi-Cheekye River area by Mathews (1952a, 1958). They cover a large area of the Squamish valley (Fig. 24) and consist of large dacitic blocks set in a matrix of pulverized tuff/tuff breccia, typical of debris avalanche deposits described elsewhere (e.g., Crandell, 1971; Evans and Brooks, 1991).

Mathews (1952a) has argued that the Mount Garibaldi volcanic cone was partially built over Fraser Glaciation ice, the melting of which during deglaciation removed support from the volcanic edifice resulting in the collapse of its western flank.

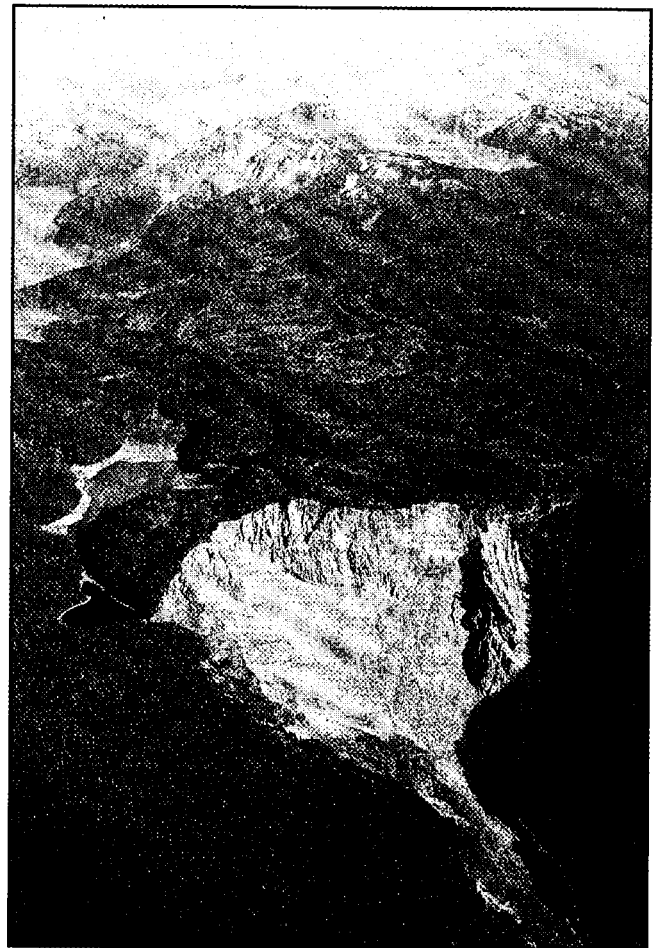
The area of the debris (including the Cheekye Fan) is 25 km<sup>2</sup> (Evans, 1990b). Assuming a mean thickness of 100 m this yields a volume of approximately 2.5·10<sup>9</sup> m<sup>3</sup>. This is identical to Mathews (1952a) estimate and compares favourably to his estimate of the missing volume from the western flank of Mount Garibaldi (2.9·10<sup>9</sup> m<sup>3</sup>).

The debris avalanche deposits originated in the dacitic lavas and tuff-breccias which make up the western flank of Mount Garibaldi. The amphitheatre-shaped headwater region of the Cheekye River (Fig. 25) is in effect a massive landslide scar created by multiple failure events. Successive failure events may have built up what Mathews (1952a) termed the 'terraced fanglomerates' at the mouth of the Cheekye valley. Unpublished radiocarbon dates obtained by S.G. Evans and Thurber Engineering/Golder Associates (1993) suggest that large landslides continued to occur on the western slopes of Mount Garibaldi and travelled down the Cheekye valley to the Cheekye Fan through prehistoric time. The occurrence of these events has had a major impact on recent land-use decisions regarding the fan (Hungry et al., 1993; Thurber Engineering/Golder Associates, 1993).

Debris flows have continued in historical times. As described by Jones (1959), following heavy rains in August 1958, a debris flow swept down the Cheekye River and formed a 5 m high temporary dam across the Cheakamus River at its mouth. Local residents reported that a similar debris flow occurred in the 1930s (Jones, 1959). Both flows were of the order of 100 000 m<sup>3</sup> (Thurber Engineering/Golder Associates, 1993).

### **Rubble Creek**

The Rubble Creek basin has been the site of at least two large debris avalanches and several debris flows during the Holocene (Mathews, 1952b; Moore and Mathews, 1978; Hardy et al., 1978). The source of the landslides is The Barrier, a precipitous face forming the margin of a dacite lava flow that erupted from Clinker Peak in the late Pleistocene (Fig. 26; Mathews, 1952b). Much of the debris has accumulated in the



**Figure 26.** Aerial view of *The Barrier*, a steep rock face formed by the successive failure of the margin of the Clinker Peak lava flow, the most recent failure being the 1855-56 rock avalanche. Clinker Peak is visible as the obvious source of the lava flow. Mount Garibaldi is visible in right background. GSC 1991-300

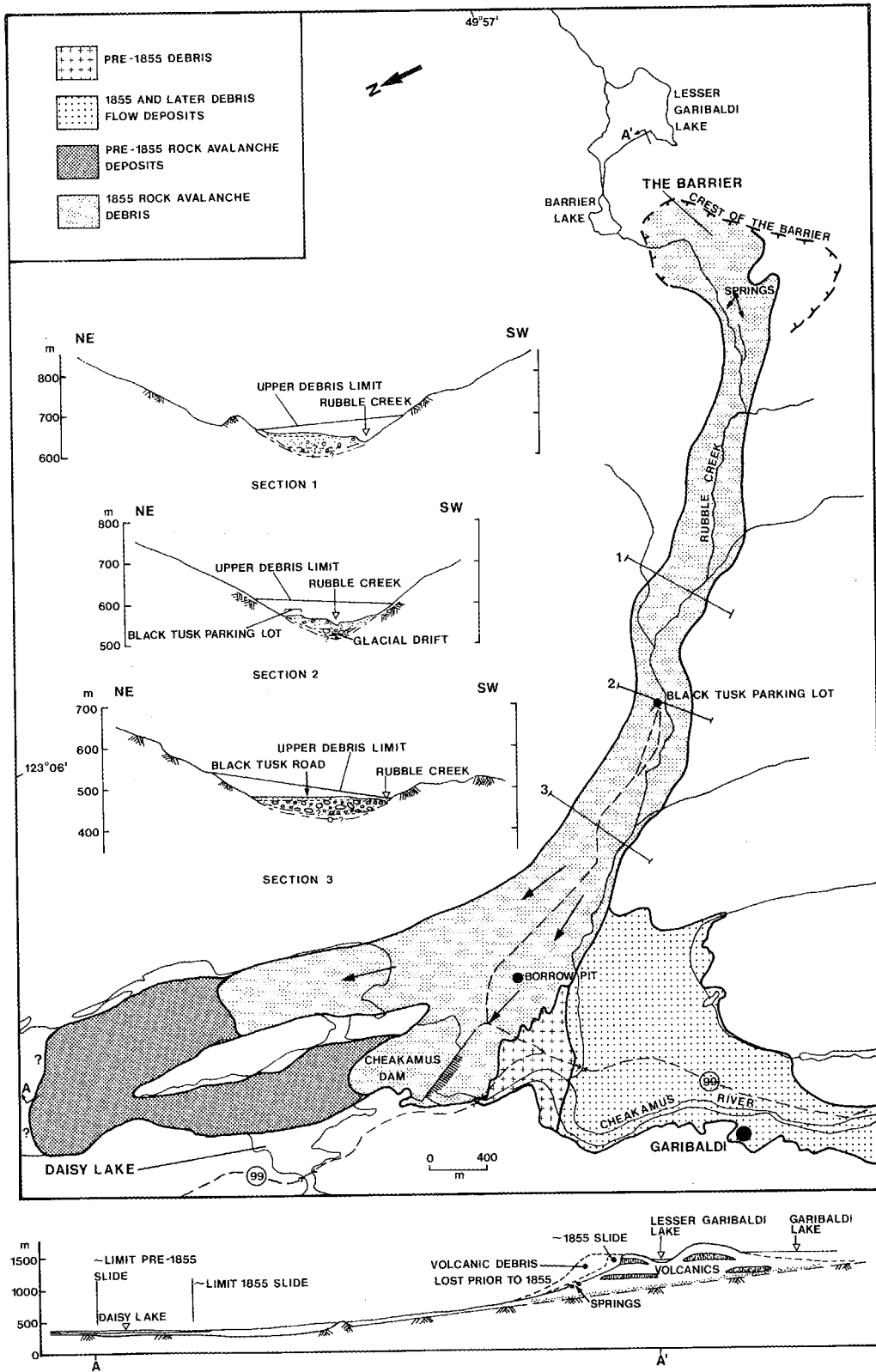


Figure 27. Landslides in Rubble Creek, Mount Garibaldi volcanic complex; map, longitudinal profile, and cross-sections showing upper limit of debris of 1855-56 rock avalanche (reproduced from Clague et al., 1987 which was redrawn from Hardy et al., 1978).

Cheakamus valley in a large fan at the mouth of Rubble Creek. Subsurface investigations indicate that the volume of the fan is between  $156-186 \cdot 10^6 \text{ m}^3$  and contains between 5-10 separate landslide units averaging 5-10 m in thickness (Hardy et al., 1978). A weathered surface exposed near the mouth of Rubble Creek separates historic landslide debris from similar materials which are older than about 600 calendar years (Hardy et al., 1978).

The most recent major failure occurred during the winter of 1855-56, when a major part of The Barrier failed along vertical fractures producing a large debris avalanche (estimated volume  $30-36 \cdot 10^6 \text{ m}^3$ ; this volume estimate is from Hardy et al. (1978)). Earlier estimates ranged from  $15-25 \cdot 10^6 \text{ m}^3$  (Mathews, 1952b; Moore and Mathews, 1978)). The debris travelled 6 km down Rubble Creek to the Cheakamus valley on an average gradient of  $7^\circ$  (Fig. 27; Moore and Mathews, 1978; Hardy et al., 1978). Based on superelevation data (Fig. 27) the debris reached velocities in excess of  $20-25 \text{ m} \cdot \text{s}^{-1}$  (Moore and Mathews, 1978). A more complex analysis of the movement in Hardy et al. (1978) suggested that velocities may have reached  $60 \text{ m} \cdot \text{s}^{-1}$  in the upper part of the path and that the landslide decelerated down the valley emerging from it onto the fan at about  $25-40 \text{ m} \cdot \text{s}^{-1}$ .

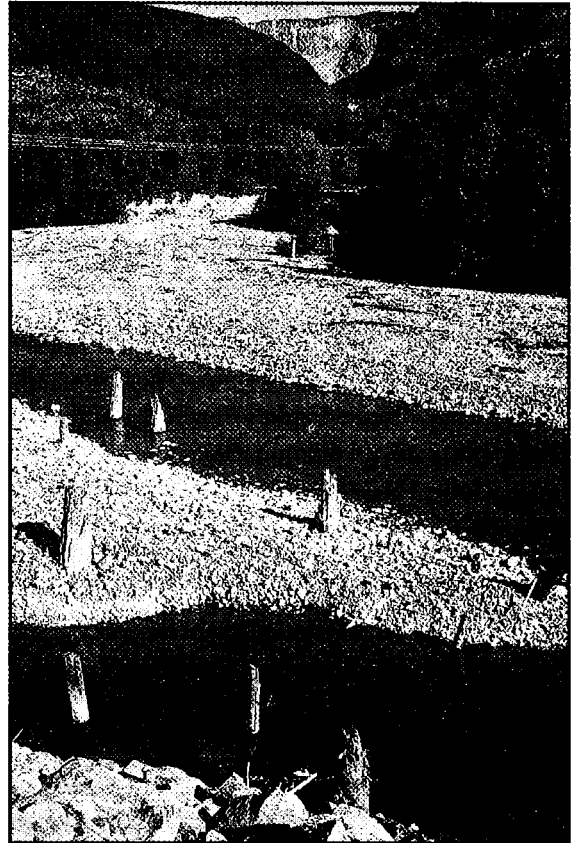


Figure 28. View across Cheakamus River up Rubble Creek to the Barrier showing trees killed in growing position by the 1855-56 debris avalanche and/or subsequent debris flows. GSC 1994-7091

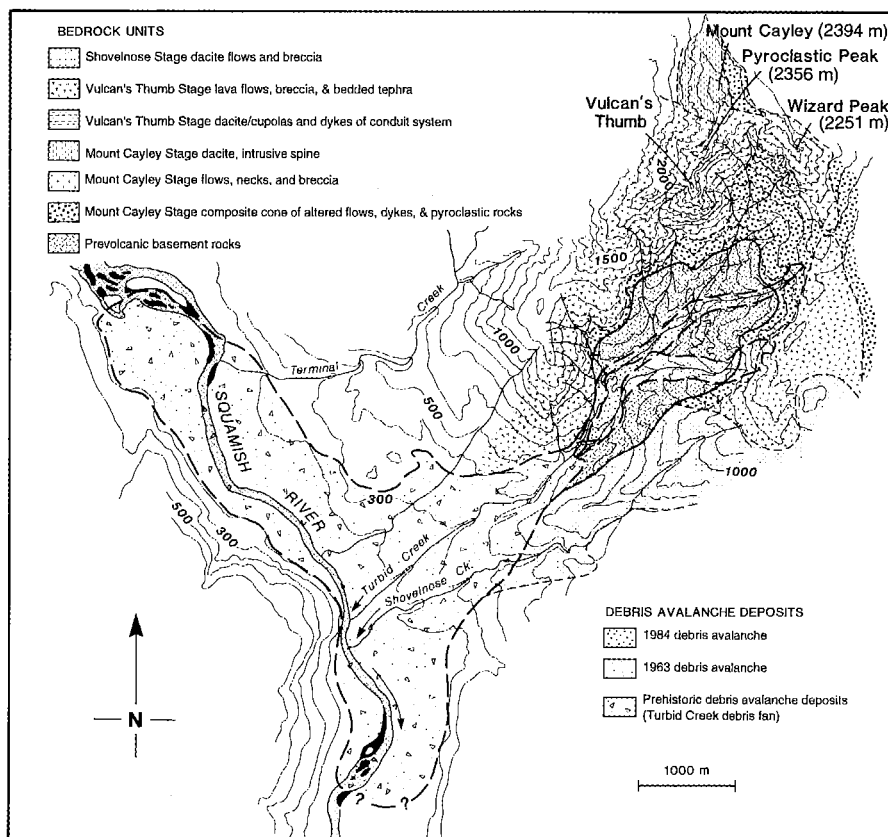


Figure 29.

Map of the Mount Cayley area showing the geology of Turbid Creek basin (after Souther, 1980), limit of prehistoric debris avalanche accumulation and historic debris avalanche paths (after Evans and Brooks, 1991).

The main debris stream spread over the northern half of the Rubble Creek fan and blocked the Cheakamus River (Evans, 1986). Debris flows associated with and following the rock avalanche covered the southern sector of the fan (Hardy et al., 1978). Debris floods, initiated when the Cheakamus River overtopped the landslide dam, buried tracts of forest on the floor of the Cheakamus valley up to 3.5 km below Rubble Creek; numerous rooted stumps of trees killed by these floods are still visible in the channel of the Cheakamus River (Fig. 28).

Between 1955 and 1957, B.C. Hydro constructed an earth and rockfill dam (Cheakamus Dam) across the Cheakamus River less than 1 km north of Rubble Creek (Fig. 27). The southeast abutment is located on the 1855-56 rock avalanche debris. Material obtained from a borrow pit in the 1855-56 debris was incorporated into the core of the dam (Terzaghi, 1960a, b).

A ban on the development of a housing subdivision on the fan was upheld by the B.C. Supreme Court in 1973 (Berger, 1973) because of the risk of another catastrophic landslide from The Barrier and adjacent steep slopes at the margin of the Clinker Peak lava flow. In 1980, Provincial Order in

Council 1185 under the Emergency Program Act, designated the Rubble Creek area too hazardous for human habitation. Property owners in the area were bought out, or relocated, at a cost of \$17.4 million (Morgan, 1992).

### *Debris avalanches from Mount Cayley Volcano and the damming of the Squamish River*

Investigation of diamicton units exposed in an extensive accumulation of volcanic debris in the Squamish valley, west of Mount Cayley volcano (Fig. 29), has yielded evidence for the occurrence of at least three major debris avalanches, initiated by the collapse of its western flank in the mid-Holocene (Evans and Brooks, 1991, 1992; Brooks, 1992).

Radiocarbon dates obtained from tree fragments (Fig. 30) contained in the deposits indicate that the events took place at approximately 4800, 1100, and 500 BP. All three events dammed the Squamish River and formed temporary lakes upstream of the debris (Brooks, 1992; Brooks and Hickin, 1991) in which fine grained sediments accumulated (Fig. 31).



*Figure 30. Broken trees in debris avalanche deposits in Turbid Creek. Tree above person's head gave radiocarbon date of  $950 \pm 80$  (GSC-5195). GSC 1994-709J*





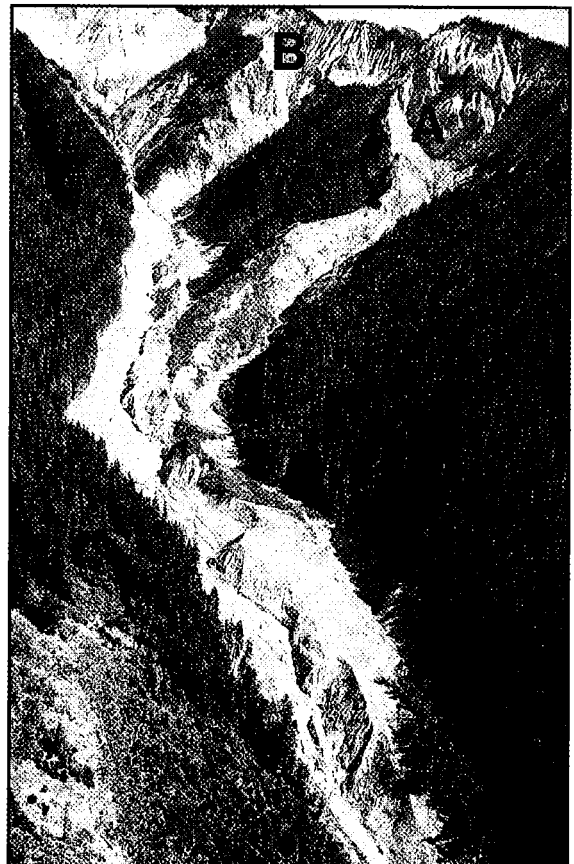
**Figure 31.**

*Varved lacustrine sediments deposited in Squamish valley in lake formed by the blockage of Squamish River by mid-Holocene collapse of Mount Cayley. GSC 1994-709L*

As described by Evans and Brooks (1991), failure of the cone took place after considerable dissection of the original edifice had exposed weak pyroclastic materials at the base of the steep upper slope of the volcano. No evidence of older debris avalanches from Mount Cayley has been discovered.

Smaller scale debris avalanches involving mechanically weak pyroclastic materials continue to occur from Mount Cayley's western flank in historic time. A 1963 event (Fig. 32; estimated volume  $5 \cdot 10^6 \text{ m}^3$ ) has been described by Souther (1980) and Clague and Souther (1982). The *fahrböschung*<sup>1</sup> of the landslide was  $22^\circ$  and velocities, calculated from superelevation data, reached  $15\text{--}20 \text{ m}\cdot\text{s}^{-1}$ .

In 1984 a similar debris avalanche took place from Mount Cayley's western flank (Fig. 32) and resulted in a debris flow which temporarily dammed the Squamish River (Evans, 1986; Jordan, 1987; Cruden and Lu, 1989). Two different interpretations have been made of the event. According to Cruden and Lu (1992) approximately 3.2 million cubic metres of material travelled down into Turbid Creek and blocked it. The breaking of the dam then caused an extremely fast debris flow in Turbid Creek which produced wind gusts up to  $34 \text{ m}\cdot\text{s}^{-1}$  and travelled down to the Squamish River. By contrast, Evans (1993) suggested that the 1984 event, contrary to an initial estimate of (Evans and Gardner, 1989), was an order of magnitude smaller (estimated volume  $0.5 \cdot 10^6 \text{ m}^3$ ). He did not find evidence to suggest that the debris stopped in Turbid Creek to form a dam. Instead, he proposed that the movement was continuous over a vertical distance of 1.18 km, to 3.46 km from its source. Below this point a debris flow was then initiated which travelled down the lower reaches of Turbid Creek and blocked the Squamish River as described by Cruden and Lu (1992). Evans (1993) concluded that the 1984 event showed hyper-mobile characteristics, i.e. the distance of travel of the debris was typical of a debris avalanche an



**Figure 32.** *Aerial view of historic debris avalanches in Turbid Creek on the western slopes of Mount Cayley volcano; "A" is the source of the 1963 debris avalanche and "B" is the source of the 1984 event. Both landslides involved initial failure in Pleistocene pyroclastic rocks. This photograph, taken in 1985, shows the swath cut through the tree cover by the 1984 debris avalanche. GSC 204857-F*

<sup>1</sup> The *Fahrböschung* of a landslide is the angle of the line joining the top of the headscarp and the distal limit of the debris.

order of magnitude greater. The *fahrböschung* for the 1984 landslide was  $19^\circ$  and based on superelevation measurements, velocities reached at least  $31 \text{ m s}^{-1}$ .

Debris avalanches from Mount Cayley and the effects of a possible damming of the Squamish River are major geomorphic hazards to public safety and economic development in the Squamish valley.

## DEBRIS FLOWS

Channellized debris flows (also known as debris torrents) occurring in steep mountain watersheds and triggered by heavy, intense rains have been responsible for much damage in the Vancouver region (Evans and Clague, unpublished data; Evans, 1982; VanDine, 1985). They are defined by VanDine (1985, p. 44) as "a mass movement that involves water-charged, predominantly coarse grained inorganic and organic material flowing rapidly down a steep, confined,

pre-existing channel". They are relatively frequent and are generally less than  $100\,000 \text{ m}^3$  in magnitude; many are less than  $50\,000 \text{ m}^3$ .

Debris flows are initiated by shallow slides in thin mantles of colluvium or till on slopes above a creek channel bed into which they travel and where they become transformed into debris flows by undrained impulse loading of saturated channel materials (Bovis and Dagg, 1992). Rockfall may also provide a debris flow trigger by undrained impulse loading of channel materials. In other cases, debris flows become mobilized by a large increase in creek discharge (e.g., by the bursting of a debris dam), to a critical stream discharge, which causes the destabilization of channelled bed materials (VanDine, 1985; Bovis et al., 1985; Boris and Dagg, 1988).

Shallow failures occurring on steep, open slopes do not necessarily become channellized, but may still develop into what are termed debris avalanches or open slope debris flows (Evans, 1982). Figure 33 shows an example from the northern side of Britannia Creek which occurred as a result of heavy rains in September 1991. The landslide overrode part of the abandoned townsite of Tunnel Camp.



**Figure 33.** Debris avalanche (or open slope debris flow) which occurred in August 1991 as a result of heavy rains on north side of Britannia Creek, 4 km upstream of Britannia Beach. The landslide overran part of the abandoned townsite of Tunnel Camp. GSC 1994-492B



**Figure 34.** Aerial photograph showing 1983 debris flows in vicinity of Wahleach Power Station (circled) in the Fraser Valley. Multiple starting points of debris flows are arrowed. Note at least three sources for the debris flow in Ted Creek (A) discussed in text. Point "D", located just south of Ted Creek, is an area of topographic linears associated with rock slope deformation illustrated in Figure 19. (BC 83020-104)

### ***Lower Fraser valley/Hope-Chilliwack***

Debris flows triggered by intense rains have occurred frequently in the lower Fraser valley in this century (Miles and Kellerhals, 1981; Evans and Clague, unpublished data) resulting in numerous deaths and extensive property damage. In July 1983, for example, a series of debris flows triggered by a severe local rainfall blocked the Trans-Canada Highway and the Canadian National Railway mainline for three days at a number of locations between Chilliwack and Hope (Evans and Lister, 1984) triggered by a locally intense rainfall (Slaymaker et al., 1987). The debris flows originated as shallow failures on steep mountain slopes covered with a thin veneer of colluvial and/or till materials that had been logged in the recent past. Some debris flows had multiple initiating point slides (Fig. 34). At least 14 debris flows reached the Trans-Canada Highway. No loss of life was associated with the debris flow activity although one house was partially engulfed. The cost of repairs to road and railway was estimated to be \$300 000. The debris flow in Ted Creek (Fig. 34) had a volume of about 60 000 m<sup>3</sup>, one of the largest debris torrent events to be documented in the Vancouver region (Slaymaker et al., 1987), and the velocity of the debris flow, estimated from super-elevation data, reached at least 9.4 m·s<sup>-1</sup> (Hung et al., 1984).

### ***Howe Sound-Whistler area***

Debris flows, triggered by heavy rains, have occurred in the steep watersheds along the east side of Howe Sound fiord (Fig. 1). These have impacted on communities along the fiord as well as on the British Columbia railway and the Squamish Highway which run along its east side (Thurber Consultants, 1983; Jackson et al., 1985). In the 25 years between the completion of construction of both the railway and the highway in 1958, and 1983, 14 debris torrents occurred on six creeks resulting in 12 deaths, the destruction of 11 bridges, four houses, and other property damage (Lister et al., 1984). Four debris flows were described by Lister et al. (1984) (Fig. 35). They involved volumes in the range of 10 000 to 20 000 m<sup>3</sup>; velocities were in the order of 3-6 m·s<sup>-1</sup> and discharges were in the range 100-350 m<sup>3</sup>·s<sup>-1</sup>.

On October 31, 1981, a debris flow of about 20 000 m<sup>3</sup> in M Creek (Fig. 35, 36) swept down the steep mountain watershed over a distance of 2.2 km and destroyed the highway bridge crossing the creek. Nine people were killed when several vehicles drove into the chasm spanned by the destroyed bridge.

A similar debris flow occurred in Alberta Creek on February 11, 1983 and had a disastrous impact on the community of Lions Bay (Fig. 35, 37). The debris flow consisted of six surges during a period of approximately two and one-half hours in the early hours of the morning (Lister et al., 1984). In addition to substantial damage to transportation facilities, three houses in Lions Bay were destroyed and a house trailer crushed; two people in the trailer were killed.

In an earlier disaster, a debris flood in Britannia Creek in 1921, caused by the collapse of a blocked culverted, fill during heavy rains, devastated Britannia Beach destroying 60 houses and causing 37 deaths (Hung and Skermer, 1992; Evans and Clague, unpublished data).

### ***Triggers***

Although debris flows are usually associated with heavy rainfall, attempts to specify weather conditions (e.g., total rainfall or intensity thresholds) which trigger debris flows have not been successful (e.g., Church and Miles, 1987). Factors that complicate such attempts include the role of snowmelt, antecedent moisture conditions, the availability of debris, and the fact that rain gauges are generally spaced too widely to detect localized high intensity rainfall cells which may trigger debris flows (e.g., the 1983 Wahleach events described above).

A second complex causative relationship is that between debris flow initiation and change in land use in the source watershed either by deforestation or forest fire. Studies by O'Loughlin (1972) and Howes (1987) for example, found that clearcut logging and logging road construction increased the occurrence of initial shallow landslides of the type that could be transformed into debris flows. In contrast, many major historical debris flows have been initiated on slopes that have not been logged (e.g., the M Creek event described above) and slopes with natural vegetation can undergo significant landslide activity (Howes, 1987).

### ***Defensive structures***

As described by Hung et al. (1987), Slaymaker et al. (1987), and Kellerhals and Church (1990) a variety of debris flow defensive structures have been constructed at numerous locations in the Vancouver region in recent years, following the construction of debris flow defensive works to protect the Vancouver Island community of Port Alice (Nasmith and Mercer, 1979). They include debris retention structures that stop and dewater debris in containment basins upstream, channellization works that confine the debris in its passage over a fan surface, and deflection berms that either divert the flow away from potential impacts on infrastructural facilities into a predetermined deposition area, or create open containment areas (Hung et al., 1987).

The most sophisticated structures in the region have been constructed at several locations along Howe Sound in the vicinity of Lions Bay (Fig. 1) for a total cost of about \$20 million (Evans and Clague, unpublished data). At Charles Creek, (Fig. 35) a large debris retention basin (Fig. 38) was constructed in the mid-1980s at the head of the bay, to protect transportation routes and expensive homes below on the fan. A similar structure was constructed on Harvey Creek at the head of the fan which has a debris retention capacity of 70 000 m<sup>3</sup>. At Alberta Creek, scene of the 1983 fatal accident, channellization of the creek (Fig. 39) was carried out to confine flood or debris flow discharges in its passage over the Alberta Creek fan within a gently curving concrete-lined channel (Hung et al., 1987).

Less sophisticated debris retention structures have been built or have been planned in the region. Hungr (1993), for example, described proposed debris retention structures to protect part of Whistler (Fig. 1) from possible debris flows in Whistler Creek. They consist of two 11 m high debris flow barriers consisting of a series of triangular buttresses of tubular steel, connected by massive steel grating (Fig. 40) which would create a total retention capacity of about 24 000 m<sup>3</sup>.

Since the introduction of deflection berms as debris flow defensive structures at Port Alice, Vancouver Island in the 1970s, a number have been built in the Vancouver region. Deflection berms have been constructed at several locations in the vicinity of Wahleach to protect the Trans-Canada Highway from debris flows (Fig. 1, 41). At Ted Creek, for example (see location in Fig. 34) a gravel borrow pit on the Ted Creek fan was shaped to act as a retention basin and a

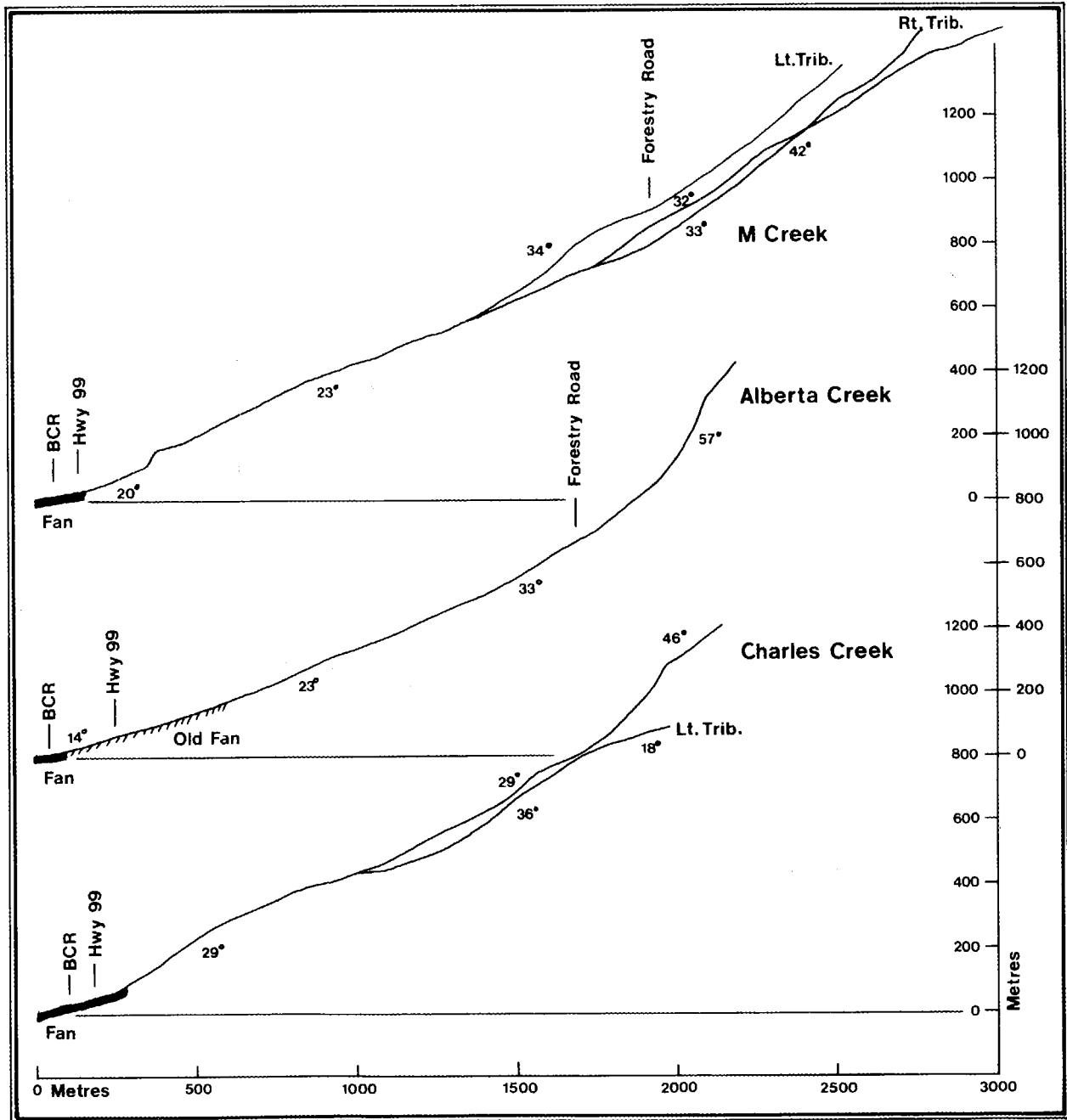
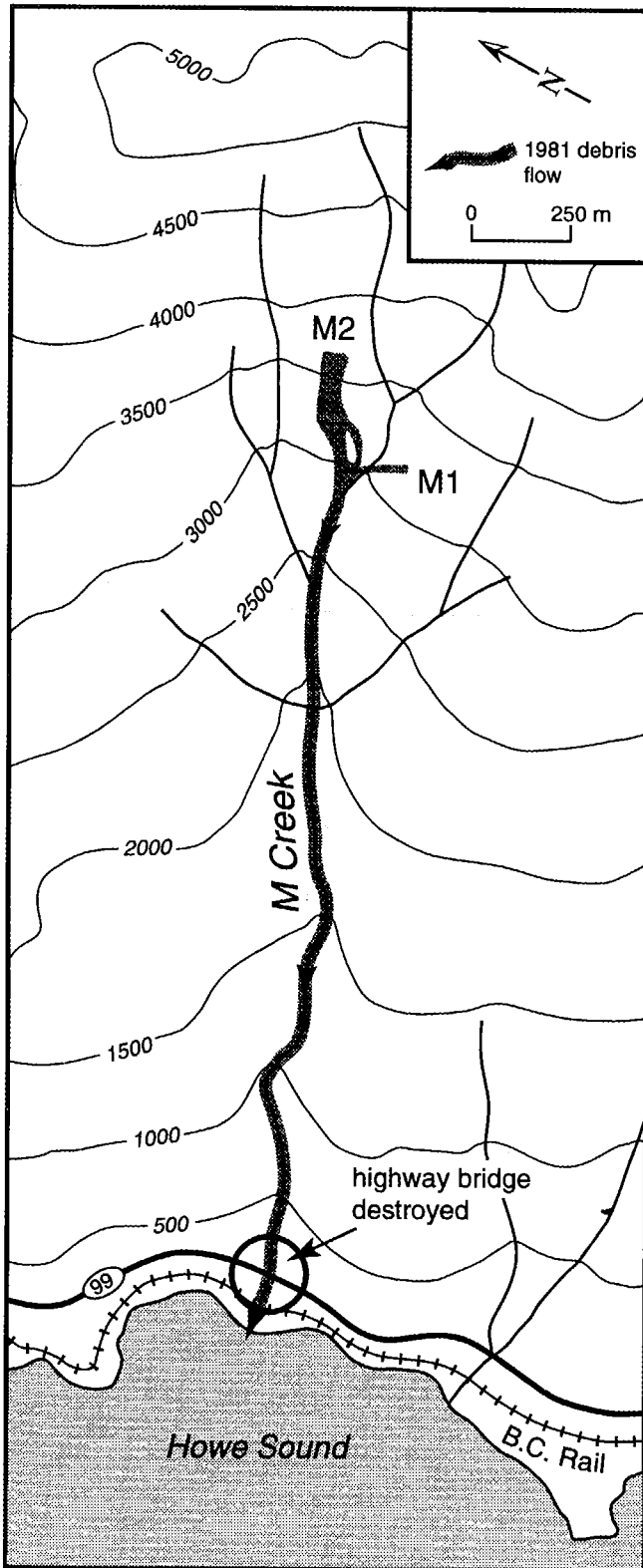
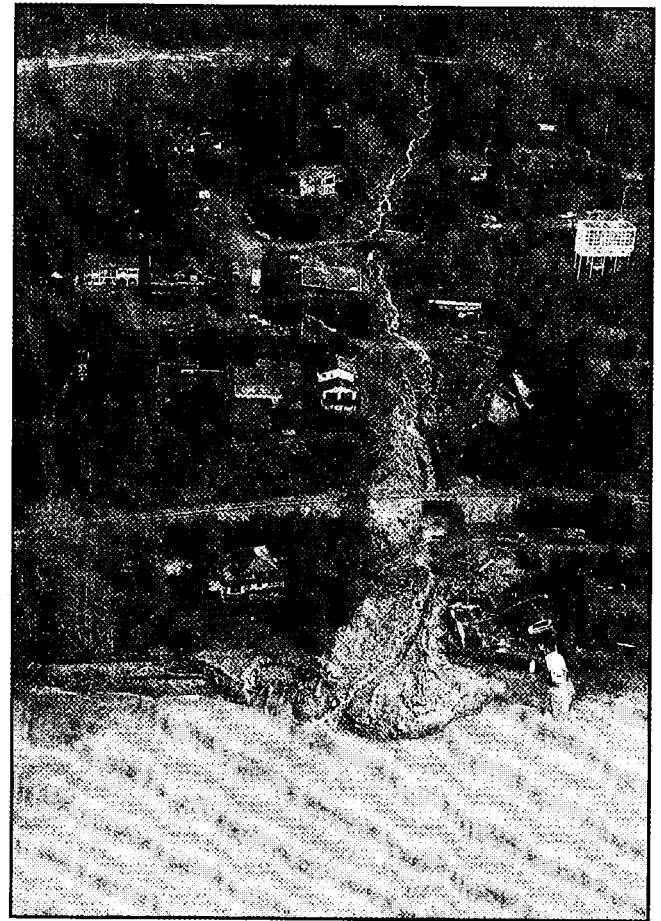


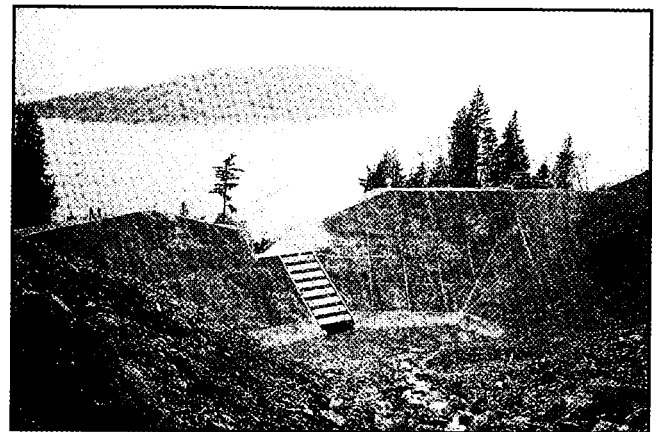
Figure 35. Profiles of creeks on east side of Howe Sound in which debris flows occurred between 1981 and 1983 (after Lister et al., 1984).



**Figure 36.** Map of M Creek debris flow which occurred on October 28, 1981, 2.5 km north of Lions Bay, east side of Howe Sound; M1 and M2 are probable source landslides for the debris flow (modified after Bovis and Dagg, 1992).



**Figure 37.** Alberta Creek debris flow, Lions Bay, which occurred on February 11, 1983. Note damaged buildings and bridges (photo courtesy of British Columbia Ministry of Highways and Communications).

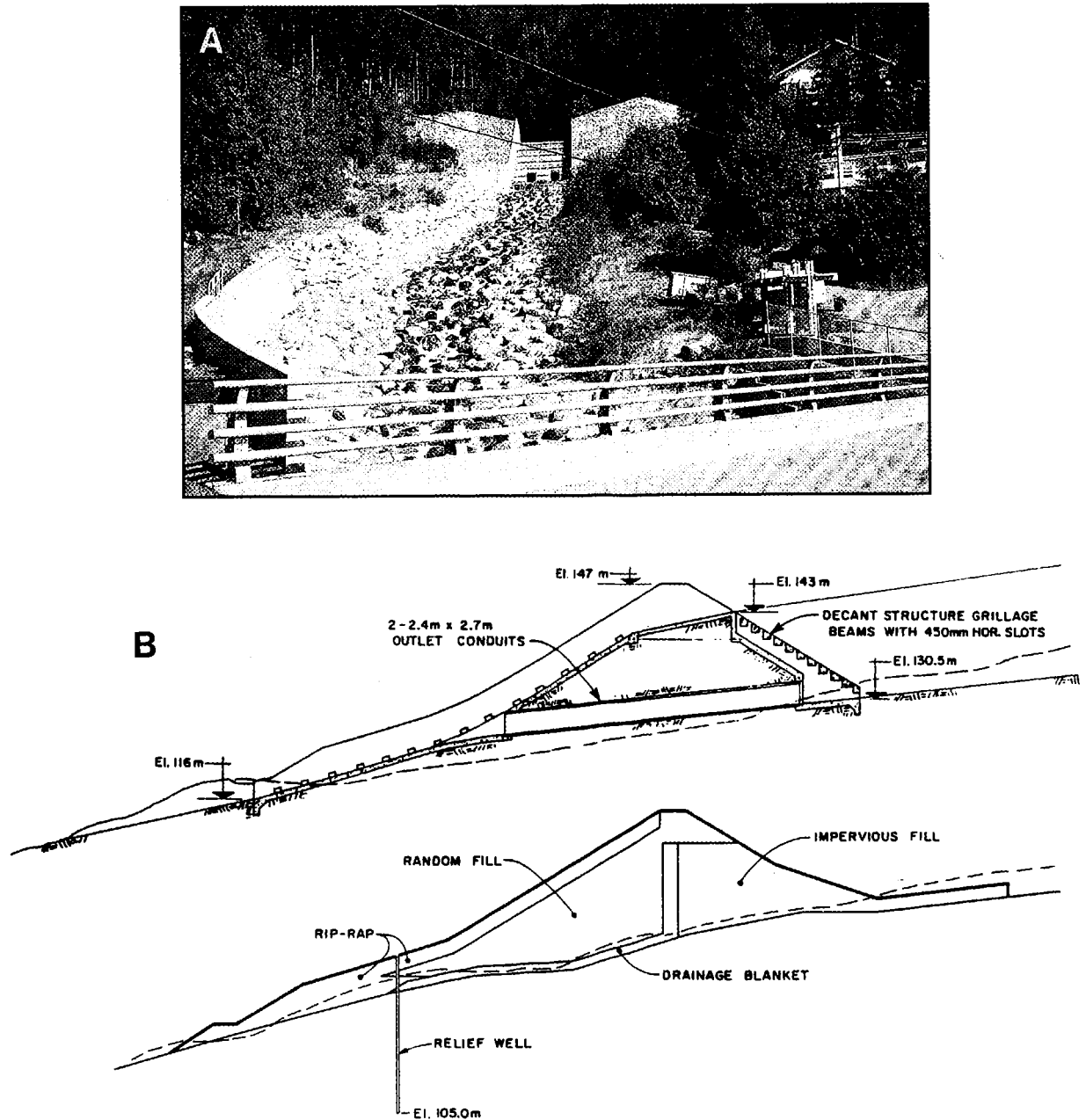


**Figure 38.** Debris flow retention structure on Charles Creek, Howe Sound constructed in the mid-1980s; view downstream. GSC 1991-298

deflection berm for a retention capacity of 60 000 m<sup>3</sup> (Hung et al., 1987); deflection berms were also constructed to protect the Agassiz Mountain Correctional Institution from debris flows (Martin et al., 1984) creating a total containment capacity of 12 000 m<sup>3</sup>. In addition channellization works and deflection berms have been constructed in several locations along the Coquihalla Highway (Slaymaker et al., 1987) for a total cost of \$1.1 million.

## LANDSLIDES IN PLEISTOCENE SEDIMENTS

Numerous landslides have taken place in the Pleistocene sediments of the Vancouver region in the historical period, particularly in the Lower Mainland (Eisbacher and Clague, 1981; Evans and Clague, in press). They are most common along the escarpments composed of unconsolidated Wisconsinian sediments that define the edge of terraced



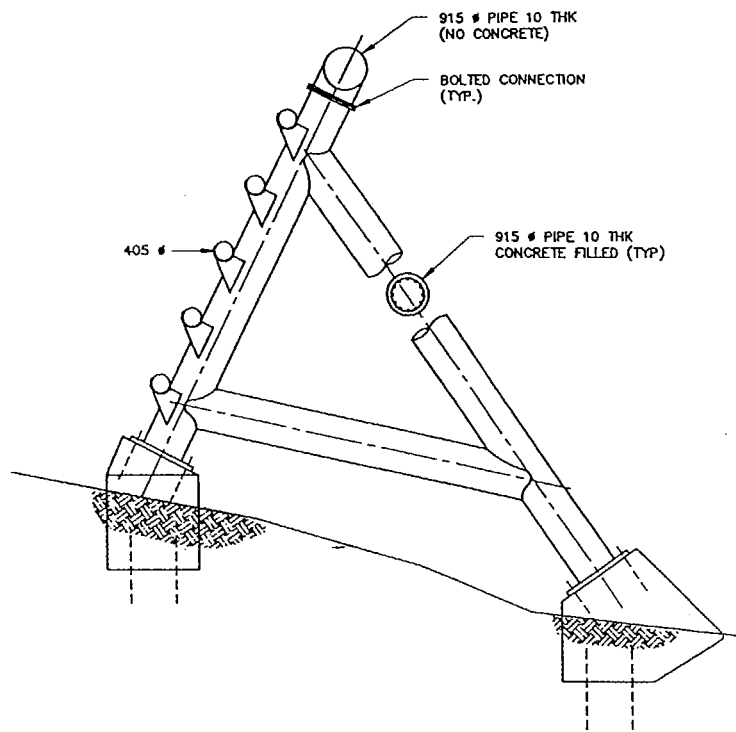
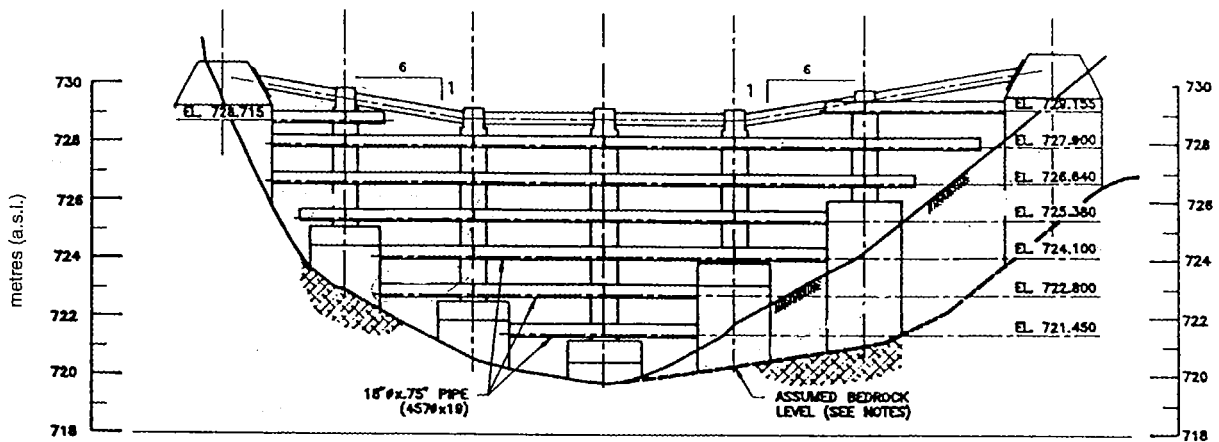
**Figure 39.** Debris flow retention dam at Harvey Creek, Lions Bay, Howe Sound. A) View upstream; GSC 1994-709K B) Structural cross-section (after Hung and Skermer, (1992) from a sketch drawing by Ker Priestman Associates).



uplands in the Greater Vancouver area (see Fig. 2 in Eisbacher and Clague, 1981). Materials involved in these events consist of glacial, glaciofluvial, glaciomarine, and glaciolacustrine sediments (Armstrong, 1984) that exhibit considerable geological, hydrogeological, and geotechnical complexity (Eisbacher and Clague, 1981; Evans, 1982; Hungr and Smith, 1985). Problems related to landslides in Pleistocene sediments are not restricted to the Lower Mainland. Recently, Gerath (1993a, b) has pointed out the hazards posed by landslides and related processes on the Redroofs Escarpment on the Sunshine Coast (Fig. 1).

**Rapid earthflow in sensitive glaciomarine sediments**

Glaciomarine sediments are widespread in the Lower Mainland (Armstrong, 1984) but only one large landslide has occurred in these deposits in historical times. On January 30, 1880, a major landslide (estimated volume  $10^6$  m<sup>3</sup>) occurred at Haney (Fig. 1) in glaciomarine sediments on the eroding north bank of the Fraser River (Fig. 42; Evans, 1982). Eyewitnesses reported that they heard the cracking of the ground and watched as a "great .. moving mass of earth and trees...slid



**Figure 40.** Conceptual design of debris retention barrier for Whistler Creek (from Hungr, 1993, courtesy Ker Priestman Associates).

into the Fraser River" (Victoria Daily Colonist, February 5, 1880). The slide partially blocked the Fraser River and resulted in the death of one person (killed by the 12 m high displacement wave caused by the slide). Substantial damage to docking facilities occurred along the Fraser River (Evans and Clague, unpublished data). Excess pore pressures within sandy interbeds in the sensitive glaciomarine silts and clays and erosion at the toe of the slope by the Fraser River are probable causes of the slide (Evans, 1982).

### ***Debris avalanches and debris flows***

The occurrence of debris flows and debris avalanches along escarpments in Pleistocene sediments in the Greater Vancouver area have been described by Eisbacher and Clague (1981), Woods (1984), and Hungr and Smith (1985). They are triggered by heavy autumn and winter rains. The steep ravines and gully walls along the escarpments, which range up to 125 m in height, produce channellized debris flows by two initial mechanisms (a) the failure of a relatively thin

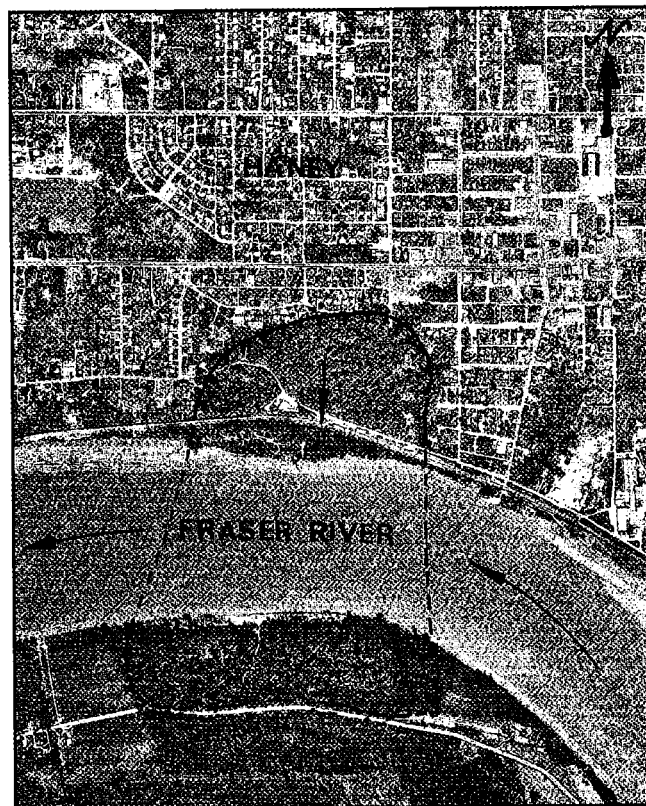
(1-2 m) cover of colluvium on slopes steeper than 30° or (b) the slumping of material at the head of a gully. Both these initial failures are transformed into debris flows which run out on areas below the escarpments. The possibility of initial failure may be increased by the placement of loose fill at the heads of the gullies or steep ravines (Hungr and Smith, 1985) which has the effect of loading the slope or impeding drainage.

Open slope debris flows or debris avalanches also occur (Eisbacher and Clague, 1981).

A typical example of this style of landslide is the Port Moody debris flow of December 1979 (Eisbacher and Clague, 1981; Woods, 1984) (Fig. 43). Triggered by torrential rains, a slide involving 4000 m<sup>3</sup> of dumped fill at the crest of a ravine, entered a steep sided gully and surcharged loose material in the floor of the gully. Under undrained loading the debris began moving on a slope of 15°, entrained other materials from the gully bottom, and travelled a distance of 600 m over an average slope of 9°. The debris flow demolished one house and inundated other houses and apartments with debris (Fig. 43). Evidence noted by Armstrong, (1984) suggests that the escarpment had been subject to large debris flows in the prehistoric past.



**Figure 41.** Debris deflection barrier (or berm) constructed to protect Trans-Canada Highway and Canadian National Railway rail track, 5 km southwest of Laidlaw in the Fraser Valley. GSC 1994-492E



**Figure 42.** Airphoto of site of 1880 Haney landslide (from BC 7056-116).

### Catastrophic seepage erosion

Catastrophic seepage erosion (Hutchinson, 1982), which is also known as caving erosion (Hungr and Smith, 1985), results in what are locally referred to as "washouts"; it occurs both on natural slopes on the escarpments, and in the excavated faces of gravel pits (Allan, 1957; Armstrong, 1984). The process has considerable destructive potential and, according to Armstrong (1984), is the dominant mass movement phenomena occurring in the Fraser Lowland.

Seepage erosion (Fig. 44) occurs in steep slopes where thick, pervious sand, sandy silt, or gravel beds are confined between overlying impervious Late Wisconsin till and/or glaciolacustrine stony clay (Hungr and Smith, 1985) and underlying impervious or less pervious materials. Seepage erosion in the pervious layer undercuts the overlying material resulting in its collapse. Under sustained or increased seepage this type of erosion may increase progressively by the rapid retrogression of a seepage front thus creating significant gullies in a matter of hours. The failed material, which is

easily liquified, flows rapidly from the seepage front to the toe of the escarpment where it accumulates in a fan. Seepage erosion may therefore result in inundation of areas downstream in the depositional fan area and also endanger areas upstream by the rapid retrogression of the seepage front.

On natural slopes, the famous UBC Campus washout of 1935 in the Point Grey seacliff, resulted from seepage erosion (Armstrong, 1984). At the cliffs, which are up to 70 m high, a thin veneer of till overlies Quadra Sand and, at the time of the washout, cliff slopes were being steepened by marine erosion. According to Armstrong (1984), the lowest 15 m of Quadra Sand in the section contains impervious clayey silt and organic sediment and much seepage occurs at the upper boundary of this zone. In January 1935, following two days of torrential rain after a week of heavy snowfall, seepage erosion removed about 100 000 m<sup>3</sup> of Quadra Sand, creating an instant canyon about 100 m long in less than two days. During the period of erosion, which drew a crowd of spectators, the steep walls of the canyon repeatedly collapsed sending surges of sand and water down to the sea (Eisbacher and Clague, 1981).

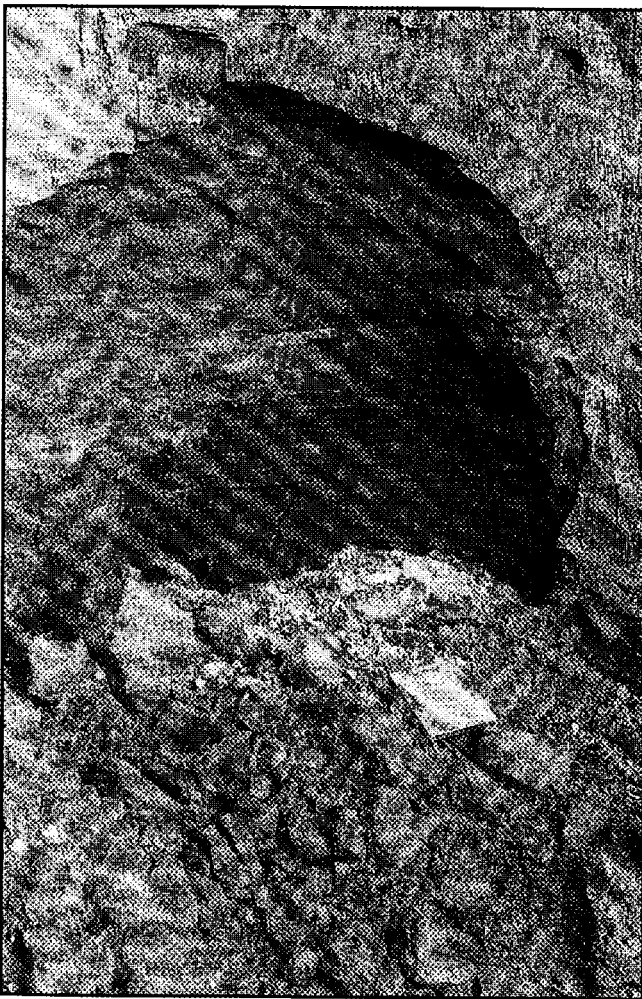


Figure 43. Seepage erosion in glaciofluvial sand at gravel pit in Coquitlam River valley. Note field book for scale (courtesy of O. Hungr, Thurber Engineering).

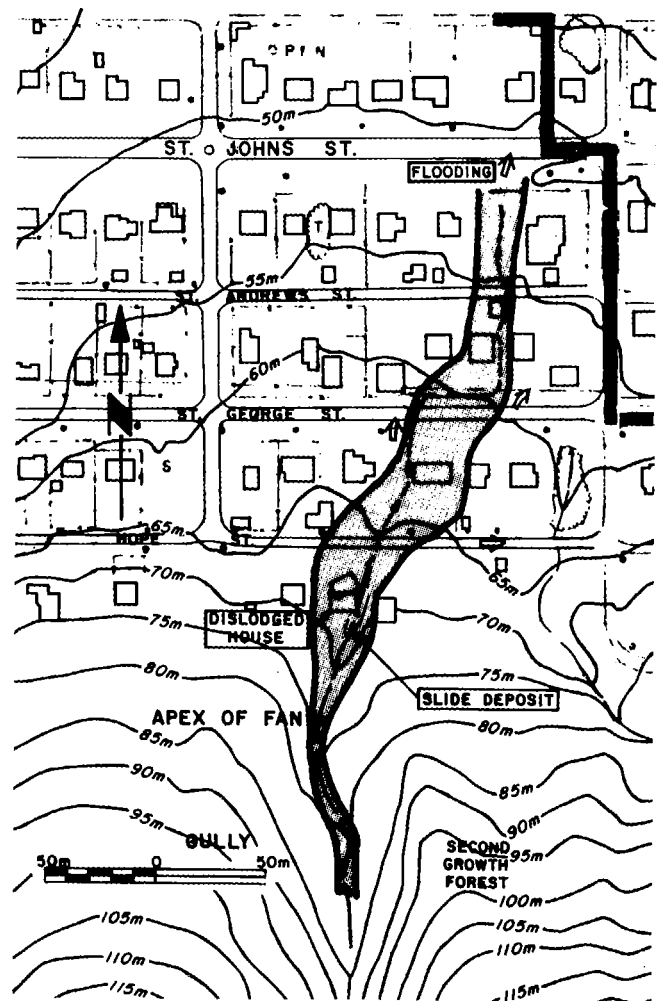


Figure 44. Map of run-out of 1979 Port Moody debris flow (after Woods, 1984).

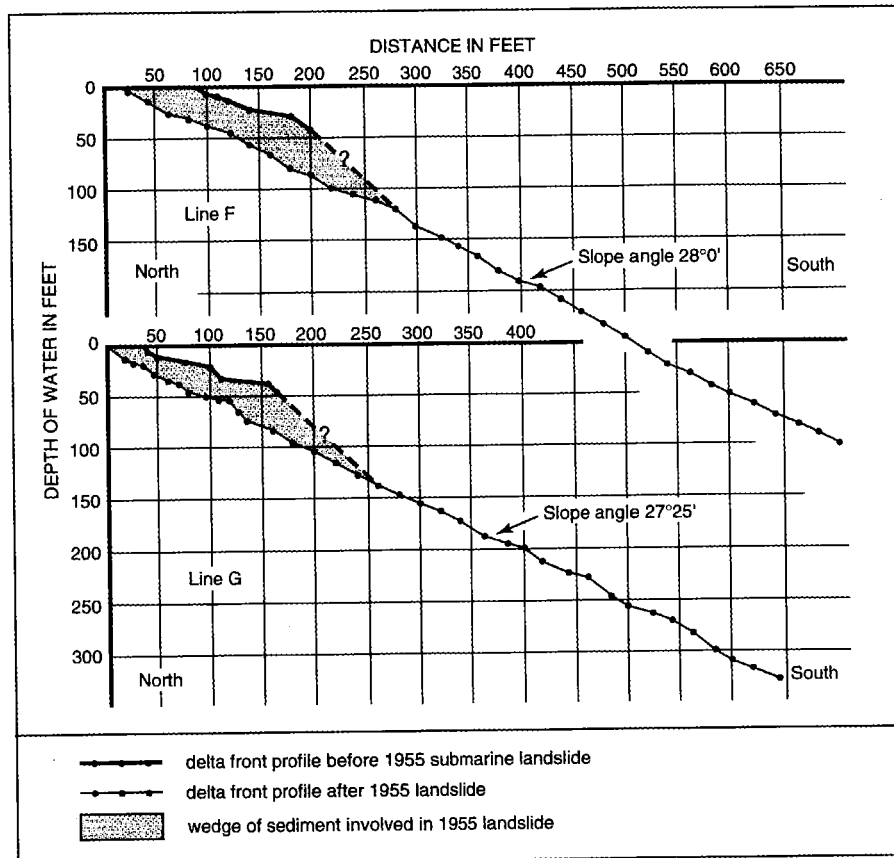


Figure 45. Vertical sections through Woodfibre delta front before and after 1955 slide (modified after Terzaghi, 1956).

Another major catastrophic seepage erosion event in a natural slope is described by Allan (1957) and Armstrong (1984) in the Coquitlam River valley. It occurred in 1952 and was initiated by seepage at the base of a 100 m section of pervious sands and silts at its contact with impervious, partly compacted glaciofluvial gravel. Within 24 hours, approximately 300 000 m<sup>3</sup> of material was washed out into the Coquitlam River blocking it for several days and an amphitheatre-shaped gully complex up to 300 m long had formed in the valley side.

Catastrophic seepage erosion is particularly common in the faces of gravel pits in the Vancouver region (Armstrong, 1984). According to Hungr and Smith (1985) seepage erosion in Coquitlam River gravel pits may take place at a rate of 50 m·a<sup>-1</sup>. In 1953 in a pit at Mary Hill, for example, sand and gravel was being mined from beneath an impervious cap of till. A mechanical shovel cut through a silty bed of gravel and tapped a groundwater reservoir which led to excessive seepage. Within 15 hours, 70 000 m<sup>3</sup> of material had flowed from the face.

#### *Landslides in glaciolacustrine deposits*

Glaciolacustrine sediments were deposited in the mountain valleys of the Vancouver region when glacier ice in the Fraser Lowland blocked their outlet (e.g., Saunders et al., 1987). The

deposits are not widespread but consist of varved silts and clays and are prone to landslides. Extensive retrogressive landslides have occurred in these deposits, for example, on the north side of the Chilliwack River valley, westward from Tamihi Creek (Fig. 1; Armstrong, 1984).

#### **SUBMARINE FAILURES (OUTSIDE FRASER DELTA)**

Submarine failures are common in the Vancouver region particularly on delta fronts in both marine and lacustrine environments. The failures largely involve unstable wedges of sediment which form as a result of rapid subaqueous deposition. Instability on the Fraser Delta front is described in Luternauer et al. (1994).

#### *Marine*

Submarine failures have been documented in (Fig. 1) Howe Sound on several deltas. In 1955, at Woodfibre, failure of a delta slope at the mouth of Woodfibre Creek damaged warehouses and wharf facilities constructed on the delta. The cost of the damage was in the range of \$500 000 to \$750 000 (Bornhold, 1983) and the pulp mill was forced to shut down

## Marine

Submarine failures have been documented in (Fig. 1) Howe Sound on several deltas. In 1955, at Woodfibre, failure of a delta slope at the mouth of Woodfibre Creek damaged warehouses and wharf facilities constructed on the delta. The cost of the damage was in the range of \$500 000 to \$750 000 (Bornhold, 1983) and the pulp mill was forced to shut down for a time. The failure mechanics of the wedge of sediment perched at the top of the steep delta slope (Fig. 45) were analyzed in a classic paper by Terzaghi (1956) who concluded that the failure was triggered by excess pore pressures generated by an extreme low tide. A side-scan sonar survey of the site by Prior et al. (1981) found that evidence of mass movement on the delta was widespread and not confined to the 1955 event.

Submarine slope failures have also been documented on the delta of Britannia Creek at Britannia Beach on the east side of Howe Sound (Fig. 1; Moore, 1983; Prior and Bornhold, 1986). A history of instability on this delta is described by Moore (1983). In June 1957, for example, a section of the British Columbia Railway was destroyed by a submarine slump on the delta shortly after the grade was constructed.

The Squamish Delta at the head of Howe Sound is of strategic economic importance. According to Hickin (1989) the mean annual sediment flux to Howe Sound from the Squamish River is 1.29 million cubic metres per year and the Squamish Delta is prograding downfiord at a rate of  $3.86 \text{ m a}^{-1}$ . Instability on the Squamish Delta (Fig. 1) in response to this sediment input, detected by side-scan sonar, (Fig. 46) is illustrated by Prior and Bornhold (1984).

## Lacustrine

As noted above, submarine failures are not limited to marine environments. Submarine landslide deposits have been detected in several lakes in the Vancouver region. In his study of Lillooet Lake, Gilbert (1975) described mounds of slumped material on the foreset slope of the Lillooet Delta. In Stave Lake, acoustic profiles (Gilbert and Desloges, 1992) indicate extensive slumping in underwater sediments; one extends for 7 km on the west side of the lake, and a second overlying slump deposit occurs over a distance of 3 km in the same region. In Garibaldi Lake, Mathews (1956) noted the occurrence of graded laminae of sand and coarse silt in the deep, flat-bottomed part of the lake 4 km from their source, and concluded that they were deposited by turbidity currents generated by submarine slumps.

## EARTHQUAKE-TRIGGERED LANDSLIDES

There has been much discussion on the possibility of a future megathrust earthquake of high magnitude ( $M \geq 8$ ) affecting the Vancouver region (e.g., Rogers, 1988). Such an event would have an important impact on slope stability. Given a range in epicentral distance to the Cascadia subduction zone of between 200 and 350 km, the empirical thresholds established by Keefer (1984) suggest that for  $M \geq 8$  earthquake, disrupted landslides (including rock avalanches and rockfalls) will occur throughout most of the region, particularly west of the Lillooet River-Harrison Lake lineament. As a corollary, if this magnitude event has occurred on the Cascadia Subduction zone in the prehistoric past, it is assumed that a number of seismic triggered landslides would have occurred in the region.

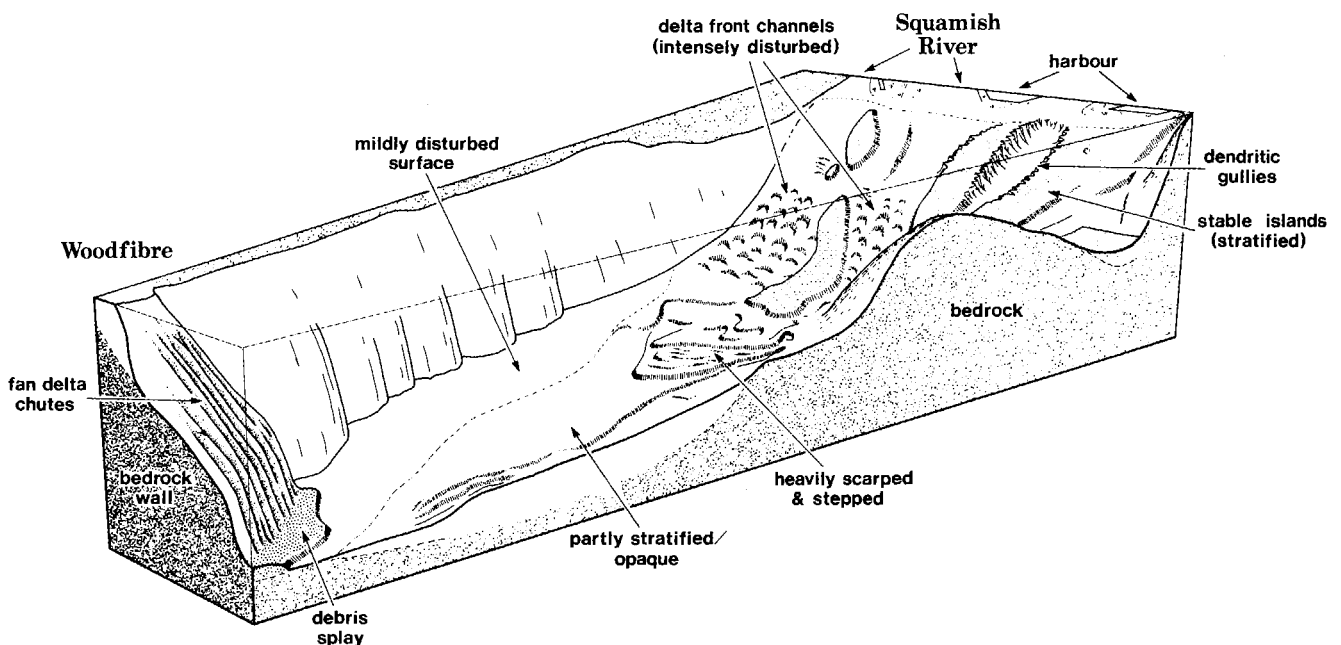


Figure 46. Submarine geomorphology of Howe Sound from the Squamish delta to the Woodfibre delta showing mass movement features (after Prior and Bornhold, 1984).

region is within Keefer's (1984) limit for the occurrence of disrupted slides. The earthquake did not trigger the Hope slide which, as noted above was in a state of limiting equilibrium. With reference to the 1946 Vancouver Island earthquake, Rogers (1980) mentions a slump at Matsqui triggered by the earthquake at an epicentral distance of about 250 km. It is also noted that the earthquake triggered several major landslides on Vancouver Island itself (Mathews, 1979) including the 1946 Mount Colonel Foster rock avalanche (Evans, 1989b).

## DISCUSSION AND CONCLUSIONS

Landslides in the Vancouver region have had a direct impact on mining camps, residential communities, transportation routes, energy generation and transmission facilities, industrial sites, and on the quality of the forestry and fishery resource base.

The highest impact of landslides in the Vancouver region, in terms of direct cost, cost of mitigation, and loss of life, is by high frequency low-magnitude events ( $\leq 100\,000\text{ m}^3$ ). These events have an annual frequency of about 1:10 and consist of rainfall triggered debris flows and debris avalanches from steep mountain watersheds and escarpments in Pleistocene sediments, catastrophic seepage erosion events, and rockfalls and small rock avalanches.

Canada's second largest landslide disaster (1915 at Jane Camp, Britannia Mine; 56 deaths) and the country's largest known historical rock avalanche (1965 Hope slide) have occurred in the Vancouver region. The Hope slide occurred in two phases separated by 3 hours and occurred at the same location as a prehistoric landslide of similar magnitude. Several large rock avalanche debris accumulations in the region are seen to be the product of multiple events separated by as much as thousands of years.

Two major landslides with volumes in excess of  $20\,000\,000\text{ m}^3$  have blocked major transportation corridors in the Vancouver region since 1855, viz. the Rubble Creek and Hope events. This indicates an annual frequency of 1:100. Previous to 1855, published and unpublished field data indicate that the same transportation corridors have been blocked by landslides of similar magnitude about ten times since deglaciation, indicating a frequency of 1:1000, assuming no decay effect. Thus the historic frequency appears to an order of magnitude greater than the prehistoric frequency. No explanation of this discrepancy is offered at present.

Noncatastrophic mountain slope deformation has had important direct impact on civil engineering structures, and indirect impact because of uncertainty about their future behaviour.

The Garibaldi Volcanic Belt is highly susceptible to major landslides ( $\geq 0.5$  million cubic m). The Mount Garibaldi volcanic complex and Mount Cayley volcano (Hickson, 1994) have been the subject to frequent large-scale landslide activity in the Holocene which continues into the present century. At

the debris accumulation fans formed by such activity, stratigraphic evidence and radiocarbon dates suggest that they have formed by multiple landslide events.

Pleistocene deposits in the region show a wide variety of landslide types reflecting the stratigraphical, geotechnical, and hydrogeological complexity of the materials. Landslides in these materials are generally triggered by heavy rains.

Submarine failures have occurred on steep delta slopes in both marine and lacustrine environments in response to rapid deposition in a high energy geomorphic environment.

It is noted that even in the absence of a significant historical earthquake, the frequency of landslides and the variety of landslide styles in the Vancouver region is notable. Large prehistoric earthquakes have undoubtedly triggered landslides in the region. Any future large earthquakes affecting the region must be expected to trigger widespread slope movements.

As our knowledge of the distribution of landslides in both space and time increases and our ability to quantify landslide mechanics improves, land use decisions based on this better understanding are increasingly being made. This has the effect of increasing the amount of land sterilized (i.e. taken out of productive use), due to exposure to perceived landslide hazard. In addition, as landslide hazards become better known, retrofitting of existing facilities is increasingly being undertaken, frequently at substantial cost. Both of these responses to an increased knowledge of landslides in the Vancouver region contribute to their indirect cost.

Because of the increasing vulnerability of developed sites associated with rapid economic development, it is concluded that all of the landslide types and processes discussed here will have increasing impact on facilities in the Vancouver region. Much research remains to be done on the nature of their occurrence and the mechanics of their behaviour.

## ACKNOWLEDGMENT

We are grateful to Dr. Greg Brooks, Geological Survey of Canada, for a thorough review of the original manuscript.

## REFERENCES

- Allan, J.F.**  
1957: Landslides, washouts and mudflows in the Lower Fraser Valley, British Columbia; B.A.Sc. thesis, University of British Columbia, Vancouver, British Columbia, 45 p.
- Armstrong, J.E.**  
1980: Surficial geology, Chilliwack, B.C.; Geological Survey of Canada, Map 1487A, scale 1:50 000.  
1984: Environmental and engineering applications of the surficial geology of the Fraser Lowland, British Columbia; Geological Survey of Canada, Paper 83-23, 54 p.
- Berger, T.B.**  
1973: Reasons for Judgement of the Honourable Justice Berger on the matter of the Land Registry Act and an application for approval of a proposed subdivision by Cleveland Holdings Ltd.; Supreme Court of British Columbia (legal document available from court registry).



- Bornhold, B.D.**  
1983: Fjords; *Geos*, v. 12, no. 1, p. 1-4.
- Bovis, M.J. and Dagg, B.R.**  
1988: A model for debris accumulation and mobilization in steep mountain streams; *Hydrological Sciences Journal*, v. 33, p. 589-604.  
1992: Debris flow triggering by impulsive loading; mechanical modelling and case studies; *Canadian Geotechnical Journal*, v. 29, p. 345-352.
- Bovis, M.J., Dagg, B.R., and Kaye, D.**  
1985: Debris flows and debris torrents in the southern Canadian Cordillera. Discussion; *Canadian Geotechnical Journal*, v. 22, p. 608.
- British Columbia Ministry of Energy, Mines, and Petroleum Resources**  
1993: Landslides in British Columbia; Information Circular 1993-7 (pamphlet).
- Brooks, G.R.**  
1992: Aspects of post-glacial sediment supply and its control upon the morphology of Squamish River, southwestern British Columbia; Ph.D. thesis, Simon Fraser University, Burnaby, British Columbia, 448 p.
- Brooks, G.R. and Hickin, E.J.**  
1991: Backwater deposits from Mount Cayley debris avalanche dammings of Squamish River, southwestern British Columbia; *Canadian Journal of Earth Sciences*, v. 28, p. 1375-1385.
- Bruce, I. and Cruden, D.**  
1977: The dynamics of the Hope slide; *International Association of Engineering Geology, Bulletin*, v. 16, p. 94-98.
- Buchanan, R.G.**  
1983: An assessment of natural hazards management in British Columbia; M.A. thesis, University of Victoria, Victoria, British Columbia, 160 p.
- Cave, P.W.**  
1992a: Hazard acceptability thresholds for development approvals by local government; Proceedings, British Columbia Geological Survey Workshop on Geologic Hazards in British Columbia, British Columbia Ministry of Energy Mines and Petroleum Resources, Open File 1992-15, p. 15-25.  
1992b: Natural hazards, risk assessment and land use planning in British Columbia: progress and problems; in *Geotechnique and Natural Hazards*, Bitech Publishers, Vancouver, British Columbia, p. 1-11.
- Church, M. and Miles, M.J.**  
1987: Meteorological antecedents to debris flow in southwestern British Columbia; some case histories; in *Debris Flows/Avalanches: Process, Recognition, and Mitigation*, (ed.) J.E. Costa and G.F. Wieczorek; Geological Society of America, *Reviews in Engineering Geology*, v. VII, p. 63-79.
- Clague, J.J.**  
1991: Natural hazards, Chapter 21; in *Geology of the Cordilleran Orogen in Canada*, (ed.) H. Gabrielse and C.J. Yorath; Geological Survey of Canada, Geological Survey of Canada, no. 4, p. 803-815 (also Geological Society of America, *The Geology of North America*, v. G-2).
- Clague, J.J. and Evans, S.G.**  
1987: Rock avalanches; *Canadian Geographer*, v. 31, p. 278-282.  
1994a: A gravitational origin for the Hell Creek "fault", British Columbia; in *Current Research 1994-A*; Geological Survey of Canada, p. 193-200.  
1994b: Formation and failure of natural dams in the Canadian Cordillera; Geological Survey of Canada, Bulletin 464, 35 p.
- Clague, J.J. and Shilts, W.W.**  
1993: Two landslide-dammed lakes in the Cascade Mountains, southwestern British Columbia; in *Current Research, Part E*; Geological Survey of Canada, Paper 93-1E, p. 47-54.
- Clague, J.J. and Souther, J.G.**  
1982: The Dusty Creek landslide on Mount Cayley, British Columbia; *Canadian Journal of Earth Sciences*, v. 19, p. 524-539.
- Clague, J.J., Evans, S.G., Fulton, R.J., Ryder, J.M., and Stryd, A.H.**  
1987: Quaternary geology of the southwestern Canadian Cordillera; 12th INQUA Congress, Guidebook, Field Excursion A-18, 67 p.
- Crandell, D.**  
1971: Postglacial lahars from Mount Rainier volcano, Washington; United States Geological Survey, Professional Paper 667, 73 p.
- Cruden, D.M.**  
1985: Rock slope movements in the Canadian Cordillera; *Canadian Geotechnical Journal*, v. 22, p. 528-540.
- Cruden, D.M. and Lu, Z.-Y.**  
1989: The geomorphic impact of the catastrophic October 1984 flood on the planform of Squamish River, southwestern British Columbia: Discussion; *Canadian Journal of Earth Sciences*, v. 26, p. 336.  
1992: The rockslide and debris flow from Mount Cayley, B.C., in June 1984; *Canadian Geotechnical Journal*, v. 29, p. 614-626.
- Cruden, D.M., Bornhold, B.D., Chagnon, J.-Y., Evans, S.G., Heginbottom, J.A., Locat, J., Moran, K., Piper, D.J.W., Powell, R., Prior, D., Quigley, R.M., and Thomson, S.**  
1989: Landslides: extent and economic significance in Canada; in *Landslides: Extent and Economic Significance*, (ed.) E.E. Brabb and B.L. Harrod, Balkema, Rotterdam, p. 1-24.
- Dawson, G.M.**  
1879: Report on exploration in the southern portion of British Columbia; Geological Survey of Canada, Report of Progress, 1877-1878, Part B, p. 1-173.
- Desloges, J.R. and Gilbert, R.**  
1991: Sedimentary record of Harrison Lake: implications for deglaciation in southwestern British Columbia; *Canadian Journal of Earth Sciences*, v. 28, p. 800-815.
- Eisbacher, G.H.**  
1979: First-order regionalization of landslide characteristics in the Canadian Cordillera; *Geoscience Canada*, v. 6, p. 69-79.  
1982: Slope stability and land use in mountain valleys; *Geoscience Canada*, v. 9, p. 14-27.  
1983: Slope stability and mountain torrents, Fraser Lowlands and southern Coast Mountains, British Columbia; Geological Association of Canada/Mineralogical Association of Canada/Canadian Geophysical Union Annual Meeting, Field Trip Guide Book No. 15, 46 p.
- Eisbacher, G.H. and Clague, J.J.**  
1981: Urban landslides in the vicinity of Vancouver, British Columbia, with special reference to the December 1979 rainstorm; *Canadian Geotechnical Journal*, v. 18, p. 205-216.  
1984: Destructive mass movements in high mountains: hazard and management; Geological Survey of Canada, Paper 84-16, 230 p.
- Evans, S.G.**  
1982: Landslides and surficial deposits in urban areas of British Columbia: a review; *Canadian Geotechnical Journal*, v. 19, p. 269-288.  
1984: The landslide response of tectonic assemblages in the southern Canadian Cordillera; Proceedings, IV International Symposium on Landslides, v. 1, p. 495-502.  
1986: Landslide damming in the Cordillera of Western Canada; in *Landslide Dams: Processes, Risk, and Mitigation*, (ed.) R.L. Schuster; American Society of Civil Engineers, *Geotechnical Special Publication*, no. 3, p. 111-130.  
1987: Surface displacement and massive toppling on the northeast ridge of Mount Currie, British Columbia; in *Current Research, Part A*; Geological Survey of Canada, Paper 87-1A, p. 181-189.  
1988: Ground failure hazards in the Canadian Cordillera; *Ground Failure (USA)*, v. 4, p. 7-8.  
1989a: Landslides and related processes in the Canadian Cordillera; *Landslide News (Japan)*, v. 3, p. 3-6.  
1989b: The 1946 Mount Colonel Foster rock avalanche and associated displacement wave, Vancouver Island, British Columbia; *Canadian Geotechnical Journal*, v. 26, p. 447-452.  
1989c: Landslides in the Cordillera; *Geotechnical News*, v. 7, p. 39-41.  
1990a: Landslides in the Cordillera; an overview; Program with Abstracts, v. 15, Geological Association of Canada / Mineralogical Association of Canada, Annual Meeting, Vancouver, British Columbia, p. A38.  
1990b: Massive debris avalanches from volcanoes in the Garibaldi Volcanic Belt, British Columbia; Program with Abstracts, v. 15, Geological Association of Canada / Mineralogical Association of Canada, Annual Meeting, Vancouver, British Columbia, p. A38.  
1992a: High-magnitude low frequency catastrophic landslides in British Columbia; Proceedings, British Columbia Geological Survey Workshop on Geologic Hazards in British Columbia, British Columbia Ministry of Energy Mines and Petroleum Resources, Open File 1992-15, p. 71-98.  
1992b: Landslides and river damming events associated with the Plinth Peak volcanic eruption, southwestern British Columbia; Proceedings, First Canadian Symposium on Geotechnique and Natural Hazards, Vancouver, British Columbia, p. 405-412.  
1993: The field documentation of highly mobile rock and debris avalanches in the Canadian Cordillera; Preprint, Pierre Beghin International Workshop on rapid gravitational mass movements, Grenoble, France, December 1993.

- Evans, S.G. and Brooks, G.R.**  
 1991: Prehistoric debris avalanches from Mount Cayley volcano, British Columbia; *Canadian Journal of Earth Sciences*, v. 28, p. 1365-1374  
 1992: Prehistoric debris avalanches from Mount Cayley volcano, British Columbia: Reply; *Canadian Journal of Earth Sciences*, v. 29, p. 1343-1347.
- Evans, S.G. and Clague, J.J.**  
 1988: Catastrophic rock avalanches in glacial environments; in *Landslides*, (ed.) C. Bonnard; Proceedings, 5th International Symposium on Landslides, v. 2, p. 1153-1158.
- Evans, S.G. and Gardner, J.**  
 1989: Geological hazards in the Canadian Cordillera; in Chapter 12 of *Quaternary Geology of Canada and Greenland*, (ed.) R.J. Fulton; Geological Survey of Canada, *Geology of Canada*, no. 1, p. 702-713 (also *Geological Society of America, The Geology of North America*, v. K-1).
- Evans, S.G. and Hungr, O.**  
 1993: The analysis of rockfall hazard at the base of talus slopes; *Canadian Geotechnical Journal*, v. 30, p. 620-636.
- Evans, S.G. and Lister, D.R.**  
 1984: The geomorphic effects of the July 1983 rainstorms in the southern Cordillera and their impact on transportation facilities; in *Current Research, Part B*; Geological Survey of Canada, Paper 84-1B, p. 223-235.
- Evans, S.G., Clague, J.J., Woodsworth, G.J., and Hungr, O.**  
 1989: The Pandemonium Creek rock avalanche, British Columbia; *Canadian Geotechnical Journal*, v. 26, p. 427-446.
- Fell, R.**  
 1994: Landslide risk assessment and acceptable risk; *Canadian Geotechnical Journal*, v. 31, p. 261-272.
- Gerath, R.F.**  
 1993a: Hazard zonation mapping on the Redrofs escarpment: a geotechnical hot spot on the Sunshine Coast of British Columbia; Biennial Meeting, Canadian Quaternary Association, Victoria, British Columbia, Program with Abstracts, p. A15.  
 1993b: Quaternary geology and slope activity on the Redrofs Escarpment, Sunshine Coast of British Columbia; Biennial Meeting, Canadian Quaternary Association, Victoria, British Columbia, Program with Abstracts, p. A16.
- Gilbert, R.**  
 1975: Sedimentation in Lillooet Lake, British Columbia; *Canadian Journal of Earth Sciences*, v. 12, p. 1697-1711.
- Gilbert, R. and Desloges, J.R.**  
 1992: The late Quaternary sedimentary record of Stave Lake, southwestern British Columbia; *Canadian Journal of Earth Sciences*, v. 29, p. 1997-2006.
- Hardy, R.M., Morgenstern, N.R., and Patton, F.D.**  
 1978: Report of the Garibaldi Advisory Panel; British Columbia Department of Highways, Victoria, British Columbia, 371 p.
- Hickin, E.J.**  
 1989: Contemporary Squamish River sediment flux to Howe Sound, British Columbia; *Canadian Journal of Earth Sciences*, v. 26, p. 1953-1963.
- Hickson, C.J.**  
 1994: Character of volcanism, volcanic hazards, and risk, northern end of the cascade magmatic arc, British Columbia and Washington; in *Geology and geological hazards of the Vancouver region, southwestern British Columbia*, (ed.) J.W.H. Monger, Geological Survey of Canada Bulletin 481 (this volume).
- Howes, D.**  
 1987: A terrain evaluation method for predicting terrain susceptible to post-logging landslide activity; British Columbia Ministry of Environment and Parks Technical Report 28, 38 p.
- Hungr, O.**  
 1993: Flood and debris flow mitigation for proposed Whistler Creek redevelopment; Preprint, Conference on Whistler and Water: Building a City in the Mountains, Whistler, British Columbia.
- Hungr, O. and Evans, S.G.**  
 1988: Engineering evaluation of fragmental rockfall hazards; in *Landslides*, (ed.) C. Bonnard; Proceedings, 5th International Symposium on Landslide, v. 1, p. 685-690.  
 1989: Engineering aspects of rockfall hazards in Canada; Geological Survey Canada, Open File 2061, 102 p.
- Hungr, O. and Skermer, N.A.**  
 1992: Squamish Highway, Squamish-Whistler areas; Technical Tours Guidebook, GeoHazards '92, BiTech Publishers, Vancouver, British Columbia, p. 4-46.
- Hungr, O. and Smith, D.**  
 1985: Landslides and development in the Lower Mainland, British Columbia; *B.C. Professional Engineer*, v. 36, p. 11-14.
- Hungr, O., Morgan, G.C., and Kellerhals, R.**  
 1984: Quantitative analysis of debris torrent hazards for design of remedial measures; *Canadian Geotechnical Journal*, v. 21, p. 663-677.
- Hungr, O., Morgan, G.C., VanDine, D.F., and Lister, D.R.**  
 1987: Debris flow defences in British Columbia; in *Debris Flows/Avalanches: Process, Recognition, and Mitigation*, (ed.) J.E. Costa and G.F. Wieczorek; Geological Society of America, *Reviews in Engineering Geology*, v. VII, p. 201-222.
- Hungr, O., Sobkowicz, J., and Morgan, G.C.**  
 1993: How to economize on natural hazards; *Geotechnical News*, v. 11, p. 54-57.
- Hutchinson, J.N.**  
 1982: Slope failures produced by seepage erosion in sands; in *Landslides and Mudflows*; reports of Alma-Ata International seminar, October 1981 (ed.) A. Sheko; p. 250-268.  
 1988: Morphological and technical parameters of landslides in relation to geology and hydrogeology, state-of-the-art report; in *Landslides*, (ed.) C. Bonnard; Proceedings, 5th International Symposium on Landslides, v. 1, p. 3-35.
- International Pacific Salmon Fisheries Commission**  
 1980: Hell's Gate Fishways; New Westminster, British Columbia, 8 p.
- Jackson, L.E., Church, M., Clague, J.J., and Eisbacher, G.H.**  
 1985: Slope hazards in the southern Coast Mountains of British Columbia, Field Trip 4; in *Field Guides to Geology and Mineral Deposits in the Southern Canadian Cordillera*, (ed.) D.J. Tempelman-Kluit; Geological Society of America, Cordilleran Section, 1985 Annual Meeting, Field Trip Guidebook, p. 4-1 to 4-34.
- Jones, W.C.**  
 1959: Cheekye River mudflows; Unpublished report, British Columbia Department of Mines, Victoria, British Columbia, 9 p.
- Jordan, P.**  
 1987: Impacts of mass movement events on rivers in the southern Coast Mountains, British Columbia: summary report; Water Resources Branch, Inland Waters Directorate, Environment Canada, Report IWD-HQ-WRB-SS-87-3, 62 p.
- Kalkani, E.C. and Piteau, D.R.**  
 1976: Finite element analysis of toppling failure at Hell's Gate Bluffs, British Columbia; *Bulletin, Association of Engineering Geologists*; v. 13, p. 315-327.
- Keefer, D.K.**  
 1984: Landslides caused by earthquakes; *Geological Society of America, Bulletin*, v. 95, p. 406-421.
- Kellerhals, R. and Church, M.**  
 1990: Hazard management on fans, with examples from British Columbia; in *Alluvial Fans: a Field Approach*, (ed.) A.H. Rachoeki and M. Church; John Wiley and Sons, Chichester, p. 335-354.
- Lister, D.R.**  
 1980: Geotechnical studies and land subdivision in B.C.; Proceedings, Specialty Conference on Slope Activity Problems in Urban Areas, Canadian Geotechnical Society, Toronto, Ontario, 14 p.
- Lister, D.R., Kerr, J.W.G., Morgan, G.C., and VanDine, D.F.**  
 1984: Debris torrents along Howe Sound, British Columbia; Proceedings, 4th International Symposium on Landslides, v. 1, p. 649-654.
- Luternauer, J.L., Barrie, J.V., Christian, H.A., Clague, J.J., Evoj, R.W., Hart, B.S., Hunter, J.A., Killeen, P.G., Kostaschuk, R.A., Mathewes, R.W., Monahan, P.A., Moslow, T.F., Mwenifumbo, C.J., Olynyk, H.W., Patterson, R.T., Pullan, S.E., Roberts, M.C., Robertson, P.K., Tarbotton, M.R., and Woeller, D.J.**  
 1994: Fraser River delta: geology, geohazards, and human impact; in *Geology and Geological Hazards of the Vancouver Region, Southwestern British Columbia*, (ed.) J.W.H. Monger; Geological Survey of Canada, Bulletin 481.
- Martin, D.C., Piteau, D.R., Pearce, R.A., and Hawley, P.M.**  
 1984: Remedial measures for debris flows at the Agassiz Mountain Institution, British Columbia; *Canadian Geotechnical Journal*, v. 21, p. 505-517.

**Mathews, W.H.**

- 1952a: Mount Garibaldi, a superglacial Pleistocene volcano in southwestern British Columbia; *American Journal of Science*, v. 250, p. 81-103.
- 1952b: Ice-dammed lavas from Clinker Mountain, southwestern British Columbia; *American Journal of Science*, v. 250, p. 553-565.
- 1956: Physical limnology and sedimentation in a glacial lakes; *Geological Society of America Bulletin*, v. 67, p. 537-552.
- 1958: Geology of the Mount Garibaldi map-area, southwestern British Columbia, Canada Part II: geomorphology and Quaternary volcanic rock; *Geological Society of America Bulletin*, v. 69, p. 179-196.
- 1979: Landslides of central Vancouver Island and the 1946 earthquake; *Seismological Society of America, Bulletin*, v. 69, p. 445-450.

**Mathews, W.H. and McTaggart, K.C.**

- 1978: Hope rockslides, British Columbia, Canada; in *Rockslides and Avalanches, 1, Natural Phenomena*, (ed.) B. Voight; Elsevier Scientific Publishing Company, New York, p. 259-275.

**Miles, M.J. and Kellerhals, R.**

- 1981: Some engineering aspects of debris torrents; *Proceedings, 5th Canadian Hydrotechnical Conference*, v. 1, p. 395-420

**Milne, W.G., Rogers, G.C., Riddihough, R.P., McMechan, G.A., and Hyndman, R.D.**

- 1978: Seismicity of western Canada; *Canadian Journal of Earth Sciences*, v. 15, p. 1170-1193.

**Moore, D.P.**

- 1983: Highway and landslide tour, southern Coast Mountains, British Columbia; 7th Pan American Conference on Soil Mechanics and Foundation Engineering, Guidebook, Tour No. 2, 82 p.

**Moore, D.P. and Mathews, W.H.**

- 1978: The Rubble Creek landslide, southwestern British Columbia; *Canadian Journal of Earth Sciences*, v. 15, p. 1039-1052.

**Moore, D.P., Ripley, B.D., and Groves, K.L.**

- 1992: Evaluation of mountainslope movements at Wahleach; in *Geotechnique and Natural Hazards*, Bitech Publishers, Vancouver, British Columbia, p. 99-107.

**Morgan, G.C.**

- 1986: Acceptability of natural hazards in transportation corridors; in *Transportation Geotechnique*, Vancouver Geotechnical Society, 24 p.
- 1992: Quantification of risks from slope hazards; *Proceedings, British Columbia Geological Survey Workshop on Geologic Hazards in British Columbia*, British Columbia Ministry of Energy Mines and Petroleum Resources, Open File 1992-15, p. 57-70.

**Morgan, G.C., Rawlings, G.E., and Sobkowitz, J.C.**

- 1992: Evaluating total risk to communities from large debris flows; in *Geotechnique and Natural Hazards*, Bitech Publishers, Vancouver, British Columbia, p. 225-236.

**Nasmith, H.**

- 1972: Engineering geology of the southern Cordillera of British Columbia; 24th International Geological Congress, Guidebook, Field Excursion A08-C08, 34 p.

**Nasmith, H.W. and Mercer, A.G.**

- 1979: Design of dykes to protect against debris flows at Port Alice, British Columbia; *Canadian Geotechnical Journal*, v. 16, p. 748-757.

**Nasmith, H.W., Mathews, W.H., and Rouse, G.E.**

- 1967: Bridge River Ash and some other Recent ash beds in British Columbia; *Canadian Journal of Earth Sciences*, v. 4, p. 163-170.

**Naumann, C.M.**

- 1990: The Cheam Slide: a study of the interrelationship of rock avalanches and seismicity; M.A.Sc. Thesis, University of British Columbia, Vancouver, British Columbia, 203 p.

**Naumann, C.M. and Savigny, K.W.**

- 1992: Large rock avalanches and seismicity in southeastern British Columbia; in *Landslides*, (ed.) D.H. Bell; A.A. Balkema, Rotterdam, v. 2, p. 1187-1192.

**O'Loughlin, C.L.**

- 1972: A preliminary study of landslides in the Coast Mountains of southwestern British Columbia; in *Mountain Geomorphology: Geomorphological Processes in the Canadian Cordillera*, (ed.) H.O. Slaymaker and H.J. McPherson; Tantalus Research Ltd., Vancouver, British Columbia, p. 101-111.

**Peckover, F.L. and Kerr, J.W.G.**

- 1977: Treatment and maintenance of rock slopes on transportation routes; *Canadian Geotechnical Journal*, v. 14, p. 487-507.

**Piteau, D.R.**

- 1977: Regional slope-stability controls and engineering geology of the Fraser Canyon, British Columbia; in *Landslides*, (ed.) D.R. Coates; Geological Society of America, Reviews in Engineering Geology, v. 3, p. 85-111.

**Piteau, D.R. and Peckover, F.L.**

- 1978: Engineering of rock slopes; in *Landslides: Analysis and Control*, (ed.) R.L. Schuster and R.J. Krizek; National Research Council, Transportation Research Board, Special Report 176, p. 192-228.

**Piteau, D.R., McLeod, B.C., Parks, D.R., and Lou, J.K.**

- 1979: Rock slope failure at Hell's Gate, British Columbia, Canada; in *Rockslides and Avalanches, 2, Engineering Sites*, (ed.) B. Voight; Elsevier Scientific Publishing Company, New York, p. 541-574.

**Prior, D.B. and Bornhold, B.D.**

- 1984: Geomorphology of slope instability features of Squamish Harbour, Howe Sound, British Columbia; *Geological Survey of Canada, Open File 1095*.

- 1986: Sediment transport on subaqueous fan delta slopes, Britannia Beach, British Columbia; *Geo-Marine Letters*, v. 5, p. 217-224.

**Prior, D.B., Wiseman, W.J., and Gilbert, R.**

- 1981: Submarine slope processes on a fan delta, Howe Sound, British Columbia; *Geo-Marine Letters*, v. 1, p. 85-90.

**Ramsey, B.**

- 1967: *Britannia - the story of a mine*; Agency Press Limited, Vancouver, British Columbia, 177 p.

**Read, P.B.**

- 1990: Mount Meager Complex, Garibaldi Belt, southwestern British Columbia; *Geoscience Canada*, v. 17, p. 167-170.

**Rogers, G.C.**

- 1980: A documentation of soil failure during the British Columbia earthquake of 23 June, 1946; *Canadian Geotechnical Journal*, v. 17, p. 122-127.

- 1988: An assessment of the megathrust earthquake potential of the Cascadia subduction zone; *Canadian Journal of Earth Sciences*, v. 25, p. 844-852.

**Saunders, I.R., Clague, J.J., and Roberts, M.C.**

- 1987: Deglaciation of Chilliwack River valley, British Columbia; *Canadian Journal of Earth Sciences*, v. 24, p. 915-923.

**Savigny, K.W.**

- in press: Engineering geology of large landslides in the Lower Fraser River Valley area, southwestern Canadian Cordillera; *Canadian Geotechnical Journal*.

**Savigny, K.W. and Clague, J.J.**

- 1992: Fraser Valley and Fraser Canyon areas; *Technical Tours Guidebook, GeoHazards '92*, BiTech Publishers, Vancouver, British Columbia, p. 47-99.

**Savigny, K.W. and Rinne, N.F.**

- 1991: Assessment of landslide hazards along a pipeline corridor in mountainous terrain of southwestern British Columbia; Preprint, 44th Canadian Geotechnical Conference, Calgary, 20 p.

**Scheidegger, A.**

- 1973: On the prediction of the reach and velocity of catastrophic landslides; *Rock Mechanics*, v. 5, p. 231-236.

**Schuster, R.L. and Crandell, D.R.**

- 1984: Catastrophic debris avalanches from volcanoes; *Proceedings, 4th International Symposium on Landslides*, v. 1, p. 567-572.

**Skempton, A.W. and Hutchinson, J.N.**

- 1969: Stability of natural slopes and embankment foundations; *Proceedings, 7th International Conference on Soil Mechanics and Foundation Engineering, Mexico, State-of-the-Art Volume*, p. 291-340.

**Slaymaker, H.O., Hungr, O., Desloges, J., Lister, D.R., Miles, M.J., and VanDine, D.F.**

- 1987: Debris torrent and debris flood hazards, Lower Fraser, Nicolum and Coquihalla valleys, B.C.; 19th General Assembly, International Union of Geodesy and Geophysics, Guidebook Excursion B2, 70 p.

**Smith, H.R.**

- 1971: A study of a prehistoric landslide surface at Cheam Lake, east of Chilliwack, British Columbia; B.A.Sc. thesis, University of British Columbia, Vancouver, British Columbia, 24 p.

**Souther, J.G.**

- 1980: Geothermal reconnaissance in the central Garibaldi Belt, British Columbia; in *Current Research, Part A*; Geological Survey of Canada, Paper 80-1A, p. 1-11.

**Spearing, D.N.**

- 1976: Living on mountain slopes; J.J. Douglas Ltd., North Vancouver, British Columbia, 48 p.

**Terzaghi, K.**

- 1956: Varieties of submarine slope failures; Proceedings, 8th Texas Conference on Soil Mechanics and Foundation Engineering, p. 1-41.
- 1960a: Storage dam founded on landslide debris; Boston Society of Civil Engineers, Journal, v. 47, p. 64-94.
- 1960b: Report on the proposed storage dam south of Lower Stillwater Lake on the Cheakamus River, B.C.; in From theory to practice in soil mechanics-selections from the writings of Karl Terzaghi; J. Wiley, New York, N.Y., p. 395-408.

**Theodore, M.H.**

- 1986: Review and case examples of rockfall protection measures in the mountain region of Canadian National Railway; in Transportation Geotechnique; Vancouver Geotechnical Society, 12 p.

**Thurber Consultants**

- 1983: Debris torrent and flooding hazards, Highway 99, Howe Sound; Report to British Columbia Ministry of Transportation and Highways, 25 p. and appendices.

**Thurber Engineering/Golder Associates**

- 1993: Summary report on Cheekye River terrain hazard and land use study; Report to British Columbia Ministry of Environment, Lands and Parks, Lower Mainland Region.

**VanDine, D.F.**

- 1985: Debris flows and debris torrents in the southern Canadian Cordillera; Canadian Geotechnical Journal, v. 22, p. 44-68.
- 1992: Low magnitude/high frequency mass movements; Proceedings, British Columbia Geological Survey Workshop on Geologic Hazards in British Columbia, British Columbia Ministry of Energy Mines and Petroleum Resources, Open File 1992-15, p. 99-107.

**Varnes, D.J.**

- 1978: Slope movement types and processes; in Landslides: Analysis and Control, (ed.) R.L. Schuster and R.J. Krizek; National Research Council, Transportation Research Board, Special Report 176, p. 11-33.

**Von Sacken, R.S.**

- 1991: New data and re-evaluation of the 1965 Hope Slide, British Columbia; M.Sc. thesis, University of British Columbia, Vancouver, British Columbia, 195 p.

**Von Sacken, R.S., Savigny, K.W., and Evans, S.G.**

- 1992: The detachment zone of the 1965 Hope Slide, British Columbia, Canada; Proceedings, VI International Symposium on Landslides, v. 1, p. 249-254.

**Weichert, D.H., Horner, R.B., and Evans, S.G.**

- 1990: Earthquakes and the 1965 Hope Landslide; EOS, Transactions of the American Geophysical Union, v. 71, p. 1145.
- in press: Seismic signatures of landslides: the 1990 Brenda Mine collapse and the 1965 Hope rockslides; Bulletin, Seismological Society of America, v. 84.

**Wetmiller, R.J. and Evans, S.G.**

- 1989: Analysis of the earthquakes associated with the 1965 Hope Landslide and their effects on slope stability at the site; Canadian Geotechnical Journal, v. 26, p. 484-490.

**Woods, P.J.**

- 1984: A debris flow landslide at Port Moody; Preprint volume, 37th Canadian Geotechnical Conference, Toronto, p. 217-222.

**Wyllie, D.C.**

- 1991: Rock slope stabilization and protection measures; in Proceedings, National Symposium on Highway and Railroad Slope Maintenance, Chicago, p. 41-63.