



The Hydrology of the Nile

by

J. V. Sutcliffe

Gibb Ltd, Gibb House, London Road, Reading RG6 1BL, UK

Y. P. Parks

Institute of Hydrology, Wallingford, Oxfordshire OX10 8BB, UK

This publication was financially sponsored by:



The International Water Management Institute, Colombo, Sri Lanka

and



Gibb Water, Reading, UK

IAHS Special Publication no. 5

(February 1999)

IAHS Special Publication no. 5

ISBN 1-910502-75-9

Published by the International Association of Hydrological Sciences 1999

IAHS Press, Institute of Hydrology, Wallingford, Oxfordshire OX10 8BB, UK

British Library Cataloguing-in-Publication Data. A catalogue record for this book is available from the British Library.

Editors for the Series of IAHS Special Publications:

H. Salz

The International Institute for Infrastructural, Hydraulic and Environmental Engineering,
Delft, The Netherlands

Zbigniew W. Kundzewicz

Editor *Hydrological Sciences Journal*, Research Centre of Agricultural and Forest
Environment, Polish Academy of Sciences, Poznan, Poland

The designations employed and the presentation of material throughout the publication do not imply the expression of any opinion whatsoever on the part of IAHS concerning the legal status of any country, territory, city or area or of its authorities, or concerning the delimitation of its frontiers or boundaries.

The use of trade, firm, or corporate names in the publication is for the information and convenience of the reader. Such use does not constitute an official endorsement or approval by IAHS of any product or service to the exclusion of others that may be suitable.

© IAHS Press and the authors 1999

This publication may be reproduced in whole or in part in any form for education or nonprofit uses, without special permission from the copyright holders, provided acknowledgement of the source is made. As a courtesy the authors should be informed of any use made of their work. No use of this publication may be made for resale or other commercial purposes without the prior written permission of IAHS Press and the authors.

The camera-ready pages papers were produced at IAHS Press, Wallingford, UK, by Penny Kisby.

IAHS Special Publications are available *only* from:
IAHS Press, Institute of Hydrology, Wallingford, Oxfordshire OX10 8BB, UK
tel.: +44 1491 692442; fax: +44 1491 692448; e-mail: jilly@iahs.demon.co.uk

Printed in the UK by Alden Press Ltd, Oxford

Foreword

A source of life, a stimulus to exploration, a bone of contention, a magnet for tourism, a conundrum to research—whichever the view of the Nile, the World's longest river has always been a focus of attention. From the time of the first Egyptian civilization to the present, the river has invariably been of enormous importance and, at the same time, something of an enigma. Now, with the ever increasing demands for water and the changes in its regime, it is even more prominent in the actions of the nations sharing the basin and in the minds and activities of different communities that have concern for the river, local, national and international.

Against such a background, this volume provides a timely overview of the Nile system—the White Nile, the Blue Nile and the main Nile, together with the lakes they connect, Victoria, Albert and Tana for example. It discusses the areas they flow through, particularly the Sudd and the roles of the different dams and reservoirs, those at Aswan for instance. The authors draw on earlier works, some from the nineteenth century and on the vital records of rainfall, water level and flow that have been collected at various stations throughout the basin, in order to paint a detailed hydrological picture of the regime of the Nile and its surroundings. One of the authors has devoted much of his life to work on the Nile (literally in the Nile when he started his career). He is the author of many papers and reports on the different hydrological problems of the basin. The other has spent some of hers unravelling the secrets of the Sudd and researching other Nile water resources problems. John Sutcliffe and Yvonne Parks are to be commended highly for the arduous task they have performed of bringing together information on the Nile from a wide range of sources and compiling it to fashion *The Hydrology of the Nile*.

This is the first occasion when a monograph in the Series of Special Publications, the blue books which started in 1989, has been aimed at a hydrological feature, in this case a river basin. Previous titles have dealt with a range of topics which have not been geographically referenced in the same way. It would be appropriate if this volume could be followed by similar ones on some of the other rivers of global importance.

John C. Rodda

President, International Association of Hydrological Sciences

Preface

The decision to add to the existing books on the Nile needs explanation. The main sources of information on the hydrology of the Nile are the books written by Dr H. E. Hurst and his collaborators. *The Nile* (Hurst, 1952 and 1957) deals with the river on a fairly popular level and the more technical volumes of *The Nile Basin* deal in turn with the different tributaries. These books are underpinned by Hurst's 60 years of experience on the Nile, including field work throughout the basin. They include numerous photographs, descriptions and technical analysis. However, the detailed books are of limited availability and seven volumes, in addition to the statistical volumes, are required to cover the whole area. Dramatic changes have occurred in the hydrology of the Nile since most of these volumes were produced, and the evidence of these changed conditions has not been assimilated into accounts of the whole basin.

Later books by Rzóska (1976), Shahin (1985) and Said (1993) are useful additions to the corpus. Rzóska dealt particularly with the biology of the basin; Shahin covered the climate and hydrology, and presented a mass of records which he analysed statistically; Said discussed the evolution of the river, the long-term river flows, and the history of water use. Howell *et al.* (1988) and Howell & Allan (1994) concentrated on specific topics: the Jonglei Canal and its effects and water management. The present authors contributed to both these books but feel that there is a need for an account of the whole basin which describes the present hydrology in its historical setting. This book takes account of recent changes, and in particular the change of regime of the Lake Victoria basin which occurred after 1961. It does not attempt to cover water quality or groundwater resources.

Several recent unpublished studies of the hydrology of different parts of the Nile basin do not appear to take full advantage of available knowledge. The whole basin is linked so that evidence from one tributary can be vital to the study of another; for example, flows at Aswan confirm evidence of early levels of Lake Victoria. This book is intended for hydrologists and water resource engineers confronted with such studies, who could benefit from an overall view of the river. It is hoped that the account will also be of interest to a wider readership. The book presents an account of the hydrology of the whole basin, dealing with each tributary in turn but drawing attention to links between reaches. Indeed, the Nile is shown to be one long interconnected hydrological entity, with slowly altering baseflow, each reach superimposing a seasonal fluctuation derived from the hydrological characteristics of the immediate region. The relationship between hydrology and vegetation affects the economy of the wetlands of the White Nile basin, and this relation is discussed.

Although he cannot claim the detailed experience of Hurst, John Sutcliffe has visited most of the Nile system during a career as a hydrologist who has continued to "drink the waters of the Nile". His initial experience during the 1950s as a member of the Jonglei Investigation Team was concentrated on the Bahr el Jebel flood plain. It included surveys on the Bahr el Ghazal, the Kinyeti to the east of the Bahr el Jebel, the Khor Fullus tributary of the Sobat, and along the White Nile reach. His subsequent research on the hydrology of the Sudd region included the ecology of the flood-plain grazing. He has taken part in studies of the upstream effects of a possible dam on Lake Albert, the effects of a potential hydroelectric project on the Kagera, and the water balance of Lake Victoria. He has also taken part in water resources planning for Sudan, and a hydrological study of

the impact of a revised Jonglei Canal project. Recent studies have included hydrological assessments of Sudan and Uganda, a study of the 1988 floods on the Blue Nile and Atbara, and hydrological aspects of hydroelectric planning for Uganda and Sudan. He has also taken part in a number of conferences on the Nile, including a keynote paper on the wetlands of the upper Nile, and has discussed Nile problems in Egypt.

Yvonne Parks has collaborated in assessment of the effects of the Jonglei Canal and hydrological studies of the wetlands of southern Sudan, which form the core of this book, and in the course of water resources studies in various parts of Africa has visited the Bahr el Ghazal, White Nile and Blue Nile tributaries.

Most of the basic data used in this study have been published in the relevant Supplements of *The Nile Basin*, or in other countries' yearbooks. They have not been reproduced here, but use has been made of diagrams to illustrate trends and flow patterns. The emphasis has been on basic hydrological processes, though some mention has been made of water resources problems and projects in order to put the hydrology in its practical context.

The authors are grateful to numerous colleagues for help and discussion over the years, including Dr H. E. Hurst and colleagues of the Jonglei Investigation Team (Paul Howell, John Glennie and Ken Snelson) and the Mefit-Babtie team. They would like to thank in particular Seán Avery, John Hennessy, David Knott, Jeremy Lazenby, Peter Mason, Bob Rangeley, Tim Sharp, Christopher Swan, and Nigel Widgery of Gibb Ltd (Sir Alexander Gibb & Partners); Val Bronsdon, Frank Farquharson, Jeremy Meigh, Ben Piper, David Plinston and Kevin Sene of the Institute of Hydrology; Tony Allan, Declan Conway, Dick Grove and Geoff Kite; also hydrologists throughout the basin, in particular Enoch Dribidu and Patrick Kahangire in Uganda, Kamal Ali Mohamed, Yahia Abdel Mageed, Isam Mustafa, Ibrahim Saleh, Osman el Tom Hamad, Saghayroon el Zein in Sudan, and Mohamed Nasser Ezzat, Abd el Kerim Afifi and Yasser Hamdi Elwan in Egypt. The errors of interpretation are those of the authors.

Thanks are also due to Gibb Ltd (formerly Sir Alexander Gibb & Partners) for support and sponsorship, to the International Water Management Institute for sponsorship and assistance with consultation, and to the Institute of Hydrology for help, including access to the "Hurst collection" of books.

The choice of place-names presents some problems, as rivers tend to have different names in different countries and change over short distances. Some names have been changed in recent years, but some have been changed back after political changes. The better known names have been used in general, in order to facilitate international reading. Although the metric system has always been used in Nile studies, some units like "milliards" ($\text{m}^3 \times 10^9$ or km^3) and millions per day ($\text{m}^3 \times 10^6 \text{ day}^{-1}$) are generally used and understood; some compromise has been made.

Some expressions peculiar to Nile studies require explanation. Timely water is water arriving at a time when the natural supply is inadequate for irrigation, and is roughly 1 February to 31 July at Aswan; at sites upstream the period must allow for time of travel, and at Malakal, for example, is 21 December to 20 June. Century storage describes overyear storage sufficient to guarantee a steady discharge equal to the average over a period of 100 years. It will be noted that the provision of overyear storage reduces the importance of timely flow. An attempt has been made to list references to assist further research.

Contents

Foreword <i>by J. C. Rodda</i>	iii
Preface	v

CHAPTER 1

An Outline of the Nile Basin

Introduction	1
Extent of the Nile basin	1
Rainfall and runoff	3
Main tributaries	5
White Nile	5
Blue Nile and main Nile	6

CHAPTER 2

Early Studies and Flow Measurement

Introduction	8
Early investigations	8
Establishment of the hydrological network	11
Numbers of gauging stations	12
Collaboration with other hydrological services	15
Records available at key sites	16

CHAPTER 3

The Lake Victoria Basin

Introduction	18
Early studies of the water balance	18
The Kagera basin	20
Lakes and swamps in lower Kagera	21
Contribution of other tributaries	23
Rainfall over Lake Victoria	25
Evaporation	27
Lake levels	28
Lake Victoria outflows	28
Water balance of Lake Victoria	30
The WMO/UNDP Hydrometeorological Survey	31
Reviews by the Institute of Hydrology	31
Long-term Lake Victoria balance	33
Downstream influence	35

CHAPTER 4

The East African Lakes below Lake Victoria

Introduction	37
Geography of the lake system	37
Early water balance observations	39
General climate of Lake Kyoga and Lake Albert basins	39
Published flow records	40
Main Nile between Lake Kyoga and Lake Albert	40
Semliki at Bweramule	40
Lake Albert outflows	41
Review of river flows at key sites	41
Lake Kyoga outflows at Masindi Port	41
River flows at Kamdini	42
Comparison of flows at Masindi Port and Kamdini	43
Comparisons of inflows and outflows for Lake Kyoga	43
Water balance of Lake Kyoga	45
Lakes Edward and George	48
Lake Albert	49
Kyoga Nile inflows	49
Semliki and local inflows	49
Albert Nile outflows	50
Other components of Lake Albert balance	50
Water balance	51
The surroundings of Lake Albert	53
Potential of Lake Albert as a reservoir	53
Effect on flows of Lake Kyoga and Lake Albert basins	53

CHAPTER 5

The Bahr el Jebel and the Sudd

Introduction	57
Early studies	60
Studies of the Jonglei Canal	61
Flows of the Bahr el Jebel	64
Available river flow records	64
Published river flow records	65
The Bahr el Jebel swamps	67
The influence of topography	68
The flooding regime	70
Study of a sample reach	73
Hydrological model of the Sudd	73
The hydrological model	74
Effect on areas of seasonal flooding	75
Hydrological control of flood-plain vegetation	76
Early observations and botanical studies	76
Botanical studies of the Jonglei Investigation Team	77

Juba–Bor survey	77
Description of flooding mechanism	79
Statistical analysis of vegetation distribution	79
Effect of rise in Lake Victoria	82
Importance of seasonal flooding to grazing	83
Effects of the Jonglei Canal	84
Assessment of the effects of the Jonglei Canal	84
Conclusion	87

CHAPTER 6

The Bahr el Ghazal Basin

Introduction	88
Early studies	88
Physical background	88
River profile	89
Early water balance	89
Estimates of tributary inflow	90
Topics for investigation	91
Available flow records	91
Flows estimated for the MIT study	92
Revised analysis of available river flow records	93
Derivation of total inflow series	94
Other water balance elements	96
Spill from Bahr el Jebel to Bahr el Ghazal	96
Area of Bahr el Ghazal swamps	96
The water balance model	98
Distribution of wetlands	99
Plans for reducing losses in the Bahr el Ghazal basin	102
Conclusion	102

CHAPTER 7

The Sobat Basin and the Machar Marshes

Introduction	103
Geography of the Sobat basin	103
General hydrology	104
Spill from the Sobat tributaries	104
The Machar marshes	106
Contributions of the Pibor	109
Spill from Baro to Machar marshes	109
Balance of Sobat channel	110
Water balance of the Machar marshes	111
Analysis by Hurst (1950)	111
Jonglei Investigation Team (1954)	111
Analysis by MIT (1980)	113
Analysis of years 1950–1955 (after Sutcliffe, 1993)	114

General environment	115
Analysis of Sobat channel storage	116
Runoff from the eastern plain	117
Conclusions	118

CHAPTER 8

The White Nile below Malakal

Introduction	119
Inflows to the White Nile	119
Outflows from the White Nile	121
Water balance of the White Nile from Malakal to Renk	122
Trends of losses on the White Nile	124
Vegetation of the White Nile flood plain	124
Effect of water-saving projects	126
Conclusion	126

CHAPTER 9

The Blue Nile and its Tributaries

Introduction	127
Geography of the basin	127
Rainfall and evaporation	130
Availability of flow records	130
Flows at various sites on the Blue Nile	135
Losses between Roseires and Khartoum	137
Flood regime	138
Flow forecasting systems	139
Sedimentation	140
Operation of Blue Nile reservoirs	140
Conclusions	141

CHAPTER 10

The Atbara and Main Nile to Wadi Halfa

Introduction	142
Topography	142
Land use and climate	143
Early account of the hydrology of the reach from Khartoum to Wadi Halfa	144
Available flow records	144
Flow measurements	145
Hydrology of individual components	146
Comparisons of inflows and outflows	148
Conclusions	149

CHAPTER 11
The Main Nile in Egypt

Introduction	151
Flow records at Aswan	151
Comparison with upstream flows	153
The genesis of the Aswan High Dam	154
Elimination of flood reserve	155
The effects of the Aswan High Dam	155
Flows down the Nile below Aswan	156
Evidence of the Roda gauge	158
Conclusion	160

CHAPTER 12
The Nile and Hydrological Aspects of Water Use

Introduction	161
Summary of flow series	161
Water use in the Nile basin	165
East Africa	168
Rwanda, Burundi and Congo	168
Uganda, Kenya and Tanzania	169
Ethiopia and Eritrea	170
Sudan	171
Egypt	171
Projects to increase river flows	172
Conclusion	173

References

<i>The Nile Basin</i> , vols I–XI	175
All cited references	175

CHAPTER 1

AN OUTLINE OF THE NILE BASIN

INTRODUCTION

The hydrology of the Nile basin cannot be understood without some knowledge of its complex geography. This chapter introduces the the important elements of the basin. The Nile is made up of a diverse group of different tributaries, which by a series of accidents meet and flow together into the Mediterranean Sea. The contrast between the size of the basin and the comparatively small volume of runoff is an important feature. The areas which contribute significantly to the total flow are relatively small and isolated: the East African lake region and the Ethiopian highlands. The water balance concept, which forms the basis of much of the discussion, is introduced, and the climate of the basin is discussed briefly. A description of the main tributaries is intended to put into context the later chapters which concentrate on each tributary or river reach in turn.

EXTENT OF THE NILE BASIN

The Nile is the longest river in the world at about 6700 km. It extends (Fig. 1.1) over an extremely wide band of latitude, from 4°S to 32°N, with a total catchment area of nearly 3 million km². Rushdi Said (Said, 1993) has pointed out that the present basin is a very recent development, as illustrated by the longitudinal profile (Fig. 1.2). It consists of a series of flat reaches in basins which evolved independently and are now linked by steep channels. He has described how the basin drainage evolved from a relatively short river. This excavated a canyon up to 4000 m deep some 6 million years ago, at a time when the Mediterranean Sea was isolated from the ocean and desiccated. This river was separated from the rest of Africa by the Nubian massif. At the time the Ethiopian plateau drained towards the Indian Ocean, though some flow entered the Sudd to the west. The Sudd formed an enormous lake with a depth of sediment up to 10 km thick which covered much of the present Nile basin within the Sudan. The Equatorial plateau drained towards the west into the Congo, with some flow to the Indian Ocean or north into the Sudd.

The Egyptian Nile formed a connection with the Ethiopian plateau some 750 000 years ago, though this connection was interrupted many times. Meanwhile the formation of the African Rift had caused major changes in the drainage pattern further south. The rivers of the Ethiopian plateau, which had flowed eastwards, were interrupted by the eastern arm of the Rift Valley. They were diverted to flow to the west towards the Nile. Drainage from the Equatorial plateau, towards the Congo basin, was also diverted by the development of the African Rift. This led to the formation of Lake Victoria within the depression between the two arms of the Rift Valley, and to the reversal of west-flowing rivers like the Kagera, the Kafu and the Katonga. Both the Sudd and Lake Victoria were closed basins until they overflowed to the north through Sabaloka gorge and Jinja respectively some 12 500 years ago. The levels of Lake Turkana (Rudolf) were sufficiently high about 9500 years ago that the lake contributed to the Nile system through the Sobat. This amalgamation of separate entities is illustrated by the longitudinal profile of the Nile, which is made up of a succession of steep

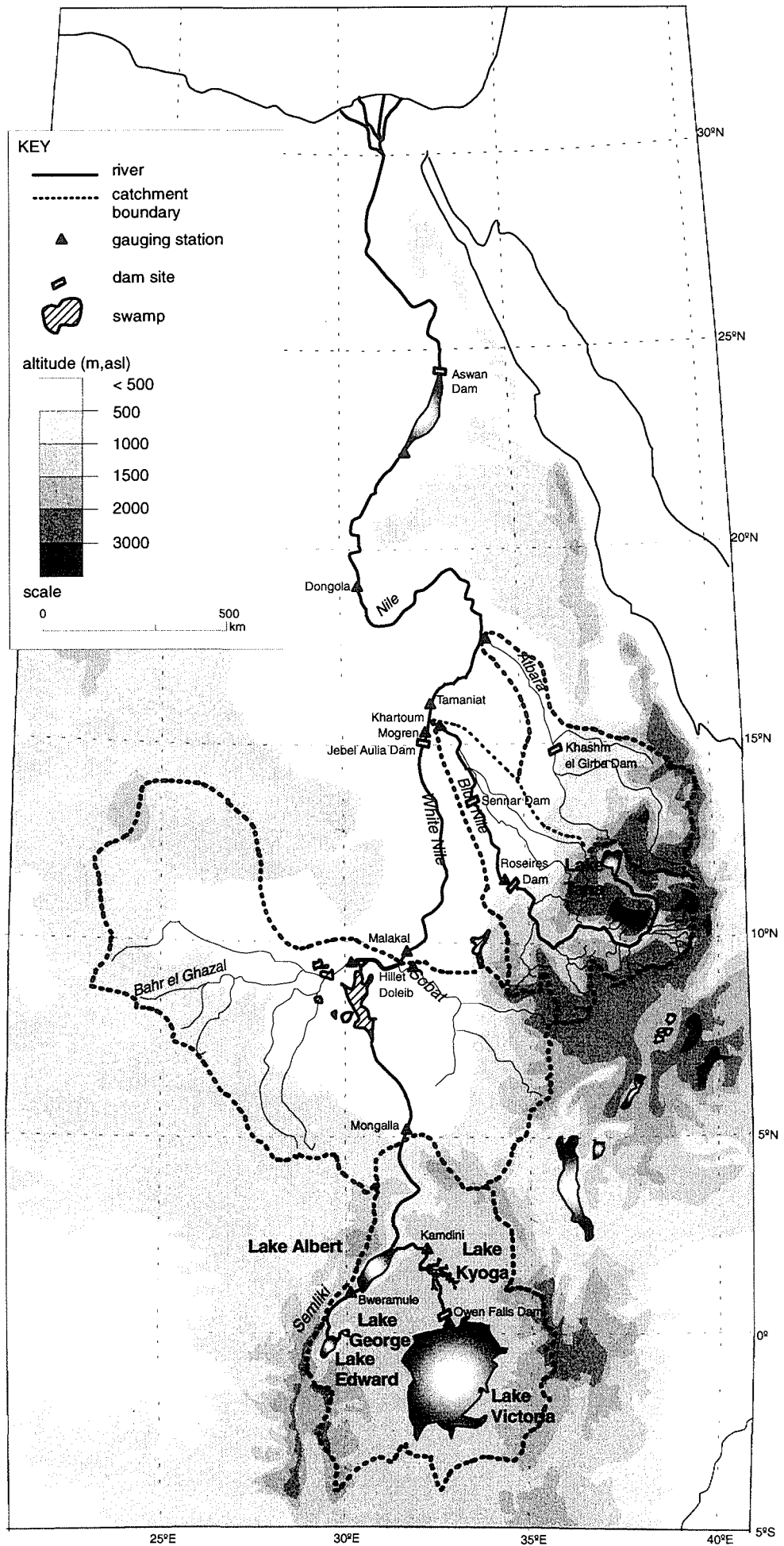

Fig. 1.1 Map of the Nile basin.

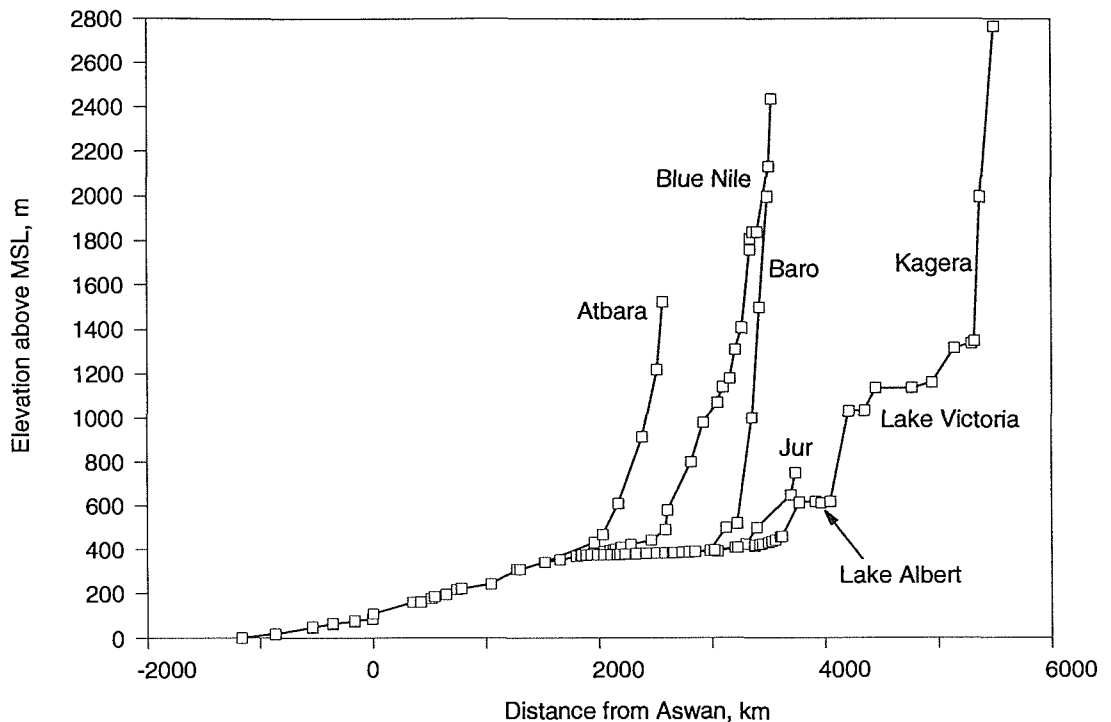

Fig. 1.2 Profile of the Nile and its tributaries.

sections and landings which show interior drainage basins. The present shape of the Nile basin is believed to be only 10 000 years old.

RAINFALL AND RUNOFF

A water balance often leads to the understanding of hydrological systems. This states that the water inflow to an area must equal the outflow, plus any increase of water storage within the area. Inflow is largely made up of rainfall and river inflow, while outflow consists mainly of river outflow or diversion, and evaporation from open water and vegetation. Groundwater flow is a component of inflow and outflow, but is generally small compared with river flows in this basin. Water storage is made up of soil moisture and groundwater storage, together with channel storage and lake or wetland storage. Lake and wetland storage are of particular importance in the White Nile basin, where spill from the river into wetlands and subsequent evaporation are major components of the balance. In these wetlands and adjoining plains a distinctive vegetation has adapted to the conditions. The vegetation provides a useful pointer to the hydrological conditions, and the links between vegetation type and flooding conditions are a key to interpreting this information.

Because of its extent over 36 degrees of latitude, the climate of the Nile basin is extremely variable. Table 1.1 illustrates the rainfall of the different parts of the system. This table is based on rainfall averages up to 1972 of the stations available in each case; the number of stations varies from five to over 50 and the periods of record vary. The table mainly indicates the seasonal pattern of the rainfall regime. It shows how the regime changes from the bimodal rainfall of the Lake Plateau area, with a transitional zone between Lake Albert and Mongalla, to a single rainfall season between Mongalla and Lake No. The trend towards shorter rainfall seasons continues to the north, from the Bahr el Ghazal and Baro tributaries, and the Ethiopian stations, to the relatively dry regime of the lower Blue Nile and main Nile reaches. The rainfall regimes of the important tributaries are discussed in later chapters.

Table 1.1 Average monthly rainfall over parts of the Nile basin (mm).

Jan.	Feb.	March	April	May	June	July	Aug.	Sept.	Oct.	Nov.	Dec.	Year
Lake Victoria basin (excluding the lake)												
75	90	134	194	145	61	47	68	72	89	111	100	1186
Lake Kyoga basin												
38	64	108	176	159	99	89	127	121	120	109	66	1276
Lake Albert basin												
27	55	95	149	137	81	87	128	134	142	121	58	1214
Lake Albert to Mongalla												
9	25	62	122	154	131	150	162	139	135	68	23	1180
Mongalla to Lake No												
2	6	25	70	119	121	147	141	125	90	19	6	871
Bahr el Ghazal basin												
4	12	39	90	143	162	186	205	174	118	31	5	1169
River Baro basin												
18	25	61	118	198	207	220	244	202	125	63	22	1503
Pibor, Akobo, Veveno basin												
4	12	33	89	122	118	155	165	123	88	35	10	954
Ethiopia												
14	28	57	91	125	137	237	243	167	73	34	21	1227
Lower Blue Nile basin												
0	0	0	2	8	24	84	109	44	8	0	0	279
Main Nile												
0	0	0	0	2	1	12	18	3	0	0	0	36

(from *The Nile Basin*, vol. VI, supplement 7)

Compared with the size of its basin, the total flow of the Nile is relatively small, though this does not affect its importance to the countries through which it flows. The average annual runoff from the entire basin is very low at about 30 mm expressed as a depth over the basin. However, this runoff is far from uniform. Although the basin is spread over 10 countries, the areas which actually contribute significant volumes to the river flow are relatively small and isolated. These are largely confined to the East African lake region, where rainfall is high and distributed between two rainfall seasons, and to the Ethiopian highlands where high rainfall within a single season and steep topography give rise to relatively high and concentrated runoff. Over most of the basin the runoff is low; in a number of areas the tributary inflow is in fact reduced by evaporation from wetlands or by channel losses. Moreover, both the total flow and the relative contributions of the different tributaries have varied considerably over the years. The relatively low runoff depths mean that runoff is sensitive to changes in basin rainfall. This leads to great variability of runoff from year to year.

The areas of high rainfall are naturally associated with the mountainous portions of the basin. The high ground is also concentrated in two main areas flanking the Rift Valley. This passes through Lakes Tanganyika, Edward and Albert and also to the east of Lake Victoria through Lake Turkana to the Ethiopian lakes. The mountains of Burundi, Rwanda and western Uganda, near the western arm of the Rift Valley, and the mountains of southwest Kenya and Mount Elgon in the eastern branch, form the rim of an area draining to Lake Victoria. The lake lies in a depression between these two arms. Further to the north, the mountains to the west of the Ethiopian Rift Valley form the source of a number of tributaries, including the Blue Nile and Atbara, which contribute most of the annual volume.

MAIN TRIBUTARIES

White Nile

The furthest tributary of the Nile is the Kagera which drains the mountains of Burundi and Rwanda, with average rainfall up to 1800 mm. It flows into Lake Victoria (about 1134 m elevation) after meandering through a series of lakes and swamps adjoining the river channel. A number of tributaries drain the forested escarpment to the northeast of the lake. Other less productive water courses drain the plains of the Serengeti to the southeast of the lake and the swamps of Uganda to the northwest. The water balance of the lake has presented a problem to hydrologists over many years. The outflow has been sensitive to periods of high rainfall, though the lake storage dampens both seasonal and short-term fluctuations.

The outflow from the lake is confined to a single channel heading north towards Lake Kyoga, through several shallow falls and rapids. The outflow from the lake was controlled naturally by the geometry of the Ripon Falls. Since 1953, when the Owen Falls dam was constructed just downstream, the outflow has been controlled by international agreement according to the same relation between lake level and outflow. The Victoria Nile reaches Lake Kyoga (1031 m) some 100 km north of its outfall. This lake is essentially a grass-filled valley which used to drain to the west towards the Congo. In some periods the lake causes a net loss of river flow and in other periods provides a net gain.

The Kyoga Nile flows west from the lake towards the western arm of the Rift Valley through level reaches with swamp vegetation, interrupted by rapids and falls culminating in the Murchison Falls. The river enters Lake Albert (Mobutu Sese Seko) (620 m) through a swamp near the northern end of the lake. The lake also receives the inflow of the river Semliki, draining Lake Edward (912 m) and the Ruwenzori and other mountains. The lake is within the Rift Valley and rainfall over the lake is low compared with evaporation.

The Albert Nile or Bahr el Jebel leaves Lake Albert at its northern end and flows northeast towards Nimule in a flat reach flanked by swamp vegetation. At Nimule the river crosses the Sudan border, turns abruptly to the northwest and flows in a steeper channel, with several rapids, towards Juba and Mongalla. Here the river enters the Sudd or Bahr el Jebel swamps. In the reach between Lake Albert and Mongalla the river receives seasonal runoff from a number of streams known as the torrents; these provide the high flows of the river following the single rainfall season. Thus the river flow at Mongalla is made up of a damped contribution from the East African lakes, which is liable to medium-term fluctuations between periods of high and low flow, and also the seasonal and sediment-laden flows of the torrents.

Within the Sudd the higher flows spill from the main channel into swamps and seasonally flooded areas. Evaporation from the flooded areas greatly exceeds rainfall, which itself is confined to a few months before the river rises. The effect of this spilling is that the outflow from the swamp is only about half the inflow and has little seasonal variation. The large volumes of water evaporated from these swamps gave rise to the proposal in 1904 for a canal, later known as the Jonglei Canal, to bypass the swamps and reduce the losses. This has ensured that hydrological attention has been focussed on this region. However, the complexity of the channels and the problem of measuring evaporation from swamp vegetation have meant that the flow processes within the Sudd were not understood until research into evaporation made it possible to estimate the water balance of the area as a whole.

At Lake No the Bahr el Jebel turns east and becomes the White Nile, and the Bahr el Ghazal flows into the lake from the west. The Bahr el Ghazal basin is relatively large and has the highest rainfall of any basin within the Sudan. However, the flows of the various tributaries of the Bahr el Ghazal are spilled into seasonal and permanent swamps, and virtually no flow reaches the White Nile.

The White Nile is joined from the east by the Sobat, whose tributaries, the Baro and Akobo, drain the southwestern part of the Ethiopian highlands. The Pibor also receives occasional high runoff from an indeterminate area of southeast Sudan. However, the Baro and Akobo both spill in high flow periods into adjoining wetlands; the Baro also spills north across the Ethiopia–Sudan border towards the little known Machar marshes. Thus the hydrological regime of the Sobat is also complicated by the influence of wetlands; the relative remoteness of these wetlands has meant that hydrological measurements and study have been less advanced than in the other tributaries.

The regime of the White Nile from the Sobat mouth near Malakal to its confluence with the Blue Nile at Khartoum is relatively simple. The river flows in a single trough and only receives significant local inflow in years of exceptional conditions in the Machar marshes. Its balance over the years has been influenced by the construction of the Jebel Aulia dam (1937) above the Blue Nile confluence to maintain downstream flows during the low flow season; this has resulted in wider areas of flooding and increased evaporation losses. Irrigation along the White Nile has grown considerably over the years, with abstraction made easier by the raised levels of the river upstream of the dam.

Blue Nile and main Nile

The bulk of the flow of the main Nile at Khartoum is provided by the Blue Nile, with its smaller tributaries the Dinder and Rahad. The Blue Nile drains a major part of the western Ethiopian highlands, with a small part of its basin subject to storage in Lake Tana. The rainfall over this basin is confined to a single season, and the river flows are therefore concentrated in a short period. Consequent problems of erosion and potential sedimentation make storage of flood waters difficult to achieve. Relatively small dams have been built at Sennar (1925) and at Roseires (1966) near the Sudan–Ethiopian border, in order to provide water for irrigation in the Gezira and other areas. Hydroelectric power has also been developed at these sites. The rainfall regime depends on the seasonal fluctuation of the ITCZ (InterTropical Convergence Zone). Thus the length of the rainfall and runoff seasons decreases from the Sobat in the south to the Blue Nile and its northern tributaries. This results in a short season of runoff in the Dinder and Rahad basins, which dry up for about half the year.

The main Nile below Khartoum flows north through the Sabaloka gorge and is joined 325 km north by its last tributary, the Atbara, which drains the northern portion of the highlands of Ethiopia and also part of Eritrea. The runoff season is even shorter than the Dinder and Rahad and the river is dry for much of the year. The Khashm el Girba reservoir was built on the upper Atbara in 1960–1964 to store this runoff for irrigation, but the flashy nature of the inflow has resulted in considerable siltation. Below the Atbara mouth the river flows in a series of wide loops through an arid area of successive cataracts and flatter reaches. The river flows are reduced by evaporation and irrigation abstractions. The Nile enters Egypt below Wadi Halfa where the reservoir formed by the Aswan High Dam now extends south of the border.

In order to store increasing portions of the Nile flow for irrigation and more recently for hydroelectric power, successive dams have been built at Aswan. The latest reservoir, above the Aswan High Dam or Sadd al Aali, has a capacity of nearly twice the mean annual flow. It was designed to provide overyear storage to alleviate periods of low annual flows. Flow records are available since 1870 at or above Aswan, though the site of the upstream river gauging station has been moved on several occasions as the dam was raised. These flow records summarize the changes of regime which have occurred over the past century on both the White and Blue Niles. Comparisons of flows along the reach between Khartoum and

Aswan reveal the effect of channel losses and abstractions as well as evaporation from the Aswan reservoir. The flow records below Aswan reflect both the role of the reservoir in equalizing flows and successive diversions for irrigation down the final reach between the High Dam and the Delta barrages.

CHAPTER 2

EARLY STUDIES AND FLOW MEASUREMENT

INTRODUCTION

The geography of the Nile basin, including its geology, topography, channel characteristics, and vegetation, could be deduced from exploratory travels and investigations. This information is easily stored in the form of maps and detailed descriptions. Indeed, a fairly comprehensive description of the Nile basin (Lyons, 1906) was based on early accounts and personal travels. Information can now be obtained from satellite imagery.

By contrast, the hydrological behaviour of the various tributaries can only be deduced from river flow records compiled over many years of field work. In this respect the countries of the Nile basin (Fig. 2.1) are fortunate that the importance of accurate and continuous records was understood by early investigators and as a result long records exist. It will be shown, in subsequent chapters, that the tributaries of the basin behave very differently from each other. They are also subject to fluctuations in rainfall and river flow which are maintained over periods of years. It is therefore important that flow records of consistent accuracy cover the whole river system. Records must be maintained continuously to monitor variations which occur in different basins over the years. An outline of early studies and available records provides an introduction to the hydrology.

EARLY INVESTIGATIONS

The early explorations of the White and Blue Nile basins have been described by a number of authors; Moorehead (1960, 1962) provides an easily accessible example. The sources of the White Nile were not known until the 1860s. Travel up the Bahr el Jebel was prevented by the physical barrier posed by the swamps of the Sudd. The floating vegetation, also known as "Sudd", made it impossible for boats to pass through the area without the considerable task of clearing blockages. Indeed, the Arabic word "Sudd" (pronounced as in "flood") means blockage or barrier. In spite of the interest and importance of the regime of the White Nile to Egypt, little was known for certain about its source. Herodotus had reached the first cataract at Aswan about 460 BC, but an expedition sent by Nero some 500 years later returned after being blocked by an impenetrable swamp.

In the end a combination of travels up the Nile and from the East African coast solved the problem. Egyptian expeditions opened up the White Nile from 1840 (Werne, 1849) and established stations like Gondokoro on the Bahr el Jebel. Burton and Speke left Zanzibar in 1857 and Speke reached the southern shore of Lake Victoria in 1858; it was not until 1862 that Speke and Grant established that a large river flowed north out of Lake Victoria. They then travelled north to Gondokoro and met Baker, who reached Lake Albert in 1864. He established the connection between the Lake Victoria outfall through Lake Kyoga and Lake Albert to the Bahr el Jebel. Thereafter little time was wasted before scientific exploration began, though access through the Sudan was effectively closed between about 1882 and 1898. Gordon mapped the course of the Bahr el Jebel in 1874, and climate data and subjective river level observations were recorded at Lado by Emin and others. The scientific expeditions of

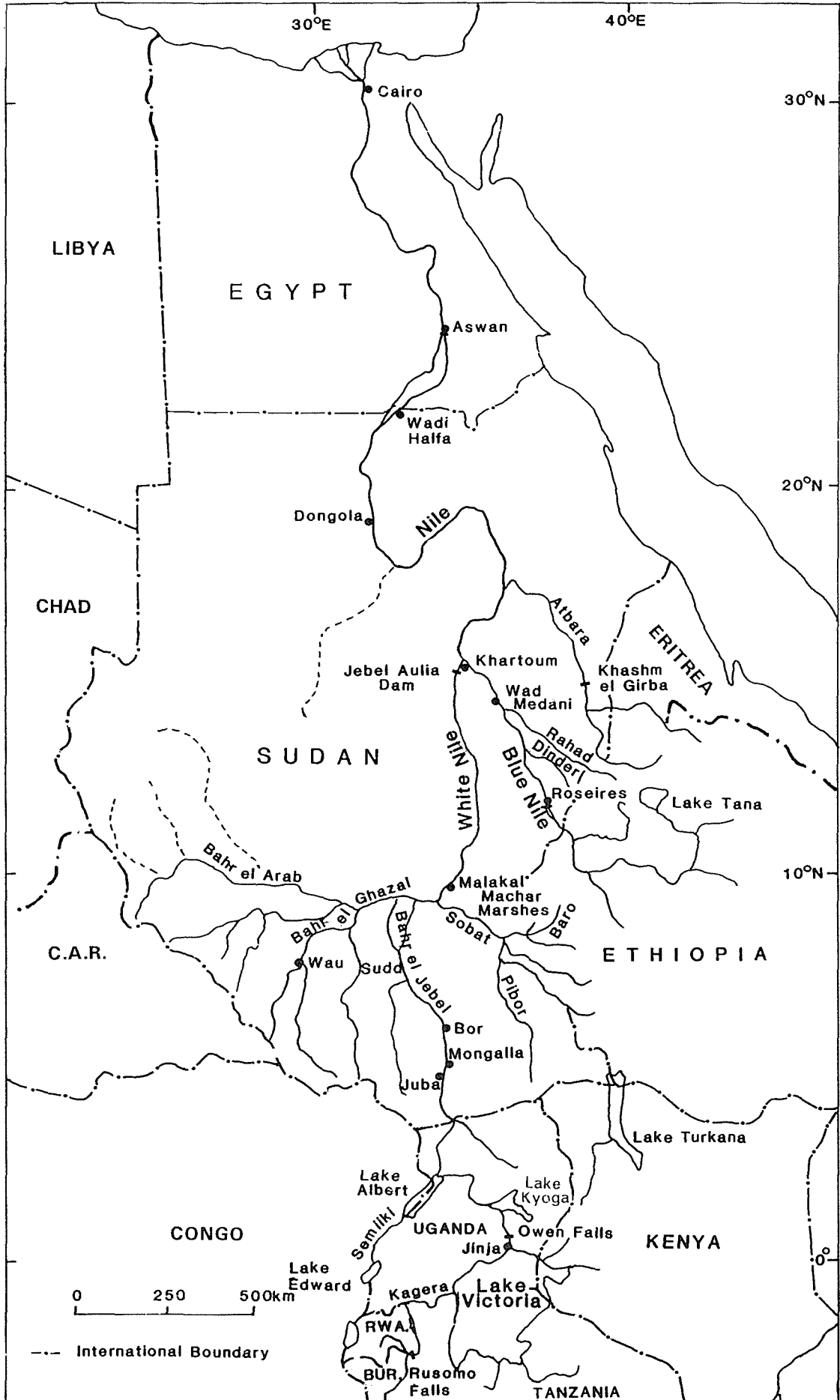

Fig. 2.1 Key sites of the Nile basin.

Garstin and Lyons between 1899 and 1903 led to the start of systematic hydrological measurements.

Garstin's tour of the White Nile and the East African lakes resulted in detailed mapping of certain reaches. It led to the proposal (Garstin, 1904) to bypass the Sudd by a channel to reduce the evaporation loss, which had been observed to amount to about half the inflow. Lyons (1906) published an account entitled *The Physiography of the River Nile and its Basin*. This included a great deal of information on the topography of the basin, and also some of the early hydrological records, including Lake Victoria levels. He was able to discuss channel changes in the Bahr el Jebel by comparing surveys, and to describe the different flooding conditions tolerated by the main species of swamp vegetation. He also noted (p. 26) that the interaction of the lake breeze and the prevailing winds was a likely cause of the high rainfall to the west of Lake Victoria.

Lake Victoria and the White Nile played an important part in regulating seasonal and annual flows before flow control was introduced with the first reservoirs downstream. However, the Lake Plateau basin was the last of the Nile sources to be delineated, and hydrological study did not start as early as on the other tributaries. Garstin (1901, 1904) and Lyons (1906) studied the lake levels as part of their investigation of the East African lakes, which they suggested as a possible site for water storage (Garstin, 1904, p. 165). They obtained information on the history of the lakes before formal level measurements began. They found that the levels of Lake Victoria had been high in 1878 and 1892–1995, and that the start of gauge readings in 1896 marked the recession from a period of high lake levels.

Hurst explored the southern shore of the lake in 1926 and measured flows on several branches of the Kagera tributary. Regular gaugings began in 1940, though levels were read from 1933. Hurst & Phillips (1938) made the first study of the water balance of Lake Victoria. They noted that the data were very scanty, with lake levels and rainfall observations at some stations for about 30 years.

The area between Lake Victoria and Lake Albert has received less scientific study than the Lake Victoria basin. Its geography was investigated by a number of travellers after Speke and Baker. After Gordon transferred the capital of Equatoria from Gondokoro to Lado in 1874, Emin Pasha occupied a number of sites as Governor of Equatoria from 1878 until the Stanley Relief Expedition forced him to leave during the Mahdiya in 1889. As a result there are early observations of climate from the 1880s (Lyons, 1906, pp. 82–86) and notes of river levels (Lyons, 1906, p. 102 and p. 362), but no systematic flow records. There is evidence from Lado (Lyons, 1906, p. 103) that Lake Albert was exceptionally high in 1878, and other evidence of lake levels similar to that on Lake Victoria. An example of such evidence of early high levels is a photograph of the Murchison Falls, probably taken in 1887, in the memoirs of Casati (1891, vol. II, p. 136). This appears to show the extension of the falls to the north, in contrast to the single channel sketched in 1864 by Baker (1866, vol. II, p. 143). A similar change also occurred after 1964 with the rise in Lake Victoria and the doubling of the outflow.

The first water balance of the lake basins was given by Hurst & Phillips (1938). They compared inflow with outflow for the Victoria Nile through Lake Kyoga. Similar estimates were made for the Lake Albert basin, and they estimated the torrent flows above Mongalla. The possibility of a reservoir on Lake Albert was discussed by Hurst & Phillips (1938, p. 81); it was noted that contours at a level of 20 m on the Butiaba gauge had been deduced by air survey.

River flows above and below the Sudd were measured during Garstin's visits to the upper Nile, suggesting that the outflow was only about half the inflow (Garstin, 1901, 1904). Willcocks had proposed the use of the East African lakes as reservoirs in 1893, and Garstin suggested a canal from Bor to the Sobat mouth in 1904. The main scientific information from the early studies was Garstin's and Lyons' accounts of the topography (Lyons, 1906) and their

compilation of early levels. High and low years were summarized by Lyons, who also pointed out that Sudd blockages in 1863, 1872 and 1878–1880 were associated with water level rises.

The topography of the Sudd was described by Garstin (1901, 1904) following several reconnaissance journeys. The spilling through the banks was observed, and it was noted (Garstin, 1904, p. 94) that the character of the marshes changed near Bor: ...“North of this place papyrus and ambatch, with those reeds which require to have their roots under water for a great portion of the year, take the place of the grasses met more to the south. The general level of the swamps, too, is much lower”. Hope (1902) described the effect of the flood of 1878 on the White Nile. Enormous quantities of vegetable debris were carried off by the current and communication was not restored until 1880. A more comprehensive account of the vegetation followed the botanical investigations of Migahid and others (Migahid, 1948, 1952). They identified the main species of the permanent swamp as *Cyperus papyrus*, *Vossia cuspidata*, *Phragmites communis* and *Typha australis* and identified the main controls as water depth, current velocity and ground level.

A preliminary water balance of the Bahr el Ghazal swamps was outlined in Hurst & Phillips (1938). During reconnaissance in 1930–1931, Hurst had been able to establish, in general terms, the areas of runoff accumulation and those of spill and evaporation. The tributary inflows were measured regularly at a series of sites along the main road from Juba to Wau and Nyamlel, at the limit of the zone of runoff generation. The Bahr el Ghazal measurements were interrupted about 1961, but were resumed by the Sudan authorities at several sites about 1970.

The hydrology of the Sobat basin was studied because of the spills from the Baro and Akobo, and the possibility of reducing the losses in the Machar marshes. Hurst (1950) investigated the losses from the upper Baro. Flow measurements revealed a succession of inflows, outflows and overbank spills. The Baro loses water by spill over the bank and through the Khor Machar channel towards the Machar marshes. However, the Machar marshes were the least known of the southern Sudan wetlands, and the sparsity of hydrological data for aspects of their water balance made it difficult to analyse their regime completely.

ESTABLISHMENT OF THE HYDROLOGICAL NETWORK

The history of the establishment of the hydrometric system is summarized by Hurst & Phillips (1932) and by Hurst (1952, chapter 14). Although Nilometers, to measure flood levels, had been used for thousands of years, and a level gauge was read daily at the Delta Barrage below Cairo from 1846 to 1878, the first modern staff gauge at Aswan was erected in 1869. Another was established about 1864 (Lyons, 1906, p. 261) at Khartoum near the confluence of the Blue Nile with the White Nile (Walsh *et al.*, 1994); 10-day levels at Khartoum during the flood season from 1869 to 1883 are available (*The Nile Basin*, vol. III).

Scientific measurement began about 1900, when Lyons introduced Price current meters for river flow measurements. Discharge measurements of the Blue and White Niles were made by staff of the Survey Department of Egypt from 1900. Two Irrigation Department expeditions started, one under C. E. Dupuis to visit Lake Tana and the Blue Nile, and the other under Sir William Garstin to visit the White Nile and the East African lakes. The Sudan branch of the Egyptian Irrigation Service was formed in 1905 to erect gauges on the different branches of the Nile. They also undertook lines of levelling as far as the East African lakes. They established, for example, a network of benchmarks on both sides of the Bahr el Jebel with known levels from which surveys could be based. By 1912 gauges had been established on most of the important sites on the river system within the Sudan.

Meanwhile Lyons, who was at the time Director General of the Survey Department of Egypt, had recruited H. E. Hurst to the Egyptian Service (Sutcliffe, 1979). Hurst subsequently became head of the Meteorological Service and in 1915 of the Physical Department. He established the comprehensive network of gauges throughout the Nile basin. He made many journeys to the upper Nile, where the hydrology of the Sudd was a particular concern. He also travelled to the Kagera and other tributaries of Lake Victoria, Lake Edward and the Semliki system, the Baro and the Bahr el Ghazal tributaries. The different basins are well described in the relevant volumes of *The Nile Basin*, which are fully illustrated with photographs giving a vivid impression of the variety of terrain, vegetation and river characteristics.

The Physical Department was responsible for establishing and maintaining river level gauges on the different tributaries. They established discharge measurements, usually with the aid of cableways, and derived rating curves from which the level records could be converted to river discharges. The discharge measurements were made, with the current meter at half depth, at about 20 points evenly spaced across the river; the mean water velocity at each point has always been taken as the measured velocity multiplied by 0.96. This was checked at a number of points by measuring the velocity–depth profile. Flows over 10-day and monthly periods were deduced by means of annual rating curves, though in some cases flows were interpolated.

The results of this work were published as successive volumes and supplements of *The Nile Basin*. Over 60 volumes and supplements of *The Nile Basin* have now been published. This comprises perhaps the most detailed set of records available for any river system in the world, and constitutes a major asset for the countries of the basin.

At the present time these volumes and supplements comprise:

- vol. I: General description of the White Nile basin
- vol. II and supplements 1–13: Measured discharges of the Nile and its tributaries
- vol. III and supplements 1–13: Ten-day and monthly mean gauge readings
- vol. IV and supplements 1–13: Ten-day and monthly mean discharges
- vol. V: The hydrology of the Lake Plateau and Bahr el Jebel
- vol. VI and supplements 1–11: Monthly and annual rainfall
- vol. VII: The future conservation of the Nile
- vol. VIII: The hydrology of the Sobat and White Nile and the topography of the Blue Nile and Atbara
- vol. IX: The hydrology of the Blue Nile and Atbara and of the main Nile to Aswan, with some reference to projects
- vol. X: The major Nile projects
- vol. XI: The hydrology of the Sadd al Aali and other topics.

The titles are abbreviated in the list above but given in full at the beginning of the References.

NUMBERS OF GAUGING STATIONS

The river flow records available for the basin are best summarized by statistics concerning numbers of gauges, the number of gaugings carried out annually and the duration of records at key sites.

In the first summary of river levels (*The Nile Basin*, vol. III, 1933) the records of 100 gauges are listed. These include two on Lake Tana and one at Gambeila on the Baro, in

Ethiopia, and 15 on lakes and rivers in Uganda and Kenya. By 1952, in the 5th supplement, the total number had risen to 174; this included eight stations on the Baro system and 25 stations on the Nile system in East Africa including the Kagera. By 1957 this number had risen to 179 and to 189 in 1962 but had reduced to 165 in 1967 and to 129 by 1977. By this time all the countries of the Nile basin were independent and had established their own hydrological services.

A similar progression has occurred in the records of 10-day, monthly and annual discharges, which require a number of gaugings and considerable analysis before discharge totals can be published. In the first record (*The Nile Basin*, vol. IV, 1933), covering flows up to 1927, 42 stations were listed. By 1943 this number had risen to 144. These were to a large extent concentrated in the Bahr el Jebel, Bahr el Ghazal and Sobat basins for projects to reduce the losses from wetlands. By 1953 the number of flow records reached a maximum of 159 and in 1958 there were 135. In 1963 this had been reduced to 86 and continued at this level until 1978; the flows of the Sobat tributaries and minor Bahr el Jebel stations were very intermittently observed, and the upper Bahr el Ghazal records discontinued. Hydrological measurements within Ethiopia were taken over by the Ethiopian authorities. Political problems in the southern Sudan prevented the network from being reinstated completely, though several records for the Bahr el Ghazal tributaries were maintained by the Sudan authorities in the 1970s (see Chapter 6). Since about 1985 measurements have not been carried out south of Malakal.

The accuracy of flow records is largely determined by the frequency with which gaugings have been carried out. The accuracy also depends on the precision and stability of the relation between level and flow at a particular site. The frequency of gaugings at key sites indicates the effort undertaken over the years, mostly by the Egyptian authorities.

The annual gaugings at key stations are given in Table 2.1; some explanation of the table may be necessary. The gaugings at Namasagali and subsequently at Mbulamuti were taken some 80 and 60 km below the Ripon Falls, but related to the Lake Victoria lake level, in order to derive a relation between lake level and outflow. After the lakes rose in 1961–1964 the gauging site was moved to Mbulamuti. Between Lake Kyoga and Lake Albert gaugings have been made at various sites; it will be seen in Chapter 4 that because the river flow is stable these gaugings can be combined to derive rating curves. Conditions led to an interruption of gauging after 1978 in Uganda, and at Mongalla and Doleib Hill in 1984. The gauging site for the natural river above Aswan dam had to be moved from Wadi Halfa to Kajnarty and to Dongola as the dam was raised, but the record can be regarded as continuous. At Aswan itself the gaugings were used to supplement sluice measurements. At most sites the number of gaugings reached a peak in the 1920s, when interpolation of gauged flows was used at several sites to estimate volumes. After this period annual rating curves, derived from gaugings during the year, were used in most cases to estimate flows. In general terms the number of measurements was entirely adequate to monitor any changes in channel rating.

Although the rating curves at some key stations are discussed in subsequent chapters, an overview of the precision and form of the ratings may be derived from Shahin (1985, appendix E), where 35 sites are illustrated. Ratings are looped, with separate curves for rising and falling stage, at sites above junctions, like the Sobat at Doleib Hill or the Blue Nile at Khartoum. This is also true below junctions like the White Nile at Malakal and the main Nile at Tamaniat. At other sites, such as the White Nile near Lake No, or the White Nile above the confluence with the Blue Nile, the relation is so poor that only interpolation is possible. At some sites where the rating is straightforward, the rating is stable as at Jinja at the outfall from Lake Victoria. At other sites, like the Bahr el Jebel at Mongalla, there have been changes over the years. Thus the precision and stability of the rating depend on the site.

Table 2.1 Annual numbers of gaugings at key sites.

	Namasagali/ Mbulamuti	Masindi Port	Kamdini	Fajao/ Paraa	Mongalla	Doleib Hill	Malakal	Mogren	Khartoum	Tamaniat	Atbara	Wadi Halfa	Kajnarty	Dongola	Aswan
1901															
1902									30		8				
1903									43		17				
1904									3						
1905					2				8						
1906					1	3	7		7						
1907				2	1		13		12	4					
1908					5	7	38	5	8	1					
1909					5	16	32		7	1					
1910						29	43	8	27	3					
1911					5	34	25	15	28	28		33			
1912					3	23	10	26	91	42		88			
1913					2	24	2	85	110	99	80	119			
1914					3	23	20	105	32	88		80			18
1915						23	45	107	40	50					
1916					5	17	28	92	4	54					
1917					2	20	31	91	43	73					
1918						27	78	69	73	66					56
1919						21	74	98	96	21					117
1920						14	63	50	19	49		4			166
1921					1	24	71	64	72	65	21	166			206
1922				2	223	44	72	93	101	114	36	147			126
1923	3			2	201	75	72	97	110	108	81	125			111
1924					303	71	72	93	100	114	75	132			131
1925					294	72	71	117	108	142	52	94			113
1926	2				242	72	74	113	149	147	56	150			48
1927					310	72	86	147	160	205	64	109			53
1928					287	71	94	206	205	192	71	169			40
1929					304	72	86	185	186	155	61	190			51
1930					268	72	91	122	132	129	34	220			
1931					175	71	81	71	71	72	34	197	76		38
1932				60	72	69	82	72	72	72	40	50	163		84
1933					72	72	87	72	74	71	35	64	161		26
1934					72	72	86	72	78	77	44	28	165		11
1935	2	1			70	72	84	69	73	72	40	15	178		12
1936	1	1			58	52	86	73	72	71	34	36	185		
1937					60	46	86	71	73	72	38	84	128		
1938					60	48	84	68	75	74	34	125	156		64
1939		2			44	48	88	103	72	71	34	14	289		
1940	10	8	5	5	22	48	94	74	72	71	39		354		
1941	10	10	7	8	24	47	87	80	72	72	36		210		42
1942	11	11	6	11	26	47	87	103	78	74	34		241		32
1943	12	11	10	9	22	47	97	72	70	73	44		228		33
1944	7	7	8	1	23	48	89	58	72	72	36		295		
1945	8	2	8		24	48	90	58	70	71	38		215		
1946	8		5		24	48	93	60	76	75	41		168		34
1947	11		5	4	23	48	91	52	72	72	39		121		29
1948	10		6	4	24	47	87	48	70	68	40		132		83
1949	5		8	6	24	48	86	55	55	57	38		139		
1950	14		11	9	24	46	84	53	64	63	39		125		29
1951	48		7	9	18	48	86	44	56	55	40		150		29
1952	46		9	11	23	25	87	50	56	47	35		136		31
1953	46		10	10	19	31	87	54	67	67	44		112		37
1954	48		7	11	12	26	88	45	70	66	45		150		50
1955	48			11	11	20	87	45	71	68	38		144		43
1956	48		4	12	12	23	87	39	68	68	48		149		39
1957	47		4	12	12	26	89	48	65	60	59		139		35
1958	12		10	12	12	50	88	41	72	66	50		152		46
1959	11		11	12	12	36	87	44	67	63	40		158		63
1960	12			12	11	22	88	44	70	63	47		158		81
1961	13			11	10	26	87	42	67	69	44		156		205

	Namasagali/ Mbulamuti	Masindi Port	Kamdini	Fajao/ Paraa	Mongalla	Doleib Hill	Malakal	Mogren	Khartoum	Tamaniat	Atbara	Wadi Halfa	Kajnarty	Dongola	Aswan
1962	12			5	9	29	86	48	70	70	40		176	61	76
1963	32			10	10	27	87	47	69	67	46		168	129	50
1964	24			12	9	22	87	42	67	65	47		76	134	58
1965	34			11			87	41	65	66	80			129	43
1966	18			12		1	84	49	70	68	74			126	121
1967	19			12	12	10	87	46	68	68	92			100	76
1968	19			1	17	11	72	47	69	69	81			150	86
1969	13				19	18	72	40	65	65	60			139	86
1970	5			16	18	18	72	39	65	64	62			127	68
1971	33	2		11	15	5	71	39	66	60	43			126	113
1972	30			5	14	13	72	49	63	67	28			127	51
1973	21			3	11	12	68	43	63	62	30			125	42
1974	12			4	4	7	72	33	62	68	23			103	70
1975	3			4	5	7	67	32	68	60	17			106	56
1976	6	1		1	10	8	72	34	52	61	4			80	70
1977	4	12		4	8	8	72	27	41	46	5			84	97
1978	18	12		4	8	8	71	32	49	47	8			108	85
1979				1	7	12	72	38	54	58	4			104	84
1980					3	5	72	25	38	30	9			103	70
1981					8	7	72	24	33	37	5			123	79
1982					6	7	72	23	33	51	8			87	81
1983					7	10	72	30	17	51	11			83	113
1984					3	2	72	44	15	49	8			79	174
1985							72	32	22	49	3			113	200
1986							72	36	23	26				106	168
1987							72	27	50	36				110	182
1988							72	24	47	38				113	172
1989							72		61	43	9			119	173
1990							69	1	53	43	7			119	162
1991							72		34	20	10			117	143
1992							64		34	27				122	162

COLLABORATION WITH OTHER HYDROLOGICAL SERVICES

From about 1950 hydrological services were established by Uganda, Sudan and Ethiopia. Responsibility for measuring most levels and river gaugings was taken over by the upstream countries. Inevitably, the objectives of these hydrological services were redirected to focus on local water resources development rather than the integrated development of the Nile basin. However, the key hydrological stations have been maintained, often in collaboration, and many of the records have been published in *The Nile Basin*.

In Uganda the Department of Hydrological Survey was established in 1947 and became the Water Development Department in 1956. The number of discharge sites operated by the department rose from 8 in 1948 to 95 in 1956 (Water Development Department, 1957); most of these stations were on small tributaries of Lakes Kyoga, Edward and George. Flow records for 24 stations for the period up to 1968 were published in 1970 (Water Development Department, 1970). The Egyptian Irrigation Service continued to carry out gaugings on the main river; in fact the calibration of some stations is best carried out by using both sources of data (see Chapter 4). Flow measurement in the East African lake basin was stimulated by the establishment in 1967 of the WMO/UNDP Hydrometeorological Survey, which measured inflows to Lake Victoria. After 1979, when most of the equipment was destroyed, the political situation in Uganda resulted in the suspension of much hydrological work. After about 1987 the rehabilitation of the network began. Since then the hydrological data have been computerized but there was a gap in the continuity of all but the outflows from Lake Victoria.

The Sudan Ministry of Irrigation also set up a hydrological organization in about 1964 which has been responsible for producing yearbooks since 1971. However, the responsibility for gauging some of the major Nile stations has been shared between Egypt and Sudan, who established the Permanent Joint Technical Committee to coordinate investigations. In general the Egyptian service, which maintains offices in Khartoum and Malakal, has continued to measure flows on the main Nile, the Blue Nile and White Nile, Sobat and Bahr el Jebel. The Sudan Ministry of Irrigation has measured flows on the upper Atbara, the Dinder and Rahad, the Blue Nile at el Deim, and also the upper tributaries of the Bahr el Ghazal. The flow records for which the Sudan has been responsible have been published in yearbooks and are maintained in computer form in the Ministry.

During the first half of this century the Egyptian Irrigation Service undertook investigations and flow measurements in the Ethiopian portion of the Nile basin. In particular they studied the flows around Lake Tana in 1920–1933, where the possibility of storage was envisaged. They also studied the Baro from 1928 to 1959 below Gambeila, where an outpost of the Sudan Government was maintained for many years and a staff gauge had been established in 1905. Flows were measured at a number of points to investigate the regime of the Baro above its confluence with the Sobat. Spill from the river was noted to truncate the high flows where the Baro emerges from the Ethiopian frontier to the Sudan.

Hydrological investigation of the Blue Nile basin within Ethiopia was undertaken by the United States Government between 1959 and 1964 at the request of the Ethiopian Government (US Bureau of Reclamation, 1964; Said, 1993). During this study river gauges were established at about 60 sites within the Blue Nile basin, and flows were calculated for over 50 sites. The Ethiopian Hydrological Service has taken over the responsibility for flow measurement within its territory. At present (Asefa, 1997) the network of stations in the Baro-Akobo basin, draining to the Sobat, consists of 24 stations. The network in the Abbay or Blue Nile basin has 100 stations, while that in the Tekeze or Atbara basin has 26 stations. Discharge measurements are taken using Price current meters, and standard techniques are used to derive rating curves. Hydrological yearbooks have been compiled up to 1980, and manuscript data are available up to 1996. Although yearbooks have not been published in the same way as *The Nile Basin*, government organizations have free access to the data. The HYDATA system for processing of hydrological data has been installed, and data entry is in progress.

The Egyptian authorities have also published in *The Nile Basin*, vol. VI, rainfall records for stations throughout the basin, though these records were provided by the national meteorological services.

From 1967 to 1992, collaboration between the countries of the Nile basin has been focussed on the work of the Hydrometeorological Survey of the East African Lakes. This project was supported for much of this period by WMO/UNDP and produced reports in 1974 and 1982 (WMO, 1974, 1982). This joint investigation was responsible for collating measurements throughout the East African basin of the Nile, including tributaries of the Lake Victoria basin within Kenya, Tanzania, Uganda, Rwanda and Burundi. From 1980 the project was administered by its Technical Committee and financed by the participants. In 1992 (Bakhiet, 1996) the project changed its name to Tecconile, based at Entebbe, with objectives set by Ministerial meetings. Since 1993, a series of conferences named the Nile 2002 series, held in different basin countries, has led to informal exchange of technical findings and views.

RECORDS AVAILABLE AT KEY SITES

The extent of records at some of the key stations is shown below. The dates in brackets indicate that records have been derived in this study, or that flows have been deduced by correlation. A number of these stations are still being maintained, so that no end date is given:

Kagera at Kyaka Ferry/Nyakanyasi	1940–1978
Victoria Nile at Jinja	1896–1897, 1898–
Kyoga Nile at Kamdini	1940–1980
Semliki at Bweramule	1940–1978
Bahr el Jebel at Mongalla	1905–1983
Jur at Wau	(1904–1941), 1942–1961, 1970–1986
Baro at Gambeila	(1905–1927), 1928–1959
Sobat at Doleib Hill	1905–1983
White Nile at Malakal	1905–
Blue Nile at Roseires/el Deim	1912–
Dinder at mouth/Gwasi	1907–1951, (1952–1971), 1972–
Rahad at mouth/el Hawata	1908–1951, (1952–1971), 1972–
Blue Nile at Khartoum	1900–
Main Nile at Tamaniat	1911–
Atbara at mouth	1903–
Main Nile at Wadi Halfa/Kajnarty/Dongola	1890–
Main Nile at Aswan	1869–

It will be seen that records began at most sites between 1905 and 1912, though some records began earlier. On the other hand, most of the records in the southern Sudan and Uganda were interrupted about 1980, though some have been continued and others are being reinstated. These records are the raw material for study of the hydrology of the various tributaries, so it can be seen that discussions are not always based on a common period of record

CHAPTER 3

THE LAKE VICTORIA BASIN

INTRODUCTION

It has been pointed out strikingly (Flohn & Burkhardt, 1985) that the true source of the Nile is not the Ripon Falls, where the river leaves Lake Victoria on its long course to the sea, nor the headwaters of the Kagera tributary draining the highlands of Rwanda and Burundi (Fig. 3.1), but rather the nocturnal cloud above the lake itself which provides most of the water supply to the lake. Therefore in the search for the source of the White Nile the successive studies of the lake water balance have been as important as the early explorations of the course of the river. This account of the Lake Victoria basin includes the historical studies of the water balance, which have depended as much on the accumulation of reliable measurements as on scientific insight.

EARLY STUDIES OF THE WATER BALANCE

The first study by Hurst & Phillips (1938) of the water balance of Lake Victoria was based largely on lake levels and some rainfall observations. The average lake rainfall was estimated as 1151 mm, the tributary inflow as 276 mm over the lake area, the mean outflow as 311 mm, and the evaporation therefore as 1116 mm. The flow of the Kagera was estimated from some 15 measurements, but the runoff estimates for the rest of the basin were "rough guesses based on a knowledge of the character of the country and the streams". The inflow estimates were nevertheless remarkably accurate, and although the rainfall was underestimated they established that lake rainfall and evaporation were roughly in balance. They showed that all the components of the water balance were important and thus laid the framework for future study.

There was a dramatic change in the lake regime with the sudden rise which occurred in 1961–1964 (Fig. 3.2). The lake level had fluctuated between relatively narrow limits since measurements began in 1896. Then a rise of 2.5 m after a period of heavy rainfall in 1961/62 led to general levels well above previous measured limits and raised the question of the cause of the rise. The fact that the rise followed the construction of the Owen Falls dam in 1951–1953 suggested to some that the two events were connected.

This event eventually led to the establishment, in 1967, of the WMO/UNDP Hydrometeorological Survey of the lakes (WMO, 1974, 1982) which has provided much of

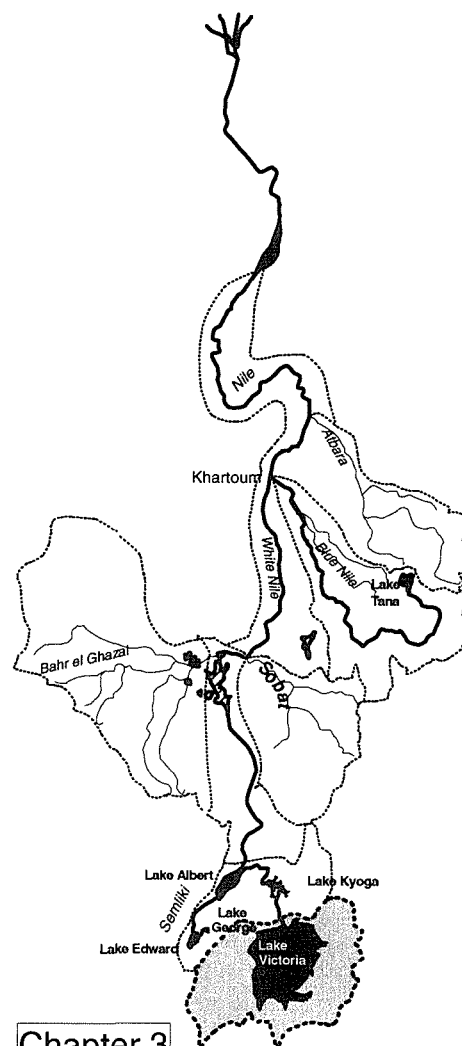

THE KAGERA BASIN

The principal river flowing into Lake Victoria is the Kagera, with a basin of 60 000 km². With its main tributaries the Ruvuvu and Nyabarongo it drains most of Rwanda, about half of Burundi and parts of northwest Tanzania and southeast Uganda.

The basin has a general elevation of 1200–1600 m, but rises above 2500 m in the west, with peaks reaching 4500 m. The rainfall is less than 1000 mm over most of the eastern half of the basin but rises to over 1800 mm in the west, where most of the runoff is generated. Although the west is partly forested, much of the basin has become intensively cultivated, resulting in erosion and river sediment load from the high rainfall areas. The upper tributaries are generally steep but include flatter reaches where swamps have formed. The middle course of the river and its tributaries above Rusumo Falls is extremely convoluted; this reach reflects regional warping and drainage reversal, with some tributaries retaining the appearance of flowing towards the Congo. Several side valleys enter the river with their courses filled with either lakes or swamps. Between Kigali and Rusumo Falls (Plate 1) the slope diminishes from about 0.30 m km⁻¹ to 0.05 m km⁻¹, and the valley is filled with papyrus swamp. Below the falls the Kagera flows north for 150 km flanked by a zone of lakes and swamps up to 15 km wide; it then turns east and flows across a plain in an incised channel before entering Lake Victoria through papyrus swamp.

There are two rainfall seasons, with the longer southeasterly monsoon bringing rain between about February and May, and the shorter northeasterly monsoon from about September to November. The runoff responds to the rainfall with a higher peak in May and a smaller peak in November. However, the river flows are attenuated by a number of lakes, and in particular by two sets of swamps and associated lakes above and below Rusumo Falls. The peak flow occurs in April in the upper tributaries, in May at Kigali and Rusumo Falls, but has been delayed to July at Kyaka Ferry on the lower Kagera. At this site the long-term mean runoff is relatively low at 136 mm compared with rainfall of 1170 mm. Near the western shore of Lake Victoria there is a belt with rainfall of over 2000 mm; the Ngono, draining this area of heavy rainfall, contributes a highly seasonal flow to the lower Kagera.

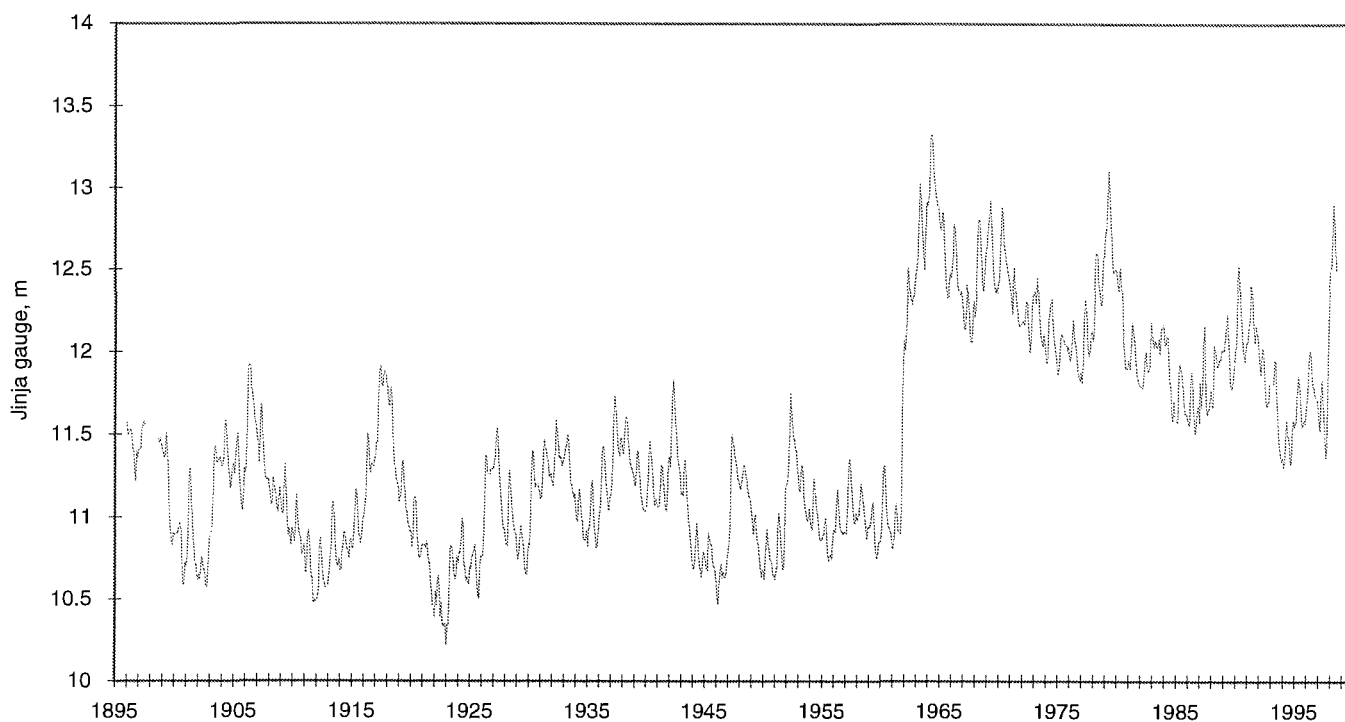

Fig. 3.2 Lake Victoria monthly levels, 1896–1998.

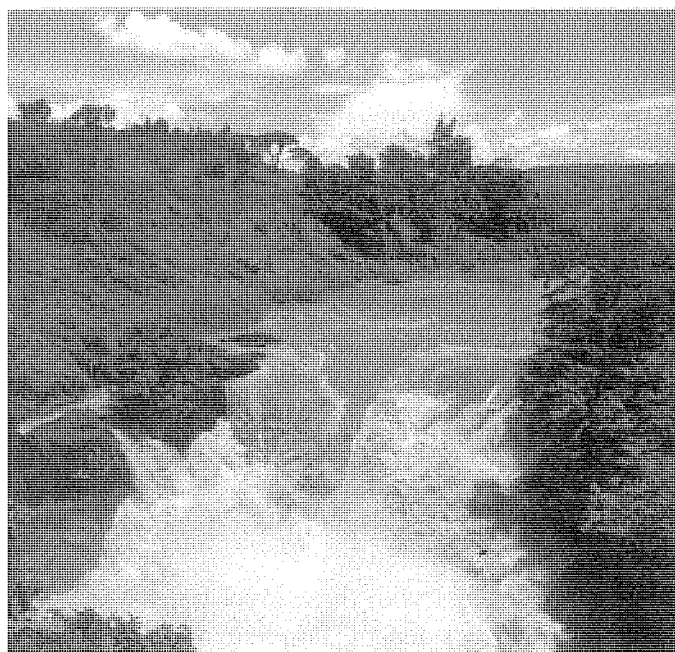

Plate 1 Kagera at Rusumo Falls.

The monthly flow series (Fig. 3.3) of the Kagera at Kyaka Ferry, or at Nyakanyasi some 80 km upstream, shows the high baseflow component of the Kagera flow, resulting from storage in lakes and swamps. This figure reveals that the seasonal rise, though pronounced, does not occur in all years. The most obvious feature of this series is the rise occurring after 1961, when the peak flows and also the baseflows increased markedly. The annual runoff doubled after 1961, although the basin rainfall only increased slightly; this illustrates the sensitivity of runoff in this regime to changes in rainfall amount and seasonal distribution. The timing of the Kagera flows is different from that of the other tributaries, mainly because of the wetland attenuation.

LAKES AND SWAMPS IN LOWER KAGERA

The river meanders through extensive areas of swamps and lakes both upstream and downstream of Rusumo Falls. Upstream of the falls papyrus swamps begin near Kigali where

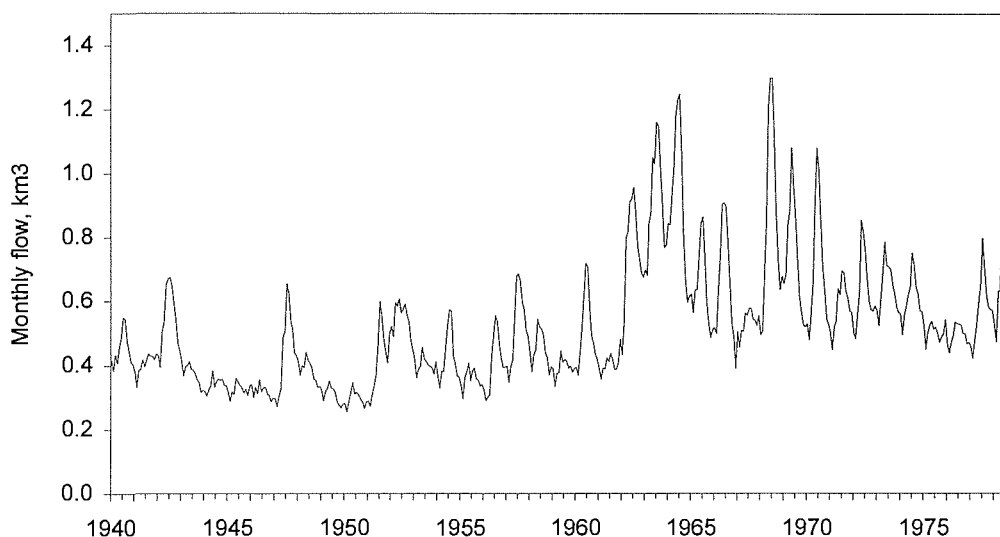

Fig. 3.3 Kagera at Kyaka Ferry/Nyakanyasi: monthly flows, 1940–1978.

the valley is some 0.5 km wide. The valley widens downstream of Kigali before narrowing again above the falls. The total area of swamps and lakes is about 1400 km². Below Rusumo Falls the Kagera flows north through about 1600 km² of swamps and lakes before turning east. The meandering channel is separated by dense papyrus from the lakes, some of which are near the river while others are comparatively isolated. However, there are usually hydraulic connections between the river and the lakes through channels or swamp.

It is possible to study the water balance of these two reaches by comparing inflows and outflows, rainfall and evaporation. For the lower reach, inflows are measured at Rusumo Falls and outflows at Kyaka Ferry, allowing for the Kagitumba inflows at the confluence. These flows (Fig. 3.4(a)) show the lag between the two sites. Rainfall and evaporation estimates have been included in a water balance expressed as water level changes over 1600 km². Figure 3.4(b) shows that the deduced levels for 1970–1973 exhibit an annual range of about 1 m and correspond with levels measured on Lake Ihema in 1970–1973. For the upper reach, similar comparisons (Sutcliffe, 1993) have shown that water level fluctuations are also about 1 m.

The vegetation distribution is consistent with these level ranges. In general, swamp and flood-plain vegetation require varying periods of flooding and are sensitive to range of

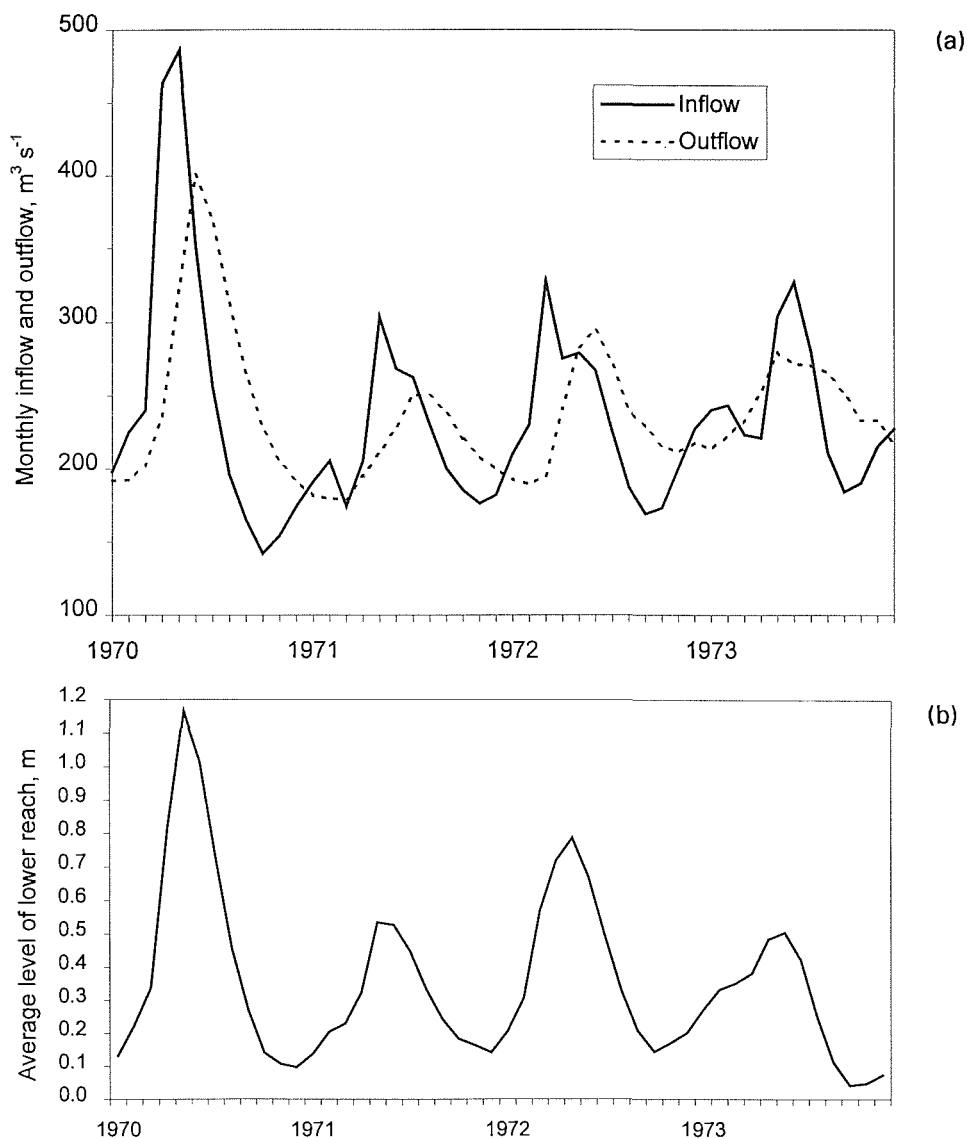

Fig. 3.4 Kagera swamp below Rusumo Falls: (a) monthly inflows and outflows, 1970–1973; (b) deduced monthly water levels, 1970–1973.

flooding level. Evidence from the Bahr el Jebel (Sutcliffe, 1974; Sutcliffe & Parks, 1996) showed that papyrus is limited by range of flooding, that *Vossia* can tolerate faster currents, and that *Echinochloa pyramidalis* is limited by depth of flooding. Above Rusumo Falls the river valleys are filled with papyrus swamps and lakes. Immediately below the falls the range of water level is probably higher and papyrus is absent except in off-stream basins, with *Vossia* along the river bank. Further down the lower reach, where the river floods a succession of papyrus swamps and lakes, there is a strip of *Vossia* near the river and *Echinochloa pyramidalis* along the shoreline away from the river, where the ground rises steeply from the lake or swamp. The growth of papyrus was less vigorous in the lower end of the reach, where the nutrient supply would be least. This distribution, observed in 1980 (Sutcliffe & Mhlanga, 1980), is consistent with findings from the Bahr el Jebel. The links between swamp vegetation and hydrology are discussed more fully in Chapter 5.

CONTRIBUTION OF OTHER TRIBUTARIES

Although the Kagera provides the largest component of the tributary inflow to Lake Victoria, a large number of other streams flow into the lake and together contribute twice that from the Kagera alone. Moreover, the annual variability of this input is exaggerated, because the runoff coefficient increases with basin rainfall. Thus the variability of the tributary inflow component of the lake balance is greater than that of direct rainfall on the lake. Indeed, earlier difficulties in explaining the historical lake level variations have partly stemmed from underestimation of the variability of this tributary inflow.

Rainfall records around the lake illustrate the rainfall regime in the contributing basins. Monthly averages at key stations (Table 3.1) show that the bimodal distribution is common to all, with the main rainfall season occurring from March to May and a secondary season from October to December. There are differences in the relative magnitude and the timing of these two seasons around the lake, and there is in particular evidence at Kisumu and Jinja of higher rainfall in July and August which is more marked in the northeastern tributary basins. There is also a contrast between the heavy rainfall in the west and northwest of the lake, at Bukoba and Kalangala, and the lower rainfall in the southeast, at Musoma, where the dry seasons in June–August and January–February are more marked.

Table 3.1 Mean rainfall at key stations, 1956–1978, mm (after Piper *et al.*, 1986).

Jan.	Feb.	March	April	May	June	July	Aug.	Sept.	Oct.	Nov.	Dec.	Year
Jinja												
64	85	141	195	140	69	70	83	100	141	161	87	1336
Entebbe												
88	101	179	260	235	121	69	79	72	126	179	111	1620
Kalangala												
135	137	239	340	322	162	96	94	114	159	210	208	2216
Bukoba												
150	180	254	398	316	89	51	66	102	153	195	193	2147
Kagondo												
119	152	219	362	234	47	26	40	94	115	201	161	1770
Mwanza												
102	114	156	177	71	16	15	21	25	99	158	146	1100
Musoma												
59	84	123	182	101	24	21	22	31	53	117	78	895
Kisumu												
71	98	155	234	175	79	63	90	84	87	139	102	1377

The tributary flows reflect this rainfall distribution; the runoff patterns are highly seasonal and accentuate the seasonal rainfall. The individual monthly totals for the whole period of record are included in a report by the UK Institute of Hydrology (1984, Fig. 2.7), but are not reproduced here. The flows of the Nzoia reflect more clearly than the other rivers the July–August rainfall to the northeast of the lake, superimposed on the effect of the other seasonal variations. The Yala and the Sondu reveal a greater proportion of baseflow; to the south, the Gucha shows much greater variability of flow and the dominant influence of the March–April rainfall season. Further south still the Mara, Rwana and Simyu show similar seasonal patterns but even less flow in the dry season. The other tributaries have an earlier peak and less baseflow than the Kagera, as they do not have the same extent of lakes and swamps. However, several tributaries, especially in Uganda, enter the lake through swamps, with estimated areas totalling 2600 km² (Brown *et al.*, 1979). In recent years many of the bays around the shore have been invaded by water hyacinth (*Eichhornia crassipes*); the influence on the lake water balance will depend on its extent.

The average annual inflows of the different tributaries for the period of records, expressed as mm over the basin, are compared with basin rainfall deduced from isohyetal maps in

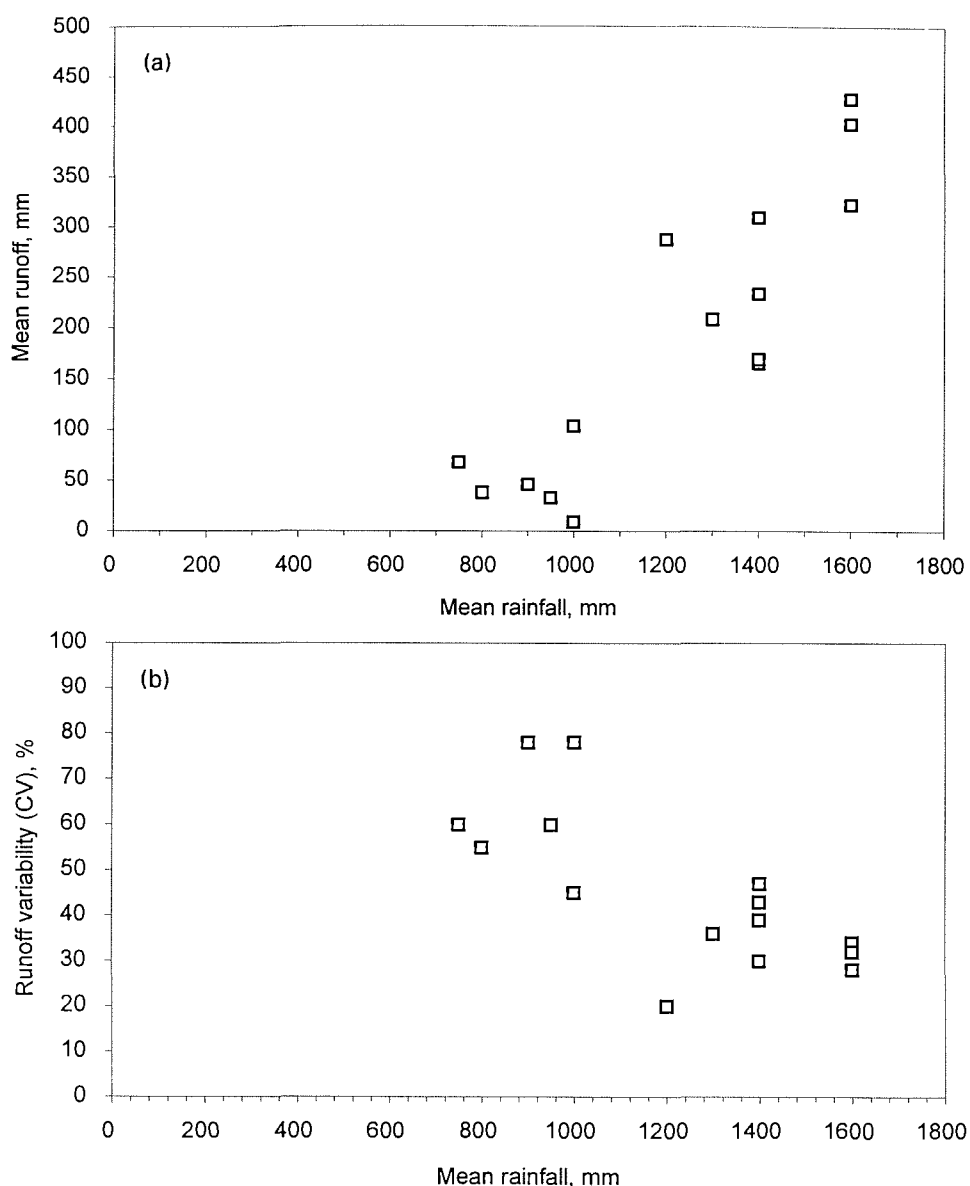

Fig. 3.5 Lake Victoria tributaries: (a) mean runoff and mean rainfall; (b) runoff variability and mean rainfall.

Fig. 3.5(a). It is clear that the average runoff from these tributaries is closely related to the average rainfall. On the other hand, the variability of annual runoff, expressed as the coefficient of variation, is inversely related (Fig. 3.5(b)) to mean rainfall. As expected, the drier tributaries have lower but more variable runoff than the wetter tributaries.

In order to estimate the total tributary inflow series it was possible to compare a short period with total flows against a longer period with some records. There are almost complete records of the tributaries measured by the WMO Hydrometeorological Survey for the period 1969–1978, and the runoff from the ungauged perimeter of the lake was estimated from the relation between mean rainfall and runoff. In addition, the flows of four major tributaries in the northeast of the lake—the Nzoia, Yala, Sondu and Awash Kaboun—are available for the period 1956–1978, with some short gaps filled by comparison. The total flows of the four tributaries were compared (Institute of Hydrology, 1985) with the total tributary runoff (excluding the Kagera and Ngonzo whose regime was different). The ratio between the flows of the four Kenyan tributaries and the total inflow was found to vary seasonally, and monthly multipliers were calculated to extend the total tributary runoff from the flows of the four tributaries. The mean seasonal distribution of the total tributary inflow for the period 1956–1978, including the Kagera, is expressed as volumes and as mm over the lake in Table 3.2. The average tributary inflow of 343 mm over the lake is only about 15% of the total supply to the lake, which is dominated by the rainfall component. However, because runoff coefficients increase with rainfall amount, runoff is more variable than the rainfall from which it is derived. The monthly flows for the years 1956–1978 are shown in Fig. 3.6 and the annual totals summarized in Table 3.3. Just as the Kagera flows increased after 1961, so the total tributary flows increased by about 50%. The variability of the tributary inflow is in percentage terms about three times higher than that of rainfall. Thus this component is important to the water balance of the lake.

RAINFALL OVER LAKE VICTORIA

The rainfall over the lake surface provides the greater part, on average about 85%, of the input to the lake water balance. However, it is not easy to estimate this rainfall as the only regular

Table 3.2 Monthly components of Lake Victoria balance, 1956–1978.

Jan.	Feb.	March	April	May	June	July	Aug.	Sept.	Oct.	Nov.	Dec.	Year
Lake rainfall (mm)												
138	153	228	309	208	71	52	68	104	157	201	170	1 858
Kagera inflow ($m^3 \times 10^6$)												
511	481	570	611	743	765	780	711	616	571	527	531	7 418
Total tributary inflow ($m^3 \times 10^6$)												
1330	1059	1542	2714	3217	2107	1981	2098	1948	1570	1678	1738	22 982
Total inflow (mm over lake of 67 000 km²)												
19.9	15.8	23.0	40.5	48.0	31.4	29.6	31.3	29.1	23.4	25.0	25.9	343.0
Lake evaporation (mm)												
135	135	145	130	125	120	125	135	140	145	130	130	1 595
Lake outflow ($m^3 \times 10^6$)												
2902	2619	2884	2920	3182	3136	3093	2976	2859	2855	2736	2973	35 136
Lake outflow (mm over 67 000 km²)												
43.3	39.1	43.0	43.6	47.5	46.8	46.2	44.4	42.7	42.6	40.8	44.4	524.4
Lake level (m on Jinja gauge)												
11.93	11.93	11.99	12.15	12.23	12.16	12.06	11.98	11.92	11.90	11.97	12.01	

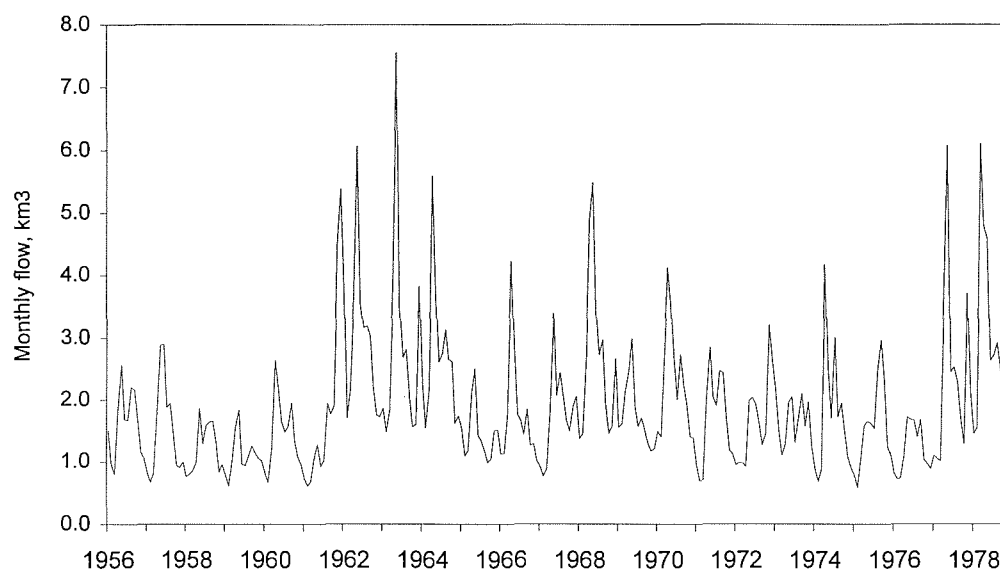

Fig. 3.6 Lake Victoria tributaries: monthly inflows, 1956–1978.

measurements have been around the lake perimeter. There are only eight stations with records since 1925 or earlier, and these have been used by various authors to estimate the rainfall over the lake. This approach has the advantage that a reasonably homogeneous set of records can be used to monitor rainfall variations from year to year.

Table 3.3 Annual water balance of Lake Victoria, 1956–1978.

Year	Lake rainfall (mm)	Kagera inflow ($m^3 \times 10^6$)	Total inflow: ($m^3 \times 10^6$)	(mm)	Outflow: ($m^3 \times 10^6$)	(mm)	Lake level (m)
1956	1787	4 918	19 326	288	19 636	293	10.91
1957	1727	6 299	18 121	270	20 112	300	11.02
1958	1622	5 412	14 629	218	19 671	294	10.94
1959	1702	4 730	13 310	199	18 434	275	10.84
1960	1827	6 160	17 526	262	20 348	304	10.87
1961	2370	4 895	21 856	326	20 577	307	11.94
1962	1919	9 114	36 136	539	38 716	578	12.39
1963	2121	10 941	34 664	517	44 788	668	12.91
1964	2011	11 045	32 332	483	50 476	753	12.88
1965	1663	7 760	17 428	260	46 878	700	12.48
1966	1889	7 951	21 435	320	42 950	641	12.32
1967	1752	6 421	21 448	320	37 832	565	12.31
1968	2114	10 375	32 600	487	43 305	646	12.58
1969	1770	8 923	21 083	315	46 006	687	12.36
1970	1865	8 477	27 572	412	44 282	661	12.45
1971	1639	7 030	20 139	301	39 510	590	12.17
1972	1975	7 587	19 950	298	37 540	560	12.35
1973	1749	7 717	19 982	298	38 467	574	12.05
1974	1657	7 331	20 946	313	35 046	523	11.97
1975	1826	6 082	18 968	283	33 326	497	12.04
1976	1781	5 932	14 409	215	34 835	520	11.82
1977	1938	6 980	29 147	435	35 999	537	12.13
1978	2041	8 525	35 575	531	39 383	588	12.56
Mean	1858	7 418	22 982	343	35 136	524	
SD	180	1799	6908	103	9976	149	
CV (%)	9.7	24.2	30.1	30.1	28.4	28.4	

Sources: Lake rainfall and outflow from Institute of Hydrology (1993); Kagera inflow from *The Nile Basin* and WMO (1982); total inflow from Institute of Hydrology (1985).

The problem of estimation is complicated because evidence from the timing of rainfall on different shores, supported by rainfall observations from island stations, suggests that rainfall over the lake itself is higher than at the lakeside stations. The incidence of rainfall is linked with the seasonal migration of the InterTropical Convergence Zone (ITCZ) which gives rise to two rainy seasons in about March–May and October–December. The atmospheric circulation over Lake Victoria is approximately from east to west but is strongly influenced by onshore and offshore breezes generated by the lake itself. This local circulation frequently results in the formation of cumulonimbus clouds over the southwestern portion of the lake and in a narrow strip of land some 30 km wide around the shore (Channon, 1968).

The impact of the lake has been illustrated by measurements of rainfall near its centre, which indicated rainfall some 30% higher than observed at any lakeshore station. This is consistent with a model (Datta, 1981) in which the maximum rainfall on the west coast and the western centre of the lake is caused by convergence and lifting of westerly land breezes and prevailing easterlies. This interaction gives rise to convection storms in the morning on the western shore and in the evening on the eastern shore. This effect has been estimated to double the rainfall which would have occurred if the lake were not present (Flohn & Burkhardt, 1985).

In an early attempt to take account of this increase over the lake, de Baulny & Baker (1970) assumed that rainfall over the lake was fairly uniform with gradients around the shore. They used the eight long-term rainfall stations with monthly weighting coefficients to reconstruct a rainfall record for the period 1925–1969. However, when this technique was used by the Institute of Hydrology (1984) to extend the series to 1979, it was found that the coefficients gave particular weight to the higher rainfall stations and gave a series which did not reflect the increased rainfall of the later years.

In a further review, the Institute of Hydrology (1985) argued that the set of eight long-term gauges, after quality control had corrected some inconsistencies, provided the best basic data for estimating the lake rainfall series. However, they used the lake itself to measure rainfall by a water balance approach. Comparison of individual rainfall records with the inferred lake rainfall suggested that a reasonable series could be derived after normalizing each record in terms of its mean and standard deviation. The estimated mean annual lake rainfall was multiplied by the mean of the normalized series with the deviations enhanced by a factor of 1.3, on the assumption that taking the mean of the normalized series reduced its variability. This provided a monthly rainfall series based on continuous records. It could be argued that this procedure was somewhat arbitrary and even circular, but this rainfall series provided a reasonable answer not only to the problem of average water balance, which followed from the procedure, but also to the variations over the record period.

In a later study (Institute of Hydrology, 1993; Sene & Plinston, 1994) direct comparison between the lakeside rainfall and net lake rainfall for calendar months deduced from water balance for 1969–1978 suggested that they were linearly related. Rainfall series were derived for 1925–1990 using constant evaporation estimates. This lake rainfall series for 1956–1978 (Table 3.3) shows that there has been a trend to higher rainfall. This is largely explained by an increase in rainfall in October and November, according to Farmer (1981), who suggested a shift in East African rainfall after the heavy rains of 1961/62, and noted that the mean rainfall since then has been significantly above the mean for the previous 30-year period. Longer-term trends in rainfall are discussed at the end of this chapter.

EVAPORATION

A number of approaches have been used to estimate evaporation from the lake surface. WMO (1982) compared pan evaporation estimates, a water balance for the period 1970–1974, a heat budget method and models using global solar radiation. These different methods gave results

which agreed reasonably well in annual total but not in monthly distribution. The estimation of evaporation from a lake of this size is complicated by the seasonal effect of heat storage and the difficulties of measuring small changes in monthly lake level. Because it is not possible in practice to differentiate between underestimates of rainfall and overestimates of evaporation, the choice of estimate becomes somewhat arbitrary. It is believed that variations of evaporation from year to year are likely to be relatively small, so the estimates of monthly evaporation used by the Institute of Hydrology (1985) were based on monthly averages obtained by the Penman method for stations around the lake. The monthly values were adjusted slightly so that the annual total approximated to the WMO estimates. The resulting estimates are given in Table 3.2.

LAKE LEVELS

Lake Victoria levels have been measured regularly since 1896, with a gap in 1897–1898. Early records at Entebbe and other sites were converted to equivalent level series at Jinja, near the outfall from the lake. The resulting end-month levels (Fig. 3.2) fluctuated from 1896 to 1960 between 10.2 and 12.0 m on the Jinja gauge. There were rises in 1906 and 1917, but the lake was relatively stable before 1961. The rise of almost 2.5 m between October 1961 and May 1964 is the most prominent feature of the whole series. Since 1964 the lake level trend has been generally downwards, with an interruption in 1979 when a peak of 13.0 m was reached. By 1995 the lake had fallen to 11.5 m, near the long-term mean of the series, but nearly reached 13.0 m in early 1998.

As mentioned earlier, the rise in 1961–1964 focussed attention on the cause, and led to the WMO Hydrometeorological Survey of the lake regime which provided most of the available measurements. After this event the evidence of earlier lake levels was examined to investigate whether any precedents for the rise existed, and this evidence is discussed at the end of this chapter.

LAKE VICTORIA OUTFLOWS

The outflows from Lake Victoria were controlled naturally by the Ripon Falls until the construction, some 3 km downstream, of the Owen Falls dam, which was begun in 1951 with the construction of a coffer dam. Although there is evidence of erosion over long periods, it can be assumed that the relation between lake level and outflow has been stable over the historical period.

The relation was studied at the time of the construction of the Owen Falls dam, because its operation was the subject of negotiation between Uganda and Egypt. It was agreed that the dam would be operated on a run-of-river basis, so that the flows of the White Nile, which provided the so-called “timely flows” (see Preface) would not be affected by the project. It was necessary to establish a rating curve between lake level and outflow which could be used as an operating rule. After study of the gaugings which had been made at Namasagali some 80 km downstream of the lake, an “Agreed Curve” was established. This relation is illustrated by Fig. 3.7 comparing gaugings from 1923 to 1950 with simultaneous Jinja levels.

Although flows through the Owen Falls site were reduced temporarily during construction, this Agreed Curve has been followed over periods of 10 days to a month. However, after 1961–1964, the lake level rose above the limit of the gaugings on which the curve was based, and a linear extrapolation was used until 1967. A model investigation was carried out at the Hydraulics Research Station, Wallingford (1966), based on surveys of the

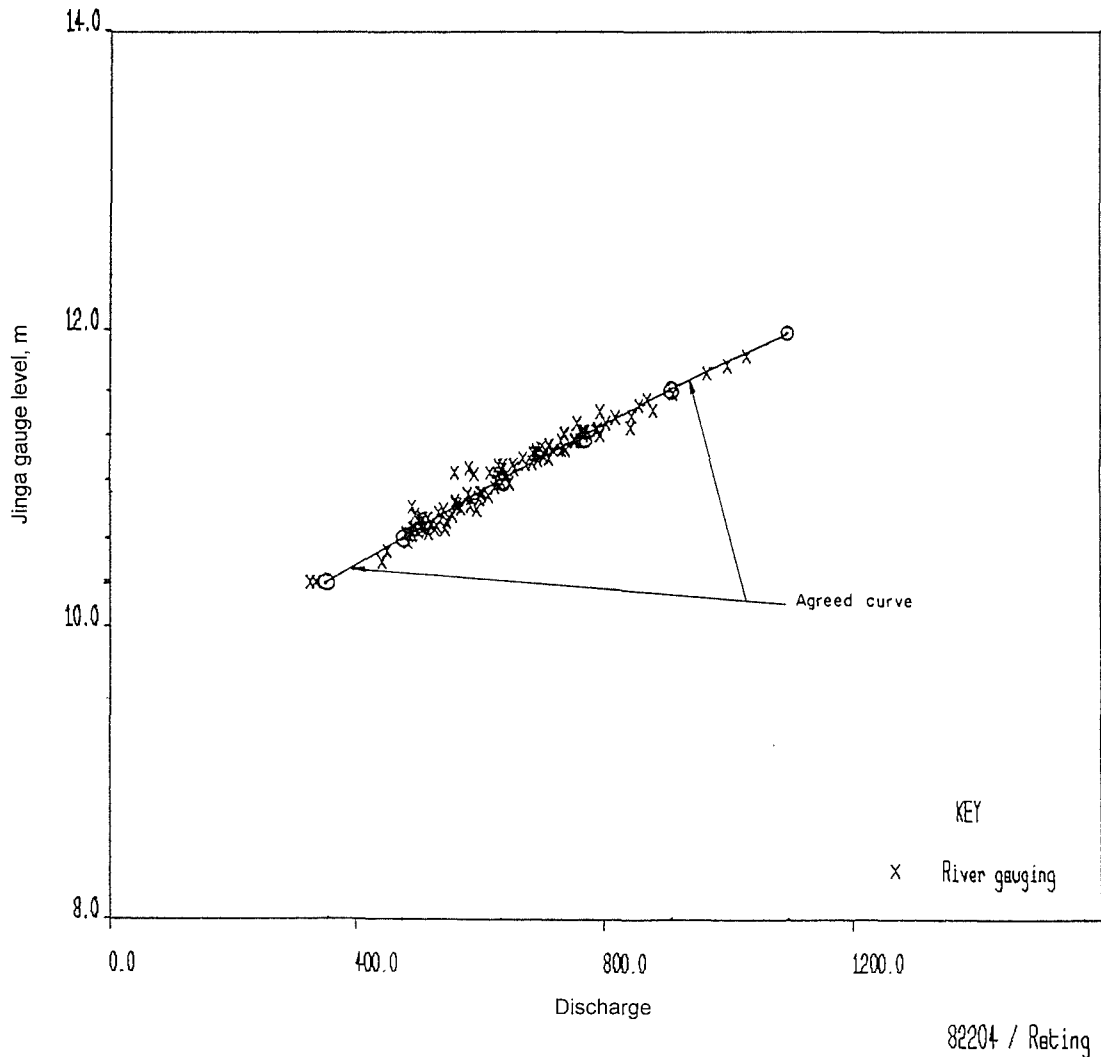

Fig. 3.7 Agreed Curve and gaugings ($\text{m}^3 \text{s}^{-1}$) at Namasagali, 1923–1950.

site. A curve was derived which fitted the Agreed Curve where it was supported by gaugings and was extrapolated in accordance with site conditions. Once this adjusted curve was accepted in 1968, the outflows were raised in accordance and the net cumulative effect of the dam has been shown to be small (Kite, 1981).

Recently, a detailed study was carried out by the Institute of Hydrology (Sene & Plinston, 1994). They compared three different estimates for the lake outflows after the completion of the Owen Falls dam. The first estimate is based on observed lake levels and the Agreed Curve; the second on the turbine flows and sluice releases for the period from 1957 to 1991; the third on interpolations between individual discharge measurements at Namasagali and Mbulamuti. These comparisons confirmed that there were shortfalls in the outflow in 1952–1954, during the construction of the dam, and in 1962–1967, when the linear extrapolation of the Agreed Curve was being used. Other differences occurred in the late 1970s and early 1980s, but the cumulative effect of these differences on lake levels was small.

Thus the best estimate of outflow from the lake was considered to be obtained from the lake levels and Agreed Curve for the period 1896–1939; from the Namasagali discharge measurements for the period 1940–1956; and from the turbine/sluice releases after 1956. These sources were used to compile a composite record (Sene & Plinston, 1994) and have been brought up to date in Fig. 3.8. Studies of the Namasagali discharge measurements and comparisons of the revised outflow records with independent flow records downstream led to the conclusion that the Agreed Curve is reasonable and provides a good estimate of the lake outflows for the whole early period of record.

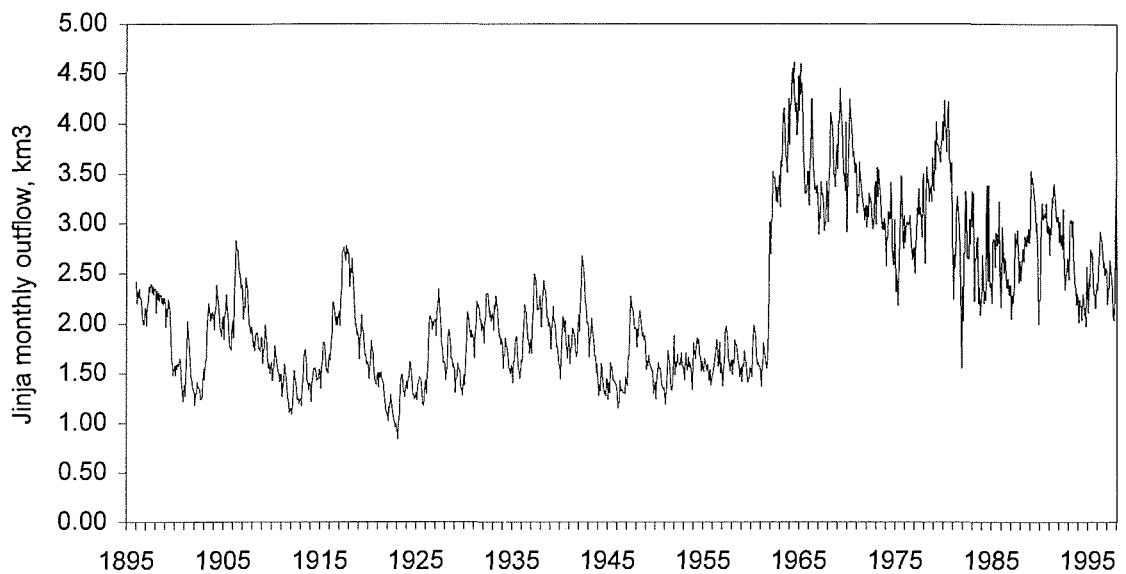

Fig. 3.8 Lake Victoria monthly outflows, 1896–1997.

This outflow record provides the longest flow series in the White Nile basin, and forms the basis for studies of the regime of the lakes and wetlands downstream of Lake Victoria. In order to understand the physical causes of the fluctuations of this important component of the river flows, it is desirable to compare the fluctuations of lake levels and lake outflows with the water balance of the lake basin. This has also been the subject of various investigations over the years, and some of these studies are described in the next section.

WATER BALANCE OF LAKE VICTORIA

The regime of Lake Victoria has been the subject of enquiry since the first quantitative study of Hurst & Phillips (1938), who set in train the measurements on which subsequent studies have been based.

The rise in the lake level in 1961–1964 led to several studies of the available data in attempts to explain the rise. Morth (1967) studied the relations between monthly rainfall and lake level changes. He used the average rainfall over all available stations, which grew from 150 in 1938 to 300 in 1963. He obtained reasonable relations for each calendar month, but the rainfall coverage used was uneven and not consistent over the whole period.

A more comprehensive study by de Baulny & Baker (1970) dealt with the components of the balance. They produced monthly isohyetal maps for the lake and deduced a mean rainfall of 1650 mm; they derived a monthly rainfall series from the records of eight long-term stations around the lake. Their series was brought up to date and reproduced by the Institute of Hydrology (1984); the annual totals ranged from 1281 mm in 1949 to 2201 mm in 1961. Tributary inflows were tabulated for the period 1959–1967, but the source of these flows is unclear. Changes of storage were deduced from gauge records and outflows were calculated from Jinja levels. A comparison between lake rainfall and deduced evaporation suggested that evaporation increased with rainfall until rainfall reached 1650 mm and then decreased. However, the evaporation term included all the uncertainties of measurement and it seems likely that high rainfall totals or inflows were underestimated.

The WMO/UNDP Hydrometeorological Survey

In these early studies the main sources of uncertainty had been the rainfall over the lake and the tributary inflow, and the first priority of the WMO Hydrometeorological Survey which started work in 1967 was to measure these. A network was established (WMO, 1974) which included 25 meteorological stations, 200 rainfall stations, and 45 streamgauging stations. A Data Centre was established and a series of yearbooks compiled. Seven index basins were chosen for study of rainfall–runoff relationships.

The report of Phase I of the survey used measured lake inflows for the years 1969 and 1970 to estimate the water balance. It was concluded that in a normal year lake rainfall is 50% higher than over the land basin, that lake rainfall exceeds evaporation by about 10%, and that direct rainfall is about six times the inflow and three times the outflow. Rainfall records showed that wet years are associated with heavy rainfall in the October–December season.

In Phase II the survey also developed mathematical models of the Nile system, and studied alternative patterns of regulation of the East African lakes. A monthly water balance of Lake Victoria for the years 1950–1980 used lake rainfall, evaporation and tributary inflow data to estimate lake levels and lake outflows (Kite, 1981, 1982; WMO, 1982). However, this balance did not reproduce the observed rise in lake level, and the basic data were re-examined. They used the de Baulny & Baker (1970) estimates for the years 1925–1969, isohyetal maps of shore and island stations for 1970–1977, and the mean of eight stations for 1978–1979. A detailed study of the years 1977–1980 showed that the observed rise of 1.5 m in lake level could have been caused by rainfall 25–30% higher than recorded. The tributary inflow data were also scarce in the early years and were estimated from Kagera flows. The only possible manmade cause was the Owen Falls dam, but it was found that this caused a rise of only 0.03 m over the period 1957–1980. Although the rise must therefore have been due to natural causes, neither a simple water balance nor the use of a mathematical model was able to reproduce it; this was attributed to inaccurate knowledge of lake rainfall and evaporation.

Retrospective analysis of the failure to explain the rise suggests that it was difficult to estimate accurately the increase in lake rainfall using the de Baulny & Baker method in the early years, and a different method for the later years; further, the de Baulny & Baker technique appears to underestimate rainfall in wet years. It also seems that the importance of the variability of tributary inflow was underestimated. It was claimed that the annual total inflows for the early years (1950–1958) were estimated by correlation with the Kagera flows. In fact the estimated inflows for these years apart from the Kagera varied only from 498 to 502 m³ s⁻¹, and the variability was therefore greatly underestimated. In addition, the inflows for 1959–1967 were taken from de Baulny & Baker, and their derivation is unclear as measurements had not begun. In fact the tributary inflow should be more variable than the rainfall itself, because of the sensitivity of the rainfall/runoff process, and this damping of inflow variability must have been an obstacle to realistic modelling.

Reviews by the Institute of Hydrology

The Institute of Hydrology, in a series of reviews of the Lake Victoria water balance, was able to take advantage of the earlier measurements and analyses, in particular the evaporation estimates, the study of rainfall mechanism and the tributary measurements of the WMO Hydrometeorological Survey.

The way in which a consistent lake rainfall series was derived from the eight long-term stations was described earlier. The individual rainfall series were normalized and averaged to give an index which was multiplied by the average lake rainfall (Institute of Hydrology,

1985); the deviations from the mean were enhanced by 1.3 to overcome the effect of averaging on the overall variability. A later series (Institute of Hydrology, 1993) was derived by calendar month comparisons of lake-side rainfall and net rainfall deduced from lake balance. Lake evaporation was based on mean estimates for the period 1970–1974. The tributary inflows were based on actual measurements covering the period 1969–1978 for nearly all the tributaries, and measurements for four of the major Kenya tributaries for the longer period 1956–1978. The shorter series were extended to cover the period of the longer records using the monthly proportions of the long records to the total inflow during the joint period. The Kagera, with its different regime, was treated separately. Excellent results were obtained from a monthly water balance model (Institute of Hydrology, 1985; Piper *et al.*, 1986). The outflow records were originally based on the Jinja levels and the Agreed Curve, but in recent studies the actual turbine/sluice releases have been substituted.

When these components of the water balance are used to estimate the expected annual rise or fall in lake levels and are compared with the measured levels, the correspondence between model and measured levels is close. Reasonable results (Sene & Plinston, 1994) have been obtained for monthly water balances for the period 1956–1990, for the period 1925–1990 by extending inflows using a conceptual model, and also for an annual water balance for the longer period 1900–1990 with inflows estimated from lake rainfall. It may therefore be concluded that the problem of the regime of Lake Victoria, and in particular the rise of 1961–1964, has been satisfactorily explained as being largely due to an unusual variation in rainfall. Recently, Yin & Nicholson (1998) have suggested that variations in lake evaporation are sensitive to climate input, including cloud cover, and that these should be investigated.

The seasonal lake balance can be illustrated by Table 3.2, where the monthly components of the balance are compared with the lake level. The components of the annual lake balance, including their means and standard deviations, are listed in Table 3.3 for the most reliable period 1956–1978. The annual predicted and observed lake levels are compared in Fig. 3.9. It is clear that although the rainfall is the main component of the inflow, the tributary inflow is important in terms of its average, but even more because of its contribution to the variability of the inflow. The sensitivity of the lake balance can be explained by the similarity of average lake rainfall and evaporation, and the sensitivity of tributary inflow to high rainfall. Both the seasonal fluctuations and the longer-term variability of the Lake Victoria outflows are illustrated by the average flows for different periods summarized in Table 3.4. This shows the similarity of the periods 1901–1930 and 1931–1960, and the near doubling of outflows in the 1961–1990 period.

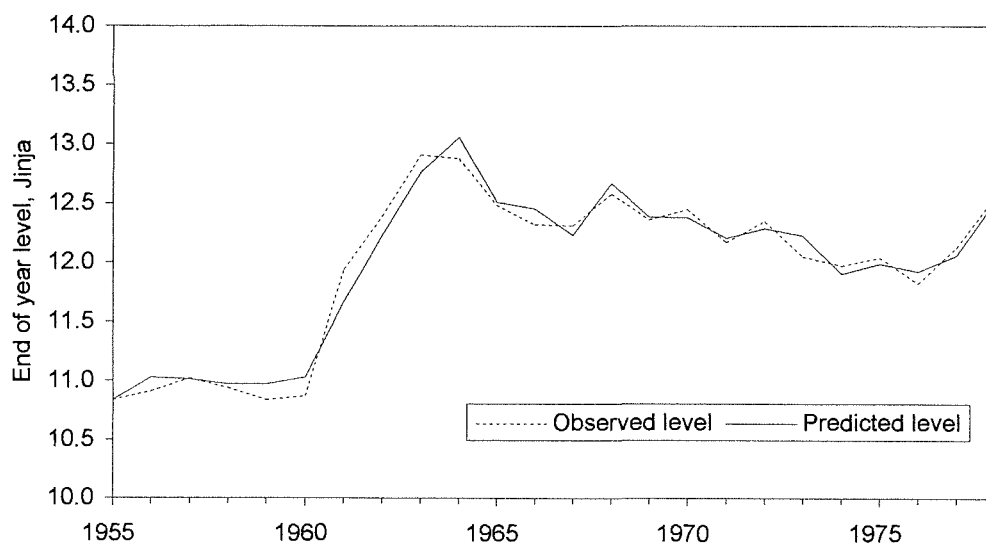

Fig. 3.9 Lake Victoria annual water balance, 1956–1978.

Table 3.4 Monthly mean Lake Victoria outflows for various periods ($\text{m}^3 \times 10^6$).

Jan.	Feb.	March	April	May	June	July	Aug.	Sept.	Oct.	Nov.	Dec.	Year
1901–1930												
1640	1485	1659	1716	1926	1890	1854	1751	1634	1643	1577	1653	20 428
1931–1960												
1693	1536	1719	1755	1929	1908	1878	1792	1691	1699	1606	1684	20 888
1961–1990												
3056	2811	3146	3099	3331	3276	3314	3242	3073	3120	2955	3073	37 497
1901–1995												
2157	1968	2204	2214	2417	2376	2378	2282	2150	2170	2063	2160	26 539

LONG-TERM LAKE VICTORIA BALANCE

It is possible to take the study of Lake Victoria hydrology back before the start of historic lake levels by using indirect evidence. Lamb (1966) described the evidence for high Lake Victoria levels 10–20 years before the lake level gauges were installed in 1896. He noted that Catholic missionaries in Buganda reported that around 1876–1880 the average water level was about 8 feet (2.4 m) higher than in 1898, which would be as high or higher than the 1964 peak. The most thorough assembly of evidence was compiled by Lyons (1906) who took part in Garstin's (1904) expedition to the upper Nile and contributed an appendix to this report. He provided a number of travellers' observations of the very high level in August 1878 and a fall of 8–9 feet (2.5 m) by 1891, followed by a rise in 1892–1895 and a period of falling levels from 1896 to 1902. He was able to provide evidence of a rise about 1850 which inundated areas which were uncovered about 1890. The 1878 peak was supported by observations of flooding at Lado on the Bahr el Jebel, where levels were still high in December after a peak in August 1878, pointing to an unusually high level of Lake Albert and thus Lake Victoria (Lyons, 1906, p. 103).

There is indirect evidence from downstream to support these high levels. The flooding in the Sudd is known to have been more widespread at the end of the nineteenth century than in the early years of the twentieth century. Hurst & Phillips (1938), in discussing the outflows from Lake Albert, pointed out that the average discharge at Aswan from 1871 to 1898 was much greater than the average from 1899 to 1936, and they deduced that part of the cause would have been higher outflows from the lakes. They "infer that from 1870 to 1900 high floods seem to have been more common than in the period following 1900". The historic level records measured at Khartoum from 1869 to 1883 near the confluence of the White and Blue Niles show a very high level in May 1879, indicating high lake outflows in 1878. In the context of flood control, the Jonglei Investigation Team (1948) noted a "remarkable series of high floods" at the end of the nineteenth century, and pointed out that the 1878 flood was larger than that of 1917, quoting several early travellers and the history of Sudd blockages. There is evidence from the Sudd that these floods affected the Nuer of the Bahr el Zeraf; "the high flood of 1878 contributed to a major internal conflict among the Gaawar, and the continuous high levels of 1892–1896 encouraged the Bar Gaawar to occupy the northern half of the Duk ridge" (Howell *et al.*, 1988, p. 217). Johnson (1992) has presented a chronology of floods on the Bahr el Jebel based on oral and contemporary sources; the local impacts of the floods of 1878, 1895, 1917 and 1961–1964 are described in graphic detail.

Flohn & Burkhardt (1985) have attempted a tentative reconstruction of lake levels for the period 1870–1898 from observed Aswan low season flows. They deduce from statistical trials that the low season discharge at Aswan is controlled about half by the baseflow from the previous Blue Nile flood and half by the Lake Victoria level at the end of the previous year.

They provide lake series with peaks in 1878 and 1892–1895 which correspond fairly closely with those deduced from subjective evidence by Lyons. Thus there is strong evidence that the rise in Lake Victoria in 1961–1964 was not unique and has been equalled, in level if not in duration, less than a century before.

These variations are consistent with trends in East African rainfall over a longer time scale, which have been described by Nicholson (1980, 1989). Historical accounts and observations suggest a period of frequent but short dry episodes in the mid 1800s, a relatively wet period between the 1870s and 1890s and an abrupt continent-wide decrease starting in 1895 and lasting until the 1910s. Since then dry periods have occurred around 1920, in the 1940s and 1950s and the early 1970s, with wet periods in the 1960s and the late 1970s. A number of reasons have been put forward for these fluctuations, including sea surface temperatures and sunspot activity (Mason, 1993), but research is still required on this topic. The scale is such that they have important water resources implications and therefore research could help with global trends.

One question which arises from this evidence is whether an upper bound exists to the lake level fluctuations in the more distant past. The most direct evidence for such an upper limit is provided by evidence from an excavated cave (Plate 2) near Entebbe. Beach sands overlain by occupation debris in the mouth of Hippo Bay cave (near the southern end of the runway at Entebbe airport) were found to contain water-rolled fragments of charcoal distributed throughout the sands; a sample of charcoal was dated as 3720 ± 120 years BP (before present) (Bishop, 1969). The evidence of the excavation (Brachi, 1960) suggested that “the sand was deposited and the charcoal fragments incorporated at a time when Lake Victoria stood at least nine feet higher than at present”. Unlike higher strand lines around Lake Victoria which show signs of tilting due to earth movement, the Hippo Bay level maintains a constant height above the lake. Therefore comparison of levels at the cave site with those at the lake outlet at Ripon Falls, are relevant though it should be remembered that downcutting will have occurred at Ripon Falls since the deposition of the sands in the Hippo Bay cave.

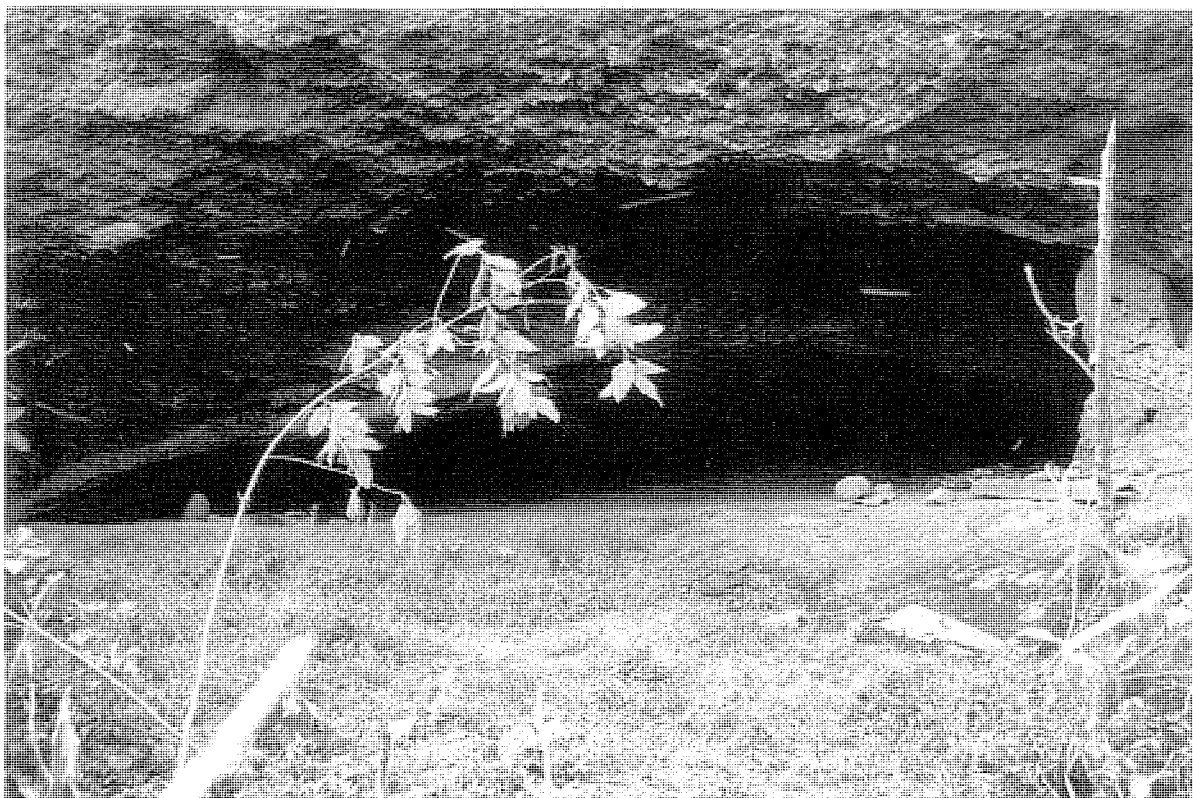

Plate 2 Mouth of cave at Hippo Bay, Entebbe (photo: Tim Sharp).

This excavation was of course undertaken and described before the rise in Lake Victoria levels. Bishop subsequently noted that “the recently recorded rise in the level of Lake Victoria between 1961 and 1964 is of interest as, at their maximum, the lake waters were within two feet of the dated beach gravel in Hippo Bay cave (Fig. 17). This cave fill is so unconsolidated that even a few weeks would suffice to remove the whole deposit. It is certain that at no time since $3720 \pm$ years ago has Lake Victoria risen to re-occupy the 10- to 12-foot cliff notch”. It certainly seems that such a rise in the lake would have disturbed the charcoal fragments which were found to have been distributed throughout the sand. Given that the mean Jinja gauge level for 21–31 August 1959 was 10.80 m, and the range of 10–12 feet (3.05–3.66 m) above this level is equivalent to 13.85–14.46 m on the Jinja gauge, this information provides a bound to the lake level fluctuations and an upper outflow limit of $3000 \text{ m}^3 \text{ s}^{-1}$ (Sutcliffe, 1987) converted by the present rating curve.

It is possible to compare this evidence with the flood series derived from the historic lake level series. Annual levels are not independent over time scales up to about 10 years, due to storage effects. Therefore a series of the decade maximum levels for the years 1896–1905, etc., have been abstracted and the equivalent outflows deduced from the Agreed Curve. These have been plotted (Fig. 3.10) against their adjusted Gumbel reduced variates, according to the Gringorten plotting position (Cunnane, 1978), with the upper bound plotted as the highest of a 3720-year period. This graph provides a reasonable flood estimate of about $3000 \text{ m}^3 \text{ s}^{-1}$ corresponding to a return period of over 4000 years.

DOWNSTREAM INFLUENCE

The whole of the Nile system may be regarded as a set of tributaries providing a slowly moving baseflow, with local contributions or influences causing seasonal fluctuations. The extent of these local fluctuations determines their downstream influence. The influence of the Lake Victoria basin on downstream flows is to provide such a baseflow, which after attenuation in the lower lakes, forms the relatively steady contribution of the inflows to the

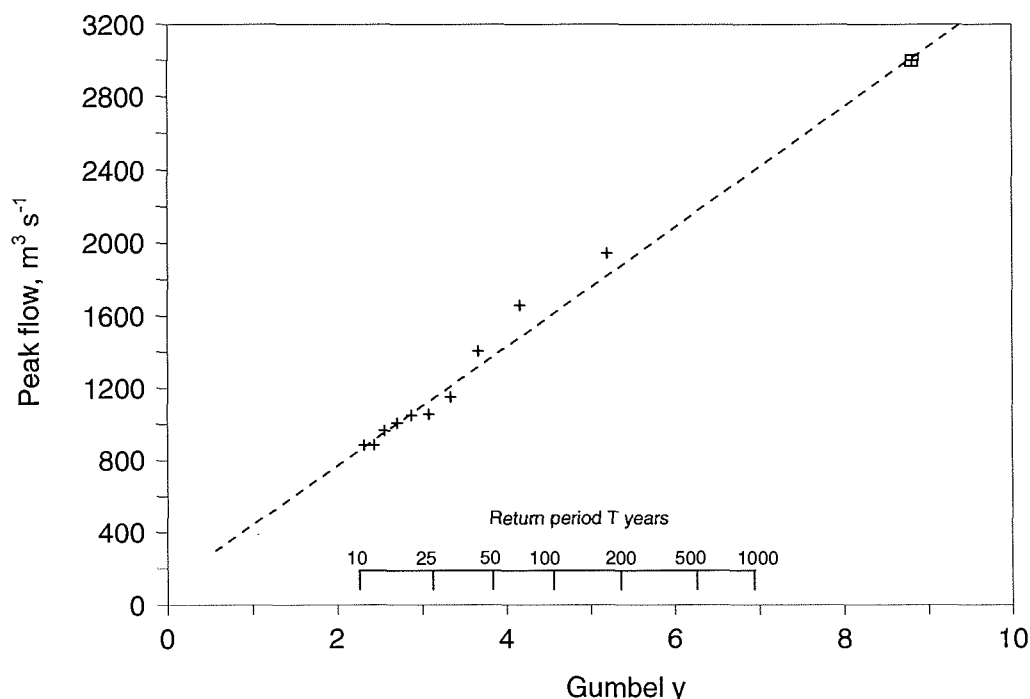

Fig. 3.10 Lake Victoria: decade peak outflows, 1896–1995.

Sudd. The extended seasons of rainfall, the storage in some of the tributaries, especially the Kagera, and the large storage available in Lake Victoria itself, ensure that the outflows vary little through the year. However, the balance of the lake system is not very stable, as average rainfall over the lake is almost in balance with open water evaporation. A period of high rainfall, such as occurred in 1961–1964, together with the effect on tributary inflow, can have a disproportionate effect on the lake balance. A large rise in the lake level may occur and persist for some years because of lake storage. The variations from year to year and the seasonal distribution of the outflows form the inflow to Lakes Kyoga and Albert downstream, and, after modification through the lake system, provide the major contribution to the flows of the Bahr el Jebel where it enters the Sudd. This has important implications for the regime of the Bahr el Jebel, which will become more evident in Chapter 5.

CHAPTER 4

THE EAST AFRICAN LAKES BELOW LAKE VICTORIA

INTRODUCTION

The outflows from Lake Victoria have a small seasonal variation, as the inflows and the direct rainfall on the lake are attenuated by the large lake storage. Table 3.4 shows that overall the highest monthly outflow in June is only 15% above the lowest in November, though the variation averages 20% in the earlier periods of low lake levels and 11% in the high lake period. Also, the lake storage corresponding to the rise in 1961–1964 was equivalent to five years' long-term outflow. An increase in inflows takes up to 10 years to reach a new equilibrium, so that major changes in the water balance take some years to work through the lake. In their turn the lake outflows form the major part of the White Nile flow. They are modified by their passage through Lakes Kyoga and Albert, and by the flows of various tributaries which enter the river network in most cases through these lakes. Thus the effects of the lake system between Jinja and Mongalla, the next reliable long-term gauging site, can be divided into net contributions in different reaches, and attenuation through lake storage. The aim of this chapter is to describe and quantify the effects of the individual lakes and their tributaries.

GEOGRAPHY OF THE LAKE SYSTEM

The geography of the upper White Nile basin has been described briefly in Chapter 1; it may be useful to give more detail here. The pattern of lakes and tributaries, dominated by the geological evolution of the basin, is particularly complex (Fig. 3.1). Lake Victoria itself developed following the uplift of the earth's crust east of the western Rift Valley. This rise prevented the outflow of previously west-flowing rivers, like the Kagera and the Katonga, and Lake Victoria itself was formed in the basin between the two branches of the Rift Valley. The lake overflowed to the north at Jinja (Plate 3) and flowed down a tributary of the Kafu-Kyoga and thus into Lakes Kyoga and Albert. The course of the Kafu was also reversed so that the river flows both east and west from a point about 50 km east of the southern end of Lake Albert. This history explains not only the peculiar shape of the upper Kagera river system, but also the dendritic shape of Lake Kyoga, which is essentially a submerged river valley.

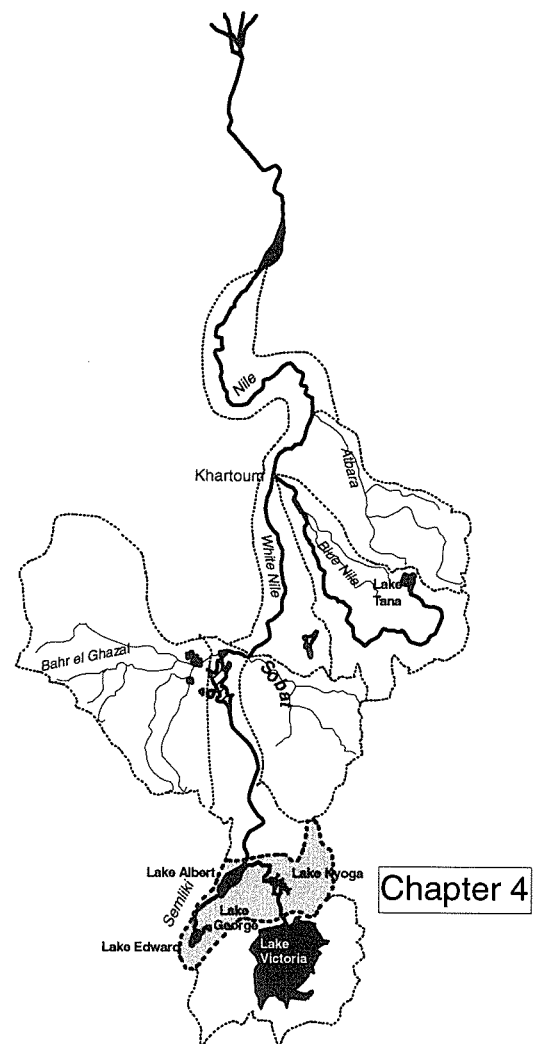

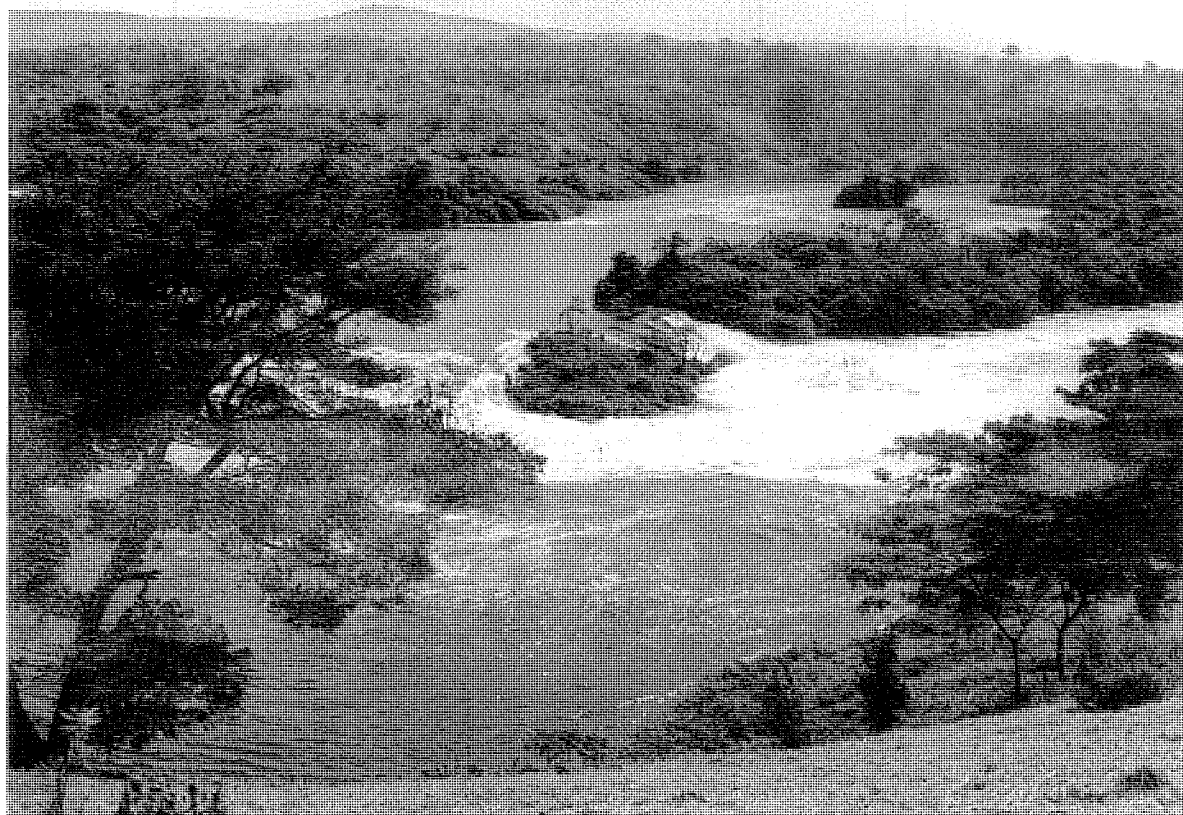

Plate 3 Victoria Nile at Bujagali Falls, below Owen Falls dam.

The course of the Nile between Lake Kyoga and Lake Albert is similarly influenced by the geological history of the area. The river flows up a former tributary of the Kafu after turning northeast at Masindi Port, and then swings west to enter the Rift Valley and Lake Albert through the Murchison Falls. The surroundings of Lake Kyoga are dominated by swamps along the various arms of the lake, and the topography is of moderate relief. In contrast Lake Albert is within the western Rift Valley, and the lake is flanked by the escarpment on the east and by steep mountains on the western or Congo side of the lake.

To the south of Lake Albert and the Ruwenzori mountains, Lakes George (300 km²) and Edward (2200 km²) are connected by the Kazinga channel. Although the Katonga tributary appears to drain a wide area, its course from a swamp is in fact relatively short. While Lake George is shallow at only 3 m and its basin is flat, Lake Edward is flanked by steep mountains to the west and is over 100 m deep in parts (Worthington & Worthington, 1933). The River Semliki drains Lakes Edward and George and thus both sides of the Ruwenzori mountains. Below Lake Edward its course is mainly across the Congo border, but the main channel forms the border with Uganda before entering the southwestern end of Lake Albert through the Semliki flats.

Below Lake Albert, the main river, here known as the Albert Nile or the Bahr el Jebel, flows along an extremely flat channel through a fringe of swamps as far as Nimule on the Sudan border. North of this point, the river turns again to the northwest on a continuation of the line of the River Aswa or Achwa, and passes through a series of rapids before entering the plains of the Sudd or Bahr el Jebel swamps. As well as the Aswa, there are a number of streams, known as the torrents, which flow into the Bahr el Jebel between Lake Albert and Mongalla. These streams, some of which rise within Uganda and others within the southern Sudan, are important because they provide the seasonal as opposed to the steady component of the inflows to the Sudd.

EARLY WATER BALANCE OBSERVATIONS

An early water balance of the lake basins was given by Hurst & Phillips (1938). They described the course of the Victoria Nile through Lake Kyoga, with an area of 1760 km² of open water and 4510 km² of swamps. They compared the 1913–1932 average inflow (20.5 km³) with outflow at Masindi Port (18.0 km³) and deduced an annual loss of about 2.5 km³. They suggested a balance between direct rainfall (1295 mm or 8.1 km³), local runoff at only 3% of rainfall over a flat and swampy area of 69 000 km² (2.7 km³), and estimated evaporation of 1205 mm from the open water and 2230 mm from the swamps (12.2 km³). This implied a net loss of 1.4 km³. These figures are still quite reasonable.

Similar estimates were made for the Lake Albert basin. The runoff from the Semliki basin below Lake Edward was taken as 2.05 km³ (16% of 1600 mm rainfall over 8000 km²), added to the outflow of 3.69 km³ from Lake Edward. The direct runoff to the lake was taken as 12% of 1256 mm over a relatively steep area of 17 000 km² or 2.56 km³. The direct rainfall on the lake (5300 km²) was estimated from the Butiaba records as 810 mm, and the evaporation as 1200 mm; the net evaporation is 2.07 km³, and the net gain is thus 6.23 km³. The Kyoga Nile inflows were estimated as 18.0 km³, and an attempt was made to estimate the Bahr el Jebel outflow from Lake Albert.

The torrent flows between Lake Albert and Mongalla are significant during the rains but negligible in the dry season. Consequently Lake Albert levels at Butiaba gauge were related to monthly mean dry season flows at Mongalla, assuming an estimated 5% loss between the sites. This provided a rating curve to estimate outflows from Lake Albert throughout the year; the relation changed in 1922 after prolonged low levels. The monthly outflows from Lake Albert were published from 1904, and the average outflow for the period 1913–1932 was estimated as 24.0 km³, compared with the Kyoga Nile inflow of 18.0 km³. The balance between total inflows and outflows, including rainfall and evaporation, was thus close. The seasonal distribution of lake levels, calculated from the monthly water balance, corresponded closely with observed levels, whose seasonal fluctuations are largely due to rainfall and local runoff.

GENERAL CLIMATE OF LAKE KYOGA AND LAKE ALBERT BASINS

The rainfall of the two lake basins is intermediate between the bimodal regime of the Lake Victoria basin and the unimodal regime of the southern Sudan. Monthly rainfall averages for the different sub-basins of the Nile have been published in *The Nile Basin*, vol. VI and supplements, and Table 1.1 illustrates the seasonal distributions. The Lake Kyoga basin and the Lake Albert basin have two distinct rainfall seasons, with a maximum in April and a lesser peak around October. However, the area between Lake Albert and Mongalla has an extended single season, at least on average. The average annual rainfall is fairly constant over much of the plateau between Lake Victoria and Lake Albert, but decreases to the northeast of Lake Kyoga in the drier region of Karamoja, and is low over Lake Albert in the floor of the Rift Valley. Comparisons with Penman estimates of potential transpiration show that there is a surplus during the two rainy seasons in the south, and during the single rainy season in the north. Comparisons of rainfall averages for different periods show that while there was increased rainfall in parts of the Lake Kyoga basin since 1961, as in the Lake Victoria basin, there was little evidence of change in the few stations available in northern Uganda.

PUBLISHED FLOW RECORDS

Main Nile between Lake Kyoga and Lake Albert

The major components of the water balance of the Lake Kyoga and Albert basins are the inflows and outflows of the main Nile. The key hydrometric stations are those on the Kyoga Nile between the two lakes, and on the Bahr el Jebel between Lake Albert and Mongalla. Another is on the River Semliki at Bweramule above Lake Albert, together with the level gauges on the different lakes.

The main river gauges below Lake Kyoga were at Masindi Port just below the lake, at Kamdini about 80 km downstream, and at Fajao 1 km below the Murchison Falls and Paraa 5 km downstream. Levels have been measured at Masindi Port since 1912, at Fajao irregularly since 1932 and at Kamdini since 1940. The levels at Masindi Port and at Kamdini have been published as 10-day means in *The Nile Basin*, vol. III and supplements. Few records are available after 1980.

The discharge measurements made at various stations between Lake Victoria and Lake Albert have been published in *The Nile Basin*, vol. II and supplements, and the annual numbers of these gaugings are summarized in Table 2.1. Gaugings have been made regularly below Lake Victoria, either at Namasagali or more recently at Mbulamuti. Those at Masindi Port were concentrated in two periods, from 1935 to 1945, and in 1971 and 1976–1978; in the later period they were carried out by the Uganda Hydrological Department. At Kamdini, gaugings were carried out between 1940 and 1959, and at Fajao or Paraa downstream more or less continuously between 1922 and 1978.

Summaries of 10-day and monthly flows were calculated from levels, using in general annual ratings, and published in *The Nile Basin*, vol. IV and supplements. Flows at Masindi Port from 1912 were based on a rating curve for Masindi Port derived from gaugings made at Fajao downstream between 1907 and 1935. This curve was published in *The Nile Basin*, vol. V, and it was noted that the observations were fairly consistent over a long period. The flows for 1917–1918 were later revised. This record before 1940 was based on few gaugings but these include measurements in 1922–1923 when river levels were at their lowest. Later flows based on annual gaugings were published up to 1944. It was noted in *The Nile Basin*, vol. VII, p. 74 (Hurst *et al.*, 1946) that the rating was not stable and flows were discontinued. However, during 1988 (Gibb, 1989) the records at Masindi Port were examined in some detail and a flow record derived as discussed later.

Flows at Kamdini for 1940–1955 were published in *The Nile Basin*, vol. IV, based on annual gaugings. Gauge levels were published in vol. III from 1940 to 1977 as 10-day and monthly means, and further levels for 1978–1980 were kept by the Water Development Department, Entebbe. In order to obtain a record which should be more reliable than Masindi Port, gaugings at Fajao and Paraa downstream have been used to derive rating curves to cover this whole period, as discussed below.

A flow record for Fajao, derived by linear interpolation between monthly gaugings, was published for 1940–October 1961, with considerable gaps between 1944 and 1950. A similar record was derived for Paraa for 1963–1967. These flows have value for completion of other records.

Semliki at Bweramule

Discharges of the River Semliki have been measured regularly at Bweramule from 1940 to 1978, and the rating curve is reasonably stable. The early flows have been published in *The*

Nile Basin, vol. IV, based on annual rating curves, and are also available in the Uganda archive from 1950 to 1978. The two sources are compatible and a joint record can be compiled for the period 1940–1978.

Lake Albert outflows

Attempts have been made to measure Lake Albert outflows directly at Pakwach and elsewhere, but the rating curves at these sites were not stable. Estimates of Lake Albert outflows, as described earlier, have continued to be based on a relationship between monthly dry season flows at Mongalla, increased by 5% to allow for losses, and simultaneous Butiaba lake levels. This relation was assumed to apply throughout the year to give the lake outflows during periods when there would be inflows between the two sites. Although this relation changed in 1922, recent comparisons show that it changed back after the high flows of 1964.

It is doubtful whether the dry season losses between Lake Albert and Mongalla still amount to 5% after the doubling of outflows after 1961. The earlier assumption relied on simultaneous gaugings at both sites and on estimates of evaporation from swamps and open water. Its continued use implies that these areas also doubled. The later flows are therefore less precise.

An alternative is to treat the Lake Albert basin as extending down to Mongalla, where the inflow to the Sudd is confined to a single channel and gaugings have been carried out from 1905 and regularly from 1922. Flows have been computed regularly from continuous level observations and published in *The Nile Basin*, vol. IV and supplements. There have been changes in the rating over the years; for a given flow there was a continuous rise from 1905 to 1960 but a fall after 1962 to earlier levels. These flows are discussed in more detail in Chapter 5. It is sufficient to note that the flow records at Mongalla are reasonably reliable and that the estimated outflows from Lake Albert have been used to derive the flows of the seasonal torrents between Lake Albert and Mongalla.

REVIEW OF RIVER FLOWS AT KEY SITES

Lake Kyoga outflows at Masindi Port

A monthly flow record for 1912–1944 was published in *The Nile Basin* based on levels at Masindi Port and a rating based on gaugings at Fajao between 1907 and 1935, extended by later measurements. There are no other flow records for this reach before 1940, which includes the lowest outflows from Lake Victoria in 1922–1923. Because the rating is based on gaugings during this low flow episode, the flows may be accepted with caution.

During a recent study (Gibb, 1989) attention was paid to the later record at Masindi Port because of its potential length. The level record was considered reasonable, but gaugings were confined mainly to the two periods 1939–1945 and 1976–1978. The only rating which could be applied to the period 1945–1970 was that from 1942–1945. The level records were used to compile daily and monthly flows for the period February 1947–September 1978 (Gibb, 1989). At the time certain level records were not available in Uganda, but it has since been possible to complete these flows using 10-day levels published in *The Nile Basin*, vol. III. Thus the flow record, with its admitted limitations, has been completed for the period 1912–1978 and summarized as monthly flows in Fig. 4.1.

It would be possible to investigate further the ratings between 1945 and 1971 by comparing levels at Masindi Port with gaugings made downstream at Kamdini, Fajao and

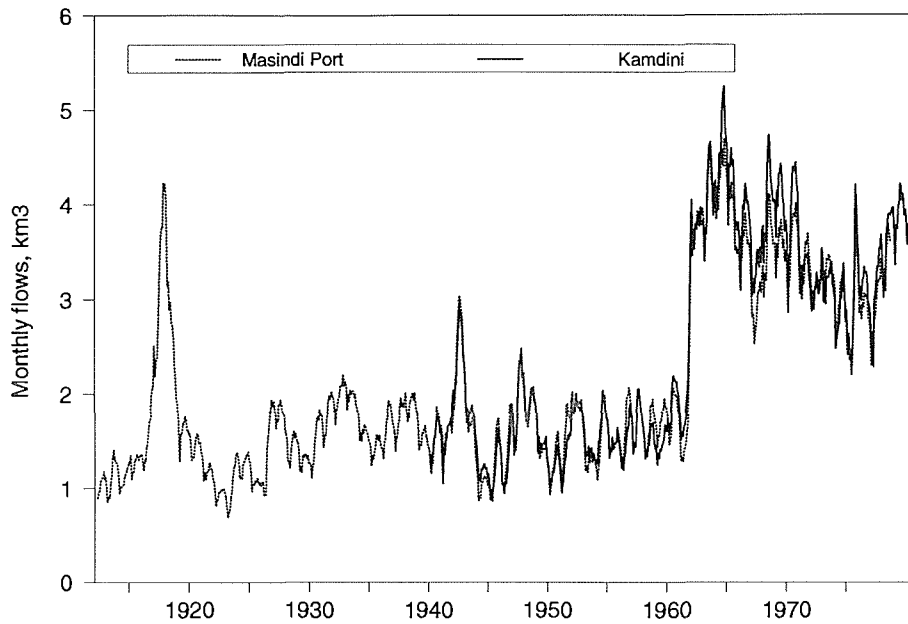

Fig. 4.1 Comparison of flows on Kyoga Nile, 1912–1980: Masindi Port and Kamdini.

Paraa. However, this would not add significant information to the flows derived in a similar manner downstream at Kamdini, where gaugings cover a longer period and analysis has been concentrated.

River flows at Kamdini

There is also a level record at Kamdini, where the rating should be more stable than at Masindi Port. Therefore records at or near Kamdini have been used (Gibb, 1996) to derive an independent flow record. Flows for the period 1940–1955 have been published in *The Nile Basin*, but these were deduced from gaugings made during each year. It is not easy to derive a reliable curve from individual years, because the range of levels and flows is limited during a

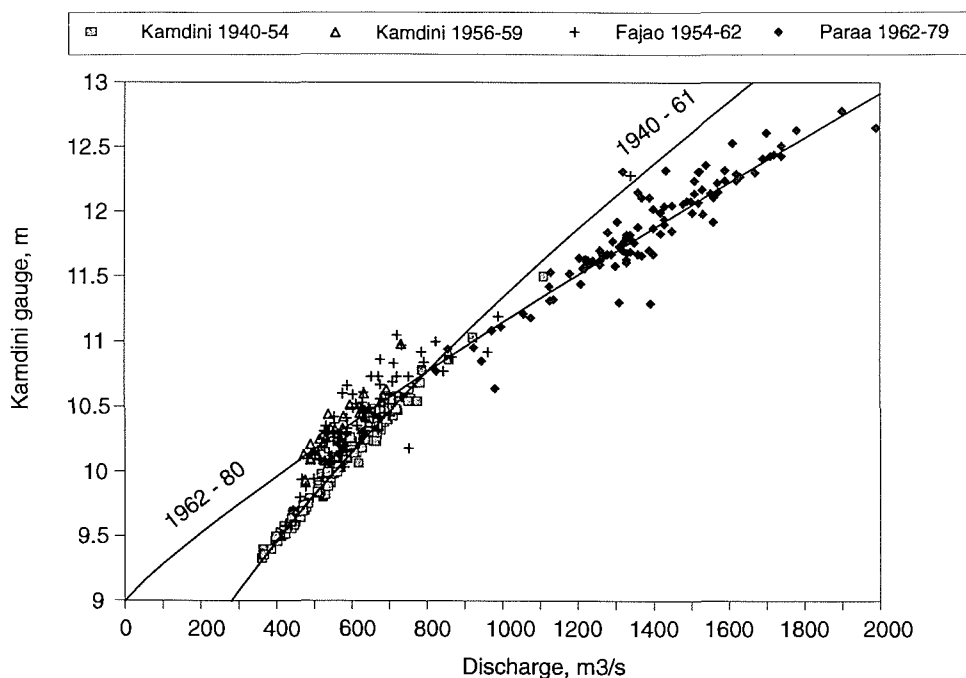

Fig. 4.2 Gaugings at Kamdini, Fajao and Paraa, 1940–1979.

single year on these lake-fed rivers. It is preferable to deduce a rating curve based on all available gaugings, and these have been used to derive two rating curves for the whole period. Gaugings at Kamdini itself were only made during the period 1940–1959; later gaugings from 1954 measured at Fajao and then Paraa downstream were included by comparison with the contemporary 10-day mean level at Kamdini. The inflows between Kamdini and the downstream sites are likely to be relatively small. Consequently it has been possible to monitor the rating at Kamdini over the whole period of level records (1940–mid 1980).

A total of over 330 discharge measurements were extracted from *The Nile Basin*, vol. II and supplements, and from gaugings available in the Uganda archive. The gaugings at different sites are distinguished in Fig. 4.2. There appeared to be a significant shift in the rating about 1955, according to the later gaugings at Kamdini as well as those at Fajao. There was a major change in 1962, when the lake and river levels rose following Lake Victoria. Using the HYDATA system (Institute of Hydrology, 1995) for deriving rating curves, a best fit equation was fitted to all gaugings in the period 1940–1961, and a second derived for the period 1962–1979. Because the annual range of levels is limited, it was preferred to derive a rating from the whole set of consistent gaugings and then monitor apparent annual changes in control. The program lists the deviations of individual gaugings from the derived rating curve, and these were averaged for each year or longer periods to obtain a rating in the form $Q = a(h - h_0 - dh)^b$ where dh is the vertical deviation from the rating curve. These adjusted rating curves have been used to derive 10-day and monthly flows, with some gaps filled from other sources (Sutcliffe, 1996). A monthly summary of this record is included in Fig. 4.1. This record is considered reasonable and preferable to other records on the Kyoga Nile, as it is based on contemporary gaugings either at the site or downstream.

Comparison of flows at Masindi Port and Kamdini

The independent flow records for Masindi Port and Kamdini may be compared in Fig. 4.1. The monthly flows for the common period suggest that both are reasonably reliable, although the Kamdini record is to be preferred where available. Both records exhibit increased flows after the rise in Lake Victoria levels after 1961 and are similar in form. Between about 1966 and 1970 the Kamdini record is the higher, but the overall difference over the common record is only about 3%. It should be noted that tributary inflow between the two sites is relatively small; the main tributary is the River Tochi, which contributes less than 1% to the flow of the main river. The two records are compared with the outflows from Lake Victoria in Fig. 4.3. The fact that the flows for Masindi Port and Kamdini both confirm the rise in outflows from Lake Victoria provides further proof that the Agreed Curve gave realistic estimates of the Lake Victoria outflows. The availability of reliable flows at Kamdini makes it possible to separate the net contributions of the Lake Kyoga basin between Jinja and Kamdini from those of the Lake Albert basin between Kamdini and Mongalla.

COMPARISONS OF INFLOWS AND OUTFLOWS FOR LAKE KYOGA

The net effect of Lake Kyoga on the Nile flows can be studied by comparing river flows below Lake Kyoga with Lake Victoria outflows. The most reliable record in this reach is at Kamdini, and analysis must be based on the period 1940–1977 when these flows are available; the gaugings during 1978–1979 were infrequent. Study is based on monthly flows, but when comparisons are made with lags of one or more months, the flows have to be

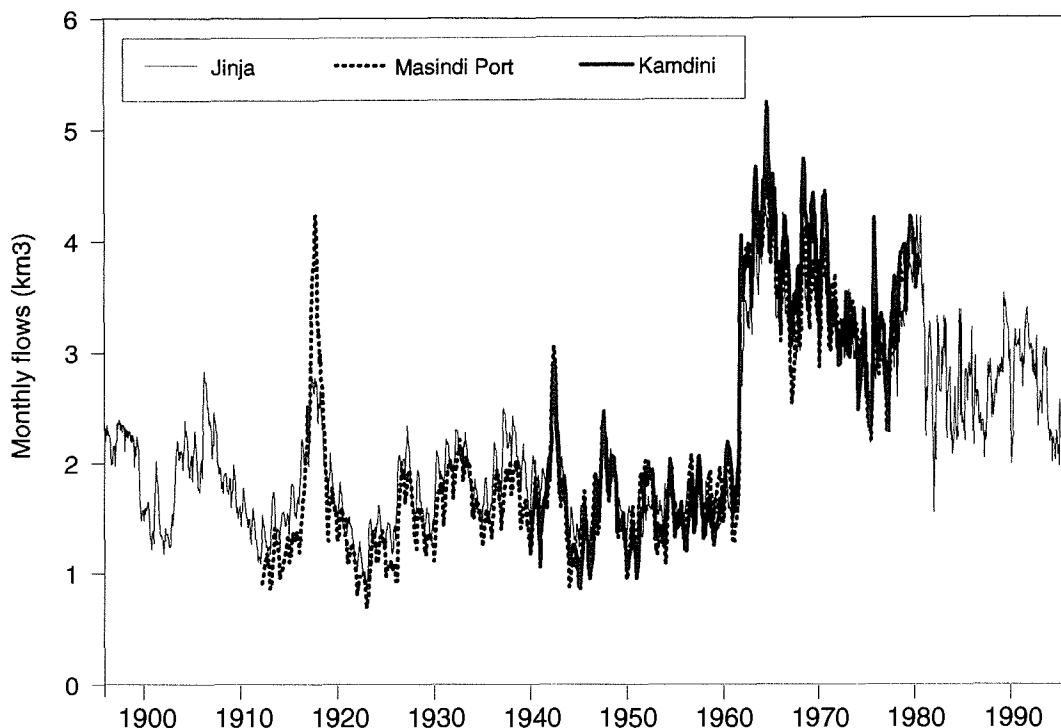

Fig. 4.3 Lake Victoria and Lake Kyoga monthly outflows, 1896–1995: Jinja, Masindi Port and Kamdini.

converted to $\text{m}^3 \times 10^6 \text{ day}^{-1}$ to take account of different month lengths. The results (Table 4.1) show that the regression is improved when lags of one month are taken into account, but not for greater lags.

The comparison based on annual Lake Kyoga inflows and outflows for 1940–1979 (Fig. 4.4) is similar to the monthly comparison, but the scatter has been much reduced; the line of equality has been superimposed. The comparison supports the hypothesis of Hurst & Phillips (1938) that the lake system is responsible for net losses in dry years and for net gains

Table 4.1 Regression of monthly outflows from Lake Kyoga on inflows (based on Kamdini flows, 1940–1977, and Lake Victoria outflows).

Lag (months)	Coeff.	seb	R	R^2	see	Constant
Monthly flows, $\text{m}^3 \times 10^6 \text{ month}^{-1}$ (456 observations)						
0	1.1331	0.0150	0.9624	0.9263	300	–247
1	1.1331	0.0151	0.9619	0.9252	302	–242
2	1.1309	0.0154	0.9603	0.9221	308	–234
Monthly flows, $\text{m}^3 \times 10^6 \text{ day}^{-1}$						
0	1.1319	0.0151	0.9620	0.9255	9.85	–8.03
1	1.1390	0.0139	0.9677	0.9365	9.09	–8.44
2	1.1336	0.0148	0.9633	0.9280	9.68	–7.92
3	1.1205	0.0169	0.9522	0.9067	11.02	–6.80

Coeff. is the regression coefficient b in an equation of the form $Q_o = a + bQ_i$.

seb is the standard error of b .

R , R^2 are the coefficients of correlation and determination.

see is the standard error of estimate.

Const. is the constant a in the equation.

The optimum equation linking inflow (Q_i) and outflow (Q_o) for Lake Kyoga is:

$$Q_o(t) = 1.1331 Q_i(t-1) - 242 \text{ in terms of } \text{m}^3 \times 10^6 \text{ (ignoring length of month)}$$

or

$$q_o(t) = 1.139044 q_i(t-1) - 8.44181 \text{ in terms of } \text{m}^3 \times 10^6 \text{ day}^{-1}.$$

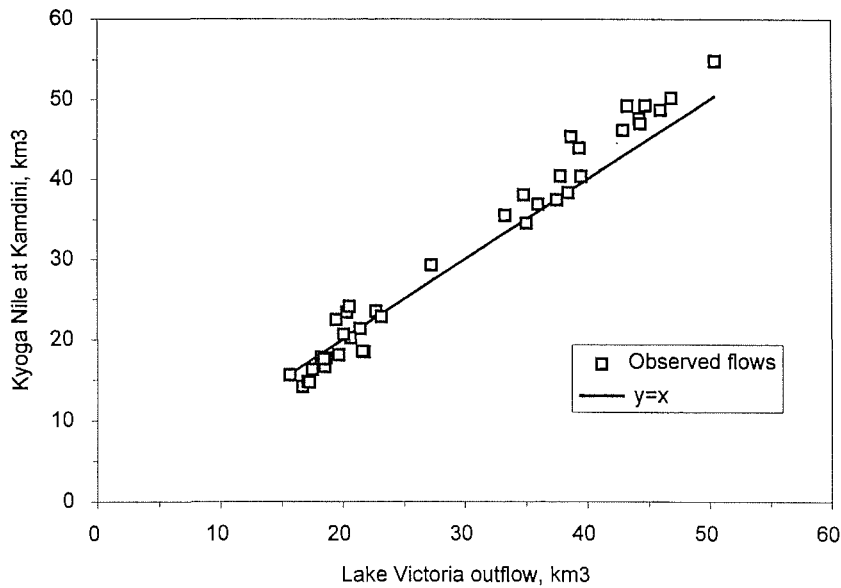

Fig. 4.4 Lake Kyoga annual inflows and outflows, 1940–1979.

in wetter years. This has been attributed (Institute of Hydrology, 1984) to the evaporation from Lake Kyoga exceeding direct rainfall and local runoff during relatively dry periods. In contrast the local runoff increases during wetter periods and together with lake rainfall exceeds lake evaporation, which should be relatively constant from year to year.

WATER BALANCE OF LAKE KYOGA

There are few records of the local inflow, mainly from east of Lake Kyoga, and it is not possible to make a complete study of the lake water balance. Differences between lake inflow and outflow are small by comparison with either river flow record and therefore affected by measurement errors at both sites. However, the hypothesis that net gain or loss is due to the balance between rainfall with its associated runoff and lake evaporation has been tested by analysis of the period 1940–1977.

A lake level record (Fig. 4.5) has been derived for Lake Kyoga from the 10-day mean levels at Masindi Port. This site is just below Lake Kyoga, but has the most complete record.

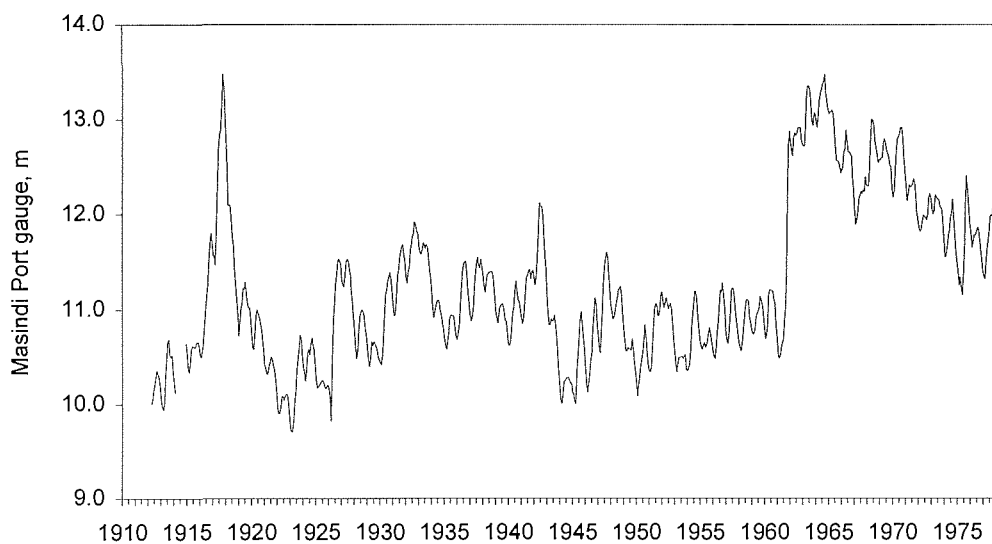

Fig. 4.5 Lake Kyoga monthly levels, 1912–1977.

The annual differences between Lake Kyoga inflow and outflow need to be adjusted for storage change within the lake by multiplying the level rise by the area of the lake and swamp. There is some uncertainty about the area of the lake and adjoining swamp, which must vary with elevation to some extent. A recent estimate by WMO (1982) of 4700 km² was adopted as fixed for this comparison. The net basin supply, which includes rainfall less evaporation on the lake, and local runoff into the lake, has been compared with the average annual rainfall at eight stations in the general area around the lake, as listed below:

Jinja	0°16'N, 33°06'E	Katakwi	2°00'N, 33°42'E
Kaberaido	1°48'N, 33°18'E	Lira	2°18'N, 32°54'E
Masindi	1°42'N, 31°42'E	Mbale	1°06'N, 34°06'E
Namasagali	1°00'N, 32°54'E	Serere	1°30'N, 33°48'E

The annual net basin supply is plotted against this rainfall average in Fig. 4.6, which shows a fair degree of scatter indicated by the correlation coefficient ($R^2 = 0.640$). Nevertheless, the comparison suggests that the gains and losses through Lake Kyoga are real and are associated with local rainfall. The lack of local runoff records means that it is not possible to derive a precise water balance of the Lake Kyoga system. Assuming that the mean relation between Lake Kyoga net gain and regional rainfall is accepted, and the balance between rainfall and evaporation over the lake is taken as annual rainfall less 1600 mm for evaporation, the implied runoff into the lake system can be deduced. This infers that the runoff is insignificant when the annual rainfall is of the order of 1000 mm, but that it increases to 1% at 1200 mm and to 6% at a regional rainfall of 1500 mm. This is not unrealistic; an estimate of the local runoff into Lake Kyoga for a normal year was made by WMO (1974) of 2.91 km³ or 50 mm over the effective basin of 59 000 km², which implies a runoff coefficient of 3.7% for an average rainfall of 1350 mm.

The delay of river flows as a result of lake storage may be deduced from comparison of monthly mean outflows with inflows over a common period. These have been compared in Table 4.2 for the periods 1951–1960 and 1966–1975, before and after the rise in Lake Victoria. In the earlier period the maximum inflow occurred in June, while the outflow reached its peak in September; in the later period the corresponding maxima were in June and October. The delay is about 2–3 months, but the timing of the peak appears to become later after 1961–1964.

In order to show that measured and inferred inputs are consistent with measured lake levels, monthly balances have been calculated (Table 4.2) for two periods. These illustrate the dramatic change in the lake regime after the rise in Lake Victoria. The balance includes inflows and outflows, rainfall in the area of the lake estimated from the mean of eight stations,

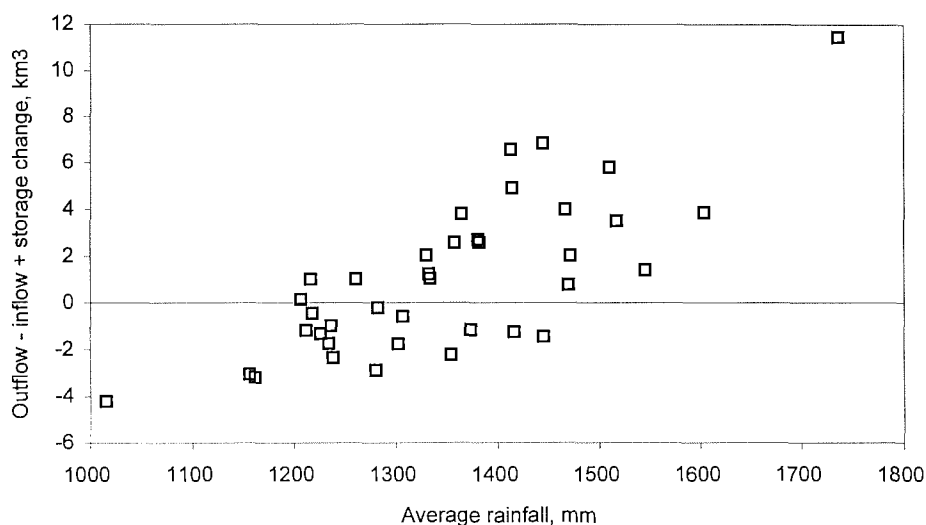

Fig. 4.6 Water balance of Lake Kyoga: net outflow + storage change vs rainfall, 1940–1977.

Table 4.2 Monthly water balance of Lake Kyoga (mm over 4700 km²).

	Jan.	Feb.	Mar.	April	May	June	July	Aug.	Sept.	Oct.	Nov.	Dec.	Year
Balance (1951–1960)													
Inflow	336	309	341	348	372	370	366	345	330	337	314	329	4098
Outflow	322	285	306	300	334	339	360	370	366	374	354	351	4061
Local inflow	14	15	32	57	50	28	27	44	40	41	28	20	394
Rainfall	44	47	101	181	158	90	88	140	126	132	89	64	1257
Evaporation	135	135	145	130	125	120	125	135	140	145	130	130	1595
Balance	-64	-50	23	155	120	29	-3	24	-10	-9	-54	-68	93
Level (m)	10.76	10.66	10.60	10.59	10.70	10.85	10.92	10.97	11.02	11.01	10.98	10.90	10.80
Balance (1966–1975)													
Inflow	702	632	706	701	768	755	740	723	696	687	657	704	8474
Outflow	740	648	699	678	736	742	781	782	768	803	765	762	8902
Local inflow	17	31	56	86	89	50	52	66	71	76	55	17	667
Rainfall	34	62	111	171	177	100	105	132	142	152	110	33	1328
Evaporation	135	135	145	130	125	120	125	135	140	145	130	130	1595
Balance	-122	-58	29	150	174	43	-8	4	1	-32	-72	-137	-28
Level (m)	12.28	12.16	12.08	12.03	12.12	12.24	12.31	12.33	12.35	12.39	12.39	12.33	12.23

evaporation taken from Lake Victoria, and local inflow deduced as a function of rainfall. In order to balance the two 10-year periods, the runoff coefficient for the first period can be calculated as 2.5% of areal rainfall, while the corresponding figure for the second period is 4%. Using these figures, the average predicted lake levels are compared with the measured levels in Fig. 4.7. Because the local inflows have been calculated to close the balance, and are about 10% of the main river inflows, their values should not be taken as more than approximate. However, the main features of the level regime have been reproduced with a range of about 400 mm, with a minimum level in March and a peak about September.

Lake Kyoga is relatively shallow, being 3–5 m deep at its western end and shallower in its upstream arms. The wider parts of the lake were previously open water fringed with papyrus and floating vegetation, while the narrower arms and inflow tributaries were overgrown with papyrus; this is related (Chapter 5) to the moderate range of lake levels. However, the southern fringes of the lake have recently been invaded with water hyacinth (*Eichhornia crassipes*) (Ntale, 1996).

The outflows from Lake Kyoga form the main component of the inflow to Lake Albert; they are closely related to the outflows from Lake Victoria, but there is evidently a net contribution in passage through Lake Kyoga in relatively wet periods and a net loss in drier periods.

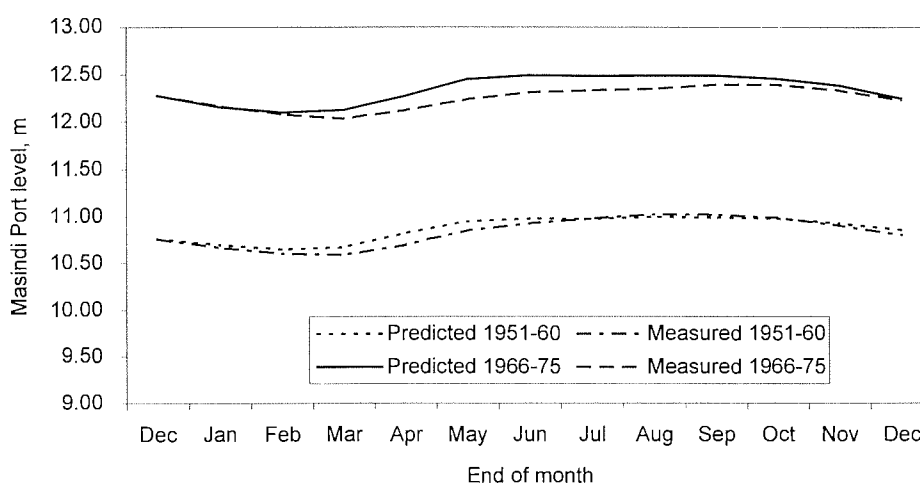
**Fig. 4.7** Lake Kyoga monthly balance: measured and predicted levels, end of month, 1951–1960 and 1966–1975.

LAKES EDWARD AND GEORGE

The second largest inflow to Lake Albert is provided by the River Semliki. This river drains the basins of Lakes Edward and George, and a contributing area downstream which includes the western slopes of the Ruwenzori range. The western part of Lake Edward, and much of the lower Semliki, are within the Congo and hydrological data are not available. Records are not yet sufficient to deduce a precise water balance for the lake system. The main information consists of a series of lake levels extending from 1942 to 1978, and flow records for the Semliki at Bweramule, some 40 km above Lake Albert, from 1940 to 1978.

The monthly series of lake levels (Fig. 4.8) reveal a similar pattern to the other East African lakes, with a seasonal pattern superimposed on the longer-term fluctuations. The rise in 1961–1964 is similar to those of the other lakes, but the subsequent fall was more rapid than in those lakes which depend on the storage of Lake Victoria. They did however remain higher than before the rise. Long-term averages show that the level range is only about 0.2 m, with peaks in December and June and minima in March and April. The Semliki outflows are illustrated in Fig. 4.9. The seasonal distribution of flows is similar to the lake levels; the rise in Semliki flows since 1962 has been similar to the Kagera or the Victoria Nile.

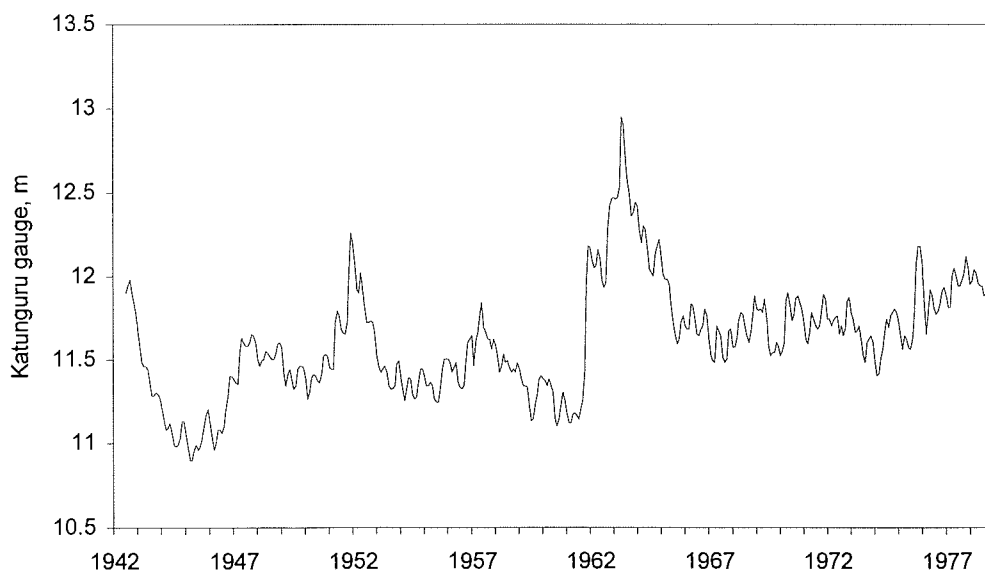

Fig. 4.8 Lake Edward monthly levels, 1942–1978.

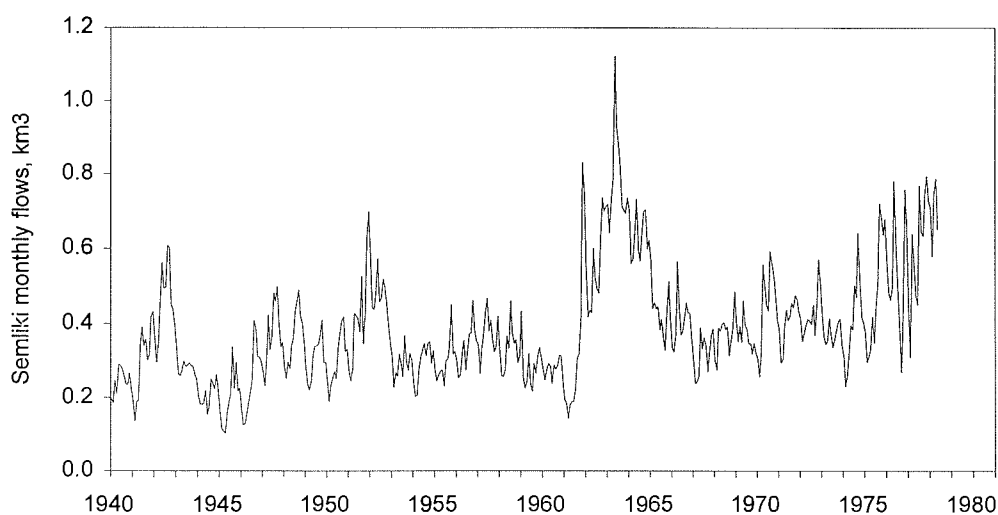

Fig. 4.9 Semliki at Bweramule: monthly flows, 1940–1978.

The vegetation of Lake George has been examined in some detail by Lock (1973). The lake is relatively shallow with a mean depth of 2.5 m. *Cyperus papyrus* forms a large area of swamp covering the northern half of the lake, through which most of the inflow, originating on Ruwenzori, enters the lake. Comparison of air photographs taken in 1954 and 1970 suggested that the northern shoreline with its papyrus fringe has been stable, in spite of the general rise in lake levels over the region. There are also fringes of *Vossia* and *Phragmites* in certain parts of the lake, with floating vegetation like *Pistia stratiotes* on sheltered shores around the lake. Papyrus, on the other hand, is limited to river mouths on Lake Edward.

LAKE ALBERT

The hydrology of Lake Albert is better known than that of Lakes Edward and George, because the main inflows have been measured for a reasonable period. However, the rainfall and evaporation over the lake are not known with any precision, while the lake outflow is not measured directly at its mouth. A major problem is that inflows and outflows are similar, so that measurement errors may disguise the main features of the balance. Before considering the balance of the basin as a whole, its various components are discussed in turn.

Kyoga Nile inflows

Without precise measurements of river flows on the Kyoga Nile, the water balances of the Lake Kyoga and Lake Albert basins cannot be established separately. Flows at Masindi Port are available from 1912, but records for the period 1912–1939 are not sufficiently precise for this purpose. Lake Victoria outflows date from 1896, but accurate flows at Kamdini are limited to the period 1940–1977.

Some tributaries flow into the Kyoga Nile between the lakes, such as the Tochi and Ayago. The annual flow of the Tochi, the largest of these rivers, averages 0.230 km^3 , or less than 1% of the flows of the main river. The increase in flow from these tributaries can reasonably be neglected.

Semliki and local inflows

The net contribution of the Lake Edward and Lake George basins is combined in the outflows of the Semliki, and the flows measured at Bweramule (Fig. 4.9) give a reasonable estimate of this contribution. These flows are also available for the period 1940–1977.

There is also some direct inflow from local streams. The largest basins, the Muzizi and Nkuzi, drain into the southern corner of the lake from the east. Previous estimates (Hurst & Phillips, 1938) of this local runoff (2.56 km^3) were based on average rainfall (1256 mm) and a runoff coefficient of 12% over a relatively steep area of $17\,000 \text{ km}^2$. Estimates of this local runoff were also made by WMO (1974) based on gauged flows of four tributaries and an isohyetal map; a relationship was found between the runoff coefficients for the four basins, ranging from 6 to 15%, and their channel slope. This led to an estimated average runoff of 2.7 km^3 from a rainfall of 1192 mm and a mean runoff coefficient of 12.4%. As the annual distribution of this runoff is required in this study, it seems reasonable to express it as a fixed ratio of the Semliki flows, corresponding to the basin areas, e.g. $17\,000/30\,500$. This results in a mean runoff for 1940–1977 of 2.576 km^3 , based on the Semliki flow at Bweramule of 4.622 km^3 .

Albert Nile outflows

The most reliable gauging station below Lake Albert is at Mongalla on the Bahr el Jebel. River gauge levels have been recorded here since 1905, at a site where the river enters the Sudd in a single channel. Gaugings have been made since 1907, and have been frequent in some periods and regular in other periods. Although the rating curve has altered, the changes from year to year have been fairly regular, except immediately after the rise in Lake Victoria when the flows suddenly doubled. The changes in channel control are discussed in more detail in the next chapter, but it is sufficient to accept that reasonable flows at this site have been calculated and published in *The Nile Basin*.

Although the gains of flow between Lake Victoria and Mongalla can be deduced from flow series over the whole period 1905–1983, the balance of the Lake Albert basin can only be deduced for the period 1940–1977 between Kamdini and Mongalla. The outflows from Lake Albert itself have been estimated by relating Butiaba levels to Mongalla dry season flows. These have been published for the period 1904–1978, but there is a possibility that the losses between Lake Albert and Mongalla have been overestimated after 1964, and thus that the Lake Albert outflows have been overestimated. There is also direct evidence that the flows at Mongalla have been estimated incorrectly in 1963–1964, when gaugings were not possible, and this is in fact confirmed by the following analysis.

Other components of Lake Albert balance

The balance also requires rainfall on the lake, lake evaporation and changes of storage. The only long-term rainfall station near the lake is at Butiaba, and records have been somewhat sporadic in recent years. However, a record is available for the years 1904–1977, with an intermittent record in 1968–1970 and 1975–1977. It is not certain how lake rainfall compares with this record situated on a spit on the eastern shore of the lake. As a first approximation, the evaporation may be taken as the same as that derived for Lake Victoria, though the lower elevation and the drier climate are likely to result in a higher total for Lake Albert. The changes of lake storage may be assessed by using the end-month Butiaba gauge levels (Fig. 4.10) and an average area of 5300 km².

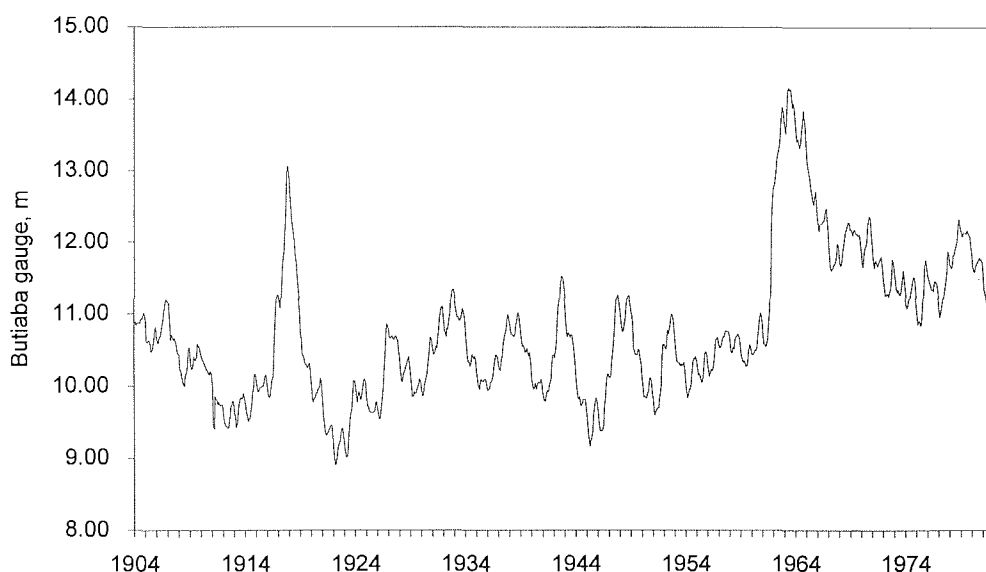

Fig. 4.10 Lake Albert monthly levels, 1904–1981.

Water balance

The results of this water balance analysis are presented in the form of a comparison between inflows, including rainfall, and outflows, including evaporation, and storage change. It should be stressed that two components of the balance, the inflow from the Kyoga Nile and the outflow down the Bahr el Jebel, are large by comparison with other components. Errors in their estimation will have a large effect on the estimated lake balance. The results of a provisional annual lake water balance are presented in Fig. 4.11. The annual outflows from Lake Albert, estimated but not directly measured, and increases in lake storage plus evaporation, are compared with the lake inflows. These inflows are measured for the Kyoga Nile at Kamdini and the Semliki at Bweramule, and estimated by analogy with the Semliki for the rest of the land catchment. They include rainfall at Butiaba. There is a fair degree of scatter; in particular, the years with the highest inflows, 1963 and 1964, are anomalous, as discussed in Chapter 5. An attempt to see how far lake rainfall is relevant is shown in Fig. 4.12, where Butiaba rainfall is compared with the difference between lake outflow and storage change, and inflows from the Kyoga Nile, Semliki and other basins. The scatter is considerable, even after omitting 1963 and 1964, when the outflows were underestimated.

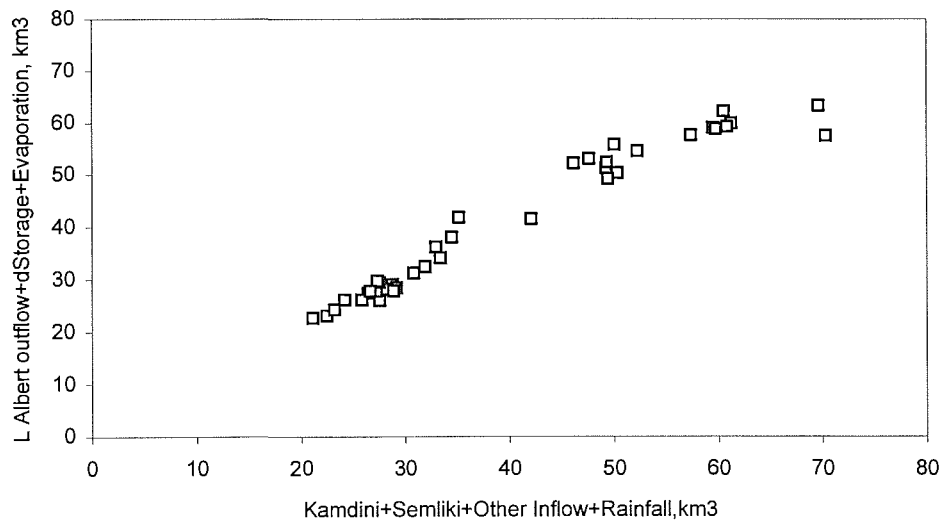

Fig. 4.11 Lake Albert annual balance: outflow + storage change + evaporation vs inflow + rainfall, 1940–1977.

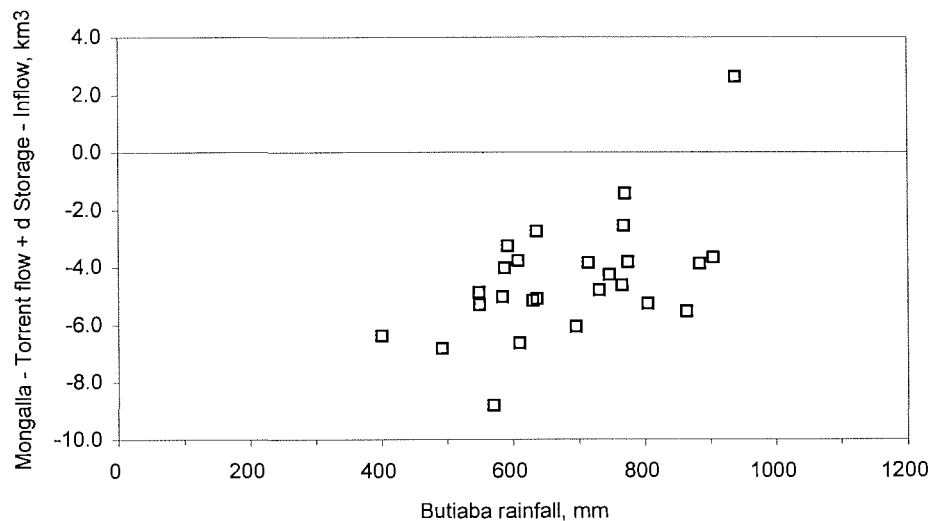

Fig. 4.12 Lake Albert annual balance: outflow + storage change – inflow vs rainfall, 1940–1967 excluding 1963–1964.

Table 4.3 Monthly water balance of Lake Albert (mm over 5300 km²).

	Jan.	Feb.	Mar.	April	May	June	July	Aug.	Sept.	Oct.	Nov.	Dec.	Year
Balance (1951–1960)													
Kamdini	286	253	271	266	297	300	319	328	324	332	314	311	3601
Semliki	63	50	53	60	69	62	64	71	65	70	68	68	762
Local inflow	35	28	29	34	38	34	36	39	36	39	38	38	425
Mongalla	320	277	296	312	379	367	392	480	473	468	397	358	4519
Torrents	0	0	0	19	69	63	81	162	154	127	55	7	738
Rainfall	19	22	55	107	50	31	59	63	62	85	58	31	643
Evaporation	135	135	145	130	125	120	125	135	140	145	130	130	1595
Balance	-52	-61	-33	45	19	4	42	48	28	41	6	-32	56
Level (m)	10.56	10.41	10.31	10.24	10.27	10.32	10.30	10.33	10.41	10.49	10.57	10.62	10.62
Balance (1966–1975)													
Kamdini	656	575	620	601	653	758	692	694	681	712	678	676	7895
Semliki	67	56	62	73	80	73	76	81	85	84	85	81	904
Local inflow	37	31	35	41	45	40	42	45	47	47	47	45	504
Mongalla	744	643	692	671	746	727	775	897	901	892	842	795	9326
Torrents	0	0	0	10	50	49	77	186	195	147	93	26	832
Rainfall	16	32	63	107	102	56	63	53	87	102	82	3	766
Evaporation	135	135	145	130	125	120	125	135	140	145	130	130	1595
Balance	-103	-84	-57	31	58	30	51	27	53	54	13	-94	-20
Level (m)	11.94	11.78	11.64	11.55	11.58	11.63	11.63	11.65	11.73	11.79	11.89	11.96	11.85

The rainfall on the lake is on average less than 10% of the total inflow, so that it is not surprising that its influence is not clear. The use of a single rainfall station and flow measurement problems must obscure any relationship.

In the hope that the effect of measurement errors might be reduced in the average conditions of a sample period, a study has been made of the monthly water balance of two periods: 1951–1960 and 1966–1975 to represent periods before and after the rise of Lake Victoria. Table 4.3 shows the balance for these periods, with rainfall taken as the average monthly Butiaba rainfall for each period, without attempting to fill gaps. More consistent results were obtained from estimating Lake Albert outflows from Mongalla flows less estimated torrent flows, though the overall balance must be fortuitous. The seasonal balance is illustrated by comparisons of predicted Butiaba levels in Fig. 4.13. This study also shows the effect of storage in delaying the lake outflow, and illustrates the effect of seasonal patterns of inflow and rainfall. Although the peak inflow occurs in September or October, the peak lake level and lake outflow occur in November.

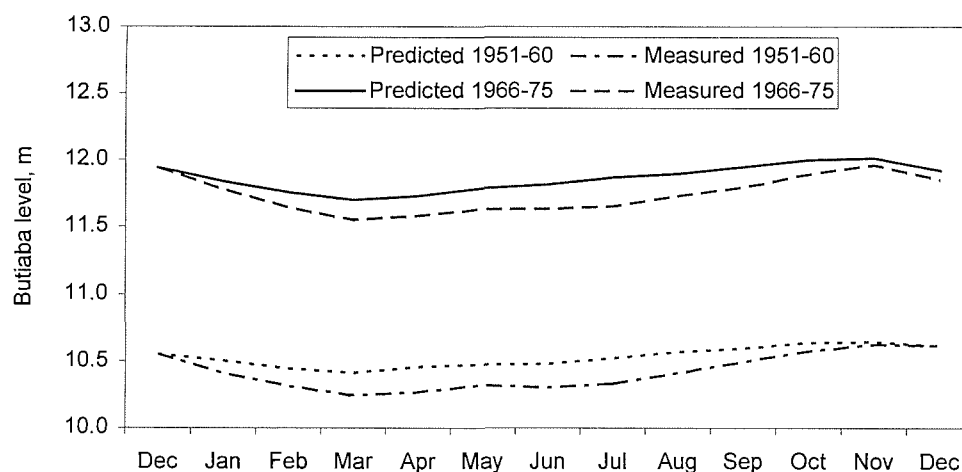

Fig. 4.13 Lake Albert monthly balance: measured and predicted levels, end of month, 1951–1960 and 1966–1975.

The surroundings of Lake Albert

The monthly lake levels show that, although the range of levels over the years has been relatively large, the seasonal range of levels has been comparatively small at about 0.4 m. The small range of levels is reflected in the vegetation. The main channel of the Kyoga Nile enters the lake below the Murchison Falls in a delta about 10 km in length; the mouth is surrounded by permanent papyrus swamp, with fringes of *Vossia* near the main channel. The shores of the lake are in general extremely steep, and there is no room for significant wetlands. To the southwest of the lake, the mouth of the Semliki lies adjacent to a wide sedimentary plain, and the river has been described as passing through wide papyrus swamps for the last 25–30 km of its course (Garstin, 1904, p. 58). The extent of the permanent swamp in about 1931 may be deduced from air survey maps of the period (Air Survey Company, Ltd, 1931/32, Sheets 100/3015 and 100/3030); these reveal a width of 5–10 km of swamp near the lake. All this vegetation would be vulnerable to changes in regime caused by regulating outflows from Lake Victoria.

Below Lake Albert the river is fringed by papyrus and other swamp between Pakwach and Nimule. The flood plain is shown on the Air Survey maps of 1931/32, and the extent is given by Hurst & Phillips (1938) as consisting of about 260 km² of open water and 120 km² of swamp. This swamp was noted by Sutcliffe in 1956 to consist mainly of papyrus and *Vossia* over this reach of about 200 km.

Potential of Lake Albert as a reservoir

The potential for Lake Albert as a reservoir has been considered over many years, on the basis that the relatively steep shores make it more suitable than Lake Victoria for overyear storage. The possibility of a reservoir on Lake Albert was discussed briefly by Hurst & Phillips (1938, p. 81) and it was noted that contours corresponding with a level of 20 m on the Butiaba gauge had been deduced by air survey. In the past it was considered as a possible site for “century storage” to control the supply of water to Egypt to arrive in the timely or irrigation season. It was proposed to store the flows of the torrents either by locating a dam at Nimule or by virtual storage based on forecasting. The Jonglei Investigation Team (1954) suggested that the dam could be used to provide the normal pattern of flow at Mongalla, and also for flood control, and this would have precluded its use for virtual storage (Hurst *et al.*, 1966).

The effect of flooding around Lake Albert was studied in 1956 to assist Uganda in possible negotiations (Sutcliffe *et al.*, 1957), but the construction of the Aswan High Dam reduced the immediate need for overyear storage. It was studied as one component of Nile control by WMO (1982). It may be useful as a way to reconcile the need for Uganda to optimize the hydroelectric potential of the Nile below Lake Victoria by storage, and the present requirement of those inhabitants of the southern Sudan dependent on the natural regime of the Bahr el Jebel to avoid disturbance of the pattern of seasonal flooding.

EFFECT ON FLOWS OF LAKE KYOGA AND LAKE ALBERT BASINS

The net effect on the flows of the White Nile of Lake Kyoga and Lake Albert and their tributaries may be illustrated (Sutcliffe, 1996) by monthly gains and losses between Jinja and Kamdini and between Kamdini and Mongalla (Fig. 4.14(a)–(b)) and by the annual equivalent

(Fig. 4.15(a)–(b)). The periods of net gain through Lake Kyoga after 1960 and the highly seasonal gains at Mongalla are clearly shown. This information is supplemented by mean flows for the common period of record of 1940–1977 at various sites between Jinja and Mongalla (Table 4.4). There is a difference of about 3% between Masindi Port and Kamdini, which is likely to be due to measurement problems; the Kamdini record is preferable. The effect of Lake Kyoga and its basin appears on average to be a small increase, with the peak flow at Jinja in June being delayed to September (allowing for length of month); however, the net effect has been a decrease in drier periods and an increase in wetter periods. The effect of the Lake Albert basin, with the Semliki contribution at its maximum in November, is a net increase in flow and a delay to November in the Lake Albert outflow. The average contribution of the torrents between Lake Albert and Mongalla is of similar magnitude to the Semliki, but its highly seasonal distribution with a peak in September leads to a peak flow at Mongalla in the same month. The overall effect of the lake basins is to delay the outflows from Lake Victoria and to increase the flows in magnitude and seasonal variability.

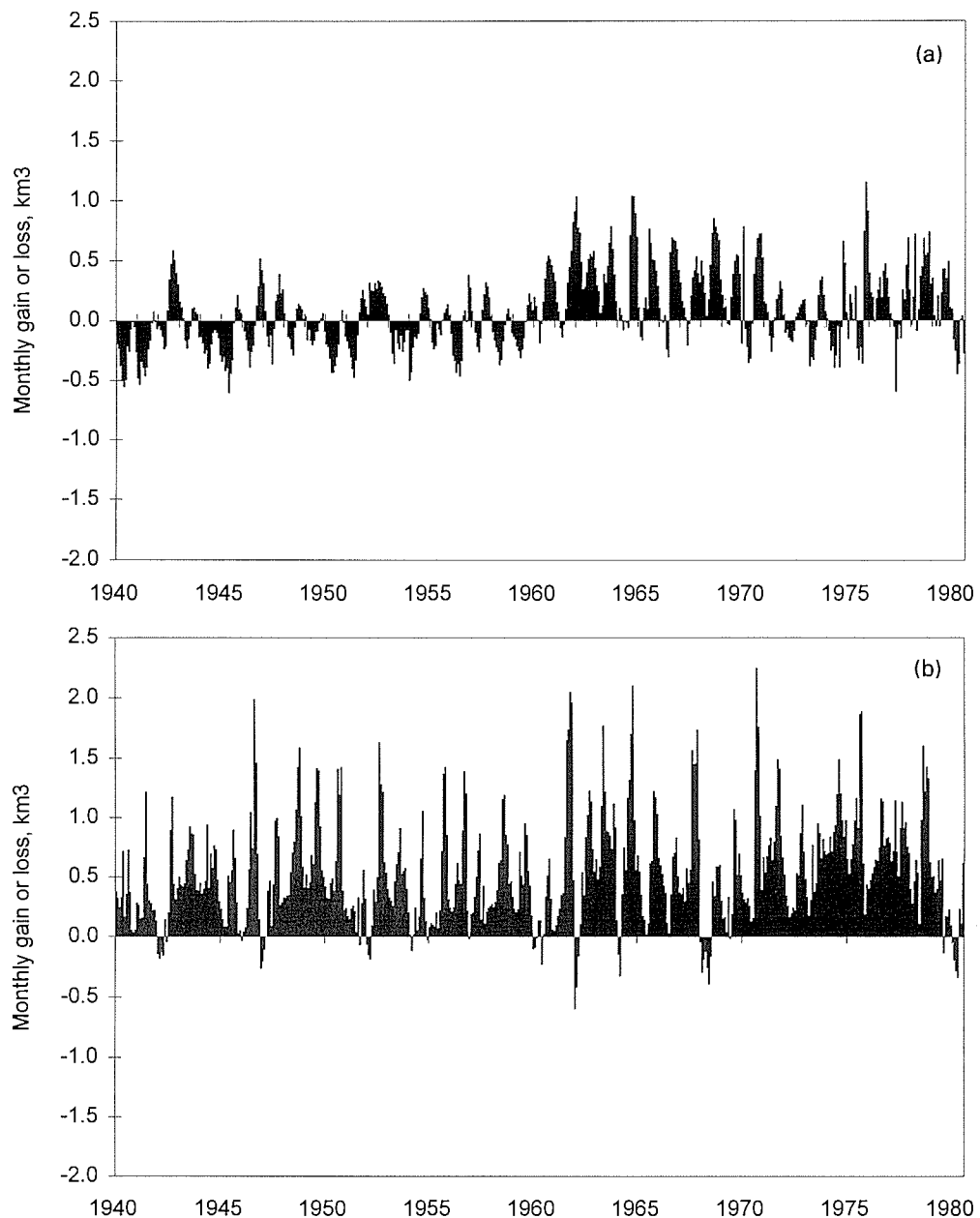

Fig. 4.14 Monthly gains and losses: (a) Jinja to Kamdini, 1940–1980; (b) Kamdini to Mongalla, 1940–1980 (after Sutcliffe, 1996).

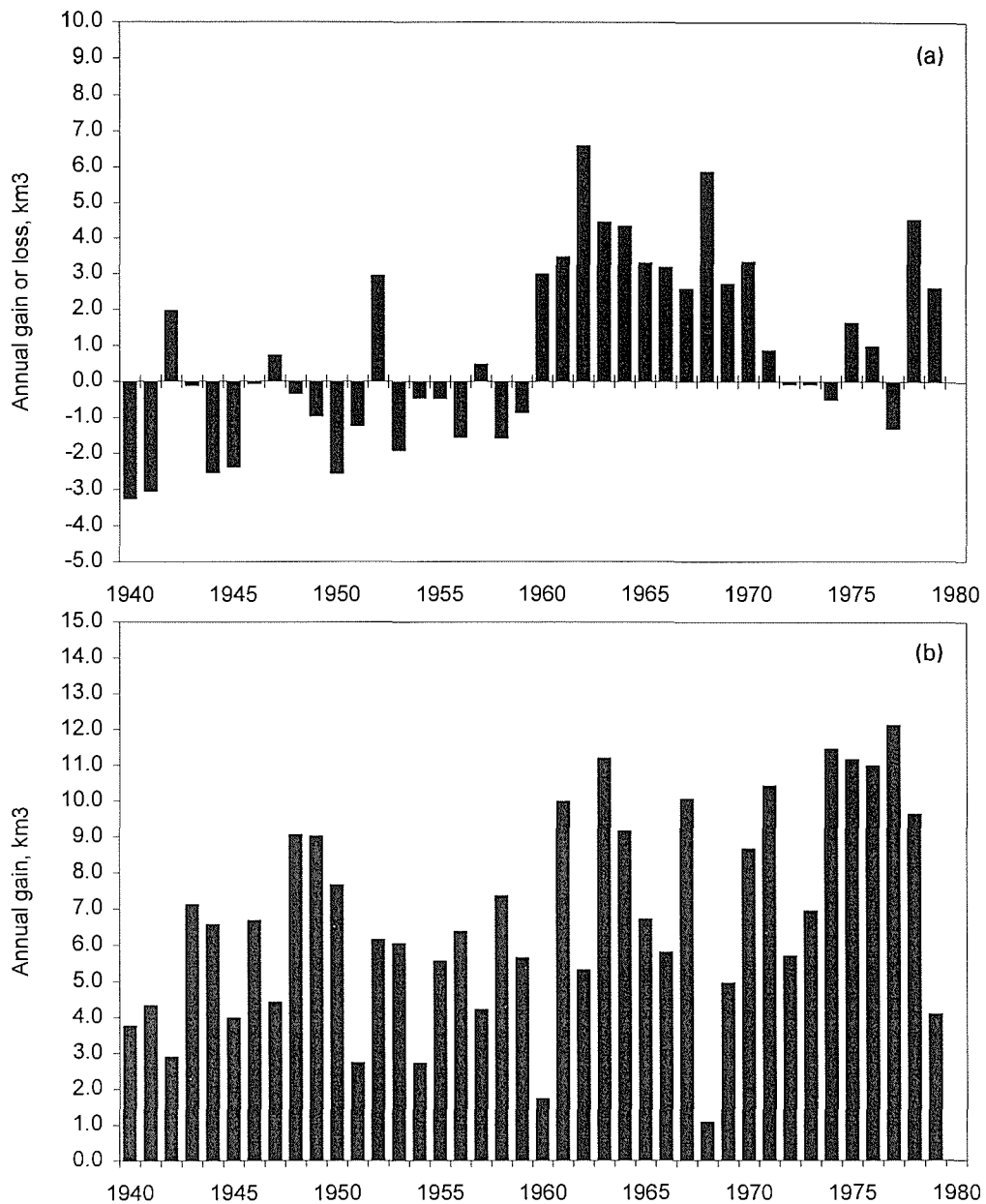

Fig. 4.15 Annual gains and losses: (a) Jinja to Kamdini, 1940–1979; (b) Kamdini to Mongalla, 1940–1979 (after Sutcliffe, 1996).

Table 4.4 Mean flows ($m^3 \times 10^6$) at sites between Jinja and Mongalla (1940–1977).

Jan.	Feb.	March	April	May	June	July	Aug.	Sept.	Oct.	Nov.	Dec.	Year
Victoria Nile at Jinja												
2352	2128	2366	2377	2594	2566	2524	2436	2327	2323	2216	2386	28 593
Kyoga Nile at Masindi Port												
2336	2047	2181	2122	2340	2372	2516	2567	2525	2598	2472	2489	28 564
Kyoga Nile at Kamdini												
2418	2111	2273	2205	2424	2447	2577	2624	2592	2665	2540	2563	29 438
Semliki at Bweramule												
350	285	316	352	409	371	392	417	409	423	435	419	4 577
Outflows from Lake Albert												
2829	2459	2615	2526	2684	2620	2712	2771	2768	2923	2906	2998	32 809
Torrent flows between Lake Albert and Mongalla												
0	0	3	119	406	386	538	973	967	765	404	130	4 691
Bahr el Jebel at Mongalla												
2714	2348	2519	2548	2965	2884	3121	3617	3601	3547	3184	3000	36 047

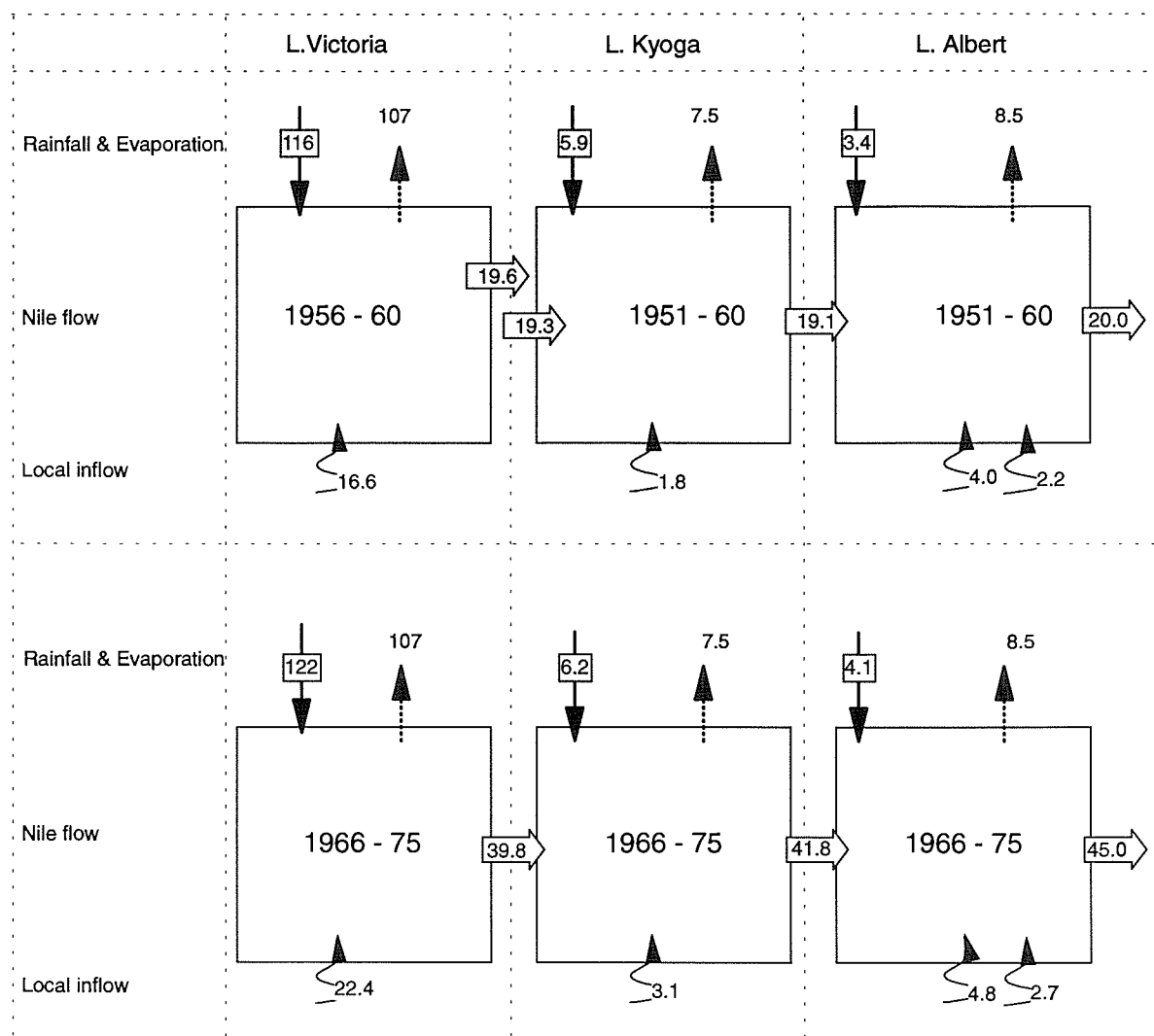

Fig. 4.16 Schematic balance of Lakes Victoria, Kyoga and Albert, $\text{km}^3 \text{ year}^{-1}$.

The overall balance of Lakes Victoria, Kyoga and Albert is indicated in Fig. 4.16, where lake rainfall and local inflow are compared with lake evaporation and outflow for 1951–1960 (1956–1960 for Lake Victoria) and 1966–1975. Each component is estimated as described in the text and expressed as an annual volume (km^3). The balance is not precise and this is partly explained by storage change. However, the figures demonstrate the dominance of lake rainfall and evaporation on Lake Victoria, but also the importance of increased inflow in the later period. The dominance of Nile inflow and outflow for the lower lakes is apparent. The doubling of the overall outflow between the two periods is largely generated in the Lake Victoria basin, but the lower lake basins also contribute to the increase.

CHAPTER 5

THE BAHR EL JEBEL AND THE SUDD

INTRODUCTION

The Bahr el Jebel extends from Lake Albert to the confluence with the Bahr el Ghazal at Lake No, where the combined river becomes the White Nile (see Fig. 5.1). However, it is hydrologically more logical to take the upper limit at Mongalla, the key gauging station where the river is measured in a single channel as it enters the Sudd, and the lower limit at the confluence of the White Nile and the Sobat, where outflows from the Sudd are measured. One of the channels flowing out of the Sudd is the Bahr el Zeraf which flows into the White Nile between Lake No and the Sobat mouth.

The Bahr el Jebel is the most complex of the Nile reaches as it receives inflows from a number of seasonal torrents which are not measured directly; it loses water by spill from the river into adjacent flood plains at a rate which can only be inferred by measurements at intervals down the course of the reach; its outflow is only about half the inflow on average and has a totally different seasonal distribution. The Sudd has been studied over many years but it is only recently that the water balance has been understood to any degree. More accurate estimates of evaporation from open water and swamp vegetation, and satellite imagery have both been useful.

In this chapter brief accounts of early hydrological studies, and the available river flows, are followed by a discussion of the Bahr el Jebel inflows. A comparison of the historic inflows and outflows presents the problem of the Sudd: the cause of the losses within the reach and their historic variations. An account follows of the topography and in particular the relation between river channel, river bank and adjoining flood plain; this is based both on general observation over the whole reach and on detailed topographic surveys of sample basins. This description leads to an account of the flooding mechanism by which the higher river flows spill over the banks and flow parallel to the main river down the flood plain; they rejoin the river downstream and the process is repeated. The overall spilling has varied over the years as a function of Lake Victoria outflows.

The loss of half the inflow in the Sudd has led to a number of studies, either of the whole Sudd or of smaller reaches or individual basins. The studies are described in turn, leading to a water balance analysis over the whole period of records. The losses form an important fraction of the water resources of the region, and there have been proposals for engineering schemes, including the Jonglei Canal, to reduce these losses. The historical development of these

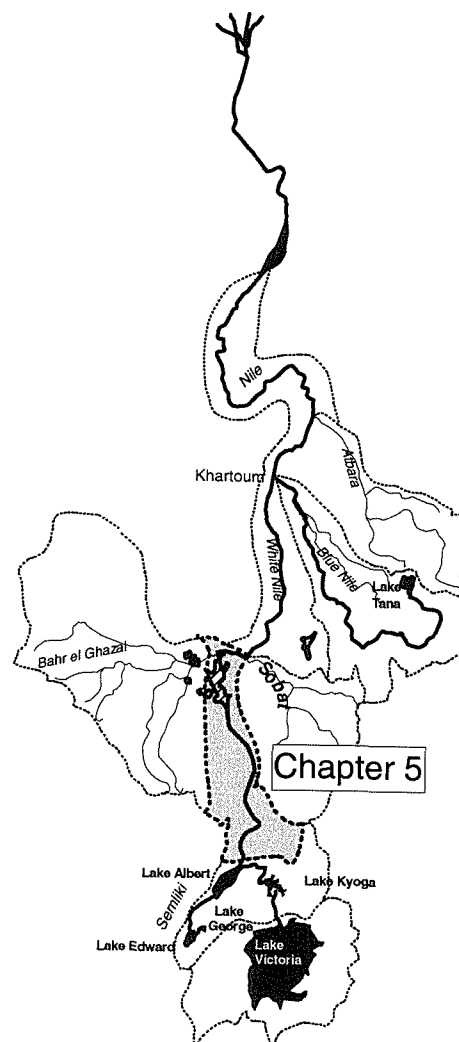

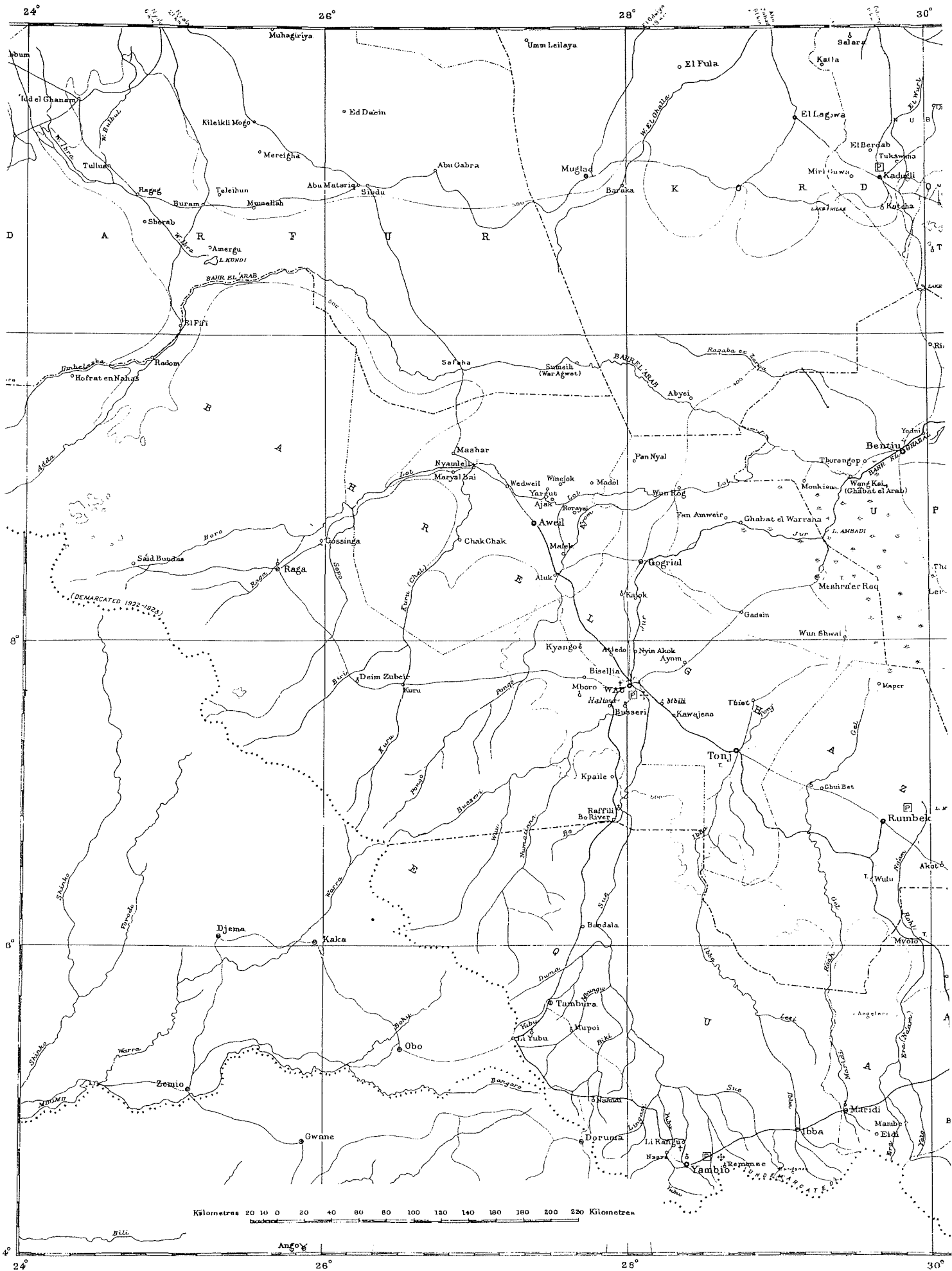
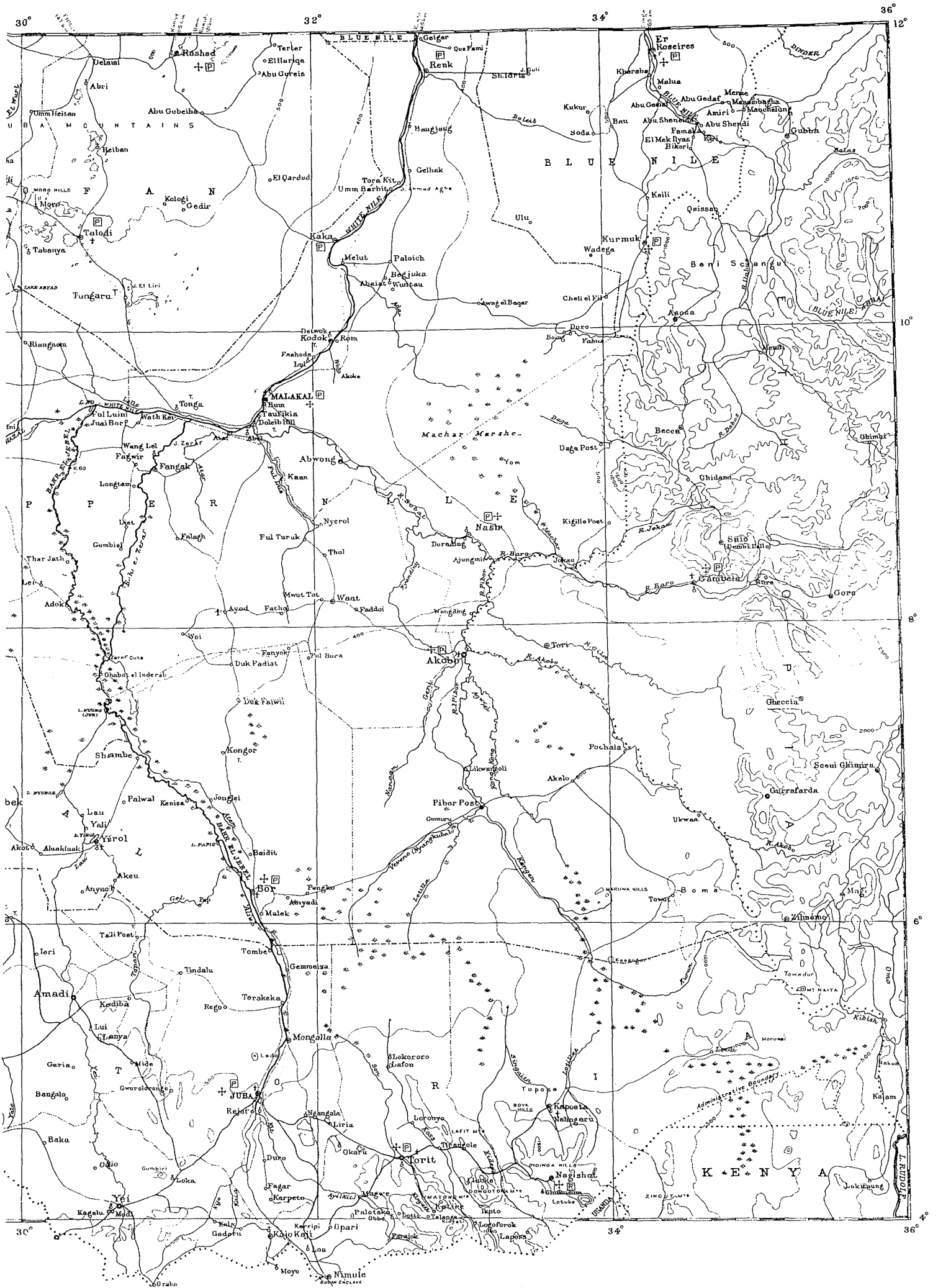

Fig. 5.1 Map of southern Sudan showing Bahr el Ghazal, Bahr el Jebel, Sobat.



proposals is described together with the investigations into their interaction with the environment. The most recent proposals and the ways in which their effects might be mitigated are reviewed.

The hydrological regime gives rise to a distinctive flood-plain vegetation, which can be described in geographical terms or analysed in terms of elevations on cross-sections. The links between hydrology and ecology, or between flooding regime and vegetation species, and the nature of the controls, are deduced from local surveys. The changes over the years in the inflow have been mirrored in vegetation changes. The flood-plain vegetation, and the hydrological regime which has given rise to it, are an integral part of the economy of the area, where flood-plain grazing is important in the absence of alternatives. The link between hydrology and vegetation is described in detail in this chapter because most of the quantitative evidence has been derived from the Bahr el Jebel. However, the importance of this link applies to the Bahr el Ghazal basin (Chapter 6), the Sobat basin and the Machar marshes (Chapter 7), and the White Nile (Chapter 8), as well as the Lake Plateau.

EARLY STUDIES

Two early studies dealing with the Sudd were those of Newhouse (1929) and Butcher (1938). Newhouse noted the importance of the torrents between Lake Albert and Mongalla in providing the seasonally variable element of the Sudd inflows and stressed the need for continuous measurements. He noted numerous channels flowing from the river into the swamps and returning to the river, calling them heads and tails. He compared flows at Mongalla and Bor and noted the losses at high flows. He pointed out that gauging stations within the Sudd might not measure all the flow without cross-banks. He estimated the total loss as about 13 km^3 or half the inflow, and described the swamps as “not a reservoir where water is stored, but a sink where it is wasted”.

Butcher (1938) discussed the losses in terms of areas of flooding and evaporation. He deduced from air photography that the swamp area was about 7200 km^2 . He estimated annual gross evaporation from a tank filled with papyrus at 1533 mm ; this explained less than half the measured loss. He noted that series of discharges measured along the river channel showed rapid fluctuations as spill left the river and returned lower down. The loss between Mongalla and Bor, for example, was due to water spilling through spill channels and over river banks into the subsidiary Aliab channel system. This bypassed Bor and returned to the river at Lake Papiu some 60 km downstream. This observation led to the concept of “latitude flow”, with flows measured in a series of parallel channels across the flood plain. Examples

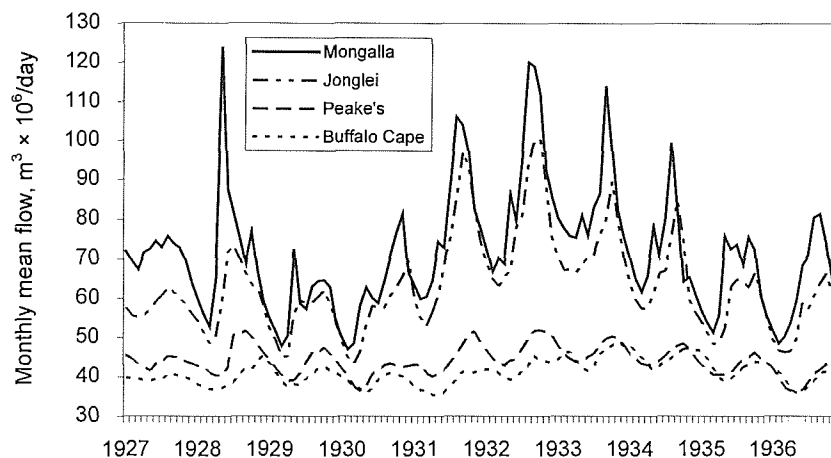

Fig. 5.2 Latitude monthly flows, 1927–1936.

are Gemmeiza and Giggling about 60 km below Mongalla, Jonglei latitude (Jonglei and Kenisa at 6°50'N), Peake's latitude (Bahr el Jebel below Peake's channel and Bahr el Zeraf below Jebel-Zeraf cuts at 7°50'N), and Buffalo Cape/Zeraf mouth. Butcher compared flows for 1927–1936 at Mongalla with these lower sites (Fig. 5.2); these flows clearly show the attenuation and losses. However, he was unable, because of the low estimate of evaporation, to explain these losses without postulating considerable spill towards the Bahr el Ghazal below Shambe. When the estimated evaporation is increased to more reasonable amounts, these spills are no longer necessary to explain the balance.

Hurst & Phillips (1938) summarized the hydrological measurements and discussed the water balance in terms of the equation of continuity. The inflow and local rainfall must equal the outflow and evaporation, after allowing for water absorption by newly flooded ground and increased storage; this was estimated from the swamp area and the change of river level at 10 key gauges. Losses to groundwater storage were neglected. They estimated the area of swamp in 1931/32 as 8300 km², and deduced that the evaporation estimate would have to be increased by at least 30% to provide a seasonal balance. They carried out similar balances to Butcher but dismissed the explanation of spill from the Bahr el Jebel towards the Bahr el Ghazal as untenable. They pointed out that the apparent loss was higher in terms of depth over flooded areas in the upper reaches, whereas the opposite would be true if spill to the Bahr el Ghazal below Shambe was significant. This suggested that some of the flow occurred down the flood plain without being measured at channel gauges (see Fig. 5.8 and discussion). They also derived a relation between Mongalla inflow and swamp outflow by comparing quarterly discharges with varying lag.

Subsequent hydrological analysis has been made possible by empirical measurements of higher evaporation from swamp vegetation (Migahid, 1948) and greater understanding of the evaporation process (Penman, 1948). This enabled evaporation from an open water surface or transpiration from vegetation to be estimated from records of temperature, humidity, wind speed and insolation. In fact Penman (1963) pointed out that swamp evaporation measurements in the Sudd corresponded with estimates of open-water evaporation.

STUDIES OF THE JONGLEI CANAL

These early studies led to detailed proposals (Hurst *et al.*, 1946) for the Jonglei Canal, which was planned to bypass the Sudd as part of the Equatorial Nile Project. This project included a main reservoir to be located in Lake Albert, supplemented by a regulator at the Ripon Falls to control outflows from Lake Victoria. This would be operated to augment flows for irrigation below the Sudd. The outflow from this storage would have to be carried in a Sudd Diversion Canal in order to avoid losses within the Sudd.

In a later phase, there were plans to increase flows during periods of shortage on the main Nile at Aswan, using virtual Blue Nile storage in Lake Albert supplemented by Lake Victoria. This would require "Century Storage" to equalize available water at Aswan over a period of 100 years. It would involve releasing higher flows down the White Nile in years of low Blue Nile flows. It was envisaged that storage in Lake Tana, on the Blue Nile, could form part of this project.

The studies of the Jonglei Investigation Team (1954), set up by the Sudan Government in 1946, were geared to the estimation of the effects which the Jonglei Canal and the Equatorial Nile Project, as then formulated, would have on the seasonal flooding of the Bahr el Jebel and White Nile wetlands. They traced the interaction of flooding and vegetation distribution and also the role of the wetlands in the local economy. Their

hydrological studies concentrated on the effect which the requirement for “timely flow” or flow during the downstream irrigation season would have on the operation of the canal and the resulting changed flow regimes within the Sudd. The need to supplement timely flows would require high flows at Mongalla from 11 December to 20 June and lower flows during the remainder of the year. This mode of operation would have led to reversed seasonal flows from Nimule to the canal head, as the timely flows would be released in the local dry season. It would also lead to greatly reduced seasonal flooding from the canal head to points above the canal outfall near the Sobat mouth, and continued high flows downstream to Kosti. The need to supplement low flows on the Blue Nile would also affect the natural regime. In addition disastrous periodic flooding would be caused by spills from the reservoir when full, with the local population adapted to reduced natural flooding. These proposals were deemed unacceptable by the Jonglei Investigation Team (1954), and a Revised Operation in phase with the seasons was advocated, which would reduce loss of pasture by nearly half, and also provide flood protection for the area. This Revised Operation depended on equalizing annual discharges at Mongalla, using storage in Lake Victoria and Lake Albert, with a reserve for flood control in Lake Albert. It would be operated to reproduce the natural seasonal regime at Mongalla.

The basic information collected by the Jonglei Investigation Team is still relevant. For instance, an overall review of the hydrology of the area was supplemented by a detailed survey of the Aliab valley opposite Bor (see Fig. 5.7 and Plates 4 and 5) which was completed under favourable low flow conditions during the 1950/51 field season. This survey was extended to the whole reach from Juba to Bor in 1951/52 and provided information from a sample reach on topography, hydrology, seasonal flooding, vegetation distribution and grazing use. This information was used in an account of the area (Jonglei Investigation Team,



Plate 4 Aliab valley: survey party (including the first author!) traversing cross-section 15 (cross-section P in Fig. 5.7) (after Howell, 1953).



Plate 5 Aliab valley: inserting survey peg on cross-section 15 (cross-section P), February 1951.

1954, vol. III), and was further used by Sutcliffe (1957, 1974) in a hydrological study which also quantified the hydrological controls of vegetation.

The rise of Lake Victoria in 1961–1964 led to doubled inflows to the Sudd. The resulting increase in the area of the swamps and the losses within the Sudd not only led to the need to reappraise the hydrology but also provided further evidence of the importance of upstream conditions on the Bahr el Jebel. The construction of the Aswan High Dam after 1959 made the concept of “timely flow” unnecessary and reduced the need for over-year storage in the East African lakes. The changed political situation in the upstream basin led to different proposals for the Jonglei Canal which did not depend on upstream storage (Abdel Mageed, 1985). In Phase I of the revised Jonglei Project a canal was planned to divert part of the natural flows around the swamps and thus to increase the downstream flows by about 4 km³, which was to be shared between Sudan and Egypt. Construction of the canal was begun in 1978 but was suspended in 1983. The changed conditions and design led to a new investigation in 1979–1983 of the potential effects of the Jonglei Canal, which has been summarized in Howell *et al.* (1988). As part of this investigation a hydrological study of the Sudd and the effect of the canal on flooded areas was carried out in 1982 by the Institute of Hydrology (Sutcliffe & Parks, 1982, 1987, chapters 5 and 16 in Howell *et al.*, 1988). This analysis was based on the earlier analysis of the sample areas, but was applied to a wider area. A visit was made to these sample areas and changes of spill channels, flooding and vegetation were observed from the air (Fig. 5.15).

Thus the study of this reach of the overall Nile covers the upstream hydrology, including the outflows from the lake system and the flows of the seasonal torrents. It also deals with the Bahr el Jebel channels and the adjacent flood plain, the combination of these factors in controlling seasonal flooding, and the effect of this flooding on the flood-plain vegetation. This in turn affects the local economy, in which seasonal grazing is important.

FLOWS OF THE BAHR EL JEBEL

Available river flow records

The recorded outflows from the East African lakes have been discussed in Chapters 3 and 4. The record at Mongalla, where flows have been measured since 1905, is the key record of inflow to the Sudd. The numbers of gaugings on which the inflows and outflows were based have been discussed in Chapter 2. Few gaugings were carried out at Mongalla between 1905 and 1921, with only 35 measurements in the first 17 years. More frequent measurements began in 1922, with an annual average of 260 measurements from 1922 to 1931. After 1940, the frequency of gaugings fell to about 2 a month, to monthly after 1954 and fewer after 1974. There were gaps from September 1964 to June 1967, at a time when the river flows had doubled, and gaugings ceased in 1984. The flows were derived from a general rating curve from 1905 to 1921, by interpolation between measured discharges from 1922 to 1931, and on annual rating curves from 1932 until 1963. The record for 1964–1967 was based on a mean rating derived for the period 1963–1969, and thereafter on annual ratings; records ceased in 1983. The quality of the flow record must have varied with the frequency of gauging but in general has been reasonable. However, comparisons with upstream records showed that flows in 1963–1964, during the rise in lake levels and a rapid change of rating, were not reliable. Comparison of 1978 flows with gaugings shows that the published flows are incorrect; the provisional flows obtained for the 1982 study are more acceptable.

A comparison of the rating curves at Mongalla over the period of record reveals that from 1905 to 1963 there had been a steady rise of about 0.5 m in the river level corresponding to a given flow; this was also observed at other sites (Sutcliffe, 1957). This trend was disrupted by the increase in flows in 1963 (Sutcliffe & Parks, 1994a). After gaugings were resumed in 1967 the earlier rise had been reversed and by 1980 the level was about 1.0 m below 1962 levels (Fig. 5.3). The changes in level were mirrored in bed levels, so that it is possible that a period of aggradation occurred after the period of high lake levels at the end of the nineteenth century, but was reversed by the recent high flows. At the same time, new spill channels were formed. These changes must be considered in terms of the relation between river flows and flooding, at least in the upper reaches.

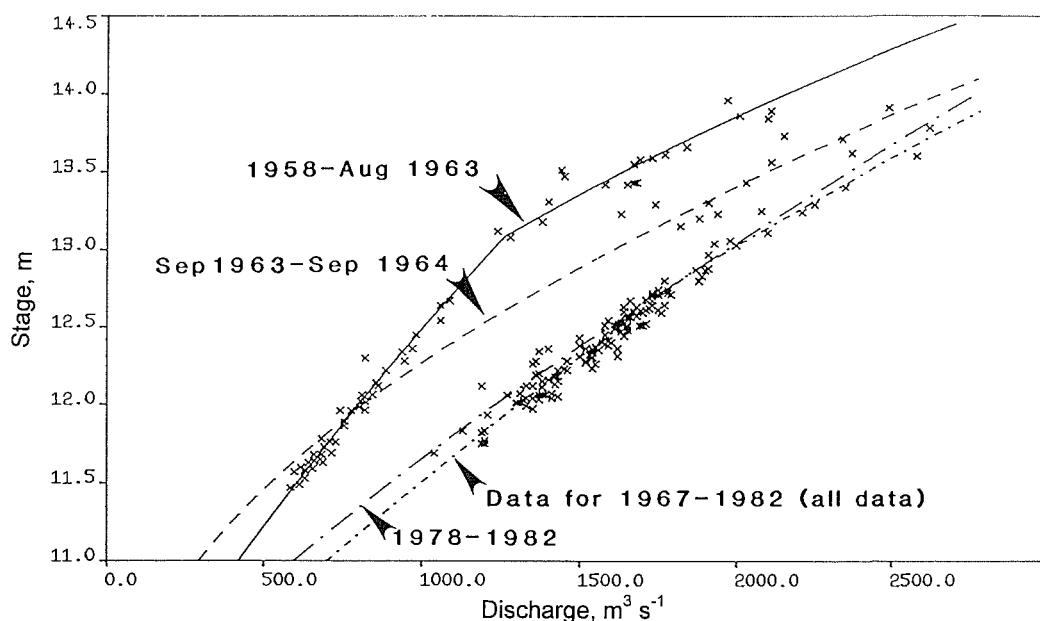

Fig. 5.3 Bahr el Jebel at Mongalla: rating curves, 1958–1982 (after Sutcliffe & Parks, 1994a).

The outflows from the Sudd have been measured directly for short periods, but the only long-term flow record is derived from the difference between the flows of the White Nile at Malakal and the Sobat at Doleib Hill near its mouth. Measurements at Malakal have been regular since 1906, and have continued to the present. Gaugings at Doleib Hill began in 1906, and continued until 1983; the outflows, like the inflows, are not known since 1983. These records are discussed further in Chapters 7 and 8; the records at Malakal are reliable, but the Sobat flows are less reliable after the outflows from the Sudd increased in 1964. In some years (e.g. 1979 and 1981) the published flows appear to be incorrect as they diverge markedly from the norm. Although flows had been measured at a number of "latitude sites" within the Sudd before 1964, after the lake rise and doubled inflows it was not possible to measure complete flows.

Published river flow records

The inflow record at Mongalla for 1905–1983 (Fig. 5.4) illustrates the seasonal component of the Sudd inflows. The graph shows the marked effect of the 1917–1918 flood, and the high proportion of the flow which is relatively steady and due to outflow from lake storage. It also shows the great increase in this lake outflow which occurred after 1961, and the decline which occurred after this rise. The flows at Mongalla have not been measured after 1983, but an indication of the flows since that date can be inferred from the Lake Victoria level or outflow series (see Chapter 3); the decline has continued fairly steadily, interrupted by rises in 1978–1980 and 1998 and by seasonal variations.

In spite of the marked effect of the lake level on the "baseflow" component of the Mongalla flows, there is no evidence from the flows before and after 1961 of a corresponding increase in the seasonal torrent flows. The average flows at Mongalla are compared in Table 5.1 for different periods; although the total inflow nearly doubled between 1905–1960 and 1961–1983, the seasonal component which reflects the torrent flows below Lake Albert did not change. Another method of estimating the torrent flows, described in Chapter 4, was

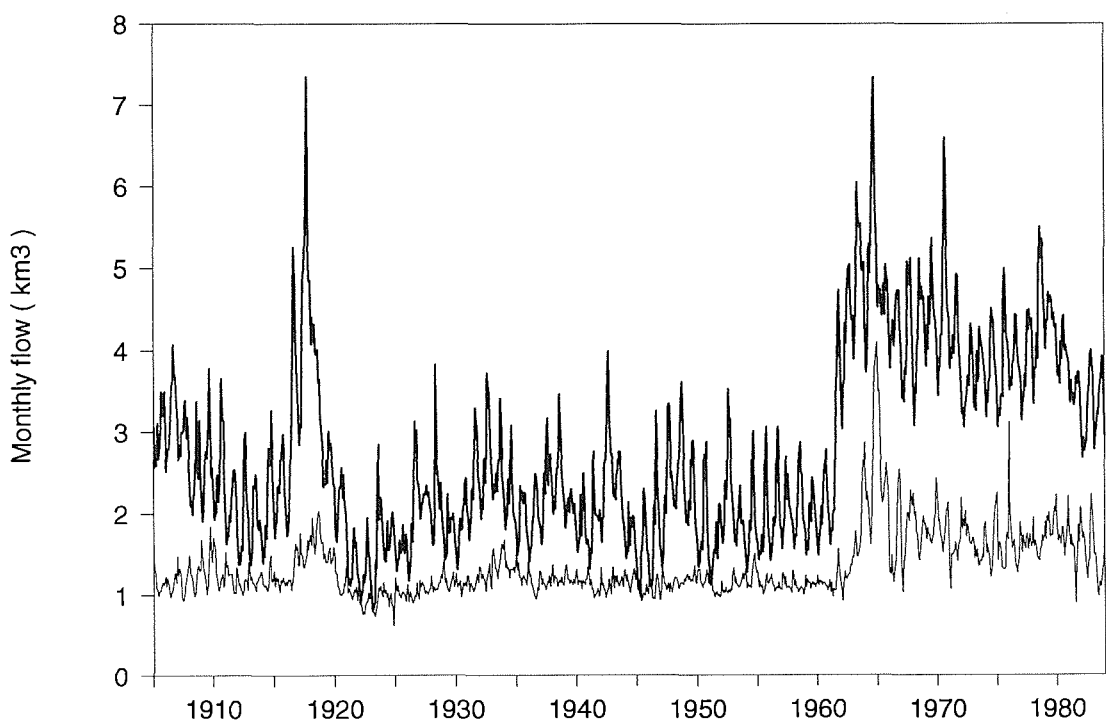

Fig. 5.4 Sudd monthly inflows and outflows, 1905–1983.

Table 5.1 Comparison of Sudd inflows, torrent flows and outflows ($\text{m}^3 \times 10^6$).

Jan.	Feb.	March	April	May	June	July	Aug.	Sept.	Oct.	Nov.	Dec.	Year
Sudd inflows, 1905–1960												
1979	1692	1795	1850	2260	2169	2398	2771	2754	2650	2362	2151	26831
Sudd inflows, 1961–1983												
3885	3366	3624	3602	4001	3864	4190	4646	4610	4690	4468	4213	49159
Sudd inflows, 1905–1983												
2534	2180	2327	2360	2767	2663	2920	3317	3295	3244	2975	2751	33332
Torrent flows, 1907–1960												
8	0	3	137	474	419	583	910	853	643	347	82	4459
Torrent flows, 1961–1980, excluding 1964												
0	0	0	100	327	291	431	902	895	738	516	176	4377
Torrent flows, 1907–1980, excluding 1964												
6	0	2	127	434	385	543	908	864	668	391	107	4436
Sudd outflows, 1905–1960												
1337	1188	1236	1140	1131	1058	1109	1159	1176	1242	1150	1230	14157
Sudd outflows, 1961–1983												
1950	1634	1771	1619	1582	1504	1513	1589	1697	1936	1940	2064	20799
Sudd outflows, 1905–1983												
1515	1318	1392	1280	1262	1188	1227	1284	1328	1444	1379	1473	16091

based on a comparison of dry season Mongalla flows and Lake Albert levels to estimate the lake outflows. The lake outflows reach their maximum in October–December, after the peak of the torrent flows. Approximate torrent flows were deduced and published in *The Nile Basin*, vol. V (Hurst & Phillips, 1938) and subsequent supplements to vol. IV. Figure 5.5 illustrates these monthly flows and their extreme seasonal and annual variability. Table 5.1 includes these estimated torrent inflows for the periods 1907–1960 and 1961–1980, excluding the dubious value for 1964. The annual totals average 4.4 km^3 , but range from 1.3 to 11.8 km^3 with a standard deviation of 1.9 km^3 .

These seasonal flows contribute to the annual high flows whose spilling inundates the areas of the flood plain, which are later uncovered and provide the seasonal grazing of importance to the local population. As the torrent inflow did not increase after 1961 and the average area of flooding more than doubled, the average range of flooding in terms of depth will have decreased.

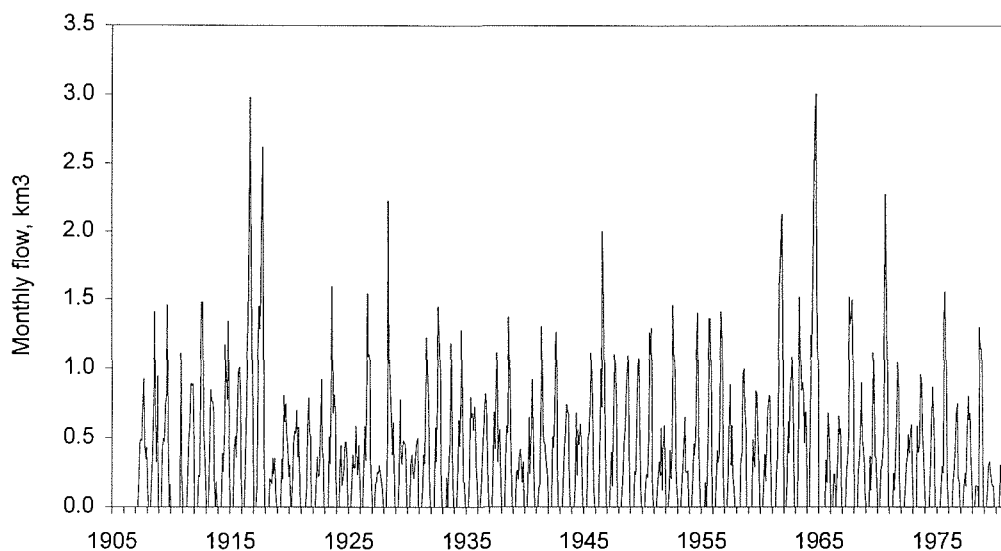
**Fig. 5.5** Torrent flows: Lake Albert to Mongalla, 1907–1980.

The outflows, deduced from flows at Malakal and the Sobat mouth, include the outflows of the Bahr el Zeraf as well as the Bahr el Jebel. They also include the outflows of the Bahr el Ghazal, but these flows are small by comparison with other components and have not been deducted. The outflows from the Sudd are also illustrated in Fig. 5.4.

The losses over the whole reach from Mongalla to the Sobat mouth can be derived from the difference between the inflows and outflows. The losses in the early years 1905–1960 averaged 47.2% but increased to 57.7% in the years 1961–1983 because of the higher inflows. The reason for these losses must be sought in the interaction between the inflows and the topography.

THE BAHR EL JEBEL SWAMPS

Below Mongalla the channel carrying capacities are less than the high flows, and the alluvial channels themselves are built up above the adjacent flood plain (Figs 5.6 and 5.8). The excess flows leave the river through small channels which pierce the river banks, or spill over the banks themselves at higher flows; they then inundate large areas on either side of the river. In the southern part of the swamps this flooding is limited by higher ground flanking the flood plain, but further north (Plate 6) the lateral spread of water is not limited in this way. High river flows from the torrents are based on rainfall to the south of Mongalla; the timing coincides with the rainfall within the swamps, which contributes to the inundation. The maximum extent of flooding occurs after the rainfall season, when net evaporation is comparatively high, and much water is lost from the swamps by evaporation and transpiration. As a result the outflow is relatively constant, with little seasonal variation and with annual



Plate 6 River transport on the Bahr el Jebel, showing papyrus beside river (after Howell, 1953).

totals about half the inflow. There has been some discussion as to whether the spilled water returns to the river in significant amounts, and thus whether the swamps act to any degree as storage or simply as a sink. This varies with the topography, but in general terms there is return flow in the higher reaches and less return flow in the lower reaches of the Sudd.

The overall effect of these processes is that varying areas are inundated “permanently” or seasonally, with the uncovering of the seasonal swamp coinciding with the dry season when grazing is not available elsewhere. The areas of permanent swamp depend on the baseflows from the East African lakes, and reflect the medium-term variations of the baseflows. The seasonal swamps also reflect the seasonal variations of the lake outflows, but depend mainly on the seasonal flows of the torrents and the seasonal balance between rainfall and evaporation within the swamps.

The influence of topography

Because the flooding regimes of the different parts of the Sudd vary, some description of the topography is needed to understand the hydrology. The river is incised within an even plain sloping gently north or slightly east of north, while the Bahr el Jebel north of Gemmeiza runs west of north at an angle to the ground slope. North of Juba the river runs in an incised trough, bounded by scarps with a rise of a few metres marking the limit of the woodland on either flank. The scarps decrease in height from south to north, and disappear just north of Bor on the east bank, and south of Shambe on the west.

From Juba to Bor the river meanders (Fig. 5.7) in one or more channels from one side of the restraining trough to the other, dividing the flood plain into a series of isolated basins or islands. These basins lie below the levels of the alluvial banks of the river, through which a

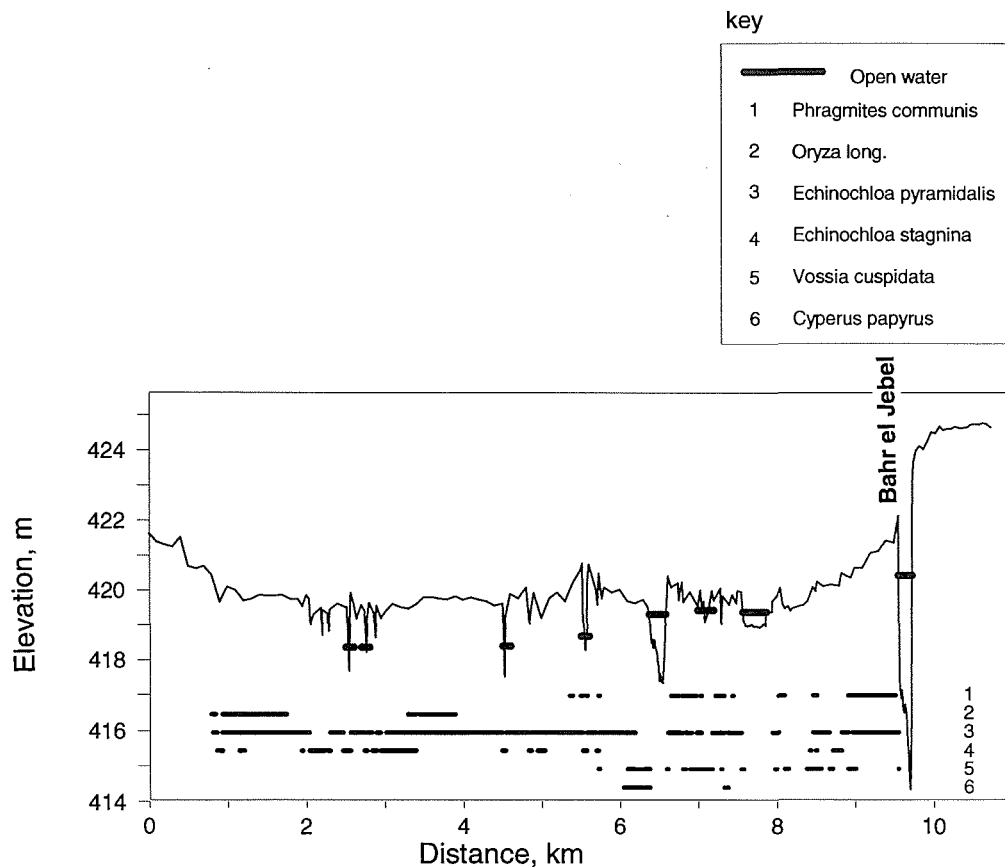

Fig. 5.6 Aliab valley cross-section CS 12 (cross-section O in Fig. 5.7) (after Sutcliffe & Parks, 1996).

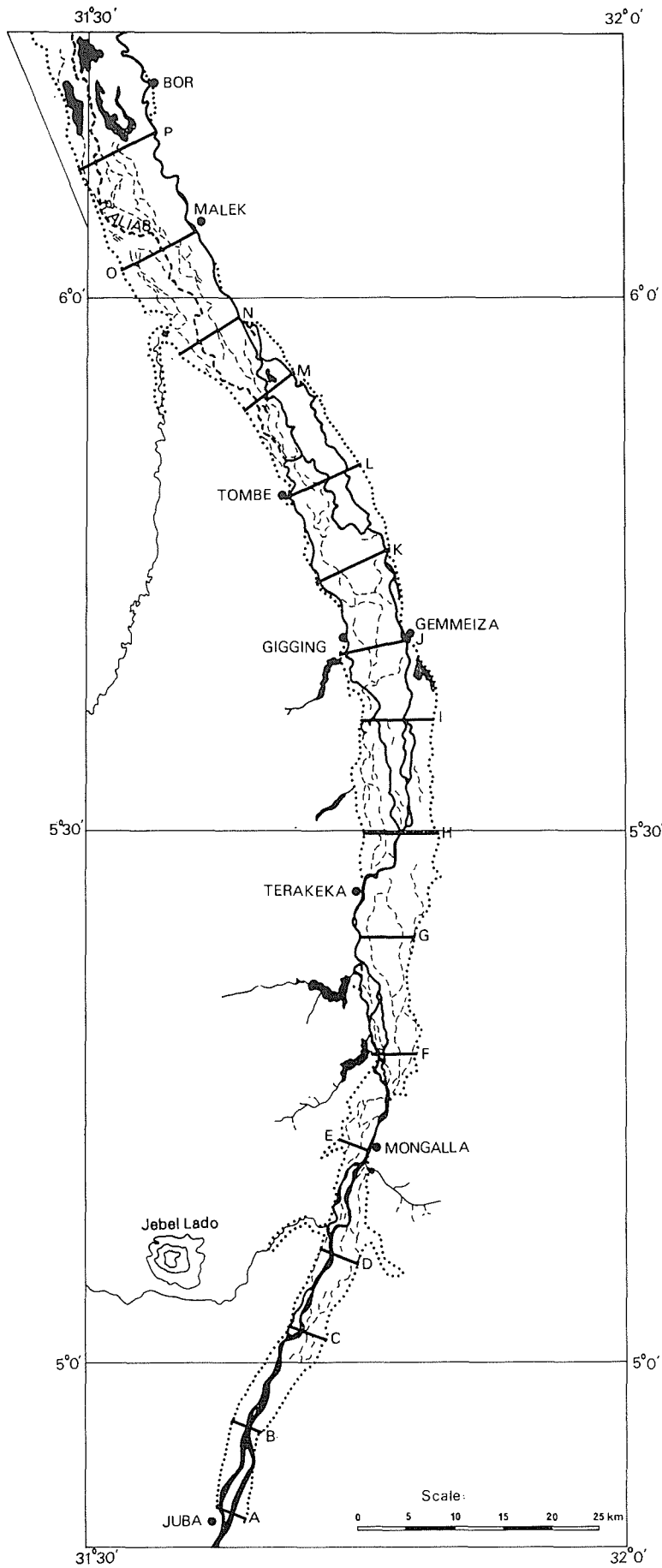

Fig. 5.7 Map of Bahr el Jebel flood plain from Juba to Bor (after Sutcliffe, 1974).

number of small channels carry spill. At the downstream end of each basin, where the river meets the high ground, a large channel carries spill back into the river. Further north, where the basins are not confined, the system of channels becomes more complicated but the pattern can be visualized as a series of basins receiving spill and discharging some spill back to the river.

Between Bor and Jonglei the river flows in a shallow trough about 15 km wide, and in the southern part there is little lateral spill outside the trough. About half way between the two sites, the eastern margin of the trough becomes less distinct and a belt of seasonally flooded grassland increases in width. The river flows in three distinct channels with interconnecting lakes throughout this reach and there have been changes since the 1960s.

From Jonglei to Shambe the main complex of channels and lakes remains in a band about 15 km wide, but there is no eastern limit to the trough and there is extensive spillage to the east resulting in large areas of seasonally flooded grassland and permanent swamp. Between Shambe and Adok the Sudd is at its widest, with large inaccessible swamps and fewer side channels. Some of the eastern flow forms the Bahr el Zeraf. There are a number of small channels flowing west of the Bahr el Jebel, some of which rejoin the main channel south of Adok; some may be linked with the Bahr el Ghazal system to the west, though any outflow is likely to be small.

Between Adok and Malakal the Bahr el Ghazal joins the main river from the west at Lake No, where the river turns east and becomes the White Nile; it is joined by the Bahr el Zeraf and the seasonal Sobat.

The flooding regime

The complexity of the area is such that it is difficult to describe the flooding process, except in sample areas. At a time when inflows and flooding levels were low, it was possible to survey

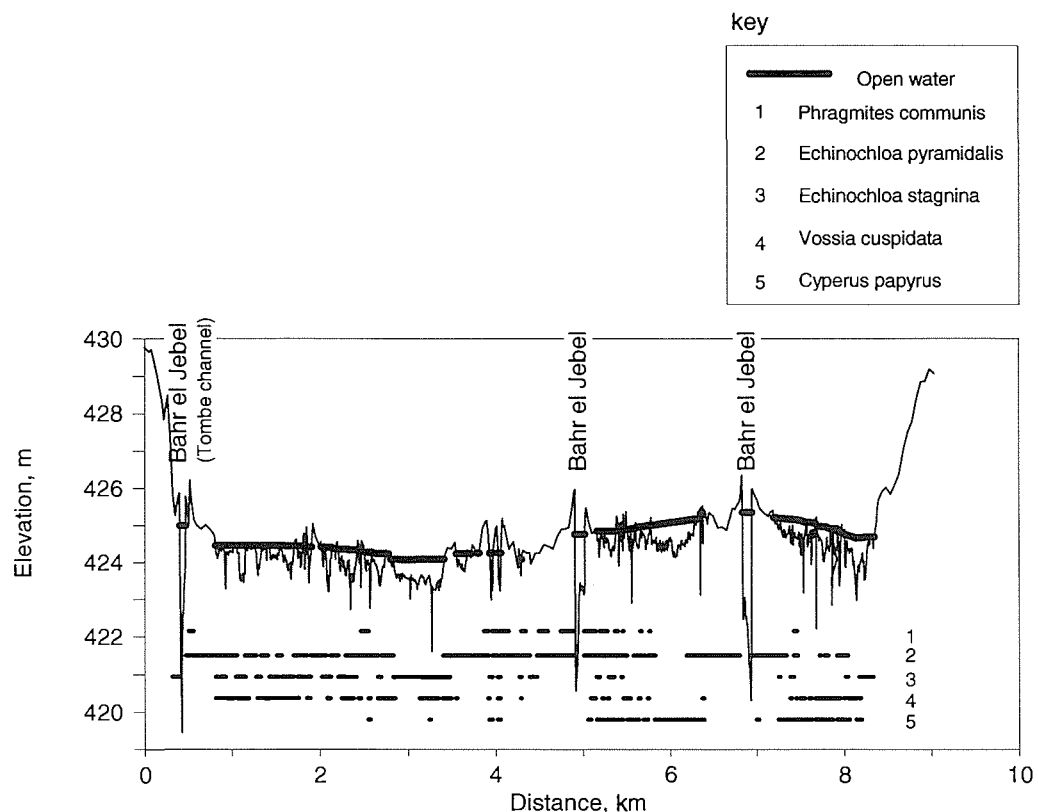

Fig. 5.8 Bahr el Jebel valley cross-section east from Tombe (cross-section L in Fig. 5.7).

sample reaches between Juba and Bor. Some detail on how spill leaves the river may be deduced from cross-sections of the flood plain and sections along the river bank. This spill flows down the flood plain and either returns to the river or is lost by evaporation. A detailed account of the sample reach is given elsewhere by the present authors (Howell *et al.*, 1988, Chapter 5) but a general summary may illustrate the processes. At moderate flows and levels, river spilling occurs through the alluvial banks of the main channel in a succession of spill channels. Some of these are deep and may become part of the main channel network, while others are simply cattle watering points or hippopotamus access points which carry spill through the bank. Some 370 spill channels were surveyed in 1952 along 58 km of the west bank of the Bahr el Jebel bordering the Aliab valley from Tombe to opposite Bor. A similar survey along the east bank from Mongalla to Gemmeiza revealed about 170 spill channels over 57 km. When river levels are high, widespread spilling occurs over the banks of the main river.

There is evidence from successive maps and observation that spill channels develop from small breaks in the bank. These grow into major channels in periods of higher flows, and finally silt up at their head and become obsolete, with their high alluvial banks forming barriers to the lateral flow of spill. The River Aliab is an example of such a river. When the reach was surveyed by Gordon in 1874, this was the main navigation channel; by 1951–1952 it was obsolete and formed a barrier to lateral flooding, but in 1982 it was observed from the air to be carrying spill again.

A cross-section (cross-section L in Fig. 5.7) from Tombe to the east of the valley illustrates several features of the topography (Fig. 5.8). The problem of access across the flood plain is clear, even in March 1952 when the Tombe gauge was at the normal minimum before the rise of Lake Victoria; the Mongalla flow was $54 \text{ m}^3 \times 10^6 \text{ day}^{-1}$. The section crosses three branches of the Bahr el Jebel, including the Tombe and the eastern channels. A number of small channels in the flood plain, including Khor Kongolayum (“Alum was eaten by a crocodile”) contribute to the flooding, with flows of 0.25 to 0.3 m s^{-1} . The lateral flow of water is clearly illustrated by the gradient away from the main river or spill channel. Spilled water also drains down gradient parallel to the river, either through drainage channels or through the swamps; velocities of 0.025 up to 0.167 m s^{-1} were noted. The protection provided by the alluvial banks is illustrated near the main channels. There is a striking contrast in vegetation between papyrus on the eastern part of the section and pasture grass like *Echinochloa stagnina* on the western island. The flooding depends on the detailed topography.

Where the river crosses the flood plain and touches the high ground, as at Gemmeiza (Fig. 5.7), a channel invariably carries upstream spill back into the river. Thus the basins of the flood plain, especially above Bor, act as a series of reservoirs which receive flood water from the river and return water lower down. The amount in passage or temporary storage increases as the river rises and decreases as it falls. In fact the return channel is a sensitive indicator of flooding conditions within the basin. For example, the large channel returning to the river at Gemmeiza was stagnant in March 1952 when the Mongalla basin was receiving little spill, but was flowing strongly in February 1982 when higher river flows caused large-scale spilling upstream.

Between Juba and Bor the flood plain is eroded below the woodland fringe and flooding is confined by higher ground. These limits disappear downstream of Bor on the east and near Shambe on the west and the constraint on lateral flooding is lost; also the river banks and channel capacities are smaller and spilling is more continuous. There is no barrier to the east in the direction of the overall slope and flooding extends further during high flows; much of the spill does not return to the river. The outline of flooded areas after 1964 (Fig. 5.9 and Fig. 6.4) shows that most of the increased flooding occurred to the east of the river.

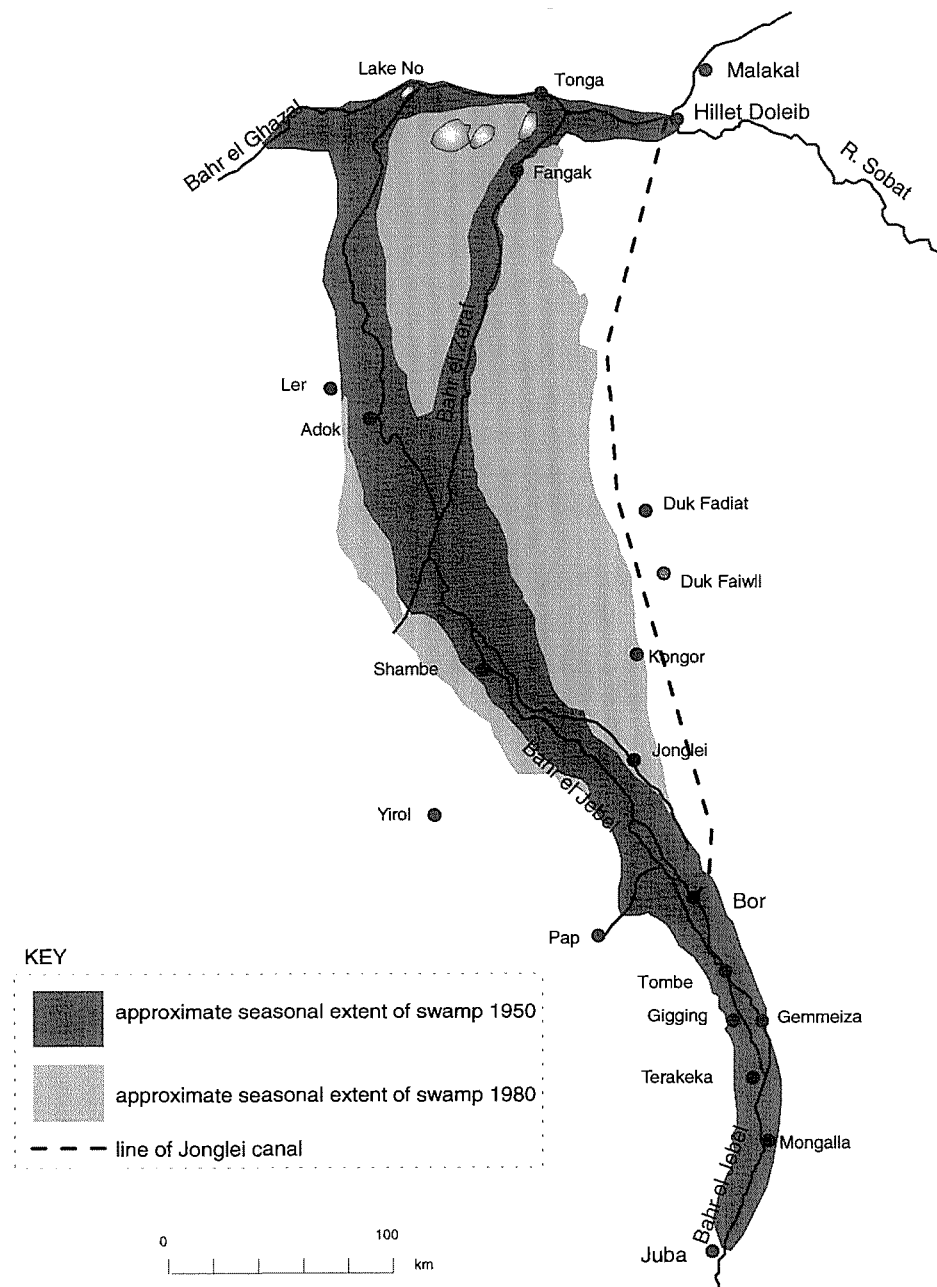

Fig. 5.9 Map of the Sudd (after Howell *et al.*, 1988).

The pattern of flooding appears to be fairly similar to that described for the upper reaches, with spill spreading from the river to inundate a wide area but with some spill flowing parallel to the river in drainage channels like the Atem which rejoin the main river downstream. As a result of these successive spills the seasonal variations of inflows are damped to a fairly steady and lower outflow (Fig. 5.4), except in periods of sustained high inflows as in 1961–1966. The area of inundation increased markedly after 1961, as indicated by comparisons of sample areas between Juba and Bor and by satellite imagery of the whole area. In spite of the complexity of the physical situation, it may be represented by a simple hydrological model of a reservoir which rises and spreads as the inflow increases.

Study of a sample reach

A detailed study of a sample reach between Mongalla and Gemmeiza (Sutcliffe, 1957, 1974) showed that it was possible to reconstruct volumes and levels of flooding from inflow records at Mongalla and outflow records at Gemmeiza and Giggig. It was necessary to estimate unmeasured outflow between Gemmeiza and Giggig during high flows. Comparison of flooding levels and vegetation species showed that not only do hydrological factors control the vegetation, but also the vegetation distribution can reveal the shape of flooding parallel to and away from the river channel. The volumes of flooding were related directly to Mongalla inflows, and in turn to frequency and duration of flooding. This study is discussed later in relation to vegetation.

This procedure can be extended to develop a simple hydrological model to describe the behaviour of the whole of the Sudd over the period of flow records. The model must take account of river inflows and outflows, rainfall on the flooded area and evaporation from this area. It should be able to reflect the increased Bahr el Jebel inflows after 1961, and the subsequent increase of both permanent and seasonal flooded areas and of evaporation losses. The model should use actual measurements as far as possible, in order that the results should be physically reasonable.

HYDROLOGICAL MODEL OF THE SUDD

After construction of the Jonglei Canal had begun, interest in the effects of the canal was renewed and an environmental study was carried out between 1979 and 1983 (Howell *et al.*, 1988). As a complement to this study a hydrological analysis of the Sudd was carried out by the Institute of Hydrology (Sutcliffe & Parks, 1982, 1987; chapter 5 of Howell *et al.*, 1988). The area was treated as a simple reservoir, and the volumes and areas of flooding were estimated for the period 1905–1980. This demonstrated the dramatic rise in the area of flooding, which trebled after 1964. The effect was concentrated on the permanent swamp rather than the seasonal flood plain, as the torrent flows had not increased.

The whole of the Sudd was taken as the limits of the model, as flow records were not available for a smaller area after the rise of Lake Victoria and Bahr el Jebel flows. The inflows at Mongalla and the outflows from the swamps were available from 1905 to 1980. The flows have been estimated from regular level and discharge measurements, using rating curves deduced generally from contemporary gaugings.

Monthly rainfall records at eight stations were used to derive a swamp rainfall series for the period 1905–1980. Long-term variations (Howell *et al.*, 1988, Fig. 5.8), showed that the high flows around 1917 coincided with a period of high local rainfall but the period of high flows since 1961 was not reflected in Sudd rainfall. In other words, the high flows after 1961 were based on high rainfall in the lake region alone. This is important when comparing the changes in permanent and seasonal flooding.

A reasonable estimate of swamp evaporation is important to modelling of the Sudd. Early estimates were based on papyrus grown in tanks, but it was difficult to maintain vigorous growth. Penman (1963), discussing improved experiments by Migahid using tanks filled with papyrus and open water, suggested that the transpiration from the papyrus and evaporation from the open lagoon would be nearly equal. Open-water evaporation, estimated by the Penman method from temperature, humidity, sunshine and wind speed at Bor, corresponds to 2150 mm year⁻¹, and average values were used in the model. Table 5.2 gives monthly average rainfall and evaporation totals used in this study.

Table 5.2 Average Sudd rainfall (1941–1970) and open water evaporation (mm).

Jan.	Feb.	March	April	May	June	July	Aug.	Sept.	Oct.	Nov.	Dec.	Year
Rainfall												
2	3	22	59	101	116	159	160	136	93	17	3	871
Evaporation												
217	190	202	186	183	159	140	140	150	177	189	217	2150

The model is simply based on the equation of continuity and treats the swamp as a reservoir which receives inflow from the river and rainfall on the flooded area. The losses include outflow, evaporation from the flooded area, and infiltration into newly flooded ground. This was estimated as 200 mm at the beginning of the wet season and reduced to take account of net rainfall during this season. To complete the water balance a relation between volume V and area A of flooding was required, and evidence from the Mongalla basin and studies of the White Nile and Sobat suggested that a simple linear relation was reasonable. Thus $A = kV$ was used which implies a constant mean depth ($1/k$) as the area of flooding increases; $1/k$ was estimated as 1 m.

The hydrological model

The model may be expressed as follows:

$$\delta V = [Q - q + A(R - E)]\delta t - r\delta A$$

where V is volume of flooding, Q is inflow, q is outflow, R is rainfall, E is evaporation, A is flooded area and r is soil moisture recharge, which is positive when δA is positive and zero when δA is negative. The analysis for month i is:

$$V_{i+1} = V_i + Q_i - q_i - kV_i(E_i - R_i) - kr_i(V_{i+1} - V_i)$$

whence

$$V_{i+1}(1 + kr_i) = V_i(1 + kr_i) + Q_i - q_i - kV_i(E_i - R_i)$$

which requires a second iteration to allow for the fact that evaporation occurs from $(A_i + A_{i+1})/2$. However, a linear relation between A and V leads to a direct relationship:

$$V_{i+1} = \frac{V_i[1 + k\{r_i - (E_i - R_i)/2\}] + Q_i - q_i}{1 + k\{r_i + (E_i - R_i)/2\}}$$

Starting from an initial storage of 8 km³ on 1 January 1905, or 8000 km² of flooding, the storages and flooded areas were estimated at monthly intervals to the end of 1980. The predicted flooded areas were compared with gauge levels at Shambe near the centre of the Sudd; the seasonal fluctuations were reasonably reproduced.

Areas of flooding on specific dates were used to test the model. Measurements were found corresponding to four dates. Maps based on air photography of 1930/31 gave a swamp area below Mongalla of 8300 km², of which 845 km² was between Mongalla and Bor; these estimates (Hurst & Phillips, 1938) were assumed to correspond with the mean area. Satellite imagery of February 1973 gave a flooded area from Bor to Malakal of 21 300 km², illustrating the increase after 1964. Flooded areas can also be deduced from vegetation maps, and a map in the Jonglei Report (1954) suggested 2700 km² of permanent swamp below Bor and seasonal swamp of 10 400 km². Similar maps compiled from systematic aerial reconnaissance supported by satellite imagery of 1979/80 suggest an area of permanent swamp below Bor of 16 200 km², with additional seasonal swamp of 13 600 km². Thus six measurements of

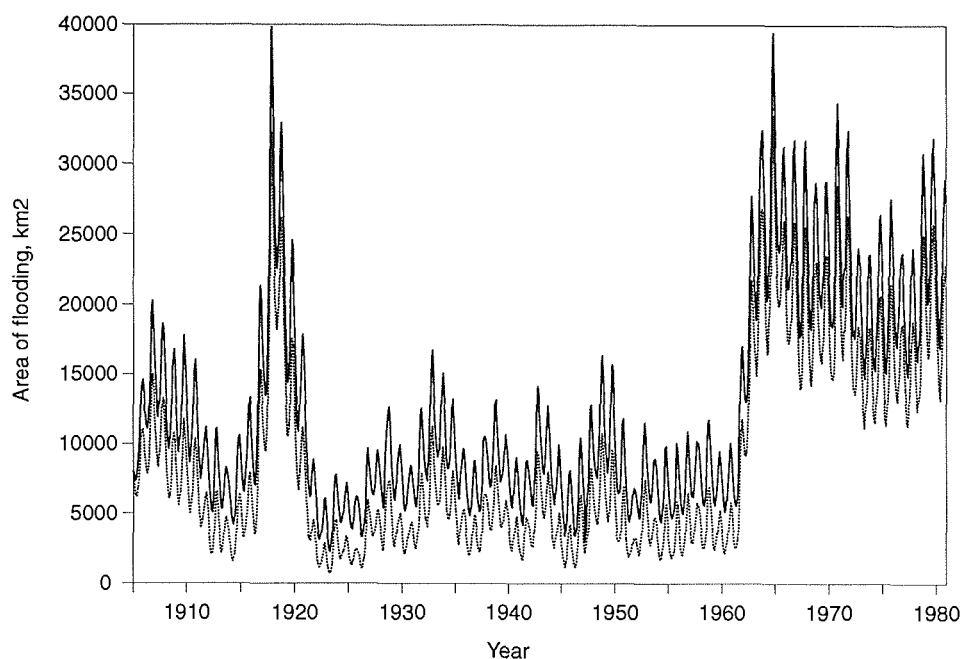

Fig. 5.10 Effects of the Jonglei Canal: estimated areas of flooding below Bor, with and without the Jonglei Canal ($20 \text{ m}^3 \times 10^6 \text{ day}^{-1}$).

flooded areas on specific dates were compared with the predicted values (Sutcliffe & Parks, 1987). They provided a reasonable fit on the assumption that the measured areas based on vegetation maps corresponded with average values of permanent and seasonal swamp over three years. Thus the model was taken as providing reasonable estimates of the historical areas and volumes of flooding.

The estimated areas of flooding follow quite closely the measured inflows. The time series of flooded areas (Fig. 5.10) shows clearly the short-lived increase in flooding during the 1917–1918 period, and the prolonged period of increased flooding after 1961–1964. It is clear that the area of seasonal flooding, due to the torrents, did not increase significantly after 1961, whereas the area of permanent swamp increased dramatically. The estimated areas at the start of each month are given as averages for different periods in Table 5.3. This shows the extent of the increase after 1961, and illustrates the seasonal pattern. The model was adapted, as described later, to assess the effect of the Jonglei Canal on areas of flooding, and Fig. 5.10 includes an estimate of the effect of a canal operated on a constant flow of $20 \text{ m}^3 \times 10^6 \text{ day}^{-1}$.

Effect on areas of seasonal flooding

The important local effect of the operation of the Jonglei Canal would be the reduction in seasonally flooded land which provides dry season grazing to cattle and wildlife. The permanent swamp, flooded throughout the year, is less economically valuable, though it

Table 5.3 Average monthly estimated areas of flooding below Bor (km^2).

Jan.	Feb.	March	April	May	June	July	Aug.	Sept.	Oct.	Nov.	Dec.
1905–1960											
10 148	8 786	7 727	6 947	6 753	7 370	8 114	9 382	11 123	12 483	12 711	11 642
1961–1980											
23 233	20 713	18 781	17 572	17 387	18 619	19 862	22 130	25 504	27 776	28 679	26 865
1905–1980											
13 592	11 925	10 636	9 743	9 551	10 330	11 206	12 737	14 907	16 508	16 913	15 648

Table 5.4 Estimated effects of canal on average areas of flooding ($\text{km}^2 \times 10^3$).

Canal flow	Jan.	Feb.	March	April	May	June	July	Aug.	Sept.	Oct.	Nov.	Dec.
1905–1960												
-	10.1	8.8	7.7	6.9	6.8	7.4	8.1	9.4	11.1	12.5	12.7	11.6
20	6.2	5.2	4.4	3.6	3.4	4.1	4.8	5.4	6.6	7.8	8.5	8.1
1961–1980												
-	23.2	20.7	18.8	17.6	17.4	18.6	19.9	22.1	25.5	27.8	28.7	26.9
20	18.6	16.5	14.8	13.8	13.6	14.6	15.6	17.5	20.3	22.2	23.0	21.6
1905–1980												
-	13.6	11.9	10.6	9.7	9.6	10.3	11.2	12.7	14.9	16.5	16.9	15.6
20	9.5	8.2	7.2	6.5	6.3	6.9	7.5	8.7	10.3	11.6	11.9	11.0

provides a refuge to wildlife. The estimated monthly areas of flooding for three periods corresponding to Jonglei Canal flows of $20 \text{ m}^3 \times 10^6 \text{ day}^{-1}$ are compared in Table 5.4 with the natural areas.

It will be seen from Table 5.4 and Fig. 5.10 that under the regime of a steady flow down the canal the area of seasonally flooded land or “toich” would decrease, but that the area of so-called permanent swamp would decrease more. In addition the effect of the canal would be very different between the low flow or high flow period before and after 1961. It would be possible to mitigate the adverse effect of the canal by choosing suitable operating rules. This can only be fully appreciated with an understanding of the way in which the hydrological regime controls the distribution of the vegetation of the flood plain, so that further discussion of the Jonglei Canal follows an account of the links between hydrology and vegetation.

The increase in naturally flooded areas after 1961, and the seasonal pattern of flooding, are relevant to one objection to the Jonglei Canal. Eagleson (1986), in discussing the prospect of hydrological forecasting on a global scale, has drawn attention to the wide region of influence of evaporation from the Sudd. More specifically, it has been suggested by others that the canal, in reducing the flooded area, would by decreasing local evaporation also reduce rainfall either locally or in the Blue Nile basin. There has been no evidence that the natural increase of flooding after 1961 affected rainfall either locally or in the Blue Nile basin; further, the maximum area of flooding and high net evaporation occur in October–December, after the rainfall season in the Bahr el Jebel or Blue Nile basins (Sutcliffe & Parks, 1993). However, it would be interesting to trace the effect of water evaporated from the area during different seasons.

HYDROLOGICAL CONTROL OF FLOOD-PLAIN VEGETATION

The linkage between flood-plain vegetation and hydrology, in particular the duration, depth and range of seasonal flooding, has been described from a hydrological viewpoint (Sutcliffe & Parks, 1996) but it is convenient to describe the findings here.

Early observations and botanical studies

After botanical investigations, Migahid (1948, 1952) identified the main species of the permanent swamp as *Cyperus papyrus*, *Vossia cuspidata*, *Phragmites communis* and *Typha australis* and identified the main controls as water depth, current velocity and ground level. He distinguished between those species like *Cyperus papyrus* and *Vossia cuspidata* with

superficial rhizomes which can float on the surface of rising water, and such species as *Phragmites* and *Typha* which are anchored by their roots and unable to survive deep flooding. Further, the papyrus roots can only penetrate the clay soils of the Sudd where these are nearly permanently flooded, while those of *Vossia* can penetrate relatively dry soil. Thus both papyrus and *Vossia* can tolerate deep flooding, but papyrus requires considerable duration of flooding. *Vossia* can tolerate higher current velocities.

Migahid also observed that hydrological conditions varied along the course of the Bahr el Jebel from Lake No to Mongalla. The river banks and the swamp rise relative to the river level, while the annual range of river levels increases. The time the bank remains above the river level increases from north to south, and the swamp itself is uncovered for varying periods. Thus he drew attention to the influence of depth and duration of flooding, and the importance of relative levels of river level, bank and swamp.

Botanical studies of the Jonglei Investigation Team

The studies of the Jonglei Investigation Team from 1948 to 1954 concentrated on the grasses of the seasonally flooded areas, the vital component of the grazing cycle. The importance of depth and duration of flooding was accepted. Distinction was made between the deep-flooded species of *Cyperus papyrus*, *Vossia cuspidata* and *Echinochloa stagnina* with floating rhizomes, and the shallow-flooded species of *Phragmites communis*, *Echinochloa pyramidalis* and *Oryza spp.*, which are anchored by their rhizomes and root systems. The duration of flooding was accepted as important through its relation to root resistance. However, depth and duration of flooding, and other hydrological factors, are inter-related at any one site; the important controls can only be determined from detailed surveys.

The elevations of different species were studied (Jonglei Investigation Team, 1954, p.154 *et seq.*) at sites on the White Nile, the Sobat, and the Bahr el Ghazal. These observations covered different hydrological regimes, in particular ranges of flooding. The levels of the boundary between the shallow-flooded species and deep-flooded species are related to the maximum depth of flooding. The presence or absence of papyrus indicates that range of flooding is important.

Juba–Bor survey

Detailed evidence of the link between hydrology and vegetation was obtained from surveys carried out between Juba and Bor (Jonglei Investigation Team, 1954, pp. 823–847; Sutcliffe, 1957, 1974). A survey of the Aliab valley west of the Bahr el Jebel above Bor was completed in January–May 1951. Some 15 cross-sections were surveyed, with changes of slope and vegetation species recorded. An example is given in Fig. 5.6. The flood plain is well below the level of the river and the water level does not correspond directly with that in the river channel. A vegetation map (Jonglei Investigation Team, 1954, Fig. H3) showed that all six main species were found in the sample reach, and their distributions on each cross-section were clearly related to elevation. There was also a progression of species along the valley. The lower end of the reach, opposite Bor, was dominated by *Cyperus papyrus*, *Vossia* and open water, while the upper end was occupied by *Echinochloa pyramidalis*, with *Phragmites communis* along the alluvial banks of the channels. The lower ground was occupied by *Echinochloa stagnina*, with *Oryza spp.* in an inland basin protected by the obsolete Aliab channel and watered by Khor Gwir.

In 1951–1952 the survey was extended to the whole reach between Juba and Bor (Fig. 5.7, 16 cross-sections A–P). A second sample basin on the right bank between Mongalla and Gemmeiza (12 cross-sections) was investigated; the alluvial banks of the main river were also surveyed as spills over and through the banks were observed to be a key to basin flooding. These showed that the bank slope was greater than the water slope, not only over the whole reach, but also within each basin, and that the slope of the flood plain was even greater. A similar progression of vegetation was found in this basin, but *Cyperus papyrus* and *Vossia* were confined to a small area at the lower end of the valley, and *Echinochloa pyramidalis* and *Phragmites communis* dominated much of the basin. This qualitative information was analysed further in comparison with hydrology to deduce the precise mechanism.

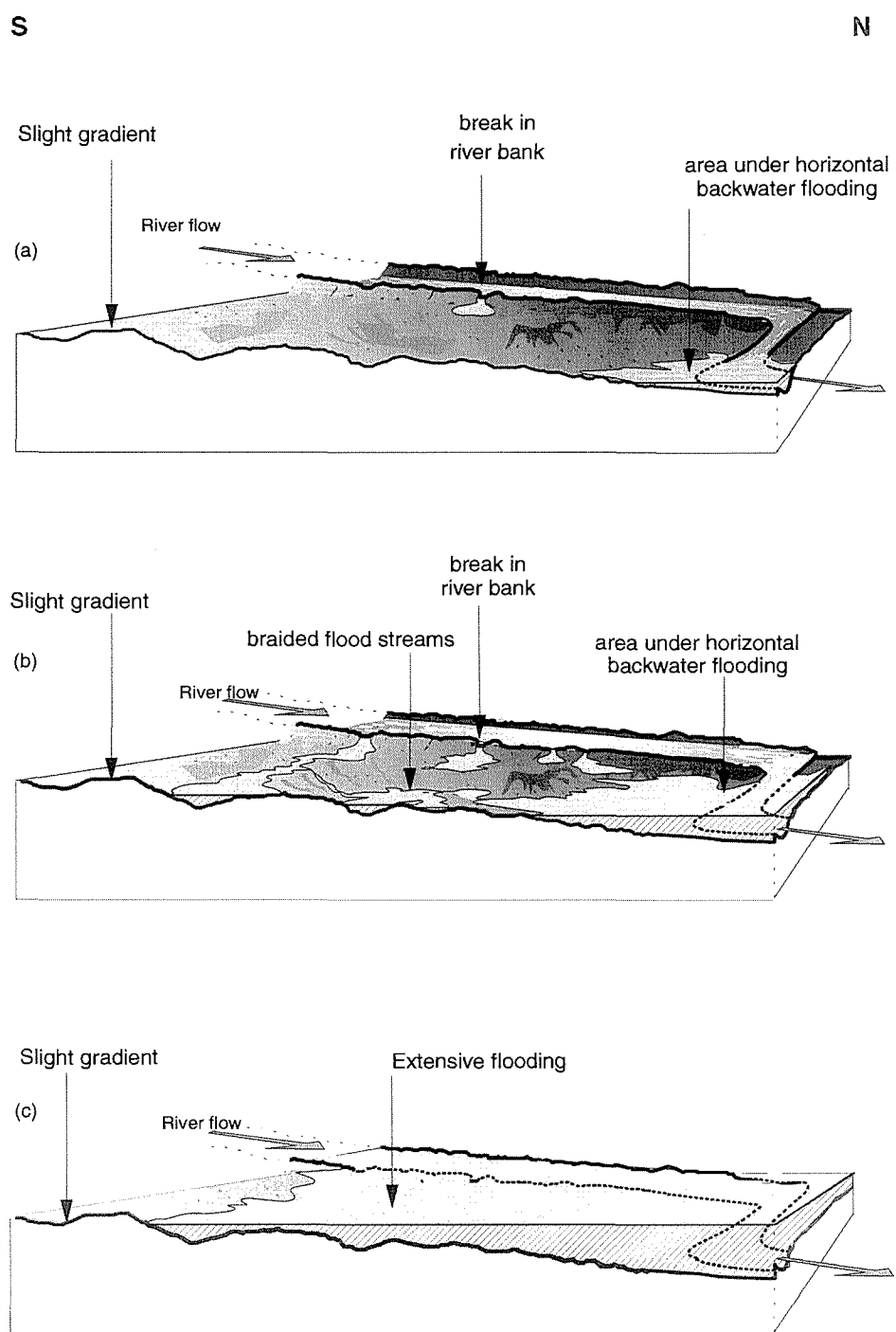

Fig. 5.11 Flood plain inundation and flow mechanisms: (a) low wet season flows; (b) moderate wet season flows; (c) high wet season flows (after Sutcliffe & Parks, 1996).

Description of flooding mechanism

Detailed study of these sample basins confirms the mode of flooding. As the relative levels of the river and bank change downstream, there is for any given inflow a point below which the bank is below river level, and water is able to flow directly across the flood plain. The limit of the overbank flow moves upstream as the inflow increases. Above this point the spill is confined to channels through the bank, and is related to river level. This process is illustrated in simplified form in Fig. 5.11. At the foot of the basin a channel connects the flood plain with the river and the spill flows back into the river. At very low flows (a) the flooding is dependent on this channel alone and the range of flooding corresponds with the range of river level. As the inflow increases (b) the point at which the bank was below the river migrates upstream, while flooding above this point increases. At very high flows (c) the river level is above the bank along the whole basin, and the flooding spreads laterally across the valley and then downstream at a slope which approximates to the river slope. Because the upper end of the basin is protected by the bank at low flows, the range of flooding is much higher at the upstream than the downstream end of the basin, and the flooding profile swings about a hinge at the lower end of the valley where the connection with the river is direct. Thus the sample basin contains not only a variety of levels and depths of flooding on each cross-section, but also differences in range of flooding from upstream to downstream.

The flood-plain topography is illustrated (Fig. 5.12) by four of the 12 sections of the Mongalla basin, which include the vegetation distribution. The river level rises in relation to the bank level as one proceeds downstream, while the flood plain is deeper below the bank level at the lower end of the basin. The increased flooding at the lower end of the basin is indicated by the surveyed water levels and the corresponding progression in vegetation type.

As described earlier, by comparing the inflows at Mongalla with the outflows between Gemmeiza and Giggling, it was possible (Sutcliffe, 1957, 1974) to deduce the volume of flooding. Because the time lag between Mongalla and Gemmeiza was not large, there was a direct relation between Mongalla flow and flooding volume, which was a function of the relative geometry of river level, bank level, and flood plain. Given the shape of the flooding surface, the depth of flooding at any point on the flood plain could be deduced.

Statistical analysis of vegetation distribution

The level and the vegetation for each point on the sections were recorded. Therefore it was possible to deduce the percentage of each species found at each range of level on each cross-section, and even on each kilometre of each section. Vertical histograms of vegetation were deduced for each segment of each section, and it was found that the pattern of distribution was similar in each case. A distinct boundary between shallow- and deep-flooded species sloped away from the river and downstream parallel to the high river level. Examples of these histograms for the complete Mongalla sections are shown as Fig. 5.13. Because of the manner in which the water surface swings about the lower end of the reach, it was possible to deduce from the longitudinal profile (Fig. 5.14) the precise nature of the control. Because the vegetation boundary is parallel to the maximum river level profile, and therefore the maximum flooding profile, it was clear that the boundary is controlled by the maximum depth of flooding; comparison with flooding volumes showed that the critical depth is about 1.30 m. Papyrus was only present at the lower end of the reach, and the range of flooding increases upstream. It was concluded that the range of flooding was the controlling factor for papyrus; the critical range is about 1.50 m. These deductions were supported by analysis of the distribution of vegetation in the Aliab valley. It may be noted that they are supported by analysis of flooding in the Okavango, Niger and Senegal wetlands (Sutcliffe & Parks, 1989).

CS 2

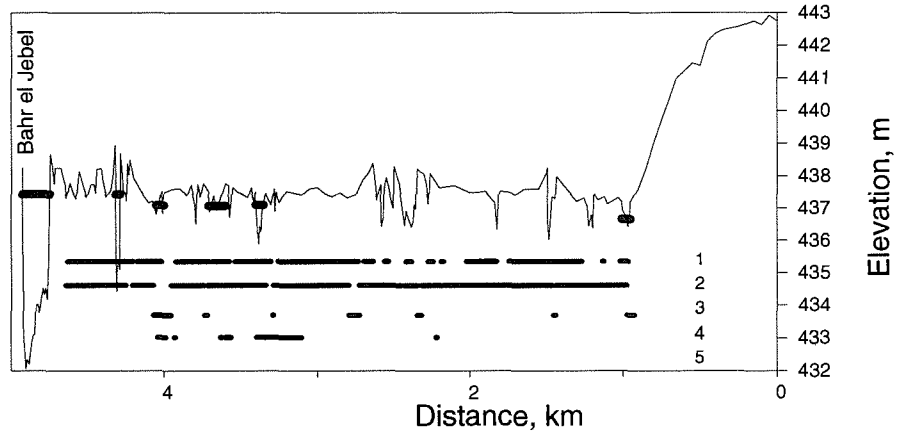

CS 5

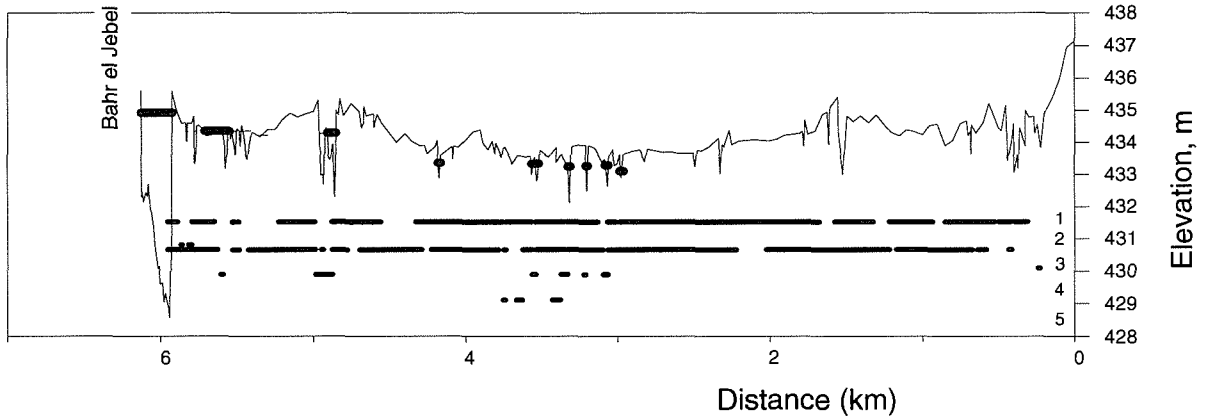

CS8

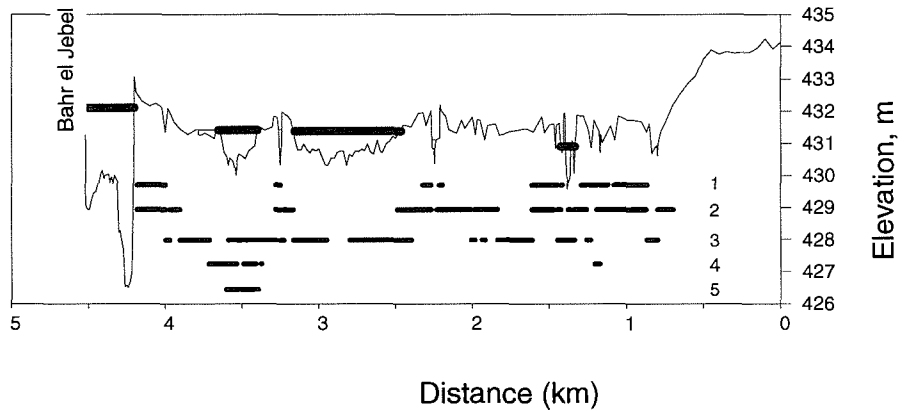

CS11

- KEY
- Open water
 - 1 Phragmites communis
 - 2 Echinochloa pyramidalis
 - 3 Echinochloa stagnina
 - 4 Vossia cuspidata
 - 5 Cyperus papyrus

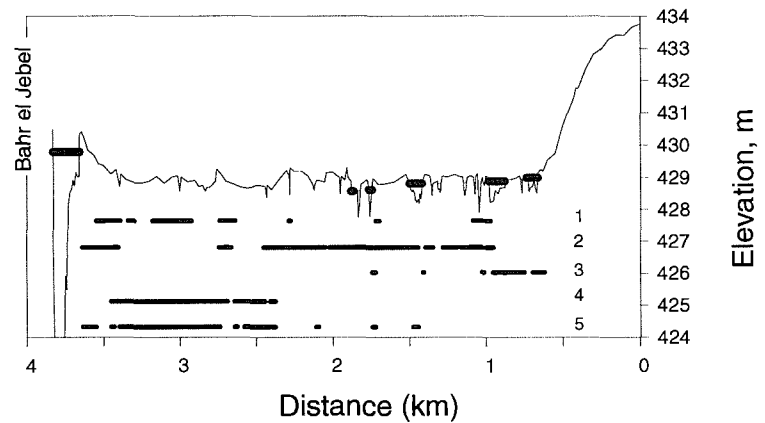

Fig. 5.12 Mongalla basin: elevation, dry season water levels and vegetation, cross-section (CS) 2 upstream to CS 11 downstream (cross-sections F-I in Fig. 5.7), 1951-1952 (after Sutcliffe & Parks, 1996).

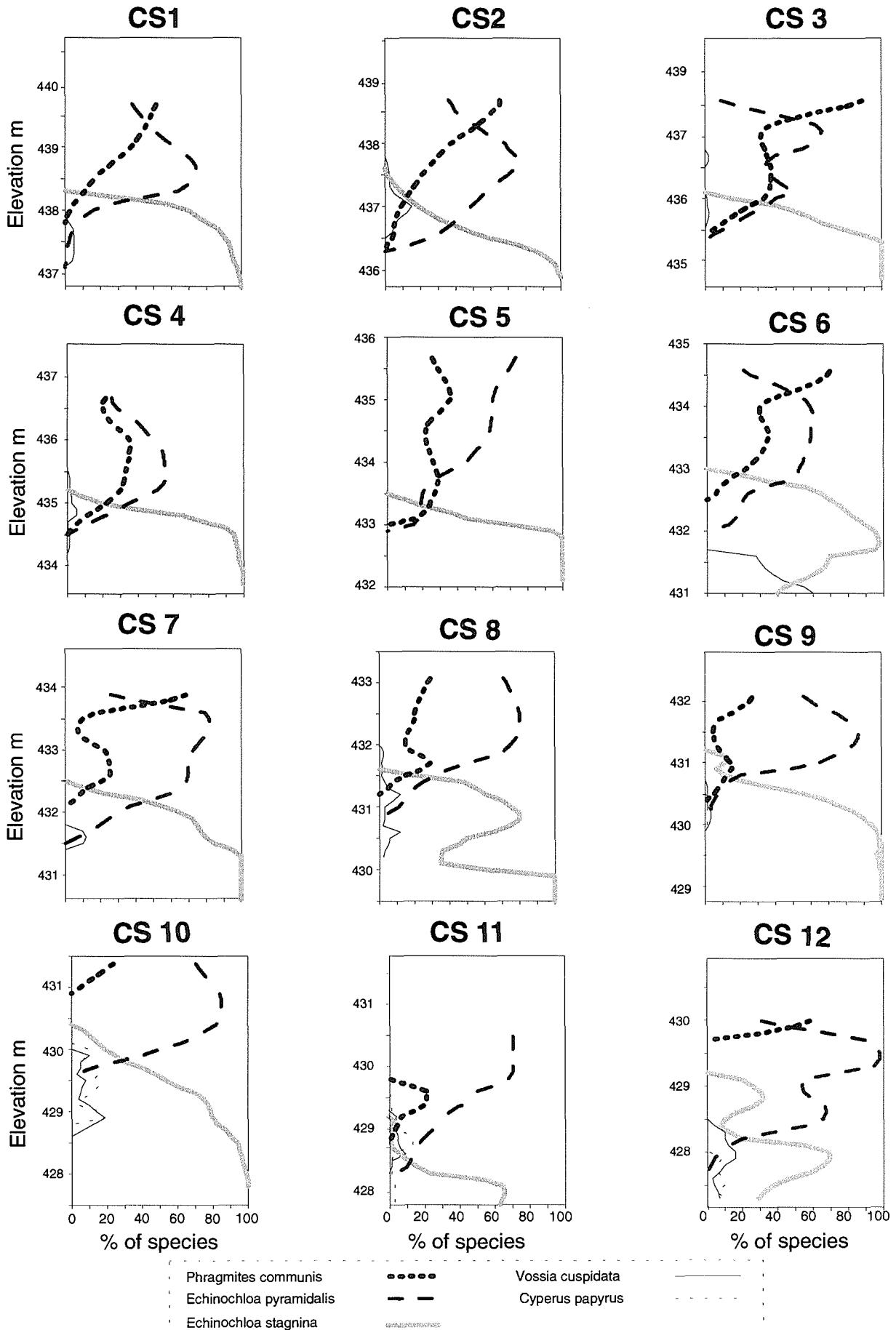

Fig. 5.13 Mongalla basin: vegetation and elevation on cross-sections (after Sutcliffe & Parks, 1996).

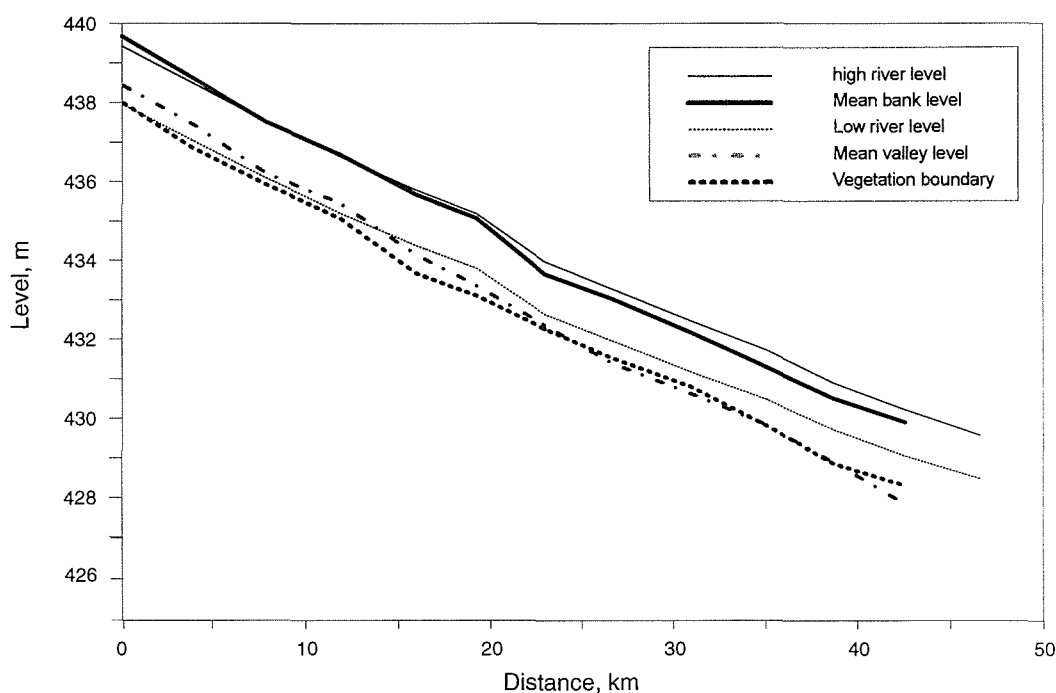

Fig. 5.14 Mongalla basin: profile of flood plain and bank, low and high water levels and vegetation boundary (after Sutcliffe & Parks, 1996).

Effect of rise in Lake Victoria

Hydrological modelling of the Sudd over the period 1905–1980 showed that the rise of Lake Victoria had a dramatic effect on the areas of permanent flooding, which trebled after 1964. The effect on the areas of seasonal flooding was much less, and the range of flooding level would have decreased.

During the environmental study of 1979–1983 (Howell *et al.*, 1988) a regional vegetation map was compiled. This confirmed that the areas of swamp had spread dramatically (Fig. 5.9) and that the papyrus had spread upstream and laterally. Large areas on the fringe of the permanent swamp had been invaded with *Typha dominensis*. It seems probable that the reduced range of flooding was also important in terms of vegetation change.

During a visit to the area in February 1982, the Aliab valley was examined from an aircraft at 150 m, with reference to the original topographic and vegetation maps of the area (Lock & Sutcliffe, chapter 8 in Howell *et al.*, 1988, p. 194). The higher flows and the reduced range of flooding had caused a dramatic change in the environment (Fig. 5.15), with a number of channels flowing through the valley and papyrus and *Vossia* spreading upstream. In the Mongalla basin, on the other hand, papyrus and *Vossia* had also spread upstream but *Echinochloa pyramidalis* was providing grazing where in the past the dominance of *Phragmites* limited its availability. In fact this reach may well have returned to the situation at the time of early exploration, when large herds of cattle were reported in an area where there was little grazing during the 1950s in a period of low Lake Victoria levels. This apparent anomaly was discussed by Sutcliffe (1957), who suggested that the high lake levels at the end of the last century might have provided an explanation.

This comparison reinforced the observation of the interdependence of hydrology and vegetation, but showed that the hydrology was also dependent on upstream external factors. The land use of the area had changed between the two surveys in the sense that the positions of dry season cattle-camps had adapted to the change of hydrology; the importance of the grazing provided by the seasonally flooded areas had not changed.

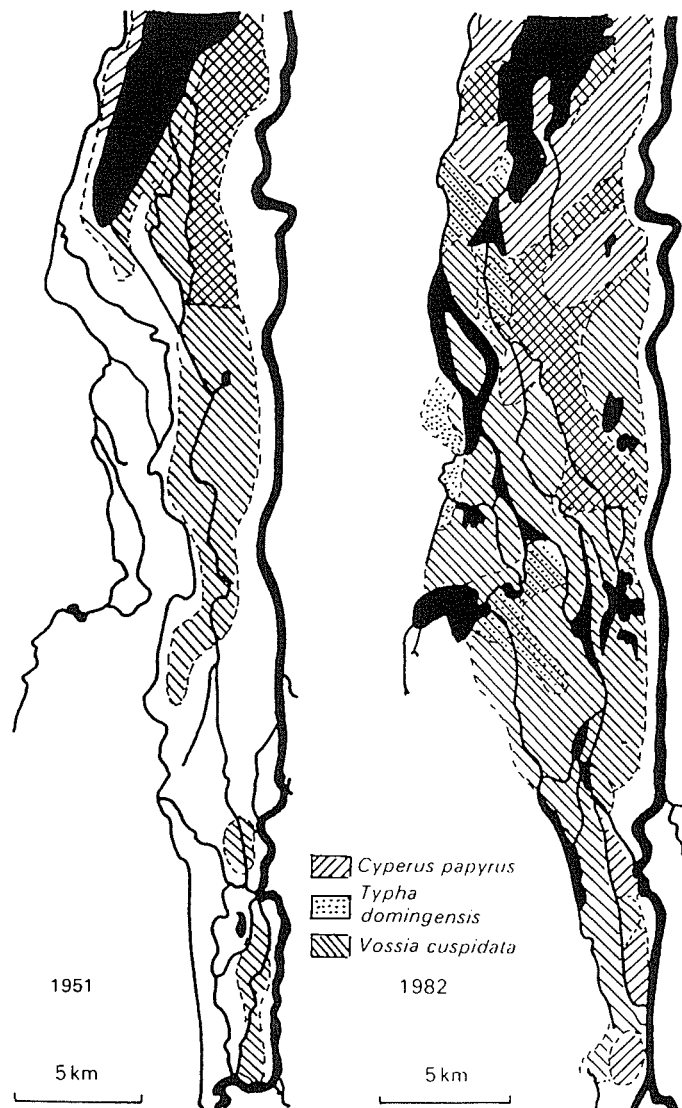

Fig. 5.15 Aliab valley: channels and vegetation in 1951 and 1982 (after Howell *et al.*, 1988).

Importance of seasonal flooding to grazing

The importance of the ecological controls is that their understanding may enable predictions to be made of the conditions which would follow the completion of the Jonglei Canal, though these would depend to some extent on the operating rules which were followed. The importance of the seasonally flooded areas was noted as early as Evans-Pritchard (1940).

The extreme seasonal variability of climate and in particular the dry season which extends from December to April (Howell *et al.*, 1988) make the seasonally flooded land or “toich” a vital component of the grazing cycle for the herds of the Nuer and Dinka in particular. They migrate from so-called high land during the rain season to intermediate land or rain-flooded grasslands at the end of the rains and also at the beginning of the rain season. They move to seasonally flooded flood plains of the main river and to a lesser extent other water courses during the main dry season. The short and relatively unreliable nature of the rainfall regime makes livestock an important part of the economy, and there is no alternative to the toich in a grazing economy without recourse to irrigated grassland.

The flood plain between Juba and Bor illustrates this dependence. The Aliab valley was used extensively for grazing in 1951 during the dry season (Plate 7), from cattle camps sited on



Plate 7 Dinka cattle in the Aliab valley.

the alluvial banks of the main river and the Aliab channel. During the early dry season the mature growth of *Echinochloa stagnina* was used, while the shallow-flooded *Echinochloa pyramidalis* was burned to produce regrowth; both species were grazed later in the dry season. In February 1982 access to the Aliab valley had been made difficult by new channels down the valley and the spread of papyrus, but the cattle camps along the main Bahr el Jebel were largely in the same positions. In the Mongalla basin, the situation was the reverse. Whereas in 1952 there was little grazing because of the dominance of *Phragmites* in the relatively low flow regime, in 1982 large numbers of cattle were observed grazing *Echinochloa pyramidalis* within the basin.

EFFECTS OF THE JONGLEI CANAL

Because the objective of the Jonglei Canal is to reduce evaporation losses within the Sudd, it is clear that the area flooded would be reduced. However, the economic value of the permanent swamp is mainly limited to the refuge which it affords to wildlife and in particular to the elephant population. The effect of the Jonglei Canal can be assessed not only in terms of the reduction caused in the areas of seasonally flooded land, but also in the timing of the flooding and uncovering to coincide with the dry season, and also the effect of depths and level range of flooding on the vegetation.

Assessment of the effects of the Jonglei Canal

The hydrological model described earlier was adapted (Sutcliffe & Parks, 1982, 1987; chapter 16 and Appendix 9 in Howell *et al.*, 1988) to simulate the effect which the Jonglei Canal

would have on areas of flooding. This was done by obtaining a relation between Sudd inflows and outflows, and then running the model with historic inflows reduced by diversions to the canal while assuming that the relation between inflows to the natural river and outflows would remain unchanged. The outflows then take account of the reduced losses due to the reduced inflows to the natural river.

The key to this analysis was the relation derived between inflow to the Sudd at Mongalla and outflow at Malakal less the Sobat inflow. Although the flows at Mongalla were less reliable before 1922, when a general rating curve was based on a small number of gaugings, records between 1916 and 1972 were used to include the flows of the high flood of 1916–1918. However, the years 1963–1966 were omitted as a gap in the measurements at Mongalla coincided with an abrupt change of the rating curve. Monthly outflows were compared with monthly inflows with different time lags; it was found that the regression improved as the assumed lag increased to three months, but improved little for longer lags. The shape of the relation suggested that it was appropriate to use a logarithmic form with a three-month lag. The regression was improved by averaging inflows and outflows over calendar quarters to give a relation $\ln q_t = 3.928 + 0.411 \ln Q_{t-3}$ where outflow q and inflow Q are in $\text{m}^3 \times 10^6 \text{ month}^{-1}$. This implies that outflows exceed inflows for values of inflow below $800 \text{ m}^3 \times 10^6 \text{ month}^{-1}$. This is based on extrapolation below the range of measured flows, and is not appropriate to predict the effect of reducing the inflows to the Sudd by diversion through the canal. In order to represent the relation between inflow and outflow over a period of steady flows, it is logical to assume that losses from the river would occur at all flows above zero. The relation should meet the conditions $q = Q$ when $Q = 0$ and $dq/dQ = 1$ when $Q = 0$. This is met by a quadratic $q = Q - aQ^2$ and the equation which joins the regression equation above without discontinuity of gradient is $q = Q - 0.0002144 Q^2$ when $Q < 1730$. The details of this analysis have been reproduced in Howell *et al.* (1988, Appendix 9). The relation derived is compared with annual inflows and outflows for 1905–1983, excluding 1963–1966, in Fig. 5.16 and this suggests that a reasonable relation has been deduced.

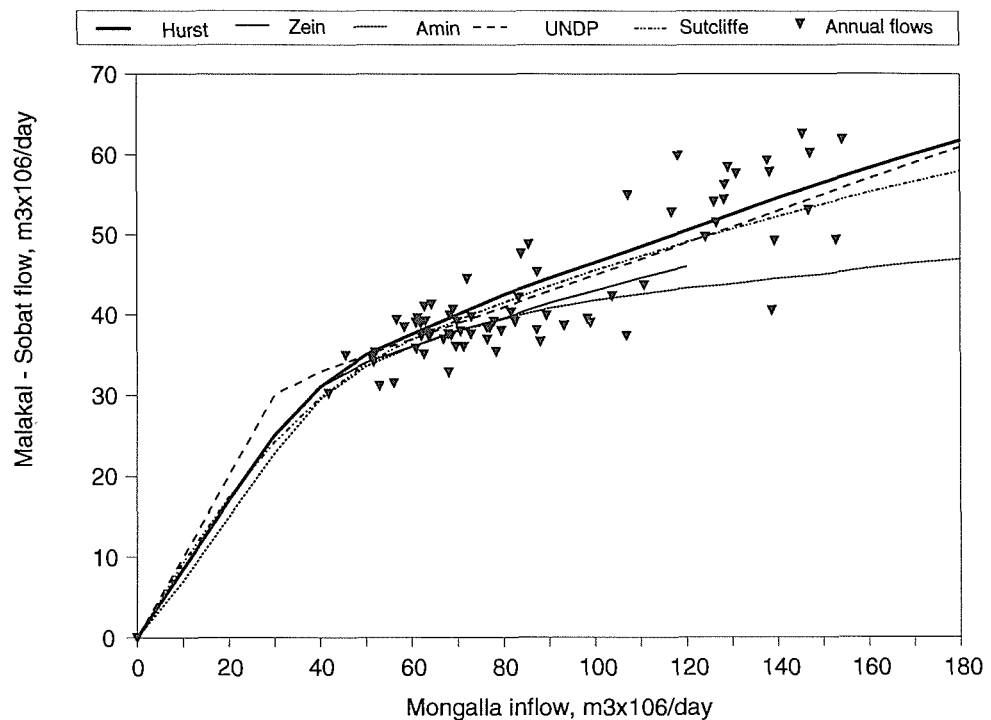

Fig. 5.16 Sudd inflows and outflows: relations estimated in various studies and annual flows, 1905–1983, excluding 1963–1966.

The form of the relation, particularly at low flows, is important in estimating the effect of the canal; it is useful to compare this relation with those used by others. Figure 5.16 includes that derived by Hurst *et al.* (1946) from 1912–1945 flows, with those of Soghayroon el Zein (El Zein, 1974) from 1905–1965 flows, and those of El Amin & Nasser Ezzat (1978) based on 1905–1962 flows. These have similar losses at low flows to those of Sutcliffe & Parks (1982). On the other hand, UNDP, IBRD & Ministry of Irrigation (1981) compared inflows and losses for the period 1912–1975, without lag, and deduced that outflows equalled inflows until Mongalla inflows exceeded $30 \text{ m}^3 \times 10^6 \text{ day}^{-1}$, and then equalled $25 \text{ m}^3 \times 10^6 \text{ day}^{-1} + 20\%$ of the inflow. Georgakakos & Klohn (1997) similarly assumed that losses were negligible until Mongalla flows reached $35 \text{ m}^3 \times 10^6 \text{ day}^{-1}$. It is true that the losses, expressed as the difference between inflows and outflows, are well related to inflows, with an intercept at about $30\text{--}35 \text{ m}^3 \times 10^6 \text{ day}^{-1}$. However, the assumption that losses do not start until this inflow differs from the other relations and seems to be at variance with the physical evidence. In February–March 1951, when the Mongalla flow averaged $39 \text{ m}^3 \times 10^6 \text{ day}^{-1}$ after moderate torrent flows, cross-section P (see Fig. 5.7) of the Aliab valley above Bor (Jonglei Investigation Team, 1954, Fig. A 9), contained over 4 km of open water and papyrus (see Plates 4 and 5) out of 8 km of flood plain. This cross-section is at the upper limit of the Sudd proper. The extrapolation of an inflow–outflow relation below the range of observations is somewhat subjective, but it does not seem likely that losses are negligible in these conditions; it seems probable that these outflows which equal low inflows include some return of stored water.

Because the offtake of the canal is sited at Bor rather than Mongalla, the relations had to be adjusted. The inflows measured at Mongalla were converted to flows at Bor latitude, together with the relation between inflows and outflows. The assumption must be made that the relation between inflow and outflow is valid after part of the natural inflow has been diverted into the canal. It is then possible to estimate the effect on areas of flooding of different regimes of the Jonglei Canal over the period of historic flows. Initial trials were based on constant flows down the canal of $20 \text{ m}^3 \times 10^6 \text{ day}^{-1}$, modified by implementing the PJTC (Permanent Joint Technical Committee) rules, with canal flows reduced during periods of low flow to allow navigation in the river. The effect of this combination on areas of flooding during the period 1905–1980 is included in Fig. 5.10.

The results of this modelling, based on historical flows and simple water balance considerations, are summarized in Table 5.5. Two main canal flows were tested, 20 and $25 \text{ m}^3 \times 10^6 \text{ day}^{-1}$, modified by the PJTC rules. The effect of the canal operation would have been very different in the period of relatively low Lake Victoria outflows before 1961 and the period of high flows after 1961. The important figure, the reduction in seasonally flooded land, would have been 26% for a diversion of $20 \text{ m}^3 \times 10^6 \text{ day}^{-1}$ during the early years and

Table 5.5 Estimated effect of canal on areas of flooding (km^2 and % reduction).

Canal flow ($\text{m}^3 \times 10^6 \text{ day}^{-1}$)	1905–1961			1961–1980			1905–1980		
	Perm. swamp	Seasonal swamp	Total	Perm. swamp	Seasonal swamp	Total	Perm. swamp	Seasonal swamp	Total
0	6700	6200	12 900	17 900	11 000	28 900	9500	7400	16 900
20	3600	4600	8200	14 000	9100	23 100	6200	5700	11 900
	46	26	37	21	17	20	35	23	29
25	3000	4200	7200	13 100	8700	21 800	5500	5300	10 800
	56	32	44	27	21	24	42	28	36
25 Nov.–April	3300	5400	8700	13 700	9900	23 600	5900	6600	12 500
15 May–Oct.	51	12	32	23	10	18	38	11	26
15 Nov.–April	3800	3900	7700	14 400	8400	22 800	6500	5000	11 500
25 May–Oct.	43	38	41	19	24	21	32	32	32

17% in the later years; the equivalent figures for a diversion of $25 \text{ m}^3 \times 10^6 \text{ day}^{-1}$ would have been 32 and 21%. However, at the request of the Jonglei Executive Organ, the effect of varying the flows down the canal and river according to season was examined. The model suggested that the loss of seasonally flooded land could be reduced to 12 and 10% by varying the canal flow between 25 and $15 \text{ m}^3 \times 10^6 \text{ day}^{-1}$ according to season, with little effect on the predicted benefit downstream. Thus control rules for the flows down the canal could be developed to maximize the seasonal swamp at the expense of the permanent swamp.

Such an operating policy would have other benefits. It has been shown that the level range of flooding decreased after 1961, mainly because the seasonal runoff did not increase when the Lake Victoria outflow increased. Meanwhile the area over which this seasonal component was spread doubled after 1961. The range was estimated to decrease over the whole swamp from 0.66 m before 1961 to 0.48 m after the rise in lake level; this estimate is broadly in line with measured river levels. The decreased range is likely to have been at least partly responsible for the increase of papyrus. If the flows down the canal were adjusted seasonally to favour the seasonally flooded area (Sutcliffe & Parks, 1993), this would not only reduce the loss of the valuable seasonally flooded area but would also increase the range and encourage useful deep-flooded grasses like *Echinochloa stagnina* at the expense of papyrus.

This analysis has not taken any account of the inflow regime to the Sudd which could result from the control by storage in Lake Albert or in Lake Victoria. In fact the proposals for Jonglei Stage II imply that the outflows from the lake would be equalized seasonally, and possibly that the torrent flows would be stored virtually in Lake Albert. The effect of such plans would be far-reaching but are difficult to predict without more detailed accounts of the proposed mode of operation. However, the interests of the inhabitants of the Sudd would be affected by any sudden increases or decreases in the outflow from the East African lakes which might result from upstream control, while any attempt to reduce the seasonal regime of the torrents above Mongalla would directly destroy the grazing potential of the Sudd.

CONCLUSION

The Bahr el Jebel receives the outflow from the East African lakes, which has varied dramatically over the historic period, and also the highly seasonal flows of torrents above Mongalla. As a result of spill from channels into wide flood plains, about half the inflow is lost by evaporation and the outflow is fairly constant. A water balance study shows that the total area of flooding doubled after 1961, but that the seasonal flooding which provides dry season grazing increased less than the permanent swamp. The effect of the Jonglei Canal, proposed to increase the flow downstream, has been estimated by an extension of the water balance study. The effect on flooding and thus on grazing potential would be affected by operating policy.

CHAPTER 6

THE BAHR EL GHAZAL BASIN

INTRODUCTION

The Bahr el Ghazal is unique among the Nile tributaries in that its outflow to the White Nile is almost negligible. The rainfall of 1200–1400 mm in the upper basin is the highest in the Sudan and gives rise to a number of seasonal tributaries, which converge towards the confluence of the Bahr el Ghazal with the White Nile (Fig. 5.1). These contribute about 12 km³ of water from their upper catchments to areas of swamp in the lower basin, where the inflows are almost entirely lost to evaporation. The most recent study of the Bahr el Ghazal swamps was that of Sutcliffe & Parks (1994b), which made use of recent flow records and a water balance model developed for the Sudd (Sutcliffe & Parks, 1987). This model was applied to the Bahr el Ghazal swamps in order to compare their regime with that of the Bahr el Jebel swamps.

Previous hydrological studies of the Bahr el Ghazal basin have been published in *The Nile Basin*, vols I and V (Hurst & Phillips, 1931, 1938), in the reports of the Jonglei Investigation Team (1954), Southern Development Investigation Team (1955), and Chan & Eagleson (1980).

In this chapter the findings of these earlier studies are followed by discussion of the available flow records and the main topics whose solution is essential to a realistic water balance of the basin. These are an assessment of the total inflow of the various tributaries, whether there is significant spill from the Bahr el Jebel towards the Bahr el Ghazal, and the estimated area of the Bahr el Ghazal swamps. Recent records show that the inflows of the Bahr el Ghazal tributaries have decreased in recent years, in contrast to the increase in the Bahr el Jebel. A hydrological model, supported by satellite imagery, shows that the area of the Bahr el Ghazal swamps has become small compared with the Bahr el Jebel swamps.

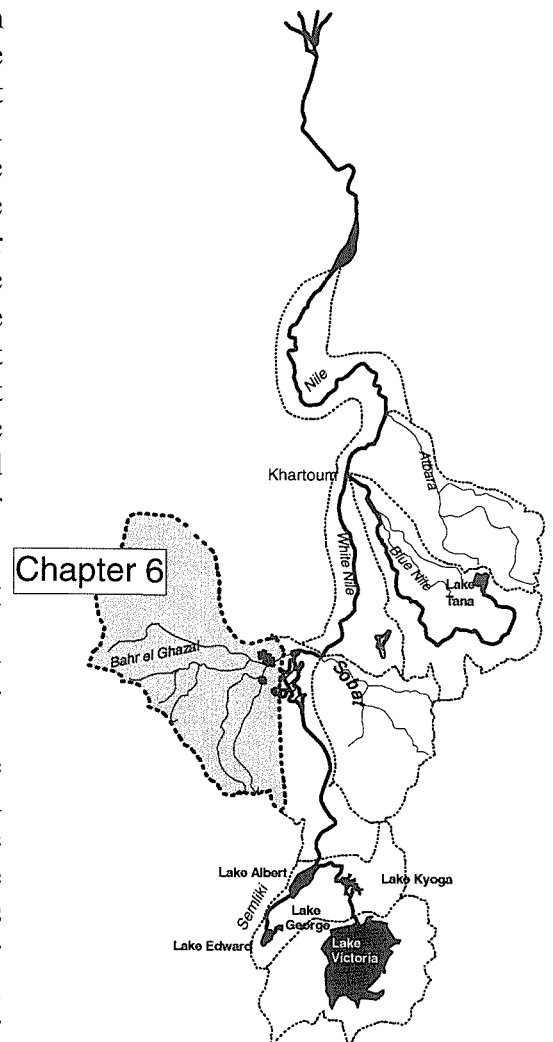

EARLY STUDIES

Physical background

The Nile Basin, vol. I (Hurst & Phillips, 1931), contains first-hand descriptions of the topography of the basin as a whole and of individual rivers; it is particularly useful as it is

illustrated by a number of photographs. These show the rivers at the sites of key road crossings during both the wet and dry seasons, and together with the text give a clear picture of the country. Of particular interest are photographs of the River Tonj at Tonj, where a level gauge was established in 1932. One oblique photograph taken from the air (their Plate 81) shows the river full and beginning to overflow into the “toich”, or seasonally inundated grassland, on the flood plain. The toich is relatively limited in width at this point, being contained between slightly higher ground with woodland. A pair of photographs (Plates 86c and d) show the Lol at Nyamlel as a narrow channel through higher ground, though the river is said to flood upstream of this site. Another photograph (Plate 89a) shows the Jur at Wau in September 1930, when the river flow was above the average peak flow. These three sites have been used to measure the three largest tributaries, which as shown later together contribute 80% of the inflow of the 10 Bahr el Ghazal tributaries.

There are also three rivers to the southeast of the Bahr el Ghazal tributaries which flow towards the Bahr el Jebel, but their contribution to the Bahr el Jebel swamps is likely to be relatively small.

River profile

The Bahr el Ghazal tributaries follow a common pattern, first described by the Southern Development Investigation Team (1955). They develop from an area of rapid runoff along the Nile–Congo divide, where rainfall is relatively high at 1200–1400 mm and the relief up to 1000 m provides good drainage. The rivers drain across an ironstone peneplain, covered by woodland; this is overlain in its lower reaches by clay grassland plains northeast of a line Aweil–Wau–Tonj–Rumbek–Yirol–Juba. Some 5–10% of the rainfall drains in numerous small streams, which unite to form rivers which are at this stage erratic in flow. As the rivers leave the upper zone the extreme flows are damped to some extent, but still carry sediment during the rainy season. The rivers leave the upper catchment in defined valleys where the slopes decrease and sediment is deposited. They traverse a zone where they meander between alluvial banks in a widening flood plain defined by the slightly higher land of the valley sides. Much of the low dry season flow takes place through the sandy bed. Eventually the rivers emerge into a zone of unrestricted flooding over clay plains, where the vegetation provides the main resistance to the spread of water. In this sense the Bahr el Ghazal tributaries are similar to the main channel of the Bahr el Jebel. However, the inflows are divided between a number of channels rather than a single river, and the volumes are relatively small compared with the areas over which flooding can spread. Also the sediment load of these rivers is higher than the lake-fed Bahr el Jebel, and there is a greater potential for the formation of alluvial channels. The lower course of the Bahr el Ghazal consists of a series of channels and lakes, with somewhat stunted papyrus swamp on either side of the channels. A much smaller fraction of the inflow, less than 3%, emerges from the Bahr el Ghazal swamps compared with about 50% on the Bahr el Jebel, but the processes of spilling and drainage are similar.

Early water balance

A preliminary water balance of the Bahr el Ghazal swamps was outlined in *The Nile Basin*, vol. V (Hurst & Phillips, 1938), with measured flows of the Jur at Wau supplemented by estimates for the other tributaries. The average flow of the Jur at Wau was assessed as 5.0 km³, based on levels from 1912 to 1932 and discharge measurements in 1930–1932. From rainfall estimates of 1140–1450 mm over the useful catchments, the total average runoff from the Bahr el Ghazal tributaries was estimated as 15.7 km³, with an additional 2.7 km³ from the

Bahr el Jebel tributaries. These total flows were compared with estimated evaporation from the areas of swamps in the lower Bahr el Ghazal basin, estimated from survey maps. The total area of the Bahr el Ghazal swamps, including those fed by the Bahr el Jebel tributaries, was tentatively assessed as 16 700 km², from which the net evaporation loss was deduced as slightly over 1 m, plus 0.8–0.9 m average rainfall.

At the same time, Butcher (1938) had been studying the water balance of the Bahr el Jebel swamps (Chapter 5) and had deduced from comparative balances, at different latitudes down the length of the river, that there was a possible spill of about 6 km³ year⁻¹ from the lower Bahr el Jebel towards the Bahr el Ghazal swamps to the west.

Estimates of tributary inflow

After reconnaissance in 1930–1931, when Hurst noted the areas of runoff accumulation and of spill, the tributary inflows were measured at a series of sites established along the main road from Juba to Wau and Nyamlel. These sites roughly follow the boundary of the ironstone plateau, and thus lie at the limit of the zone of runoff generation. Level gauges were erected from 1932, though one had been read at Wau from 1904. Regular gaugings began about 1941–1942 at these sites, and flow records were published in *The Nile Basin*, vol. IV and supplements. Flow measurements were interrupted about 1961, but were resumed by the Sudan authorities at several major sites about 1970 and records have been printed in Sudan yearbooks.

Summaries of measured and estimated flows along this line of gauges were given in Jonglei Investigation Team (1954), and flows were estimated for all the main rivers by the Southern Development Investigation Team (1955). These estimates have been revised in subsequent studies. Hurst *et al.* (1978) used records up to 1962 to estimate average flows. Chan & Eagleson of MIT (1980) used flow records up to 1961 (*The Nile Basin*, vol. IV, supplement 8) as a preliminary input to a water balance study of the Bahr el Ghazal basin. These estimates are compared in Table 6.1.

Following agreement to divide responsibility for river flow measurement between Egypt and Sudan, river flows were measured by the Sudan authorities in a revived programme from 1970, and recent statistics differ somewhat from earlier estimates. At those sites where recent records are available, the revised estimates of mean flow have decreased. It appears

Table 6.1 Estimated flows of Bahr el Ghazal tributaries (km³) (after Sutcliffe & Parks, 1994b).

River	Southern Development Investigation Team (1955)	Hurst (1978)	MIT (Chan & Eagleson, 1980)	Sutcliffe & Parks (1994b)
Raqaba el Zarqa	0.10		0.100	0.100
Bahr el Arab	0.32		0.300	0.300
Lol at Nyamlel	4.23	4.2	3.900	3.243
Pongo		0.6	0.575	0.597
Geti				0.095
Jur at Wau	4.52	5.0	5.220	4.496
Tonj at Tonj	1.11	1.5	1.600	1.363
Gel	0.55	0.5	0.520	0.523
Wokko				0.130
Naam at Mvolo	0.64	0.5	0.476	0.476
Total	11.47	12.3	12.69	11.323
Bahr el Jebel tributaries				
Lau/Yei at Yirol	1.02		2.060	
Tapari	0.44			
Gwir	0.12			

(Chapter 12) that the flows of the Bahr el Ghazal tributaries are correlated with the Ethiopian tributaries like the Blue Nile, Dinder and Rahad. These have tended to decrease in recent years, in contrast to the outflows from the East African lakes which provide the main contribution to the Bahr el Jebel and which increased dramatically after 1961.

TOPICS FOR INVESTIGATION

Thus the pattern is of a complex system converging on Lake No, draining a impermeable plateau with rainfall of about 1200–1400 mm between March and October. After soil moisture recharge, runoff occurs between June and November and averages about 60–100 mm over the gauged basins. The rivers leave the plateau in defined channels and then meander in alluvial channels through flood plains, with spill over limited areas. They converge downstream in complex swamps from which little flow reaches the White Nile. The rivers spill first into local and then wider flood plains in a pattern which gives rise to seasonally flooded grasslands and permanent papyrus swamp. The analysis (Sutcliffe & Parks, 1994b) drawn on in this chapter used up-to-date hydrological records to revise the estimated inflow and to study the extent of this seasonal and permanent flooding. The items needed to provide a realistic balance are a historical sequence of river inflows, an assessment of spill from the Bahr el Jebel to the Bahr el Ghazal swamps, and the area of the permanent and seasonal swamps.

AVAILABLE FLOW RECORDS

River flow records for eight tributaries were published in *The Nile Basin* up to 1962, though records became intermittent towards the end of this period. Estimates have been made for the Bahr el Arab and Raqaba el Zarqa, whose flows are small. Since 1970 flows for the Lol at Nyamlel, the Jur at Wau and the Tonj at Tonj were measured by the Sudan authorities (Gibb, 1989). Although a reasonable number of gaugings were carried out yearly at Nyamlel since 1944, the number of high flow measurements has been limited; the ratings have broadly been stable but there have been some shifts and the flows are not precise. At Tonj, where gaugings began in 1942, the ratings have been reasonably stable and well defined, but in some years there were few high flow gaugings and flows may have been underestimated. At Wau, on the other hand, where gaugings have been regular from 1942, the high flow ratings have been well defined and stable, but the low flow ratings are less well defined.

The longest potential flow record in the upper Bahr el Ghazal basin is on the Jur at Wau, where a level gauge was established in 1904. Regular flow gaugings were not begun until 1942, but a total of 21 gaugings were carried out in 1930–1932. These were used by Hurst & Phillips (1938, p. 171) to construct a rating curve, which they believed could be fairly permanent; there is in fact a protruding rock bar at the site. These gaugings provide a rating derived by HYDATA of $Q = 49.14 (h - 9.64)^{1.646}$, with Q in $\text{m}^3 \text{s}^{-1}$, which is similar to more recent ratings. An appraisal of the site (Gibb, 1989) suggested that the higher flows would be reasonably estimated from the rating curves, though low flow ratings would be less stable. This equation has been applied to 10-day gauge levels for the period 1904–1941 to indicate long-term flows for comparison with the more recent record. Monthly flows for the whole period, with some gaps filled by averages, are illustrated in Fig. 6.1(a) while annual totals are shown in Fig. 6.1(b). These records illustrate the seasonal nature of the runoff, its annual variability and its decline in recent years. Flows for various periods are summarized in Table 6.2. There is little difference between the estimated flows for 1904–1941 and those for 1942–1961; the difference in low flows is likely to be due to uncertainties in the early rating. The decline of total flows in recent years is clear.

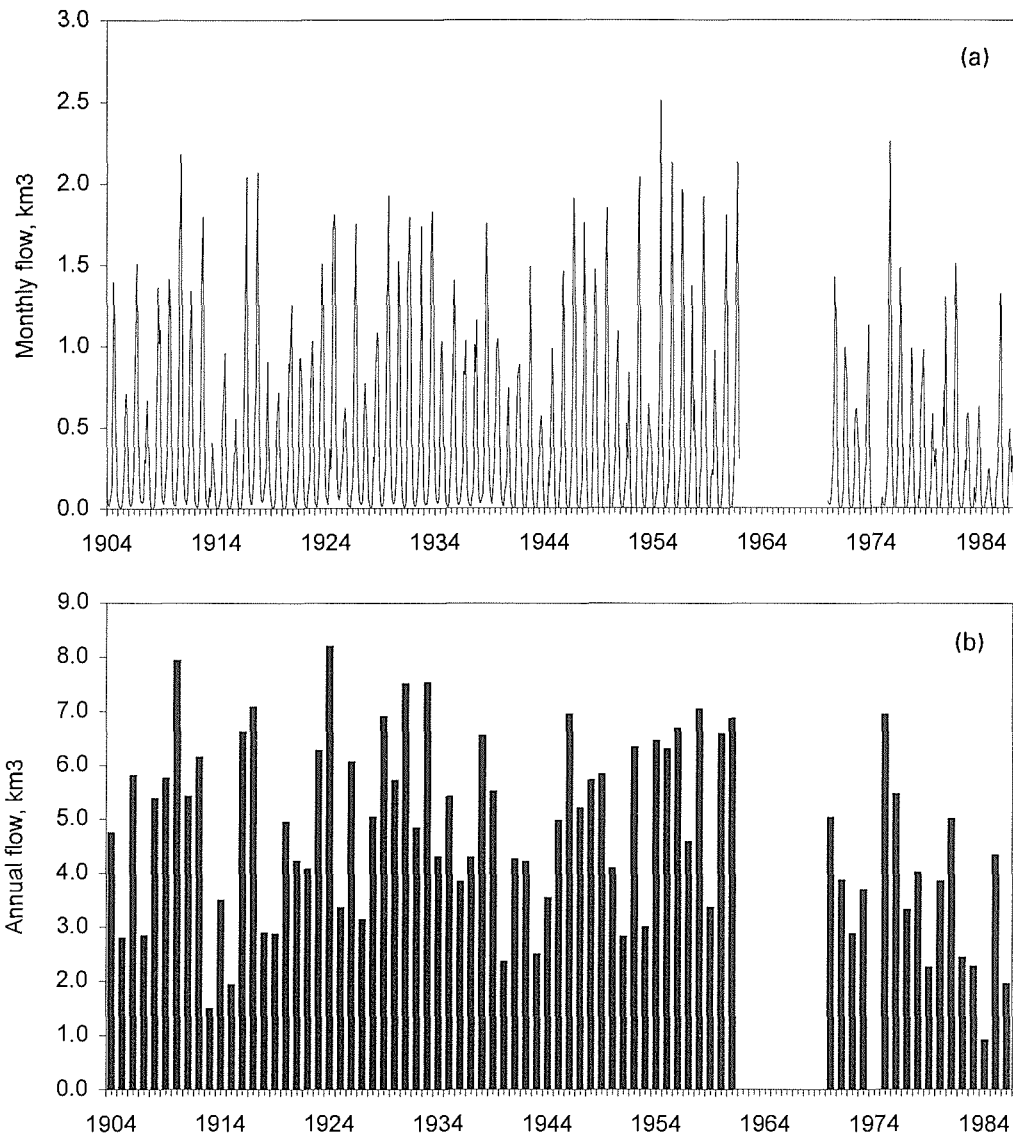

Fig. 6.1 River Jur at Wau: (a) monthly flows, 1904–1986; (b) annual flows, 1904–1986.

The seasonal distributions of the Bahr el Ghazal tributaries were compared in Sutcliffe & Parks (1994b, Table 2) from the monthly normals up to 1962 published in *The Nile Basin*. This comparison showed that the seasonal distribution of runoff is similar at the different sites.

Flows estimated for the MIT study

In their water balance study, Chan & Eagleson (1980) initially used the river flows published in *The Nile Basin* up to 1962, with a total average annual flow of 12.7 km^3 . They also added

Table 6.2 Average flows of Jur at Wau for various periods ($\text{m}^3 \times 10^6$).

Jan.	Feb.	March	April	May	June	July	Aug.	Sept.	Oct.	Nov.	Dec.	Year
1904–1941												
65	28	17	31	110	227	498	911	1116	1118	636	193	4951
1942–1961												
19	4	1	7	95	227	427	803	1308	1383	700	196	5171
1970–1986												
29	5	3	4	74	155	366	615	871	927	494	111	3653

spilling of 6 km^3 from the Bahr el Jebel to the Bahr el Ghazal, citing Jonglei Investigation Team (1954). However, they then doubled these total flows following a preliminary water balance. They first compared the measured river inflows with the estimated evaporation (2200 mm) from the areas of swamp ($16\,600 \text{ km}^2$) given by *The Nile Basin*, vol. V, taking the whole area to be permanent papyrus swamp. They then added evaporation from the area below the road linking the gauging stations, which they termed the Central Swampland ($84\,950 \text{ km}^2$). They assumed this to include both the papyrus swamp ($16\,600 \text{ km}^2$) and grassland ($68\,400 \text{ km}^2$), part of which was seasonally inundated.

In the absence of direct evidence, they assumed that in addition to the papyrus swamp there was $28\,500 \text{ km}^2$ of seasonally flooded grassland, which would transpire at the potential rate (1440 mm) throughout the year; and $39\,900 \text{ km}^2$ of unflooded grassland, transpiring only during the rainy season (840 mm). The total evaporation loss was compared with direct rainfall and river inflows, but a preliminary water balance left a shortfall of some 15 km^3 , even after including Bahr el Jebel spill of 6 km^3 . This apparent shortfall was assumed to be due to ungauged runoff or groundwater flow down the various tributary valleys.

A further water balance was then carried out, using the catchment water balance model developed by Eagleson (1978). Each component was formulated as a function of the climate, soil and vegetation of the basin. Deep underground and lateral seepage are neglected but it is argued (Chan & Eagleson, 1980) that "wherever there is a large discrepancy between the computed mean annual basin yield and that obtained from a long series of historical records of discharge, the groundwater seepage term or the ungauged discharge has to be included". On this basis, unmeasured flows were estimated at 19.8 km^3 by comparing the total measured inflow from each basin with the catchment yield simulated by the conceptual model. With measured inflow of 12.7 km^3 and Bahr el Jebel spill of 6 km^3 this gave a total inflow of 38.5 km^3 . Thus the assumed inflow was three times the measured runoff.

Although the measured flows of the main Bahr el Ghazal tributaries are low (3–7%) when expressed as percentages of rainfall, this does not seem to justify trebling the published flows. Available knowledge of the area, supported by the photographs mentioned earlier, suggests that the gauging sites were well located in defined valleys with limited flood plains. Unmeasured flow through the sand bed or valley vegetation is likely to be small by comparison with channel flow; so is underground flow through these relatively hard rock basins. The rating curves at some sites may be imprecise at high flows, but such problems are not unusual. It seems preferable to use the measured flows and to take advantage of the fact that measurements have been continued on the main rivers to bring up to date the earlier estimates.

REVISED ANALYSIS OF AVAILABLE RIVER FLOW RECORDS

Recent records of discharge exist for the three major tributaries (Lol, Jur and Tonj) and account for over 80% of the total inflow. A reasonable extended time series and long-term average total inflow may be obtained from these three records and estimates of average flows from early records at other sites. The records of the minor tributaries are too intermittent to complete the time series. Early flows for the Jur have now been estimated for 1904–1941; however, these flows are not sufficiently precise for use in extension.

Flow measurements are available for the three sites for much of the period between 1942 and 1986, but each record is somewhat intermittent, with a gap at all sites between 1963 and 1969. There have been problems in gauging these rivers over the years; some spill occurs at high flows, the flow regimes are highly seasonal with negligible or zero flows during the dry season, and access to the sites has not been easy in recent years. For example, the records of

the Jur at Wau show zero flow for several months of the dry season in some years, and have gaps in the record in other dry seasons. Field inspection of the site and records suggested that gauge levels and flows were often left unrecorded when river flows were low. However, the bulk of the flows occurs during the wet season and recession months of June to November inclusive, and therefore total flows are acceptable. Other problems are found with the Tonj at Tonj, where two gauges were maintained and recorded separately as “through road bridge” and “downstream road bridge”. These two flow records differ significantly but the former, larger, flows have been accepted for the overall water balance.

Before deriving the total inflow series from the three major records, these were first completed to give full years of record. During the recession period short gaps were estimated by comparison of adjacent records. In other months, which were usually during the dry season, long-term monthly average flows were inserted provided that measured flows gave a high percentage of the year’s total; where this was not the case the year was treated as missing. After this process a total 36 years of flow record were available for the Jur, 26 years for the Tonj and 34 years for the Lol. Monthly and annual average flows calculated from these complete years are included in Table 6.3 for the three sites. This illustrates the similarity of the seasonal flow distributions, with minor differences reflecting the larger catchment area above Wau. The three annual flow series reveal similar patterns of runoff (Sutcliffe & Parks, 1994b, Fig. 2a–c) with high and low years coinciding in general and a decline in recent years evident.

Table 6.3 Average river flows ($\text{m}^3 \times 10^6$), rainfall and evaporation (after Sutcliffe & Parks, 1994b).

Jan.	Feb.	March	April	May	June	July	Aug.	Sept.	Oct.	Nov.	Dec.	Year
Lol at Nyamlal (1944–1985)												
10.2	2.0	0.6	1.6	14.6	106	293	652	995	851	268	49.1	3 243
Jur at Wau (1942–1986)												
23.6	4.4	2.0	5.6	85.8	195	400	719	1114	1181	608	158	4 496
Tonj at Tonj (1944–1985)												
4.8	1.3	1.4	1.1	30.9	74.6	158	250	342	304	161	33.6	1 363
Total inflow (1942–1986)												
52.0	9.8	4.9	10.4	157	465	1061	2012	3048	2919	1290	305	11 333
Outflow at Khor Doleib (1937–1964)												
22.6	31.5	41.9	41.7	29.4	22.6	24.6	28.5	17.9	18.2	13.7	12.5	305
Rainfall (mm)												
0	4	14	49	110	143	175	184	141	69	10	1	900
Evaporation (mm)												
217	190	202	186	183	159	140	140	150	177	189	217	2 150

DERIVATION OF TOTAL INFLOW SERIES

For a water balance study of the Bahr el Ghazal basin, a time series of total inflow was required for as many years as possible. This was derived by comparing the measured flows at the three main sites with the estimated mean flows of other tributaries. Normal monthly and annual flows for these other tributaries were published in *The Nile Basin*, vol. IV, supplement 8, for the years up to 1962, and these flows have been used to estimate the total inflow. Although recent records on the three major rivers show that runoff has decreased in this area, there is no recent evidence for the smaller tributaries, and the early estimates have been used to complete the average total inflow. The estimated flows of the Bahr el Arab and Raqaba el Zarqa were derived from *The Nile Basin*, vol. V (1938). Two additional small

tributaries which appear to have been overlooked in earlier studies are the Geti and Wokko, whose normal flows are included in the total (Table 6.1).

Thus the total average inflow has been taken as the sum of the recent average flows at the three sites and the earlier normal flows at other sites. Comparison of the estimated total inflow with the total from the three measured sites gives a multiplier of 11.323/9.102 which has been applied to monthly flows when flows at all three sites are available. Other multipliers were derived in similar fashion for years when less than three measured flows were available. These multipliers were applied to as many years as possible to give the monthly total inflow series given in Fig. 6.2(a). The annual totals of this integrated series are shown in Fig. 6.2(b); this illustrates the considerable variation in total inflows from year to year, and also the decline in inflows after 1975. The discharges of the Lau or Yei (2.060 km³), Tapari (estimated 0.440 km³) and Gwir (estimated 0.120 km³) have not been included in the water balance of the Bahr el Ghazal swamps as they flow towards the Bahr el Jebel. It is unlikely that they contribute significantly to the flow of the main river, as they flow through flood plains before they reach the Bahr el Jebel valley. However, the flows of the Gwir and Tapari are significant in terms of the Aliab valley (Chapter 5).

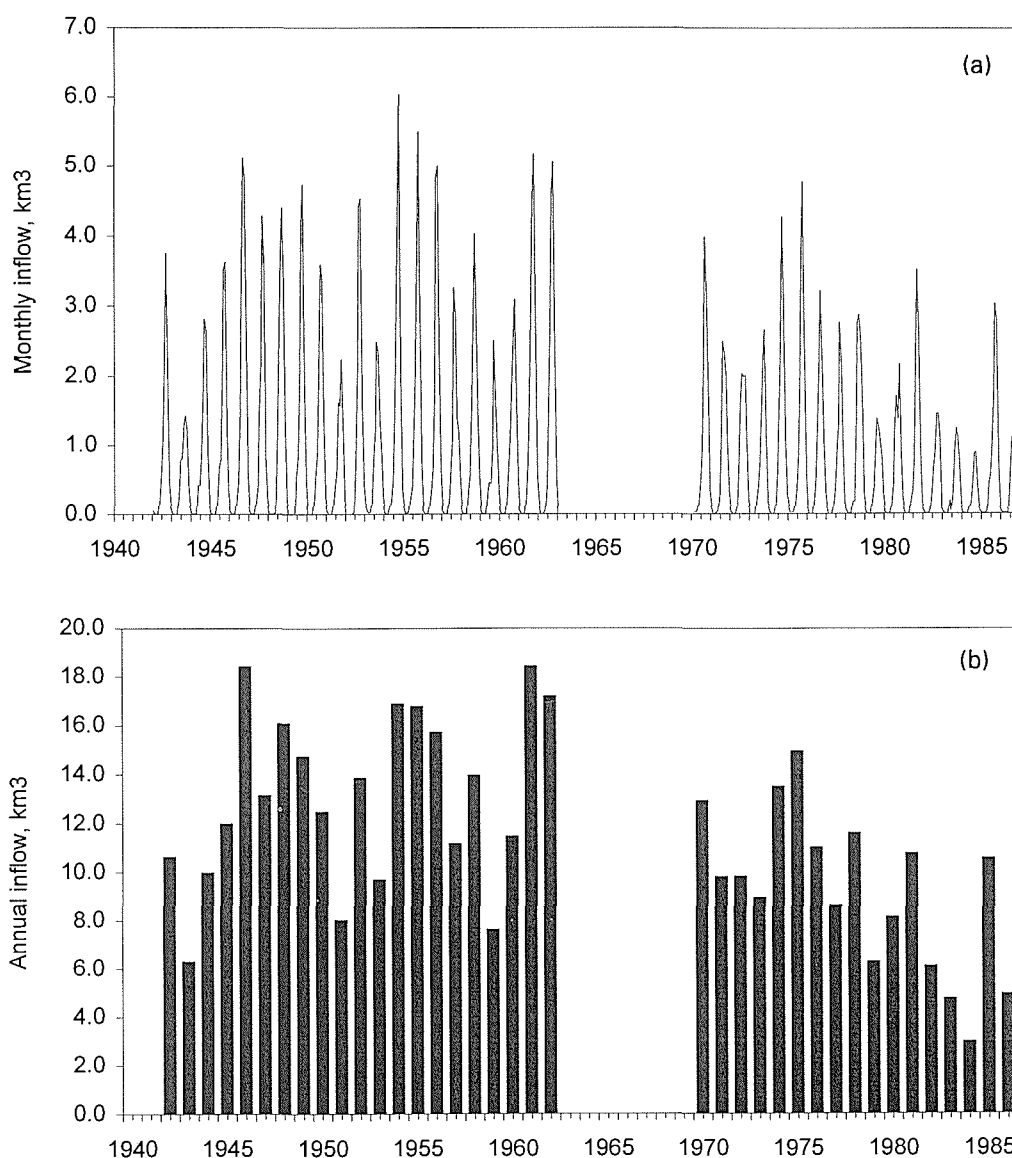

Fig. 6.2 Bahr el Ghazal tributary inflow: (a) monthly flows, 1942–1986; annual flows, 1942–1986 (after Sutcliffe & Parks, 1994b).

OTHER WATER BALANCE ELEMENTS

The outflow series has been deduced from the published flows of the Bahr el Ghazal below Khor Doleib, about 40 km above Lake No, where the average annual discharge is only 0.305 km³ compared with the average inflow of 11.323 km³. The flows of the Bahr el Ghazal at its confluence with the Bahr el Jebel at Lake No (0.634 km³) are somewhat higher but these appear to include some spill from the Bahr el Jebel just above the confluence.

Because the use of average rainfall had little effect on the predicted flooded areas in the Bahr el Jebel swamps (Sutcliffe & Parks, 1989), the combined average monthly rainfall totals at Aweil, Rumbek, Meshra el Req and Shambe (Shahin, 1985) and average open water evaporation for the Sudd (Table 6.3) have been used for the modelling of the Bahr el Ghazal swamps.

SPILL FROM BAHR EL JEBEL TO BAHR EL GHAZAL

As mentioned above, Chan & Eagleson (1980) took account of an annual spill of 6 km³ from the Bahr el Jebel north of Shambe westwards to the Bahr el Ghazal swamps. They cite the Jonglei Investigation Team (1954) but this estimate draws on the study of "latitude flows" by Butcher (1938). Such a flow, if it existed, would be a significant factor in the water balance of both swamps, and it is worth tracing this hypothesis to its source.

There is evidence of physical links between the two swamps. Hurst & Phillips (1931), after air reconnaissance, observed that "the swamps of the Bahr el Jebel and Bahr el Ghazal north of Hillet Nuer are connected by depressions which are for the most part full of papyrus". Newhouse (1929, p. 12) described channels which take off west of the Bahr el Jebel below Shambe and rejoin the main river downstream. He drew attention to Gage's Channel starting at Hillet Nuer (Adok) which, though completely overgrown by papyrus, had been traced to Khor Doleib joining the Bahr el Ghazal; however, he commented that the discharge was trifling.

Butcher (1938) attempted water balances (see Chapter 5) between latitude sites along the Bahr el Jebel and found that only some 40% of the losses could be attributed to evaporation; the most likely explanation of the shortfall was flow towards the Bahr el Ghazal, though no trace of a passage had been found. However, his estimate of swamp evaporation (1533 mm year⁻¹ less 912 mm rainfall) was based on tank measurements where evaporation was greatly underestimated because of stagnant conditions (Chapter 5). Hurst & Phillips (1938) concluded that swamp transpiration was about 30% higher than tank estimates, and that flows from the Bahr el Jebel to the Bahr el Ghazal swamps were an untenable explanation of the Bahr el Jebel losses.

Nevertheless, the Jonglei Investigation Team (1954) repeated that "6.0 milliards of Bahr el Jebel spill, it is estimated, flow westwards between Lake Nuong and Buffalo Cape". They examined physical links in some detail, but noted that channels were overgrown and quoted flows were small. However, when a more realistic estimate of evaporation rates is included in a water balance study of the Bahr el Jebel swamps, the necessity for this spill disappears (Chapter 5). Although the Bahr el Jebel swamps extend to the northwest near Adok (Fig. 6.4) and there is evidence of some local loss to the Bahr el Ghazal near Lake No, there is no evidence of spill of this magnitude from basin to basin.

AREA OF BAHR EL GHAZAL SWAMPS

An early estimate of areas flooded in the Bahr el Ghazal swamps was published in *The Nile Basin*, vol. V (Hurst & Phillips, 1938, p. 185). Areas marked as swamp or reported

swamp were estimated from recent 1:250 000 mapping. It was noted that detailed survey had in the past reduced the areas classified as swamp, though large areas were swampy during the rainfall season. The areas of swamp fed from the Lol, Jur, Tonj, Meridi and Bahr el Arab were given as 7700 km² of definite swamp and 6800 km² of reported swamp, with an additional 2100 km² fed from the Naam and the Lau, which flows towards the Bahr el Jebel.

Chan & Eagleson (1980) took this total of 16 600 km² as papyrus swamp and assumed that over half the area below the gauging stations was inundated permanently or seasonally. They assumed additional seasonally flooded areas of 28 500 km², but the evidence for this assumption is unclear. This required a large increase in the measured inflows to approach a water balance.

The approach of Sutcliffe & Parks (1994b) was to derive a total inflow series from the whole flow record, to make the assumption that the evaporation and transpiration from inundated land were similar to open-water evaporation, as in the Bahr el Jebel swamps, and to deduce a historic series of flooded areas from a water balance model. This study gave estimates of flooded areas which varied between about 4000 and 17 000 km², before the reduced flooding during the low flow years of 1983–1984. It was possible to compare this result with the evidence of thermal infrared satellite imagery of 30 December 1986. This showed that the areas flooded by each tributary on that date were in fact quite separate, rather than a continuous swamp, and were relatively limited in extent at about 4600 km² in total. This evidence is preferred to previous estimates, though the variation of flooded areas over the years has been shown to be significant.

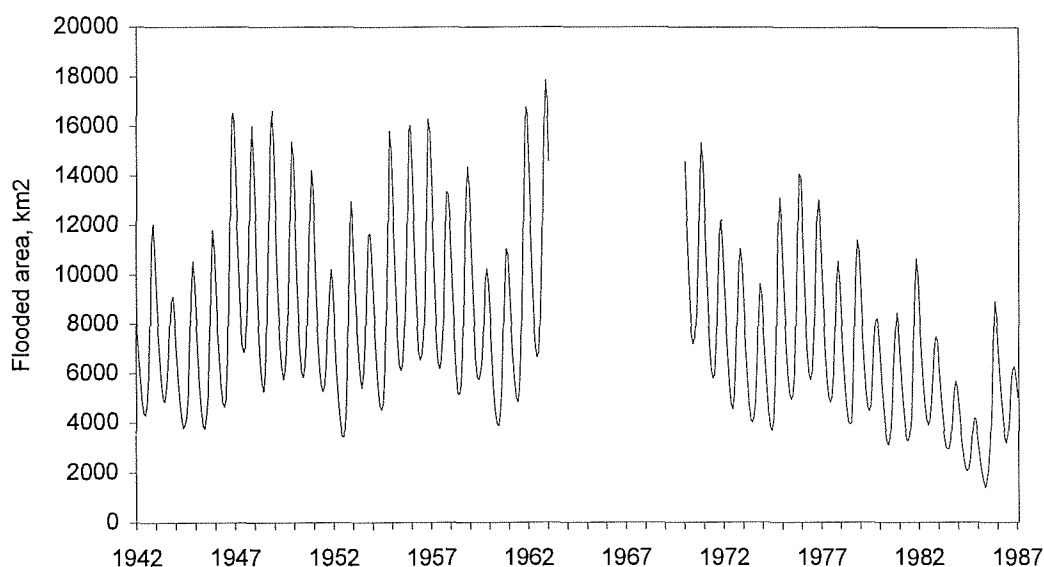

Fig. 6.3 Estimated flooded areas in Bahr el Ghazal swamps, 1942–1986 (after Sutcliffe & Parks, 1994b).

Table 6.4 Monthly average estimated areas of Bahr el Ghazal flooding (km²).

Jan.	Feb.	March	April	May	June	July	Aug.	Sept.	Oct.	Nov.	Dec.	Year
(1942–1962)												
10 805	8904	7433	6156	5380	5176	5531	6661	8931	11 993	13 746	12 994	8643
(1970–1986)												
8 588	7158	5938	4885	4226	4064	4303	5267	7039	9 078	10 024	9 417	6665
(1942–1986)												
9 813	8123	6764	5587	4864	4679	4982	6037	8085	10 689	12 081	11 394	7758

THE WATER BALANCE MODEL

A simple water balance model (Sutcliffe & Parks, 1987, 1989) was developed to make use of the facts that inflow and rainfall equal evaporation, storage change and outflow for any wetland area. Evaporation from a flooded wetland can be estimated on the assumption that it approximates to open-water evaporation. The model also allows for infiltration into newly flooded ground, and uses an empirical observation, based on surveys around the Sudd, that flooded volume is linearly related to flooded area. In other words the average depth of flooding remains approximately constant as flooding spreads. It is assumed that deep percolation is negligible by comparison with evaporation. The model does not include areas where grassland is maintained by rainfall without river spillage. These areas do not contribute significantly to the water balance of the inundated areas.

This model was applied to the hydrological data to give a monthly series (Fig. 6.3) of estimated inundated areas for the periods 1942–1962 and 1970–1986. An initial area of 8000 km² and an average depth of 1.0 m were assumed in line with the Bahr el Jebel model. The modelling gives estimates of flooded areas for 1942–1962 varying between 9000 and 18 000 km² in November at the end of the wet season and about 3400–6800 km² in June at the end of the dry season. This is compatible with the estimate of 14 500 km² for the Bahr el Ghazal tributaries given in *The Nile Basin*, vol. V (1938), though it is not clear whether this

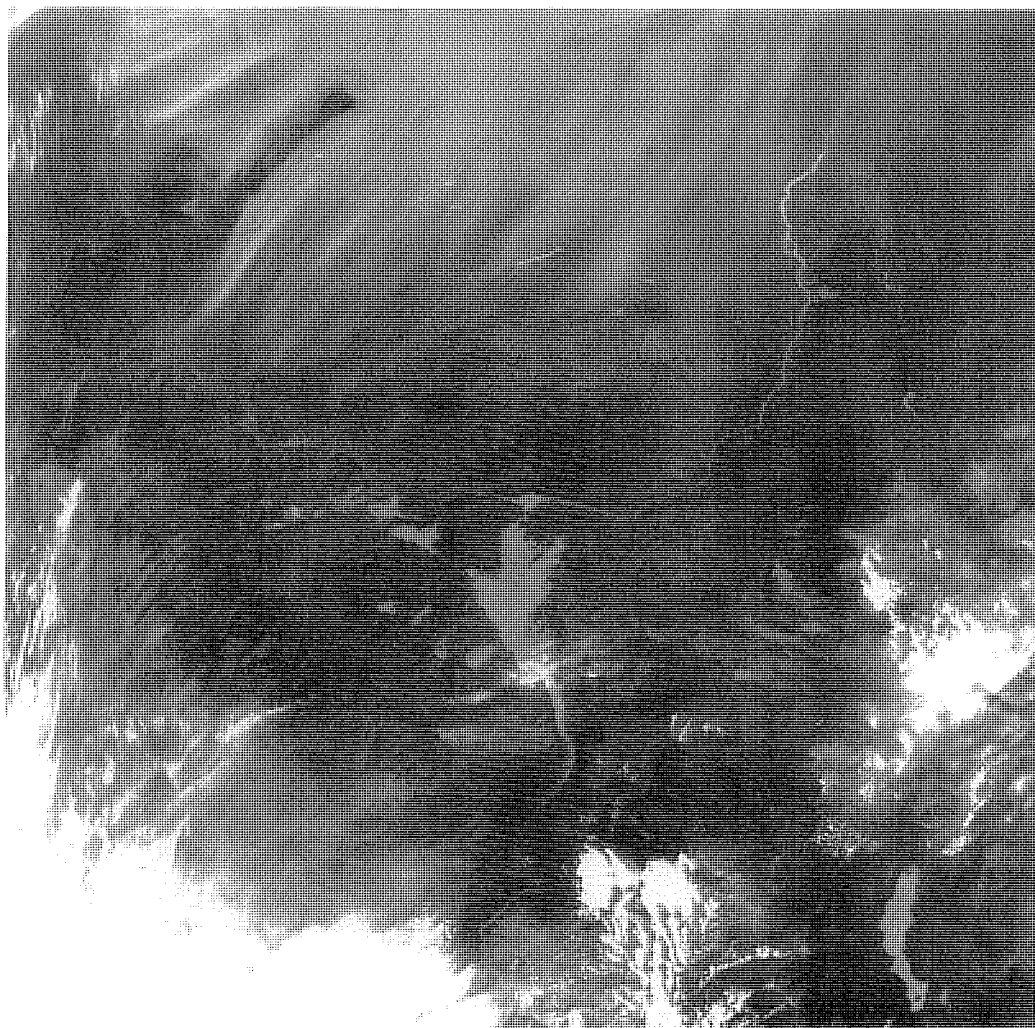

Fig. 6.4 Satellite image of 30 December 1986 [Reproduced by kind permission of the Mullard Space Science Laboratory, University College, London].

estimate referred to the average, minimum or maximum extent. After 1970, the estimated areas of flooding decreased fairly steadily in line with the reduced inflows of recent years. After 1976 the areas of flooding varied seasonally between about 4600–11 000 km² and 1400–4800 km². Table 6.4 summarizes average monthly areas in the different periods of record.

After this reappraisal of tributary flows and swamp modelling had been completed, evidence which provided a check on the analysis was found. The Mullard Space Science Laboratory (Harris, 1991) had developed a technique for remote sensing of wetland areas using thermal infrared satellite data based on the temperature contrast between dry and inundated ground; they provided a typical AVHRR band 4 image dated 30 December 1986 (Sutcliffe & Parks, 1994b, Fig. 5) showing the extent (Fig. 6.4) of the inundated flood plains of the Bahr el Ghazal tributaries, which could clearly be located from a map of the river system. It also showed the outline of the Sudd or Bahr el Jebel swamps.

The image corresponded with the end date of the hydrological modelling, and appeared to verify the modelling. The total flooded area of the Bahr el Ghazal swamps has a range of estimates of 4000–5000 km², because of some subjective interpretation of cloud cover and wetland outline. The model estimate of flooded area on 1 January 1987 was 5000 km². This comparison suggested that the estimated inflows on which the model was based, and the calibration of the model, were both realistic and provided reasonable estimates of the extent of flooding. The model could in future be refined by using further satellite imagery, given a resumption of flow measurements. The range of flooded areas could be changed by altering the model depth parameter, but this would have little effect on the average areas of flooding.

DISTRIBUTION OF WETLANDS

The satellite image showed that the areas flooded from each tributary were quite separate and relatively limited in extent by comparison with the Bahr el Jebel swamps, and they did not form extensive continuous swamps. The estimated areas flooded from each tributary on the date of the image were also proportional to the estimated long-term mean flow of the individual tributaries (Sutcliffe & Parks, 1994b, Fig. 6). It is interesting to note that the areas of inundation correspond quite clearly with the distribution of population (Fig. 6.5) recorded in 1955 (Southern Development Investigation Team, 1955, Map A).

The study quantifies the seasonal cycle of flooding and uncovering of the Bahr el Ghazal swamps which may be compared with the regime of the Bahr el Jebel swamps. It shows that the regime of the Bahr el Ghazal swamps is highly seasonal, and that the extent of flooding has in general decreased in recent years. This is in marked contrast with the behaviour of the Sudd or Bahr el Jebel swamps, which increased greatly, especially in terms of permanent swamp, after the rise in Lake Victoria. By contrast the inflows and flooding of the Bahr el Ghazal tributaries have decreased during the Sahel drought of recent years.

Thus the study has brought out important differences between the behaviour of the Bahr el Ghazal and Bahr el Jebel swamps. In particular it has put into perspective the difference of scale between these two wetlands. In 1986 the area flooded in the Bahr el Ghazal swamps was only about one third that of the Bahr el Jebel swamps. Figure 6.6 shows the mean annual areas of flooding of the two swamps over the period of record for the Bahr el Ghazal. This shows that the two areas were of similar size from 1942 to 1961, but that since then the area of the Bahr el Ghazal swamps has tended to decrease while the Bahr el Jebel swamps increased greatly. This comparison contradicts the suggestion that the losses from the Bahr el Ghazal swamps are twice those of the Bahr el Jebel (Chan & Eagleson, 1980, p. 36), and the statement that “clearly, the Ghazal area has the greatest development potential”.

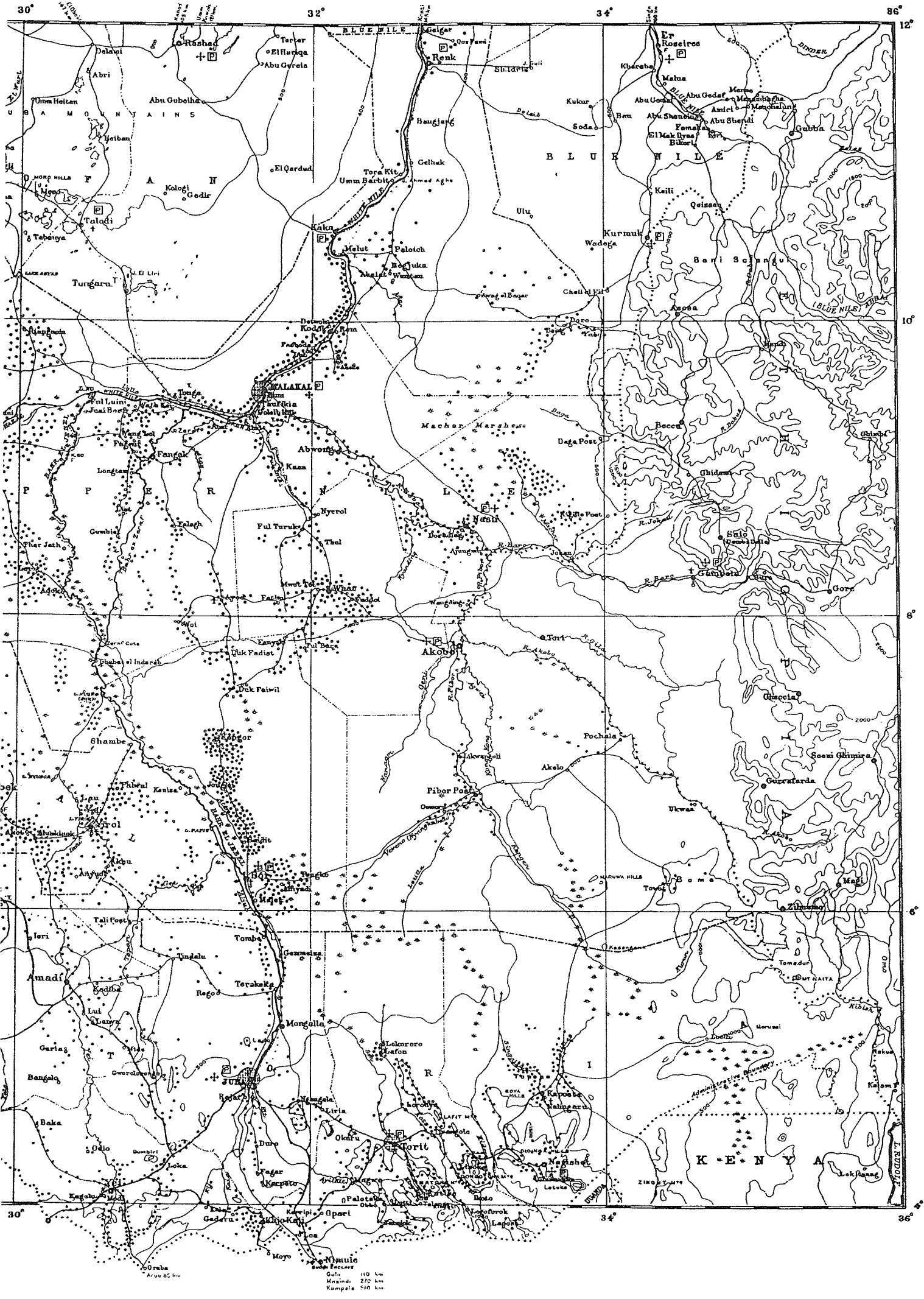

Scale:
Gulf: 110 km
Marsala: 270 km
Kampala: 310 km

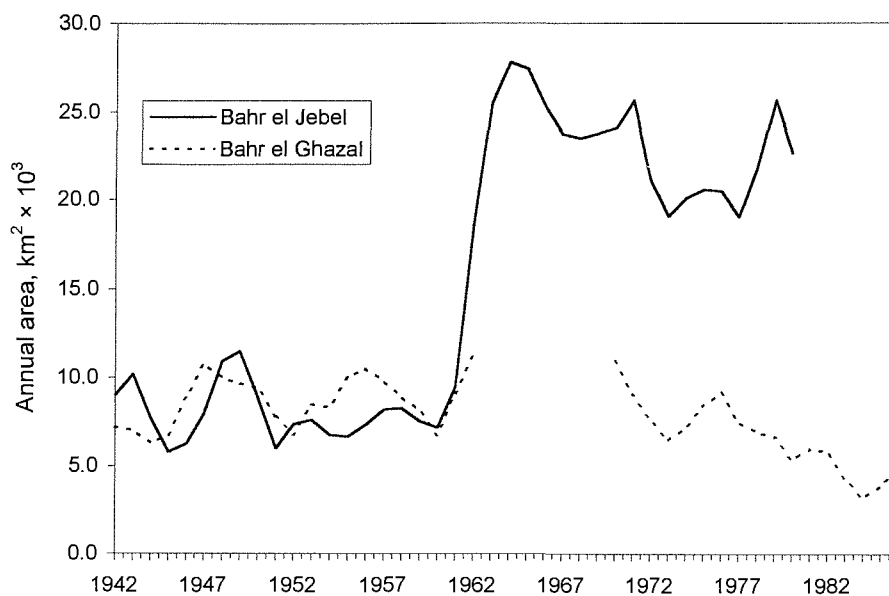

Fig. 6.6 Mean annual areas of swamps: Bahr el Jebel and Bahr el Ghazal, 1942–1986.

PLANS FOR REDUCING LOSSES IN THE BAHR EL GHAZAL BASIN

There have been plans for the conservation of losses in the Bahr el Ghazal basin over the years. After failure to reach agreement on the use of Lake Albert as a storage reservoir, these plans were given priority as “the Upper Nile project most likely to produce substantial additional supplies of water within a reasonable time, since agreement with only one other country, the Sudan, is involved” (Hurst *et al.*, *The Nile Basin*, vol. XI, 1978). These plans have not been published in any detail, although it appears that some storage sites with capacities of 0.5–2 km³ have been found near Wau. The main features of the project are collector canals to divert the flows of the tributaries to the White Nile and the Bahr el Jebel (Ezzat, 1993). It has been suggested (Hurst *et al.*, 1978) that the yield from the Lol and Jur alone could average 8.3 km³, but this implies that all the flows of the rivers are diverted.

A comparison of the areas of flooding revealed from the satellite image of 1986 with the population map compiled in 1954 (Fig. 6.5) shows that there is a close connection, which has persisted over many years, between the areas of flooding and the population centres. This enables the population to take advantage of the seasonally flooded wetlands during the dry season. In other words, the population of the Bahr el Ghazal basin, like that of the Bahr el Jebel, is closely dependent on the hydrology of the wetlands. This dependence is linked to the seasonally flooded areas which provide grazing, rather than the permanently flooded areas dominated by papyrus; any diversion of river flows should be designed to take account of this dependence.

CONCLUSION

Although a number of Bahr el Ghazal tributaries converge towards the confluence with the Bahr el Jebel at Lake No, the contribution to the combined flow is very small. The upper basins have relatively high rainfall, but the river flows spill into flood plains and are lost by evaporation. A water balance study based on measured flows, supported by satellite imagery, shows that areas of flooding have decreased in recent years in contrast to the Bahr el Jebel.

CHAPTER 7

THE SOBAT BASIN AND THE MACHAR MARSHES

INTRODUCTION

The Sobat contributes about half the flow of the White Nile and about a sixth of the whole Nile; its flow is therefore almost equal to the outflow from the Sudd. The basin derives most of its runoff from the Ethiopian mountains and in the absence of lake storage provides the seasonal element to the flows of the White Nile. It also receives occasional contributions from the Pibor which drains a wide area to the south. During years of heavy rainfall on the Baro and other Ethiopian tributaries, high flows are spilled from the river system to the Machar marshes and other wetlands. For this reason the river was studied for one of the early water-saving or conservation schemes to reduce evaporation losses in these wetlands. However, the hydrology of the basin is relatively little known as the river straddles the border between Sudan and Ethiopia, and access has not been easy to determine the flows at key points of the river network and in particular the spills from the main rivers into adjoining wetlands.

In this chapter a description of the river network and the climate of the basin is followed by an account of the flow regime as indicated by the existing hydrological records. This leads to an analysis of the interaction of the inflows, spillage and storage within the wetlands and the channel of the main Sobat. Sources of information include *The Nile Basin*, vol. I (Hurst & Phillips, 1931), with a chapter illustrated with photographs describing the Sobat basin, and vol. VIII (Hurst, 1950), discussing the hydrology of the Sobat and White Nile. Other accounts include the Jonglei Investigation Team (1954) on the Machar marshes and the hydrology of the Sobat, the analysis by El-Hemry & Eagleson (1980) of the water balance of the Machar marshes, and recent analysis by Sutcliffe (1993) of the hydrology of the area.

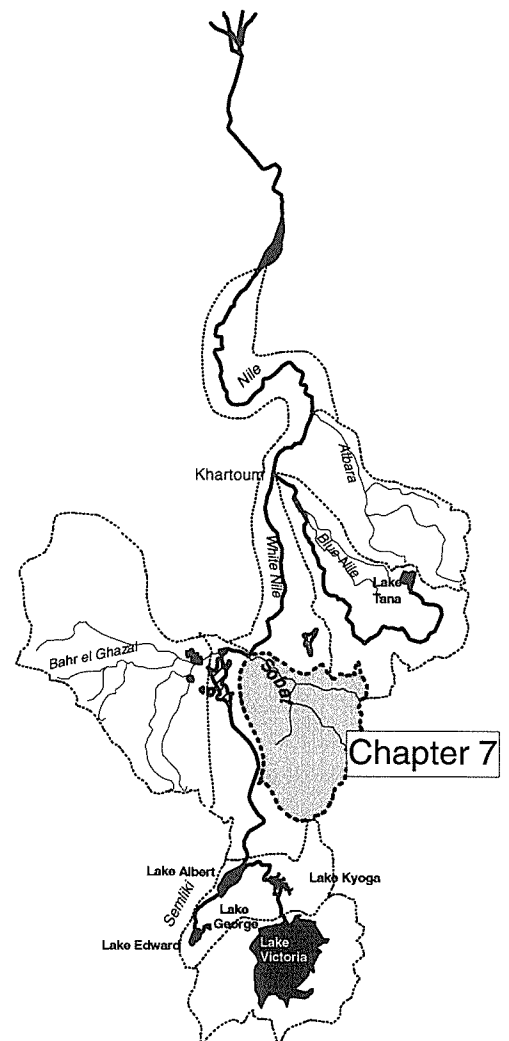

GEOGRAPHY OF THE SOBAT BASIN

The Sobat (Fig. 5.1) flows to the White Nile from the confluence of its two major tributaries: the Baro and the Pibor. The Baro (41 400 km²) drains an area of the Ethiopian mountains east of Gambela rising to a peak of 3300 m. The Pibor (109 000 km²) receives the Gila and Akobo

from the mountains south of the Baro basin. but also drains a wide area of the plains east of the Bahr el Jebel, from which there is little runoff in most years but high flows in some years. The mountain catchment is largely thickly wooded, with vegetation ranging from thorny savannah to thick tropical forest. On the plains at the foot of the hills the woodland gives way to the west to open grassland, which is swampy in the rains but nearly waterless in the dry season (Hurst & Phillips, 1931).

The upper Baro above Gambeila (23 500 km²) collects a number of mountain streams descending from the Ethiopian plateau through deep gorges. Below Gambeila it flows west towards the Pibor junction through a tree-bordered channel which emerges into a grass-dominated area. About 100 km above the junction it splits into the Adura and the Baro which rejoin 70 km downstream; the Baro receives the Jokau tributary but several spill channels to the north connect the river with the Machar marshes, and at high flows the river is also liable to overtop its banks and inundate large areas.

A recent detailed account of the Mekoy tributary of the Baro (Woube, 1997) describes the river originating in the highland, spreading in a braided channel over the plain, and forming swamps and seasonal wetlands due to backwater from the main rivers. The mean runoff is 0.51 km³ or 183 mm derived from 2790 km² of upland basin. The area has been settled in recent years and a small dam (0.075 km³) constructed for irrigation.

The Machar marshes are a wetland area to the north of the Baro. It has been mapped from the air but the area is little known directly because of its inaccessibility. Apart from the spill from the Baro, several other streams feed the wetland from the Ethiopian foothills. A number of channels, flanked by wetland areas, cross the plain towards the White Nile.

The Pibor above the Akobo junction forms the outlet for a number of ephemeral streams draining a large area of the plain to the east of the Bahr el Jebel. Although this area includes the larger part of the Pibor basin, the runoff is likely to be small in most years as rainfall is low and the area is dry for much of the year; the streams which start as depressions in the southern part of the plain are ill-defined at first and are filled with swamp vegetation towards the northern limit. However, there is evidence that in a few years there is significant inflow from the Pibor basin. In most years the main contribution is from the Akobo and Gila, which join the Pibor within about 80 km south of its confluence with the Baro, and which drain areas of the Ethiopian plateau up to 2500 m in elevation. Downstream of the Gila the Mokwai joins the Pibor, but this is thought to carry spill from the Baro.

Below the Baro–Pibor confluence the Sobat follows a winding course about 100–200 m wide through alluvial banks in a grass plain, with adjacent grass swamps. Several small seasonal water courses, like the Khor Nyanding and Khor Fullus, join the river from the south; the Sobat catchment is about 36 800 km².

The climate of the Sobat basin varies greatly between the Ethiopian mountains and the plain. The rainfall of the upper Baro basin ranges from 1300 mm at Gambeila to 2370 mm at Gore, between April and October, with a tendency towards two rainfall seasons evident in individual years. The Pibor basin has lower rainfall, with an average of about 950 mm over the same months, but the rainfall on the plain is only about 800 mm.

GENERAL HYDROLOGY

Spill from the Sobat tributaries

The major wetland within the Sobat basin, the Machar marshes, is little known, but its hydrology may be indicated by comparing flow records at sites down the Baro and Sobat. A major source of inflow to the marshes is channel flow and overbank spill from the Baro, and this spill is illustrated by flows along the Baro.

The flows of the upper Baro have been measured at Gambeila. Levels have been measured since 1905 but no flows calculated until 1928. However, Hurst (1950) derived a rating from almost 700 gaugings between 1928 and 1947 (35 per year), which suggested that the relation had not changed much over the period. This relation [$Q = 100(h - 8.77)^{1.54}$ in $\text{m}^3 \text{s}^{-1}$] has now been used to convert 10-day levels to flows for 1905–1927, which extend the record. From 1928 to 1959 both levels and discharges were measured regularly and flows were calculated from gaugings during each year. These later monthly flows (*The Nile Basin*, vol. IV) are shown in Fig. 7.1. Annual flows for 1905–1959 are shown in Fig. 7.2 and monthly averages for this period are given in Table 7.1. The flows of the Baro at its mouth, above the Pibor junction, were measured almost daily in 1929–1933, and then about twice a month from June to December in 1941–1962, when gaugings became less frequent. Flows have been published for the years 1929–1932, for the high flow season from 1941 to 1963, and intermittently until 1981. These flows from 1929 to 1959 are included in Fig. 7.1.

Comparisons of flows at Gambeila and at the Baro mouth, 200 km downstream, illustrate the spilling of high flows; Fig. 7.1 shows that the flows are similar until a flow of about $1.5 \text{ km}^3 \text{ month}^{-1}$ is exceeded, when the downstream flow is virtually constant at that figure. On the other hand, comparisons of Baro and Pibor flows above their confluence, with the Sobat below the junction, show a net gain at the junction, attributed to left bank spill from the Baro returning through the Pibor.

The overall losses on the Baro system may also be illustrated (Fig. 7.3) from annual flows at Gambeila and the Baro mouth. An increase in flow has little effect downstream. However, the complex pattern of spilling, with outflows and return inflows through channels, can be deduced by direct measurement or by measuring flows upstream and downstream of each junction. Overbank spilling also occurs over both banks and can only be estimated using successive measurements and observation of the proportion of spill over each bank. For this reason detailed study, described later, is required to estimate the spill to the Machar marshes.

The Sobat flows below the Pibor confluence have also been calculated from annual rating curves based on gaugings below the confluence and at Nasir, some 60 km downstream. These flows are available from 1929 to 1977, with a gap between 1964 and 1967 and only intermittent high flows measured after 1970.

The Sobat flows at Doleib Hill, 8 km above the White Nile confluence, have been calculated from annual ratings from 1905 to 1983. The ratings are looped and affected by White Nile levels; the level of the rating curves rose about 1 m after 1964. The number of annual gaugings is thus important; these averaged (Chapter 2) about 20 until 1921, reached a

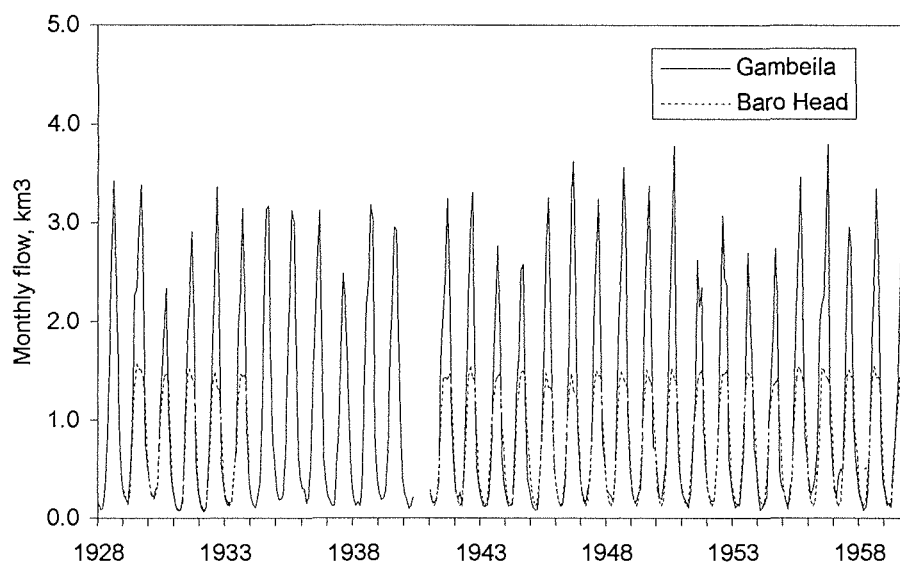

Fig. 7.1 Baro at Gambeila and Baro head: monthly flows, 1928–1959.

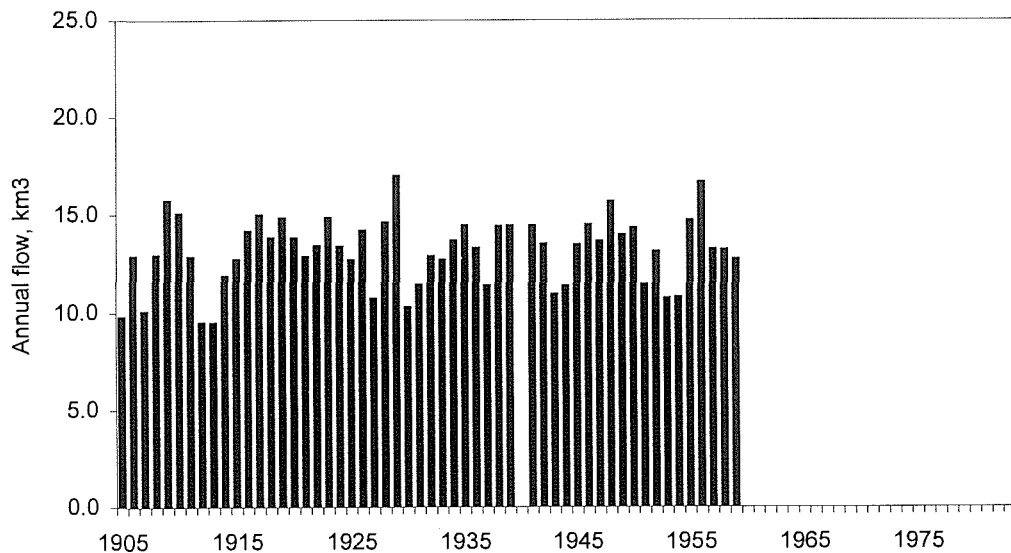

Fig. 7.2 Baro at Gambeila: annual flows, 1905–1959.

peak of 70 in 1923–1935, averaged 40 in 1936–1951, 20 in 1952–1964, and fell to about 10 until 1983. The monthly and annual flows are illustrated in Figs 7.4(a) and (b). Published dry season flows appear to have been high in certain years since 1962. Although flows could have been held up by high White Nile levels after the rise in Lake Victoria, it also appears that in some years (e.g. 1965–1967) these flows may have been overestimated because of a lack of dry season gaugings. Some of the later published flows are clearly incorrect; in 1979 and 1981 the dry season flows are implausible and have been corrected here from provisional flows obtained in 1982 or by comparison of Sudd outflows with Malakal. The monthly average flows for different periods are included in Table 7.1. The attenuation of high flows, compared with the Baro at Gambeila, is illustrated; there has been little change in average flows over the years.

The Machar marshes

The Machar marshes, in addition to spill from the Baro, also receive inflow from local streams flowing from the Ethiopian foothills north of the Baro. These so-called eastern

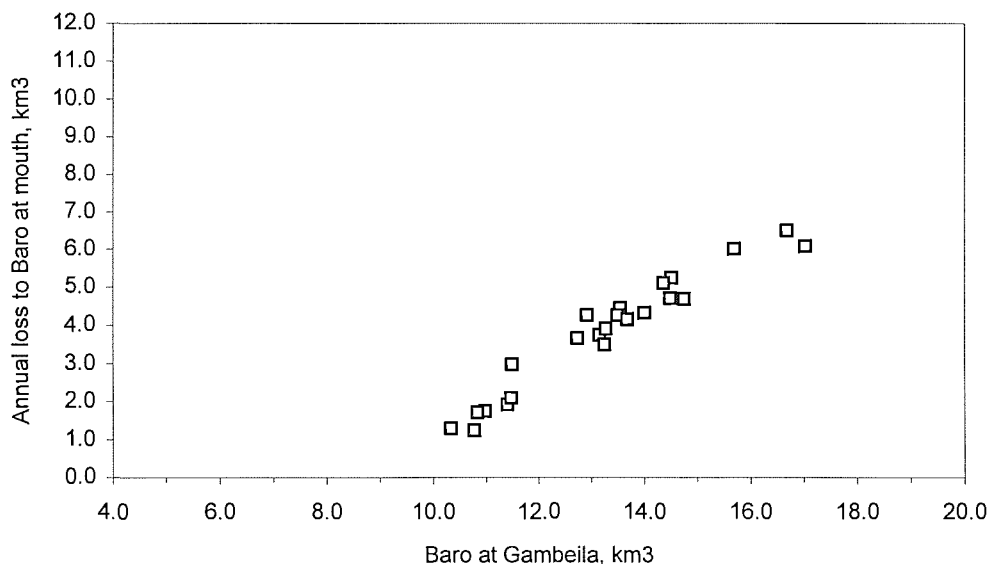

Fig. 7.3 Annual losses on Baro: 1929–1933, 1941–1959.

Table 7.1 Monthly average flows of Baro and Sobat ($m^3 \times 10^6$).

Jan.	Feb.	March	April	May	June	July	Aug.	Sept.	Oct.	Nov.	Dec.	Year
Baro at Gambeila (1905–1959)												
257	169	163	202	454	1154	1946	2590	2971	2022	816	440	13184
Sobat at Doleib Hill (1905–1960)												
929	363	246	222	410	870	1303	1603	1779	2008	1995	1743	13471
Sobat at Doleib Hill (1961–1983)												
1059	595	341	257	419	807	1297	1619	1781	1951	1889	1656	13672
Sobat at Doleib Hill (1905–1983)												
967	431	273	232	413	851	1301	1608	1780	1992	1964	1718	13530

torrents are ephemeral and their contributions were estimated from rainfall by Hurst (1950). The Jonglei Investigation Team (1954) initiated flow measurements in 1950 and later assessed flows. Little is known about the extent of the Machar marshes, so that a water balance is difficult to achieve. According to Hurst (1950, p. 24), the area of swamp was estimated from maps as 6500 km², but it was noted that experience from the Bahr el Jebel and Bahr el Ghazal swamps suggested that the area of permanent swamp would be reduced considerably when the area was surveyed directly.

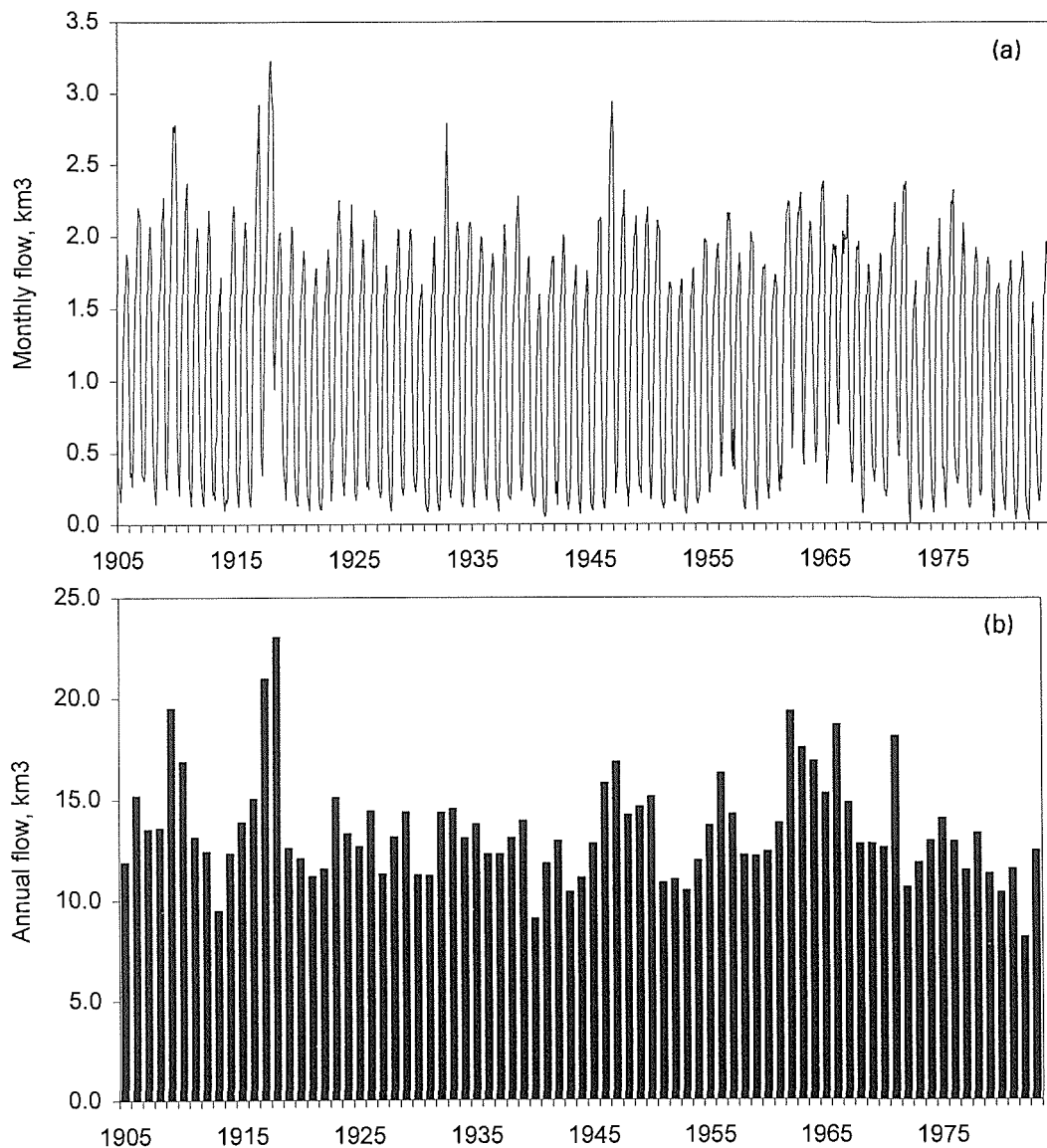

Fig. 7.4 Sobat at Doleib Hill: (a) monthly flows, 1905–1983; (b) annual flows, 1905–1983.

Khor Adar connects the Machar marshes with the White Nile through an extended grass-filled channel. The outflow through Khor Adar has been measured for short periods (0.058 km^3 in 1948 and 0.029 km^3 in 1957) and is considered negligible except after years of heavy rainfall and inflow to the swamps.

The balance of the Sobat itself was analysed by Wright (Jonglei Investigation Team, 1954, vol. III), and this suggested that there could be contributions from the Machar marshes to the lower Sobat in some years. This analysis is discussed later. The Machar marshes have also been the subject of analysis by El-Henry & Eagleson (1980); this study was based on measurements but also made use of conceptual modelling to assess the contributions of the eastern torrents and the ungauged area to the east of the marshes.

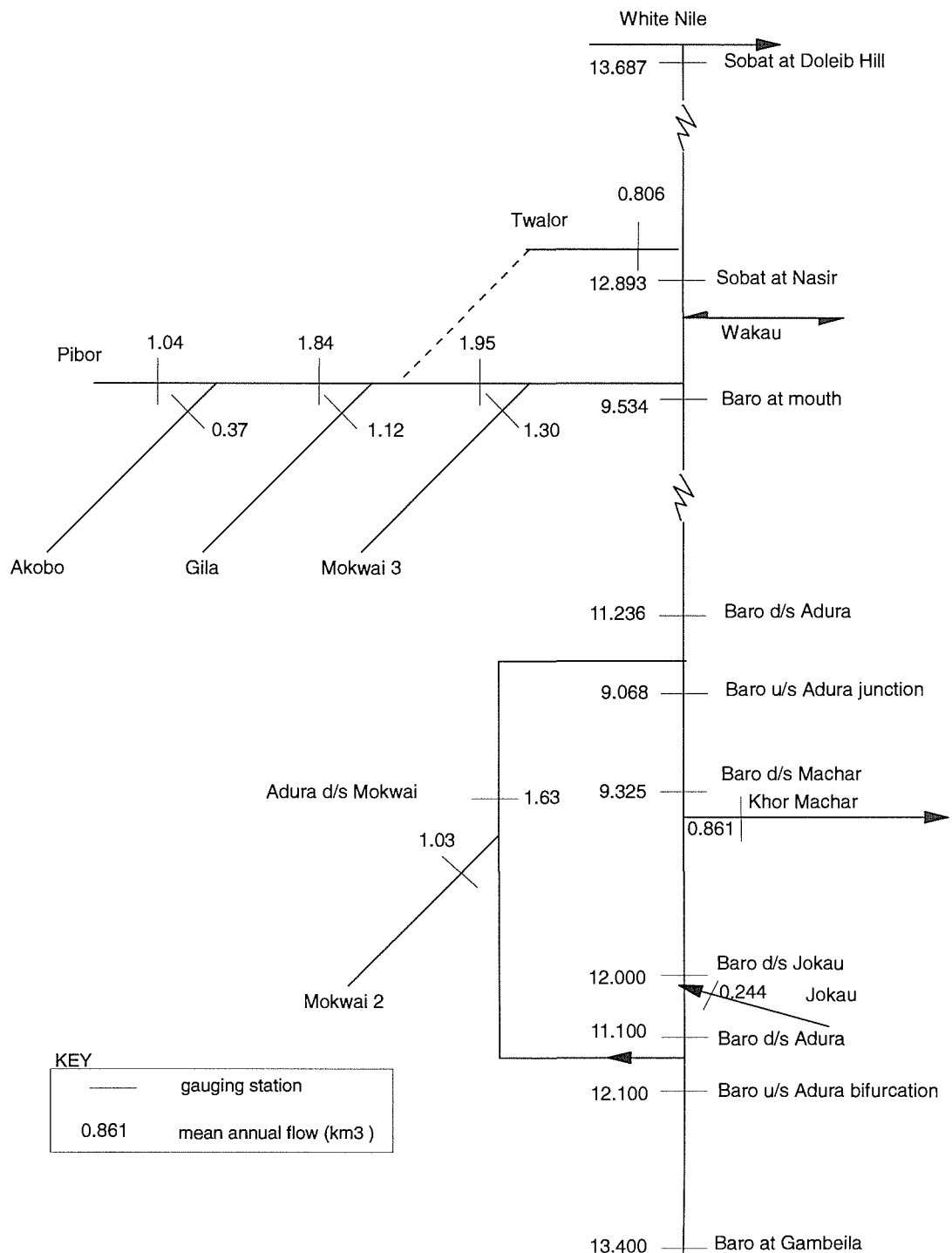

Fig. 7.5 Schematic plan of Baro-Pibor basins and mean annual flows, km^3 .

Contributions of the Pibor

The River Pibor drains a wide area of plains, which in theory extends to the mountains of southeast Sudan. However, the Kidepo which drains the Didinga hills and even a small area in northeast Uganda, disappears into a swamp about 5°N and loses definition (Jonglei Investigation Team, 1954, p. 18). The Kinyeti, which rises in the Imatong mountains, drains into a swamp west of Jebel Lafon at the same latitude. It is doubtful whether significant flow reaches the Lotilla and thus Pibor Post in a normal year. Detailed surveys of the Veveno channel were obtained during study of the Veveno Pibor Diversion Scheme, which was an alternative to the Jonglei Canal (Ministry of Public Works, Egypt, 1938); it starts as a depression in the plain but develops into a channel some 4 m deep. Some flow records exist at Pibor Post for the period 1928–1931, with an average annual flow of 0.44 km³, which is less than 1 mm over the basin, but a range from 0.14 to 1.03 km³ over the four years of records; approximate records for the period 1929–1944 (Hurst, 1950, p. 40) average 0.57 km³ with an estimated flow for 1932 of 4.0 km³.

The average flow of the Pibor (Fig. 7.5) above the Akobo confluence is estimated as 1.04 km³ (1929–1944) compared with the Akobo inflow of 0.37 km³ (1929–1944); while above the Gila confluence the Pibor flow is estimated as 1.84 km³, compared with the Gila inflow of 1.12 km³ (both 1929–1947). As the average Pibor flow is 1.95 km³ (1929–1947) at the junction downstream with the Mokwai (inflow 1.30 km³), there is clearly spill from the Pibor. It is not easy to assess the situation in detail as the records, quoted from early periods for compatibility, are somewhat intermittent. It appears from the difference between the flows of the Baro above and below the Pibor confluence that the average inflow from the Pibor is about 3.4 km³, but the flow of the Twalor spill channel to the Sobat below Nasir (0.56 km³ in 1934–1947) must be supplied by spill from the Pibor.

The individual flow records reveal various interesting facts. Comparison of the annual flows of the Baro and Sobat (Figs 7.2 and 7.4(b)) with those of the Pibor above the Gila mouth (Fig. 7.6) show that the Pibor provides much of the variability of the Sobat flows. Although most of the flow of the lower Pibor is supplied by the Ethiopian tributaries, there appear to be large contributions from the Pibor itself in exceptional years. The floods of 1917 were concentrated in the area north of Lake Victoria; comparison of the flows at Gambeila and Doleib Hill, the only records available for that year, suggest that this flood was also important on the lower Sobat and probably derived from the Pibor. It is more clearly shown by the flows of the Pibor above the Gila mouth that the Pibor basin also received a significant contribution from the heavy rainfall of 1961/62, when unprecedented flows were recorded. For example, the flow of the Pibor above the Gila mouth was 7.50 km³ in 1962, while the net inflow from Khor Twalor into the Sobat was 2.60 km³ in 1961–1962.

This evidence of occasional contributions from the Pibor itself is supported by a comparison of the annual flows of the Pibor above the Gila mouth (Fig. 7.6) with the annual gains on the Sobat between Sobat Head and Doleib Hill (Fig. 7.7). The latter reveals significant gains in 1933, 1946–1950, and 1962–1963, which follow high flows on the Pibor above Gila mouth. These gains appear to be caused by spill from the Pibor finding its way through the Twalor to the Sobat rather than direct inflow from the plain south of the Sobat.

Spill from Baro to Machar marshes

The spills from the Baro have been indicated above by comparing the flows at Gambeila with those at the Baro mouth, which were only recorded during the flood season. These comparisons are useful in showing how the overall spills vary over the years; it is clear that losses increase markedly during years of high flows at Gambeila. For detailed analysis it is

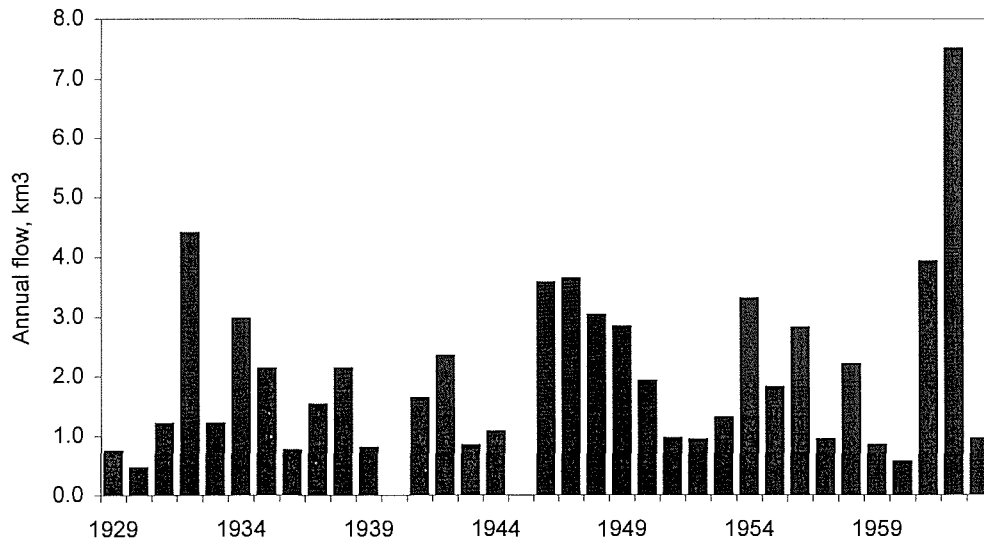

Fig. 7.6 Pibor above Gila mouth: annual flows, 1929–1963 (excluding 1940, 1945).

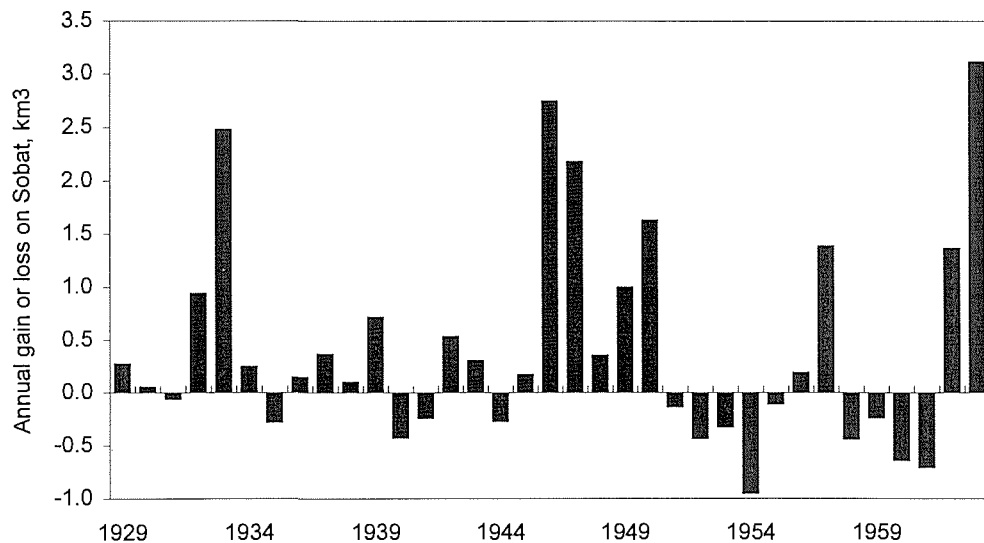

Fig. 7.7 Annual gains on Sobat: Sobat Head to Doleib Hill, 1929–1963.

necessary to study the series of flows down the Baro and estimate the proportions which spill on each bank. Some deductions may be based on average flows; however, the complexity of the river system is such that detailed analysis of individual years is essential if the spills are to be quantified.

Balance of Sobat channel

The comparison of monthly flows at Nasir and Doleib Hill for a selected period (1950–1959) (Fig. 7.8), reveals fairly limited losses and gains in normal years, and the main effect is the attenuation of the flow hydrograph by storage within the flood plain. An analysis of the balance of the Sobat channel between Nasir and Doleib Hill was carried out by Wright (Jonglei Investigation Team, 1954, vol. III). A detailed description of this follows later.

The effect of the losses from the Baro, and the attenuation in the course of the Sobat, is to reduce the total flows, especially in high years, and to delay the peak flow by 1–2 months. It is interesting to compare the duration of the high flows of the Sobat at Doleib Hill and those of the Blue Nile at Khartoum. Whereas the Blue Nile flood is concentrated between July and October, that of the Sobat extends from June to January, because of the longer rainfall season

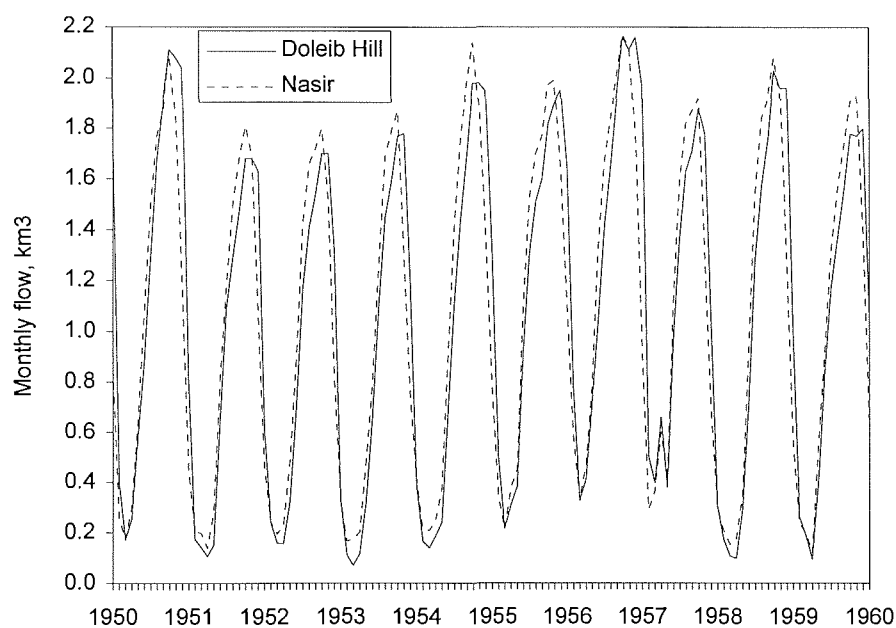

Fig. 7.8 Sobat flows at Nasir and Doleib Hill: monthly flows, 1950–1959.

and the attenuation of the Sobat flood. However, the Pibor appears to contribute an annual variability which is not present in the Baro.

WATER BALANCE OF THE MACHAR MARSHES

The Machar marshes are the least known of the southern Sudan wetlands, and the sparsity of hydrological data for aspects of their water balance makes it difficult to analyse their regime completely. Previous studies are described in *The Nile Basin*, vol. VIII (Hurst, 1950), the account of the Machar marshes by the Jonglei Investigation Team (1954, vol. III, chapter 4), the analysis by El-Henry & Eagleson (1980), and that by Sutcliffe (1993).

Analysis by Hurst (1950)

The analysis by Hurst concentrates on the losses from the River Baro above the Sobat head. Flow measurements down the Baro illustrate the succession of inflows, outflows and overbank spills. Measurements show that there is significant flow down the Adura branch which leaves the left bank of the Baro (Fig. 7.5) and returns to the Baro downstream, having received inflow from another tributary called the Mokwai. Below the bifurcation with the Adura, the Baro receives inflow in the Jokau from the right bank, and loses water by spill over the right bank and through the Khor Machar channel towards the Machar marshes. The overbank spill and smaller channel flows occur on both banks, and assumptions have to be made on the proportions of spill on each bank. It was concluded (Hurst, 1950, p. 24) that most of the loss from the Baro between the bifurcation of the Adura and their downstream junction is to the north. Between the junction of the Baro and Adura and the Baro mouth more than half of the spill goes towards the Machar marshes.

Jonglei Investigation Team (1954)

This analysis was brought up to date by the Jonglei Investigation Team (1954), who estimated the spill to the north from the Baro by comparison of average flows at different sites. These

flows (brought up to 1967) are illustrated in Table 7.2 and Fig. 7.5, where the river system is shown in diagrammatic form with estimates of mean flows at key sites. The Jonglei Investigation Team (1954) provide the only first-hand accounts of the area, but these are confined to the perimeters of the swamps. Air photography taken by the US Air Force in 1944–1945 was used to prepare air survey maps by 1949–1950. While providing astronomical fixes for this mapping, the channels flowing directly from the Ethiopian hills towards the swamps were measured. River gauges were erected on the Yabus and Daga, the largest of these rivers, and nearly 3 years of flow measurements were collected to revise the estimates of the direct inflow. Air reconnaissances in 1949–1950 provided an understanding of the flow patterns in the area, which was summarized in the Jonglei Report (1954) and the accompanying map (see Howell & Allan, 1994, p. 273).

Table 7.2 Average flows at sites on Baro and Sobat ($\text{m}^3 \times 10^6$).

Jan.	Feb.	March	April	May	June	July	Aug	Sept.	Oct.	Nov.	Dec.	Year
Baro at Gambeila (1905–1959)												
257	169	163	202	454	1154	1946	2590	2971	2022	816	440	13 184
Jokau at mouth (1942–1963)												
					6.2	38.9	57.2	62.1	57.5	22.0		244
Baro below Khor Jokau (1947–1963)												
440	240	200	270	580	964	1630	1940	2050	1910	1020	755	12 000
Khor Machar outflow (1928–1963)												
0.9	0.2	0	3.3	37	118	145	157	156	147	75.7	20.7	861
Baro above Adura junction (1945–1963)												
357	200	180	230	480	889	1280	1340	1280	1280	933	619	9 068
Baro below Adura junction (1942–1963)												
442	240	200	270	580	862	1350	1640	1760	1860	1280	752	11 236
Baro at mouth (1929–1963)												
297	162	129	176	429	925	1340	1480	1430	1430	1120	616	9 534
Sobat at Head and Nasir (1929–1963)												
588	276	211	249	489	1030	1500	1760	1860	2020	1750	1160	12 893
Sobat at Doleib Hill (1912–1967)												
1020	454	289	251	431	862	1290	1590	1770	1990	1980	1760	13 687

Note: Low flows on lower Baro are estimated by El-Henry & Eagleson (1980).

Analysis confirmed that the Baro flow exceeding about $1.500 \text{ km}^3 \text{ month}^{-1}$ spills from the river between Gambeila and the Baro mouth or Sobat confluence, and this spill is concentrated in June–November. The total spill was estimated as $3.600 \text{ km}^3 \text{ year}^{-1}$, varying annually with Gambeila flow from 1 to $5\text{--}6 \text{ km}^3$. In order to make assumptions about the proportion of spill to the north, they refined “most of the loss” in the middle reach as three-quarters, and “more than half of the loss” in the lower reach as two-thirds. Applied to the total spill of 3.600 km^3 , this led to estimated spill towards the Machar marshes of 2.820 km^3 .

This average annual spill to the north of 2.820 km^3 is the major river contribution to the Machar marshes. The eastern torrents provide the second river contribution to the marshes, through runoff from the western fringe of the Ethiopian mountains. The contributing areas at the two gauging stations on the Yabus and Daga total 5000 km^2 . The runoff from the whole area of $10\,300 \text{ km}^2$ from gauged and ungauged streams was estimated at 1.744 km^3 , based on average basin rainfall and the gauged runoff coefficient of 15%.

Direct rainfall on the Machar marshes was estimated from gauges around the periphery, and the annual average, based on seven stations with records from 1940–1952, was estimated as 788 mm. This contribution will vary with the area flooded, but exceeds the other sources of water input.

The air survey maps showed that water passes through the swamps by three main routes: from the eastern torrents through the Daga to the Adar; from the eastern Baro through a branch of the Machar to the Adar; and from another branch of the Machar through the Tierbor running parallel to the Sobat to the Khor Wol and the White Nile. This is supported by accounts of field visits.

There is little direct evidence of how much water reaches the White Nile. It has been deduced from the Sobat water balance that there is some spill from the Sobat north above Nasir through the Wakau, but that the average spill (0.150 km^3) is more than compensated by return flow into the Sobat (average 0.400 km^3). The main channel connecting the Machar marshes to the White Nile is the Khor Adar, which survey shows to have a channel about 2.5 m deep and 100 m wide, separated by alluvial banks from a flood plain about 800 m wide. However, the channel is normally choked with grass, and the flows are small except when exceptional floods, as in 1947, flatten these grasses. The Khor Wol is similar and the average outflow from the Machar marshes to the White Nile was estimated at about 0.10 km^3 , though in exceptional years like 1947 it might reach 0.50 km^3 or even 1.00 km^3 .

There was little direct evidence of the area flooded in the marshes, but from the sources of inflow it was thought to vary considerably both seasonally and from year to year. There were subjective accounts from field visits of the areas which provided grazing in the past, but these did not provide estimates of the total area flooded. The precise areas could then only be deduced from air photography, which is not easy to interpret, or by water balance methods which depend on accurate estimates of inflow and evaporation.

Analysis by MIT (1980)

Subsequent analysis was carried out by El-Hemry & Eagleson (1980). As with the concurrent study of the Bahr el Ghazal swamps (Chapter 6), an important feature of this study was that the conceptual water balance model developed by Eagleson (1978) was used to estimate ungauged runoff from rainfall and other factors.

Landsat satellite imagery of February 1973 had been used to map the drainage of the Machar area and the vegetation distribution. These maps were reproduced at a reduced scale (El-Hemry & Eagleson, 1980, Figs 4.1 and 4.2). The drainage pattern is very similar to that deduced from air photography by the Jonglei Investigation Team (1954). The area is divided in the report into $16\,300 \text{ km}^2$ of eastern catchments, $14\,100 \text{ km}^2$ of plains, much of which is to the west of the swamps, and $8\,700 \text{ km}^2$ of permanent swamps; however, some 60% of the swamps are noted as grass and forest, leaving 40% or $3\,500 \text{ km}^2$ as wet soil and water bodies covered by papyrus. It is not clear whether this includes seasonally flooded areas inundated at the time of the imagery.

The progression of vegetation is clear: the catchments of the torrents from the Ethiopian foothills are shown as forest, which gives way to grass with trees and bush to the west of the international boundary and then to grass plain. The lower courses of the Ahmar, Tombak, Yabus and Daga are marked as meandering river systems or marshland/swamps with fringes of seasonally flooded wetland. The area north of the Baro and Sobat which is fed from the Machar and the Wakau, and the upper reaches of the Wol, are also shown as wetland. Between these isolated areas of wetland large areas north of Nasir are shown as forest.

El-Hemry & Eagleson (1980) assembled valuable data. They assessed the vegetation for the eastern streams and derived parameters for the Eagleson model. They assembled basic rainfall data up to 1975, and derived statistics of mean annual rainfall and coefficient of variation, seasonal rainfall and number of raindays; they developed Thiessen weightings for the stream basins, plains and swamps. They assembled monthly flow data for the stations at Yabus Bridge and Daga Post installed by the Jonglei Investigation Team and continued up to

1955. These are summarized in Table 7.3; the average flows at these two stations are 0.455 and 0.420 km³. Flow starts in June, about two months after rainfall in April–October, and some flow continues through the dry season. Very short records (July–October 1974) for the Ahmar at Kofa, the Tombak at Nela, and the Lau at Kigille provided total flows of 0.075, 0.715 and 0.300 km³ respectively. The flow of the Tombak appears unreasonably high compared with the other rivers, being over 30% of average rainfall.

The total inflow from these five rivers was given as 1.965 km³. This was considered an underestimate on the grounds that the stations at Yabus Bridge and Daga Post are above the mouths of the rivers, while the estimate included only one of the three branches of the Lau. It was increased to 3.30 km³ by comparing rainfall and potential evaporation over the total tributary area, and was later increased to 4.2 km³ by applying a single-parameter model to the separate basins. This estimate is very indirect, and the open-water evaporation used is very low at 1340 mm. Gauged stations on the Yabus and Daga are likely to be at the limit of the productive catchment. Pending further flow measurements, particularly for the anomalous Tombak station, the estimate of 1.744 km³ prepared by the Jonglei Investigation Team from local knowledge is preferred. This was based on Daga and Yabus flows similar to those used by El-Hemry & Eagleson, and the total runoff was estimated from rainfall and measured runoff coefficients (K. E. Snelson, Jonglei Investigation Team, personal communication).

El-Hemry & Eagleson also estimated further runoff from the plains of about 1.41 km³ by comparison of rainfall and evaporation over an area of 14 100 km². This estimate is also indirect and at 100 mm exceeds local experience; runoff from the Pibor and the plains south of the Sobat is seldom appreciable.

The total spill from the Baro was estimated by El-Hemry & Eagleson in a similar way to earlier attempts, using normals up to 1963, and the results were somewhat higher with a spill of 4.63 km³. They were based on flows of the Baro below Khor Jokau which were not available previously. The proportions (two-thirds and three-quarters) of the Jonglei Investigation Team were used to divide the spill north and south of the Baro. The average flow to the north was estimated as 3.54 km³. This total was higher than those of Hurst (1950) and the Jonglei Investigation Team (1954), but the estimates also included spill derived from estimated low flows during the dry season; this does not seem logical as even spill through the Machar channel is negligible during the dry season, and it is unlikely that spill over the bank occurs. If low flows had been eliminated from this study, then the estimated spill would have reduced the total spill to 3.664 km³ and spill to the north to 2.873 km³; these are similar to the Jonglei Investigation Team (1954) estimates.

The sum of the estimated runoff from the eastern torrents and plains was given as 5.61 km³, plus 3.54 km³ spill from the Baro. Drainage to the Sobat through the Wakau and Adar totalling 0.12 km³ is deducted. It was concluded that more than 8 km³ could be contributed annually from the Machar region to the White Nile by a channel diversion system. This would be twice the estimated benefit of the Jonglei Canal, Stage I. It was, however, proposed that further measurements and studies should be carried out, and it seems that the potential savings from the Machar area may have been somewhat overestimated.

Analysis of years 1950–1955 (after Sutcliffe, 1993)

It is preferable to analyse the water balance of the Machar marshes over a consistent period when all factors are available; the eastern tributaries have only been measured in 1950–1955. Flows along the Baro are also available, together with flows of the Machar channel. As before, spills towards the Machar marshes can be estimated on the basis that two-thirds of the upper Baro loss and the whole flow of the Machar channel, spill towards the north, with three-quarters of the lower Baro loss. The average estimates are given in Table 7.3. The spills occur between

July and October, and the spills from the upper Baro occur earlier in the year than those of the lower Baro. The average spill for the years 1950–1955 at 2.328 km³ is lower than the estimate of 2.82 km³ (Jonglei Investigation Team, 1954) based on the years up to 1947 or the average (2.87 km³) up to 1967. This is due to the period 1950–1955 being somewhat drier than average, and the sensitivity of spilling to the flows of the Baro. The flows of the Baro at Gambailla averaged 12.56 km³ in 1950–1955 compared with 13.35 km³ normal from 1928 to 1959.

Table 7.3 Components of Machar marshes water balance (m³ × 10⁶).

Jan.	Feb.	March	April	May	June	July	Aug.	Sept.	Oct.	Nov.	Dec.	Year
Spill from Baro towards Machar (1950–1955)												
					44	218	504	738	689	135	0	2328
Inflow of Yabus at Yabus bridge (1950–1955)												
9.88	4.70	3.39	3.15	8.59	17.7	30.1	88.7	118	108	42.8	19.6	455
Daga at Daga Post (1950–1954)												
1.78	1.24	0.31	1.04	5.85	16.4	48.1	113	93.8	91.5	36.3	10.9	420
Total estimated inflow (1950–1955)												
23	12	7	8	29	68	156	401	423	398	158	61	1744
Average rainfall (1950–1955, mm)												
0	2	3	31	109	126	179	241	139	77	26	0	933
Average evaporation (mm)												
217	190	202	186	183	159	140	140	150	177	189	217	2150

The monthly torrent inflows for the same period were estimated by multiplying the sum of the two measured torrents, the Yabus and Daga, by a constant to give the estimated average of 1.744 km³. The outflow from the Machar marshes to the White Nile only occurs in exceptional years, as in 1946/47, and has been estimated to average 0.12 km³ (El-Hemry & Eagleson, 1980). The drainage to the White Nile and the reverse flow to the Sobat have therefore been neglected. The average rainfall has been estimated from six stations (Kurmuk, Chali, Doro, Yabus Bridge, Daga Post and Nasir) around the swamps at 933 mm. The annual series for the period 1950–1955 have been estimated from these six stations by the isopercentile method, and distributed according to the monthly distributions at Kurmuk and Nasir. The averages for this period are included in the summary table, together with the Penman open-water evaporation for the Sudd which should provide a reasonable estimate for the Machar marshes.

The comparison of annual averages in this table leads to an estimate of average swamp area of 3350 km², which is lower than previous estimates. It seems likely that previous estimates have included areas of seasonal flooding.

An indication of the seasonal distribution of flooding has been derived from the monthly spill and inflow data, by using the water balance model developed for the Sudd. It was assumed that once the spill and torrent inflows have spread to areas outside the stream channels, the relation between flood area and volume is linear and similar to that deduced for the Bahr el Jebel flood plain. Monthly rainfall evaporation estimates have been used; soil moisture recharge has been neglected in this case as tributary inflow does not occur until local soil moisture has been recharged. The results (Fig. 7.9) show that estimated areas of flooding vary between about 1500 and 6000 km² over the 5-year period, which was drier than the average.

GENERAL ENVIRONMENT

There is no direct evidence for the distribution of permanent and seasonal swamp. El-Hemry & Eagleson (1980) reproduced a map based on imagery for a later year (February

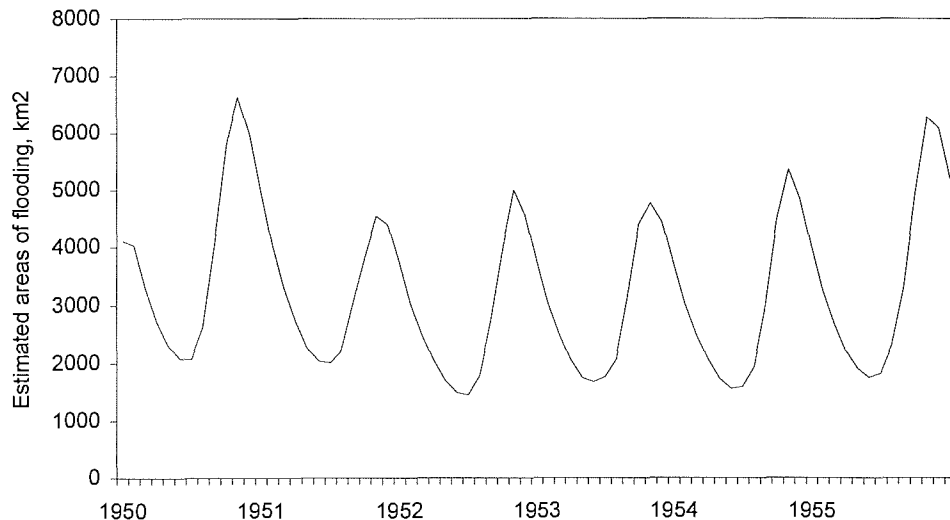

Fig. 7.9 Machar marshes: estimated areas of flooding, January 1950–December 1955.

1973). A subjective appraisal of this map is not incompatible with the hydrological analysis, but the flooded areas should be confirmed in due course with thermal infrared satellite imagery.

Little direct information is available on the vegetation of the area. According to Hughes & Hughes (1992), there are extensive permanent swamps dominated by papyrus along the water courses, or by *Phragmites* and *Typha* away from them. There is unlikely to be much papyrus except in the centre of the marshes, because of the high level range on the Sobat (over 5 m at Nasir) and the seasonal pattern of spill and flooding. The maps of population (Fig. 6.5) and seasonal cattle movements (Southern Development Investigation Team, 1955) show settlements spread along the spill channels from the Baro and Sobat, north and northeast of Nasir, and also along the lower Yabus. These must indicate the existence of grazing grasses.

There have been proposals (Hurst, 1950) to reduce the amount of water evaporated in the Machar marshes either by regulating the river flows with upstream storage to reduce spill or by constructing a channel to convey water through the swamps. As mentioned earlier, the area upstream is being developed by immigration and dam construction. Further hydrological analysis is clearly required to review the estimates of spills and torrent flows. In view of the likely difficulty of re-establishing gauging stations in this rather remote and inaccessible region, satellite imagery could be useful to estimate the seasonal fluctuations in areas of inundation. For example, the thermal infrared image of December 1986 (Fig. 6.4), which was used to estimate the areas of flooding in the Bahr el Ghazal basin, suggests an approximate evaporating area of 3000 km², though the interpretation is less clear than in the outline of the Bahr el Ghazal and Bahr el Jebel swamps.

ANALYSIS OF SOBAT CHANNEL STORAGE

A study of the Sobat flood was carried out by J. W. Wright of the Sudan Survey Department as a special investigation of the Jonglei Investigation Team (1954, vol. III, chapter 3). This analysis was based on the floods from 1934–1935 to 1947–1948, excluding 1940–1941 for which records were incomplete. The records comprised 10-day inflows at Sobat Head or Nasir and outflows at Doleib Hill; 10-day gauge levels at four stations, from which the storage within the reach was deduced; rainfall records at three stations and evaporation of 1760 mm deduced from Piche measurements (the only estimate then available).

It was assumed that the cumulative difference between inflows and outflows, allowing for tributary flows, was explained by temporary flood-plain storage. As there were no measured cross-sections in the upper Sobat, their form was deduced from a preliminary balance and gauge levels. The balance took into account rainfall and evaporation on flooded areas and soil moisture recharge on newly flooded ground, estimated to be about 300 mm depth. The cross-sections of the lower Sobat had a parabolic form. This seemed true of the upper Sobat only up to the average flood level; above this level the trough appeared to be incised in a plain sloping gently towards the river.

The water balance suggested that, apart from the inflows and outflows between the Sobat and the two measured tributaries, the Twalor and Wakau, the Sobat system is in nearly all years self-contained. The Twalor acts as a spill channel from the Pibor in years of high flow. The Wakau both receives spill and discharges into the Sobat. Although the eastern plains may contribute inflow during exceptional years, the losses and gains can best be explained by the flooding and drainage of a wide area of plain flanking the Sobat.

The storage is contained within the trough beside the river in average years, and spreads on to a wider plain in higher years. Apart from rainfall and evaporation over flooded areas, and absorption on newly flooded land, the river loses and gains some water through the tributaries Wakau and Twalor, but otherwise the river is self-contained and acts simply as a reservoir. Its principal effect is to delay the passage of the flood by about a month.

RUNOFF FROM THE EASTERN PLAIN

The eastern plain south of the Sobat is a potential source of inflow after periods of heavy rain. There have been a number of observations of a phenomenon named as “creeping flow”, which has been defined (Jonglei Investigation Team, 1947, p. 85) as “the slow movement of large bodies of water across a plain which slopes very gently and is almost impermeable”. This definition is followed by analysis of flow over a uniformly sloping plain. To illustrate the extremely limited relief of wide areas of these plains, the gradients from east of Bor towards the Sobat mouth are about 0.10 m km^{-1} ; a cross-section at about 8°N (Jonglei Investigation Team, 1954, Fig. A28) shows a variation of only about 0.20 m from the mean elevation over a distance of 10 km. An eye-witness account of creeping flow in 1947 (Howell *et al.*, 1988, p. 480) describes it as advancing about 50 km in two weeks over a front of over 30 km with a depth of about 0.30 m.

Such flow would eventually reach channels like the Khor Fullus, which starts as traces in the plain. They develop into depressions about one km wide and converge into a single channel with a flood plain about 200 m wide before flowing into the Sobat. An indication of scale is given by flows measured at the mouth between 1929 and 1939. Flows only extend from August to February. The average flow is equivalent to only 12 mm from some $12\,000 \text{ km}^2$, though the range is high. The average runoff is a small proportion of the rainfall and is not a large contribution to the flow of the Sobat. However, there is evidence from the river flow records of 1917 and 1961/62 that in exceptional years there is significant flow into the Sobat.

A detailed survey, carried out in March 1954 (Southern Development Investigation Team, 1955) included five cross-sections of the channel and flood plain near Ful Turuk ($8^{\circ}35'\text{N}$), with details of the vegetation on all sections. The channel was about 150–200 m wide and about 1–2 m deep, filled with the deep-flooded grass *Echinochloa stagnina*, with some water sloping at about 0.04 m km^{-1} towards the end of the dry season. The channel was incised in a flood plain about 2 km wide, which was partly dominated by the shallow-flooded *Echinochloa pyramidalis* flanked by *Hyparrhenia sp.* Other tributaries contained the same vegetation. The flood plain and channel were being grazed from a Nuer cattle-camp at the time.

CONCLUSIONS

The regime of the Sobat and its tributaries is complex, with most of the runoff developed in the mountains and foothills of the Ethiopian portion of the basin, and reaching either the Sobat or the Machar marshes through a series of parallel river channels. However, the Pibor, which drains a wide area of plains to the south, contributes significantly in some years. Moreover, the main tributary, which is the Baro, loses a significant proportion of its high flows by outflow through spill channels or by overbank spilling. A proportion of the water which leaves the Baro to the south returns to the river system through various channels which flow into the Pibor above its confluence with the Baro. The water which leaves the Baro to the north flows to the Machar marshes, which also receive inflows from several tributaries draining the foothills of the Ethiopian plateau. Little of this water reaches either the White Nile or the Sobat. Analysis of the water balance of the area is made difficult by the shortage of long-term flow records at most of the key points. An attempt has been made here to produce reasonable estimates, but coincident flow measurements and satellite imagery will be required for detailed study. The balance of the Sobat between the confluence of the Baro and Pibor and its outflow to the White Nile is comparatively well known through analysis of flow records. The system is reasonably self-contained with water stored in the channel and flood plain during high flow periods returning to the channel when the flow recedes, after losing some volume by net evaporation and soil moisture recharge.

CHAPTER 8

THE WHITE NILE BELOW MALAKAL

INTRODUCTION

The White Nile from its confluence with the Sobat is reasonably self-contained and has a character of its own. Although the White Nile strictly begins at Lake No with the confluence of the Bahr el Jebel and the Bahr el Ghazal, the reach between Lake No and the Sobat mouth is essentially an extension of the Sudd, of which one outlet is the Bahr el Zeraf. The Sudd outflows are best deduced from the difference between the flows of the White Nile at Malakal and the outflows of the Sobat, and conversely the inflows to the White Nile at Malakal can be separated into its two components.

Between the Sobat mouth and the junction with the Blue Nile at Khartoum, the White Nile falls about 13 m over a reach of 840 km. The inflows from tributaries are sporadic and relatively small. The flood-plain storage results in some delay of the outflows and losses by evaporation. The backing up of the White Nile during the Blue Nile flood, which raises water levels, further increases storage and evaporation losses. Over the period of flow records the natural regime has been affected by the construction in 1934–1937 of the Jebel Aulia dam, 40 km above the confluence, and the development of irrigation along the White Nile. The dam further raised upstream river levels from June 1937, and irrigation and evaporation have both led to increased losses.

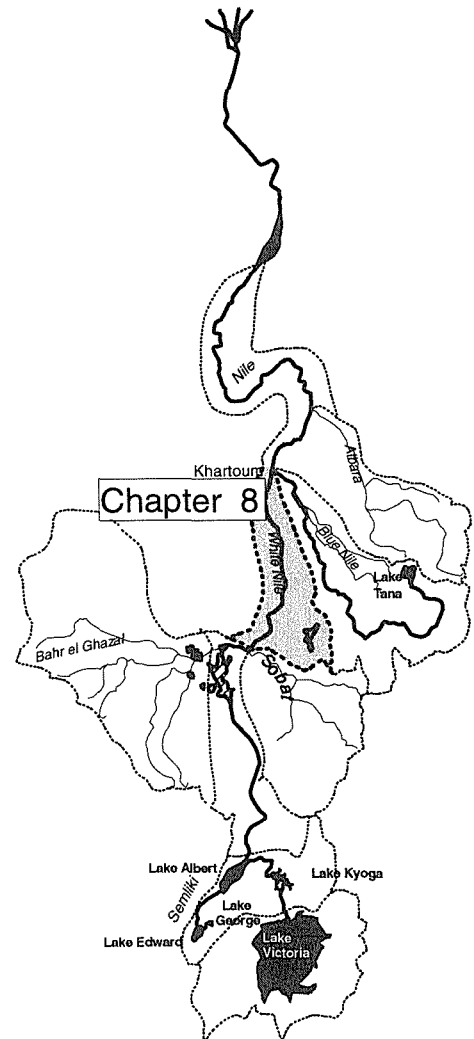

INFLOWS TO THE WHITE NILE

The inflows to the White Nile, which have been measured at Malakal since 1905, are made up of two very different components. The outflows from the Sudd have been discussed in Chapter 5, but essentially they are the highly damped and reduced inflows of the Bahr el Jebel. These outflows therefore reflect the rise in Lake Victoria and the subsequent doubling of the outflow from the lakes after 1961–1964, but the seasonal element supplied by the torrents above Mongalla has been virtually eliminated by the repeated spills and evaporation losses in the series of offstream basins and swamps through the Sudd. The rise of lake outflows was responsible for the increased area of the swamps after 1961, which in turn led to greatly increased evaporation between Mongalla and the tail of the swamps. Thus the outflow from the Bahr el Jebel swamps increased after the lake rise, but the losses have been proportionately larger and the outflows have not increased in proportion to the inflows. The

Table 8.1 Average flows at key sites for various periods ($\text{m}^3 \times 10^6$).

Jan.	Feb.	March	April	May	June	July	Aug.	Sept.	Oct.	Nov.	Dec.	Year
Outflow from Sudd:						1905–1960						
1337	1188	1236	1140	1131	1058	1109	1159	1177	1242	1148	1231	14 157
						1961–1983						
1950	1634	1771	1619	1582	1504	1513	1589	1697	1936	1940	2064	20 799
						1905–1983						
1515	1318	1392	1280	1262	1188	1227	1284	1328	1444	1379	1473	16 091
Sobat at Doleib Hill:						1905–1960						
929	363	246	222	410	870	1303	1603	1779	2008	1995	1743	13 471
						1961–1983						
1059	595	341	257	419	807	1297	1619	1781	1951	1889	1656	13 672
						1905–1983						
967	431	273	232	413	851	1301	1608	1780	1992	1964	1718	13 530
White Nile at Malakal:						1905–1960						
2266	1551	1482	1362	1541	1928	2412	2762	2956	3250	3143	2974	27 628
						1961–1995						
2786	2058	1972	1779	1918	2228	2766	3140	3362	3718	3646	3478	32 850
						1905–1995						
2466	1746	1670	1522	1686	2043	2548	2907	3112	3430	3337	3168	29 636
White Nile at Mogren:						1911–1935						
2499	1723	1511	1368	1470	1634	1575	1622	2972	3773	3148	2904	26 198
						1936–1960						
2140	1887	2177	1963	1635	1601	1031	1308	1764	2658	2484	2436	23 083
						1961–1995						
2682	2047	2258	3024	2701	2042	1463	1407	2106	2786	2753	2860	28 130
						1911–1995						
2469	1905	2014	2225	2026	1792	1368	1435	2236	3024	2786	2747	26 026

outflows are illustrated by Table 8.1 and Fig. 5.4, which illustrate the lack of seasonal variability and the damped response to the increase of Sudd inflows. These flows include the outflows from the Bahr el Ghazal swamps, but as noted in Chapter 6 these are comparatively small.

The other component of the White Nile inflows is the contribution of the Sobat, which has been measured at Doleib Hill near the mouth since 1905. These flows are illustrated in Table 8.1 and Fig. 7.4 and are more seasonal than the Sudd outflows. The high flow contributions of the Baro and adjacent Ethiopian rivers are attenuated by spill, especially in years of high flow. However, the Pibor to the south contributes significant flows in some years, so the annual variability of the Sobat is greater than the upper Baro. The dry season flows are small compared with the Sudd outflows.

Thus the inflows to the White Nile system are made up from a relatively steady seasonal outflow from the Bahr el Jebel swamps, and the contribution of the Sobat which retains seasonal variability after Baro spillage. The Sobat has, to some extent, been subject to decline in flows in recent years. This decline has also been a feature of the Blue Nile and other Ethiopian tributaries.

The combined inflows to the White Nile system have been measured at Malakal; although the rating curve is somewhat looped, the number of gaugings have been sufficient at over 70 a year and the flows are accurate. They are summarized in Table 8.1 and illustrated in Fig. 8.1. These show the muted seasonality of the flows and the increase after 1961–1964 which reflects the higher Bahr el Jebel contribution. However, the flows of the White Nile have decreased again in recent years as Lake Victoria levels and outflows have fallen, and the total flows are now little above those which occurred before 1961.

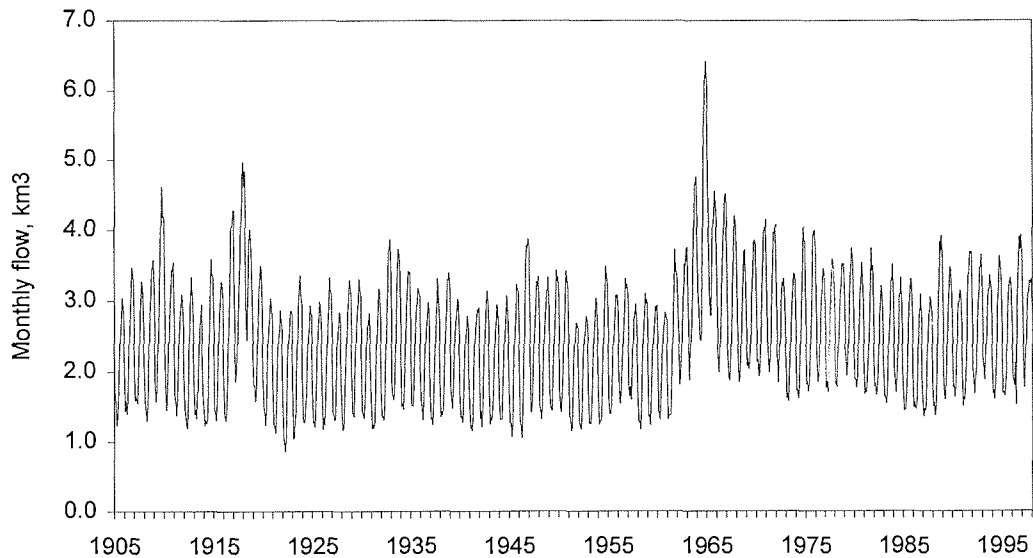

Fig. 8.1 White Nile at Malakal: monthly flows, 1905–1997.

OUTFLOWS FROM THE WHITE NILE

The White Nile outflows have been measured at the junction with the Blue Nile at Mogren in Khartoum since 1911, though the records for the first three years are incomplete during the period of the Blue Nile flood. Because the rating relation at this site is dominated by the Blue Nile levels the flows are interpolated between measurements. Thus the quality of the records is largely determined by the number of gaugings made each year; this information is summarized in Table 2.1. Between 1913 and 1943 the number of annual gaugings was usually between 60 and 120, with 150–200 in 1927–1929, but the number has declined since 1944 from 50 to about 30. However, since 1947 the number of measurements from July to October has decreased, and the discharges have been estimated from the sluice discharges at Jebel Aulia dam. This frequency of measurement is relevant to the losses derived by comparisons of inflows and outflows.

The effect on outflows in the early years of the natural backing up of the White Nile by the Blue Nile flood is illustrated by the flow record in Table 8.1, and in Fig. 8.2 by a

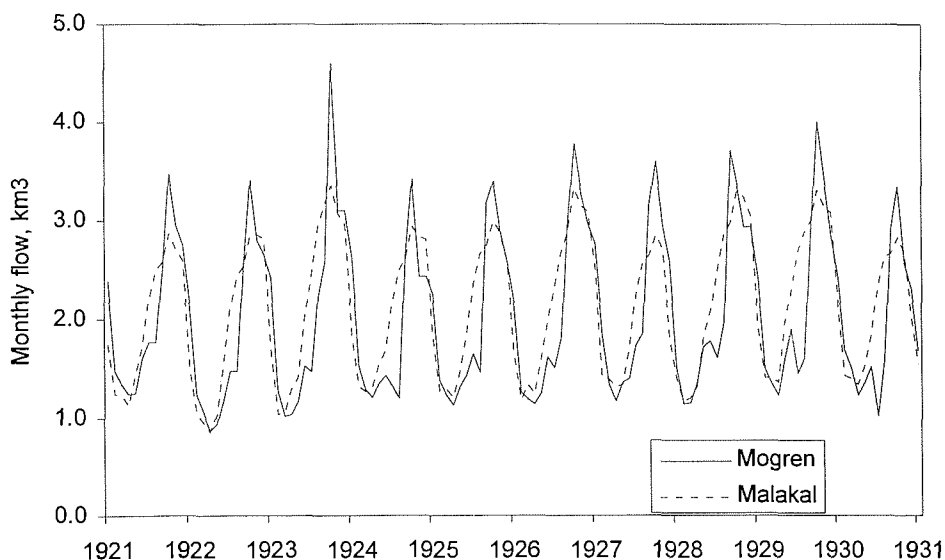

Fig. 8.2 White Nile at Malakal and Mogren: monthly flows, 1921–1930.

comparison of flows at Malakal and Mogren during the period 1921–1930. The flows at Malakal increase in June and rise to a peak in October, with a gradual recession until December or January. In contrast, the outflows at Mogren in these early years are held up by the Blue Nile flood until September or October, when the White Nile outflow exceeds the inflow at Malakal.

The flow pattern changed after 1937 when the White Nile outflow began to be controlled by the Jebel Aulia reservoir. The objective of the reservoir was to prolong the natural White Nile recession for irrigation downstream; the outflows were further decreased in July, August and September and the stored water released from October to April or May. Comparisons of flows at Malakal and Mogren are complicated by the construction of the dam and the natural increase in flows at Malakal after 1961. However, studies described below have been carried out to distinguish the natural attenuation and evaporation losses, from abstractions for irrigation and tributary contributions.

WATER BALANCE OF THE WHITE NILE FROM MALAKAL TO RENK

As part of the programme of the Jonglei Investigation Team (1954, vol. III, chapter 2) the water balance of the reach from Malakal to Renk was studied by J. W. Wright. Comparison of flows at Malakal and Renk showed that the Malakal flows exceeded those at Renk while river levels were rising, and the flows at Renk were the greater when levels were falling. This was assumed due to water spilling from the river to the flood plain and being held in storage until the river falls, when the stored water returns to the river. During the flood there is a water loss as a result of net evaporation from the water surface, and also from absorption or soil moisture recharge of newly flooded ground.

A water balance of the reach was based on measured 10-day inflows and outflows, 10-day river levels at different gauge sites and a relation between level and storage volume, with estimates of rainfall, evaporation and soil moisture recharge. The inflows and outflows, together with gauge levels, were available for 15 floods during the period 1928/29 to 1946/47. The means of rainfall records at Malakal, Melut and Renk were used to indicate rainfall over the flooded area. Open-water evaporation was estimated from Piche evaporimeter measurements at 2150 mm, which is not unreasonable. The absorption depth was estimated as 800 mm, which is high in physical terms; indeed, a much lower estimate of 300 mm was used in the water balance of the Sobat flood plain.

In order to derive a relation between gauge levels and storage volume over the valley, 22 cross-sections were analysed to provide mean idealized cross-sections linking elevation and total width. Thus the mean width, the total surface area and the volumes of the trough between Malakal and Melut and between Melut and Renk were related to the mean gauge levels at these pairs of sites. The assumption was made that the level in the flood plain coincided with the river level; this was not the case in the Bahr el Jebel basins surveyed but it is not unreasonable for the narrower flood plain of the White Nile. From this analysis the areas and volumes of flooding could be deduced for each 10-day period from the gauge levels at these three sites.

The apparent increases in storage deduced from inflows and outflows were compared with the observed levels and corresponding volumes of flood-plain storage, adjusted for absorption, rainfall on and evaporation from the flooded areas. This comparison gave a cumulative error in individual years which was attributed to inflow from tributaries along the White Nile. This analysis suggested that inflow was significant during certain years of high floods, especially on the Baro. Inflows from the Machar marshes appear to enter the White

Nile in some years and there are eye-witness accounts of such events (e.g. 1938–1939, 1942–1943, 1946–1947) but not systematic measurements. The analysis showed that the variation of flows between Malakal and Renk could be satisfactorily explained by analysis of the water balance of inflows, outflows and flood-plain storage.

Subsequent analysis (Institute of Hydrology, 1978) extended this study down to Jebel Aulia and used more recent records. Advantage was taken of the published relations (Hurst, 1950) between reservoir levels, storage volumes and surface areas to relate the total areas of flooding between Malakal and Jebel Aulia to observed water levels for the historical period. The estimation of evaporation losses from the flooded areas was based on average rainfall subtracted from Penman estimates of open water evaporation totalling 2350 mm. This had to be increased by 10%, including seepage, to equate predicted losses to those observed during the test period from 1948/49 to 1961/62, which was chosen for relatively low abstractions for irrigation. The water balance approach was found to give reasonable estimates of the total evaporation losses in this reach. When an attempt was made to estimate the effect of future levels influenced by water-saving projects like the Jonglei

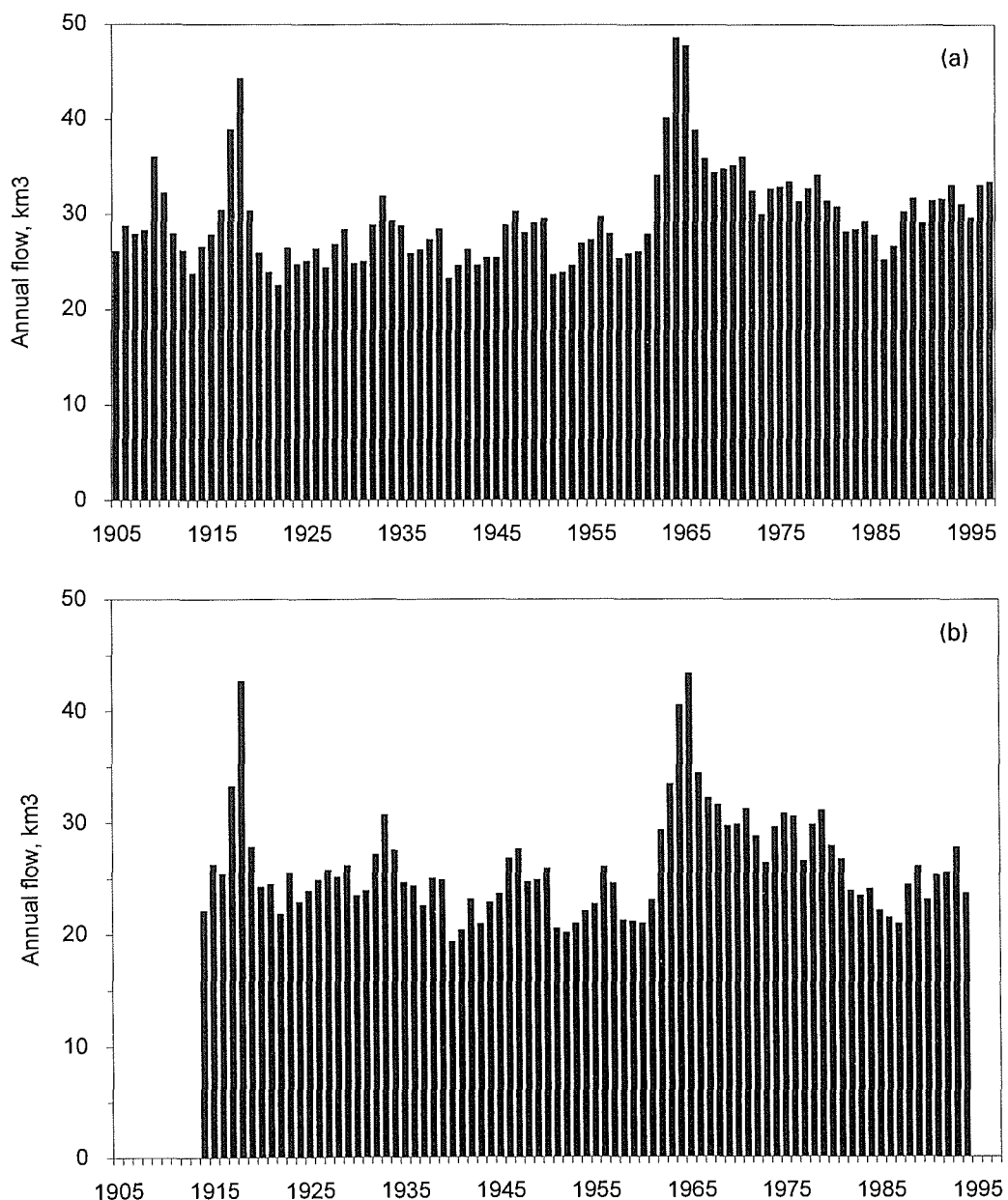

Fig. 8.3 White Nile at (a) Malakal and (b) Mogren: annual flows, 1905–1997.

Canal, Phase I, flows and thus water levels at Malakal exceeded their historic range. The rating curves at key sites and the relations between levels and valley storage required extrapolation, and hydraulic input would be needed if reliable estimates of the effect of further projects were to be made.

TRENDS OF LOSSES ON THE WHITE NILE

It is interesting to compare the measured inflows to the White Nile reach with the outflows over a longer period. Figures 8.3(a) and (b) compare the annual inflows at Malakal between 1905 and 1995 with the outflows at Mogren. The similarities between the two flow series are to be expected; the differences are shown in Fig. 8.4. The losses have clearly increased over the years, with scatter which is partly caused by random errors of measurement or over-year storage changes. The high losses in 1916–1917 are doubtless due to the high floods of that period. There is evidence of an increase in losses after the construction of the Jebel Aulia dam in 1934–1937, when the increase in maximum water surface between Melut and Jebel Aulia has been estimated as 1200 km² and the increased loss as 2.5 km³. There is also an apparent rise in the losses immediately after 1961–1964, when the increased Sudd outflows led to higher river levels. The trend also reflects increased irrigation abstractions in this reach, which have been estimated to have increased from 0.2 km³ in 1940 to 0.6 km³ in 1977, and thereafter to 1.6 km³.

VEGETATION OF THE WHITE NILE FLOOD PLAIN

The vegetation of the White Nile reach is affected by the large seasonal range of water levels, averaging about 2 m. Papyrus is not found in this reach, or in the White Nile upstream of the Sobat mouth, which is affected by backwater from the Sobat. Some studies carried out by the Jonglei Investigation Team have been analysed afresh and there is also a small-scale description of the White Nile flood plain near Gelhak.

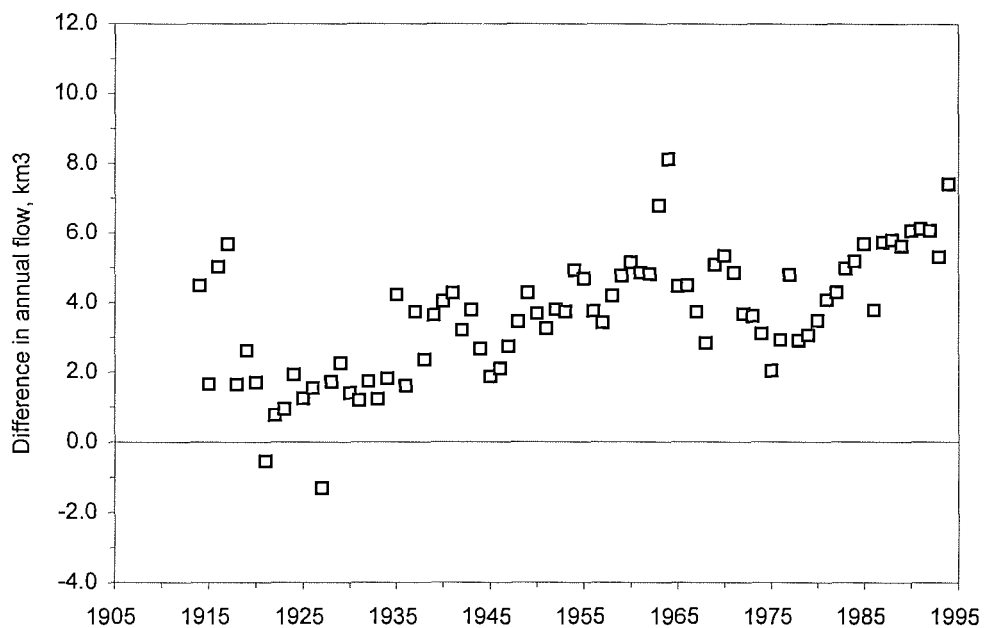

Fig. 8.4 White Nile: annual loss between Malakal and Mogren, 1914–1994.



Plate 8 The White Nile near Gelhak: view upstream from Jebel Ahmed Agha. The main river can be seen at the extreme right of the photograph.

As mentioned in Chapter 5, the Jonglei Investigation Team (1954, p. 154 *et seq.*) carried out studies of ground levels and vegetation at five sites on the White Nile. There were significant differences at each site between the levels at which various species were found, but these differences were not consistent from site to site. However, further analysis of the original data (Sutcliffe & Parks, 1996) showed that the levels of the transition between the shallow-flooded species (*Echinochloa pyramidalis* and *Oryza spp.*) and deep-flooded species (*Vossia* and *Echinochloa stagnina*) were related to maximum river levels, which were about 1.40–1.70 m above this vegetation transition.

Air photography was used to study the distribution of vegetation on the flood plain near Gelhak (11°N) and between Gelhak and Renk (11°20'N) in May 1953 during the dry season. The flood plain was divided into small basins on the same lines as the larger basins of the Bahr el Jebel swamps. There were obsolete channels parallel to the current channel which contained the remains of spill, especially where the side channels were prevented by the alluvial banks from draining back into the main river. The distribution of the vegetation, between the two bands of woodland which marked the limits of the flood plain, reflected the topography of these old channels (Plate 8). Bands of shrub or woodland flanked the banks of the river or the obsolete channels. The lower ground along the channel beds was subject to deeper flooding, which resulted in bands of *Echinochloa stagnina* with some *Vossia*. Adjacent to this deep-flooded vegetation were bands of *Echinochloa pyramidalis* and *Oryza spp.* on ground which was less deeply flooded. Thus the process of flooding in the White Nile reach was similar to that observed elsewhere, and the distribution of the flood-plain species was also similar.

EFFECT OF WATER-SAVING PROJECTS

The various projects which have been proposed to reduce evaporation losses in the wetlands of the Bahr el Jebel, Bahr el Ghazal and Machar marshes would have the effect of increasing the flows of the White Nile and perhaps of altering the seasonal variations of flow. It is clear that the ecological regime of the White Nile flood plain is similar to that of the other wetlands. The potential effects of the different proposals on water levels, evaporation losses and the flooding regime will require further investigation as the total flows will exceed those which have been experienced under natural conditions.

CONCLUSION

The White Nile receives the outflow from the Sudd, which provides the baseflow component, and the more seasonal contribution of the Sobat basin. The reach between Malakal and Khartoum caused natural attenuation through flood-plain storage, affected by the Blue Nile flood downstream. Since the construction of the Jebel Aulia dam the storage has resulted in increased evaporation, and the outflow has been delayed to supplement the Blue Nile in the low flow season.

CHAPTER 9

THE BLUE NILE AND ITS TRIBUTARIES

INTRODUCTION

The Blue Nile provides the greater part (about 60%) of the flow of the main Nile. However, rather limited information about its hydrology, especially in its upper basin within Ethiopia, has been published. In this chapter the available information has been used to compare its regime with that of the other tributaries and particularly the White Nile and its components.

This chapter deals in turn with the geography of the basin, the rainfall regime, the availability of flow records and the characteristics of the longer flow series; and a comparison of key stations to monitor losses and abstractions from the main river. A review of flood potential is illustrated with accounts of the 1988 flood and the development of flow forecasting. A brief review of sedimentation is followed by a discussion of reservoir control.

GEOGRAPHY OF THE BASIN

The topography of the Blue Nile basin is described from a hydrological viewpoint in *The Nile Basin*, vols VIII and IX (Hurst, 1950; Hurst *et al.*, 1959), which are well illustrated by photographs. The description is based on personal observation and the reports of the Lake Tana mission (Grabham & Black, 1925) and others for the Ethiopian basin. The Blue Nile and its tributaries (Fig. 9.1) rise on the Ethiopian plateau, which is concentrated at elevations of 2000–3000 m, with several peaks up to 4000 m or more. The plateau country is not flat but very broken and hilly, with grassy uplands, swamp valleys and scattered trees. There are occasional rocky peaks, some of which are of volcanic origin. The curious course of the river may follow the original drainage pattern radiating from such volcanic centres. The basin is cut by deep ravines or canyons in which the Blue Nile and other rivers flow. The valley of the Blue Nile is 1300 m deep in places, and the course of the river is often difficult to cross. The whole area is intersected by streams, most of which are perennial though highly seasonal in their flow.

The plateau drops steeply to the Sudan plains where there are many isolated outlying hills, some of which are as high as the plateau. The vegetation varies with altitude; the plateau is not in general thickly wooded, doubtless because of the seasonal nature of the rainfall. The extent of woodland appears to have decreased over the past 50 years. The Sudan plain, which

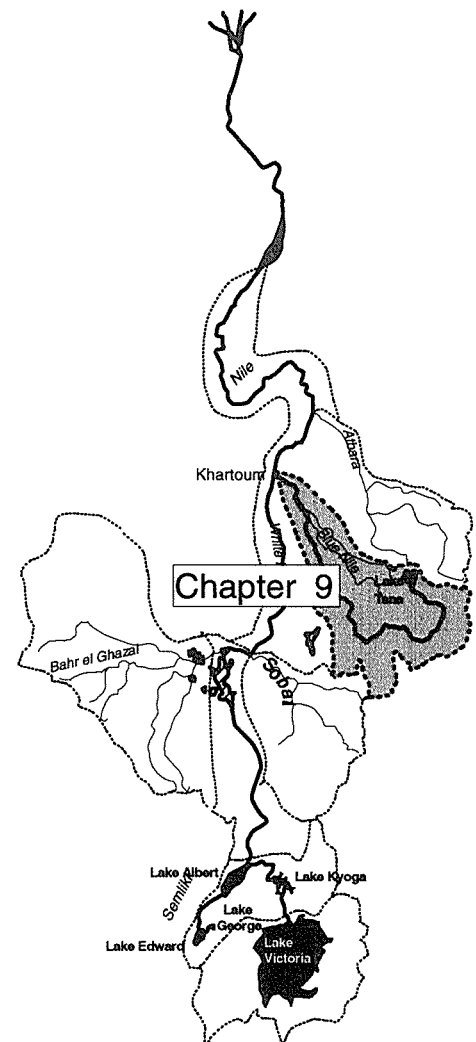

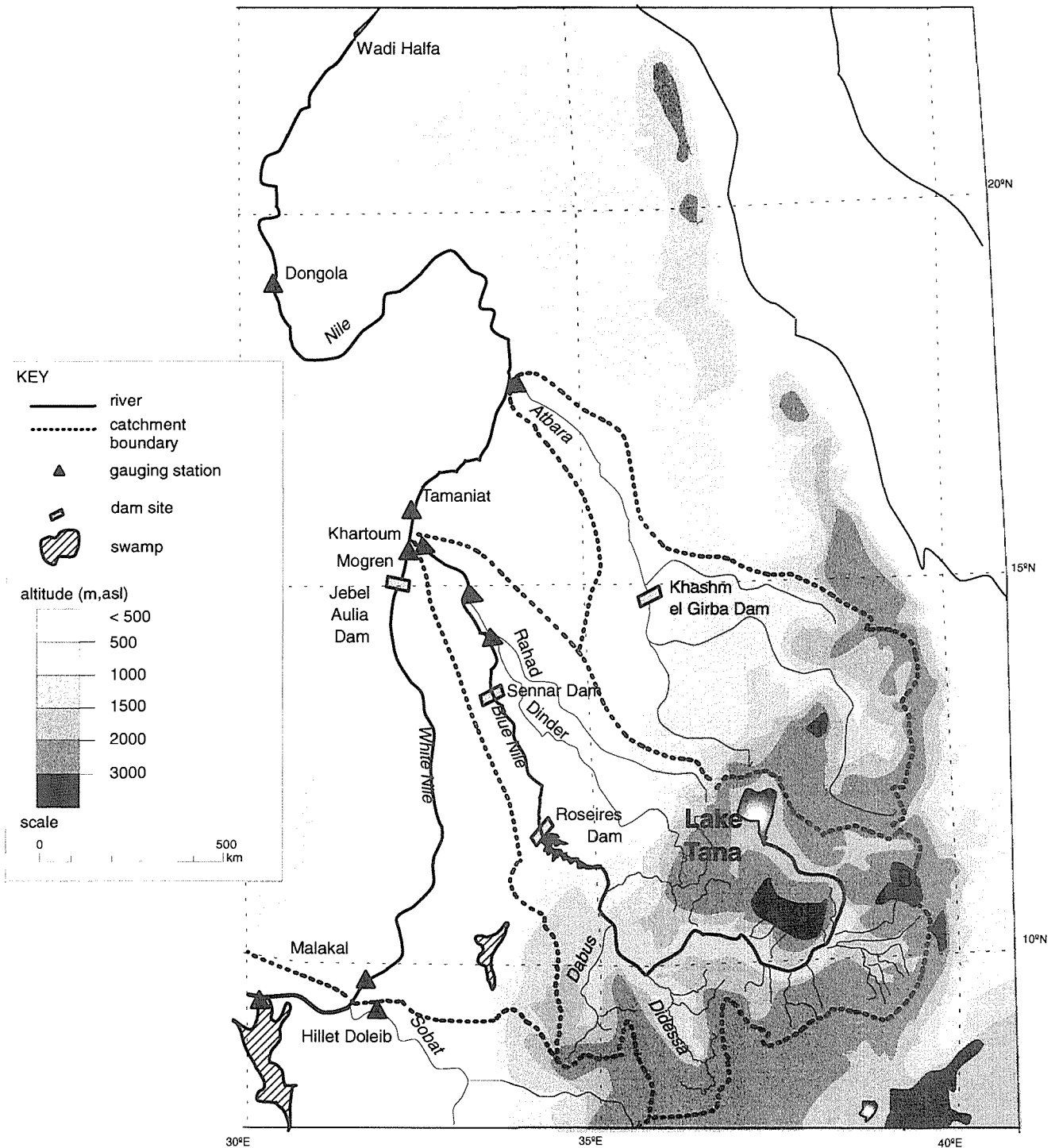

Fig. 9.1 Map of the Blue Nile, Atbara and main Nile.

slopes west from an elevation of about 700 m, is largely covered with thin savannah or thorn scrub.

Lake Tana is a feature of the upper basin which was studied (Grabham & Black, 1925) as a possible site for storage. The lake, at an elevation of about 1800 m, has a surface area of about 3000 km². Little of the 13 750 km² basin draining to the lake is above 2400 m, though it rises to nearly 4000 m to the northeast. The lake has many tributaries, like the Gilgel Abbay or Little Abbai with high and perennial, but highly seasonal, runoff. The level range of the lake between 1920 and 1933 was about 2 m, and the shoreline contains a number of swamps dominated by *Cyperus papyrus*; *Echinochloa pyramidalis* and *Echinochloa stagnina* provide grazing in areas flooded annually by the lake.

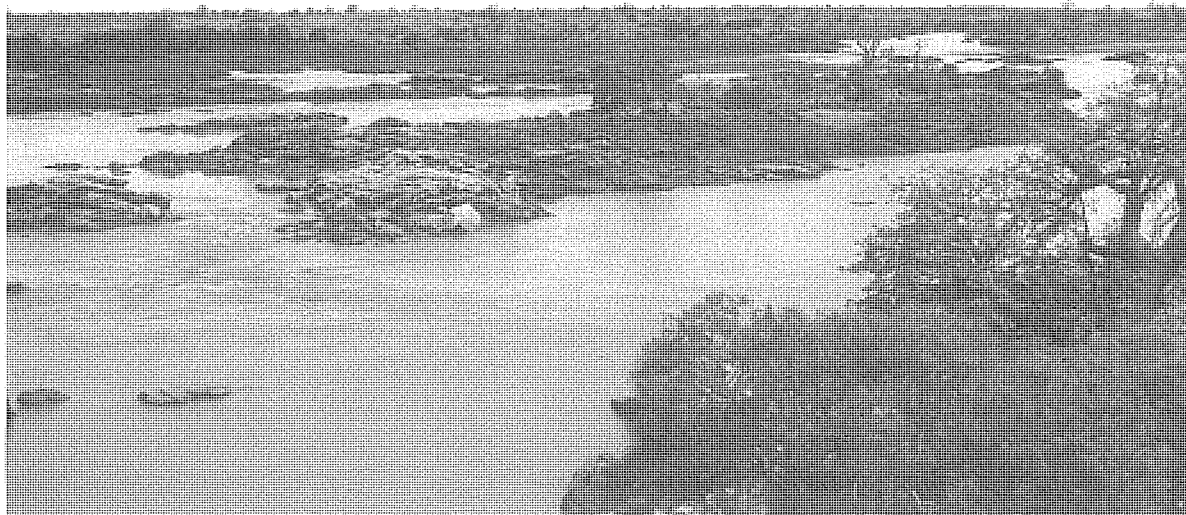

Plate 9 The Blue Nile below Roseires dam during the dry season.

The Blue Nile leaves the lake, which was formed by a relatively recent lava flow, through a series of cataracts. The Tississat Falls has a drop of 50 m. It then enters the Blue Nile ravine or canyon; the river profile is illustrated in Fig. 1.2. The vegetation is mainly thin savannah with small trees of acacia, Dom palms (*Hyphaene thebaica*) and Tebeldi (*adansonia*). The main river is joined by a large number of tributaries in steep valleys which are oversized by comparison with the present streams. The relative importance of the tributaries is indicated by the graph of contributions given by Rushdi Said (Said, 1993, p. 284) after the US Bureau of Reclamation (1964) study. The Didessa and Dabus, draining the southwestern and humid portion of the Ethiopian basin adjacent to the Baro, contribute significant fractions (over a third) of the total flow, especially at the start and the end of the runoff season. Other tributaries joining the main river from the east drain a wide area north of Addis Ababa. A number of tributaries drain an area of high rainfall in Gojjam in the loop of the river below Lake Tana. A feature of the Dabus tributary, the wetlands with an area of about 900 km² (Conway, 1997), has an effect in delaying runoff. There are smaller swamps in the Didessa and Finchaa basins, which are also in the south of the basin where the longer rainfall season allows wetlands to develop. There is a weir on the Blue Nile below Lake Tana for hydroelectric power and a regulator on the lake outlet. A dam was built on the Finchaa in 1972 with a capacity of 0.4 km³.

Below the Damazin rapids at Roseires, where the main reservoir storing Blue Nile waters for irrigation within Sudan was built in 1961–1966, the character of the Blue Nile (Plate 9) changes in response to its change of profile (Fig. 1.2). The river is little below the level of the surrounding plain, and some areas are inundated during the flood season. The country near the river is covered with thin acacia woodland, though much of the Gezira plain has been irrigated since the construction of the Sennar dam in 1925. The recent capacity of the Roseires reservoir is 2.4 km³ and that of Sennar is about 0.5 km³.

The Blue Nile receives two major tributaries from the north, the Dinder between Sennar and Wad Medani and the Rahad below Wad Medani. These drain country which is similar to

the lower Blue Nile basin within Ethiopia; both streams are highly seasonal. When they reached the plains in their natural condition they meandered and overflowed their banks to form basin lakes; they were reduced in the dry season (January–May) to a series of pools and a dry sandy bed.

RAINFALL AND EVAPORATION

The average annual rainfall over the Blue Nile basin above Roseires is about 1600 mm. It increases (Gamachu, 1977) from about 1000 mm near the Sudan border to about 1400–1800 mm over parts of the upper basin, in particular in the loop of the Blue Nile below Lake Tana, and above 1800 mm in the south within the Didessa basin. This high rainfall extends into the upper Baro basin (Chapter 7), with a value of 2400 mm at Gore. The seasonal rainfall distribution is governed by the migration of the ITCZ from south to north and back, so that the duration of the rainfall season decreases from south to north. In the south, in the upper basins of the Didessa and Baro, there is a tendency towards two rainfall maxima at some stations, especially in individual years. Gamachu (1977) compared rainfall with potential evapotranspiration, estimated by the Thornthwaite method, to give water budgets for selected stations. This revealed that the two main areas of high annual water surplus in Ethiopia are within the Nile basin in the Didessa and Baro basins and near Lake Tana.

In fact the runoff in Ethiopia is concentrated to the west of the Rift Valley. This corresponds broadly with the areas draining towards the Nile, where the rainfall in general occurs within a single season.

Figure 9.2 shows monthly mean rainfall totals at a number of stations in the Blue Nile and Sobat basins (Gamachu, 1977), with their relative positions maintained. This illustrates the tendency for rainfall to be concentrated within a shorter season from south to north. This is reflected in the river flows of the different tributaries. Conway (1997) has shown that it is possible to reproduce the 1951–1987 Blue Nile flow series near the Sudan border from distributed rainfall and potential transpiration estimates. He used a simple water balance approach in which runoff is generated by net rainfall after the soil moisture deficit has been satisfied, with a small component for direct runoff. Separate components were used for the outflows from Lake Tana and the Dabus swamps. The model was tested on short periods of flow records for other tributaries. The mean annual runoff for the 1951–1987 period was 47.37 km³ or 269 mm over the basin of 176 000 km², compared with an estimated mean annual rainfall of 1590 mm. This corresponds to a runoff coefficient of 17%; this reflects the relatively short rainfall season.

AVAILABILITY OF FLOW RECORDS

The assessment of the water balance of the Blue Nile is more dependent on downstream measurements than elsewhere in the Nile basin, as available information on the rainfall and water balance within Ethiopia is limited. Although some 100 gauging stations have been established within the basin in Ethiopia and flows are being processed using the HYDATA system (Asefa, 1997), only limited data have been published. Increased availability of hydrological information could only increase scientific understanding of the Nile system.

Gamachu (1977) has summarized the flows of four stations within the basin: the Angar (4349 km²); the Beles (3520 km²); the Chemoga (320 km²); the Gilgel Abbay (1600 km²). The mean flows from the five years 1965–1969 are summarized in Table 9.1. The runoff coefficients vary from 27% to 70%, though the latter figure is surprisingly high for a natural

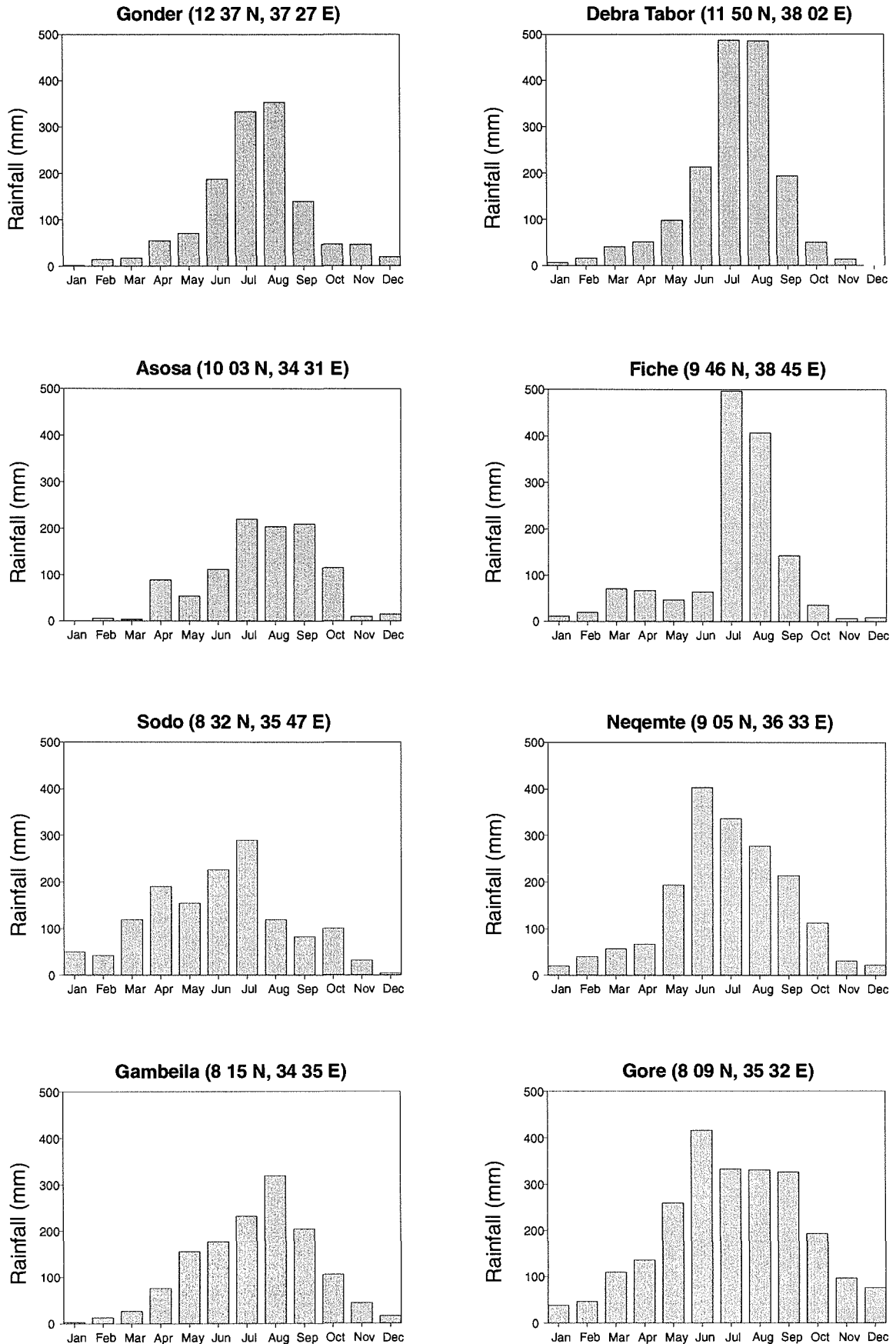

Fig. 9.2 Average monthly rainfall at Ethiopian stations (after Gamachu, 1977).

Table 9.1 Mean tributary flows in Blue Nile basin (1965–1969).

River	Lat. N	Long. E	Area (km ²)	Runoff: (km ³)	(mm)	Rain (mm)	Runoff coefficient (%)
Angar	9°26'	36°33'	4349	2.043	470	1500	31
Beles	11°10'	36°20'	3520	1.135	322	1200	27
Chemoga	10°18'	37°46'	320	0.179	559	1600	35
Gilgel Abbay	11°22'	37°01'	1600	1.681	1051	1500	70

basin. These tributaries have similar seasonal distributions, with about 90% of the runoff occurring in the four months July–October. Figure 9.3 (after Johnson & Curtis, 1994) shows monthly rainfall and runoff for the Chemoga basin, and illustrates the course of the runoff process. It shows that the early rainfall is required to replenish the soil moisture storage after the dry season, followed by the runoff of most of the later rainfall. This results in a lag of about a month between rainfall and runoff, even on a small tributary.

On the Blue Nile itself, flow records are available at the outlet from Lake Tana for the period 1920–1933 (with some gaps), at el Deim about 85 km above Roseires from 1962, at Roseires/Wad el Aies from 1912, and at Khartoum/Soba from 1900. There was an earlier level record at Khartoum from 1869 to 1883 during the flood period, but this was not supported by gauging; this record provides a comparison with flood levels recorded at Aswan during this period of high flows (Walsh *et al.*, 1994). The Dinder has been measured at Hillet Idris, near its mouth, from 1907 to 1951, with a record at Gwasi upstream from 1972; the Rahad has been measured at Abu Haraz near its mouth from 1908 to 1951, with a record at el Hawata from 1972. The gaps in the record between 1951 and 1972 were filled by means of a statistical model (Institute of Hydrology, 1978) based on the earlier concurrent series of monthly flows of the Blue Nile at Roseires and the Dinder and Rahad at their mouths. Months of low flow were grouped into seasons and a logarithmic transformation was used before analysis. Cross-correlations between the three flow series, and lag-one serial correlations within each series, were preserved in the flow generation, and a random element was introduced and a typical series selected. Monthly flow series are illustrated in Figs 9.4 and 9.5.

The records at el Deim and Roseires at the upstream end of the main channel of the Blue Nile within Sudan, and at Khartoum above its confluence with the White Nile (Plate 10), provide a comparison of flows. These indicate the balance between inflows, losses, abstractions and outflows within the reach.

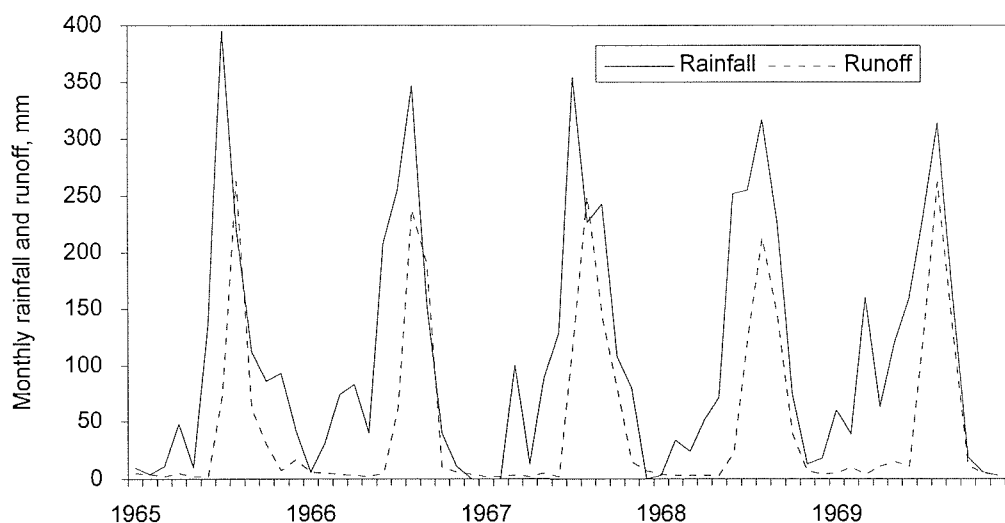
**Fig. 9.3** Rainfall and runoff for Chemoga basin, 1965–1969 (after Johnson & Curtis, 1994).

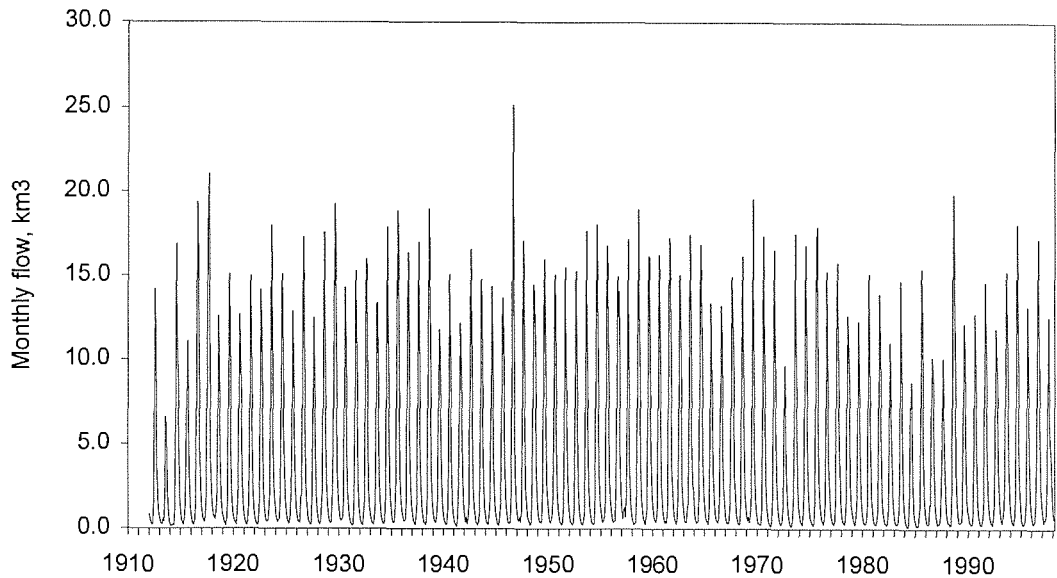

Fig. 9.4 Blue Nile at Roseires/el Deim: monthly flows, 1912–1997.

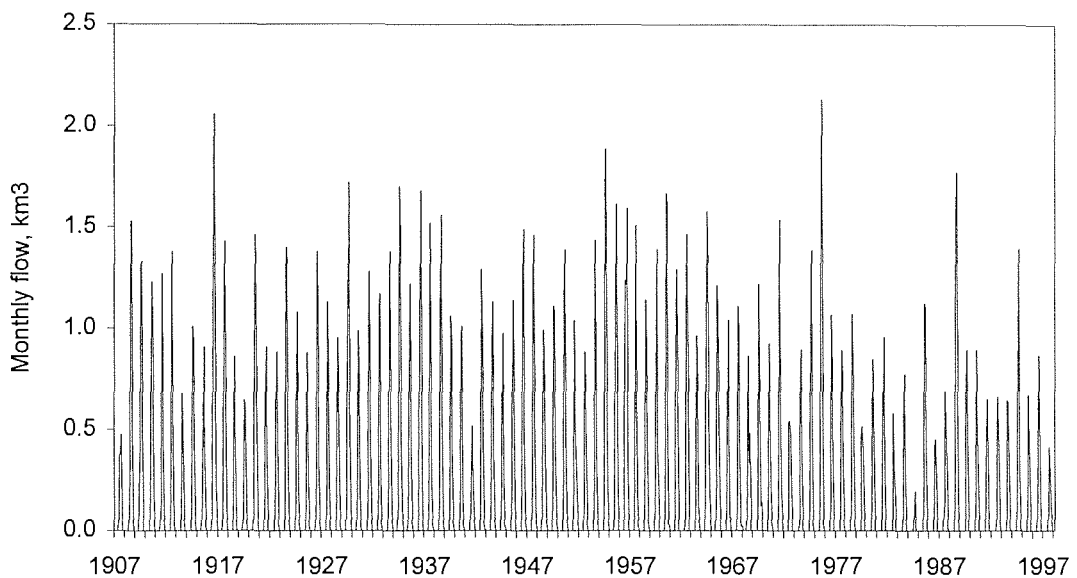

Fig. 9.5 Dinder at mouth/Gwasi: monthly flows, 1907–1997.

The key to the precision of the flow records is the number of gaugings carried out at each site during the period of records. Regular gaugings have been made at or near Khartoum (Table 2.1) since 1902, with about 40 a year at Soba for low flows and 30 at Khartoum for high flows. Levels have been recorded at Roseires since 1912; gaugings have been made at Roseires since 1918 for low flows and since 1922 at Wad el Aies for high flows, with up to 100 gaugings a year at Roseires and 30 a year at Wad el Aies. Thus the published flow record from 1912 to 1922 was based on general rating curves and may be considered less reliable than the later record. Gaugings were carried out on the River Dinder near its mouth from 1911, with more frequent measurements from 1922; about 30–100 gaugings were made annually. After the upstream site was established at Gwasi, frequent gaugings were carried out and the ratings were well defined. The same is true of the River Rahad, though there have been changes in bed levels at el Hawata at the upper site. The gaugings at el Deim started in 1962 and many measurements (over 200) were carried out in some years; the site is stable and the rating is reliable and precise.

The existence of flow records at Khartoum on the Blue Nile, at Mogren or Jebel Aulia dam on the White Nile, and at Tamaniat on the main Nile below the confluence, allows a



Plate 10 Confluence of the Blue Nile and White Nile, Khartoum. Note the lighter shade of the White Nile flowing from the far left.

check to be made by comparison. This (Fig. 9.6) showed annual differences with a fair amount of scatter in the early years from 1914 to 1930. After 1980 the apparent error increased again, with errors in 1986 and 1988 exceeding 10 km^3 . It is clear that some of the flows recorded for recent years have not been accurate; it was not possible to gauge the river at Khartoum or Tamaniat between mid-July and the beginning of October in 1988. In order to minimize the corrections to the published record, the Khartoum flows for August and September 1988 have been replaced in Fig. 9.8 and subsequent calculations by the differences between the flows at Tamaniat and those at Jebel Aulia dam.

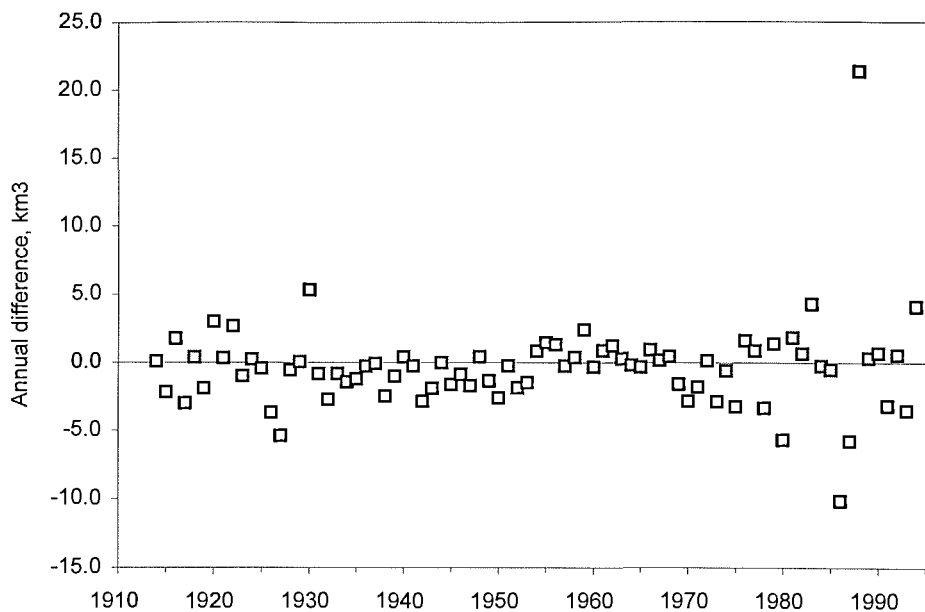

Fig. 9.6 Comparison of Khartoum flows: Tamaniat less Khartoum and Mogren, 1914–1994.

FLOWS AT VARIOUS SITES ON THE BLUE NILE

The flow records at the main sites are summarized in Table 9.2, and show the progress of the flow down the river system. Flows for different periods are summarized to illustrate declines since 1961, together with the overall mean. The outflow from Lake Tana is only available for the relatively short period 1920–1933. Over this period the total runoff average is 3.810 km³, with a range between 5.6 km³ in 1929 and 1.9 km³ in 1925 and 1930. The total outflow is about 230 mm from the lake area of 3000 km² and its basin of 13 750 km², but its seasonal distribution is not greatly damped by the lake storage. The peak outflow occurs in September–October, with a long low flow recession from January to June. The average flow of 3.81 km³ during the years of record compares with an average of 49.564 km³ during the equivalent years at Roseires; thus the lake outflow is only some 7.7% of the flow at Roseires.

The annual measured flows at Roseires/el Deim and Khartoum are illustrated in Figs 9.7 and 9.8. The long-term mean annual flow of 48.658 km³ at Roseires/el Deim from 1912 masks a variation from low annual totals of 20.69 km³ in 1913 and 29.65 km³ in 1984, to high totals of 69.67 km³ in 1917 and 69.85 km³ in 1929. The seasonal distribution of flows is very marked, with maximum monthly flows averaging 15.23 km³ in August contrasting with 0.32 km³ in April. The bulk of the runoff (84% on average) occurs between June and October. Since 1960 the average has declined because of the relatively low flows of 1979–1987, from 50.36 km³ in 1912–1960 to 46.47 km³ in 1961–1997. The difference between the peak month in August at Roseires/el Deim and in September at the outfall of Lake Tana shows the relatively slight effect of lake storage.

The Dinder (Fig. 9.9) and Rahad records also illustrate the reduction of flows in recent years. The average flow recorded at the mouth of the Dinder (1907–1960) is 3.086 km³,

Table 9.2 Mean flows at key sites on Blue Nile (m³ × 10⁶).

Jan.	Feb.	March	April	May	June	July	Aug.	Sept.	Oct.	Nov.	Dec.	Year
Blue Nile (Abbey) at outlet of Lake Tana (1920–1933)												
208	124	83	43	28	26	97	503	995	841	519	344	3 810
Blue Nile at Roseires/el Deim (1912–1960)												
796	468	376	331	621	1648	6651	15 647	12 859	6889	2684	1385	50 355
(1961–1997)												
716	417	348	315	600	1672	6911	14 672	11 119	5946	2394	1299	46 411
(1912–1997)												
762	446	364	324	612	1659	6763	15 228	12 111	6484	2559	1348	48 658
Blue Nile at Khartoum (1900–1960)												
852	509	437	367	490	1210	5401	15 963	14 931	8245	2889	1497	52 791
(1961–1995)												
501	342	352	532	526	865	4248	13 933	11 280	5128	1665	826	40 199
(1900–1995)												
724	448	406	427	503	1084	4989	15 237	13 625	7130	2451	1257	48 279
Dinder at mouth/Gwasi (1907–1960)												
0	0	0	0	0	17	355	1 085	1 123	433	64	8	3 086
(1961–1997)												
1	0	0	0	0	15	265	887	841	333	31	2	2 374
(1907–1997)												
0	0	0	0	0	16	318	1 005	1 009	392	51	6	2 797
Rahad at mouth/el Hawata (1908–1960)												
0	0	0	0	0	2	106	350	396	259	29	3	1 145
(1961–1997)												
0	0	0	0	0	2	137	342	353	185	25	1	1 044
(1908–1997)												
0	0	0	0	0	2	119	346	378	228	27	2	1 102

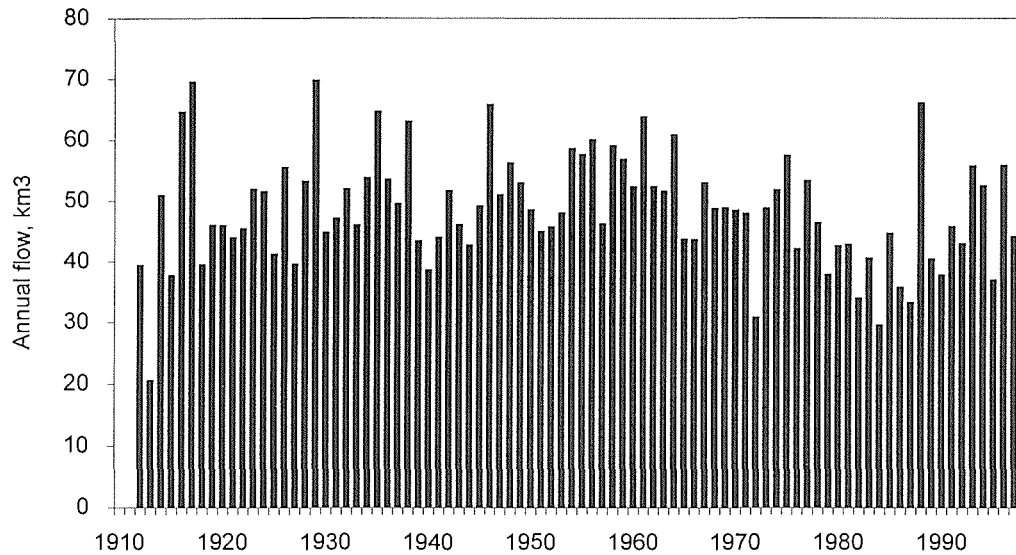

Fig. 9.7 Blue Nile at Roseires/el Deim: annual flows, 1912–1997.

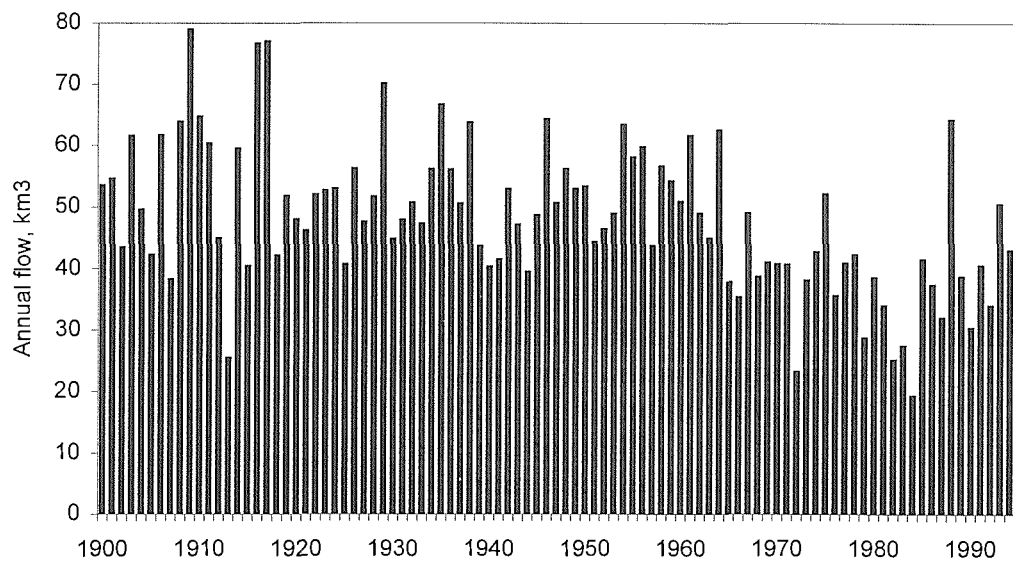

Fig. 9.8 Blue Nile at Khartoum: annual flows, 1900–1994.

compared with the later upstream record (1961–1997) of 2.374 km^3 . The corresponding average flows for the Rahad are 1.145 km^3 (1908–1960) and 1.044 km^3 (1961–1997). These comparisons underestimate the real decline because channel losses between the upper and lower sites are neglected. The range of annual flows is great in both cases; the maximum recorded in the early years was 5.65 km^3 in 1916 for the Dinder and 1.96 km^3 in 1909 for the Rahad, compared with low flows in 1941 of 1.24 and 0.53 km^3 respectively. These low flows have been superseded in 1984 by flows of 0.31 km^3 on the Dinder and of 0.34 km^3 on the Rahad. In each case the average peak flow occurs in September, marginally above the average for August; there is an extended period from January to May or June in most years when there is no flow recorded.

The flows of the Blue Nile recorded at Khartoum and Soba reflect the inflows of the Dinder and Rahad to the Blue Nile, the natural channel losses between Roseires and Khartoum and significantly the abstractions for irrigation and to a lesser extent for urban supply. The annual flows at Khartoum (Fig. 9.8), compared with Roseires (Fig. 9.7), show the effect of these factors. Together with the recent decline in runoff from the Blue Nile basin, these are responsible for the marked decline in Khartoum flows since about 1965.

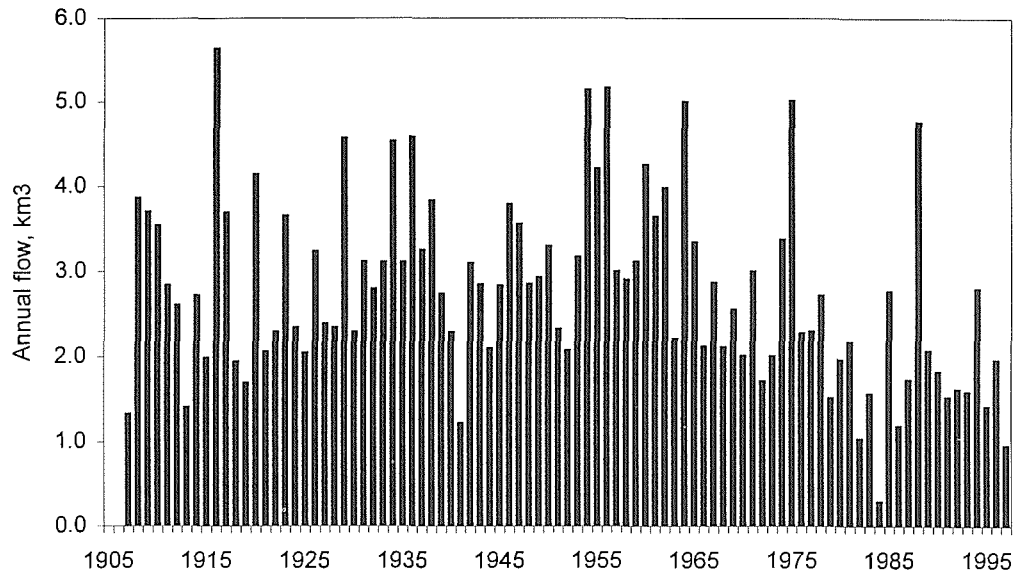

Fig. 9.9 Dinder at mouth/Gwasi: annual flows, 1907–1997.

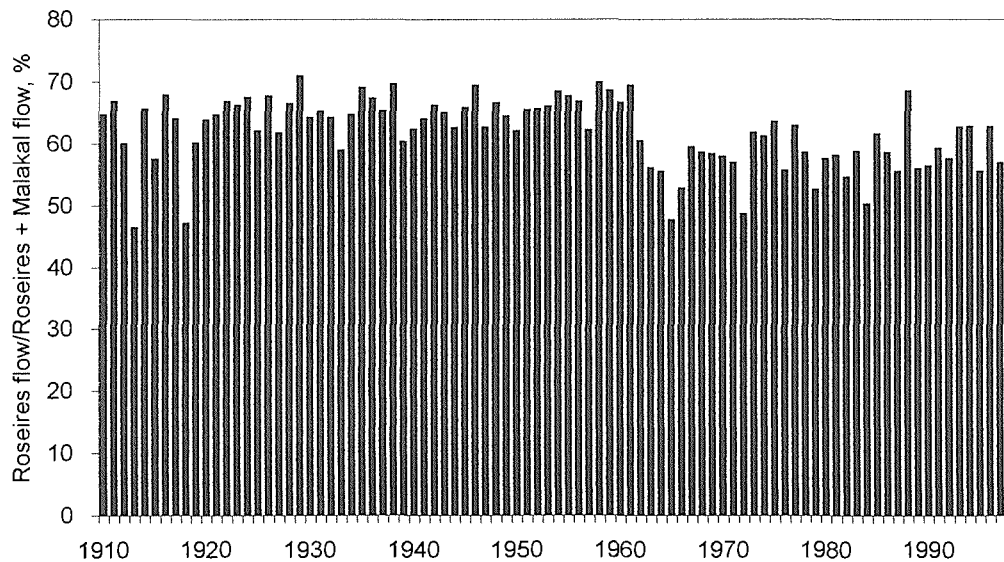

Fig. 9.10 Blue Nile contribution to total flow: Roseires flow as percentage of Roseires + Malakal, 1912–1995.

There has been a marked contrast between the annual series of contributions of the White Nile and the Blue Nile to the total resources of the Nile. Because of abstractions it is preferable to compare the flows at Roseires or el Deim with those at Malakal; the latter include the losses in the Sudd. The change over the years is illustrated by Fig. 9.10, where the annual flows at Roseires/el Deim are expressed as a percentage of the sum of the flows at Roseires and at Malakal. It is clear that the contributions of the Blue Nile, though still the major part of the joint flow, have decreased in importance from about 65% to about 55% over the course of the century. This is due to a combination of the rise in Lake Victoria after 1961 and the more recent decline in Blue Nile flows. It would, however, be unwise to predict future trends.

LOSSES BETWEEN ROSEIRES AND KHARTOUM

Evidence of channel losses and abstractions is given by the differences over the years between the sum of Roseires/el Deim, Dinder and Rahad, and those at Khartoum, which are shown in

Fig. 9.11. There is evidence of a steady increase over the years, but this is to some extent obscured by scatter caused largely by random errors. The apparent losses must be affected by the comparatively poor flow records at Roseires before 1922, when a general rating curve was used due to lack of gaugings. The recent scatter can be attributed largely to data uncertainties.

The main abstractions from the Blue Nile, the discharges of the Gezira main canal from 1925 and the discharges of the Managil main canal from 1959, have been published in *The Nile Basin*, vol. IV and supplements. The total abstractions over the period are included in Fig. 9.11. The net loss, indicated by the difference between apparent loss and abstractions, has averaged about 2 km³. This is not unreasonable for net evaporation from a main river length of 624 km between Roseires and Khartoum, with an average width of about 300 m. Reservoir evaporation, which includes Sennar from 1925 and increased after 1966 with the completion of Roseires dam, has been estimated as about 0.5 km³.

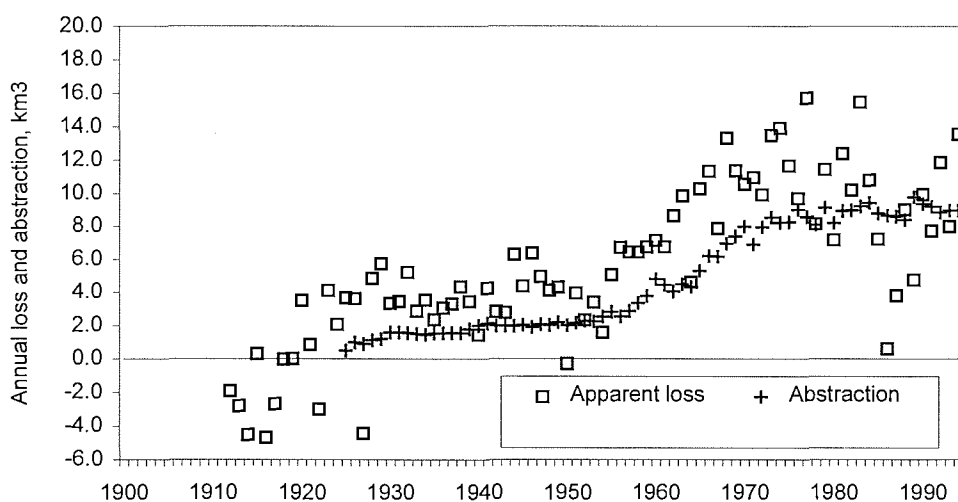

Fig. 9.11 Blue Nile: annual losses from Roseires (including Rahad and Dinder) to Khartoum, 1912–1994.

FLOOD REGIME

The Blue Nile at Khartoum has greater flood potential than the White Nile as flood peaks are experienced without attenuation by major lake storage or wetland spilling. This was illustrated during 1988, when heavy rainfall over Khartoum and to the north was compounded by floods on the Blue Nile and Atbara (Sutcliffe *et al.*, 1989). These together caused severe damage along the river. The main immediate damage in the Khartoum area was caused by a severe storm on the night of 4/5 August 1988 which recorded daily rainfall of 200 mm or more at sites in the city. An approximate estimate of 500 years (Hulme & Trilsbach, 1989) was made for the return period of the storm. The river flood was also significant, with a peak level reached on 27 August 1988 which was second only in this century to the flood of 1946. There was at the time concern in Khartoum about the possibility of inundation, and information on cold cloud cover over the Ethiopian basins of the Blue Nile and Atbara was derived at Reading University and passed to Khartoum, providing assurance that further rises were not imminent.

The 1988 floods can be put into perspective by flood frequency analyses at gauging sites. The peak flows were not published, so the highest discharge measurement in each year was taken as the annual maximum flow. Linear flood frequency relations were fitted at a number of sites. An example (Fig. 9.12) for the Blue Nile at Khartoum shows that the 1988 peak flow (estimated at 8500 m³ s⁻¹) had a return period of about 10 years. Analysis at other sites

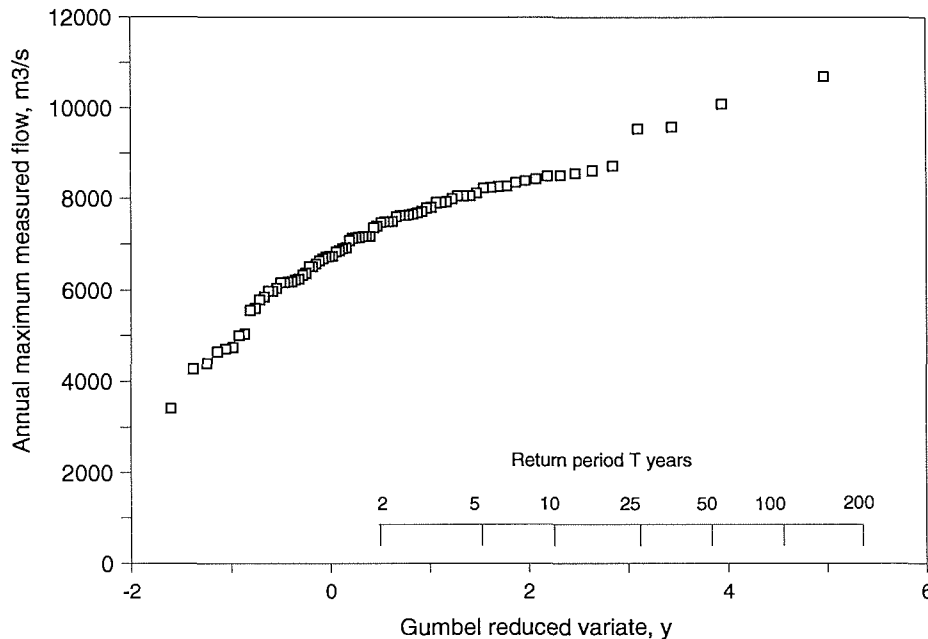

Fig. 9.12 Blue Nile at Khartoum: flood frequency, 1902–1992.

(Sutcliffe *et al.*, 1989) showed that the flow had a return period of about 10 years from Roseires to Tamaniat, but a higher return period of 50–100 years on the main Nile below the Atbara confluence.

However, a similar study of historical peak levels at Khartoum suggested that the 1988 peak level corresponded to a return period of about 50 years, exceeding the 10-year estimate for flows. A comparison of annual maximum measured flows and corresponding levels for the period 1902–1982 suggested that the level at Khartoum gauge had risen by about 0.5 m over this period for a typical flood flow. Similar trends were found at Tamaniat below the confluence and suggested that channel change or aggradation might have occurred. This would account for the apparent discrepancy between the return periods of flows and levels.

The record length at Khartoum has been extended by research on historic level records. Walsh *et al.* (1994) made use of the levels observed between 1869 and 1883, which Hurst & Phillips (1932) in *The Nile Basin*, vol. III had related to the zero of the later gauge. They (Walsh *et al.*) also estimated annual flood levels at Khartoum for the period 1884–1898 by regression from peak levels at Aswan. They concluded that the 1946 peak had been exceeded at least three times between 1869 and 1900. Inclusion of these floods would reduce the return period of the floods recorded in this century; floods of this magnitude could occur more frequently than recent records suggest.

The floods of the Blue Nile are less variable than those of rivers in many parts of the world (Meigh *et al.*, 1997). Consequently, floods of high return period are unlikely to reach high multiples of the mean annual flood. This is a common feature of rivers relying on a single well-defined rainfall season, as opposed to rivers in semiarid areas. For example, the daily peak of the probable maximum inflow flood at Roseires has been estimated (Snyder *et al.*, 1961) as about $19\,000\text{ m}^3\text{ s}^{-1}$ compared with the 1946 daily peak of about $11\,000\text{ m}^3\text{ s}^{-1}$.

FLOW FORECASTING SYSTEMS

It was shown during the 1988 flood that cold cloud data from satellite imagery could provide useful information on rainfall amounts, from which flow forecasts could be made. This procedure has the advantage, in areas of difficult access, that it does not depend on direct

rainfall measurement and data transmission in real time. This was developed in the River Senegal (Hardy *et al.*, 1989) and was used to provide a flow forecasting system for the Blue Nile and the River Atbara.

The three main components of the forecasting system (Grijzen *et al.*, 1992) are: the collection of cold cloud duration data and their conversion to rainfall estimates in real time; the conversion of rainfall estimates to river flow forecasts at key sites; the modelling of flood transmission down the main channels to forecast levels and flows at key points. These components are supported by a data collection and transmission system.

Rainfall estimation is based on cold cloud duration (CCD) below a temperature threshold, and linear regression with rainfall records by calendar months and sub-catchments. The conversion of rainfall estimates to river inflows was based on development of the Sacramento conceptual model, which is quasiphysical and allows limits to be set for certain parameters. Daily actual flows are used to update the model parameters, and this procedure was extended to operate on the CCD-rainfall conversion within the model. The combination of rainfall estimation and a rainfall-runoff model allows river flows to be forecast up to three days ahead on the Blue Nile and thus increases the forecast lead at Khartoum from three to six days. The forecasts for the Dinder and Rahad are based on regression. The transmission of the inflow flood hydrograph down the channel and reservoir system is analysed by a one-dimensional dynamic flow model, based on the equations of continuity and momentum; this model takes account of abstractions and tributary inflows. Although the system is geared to forecasting flows during the flood season, there is the prospect that it could be used to forecast the start of runoff on the various Blue Nile tributaries.

SEDIMENTATION

The Blue Nile is the first of the Nile tributaries where the sediment load is of critical importance. The White Nile tributaries on the whole are lake-fed or lose much of their sediment load by spilling and deposition over flood plains. The Blue Nile, by contrast, has a highly seasonal flow regime and carries a significant sediment load during the flood period. The basin is steep and the vegetation is relatively sparse because of the short rainfall season. The seasonal distribution of sediment is important. The storage available in Roseires and Sennar reservoirs is fairly limited and it is vital to minimize the sedimentation by reservoir operation during the period of filling. According to El Moushid *et al.* (1997), the suspended sediment load of the Blue Nile at el Deim is estimated as 140 million tonnes per year during the flood season. The sediment concentration reaches a peak of nearly 6000 ppm in early August, before the peak discharge is reached, and decreases until the end of the flood. After nearly 30 years, the capacity of Roseires reservoir had been reduced by 0.9 km³ by 1995, when the capacity was estimated from satellite imagery at 2.4 km³. The dam is currently being raised. The strategy for the Blue Nile reservoirs is to delay the filling until the peak of the flood has passed through the reservoir, as the sediment load is greatest on the rising limb of the hydrograph. Forecasting of future flows could provide a means of minimizing the risk of the reservoir not being filled while postponing the filling as late as possible in order to reduce sedimentation.

OPERATION OF BLUE NILE RESERVOIRS

Because the dry season flows of the Blue Nile and its tributaries are limited, the water stored from the previous flood season in Roseires and Sennar reservoirs is essential to the irrigated

agriculture of the Gezira and associated schemes. A second important function of the reservoirs is to provide hydroelectric power, and the joint operation of the reservoirs needs careful planning.

Within the limits on inflows and storage, and on abstraction permitted by the Egypt–Sudan agreement of 1959, the aim of the Sudan authorities (Sutcliffe & Widgery, 1997) is to maximize irrigation, hydropower and water supply while minimizing sedimentation. The policy has been to draw down Roseires and Sennar reservoirs during the flood season. This drawdown, which coincides with high tail water levels, has a major impact on hydropower operation. Reservoir filling rules have been based on flow statistics to minimize sedimentation while ensuring filling. During the flood recession, when the future inflow may be estimated, the area to be planted with wheat must be decided; other crops like cotton will already have been planted. Operating rules have been developed to optimize hydropower production at Roseires (capacity 275 MW) and Sennar (15 MW) in terms of water availability and irrigation demand; the problem is complex because energy demand increases during the hot season and does not coincide with irrigation releases.

In the past the dry season recession flow of the Blue Nile, which forms a useful supplement to the stored water, was forecast using either a “similar year” method or a recession constant linking successive 10-day flows. A recent case study by Osman Eltom Hamad (Hamad, 1993) was designed to provide an improved method of operating the reservoirs during the dry season. To model the inflows he proposed the use of a nonlinear reservoir system, whose parameters are derived from the flow records for individual years. It was found that the flow series for each dry season could be forecast from the flow in October, using a single slope parameter related to the preceding flood and the previous year’s flow. This forecast method provided generally better results than previous methods.

In some years flows rise in March–May because of equatorial spring rains on the southern tributaries. A forecast of these flows might be used to plan the area of irrigable crops to be planted each season, and also to plan the operation of the reservoir system: to provide irrigation requirements, to provide minimum releases downstream and to generate hydropower while taking into account channel losses. The model includes a water balance of the reservoir, which takes account of changes of storage, rainfall and evaporation, river inflow, abstractions, releases and transmission losses. The simulation of hydropower generation takes account not only of turbine flow but also head differences and efficiency; it has to take account of the relation of reservoir storage to level, which again varies over time with sedimentation. Comparison of hydropower generation with the reservoir operated according to this model, with results obtained earlier, showed that there would have been significant improvement.

CONCLUSIONS

The Blue Nile contributes a large proportion of the total flow of the Nile, but its regime differs markedly from the White Nile tributaries because of pronounced seasonal and annual variations. The decrease in flows over the years, influenced to some extent by increasing irrigation abstractions, contrasts with the outflows from Lake Victoria and thus the flows of the White Nile which have shown considerable increases after 1961–1964. The management of water resources systems can be improved by better forecasting of flood flows, and a review of flood potential is needed. It is possible that the extension of rainfall monitoring to the early rains, which result in the inflow to Roseires reservoir during April/May, could also improve the operation of the joint reservoirs. An exchange of hydrological information between Ethiopia and Sudan could lead to improved operation of the reservoir system.

CHAPTER 10

THE ATBARA AND MAIN NILE TO WADI HALFA

INTRODUCTION

The reach from Khartoum to Wadi Halfa is about 1500 km in length and receives the last tributary to join the Main Nile; the Atbara is the most seasonal of the major tributaries. This chapter describes the topography and climate of this reach, and compares the regime of the Atbara with the other tributaries. The flow records at various sites on the main river are presented, and the precision of measurements is discussed. Comparisons over the period of record illustrate channel losses and abstractions for irrigation.

TOPOGRAPHY

This reach stretches from the confluence of the Blue Nile and White Nile down to Wadi Halfa. At 1490 km it is one of the longest discussed so far, but the only tributary is the Atbara. The topography of the river valley has been described by Hurst *et al.* (1959). Except for the Sabaloka gorge about 80 km north of Khartoum, the Nile flows through an arid plain which is dotted with many low hills and rock outcrops. For most of its course from Khartoum to Kerma (19°40'N) there are few hills close to the river. North of Kerma rocky hills approach the river, which runs near Wadi Halfa in a narrow rocky valley. Much of the reach is underlain by Nubian sandstone, which gives way to Basement Complex northeast of a line from Atbara to Dongola. Practically all the rapids and cataracts occur on the Basement Complex, including those between Atbara and Merowe and between Dongola and Wadi Halfa.

The river profile from Khartoum to Aswan (Fig. 10.1), adapted from Shahin (1985, Fig. 2.23), shows the comparatively gentle gradient between Khartoum and the 5th Cataract below the Atbara mouth. There is a steep segment between the 5th and 4th Cataracts and a relatively low gradient between the 4th and 3rd Cataracts, followed by a steep reach between the 3rd and 2nd Cataracts upstream of Wadi Halfa. Sixteen principal rapids between Khartoum and Wadi Halfa with a total fall of 102 m over a length of 228 km are listed by Hurst *et al.* (1959). The gradient of the river is extremely variable, with a minimum of 3.2×10^{-5} and a maximum of 1×10^{-3} . The average channel width, from gauging stations and other sites (Adam *et al.*, 1994), is about 600 m, from which the evaporation over the reach may be estimated.

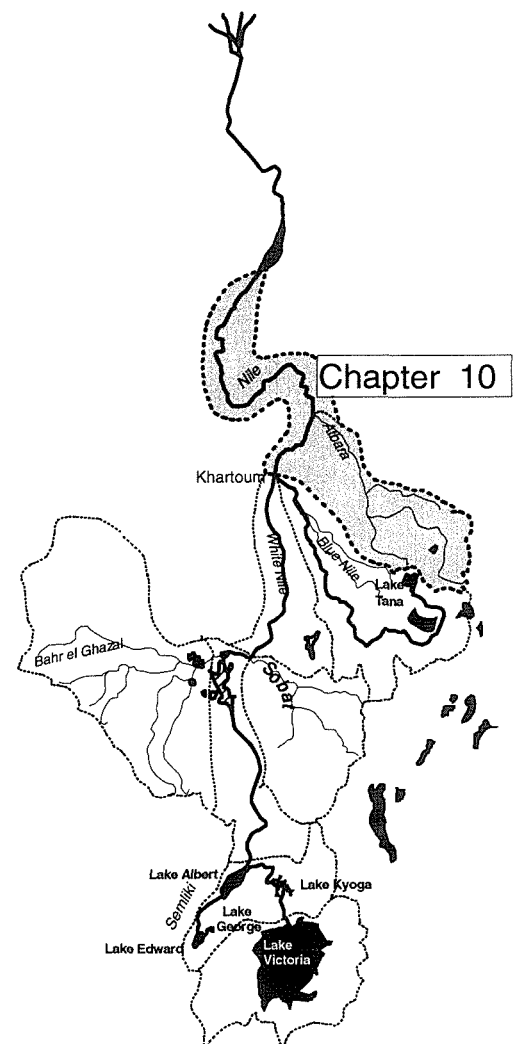

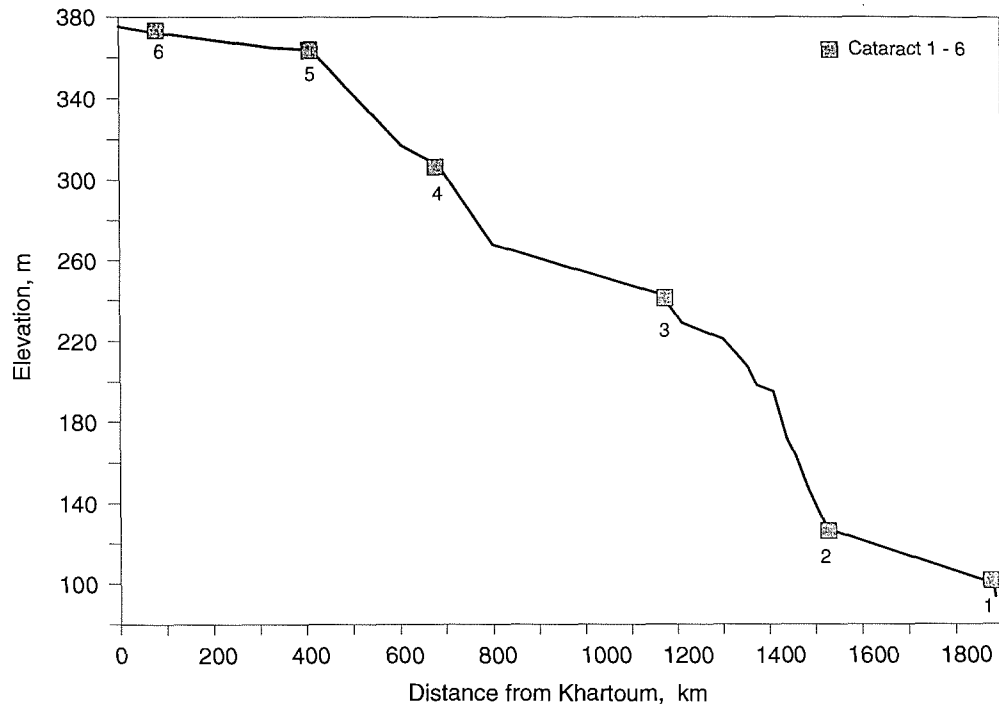

Fig. 10.1 Nile profile from Khartoum to Aswan (after Shahin, 1985).

The Atbara basin has been described by Hurst (1950). The Atbara, and in particular its more northern tributary the Setit or Tekeze, drains a wide area, 68 800 km², of northern Ethiopia and part of Eritrea. The Atbara, above its confluence with the Setit, drains about 31 400 km² of the mountains north of Lake Tana and the plain to the west. The country is rough and uneven, with some acacia bush. The lower basin within the Sudan is eroded below the plain and is joined by intermittent streams or “khors”. The mean annual rainfall has been estimated (Hurst *et al.*, 1959) as about 950 mm, with the rainfall season shorter than the Blue Nile basin and concentrated in August and September.

LAND USE AND CLIMATE

Because of the arid climate, natural vegetation along the Nile is sparse, with some acacia scrub and Dom palms. Originally the local people along the river relied on livestock and small areas of irrigated land, but pumped irrigation has allowed this area to be developed to a considerable extent. Much of the irrigated land lies between the Sabaloka gorge and Atbara, and below Merowe and Dongola. Irrigation abstraction has risen since 1950 to about 1 km³ over some 150 000 ha. The economy was sufficiently developed by 1988 for a fair amount of

Table 10.1 Average rainfall and evaporation at sites on main Nile (mm).

	Jan.	Feb.	March	April	May	June	July	Aug.	Sept.	Oct.	Nov.	Dec.	Year
Average rainfall													
Khartoum	0.0	0.0	0.1	0.3	4.6	5.6	41.0	64.7	22.0	3.8	0.5	0.0	142.6
Atbara	0.0	0.1	0.0	0.8	2.9	1.5	19.7	31.8	6.1	1.5	0.0	0.0	64.4
Wadi Halfa	0.1	0.0	0.0	0.0	0.3	0.0	0.6	0.3	0.0	0.3	0.0	0.1	1.7
Open water evaporation (Penman estimate (after Shahin, 1985))													
Khartoum	223	218	288	315	322	303	260	211	213	276	246	220	3095
Atbara	170	174	232	318	288	270	273	267	258	307	195	174	2926
Wadi Halfa	140	162	220	261	288	294	298	288	258	239	183	124	2755

damage to be caused by flooding. There was some flood irrigation along the upper Atbara before the construction in 1960–1964 of the Khashm el Girba dam with an initial capacity of 1.3 km^3 ; since then irrigation has taken about 1.4 km^3 of water annually.

The main feature of the climate of the main Nile reach is the low precipitation. The most recent normals for key stations are given in Table 10.1. This rainfall is so low by comparison with open water evaporation, also tabulated, that the focus of attention in this reach has been on channel losses. There is unlikely to be any significant inflow from local drainage, except during exceptional storms like that of August 1988 (Chapter 9).

EARLY ACCOUNT OF THE HYDROLOGY OF THE REACH FROM KHARTOUM TO WADI HALFA

The main hydrological interest of this reach is in the time of travel, which varies according to flow, and in channel losses. These are a compound of actual losses through open water evaporation and bank storage, abstractions for irrigation and other uses, and also include measurement errors at gauging sites.

The times of travel have been studied by examples of fluctuations in flood flow from the Blue Nile and of releases from Jebel Aulia reservoir (Hurst *et al.*, 1959). The travel times from Khartoum to Atbara (300 km) were found to vary from 1 day at high levels to 5 days at low levels; this is equivalent to a rate of travel varying from 300 to 60 km day^{-1} . A number of gauge fluctuations were traced between Atbara and Wadi Halfa, a distance of 1170 km; the times of travel varied between 5 and 12 days, corresponding to velocities of 230 to 100 km day^{-1} .

The average losses from Khartoum to Atbara were estimated by Hurst *et al.* (1959) from 1912–1952 flows at Tamaniat and Hassanab as 1.2 km^3 , or 1.6% of the upstream discharge. The net losses during the high flood of 1946, when $700\text{--}800 \text{ km}^2$ were inundated, were estimated as 1.8 km^3 . Comparisons of 1912–1952 flows at Hassanab, Atbara mouth and Wadi Halfa or Kajnarty led to an estimated annual loss between Atbara and Wadi Halfa of 0.800 km^3 . The distribution of losses between the two reaches seems disproportionate; however, the early flows at Hassanab were not based on contemporary gaugings, and the estimates before 1922 do not provide consistent estimates of losses. This topic is dealt with later using more recent records.

AVAILABLE FLOW RECORDS

These results on channel losses can be brought up to date, by comparing flows between successive stations. The differences between the flows of the main Nile at Tamaniat or Hassanab, plus the Atbara at its mouth, and the flows of the Nile downstream at Dongola are a useful indication of channel losses. The records cover the period 1911–1994, though the Dongola flows are a composite record. They are made up of flows at Wadi Halfa from 1911 to 1931, when the heightening of the Aswan dam affected the discharge site. Flows were then measured at Kajnarty, 47 km above Wadi Halfa, for the period from 1931 to 1962, when the Aswan High Dam made another move necessary, and at Dongola, 430 km above Wadi Halfa, for the period from 1963 to the present. The flows of the Atbara are measured at the mouth for the period up to 1992, and therefore include the storage in the Khashm el Girba reservoir from 1964. From 1993, the outflows from the Khashm el Girba reservoir have been substituted and the losses include those down the course of the River Atbara.

The upstream flows may also be compared with the recorded inflows to Aswan reservoir. Several flow records (Chapter 11) have been compiled for this site, including downstream flows, "Water Arriving", and "Natural Flows" which take account of reservoir regulation at Aswan and Sennar dams, and also abstractions above Sennar dam.

FLOW MEASUREMENTS

Before comparing flows at different sites, it is useful to compare the precision of estimation at each site. Because this depends to a large extent on the number of discharge measurements during each year, this is summarized in Table 2.1 for key stations from *The Nile Basin*, vol. II. Gaugings at Tamaniat began in 1907 and were frequent from 1911, averaging about 70 a year, until 1976, when the number decreased. Gaugings just above the Atbara confluence at Hassanab or Hodeiba began in 1922, with over 100 gaugings a year until 1930 and 70 a year thereafter. After gaugings of the Atbara at its mouth in 1913, measurements were regular from 1921 at about 30–80 a year. However, there was no level gauge near the mouth until June 1923 and these early gaugings were related to levels at the Khashm el Girba gauge some 440 km upstream. Gaugings have been sporadic since 1976. Gaugings at Wadi Halfa began in 1911, with a gap from 1915 to 1920, and then continued frequently until 1939; measurements at Kajnarty, upstream of Wadi Halfa, were begun in 1931 and continued at over 100 measurements a year until 1964; measurements at Dongola were begun in 1962 and have continued at about 100 a year to the present. Measurements at Aswan downstream are discussed in Chapter 11.

The flows published in *The Nile Basin*, vol. IV, are related to the available gaugings, though rating curves are in general looped with different curves for rising and falling rivers. The flows at Tamaniat are based on gauge–discharge curves from gaugings during the year, except for a few periods when flows are based on a general curve or on interpolation between measurements. From October 1928 to September 1929 gaugings were unreliable and flows were derived from the sum of Khartoum and Mogren flows. In later years flows were all based on annual rating curves. There was no level gauge at Hassanab before 1922, but flows from August 1908 were derived from the nearest gauge upstream at Shendi by relating gaugings at Hassanab during the period 1922–1925 against levels at Shendi and using this rating curve to estimate flows for the period 1908–1921; the flows for the period 1908–1913 were later corrected for a change in gauge zero at Shendi which had been overlooked and the revised flows published. From 1922 the flows were estimated from rating curves derived from gaugings during each year, though flows in 1923–1924 were interpolated between measurements.

The published flows of the River Atbara were estimated for the period 1903–1920 (excluding 1913) from a general rating curve based on all gaugings available, with the gaugings made near the mouth compared with levels at the Khashm el Girba gauge. Although an allowance was made for the lag between Khashm el Girba and the Atbara mouth, this procedure must increase the scatter and implies a stable section at Khashm el Girba. These early flows, published in *The Nile Basin*, vol. IV (1933) were later revised based on all observations during the years 1923–1936. The flows from 1921, and for 1913, were based on annual gaugings and rating curves; the rating near the Atbara mouth is affected by levels in the main Nile. From 1973, these flows have been supplemented by published discharges from the Khashm el Girba dam, constructed in 1960–1964, and abstractions through the Khashm el Girba canal. The latter began in 1965 and reached 1.0 km³ in 1967; recent abstractions average about 1.4 km³ per year and constitute a reduction in the natural flows of the Atbara.

Flows are available at Wadi Halfa from 1890, but the early flows, from 1890 to 1920, were estimated from a general gauge–discharge curve based on all observations, which as

noted earlier began in 1911. The flows after 1921, and 1912–1914, were based on annual ratings, except for high flow periods. The early years were revised, after extending the rating curve to higher levels, and published in *The Nile Basin*, vol. IV, supplement 2 (1939). Flood discharges between 1921 and 1927 were revised using later measurements. From 1931, a site was established at Kajnarty about 50 km above Wadi Halfa and above the 2nd Cataract to replace the earlier gauge which would be affected by the heightening of the Aswan dam. The two stations were used to give a combined record from 1931 to 1939, when gaugings ceased at Wadi Halfa, and Kajnarty provided the flow records based on annual ratings. This station was maintained until June 1964, but another station was established at Dongola, above the influence of the Aswan High Dam, from August 1962. Flow records at this station have been maintained since that date using annual rating curves. Thus a complete record is available for Wadi Halfa/Kajnarty/Dongola from 1890 to the present.

HYDROLOGY OF INDIVIDUAL COMPONENTS

The monthly flows of the main Nile at Tamaniat are presented in Fig. 10.2. These show a number of interesting features. The seasonal distribution of flows reflects the variable contribution of the Blue Nile, together with the Dinder and Rahad, contrasted with the more constant flows of the White Nile. However, concentration on the lower envelope of each year's monthly flows reveals the effect of the 1917 flood on the White Nile, which persisted during its passage through the Sudd. It also shows the increase in low flows after the construction in 1937 of the Jebel Aulia dam, which was operated to provide "timely flows" to Egypt in the period before the construction of the Aswan High Dam. The rise of Lake Victoria in 1961–1964, and the subsequent increase in lake outflows, are also reflected in the higher threshold of flows after this date but follow the general decrease in lake outflows in recent years. The Jebel Aulia dam has continued to prolong the low flow season by retaining the White Nile flood until after the Blue Nile flood has passed, and this effect may be seen in the aftermath of the 1988 Blue Nile flood.

The volume of the highest monthly flow reflects the peak of the Blue Nile flood, and this in turn is related to the annual total flow and is little affected by abstractions. The decreased Blue Nile flows of recent years are illustrated by the lower peaks occurring in the years after 1972, with the exception of 1988. Thus the Tamaniat record illustrates the history of flows of

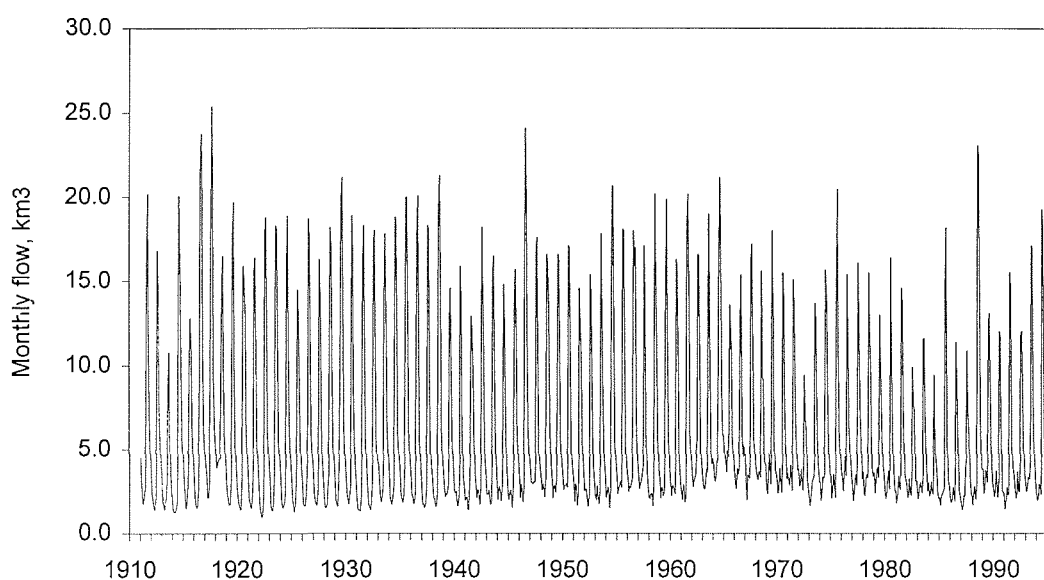

Fig. 10.2 Main Nile at Tamaniat: monthly flows, 1911–1993.

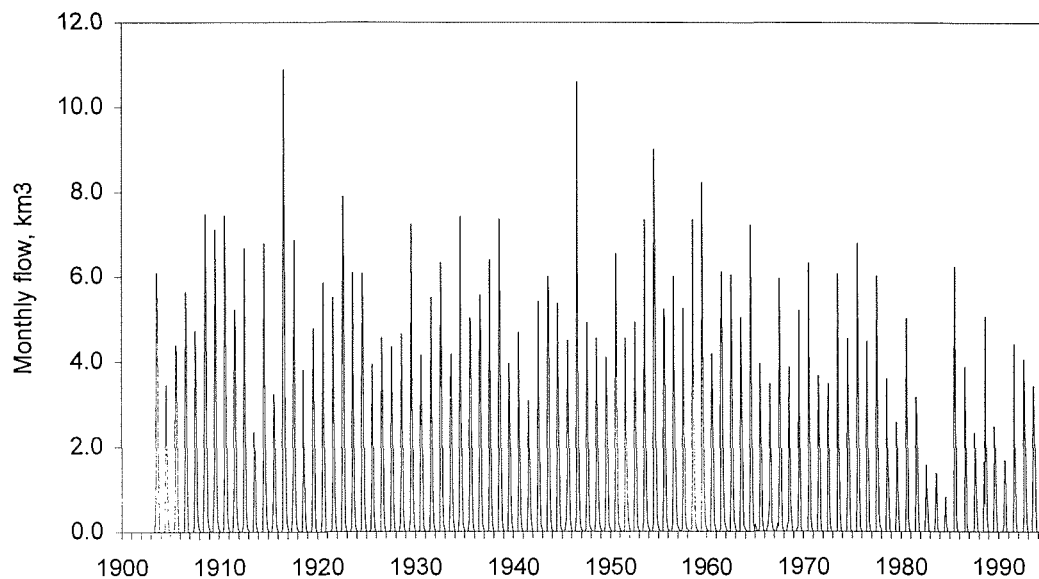

Fig. 10.3 Atbara near mouth: monthly flows, 1903–1994.

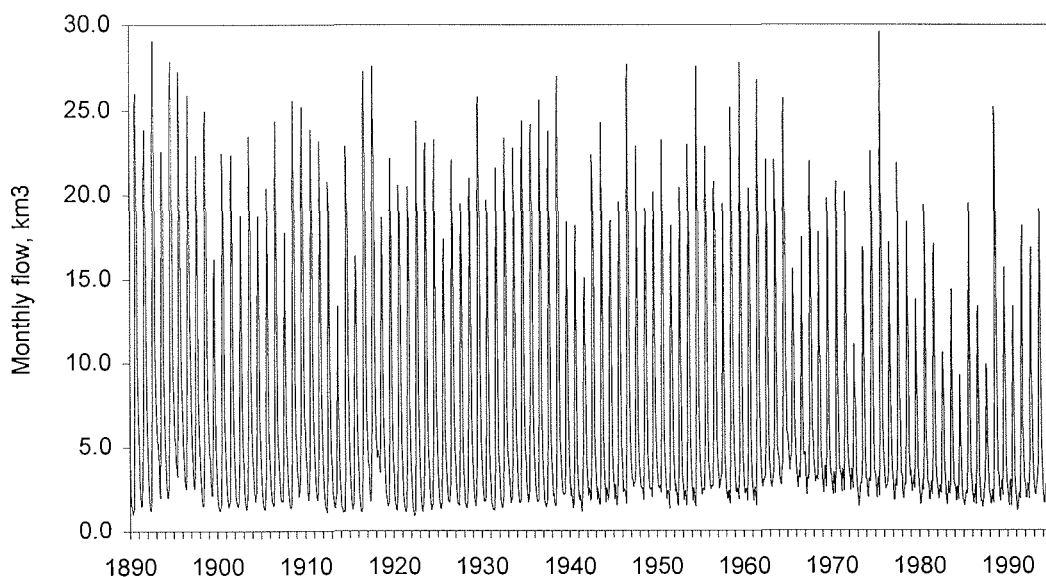

Fig. 10.4 Main Nile at Wadi Halfa/Kajnarty/Dongola: monthly flows, 1890–1995.

both the Blue and White Niles. The contributions of these two rivers to the flows at Dongola, discussed later, reflect the changing importance of the main sources (Fig. 9.10).

The monthly flows of the river Atbara (Fig. 10.3) show a similar pattern to those of the Blue Nile. The exceptional year of 1913, and the lower flows of recent years, are both illustrated by this record. The recent decline has been exaggerated by the effect of the Khashm el Girba reservoir on flows at the mouth. The extremely seasonal pattern of the Atbara flows is shown in this diagram.

The monthly flow record of the Nile at Wadi Halfa/Kajnarty/Dongola (Fig. 10.4) is similar to that at Tamaniat. However, its start in 1890 shows clearly the high Blue Nile flows of the decade 1890–1900 and also the peak flow of the White Nile around 1895. This confirms the evidence for high Lake Victoria levels at that date. However, the inflow record at Aswan (Chapter 11) takes this evidence back even further to 1870.

The seasonal distributions of flows at the different sites, and the variation in mean flows during different periods of record, are illustrated in Table 10.2. This table demonstrates the decline in flows between the periods before and after 1960, though some of this is due to increased abstraction. The increase in the White Nile contribution, as a result of Jebel Aulia

Table 10.2 Average discharges at key stations ($\text{m}^3 \times 10^6$).

Jan.	Feb.	March	April	May	June	July	Aug.	Sept.	Oct.	Nov.	Dec.	Year
Main Nile at Tamaniat						(1911–1960)						
3111	2269	2266	2016	2016	2771	6723	16 973	16 988	11 328	5566	4027	76 054
						(1961–1995)						
3082	2349	2537	3324	3168	2988	5921	14 943	13 520	8 037	4333	3491	67 693
						(1911–1995)						
3099	2302	2378	2555	2490	2860	6398	16 151	15 584	9 996	5067	3810	72 691
Main Nile at Hassanab						(1911–1960)						
3161	2284	2230	1968	1892	2506	6030	16 095	16 792	11 655	5792	4079	74 483
						(1961–1995)						
3047	2309	2355	3111	3049	2911	5676	14 674	14 059	8 215	4457	3468	67 329
						(1909–1995)						
3146	2320	2286	2428	2359	2690	5937	15 607	15 859	10 460	5351	3894	72 337
River Atbara at mouth						(1911–1960)						
22	6	1	0	3	85	1642	5 643	3 731	897	201	63	12 295
						(1961–1994)						
11	6	1	6	17	47	1325	4 206	2 412	511	61	19	8 621
						(1903–1994)						
17	6	1	3	8	88	1536	5 126	3 306	770	145	46	11 052
Main Nile at Wadi Halfa/Kajnarty/Dongola						(1890–1910)						
4715	3310	2687	2020	1808	2096	5675	20 124	23 114	16 709	8749	6250	97 256
						(1911–1960)						
3495	2408	2219	1951	1792	1945	5023	19 207	21 745	14 595	7213	4531	86 125
						(1961–1995)						
3010	2290	2086	2781	2942	2531	5373	17 078	17 221	9 403	4887	3489	73 092
						(1890–1995)						
3577	2547	2268	2239	2175	2169	5268	18 701	20 554	13 337	6767	4538	84 138

reservoir operation, is shown in the flows for April and May. The limited period of river flow in the Atbara is clearly shown.

COMPARISONS OF INFLOWS AND OUTFLOWS

The differences between the sum of the annual flows at Tamaniat and the Atbara at its mouth, and the annual flows at Dongola (and earlier records at Wadi Halfa and Kajnarty) are presented in Fig. 10.5. There is a fair amount of scatter, especially in the years before 1924 and after 1974, which as in Chapter 9 is likely to be due to random measurement errors. It has been noted that discharges at Wadi Halfa were based on a general rating curve rather than annual rating curves before 1921; the discharges of the Atbara before 1921 were based on an indirect rating curve. In recent years the abstractions have increased and the numbers of gaugings at all sites have decreased. These factors explain much of the scatter, which is a fairly small percentage of the combined flows.

In general, it appears that the total losses, which include channel evaporation, losses to bank storage and subsequent evaporation, irrigation abstraction and also any systematic measurement errors, have been rising fairly steadily over the period of records. There are some anomalous years. 1916–1917 was a period of sustained high flow from the White Nile when losses could have been higher than normal. In some years in the 1980s (e.g. 1985 and 1988) losses were apparently high, and in three years (1971, 1974, and 1975) there appear to have been net gains, which must be due to measurement errors. In order to eliminate such

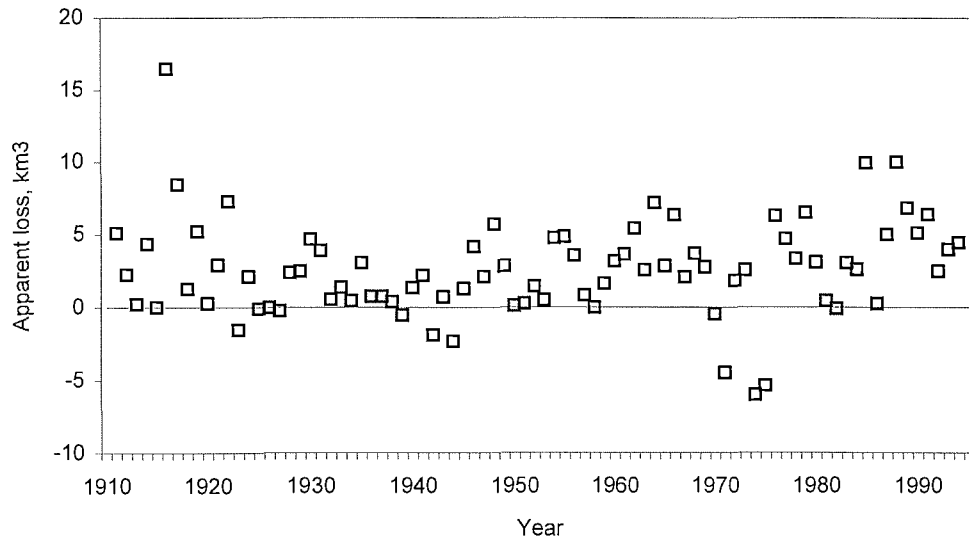

Fig. 10.5 Main Nile: annual losses from Tamaniat and Atbara to Wadi Halfa, 1911–1994.

random errors, it seems reasonable to use the periods 1911–1960 and 1961–1995, included in Table 10.2, to estimate the annual losses. These have increased from 2.2 to 3.2 km³ over the period. This is consistent with channel evaporation losses of 2.7 m over a length of 1500 km and an average width of 600 m, which would total 2.4 km³. In addition irrigation abstractions have increased in recent years from negligible volumes in 1950 to about 1.1 km³ in 1980. The sum of the evaporation losses and irrigation abstractions are consistent with the apparent losses.

The losses estimated by comparisons of flows at Hassanab, Atbara and Dongola (Table 10.2) are similar to those derived from Tamaniat. Comparison of individual years have not been illustrated, but there is more scatter, especially in the early years when the Hassanab flows were derived indirectly.

CONCLUSIONS

The inflows at Tamaniat reflect the contrasting contributions of both the White Nile and the Blue Nile. Apart from the seasonal inflows from the Atbara, this reach acts as a transmission

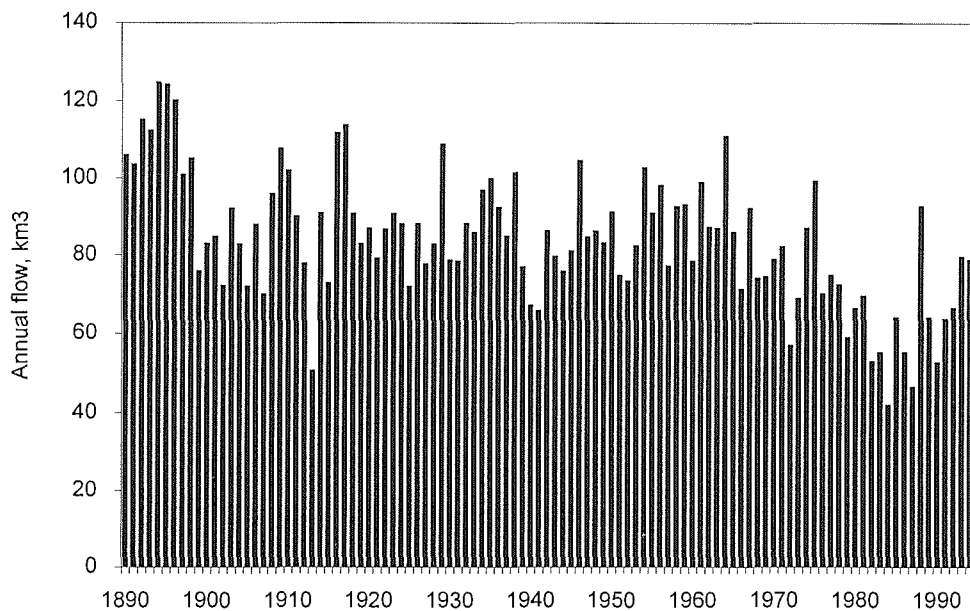

Fig. 10.6 Main Nile at Wadi Halfa/Kajrarty/Dongola: annual flows, 1890–1994.

channel conveying flows from Tamaniat to Wadi Halfa with limited channel losses and irrigation abstraction. Although the irrigation potential of this reach is likely to be limited by availability of land, the reach has hydroelectric potential. The annual flows at Wadi Halfa (Fig. 10.6) show the wide range of flows from 1890 to the present.

CHAPTER 11

THE MAIN NILE IN EGYPT

INTRODUCTION

The hydrology of the Nile in Egypt largely concerns storage and water use, as no flows are generated below the Atbara confluence. The longest record on the Nile is at Aswan, where flows are available from 1869. Volume XI of *The Nile Basin*, (Hurst *et al.*, 1978) deals with the hydrology below Aswan, and this chapter covers the same topic. The hydrology of the Aswan High Dam, or Sadd al Aali, is discussed, together with projects for providing more water for irrigation after the completion of the dam. The evidence of river flows below Aswan, and the records of the Nilometer at Roda Island, are described.

FLOW RECORDS AT ASWAN

River flows at Aswan have been published from 1869, though the construction of successive dams has complicated the background. The early flows from 1869 to 1902 were deduced from level records and a rating curve derived from Aswan downstream gauge readings and discharges measured in the sluices of the Aswan dam. Flows were first published in *The Nile Basin*, vol. IV (Hurst & Phillips, 1933), based on discharges measured in 1903–1927. They were superseded by flows published in *The Nile Basin*, vol. VII (Hurst *et al.*, 1946) derived from a general rating curve based on discharges measured during 1903–1939. It was suggested in the first reference that a shift in Aswan levels made it probable that the discharges were about 8% too high during the flood period. This was re-examined in the later reference and it was concluded that the revised flows were the best estimate available, with the reservation that the extrapolated flood discharges were rough approximations. After the construction of the first Aswan dam in 1902, the downstream flows have been based on calibrated sluice outflows. The sluices at Aswan were all calibrated (*The Nile Basin*, vol. IV, 1933) and daily discharges were computed from the reservoir level and the sluice openings. Flows during any gaps in the sluice records were estimated by interpolating downstream levels linked to calculated flows by means of a gauge–discharge curve. Measurements at Gaafra, below Aswan, were also made from 1918, especially during the high flow season; these were related to the downstream gauge readings at the old Aswan barrage, and used to complete sluice measurements. A daily record at Aswan from 1916 has been tabulated in *The Nile Basin*, vol. II, supplement 4 *et seq.* The 10-day and monthly flows for the long period 1869–1975 have been reproduced in *The Nile Basin*, vol. XI, Appendix I (Hurst *et al.*, 1978).

From 1902 the Aswan record has been published as “Flows below Aswan”, but an additional record of “Water Arriving at Aswan” has been derived by adding the change in reservoir contents to the downstream discharge. From 1925 these were further supplemented by a record of the “Natural River at Aswan”. This includes the water abstracted from the Blue Nile in the Gezira main canal, and allows for the regulation of the Sennar reservoir as well as the Aswan reservoir. Although the Jebel Aulia reservoir has affected downstream flows from June 1937, its regulation has not been included. From 1963 this record has included the water taken from the Blue Nile in the Managil canal, but did not take into account the evaporation

losses in the Aswan High Dam or in Jebel Aulia, Sennar or Roseires reservoirs. However, from 1978 (*The Nile Basin*, vol. IV, supplement 11, Preface) the Natural River flow series included evaporation from the Aswan High Dam, estimated from water balance methods, and evaporation from Jebel Aulia reservoir. The Flows below Aswan and the Water Arriving form a good basis for analysis. The Natural River record as published does not include all the effects of upstream storage and abstractions, and the basis for calculation has changed over the years.

In view of this, the most useful record appears to be that of the Water Arriving at Aswan, which is presented as Fig. 11.1. This is supplemented by Fig. 11.2, which shows the monthly levels of the Aswan High Dam from 1964. The flows of Fig. 11.1 are reasonably natural before 1964. Later records reveal the decline in recent Blue Nile and Atbara flows. They also reflect reservoir storage and water abstraction within the Sudan, and evaporation losses within the Aswan High Dam after 1964. The early records illustrate the high flows in the period 1870–1900, when the lower envelope confirms the high flows of the White Nile and high Lake Victoria levels around 1878 and 1895. The reservoir levels show the effect of the low flows in the 1980s, followed by the recovery in 1988.

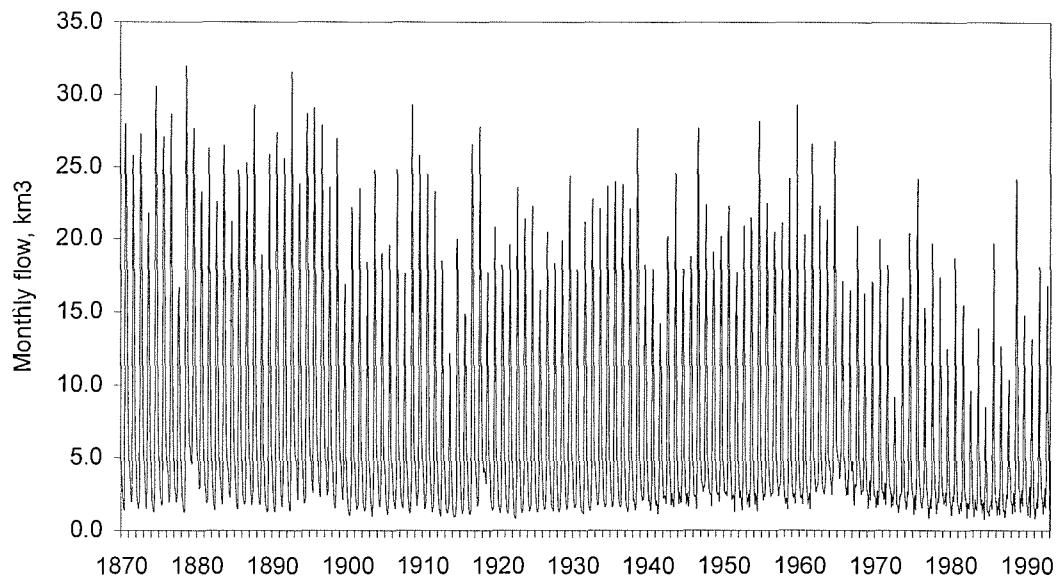

Fig. 11.1 Main Nile at Aswan: Water Arriving, monthly values, 1870–1992.

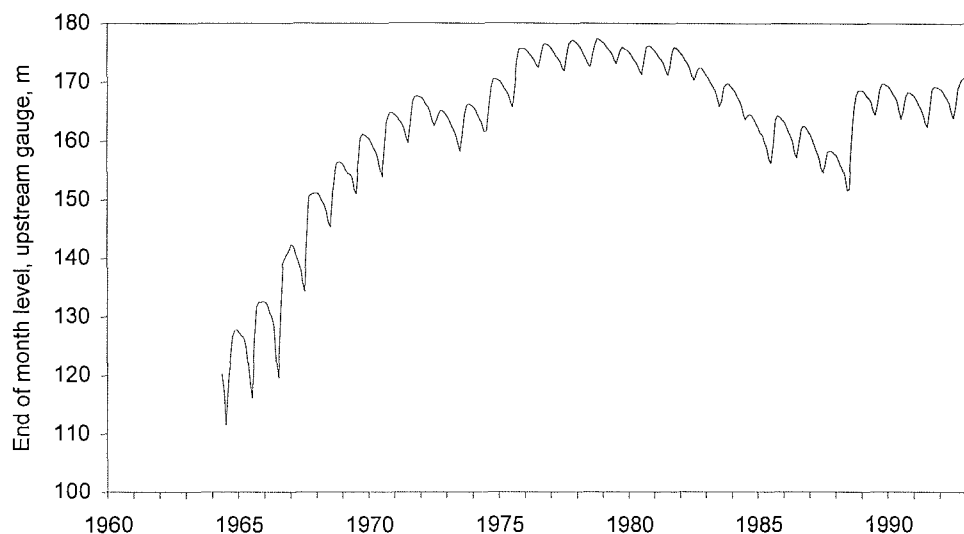

Fig. 11.2 Aswan High Dam: monthly levels, 1964–1992.

COMPARISON WITH UPSTREAM FLOWS

It is useful to compare the flows measured at Wadi Halfa/Kajnarty/Dongola with these different measures of inflow to Aswan, as comparisons can indicate the precision of the series. The apparent losses above Aswan have been deduced by comparing the annual upstream flows with the Water Arriving at Aswan (Fig. 11.3). This suggests a small gain between 1890 and 1910, followed by losses of similar magnitude between 1910 and 1960. These are likely to be due to measurement errors as evaporation losses over this short reach should be comparatively small. The most likely explanation is due to the start of gaugings at Wadi Halfa in 1911. After 1965 the losses increase rapidly to about 15 km³, which must be largely due to evaporation losses from the Aswan High Dam, but these decrease after 1975 as the reservoir levels fall. Comparison of the Water Arriving at Aswan with the flows measured after 1910 at Tamaniat and Atbara mouth shows a similar pattern of losses to that deduced from the Dongola record. In Fig. 11.4 the apparent losses between 1965 and 1992 are compared with evaporation losses of 2.7 m (Hurst *et al.*, 1966, pp. 41–45) over the mean annual reservoir area. The losses can clearly be explained by the rise and fall of the

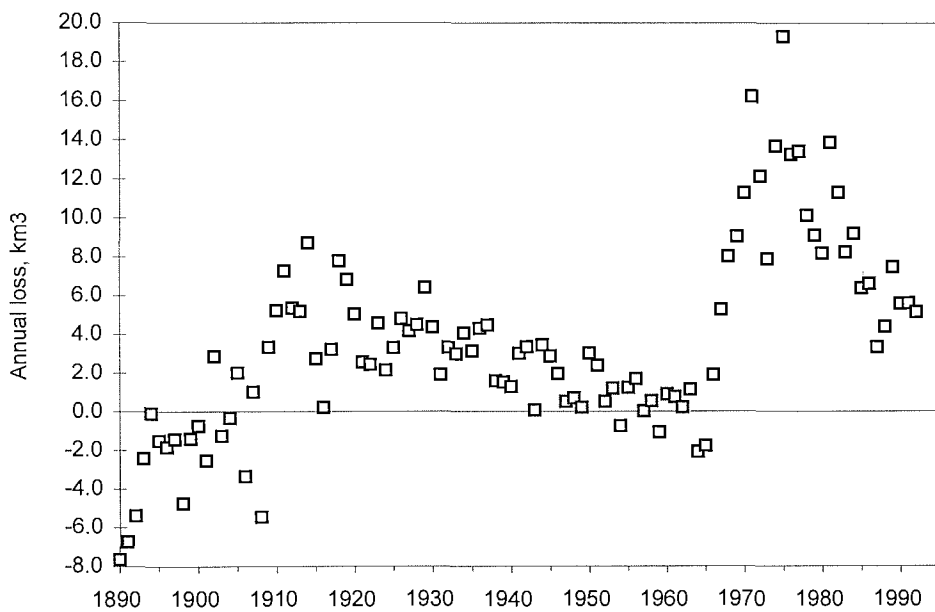

Fig. 11.3 Main Nile above Aswan: apparent loss between Dongola and Water Arriving, 1890–1992.

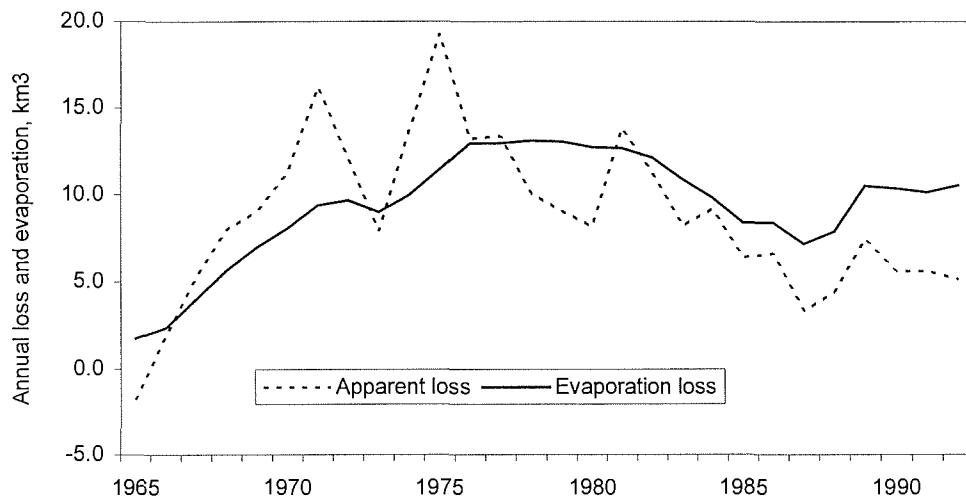

Fig. 11.4 Apparent loss above Aswan: annual loss and evaporation, 1965–1992.

reservoir. The losses also suggest losses to bank storage on a rising reservoir offset by gains when the reservoir falls.

The losses estimated from the Natural River flows at Aswan are similar, but show an apparent large gain of about 15 km³ after 1978. This coincides with the change in the basis for calculating these flows, when the evaporation losses from both the Aswan and Jebel Aulia reservoirs are added to upstream abstractions for the first time.

THE GENESIS OF THE ASWAN HIGH DAM

The concept of the Aswan High Dam or Sadd al Aali arose from theoretical work related to storage in the East African lakes. This was described by Hurst *et al.* (1959, 1978) in *The Nile Basin*, vols IX and XI. The first dam at Aswan had been constructed by 1902 with a capacity of 1 km³ and was heightened in 1912 with a capacity of 2.25 km³; a second heightening was completed in 1933 with a total capacity of 5.25 km³. The role of this reservoir was to provide annual storage and to augment the low flow of the Nile during the irrigation season; the flood flow was used for basin irrigation.

Overyear storage had been planned in the East African lakes in order to limit the effect of low years, and to supplement “timely flows” during the irrigation season. Losses in the Sudd were to be reduced by the construction of the Jonglei Canal. This project, known as the Equatorial Nile Project, clearly required the agreement of a number of countries. The original proposals would have reversed the seasonal flooding in the Bahr el Jebel swamps, and this was deemed unacceptable to the Sudan by the Jonglei Investigation Team (1954). There was also a plan to supplement storage in Lake Tana in Ethiopia. Against this background research on overyear storage had continued (Hurst *et al.*, 1964).

“Century Storage” was defined as the size of reservoir needed to guarantee a supply equal to the mean inflow over a period of 100 years. The range R of reservoir storage, ignoring rainfall and evaporation, should increase over a period of N years according to:

$$\log(R/\sigma) = K \log(N/2)$$

with $K = 0.5$ if the inflows are drawn from a random series of standard deviation σ . However, it was found empirically, from Nile flows and other physical time series, that the range increased with K values varying randomly about a mean of 0.73. Thus a markedly larger reservoir would be required to guarantee a draft equal to the mean flow from a natural rather than a random series. The same was found for drafts less than the mean inflow. In practice, the storage available in Lake Albert would be unlikely to provide the mean flow with this level of security. However, a small decrease in draft leads to a large reduction in storage (Hurst *et al.*, 1965, p. 39).

This empirical finding has become known as the Hurst phenomenon. It has not been explained in physical terms but can be simulated by various statistical models with a degree of autoregression (O’Connell, 1971). It has also given rise to advances in theoretical and practical statistics. It played an important role in Mandelbrot’s work on the “Joseph effect” (Mandelbrot & Wallis, 1968). This was named after Pharaoh’s dream of seven sleek and fat cows coming up from the Nile, followed by seven gaunt and lean cows; Joseph interpreted this dream as seven years of plenty followed by seven years of famine and recommended storage. This work in turn gave birth to a flourishing branch of applied mathematics (Gleick, 1987), epitomized by *The Fractal Geometry of Nature* (Mandelbrot, 1977).

Meanwhile an early account of the phenomenon was read by an Egyptian agricultural engineer, Adrian Daninos, who called on R. P. Black at the Physical Department in 1948. He asked whether the possibility of overyear storage at Aswan had been considered and what minimum volume of storage would be required; the rough figure of 150 km³ was given. An

initial survey, followed by an air survey, showed that such a volume could be obtained. A dam was proposed with maximum water level of 182 m, with 30 km³ dead storage for sedimentation, 90 km³ for overyear storage and 37 km³ for annual storage and flood protection. It was later decided to raise the maximum storage level to 183 m, which allowed another 6 km³ of storage. This initiative led eventually to the construction of the Aswan High Dam by 1964.

This project, which concentrated the storage for Nile control near Aswan, had obvious political advantages over schemes like the Equatorial Nile Project requiring wide international agreement. It also removed the earlier emphasis on “timely flow” which had led to the objections of the Jonglei Investigation Team (1954) to a reversal of seasonal flow through the Bahr el Jebel. An agreement between Egypt and Sudan was reached in 1959 which divided the expected yield of the project (74 km³) between the two countries, with 55.5 km³ allocated to Egypt and 18.5 km³ to Sudan. This estimate of the yield was based on a long-term annual flow of 84 km³ less an estimated evaporation loss of 10 km³. In addition, any waters to be contributed by conservation measures to reduce evaporation in the swamps of the upper Nile were to be shared between Egypt and Sudan. These included the Jonglei Canal scheme in the Sudd, with a second phase involving upstream storage, the Bahr el Ghazal diversion project and a project involving the Baro and Machar marshes.

ELIMINATION OF FLOOD RESERVE

In vol. XI of *The Nile Basin* (Hurst *et al.*, 1978) an overview of possible options was made. A large reservoir in Lake Albert was unacceptable to the Uganda Government. The Jonglei Investigation Team maintained that the economy of the swamps would remain pastoral, and that virtual storage and season reversal were unacceptable. This jeopardized the value of the Bahr el Jebel and Bahr el Ghazal conservation projects. The prospects of regulation of the Baro were unlikely to provide increased supplies in the near future.

An alternative way of increasing the yield of the Aswan High Dam was to reduce the need for flood provision. An important role of the dam was to prevent downstream flooding of urban areas and agricultural areas adapted to perennial irrigation. Considerable flood damage had been caused in 1878 and other occasions in a less developed economy. However, the allocation of 30 km³ for flood storage reduced the storage available for overyear control.

A possible alternative was the Toshka Flood Escape, where a natural depression in the western desert about 250 km above Aswan, and close to the reservoir, could be adapted to pass excess floods to the desert rather than to the sea. The prospect of flood provision through the Toshka Escape was examined by studying the effect of passing the flood series of 1870/71 to 1898/99 to the Toshka Depression. This showed that the flood storage could be reduced and overyear storage capacity increased by some 26 km³; the annual quota could be increased by about 2 km³ without the need to reach agreement with other users of Nile waters. By avoiding the downstream release of water during periods of flood, the project would reduce the risk of degradation below Aswan. Much of the estimated annual suspended sediment load of 130 million tonnes would be deposited above Aswan, and the downstream flood would be sediment free. The Toshka project came into operation in recent years.

THE EFFECTS OF THE ASWAN HIGH DAM

The benefits and effects of the Aswan High Dam have been described by Rushdi Said (Said, 1993, pp. 228–254). The dominant effect has been the storage of the flood water which used to flow to the Mediterranean, though about a third of this is lost to reservoir evaporation. As a

result, Egyptian agriculture survived the droughts of the 1970s and 1980s. Because the threat of floods was removed, areas of basin irrigation could be converted to perennial irrigation with two or three crops annually. Irrigated areas in both Egypt and the Sudan were expanded as a direct result of the increased water availability. Hydroelectric power production made a significant contribution to the economy, providing half the total electric power used in Egypt in 1977.

On the other hand, the reservoir flooding led to the resettlement of the Nubian population, either to new lands reclaimed in Egypt or to the Khashm el Girba development on the Atbara in the Sudan. The Nile sediment load is now deposited above Aswan, though the dead storage of 30 km³ has been estimated to last 400 years. In fact the sediment has accumulated in the upper 250 km of the reservoir, at an average rate of 109 m³ × 10⁶ year⁻¹. The river flow below the dam is now free of sediment; with the flood discharge eliminated, scouring occurred at a rate of 0.02–0.03 m year⁻¹ after 1966, but has been stabilized by limiting flows. The loss of silt deposition is limited to the areas of basin irrigation; Egypt had relied heavily on chemical fertilizers in areas of perennial irrigation where yields have increased. Water quality has decreased downstream, and the variety of commercial fish species has decreased. In the eastern Mediterranean, sardine fisheries which had averaged annually about 18 000 tonnes have declined to a trickle. However, new fishing grounds were created in the reservoir, and the annual catch rose to 34 000 tonnes in 1987, though this may not be sustainable. Many of these side effects were anticipated, but the benefits of the dam were considered greatly to outweigh the disadvantages. The water benefits can be illustrated by the downstream flows.

FLOWS DOWN THE NILE BELOW ASWAN

The flows at various sites on the Nile below Aswan (Plate 11) have been published in vol. IV of *The Nile Basin* and its supplements. These include the Water Arriving at Aswan, the



Plate 11 The Nile at Aswan.

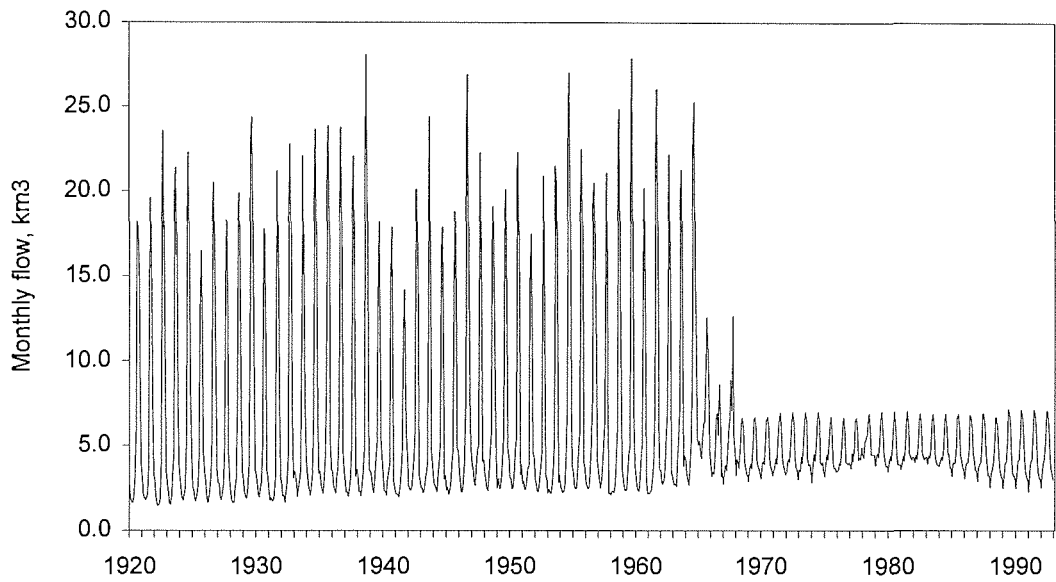

Fig. 11.5 Main Nile at Aswan: monthly downstream flows, 1920–1992.

outflows from Aswan reservoir and the successive downstream flows at the Esna barrage 166 km below Aswan from 1933, the Nag-Hammadi barrage 359 km below Aswan from 1940, and the Assiut barrage 539 km below Aswan from 1926. The Aswan outflows are shown from 1920 in Fig. 11.5, which shows the effect of the Aswan High Dam in increasing firm outflows. The annual inflows and outflows at Aswan and the flows at successive sites are presented in Fig. 11.6. In the early years there is little difference between the inflows and outflows at Aswan. After 1964 the outflows are relatively constant, showing the effect of overyear storage.

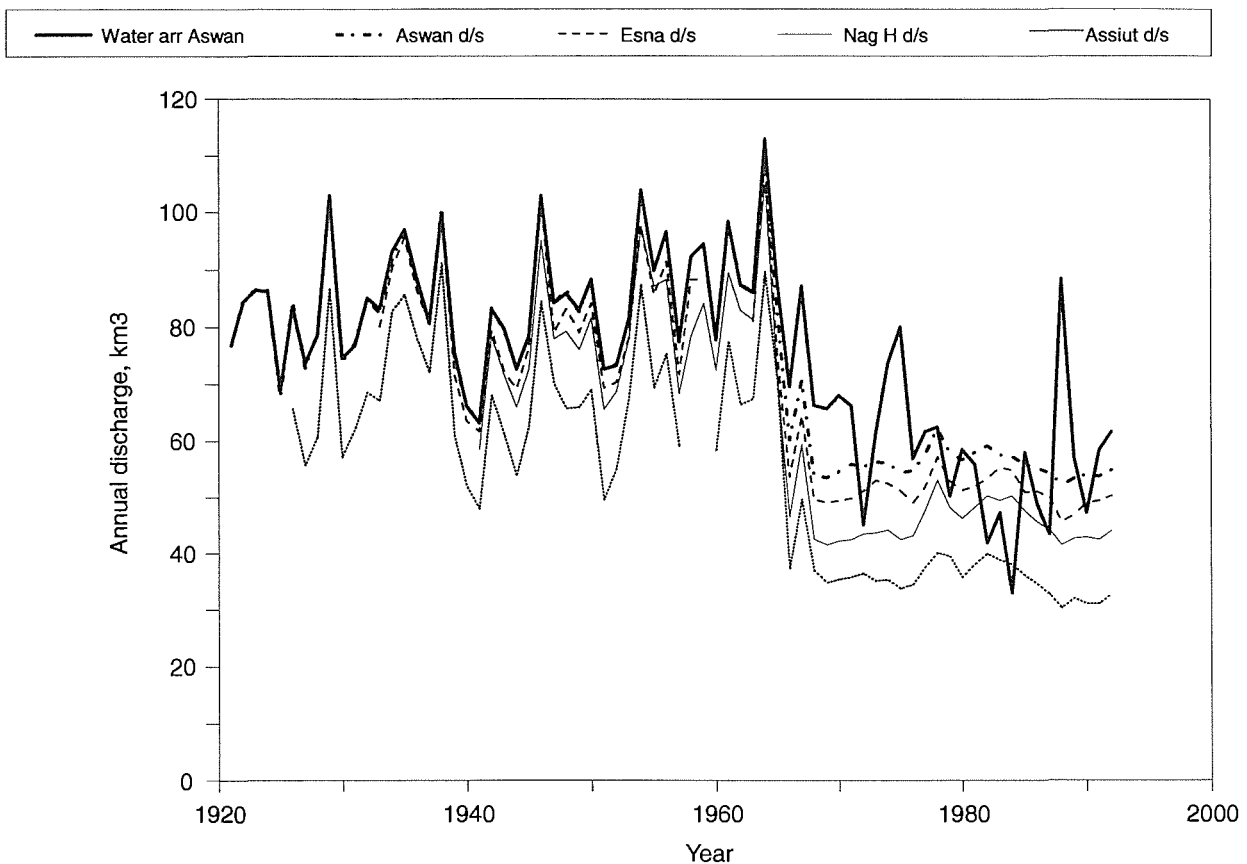

Fig. 11.6 Annual flows at Aswan and downstream flows below barrages.

The Aswan outflows are compared with flows downstream, with the difference representing the diversions for irrigation. As other sites are included the diversions from different reaches of the river can be observed. The abstractions between Aswan and Assiut have increased over recent years. After the completion of the dam annual releases have decreased, but firm flows have increased.

EVIDENCE OF THE RODA GAUGE

Because of the sensitivity of basin irrigation to the peak river level, flood levels have been recorded since early times (Said, 1993, pp. 127–169). For example, the Palermo stone records over 60 flood levels as far back as 3000 BC. Flood marks at Semna, about 50 km above Wadi Halfa, suggest exceptionally high levels between 1840 and 1770 BC. Nilometers were located at Aswan, Karnak and Memphis, and early qualitative records of floods exist. However, the longest quantitative records are from the Roda gauge (Plate 12) at the upstream end of Roda Island in Cairo.

This long record has been a continuing source of analysis and speculation. The series (Toussoun, 1925) records the annual maximum and minimum river levels for the period 622



Plate 12 Interior of the Nilometer, Roda Island, Cairo.

AD to 1921 AD, and the record was preserved because of the significance of the flood level when flood irrigation was practised. The record has been criticized (Popper, 1951) for inconsistencies of scale and zero and has some gaps, especially in recent centuries. However, much can be deduced about recent flows from the record as it exists.

It is clear from mean and maximum flood levels over successive centuries (Fig. 11.7) that there has been significant channel aggradation over the period of record, so that evidence on flood series cannot be transferred over too long a period. A comparison (Fig. 11.8) of annual maximum Roda levels with annual maximum 10-day flows at Aswan, over the common period 1869–1921, shows that there is a reasonable relation between the two. Thus the Roda record provides useful information about the incidence of floods, which should be treated with caution when extrapolated backwards in time. The Roda gauge records before this period suggest that the 1878 flood was also the highest since 1824. There was an exceptionally high level of Lake Victoria in 1878; Lado on the Bahr el Jebel was flooded in the same year and the flood of 1878 is well known in the Sudd. Thus an event which involved the Blue Nile basin, which would have been responsible for the peak Aswan flow in September 1878, also included the East African lake basin.

Although the annual Roda minima could provide information about the White Nile flows and thus Lake Victoria levels, this evidence is more sensitive to aggradation and eventually to

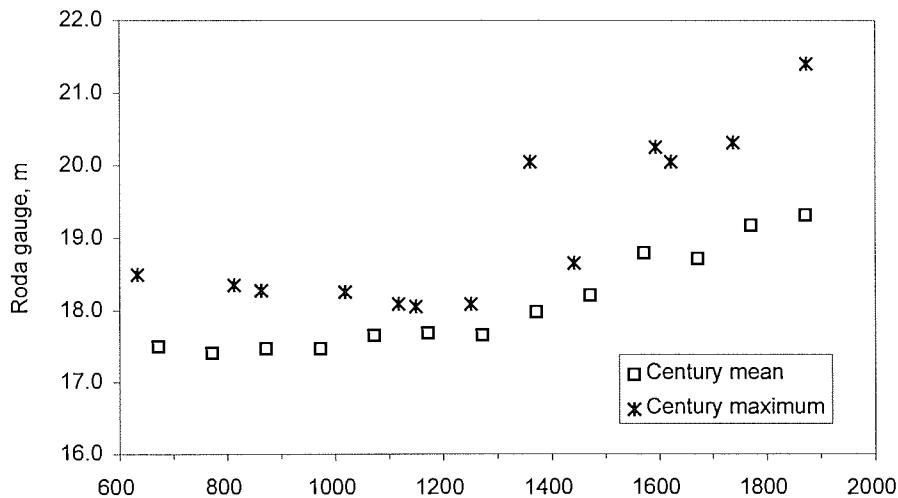

Fig. 11.7 Roda gauge: century mean and maximum flood levels, 622–1921 AD (after Sutcliffe & Lazenby, 1994).

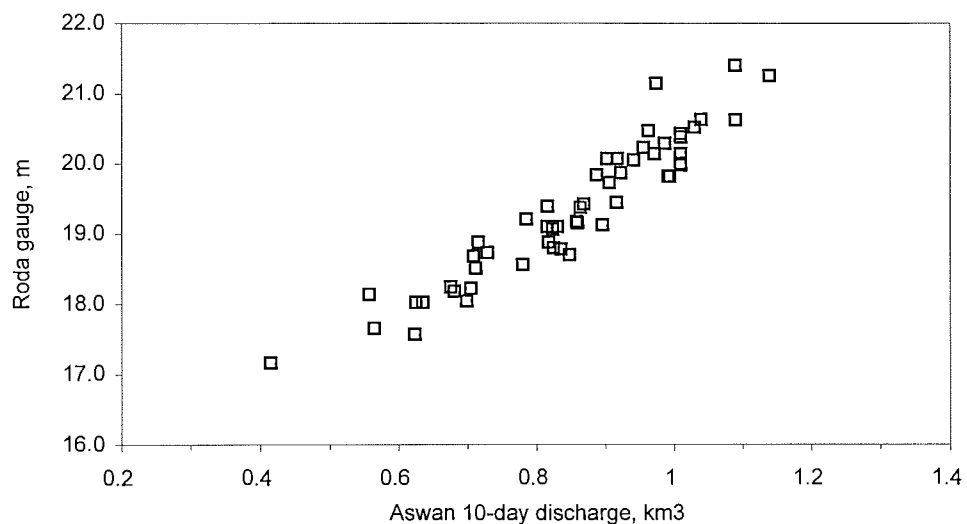

Fig. 11.8 Roda gauge and Aswan 10-day floods, 1869–1921 (after Sutcliffe & Lazenby, 1994).

the effect of reservoir storage. The evidence for high Lake Victoria levels in 1878 and 1895 is supported by high Roda minima in 1879 and 1895–1899, but the evidence from Aswan flows is more useful. As described earlier, the monthly series of inflows at Aswan (Fig. 11.1), and in particular the baseflow series, demonstrate clearly the high flows in January–May of the years 1879, 1895–1897 and 1917–1918 when the lake outflows are believed to have been high. The rise in White Nile flows after 1961 is more clearly demonstrated by the flows at Wadi Halfa/Kajnarty/Dongola (Fig. 10.4).

Flohn & Burkhardt (1985) investigated the relative role of Lake Victoria levels and the floods originating in Ethiopia on the dry season inflows to Aswan. They calculated the correlation between Aswan dry season (February–June) flows and each of Lake Victoria end year levels, and previous (August–September) flood inflows. They deduced that about half the variance was due to each source. They then used correlation to obtain a “tentative reconstruction” of the lake level series for the period 1870–1898; this was very similar to that derived by Lyons (1906) from statements by early travellers.

These two examples illustrate the way in which knowledge of one aspect of Nile hydrology can assist in understanding of the behaviour of another aspect. Although the Nile basin is extremely heterogeneous in terms of tributary behaviour, each reach reflects the character of the upstream tributaries. There are therefore links between the hydrology of widely different parts of the basin.

CONCLUSION

The inflows to Aswan integrate the complexities of the hydrology of all the upstream tributaries. The storage at Aswan was designed to release the mean annual flow with a high degree of certainty. It succeeded in doing so throughout the recent Sahel drought, and should continue to provide a firm yield if conditions in upstream basins do not change significantly. The flows below Aswan simply reflect water abstraction.

CHAPTER 12

THE NILE AND HYDROLOGICAL ASPECTS OF WATER USE

INTRODUCTION

With the long-term record of inflows to Aswan, the hydrological information on the Nile basin is complete. This presents an opportunity to describe the contributions of the different tributaries over the years, and to derive a correlation matrix to illustrate the links between them. A comparison is made of key sites throughout the basin, to help understanding of the hydrological complexity of the system. A brief discussion of rainfall and runoff over the basin is followed by a reminder of the importance of wetlands.

The development of water resources in the various countries of the Nile basin must be to a large extent dependent on the hydrology of the different tributaries. Because upstream developments could affect the availability of water downstream, there may be choices in some cases between developments upstream and water use downstream. It seems appropriate to present a brief review of some of the needs and problems of water resources development in the countries of the Nile basin in order to round off a discussion of the hydrology.

SUMMARY OF FLOW SERIES

The contributions of the different Nile tributaries have been described in previous chapters. Before discussing the way in which the available water has been used, this is a convenient point at which to compare the annual flow records at key sites over the basin. In order to compare flows on a common basis, the flows at downstream sites have been naturalized by adding the upstream abstractions to the measured flows. This has been necessary for the White Nile at Mogren, the Blue Nile at Khartoum, the Atbara, and the main Nile at Tamaniat, Hassanab, Dongola and Aswan.

The upstream sites are illustrated by annual flow series in Fig. 12.1, where common time scales have been used from 1890 to 1997, and also common volume scales. The sites in the lake basin above Mongalla all show the increase of flows after 1961, though the pattern of flows of the Semliki is less clear. By comparison with Jinja, the flows at Kamdini and Mongalla show enhanced responses to the 1961/62 event, which was not limited to the Lake Victoria basin. The Sudd outflows are very damped, but also reflect the rise in inflows at Mongalla. The flows of the Jur at Wau, the Baro at Gambeila and the Sobat at Doleib Hill do not show an increase.

The downstream sites are shown in Fig. 12.2 from 1870 to 1997, with a different volume scale. The White Nile at Malakal reflects the rise after 1962 in Sudd outflows, but these have increased less than the upstream inflows. The flows of the Blue Nile and Atbara are variable and show a decline in the 1970s and 1980s. The Tamaniat flows combine the joint flows of the White and Blue Niles, while the records at Dongola, which have been extended back to 1870 using Kajnarty, Wadi Halfa and Aswan, show the high flow period up to 1900, the variable flows until 1970, and the lower flows since 1970.

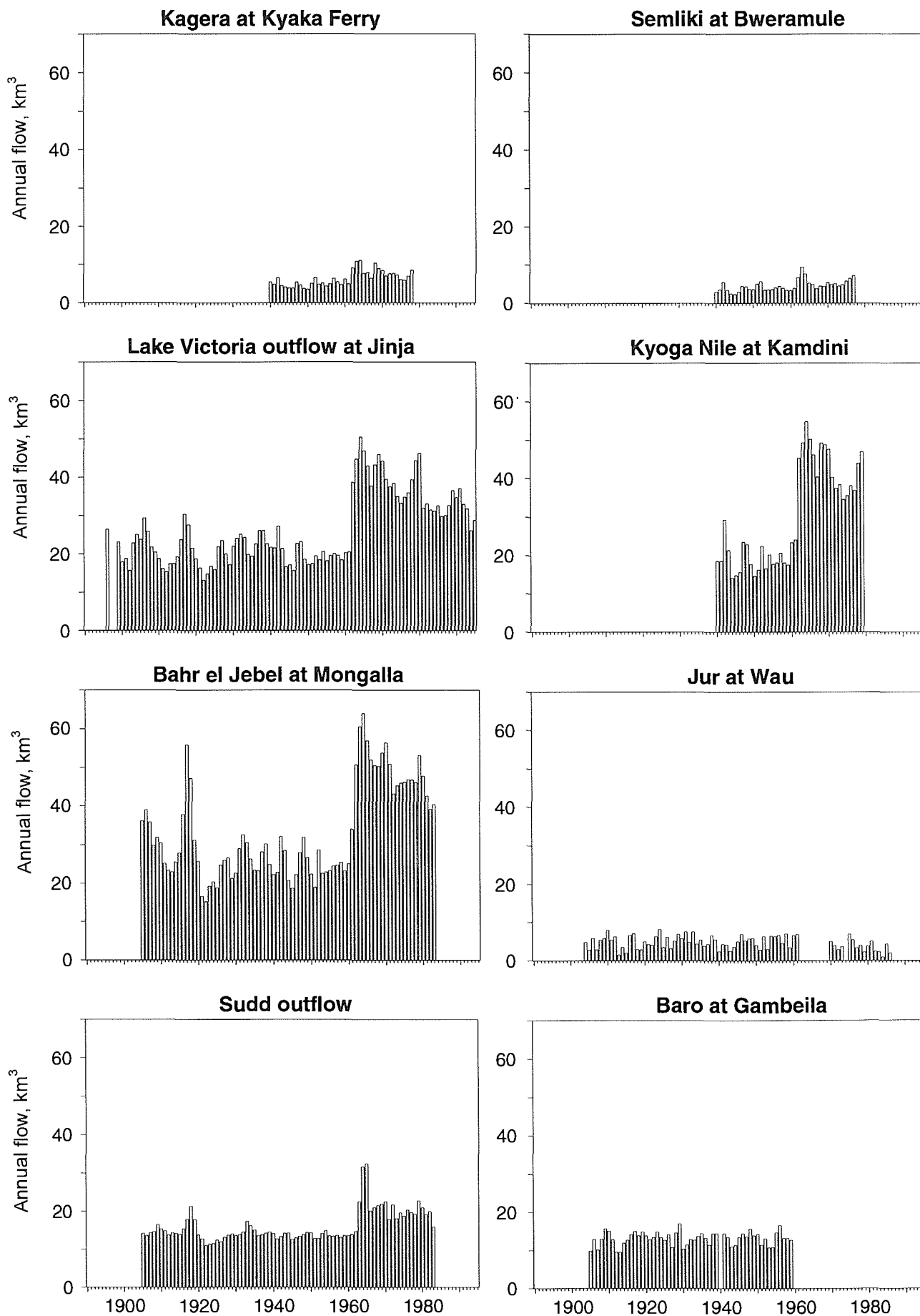

Fig. 12.1 Annual flows at upstream sites, 1890–1997.

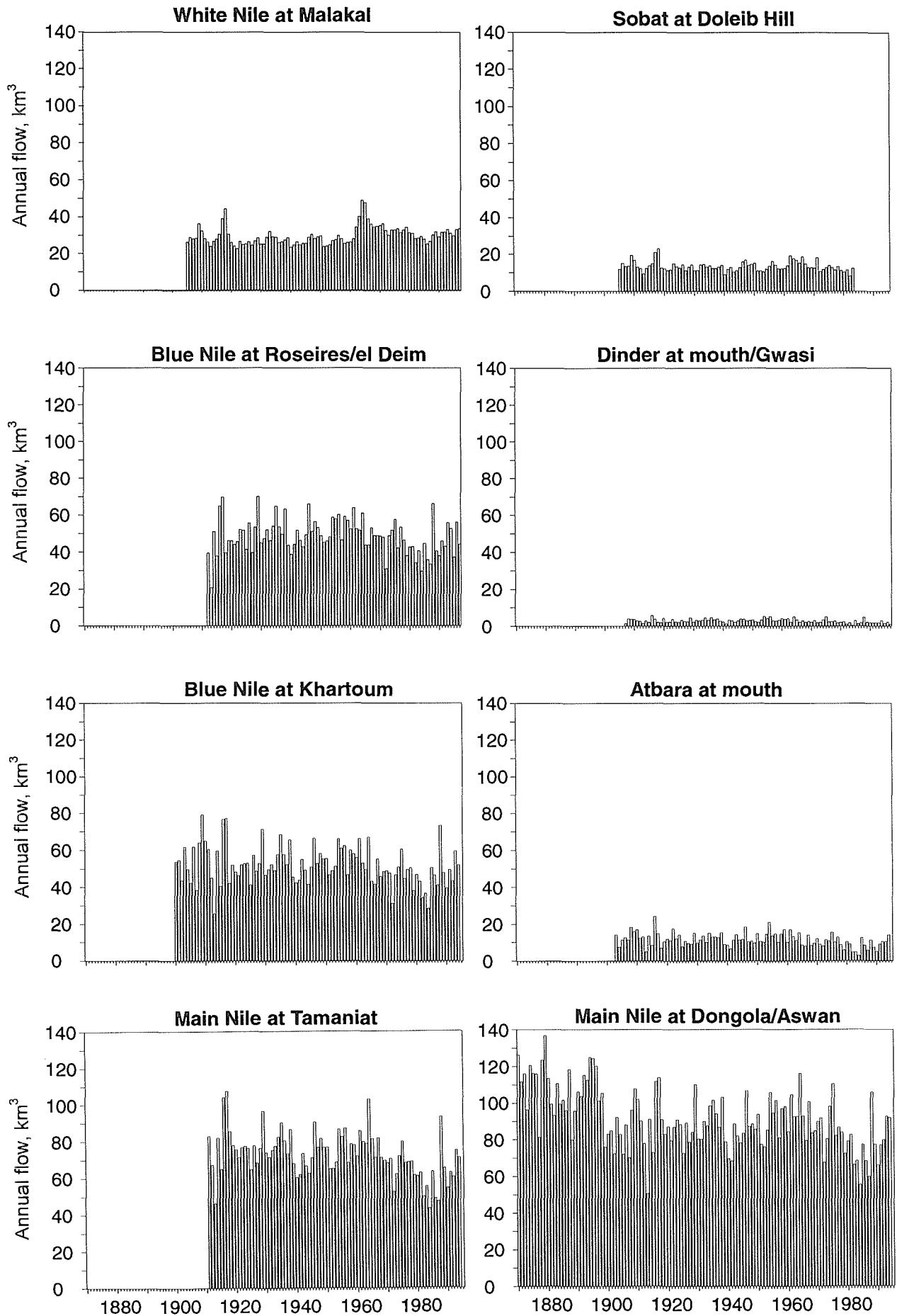

Fig. 12.2 Annual flows at downstream sites, 1870–1997.

Table 12.1 Correlation matrix of annual flows (R^2).

	Khartoum, Mogren, Tamaniat, Atbara, Dongola naturalized																					
	Kagera	Vict N	Kyog N	Semliki	L Alb.	B el J	Torr.	Jur	Baro	Sobat at	Whi N	Whi N	Blue N	Dinder	Rahad	Blue Nile	Nile	Atbara	Nile	W Arr		
	A	B	C	D	E	F	G	H	I	J	K	L	P	N	O	M	Q	R	S	T	U	
A	1.000	0.805	0.838	0.548	0.724	0.753	0.002	0.030	0.013	0.102	0.532	0.475	0.020	0.014	0.002	0.054	0.043	0.006	0.099	0.003	0.039	
B		1.000	0.981	0.446	0.903	0.888	0.002	0.066	0.000	0.031	0.520	0.488	0.019	0.039	0.027	0.046	0.008	0.017	0.106	0.001	0.111	
C			1.000	0.484	0.953	0.963	0.000	0.043	0.008	0.128	0.731	0.722	0.038	0.023	0.006	0.079	0.066	0.012	0.119	0.006	0.080	
D				1.000	0.485	0.523	0.017	0.000	0.014	0.149	0.375	0.317	0.000	0.001	0.000	0.006	0.075	0.040	0.019	0.027	0.005	
E					1.000	0.964	0.000	0.024	0.002	0.115	0.677	0.666	0.008	0.023	0.018	0.033	0.044	0.001	0.075	0.006	0.069	
F						1.000	0.023	0.014	0.008	0.132	0.705	0.653	0.000	0.007	0.013	0.009	0.081	0.008	0.035	0.022	0.030	
G							1.000	0.174	0.073	0.095	0.008	0.001	0.306	0.131	0.055	0.315	0.281	0.235	0.272	0.248	0.248	
H								1.000	0.216	0.150	0.007	0.000	0.500	0.418	0.274	0.473	0.443	0.472	0.312	0.479	0.453	
I									1.000	0.329	0.188	0.108	0.382	0.162	0.094	0.353	0.352	0.413	0.034	0.359	0.320	
J										1.000	0.433	0.382	0.167	0.124	0.069	0.187	0.386	0.399	0.038	0.308	0.276	
K											1.000	0.916	0.016	0.012	0.003	0.011	0.211	0.110	0.003	0.131	0.021	
L												1.000	0.000	0.001	0.001	0.003	0.147	0.075	0.024	0.074	0.004	
M													1.000	0.569	0.327	0.902	0.795	0.797	0.558	0.840	0.726	
N														1.000	0.405	0.600	0.563	0.611	0.532	0.667	0.646	
O															1.000	0.489	0.372	0.382	0.331	0.380	0.319	
P																1.000	0.786	0.777	0.619	0.802	0.747	
Q																	1.000	0.849	0.454	0.902	0.689	
R																		1.000	0.519	0.889	0.840	
S																			1.000	0.618	0.657	
T																				1.000	0.825	
U																					1.000	1.000

These links between key stations have been confirmed by the correlation matrix given in Table 12.1. The correlations between the Lake Victoria outflows and the sites down to Mongalla are naturally close, as shown by the R^2 values. The Kagera and the Semliki are less closely related. The flows of the torrents above Mongalla have no link with other sites, though this may reflect the method of estimation. The flows of the Baro at Gambeila, and more surprisingly the Jur at Wau, appear to be linked with the Blue Nile and Dinder; they have in common a single rainfall season. The Sobat has lower correlation with other tributaries. The Blue Nile naturally has links with the Atbara and the sites on the main Nile.

The seasonal distribution of flows has been similarly illustrated by collating the monthly mean flows for as long a period as possible in Table 12.2 and Fig. 12.3. The Kagera and Semliki are also damped by swamps and lakes. The peak month is delayed from Jinja downstream, though Mongalla shows the effect of the torrents. The halving of flows in the Sudd is clearly shown. The seasonal character of the Baro and Jur, and the attenuation on the lower Sobat, are clear, while the White Nile at Malakal combines the Sudd outflow and the Sobat. The comparison between the White Nile at Malakal and Mogren is affected by Jebel Aulia reservoir. The seasonal similarity and relative sizes of the Blue Nile tributaries and the Atbara are evident, and the attenuation between Roseires/el Deim and Khartoum is suggested. The similarities between Tamaniat and Hassanab, and between Dongola and Aswan, are to be expected, while the difference reflects the Atbara contribution.

The concept of water balance has been used throughout the book to describe individual tributaries. A regional picture can be indicated by the relation between average rainfall and runoff depth over the whole basin given in Fig. 12.4. Runoff has varied dramatically on some tributaries since records began, but periods of records vary and a concurrent series would be short; estimates have been made for the whole period of records at each site. The information is dominated by the Lake Victoria basin, but includes a few Ethiopian tributaries, where the rainfall is not known with any precision. Some conclusions can be drawn. The runoff from the Bahr el Ghazal tributaries is low by comparison with the other areas, and this reflects the low gradients of this region. Apart from these rivers, the relation between rainfall and runoff is reasonably defined, and the wide variation of both over the basin is clear. The major flow contributions are confined to mountainous areas with high rainfall.

The role of wetlands in reducing river flows is a feature of the White Nile basin. The flows of the Bahr el Jebel, Bahr el Ghazal, and the Sobat, are all affected by spill into wetlands and subsequent evaporation. The role of hydrological conditions, and in particular duration, maximum depth and level range of flooding has been shown to control the vegetation type and species. Conversely, it has also been demonstrated that the evidence of wetland distribution, and especially the evidence of key vegetation species, provides valuable information on the hydrology of a basin.

Although the Nile basin is extremely heterogeneous in terms of topography, climate, vegetation and river flows, it is nevertheless interdependent in the sense that each tributary impinges on the river basins downstream. It is hoped that this book has highlighted the links between the different parts of the basin.

WATER USE IN THE NILE BASIN

The following discussion of water use in the Nile basin is limited to hydrological aspects; there is clearly also a need for negotiations and agreements, which are matters for individual governments. This review is classified by countries for simplicity, though some of the issues have also been discussed in the chapters dealing with specific tributaries. In particular, the proposals to store water in the East African lakes in order to supplement the flows of the Blue

Nile during periods of shortage, while reducing transmission losses in the Sudd by the Jonglei Canal, were known collectively as the Equatorial Nile Project; these were described in Chapter 5. Only the Owen Falls dam, which combined hydroelectric production with the potential for outflow control, has been completed, while the construction of a modified Jonglei Canal was suspended in 1983. The alternative planning of the Aswan High Dam, to provide overyear storage, was discussed in Chapter 11.

Table 12.2 Mean monthly flows at key sites ($\text{m}^3 \times 10^6$).

Jan.	Feb.	March	April	May	June	July	Aug.	Sept.	Oct.	Nov.	Dec.	Year
Kagera at Kyaka Ferry (1940–1978)												
452	420	491	518	617	627	647	603	531	499	460	467	6 332
Other Lake Victoria tributaries (1956–1978)												
819	578	972	2103	2474	1342	1201	1 387	1 332	999	1151	1207	15 565
Victoria Nile at Jinja (1896–1997)												
2162	1973	2204	2212	2412	2369	2372	2 277	2 143	2 160	2057	2160	26 501
Kyoga Nile at Kamdini (1940–1980)												
2511	2200	2372	2301	2526	2550	2679	2 695	2 660	2 733	2609	2657	30 493
Semliki at Bweramule (1940–1978)												
359	292	327	363	415	371	392	417	409	423	435	419	4 622
Bahr el Jebel at Mongalla (1905–1983)												
2534	2180	2327	2360	2767	2663	2920	3 317	3 295	3 244	2975	2751	33 332
Jur at Wau (1904–1986)												
45	17	10	19	98	212	450	818	1 115	1 149	623	176	4 730
Sudd outflow (1905–1983)												
1515	1318	1392	1280	1262	1188	1227	1 284	1 328	1 444	1379	1473	16 091
Baro at Gambeila (1905–1959)												
257	169	163	202	454	1154	1946	2 590	2 971	2 022	816	440	13 184
Sobat at Doleib Hill (1905–1983)												
967	431	273	232	413	851	1301	1 608	1 780	1 992	1964	1718	13 530
White Nile at Malakal (1905–1997)												
2479	1756	1675	1528	1696	2042	2556	2 914	3 117	3 434	3340	3178	29 714
White Nile at Mogren (1911–1995)												
2469	1905	2014	2225	2026	1792	1368	1 435	2 236	3 024	2786	2747	26 026
Blue Nile at Roseires/el Deim (1912–1997)												
762	446	364	324	612	1659	6763	15 228	12 111	6 484	2559	1348	48 658
Dinder at Mouth (1907–1997)												
0	0	0	0	0	16	318	1 005	1 009	392	51	6	2 797
Rahad at Mouth (1908–1997)												
0	0	0	0	0	2	119	346	378	228	27	2	1 102
Blue Nile at Khartoum (1900–1995)												
724	448	406	427	503	1084	4989	15 237	13 625	7 130	2451	1257	48 279
Main Nile at Tamaniat (1911–1995)												
3099	2302	2378	2555	2490	2860	6398	16 151	15 584	9 996	5067	3810	72 691
Main Nile at Hassanab (1909–1995)												
3146	2320	2286	2428	2359	2690	5937	15 607	15 859	10 460	5351	3894	72 337
Atbara at Mouth (1903–1994)												
17	6	1	3	8	88	1536	5 126	3 306	770	145	46	11 052
Main Nile at Dongola (1890–1995)												
3577	2547	2268	2239	2175	2169	5268	18 701	20 554	13 337	6767	4538	84 138
Main Nile at Aswan (Water Arriving) (1869–1992)												
3738	2651	2257	2011	1980	1943	4754	18 207	21 189	14 318	7478	4849	85 376
Main Nile at Aswan/Dongala (1869–1995)												
3831	2715	2379	2220	2127	2178	5529	19 341	21 385	14 151	7295	4298	88 079

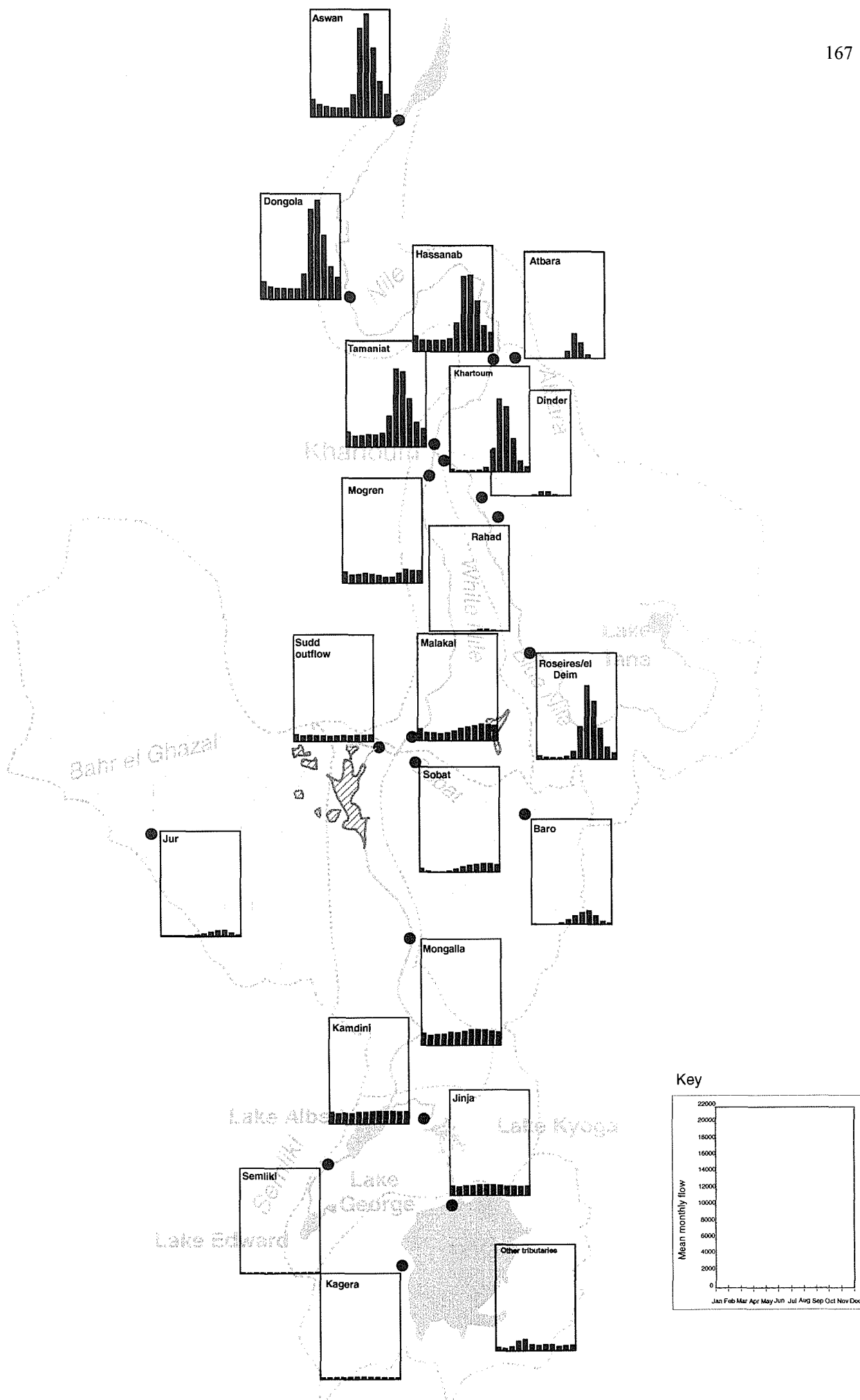

Fig. 12.3 Monthly mean flows at key sites ($m^3 \times 10^6$).

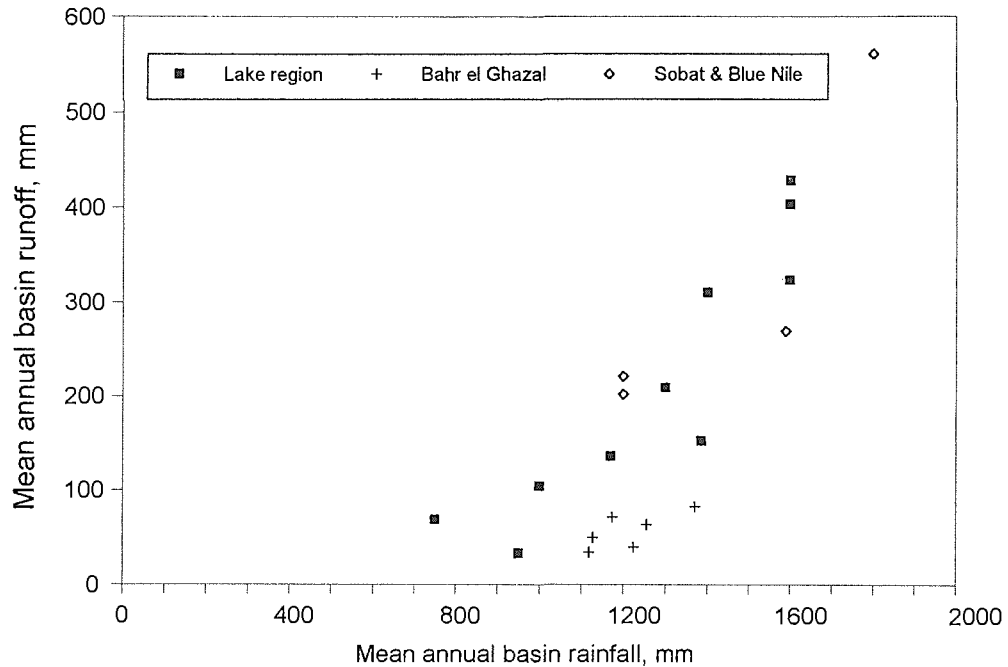

Fig. 12.4 Mean rainfall and runoff depth of Nile tributaries.

EAST AFRICA

Within the upper basin of the White Nile, the areas belonging to the various East African countries have in common a climate with two rainfall seasons and a requirement in some locations for supplementary irrigation for perennial crops. Because of their location, remote from fuel supplies, they also have a need for hydroelectric power. Thus the problems of water requirements have certain similarities over the region.

RWANDA, BURUNDI AND CONGO

Rwanda and Burundi comprise much of the catchment of the Kagera and its tributaries. The runoff of the Kagera is high, and at Rusumo Falls the annual total averages 7 km^3 from $30\,000 \text{ km}^2$ or a depth of 230 mm. The domestic and industrial supplies to the towns of Rwanda and Burundi are unlikely to be significant in the context of this amount of water. There are projects for developing rice irrigation in the valleys of various tributaries, largely in swamps which are inundated seasonally or permanently. The irrigation demand, compared with the natural evaporation from these swamps, is unlikely to result in greatly reduced runoff as these developments occur. One major project which has been investigated for the Kagera river has been the hydroelectric scheme at the Rusumo Falls on the border between Rwanda and Tanzania. The evaporation from the storage reservoir above Rusumo Falls would not be greatly different from the lakes and wetlands which cover the area at present. Thus the effect of this project would be to alter the distribution rather than the total amount of Kagera runoff, and this change would have little effect below Owen Falls because of the storage of Lake Victoria.

The Congo interest is limited to Lake Edward and the upper Semliki, where irrigation could be useful, and the western shore of Lake Albert, which would be affected by a dam below the lake.

UGANDA, KENYA AND TANZANIA

These countries need to supplement rainfall to grow some perennial crops like sugarcane. In preparation for early negotiations over Nile waters, investigations were carried out by 1955 to identify the potentially irrigable areas for Uganda. The irrigation requirements were estimated on a 25-year time scale (Howell, 1994, pp. 82 and 88). The conclusions were that some 110 000 acres (45 000 ha) were suitable for irrigation, mainly for sugarcane and paddy rice, and the water requirement was estimated at 0.535 km³. Similar surveys were also made for Kenya and Tanzania; irrigation needs were estimated as 0.297 and 0.478 km³ respectively. The total requirements for the three East African countries were provisionally estimated as 1.77 km³, of which 1.385 km³ would be required above Owen Falls. This is 5% of the long-term mean outflow. Any irrigation abstractions, except those offset by swamp reclamation, would reduce the inflow to Lake Victoria and the outflow down the Victoria Nile by a similar amount.

A later estimate of water demand was made by WMO (1982) for the years 1980 and 2000. This was based on population statistics and information supplied by governments on irrigated schemes and industrial demand, rather than detailed surveys. The 1980 total water consumption for the five countries, including Rwanda and Burundi, was estimated as 19.0 m³ s⁻¹ or 0.600 km³ year⁻¹; the equivalent estimate for the year 2000 was 185 m³ s⁻¹ or 5.834 km³ year⁻¹. The range of these estimates points to the need for more detailed studies.

At one stage the possibility for diverting water from Lake Victoria or its tributaries towards the south had been investigated (Hurst, 1952). Such diversions, for instance for irrigation, would also directly reduce the inflow to Lake Victoria and the outflow at Owen Falls.

The suggestion has been made that the growth of water hyacinth around the shores of Lake Victoria could affect the outflow by increasing the evaporation. This possibility would need experimental evidence of evaporation from an area of water hyacinth, but it seems likely that the growth will be confined to the borders of the lake and not greatly affect the water balance.

The operation of the Owen Falls dam is at present constrained by agreement to reproduce natural lake outflows by following, at least on a monthly basis, the so-called "Agreed Curve" derived from the natural relation between lake level and outflow. However, the maximization of firm hydroelectric power could give Uganda the incentive to use Lake Victoria storage to maintain outflows at a higher level than historic low flows. Reservoir trials have been carried out by a number of investigators, including WMO (Bakhiet, 1996) and FAO (Georgakakos & Klohn, 1997). The firm flow could be improved by storage; however, the range of lake levels would be increased, and this could affect installations around the lake.

In addition, any alteration of the natural flow would affect the regime of the Bahr el Jebel and the Sudd. It has been shown that the pastoral economy of the Sudd is dependent on the rhythm of flooding and uncovering of the seasonal flood plain. This pattern depends on relatively steady outflows from Lakes Victoria and Albert and the seasonal flows of the torrents above Mongalla. Any random disturbance of lake outflows would disrupt the economy of the area, but it should be possible to ensure that outflows retain a fairly natural pattern after passing through Lakes Kyoga and Albert.

Proposals have been made for a dam below Lake Albert, together with a regulator to control Lake Kyoga. These have been investigated as a part of the Equatorial Nile Project specifically to control the inflow to the Sudd to maximize the diversion down the Jonglei Canal. It would be possible to use such a reservoir in Lake Albert to balance the flows below Lake Victoria and maintain the natural flows into the Bahr el Jebel. The reservoir could provide flood protection to an economy in the southern Sudan which had adapted to the completion of the Jonglei Canal.

By contrast, a simulation study (Georgakakos & Klohn, 1997) to combine energy generation while reducing Sudd losses with the Jonglei Canal relies on curtailing releases from Lake Albert to minimize losses. This implies that water would be released during the dry

season when torrent flows are minimal, and when grazing is required. In other words, losses would be reduced by eliminating the natural fluctuations. This would have a dramatically adverse effect on the local economy.

It is essential to include an understanding of the ecology of the Sudd in modelling studies. The vegetation of the regional wetlands is controlled by the hydrology, and in particular by the flooding regime. The nature of these controls has been deduced from hydrological analysis, following collaborative investigations with ecologists. In turn the hydrological study of an area can be supported by a knowledge of the vegetation and the ecological links with flooding. Joint investigations are required.

ETHIOPIA AND ERITREA

Ethiopia is the source of a high proportion of the Nile flow. The Baro, Blue Nile, Rahad, Dinder and Atbara together provide an average 73 km³ annual inflow to Sudan, while the Bahr el Jebel contributes 33 km³ as measured at Mongalla (1905–1983). However, the flow records within Ethiopia have not been published except for early flows of the Blue Nile below Lake Tana and the Baro at Gambeila. The Eritrean contribution to the Nile is limited to a portion of the Setit tributary of the Atbara. The Gash and Baraka do not drain to the Nile.

The water balance study of runoff by Gamachu (1977) compared average rainfall with transpiration to estimate potential runoff over the country. This showed that the highest rainfall is in the mountains to the west of the central Rift Valley. Here the rainfall is concentrated in a single season and the runoff is disproportionately high. Thus the bulk of the outflow from Ethiopia is towards the Nile tributaries as opposed to the eastern and southern rivers like the Awash, Shebbeli, Juba and Omo. It has been estimated (Said, 1993) that about 70 km³ flow to the Nile compared with about 20 km³ to the Indian Ocean.

The flows of these tributaries are considered as a major resource for Ethiopia (Woudeneh, 1997). The US Bureau of Reclamation studied the Blue Nile basin on behalf of the Ethiopian Government between 1959 and 1964 (Said, 1993). This study concluded that there were no lands along the Blue Nile itself which could be irrigated. However, they located potential irrigation projects totalling 0.53 million ha near Lake Tana and along various tributaries, including the Dinder and Rahad. The potential water requirement totalled 6.4 km³. A number of major hydroelectric projects were suggested along the Blue Nile and its tributaries, including Lake Tana itself. These would involve in total over 20 dams with capacities of over 100 km³. To date projects have been constructed at the outlet of Lake Tana to generate power, and on the Finchaa with a capacity of 0.4 km³ to generate hydropower and to irrigate sugarcane downstream of a swamp.

Further studies have recently been carried out for the Baro-Akobo, Abbay (Blue Nile), and Tekeze (Atbara) basins (Amanuel, 1997). The Baro-Akobo basin is subject to considerable spillage after reaching the plains below Gambeila. This spill occurs both within Ethiopia and into the Machar marshes. There are plans to irrigate the plains and a dam is under consideration on the Baro near Gambeila with a capacity of 1.5 km³ (Said, 1993) in order to irrigate some 315 000 ha. This is an area where there have been in the past Egyptian plans to reduce spillage from the Baro-Sobat by means either of storage or channel construction. It is possible that a joint study on the Baro might show that benefits could accrue to both Ethiopia and the downstream users.

It has been argued (Guariso & Whittington, 1987) that the construction of reservoirs in the Blue Nile basin and their management in coordination with the Roseires and Aswan reservoirs need not reduce the water available to Sudan and Egypt because evaporation in the

Ethiopian reservoirs would be less than the saving of evaporation downstream. It seems that exchange of hydrological information could be of benefit to all countries.

SUDAN

As a result of negotiations between Egypt and Sudan preceding the construction of the Aswan High Dam, the two countries agreed in 1959 that the mean natural flow at Aswan, estimated as 84 km^3 less 10 km^3 reservoir evaporation, should be divided with 55.5 km^3 to Egypt and 18.5 km^3 to Sudan, which Shahin (1985) notes was in proportion to the population of the countries at that time.

The main water demand in Sudan is for irrigation, though the hydroelectric power production from existing reservoirs is an important contribution to the economy. The relative importance of the irrigation demand is illustrated by Sutcliffe & Lazenby (1990). The annual water supply demand for the Khartoum complex is only 0.07 km^3 compared with an irrigation demand of 14 km^3 . The evaporation from Roseires, Sennar and Khashm el Girba reservoirs is 0.5 km^3 . These reservoirs are used primarily for irrigation but also for hydroelectric power.

On the Blue Nile the Sennar dam was built in 1925 to provide water to the Gezira and has a current capacity of about 0.5 km^3 . The Roseires dam was completed in 1966 to provide further water for irrigation and from 1973 also provided hydroelectric power (capacity now 275 MW). After significant siltation of the dead storage in the early years of operation, the storage volume has largely stabilized at some 2.4 km^3 . The problem of operating these reservoirs is that the sediment load of the Blue Nile is high, especially on the rising flood. The storage capacity is relatively low, compared with the mean annual flow of 49 km^3 . The sediment concentration at the flood peak is some 10 times that on the falling flood. The policy has been to draw down the reservoirs during the rising flood season, which has a major impact on hydropower operation. Operating rules have been developed to optimize hydropower production in terms of water availability and irrigation demand. Similar problems arise in the case of the Khashm el Girba reservoir. This was constructed on the Atbara in 1960–1964 with an initial capacity of 1.3 km^3 . This reservoir was designed to provide an alternative livelihood to those displaced from the Sudan reach of the Aswan reservoir; it has suffered from sediment problems and alternative sites are being investigated. The Roseires dam, on the other hand, is being raised to provide increased storage capacity.

The Jebel Aulia dam on the White Nile was constructed in 1934–1937 with a capacity of 3.5 km^3 . It was built to store the flows of the White Nile for release to Egypt during the “timely season” when Blue Nile flows are low. Since the construction of the Aswan High Dam this role is no longer vital; on the other hand it is responsible for a significant evaporation loss. However, the development of irrigation along the White Nile has been facilitated by the higher levels of the reservoir, which also provide recession agriculture and grazing at some cost in evaporation.

Potential hydropower development along the relatively steep course of the main Nile between Khartoum and the Aswan reservoir has been investigated, with possible sites including Merowe (Knott & Hewett, 1994).

EGYPT

The history of water resources development in Egypt, and the change from basin to perennial irrigation, cannot be treated fully here, but has been discussed elsewhere (e.g. Said, 1993). A dam at Aswan was first completed in 1902 and heightened in 1912 and 1933. The reservoir

capacities (1–5 km³) were sufficient only for annual storage, to retain part of the main Nile flow, supplemented by Jebel Aulia storage, for release during the irrigation season.

Hurst *et al.* (1946) carried out research on the storage volume required to maintain a draft equal to or near the long-term mean flow. At that time the search for overyear storage was concentrated on the East African lakes and to a lesser extent on Lake Tana, where rainfall could reduce or eliminate the effect of reservoir evaporation. This basinwide planning involved the use of storage in Lakes Albert or Victoria to overcome flow variations of the Ethiopian tributaries. It necessarily led to the inclusion of a proposed Jonglei Canal to route the flows from the lakes through the Sudd, where the flows would otherwise have been much reduced. This so-called Equatorial Nile Project required the concentration of flows through the canal during periods when “timely flow” was required in Egypt and this meant the reversal of seasonal flows in the Sudd. The insistence of the Jonglei Investigation Team (1954) that this was unacceptable, and the move towards political independence of the countries of the White Nile basin, led towards the alternative solution of the Aswan High Dam. This has provided overyear storage and an assured supply of water during periods of drought on the Blue Nile, though the annual cost in increased evaporation has been estimated as about 10 km³.

A series of barrages along the Nile below Aswan has been constructed over the years to facilitate the distribution of water for irrigation. Flows at these sites provide estimates of the water diverted along the course of the river. The construction of the Aswan High Dam by 1964 has made it possible to equalize the water available from year to year, and has allowed the water diverted above the Delta barrage to be increased over the years.

Irrigated agriculture could be increased further by improving the efficiency of existing irrigation. An alternative is increasing the available water by reducing the evaporation losses in the White Nile basin, mainly in the southern Sudan. The scope for agricultural improvement has been described as large (Stoner, 1994); increases in crop yields could be substantial while the choice of area for development, improvement in distribution systems, and drainage re-use could all contribute. As part of a project to improve water-use efficiency, a network of over 800 sites is at present being developed as part of a system of monitoring and telemetering water levels and flows along the Nile and distribution systems.

PROJECTS TO INCREASE RIVER FLOWS

The background to the various projects to increase the yield of the White Nile by reducing evaporation in the wetlands of the Bahr el Jebel, Bahr el Ghazal and Sobat basins has been described in Chapters 5, 6 and 7. These projects have been investigated over many years since the Jonglei Canal was first suggested in 1904. However, the project known as Jonglei I, which was two-thirds completed by 1983 before suspension, was quite different from the earlier project which was examined by the Jonglei Investigation Team (1954). The recent project was based on a canal to pass a steady flow of $20 \text{ m}^3 \times 10^6 \text{ day}^{-1}$ without control of the inflows. This project was estimated to increase White Nile flows by $4 \text{ km}^3 \text{ year}^{-1}$, and its effect has been estimated to reduce the area of permanent swamp by 35% and the important area of seasonal swamp by 22% over the historic period 1905–1980. More importantly, the seasonal cycle of inundation would not have been affected. However, this effect would have been proportionally higher during the low flow period 1905–1961 than the high flow period 1961–1980. It would be possible to reduce the adverse effects of this project by varying the flow down the canal between seasons and thus alter the residual flow down the Bahr el Jebel. Initial estimates have suggested that amending the constant flow of $20 \text{ m}^3 \times 10^6 \text{ day}^{-1}$ to a flow of $25 \text{ m}^3 \times 10^6 \text{ day}^{-1}$ during November–April and $15 \text{ m}^3 \times 10^6 \text{ day}^{-1}$ during May–October would

result in a decrease of only 11% in the seasonal swamp and a decrease of 38% in the permanent swamp. This would also have the advantage that the level range of seasonal flooding, due to the uncontrolled flows of the torrents above Mongalla, would be increased by this mode of operation. This would favour grassland rather than papyrus.

The scheme known as Jonglei II would include the use of storage in Lake Victoria or Lake Albert to regulate the flows of the Bahr el Jebel. Variations of inflows to the Sudd would be reduced and flows down the canal would be doubled to provide a capacity of $50 \text{ m}^3 \times 10^6 \text{ day}^{-1}$. The control of inflows to the Sudd would clearly have a major effect on the seasonal fluctuations of inundation. At present these provide the dry season grazing on which the pastoral economy depends. However, it is the torrents between Lake Albert and Mongalla which provide most of the seasonal inundation. Provided no attempt were made to store these virtually in Lake Albert, this seasonal pattern would continue. Alternatively, the operation of any Lake Albert reservoir might reproduce the present pattern of inundation. Further study of detailed proposals would be necessary.

Another project is known as the Bahr el Ghazal conservation scheme, but details do not appear to have been formulated. The inflows of the Bahr el Ghazal tributaries are highly seasonal and average about 11 km^3 . Three other tributaries contribute 2.6 km^3 towards the Bahr el Jebel. The flows are spilled into the flood plains and evaporation accounts for virtually all the inflow. The proposals include storage on the tributaries, for example on the Jur and Busseri above Wau (*The Nile Basin*, vol. XI, pp. 66–89). It would be necessary to construct canals to divert the stored water to the Bahr el Jebel for transmission by the Jonglei Canal or directly to the White Nile. The upper reaches of the Bahr el Ghazal flood plains provide grazing to the inhabitants of the area, as illustrated by Maps A and B of the Southern Development Investigation Team report (1955). The effect of storage and diversion of the tributary flows would clearly affect the vegetation of the flood plains. There would presumably be scope to pass sufficient of the flood flows to provide seasonal inundation and grazing at the expense of permanent swamp. Ecological input to the planning of these projects is essential.

The high flows of the Baro and other Sobat tributaries are spilled into adjacent wetlands and towards the Machar marshes. The losses have not been estimated with precision, as the area has not been investigated in detail because of access problems. Schemes to reduce these losses have only been planned in general terms. Alternative proposals have included a storage reservoir on the Baro, and a channel to carry excess flows from the Baro through the Machar marshes. However, any developments would need collaboration with Ethiopia, and there are also proposals for development of the Baro and other tributaries within Ethiopia itself.

Although the area of the lower Baro and adjacent tributaries was sparsely occupied by 50 000 Anuak up to 1984, the population had quadrupled by 1996. To support this increase, projects are being studied for a dam on the Mekoy (Woube, 1997) and for a dam at Gambeila (Said, 1993). It is doubtful that the construction of these dams for local irrigation would have sufficient capacity to prevent some continued losses to the Machar marshes. A larger dam on the Baro might both provide water for local irrigation and also control flows on the lower Baro sufficiently to reduce spilling and thus increase downstream contributions. It is possible that this area could provide a fruitful topic for collaborative investigation, leading to a project to benefit both upstream and downstream users.

CONCLUSION

This book has treated each major tributary or reach of the Nile as a separate entity, and has described its hydrological character. However, the unique feature of the Nile is that a number of disparate tributaries have, by geological accident, combined into one long river system. Thus the whole river has developed a complex joint character of its own.

The overall impression is of a persistent baseflow, reflecting the outflow from the Lake Victoria basin, but modified by other lake systems and wetlands as the river flows downstream. The influence of each reach is very different, depending on topography and local water balance; this is expressed by an increase or decrease in the baseflow, and the addition of seasonal variations.

The importance of seasonal variation changes dramatically below the Sudd, because the local inflow is then derived from the Ethiopian tributaries. These have limited rainfall seasons and steep upland catchments, and thus relatively fast response. In addition the rainfall season becomes shorter as one moves north, and consequently the runoff season becomes progressively shorter and the flow more seasonal in character.

The Nile waters are at present used mainly well below the sources of inflow. The cumulative effect of all these influences on the series of annual flows and their seasonal distribution has been the source of hydrological interest in the Nile over many centuries and will remain so.

It is promising to note that the series of Nile 2002 conferences being held annually are leading to an atmosphere in which information is being shared, and it is to be hoped that this will lead to collaborative studies throughout the Nile basin. This has already been achieved between Egypt and Sudan through the PJTC, and in the East African basin through the Hydrometeorological Survey and Tecconile. It could be argued that local studies would be practicable, dealing for example with the Baro basin and the conveyance losses, or the possible role of Lake Albert in reconciling the hydroelectric benefits of equalizing the flows of the Nile below Lake Victoria with the concerns of downstream countries.

It is now over 40 years since H. A. W. Morrice, as Irrigation Adviser to the Republic of the Sudan, prepared a Nile Valley Plan (Morrice, 1956, with tables published by the Ministry of Irrigation and Hydroelectric Power). This considered the role which reservoirs in Lake Victoria and Lake Albert, together with a Jonglei Canal designed to pass much of the lake outflow past the Sudd, could play in increasing the water available for irrigation. Reservoirs on Lake Tana and on the Baro near Gambeila were included in the modelling, and the hydroelectric potential of the Ethiopian tributaries, and the irrigation requirements of East Africa, were acknowledged but not quantified. The transmission losses in the Sudd, and the flow requirements of the area, as expressed by the Jonglei Investigation Team (1954), were included. An account of this first modelling exercise was published by IAHS (Morrice, 1957) under the title "The use of electronic computing machines to plan the Nile Valley as a whole". The modelling was based on flow records from 1905 to 1952, but the dramatic changes which have occurred in the subsequent period make it desirable to make another trial with longer records and wider objectives.

REFERENCES

The Nile Basin, vols I–XI

Because the various volumes and supplements of *The Nile Basin* have been quoted frequently, and the authors vary, the volumes are listed here in sequence.

- The Nile Basin*, vol. I (1931) *General Description of the Basin, Meteorology, Topography of the White Nile Basin*. Government Press, Cairo.
- The Nile Basin*, vol. II and supplements 1–13 (1932–date) *Measured Discharges of the Nile and its Tributaries*. Government Press, Cairo.
- The Nile Basin*, vol. III and supplements 1–13 (1933–date) *Ten-day Mean and Monthly Mean Gauge Readings of the Nile and its Tributaries*. Government Press, Cairo.
- The Nile Basin*, vol. IV and supplements 1–13 (1933–date) *Ten-day Mean and Monthly Mean Discharges of the Nile and its Tributaries*. Government Press, Cairo.
- The Nile Basin*, vol. V (1938) *The Hydrology of the Lake Plateau and Bahr El Jebel*. Government Press, Cairo.
- The Nile Basin*, vol. VI and supplements 1–11 (1943–date) *Monthly and Annual Rainfall Totals and Number of Rainy Days at Stations in and near the Nile Basin*. Government Press, Cairo.
- The Nile Basin*, vol. VII (1946) *The Future Conservation of the Nile*. Government Press, Cairo.
- The Nile Basin*, vol. VIII (1950) *The Hydrology of the Sobat and White Nile and the Topography of the Blue Nile and Atbara*. Government Press, Cairo.
- The Nile Basin*, vol. IX (1959) *The Hydrology of the Blue Nile and Atbara and of the Main Nile to Aswan, with some Reference to Projects*. Government Press, Cairo.
- The Nile Basin*, vol. X (1966) *The Major Nile Projects*. Government Press, Cairo.
- The Nile Basin*, vol. XI (1978) *The Hydrology of the Sadd El Aali, and Other Topics*. Government Press, Cairo.

All cited references

- Abdel Mageed, Y. (1985) The Jonglei Canal: a conservation project of the Nile. In: *Large-scale Water Transfers: Emerging Environmental and Social Experiences* (ed. by G. N. Golubev & A. K. Biswas), 85–101. Tycooley, Oxford, UK.
- Adam, A. M., Munshid, F. E. & Ahmed, S. E. (1994) Bank erosion of the River Nile in northern Sudan. In: *2nd Nile 2002 Conf.* (Khartoum).
- Air Survey Company, Ltd 1931/32 Air survey maps. London.
- Amanuel, H. W. (1997) The headwaters of the Nile basin: toward a concerted action for integrated development, preservation and conservation. In: *5th Nile 2002 Conf.* (Addis Ababa).
- Asefa, K. (1997) Aspects of water resources monitoring and assessment in Ethiopia. In: *5th Nile 2002 Conf.* (Addis Ababa).
- Baker, S. W. (1866) *The Albert N'yanza, Great Basin of the Nile, and Explorations of the Nile Sources*. MacMillan, London.
- Bakhiet, H. B. (1996) Regulation plans of the Equatorial lakes. In: *4th Nile 2002 Conf.* (Kampala).
- Bishop, W. W. (1969) Pleistocene stratigraphy in Uganda. *Geological Survey Uganda, Memoir 10*. Entebbe.
- Brachi, R. M. (1960) Excavation of a rock shelter at Hippo Bay, Entebbe. *Uganda J.* **24**, 62–70.
- Brown, J. A. H., Ribeny, F. M. J., Wolanski, E. J. & Codner, G. P. (1979) A summary of the Upper Nile basin model. *Snowy Mountains Engineering Corporation, Cooma, NSW 2630, Australia*.
- Butcher, A. D. (1938) *The Sadd Hydraulics*. Ministry of Public Works, Cairo.
- Casati, G. (1891) *Ten Years in Equatoria and the Return with Emin Pasha* (tr. by J. R. F. Clay). Warne & Co., London & New York.
- Chan, Siu-On & Eagleson, P. S. (1980) *Water Balance Studies in the Bahr el Ghazal Swamp*. Dept Civ. Engng, Mass. Inst. Tech., Report no. 261.
- Channon, J. A. (1968) The weather of Lake Victoria. *WMO Hydrometeorological Survey Inauguration, Entebbe*.
- Conway, D. (1997) A water balance model of the Upper Blue Nile in Ethiopia. *Hydrol. Sci. J.* **42**(2), 265–286.
- Cunnane, C. (1978) Unbiased plotting positions—a review. *J. Hydrol.* **37**, 205–222.
- Datta, R. K. (1981) Certain aspects of monsoonal precipitation dynamics over Lake Victoria. In: *Monsoon Dynamics* (ed. by J. Lighthill & R. Pearce), 333–349. Cambridge Univ. Press, UK.
- de Baulny, H. L. & Baker, D. (1970) *The Water Balance of Lake Victoria*. Technical Note, Water Development Department, Entebbe.
- Eagleson, P. S. (1978) Climate, soil and vegetation 1–7. *Wat. Resour. Res.* **14**, 705–776.
- Eagleson, P. S. (1986) The emergence of global-scale hydrology. *Wat. Resour. Res.* **22**(9), 6S–14S.

- El Amin, M. & Ezzat, M. N. (1978) *Jonglei Canal Water Benefit (Offtake at Bor)*. PJTC Report, Khartoum.
- El-Hemry, I. I. & Eagleson, P. S. (1980) *Water Balance Estimates of the Machar Marshes*. Dept Civ. Engng, Mass. Inst. Tech., Report no. 260.
- El Moushid, B. E. F., El Awad, O. M. A. & Ahmed, S. E. (1997) Environmental effect of the Blue Nile sediment on reservoirs and irrigation canals. In: *5th Nile 2002 Conf.* (Addis Ababa).
- El Zein, Soghayroon (1974) An approach to water conservation: projects for reduction of losses in some tributaries of the Nile. *Sudan Engng Soc. J.* **21**.
- Evans-Pritchard, E. E. (1940) *The Nuer*. Clarendon Press, Oxford, UK.
- Ezzat, M. N. (1993) Nile water flow, demand and water development. In: *Intern. Symp. on High Aswan Dam*, (Cairo), General Report, 77–89. International Commission on Large Dams.
- Farmer, G. (1981) Regionalisation and study of an alleged change in the rainfall climatology of East Africa. PhD Thesis, University of Sheffield, UK.
- Flohn, H. & Burkhardt, Th. (1985) Nile runoff at Aswan and Lake Victoria: a case of discontinuous climate time series. *Zeitschr. Gletscherkunde Glazialgeol.* **21**, 125–130.
- Gamachu, D. (1977) *Aspects of Climate and Water Budget in Ethiopia*. Addis Ababa University Press, Addis Ababa.
- Garstin, W. (1901) Report as to Irrigation Projects on the Upper Nile, etc. (In a Despatch from His Majesty's Agent and Consul-General at Cairo). *Parliamentary Accounts and Papers* **1901**, 91, 1149 *et seq.*
- Garstin, W. (1904) Report upon the basin of the Upper Nile (In a Despatch from His Majesty's Agent and Consul-General at Cairo). *Parliamentary Accounts and Papers* **1904**, 111, 315–735.
- Georgakakos, A. P. & Klohn, W. (1997) A decision support system for the Nile river. In: *5th Nile 2002 Conf.* (Addis Ababa).
- Gibb, Sir Alexander & Partners (1989) *Sub-Saharan Africa Hydrological Assessment (IGADD Countries)*. Final Report by Sir Alexander Gibb & Partners to World Bank-UN Development Programme.
- Gibb, Sir Alexander & Partners (1996) *Uganda Hydropower Development Masterplan: Report on the Hydrology of the Nile below Lake Victoria*. vol. 6 of Final Report to Uganda Electricity Board, by Kennedy & Donkin Power Ltd in association with Sir Alexander Gibb & Partners Ltd.
- Gleick, J. (1987) *Chaos: Making a New Science*. Viking Penguin, New York.
- Grabham, G. W. & Black, R. P. (1925) *Report of the Mission to Lake Tana*. Government Press, Cairo.
- Grijzen, J. G., Snoeker, X. C., Vermeulen, C. J. M., Mohamed el Amin Moh. Nur & Yasir Abbas Mohamed (1992) An information system for flood early warning. In: *3rd Int. Conf. on Floods and Flood Management*, 263–289.
- Guariso, G. & Whittington, D. (1987) Implications of Ethiopian water development for Egypt and Sudan. *Wat. Res. Development* **4**, 105–114.
- Hamad, O. E. (1993) Optimal operation of a reservoir system during a dry season. PhD Thesis, Univ. of Newcastle upon Tyne, UK.
- Hardy, S., Dugdale, G., Milford, J. R. & Sutcliffe, J. V. (1989) The use of satellite derived rainfall estimates as inputs to flow prediction in the river Senegal. In: *New Directions for Surface Water Modeling* (ed. by M. L. Kavas) (Proc. Baltimore Symp., May 1989), 23–30. IAHS Publ. no. 181.
- Harris, A. R. (1991) Remote sensing of wetland areas using infrared satellite data. Mullard Space Science Laboratory, University College, London.
- Hope, C. M. (1902) The Sudd of the Upper Nile. *Ann. Botany* **16**, 495–516.
- Howell, P. P. (1953) The Equatorial Nile Project and its effects in the Sudan: a paper by members of the Jonglei Investigation Team (ed. by P. P. Howell). *Geogr. J.* **119**, 33–48.
- Howell, P. P. (1994) East Africa's water requirements: the Equatorial Nile Project and the Nile Waters Agreement of 1929. A brief historical review. In: *The Nile: Sharing a Scarce Resource* (ed. by P. P. Howell & J. A. Allan), 81–107. Cambridge Univ. Press, UK.
- Howell, P. P. & Allan, J. A. (eds) (1994) *The Nile: Sharing a Scarce Resource*, Cambridge University Press, UK.
- Howell, P. P., Lock, J. M. & Cobb, S. M. (eds) (1988) *The Jonglei Canal: Impact and Opportunity*. Cambridge University Press, UK.
- Hughes, R. H. & Hughes, J. S. (1992) *A Directory of African Wetlands*. IUCN, Gland/UN Environment Programme, Nairobi/WCMC, Cambridge.
- Hulme, M. & Trilsbach, A. (1989) The August 1988 storm over Khartoum: its climatology and impact. *Weather* **44**, 82–90.
- Hurst, H. E. (1950) *The Hydrology of the Sobat and White Nile and the Topography of the Blue Nile and Atbara*. *The Nile Basin*, vol. VIII. Government Press, Cairo.
- Hurst, H. E. (1952, 1957 2nd enlarged edn) *The Nile*. Constable, London.
- Hurst, H. E. & Phillips, P. (1931) *General Description of the Basin, Meteorology, Topography of the White Nile Basin*. *The Nile Basin*, vol. I, Government Press, Cairo.
- Hurst, H. E. & Phillips, P. (1938) *The Hydrology of the Lake Plateau and Bahr el Jebel*. *The Nile Basin*, vol. V. Government Press, Cairo.
- Hurst, H. E. & Black, R. P./Nile Control Staff (1943–date) *Monthly and Annual Rainfall Totals and Number of Rainy Days at Stations in and near the Nile Basin*. *The Nile Basin*, vol. VI and supplements 1–11. Government Press, Cairo.

- Hurst, H. E., Black, R. P. & Simaika, Y. M. (1946) *The Future Conservation of the Nile. The Nile Basin*, vol. VII. Government Press, Cairo.
- Hurst, H. E., Black, R. P. & Simaika, Y. M. (1959) *The Hydrology of the Blue Nile and Atbara and of the Main Nile to Aswan, with some reference to Projects. The Nile Basin*, vol. IX. Government Press, Cairo.
- Hurst, H. E., Black, R. P. & Simaika, Y. M. (1965) *Long-Term Storage: An Experimental Study*. Constable, London.
- Hurst, H. E., Black, R. P. & Simaika, Y. M. (1966) *The Major Nile Projects. The Nile Basin*, vol. X. Government Press, Cairo.
- Hurst, H. E., Black, R. P. & Simaika, Y. M. (1978) *The Hydrology of the Sadd el Aali. The Nile Basin*, vol. XI. Government Press, Cairo.
- Hurst, H. E. & Phillips, P./Nile Control Staff (1932-date) *Measured Discharges of the Nile and its Tributaries. The Nile Basin*, vol. II and supplements 1–13. Government Press, Cairo.
- Hurst, H. E. & Phillips, P./Nile Control Staff (1933-date) *Ten-day Mean and Monthly Mean Gauge Readings of the Nile and its Tributaries. The Nile Basin*, vol. III and supplements 1–13. Government Press, Cairo.
- Hurst, H. E. & Phillips, P./Nile Control Staff (1933-date) *Ten-day Mean and Monthly Mean Discharges of the Nile and its Tributaries. The Nile Basin*, vol. IV and supplements 1–13. Government Press, Cairo.
- Hydraulics Research Station (1966) *Ripon Falls, Uganda: Stage Discharge Relationship. Report on Model Investigation*. Report no. EX 316, Hydraulics Research Station, Wallingford, UK.
- Institute of Hydrology (1978) *Nile Waters Study: Hydrology*. Report to Sir Alexander Gibb & Partners, forming Supporting Report VI of Nile Waters Study, Report by Nile Waters Consultants (Coyne et Bellier, Sir Alexander Gibb & Partners, Hunting Technical Services Limited, Sir M MacDonald & Partners) to Sudan Ministry of Irrigation.
- Institute of Hydrology (1984) *A Review of the Hydrology of Lake Victoria and the Victoria Nile*. Report to Sir Alexander Gibb & Partners. Institute of Hydrology, Wallingford, UK.
- Institute of Hydrology (1985) *Further Review of the Hydrology of Lake Victoria*. Report to Overseas Development Authority. Institute of Hydrology, Wallingford, UK.
- Institute of Hydrology (1993) *A Review and Update of the Water Balance of Lake Victoria in East Africa*. Report to the Overseas Development Administration. Institute of Hydrology, Wallingford, UK.
- Institute of Hydrology (1995) *HYDATA Operation Manual: Version 3.21*. Institute of Hydrology, Wallingford, UK.
- Johnson, D. H. (1992) Reconstructing a history of local floods in the Upper Nile Region of the Sudan. *Intern. J. African Hist. Studies* **25**, 607–649.
- Johnson, P. A. & Curtis, P. D. (1994) Water balance of Blue Nile River basin in Ethiopia. *J. Irrig. Drain. Engng* **120**, 573–590.
- Jonglei Investigation Team (1947) *Second Interim Report*. Sudan Government.
- Jonglei Investigation Team (1948) *Third Interim Report*. Sudan Government.
- Jonglei Investigation Team (1954) *The Equatorial Nile Project and its Effects in the Anglo-Egyptian Sudan*. Report of the Jonglei Investigation Team, 4 vols. Sudan Government, Khartoum.
- Kite, G. W. (1981) Recent changes in level of Lake Victoria. *Hydrol. Sci. Bull.* **26**(3), 233–243.
- Kite, G. W. (1982) Analysis of Lake Victoria levels. *Hydrol. Sci. J.* **27**(1), 99–110.
- Knott, D. G. & Hewett, R. (1994) Water resources planning in the Sudan. In: *The Nile: Sharing a Scarce Resource* (ed. by P. P. Howell & J. A. Allan), 205–216. Cambridge Univ. Press, UK.
- Lamb, H. H. (1966) Climate in the 1960s. *Geogr. J.* **132**, 183–212.
- Lock, J. M. (1973) The aquatic vegetation of Lake George, Uganda. *Photocoenolia* **1**(2), 250–262.
- Lyons, H. G. (1906) *The Physiography of the River Nile and its Basin*. Survey Department, Cairo.
- Mandelbrot, B. B. (1977) *The Fractal Geometry of Nature*. Freeman, New York.
- Mandelbrot, B. B. & Wallis, J. R. (1968) Noah, Joseph and operational hydrology. *Wat. Resour. Res.* **4**, 909–918.
- Mason, P. J. (1993) Hydrology or climate change? A case study. *Dams & Reservoirs* **3**(2), 10–12.
- Meigh, J. R., Farquharson, F. A. K. & Sutcliffe, J. V. (1997) A worldwide comparison of regional flood estimation methods and climate. *Hydrol. Sci. J.* **42**(2), 225–244.
- Migahid, A. M. (1948) *Report on a Botanical Excursion to the Sudd Region*. Fouad I University Press, Cairo.
- Migahid, A. M. (1952) *Further Observations on the Flow and Loss of Water in the "Sudd" Swamps of the Upper Nile*. Fouad I University Press, Cairo.
- Ministry of Public Works, Egypt (1938) *Upper Nile Projects. Veveno Pibor Diversion Scheme: Bahr-el-Gebel Banking Scheme: Jonglei Canal Diversion Scheme*. Government Press, Cairo.
- Moorehead, A. (1960) *The White Nile*. Hamish Hamilton, London.
- Moorehead, A. (1962) *The Blue Nile*. Hamish Hamilton, London.
- Morrice, H. A. W. (1956) A plan for the Nile Valley. *Sudan Engng Soc. J.*, May 1956.
- Morrice, H. A. (1957) The use of electronic computing machines to plan the Nile Valley as a whole. In: *General Assembly of Toronto, 3–14 September 1957*, vol. III: *Surface Water, Prevision, Evaporation*, 95–105. IAHS Publ. no. 45.

- Morth, H. T. (1967) Investigation into the meteorological aspects of the variations in the level of lake Victoria. *East African Met. Dept Mem. IV(2)*, Nairobi.
- Newhouse, F. (1929) *The Problem of the Upper Nile*. Ministry of Public Works, Cairo.
- Nicholson, S. E. (1980) Saharan climates in historic times. In: *The Sahara and the Nile* (ed by M. A. J. Williams. & H. Faure), 173–200. A. A. Balkema, Rotterdam.
- Nicholson, S. E. (1989) Long term changes in African rainfall. *Weather* **44**, 47–56.
- Ntale, H. K. (1996) Lake Kyoga, The Nile 'green' lake that is dying unnoticed. In: *4th Nile 2002 Conf.* (Kampala).
- O'Connell, P.E. (1971) A simple stochastic modelling of Hurst's law. In: *Mathematical Models in Hydrology* (Proc. Warsaw Symp., July 1971), vol. 1, 169–187.
- Penman, H. L. (1948) Natural evaporation from open water, bare soil and grass. *Proc. Roy. Soc.* **193**, 120–145.
- Penman, H. L. (1963) *Vegetation and Hydrology*. Commonwealth Agricultural Bureaux, Farnham Royal.
- Piper, B. S., Plinston, D. T. & Sutcliffe, J. V. (1986) The water balance of Lake Victoria. *Hydrol. Sci. J.* **31(1)**, 25–47.
- Popper, W. (1951) *The Cairo Nilometer*. University of California Press, Berkeley and Los Angeles.
- Rzóska, J. (ed.) (1976) *The Nile: Biology of an Ancient River*. Junk., The Hague.
- Said, R. (1993) *The River Nile: Geology, Hydrology and Utilization*. Pergamon Press, Oxford.
- Sene, K. J. & Plinston, D. T. (1994) A review and update of the water balance of Lake Victoria in East Africa. *Hydrol. Sci. J.* **39(1)**, 47–63.
- Shahin, M. M. A. (1985) *Hydrology of the Nile Basin*. Developments in Water Science, 21, Elsevier, Amsterdam.
- Snyder, F. F., Bleasdale, A. & Thompson, T. F. (1961) *Studies of the Probable Maximum Flood for the Roseires Dam Project*. Report to the Joint Consulting Engineers in connection with Engineering Services for the Ministry of Irrigation and Hydro-Electric Power, Khartoum.
- Southern Development Investigation Team (1955) *Natural Resources and Development Potential in the Southern Provinces of the Sudan*. Sudan Government, Khartoum.
- Stoner, R. (1994) Future irrigation planning in Egypt. In: *The Nile: Sharing a Scarce Resource* (ed. by P. P. Howell & J. A. Allan), 195–204. Cambridge Univ. Press, UK.
- Sutcliffe, J. V. (1957) The hydrology of the Sudd region of the upper Nile. PhD Thesis, University of Cambridge.
- Sutcliffe, J. V. (1974) A hydrological study of the southern Sudd region of the upper Nile. *Hydrol. Sci. Bull.* **19(2)**, 237–255.
- Sutcliffe, J. V. (1979) Obituary: Harold Edwin Hurst. *Hydrol. Sci. Bull.* **24(4)**, 539–541.
- Sutcliffe, J. V. (1987) The use of historical records in flood frequency analysis. *J. Hydrol.* **96**, 159–171.
- Sutcliffe, J. V. (1993) Hydrological regimes and vegetation of Nile basin wetlands. In: *Regional Conf. on Environmentally Sound Management of the Upper Nile Watershed* (Khartoum).
- Sutcliffe, J. V. (1996) The role of local hydrological studies in the water resources management of the Nile basin. In: *4th Nile 2002 Conf.* (Kampala).
- Sutcliffe, J. V. & Lazenby, J. B. C. (1990) Hydrological data for surface water resources assessment. In: *The Hydrological Basis for Water Resources Management* (ed. by U. Shamir & Chen Jiaqi) (Proc. Beijing Symp., October 1990), 251–259. IAHS Publ. no. 197.
- Sutcliffe, J. V. & Lazenby, J. B. C. (1994) Hydrological data requirement for planning Nile management. In: *The Nile: Sharing a Scarce Resource* (ed. by P. P. Howell & J. A. Allan), 163–192. Cambridge Univ. Press, UK.
- Sutcliffe, J. V. & Mhlanga, L. (1980) *Prediction of the Environmental Effects of the Kagera River Basin Development*. Report to UNESCO, Institute of Hydrology, Wallingford, UK.
- Sutcliffe, J. V., Dugdale, G. & Milford, J. R. (1989) The Sudan floods of 1988. *Hydrol. Sci. J.* **31(3)**, 355–364.
- Sutcliffe, J. V., Ollier, C. D. & Shannon, G. (1957) *The Upstream Effects of the Proposed Mutir Dam*. Ministry of Agriculture and Natural Resources, Entebbe.
- Sutcliffe, J. V. & Parks, Y. P. (1982) *A Hydrological Estimate of the Effects of the Jonglei Canal on Areas of Flooding*. Report to FAO, Institute of Hydrology, Wallingford.
- Sutcliffe, J. V. & Parks, Y. P. (1987) Hydrological modelling of the Sudd and Jonglei Canal. *Hydrol. Sci. J.* **32(2)**, 143–159.
- Sutcliffe, J. V. & Parks, Y. P. (1989) Comparative water balances of selected African wetlands. *Hydrol. Sci. J.*, **34(1)**, 49–62.
- Sutcliffe, J. V. & Parks, Y. P. (1993) Environmental aspects of the Jonglei Canal. In: *1st Nile 2002 Conf.*, (Aswan), VI 4-1–VI 4-15.
- Sutcliffe, J. V. & Parks, Y. P. (1994a) The role of modern data processing in the Nile basin. In: *2nd Nile 2002 Conf.* (Khartoum), 403–417.
- Sutcliffe, J. V. & Parks, Y. P. (1994b) The water balance of the Bahr el Ghazal swamps. In: *The Nile: Sharing a Scarce Resource* (ed. by P. P. Howell & J. A. Allan), 281–298. Cambridge Univ. Press, UK.
- Sutcliffe, J. V. & Parks, Y. P. (1996) Hydrological controls of Sudd ecology. In: *Water Management and Wetlands in Sub-Saharan Africa* (ed. by M. C. Acreman & G. E. Hollis), 51–72. IUCN, Gland, Switzerland.

- Sutcliffe, J. V. & Widgery, N. J. (1997) The problems of sustainable water resources management in Sudan. In: *Sustainability of Water Resources under Increasing Uncertainty* (ed. by D. Rosbjerg, N.-E. Boutayeb, A. Gustard, Z. W. Kundzewicz & P. F. Rasmussen) (Proc. Rabat Symp. S1, April 1997), 259–265. IAHS Publ. no. 240.
- Toussouin, Prince Omar (1925) *Memoire sur l'Histoire du Nil*. Memoires de l'Institut d'Egypte, vol. 8.
- UNDP, IBRD, & Ministry of Irrigation (1981) *Mathematical Model of the Upper Nile System. Technical Report 15*. UNDP-EGY/73/024.
- US Bureau of Reclamation (USBR) (1964) *Land and Water Resources of the Blue Nile Basin*. US Dept of the Interior Bureau of Reclamation, Washington, DC, USA.
- Walsh, R. P. D., Davies, H. R. J. & Musa, S. B. (1994) Flood frequency and impacts at Khartoum since the early nineteenth century. *Geogr. J.* **160**, 266–279.
- Water Development Department, Uganda (1957) *Annual Report for 1956*. Water Development Department, Entebbe.
- Water Development Department, Uganda (1970) *Summary of Hydrological Records, 1962–1968*. Water Development Department, Entebbe.
- Werne, F. (1849) *Expedition to Discover the Sources of the Nile* (tr. by C. W. O'Reilly). Bentley, London.
- Worthington, S. & Worthington, E. B. (1933) *Inland Waters of Africa*. MacMillan, London.
- WMO (1974) *Hydrometeorological Survey of the Catchments of Lake Victoria, Kyoga and Albert*. WMO/UNDP, Geneva.
- WMO (1982) *Hydrometeorological Survey of the Catchments of Lake Victoria, Kyoga and Mobutu Sese Seko: Project Findings and Recommendations*. WMO/UNDP, Geneva.
- Woube, M. (1997) The unutilised fresh water resources in Gambela, Ethiopia: hydro-environmental approach. In: *5th Nile 2002 Conf.* (Addis Ababa).
- Woudeneh, T. (1997) Water demand scenario in the Ethiopian portion of the Nile Basin. In: *5th Nile 2002 Conf.* (Addis Ababa).
- Yin, X. & Nicholson, S. E. (1998) The water balance of Lake Victoria. *Hydrol. Sci. J.* **43**(5), 789–811.

