

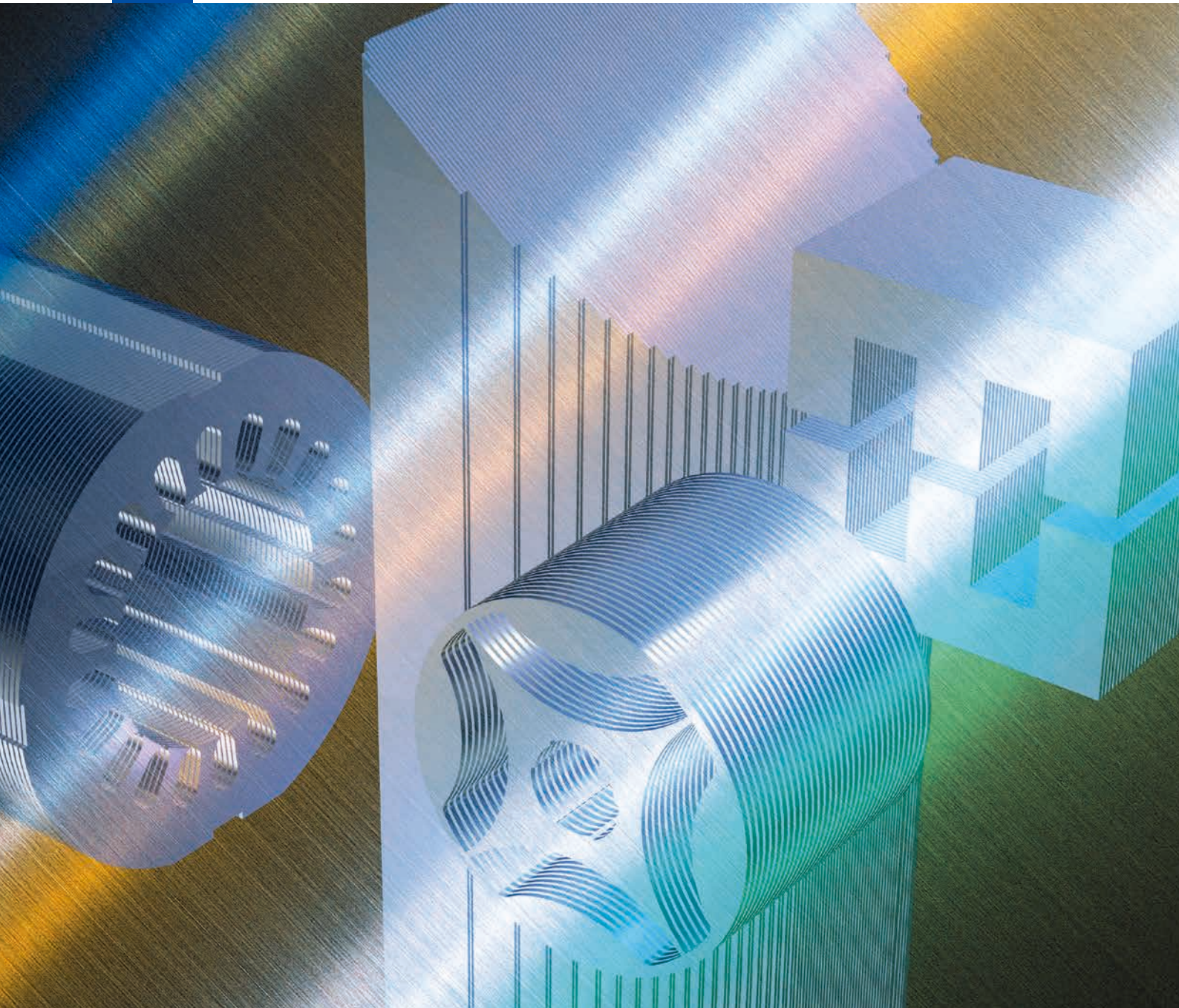

ELECTRICAL STEEL SHEETS

JFE G-CORE, JFE N-CORE

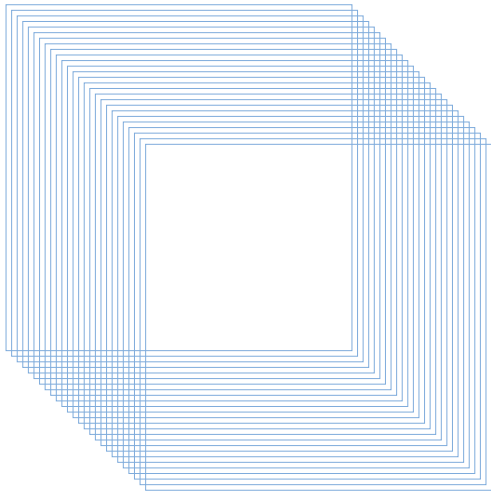



Contents

Foreword	1
Types and Applications	2
Grain-Oriented Electrical Steel Sheets	4
Non-Oriented Electrical Steel Sheets	12
Stress-Relief Annealing	21
Surface Insulation	22
Substances of Environmental Concern Data	24
Relations among Coil Weight, Outside Coil Diameter and Slit Width	25
Packaging	26
Conversion Factors	27
Comparison of specification	28

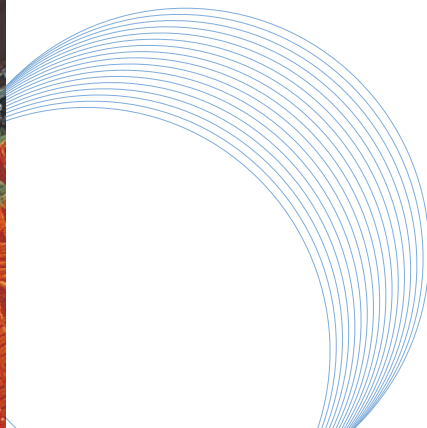
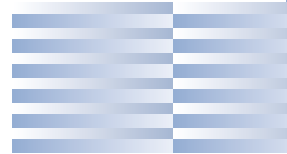
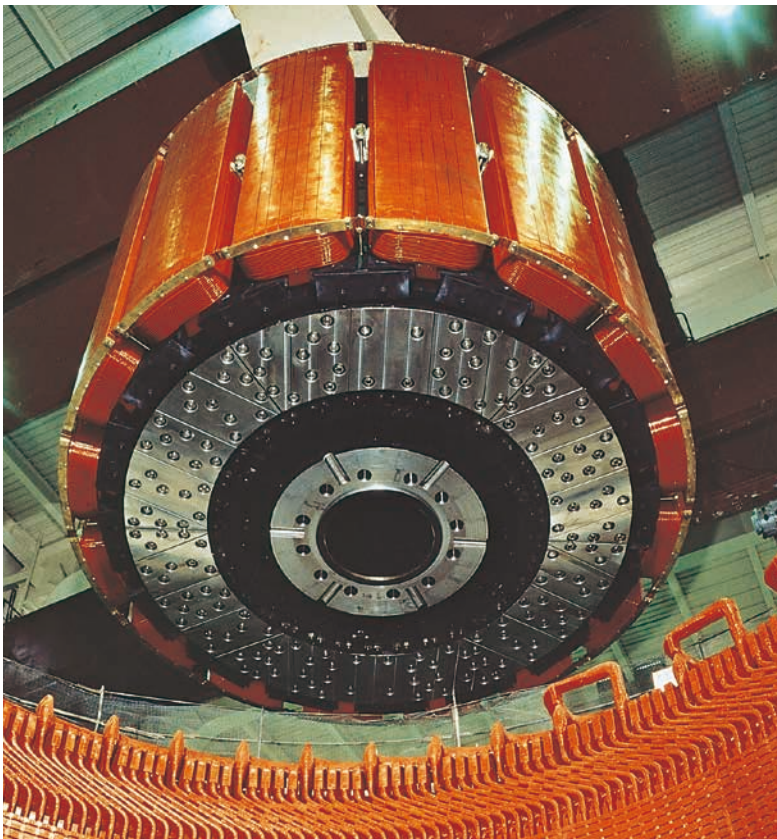

Foreword

JFE Steel's electrical steel sheets have a long tradition dating back to 1931 when we started the production of hot-rolled magnetic steel sheets. Ever since, we have maintained the world's top-level track record through continuous quality improvements and the development of innovative products. Certified for compliance with the ISO9001 and ISO14001 standards, JFE Steel produces high-quality, energy-saving and environmentally compatible electrical steel sheets for a wide range of customers.

This catalog outlines the features and representative properties of various electrical steel sheets manufactured by JFE Steel. For detailed data and characteristic curves of each type of electrical steel sheet, please read the relevant separate catalog.

We at JFE Steel are committed to making continuous efforts so as to meet all requirements of our customers and ensure even greater customer satisfaction. We look forward to serving your current and future needs.

JFE G-CORE

JG CORE

JGH CORE

JGHE CORE

JGS CORE

JGSD CORE

JGSE CORE

Grain-Oriented Electrical Steel Sheets

JFE G-CORE is so manufactured as to possess a well-aligned crystal orientation to the rolling direction.

Therefore, it has superior properties such as high permeability, low core loss and low magnetostriction.

JGSD is a core material with fine magnetic domains subdivided by grooves formed by electrolytic etching and is ideal with its low iron loss both in wound core and stacked core applications.

JGHE and JGSE are non-heat resistant magnetic domain-refined material suitable for stacked core applications.

Used mainly for power transformers and distribution transformers as well as for large rotating machines, JG, JGH, JGHE, JGS, JGSD and JGSE CORE contribute greatly to improving the efficiency of machines and to reducing their weight.

Applications		Types	Grain-Oriented	
			JG	JGH, JGHE, JGS, JGSD, JGSE
Rotating Machines	Large Rotating Machines			
	Medium Rotating Machines			
	Hermetical Motors			
	General use A.C. Motors			
	Small Motors and Intermittent Service A.C. Motors			
	Electrical Vehicle Driving Motors			
Static Machines	Power Transformers			
	Distribution Transformers			
	Audio Transformers			
	Current and Potential Transformers			
	Reactors and Magnetic Amplifiers			
	Magnetic Switches			
	Welding Transformers			
	Ballast			

JFE N-CORE

JN CORE

JNE CORE

THINNER GAUGE

JNE CORE

JNA CORE

Non-Oriented Electrical Steel Sheets

JFE N-CORE is so manufactured as to render magnetic properties almost uniform in any direction of the coil. Used mainly for medium and large rotating machines, and small transformers, JFE N-CORE contributes to improving machine efficiency.

JNE is a core material which can achieve low core loss and high permeability. THINNER GAUGE JNE is a core material which can achieve low core loss in the high frequency range.

JNA is a core material which can achieve low core loss and high permeability after stress relief annealing by customers.

For applications such as electric household appliances, office equipment and stabilizers, JN, JNE, THINNER GAUGE JNE and JNA CORE provide superior coatings, coupled with excellent thickness accuracy, to say nothing of superior magnetic properties.

Non-Oriented					
JN 210~400	JN 440~700	JN 800~1600	JNE 230~470	THINNER GAUGE JNE	JNA 300~500
■					
■	■				
■	■	■	■		■
■	■	■	■		■
■	■		■	■	■
■			■	■	■
■	■	■	■		■
■					
■					
■					
	■	■			
■	■	■	■		■

Note : JGH, JGS, JGSD, JGSE, JNE, and JNA are registered trademarks of JFE Steel Corporation in Japan.

Grain-Oriented Electrical Steel Sheets

JFE G-CORE

Grades and Specifications

Core loss values are to be specified at either 50Hz or 60Hz and 1.7T.
Magnetic polarization values are to be specified at 800A/m.

JG CORE

Thickness mm (in.)	Grade	Assumed Density kg/dm ³	Max. Core Loss at 1.7T				Min. Magnetic Polarization at 800A/m T	Min. Lamination Factor %
			Watts per kilogram		Watts per pound			
			50Hz	60Hz	50Hz	60Hz		
0.23 (0.0090)	23JG110	7.65	1.10	1.45	0.50	0.66	1.80	94.5
0.27 (0.0106)	27JG120		1.20	1.58	0.54	0.72	1.80	95.0
	27JG130		1.30	1.72	0.59	0.78	1.80	
0.30 (0.0118)	30JG120		1.20	1.58	0.54	0.72	1.80	95.5
	30JG130		1.30	1.72	0.59	0.78	1.80	
	30JG140		1.40	1.85	0.64	0.84	1.80	
0.35 (0.0138)	35JG135		1.35	1.78	0.61	0.81	1.80	96.0
	35JG145		1.45	1.91	0.66	0.87	1.80	
	35JG155		1.55	2.04	0.70	0.93	1.80	

JGH™ CORE

Thickness mm (in.)	Grade	Assumed Density kg/dm ³	Max. Core Loss at 1.7T				Min. Magnetic Polarization at 800A/m T	Min. Lamination Factor %
			Watts per kilogram		Watts per pound			
			50Hz	60Hz	50Hz	60Hz		
0.23 (0.0090)	23JGH090	7.65	0.90	1.19	0.41	0.54	1.87	94.5
	23JGH095		0.95	1.25	0.43	0.57	1.87	
	23JGH100		1.00	1.32	0.45	0.60	1.87	
0.27 (0.0106)	27JGH100		1.00	1.32	0.45	0.60	1.88	95.0
	27JGH110		1.10	1.45	0.50	0.66	1.88	
0.30 (0.0118)	30JGH105		1.05	1.39	0.48	0.63	1.88	95.5
	30JGH110		1.10	1.45	0.50	0.66	1.88	
	30JGH120		1.20	1.58	0.54	0.72	1.88	
0.35 (0.0138)	35JGH115		1.15	1.52	0.52	0.69	1.88	96.0
	35JGH125		1.25	1.65	0.57	0.75	1.88	
	35JGH135		1.35	1.78	0.61	0.81	1.88	

JGHE CORE

Thickness mm (in.)	Grade	Assumed Density kg/dm ³	Max. Core Loss at 1.7T				Min. Magnetic Polarization at 800A/m T	Min. Lamination Factor %
			Watts per kilogram		Watts per pound			
			50Hz	60Hz	50Hz	60Hz		
0.23 (0.0090)	23JGHE080	7.65	0.80	1.05	0.36	0.48	1.87	94.5
	23JGHE085		0.85	1.12	0.39	0.51	1.87	

JGS™ CORE

Thickness mm (in.)	Grade	Assumed Density kg/dm ³	Max. Core Loss at 1.7T				Min.Magnetic Polarization at 800A/m T	Min. Lamination Factor %
			Watts per kilogram		Watts per pound			
			50Hz	60Hz	50Hz	60Hz		
0.23 (0.0090)	23JGS085	7.65	0.85	1.12	0.39	0.51	1.90	94.5
	23JGS090		0.90	1.19	0.41	0.54	1.90	
	23JGS095		0.95	1.25	0.43	0.57	1.90	
0.27 (0.0106)	27JGS090		0.90	1.19	0.41	0.54	1.90	95.0
	27JGS095		0.95	1.25	0.43	0.57	1.90	
	27JGS100		1.00	1.32	0.45	0.60	1.90	
0.30 (0.0118)	30JGS095		0.95	1.27	0.43	0.58	1.90	95.5
	30JGS100		1.00	1.32	0.45	0.60	1.90	
	30JGS105		1.05	1.39	0.48	0.63	1.90	
0.35 (0.0138)	35JGS115		1.15	1.52	0.52	0.69	1.90	96.0
	35JGS125		1.25	1.65	0.57	0.75	1.90	

JGSD™ CORE

Thickness mm (in.)	Grade	Assumed Density kg/dm ³	Max. Core Loss at 1.7T				Min.Magnetic Polarization at 800A/m T	Min. Lamination Factor %
			Watts per kilogram		Watts per pound			
			50Hz	60Hz	50Hz	60Hz		
0.23 (0.0090)	23JGSD075	7.65	0.75	0.99	0.34	0.45	1.87	94.5
	23JGSD080		0.80	1.04	0.37	0.48	1.87	
	23JGSD085		0.85	1.12	0.39	0.51	1.87	
0.27 (0.0106)	27JGSD090		0.90	1.18	0.41	0.54	1.87	95.0
	27JGSD095		0.95	1.25	0.43	0.57	1.87	

JGSE™ CORE

Thickness mm (in.)	Grade	Assumed Density kg/dm ³	Max. Core Loss at 1.7T				Min.Magnetic Polarization at 800A/m T	Min. Lamination Factor %
			Watts per kilogram		Watts per pound			
			50Hz	60Hz	50Hz	60Hz		
0.23 (0.0090)	23JGSE070	7.65	0.70	0.91	0.32	0.41	1.90	94.5
	23JGSE075		0.75	0.99	0.34	0.45	1.90	
	23JGSE080		0.80	1.05	0.36	0.48	1.90	
0.27 (0.0106)	27JGSE085		0.85	1.13	0.39	0.51	1.90	95.0
	27JGSE090		0.90	1.19	0.41	0.54	1.90	

Note : The values of JG, JGH, JGS and JGSD CORE are to be measured according to the method JIS C 2550-1 (2011) on the specimens sheared parallel to the rolling direction and annealed for stress relieving. The method JIS C 2550-1 (2011) is practically the same as ASTM A343. The values of JGHE and JGSE CORE are to be measured according to the method JIS C 2556 (2015) on the specimens sheared parallel to the rolling direction without stress relief annealing. The method JIS C 2556 (2015) is practically the same as IEC 60404-3 (2010).

Grain-Oriented Electrical Steel Sheets

JFE G-CORE

Typical Electrical and Magnetic Properties

JG CORE

Thickness mm (in.)	Grade	Assumed Density kg/dm ³	Resistivity $\mu\Omega\cdot\text{cm}$	Core Loss								Magnetic Polarization T		
				Watts per kilogram				Watts per pound				J 3	J 8	J 25
				W15/50	W17/50	W15/60	W17/60	W15/50	W17/50	W15/60	W17/60			
0.23 (0.0090)	23JG110	7.65	49	0.70	1.00	0.93	1.30	0.32	0.45	0.42	0.59	1.76	1.85	1.92
0.27 (0.0106)	27JG120		46	0.78	1.14	1.01	1.47	0.36	0.52	0.46	0.67	1.76	1.85	1.92
	27JG130		46	0.83	1.23	1.08	1.59	0.38	0.56	0.49	0.72	1.74	1.84	1.91
0.30 (0.0118)	30JG120		46	0.83	1.17	1.10	1.54	0.38	0.54	0.50	0.70	1.76	1.85	1.92
	30JG130		46	0.87	1.24	1.15	1.63	0.39	0.56	0.52	0.74	1.74	1.84	1.91
	30JG140		46	0.90	1.32	1.19	1.71	0.41	0.60	0.54	0.78	1.73	1.83	1.91
0.35 (0.0138)	35JG135		46	0.95	1.33	1.26	1.76	0.43	0.60	0.57	0.80	1.77	1.85	1.91
	35JG145		46	0.98	1.38	1.30	1.81	0.44	0.63	0.59	0.82	1.76	1.84	1.91
	35JG155		46	1.02	1.47	1.34	1.92	0.46	0.67	0.61	0.87	1.74	1.83	1.90

JGH™ CORE

Thickness mm (in.)	Grade	Assumed Density kg/dm ³	Resistivity $\mu\Omega\cdot\text{cm}$	Core Loss								Magnetic Polarization T		
				Watts per kilogram				Watts per pound				J 3	J 8	J 25
				W15/50	W17/50	W15/60	W17/60	W15/50	W17/50	W15/60	W17/60			
0.23 (0.0090)	23JGH090	7.65	49	0.63	0.88	0.81	1.15	0.28	0.40	0.37	0.52	1.81	1.89	1.94
	23JGH095			0.64	0.91	0.84	1.19	0.29	0.41	0.38	0.54	1.81	1.89	1.94
	23JGH100			0.66	0.95	0.86	1.23	0.30	0.43	0.39	0.56	1.81	1.89	1.94
0.27 (0.0106)	27JGH100		49	0.71	0.98	0.93	1.30	0.32	0.44	0.42	0.59	1.81	1.89	1.94
	27JGH110		49	0.74	1.03	0.97	1.34	0.34	0.47	0.44	0.61	1.81	1.89	1.94
0.30 (0.0118)	30JGH105		49	0.75	1.03	0.97	1.36	0.34	0.47	0.44	0.62	1.82	1.89	1.94
	30JGH110		49	0.78	1.07	1.01	1.41	0.35	0.49	0.46	0.64	1.82	1.89	1.94
	30JGH120		49	0.83	1.14	1.10	1.50	0.38	0.52	0.50	0.68	1.82	1.89	1.94
0.35 (0.0138)	35JGH115		49	0.86	1.13	1.15	1.53	0.39	0.51	0.52	0.70	1.83	1.89	1.96
	35JGH125		49	0.89	1.22	1.19	1.60	0.40	0.55	0.54	0.73	1.83	1.89	1.96
	35JGH135		49	0.91	1.26	1.21	1.65	0.41	0.57	0.55	0.75	1.83	1.89	1.96

JGHE CORE

Thickness mm (in.)	Grade	Assumed Density kg/dm ³	Resistivity $\mu\Omega\cdot\text{cm}$	Core Loss								Magnetic Polarization T		
				Watts per kilogram				Watts per pound				J 3	J 8	J 25
				W15/50	W17/50	W15/60	W17/60	W15/50	W17/50	W15/60	W17/60			
0.23 (0.0090)	23JGHE080	7.65	49	0.56	0.77	0.74	1.01	0.25	0.35	0.34	0.46	1.85	1.91	1.96
	23JGHE085			0.57	0.80	0.75	1.04	0.26	0.36	0.34	0.47	1.84	1.89	1.94

JGS™ CORE

Thickness mm (in.)	Grade	Assumed Density kg/dm ³	Resistivity $\mu\Omega \cdot \text{cm}$	Core Loss								Magnetic Polarization T		
				Watts per kilogram				Watts per pound				J 3	J 8	J 25
				W15/50	W17/50	W15/60	W17/60	W15/50	W17/50	W15/60	W17/60			
0.23 (0.0090)	23JGS085	7.65	48	0.61	0.83	0.80	1.09	0.28	0.38	0.36	0.49	1.89	1.93	1.97
	23JGS090			0.63	0.87	0.82	1.12	0.29	0.39	0.37	0.51	1.89	1.92	1.97
	23JGS095			0.64	0.90	0.83	1.16	0.29	0.41	0.38	0.53	1.89	1.92	1.97
0.27 (0.0106)	27JGS090		48	0.66	0.88	0.87	1.16	0.31	0.40	0.40	0.54	1.91	1.94	1.98
	27JGS095			0.69	0.92	0.91	1.22	0.31	0.42	0.41	0.55	1.90	1.93	1.98
	27JGS100			0.70	0.95	0.94	1.25	0.32	0.44	0.42	0.57	1.90	1.93	1.98
0.30 (0.0118)	30JGS095		48	0.70	0.93	0.93	1.25	0.33	0.43	0.43	0.58	1.92	1.95	1.98
	30JGS100			0.72	0.96	0.96	1.27	0.34	0.45	0.44	0.59	1.91	1.94	1.98
	30JGS105			0.75	1.00	0.99	1.29	0.34	0.46	0.46	0.61	1.90	1.93	1.98
0.35 (0.0138)	35JGS115		48	0.84	1.10	1.11	1.47	0.39	0.52	0.51	0.68	1.90	1.93	1.98
	35JGS125			0.91	1.20	1.20	1.60	0.41	0.55	0.54	0.72	1.89	1.92	1.97

JGSD™ CORE

Thickness mm (in.)	Grade	Assumed Density kg/dm ³	Resistivity $\mu\Omega \cdot \text{cm}$	Core Loss								Magnetic Polarization T		
				Watts per kilogram				Watts per pound				J 3	J 8	J 25
				W15/50	W17/50	W15/60	W17/60	W15/50	W17/50	W15/60	W17/60			
0.23 (0.0090)	23JGSD075	7.65	48	0.53	0.72	0.71	0.95	0.24	0.33	0.32	0.43	1.84	1.89	1.94
	23JGSD080			0.55	0.75	0.73	0.97	0.25	0.34	0.33	0.44	1.83	1.89	1.94
	23JGSD085			0.57	0.78	0.75	1.02	0.26	0.35	0.34	0.46	1.82	1.89	1.94
0.27 (0.0106)	27JGSD090		48	0.62	0.84	0.82	1.11	0.28	0.38	0.37	0.50	1.84	1.89	1.94
	27JGSD095			0.65	0.88	0.85	1.16	0.29	0.40	0.39	0.53	1.84	1.89	1.94

JGSE™ CORE

Thickness mm (in.)	Grade	Assumed Density kg/dm ³	Resistivity $\mu\Omega \cdot \text{cm}$	Core Loss								Magnetic Polarization T		
				Watts per kilogram				Watts per pound				J 3	J 8	J 25
				W15/50	W17/50	W15/60	W17/60	W15/50	W17/50	W15/60	W17/60			
0.23 (0.0090)	23JGSE070	7.65	48	0.50	0.68	0.66	0.89	0.23	0.31	0.30	0.40	1.89	1.93	1.97
	23JGSE075			0.52	0.72	0.70	0.95	0.24	0.33	0.32	0.43	1.89	1.92	1.97
	23JGSE080			0.54	0.75	0.72	0.98	0.25	0.34	0.33	0.45	1.89	1.92	1.97
0.27 (0.0106)	27JGSE085		48	0.61	0.81	0.82	1.08	0.28	0.37	0.37	0.49	1.90	1.93	1.98
	27JGSE090			0.63	0.84	0.84	1.12	0.29	0.38	0.38	0.51	1.90	1.93	1.98

- Note :**
1. Values of JG, JGH, JGS and JGSD CORE were measured in accordance with JIS C 2550-1 (2011) and test specimens were sheared parallel to the rolling direction and annealed for stress relieving.
 2. Values of JGHE and JGSE CORE were measured in accordance with JIS C 2556 (2015)(or IEC 60404-3 (2010)), using single sheet tester, and test specimens were sheared parallel to the rolling direction and prepared without stress relief annealing.
 3. Stress relief annealing will nullify the domain refining effect of JGHE and JGSE CORE.
The values of JG, JGH, JGS and JGSD CORE are to be measured after stress relief annealing.
 4. W17/50 indicates the core loss at the frequency of 50Hz and the maximum magnetic polarization of 1.7T.
J8 indicates the magnetic polarization at the magnetizing force of 800A/m.
 5. Values shown are the typical ones, not for guarantee.

Grain-Oriented Electrical Steel Sheets

JFE G-CORE

Grades and Specifications in conformity with AISI

JGH, JGS grade is to be guaranteed in terms of maximum core loss at either 50Hz or 60Hz and 1.5T or 1.7T.

Thickness in. (mm)	Grade	Assumed Density kg/dm ³	Max. Core Loss at 1.5T				Max. Core Loss at 1.7T				Min.Magnetic Polarization at 800A/m T
			Watts per kilogram		Watts per pound		Watts per kilogram		Watts per pound		
			50Hz	60Hz	50Hz	60Hz	50Hz	60Hz	50Hz	60Hz	
0.0090 (0.23)	M-0H	7.65	0.67	0.88	0.30	0.40	1.00	1.32	0.45	0.60	1.87
	M-3		0.79	1.04	0.36	0.47	1.18	1.55	0.54	0.70	1.80
0.0106 (0.27)	M-0H		0.73	0.95	0.33	0.43	1.03	1.36	0.47	0.62	1.88
	M-1H		0.77	1.01	0.35	0.46	1.09	1.44	0.49	0.65	1.88
	M-3		0.83	1.09	0.38	0.49	1.21	1.59	0.55	0.72	1.80
	M-4		0.89	1.17	0.40	0.53	1.27	1.68	0.58	0.76	1.80
0.0118 (0.30)	M-0H		0.76	0.99	0.34	0.45	1.05	1.39	0.48	0.63	1.88
	M-1H		0.80	1.06	0.36	0.48	1.11	1.45	0.50	0.66	1.88
	M-2H		0.85	1.15	0.39	0.52	1.17	1.54	0.53	0.70	1.88
	M-4		0.90	1.19	0.41	0.54	1.32	1.74	0.60	0.79	1.80
	M-5		0.97	1.28	0.44	0.58	1.39	1.83	0.63	0.83	1.80
0.0138 (0.35)	M-1H		0.87	1.15	0.39	0.52	1.16	1.53	0.53	0.69	1.88
	M-2H	0.90	1.19	0.41	0.54	1.22	1.59	0.55	0.72	1.88	
	M-3H	0.96	1.28	0.44	0.58	1.28	1.68	0.58	0.76	1.88	
	M-5	1.01	1.32	0.46	0.60	1.45	1.91	0.66	0.87	1.80	
	M-6	1.11	1.46	0.50	0.66	1.57	2.07	0.71	0.94	1.80	

Note : The values are to be measured according to the method JIS C 2550-1 (2011) on the specimens sheared parallel to the rolling direction and annealed for stress relieving. The method JIS C 2550-1 (2011) is practically the same as ASTM A343.

Typical Magnetic Properties

Thickness in. (mm)	Grade	Assumed Density kg/dm ³	Typ. Core Loss at 1.5T				Typ. Core Loss at 1.7T				Typ. Magnetic Polarization at 800A/m T
			Watts per kilogram		Watts per pound		Watts per kilogram		Watts per pound		
			50Hz	60Hz	50Hz	60Hz	50Hz	60Hz	50Hz	60Hz	
0.0090 (0.23)	M-0H	7.65	0.65	0.85	0.30	0.38	0.93	1.20	0.42	0.55	1.89
	M-3		0.70	0.93	0.32	0.42	1.00	1.30	0.45	0.59	1.85
0.0106 (0.27)	M-0H		0.72	0.95	0.32	0.43	1.01	1.32	0.46	0.60	1.89
	M-1H		0.74	0.97	0.34	0.44	1.05	1.37	0.48	0.62	1.89
	M-3		0.80	1.06	0.36	0.48	1.17	1.52	0.53	0.69	1.85
0.0118 (0.30)	M-4		0.82	1.08	0.37	0.49	1.22	1.59	0.55	0.72	1.84
	M-0H		0.75	0.99	0.34	0.45	1.04	1.37	0.47	0.62	1.89
	M-1H		0.78	1.01	0.35	0.46	1.08	1.41	0.49	0.64	1.89
	M-2H		0.81	1.06	0.37	0.48	1.13	1.50	0.51	0.68	1.89
0.0138 (0.35)	M-4		0.87	1.15	0.39	0.52	1.24	1.63	0.56	0.74	1.85
	M-5		0.90	1.19	0.41	0.54	1.32	1.71	0.60	0.78	1.84
	M-1H		0.86	1.14	0.39	0.52	1.14	1.54	0.52	0.70	1.89
	M-2H	0.88	1.17	0.40	0.53	1.20	1.59	0.54	0.72	1.89	
	M-3H	0.90	1.19	0.41	0.54	1.24	1.63	0.56	0.74	1.89	
M-5	0.97	1.30	0.44	0.59	1.36	1.79	0.62	0.81	1.84		
M-6	1.02	1.34	0.46	0.61	1.47	1.92	0.67	0.87	1.83		

Note : Values shown are the typical ones, not for guarantee.



Grain-Oriented Electrical Steel Sheets

JFE G-CORE

Typical Mechanical Properties

Grade	Thickness mm (in.)	Yield Point				Tensile Strength				Elongation		Hardness HV (1)	Number of Bends		Lamination Factor %
		N/mm ²		lb/in ²		N/mm ²		lb/in ²		%			L	C	
		L	C	L	C	L	C	L	C	L	C				
JG CORE	0.27 (0.0106)	285	295	41,300	42,800	310	360	45,000	52,200	9	32	188	20	14	97.8
	0.30 (0.0118)	285	297	41,300	43,100	313	362	45,400	52,500	11	35	188	20	14	98.0
	0.35 (0.0138)	296	302	42,900	43,800	326	369	47,300	53,500	10	35	188	20	12	98.3
JGH CORE	0.23 (0.0090)	330	342	47,900	49,600	350	400	50,800	58,000	9	29	200	21	14	97.2
	0.27 (0.0106)	330	341	47,900	49,500	348	402	50,500	58,300	10	28	200	21	14	97.6
	0.30 (0.0118)	333	339	48,300	49,200	350	404	50,800	58,600	8	32	200	20	13	97.8
	0.35 (0.0138)	339	344	49,200	49,900	357	408	51,800	59,200	9	32	200	20	12	98.0
JGHE CORE	0.23 (0.0090)	330	342	47,900	49,600	350	400	50,800	58,000	9	29	200	21	14	97.2
JGS CORE	0.23 (0.0090)	330	358	47,900	51,900	348	411	50,500	59,600	11	31	204	21	15	97.2
	0.27 (0.0106)	330	358	47,900	51,900	348	411	50,500	59,600	11	31	204	21	15	97.6
	0.30 (0.0118)	322	346	46,700	50,200	338	405	49,000	58,700	10	29	204	21	14	97.8
	0.35 (0.0138)	327	350	47,400	50,800	345	405	50,000	58,700	10	28	204	20	13	98.0
JGSD CORE	0.23 (0.0090)	330	358	47,900	56,900	348	411	50,500	59,600	11	31	204	21	15	96.9
	0.27 (0.0106)	330	358	47,900	56,900	348	411	50,500	59,600	11	31	204	21	15	97.2
JGSE CORE	0.23 (0.0090)	330	358	47,900	56,900	348	411	50,500	59,600	11	31	204	21	15	97.2
	0.27 (0.0106)	330	358	47,900	56,900	348	411	50,500	59,600	11	31	204	21	15	97.6

- Note :**
1. "L" and "C" means the specimens cut parallel and traverse to the rolling direction, respectively.
 2. Tension tests were made on No.13A specimens according to JIS Z 2241 (2011).
 3. Bend and lamination factor tests were made according to the method JIS C 2553 (2019) and JIS C 2550-5 (2011), respectively.
 4. The specimens were tested as sheared.
 5. Test values shown above are the typical ones, not for guarantee.

Surface Insulation

A special glass coating with a low coefficient of thermal expansion is used to reduce magnetostriction and provide low strain susceptibility. Furthermore this coating has the excellent properties as follows.

- The coating provides high interlaminar resistance, and it is thin and adheres to the steel surface tightly.
- The coating is not affected by transformer oil or machine oil. Core material are also free from rust because of its high corrosion resistance.

Dimensions and Tolerances

■ Dimensions

Form	Grade	Thickness	Available width range	Inside coil diameter
Coils	JG CORE	0.23mm (0.0090 in.)	from 50mm (2 in.) to 1,160mm (45.67 in.)	508mm (20 in.)
		0.27mm (0.0106 in.)		
		0.30mm (0.0118 in.)		
		0.35mm (0.0138 in.)		
	JGH CORE	0.23mm (0.0090 in.)	from 50mm (2 in.) to 1,160mm (45.67 in.)	
		0.27mm (0.0106 in.)		
JGHE CORE	0.23mm (0.0090 in.)	from 50mm (2 in.) to 1,160mm (45.67 in.)		
JGS CORE	0.23mm (0.0090 in.)	from 50mm (2 in.) to 1,050mm (41.34 in.)		
	0.27mm (0.0106 in.)	from 50mm (2 in.) to 1,100mm (43.30 in.)		
JGSD CORE	0.23mm (0.0090 in.)	from 50mm (2 in.) to 1,050mm (41.34 in.)		
JGSE CORE	0.23mm (0.0090 in.)	from 50mm (2 in.) to 1,050mm (41.34 in.)		
	0.27mm (0.0106 in.)			

■ Tolerances in Dimension and Shape

Tolerances in dimension and shape conform to JIS C 2553 (2019)

Width mm	Thickness mm	Tolerance				
		Thickness mm	Deviation of thickness in transverse direction mm	Width mm	Camber in any 2 meters (Slit Products) mm	Shear Burr mm
150 or under	0.23	± 0.02	0.02 or under	0 -0.2	0.9 or under	0.025 or under
	0.27	± 0.03				
	0.30	± 0.03				
	0.35	± 0.03				
Over 150 to 400	0.23	± 0.02	0.02 or under	0 -0.3		
	0.27	± 0.03				
	0.30	± 0.03				
	0.35	± 0.03				
Over 400 to 750	0.23	± 0.02	0.02 or under	0 -0.5		
	0.27	± 0.03				
	0.30	± 0.03				
	0.35	± 0.03				
Over 750	0.23	± 0.02	0.02 or under	0 -0.6		
	0.27	± 0.03				
	0.30	± 0.03				
	0.35	± 0.03				

Note : Stipulation of camber shall be applied only for the steel strips width 75 mm over.

Non-Oriented Electrical Steel Sheets

JFE N-CORE

Grades and Specifications in conformity with JIS

Core loss values are to be specified at either 50Hz or 60Hz, and at 1.0T or 1.5T each, but not at both. Magnetic flux density is to be specified at 5000A/m.

Unless otherwise specified, each grade supplied will have its core loss value at 50Hz and at 1.5T.

JN CORE

Grade	Thickness mm (in.)	Assumed Density kg/dm ³	Max. Core Loss								Min. Magnetic Flux Density at 5000A/m T	Min. Lamination Factor %
			Watts per kilogram				Watts per pound					
			50Hz		60Hz		50Hz		60Hz			
			1.0T	1.5T	1.0T	1.5T	1.0T	1.5T	1.0T	1.5T		
35JN210	0.35 (0.0138)	7.60	0.90	2.10	1.15	2.65	0.41	0.95	0.52	1.20	1.62	95.0
35JN230		7.60	0.95	2.30	1.20	2.90	0.43	1.04	0.54	1.32	1.62	
35JN250		7.60	1.00	2.50	1.25	3.20	0.45	1.13	0.57	1.45	1.62	
35JN270		7.65	1.10	2.70	1.40	3.45	0.50	1.22	0.64	1.56	1.62	
35JN300		7.65	1.20	3.00	1.50	3.80	0.54	1.36	0.68	1.72	1.62	
35JN360		7.65	1.45	3.60	1.85	4.55	0.66	1.63	0.84	2.06	1.63	
35JN440		7.70	1.80	4.40	2.30	5.60	0.82	2.00	1.04	2.54	1.65	
50JN230	0.50 (0.0197)	7.60	1.00	2.30	1.30	2.95	0.45	1.04	0.59	1.34	1.62	96.0
50JN250		7.60	1.05	2.50	1.35	3.20	0.48	1.13	0.61	1.45	1.62	
50JN270		7.60	1.10	2.70	1.40	3.45	0.50	1.22	0.64	1.56	1.62	
50JN290		7.60	1.15	2.90	1.45	3.70	0.52	1.32	0.66	1.68	1.62	
50JN310		7.65	1.25	3.10	1.60	3.95	0.57	1.41	0.73	1.79	1.62	
50JN350		7.65	1.50	3.50	1.90	4.45	0.68	1.59	0.86	2.02	1.62	
50JN400		7.65	1.70	4.00	2.15	5.10	0.77	1.81	0.98	2.31	1.63	
50JN470		7.70	2.00	4.70	2.55	5.95	0.91	2.13	1.16	2.70	1.64	
50JN600		7.75	2.60	6.00	3.30	7.60	1.18	2.72	1.50	3.45	1.66	
50JN700		7.80	3.00	7.00	3.80	8.90	1.36	3.18	1.72	4.04	1.70	
50JN800		7.80	3.60	8.00	4.55	10.15	1.63	3.63	2.06	4.60	1.70	
50JN1000		7.85	4.40	10.00	5.60	12.70	2.00	4.54	2.54	5.76	1.72	
50JN1300	7.85	5.80	13.00	7.35	16.50	2.63	5.90	3.33	7.48	1.72		
65JN800	0.65 (0.0256)	7.80	3.60	8.00	4.55	10.15	1.63	3.63	2.07	4.60	1.70	97.0
65JN1000		7.80	4.40	10.00	5.60	12.70	2.00	4.54	2.54	5.76	1.71	
65JN1300		7.85	5.80	13.00	7.35	16.50	2.63	5.90	3.33	7.48	1.71	
65JN1600		7.85	7.10	16.00	9.00	20.30	3.22	7.26	4.09	9.22	1.71	

Note : The values are to be measured to the method JIS C 2550-1 (2011) on the specimens consisted of half the strip sheared parallel and half sheared transverse to the rolling direction. The specimens are to be tested as sheared.

JNE™ CORE

Grade	Thickness mm (in.)	Assumed Density kg/dm ³	Max. Core Loss				Min.Magnetic Flux Density at 5000A/m T	Min. Lamination Factor %
			Watts per kilogram		Watts per pound			
			50Hz	60Hz	50Hz	60Hz		
			1.5T	1.5T	1.5T	1.5T		
35JNE230	0.35 (0.0138)	7.65	2.30	2.90	1.04	1.32	1.66	95.0
35JNE250		7.65	2.50	3.20	1.13	1.45	1.67	
35JNE300		7.70	3.00	3.80	1.36	1.72	1.69	
35JNE440		7.75	4.40	5.60	2.00	2.52	1.70	
50JNE300	0.50 (0.0197)	7.65	3.00	3.80	1.36	1.72	1.67	96.0
50JNE350		7.70	3.50	4.45	1.59	2.02	1.70	
50JNE470		7.75	4.70	5.95	2.13	2.70	1.72	

Note : The values are to be measured to the method JIS C 2550-1 (2011) on the specimens consisted of half the strip sheared parallel and half sheared transverse to the rolling direction. The specimens are to be tested as sheared.

THINNER GAUGE JNE CORE

Grade	Thickness mm (in.)	Assumed Density kg/dm ³	Max. Core Loss		Min.Magnetic Flux Density at 5000A/m T	Min. Lamination Factor %
			Watts per kilogram	Watts per pound		
			400Hz	400Hz		
			1.0T	1.0T		
20JNEH1200	0.20 (0.0080)	7.65	12.00	5.44	1.62	93.0
20JNEH1500		7.65	15.00	6.80	1.63	
25JNE1350	0.25 (0.0098)	7.60	13.50	6.12	1.62	94.0
30JNE1500	0.30 (0.0118)	7.60	15.00	6.80	1.62	94.0

Note : The values are to be measured to the method JIS C 2550-1, 3 (2011) on the specimens consisted of half the strip sheared parallel and half sheared transverse to the rolling direction. The specimens are to be tested as sheared.

JNA™ CORE

Grade	Thickness mm (in.)	Assumed Density kg/dm ³	Max. Core Loss				Min.Magnetic Flux Density at 5000A/m T	Min. Lamination Factor %
			Watts per kilogram		Watts per pound			
			50Hz	60Hz	50Hz	60Hz		
			1.5T	1.5T	1.5T	1.5T		
50JNA300	0.50 (0.0197)	7.75	3.00	3.80	1.36	1.72	96.0	
50JNA350		7.80	3.50	4.52	1.59	2.05		
50JNA500		7.80	5.00	6.50	2.27	2.95		

Note : The values are to be measured to the method JIS C 2550-1 (2011) on the specimens consisted of half the strip sheared parallel and half sheared transverse to the rolling direction. The specimens are to be tested after stress relief annealing. Annealing condition : 750 C°(1382°F) for 2hrs. under neutral atmosphere.

Non-Oriented Electrical Steel Sheets

JFE N-CORE

Grades and Specifications in conformity with AISI

Core loss values are to be specified at either 50Hz or 60Hz, and 1.5T, but not at both. Unless otherwise specified, each grade supplied will have its core loss value at 60Hz and at 1.5T.

Grade	Thickness in. (mm)	Max. Core Loss at 1.5T			
		Watts per kilogram		Watts per pound	
		50Hz	60Hz	50Hz	60Hz
M-15	0.014 (0.36)	2.53	3.20	1.15	1.45
M-19		2.75	3.48	1.25	1.58
M-22		2.93	3.70	1.33	1.68
M-27		3.13	3.97	1.42	1.80
M-36		3.31	4.19	1.50	1.90
M-15	0.0185 (0.47)	2.93	3.70	1.33	1.68
M-19		3.03	3.83	1.37	1.74
M-22		3.22	4.08	1.46	1.85
M-27		3.31	4.19	1.50	1.90
M-36		3.57	4.52	1.62	2.05
M-43		4.01	5.07	1.82	2.30
M-45		5.31	6.72	2.41	3.05
M-47		6.96	8.82	3.16	4.00
M-19	0.025 (0.64)	3.62	4.58	1.64	2.08
M-22		3.80	4.80	1.72	2.18
M-27		3.92	4.96	1.78	2.25
M-36		4.18	5.29	1.90	2.40
M-43		4.70	5.95	2.13	2.70
M-45		6.27	7.93	2.84	3.60
M-47		8.53	10.80	3.87	4.90

Note : The Values are to be measured to the method JIS C 2550-1 (2011) on the specimens consisted of half the strip sheared parallel and half sheared transverse to the rolling direction. The specimens are to be tested as sheared.

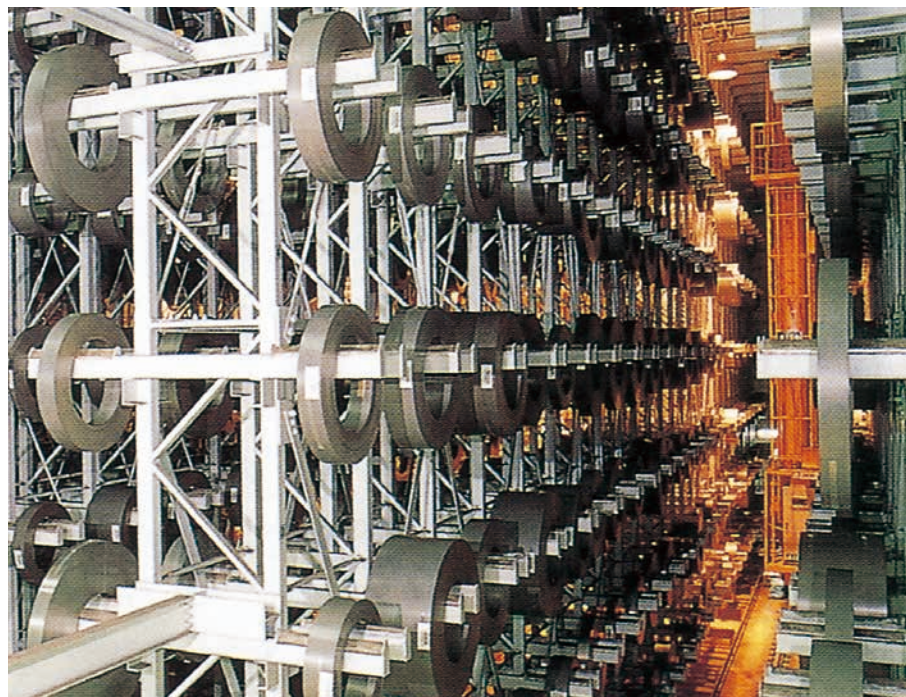
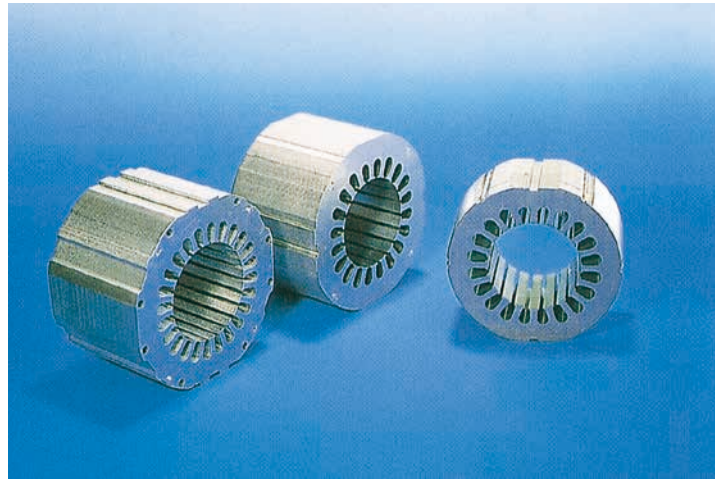
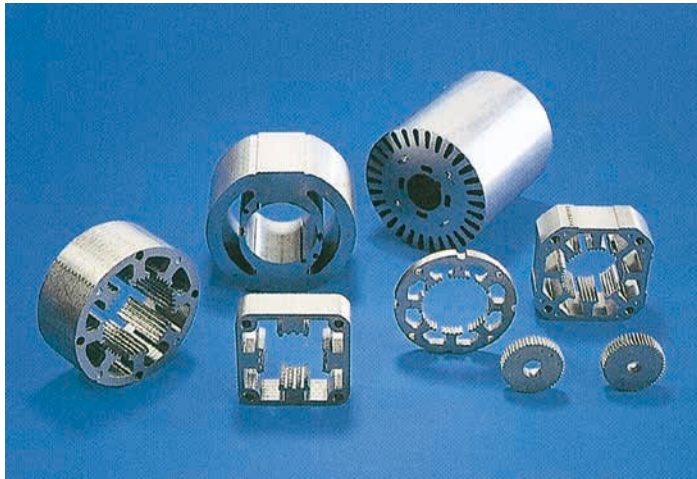
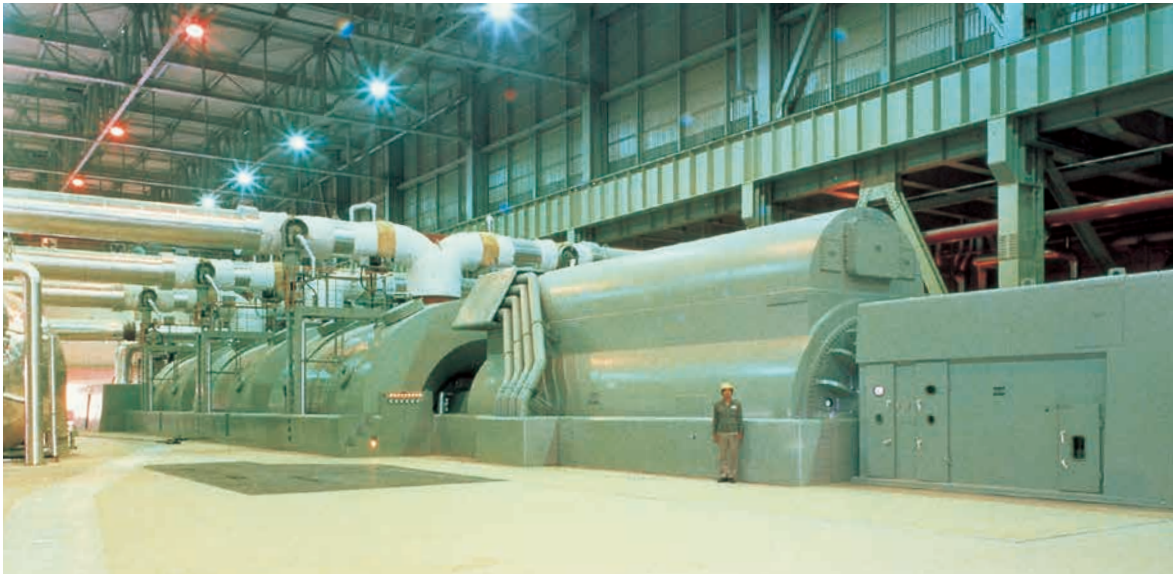

Non-Oriented Electrical Steel Sheets

JFE N-CORE

Typical Electrical and Magnetic Properties

JN CORE

Grade	Thickness mm (in.)	Assumed Density kg/dm ³	Resistivity $\mu\Omega \cdot \text{cm}$	Core Loss								Magnetic Flux Density T			
				Watts per kilogram				Watts per pound							
				50Hz		60Hz		50Hz		60Hz		B10	B25	B50	B100
				1.0T	1.5T	1.0T	1.5T	1.0T	1.5T	1.0T	1.5T				
35JN210	0.35 (0.0138)	7.60	59	0.85	2.05	1.05	2.55	0.39	0.93	0.48	1.16	1.47	1.57	1.65	1.77
35JN230		7.60	55	0.89	2.10	1.10	2.60	0.40	0.95	0.50	1.18	1.47	1.57	1.66	1.78
35JN250		7.60	54	0.93	2.25	1.20	2.75	0.42	1.02	0.54	1.25	1.48	1.57	1.66	1.78
35JN270		7.65	54	1.00	2.40	1.25	2.95	0.45	1.09	0.57	1.34	1.48	1.58	1.67	1.79
35JN300		7.65	51	1.10	2.60	1.40	3.20	0.50	1.18	0.64	1.45	1.50	1.59	1.68	1.80
35JN360		7.65	47	1.25	2.95	1.60	3.60	0.57	1.34	0.73	1.63	1.51	1.61	1.69	1.81
35JN440		7.70	38	1.45	3.40	1.77	4.23	0.66	1.54	0.80	1.92	1.53	1.62	1.71	1.82
50JN230	0.50 (0.0197)	7.60	59	0.95	2.25	1.22	2.93	0.43	1.02	0.55	1.33	1.48	1.57	1.66	1.78
50JN250		7.60	55	1.00	2.40	1.30	3.05	0.45	1.09	0.59	1.38	1.49	1.57	1.67	1.79
50JN270		7.60	55	1.05	2.50	1.35	3.17	0.48	1.13	0.61	1.44	1.49	1.57	1.67	1.80
50JN290		7.60	54	1.08	2.60	1.40	3.25	0.49	1.18	0.64	1.47	1.49	1.58	1.67	1.79
50JN310		7.65	54	1.15	2.70	1.45	3.35	0.52	1.22	0.66	1.52	1.49	1.59	1.67	1.79
50JN350		7.65	51	1.30	3.00	1.64	3.75	0.59	1.36	0.74	1.70	1.50	1.59	1.68	1.80
50JN400		7.65	47	1.45	3.25	1.85	4.05	0.66	1.47	0.84	1.84	1.52	1.61	1.69	1.81
50JN470		7.70	38	1.65	3.65	2.10	4.65	0.75	1.66	0.95	2.11	1.54	1.63	1.71	1.82
50JN600		7.75	32	2.00	4.50	2.50	5.62	0.91	2.04	1.13	2.55	1.52	1.61	1.70	1.81
50JN700		7.80	28	2.52	5.50	3.30	6.90	1.14	2.49	1.50	3.13	1.55	1.65	1.73	1.84
50JN800		7.80	24	2.95	6.30	3.65	8.00	1.34	2.86	1.66	3.63	1.57	1.66	1.74	1.84
50JN1000		7.85	18	3.25	7.20	4.15	9.15	1.47	3.27	1.88	4.15	1.59	1.69	1.75	1.85
50JN1300		7.85	15	3.75	8.10	4.75	10.20	1.70	3.67	2.15	4.63	1.58	1.67	1.76	1.87
65JN800		0.65 (0.0256)	7.80	28	3.25	7.00	4.20	8.90	1.47	3.18	1.91	4.04	1.56	1.64	1.72
65JN1600	7.85		15	4.90	9.90	6.15	13.00	2.22	4.49	2.79	5.90	1.57	1.67	1.76	1.86

- Note :**
1. Values above were measured according to the method JIS C 2550-1 (2011).
 2. Test samples were consisted of half the strips sheared parallel and half sheared transverse to the rolling direction.
 3. W15/50 indicates the core loss at 50Hz and 1.5T. B50 indicates the magnetic flux density at 5000A/m.
 4. The specimens were tested as sheared.
 5. The values shown above are the typical ones, not for guarantee.

JNE™ CORE

Grade	Thickness mm (in.)	Assumed Density kg/dm ³	Resistivity $\mu\Omega \cdot \text{cm}$	Core Loss								Magnetic Flux Density T			
				Watts per kilogram				Watts per pound							
				50Hz		60Hz		50Hz		60Hz		B10	B25	B50	B100
				1.0T	1.5T	1.0T	1.5T	1.0T	1.5T	1.0T	1.5T				
35JNE230	0.35 (0.0138)	7.65	55	0.98	2.15	1.20	2.70	0.44	0.97	0.54	1.22	1.51	1.59	1.69	1.82
35JNE250		7.65	47	1.02	2.30	1.27	2.90	0.46	1.04	0.58	1.31	1.53	1.60	1.70	1.83
35JNE300		7.70	41	1.14	2.60	1.42	3.25	0.52	1.18	0.64	1.47	1.54	1.63	1.72	1.85
35JNE440		7.75	36	1.35	3.00	1.70	3.75	0.61	1.36	0.77	1.70	1.55	1.64	1.73	1.85
50JNE300	0.50 (0.0197)	7.65	47	1.18	2.70	1.51	3.45	0.53	1.22	0.68	1.56	1.53	1.61	1.70	1.83
50JNE350		7.70	41	1.41	3.10	1.80	3.95	0.64	1.41	0.82	1.79	1.55	1.64	1.73	1.85
50JNE470		7.75	36	1.43	3.20	1.81	4.00	0.65	1.45	0.82	1.82	1.56	1.65	1.74	1.86

- Note :
1. Values above were measured according to the method JIS C 2550-1 (2011).
 2. Test samples were consisted of half the strips sheared parallel and half sheared transverse to the rolling direction.
 3. W15/50 indicates the core loss at 50Hz and 1.5T. B50 indicates the magnetic flux density at 5000A/m.
 4. The specimens were tested as sheared.
 5. The values shown above are the typical ones, not for guarantee.

THINNER GAUGE JNE CORE

Grade	Thickness mm (in.)	Assumed Density kg/dm ³	Resis- tivity $\mu\Omega \cdot \text{cm}$	Core Loss									Magnetic Flux Density T				
				Watts per kilogram					Watts per pound								
				50Hz		60Hz		400Hz	50Hz		60Hz		400Hz	B10	B25	B50	B100
				1.0T	1.5T	1.0T	1.5T	1.0T	1.0T	1.5T	1.0T	1.5T	1.0T				
20JNEH1200	0.20 (0.0080)	7.65	55	0.92	2.13	1.12	2.62	11.0	0.42	0.97	0.51	1.19	4.85	1.46	1.57	1.67	1.78
20JNEH1500		7.65	47	1.09	2.55	1.33	3.13	12.5	0.49	1.16	0.60	1.42	5.67	1.48	1.57	1.66	1.79
25JNE1350	0.25 (0.0098)	7.60	58	0.93	2.05	1.12	2.53	12.4	0.42	0.93	0.51	1.15	5.62	1.48	1.58	1.67	1.79
30JNE1500	0.30 (0.0118)	7.60	58	0.96	2.10	1.18	2.61	14.2	0.44	0.95	0.54	1.18	6.44	1.49	1.58	1.68	1.80

- Note :
1. Values above were measured according to the method JIS C 2550-1, 3 (2011).
 2. Test samples were consisted of half the strips sheared parallel and half sheared transverse to the rolling direction.
 3. W15/50 indicates the core loss at 50Hz and 1.5T. B50 indicates the magnetic flux density at 5000A/m.
 4. The specimens were tested as sheared.
 5. The values shown above are the typical ones, not for guarantee.

JNA™ CORE

Grade	Thickness mm (in.)	Assumed Density kg/dm ³	Resistivity $\mu\Omega \cdot \text{cm}$	Core Loss								Magnetic Flux Density T			
				Watts per kilogram				Watts per pound							
				50Hz		60Hz		50Hz		60Hz		B10	B25	B50	B100
				1.0T	1.5T	1.0T	1.5T	1.0T	1.5T	1.0T	1.5T				
50JNA300	0.50 (0.0197)	7.75	36	1.21	2.66	1.55	3.44	0.55	1.21	0.70	1.56	1.59	1.66	1.74	1.86
50JNA350		7.80	32	1.40	3.10	1.88	4.05	0.64	1.41	0.85	1.84	1.60	1.68	1.75	1.86
50JNA500		7.80	20	2.08	4.60	2.60	6.02	0.94	2.09	1.18	2.73	1.59	1.68	1.74	1.84

- Note :
1. Values above were measured according to the method JIS C 2550-1 (2011).
 2. Test samples were consisted of half the strips sheared parallel and half sheared transverse to the rolling direction.
 3. W15/50 indicates the core loss at 50Hz and 1.5T. B50 indicates the magnetic flux density at 5000A/m.
 4. The specimens were tested after stress relief annealing.
Annealing condition : 750°C (1382°F) for 2hrs. under neutral atmosphere.
 5. The values shown above are the typical ones, not for guarantee.

Non-Oriented Electrical Steel Sheets

JFE N-CORE

Typical Mechanical Properties

JN CORE

Grade	Thickness mm (in.)	Yield Point				Tensile Strength				Elongation		Hardness HV (1)	Number of Bends		Lamination Factor %
		N/mm ²		lb/in ²		N/mm ²		lb/in ²		%			L	C	
		L	C	L	C	L	C	L	C	L	C				
35JN210	0.35 (0.0138)	432	450	62,700	65,300	555	574	80,500	83,200	19	20	222	5	5	98.3
35JN230		401	413	58,200	59,900	527	543	76,400	78,800	20	22	215	5	5	98.3
35JN250		405	417	58,700	60,500	531	546	77,000	79,200	20	22	215	5	5	98.3
35JN270		415	429	60,200	62,200	540	556	78,300	80,600	20	21	216	10	9	98.3
35JN300		393	402	57,000	58,300	523	541	75,900	78,500	24	25	201	11	10	98.3
35JN360		351	356	50,900	51,600	489	504	70,900	73,100	27	28	182	15 or more	15 or more	98.3
35JN440		278	279	40,300	40,500	418	430	60,600	62,400	32	33	150	15 or more	15 or more	98.3
50JN230	0.50 (0.0197)	435	453	63,100	65,700	557	576	80,800	83,500	19	20	221	4	5	98.8
50JN250		407	421	59,000	61,100	534	552	77,400	80,100	21	23	213	4	5	98.8
50JN270		410	424	59,500	61,500	534	555	77,400	80,500	22	24	213	4	5	98.8
50JN290		414	427	60,000	61,900	534	560	77,400	81,200	23	25	213	5	5	98.8
50JN310		414	427	60,000	61,900	534	560	77,400	81,200	23	25	213	12	11	98.8
50JN350		389	403	56,400	58,400	529	547	76,700	79,300	27	28	207	14	13	98.8
50JN400		332	343	48,200	49,700	476	494	69,000	71,600	29	31	184	15 or more	15 or more	98.8
50JN470		285	290	41,300	42,100	423	433	61,300	62,800	34	35	153	15 or more	15 or more	98.8
50JN600		265	268	38,400	38,900	400	406	58,000	58,900	34	36	137	15 or more	15 or more	98.8
50JN700		276	278	40,000	40,300	398	402	57,700	58,300	35	36	127	15 or more	15 or more	99.0
50JN800		275	276	39,900	40,000	390	395	56,600	57,300	36	37	125	15 or more	15 or more	99.0
50JN1000		260	262	37,700	38,000	367	370	53,200	53,700	37	39	117	15 or more	15 or more	99.0
50JN1300		256	258	37,100	37,400	358	360	51,900	52,200	39	39	112	15 or more	15 or more	99.0
65JN800	0.65 (0.0256)	276	278	40,000	40,300	398	402	57,700	58,300	36	37	127	15 or more	15 or more	99.3
65JN1600		256	258	37,100	37,400	358	360	51,900	52,200	39	39	112	15 or more	15 or more	99.3

JNE™ CORE

Grade	Thickness mm (in.)	Yield Point				Tensile Strength				Elongation		Hardness HV (1)	Number of Bends		Lamination Factor %
		N/mm ²		lb/in ²		N/mm ²		lb/in ²		%			L	C	
		L	C	L	C	L	C	L	C	L	C				
35JNE230	0.35 (0.0138)	398	396	57,700	57,400	515	531	74,700	77,000	20	21	201	15 or more	15 or more	98.5
35JNE250		349	351	50,600	50,900	468	482	67,900	69,900	21	22	182	15 or more	15 or more	98.5
35JNE300		305	308	44,200	44,700	438	453	63,500	65,700	27	28	159	15 or more	15 or more	98.5
35JNE440		296	291	43,000	42,200	415	399	60,200	57,900	33	33	140	15 or more	15 or more	98.5
50JNE300	0.50 (0.0197)	350	354	50,800	51,300	478	494	69,300	71,600	25	26	182	15 or more	15 or more	99.0
50JNE350		315	318	45,700	46,100	441	457	63,900	66,300	31	32	156	15 or more	15 or more	99.0
50JNE470		264	265	38,300	38,400	388	398	56,300	57,700	32	34	140	15 or more	15 or more	99.0

THINNER GAUGE JNE CORE

Grade	Thickness mm (in.)	Yield Point				Tensile Strength				Elongation		Hardness HV (1)	Number of Bends		Lamination Factor %
		N/mm ²		lb/in ²		N/mm ²		lb/in ²		%			L	C	
		L	C	L	C	L	C	L	C	L	C				
20JNEH1200	0.20 (0.0080)	375	388	54,300	56,200	496	515	71,900	74,700	16	16	199	10	9	97.0
20JNEH1500		370	377	53,700	54,700	481	497	69,800	72,100	18	19	187	15 or more	15 or more	97.0
25JNE1350	0.25 (0.0098)	400	411	58,000	59,600	515	536	74,700	77,700	19	19	208	10	9	98.0
30JNE1500	0.30 (0.0118)	400	411	58,000	59,600	515	536	74,700	77,700	19	19	208	10	9	98.0

JNA™ CORE

Grade	Thickness mm (in.)	Yield Point				Tensile Strength				Elongation		Hardness HV (1)	Number of Bends		Lamination Factor %
		N/mm ²		lb/in ²		N/mm ²		lb/in ²		%			L	C	
		L	C	L	C	L	C	L	C	L	C				
50JNA300	0.50 (0.0197)	264	265	38,300	38,400	388	398	56,300	57,700	32	34	140	15 or more	15 or more	99.0
50JNA350		260	263	37,700	38,100	370	380	53,700	55,100	36	38	127	15 or more	15 or more	99.0
50JNA500		248	253	36,000	36,700	362	364	52,500	52,800	38	39	115	15 or more	15 or more	99.0

Note : 1. "L" and "C" means the specimens cut parallel and traverse to the rolling direction, respectively.

2. Tension tests were made on No.13A specimens according to JIS Z 2241 (2011).

3. Bend and lamination factor tests were made according to the method JIS C 2552 (2014) and JIS C 2550-5 (2011), respectively.

4. The specimens were tested as sheared.

5. Test values shown above are the typical ones, not for guarantee.

6. The specimens with A coating were used for lamination factor tests according to the method JIS C 2550-5 (2011).

Non-Oriented Electrical Steel Sheets

JFE N-CORE

Dimensions and Tolerances

Dimensions

Form	Grade		Thickness	Available width range	Inside coil diameter
Coils	JN CORE	35JN210	0.35 (0.0138)	from 50 mm (2 in.) to 1,160 mm (45.67 in.)	508 mm (20 in.)
		50JN230	0.50 (0.0197)		
		35JN230, 35JN250, 35JN270	0.35 (0.0138)	from 50 mm (2 in.) to 1,230 mm (48.42 in.)	
		50JN250, 50JN270, 50JN290, 50JN310	0.50 (0.0197)		
		35JN300, 35JN360, 35JN440	0.35 (0.0138)	from 50 mm (2 in.) to 1,250 mm (49.21 in.)	
		50JN350, 50JN400, 50JN470, 50JN600, 50JN700, 50JN800, 50JN1000, 50JN1300	0.50 (0.0197)		
		65JN800, 65JN1000, 65JN1300, 65JN1600	0.65 (0.0256)		
	JNE CORE	35JNE230, 35JNE250, 35JNE300, 35JNE440	0.35 (0.0138)	from 50 mm (2 in.) to 1,250 mm (49.21 in.)	
		50JNE300, 50JNE350, 50JNE470	0.50 (0.0197)		
	THINNER GAUGE JNE CORE	20JNEH1200, 20JNEH1500	0.20 (0.0080)	from 50 mm (2 in.) to 1,160 mm (45.67 in.)	
		25JNE1350	0.25 (0.0098)	from 50 mm (2 in.)	
		30JNE1500	0.30 (0.0118)	to 1,250 mm (49.21 in.)	
	JNA CORE	50JNA300, 50JNA350, 50JNA500	0.50 (0.0197)	from 50 mm (2 in.) to 1,250 mm (49.21 in.)	

Tolerances in Dimension and Shape of Slit coils

Width mm	Thickness mm	Tolerance				
		Thickness %	Deviation of thickness in transverse direction mm	Width mm	Camber in any 2 meters (Slit Products) mm	Shear Burr mm
150 or under	0.20 – 0.30	± 10	0.02 or under	+ 0.3 0	1.0 or under	0.035 or under
	0.35	± 8	0.02 or under			
	0.50	± 8	0.02 or under			
	0.65	± 6	0.03 or under			
Over 150 to 300	0.20 – 0.30	± 10	0.02 or under	+ 0.5 0		
	0.35	± 8	0.02 or under			
	0.50	± 8	0.02 or under			
	0.65	± 6	0.03 or under			
Over 300 to 600	0.20 – 0.30	± 10	0.02 or under	+ 0.5 0		
	0.35	± 8	0.02 or under			
	0.50	± 8	0.02 or under			
	0.65	± 6	0.03 or under			
Over 600 to 1000	0.20 – 0.30	± 10	0.02 or under	+ 1.0 0		
	0.35	± 8	0.02 or under			
	0.50	± 8	0.02 or under			
	0.65	± 6	0.03 or under			
Over 1000	0.20 – 0.30	± 10	0.03 or under	+ 1.5 0		
	0.35	± 8	0.03 or under			
	0.50	± 8	0.03 or under			
	0.65	± 6	0.04 or under			

Note: Stipulation of camber shall be applied only for the steel strips width 75mm over.

Magnetic properties of electrical steel sheets are deteriorated by a mechanical strain caused by shearing, punching, bend-forming.

Stress-relief annealing is performed to remove such strain and to restore the inherent good magnetic properties.

Stress-relief annealing may vary according to the degree of fabrication and the type of annealing equipment.

The following points call for attention:

Heating and cooling rates

Magnetic properties are not affected by heating or cooling rates as performed on an ordinary industrial scale. However, care must be taken so that no strain will remain in the material.

Annealing temperature and holding time

a. Grain-oriented Electrical steel sheets

Optimum annealing temperature range is 780 - 850 °C. (1436 °F - 1562 °F)
Material must be maintained until heated up uniformly within this temperature range. Holding time varies depending upon the shape of core, the number of coils charged and the type of furnace.

b. Non-oriented Electrical steel sheets

Optimum temperature of the stress-relief annealing, when required, is 720-750 °C. (1328 °F - 1382 °F)

Prevention of carburization and oxidation

Since carburization and an excessive oxidation will cause the deterioration of magnetic properties of the steel, the atmospheric gas must be carefully controlled and the gas must also have a low dew point.

For the prevention of the carburization during annealing, organic compounds such as oil and grease remained on the coil surface during the fabrication must also be removed completely in advance. The use of material of low carbon content is recommended for the base and cover of the annealing furnace.

JFE Steel offers the following types of coatings for surface insulation. The customers can select one that best meets their requirements for interlamination resistance, punchability, heat resistance, Freon resistance and other properties.

A, N Coating

As to A, N coating, an organic resin is added to inorganic coating.

It has excellent punchability, corrosion resistivity and Freon resistance, with exceedingly high interlamination resistance shown in the case of the higher grades. Suited to large rotors, especially to motors for electric household appliances where good punchability is required.

A and N Coating has no equivalent in the AISI standards.

D Coating

This phosphate-based inorganic coating has been extensively used since its development in 1959, as it has such excellent characteristics as interlamination resistance, adhesion, heat resistance, lamination factor required for coating.

The interlamination resistance becomes better as the grade becomes higher. D-coating is equivalent to AISI Core Plate C4.

J Coating

An organic resin is also partially added to inorganic coating.

In comparison with A,N coating, it has excellent heat-resistancy due to the improvement of an organic resin itself.

J coating has no equivalent in the AISI standards.

Unless otherwise specified, A Coating will be applied and at the end of grade designation, type of surface insulation is indicated.

Ex : 50JN600*A — means 50JN600 applied with A coating.

The Characteristics of Insulating Coatings for JFE N-CORE(0.5mm thick)

Items		
(1) Applied grades		
(2) Comparable to AISI Core-Plate		
(3) Composition		
(4) Thickness of coating (μm per side)		
(5) Lamination factor (%)		
(6) Adhesion (mm ϕ)		
(7) Interlaminar resistance ($\Omega\text{-cm}^2/\text{sheet}$)	Before annealing	
	After annealing	
(8) Resistance to rust, Appearance change		
(9) Resistance to freon	Appearance change	
	Weight change	
(10) Resistance to insulating oil	Appearance change	
	Weight change	
(11) Punchability Number of punchings at which burr height reaches $50\mu\text{m}$. ($\times 10^3$)	Steel die	50JN350
		50JN470
		50JN800
	Carbide die	50JN800
(12) Weldability Max.welding speed without blowholes(cm/min)		
(13) Heat resistance Flaking after annealing		

A, N (thin)	J (thin)	A, N (thick)	D	Notice
JN, JNE, THINNER GAUGE JNE, JNA	JN, JNA	JN, JNE, THINNER GAUGE JNE, JNA	JN, JNE, JNA	
—	—	—	C-4	
Inorganic with some organic materials	Inorganic with some organic materials	Inorganic with some organic materials	Inorganic (Phosphate)	
0.2 - 0.5	0.2 - 0.5	0.6 - 1.4 *	0.3 - 0.8 *	*The higher grade, the higher value.
98.5	98.5	98.0	98.0 - 98.5	Pressure : 1N/mm ² (JIS C 2550)
10	10	10	20	Minimum mandrel diameter without flaking
1 - 10	1 - 10	10 - 80	1 - 30	JIS C 2550, Pressure : 2N/mm ² , Electrode : 1cm ² × 10 pieces, Voltage : 0.5V D.C.
< 1 - 5	< 1 - 5	< 1 - 20	< 1 - 5	Annealing condition : 750°C×2hrs. in DX rich gas
not recognized	not recognized	not recognized	not recognized	Humidity cabinet test at 49°C (relative humidity ≥ 98%) for 50 hrs.
〃	〃	〃	〃	Freon : Lubricating oil = 9:1 at 80°C for 10 days
〃	〃	〃	〃	
〃	〃	〃	〃	at 120°C for 72 hrs. (oil : JIS C 2320)
〃	〃	〃	〃	
—	—	500	30	Material of die : Tool steel Shape of punch : 15mm dia. Clearance : 5% of sheet thickness Punching oil : Applied
—	—	600	40	
1000	1000	1500	80	
3000	3000	3000	1100	Material of die : WC-Co (JIS B 4104 V2)
60	60	30	120	Current : 120A, Ar gas flow : 6l/min., Electrode : Th-W 2.6mm φ, Gap between material and electrode : 15mm, Clamping pressure : 100kg/cm ² , Weld groove : Provided
not recognized	not recognized	not recognized	not recognized	Annealing condition : 750°C × 2hrs. in DX rich gas

Note : These above values are those obtained under the certain limited conditions in our laboratory.

Substances of Environmental Concern Data

In JFE's Electrical Steel Sheet products, substances of environmental concern listed below are not detected in the results of analyses conducted by following methods.

Analytical method

Substance	Preparation	Analytical method	Minimum limit of determination
Hg	Wet digestion	Atomic absorption spectrometric method after reduction-generation as Mercury gas	1 ppm
Cd	Wet digestion (dissolved completely)	Atomic absorption spectrometric method	10 ppm
Pb			10 ppm
Cr ⁶⁺	Extraction in boiling water	Diphenylcarbazide spectrophotometric method	0.01 μg/cm ²

Note : 1. Insulation coating contains Cr³⁺.

Please pay attention when heating in the oxidizing atmosphere or using in the high temperature conditions.

2. Chemical substances such as PBB and PBDE are neither intentionally added nor used in our production processes.

Relations among Coil Weight, Outside Coil Diameter and Slit Width

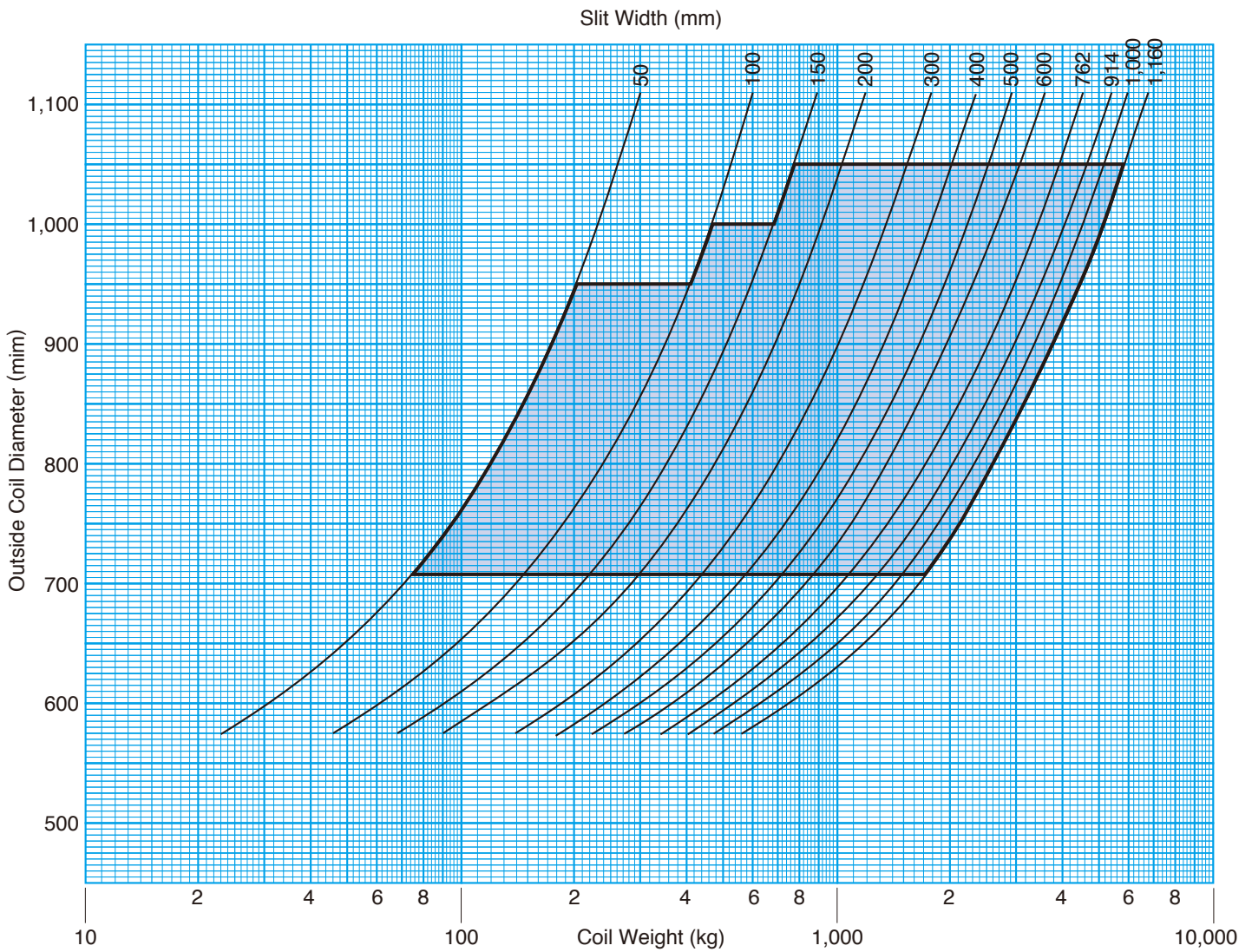

- Note :**
1. Inside Coil Diameter 508mm (20 in.)
 2. This chart is for JFE G-CORE. In applying to JFE N-CORE, the curves are a little different from this.
 3. The shadowed portion shows the general available dimensions.
Please contact to us if there is any request about the other available sizes.

Coil Vertical Axis Type

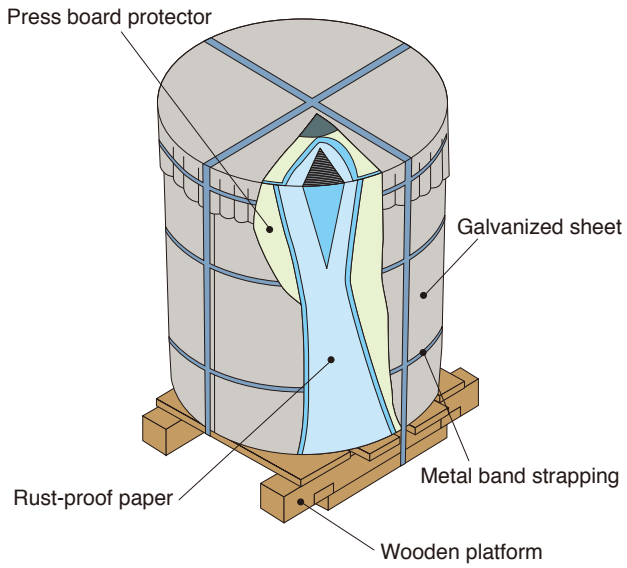

Coil Horizontal Axis Eye Hole Type

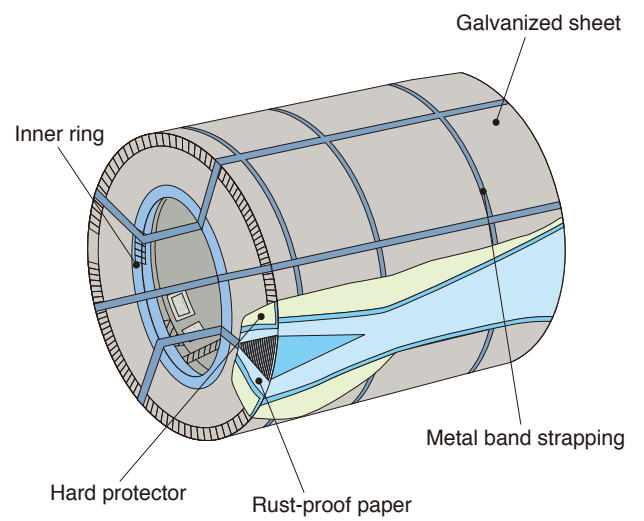

Conversion Factors

Units	Multiply	By	To Obtain
Magnetizing Force	Oersted (Oe)	7.958×10	Ampere per meter (A/m)
	Oersted (Oe)	2.021	Ampere per inch (A/in)
	Ampere per meter (A/m)	1.257×10^{-2}	Oersted (Oe)
	Ampere per meter (A/m)	2.540×10^{-2}	Ampere per inch (A/in)
	Ampere per inch (A/in)	4.947×10^{-1}	Oersted (Oe)
	Ampere per inch (A/in)	3.937×10	Ampere per meter (A/m)
	Ampere per centimeter (A/cm)	10^2	Ampere per meter (A/m)
Magnetic Polarization	Tesla (T)	10^4	Gauss (G)
	Tesla (T)	1	Weber per square meter (Wb/m ²)
	Gauss(G)	10^{-4}	Weber per square meter (Wb/m ²)
	Gauss(G)	6.452	Lines per square inch (Line/in ²)
Magnetic Flux Density	Weber per square meter (Wb/m ²)	10^4	Gauss (G)
	Weber per square meter (Wb/m ²)	1	Tesla (T)
	Weber per square meter (Wb/m ²)	6.452×10^4	Lines per square inch (Line/in ²)
	Lines per square inch (Line/in ²)	1.550×10^{-1}	Gauss (G)
	Lines per square inch (Line/in ²)	1.550×10^{-5}	Weber per square meter (Wb/m ²)
Core Loss	Watt per kilogram (W/kg)	4.536×10^{-1}	Watt per pound (W/lb)
	Watt per pound (W/lb)	2.204	Watt per kilogram (W/kg)
Permeability	CGS electro-magnetic unit (emu)	1	Gauss per Oersted (G/Oe)
	CGS electro-magnetic unit (emu)	1.257×10^{-6}	Henry per meter (H/m)
	CGS electro-magnetic unit (emu)	1.257×10^{-6}	Weber per Ampere-meter (Wb/A-m)
	CGS electro-magnetic unit (emu)	3.192×10^{-8}	Weber per Ampere-inch (Wb/A-in)
	CGS electro-magnetic unit (emu)	3.192	Lines per Ampere-inch (Line/A-in)
	Henry per meter (H/m)	7.958×10^5	CGS electro-magnetic unit (emu)
	Henry per meter (H/m)	7.958×10^5	Gauss per Oersted (G/Oe)
	Henry per meter (H/m)	2.540×10^{-2}	Weber per Ampere-inch (Wb/A-in)
	Henry per meter (H/m)	2.540×10^6	Lines per Ampere-inch (Line/A-in)
Length	Meter (m)	3.937×10	Inch (in)
	Inch (in)	2.540×10^{-2}	Meter (m)
	Meter (m)	3.281	Feet (ft)
	Feet (ft)	3.048×10^{-1}	Meter (m)
Weight	Kilogram (kg)	2.204	Pound (lb)
	Pound (lb)	4.536×10^{-1}	Kilogram (kg)

Comparison of specification

Grain-Oriented

JFE STANDARD
vs JIS,AISI,IEC
Core Loss W17/50
(at 1.7T and 50Hz)

Thickness	0.60		0.70		0.80		0.90	
	0.23mm	JFE	23JGSE070	23JGSD075 23JGSE075	23JGHE080 23JGSD080 23JGSE080	23JGHE085 23JGS085 23JGSD085	23JGH090 23JGS090	23JGH095 23JGS095
	JIS (2019)	23R075		23R080	23P085 23R085	23P090	23P095	
	AISI (1983)	M-3						
	IEC (2017)	M80-23P5			M85-23P5	M90-23P5	M95-23P5	
0.27mm	JFE	27JGSE085				27JGS090 27JGSD090 27JGSE090	27JGS095 27JGSD095	
	JIS (2019)	27R085				27P090 27R090	27P095 27R095	
	AISI (1983)	M-3						
	IEC (2017)	M90-27P5					M95-27P5	
0.30mm	JFE	30JGS095						
	JIS (2019)	30P095						
	AISI (1983)	M-3						
	IEC (2017)	M100-30P5						
0.35mm	JFE						35JGH115 35JGS115	
	JIS (2019)						35P115	
	AISI (1983)	M-3						
	IEC (2017)	M115-35P5						

Non-Oriented

JFE STANDARD
vs JIS,AISI,IEC
Core Loss W15/50
(at 1.5T and 50Hz)

Thickness	2.0		2.5			3.0		
	0.35mm	JFE	35JN210	35JN 230	35JN 250	35JN 270	35JN300	35JN360
0.35mm	JIS (2014)	35A210	35A 230	35A 250	35A 270	35A300	35A330	
0.36mm	AISI (1983)	M-15			M-19	M-22	M-27	M-36
0.35mm	IEC (2013)	M210-35A5	M230-35A5	M250-35A5	M270-35A5	M300-35A5	M330-35A5	
0.50mm	JFE	50JN230	50JN 250	50JN 270	50JN 290	50JN 310	50JN 350	
0.50mm	JIS (2014)	50A230	50A 250	50A 270	50A 290	50A 310	50A 330	
0.47mm	AISI (1983)	M-15				M-19	M-22	M-27
0.50mm	IEC (2013)	M230-50A5	M250-50A5	M270-50A5	M290-50A5	M310-50A5	M330-50A5	
0.65mm	JFE							
0.65mm	JIS (2014)	65A310					65A 330	
0.64mm	AISI (1983)	M-19						
0.65mm	IEC (2013)	M310-65A5					M330-65A5	

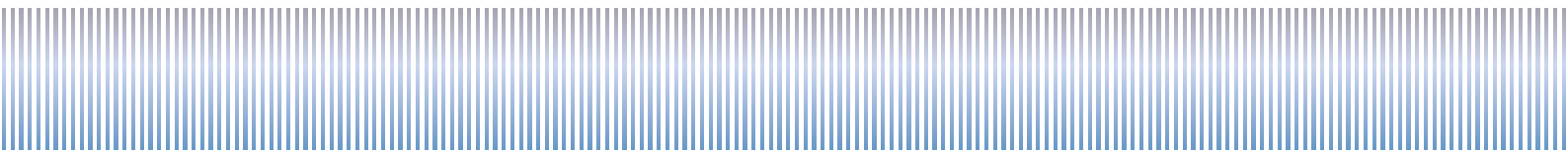

1.0		1.1		1.2		1.3		1.4		1.5		1.6		1.7 W/kg	
23JGH100	23JG110														
23P100	23G110														
M100-23P5		M110-23S5													
27JGH100	27JGH110	27JG120	27JG130												
27JGS100															
27P100	27P110	27G120	27G130												
M-4															
M100-27P5	M110-27P5	M120-27S5	M130-27S5												
30JGS100	30JGH105 30JGS105	30JGH110	30JG120 30JGH120	30JG130	30JG140										
30P100	30P105	30P110	30G120 30P120	30G130	30G140										
M-5															
	M105-30P5	M110-30P5	M120-30P5	M130-30S5	M140-30S5										
			35JGH125 35JGS125	35JG135 35JGH135	35JG145	35JG155									
			35P125	35G135 35P135	35G145	35G155									
M-6															
			M125-35P5	M135-35P5	M145-35S5	M155-35S5									

3.5		4.0		4.5		5.0		5.5		6.0		6.5		7.0		7.5		8.0		9.0		10.0		12.0		14.0		16.0 W/kg	
		35JN440																											
35A360		35A440																											

M360-35A5 ①: M235- 35A5

50JN400		50JN470	50JN600		50JN700	50JN800	50JN1000		50JN1300									
50A350	50A400	50A470	50A530	50A600	50A700	50A800	50A940	50A1000	50A1300									
M-36		M-43		M-45		M-47												
M350-50A5	M400-50A5	M470-50A5	M530-50A5	M600-50A5	M700-50A5	M800-50A5	M940-50A5	M1000-50A5										
65JN800							65JN1000	65JN1300	65JN1600									
65A350	65A400	65A470	65A530	65A600	65A700	65A800	65A1000	65A1300	65A1600									
M-22		M-27	M-36	M-43	M-45			M-47										
M350-65A5	M400-65A5	M470-65A5	M530-65A5	M600-65A5	M700-65A5	M800-65A5	M1000-65A5											

• For further information, please contact our nearest office or send your inquiries directly to:

Electrical Steel Export Sec. Electrical Steel Sales Dept.
Electrical Steel Business Planning Dept.

Phone (81)3-3597-4096 Fax (81)3-3597-4779
Phone (81)3-3597-3480 Fax (81)3-3597-4779

JFE Steel Corporation<http://www.jfe-steel.co.jp/en/>**HEAD OFFICE**

Hibiya Kokusai Building, 2-3 Uchisaiwaicho 2-chome, Chiyodaku, Tokyo 100-0011, Japan Phone: (81)3-3597-3111 Fax: (81)3-3597-4860

ASIA PACIFIC**SEOUL**JFE Steel Korea Corporation
16th Floor, 41, Cheonggyecheon-ro, Jongno-gu, Seoul,
03188, Korea
(Youngpung Building, Seorin-dong)
Phone: (82)2-399-6337 Fax: (82)2-399-6347**BEIJING**JFE Steel Corporation Beijing
1009 Beijing Fortune Building No.5, Dongsanhuan
North Road, Chaoyang District, Beijing, 100004,
P.R.China
Phone: (86)10-6590-9051 Fax: (86)10-6590-9056**SHANGHAI**JFE Consulting (Shanghai) Co., Ltd.
Room 801, Building A, Far East International Plaza,
319 Xianxia Road, Shanghai 200051, P.R.China
Phone: (86)21-6235-1345 Fax: (86)21-6235-1346**GUANGZHOU**JFE Consulting (Guangzhou) Co., Ltd.
Room 3901 Citic Plaza, 233 Tian He North Road,
Guangzhou, 510613, P.R.China
Phone: (86)20-3891-2467 Fax: (86)20-3891-2469**MANILA**JFE Steel Corporation, Manila Office
23rd Floor 6788 Ayala Avenue, Oledan Square,
Makati City, Metro Manila, Philippines
Phone: (63)2-886-7432 Fax: (63)2-886-7315**HO CHI MINH CITY**JFE Steel Vietnam Co., Ltd.
Unit 1704, 17th Floor, MPlaza, 39 Le Duan Street,
Dist 1, HCMC, Vietnam
Phone: (84)28-3825-8576 Fax: (84)28-3825-8562**HANOI**JFE Steel Vietnam Co., Ltd., Hanoi Branch
Unit 1501, 15th Floor, Cornerstone Building, 16 Phan
Chu Trinh Street, Hoan Kiem Dist., Hanoi, Vietnam
Phone: (84)24-3855-2266 Fax: (84)24-3533-1166**BANGKOK**JFE Steel (Thailand) Ltd.
22nd Floor, Abdulrahim Place 990, Rama IV Road,
Silom, Bangrak, Bangkok 10500, Thailand
Phone: (66)2-636-1886 Fax: (66)2-636-1891**YANGON**JFE Steel (Thailand) Ltd., Yangon Office
Unit 05-01, Union Business Center, Nat Mauk Road,
Bocho Quarter, Bahan Tsp, Yangon, 11201, Myanmar
Phone: (95)1-860-3352**SINGAPORE**JFE Steel Asia Pte. Ltd.
16 Raffles Quay, No.15-03, Hong Leong Building,
048581, Singapore
Phone: (65)6220-1174 Fax: (65)6224-8357**JAKARTA**PT. JFE STEEL INDONESIA
6th Floor Summitmas II, JL Jendral Sudirman Kav.
61-62, Jakarta 12190, Indonesia
Phone: (62)21-522-6405 Fax: (62)21-522-6408**NEW DELHI**JFE Steel India Private Limited
806, 8th Floor, Tower-B, Unitech Signature Towers,
South City-I, NH-8, Gurgaon-122001, Haryana, India
Phone: (91)124-426-4981 Fax: (91)124-426-4982**MUMBAI**JFE Steel India Private Limited, Mumbai Office
603-604, A Wing, 215 Atrium Building, Andheri-Kurla
Road, Andheri (East), Mumbai-400093, Maharashtra,
India
Phone: (91)22-3076-2760 Fax: (91)22-3076-2764**CHENNAI**JFE Steel India Private Limited, Chennai Office
No.86, Ground Floor, Polyhose Towers(SPIC Annexe),
Mount Road, Guindy, Chennai-600032, Tamil Nadu,
India
Phone: (91)44-2230-0285 Fax: (91)44-2230-0287**BRISBANE**JFE Steel Australia Resources Pty Ltd.
Level28, 12 Creek Street, Brisbane QLD 4000
Australia
Phone: (61)7-3229-3855 Fax: (61)7-3229-4377**EUROPE and MIDDLE EAST****LONDON**JFE Steel Europe Limited
15th Floor, The Broadgate Tower, 20 Primrose Street,
London EC2A 2EW, U.K.
Phone: (44)20-7426-0166 Fax: (44)20-7247-0168**DUBAI**JFE Steel Corporation, Dubai Office
P.O.Box 261791 LOB19-1208, Jebel Ali Free Zone
Dubai, U.A.E.
Phone: (971)4-884-1833 Fax: (971)4-884-1472**NORTH, CENTRAL and SOUTH AMERICA****NEW YORK**JFE Steel America, Inc.
600 Third Avenue, 12th Floor, New York, NY 10016,
U.S.A.
Phone: (1)212-310-9320 Fax: (1)212-308-9292**HOUSTON**JFE Steel America, Inc., Houston Office
750 Town & Country Blvd., Suite 705 Houston,
Texas 77024, U.S.A.
Phone: (1)713-532-0052 Fax: (1)713-532-0062**MEXICO CITY**JFE Steel America, Inc., Mexico Office
Ruben Dario #281-1002, Col. Bosque de
Chapultepec, C.P. 11580, CDMX. D.F. Mexico
Phone: (52)55-5985-0097 Fax: (52)55-5985-0099**RIO DE JANEIRO**JFE Steel do Brasil LTDA
Praia de Botafogo, 228 Setor B, Salas 508 & 509,
Botafogo, CEP 22250-040, Rio de Janeiro-RJ, Brazil
Phone: (55)21-2553-1132 Fax: (55)21-2553-3430**Notice**

While every effort has been made to ensure the accuracy of the information contained within this publication, the use of the information is at the reader's risk and no warranty is implied or expressed by JFE Steel Corporation with respect to the use of information contained herein. The information in this publication is subject to change or modification without notice. Please contact the JFE Steel office for the latest information.