

UNCLASSIFIED

AD NUMBER

ADB228585

LIMITATION CHANGES

TO:

Approved for public release; distribution is unlimited. Document partially illegible.

FROM:

Distribution authorized to U.S. Gov't. agencies and their contractors;
Administrative/Operational Use; NOV 1947. Other requests shall be referred to Office of the Historical Section, Plans, Training and Intelligence Division, Office of the Chief, Chemical Corps, Army Chemical Center, MD.
Document partially illegible.

AUTHORITY

ECBC memo dtd 30 Mar 2015

THIS PAGE IS UNCLASSIFIED

UNCLASSIFIED

~~SECRET~~
~~SECRET~~

HISTORY OF THE CHEMICAL WARFARE SERVICE

IN WORLD WAR II

(1 July 1940 - 15 August 1945)

UNCLASSIFIED

19970905 088

REGRADED TO Unclassified

BY AUTHORITY OF SECRETARY of THE DEFENSE FORM 1575, see 74

DATED Cont 1 - DANA-A-U-212 - AA
FROM Cont 2 - DANA-E-236 - AH - Ap

By: John F. Davis, CDCC
Date: 18 Sep 75

BIOLOGICAL WARFARE RESEARCH
IN THE UNITED STATES

By

REXMOND C. COCHRANE

Vol. II

EA-5-1089 (71)

UNCLASSIFIED

Historical Section
Plans, Training and Intelligence Division
Office of Chief, Chemical Corps
November 1947

UNCLASSIFIED

~~SECRET~~

~~SECRET~~

CG 1 of 1, see A
Ft. Detrick Controls
No. 75-FDS-71

Control Approval Symbol
CG-7)

UNCLASSIFIED

PREFACE

The present volume, BIOLOGICAL WARFARE RESEARCH IN THE UNITED STATES, is one of a series of historical monographs on the research and development activities of the Chemical Warfare Service (now Chemical Corps) in World War II. It is a documented account of the interest of the United States in the potentialities of biological warfare and the circumstances that made research in this field necessary. It reports in brief compass the nature and results of the research and development undertaken in the biological warfare laboratories, pilot plants and production plant established by the Chemical Corps. The history also contains some account of biological warfare research in Great Britain, Canada, and in the enemy countries, Germany and Japan.

Preceding this volume in order of presentation of material is MILITARY BIOLOGY AND BIOLOGICAL WARFARE. This introductory volume contains a section on elementary bacteriology and biology, sections describing a number of potential agents of biological warfare, including the agents investigated by the United States and our Allies, and sections on the presumptive nature of biological warfare, its munitions, tactics, defensive aspects, and organizational aspects.

In the present volume, no effort has been made to do more than describe the actual studies conducted either in the War Research Service and its contract agencies or in the Special Projects Division of the Chemical Corps. In most instances, papers published by members of these two organizations contain fairly complete references to previous studies

UNCLASSIFIED

UNCLASSIFIED

by other workers in biology and bacteriology which might have bearing on their application to biological warfare.

It is admitted that many of the statements in this history, particularly in descriptions of research on the various agents, appear as positive statements of fact, and it is more than likely that a great many of these statements are challengeable or have even been disproved since the original studies were made. However, the introduction to the history will state that the investigations reported therein were done hastily and under wartime pressure. Many of the statements of research, therefore, are assertive rather than presumptive, because positive result had to be obtained for the success of the program. Where facts are in error, due either to the writer's faulty quotation or lack of intimate knowledge of the subject matter, they will be corrected. Where statements are correctly quoted but should be qualified, where facts have since been disproved, or where a difference of opinion exists, these corrections will be put in footnotes.

A considerable collection of notes, documents, photographs and other source materials for this history were originally ^{collected} obtained by Lt. Leon Braun who visited the Special Projects Division installations in the Spring of 1945. This material has been supplemented ^{with} by that obtained by the author in the Office of the Chief, Chemical Corps, and during recent visits to Camp Detrick.

UNCLASSIFIED

November 1947
Historical Section
Plans, Training and Intelligence Division, OC Cml C
Army Chemical Center, Maryland

UNCLASSIFIED

(NOT INCLUDED IN THIS VOLUME)

VOLUME I. MILITARY BIOLOGY AND BIOLOGICAL WARFARE

Contents

Chapter	Page
I FUNDAMENTAL PRINCIPLES.....	1
General Nature and Occurrence of Micro-organisms....	1
Morphology and Reproduction.....	5
Inhibition and Destruction.....	15
Detection and Identification.....	20
Infection and Immunity.....	26
II BIOLOGICAL AGENTS.....	37
Definition.....	37
Classification of Agents.....	37
Requisites of a Biological Warfare Agent.....	40
Comparison of Biological and Chemical Warfare Agents	43
Agents Injurious to Man and Animals.....	49
Agents Injurious to Crops.....	151
Plant Growth Regulators and Defoliants.....	162
Simulated Agents.....	171
III MUNITIONS.....	174
Principles of Dispersion of Biological Agents.....	174
Factors in Choice of Munitions.....	176
Preparation of Charges or Fillings.....	181
Experimental Munitions.....	184
Potential Munitions for Biological Warfare Agents...	189

UNCLASSIFIED

Chapter	Page
IV TACTICS AND TECHNIQUES.....	194
General.....	194
Factors in the Tactical Employment of Bio- logical Warfare.....	197
Deception and Artifacts in Biological Warfare....	201
Strategic and Tactical Employment.....	205
Defensive and Offensive Employment.....	211
Tactical Aspects of Specific Biological Agents...	214
V PROTECTION.....	222
Principles of Protection.....	222
Individual Protection.....	224
Collective Protection.....	231
Decontamination.....	240
VI ORGANIZATION FOR BIOLOGICAL WARFARE.....	243
General.....	243
Organization for Defense Against Biological Attack	249
Methods and Operating Procedures for Defense.....	251
General Defensive Measures.....	271
REFERENCES.....	275
GLOSSARY.....	279

VOLUME II. BIOLOGICAL WARFARE RESEARCH IN THE UNITED STATES

History of the Special Projects Division
Chemical Warfare Service

Contents

Chapter	Page
INTRODUCTION.....	1
I PLANNING FOR BIOLOGICAL WARFARE.....	10
Early Interest of CWS in Biological Warfare.....	10
WBC Committee.....	16
War Research Service.....	13
ABC Committee.....	21
CWS Activities Under WRS.....	22
Transfer of Biological Warfare Program to War Department	27
United States Biological Warfare Committee.....	30
DEF Committee.....	31
New Developments Division, WDSS.....	32
II ORGANIZATION AND ADMINISTRATION.....	33
Organization at Edgewood Arsenal.....	33
Camp Detrick.....	36
Horn Island.....	40
Granite Peak Installation.....	44
Vigo Plant.....	46
Special Projects Division, OC CWS.....	51
Project Specifications.....	53
Navy Participation in the Program.....	60

Chapter	Page
Medical Participation in the Program.....	66
Engineer Participation in the Program.....	69
Personnel.....	74
Research Contracts.....	82
III FACILITIES AND FISCAL ACCOUNTS.....	88
Camp Detrick.....	88
Horn Island.....	92
Granite Peak Installation.....	92
Vigo Plant.....	94
Pilot Plants at Camp Detrick.....	97
Production Plant at Vigo.....	116
Laboratory Animals.....	122
IV SECURITY, INTELLIGENCE, AND TRAINING.....	125
Security.....	125
Intelligence of Enemy Activities.....	129
Counterintelligence.....	141
Training.....	145
V OPERATIONAL SAFETY AND PROTECTION.....	151
Plant Safety Supervision.....	151
Personnel Inspection and First Aid.....	152
Immunization (Special Procedures).....	152
Detection of Agents in Plants and Laboratories...	159
Decontamination Procedures.....	162
Air Treatment Testing.....	164
Sewage Treatment.....	166
Laundry Treatment.....	166

Chapter	Page
Shipment Clearance.....	166
Laboratory Techniques.....	167
Insect and Rodent Control.....	168
Laboratory Accidents and Infections.....	169
Safety Control at Vigo Plant.....	173
VI DEFENSE AGAINST BIOLOGICAL AGENTS.....	176
Physical and Chemical Protection.....	176
Biological Masks.....	177
Protective Clothing.....	184
Ointments.....	192
Decontaminating Agents.....	194
Biological Protection.....	201
VII ANTHRAX.....	209
General.....	209
Selection of Strain.....	210
<u>Simulant Agents.....</u>	<u>212</u>
Nutrition.....	213
Laboratory Production.....	215
Pilot Plant Production.....	217
Large Scale Production.....	220
Harvesting.....	225
Storage.....	226
Dissemination.....	223
Pathogenicity.....	230
Defensive Research.....	234
Anthrax Therapy.....	249
Laboratory Infection.....	252

Chapter	Page
VIII BOTULISM.....	254
General.....	254
Selection of Strain.....	255
Botulinum Toxin Simulant.....	256
Nutrition.....	257
Laboratory and Pilot Plant Production.....	259
Harvesting.....	260
Storage.....	261
Dissemination.....	261
Purification of Type A Toxin.....	263
Pathogenicity.....	266
Defensive Research.....	269
IX BRUCELLOSIS.....	276
General.....	276
Selection of Strain.....	277
<u>Simulant</u>	278
Nutrition.....	280
Laboratory and Pilot Plant Production.....	281
Harvesting, Storage, and Dissemination.....	286
Pathogenicity.....	289
Defensive Research.....	292
Laboratory Infection.....	296
X GLANDERS AND MELIOIDOSIS.....	298
General.....	298
Selection of Strains.....	299
Nutrition and Laboratory Production.....	302

Chapter	Page
Storage and Dissemination.....	303
Pathogenicity.....	305
Defensive Research.....	306
Laboratory Infection.....	311
XI TULAREMIA.....	314
General.....	314
Selection of Strain.....	314
Nutrition and Laboratory Production.....	316
Harvesting, Storage, and Dissemination.....	318
Pathogenicity.....	322
Defensive Research.....	323
Laboratory Infection.....	327
XII PSITTACOSIS.....	329
General.....	329
Selection of Strains.....	329
Simulants.....	330
Laboratory and Pilot Plant Production.....	330
Harvesting, Storage, and Dissemination.....	333
Pathogenicity.....	335
Defensive Research.....	336
Laboratory Infection.....	343
XIII COCCIDIOIDAL GRANULOMA.....	345
General.....	345
Selection of Strain.....	346
Nutrition and Laboratory Production.....	346
Storage and Dispersion.....	348

Chapter	Page
Pathogenicity.....	350
Defensive Research.....	351
Laboratory Infection.....	353
XIV NEUROTROPIC ENCEPHALITIDES.....	354
General.....	354
XV SHELLFISH (MUSSEL) POISONING.....	356
General.....	356
XVI PLAGUE.....	359
General.....	359
XVII RINDERPEST.....	360
General.....	360
Selection of Strain.....	361
Safety Precautions.....	361
Production of Inactivated Bovine Tissue Vaccines...	362
Production of Inactivated Egg-Cultivated Virus.....	365
Production of Vaccine from an Attenuated Virus Strain	366
Immunization.....	369
Survival of Rinderpest Virus.....	370
Pathogenicity.....	371
Serology and Detection.....	374
XVIII NEWCASTLE DISEASE AND FOWL PLAGUE.....	376
General.....	376
Selection of Strains.....	377
Pathogenicity.....	379
Comparative Pathology.....	380
Isolation of Newcastle Disease Virus.....	381

Chapter	Page
Immunization.....	383
XIX BROWN SPOT OF RICE.....	387
General.....	387
Selection of Strains.....	388
Laboratory and Pilot Plant Production.....	389
Harvesting, Storage, and Dissemination.....	392
Pathogenicity.....	393
XX RICE BLAST.....	395
General.....	395
Selection of Strains.....	396
Nutrition and Laboratory Production.....	396
Pilot Plant Production.....	397
Harvesting, Storage, and Dissemination.....	398
Pathogenicity.....	400
XXI LATE BLIGHT OF POTATO.....	401
General.....	401
Laboratory Production.....	402
Storage and Dissemination.....	403
Pathogenicity.....	404
XXII SOUTHERN BLIGHT.....	405
General.....	405
Selection of Strain.....	406
Laboratory and Pilot Plant Production.....	406
Storage and Dissemination.....	409
Pathogenicity.....	410

Chapter	Page
XXIII CHEMICAL PLANT GROWTH REGULATORS.....	413
General.....	413
Selection of Agents.....	414
Production.....	415
Dissemination.....	416
Toxicity of the Phenoxyacetic Acids.....	419
Toxicity of Isopropylphenylcarbamate.....	425
Supplementary Field Studies.....	427
Plans to Use LN Chemicals on Japanese Crops.....	430
XXIV CHEMICAL DEFOLIANTS.....	435
General.....	435
Selection of Agents.....	435
Dissemination.....	436
XXV MUNITIONS DEVELOPMENT.....	437
Objectives of the Program.....	437
Dispersion Factors.....	438
SPD Mark I Bomb.....	440
Other Bursting-type Munitions.....	442
Gas-expulsion Bomb.....	443
SS Bomb.....	444
SPD Mark 2 Bomb.....	445
Coagent Bomb.....	446
Miscellaneous Devices.....	447
Bomb Filling Preparations.....	449
Machine-loading of Munitions.....	452
Explosive Studies.....	454

Chapter	Page
Sampling Devices.....	456
Sampling Procedure.....	458
XXVI SPECIAL DEVICES AND SPECIAL STUDIES.....	460
British Cloud Chamber.....	460
American Cloud Chamber.....	461
Bacteriological Laboratory Studies.....	465
Chemical Laboratory Studies.....	467
Tiselius Electrophoresis Apparatus.....	467
Sonic Disintegrator.....	468
Lyophilizing Apparatus.....	468
Nerve Stimulation Recorder.....	469
Respiration Recorder.....	469
Electrical Particulate Counter.....	470
Photography.....	471
Micrometeorological Instruments.....	472
XXVII TERMINATION OF WARTIME ACTIVITIES.....	473
The End of the War.....	473
Accomplishments.....	474
Implications.....	477
Evaluations of the Program.....	479
Publication.....	484
Newspaper and Periodical Publicity.....	489
XXVIII POSTWAR OPERATIONS.....	493
Reconversion.....	493
Deactivation of Horn Island and Granite Peak.....	497
Demobilization of Vigo Plant.....	498

Chapter	Page
Reorganization of Camp Detrick.....	502
Postwar Project Programs.....	508
GUIDE TO FOOTNOTES.....	515
BIBLIOGRAPHICAL NOTE.....	520
BIBLIOGRAPHY.....	523
Standard Texts.....	523
Historical and Popular.....	525
Camp Detrick Special Reports.....	527
Published Reports by SPD Personnel.....	535
Papers Presented at Scientific Meetings.....	553
Additional Technical Journal Literature.....	556
Periodical Literature.....	558
Historical Reports in the Military Development of Biological Warfare.....	561
War Department and Service Manuals.....	562

APPENDICES

PHOTOGRAPHS

Annex

192

APPENDICES

- APPENDIX A. PERSONNEL AND INSTITUTIONS ENGAGED IN OR ASSOCIATED WITH WORK ON BIOLOGICAL WARFARE
- APPENDIX B. ORGANIZATION CHARTS, SPECIAL PROJECTS DIVISION, CWS, SEPTEMBER 1944
- APPENDIX C. ORGANIZATION CHARTS, CAMP DETRICK, SPD, CWS, NOVEMBER 1944
- APPENDIX D. TECHNICAL DEPARTMENT MEETINGS AT CAMP DETRICK
- APPENDIX E. ORGANIZATION BILL, OFFICE OF NAVAL OPERATIONS, NAVY DEPARTMENT
- APPENDIX F. BUILDING PLAN OF CAMP DETRICK
- APPENDIX G. SECURITY STATEMENTS AND AGREEMENTS
- APPENDIX H. SPECIAL PRECAUTIONS IN FORCE AT CAMP DETRICK, CD GO 17, 6 DECEMBER 1944
- APPENDIX I. FACULTY AND COURSES OF STUDY AT CAMP DETRICK SCHOOL
- APPENDIX J. SECRET DOCUMENT YF55
- APPENDIX K. CWS TRAINING MEMORANDUM, "INSTRUCTION FOR DEFENSE AGAINST BIOLOGICAL ATTACK"
- APPENDIX L. ACCIDENT REPORT FORM
- APPENDIX M. HOSPITAL PROCEDURES AT A BIOLOGICAL WARFARE INSTALLATION
- APPENDIX N. STANDING OPERATING PROCEDURE AT GRANITE PEAK INSTALLATION
- APPENDIX O. WAR DEPARTMENT PRESS RELEASE, 3 JANUARY 1946, "BIOLOGICAL WARFARE"
- APPENDIX P. JSC CLASSIFICATION OF MATTER CONCERNING BIOLOGICAL WARFARE

CHARTS

No.	Page
1 Organization of War Research Service.....	19
<i>1a War Research Service (Chart)</i>	<i>19a</i>
2 Organization of Operations Division, Camp Detrick, August 1943.....	37
3 Organization of Naval Units in Special Projects Division, OC CWS.....	62
4 Personnel of Special Projects Division, August 1943 to December 1945.....	76-78
5 Integration of the Fundamental Sciences in N Project...	248
6 Organization of Camp Detrick, November 1944.....	504
7 Organization of Camp Detrick, November 1945.....	505
8 Organization of Office of Chief, Chemical Corps, September 1946.....	506
9 Postwar Personnel Strength at Camp Detrick.....	507

FIGURES

No.	Page
1 Map of Horn Island.....	93
2 Pilot Plant Areas at Camp Detrick.....	100
3 Liquid Waste Disposal System.....	109
4 Flow Diagram of Waste Disposal System in T-280.....	110
5 Montevue Water System.....	114
6 Spray Pond Water Cooling System.....	115
7 Water Supply System.....	117
8 Plan of Vigo Plant.....	120
9 Aerial Photograph of Vigo Plant.....	121
10 Pilot Plant Cycle for Production of Us.....	284
11	...

BIOLOGICAL WARFARE RESEARCH
IN THE UNITED STATES

History of the Special Projects Division, Chemical
Warfare Service

INTRODUCTION

It is only in the twentieth century that medical science has succeeded in developing means to prevent the decimation of armies by such crowd diseases as dysentery, typhoid fever, cholera, bubonic plague, and smallpox. The campaigns of Darius, Alexander, Caesar, Attila, Gustavus Adolphus, Napoleon, often owed success or failure to the devastations of disease in their own or the enemy armies. American armies in the field have fought the inevitable battle against war-bred disease: dysentery in the Civil War, yellow fever and typhoid in the Spanish-American War, influenza in World War I, and dysentery and malaria on Bataan peninsula in World War II. Nevertheless, the progress of medicine in recent times has resulted in a great series of defenses against the bacterial world and would seem almost to preclude the deliberate use of biological agents against a modern army. Yet, paradoxically, as man's power to deal with the organisms of disease increased, so has the threat of their use as a weapon of war.

In its simplest terms, modern biological warfare is conceived as the organized cultivation and mass dissemination against an enemy of pathogen bacteria, fungi, viruses, and rickettsia and toxic agents from living

organisms. / Potential agents might include the intestinal diseases of typhoid, cholera, and dysentery, through pollution of water supplies; the respiratory diseases of smallpox, diphtheria, epidemic meningitis, scarlet fever, and influenza, which are dependent upon ideal epidemic conditions; the insect-transmitted diseases of malaria, yellow fever, dengue, typhus, and plague; infections such as tetanus, anthrax, gangrene and the pyogenic diseases; agricultural diseases in the form of the boll weevil, corn borer and Mediterranean fruit fly, as well as fungous diseases of crops and plant; and glanders, foot and mouth disease, anthrax, Newcastle disease, fowl plague and other diseases to which domestic animals and fowl are subject.

/ Although sometimes referred to as "bacteriological warfare," the term "biological warfare" is preferred because protozoa, which might become agents of war, are biologic but not bacteriologic.

An early definition of biological warfare as "the employment of living agents, or their toxic products, to produce disease or death of personnel, animals or plants useful to the enemy" (CWS Tng Memo /S/, 10 Jan 45, p.1, Appendix K), has been questioned since a soldier may be considered a living agent and unarmed he may produce the death of an enemy. The British have made rhetorical objection to the phrase "or their toxic products" because alcohol and carbon dioxide are natural toxic products of yeast and so must be defined as biological warfare agents (ltr /S/, C Brit EW Tech Lab Com to C CWS, 29 Mar 45, no sub. Brit file Z.19386; OC CWS file SPD 092-Gt Britain. In OC Cal C.). Both phrases, however, remain in the British definition: "Biological warfare may be defined as the employment in war of living organisms or their toxic products to produce disability or death in man, animals or plants" (MA London Rpt No. R1101-47 /S/, 22 Feb 47, sub: EW Information for Service Personnel, p. 1. In Hist files.). The phrases are considerably modified in the extended definition given in the Cal C technical manual on biological warfare: "Biological warfare may be defined as the use of bacteria, viruses, rickettsia, fungi, and toxic agents derived from living agents to produce disease, injury, or death in men, animals, or plants. The use of certain synthetic chemicals for crop destruction and defoliation of vegetation, and the use of chemicals as coagents integrated with a biological agent, are not true aspects of biological warfare but are considered under the subject as a matter of convenience" (Tentative TM 3-216 /S Reg Doc/, Apr 47, Military Biology and Defense Against Biological Warfare, p. 21)

The idea of deliberately using disease organisms in war is not new nor has it been untried. The ancients practiced it when they polluted wells and streams of the enemy with the carcasses of animals and men. Early employments of biological warfare, based on common knowledge of the mechanics of the spread of venereal disease, have been recorded by Gentil jurist and publicist of the sixteenth century. Ideas and practices directly relevant to modern biological warfare date back to the time of Pasteur. Pasteur and Loir made a number of experiments in an attempt to exterminate rodent pests with epidemics of salmonella. Loeffler also used salmonella infections to exterminate rats, but the immunity that developed in the rodents made the addition of poisons necessary. More successful was the use of chicken cholera to exterminate rabbits. Finally d'Herelle made an ^{abortive} ~~inconclusive~~ attempt to exterminate grasshoppers with dysentery.

Confirmed and undoubted use of certain disease agents on a small scale was made by the Germans in World War I. The Germans infected horse of the Roumanian cavalry with glanders, attempted to carry out the same activity in the French cavalry, and succeeded in infecting horses and cattle in the United States prior to their shipment to Europe. German agents in this country used "glanders and perhaps foot and mouth disease and certainly anthrax" against horses and mules which were to be sent overseas. /

/ J. P. Marquand, Dir of Int & Inf, WRS, in lecture 4 Mar 44 to Special Projects School, Camp Detrick and reported in CD Secret Document YF55. See Appendix J.

What biological warfare might mean under modern conditions has been vividly described ^{and} by popular scientists ^{in actuality} who have envisaged an enemy directly infecting masses of people gathered in public places, contaminating food and water supply centers, and inoculating animals with diseases contagious to man. The publication of speculative papers on the potentialities of biological warfare reached its peak during the nineteenth thirties, with the greatest volume coming from France and Italy and others being published in Belgium, England, Poland and other European countries. /

There have been sceptics of the feasibility of biological warfare against a modern army. With the development of modern sanitary precautions, water purification and insect and rodent control, the normal incidence of bacterial activity could largely be thwarted. Combat troops now took the field surrounded by medical protection and were ^{usually} armed with antitoxins against some of the most virile and common bacteria. Furthermore, the problem of disseminating great quantities of bacteria in order to overwhelm any possible defense presented immense technical difficulties. But the greatest deterring factor in the initiation of biological warfare was the danger in its employment to the one who unleashed it. Only an isolated enemy could be safely attacked, and there was no such thing as an isolated enemy. /

/ Technical Study 58 (S), Biological Warfare: An Annotated Bibliography (19 Jan 42). In CD Tech Lib.

/ Leon A. Fox, "Bacterial Warfare: the Use of Biologic Agents in Warfare," Military Surgeon, 72 (Mar 1933), 139-207. Reprinted in Military Surgeon, 90 (May 1942), 563-79.

His conclusions were substantially the same reported to the League of Nations in 1924 by a committee of scientists appointed to consider the potentialities of bacteriological warfare. See League of Nations

Speculation continued, and in 1934 papers alleged to have been obtained from the German War Office were made public which indicated that German scientists were studying the aerodynamics and meteorological factors in the actual dispersal of certain harmless bacteria in such ideal culture sites as the underground railways of large cities. / The were reported as experiments in preparation for biological warfare against civilian populations. In 1940 unsubstantiated but convincing claims were made by the Chinese that Japanese planes over Chekiang province had released infected fleas wrapped in little cotton bags containing grain to attract rats. Again in 1941 it was reported that Japanese planes over Changteh in Hunan Province had dropped grains of rice, samples of which were found to be infected with the short oval bacillus of bubonic plague. Changteh, which had had no plague in ten generations, within a week of the visitation had six cases, all of whom died. /

Report of the Temporary Mixed Commission for the Reduction of Armaments (A. 16. 1924. IX), Geneva, 30 Jul 1924, pp. 29-30. In Hist files. Extracts from this League report and comment may be found in the Annual Report of the Chief of Chemical Warfare Service for the Fiscal Year 1926 (20 Oct 26), pp. 8-9. In OC Cal C.

/ Wickham Steed, "Aerial Warfare: Secret German Plans," Nineteenth Century and After, 116 (Jul 1934), 1-15. See also issue Aug 1934, pp. 331-36, and Sep 1934, pp. 337-39, for subsequent controversy.

/ "Invisible Weapon," Time, XXXIX (9 Mar 1942), 22. //

In the years just prior to our entry into World War II, both Germany and Japan were reported to be engaged in preparations for biological warfare and it was believed had devised agencies capable of assailing the best defenses that medical science had evolved. In 1939 the Japanese became highly suspect when emissaries sought to obtain the virus of yellow fever from the Rockefeller Institute in New York, and attempted to bribe an employee of that Institute when the virus was refused them. ___/ In February 1941, the Japanese were reported to have attached a biological warfare battalion to each of two of their chemical warfare regiments. ___/ In May 1941 the American Military Attache in Berne, Switzerland, reported that the Germans were working in the laboratories of the Foch Foundation near Paris on the use of botulinum toxin in an inert carrier for dissemination by air-burst bombs. ___/

Such was the basis for the concern of the United States upon our entrance into World War II. Shortly thereafter, a committee of members of the National Academy of Sciences which was appointed by the Secretary of War, made an investigation of the potentialities of biological warfare and reported that such warfare was entirely feasible and urged that we begin its study at once. As a result, a War Research Service, attached to the President's Federal Security Agency, was created and given charge of all

___/ Memo (S), Geo. W. Merck Dir WRS for the Hon J.J. McCloy, 2 Jul 43, sub: BW Defense, Territory of Hawaii - Yellow Fever Vaccine. In CD 322(2).

___/ Memo (S), Asst CofS G-2 for Asst Cof S War Plans Div, 25 Feb 41, sub: Japanese Bacteriological and Parachute Troops. In CD 322(2).

___/ MA, Switzerland, Report No. 3887, 1 May 41.

preparations for biological warfare. Since the War Research Service was primarily a coordinating agency, it did not provide the necessary single organization in this country which would be fully capable of undertaking the research and development program required to ensure adequate preparations for biological warfare. To meet this need, the Chemical Warfare Service in November 1942 was directed to assume the responsibility. To that Service then, had fallen the task of uncovering the means that an enemy might use to overcome our medical defenses, determining the agents the enemy might cultivate to new extremes of virulence, the missiles he might develop in order to project these agents, and with this knowledge, to prepare for retaliation should it become necessary.

Construction of Camp Detrick, the principal biological warfare center, was begun in April 1943. With the establishment of a Special Projects Division in the Office of the Chief, CWS, eight months later, research projects which had been initiated by War Research Service were turned over to the new Division and all defensive and offensive aspects of biological warfare which were being investigated by agencies in various parts of the country were coordinated in the new organization. The Division, operating in great secrecy, expanded rapidly until its personnel numbered almost 3,900, of which approximately 2,800 were Army personnel, 1,000 Navy, and 100 civilian. Close liaison was maintained with the Medical, Ordnance, and Intelligence Departments of the Army and Navy, the Army Air Forces, the U.S. Public Health Service, Department of Agriculture, and the British and Canadian biological warfare organizations. Intelligence as to the progress of enemy plans was obtained from the Military Intelligence Service, Office of Naval Intelligence, Office of Strategic Services, and the Federal Bureau of Inves

gation. Plans for biological warfare defensive operations in this country and in overseas theaters were prepared and officers were trained in biological defense at the school established for that purpose at Camp Detrick.

The activities of the Special Projects Division became far reaching as the parent research and pilot plant center at Camp Detrick began the study of specific pathogenic agents, developing virulent strains and working on defenses against their high disease-producing properties. Manufacturing processes were devised for the mass production of certain biological agents at the Vigo Plant near Terre Haute, Indiana, which was acquired early in 1944. Field tests were conducted to determine the effectiveness of viable agents under simulated combat conditions on Horn Island near Pascagoula, Mississippi, established in the summer of 1943, and at the granite Peak Installation in Utah, which was activated early in 1944.

The range of research extended from preliminary studies concerned with one bacterial toxin and one bacterial agent to a wide variety of agents pathogenic to man, animals, and plants. Agents selected for investigation were made as virulent as possible, produced in special culture media and under optimum conditions for growth, and tested for virulence on animals or plants. Munitions for the dispersion of these agents were developed and tested in the field, and production methods for both agents and munitions were evolved and carried through the pilot plant stage. Equal weight was given to research in biological, physical, and chemical protective measures against biological attack, not only on behalf of the thousands engaged in the laboratories and plants, but also for the protection of troops in combat should such protection become necessary. Methods of decontamination of biological agents were examined and work accomplished on the impregnation of

clothing and the design of special masks to reduce permeability to biological agents. Techniques were developed for sampling, detecting, and identifying biological agents. Extreme care was taken to protect the participating personnel from infection and as a result, in spite of the hazards of the work, the variety of highly pathogenic agents being handled, the magnitude of the scale of operations, and the large number of individuals involved, there occurred only 60 cases of proven infection which required treatment and 159 cases of exposure to pathogenic agents which were treated before infection occurred. Valuable information was obtained from the treatment of these accident cases, particularly concerning the effectiveness of new antibiotics, chemotherapeutic agents, and immunizing procedures.

Among the accomplishments of the biological warfare program in this country were the development of methods for the mass production of several highly pathogenic micro-organisms or their toxic products, development of methods for accurate detection of minute quantities of disease-producing agents, contributions to the general knowledge of air-borne organisms, production for the first time of a crystalline bacterial toxin, development and production of an effective toxoid in sufficient quantities to protect great numbers of men in large scale operations, important advances in the treatment of certain infectious diseases of humans and animals, development of effective protective equipment and clothing, and studies of the production and control of certain diseases of plants.

Realism and a sense of urgency marked this first systematic incursion of our nation into the field of biological warfare research. The objective was attained, for we prepared adequate defenses against a new and potentially devastating method of warfare and surprise from this quarter was forestalled

PLANNING FOR BIOLOGICAL WARFARE

Early interest of CWS in biological warfare. As early as 1924, and again at the League of Nations Conference in 1932, biological warfare, chemical warfare and incendiary warfare were linked as related problems. Whether or not it was because poisoning by organic matter might be considered scientifically equivalent to the use of chemical poisons, biological warfare has long been considered a province of the Chemical Warfare Service.

In a report prepared by a member of the Mechanical Division at Edgewood Arsenal, Maryland, in September 1924, it was recommended that the Chemical Warfare Service make a study of biological warfare potentialities. / At that time, little promise was held for this form of warfare and was so reported by the Chief, CWS, in his annual report in 1926.

/ Edgewood Arsenal Mechanical Division Progress Report 442, 24 Sep 24. In Tech Lib ACC.

/ Said the report, "The subject of bacteriological warfare is one which has received considerable notice recently. It should be pointed out in the first place that no method for the effective use of germs in warfare is known. It has never been tried to any extent so far as is known....The following extracts from (the League of Nations committee) report are quoted as they cover quite thoroughly the question of the dangers from this form of warfare:

Professors Pfeiffer, Bordet and Madsen, however, are of the opinion that such warfare would have little effect on the actual issue of a contest in view of the protective methods which are available for circumscribing its effects.

The pollution of drinking water by cultures of typhus or cholera germs would be combated by filtering, as already practiced in large centres, or by treating the waters of rivers with chlorine. The enemy would have to contaminate, by means of aircraft, the filtered water of the reservoirs directly; this would be a difficult operation and its effects could be frustrated by preventive vaccination.

The propagation of plague by pest-infested rats would be as dangerous for the nation employing this method as for its adversary, as rats pass freely between the lines of both armies. Experience has shown, moreover, that it is possible speedily to

Nine years later Major Fox, a member of the Medical Corps on duty with the Chemical Warfare Service, wrote his article for The Military Surgeon in which he declared that technical difficulties of dissemination made biological warfare impractical.

In 1939, at the request of the Assistant Chief of Staff, War Plans Division, Major M. E. Barker, CWS, furnished a technical study which indicated a change in attitude toward biological warfare. Nine disease organisms (yellow fever, the dysenteries, cholera, typhus, bubonic plague, smallpox, influenza, sleeping sickness, and tetanus) were presented as potential agents on the ground that they required neither existing skin lesions nor a coagent in order to enter the human body. The use of bacteria as a coagent with gas was dismissed since gas would act as a bactericide. The spread of diseases by insects constituted the most serious threat. Against this potentiality, tactical protection rested upon the technical difficulties the enemy would encounter in his

check an outbreak of plague. Moreover, the danger of an epidemic of typhus propagated by lice has greatly diminished.

As regards the poisoning of weapons, the experts point out that the germs which could be employed (streptococci, staphylococci, anthrax spores, glanders bacilli, etc.) would not preserve their dangerous properties if they were prepared a long time beforehand and allowed to dry on metallic surfaces. Nor if placed in a projectile would these germs better resist the shock of discharge, the rise of temperature and the violence of an explosion which destroys all life. The only method presenting a certain danger would be that of dropping from aeroplanes, glass globes filled with germs.

Finally, the majority of the experts are of opinion that bacteriology cannot at present produce infective substances capable of destroying a country's live stock and crops."

Annual Report of the Chief of Chemical Warfare Service for the Fiscal Year 1926 (20 Oct 26), pp. 8-9. In OC Cml C.

attempt to propagate germs, infect insects, and devise a munition for their dispersal. "As yet," the report concluded, "airplanes capable of crossing the oceans both ways and delivering a pay load do not seem to be in sight. If and when such planes become practical we may be subject to attack by a powerful, but slow acting, weapon in the form of infected insects..."

It was shortly after the preparation of this report that the first serious military consideration of biological warfare became manifest. There was no thought of preparing to wage such warfare, but the defensive aspects had to be considered, and in September 1939 representatives of the Chemical Warfare Service and the Surgeon General of the United States Public Health Service met to consider its possibilities. It was concluded that the threat to national security at that time was slight and that existing public health agencies and measures were adequate to protect the civilian population against possible enemy biological action. The Chief, CWS, recommended, however, that further consultation be held with the Bureau of Medicine and Surgery, the Office of the Surgeon General, USA; and the National Institute of Health

This meeting was held almost a year later and in the discussions specific plant, animal and human infections, as well as bacterial toxins, which might be used in biological warfare, were considered. It was generally agreed that the chief danger from the early employment of biological agents against us would be its nuisance value in impeding our preparations for active defense. The waging of such war would probably have less potent

Technical Study No. 10 (S), "Bacteriological Warfare Possibilities" (28 Aug 1939). In CD Tech Lib (SW General) Acc. No. 2.

Ltr (S), C CWS to Asst CofS War Plans Div, 8 Sep 39, sub: Bacteriological Warfare. In CD 322(2).

results than were generally assumed. Nevertheless it was agreed that contact between the consultants should be maintained and important developments communicated to the National Defense Council. ___/

At this juncture in the discussions being carried on in this country, the first Intelligence reports were received which indicated that neither the Japanese nor the Germans shared our skepticism concerning the feasibility of biological warfare. Although public health defenses had been reported adequate, it had become obvious that general health measures and precautions would not be sufficient against the organized attack foreshadowed in our intelligence reports. The Army had no alternative but to prepare against a possible attack, and in August 1941 the Secretary of War requested the Chemical Warfare Service to draw up recommendations for the development of a biological defense. ___/ In the report made by the chief of the Technical Service, it was advocated that the Chemical Warfare Service, with the cooperation of the Medical Corps, be charged with responsibility for offensive and defensive biological warfare studies and that a separate division be set up in the Technical Service to coordinate this military program. It was further suggested that existing projects on toxicity with NERC and the Committee on

___/Ltr (S) Surg Gen USPHS to Chairman, Health and Medical Com, NRC,
16 Dec 1940, no sub. In CD 322(2).

___/Memo (S) Exec O, War Plans Div for C CWS, 12 Aug 1941, sub: Biological
and Bacteriological Warfare.

Medical Research, NRC, be expanded to cover experimental studies in biological warfare. ___/ The General Staff concurred in these proposals and on 20 August 1941 representatives of the Chemical Warfare Service, Office of the Surgeon General, War Plans Division, and the chairman and medical director of the National Research Council met in conference. ___/ It was decided to request the Office of Emergency Management to enlist the help of its National Defense Research Committee and Medical Research Committee in an investigation of offensive and defensive aspects of biological warfare. It was also suggested that the Secretary of War authorize the Chemical Warfare Service and the Surgeon General to undertake immediate problems of biological warfare and make specific the responsibility of each of these services. ___/

Although the General Staff was subsequently to recommend, in the interest of military security, that civilian agencies undertake all work in biological warfare, the conferees on 20 August 1941 had urged that the Chemical Warfare Service at once obtain qualified specialists in bacteriology, immunology, epidemiology, and entomology, and begin its studies. Soon after the meeting the Chemical Warfare Service received oral instructions to begin the study

___/OC CWS Progress Report No. 54, "Biological and Bacteriological Warfare" (S)(15 Aug 1941). In CD Tech Lib (EW General, Acc. No. 5).

That same month, two projects for biological studies by NDRC were included in the CWS Research and Development Project Program: Project CWS-2, Toxicity of Organic Compounds and Project CWS-20, Bacteriological Warfare.

___/The representatives were Lt. Col. M.E. Barker, C, Tech Div, CWS; Col. J. Simmons, OSG; Lt. Col. R.C. Jacobs, WPD, WDGS; Dr. Ross G. Harrison, chairman, NRC; Dr. A.H. Richards, chairman, Committee on Medical Research, NDRC; and Dr. Lewis N. Weed, Div of Medical Sciences, NRC.

___/Memo for file (S), C, Tech Serv, CC CWS, 20 Aug 1941, sub: Organization of Work on Bacteriological Warfare. In CD 322(2).

of offensive aspects of the problem and to maintain liaison with the Surgeon General on the development of defensive procedures. / The following month Lt. Colonel James H. Defendorf, Sanitary Corps, was designated chief of a new Medical Research Division (later, Special Assignments Branch) established in the Technical Service, OC CWS. The Special Assignments Branch did not advance beyond the planning stage. The chief, with four other officers, / drew up plans for the facilities that would be required for large scale investigations, established liaison with WRS and with appropriate groups in Great Britain and Canada, and made general plans for biological studies as an additional function of the Technical Division, CWS. It was contemplated that all offensive aspects and all work relating to mechanical protection would be performed by the Technical Division. Studies in immunity and other forms of biological protection were tentatively assigned to a proposed Medical Division in the Chemical Warfare Service. ✓/

✓/Memo (S), 1st Lt. Luman F. Ney, CWS, for C Tech Div, 26 Mar 1942, sub: Biological Warfare. CWS 710/7. This memo recommended that disease which might be profitably studied for their effectiveness against man were: coccidioidomycosis, psittacosis, plague, typhoid and paratyphoid, cholera, typhus, yellow fever, and anthrax; against animals: rinderpest, foot and mouth disease, and fowl plague; against plants: late blight, rice fungi, wheat rusts and smuts, South American rubber leaf blight, and plant growth regulators.

✓/Memo (S), WDCS Opns & Tng Div for CS, 27 Aug 1941, sub: Invisible Military Offensive Attack. G-3/46048 (AG381).
See also ltr (S) C CWS to CS, 26 Jun 1942, sub: Biological Warfare. CWS 719/7.

✓/These officers were Lt. Col. Arva T. Thompson, VC; Major Edward A. Richmond, CWS; Major Luman F. Ney, CWS; and Major Frank M. Schertz, CWS. In each case, the last known military rank is indicated.

WBC Committee. Following the conference of 20 August 1941, the Secretary of War wrote to the President of the National Academy of Sciences:

Because of the dangers that might confront this country from potential enemies employing what may be broadly described as biological warfare, it seems advisable that investigations be initiated to survey the present situation and the future possibilities. I am, therefore, asking if you will undertake the appointment of an appropriate committee to survey all phases of this matter. Your organization already has before it a request from the Surgeon General for the appointment of a committee by the Division of Medical Sciences of the National Research Council to examine one phase of the matter. I trust that appropriate integration of these efforts can be arranged.

A month later, on 18 November 1941, a group of scientists was appointed by the National Academy of Sciences and convened as the WBC Committee (a misleading inversion of the letters "BWC"), charged with exploration of the entire field of biological warfare. Findings of the Committee were submitted in reports to the Secretary of War on 19 February 1942 and again on 18 June 1942. In the first report, the Committee stated that the possibilities of biological warfare were maintained by scientists and militarists in many countries and, like chemical warfare, it was an eventuality for which this country must prepare. The assumption that any means which might offer advantages to a nation at war would be vigorously employed by that nation could not be dismissed. Biological warfare was regarded as distinctly

 /Ltr (S) to Dr. Frank B. Jewett, 1 Oct 1941, a copy of which is included in memo (S) CG ASF for CS, 8 Jan 1944, no sub, SPCYF 730.

 /Members of the WBC Committee are listed in Appendix A.

feasible, and it was recommended that steps be taken to formulate defensive measures and procedures for retaliation. Only by making intensive preparations ourselves might the likelihood of its initiation by the enemy be reduced, or of fear of retaliation and subsequent infection of his own troops and country.

The Secretary of War communicated the contents of the report to the General Staff and requested recommendations for War Department plans and organization for biological warfare action. ___/ The General Staff recommended that a civilian agency be selected for the task. It was pointed out that the Army was severely limited in facilities and personnel for the work; it was doubtful whether military engagement in such activities could be kept from the public and it was feared that the studies would suggest to the uninformed laity that the United States was preparing a biological offensive. On the other hand, university and research foundation laboratories were already staffed and equipped to conduct such investigations, and the establishment of a civilian agency not suspected of being associated with biological research would provide the necessary direction and ensure maintenance of secrecy. ___/

___/Ltr (S) to Secy of GS, 24 Mar 1942, WDGS A 400.112. In WRS New Dev Div WDGS.

___/Memo (TS), 5 Nov 1944, sub: Development of the Biological Warfare Program of the United States. Attached to minutes of first meeting of the U.S. Biological Warfare Committee. In SPD, OC CWS (730-EW).

War Research Service. The Secretary of War informed the President of the recommendations made by the War Department and received oral authorization to establish such a civilian organization within the Federal Security Agency. The FSA was not associated with any research activity and its official mission, "to promote social and economic security, advance educational opportunities and promote public health," was sufficiently obscure to protect the new organization. With the assistance of the president of the National Academy of Sciences, the Secretary of War selected George W. Merck, of Merck & Company, Inc., Rahway, N.J., as his special assistant, and on 15 May 1942, appointed him director of a branch of FSA to be called War Research in Chemistry (later, War Research Service). / The new organization was not organized until 11 September 1942 when funds were allocated to it from the President's Special Emergency Fund (Chart 1). /

War Research Service had been established to execute the recommendations of the WRC Committee. It was primarily a coordinating agency, using facilities, personnel, and experience already existing in government and private organizations, and its recommendations were to be implemented by orders and directives issued by various branches of the armed services, particularly the Medical

/Ltr (S), Secy of War to President of U.S., 29 Apr 1942, no sub. In WRS New Dev Div WDCS (ALSHD 334 JNR 441.2).

/Ltr (S), Administrator FSA to George W. Merck, 26 Aug 1942. In WRS New Dev Div WDCS (441.2).

/Made available in the First Supplemental National Defense Appropriation Act, 1943 (54 Stat. 704).

Chart 1

ORGANIZATION OF WRS

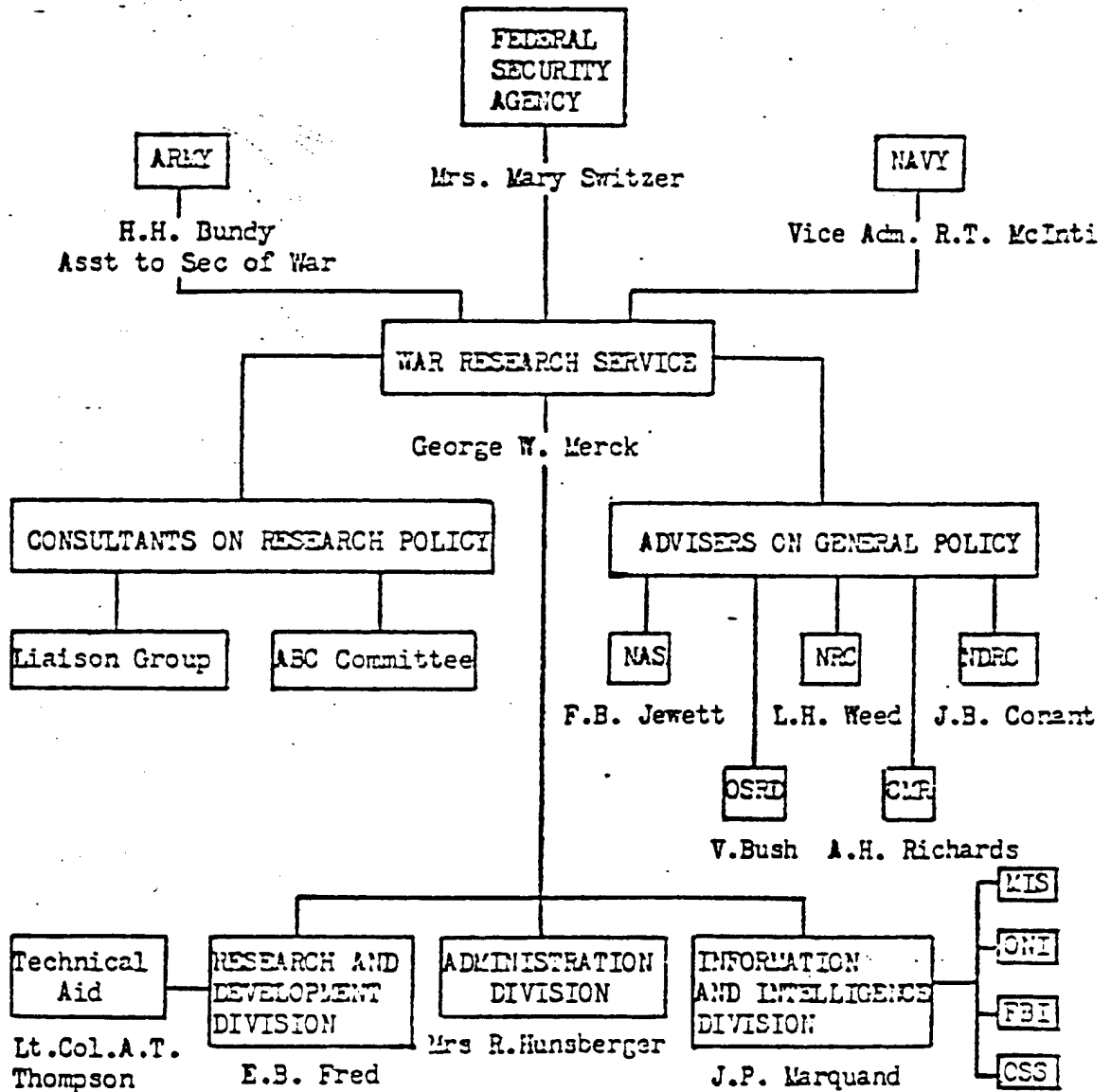

Source: files of WRS (G.W. Merck)

WAR RESEARCH SERVICE PROJECTS

Directors, Projects, Code and Location

Director	Project	Code	Location
1. ASCHOFF, F. C. Research Administrator Agricultural Research Administration U. S. Dept. of Agriculture	Pest Prevention and Plant Disease Surveys	"EP"	Continental United States
2. LEWIS, Reiner Assoc. Plant Pathologist Maine Agricultural Exper. Station	Wight of Potatoes	"LO"	Maine Agr. Exper. Station Orono, Maine
3. HANDEL, C. A. Cr. Pathologist, Regional Poultry Research Lab., U. S. Dept. of Agr., East Lansing, Michigan	Fowl Plague and	"OE"	Harvard University
4. FORD, Cornelia E. Dept. of Bacteriology University of Kansas	Tularemia	"UL"	University of Kansas Lawrence, Kansas
5. FURSE, H. J. Harvard Medical School Comparative Pathology	Dysentery	"NY"	Harvard University Cambridge, Mass.
6. EYER, Rella E. Director, Nat'l Inst. of Health U. S. Public Health Service	Flood Studies	"LT"	National Inst. of Health Bethesda, Md.
7. FORBAY, Luc Inst. of Bacteriology University of Cincinnati	Tularemia	"UL"	University of Cincinnati Cincinnati, Ohio

DOWNGRADED AT 12 YEAR INTERVALS;
NOT AUTOMATICALLY DECLASSIFIED.

DOD DIR 5200.10

U.S. GOVERNMENT PRINTING OFFICE

DECLASSIFIED
DOD DIRECTIVE 5200.9
27 SEP 58
U.S. GOVERNMENT PRINTING OFFICE
U.S. GOVERNMENT PRINTING OFFICE

MPS PROJECTS (CONT'D)

Director	Project	Code	Location
8. GRIFFITHS, J. J. P.A. Surgeon, Nat'l Inst. of Health U. S. Public Health Service	Cholera	"HO"	National Inst. of Health Bethesda, Md.
✓ 9. HAGAN, W. A. Dean, N. Y. State Veterinary Col. Cornell University	Anthrax	"IN"	Cornell University Ithaca, New York
✓ 10. HEIDLEBERGER, Michael Department of Medicine Columbia University	"IN" Immunization	"MUN"	Goldwater Memorial Hospital Welfare Island, N. Y.
✓ KENDALL, F. E. Goldwater Memorial Hospital	" "	" "	" "
✓ 11. WEDDERSON, I. Forrest Dept. of Bacteriology Michigan State College	Brucellosis	"US"	Michigan State College Lansing, Michigan
✓ 12. JULIAWILLE, Louis A. Public Health Res. Institute of the City of New York	"IN" Immunization	"MUN"	Public Health Research Inst. Em. Hallock Park Lab. New York, N. Y.
✓ 13. LACK, A. P., JR. (Capt., USA) Dept. of Pub. Health & Prev. Med. Stanford Univ. School of Medicine	Coccidioides	"OC"	Stanford Univ. School of Med. San Francisco, Calif.
✓ 14. MEYER, Karl F. and KRUEGER, A.P.	Plague	"LEN"	Geo. Wms. Hooper Foundation U.S. Navy Med. Res. Unit No. 1

CONFIDENTIAL

FHS PROJECTS (CONT'D)

Director	Project	Code	Location
✓ 15. KRAUS, F. J. Dept. of Botany University of Chicago	Plant Growth Regulating Substances	"RR"	Bureau of Plant Industry, USDA
✓ 16. MITCHELL, J. W. Bureau of Plant Industry, USDA	Botulism	"X"	Harvard University Cambridge, Mass.
✓ 17. MULLER, J. Howard Dept. of Bacteriology Harvard Medical School	Plant Growth Regulating Substances (Chemical)	"RR"	Ohio State University Columbus, Ohio
✓ 18. NEWMAN, Melvin S. Dept. of Chem., Ohio State U.	Mussel Poisoning	"SS"	Northwestern University Evanston, Illinois
✓ 19. REYNOLDS, J. A. Dir., Laboratories of Bact. University of Notre Dame	Preservation of Rickettsiae	"RI"	University of Notre Dame Notre Dame, Indiana
20. SCHWYNG, H. W. Asst. Chief, Bureau of Animal Industry, U.S. Dept. of Agr.	Foot and Mouth Disease	"OO"	Joint FHS-USDA Committee Great Britain and Washington, D. C.
21. SHOPE, R. E. (Comdr., USNR) Dir. Research, Princeton Branch Rockefeller Institute	Rinderpest	"GIR-1"	War Disease Control Station Quebec, Canada
✓ 22. SOMMER, Hermann Geo. Wms. Hooper Foundation	Mussel Poisoning	"SS"	Geo. Wms. Hooper Foundation University of California San Francisco, Calif.

NSR PROJECTS (Cont'd)

Director	Project	Code	Location
23. TOPPING, H. H. P.A. Surgeon, Nat'l Inst. of Health U. S. Public Health Service	Typhus Fever	"YF"	Nat'l Inst. of Health Bethesda, Md.
24. TULLIS, E. C. Bureau of Plant Industry U. S. Dept. of Agriculture	Rice Diseases	"RI"	Texas Sub-Station No. 4 Beaumont, Texas
25. WISS, F. A. Bur. of Plant Industry U. S. Dept. of Agriculture	Sclerotium Rolfsii	"CO"	Bureau of Plant Industry Beltsville, Md.
26. WILSON, P. W. Dept. of Bacteriology University of Wisconsin	Mass Cultures of Spores	"AU"	University of Wisconsin Madison, Wisconsin

NSR PROJECTS

~~TOP SECRET~~

War Research Service Project # 1

Subject for Research: Anthrax (Code "N")

Location: New York State Veterinary College
Cornell University
Ithaca, New York

TOP SECRET	
RECORDED	
by Authority of Historical Office	
<i>[Signature]</i>	1 MAR 1961
(Name, rank & title)	Date
U.S. Army Cal C Historical Office	

Federal Security Agency Contract # 5 (SA-54)

Term of Contract: January 1, 1943 through June 30, 1944

(Not transferred to another agency)

Expenditures:

Personnel:	\$	666.59	
Materials:		2,095.85	
Overhead:		- -	
Other:		- -	
	\$	<u>2,762.54</u>	Total Amount Expended

Project Director:

Dr. William A. Hagan
Dean, New York State
Veterinary College
Cornell University

(Services contributed
by Cornell University)

Assistants:

George Young, Jr.
Veterinarian

(Services partially
paid for by War Re-
search Service; par-
tially by Chemical
Warfare Service of
War Department)

Daniel O'Zane
Biochemist and
Bacteriologist

(Army officer -
services contributed
by Chemical Warfare
Service of War
Department)

~~TOP SECRET~~

~~TOP SECRET~~

War Research Service Project # 5

Subject for Research: Dysentery (Code "Y")

Location: Medical School Research Laboratories
Harvard University
25 Shattuck Street
Boston, Massachusetts

Federal Security Agency Contract # 12 (SA-61)

Term of Contract: May 1, 1943 through June 30, 1944

(Not transferred to another agency)

Expenditures:

Personnel: \$ 1,353.19

Materials: 5,516.51

Overhead: - -

Other: 67.63

\$ 6,937.33 Total Amount Expended

Project Director:

Dr. Rene J. Dubos
Professor of Tropical Medicine
Harvard Medical School

(Services contributed
by Harvard University)

Assistants:

Dr. Henry Don Hoberman

(Services partially
paid by War Research
Service; partially
by the Army)

Miss Jean Porter

(Services contributed
by Harvard University)

~~TOP SECRET~~

War Research Service Project # 2

Subject for Research: Botulism (Code "X")

Location: Medical School Research Laboratories
Harvard University
25 Shattuck Street
Boston, Massachusetts

Federal Security Agency Contract # 10 (SA-56)

Term of Contract: December 1, 1942 through June 30, 1944
(Not transferred to another agency)

Expenditures:

Personnel:	\$ 1,825.53	
Materials:	1,848.98	
Overhead:	- -	
Other:	211.66	
	<u>\$ 3,886.17</u>	Total Amount Expended

Project Director:

Dr. J. Howard Mueller
Professor of Bacteriology and Immunology
Department of Bacteriology and Immunology
Harvard Medical School

(Services con-
tributed by
Harvard)

Assistants:

Alvin M. Pappenheimer

(Army officer -
services con-
tributed by
Sanitary Corps,
U. S. Army)

George Philip Manire

(Services paid
for by War
Research Service

TOP SECRET

~~TOP SECRET~~

War Research Service Project # 3

Subject for Research: Brucellosis (Code "US")

Location: Central Brucella Station
Michigan State College of Agriculture and Applied Science
East Lansing, Michigan

Federal Security Agency Contract # 7 (SA-55)

Term of Contract: January 1, 1943 through June 30, 1943
(Not transferred to another agency)

Expenditures:

Personnel:	\$ 1,824.75	
Materials:	654.62	
Overhead:	- -	
Other:	5.06	
	<u>\$ 2,484.43</u>	Total Amount Expended

Project Director:

Dr. I. Forest Huddleson	(Services contributed
Research Professor	by Michigan State
Division of Veterinary Science	College)
Michigan State College	

Assistants:

Evelyn E. Wood	(Services partially paid
	for by War Research
	Service)
Ruth E. Sanders	" " "
Harold F. Redman	" " "
Thomas O. Roby	(Services paid for by
	War Research Service)
Marcelene Keefer, Secretary	(Services contributed
	by Michigan State
	College)

~~TOP SECRET~~

War Research Service Project # 7 (Continued)

List of Assistants (Continued)

Lieutenant (jg) George B. Saviers (HC) USNR
Ensign Isaac L. Sheehmeister, (HC) USNR
Chief Pharmacist Alexander I. Teplow (HC) USNR
Lieutenant Myron D. Thaxter, (HC) USNR
Lieutenant H. M. Sherman Watkins, E (S) USNR
Lieut. Comdr. Nathaniel S. West, H. (S) USNR
Ensign William D. Won, H (S) USNR

The following enlisted men were engaged in the project:

Amundson, Roger Harold, PhM 2c, V-6, USNR
Burkhead, Harold Royce, PhM 1c, V-6, USNR
Conine, William Doswell, Jr., PhM 1c, V-6, USNR
Dawson, Wood Eugene, PhM 1c, V-6, USNR
Dolan, Austin Denton, Jr., PhM, 1c, USN
Douglas, Maurice Mark, Jr., PhM 2c, USN-I
Dunn, Stephen Albert, PhM 2c, USN
Flynn, Francis William, PhM 2c, USN-I
Fowler, Howard Lester, PhM 2c, V-6, USNR-SV
Hart, Roy Anthony, PhM 1c, V-6, USNR
Kennedy, Clifton Levon, PhM 2c, V-6, USNR-
Klumpp, Melvin Norwood, PhM 2c, V-6, USNR-SV
Mackey, Robert Pharris, PhM 1c, V-6, USNR
Molesworth, Miles Alfred, CFM, USN
Muth, Roy Richard, PhM, 1c, V-6, USNR
Ratto, William Anthony, PhM, 2c, V-6, USNR-SV
Riggs, Wayne Frederick, PhM 1c, V-6, USNR-SV
Roberts, William Milton, PhM 1c, V-6, USNR
Scott, Edgar Keith, PhM 2c, V-6, USNR-SV
Thomas, Robert William, AM1c, V-2, USNR
Tiffany, Delzen Douglas, PhM 2c, V-6, USNR-SV
Timmis, John Daniel, PhM 2c, V-6, USNR-SV
Vorhof, Robert John, PhM 2c, USN

War Research Service Project # 9

Subject for Research: Preservation of Rickettsiae (Code "RI")

Location: Laboratories of Bacteriology
University of Notre Dame
Notre Dame, Indiana

Federal Security Agency Contract # 8 (SA-57)

Term of Contract: January 1, 1943 through August 31, 1944

(Transferred on September 1, 1944 to
Special Projects Division, Chemical
Warfare Service, War Department --
Contract No. 18-064-CWS-46)

Expenditures:

Personnel: \$ 17,846.64

Materials: 4,354.94

Overhead: 4,640.00

Other: - -

\$ 26,841.58 Total Amount Expended

Project Director:

Dr. James A. Reyniers
Director
Laboratories of Bacteriology
University of Notre Dame

(Services partially paid
for by War Research Ser-
vice; partially con-
tributed by Notre Dame;
and after 2/7/44 Navy
paid services since he
was commissioned)

Assistants:

Philip C. Trexler
Research Assistant

(Services partially paid
for by War Research
Service; partially paid
for by Notre Dame)

Robert F. Ervin
Research Assistant

" " "

Morris Wagner,
Technician

" " "

War Research Service Project # 9 (Continued)

List of Assistants (Continued)

John Davis
Technician

(Services partially paid
for by War Research
Service; partially paid
for by Notre Dame)

John F. Reback
Technician

" " "

Felix McPharland
Helper

" " "

Bernard Teah
Technician

" " "

Mildred Reveal
Technician

" " "

Louise Reynolds
Helper

" " "

Julian Pleasants
Helper

" " "

Vincent Stock
Instrument Maker

(Services contributed by
University of Notre Dame)

John Beckman
Machinist and Maintenance

" " "

Arthur Philips
Research Helper

" " "

Gladys Nicholson
Maintenance

" " "

Mary Jane Brabson
Secretary

" " "

Joseph Remboez
Helper with animals

" " "

Harold Thompson
Helper

" " "

~~TOP SECRET~~

War Research Service Project # 7

Subject for Research: Plague (Code "LE")

Location: United States Navy Medical Research Unit No. 1
Life Sciences Building
University of California
Berkeley, California

Federal Security Agency Contract # 21 (SA-75)

Term of Contract: September 1, 1943 through June 30, 1944

(Transferred to Bureau of Medicine and Surgery
of the Navy Department, July 1, 1944)

Expenditures:

Personnel:	\$	--
Materials:		1,237.15
Overhead:		--
Construction:		13,247.93
		<u>\$ 14,485.08</u> Total Amount Expended

Project Director: (Karl F. Meyer, Gea Loma Hoqua Foundation)
 Captain Albert P. Krueger, (MC) USNR
 Consultant Communicable Diseases
 Student Health Service
 Lecturer of Medicine
 University of California Medical School

(Navy officer --
services contributed
by Navy Department)

Assistants:

Lieutenant Harold Walter Bischoff, (MC) USNR
 Lieutenant (jg) Anthony J. Glasko, H(S) USNR
 Lieutenant Orville J. Golub, H(S) USNR
 Lieutenant Alvin H. Jacobs, (MC) USNR
 Lieutenant (jg) Walter R. Leif, (HC) USNR
 Lieutenant Jerome R. Mathews, H(S) USNR
 Chief Pharmacist William V. Palmer, USN
 Lieutenant James Arthur Reyniers, USNR (From Notre Dame)
 Lieut. Comdr. Lauren E. Rosenberg, H(S) USNR

(Services of all
assistants were
contributed by
Navy Department)

(Continued)

~~TOP SECRET~~

War Research Service Project # 11

Subject for Research: Mass Culture of Spores (Code "AU")

Location: Department of Bacteriology
University of Wisconsin
Madison, Wisconsin

Federal Security Agency Contract # 22 (SA-74)

Term of Contract: July 1, 1943 through June 30, 1944
(Not transferred to another agency)

Expenditures:

Personnel:	\$ 533.34	
Materials:	165.50	
Overhead:	- -	
Other:	- -	
	<u>\$ 698.84</u>	Total Amount Expended

Project Director:

Dr. Perry W. Wilson Associate Professor Agricultural Bacteriology Department of Bacteriology University of Wisconsin	(Services contributed by University of Wisconsin)
--	---

Assistants:

Dr. Wayne W. Umbreit Technical Assistant	(Services paid for by War Research Service)
Dr. Robert H. Burris Technical Assistant	(Services contributed by University of Wisconsin)

~~TOP SECRET~~

War Research Service Project # 12

Subject for Research: Fowl Plague and Newcastle Disease (Code "CE")

Location: Harvard University
Collis P. Huntington Memorial Hospital
695 Huntington Avenue, Boston, Massachusetts

Federal Security Agency Contract # 6 (SA-50)

Term of Contract: March 8, 1943 through August 31, 1944

(Transferred on September 1, 1944 to
Special Projects Division, Chemical
Warfare Service, War Department --
Contract No. 18-064-CWS-42)

Expenditures:

Personnel:	\$ 38,713.08
Materials:	50,932.23
Overhead:	7,384.51
Construction:	54,943.51
Other:	687.88
	<u>\$ 152,661.21</u> Total Amount Expended

Project Director:

Dr. Carl A. Brandly
Senior Pathologist
Regional Poultry Research Laboratory
U. S. Department of Agriculture
East Lansing, Michigan

(Prior to service on this project)

(Services for all
personnel paid by
War Research
Service -- except
Dr. Tyzzer, who
acted as a
consultant)

Assistants:

Dr. H. E. Moses
Special Research Assistant

Dr. E. Elizabeth Jones
Research Assistant (Part-time basis)

~~TOP SECRET~~

List of Assistants: (Continued)

Dr. E. E. Tyzzer
Consultant on Histopathology
(Retired Head of Department of
Comparative Pathology and Tropical Medicine)

Michael Ahern
Guard

Jennie P. Andreassen
Technician

Margaret Brush
Technician

Hilda M. Foster
Secretary

Mary J. Graham
Technician

John J. McLeod
Caretaker

John O'Brien
Guard

Reuben J. Scott
Caretaker

Edwin E. Smith
Caretaker

Rebecca B. Stickney
Technician

John J. Killilea
Guard-Caretaker (Transferred to another Department of University)

Carl H. Bemis
Caretaker (Discharged)

E. Louise Stone
Technician (Retired)

~~TOP SECRET~~
Carroll

War Research Service Project # 13 (a)

Subject for Research: Anthrax Immunization (Code "MR")

Location: Columbia University
Goldwater Memorial Hospital
Welfare Island
New York, New York

Federal Security Agency Contract # 11 (SA-66)

Term of Contract: March 1, 1943 through June 30, 1944

(Not transferred to another agency)

Expenditures:

Personnel:	\$ 7,680.72	
Materials:	2,002.77	
Overhead:	- -	
Other:	<u>76.71</u>	
	<u>\$ 9,760.20</u>	Total Amount Expended

Project Directors:

Dr. Forrest E. Kendall Chemist, Research Service Columbia Division Goldwater Memorial Hospital Welfare Island, New York	(Services contributed by Columbia University)
Dr. Michael Heidelberger Biochemist College of Physicians and Surgeons New York	" " "

Assistants:

Dr. Joseph Victor, Pathologist	(Services contributed by Columbia University)
Dr. Liese Lewis, Chemist	(Services paid for by War Research Service)
Walter Meyer, Chemist	" " "
Miss Anne Shwachman, Bacteriologist	" " "
Charles Navigante, Animal House Helper	" " "

~~TOP SECRET~~

War Research Service Project # 15 (b)

Subject for Research: Anthrax Immunization (Code "MN")

Location: Public Health Research Institute of the City of New York, Inc.
William Hallock Park Laboratory
Foot of East 15th Street
New York, New York

Federal Security Agency Contract # 23 (SA-76)

Term of Contract: July 1, 1943 through August 31, 1944

(Not transferred to another agency)

Expenditures:

Personnel:	\$	8,444.85	
Materials:		1,803.04	
Overhead:		- -	
Other:		<u>121.93</u>	
	\$	<u>10,369.82</u>	Total Amount Expended

Project Director:

Dr. Louis A. Julianelle (Deceased)
Chief, Division of Infectious Disease
Public Health Research Institute
of the City of New York, Inc.

(Portion of salary
paid by War Research
Service; portion by
the Institute)

Assistants:

Dr. Perry W. Wilson
Associate Director

(Detailed from
University of
Wisconsin -- paid by
War Research Service
by a direct contract

Matthew Chmela, Technician

(Services contributed
by the Institute)

Helen V. Karr, Research Assistant

(Services paid for by
War Research Service

George Anciro, Laboratory Helper

" " "

Gerard Sonnenstein, Laboratory Helper

" " "

~~TOP SECRET~~
SECRET

War Research Service Project # 15

Subject for Research: Coccidioides (Code "OC")

Location: Department of Public Health and Preventive Medicine
Stanford University School of Medicine
San Francisco, California

Federal Security Agency Contract # 24 (SA-77)

Term of Contract: July 1, 1943 through August 31, 1944

(Transferred on September 1, 1944 to
Special Projects Division, Chemical
Warfare Service, War Department --
Contract No. 18-064-CWS-44)

Expenditures:

Personnel:	\$ 4,588.75	
Materials:	4,955.83	
Overhead:	- -	
Others:	<u>1,407.30</u>	
	<u>\$ 10,951.88</u>	Total Amount Expended

Project Director:

Captain Arthur R. Lack
Medical Corps, U.S. Army

(Services contributed by
Medical Corps, U. S. Army)

Assistants:

Dr. C. E. Smith, Consultant

(Services contributed by
Stanford University)

Dr. Karl F. Meyer, Consultant

(Services contributed by
University of California)

Dr. Frederick Proescher,
Pathologist

(Services contributed by
Santa Clara County Hospital)

Mr. V. Sycheff, Chemist

" " " "

(Continued)

~~SECRET~~
[Handwritten signature]

War Research Service Project # 15 (Continued)

List of Assistants: (Continued)

	(Services paid for by War Research Service)		
Mrs. Nina Chern, Technician, Mycology	"	"	"
Miss Nellie Lomprey, Technician, Bacteriology	"	"	"
Miss Mildred Grennan, Assistant Technician	"	"	"
Miss Muriel Ash, Secretary	"	"	"
Mr. Bing Moy, Laboratory Assistant	"	"	"
Mr. George Ross, Laboratory Assistant	"	"	"

~~TOP SECRET~~

War Research Service Project # 16

Subject for Research: Tularemia (Code "UL")

Location: Department of Bacteriology
College of Medicine
University of Cincinnati
Cincinnati, Ohio

Federal Security Agency Contract # 28 (SA-86)

Term of Contract: October 1, 1943 through August 31, 1944

(Transferred on September 1, 1944 to
Special Projects Division, Chemical
Warfare Service, War Department --
Contract No. 18-064-CWS-45)

Expenditures:

Personnel:	\$ 3,898.25	
Materials:	1,062.80	
Overhead:	148.82	
Others:	- -	
	<u>\$ 5,109.87</u>	Total Amount Expended

Project Director:

Dr. Lee Foshay
Professor and Head
Department of Medicine
University of Cincinnati

(Services contributed
by University of Cincinnati)

Assistants:

Joseph T. Tamura

(Services partially con-
tributed by University of
Cincinnati; partially paid
by War Research Service)

Irvin W. Gibby

(Services paid for by
War Research Service)

Paul S. Nicholes

" " "

TOP SECRET

Copy

War Research Service Project # 16 (Continued)

List of Assistants: (Continued)

Henry T. Eigelsbach

(Services paid for by
War Research Service)

William Suyemoto

" " "

Margaret C. Menke

(Services contributed by
University of Cincinnati)

Melba M. Weber

" " "

William S. Preston

" " "

~~TOP SECRET~~

War Research Service Project # 17

Subject for Research: Mussel Poisoning (Code "SS")

Location: Department of Chemistry
Northwestern University
Evanston, Illinois

Federal Security Agency Contract # 37 (SA-108)

Term of Contract: March 1, 1944 through August 31, 1944

(Transferred on September 1, 1944 to
Special Projects Division, Chemical
Warfare Service, War Department --
Contract No. 18-064-CWS-47)

Expenditures:

Personnel:	\$ 4,085.96	
Materials:	1,755.24	
Overhead:	1,687.33	
Other:	- -	
	<u>\$ 7,528.53</u>	Total Amount Expended

Project Director:

Dr. Byron Reigel Professor, Dept. of Chemistry Northwestern University	(One-half of salary paid by War Research Service; one-half paid by North- western University)
--	--

Assistants:

Dr. D. Warren Stanger Research Associate	(Services paid for by War Research Service)
Mr. James D. Mold Research Assistant	" " "
Dr. Donald M. P. Wikholm Research Assistant	" " "
Miss Dorothy L. Butler Technical Assistant	" " "
Mrs. Helen Lorden Secretary	(Services contributed by Northwestern University)

~~TOP SECRET~~

War Research Service Project # 18

Subject for Research: Mussel Poisoning (Code "SS")

Location: The George Williams Hooper Foundation
Medical Center
University of California
San Francisco, California

Federal Security Agency Contract # 42 (SA-114)

Term of Contract: March 1, 1944 through August 31, 1944

(Transferred on September 1, 1944 to
Special Projects Division, Chemical
Warfare Service, War Department --
Contract No. 18-064-CWS-48)

Expenditures:

Personnel:	\$ 150.00	
Materials:	527.08	
Overhead:	- -	
Others:	<u>11.85</u>	
	<u>\$ 688.93</u>	Total Amount Expended

Project Director:

Dr. Hermann Sommer
Assistant Professor
Medical Research
The George Williams Hooper Foundation

(Services contributed
by the University of
California)

Assistants:

Dr. Byron Riegel
and
Dr. D. Warren Stanger

(The project director
and his assistant
from the project at
Northwestern University
acted as consultants)

Patricia A. Garbut
Laboratory Technician

(Services paid for by
War Research Service)

[Handwritten signature]

War Research Service Project # 41

Subject for Research: Tularemia (Code "UL")

Location: Department of Bacteriology
University of Kansas
Lawrence, Kansas

Federal Security Agency Contract # 14 (SA-113)

Term of Contract: March 1, 1944 through August 31, 1944

(Transferred on September 1, 1944 to
Special Projects Division, Chemical
Warfare Service, War Department --
Contract No. 18-064-CWS-43)

Expenditures:

Personnel: \$ 1,883.72

Materials: 1,625.35

Overhead: - -

Others: 266.55

\$ 3,775.62

Total Amount Expended

Project Director:

Comelia?
Dr. Cora M. Downs
Professor
Department of Bacteriology
University of Kansas

(Services partially paid for
by War Research Service;
some time contributed by
University of Kansas)

Assistants:

Mrs. Tom Hamilton
Research Assistant

(Services paid for by
War Research Service)

Helen Irene Stark
Technician

" " "

Mrs. W. A. Dill
Animal Caretaker

" " "

Miss Elizabeth Templin
Technician

" " "

Luther Buchele
Donald Kay Animal Caretakers

" " "

~~TOP SECRET~~

War Research Service Project # 50

Subject for Research: Sclerotium Rot (Code "C")
Sclerotium rolfsii "Co"

Location: Department of Agriculture
Plant Industry Station
Beltsville, Maryland

Negotiations were carried on, not by contract, but by exchange of letters between Department of Agriculture and Federal Security Agency

Term of Work: February 6, 1943 through June 30, 1944
(Work continued by the Department of Agriculture)

Expenditures:

Personnel:	\$ 6,616.98	
Materials:	1,547.57	
Overhead:	- -	
Others:	- -	
	<u>\$ 8,164.55</u>	Total Amount Expended

Project Director:

A.
Dr. Freeman Weiss
Bureau of Plant Industry
U.S. D. A.

(Services partially paid for by War Research Service; partially contributed by Department of Agriculture)

Assistants:

Dorothy B. Vaughan
Assistant Pathologist

(Services paid for by War Research Service)

Lillian C. Cash
Assistant Pathologist

" " "

E. B. Lambert
Consultant

(Services contributed by Department of Agriculture)

W. W. Diehl
Consultant

" " "

~~TOP SECRET~~

War Research Service Project # 51

Subject for Research: ^{Growth Regulating Substances} ~~Plant Inhibitors~~ (Code "LM")

Location: Department of Botany
University of Chicago
Chicago, Illinois

Federal Security Agency Contract # 16 (SA-64)

Term of Contract: December 1, 1942 through March 31, 1943
(Work not transferred to another agency)

Expenditures:

Personnel:	\$ 2,500.00	
Materials:	1,000.00	
Overhead:	--	
Others:	--	
	<u>\$ 3,500.00</u>	Total Amount Expended

Project Director:

Dr. E. J. Kraus
Chairman, Department of Botany
University of Chicago

(About one-half of services paid for by War Research Service; about one-half contributed by University of Chicago)

Assistants:

A. W. Naylor

(Most of service paid for by War Research Service)

M. J. Costello

" * "

~~TOP SECRET~~
[Handwritten signature]

War Research Service Project # 52

Subject for Research: Late Blight of Potato (Code "LO")

Location: Maine Agricultural Experiment Station
University of Maine
Orono, Maine

Federal Security Agency Contract # 9 (SA-59)

Term of Contract: February 15, 1943 through November 30, 1943
(Work not transferred to another agency)

<u>Expenditures:</u>	Personnel:	\$ 1,127.62	
	Materials:	307.36	
	Overhead:	- -	
	Others:	35.98	
		<u>\$ 1,470.96</u>	Total Amount Expended

Project Director:
Dr. Reiner Bonde
Associate Plant Pathologist
Maine Agricultural
Experiment Station

(Services contributed
by Maine Agricultural
Experiment Station)

Assistants:
S. F. Snieszko

(Services partially paid
for by War Research
Service)

Rose H. McGuigan

(Services paid for by
War Research Service)

Dr. William H. Martin
and
Dr. John C. Campbell

(These two consultants
aided in the work --
services contributed by
New Jersey Experiment
Station)

~~TOP SECRET~~

War Research Service Project # 52(a)

Subject for Research: Late Blight of Potato (Code "LO")

Location:

New Jersey Experiment Station
Rutgers University
New Brunswick, New Jersey

Federal Security Agency Contract # 13 (SA-63)

Term of Contract: May 1, 1943 through November 30, 1943

(Work not transferred to another agency)

Expenditures:

Personnel:	- -	
Materials:	\$ 143.80	
Overhead:	- -	
Others:	72.74	
	<u>\$ 216.54</u>	Total Amount Expended

Project Director:

Dr. William H. Martin
Dean and Director
New Jersey Experiment Station
Rutgers University
New Brunswick, New Jersey

(Services contributed
by New Jersey
Experiment Station)

Assistant:

John C. Campbell
Research Associate in Agriculture
Department of Plant Pathology
Rutgers University

(Services contributed
by New Jersey
Experiment Station)

EXTRA

TOP SECRET
C. J. ...

War Research Service Project # 53

Subject for Research: Agents Injurious to Rice (Code "II")

Location: Department of Agriculture
Bureau of Plant Industry
Texas Sub-Station # 4
Beaumont, Texas

Negotiations carried on not by contract but by exchange of letters between Department of Agriculture and Federal Security Agency.

Term of Work: October 1, 1943 through August 31, 1944

(Transferred to Special Projects Division,
Chemical Warfare Service, War Department.
Work continued there not by contract but
by exchange of letters.)

Expenditures:

Personnel:	--
Materials:	\$ 568.46
Overhead:	--
Others:	--
	<hr/>
	<u>\$ 568.46</u> Total Amount Expended

Project Director:

Dr. E. C. Tullis
Bureau of Plant Industry
U.S. D. A.

(Services contributed
by Department of
Agriculture)

Assistant:

Lieut. G. W. Anderson

(Army officer --
services contributed
by U. S. Army)

~~TOP SECRET~~

War Research Service Project # 54

Subject for Research: Study of Plant Growth Regulating Substances (Code "RR")

Location:
Department of Botany
University of Chicago
Chicago, Illinois

Federal Security Agency Contract # 39 (SA-111)

Term of Contract: February 16, 1944 through June 30, 1944

(Not transferred to another agency)

Expenditures:

Personnel: \$ 2,855.00

Materials: 1,021.80

Overhead: - -

Others: 60.00

\$ 3,936.80

Total Amount Expended

Project Director:

Dr. E. J. Kraus
Chairman
Department of Botany
University of Chicago

(Services partially paid for
by War Research Service;
partially by University)

Assistant:

M. J. Costello

(Services paid for by
War Research Service)

NOTE



(second contract
for Kraus)
see Proj # 51

EXTRA

~~TOP SECRET~~
[Handwritten signature]

War Research Service Project # 55

Subject for Research: Study of Plant Growth Regulating Substances (Code "RE")

Location:

Ohio State University Research Foundation
Ohio State University
Columbus, Ohio

Federal Security Agency Contract # 43 (SA-116)

Term of Contract: May 1, 1944 through August 31, 1944

(Transferred to Special Projects Division,
Chemical Warfare Service, War Department,
on September 1, 1944. Contract No. 18-064-CWS-49)

Expenditures:

Personnel: \$ 1,980.45

Materials: 771.18

Overhead: 990.23

Others: - -

\$ 3,741.86 Total Amount Expended

Project Director:

Dr. Melvin S. Newman
Assistant Professor of Chemistry
Department of Chemistry
Ohio State University

(Salary partially
paid for by War
Research Service;
partially con-
tributed by Ohio
State University)

Assistants:

William S. Fones

John H. Wotiz

(Services of both
assistants paid for
by War Research
Service)

~~SECRET~~

War Research Service Project # (Not numbered)

Subject for Research: Botulin (Code "X")

Location:

Department of Bacteriology
University of Wisconsin
Madison, Wisconsin

Federal Security Agency Contract # 4 (SA-53)

Term of Contract: January 1, 1943 through December 31, 1943

(Work not transferred to another agency)

Expenditures:

Personnel: \$ 1,489.40

Materials: 451.18

Overhead: - -

Other: - -

\$ 1,940.58 Total Amount Expended

Project Director:

Miss Elizabeth McCoy
Associate Professor
Agricultural Bacteriology
University of Wisconsin

(Services partially paid
for by War Research
Service; partially by
University of Wisconsin)

Assistants:

William B. Sarles
Research co-worker

(Services contributed by
University of Wisconsin)

Mrs. Helen King Kozlik
Laboratory Assistant

(Services paid for by
War Research Service)

Russell Farman
Dishwasher and Animal Caretaker

(Services contributed by
University of Wisconsin)

EXTRA

War Research Service Project # (Unnumbered)

Subject for Research: Analysis of Surveys of Water Supply
Systems of Primary Military Importance

Location: United States Public Health Service
Washington, D.C.

Since the United States Public Health Service and the War Research Service are both parts of the Federal Security Agency, an agreement was made by Interoffice Memorandum to reimburse the Public Health Service for services of personnel engaged in the analysis of these reports of surveys.

Term of Work: April 1, 1943 through May 31, 1943

Expenditures:

Personnel: \$ 3,066.82

Materials: - -

Overhead: - -

Others: - -

\$ 3,066.82

Director of Analysis:

Dr. Ralph Tarbett
Sanitary Engineer Director
Regular Corps, U.S.P.H.S.

(Services contributed by U.S.P.H.S.)

Assistants:

Claud Browning
Sanitary Engineer
Reserve Corps, U.S.P.H.S.

Keigh S. Krause
Assistant Sanitary Engineer
Reserve Corps, U.S.P.H.S.

(Services of all assistants listed were paid for by War Research Service -- reimbursement of \$3,066.82 made to U.S.P.H.S.)

TR:1

Department of the Army, the Bureau of Medicine and Surgery of the Navy, and the Chemical Warfare Service. By oral instructions, the mission of WRS was to make a continuous survey of the biological warfare situation and report its findings and recommendations to appropriate government agencies. It was charged with the responsibility for initiating research projects with civilian agencies. However, civilian agencies were "strictly limited to carrying out such projects as were assigned to the Chemical Warfare Service by WRS," in order to place limitations on the range of responsibility for such studies. It was understood that recommendations to the Chief, CWS, for the military development of a biological agent would be made by WRS when the basic laboratory research by civilian agencies had reached a stage that justified more elaborate investigation. ___/

In addition to its offensive development program, WRS launched an antibiological warfare program under which defensive measures were taken in collaboration with other government agencies to ensure protection of civilian and military personnel in the United States, its outlying possessions, and in the theaters of operations, against the threat of contamination of water supplies, food, milk, and biological products such as vaccines and serums.

___/Ltr (S) CG ASF to CS, 8 Jan 1944⁷, sub: Bacteriological Warfare.
SPCWF 730.

Conferences were held with the commanding generals of the Service Commands in this country and directives were prepared and sent to all theater commanders overseas. Measures were also taken to set up an adequate intelligence and information service, in order to learn enemy intentions, to alert overseas theaters to the possibilities of biological attack, and to correct leaks in security through the press.

ABC Committee. The WEC Committee had accomplished its purpose, and with the formation of War Research Service, a new committee of civilian scientists was appointed by the National Academy of Sciences and National Research Council, to act as technical advisors to WRS on all research matters. This was the ABC Committee. / In addition to it, the government agencies that came within the orbit of WRS activities included the Chemical Warfare Service, Office of the Surgeon General, Provost Marshall General's Office, War Department G-2, Office of Naval Information, Office of Strategic Services, Federal Bureau of Investigation, United States Public Health Service, Bureau of Medicine and Surgery of the Navy, and the Department of Agriculture.

/Members of the ABC Committee are listed in Appendix A.

CWS activities under WRS. With the establishment of WRS, activities of the Chemical Warfare Service in biological warfare became dependent upon decisions made by the civilian agency and requests by the Service for directives to implement its planning were refused. ___/ CWS believed that fulfillment of the WRS program depended on its experience and facilities. Defense methods could not be developed apart from experiment with actual weapons, apparatus and methods which the enemy might employ to project disease agents, and it seemed obvious that such studies, involving a knowledge of existing weapons and munitions, skill in devising new ones and actual field trials, could not be conducted satisfactorily by WRS through its civilian agencies. However, the War Department was unwilling for any part of the biological warfare work to be handled within the Army and the Chemical Warfare Service had to confine itself to abstract study and planning. ___/ A bibliography of published literature on biological warfare was prepared in cooperation with the WBC Committee, ___/ and liaison continued with Canadian and British biological agencies. In July 1942 the Joint American-Canadian Commission was organized to study rinderpest and the Chemical Warfare Service was directed to execute such recommendations as the survey committee of the Commission might direct. ___/ Despite the belief of WRS that "the whole progr

___/Memo (S), Opns Div WDGS for Asst CS G-3, 10 Jul 1942, sub: Biological Warfare. OPD 471.6.

___/Memo (S), C Spec Asgnts Br CWS for Spec Asst to Secy of War, 24 Aug 1942, sub: Resume of CWS Activities in Relation to BW, October 1, 1941 to Date. In CD 322(2).

___/Technical Study No. 58, "Biological Warfare: An Annotated Bibliography" (S)(19 Jan 1942). In CD Tech Lib.

___/Ltr (S), CG ASF to C CWS, 29 Jul 1942, sub: Grosse Ile Project. CWS 710.4.

might be jeopardized if it became known that the military forces were involved," the Chemical Warfare Service continued to believe that eventually the Army would have to establish elaborate facilities for the development of materials and equipment and for field testing. In anticipation of assumption of full responsibility for the program, the Service continued to marshall plans and directives for the conduct of operations and began quiet investigation of a number of potential sites where these operations might be carried out. ___/

In December 1942, WRS reached the stage in its development where it was possible for it to issue directives for particular projects to the Chemical Warfare Service. Then, "in order to permit the WRS to obtain a clearer understanding of the dangers that confronted the nation, the CWS was authorized to undertake the "development of ways and means of disseminating agents simulating those which may be employed in what is broadly described as BW: development of ways and means for the effective dispersal of agents destructive to animal life in an area where the experiments may be carried out in a manner which limits the destructive effects and liability to subsequent deleterious effects to the area concerned; determination of the most effective design, size and tactical use of a bomb for the dispersal

___/Memo for files (S), Col. James H. Defendorf, 2 Nov 1942, sub: Role of the Chemical Warfare Service in the Development of Defenses Against Biological Warfare. In CD 322(2).

Memo for files (S), Col. James H. Defendorf, no date, sub: Review of Situation in Biological Warfare in Respect to CWS. In CD 322(2).

of 'N' (anthrax organisms) when dropped from an aircraft."___/

In March 1943, CWS was requested to provide the necessary facilities for large scale production of anthrax and botulinum toxin, to investigate and develop military dissemination of these materials, and to develop protective measures against them. The investigation of two crop diseases, late blight of potatoes and sclerotium rot, was transferred in October 1943, and in the following March, tularemia, brucellosis, rice diseases, and plant growth regulating substances were added to the CWS program. Glanders and melioidosis were added in May 1944. ___/ By the middle of 1944, responsibility for all biological research and development had been assumed by the Chemical Warfare Service, ___/ including that being carried out in university labs and research institutions under contracts set up by WRS. ___/

Although the directive received in December 1942 clearly involved the construction and operation of specially designed laboratories and pilot plants, until April 1943 activity in the CWS was confined principally to planning, consultation and liaison. During this interim, plans were being

___/Memo (TS), Dir WRS for C CWS, 10 Dec 1942, sub: Request for Supplemental Research and Development. In SPD OC CWS.

Dr. Ira Baldwin was chosen by WRS to direct the work in CWS.

___/Ltrs (TS), Dir WRS to C CWS, 31 Mar 1943, 29 Oct 1943, 17 Mar 1944, 5 May 1944, sub: Request for Supplemental Research and Development.

___/Except for the study of plague, under investigation by the U.S. Naval Medical Research Unit No. 1 at Berkeley, Cal. Liaison with this project was maintained by the naval section at Camp Detrick.

___/Ltr (TS), Dir WRS to C CWS, 9 Jun 1944, sub: Request for Supplemental Research and Development.

made for the construction of a new medical center at Edgewood Arsenal and for the activation of a new Medical Division in the Chemical Warfare Service. It was decided that a portion of the defensive studies in biological warfare—those concerned with the prevention and treatment of biological warfare casualties and with the investigation of hazards to CWS personnel engaged in biological warfare operations—should be conducted by the Medical Division although its principal work would be in chemical warfare medicine. / A Biological Warfare Medical Research Unit was to be set up in the Medical Division and the services of Dr. Karl Meyer were sought to direct the unit.

/Memo (S), Initialed by Brig. Gen. C.C. Hillman for the SG and Brig. Gen. A.H. Waitt and Brig. Gen. P.X. English for CWS, 30 Mar 1943, sub: Proposed Medical Division for CWS. In Med Div EA (Miscellaneous).

/Ltr (S), Dir Med Res Div EA to Brig. Gen. C.C. Hillman OSG, 14 Apr 1943, no sub. In Med Div EA (Surgeon General-1943). The letter read, in part:

The position will require that he direct the activities of a special secret project to search for the most toxic biological agents which can be adapted for war, determine their toxicity, their mode of action and the pathology produced. He will develop methods of detection and methods of protection and defense against such agents. He will develop methods of therapy for treatment of the victims of such agents. Assistants will be four other officers with excellent scientific training, four civilians of professional rank and two technicians...For the exclusive use of this project there is...an office, three large laboratories, three small laboratories and an animal room. There is a specially built laboratory building...to be set up as an office, locker room, showers and clothing sterilizer room, gassing chambers room, laboratory, three isolation rooms for large animals, three isolation rooms for small animals, two isolation rooms for rodents, animal feed room...sterilizer room and an incinerator. This building is so arranged that all animals entering leave only via the incinerator. All men entering...leave only via showers after placing contaminated laboratory clothing in the autoclave. All exhaust gases from gassing chambers leave the building via the incinerator stack, where they are heated to 800 degrees F for not less than 3 seconds. All gassing chambers are sterilized by steam under pressure. All effluent leave the building via alternate pressure sterilizer sumps, where it is sterilized by steam under pressure. All exhaust ventilation leaving the building is filtered through oiled screens and is sterilized by banks of sterilamps.

Through the months of planning, however, it had become obvious that biological warfare research would have to be on an immense scale if it was to produce results in time to be of use. Neither the Technical Division nor the Medical Division of the Chemical Warfare Service could undertake this degree of research, and in April 1943 construction of a biological warfare center was begun at Frederick, Maryland. Soon after, the Service requested and received initial funds of \$3,000,000 to set up its necessary research, testing and proving facilities. ___/

Lighting is provided through glass brick; there are no windows... Facilities of all laboratories (in the Medical Division) are available to assist in this work. There are adequate departments of bacteriology, immunology, biochemistry (including microanalysis), pathology, toxicology, physiology, pharmacology, food chemistry and water chemistry.

— Ltr (S), C CWS to Secy of War, 27 Jul 1943 (SPCWM 601.1) and 1st Ind Hq ASF to C CWS, 29 Jul 1943. See also IOM (S), Asst C CWS for Materiel for Fis and Plan Div OC CWS, 3 Aug 1943, sub: Facilities for Special Research Projects at Camp Detrick, Horn Island and Dugway.

Transfer of biological program to War Department. The movement to turn the biological warfare program over to Army control began in December 1943, a year after the Chemical Warfare Service had received its first directive to begin the military study of biological warfare. At that time, the director of WRS pointed out to the Secretary of War the urgent necessity of preparing for defense against a possible immediate biological attack and also asked permission to request the Chemical Warfare Service to proceed with the manufacture and stockpiling of certain biological agents in order to permit retaliation if it became necessary. This sense of urgency came about upon the receipt of intelligence reports by G-2, OSS and WRS which intimated that the Germans might be about to initiate biological warfare, using anthrax or botulinium toxin in their new cross-channel rockets. ✓/ The agencies of WRS were not equipped to carry out research beyond the laboratory stage and plans had to be made looking to the ultimate transfer of promising laboratory results to pilot plant, field test, and eventually into mass production stages. ✓/

The requirements for waging successful biological warfare were now known. They included the development of virulent pathogenic agents or products of requisite stability, development of suitable munitions to disperse these agents, creation of industrial plants for the production of agents and munitions, and perfection of methods of protecting persons or animals against the agents developed. And there was still no single organization in the country fully capable of undertaking and coordinating the research and development program that was necessary to ensure these adequate preparations. The implications in the request by WRS for the manufacture and stockpiling of agents and munitions called for major decisions and action by the War Department.

✓/ Report, "Development of the Biological Warfare Program of the United States," appended to Ltr (TS), chairman USEWC to member USEWC, 15 Nov 1944. In NDD, WDS and in Historical files.

✓/ Memo (S), HH Bundy for SW, 23 Feb 44, sub: Re Biological Warfare. In OSW.

Discussions were held by the Secretary of War with representatives of the General Staff, War Research Service, Army Service Forces, Chemical Warfare Service, and Office of Scientific Research and Development, and it was agreed that the War Department must be charged with responsibility for the biological warfare program. It had been proved that secrecy could be maintained within the Army at least as well as in a civilian agency. Intelligence was peculiarly within the Army's province. The coordination of Army and civilian agencies in the antibiological warfare program had been successful and also had precedence in the CWS civilian defense program, then being successfully carried out. The CWS had also proved that it was capable of negotiating research contracts with university and other civilian agencies. There appeared to be no other bar to the transfer of the program from WRS to the Chemical Warfare Service. On 13 January 1944 the Secretary of War directed the Chief of Staff to take official action with regard to biological warfare: _____/

In view of the information now at hand, the time has arrived when for military reasons, work should be initiated for carrying on intensively the offensive as well as the defensive side of EW in preparation for protection against attack, and for possible retaliations should this type of offensive action be used by our enemies.

It is, therefore, directed that the WD undertake the further research, development, production, procurement, intelligence, planning, employment, etc., in connection with both defensive and offensive aspects of those EW projects developed by the WRS which have been or are later transferred by that agency to the CWS. The projects which have been

____/Memo (TS), 13 Jan 1944, sub: Biological Warfare. In SPD OC CWS.

transferred to the CWS by the WRS up to the present time are "N", "X", "LO", "CO" and certain defoliation agents.

The WD will hereafter be responsible for all matters in connection with the defensive and offensive use of all BW agents transferred from WRS, including the production of such quantities of these products and protective agents or counter measures against their use by the enemy as may be determined by the WD to be advisable, all subject to such directives as may be issued appropriately by the Joint Chiefs of Staff.

The WRS will continue its present work of coordination and research on all biological agents which have not been transferred to the CWS, and in addition will, on request, act in a consulting and advisory capacity to the agencies of the WD charged with the responsibilities pertaining to BW.

In view of the similarity of application of BW with CW, it is believed that responsibility for carrying out this work should be vested in the Chief of the Chemical Warfare Service, in cooperation with the Surgeon General for the defensive aspects, all under the direction of the CG ASF.

The Chief of Staff, forwarding this memorandum to ASF for implementation added by way of caution that "production directives, other than those for experimental purposes, and plans for employment both offensive and defensive, will be submitted to the War Department for approval." ASF, in turn, directed the Chief of the Chemical Warfare Service to establish at once an appropriate organization in his Office to execute all aspects of biological warfare indicated in the basic communication.

On 12 May 1944, the Secretary of War and the administrator of FSA recommended to the President that all biological warfare activities be transferred to the War Department. The recommendation was approved on 8 June

 1st Ind, CS to CG ASF, 14 Jan 1944, and 2d Ind, Hq ASF to C CWS, 15 Jan 1944, to memo (TS), 13 Jan 1944.

1944. ___/ War Research Service was relieved of its duties and its officials were transferred to the War Department as consultants to the Secretary of War. ___/

United States Biological Warfare Committee. In October 1944, the Chief of Staff wrote to the Commanding General, ASF, clarifying the mission outlined in the letter of 13 January. There was to be no stockpiling of biological agents or agent-filled munitions without specific permission from the War Department. ASF was charged with all biological warfare activities and was directed to confer with the Special Consultant on BW to the Secretary of War on all matters of major policy. ___/ On 11 October 1944, George W. Merck, Special Consultant, was made chairman of a new War Department committee, the United States Biological Warfare Committee, which was formed as a consultative and advisory body to make recommendations to the Secretary of War and the Chief of Staff on biological warfare policy and to establish and maintain liaison with a similar British committee, the ISSCBW. The first meeting of the USBWC was on 22 November 1944. ___/

___/Cited in ltr (TS) to members USBWC, 15 Nov 1944.

___/G. W. Merck was appointed Special Consultant on BW to the Secy of War, with Dr. E.B. Fred and J.P. Marquand as scientific adviser and intelligence aide to Merck. The Navy assigned Comdr. W.B. Sarles as technical aide and executive officer to Merck.

___/Memo (TS), CS for CG ASF, 1 Oct 1944, sub: Biological Warfare, and 1st Ind to SG and C CWS, in turn, 3 Oct 1944. In CC CWS (SPD 481-1).

___/Members of the USBWC are listed in Appendix A.

DEF Committee. In June 1944, when the last of WRS activities had been transferred to the armed forces, the ABC Committee of civilian scientists from the National Academy of Sciences and the National Research Council was abolished and was succeeded by the DEF Committee, formed from the same source. The purpose of the new committee was to give technical assistance to Army and Navy units conducting the biological warfare program, inasmuch as the fields being covered, "are so wide and diversified that it is quite impossible for the Services, without expert counsel, to give adequate coverage to all aspects of the problem.... Those responsible for conducting the war need the backing of a group of scientists outside the War Department, and the advice which they can give." ___/

Meetings of the DEF Committee were attended regularly by members of the Special Projects Division and through the subcommittees on human diseases, plant diseases, animal diseases, bacteriology, and chemistry within the DEF Committee, the technical program of the Division was established, guided and modified. In addition, a technical advisory subcommittee within the DEF Committee gave direct assistance to the Division by spending one day each month at Camp Detrick, working with the staff on its research problems. ___/

___/Ltr (S), Secy of War to President NAS, 3 Aug 1944. Quoted in report "Development of the B" Program of the United States," appended to ltr (TS), chairman USEWC to members USEWC, 15 Nov 1944. In New Dev Div WDSS and in Historical files.

___/Memo (S), Asst C for Tech Opns SPD, 21 Jun 1944, sub: Appointment of Technical Advisory Committee. SPCYF 321-SPD.

New Developments Division. Before the war came to a close, certain supervisory aspects in the biological warfare program were transferred to the New Developments Division in the War Department Special Staff. This Division, upon activation in October 1943, was authorized and charged with primary responsibility for War Department staff action relating to the initiation and coordination of all research and development for the armed forces. In keeping with this mission, it assumed the responsibility for major policy decisions in the field of biological warfare which originally had been given to the Special Consultant to the Secretary of War, as well as the supervisory functions previously delegated to the USEWC. Of the nine staff sections in the New Developments Division, one was designated as the Quartermaster, Chemical Warfare and Medical Section, and to this the biological warfare program was entrusted. ___/

___/Directive WESMO 334 JNW 441.2 (S), Deputy CS for Dir NDD, 5 Nov 1945, sub: USEWC Committee. See also WD Cir 267, sec VII, 25 Oct 1943, sub: Special Staff, and WD Cir 333, sec XI, 15 Aug 1944, sub: Special Staff.

ORGANIZATION AND ADMINISTRATION

Organization at Edgewood Arsenal. From August 1941 to January 1943 all activities of the Chemical Warfare Service in biological warfare were centered at Edgewood Arsenal, Maryland, and were limited entirely to study, planning and liaison. The Medical Research Division, activated by verbal order of the Chief, CWS, as part of the Technical Service, consisted of three sections: immunology, bacteriology, and zoology. Its mission was declared to be the "accumulation of data in connection with the medical aspects of chemical warfare, including bacteriology and immunization." ___/ The five members of this division engaged in preliminary technical studies, established liaison with British workers at Porton and with the Canadian project at Grosse Ile. Potential sites, facilities and personnel for an expanded biological program were examined and tentative programs for research were proposed, discussed and filed for future use. ___/

In the organization chart of the Chemical Warfare Service dated 1 May 1942, the name of the division had been changed to Biological Division and its functions made more explicit. It was to:

___/OC CWS Organization Chart, 1 Oct 1941, approved 20 Aug 1941, p. 23.

This Medical Research Division is not to be confused with the other Medical Research Division at Edgewood Arsenal, originally established in 1922. At this time it was under the direction of the Surgeon General's Office and was concerned with chemical warfare medicine only. See Medical Research in Chemical Warfare in Historical files.

___/Memo for file (S), 30 Jun 1942, sub: Proposed Organization and Functional Chart, Bacteriological Warfare Service, CWS. In CD 322(2).

...correlate and accumulate information and data on biological phases of chemical warfare; cooperate with the Surgeon General of the Army and with the Chief of the Bureau of Medicine and Surgery of the Navy, and maintain liaison with similar agencies of allied countries in the study of medical problems related to chemical warfare.

A third name change occurred when the Office of the Chief, CWS, was reorganized in November 1942. It was now called the Special Assignments Branch of the Technical Division. ___/

The period from December 1942, when WRS issued its first research direction to the Chemical Warfare Service, to April 1943 was spent in acquiring sites for operations, planning and constructing facilities, recruiting personnel and preparing tables of organization. In order to secure allotments of personnel and permit recruiting, the Special Assignments Branch was nominally replaced by an organization consisting of a Biological Defense Branch, Medical Branch, and Biological Defense Station. The first two branches were to conduct offensive and defensive research and the station was to be the scene of laboratory, pilot plant, test and production activities. This organization was an expedient, serving as the means of manning Camp Detrick, Horn Island and Granite Peak Installation, which were activated in

/Organization Chart, OC CWS, 1 Mar 1943, p.1. The Organization Chart of 26 Aug 1943 indicated a Medical Research Laboratory, Camp Detrick, as part of the Medical Division under Col. C.P. Rhoads, MC. This was not effected. The Organization Chart of 11 Dec 1944 indicated a Special Assignments Branch at Edgewood Arsenal, but this was no longer a part of the original biological unit, which now was the Special Projects Division, OC CWS.

/Memo (S), Deputy C Tech Div OC CWS for Brig. Gen. W.C. Kabrich C Tech Div OC CWS (EA) 19 Jan 1943. In CD 322(3).

the summer of 1943 and early in 1944. Early plans contemplated assignment to Technical Division of all offensive aspects of biological warfare, while a proposed new Medical Division in the Chemical Warfare Service was to undertake all problems of biological protection as well as therapeutics. Within a year after commencing operations at Camp Detrick, however, it became evident that the biological warfare program was going to outgrow both of its parent organizations and in view of its mission, had to become an autonomous organization, directly under the Office of the Chief, CWS. In January 1944, Special Assignments Branch, Technical Division, became the Special Projects Division, OC CWS. ___/

___/OC CWS Office 0 (unnumbered), 18 Jan 1944.

Camp Detrick. Detrick Field, a small airport with a single hangar just outside Frederick, Maryland, was acquired by the Chemical Warfare Service on 9 March 1943. Construction was started on 5 April 1943 and fifteen days later Camp Detrick was formally activated. ___/

Within a month of activation an Operations Division had been established, and had pronounced as its primary functions the immediate study on a pilot pla scale of the problems related to the production of BW agents. Although no table of organization for Camp Detrick was prepared at the time, sufficient information appears in the first report of this Division to indicate the outlines of the probable setup (Chart 2). ___/ That October the organization of Camp Detrick was resolved into spheres of greater specialization when the Operations Division was abolished and an Offensive Development Division and a Defensive Development Division were activated to replace it. (Charts in Appendix 9). ___/ The Safety and Engineering Service elements in the organiza tion were raised to equal divisional status, and administration of technical operations as well as post operations reverted to the post commanding officer.

___/Ltr (R), AG to C CWS, 17 Apr 1943, sub: Designation of Camp Detrick, Maryland. AG 680.1 (4-7-43) OB-I-SPOPU-M. In Historical files. This ltr became the authority for the original composition and subsequent changes in the operational organization at Camp Detrick.

___/CD GO 2, 4 May 1943 and MPR Opns Div for Jul 1943 (S), 5 Aug 1943. MPR Opns Div, 5 Aug 1943, placed the Opns Div, Camp Detrick, in the Technical Div, OC CWS.

Note: OC CWS Acm O 19, 27 Aug 1943, established a medical research laboratory for biological warfare at Camp Detrick as a branch of the Medical Division, OC CWS, but on 1 Sep 1943 the order was rescinded when it was decided that the biological warfare program must be an independent function of the Chemical Warfare Service, in no way connected with chemical warfare medical research.

___/CD GO 9, 19 Oct 1943.

Chart 2

ORGANIZATION OF OPERATIONS DIVISION
CAMP DETRICK, MD.
August 1943

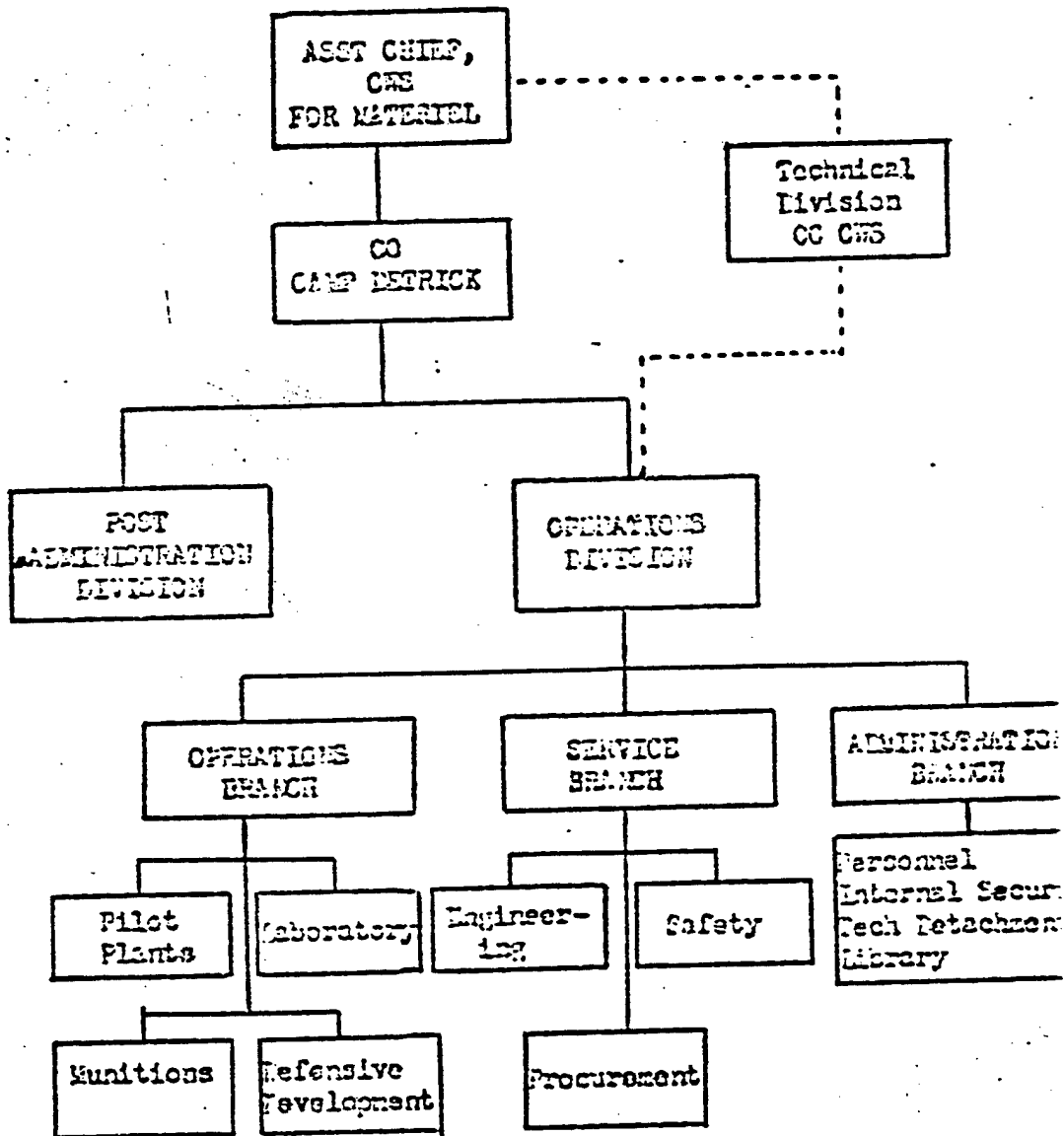

This organization of Camp Detrick lasted until November 1944 when an extensive reorganization took place. ___/ By that time it had been clearly demonstrated that the separation of post administration and technical operations, which had been in effect early in 1943 and then abandoned, was necessary to the research effort. The conduct of research through normal channels, from the command level through the post commander to the level of operations, had been found restrictive, devious and cumbersome. Unrestrained traffic was desirable between the technical departments and the Washington Office, while the general military and technical interests of the post remained the entire responsibility of the Chief of the Special Projects Division and the Assistant Chief, CWS, for Materiel, under whose command the Division was placed.

The labels "offensive" and "defensive" as applied to the development branches at Camp Detrick were considered nonspecific and the units had grown to such proportions that they required separate administrative functions of their own. Animal Research Branch of ODD, therefore, became the Animal Research Division (abbreviated, A Division). Plant Research Branch and Pilot Plant Branch of ODD were turned over to a new Crop Research Division (D Division). Munitions Branch of ODD was elevated to the status of a division (M Division). Physical and Chemical Protection Branch of DDD became the

___/CD GO 15, 1 Nov 1944 and CD GO 16, 20 Nov 1944.

Physical and Chemical Research Division (PC Division), and the Biological Protection Branch of DDD became the Biological Research Division (B Division). Safety Branch and Engineering Service Branch were elevated to divisional status (S Division and E Division). A Technical Department, with direct access to the Washington Office, was created to contain these seven divisions (Charts in Appendix C).

Horn Island. Among sites visited in search of field test areas for trials with biological agents was Horn Island, ten miles south of Pascagoula and Biloxi, Mississippi, in Mississippi Sound. The island was first visited in January 1943 and was acquired for CWS by the Corps of Engineers on 24 March 1943.

When the Engineers visited the island in May to plan construction, it was learned that restrictions on the movement of vessels in adjacent waters had recently been lifted, with considerable numbers of craft again plying the intracastal waterway. An effort was made to halt all planning for its use as a test station, but funds had already been obligated and the work proceeded. Meanwhile, Granite Peak in Utah was visited early in June and found superior in every way to Horn Island as a test installation. The chief of the Technical Division, OC CWS, was apprised of these facts and since construction on Horn Island had begun on 16 June 1943, it was decided to keep the island and hold tests with two toxins, botulinum toxin and ricin, but not to carry out any bacterial tests in that area. By that time, too, it was realized that the proximity of Horn Island to the mainland would make indiscriminate munition trials impossible. ___/

—/ Memo (S), I.L. Baldwin Tech Adviser for C Tech Div OC CWS, 23 Jul 1943.
sub: Plans for B.W. Work. 314.7. In Historical files.

At its inception, Horn Island was declared a substation of Camp Detrick and not until June 1944 did it become a separate installation, on the same level as the other installations of the Special Projects Division. ___/ No special construction, such as was necessary at Camp Detrick, was required on Horn Island. Besides quarters for the test personnel, animal housing, and munition magazines, the only other construction necessary was a grid area for field testing with adjacent technical buildings.

The single unusual feature of facilities at Horn Island was the construction of a 60 centimeter (narrow gauge) railroad with approximately 7.66 miles of track. This was built because road construction was not practicable on the sandy island and only the beaches furnished passage from one end of the island to the other. The entire railroad, consisting of track, two 14-ton steam locomotives, twenty 10-ton wooden cars, a 3-ton narrow gauge motor car (known as a Kalamazoo), and a 1000-pound car trailer, was shipped from Fort Benning, Georgia, and installed by a company of Seabees for the island project. ___/

___/Memo (S), Asst C of Opns SPD for CO CD and CO HI, 17 Jun 1944, sub: Administration of Horn Island. HI 320.3.

___/Construction Directive M-794, SAD-Mobile-M-6, Jackson Project, Office of Div Eng, So Atlantic Div, 23 Jul 1943, and Supplement No. 1 to this directive.

From its activation as a test station on 28 October 1943 until Horn Island was declared excess on 13 August 1945, 23 trials were conducted there with botulinum toxin, principally as a filling in the 4-pound Mk I bomb, and one trial with the M77 smoke bomb, containing cadmium-smoke mixtures. These test operations were conducted by three branches: defensive development, munitions, and safety. The first had charge of personnel used in the trials. The munitions branch, with field, laboratory, meteorology, and veterinary sections, conducted the tests, while the safety branch in charge of a Medical Corps officer conducted safety tests and made inspections and examinations incidental to the field tests. These included administering botulinum toxoid to test personnel and determining the effects of agents on experimental animals following the shoots. ___/

In the summer of 1944, an entomology branch was established at Horn Island, to conduct studies on the fly and mosquito populations.

Meteorological records kept at Horn Island indicated that for two-thirds of the year the winds over the island were not favorable for munition trials with viable agents since their direction was principally toward the mainland. In general, wind velocities were too low for toxic

___/MTR, Horn Island, Part I. Field Trials with "XA" Acid Mud Slurry, May 1945, p. 5. In CD Tech Lib (Horn Island-Acc. No. 24).

___/MTR, Horn Island, Jun 1945, pp. 2,3. In CD Tech Lib (H.I.-Acc. No. 26).

___/MPR, Horn Island, Jul 1944. In CD Tech Lib (HI-Acc. No. 14).

~~___/These, as well as the bomb studies, are reported in the chapter on munitions.~~

trials in summer, although both wind speed and direction were more favorable in winter. ___/

___/ "Synoptic Meteorological Summary for Horn Island, with Reference to Toxic Munitions Trials from June 1944 to April 1945," Apr 1945 (C).
"Annual Report of the Meteorological Branch for 1944, Horn Island (S), p. 3. In CD Tech Lib (HI-Acc. No. 25).

Granite Peak Installation. The principal biological warfare test station was constructed near Granite Peak, a prominence adjacent to Dugway Proving Ground, the Utah desert test installation of the Chemical Warfare Service. Granite Peak Installation was activated as a substation of Dugway Proving Ground in June 1944 and its field test program was begun shortly thereafter. ___/

Construction was begun on 10 July 1944 and completed 30 January 1945. Administration buildings and warehouses for the installation were located in the vicinity of the Dugway toxic gas yard. The service area for operations, laboratories and grid area for biological trials were located near Granite Peak, 35 miles distant. At Granite Peak, 22 miles of surfaced roads were constructed and quarters built for test personnel. Electric, water and steam distributing systems were installed, an airplane landing strip laid out, and incinerators, sewers, septic tanks and power plants, all with special features for biological warfare operations, were constructed. ___/

As a substation of Dugway Proving Ground, the usual administrative functions of Granite Peak Installation came under the supervision of the DPG post commander, but the Installation retained full autonomy with regard

___/Ltr (S), AG to C CWS, 3 Jul 1944, sub: GPI, Dugway Proving Ground, Tooele, Utah, SFX 323.361 (28 Jun 44).

___/Ltr (S), OCE to Div Eng Pacific Div, 14 Jul 1945, sub: Proving Facilities, Directive Construction M-1951, Granite Peak Installation. CE-CPEMP-600.1.

to its technical operations. Special arrangements for administration and cooperation in tests between the biological warfare and chemical warfare units were agreed upon. Operations conducted by the Granite Peak unit were coordinated where necessary with those of DPG. Range guards, as well as safety and security of operations, were responsibilities of the Officer-in-Charge, Granite Peak Installation. Airplane missions required by Granite Peak operations were flown by the Proving Ground detachment, and meteorological forecasting service was provided by existing Dugway facilities. ___/

___/Memo (S), Officer-in-Charge GPI for C SPD, 8 Sep 1944, sub: Integration of Granite Peak and Dugway Activities. SPCYF 141/1.

Vigo Plant. It was originally planned to erect a new plant for the mass production of biological warfare agents at the CWS arsenal at Huntsville, Alabama. However, when an inspection was made of the Vigo Ordnance Plant, 6 miles south of Terre Haute, Indiana, it was found that with some adjustments these existing facilities would serve the purpose with, it was hoped, considerable saving of funds. ___/ The plant was transferred to the Chemical Warfare Service for its Special Projects Division on 8 May 1944 and reconstruction of the former ordnance facilities was begun. ___/

The original structures at Vigo, erected in 1942, were built for the Ordnance Department. The installation was declared surplus to Ordnance needs in July 1943 and portions of the plant were leased to a civilian manufacturer of military radio equipment, with other portions assigned to the Corps of Engineers and to Ordnance for storage purposes. In the reconversion of existing facilities at Vigo, except for the portions leased or assigned, dormitories, cafeterias and ordnance manufacturing buildings became barracks, mess halls, work shops and warehouses. New structures built included a theater, laundry, an 85-bed hospital, maintenance shops, boiler houses and engine houses, and such special production facilities as laboratories, incinerators, steam power plants, air compressor unit,

___/Memo (S), C CWS for CG ASF Att Dir of Materiel, 3 Apr 1944, sub: Project WYE. SPD 730-WYE. In SPD OC CWS.

___/Ltr (C), AGO to C CWS, C Eng and C Ord, 13 May 1944, sub: Redesignation of Vigo Ordnance Plant. AG 322(13 May 44)OB-I-SPKOU-M. In Hq VP (M&I-VP 322). See also VP GO 1, 11 Jun 1944.

refrigerator plant and slurry heater, catalyst, reactor and separation buildings. Ordnance munition plants were reconverted to bomb assembly, fuse assembly and detonator loading buildings. ___/

Vigo Plant was obtained for the manufacture of biological warfare agents and biological vaccines, filling and loading of biological munitions, and breeding of laboratory animals. Its primary mission was specified as the manufacture and loading of a material unofficially designated INK-B. INK-B was anthrax. However, Vigo was considered to be a pilot plant rather than arsenal because of the experimental and highly technical nature of operations that were required before it could be proven for its intended purpose and accepted by the chief of the Special Projects Division and the Assistant Chief, GWS, for Materiel. ___/ The organization for administration and technical operation of the Vigo Plant is shown in the charts in Appendix .

As plans for the operation of Vigo Plant were made, it was proposed to limit the scale of operations to proving the plant, training personnel, providing end items for surveillance and proof testing, and accumulating material in anticipation of military requirements. The state of progress in research on biological warfare agents in the spring of 1944 indicated

___/Ltr (S), OCE to Div Eng Ohio River Div, 3 May 1944, sub: Terre Haute Plant, GWS (Army), Terre Haute, Indiana. L-635(Ink B GWS Plt).
See also Directive Construction M-1180.

___/Ltr (S), C SPD to Tech Dir CD and CO VP, 5 Apr 1945, sub: Assignment of Responsibility and Authority for Proving the Vigo Plant. SPCIF 400.4. In Eq VP.

that anthrax would be the agent produced and that it would be filled in the British 4-pound bomb. The use of an actual pathogenic agent was not contemplated until the plant had been thoroughly tested for safety and until personnel had been trained to satisfactory efficiency. Plans were made to begin operations by filling bombs first with water, then with an anthrax simulant and simulated explosives through each of the production, filling and loading operations. Sufficient personnel were to be trained to operate the plant at 10 percent capacity, should that become necessary, it was planned to rotate all personnel engaged in plant operations. ___/

A detailed statement of policy for proving Vigo Plant was made the subject of a directive early in 1945. Proof of the plant was considered to mean operation of all facilities at sufficiently high levels and for sufficient lengths of time to demonstrate the plant's capacity to perform its mission, that is, to produce continuously completely assembled 4-pound bombs filled with 4 percent anthrax slurry at 500,000 units per month. These end items were to be produced for surveillance, proof testing and for use in the development of tactical doctrine. The scale of operations was to be at a minimum rate consistent with the accomplishment of these objective. Significant experimental results in improvement of processes which were determined at Camp Detrick were to be incorporated into plant operations at

___/Memo (S), C SPD for Asst C CWS for Materiel, 16 Nov 1944, sub:
Operations at Vigo Plant, CWS. In VP Tech Dept (TD-461).

Vigo. Training of a skeleton force of potential key personnel was considered to mean such personnel as would be required to effect in scheduled, orderly and safe fashion, all operations necessary for the production of intermediate and end items without duplication of instruction in more than one operation for any nonsupervisory person. The effectiveness of the plant for the production of anthrax was not considered to be established by the production of the simulant. Only the actual production of anthrax, carried through to the end item, would be a sufficient test, and training of personnel would not be established as satisfactory until they had performed all operations with active pathogenic agents. Operations were to be continued until this was attained, independent of the establishment of satisfactory production rates and quality. ___/

The water testing phase of operations was completed at Vigo in April 1945. ___/ In June, production of the anthrax simulant, Bacillus globigii, was started. This operation was still in progress and approximately 8,000 pounds of agent had been produced when the end of the war brought orders to suspend further activities. ___/ By that time the first shipments of 4-pound bombs were being received from Electromaster and these were stored

___/Memo (S), C SPD for CO VP, 8 Jan 1945, sub: Directive on Operating Policy for the Vigo Plant. In VP Tech Dept (VP-635).

___/MTR, Tech Dept, VP (S), May 1945, pp. 1-17. VP Doc. 125. Instructions for the operation of the production plant were contained in Standing Operating Procedures, Prod Div, VP (S) 28 Jan 1945. VP Doc. YA-17.

___/MTR, Tech Dept, VP (S), Jun and Jul 1945. VP Doc. 156 and 216.

pending postwar operations. ___/

Unlike Camp Detrick, where both administrative and technical functions at one period were under the post commander, resulting in a certain amount of disagreement, at the Vigo Plant the technical director of the plant was given full authority and responsibility for all activities of his safety division, production division and inspection office, and all agencies and individuals having business with these activities were required to channel dealings through him. The post commander was expressly excluded from exercising authority in the plant, and in functions affecting operations or operating personnel, he obtained the prior concurrence of the technical director. ___/ This ruling on the separation of functions was laid down just prior to the activation of the Technical Department of Vigo Plant which took place in April 1945. ___/ In other respects, the administration of the Vigo Plant conformed with that of other Chemical Warfare Service arsenals. Control, cost analysis and standing operating procedures were adopted in compliance with directives of the Service Command, Office of the Chief, CWS, and the Army Service Forces.

___/One million 4-pound bombs were under procurement, to be delivered at the rate of 125,000 per month beginning in March 1945. One-half of these were to be stockpiled unfilled for the British Air Commission, one-half for CWS. It was believed that suitable filling would be in production at Vigo beginning Apr 1945 to fill 50,000 bombs per month. This was 10 percent of the estimated plant capacity, and these bombs would be used for test operations and surveillance. See ltr (S) C SPD to Dir of Supply British Air Com Washington, DC, 7 Dec 1944, no sub. In SPD OC CWS (092-Gt Britain). This was reply to ltr (S) British Air Com to C SPD, 21 Nov 1944, sub: Requisition No. 43, 188-Bomb, 4 lb Mark IV, HE/Chemical type F, same file.

___/Ltr (S), C SPD to Tech Dir CD and CO VP, 5 Apr 1945, sub: Assignment of Responsibility and Authority for Proving the Vigo Plant. SPCYF 400.4.

___/Ltr (S), Tech Dir SFD to C Tech Dept VP, 16 Apr 1945, sub: Organization of Technical Department, Vigo Plant, CWS, Terre Haute, Ind. In Hq VP. Also, VP GO 4, 19 Apr 1945.

Special Projects Division. The functions of the biological warfare organization established in the Office of the Chief, CWS, were to "develop measures and plans for defense and for retaliatory offensive use through research and development; produce or procure all material necessary for adequate defense and for effective offense; plan and supervise construction of necessary laboratories, pilot plants, proving grounds and manufacturing establishments; collect and evaluate intelligence on enemy activities; maintain liaison with appropriate military and civilian organizations and with like units of allied governments; develop doctrine, prepare training publications, and conduct instruction in both defense and offense; supply technical advice to the armed forces." ___/

In order to perform these functions successfully, the following objectives had to be achieved by the Division:

1. The offensive possibilities of biological warfare had to be extensively examined with reference to agents, munitions, weapons, and their sabotage and tactical employment.
2. Mechanical, chemical and biological defensive and control measures equal in extent to the offensive work had to be developed.
3. Laboratory, pilot plant and mass production facilities for agents and biological protection had to be designed, constructed and operated.

___/Organization Chart, SPD, JC CWS, 16 Sep 1944 (Appendix B).

4. An engineering organization capable of designing, operating and maintaining biological warfare facilities had to be created and staffed.
5. A procurement and supply organization was necessary to provide the enormous variety of experimental and production wares and machinery.
6. Experimental animals had to be obtained; a library of reference works provided; and special photographic laboratories set up and equipped.
7. A special organization had to be developed capable of devising safe procedures in the plants, laboratories and testing fields to prevent injury to personnel and animals within the organization and in adjacent territory.
8. Intelligence of enemy activity had to be acquired, strict security on internal operations maintained, and vital information disseminated to theater commanders and other interested agencies.
9. Liaison with foreign and domestic institutions, government and private agencies, had to be set up and maintained.
10. Advice and aid from technical authorities outside the project had to be enlisted.
11. A program for training officers and enlisted men in a new field of warfare had to be established. Training for technical and plant operators had to be planned and executed.
12. Special medical facilities and procedures had to be developed and installed.
13. The basic organization to recruit, house, feed, clothe, pay, entertain, guard and govern the huge staff necessary for the program had to be devised immediately and put in running order.

This was an immense task and it had to be done hurriedly because of the urgency of the situation in biological warfare as it was understood at that time. Construction and research went on simultaneously at the installations of the Division and the expansion of facilities continued right up to VJ-Day.

Among special problems of administration that are peculiar to research organizations in the Army, and therefore to the Special Projects Division, was that created by the arbitrary division of functions within the organization. By virtue of Army Regulations, the commanding officer of an installation has complete command of his post. It was felt at Camp Detrick, however, that exercises of that command should be limited as it concerned technical operations.

As Camp Detrick grows in size and complexity, it becomes increasingly necessary to work out a satisfactory balance between the military activities of the Camp and the scientific research and development for which the station was created. The Technical Staff might well be allowed to have more authority in the formation of plans for the activities of the whole station. The direction of these plans should be toward more efficient scientific work with adequate military support rather than toward greater militarization of the station with scientific activities subordinated to military rules and regulations. ___/

Hours of duty, military courtesy, dress regulations, formations and innumerable other details of life on an Army post served to generate minor but chronic difficulties. One such problem stemmed from the fact that often the progress of laboratory experiments could not be arrested at 1700 hours, the usual quitting time. Technical workers frequently pursued their activities far into the night, a normal practice in university and commercial laboratory work, and found it inconvenient to conform to the post regulation which required them to sign a register before 0800 hours the following day. A larger problem confronted the post commander, who was responsible for the health of his command as well as of the population of the adjacent countryside. Much of the work was exceedingly dangerous and the agents being

___/Memo (TS) Lt. Comdr. W.B. Sarles, USNR, WRS Staff, for George W. Merck, 20 Apr. 1944, no sub. In WRS.

handled were virulent and contagious. Many of his efforts to govern technical operations necessarily sprang from these considerations.

Certain problems of administration in the Special Projects Division were removed from controversy in November 1944 by a directive issued by the chief of the division. Commanding officers of Camp Detrick, Horn Island and Vigo Plant were declared responsible to the Chief, SPD, for the proper performance of all functions at their posts which were the responsibility of the Chief, CWS. All correspondence from SPD installations on matters of policy and CWS administration were to be forwarded to the Chief, SPD, for appropriate action. Direct communication on technical matters that involved no post action or responsibility was authorized for the chief technical officers at all installations with the Technical Director, SPD, at Camp Detrick. ___/The directive thus preserved formal processes for post administrative matters but permitted direct communication between all scientific and technical departments of the division and did much to resolve this source of friction in the military organization.

Another administrative problem was that of maintaining coordination in the technical effort, particularly at Camp Detrick. Ultimately, coordination depended on the dissemination of information to all working personnel. The source of the difficulty lay in the increasing departmentalization of

___/Ltr (TS), C SPD to CO CD, CO VP, CO HI and OinC GPI, 20 Nov 1944,
sub: Administrative Channels in SPD. SPD 321.

technical operations as the number of personnel and projects increased, and it became difficult for any individual to keep himself acquainted with all research and development work being done. The Technical Department was created to administer the technical functions of the organization, but the chief of the department simply could not keep in close touch with the work of each section, branch and division. His immediate problems were those of personnel recruitment, placement and administration. The creation of the Office of Technical Director, SPD, did not solve the problem either, for that office was concerned with the making of broad policy and its efforts were directed to maintenance of liaison with committees, consultants and specialists, as well as representing and coordinating the whole technical effort. These circumstances inevitably permitted a certain amount of duplication of effort and isolated workers from the source of the planning, for there was no regular established communication between the workers and the policy makers. The problem was presented in the memorandum of 20 April 1944, previous cited, which reported that Camp Detrick

had grown so rapidly that it is difficult for the technical staff to keep in close touch with all of the research and development work being carried on in the different divisions and departments. In addition, it is most difficult to avoid duplication of effort in the various laboratories of the station. Having separate field trial stations at Horn Island and at Dugway, Utah, will amplify the difficulties of coordinating the work of the whole project.... There is need for more frequent and more open discussion of policy and planning of the work of the station. The present tendency is for the policy to be laid down and plans made at a high level of command without consultation with officers who will be responsible for the actual work. More frequent conferences might well be held to enable the responsible experimental officers in the different divisions to learn of the work being done by other divisions or departments.

There were two sources of information available to the technicians and scientists of the laboratories. These were the progress reports issued by each section of the Detrick organization and the bimonthly meetings of the Technical Department staff. The reports contained detailed accounts of experimental work but did not discuss or reveal broad policy; they were also fragmentary and in no way reflected the immediate work or scope of work in which the unit was engaged. The bimonthly meetings were the only remaining official source of current undertakings and operations. Speakers at the meetings were selected from various sections and divisions of the Technical Department to present accounts of their particular fields, but little could be covered in a single meeting, the presentation had of necessity to be on a rather low technical level, and of course the speakers themselves were not policy makers. ___/ The problem could only be stated; because of the size of the undertaking at Camp Detrick, it could not be solved.

___/See Appendix D for subjects and speakers at these meetings. Failure to disseminate information as to the range and scope of the work in which Camp Detrick was engaged resulted in a heated discussion at the bimonthly meeting held 7 Jul 1944. The subject of the meeting was "Si and the Rickettsial Diseases." The speakers "attempted to show that typhus and psittacosis have greater possibilities than 'X' or 'N' (botulinum toxin or anthrax) as BW agents. Both became emotional, but developed considerable support for their views. Fothergill; Woolpert, Hudson and Stamp explained the present program and pointed out that work on the two agents recommended (by the speakers) had not been authorized, nor had authorization been sought, but that several outside agencies were working under WRS on possible agents, but that work was not ready to be turned over to SPD. The speaker acted for a group which feels that the BW program must be pushed more rapidly and extensively than it now is. Participation in a relatively narrow program, with little knowledge of what is being done elsewhere, has contributed to a state of mind that found expression and relief in the subject meeting." Ltr (S), Actg Asst C for Opns SPD to C SPD, 18 Jul 1944, sub: Report of Occurrences at Technical Meeting and of Subsequent Disciplinary Action. SPCYF 319.1.

The Control Branch at Camp Detrick was an administrative function of the post commander, set up to carry out certain directives of the Office of the Chief, CWS, and the Service Command, to control printed forms, to establish work measurements of administrative functions in the division, devise and maintain a pass system for restricted areas of the post, and perform similar duties. It had no counterpart in technical activities. An attempt at control within the Technical Department, through the preparation of work simplification and standardization studies, work measurement reports and simplification of forms, met with difficulty since Technical Department personnel insisted their work did not admit to such studies. (Furthermore, it does not appear that any attempt was made to collect information of a quantitative nature regarding technical operations, although this might have made it possible for the administrator to know at any time the relative quantity of work accomplished or being accomplished. More important, there was no organized means available for determining how administrative directives were being carried out - a matter of grave concern to the military mind. This lack of technical control resulted in such occurrences as the independent achievement of workers in two different divisions at Camp Detrick in isolating the Type A botulinum toxin. Each group could legitimately lay claim to the credit for the enormous effort expended by their divisions. Similarly, the lack of overall control in the Technical Department provided no means of ascertaining the patentability of new devices, procedures and methods which were worked out in this new field of research. Although the workers by agreement could not profit from such accomplishments, the delay in ascertaining the value of these developments and in patenting them tended to permit an advantage to independent investigators engaged in similar studies outside the project.

Project specifications. In April 1943, five months after receipt of the first authorization from WRS to conduct biological warfare studies, an Operations Divisions had been organized at Camp Detrick and the first project specifications were prepared. Four groups of projects were outlined, representing each of the four branches of the division: laboratory (L), pilot plant (P), munitions (M), and defensive developments (D). The initial specifications were as follows: ___/

- CD-L-1 Laboratory development of botulinum toxin as a BW agent
- 2 Laboratory development of anthrax as a BW agent
- 3 Laboratory development of simulated BW agents

- CD-P-1 Pilot plant development of botulinum toxin as a BW agent
- 2 Pilot plant development of anthrax as a BW agent
- 3 Pilot plant development of simulated BW agents

- CD-M-1 Development and testing of munitions, weapons, and offensive techniques for the use of botulinum toxin as a BW agent
- 2 Development and testing of munitions, weapons, and offensive techniques for the use of anthrax as a BW agent
- 3 Development and testing of munitions, weapons, and offensive techniques for the use of simulated BW agents

- CD-D-1 Development of protective devices and measures against botulinum
- 2 Development of protective devices and measures against anthrax toxin
- 3 Development of protective devices and measures against simulated BW agents
- 4 Protective devices which may be completely sterilized and keep their effectiveness

Early in August 1943, two new problems were given to each of the four branches: the development of rice fungi as BW agents, and the study of certain arthropods as potential BW agents for the destruction of food crops. One by one, additional biological agents were included for study in the

/Memo (TS), C Opns Div CD for C Tech Div OC CWS (EA), 20 May 1943,
sub: Project Specifications.

program: dysentery, ricin, Southern blight, rice blast, late blight, brown spot of rice, plant growth inhibitors, rinderpest, glanders, and typhus fever. (No work was done on dysentery and typhus fever; ricin was studied as a potential chemical warfare agent by the Medical Division at Edgewood Arsenal; and rinderpest was a joint Canadian-U.S. project, investigated at Grosse Ile.) The first project specifications were broad and general in their formulation, but as the number of agents to be investigated grew and as the problems to be solved for each agent became clear, the specifications became less inclusive and were broken down into more and more detail. Specifications for new studies included selection of strains, studies in pathogenesis, improvement of media, studies of factors affecting the separation of agent from media, studies of factors affecting stability, use of coagents, examination of final physical state and form of agents, adaptation of laboratory procedures for pilot plant production, development of safety measures and decontamination procedures for production operations, studies of the separation, concentration and drying of agents, packing and storage studies, development of test methods and procedures for routine process control.

Navy participation in the program. Among the Navy Department branches which contributed to the biological warfare program under War Research Service and later under the Chemical Warfare Service, were the Chief of Naval Operations, Bureau of Medicine and Surgery, Bureau of Ordnance, Bureau of Ships, Bureau of Naval Personnel, Bureau of Aeronautics, Office of Naval Intelligence, Office of Research and Development, and the Naval Research Laboratory at Bethesda, Md. The Bureau of Medicine and Surgery, however, was the principal participating agency.

Naval personnel were included in the WBC Committee, as consultants to War Research Service, on the ABC Committee, and the technical director for the United States on the Joint U.S.-Canadian Commission to study rinderpest was a member of the Bureau of Medicine and Surgery. When the War Department assumed responsibility for the biological warfare program in January 1944, the Navy was asked to increase its degree of participation in the program and the chief of the Bureau of Medicine and Surgery and Bureau of Ordnance were asked to serve on the USEW Committee and DEF Committee.

The Surgeon General of the Navy accepted the invitation of the Chief, CWS, to take a more active part in the Special Projects Division program in April 1944. "It seems to me," he wrote "that we should bend every effort to be in a position to answer any problem that might be asked of us, both as to offensive and defensive measures, in the not too distant future.... The Navy will do its part to see to it that personnel with adequate qualifications are assigned to the project." /

___/Ltr (S), SG USN to C CWS, 26 Apr 1944, sub: Navy Participation.
BUMED-S-CRM-Ser 00886.

A naval unit equal to 25 percent of Army personnel was authorized for Camp Detrick, its personnel drawn from the Bureau of Medicine and Surgery and Bureau of Ordnance. This unit was a separate organization at Camp Detrick: "Navy personnel, both officer and enlisted, will be supplemental to Army, and will not in any way be considered as filling vacancies in ratings of the Army T/O at the post."___/ Originally designated as the Naval Unit, Camp Detrick, the name was changed to U.S. Naval Unit, Special Projects Division, CWS, in July 1944, in order to permit use of the personnel at Horn Island, Granite Peak and Vigo. ___/

The organization of the naval unit in SPD is shown in Chart . Its administration was outlined in an organization bill prepared by the Chief of Naval Operations ^(Appendix E). The mission of the U.S. Naval Unit, as stated in the organization bill, was "to protect the interests of the Navy in the project under investigation and to assist the Army in every proper, practicable way."

Because the joint effort was in some respects unusual in that both services were engaged in SPD in identical work and housed together for a prolonged period of time, it may be of some interest to examine the basis

___/Memo (S), C of Naval Opns for C Bumed, 2 May 1944, sub: Official Status of Naval Unit, C.D., Frederick, Md. SPD 322-Naval Unit.

___/Ltr (S), C of Naval Opns to C CWS, 1 Jul 1944, sub: Expansion of Naval Unit, C.D., Frederick, Md., in Accordance with Expansion of Special Projects Division, CWS. Op-05-G3 (SC)S77/Ser 1051305-G. See also ltr (S), Secy of Navy to All Ships and Stations, 18 Jul 1944, sub: Establishment of U.S. Naval Unit, SPD, CWS. OP-13D-13 Jul 44 (SC)S77-Ser 049513.

Chart 3

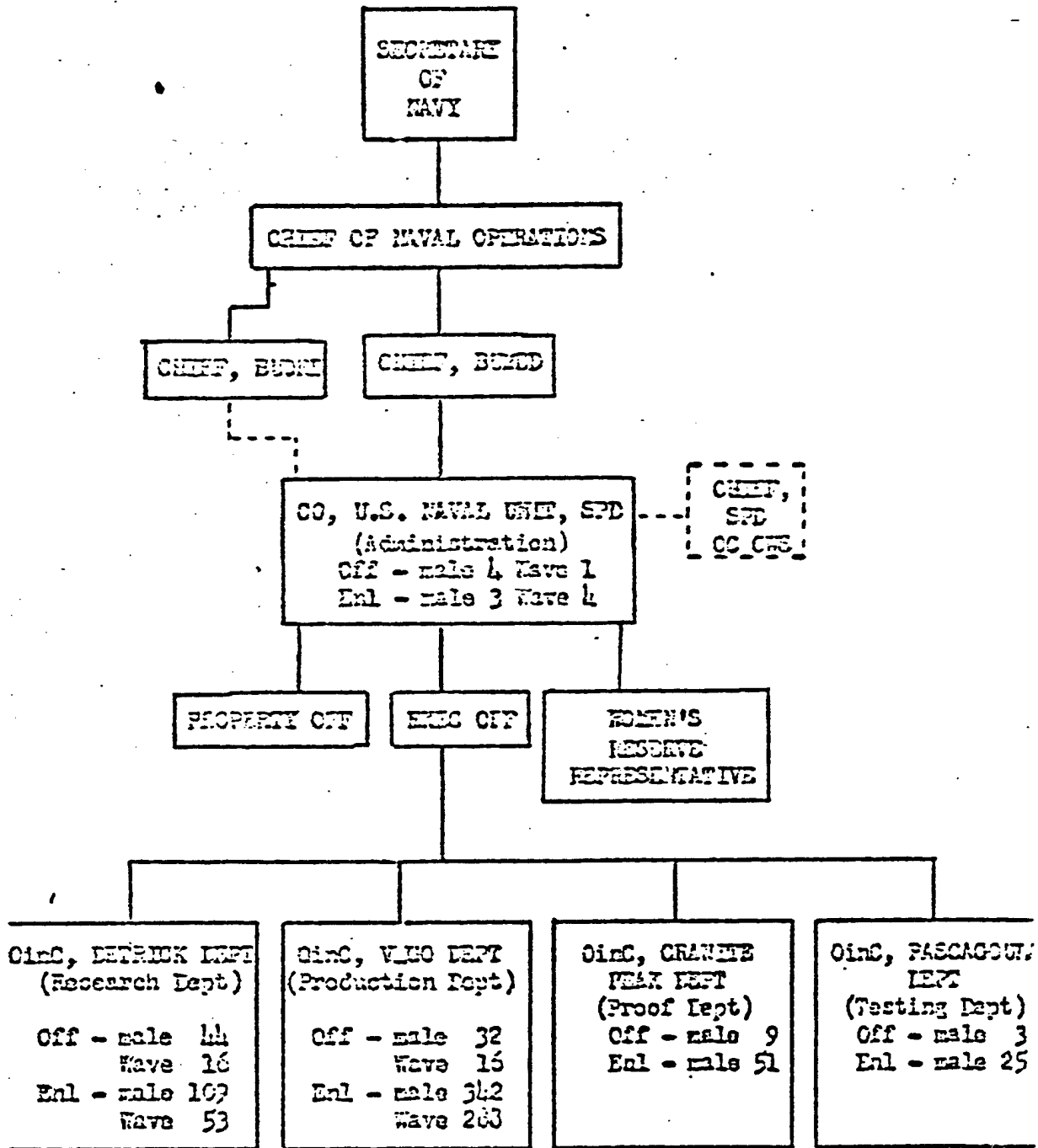

Sources: Organizational Bill, CC Nav Cons (In Hist files) and ltr (S),
 CO US Naval Unit CD to C of Naval Pers, 31 Jul 44, sub: Per-
 sonnel, U.S. Naval Unit, SPD, CMC. A3-216-NBP, Ser 00173.

for cooperation which was worked out for the undertaking. Borrowing freely from the organization bill prepared by Chief of Naval Operations, the Chief of the Special Projects Division outlined in detail for the biological warfare installations the means by which the joint Army-Navy organization was to operate. Post commanders at each of the installations were to retain full authority and responsibility for all personnel and material on each post. Post regulations applied to all personnel, unless the Navy was specifically excepted. The post commander issued orders to naval personnel through the officer-in-charge of the naval unit on the post. The latter officer was directly responsible to the post commander for the execution of orders, but this did not lessen the responsibility of the officer-in charge to the commanding officer of the Naval Unit, SPD. Naval personnel were subject to the same orders and the same discipline as Army personnel and obeyed orders and commands of both Army and Navy officers. All administrative actions initiated by the commanding officer or officers-in-charge of naval units went through the post commander for processing.

Economy and practicality directed that Navy pay, records, and reports be handled by the Navy, but messing, housing, and utilities were provided by the Army. Duplicate services were permitted only where the interests of one service were advanced without detriment to the other.

The integrity of the naval unit command was respected and the formation and character of the naval organization and administration was retained. ___/

___/An example of Navy Department punctiliousness occurred when Captain L.D. Fothergill, USNR, and Captain M.S. Prime, USNR, were named chiefs of the research and development branch and of the production branch of Special Projects Division. It was pointed out that Navy regulations (1920, Art. 178) forbids a naval officer from commanding Army forces on shore except by special authority, and the Secretary of the Navy

Discipline over naval personnel was administered by the naval unit commander who furnished copies of proceedings to the post commander. Correspondence between the commanding officer of the naval unit and his officers-in-charge of departments avoided matters pertaining to general post functions or duties, or when such functions were involved, the correspondence was forwarded through the post commander. Matters involving naval interest only were forwarded directly to recipients, though copies went to the post commander. Orders and commands to naval units from high naval authority were respected by the post commander who was supplied with a copy by the unit concerned. The naval command issued its own administrative special orders. General orders were strictly limited to naval matters and cleared in advance with the post commander. No naval order was permitted to be issued by Army personnel.

The funds of each service were administered only by personnel of that service except where, having been transferred to the other service, it had lost its identity. Equal treatment of Army and Navy personnel to the greatest extent possible under the regulations was declared an objective of the joint enterprise. ___/ In two years of good relationship almost the only conflict of any consequence arose over this latter objective, when Navy units were

was asked to approve these CWS appointments. Ltr (S), CO Naval Unit CD to C Bumed, 5 Jun 1945, sub: Exercise of Command by Naval Officers Over Army Officers on Shore for a Particular Service. NUCD-A3-NSP-Ser CO145.

___/Ltr (S), C SFD to CO US Naval Unit SFD, CO CD, CO VP, CO HI and CO GPI, 1 Mar 1945, sub: The Naval Unit, Special Projects Division, CWS. In Hq Vigo (M&R 322). See also ltr (S), C SFD to CO ALL SPD Posts, 14 Jun 1945, sub: Army-Navy Administrative Relationship. In Hq Vigo (M&R 322).

permitted to issue leave passes to two-thirds of their personnel whereas the Army was required to keep 50 percent of its personnel on the post at all times.

In addition to the four naval units in the Special Projects Division, the Navy Department maintained an independent unit engaged in biological warfare research at the University of California, Berkeley, California. At the recommendation of the WBC Committee and War Research Service late in 1942, this unit was organized to study air-borne infectious diseases, particularly the plague bacillus. It began its studies under WRS in April 1943 and upon liquidation of WRS in July 1944, the Bureau of Medicine and Surgery took over the project. The unit grew from 12 officers and 8 ratings in April 1943 to 19 officers and 45 enlisted personnel by VJ-Day. Throughout the course of the project, liaison was maintained between its personnel and the Naval Unit, SFD, CWS.

Medical participation in the program. The Office of the Surgeon General was a logical participant in all matters concerning biological warfare and was represented on each of the committees on biological warfare to investigate, advise or take action on medical aspects of the problem. In the first action of the War Research Service, the OSG and Medical Corps officers initiated the antibiological warfare programs in Hawaii, the Canal Zone, the United States, and the theaters of operations, instructing medical and security officers in detection and defense against biological attack. OSG assigned trained sanitary engineers to the Internal Security Division, PMCO, to protect essential industrial plants against possible sabotage. In cooperation with CWS and the Corps of Engineers, it developed methods and equipment for detecting toxic contaminants in water and procedures for the protection of water supplies of municipalities and Army posts. In cooperation with the Veterinary Corps and Provost Marshall General, it inspected meat and dairy products used by the Army. Food and beverage plants and water supplies in the Hawaiian Department were inspected regularly. Studies were made of the possible dangers of sabotage of medical supplies while in production, storage and distribution, and control methods were devised for use by the drug industry to prevent sabotage. The Medical Intelligence Division initiated and maintained sources for collecting biological warfare information from overseas. ___/

___/Ltr (TS), SG to George W. Merck, WRS, 1 Apr 1944, Surgeon General Functions. SPLDS 000.5-1. In OC CWS SPD (Historical Record). See also ltr (TS), TSG to Dir. WRS, 27 Sep 1944, sub: Program of the SGO in Defense Against BW. In SPD 730.

One of the special tasks assumed by the Medical Department was the testing of the blood of prisoners of war in this country and overseas for evidence of specific antibodies. This was done in 1943 when WRS suggested that the blood serum might indicate whether any of the captured soldiers had been immunized against other specific disease than those against which our own Army was inoculated. Following this request, blood samples were taken as a routine part of physical examinations and fractions were sent to biological laboratories to determine the antibody contents. No significant positive tests were revealed by this extensive study, however.

In the War Department plans for taking over the biological warfare program from WRS, the Surgeon General was directed to cooperate with CWS in the defensive aspects of the project. The line between defensive and offensive biological warfare research was relatively clear in matters pertaining to the use of toxoids and vaccines and for the procurement, storage and issue of biological products incidental to research, but beyond these primary considerations particularization became difficult. The Surgeon General considered medical research, unrelated to biological warfare, his chief concern. The Chief, CWS, however, pointed out that biological warfare agents caused infectious disease which were also medical problems of peacetime, that research on mechanisms and treatment of these disorders, insofar as they were endemic, was a function of the Medical Department which had personnel and equipment adapted for this purpose, and that the Surgeon General should therefore direct and supervise the research on the immunology and therapeutics of disorders due to biological warfare agents. ___/

___/Ltr (S), C CWS to TSG, 17 Jan 1944, sub: Biological Warfare, SPCWII
470.6, and memo (S), C CWS for CS, sub: Biological Warfare, SPCIV 730.

Because it was not possible in practice to make distinctions between defensive and offensive research, since the development of defensive measures was inseparably integrated with offensive investigations, CWS therefore assumed both aspects of biological warfare research, while the Surgeon General agreed to make certain of its medical personnel available for research and designated a liaison officer to keep the SGO apprised of the course of developments. ___/

This degree of participation in the Camp Detrick project was confirmed when plans to conduct medical research in biological warfare in a proposed Medical Division, OC CWS, had to be abandoned. It became evident to the chief of the new Medical Division that he could not effectively administer both chemical and biological warfare research, as planned, and since it was the opinion of the Surgeon General that it would not be proper or desirable for the Medical Department to accept the responsibilities of biological warfare research, both offensive and defensive aspects of the problem were accepted by CWS. ___/ The Chief, CWS, thereupon issued a directive relieving the Medical Division, OC CWS, of its responsibility for biological warfare research and transferring it to the Special Projects Division. ___/ The SPD was required to keep the Surgeon General informed of the progress of biological warfare medical research through official channels, and in turn,

___/Ltr (S), SGO to C CWS, 25 Jan 1944, sub: Liaison Officer at Camp Detrick, Md. SGO 020.

___/Memo (TS), Vol. K.R. Lundberg, MC, OSC for Maj Gen. Kirk, Maj Gen. Lull, Brig. Gen. Hillman and Brig. Gen. Simmons, 30 Mar 1944, sub: CC CWS. In OC CWS.

___/Memo (S), C CWS for C SPD, 5 Apr 1944, sub: Medical Research and Development Activities of the Special Projects Division. SPD 321.

the Surgeon General maintained a liaison officer at Camp Detrick. At the same time, the Surgeon General set up a biological warfare committee in his office, composed of members of the Medical Department serving with the Special Consultant to the Secretary of War. This committee advised the Surgeon General on biological warfare policy and procedure and was also directed to procure, store and issue all biological supplies developed to protect personnel against biological agents. ^{1/}

The liaison officer of the Surgeon General at Camp Detrick performed many duties beyond the scope of mere intercommunication, for he recommended specific fields of research; obtained the advice and cooperation of the Preventive Medicine Service, Veterinary Division and Medical Consultants Division in OSG, provided special medical facilities for SFD, served on the AEC and DEF Committees, supervised certain experimental studies in antibiotics, aided in the procurement and shipment of botulinum toxoid, collection biological warfare intelligence supplied by MED, supervised the testing of prisoners of war, prepared a medical technical bulletin containing notes on certain infectious diseases, supervised clinical activities at the SFD installations, procured medical personnel for the project, aided in the training program, and obtained special medical supplies and hospital equipment for the work at Camp Detrick. ^{2/}

Engineer participation in the program. The activities of the Corps of Engineers at Camp Detrick, Vigo Plant and Granite Peak Installation were severely limited in the interest of security of the project. Ordinarily,

^{2/} Report of Activities of the Representative of the SGO, 15 Jun 1945 (S).
In SGO 020.

^{1/} See ltr (S), C CMS to SG USA, 17 Jan 44, no sub (SPCWM 47C.6-BF-17 Jan 44), and 1st ind, SGO, 25 Jan 44, for policy on procurement of biological products devised at CD.

the Engineers at an Army post are responsible for the operation, maintenance and repair of all post utilities, as well as for all construction except that given to private contractors. Inasmuch as more than a third of Camp Detrick consisted of highly restricted area, the Special Projects Division viewed the large number of civilian employees of the Post Engineer as a possible source of leakage in security. The Special Projects Division therefore obtained permission from ASF to exclude Engineer personnel from this area and to organize its own engineer unit to perform repair and utility functions within the restricted area. Ordnance, Signal Corps and Quartermaster shops were also excluded from the area since there was always danger that the equipment of such shops might become contaminated by pathogenic organisms in the course of operations.

The engineering section in the Technical Department at Camp Detrick, designated E Division, was a self-sustaining organization, and like similar sections at Granite Peak and Vigo Plant, was responsible only to the Engineering Branch, SPD. It had no direct connections with the District Engineer, to whom the Post Engineer was immediately responsible. Facilities of E division consisted of a large machine and carpenter shop and a number of small maintenance centers, all within the restricted area. Each maintenance shop was responsible for a certain group of buildings and facilities. The division was assigned maintenance and repair of the pilot plants, laboratories and buildings, and operation of such special utilities as the process air system, water, sewage and contaminated waste gas systems, and the electrical system in the area.

By agreement with ASF, responsibility of the Chief of Engineers and the Third Service Command for repairs and utilities at Camp Detrick were limited to those areas which were not restricted. All such functions within the

restricted area were the responsibility of the Chief, CWS, and CWS funds were used for such construction and repair as was necessary. ___/

The chief of each Special Projects Division engineer unit was designated as plant engineer, as opposed to the position of Post Engineer occupied by the District Engineer representative. Funds were allocated from the Service Command for normal repair and utility maintenance of the post and this work was subject to inspection, report and control by the Service Command. In the event that dispute arose as to whether work was plant engineer or Post Engineer responsibility, the post commander resolved the matter in favor of the technical mission of the work. Sewage, for instance, was normally a Post Engineer function, but if it contained pathogens it constituted a safety problem to the post as well as to the adjacent countryside and was therefore a plant engineer responsibility.

A similar arrangement was made for the Granite Peak Installation, ___/ but at the Vigo Plant, the 5th Service Command could not agree to the dual organization and made it known that even work performed with CWS funds would require prior approval and inspection by the Service Command. ___/

___/4th Ind, Actg CS ASF, to C CE 11 Jan 1945, on ltr (S), C SFD to C CWS, 18 Dec 1944, sub: Restricted Area. SFD 323.45.

___/ltr (S), OinC GPI to CO DPG, 31 May 1945, sub: Engineering Responsibilities for GPI. SPCID 7-322.011(24 Feb 45).

___/ltr (S), CO VP to C SFD, 4 Aug 1945, no sub.

Because of difficulties attending the administration of Vigo Plant, for a time CWS officers had to be used not only for Engineer functions, but also for Signal and Ordnance functions. The commanding general of the Service Command rated Vigo Plant as a Class VII (storage) installation, although ASF had declared it a Class IV (manufacturing and technical) station, and this obliquity resulted in many operating difficulties for the post. ___/

Under the Chief, Engineering Division, at Vigo was an Outside Area Engineer and a Restricted Area Engineer. Under the Outside Area Engineer was the electrical shop (all transmission and distribution lines), compressor house (refrigeration, compressor operations, air heaters and break tanks), maintenance (tank farm, laundry, and facilities in the 800, 1200, 1300 and 1600 areas), steam plant, and machine shop. Under the Restricted Area Engineer was the instrument shop, Technical Department maintenance, Group A buildings (1166, 1167, 1173, 1131, 1132), Group B buildings (1168, 1169, 1184, 1133), and Group C buildings (1171, 1172, 1175). There were few or no functions for the Post Engineer in CWS areas at Vigo.

The duality of engineering organization in SPD, however necessary, did not go unnoticed by the Control Division, OC CWS. In March 1945, a control officer visited Camp Detrick and reported:

The principal organizational deficiency observed is division of functions by area lines rather than by identity of operation,

___/Ltr (S), CO VP to Insp Gen Hq 5th SvC Columbus Ohio, 28 Jun 45,
sub: Mission and Special Problems of Vigo Chemical Warfare Plant.
SPCYA 322. In Hq VP.

e.g., the Post Engineer and E Division. The Post Engineer has 199 people and plans to increase it to 225, a figure approved by the Service Command. E Division, a part of whose duties are of the same type conducted by Post Engineer, operates only in the restricted area and has a present strength of 221 and some projected increases. The combined total of present strength amounting to 420 is almost 20 percent of the entire strength of the installation. The duplication in personnel skills and activities is apparent from the fact that both these organizations will maintain electrical shops, machine shops, carpentry shops and sheet metal shops; both will participate in ground maintenance and rodent control; both are concerned with water utility operations and with some overlapping sewage activities. The head of E Division is principally a chemical engineer, rather than a mechanical engineer. It is believed that a considerable saving in personnel and facilities could be accomplished by a consolidation of Post Engineer activities under the Technical Division with a financial adjustment with the Service Command. At the same time, superior accomplishment could be expected. ___/

In spite of the merits of merging Post Engineer functions in those assumed by E Division, the ^{division} ~~dichotomy~~ in engineering operations continued to the end of the war.

___/ltr (S), Control Div OC CWS to C CWS, 28 Mar 45, sub: Report of Official Travel by Major Selig J. Levitan to Camp Detrick, Md. SPD 319.1.

Personnel. The Special Projects Division was a combined operation of administrative, technical and medical Army and Navy personnel and civilians. b/ Upon transfer of the biological warfare program to the Chemical Warfare Service in December 1942, War Research Service began at once to secure personnel for the project, while the Personnel Division, OC CWS, located officers and enlisted men in the Army with the necessary skills and brought them into the laboratories and shops of the project. The magnitude of medical research, both military and civilian, carried on in this country during the war created many difficulties in obtaining sufficient competent workers and these difficulties were aggravated by the fact that the project did not carry top priority for securing available workers. Leaders in the field of bacteriology who came into the project as civilians were utilized either in the DAF Committee, were among the 13 consultants to the division, or became administrators of the program.

In view of the medical hazards incidental to operations, which required close observation of all personnel at all times, it was believed desirable for the project to be completely militarized, and indeed civilian employment was held to a minimum. This was because civilians could not be maintained on Special Project Division posts, nor could they be provided with the necessary medical attention. Also it was felt that in the event of an accident to a civilian, the security of the project might be broken and undesirable political complications might result. /

 b/ See Appendix

 /Memo (S), CO CD for C SPD, 21 Jan 1944, sub: Personnel. SPCIF 290.

The tentative table of organization, prepared in February 1943, for the conduct of biological warfare research by the Technical Division, CWS, at facilities to be built at Camp Detrick, provided for 85 officers, including 2 WAC officers, and 373 enlisted personnel, including 80 WAC auxiliaries. At maximum strength, in August 1945, the Special Projects Division had 396 Army officers, 2466 Army enlisted men, 124 Navy officers, 844 Navy enlisted men, and 206 civilians. Detailed data on personnel at other periods during the wartime history of the project are contained in Charts 4, 4a, and 4b.

In mitigation of some of the difficulties of obtaining personnel for the project, enlisted men which had been secured by the division were specifically exempted from requisition for duty overseas and from requisition for the Manhattan District Project. ___/ However, enlisted men brought into the project upon their return from overseas did not, in many cases, prove desirable. A considerable number of them were PN (psychoneurotic) cases. Early in 1945, there were almost 400 enlisted men designated as PN cases at Camp Detrick, and because the nature of the work on the post was not considered conducive to rehabilitation of PN cases, these men were discharged as rapidly as possible. ___/

___/Memo (S), CG ASF for Asst CS G-1, 4 Aug 1945, sub: Procurement of Enlisted Personnel for CWS, SPD. SPD 220.3-EM. Also, directive (S), WDCS to CG ASF, 22 Aug 1945, sub: Procurement of Enlisted Men for CWS, SPL. WDGAP 220.3 CWS (4 Aug 45). Enlisted men were not sent overseas partly as a security measure, since many of them had been vaccinated against one or more of the agents being investigated in SPD and these agents might be identified in the event the men were captured by the enemy.

___/Ltr (S), Dr. I.L. Baldwin to C CWS, 6 Apr 1945, no sub. CD 319.1

Chart 4

PERSONNEL

SPECIAL PROJECTS DIVISION: OC CNS

OC CNS

CAMP FETTERICK
Activated Apr 1943

	CNS	Civ	Army						Navy				Civilian		
			Officers			Enlisted			Officers		Enlisted		CNS	S	
			CNS	SCU	WAC	TCU	SCU	WAC	Navy	Waves	EM	Waves			
AUG 1943	2	-	56	-	-	92	236	71	2	-	-	-	-	-	-
SEP	2	-	67	10	-	107	236	71	2	-	-	-	-	-	-
OCT	3	-	83	10	-	115	241	97	2	-	-	-	-	-	-
NOV	3	-	105	11	11	117	267	110	2	-	-	-	-	-	-
DEC	3	-	109	11	11	113	261	111	2	-	-	-	-	-	-
JAN 1944	4	1	114	10	12	118	280	112	9	3	-	-	-	2	-
FEB	4	1	114	9	12	124	335	111	13	4	-	-	-	2	-
MAR	4	1	119	12	12	165	523	115	17	6	77	46	-	4	-
APR	4	2	151	12	13	237	737	115	20	9	76	45	-	4	-
MAY	4	1	134	13	13	267	686	115	24	9	76	44	-	10	-
JUN	5	-	131	15	13	259	705	111	25	9	68	46	-	15	-
JUL	5	-	210	18	13	261	697	113	27	12	73	53	-	16	-
AUG	6	-	233	19	12	230	861	109	34	12	74	51	-	16	-
SEP	6	2	219	19	12	316	794	103	43	13	104	55	-	11	-
OCT	6	2	236	22	12	323	836	103	52	14	155	69	-	7	-
NOV	6	2	212	21	11	322	849	107	60	12	147	93	-	9	-
DEC	6	3	233	21	12	327	823	110	62	14	156	93	-	9	-
JAN 1945	6	3	207	23	12	333	833	113	67	13	179	98	-	9	-
FEB	6	3	207	25	11	339	831	114	73	14	276	91	-	9	-
MAR	6	4	207	26	11	355	845	117	75	14	354	103	-	8	-
APR	6	4	203	27	11	363	924	120	75	14	380	120	-	8	-
MAY	6	5	204	26	10	381	1025	117	73	14	367	103	-	8	-
JUN	6	5	210	26	10	395	949	115	71	13	353	103	-	8	-
JUL	6	5	210	29	9	407	820	116	71	13	364	113	-	8	-
AUG	5	5	203	23	9	412	933	112	74	13	364	113	-	9	-
SEP	5	4	186	32	8	414	806	64	68	10	238	72	-	9	-
OCT	4	4	161	32	7	426	322	55	56	8	271	52	-	9	-
NOV	4	3	131	28	6	377	239	44	36	3	144	7	-	69	2
DEC	3	2	102	27	5	172	120	10	32	1	107	2	-	114	17

*Figures do not include civilian consultants to SFD

Chart 4a

PERSONNEL

SPECIAL PROJECTS DIVISION OC CWS

VIGO PLANT

URBN ISLAND

GRANITE PEAK

	VIGO PLANT			URBN ISLAND				GRANITE PEAK			
	Army Off	Navy EM	Civ CWS Svc	Army Off	Navy EM	Army Off	Navy EM	Army Off	Navy EM	Army Off	Navy EM
<u>1943</u>											
AUG				Activated							
SEP				Oct 43							
OCT				4 28							
NOV				5 35							
DEC				6 31							
<u>1944</u>											
JAN				8 31							
FEB				10 50							
MAR	Activated			10 59							
APR	May 44			12 74							
MAY	2	Naval Unit	2	15 89							
JUN	8	activated	35	18 103				Activated			
JUL	33 5	Aug 44	42	18 103				Jun 44			
AUG	64 74	2	102	18 107	Naval Unit			5 60	Naval Unit		
SEP	84 112	2 1	110	18 103	Activated			5 63	Activated		
OCT	65 155	5 34	114	18 107	Oct 44			5 69	Oct 44		
NOV	71 214	10 129	117	18 110	2 24			5 70	2 39		
DEC	81 284	21 142	125	20 106	3 25			5 73	3 39		
<u>1945</u>											
JAN	82 400	22 171	125	19 110	4 22			8 76	3 40		
FEB	84 400	23 223	127	15 110	5 30			10 64	3 41		
MAR	93 425	24 235	120	14 113	5 31			9 81	4 51		
APR	96 426	24 242	116	14 114	4 28			10 96	4 53		
MAY	109 644	29 256	113	12 114	4 26			9 91	5 51		
JUN	117 795	31 298	108	12 116	4 26			10 89	5 54		
JUL	115 865	32 304	65	12 98	4 19			-10 97	5 55		
AUG	124 843	32 294	107 95	12 83	1 19			10 83	4 56		
SEP	83 431	17 112	190 80	10 85	Naval Unit			46	4 12		
OCT	63 287	5 22	147 123	5 49	Deactivated			Placed in	5 14		
NOV	38 165	Naval Unit	125 105	Deactivated	25 Sep 45			Stand-by	Deactivate		
DEC	28 123	Deactivated	50 90	18 Nov 45				Condition	30 Oct 45		
		3 Nov 45									
<u>1946</u>											
JAN	26 100		74 85								
FEB	21 67		77 83								
MAR	14 3		74 87								
APR	15		93 91								
MAY	12		91 91								
JUN	8		91 91								

Sources: Personnel Div OC CWS; Demobilization History, Vigo Plant + SPD (in Historical files); Annual Narrative Report, C SPD to C Control Div OC CWS, 4 Jun 1945 (SPD 319.1).

SUMMARIES

	ARMY				TOTAL ARMY	NAVY				TOTAL NAVY	TOTAL CIV	TOTAL PERSONNEL
	Camp Patrick		Else- where			Camp Patrick		Else- where				
	Off	EM	Off	EM		Off	EM	Off	EM			
<u>1943</u>												
AUG	56	399	2		457	2				2		459
SEP	77	414	2		493	2				2		495
OCT	93	453	7	23	531	2				2		533
NOV	127	494	8	35	604	2				2		606
DEC	151	505	9	31	675	2				2		678
<u>1944</u>												
JAN	126	520	12	31	699	12				12	3	714
FEB	135	600	14	50	859	17				17	3	879
MAR	173	753	14	59	949	23	123			146	5	1100
APR	176	1357	15	74	1355	29	121			150	6	1511
MAY	192	1303	21	89	1370	32	120			153	13	1536
JUN	209	1373	31	103	1421	34	134			158	50	1609
JUL	249	1271	63	103	1491	39	131			170	58	1919
AUG	254	1176	93	242	1491	46	128	2		176	116	2075
SEP	253	1213	90	283	1541	56	159	2	1	213	123	2132
OCT	235	1297	97	333	1575	66	204	5	31	309	123	2287
NOV	244	1280	100	394	1528	72	240	14	192	515	120	2604
DEC	241	1280	112	463	1576	76	249	27	203	533	137	2771
<u>1945</u>												
JAN	242	1234	115	536	2227	60	277	29	233	619	137	2983
FEB	243	1224	115	574	2226	67	367	31	294	779	133	3125
MAR	244	1317	122	619	2302	89	457	33	317	890	132	3410
APR	241	1412	126	636	2415	69	500	32	323	944	128	3487
MAY	240	1530	136	547	2755	67	475	38	333	933	126	3814
JUN	246	1459	145	1000	2850	84	451	40	373	963	121	3934
JUL	243	1403	143	1033	2852	84	477	41	373	980	70	3910
AUG	245	1457	151	1019	2872	97	475	37	369	948	206	4046
SEP	226	884	103	612	1325	78	310	21	124	533	285	2543
OCT	200	603	77	336	1116	64	323	10	36	433	236	2135
NOV	163	710	42	165	1092	39	151			190	371	1593
DEC	134	302	31	123	590	33	109			142	129	1161

*Figures in the Total Army and Total Civilian columns are at variance with final figures released by Personnel Division CC C.S. Representative totals for SPD compiled by Personnel Division are:
Officers & EM Civilians

Jul 1944	1420	52
Dec 1944	1362	62
Jan 1945	1906	69
Jul 1945	2226	40
Dec 1945	333	174

The Navy appeared to be able to furnish enlisted personnel with higher technical skills than the Army. In March 1945, it was noted that of the 576 Navy enlisted men assigned to Camp Detrick, over 500 were assigned to technical duties, whereas of 1240 CWS personnel at the station, approximately 700 were assigned to what were essentially post and overhead activities. ___/

Personnel problems at the Vigo Plant were described at length in a letter in June 1945 to the 5th Service Command at Columbus, Ohio. Where the Navy Department had furnished its full quota of 25 percent of the personnel, the War Department had not met its allotments. Those furnished lacked qualifications for the work they had to do and requests to ASF for special ratings for their competent technical personnel were denied. It was declared that between a third and a half of personnel furnished to the Vigo Plant were unfit, sick, or had sufficient points for discharge.

Comparisons between the quality of Army and Navy personnel and between the handling of Army and Navy personnel at Vigo Plant, as at Camp Detrick, inevitably resulted in some friction. Because Navy maximum punishments for infraction of regulations were less than those of the Army, the posts

___/Control Division CC CWS report by Major S. Levitan, 28 Mar 1945.
SPD 319.1.

tended to adopt the lesser punishments. Because Navy restrictions on liberty were considerably less than Army, Navy furloughs and leaves were reduced, with the consent of the naval commanders, to those allowed to Army personnel. Navy requests to paint or refurbish their barracks and offices had to be refused because Army facilities could not be treated the same way. ___/

It is necessary to state, however, despite these minor conflicts, that Army and Navy personnel on the various Special Projects Division posts worked together in almost exemplary harmony, with remarkably few exceptions.

___/Ltr (S), CO VP to Insp Gen Hq 5th SvC, 28 Jun 1945, sub: Mission and Special Problems of Vigo Chemical Warfare Plant. SPCYA 322. In Hq Vigo.

Of the 822 people working at Camp Detrick on 31 July 1947, 455 or more than half of them were engaged in work in the Research and Development Department. These 455 included 360 of the 574 CWS personnel at Camp Detrick and 95 of the 109 Navy personnel at Camp Detrick.

With 360 CWS personnel engaged in the Research and Development Department, the remaining 214 were working for the Executive Office, Adjutant, Fiscal, Control, Civilian Personnel, Property, and Service and Supply sections. All 139 Second Army employees were in the office of the Surgeon, Engineer, Service and Supply, or the Post Exchange. With 95 of the 109 Navy personnel in the Research and Development Department, the remaining 14 were in the Administration office of the Navy unit at Camp Detrick.

The ratings of civilian employees at Camp Detrick provide another kind of analysis of the jobs being performed. As of 30 Jun 3 1947, a total of 656 civilians were reported employed at Frederick. ___/ Of these, 112 were in professional grades, ___/ 153 in CAF grades, 79 in subprofessional grades, 30 in CPC grades, and 282 were ungraded. ___/

___/This figure is slightly at variance with the 660 reported in the Daily Personnel Strength Report for that date.

___/These included one P-1, fifteen P-2, thirty-three P-3, twenty-two P-4, thirteen P-5, eighteen P-6, two P-7, and eight P-8, most of which were in the biological and medical sciences.

___/Ltr (C), CO CD to OC Cml C, 31 Jul 1947, sub: Continuing Historical Record of Chemical Corps Installation Activities. CMLCD. In CD Tech Dept (History of Camp Detrick).

Research contracts. The War Research Service, established in the Federal Security Agency to conduct biological warfare operations in this country, had no investigative facilities of its own. It was empowered, however, to contract for all necessary research with university and institutional research laboratories. The assistant to the Federal Security Administrator was made responsible for all fiscal matters connected with these research contracts, as well as for other expenses incurred by the War Research Service. Between September 1942 and July 1943, a total of \$685,000 was made available to WRS from the President's Emergency Funds. Although the greater part of this sum went for research, it nevertheless represented only a small part of the total investment of the universities and individuals who cooperated in the program, since much of the costs were born by the universities in their eagerness to serve in the war effort. ___/

Approximately 25 such contracts were established by War Research Service. The contracts were classified secret and the subject of biological warfare did not appear anywhere in the correspondence or agreement. The work to be done was merely described as "studies and experimental investi-

___/The OSRD type of contract was used by WRS except that no provision for accident insurance or compensation for nongovernmental personnel was possible in a WRS contract, and whereas OSRD contracts provided a flat allowance to an institution for overhead costs on a percentage basis, the WRS contract provided for overhead on the basis of actual costs only. This latter proviso was adopted because WRS contracts, in contrast with those of OSRD, represented a relatively small investment, usually entailing no increase in overhead costs. The contracts were, in effect, grants-in-aid to the institution to continue or intensify investigations which were already in progress, extending them to cover biological warfare aspects.

gations in connection with research projects of the War Research Service."

In many instances, only the project director knew the secret nature of the work and he was instructed to disclose to his assistants only the minimum of information which they needed in order to carry out their laboratory assignments. ___/

In July 1944, a number of these contracts were transferred to the Chemical Warfare Service and those that were not transferred were terminated by WRS. The Federal Security Agency renewed all contracts taken over by CWS for the period to 1 September 1944, after which further costs were borne by the service. On that latter date, CWS had assumed contracts valued at approximately \$460,000.

The breakdown of War Research Service and Chemical Warfare Service contracts is as follows:

___/Summary report of WRS activities prepared by Mrs. Mary Switzer, assistant to Federal Security Administrator (no date). In WRS files of NAS, KS copy in Historical files.

Contracts set up or assumed by CWS for Special Projects Division,
1 Sep 1944:

Dr. J. W. Mitchell Bureau of Plant Industry, USDA Beltsville, Md.	Plant growth regulators	\$15,000.00 (1 Sep 44-30 Jun 44)
NAS-NRC DEF Committee	Supervisory expenses	15,000.00
Sheffield Farms Co., Inc. New York, New York	Casein research	45,000.00
U.S. Bureau of Mines Explosive Experiment Station Bruceton, Pa.	Investigation of nitroso guanidine as gas generator for propellant	(none) (MDRC, Div B)

Contracts supported by CWS but administered by Joint U.S.-Canadian Commiss

Lt.Col. M. W. Hale, VC, Director Gross Ile, Quebec, Canada (contract with War Supplies, Ltd.)	Rinderpest	\$224,350.00 (1 Sep 44-31 Aug 45)
Dr. Carl A. Brandly, USDA Huntington Memorial Hospital Harvard University (contract initiated by WRS)	Fowl plague and Newcastle disease	152,661.21 (8 Mar 43-31 Aug 44) 76,000.00 (1 Sep 44-30 Jun 45)

Contracts set up by other agencies, with CWS liaison:

Capt. Albert P. Krueger (MC), USNR U.S. Naval Medical Research Unit No. 1 University of California (originally a UofCal-Navy-WRS project)	Plague	(none) (WRS contract for \$14,485.08, 1 Sep 43- 30 Jun 44, trfd to Bumed 1 Jul 44)
Office of the Surgeon General U.S. Army	Blood studies	
Dr. James A. Reyniers Laboratories of Bacteriology University of Notre Dame	Typhus fever	

Contracts set up by WRS but terminated prior to 1 Sep 1944:

Dr. William A. Hagan N.Y. State Veterinary College Cornell University (trfd to CWS 31 Mar 43)	Anthrax	\$2,762.54 (1 Jan 43-30 Jun 44)
Dr. J. Howard Mueller Dept. of Bact. and Immun. Harvard Medical School (trfd to CWS 31 Mar 43)	Botulism	3,886.17 (1 Dec 42-30 Jun 44)
Dr. Rene J. Dubos Dept. of Tropical Medicine Harvard Medical School (trfd to CWS 1 Jul 44)	Dysentery	6,937.33 (1 May 43-30 Jun 44)
Dr. Perry W. Wilson Dept. of Bacteriology University of Wisconsin (trfd to CWS 30 Jun 44)	Mass culture of spores	698.84 (1 Jul 43-30 Jun 44)
Dr. Louis A. Julianelle Division of Infectious Diseases Pub. Health Res. Inst. of N.Y. (trfd to CWS 1 Jul 44)	Anthrax immuni- zation	10,369.82 (1 Jul 43-31 Aug 44)
Dr. Freeman A. Weiss Bureau of Plant Industry, USDA Beltsville, Md. (trfd to CWS 1 Jul 44)	Sclerotium rot	8,164.55 (6 Feb 43-30 Jun 44)
Dr. Reiner Bonde Maine Agro, Exper. Station University of Maine (trfd to CWS 29 Oct 43)	Late blight	1,470.96 (15 Feb 43-30 Nov 43)
Dr. I. Forrest Euddleson Central Brucella Station Michigan State College	Brucellosis	2,484.43 (1 Jan 43-30 Jun 43)
Dr. William H. Martin New Jersey Experimental Station Rutgers University	Late blight	216.54 (1 May 43-30 Nov 43)
Miss Elizabeth McCoy Dept. of Bacteriology University of Wisconsin	Botulism	1,940.58 (1 Jan 43-31 Dec 43)
Dr. Ralph Tarbett Sanitary Engineer Director U.S. Public Health Service	Survey of water supply systems (1 Apr of primary military importance)	3,066.82 (1 Apr 43-31 May 43)

Independent studies in which CNS was interested:

Dr. E. C. Auchter Agriculture Research Administration U.S. Department of Agriculture	Pest prevention and plant disease survey
Dr. Rolla E. Dyer National Institute of Health USPHS, Bethesda, Md.	Blood studies
Dr. J. J. Griffiths National Institute of Health USPHS, Bethesda, Md.	Cholera
Dr. H. W. Shoening Bureau of Animal Industry U.S. Department of Agriculture (for Joint WRS-USDA Committee)	Foot and mouth disease
Comdr. R. E. Shope, USNR Rockefeller Institute Princeton, N.J. (for War Disease Control Station, Quebec, Canada)	Rinderpest
Dr. N. H. Topping National Institute of Health USPHS, Bethesda, Md.	Typhus fever

Contract set up by WRS and transferred to CWS on 1 Jul 1944:

Dr. Lee Foshay Dept. of Bacteriology University of Cincinnati	Tularemia	\$ 5,109.87 (1 Oct 43-31 Aug 44) 9,600.00 (1 Sep 44-30 Jun 45)
Dr. Byron Reigel Dept. of Chemistry Northwestern University	Mussel poisoning	7,528.53 (1 Mar 43-31 Aug 44) 10,000.00 (1 Sep 44-30 Jun 45)
Dr. Hermann Sommer Geo. Williams Hooper Foundation University of California	Mussel poisoning	688.93 (1 Mar 44-31 Aug 44) 3,000.00 (1 Sep 44-30 Jun 45)
Dr. Cora M. Downs Dept. of Bacteriology University of Kansas	Tularemia	3,775.62 (1 Mar 44-31 Aug 44) 9,600.00 (1 Sep 44-30 Jun 45)
Dr. E.C. Tullis Bureau of Plant Industry, USDA Beaumont, Texas	Rice diseases	568.46 (1 Oct 43-31 Aug 44) 3,000.00 (1 Sep 44-30 Jun 45)
Dr. Melvin S. Newman Dept. of Chemistry Ohio State University	Plant growth regulators	3,741.86 (1 May 44-31 Aug 44) 9,000.00 (1 Sep 44-30 Jun 45)
Capt. Arthur R. Lack, MD, USA Stanford University School of Medicine	Coccidioidomycosis	10,951.83 (1 Jul 43-31 Aug 44) 14,000.00 (1 Sep 44-30 Jun 45)
Dr. James A. Reyniers Laboratories of Bacteriology University of Notre Dame	Preservation of rickettsia	26,841.58 (1 Jan 43-31 Aug 44) 9,000.00 (1 Sep 44-30 Jun 45)
Dr. Forrest E. Kendall Coldwater Memorial Hospital Welfare Island, New York and	Anthrax immunization	9,760.20 (1 Mar 43-30 Jun 44) 16,000.00 (1 Jul 44-30 Jun 45)
Dr. Michael Heidelberger College of Physicians and Surgeons Columbia University		
Dr. E. J. Kraus Dept. of Botany University of Chicago	Plant growth regulators	3,500.00 (1 Dec 42-31 Mar 43) 3,936.80 (16 Feb 44-30 Jun 44) 3,000.00 (1 Jul 44-30 Jun 45)

FACILITIES AND FISCAL ACCOUNTS
~~COST AND CONSTRUCTION OF FACILITIES~~

Camp Detrick. Detrick Field, 800 yards from the city line of Frederick, Maryland, was acquired as a facility of Technical Division, CWS, for experimental studies in biological warfare. The total acreage of the post when completed was 541.02 acres. Of this, 142.62 acres were purchased for \$62,000 and 398.4 acres were leased at an annual rental of \$4,850. An additional area of approximately 19 acres, designated as the Monocacy River Water Filtration Plant, had to be acquired later at a cost of \$11,101 in order to provide an adequate source of water for the camp when the city water supply failed to meet the camp's requirements.

- The original estimates for construction at Camp Detrick were \$606,375 for technical facilities and \$600,000 for troops housing and administration facilities. On 1 April 1943 the sum of \$1,250,000 was transferred from CWS funds to the Corps of Engineers, a contract was drawn up with the H. K. Ferguson Company, industrial engineers and builders of Cleveland and New York, and construction began just two weeks later.

In May 1943, it was proposed that a pilot plant for the production of botulinum toxin be added to the technical facilities and that five

 /Ltr Div Eng Middle Atlantic Div to CO CD, 29 Jun 1944, sub: Acquisition of Land. MAIRE 5-601.1

additional laboratories be erected for research to be conducted by Medical Division, CWS. Two months later, the estimate was again revised when plans were drawn up for additional installations at Horn Island and Granite Peak, where biological agents and munitions were to be tested and proved. The original estimate of costs, \$1,250,000, was therefore raised to \$5,100,000, broken down as follows: ___/

Technical research facilities at Camp Detrick	\$3,350,000
Medical research facilities at Camp Detrick	700,000
Technical and medical facilities at Horn Island	450,000
Technical and medical facilities at Granite Peak	350,000
Contingency funds	250,000

The tremendous increase in the cost of facilities at Camp Detrick, it was explained, represented increased costs of labor when the basic labor rate at Frederick of 45 cents an hour had to be raised to 75 cents an hour in order to obtain sufficient labor. Other factors were changed in basic plans to provide greater internal security and greater safety, additional construction, overtime and Sunday work to speed construction, increase in the size of the pilot plant installation, and additional water and sewage facilities.

The Camp Detrick that was finally completed in June 1945 bore little likeness to the research station originally planned. By that time a small self-contained city had been built, containing more than 245 separate structures and including quarters for 5,000 workers, a complete

___/Memo (S), Dr. I. L. Baldwin for C Tech Div OC CWS, (23 Jul 43) sub-Plans for B.W. Work. 314.7. In Historical files.

hospital unit, fire department, laundry plant, chapel and theater, library, post exchange, recreation halls, and a swimming pool. The principal structures on the post, however, were the laboratories and pilot plants within the restricted area which had to be supplied with independent water, air, and steam plants, and other units to treat air, sewage, and water leaving these structures (Appendix F). The final cost of Camp Detrick was \$12,721,700.07.

Actual obligations incurred by the Chemical Warfare Service for research and development (CWS-610 funds) and for maintenance and operation (CWS-310 and other funds) at Camp Detrick from April 1943 through June 1947 were as follows:

For period 20 Apr 1943-30 Jun 1943:

CWS-610 and 310 (Camp Detrick and Horn Island)	\$	6,990.83
3d SvC funds		1,008.58
Richmond ASF Depot funds		453.49

/Memo (S), Maj Shaw for C SPD, 1 Nov 45, sub: Expenditures of Special Projects Division. SPD 321.

/Allotment Ledger for fiscal years 1943-1948. In Fiscal Div, CD. Also ltr CO CD to OC CWS, 17 Jul 46, sub: Continuing Historical Record of CWS Activities (CWS-CD); ltr (C), CO CD to C Analysis & Files Div. CW Sch EA, 15 Jan 47, sub: Continuing Historical Record of Chemical Corps Activities; ltr (C), CO CD to OC Cml C, 31 Jul 47, sub: Continuing Historical Record of Chemical Corps Installation Activities (CMLCD). Ltrs in CD Tech Dept (History of Camp Detrick).

Note: These obligations for the period 20 Apr 43-30 Jun 45 do not include cost of construction, original equipment or pay of military personnel.

For period 1 Jul 1943-30 Jun 1944:

CWS-610 and 310 (Camp Detrick and Horn Island)	\$1,252,296.76
3d Svc funds	49,513.92
Richmond ASF Depot funds	4,292.26

For period 1 Jul 1944-30 Jun 1945:

CWS-610 and 310 (Camp Detrick and Eorn Island)	1,674,862.50
3d Svc funds	152,017.93
Richmond ASF Depot funds	13,396.52

For period 1 Jul 1945-31 Dec 1945 (half FY):

CWS-610 (Camp Detrick)	918,838.56
(Horn Island)	2,316.18
CWS-310 (Camp Detrick)	126,149.38
(Horn Island)	404.74
3d Svc funds	33,998.28

For period 1 Jan 1946-30 Jun 1946 (half FY):

CWS-610 (Camp Detrick)	639,074.11
(Horn Island)	236.89
CWS-310 (Camp Detrick)	95,933.22
2d Army and 3d Svc funds	293,960.34

For period 1 Jul 1946-31 Dec 1946 (half FY):

CWS-610	752,993.36
CWS-310	113,065.81
CWS-other	82,184.91
2d Army funds	266,226.34

For period 1 Jan 1947-30 Jun 1947 (half FY):

CWS-610	1,160,536.09
CWS-310	144,767.10
CWS-others	95,940.71
2d Army funds	295,630.83

Contracts with universities and research institutions for the fiscal year 1944 (contract obligations were assumed by CWS on 1 Sep 1944) amounted to \$681,020.71, and for the fiscal year 1945 (up to 31 Mar 1945) \$406,845.19.

Horn Island. In February 1943, the Planning and Engineering Branch, Industrial Division, OC CWS, requested the Corps of Engineers to acquire Horn Island for the Chemical Warfare Service. The 4,153.75 acres of sand dune and shrubs were leased at an annual rental of \$498.10.

It was estimated that \$350,000 would be adequate for construction required on the island and in June 1943 this amount was transferred to the Corps of Engineers who contracted with the H. K. Ferguson Company to do the work. Construction of the quarters, animal houses, munition magazines and technical buildings adjacent to the grid area was completed that October, at a total cost of \$346,179.37 (Figure 1).

Construction costs of the narrow gauge railroad laid across Horn Island, as well as maintenance and operating costs, were borne by CWS funds provided for Camp Detrick, since Horn Island in its first year of operation was a substation of Camp Detrick.

Granite Peak Installation. The Granite Peak area, 250 square miles adjacent to Dugway Proving Ground, was actually a part of the

PASCAGOULA
MISS.

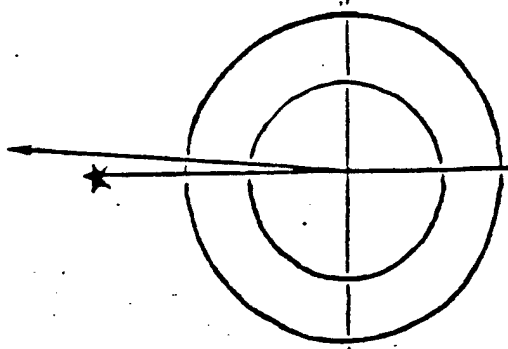

MISSISSIPPI
SOUND

GULF
OF
MEXI

Corral
Area

Dock and
Administration Area

Operations
Area

Grid
Area

HORN IS.

SPECIAL PROJECTS DIVISION, CWS

SCALE: APPROX. 1:80,000

REC

Figure 1. Map of Horn Island.

Wendover Bombing Range, under control of the Army Air Forces. Because of its extreme isolation, this area could be used more safely as a proving ground for living biological agents than Horn Island. The Army Air Forces turned Granite Peak over to the Chemical Warfare Service by verbal assent in June 1944 and the area was subsequently formally transferred to CWS as a substation of Dugway Proving Ground.

Because Granite Peak was 35 miles from the military post of Dugway Proving Ground, the facilities provided for its 150 inhabitants had to be fairly complete to provide heat, light and power for the installation, special facilities for the biological laboratories, together with quarters for the test personnel and the building of an airplane landing strip. As a result, the cost of construction at Granite Peak was \$1,343,334. Construction by the H. K. Ferguson Co. was started in July 1944 and completed at the end of November.

Vigo Plant. The Vigo Ordnance Plant, situated in a 6,100-acre tract of land six miles south of Terre Haute, Indiana, was acquired by the Chemical Warfare Service by transfer from Ordnance. It was originally estimated that to build adequate facilities for the manufacture of agents at Huntsville Arsenal would cost \$7,110,225, whereas it was believed that existing facilities at Vigo could be converted for this work for \$5,625,000, thus saving almost one and a

half million dollars. ___/ The final cost of construction at Vigo, let to the H. K. Ferguson Company on a cost-plus-a-fixed-fee basis, was \$7,880,838.

In addition to converting many of the structures at Vigo, it also became necessary to erect a laundry, theater, an 85-bed hospital, maintenance shops, boiler houses and engine houses, and such special production facilities as laboratories, incinerators, steam power plant, air compressor unit, refrigeration plant, and the complete main manufacturing unit consisting of slurry heater, catalyst, reactor and separation buildings.

Reconversion and construction was started on 15 May 1944. On 30 April 1945, at which time the Ferguson contract was closed out, the work that had been done was described as "the design and construction for the conversion of existing facilities...together with necessary additional manufacturing and auxiliary buildings, structures, utilities, facilities, and appurtenances, including process equipment and process piping for a plant for the manufacture and loading into bombs, packed and crated for shipment, of an essential war material, product 'Ink-B', and the construction of an animal farm." ___/ The total cost at that

___/Memo (S), Actg C Facilities Sec for C Facilities & Requirements Br OC CWS, 1 Apr 44, sub: The WYE Project. SPD 730-WYE.

___/Field Progress Report for Period Ending 30 Apr 45 (ED Form No. 602), 2 May 45. In Office of Resident Engineer, VP.

time had reached \$7,837,784, but certain of the equipment was to be changed or augmented before the final total of \$7,880,838 was achieved.

Manufactured materials required by the Vigo Plant, including large quantities of agent ingredients and completed, unfilled bomb casings, amounted to \$956,967.

In an informal report prepared shortly after the war, it was estimated that the total cost of biological warfare research in the Special Projects Division, OC CNS, was approximately \$25,474,526:

Camp Detrick - construction	\$12,151,348.20
maintenance and operation	189,676.32
research and development	<u>2,573,334.09</u>
	14,914,358.61
Vigo Plant - construction	7,880,838.11
manufacturing	956,967.19
maintenance and operation	<u>59.73</u>
	8,837,865.03
Horn Island - construction	346,179.37
Granite Peak - construction	1,343,334.39
maintenance and operation	2.40
research and development	<u>32,785.73</u>
	1,376,122.52

These figures represented only the costs to the Chemical Warfare Service and did not show funds supplied to SPD by the Service Commands or other agencies of the War Department which provided funds or special facilities of their own at SPD installations. Furthermore, these figures do not

 Memo (S), Maj Shaw for C SPD, 1 Nov 45, sub: Expenditures of Special Projects Division. SPD 321.

include the cost of research contracts with universities, nor do they reflect the original cost of Vigo, built with Ordnance funds for \$21,288,746.

Pilot Plants at Camp Detrick. The purpose in constructing Camp Detrick was to produce biological warfare agents on a pilot plant scale. In order to do this, sufficient information had first to be determined by laboratory study, to establish the proper design and operation of a pilot plant. Then experimental data had to be obtained through the operation of the pilot plant so that large scale production might be achieved at Vigo Plant with minimum delay and maximum efficiency. Incidental to this mission, which was that of the Pilot Plant Branch at Camp Detrick, was the requirement that its plant produce sufficient quantities of agent materials to meet the needs of other investigations being conducted at Camp Detrick, Horn Island and Granite Peak Installation. ___/

The original pilot plant was a temporary wooden two-story structure, built early in 1943 in order to obtain data for the design of future plants. Through the limited operations conducted in this plant, the problems in treatment of contaminated liquid wastes, contaminated vent gases, and process air were first realized and partially solved. Much

___/Sp Rpt 42, Engineering, Construction, Operation, Maintenance, and Development in Restricted Area, sec I. General, 15 Nov 45.

was also learned about the preparation of slurry, the piping arrangement of process tanks, and the accessories needed in a pilot plant. ___/

The first engineered pilot plant, for the production of botulinum toxin, was completed in October 1943 and designated Pilot Plant No. 1. It was constructed in the Detrick Field hangar in the southeast corner of the restricted area (Bldg 201) ^{(Figure 2).} Operations in Plant No. 1 were of the batch type, that is, the slurry was prepared individually for each separate system of catalyst and reactor tanks in which the agent material was produced. There were 7 catalyst tanks of 13 gallons capacity each and 7 reactor tanks of 250 gallons each. The plant also included a separation system of centrifuges and settling tanks, a waste liquid disposal system, and a vent gas disposal system. ___/

Pilot Plant No. 2, located adjacent to Plant No. 1 in Building 201, was built in order to produce anthrax spores and the anthrax simulant, Bacillus globigii. The plant was completed in March 1944 and while essentially similar to the previous plant, it had considerably greater production capacity. Instead of a batch system, a continuous slurry system was devised and installed in the plant. Its process tanks included 4 pre-catalyst tanks of 13 gallon capacity

___/Sp Rpt 42, sec II. Black Maria.

___/Sp Rpt 5, Pilot Plant Construction and Operation, Oct 44, pp. 1-19.
Sp Rpt 42, sec III, Plant I Area II.

MAP INDEX TO BUILDINGS IN

THE PILOT PLANT AREAS*

PLANT AREA I (Buildings in yellow)

- Bldg 201 - Pilot Plant No. 1 and Pilot Plant No. 2
- Bldg 263 - Pilot Plant T-63
- Bldg T-280 - Retention tube building
- Bldg T-270 - Sewage treatment plant
- Bldg T-235 - Incinerator
- Bldg 294 - Incinerator
- Bldg T-278 - Water storage tanks
- Bldg T-277 - Spray pond
- Bldg T-276 - Spray pond pump house
- Bldg T-243 - Animal building and laboratory

PLANT AREAS II and III (Buildings in green and blue)

- Bldg 325 - Pilot Plant No. 3
- Bldg 431 - Pilot Plant No. 4
- Bldg T-434 - Pilot Plant No. 4
- Bldg T-459 - Refrigerator building
- Bldg T-314 - Sewage treatment plant
- Bldg 312 - Waste incinerator
- Bldg 313 - Waste gas incinerator

PLANT AREA IV (Buildings in gray)

- Bldg T-522 - Animal building
- Bldg T-524 - Gas chamber and laboratory
- Bldg T-525 - Laboratory
- Bldg T-526 - Laboratory
- Bldg T-509 - Sewage treatment plant
- Bldg 520 - Incinerator

*For index to other buildings at Camp Detrick, see Appendix F .

SECRET

SECRET

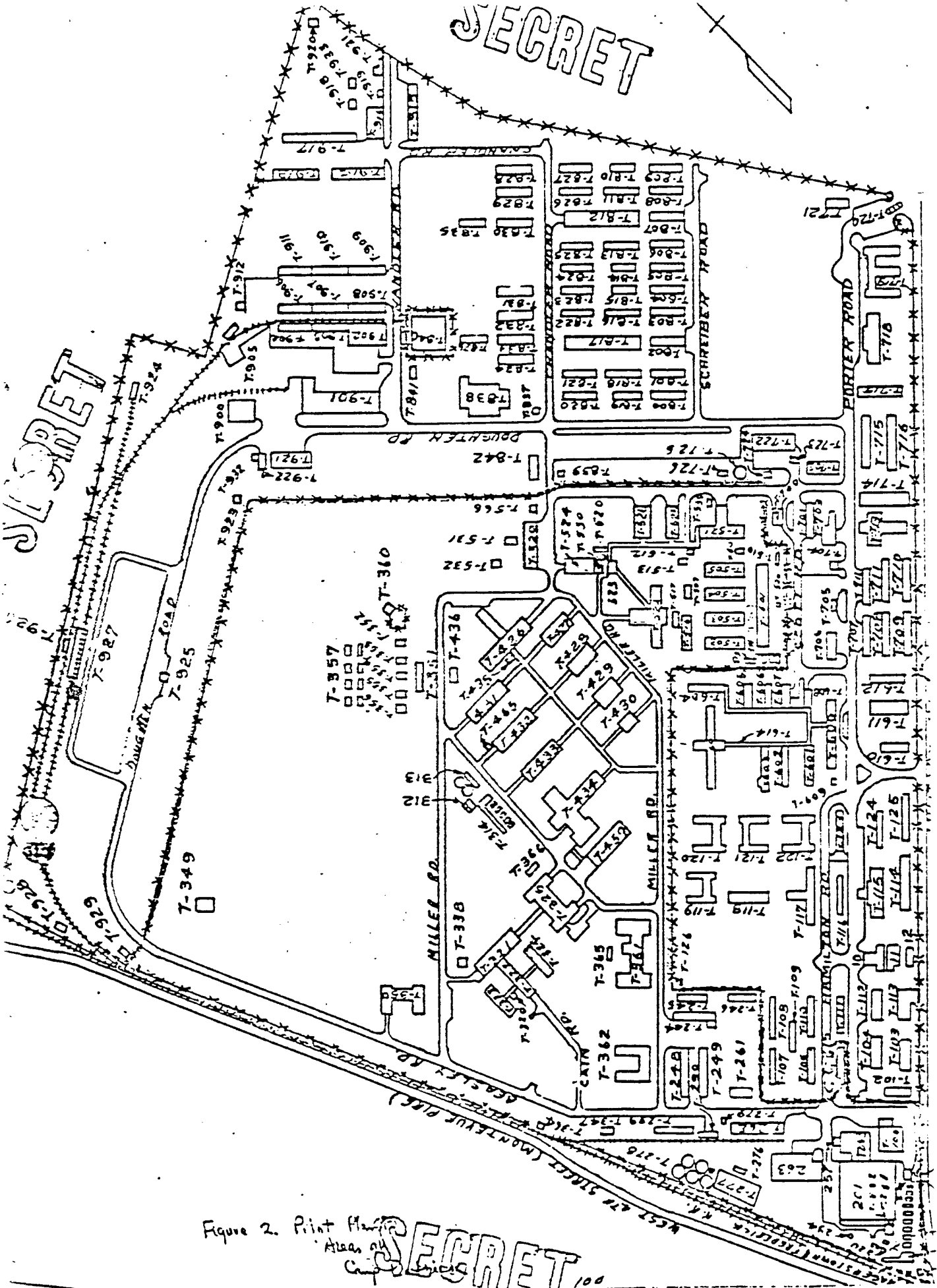

Figure 2. Point Map
Atlas of
Camp Detrick

SECRET

each, 4 catalyst tanks of 250 gallon capacity, and 3 reactor tanks, 2 of 3,700 gallon capacity and the third, 10,000 gallons. The plant consisted of a slurry preparation room apart from the plant proper, a slurry sterilization system, the process tanks for growth of the agent material, and waste and vent gas disposal systems. ___/

Pilot Plant T-62 (Bldg 263), completed in March 1944, was actually part of Pilot Plant No. 2. Agent material grown in slurry in Plant No. 2 was conveyed to Plant T-63 where the agent was separated from the mother liquor, dried and prepared as filling for munitions. The equipment used in this building to perform the separation and drying processes consisted to three 5,000-gallon receiving tanks, Dorr thickeners, Charles autojector centrifuges, vacuum evaporators, Fletcher centrifuges, lyophilizers, Buflovac drum driers, and spray driers. ___/

Pilot Plant No. 3 (Bldg 325), completed in February 1945, was designed for the production of plant pathogens. Two greenhouses and two laboratory buildings for research and control were built adjacent to the plant. ___/

___/Sp Rpt 5, pp. 19-28.
Sp Rpt 42, sec IV, Pilot Plant II.

___/Sp Rpt 5, pp. 28-34.
Sp Rpt 42, sec V, Pilot Plant T-63.

___/Sp Rpt 5, pp. 35-36.
Sp Rpt 42, sec VII, Pilot Plant III and Area.
Sp Rpt 38, A Pilot Plant for the Production of Plant Pathogens,
Nov 45.

Pilot Plant No. 4 was completed in January 1945. It consisted of two main structures. Building 431 was designed for the production of brucellosis agent material, ___/ Building T-434 for the production of psittacosis virus in embryonated eggs. The latter structure varied considerably from all previous plants; in addition to its special requirements for handling, inoculating, and incubating eggs, a refrigeration building (Bldg T-459) was also necessary for the storage of large supplies of eggs.

Further discussion of the pilot plants and the conduct of operations in them are reported in the sections on pilot plant production of the various agents.

The necessity of producing pathogenic agents in large quantities in these pilot plants created two distinct problems hitherto unknown in industry; how to prevent organisms from escaping from the plant systems and infecting operating personnel or contaminating adjacent areas, and how to prevent contamination of the agent culture itself by undesirable organisms, either through the process air or use of an

___/Sp Rpt 5, pp, 37-38.

Sp Rpt 42, sec VIII. Pilot Plant IV and Area.

unsterilized slurry. ___/

An effort was made to meet these problems by designing a system which would be closed and leakproof from the time of the initial inoculation through the filling of the munition. This was partially attained in the original pilot plants by utilizing a welded pipe system throughout, with screwed fittings and connections kept to a minimum. Apparatus such as centrifugal pumps and globe valves which could not maintain a positive seal were eliminated unless absolutely required. Wooden structures and piping insulation were prohibited since they were capable of harboring pathogenic organisms. The floors of the structures were of concrete, while all walls were faced with glazed tile.

As originally designed, the plants were rather complicated because of the desire to obtain flexibility in operation. Although either the entire plant or portions of various systems in the plant could be operated independently, it resulted in a complicated system of pipes and valves which was later found detrimental to successful operation,

___/The only analogous commercial plants similarly engaged in the mass production of micro-organisms were those producing alcohol and penicillin. However, none of the micro-organisms used in these processes was pathogenic. Yeasts which produce ethyl alcohol grow under highly acid conditions which inhibit the growth of competing organisms. Butyl alcohol production is dependent on anaerobic organisms, unlike anthrax, for example, which requires large volumes of air. Penicillin grows in a degree of acidity (pH3) which is inimical to competition, and is itself capable of destroying competing organisms which invade the culture.

particularly when decontaminating the plant system. The insistence on a closed system of production resulted in its harboring contaminants, and between the sealed system and the complicated piping, locating sites of contamination became almost impossible. It had been assumed that the entire system could be decontaminated by steam, but early production results indicated that the steam was not reaching all portions of the system. The principal sources of contamination proved to be air pockets or dead spots in the closed system in which condensate accumulated. Failure to drive all the air out of the system prior to introducing the steam resulted in the collection of blocks of air which resisted sterilization of the piping. ___/ An effort was made to eliminate certain of the valves and piping, bleeder lines were provided to facilitate steam decontamination, and by providing proper drainage in both tanks and piping and replacing the original valves with an improved type, many of these difficulties were overcome. ___/

An additional source of contamination was the absorbent material used for gasketing and packing in the valves, stems, pumps and flanges. Contaminated liquid was absorbed by the material which could not always

___/Sp Rpt 42, sec XI, Decontamination of Plant Equipment.

___/Sp Rpt 42, sec XIII, Gaskets; sec XIV, Sampling Adapters; sec XV, Catalyst Feeders; sec XVI, Shaft Seals; sec XVII, Dura-seal; sec XVIII, Liquid Level Gauge; sec XIX, Hills-McCanna Diaphragm.

be sterilized by the steam. This condition was corrected by reducing the amount of absorbent used and restricting its use to clean portions of the system. The use of metal-jacketed asbestos gaskets further improved operation results. Occasional batch contamination resulted from the process air, as a result of insufficient treatment of the air used to feed the growing organisms. To overcome this, an inlet electromagnetic filter was installed through which the air passed prior to its intake in the compressors. After leaving the compressors, the air was conveyed through a heater which raised its temperature to approximately 400° F. The air was then cooled and passed through tanks containing glass-wool filters before being supplied to the pilot plants or laboratories. ✓

A final source of culture contamination was caused by improper sterilization of the slurry media. Slow heating over an appreciable time permitted considerable spoilage which was not eliminated until this method was replaced by one analogous to flash pasteurization. The slurry media was prepared and then heated quickly to about 300° F. by means of a steam jet heater. The slurry passed through retention tubes for five minutes and then went into heat exchangers where it was cooled to 90-100° F. before it went to the growth tanks.

___/Sp Rpt 42, sec VI, Process Air for Plants I, II, and T-63.

Disposal of liquid wastes. Contamination by the laboratories and pilot plants of the surrounding area was successfully prevented by decontaminating all process waste liquids, vent gases, and ventilation air.

The system evolved by E Division for the disposal of sewage comprised sites of collection, passage of the waste to a point where it could be decontaminated by live steam, and final transfer into the City of Frederick sewer system. During this process, the waste had to be preheated before being subjected to the decontaminating steam and after decontamination had to be cooled before it was ejected into the city sewer system.

Originally, three separate centers were constructed for the collection of wastes in Plant Area No. 1, to preclude any possibility of backing up of lines or contamination of clean systems due to faulty operation or malfunctioning of equipment. (Later, all three categories of sewage were permitted to converge and be treated by the same decontaminating process.) Pilot plant wastes were collected in a tank on the top of Building 201. Laboratory wastes and sanitary wastes from the showers and laboratories were collected in sump tanks in Building T-280. From these points all wastes were fed into Building T-280 where a batch system of 4 tanks of 2,500-gallon capacity each formed the

principal collection center. ___/

When decontaminating by the batch system, the collecting tank was allowed to fill to approximately three-quarters capacity, all valves were closed, and the valve on the steam line to the tank was opened. When the temperature reached 212° F., the tank was vented to release hot air and volatile gases. The steam was again turned on and the pressure in the tank allowed to reach 40 psi or a temperature of 270° F. After holding the sewage at this temperature for 30 minutes, the vent line was opened and the tank was blown down until atmospheric pressure was reached. A sample was drawn to test for sterility, after which the drain line was opened and the waste allowed to run into the sewer. Since the temperature of the waste was very high, it was necessary to add cooling water as the waste entered the sewer, reducing the temperature from 212° F. to 140° F. This was by agreement with the City of Frederick, in order to prevent breaking city sewer lines with the hot liquid.

The batch method was found to be very efficient as far as the destruction of organisms in the waste was concerned, but its disadvantages were the high cost of steam consumption, the great volumes

___/The sewage treatment plants in Area No. 1 (T-270) and Area No. 3 (T-314, with five 17,000 gallon holding tanks) are separate. The sewage treatment plant serving the laboratories in the area just north of Scott Road (T-509) is connected to T-314 by gravity flow.

of cooling water required, the fact that relatively small quantities of waste could be treated in a single operation, and the undesirable odor produced by the process. ___/

When Pilot Plant No. 2 was put in operation in May 1944, it became necessary to replace the batch method with a continuous system. In this process, any one or all of 6 storage tanks could be used to hold plant, laboratory and sanitary wastes until such time as the material could be decontaminated. The raw sewage was pumped to a heat exchanger^v where its temperature was raised to 220° F. by outgoing heated sterile sewage. The waste was next subjected to live steam produced by a jet heater until it reached 300° F. From there the waste went to the retention tube which retained a flow of liquid at the rate of 200 gallons per minute for 20 minutes at 300° F. This decontaminated waste was then returned to the heat exchanger and cooled to about 140° F. by incoming raw sewage, and there was discharged into the Frederick city sewer line (Figures 3 and 4). ___/

Disposal of vent gases. The problem of disposing of vent gases and contaminated air from the plants and laboratories was solved by

___/Sp Rpt 42, sec IX, Liquid Contamination in Restricted Area; Sp Rpt 5, pp. 11, 12, 26, 33-36.

___/Sp Rpt 81, Sewage Decontamination at Camp Detrick (Mar 47). Difficulties with rotometers in this system are reported in Sp Rpt 42, sec XII, Rotometers vs Orifices.

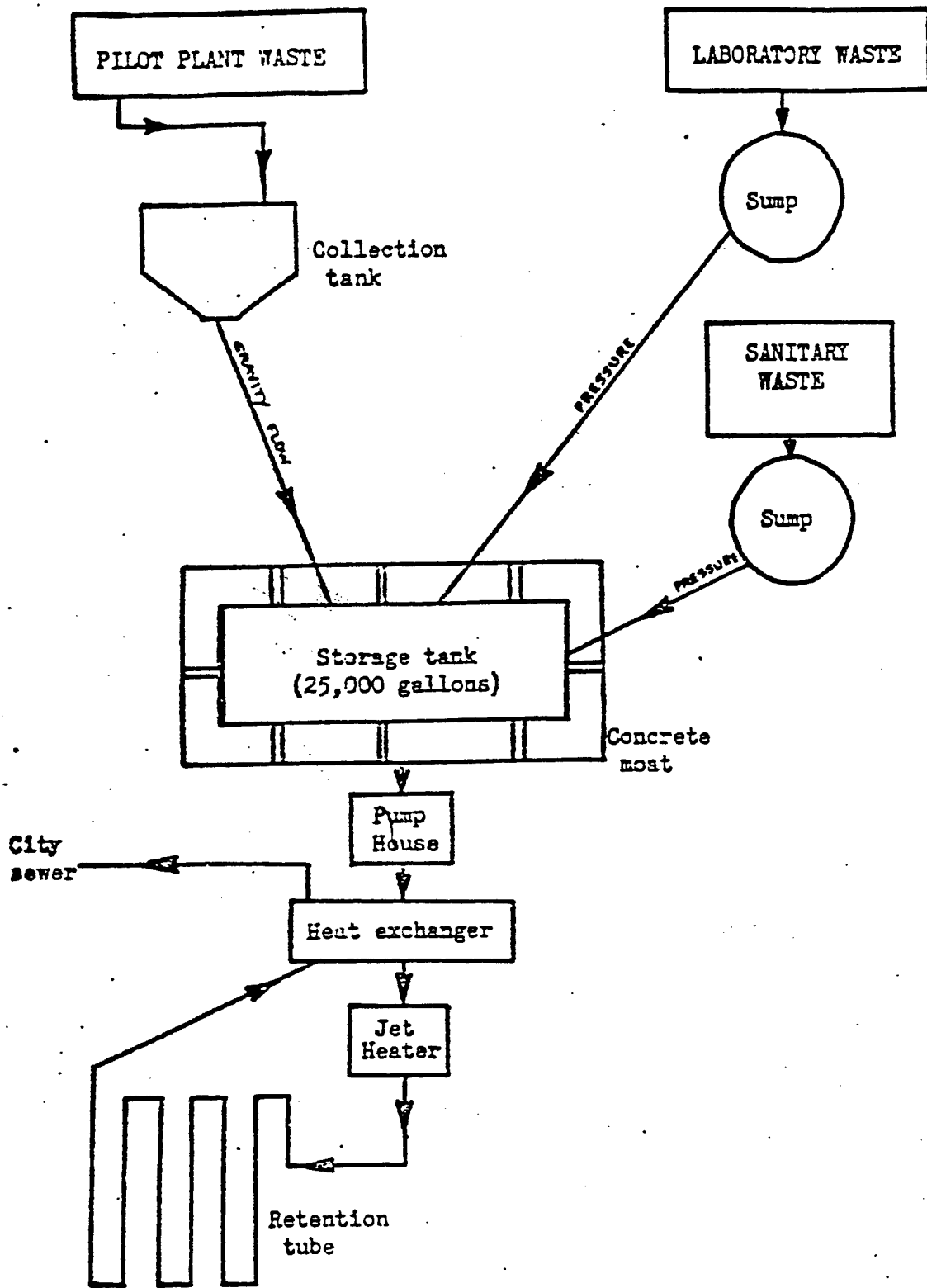

Figure 3. Liquid Waste Disposal System.

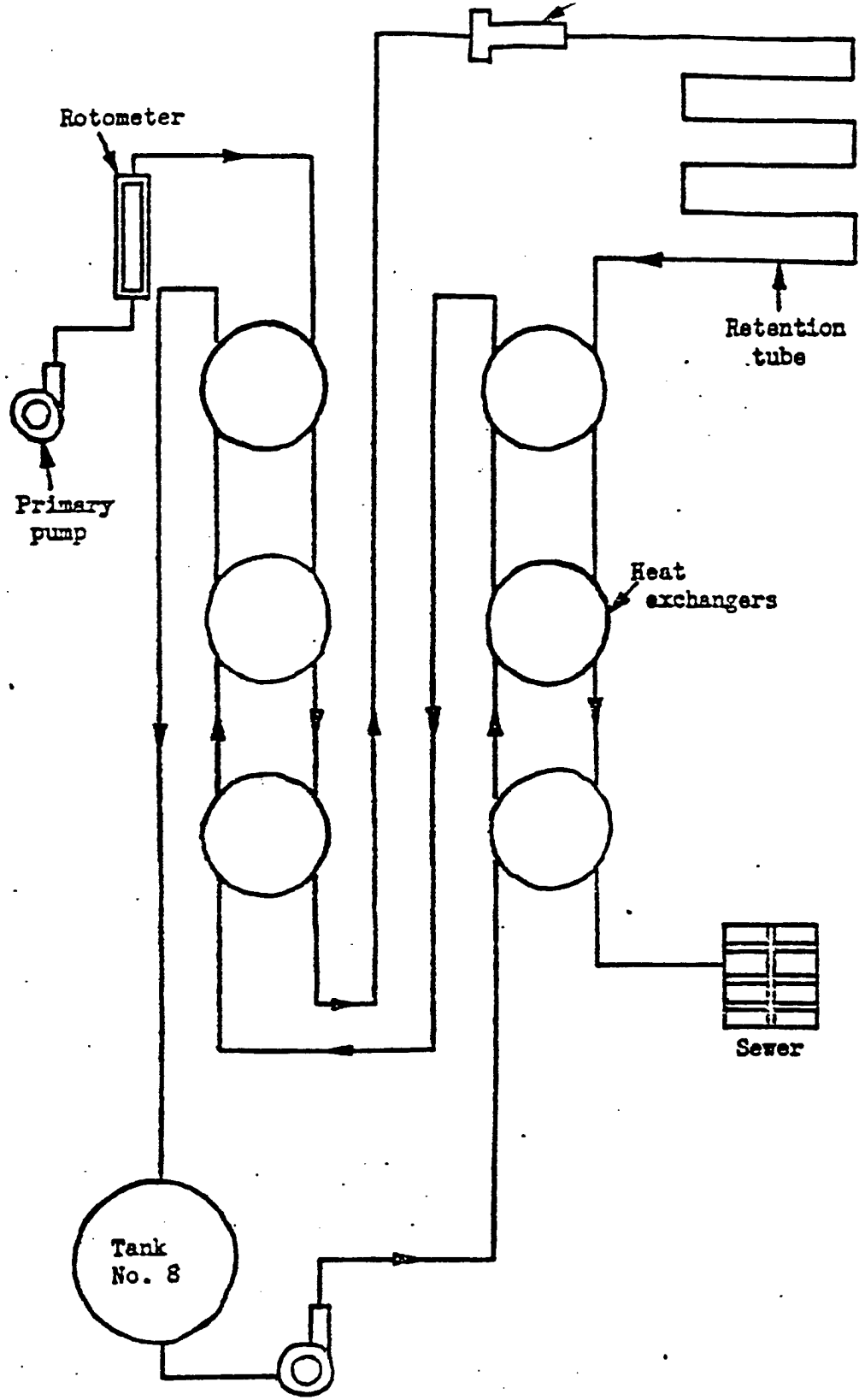

Figure 4. Flow Diagram of Waste Disposal System in T-280

constructing four incinerators. Incinerator T-235 served Pilot Plant No. 1, the sewage treatment plant in T-270 and the gas chambers in 201. Incinerator 294 served Pilot Plants No. 2 and T-73. Incinerator 313 served Pilot Plants No. 3 and No. 4 and all laboratories in that area. Incinerator 520 served the laboratories in T-522, T-525 and T-526. The incinerators are all heated by means of fuel oil atomized with steam, with a capacity air flow of approximately 2,500 cfm. The effluent gases are brought into contact with the oil flame, providing their own oxygen for combustion. After passing through the flame, the gases are filtered through check-board bricks and then discharged from the stack. Air samples can be taken from various locations throughout their structures and tests are made regularly by the Safety Division.

Until water separators were installed in the incinerators, a certain amount of condensate was found to drain from the vent gas lines into the combustion chamber of the incinerator, instead of passing through the decontamination system. It was also found that when certain concentrations of media were used in the pilot plants with excessive sparging, great quantities of foam were produced which found its way into the incinerators through the vent gas lines. To catch this liquid, a concrete moat was constructed around Incinerator 294. Any liquid entering the moat was drained into a sump pit from which it was pumped back to the decontaminating system by a steam ejector. ___/

___/Sp Rpt 42, sec IX, Incinerators.

While all vent gases from plant processes were decontaminated in the waste gas incinerators, effluent air from the ventilated laboratories and pilot plants was treated by passing through electromatic filters which removed any harmful organisms. With proper humidity and air velocities, the efficiency of these filters has been known to exceed 99 percent.

The ventilation systems in the laboratories and plants were so balanced that a constant negative pressure was maintained in the rooms being ventilated. This was done by making the discharge rate of air greater than the intake rate, thereby ensuring treatment of all air passing through the contaminated rooms. ___/

Fuel supply. The fuel oil used in the incinerators was stored in individual underground tanks of 500 to 5,000-gallon capacity at each incinerator. Bulk fuel storage tanks were located near the spray pond (T-277), with fill lines for these tanks extending to the railroad.

The system, installed by the Flotrol Company, operated by using water under pressure to fill the tanks. The water displaced the oil which was forced into the delivery lines so that at no time was there

___/Sp Rpt 42, sec X, Ventilation of Contaminated Buildings in the Restricted Area.

air in the tanks, thereby ensuring complete safety so far as fire hazards were concerned.

Water supply. When construction of Camp Detrick was planned, the Washington District Engineer's Office reported that the camp could be furnished with approximately 2,000,000 gallons of water a day from the City of Frederick water supply. Subsequently it was learned that the city could not guarantee more than 65,000 gallons a day and additional facilities were required. A new source was obtained by agreement from the overflow of a spring located on nearby Montvue Farm and a small reservoir and pumping station was constructed at the site. The overflow from the spring was estimated at approximately 200 gallons per minute or more than 250,000 gallons a day, and this was considered adequate if proper storage of water could be provided at the camp. This was done by constructing five wooden storage tanks of 100,000-gallon capacity each in the restricted area (Figure 5).

In order to conserve on water brought from Montvue, recirculation was provided involving the installation of a spray pond and pumping station (Figure 6). The spray pond, where water was continually sprayed into the air for cooling, was kept filled by overflow from one of the storage tanks or from break-tank water pumped directly from the storage tanks. These break tanks, equipped with float valves, and overflow pipes, were installed in all plants

11

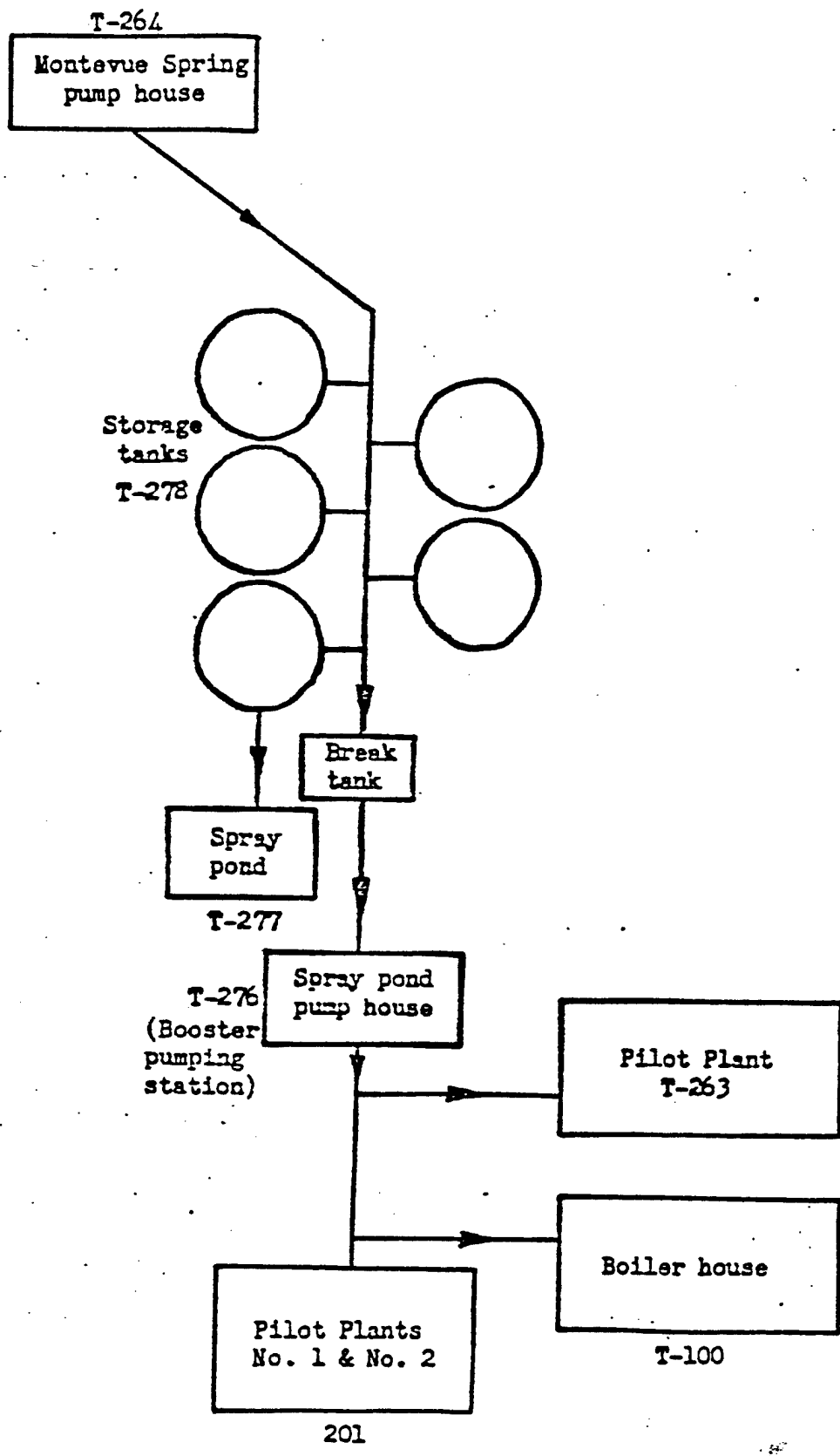

Figure 5. Montevue Water System

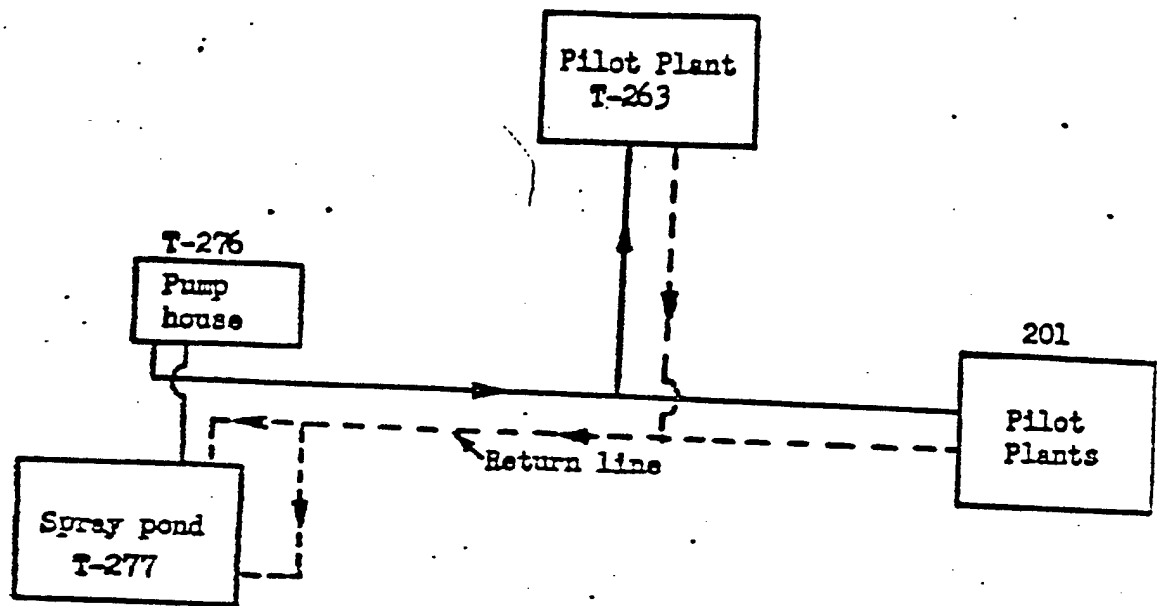

Figure 6. Spray Pond Water Cooling System

and laboratories where dangerous agents were being handled, in order to eliminate any possibility of reverse flow back into the main storage tanks. Water from the spray pond was pumped from T-276 to the pilot plants in 201 and T-63.

As Camp Detrick expanded, a third source of water became necessary in addition to that supplied by Frederick and Montevue. An area along the Monocacy River was acquired and a new plant built to chlorinate the river water and pump it to the Camp Detrick storage tanks. With these three sources of supply feeding into the tanks, the present distribution system was evolved permitting all pilot plants to receive unchlorinated water (from Montevue or Monocacy) for process operations and for cooling purposes in the heat exchangers, reactor jackets and similar equipment, and chlorinated water (from Frederick or Monocacy) for drinking purposes and for use in showers, laboratories and laboratories (Figure 7). To avoid contaminating Frederick city water lines by back siphonage in the plants areas, only drinking fountains at Camp Detrick were connected directly to the city water line. In all other operations, the water was considered non-potable and was supplied from the storage tanks.

Production plants at Vigo. The solutions found by study and experience at Camp Detrick for plant processing operations, disposal

Sp Rpt 42, sec IX, Water Distribution System.

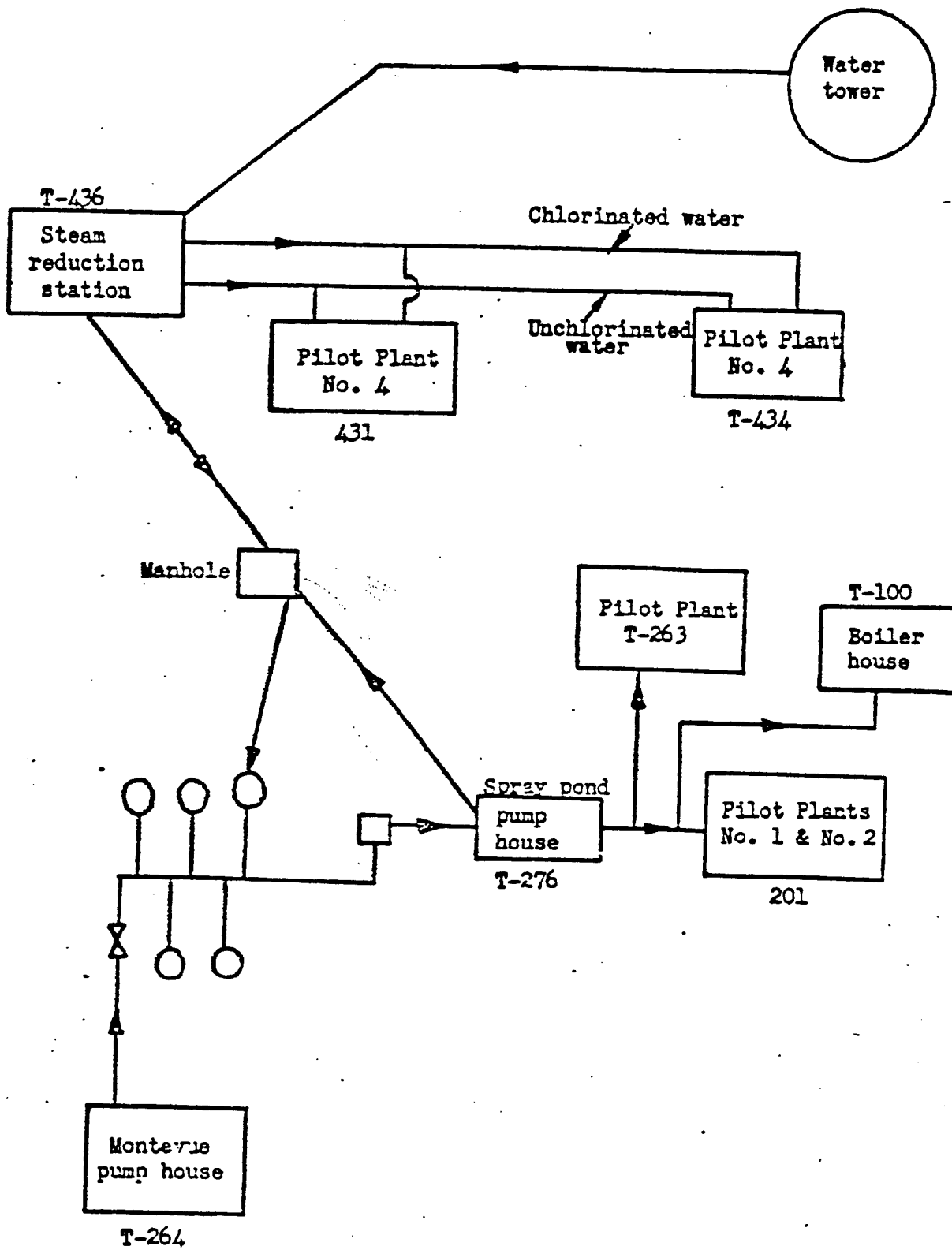

Figure 7. Water Supply System

of wastes and vent gases, and in devising effective safety procedures, were applied at Vigo Plant, thus enabling it to begin trial plant runs shortly after completion of construction. Its agent production operations were similar in almost all respects to the pilot plant processes developed at Camp Detrick. Camp Detrick, however, had no counterpart for the munition-filling, munition assembly and storage plants at Vigo.

Operations at Vigo were concentrated in four main plants. In Plant I, in the T-1100 area (Figuras 8 and 9), were concentrated all biological agent manufacturing facilities, as well as ^{those} for filling munitions. Plant II, in the T-1200 area, was the munitions center, with buildings for receiving munitions material, for burster loading, fuze assembly, and final munition assembly. In Plant III, in the T-1600 area, the biological munitions were packed and stored. Plant IV, in the T-1300 area, was the animal farm where laboratory animals

T-1164 was the slurry preparation building, with the tank farm for raw materials situated alongside. T-1166 was the catalyst building, T-1167 the reactor building, T-1168 the separation building, and T-1169 the munition-filling building. T-1171 was the air incinerator and T-1172 the sewage disposal unit.

T-1207, T-1230, T-1235, T-1237, T-1243 and T-1221 were materials control buildings where all components of munitions were stored. Their personnel was responsible for the movement of these items through all operations. T-1261 and T-1233 were the fuze assembly buildings. In the first, shutters and detonators were assembled on fuzes and in the second, the explosives were loaded in the fuzes and the fuzes then completely assembled. T-1232 was the bomb assembly building, where burster and burster rubber space balls were loaded into bombs and fuzes were added to complete bomb assembly. T-1231 was the cluster assembly building where bomb units were clustered and clusters were inserted into containers and prepared for shipment.

PLAN of VIGO PLANT

LEGEND

Areas colored red.....Restricted plant areas; responsibility
of E Division, Vigo Plant

Areas colored yellow.....Additional facilities of Vigo Plant,
Chemical Warfare Service

IDENTIFICATION OF AREAS

1	Administration area	T-100
2	Classification yard	T-200
3	Delco Radio Corporation	T-300
4	Chemical Warfare Service	T-400
5	Laundry & troop housing	T-500
6	Post Quartermaster area	T-600
7	Post Engineer area	T-700
8	C.W.S. (Technical Dept)	T-800
11	C.W.S. plant area	T-1100
12	Loading area	T-1200
13	Animal farm	T-1300
14	Chemical Warfare Service	T-1400
15	Storage	T-1500
16	Chemical Warfare Service	T-1600
17	Cincinnati Ordnance area	T-1700
18	Cincinnati Ordnance area	T-1800
19	Igloos & frost-proof vault	T-1900
20	Sewage disposal plant	T-2000
21	Water storage & treatment	T-2100
22	Burning area	T-2200
23	Pistol range area	T-2300
24	Rehabilitation staff house	T-184-5
25	Rehabilitation staff house	T-181
26	Rehabilitation staff house	T-182
27	Rehabilitation staff house	T-183
28	Hospital area	T-106
29	Incinerator	T-2501
W1	Water storage tank	T-2103
W2	Water storage tank & observation post	T-2104
FG	Fire & guard station	T-109
F	Fire station	T-2101
T	Transformer station	T-2102
CS	Coal station	T-2501

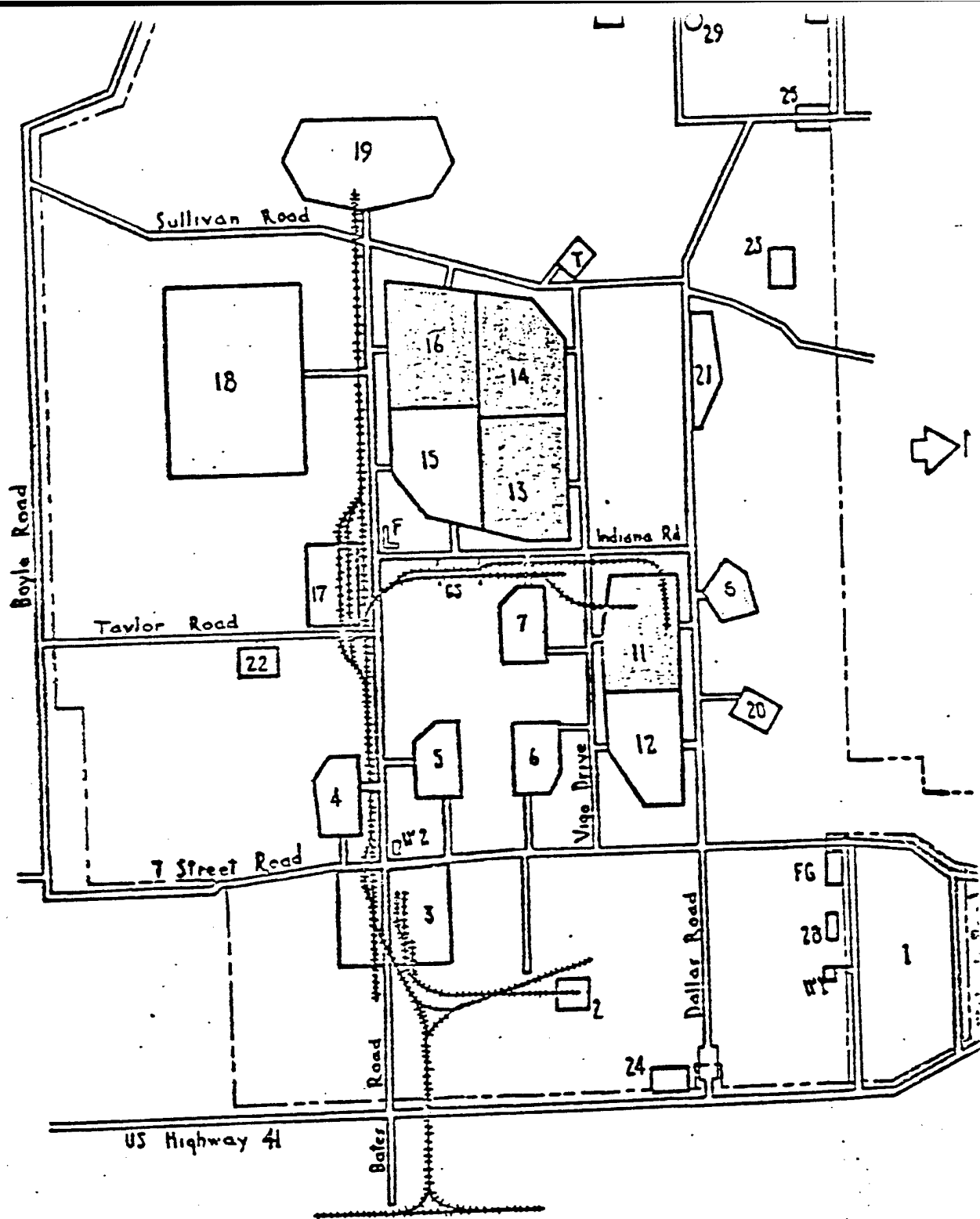

Figure 8. Plan of Vigo Plant

Approximate scale mile

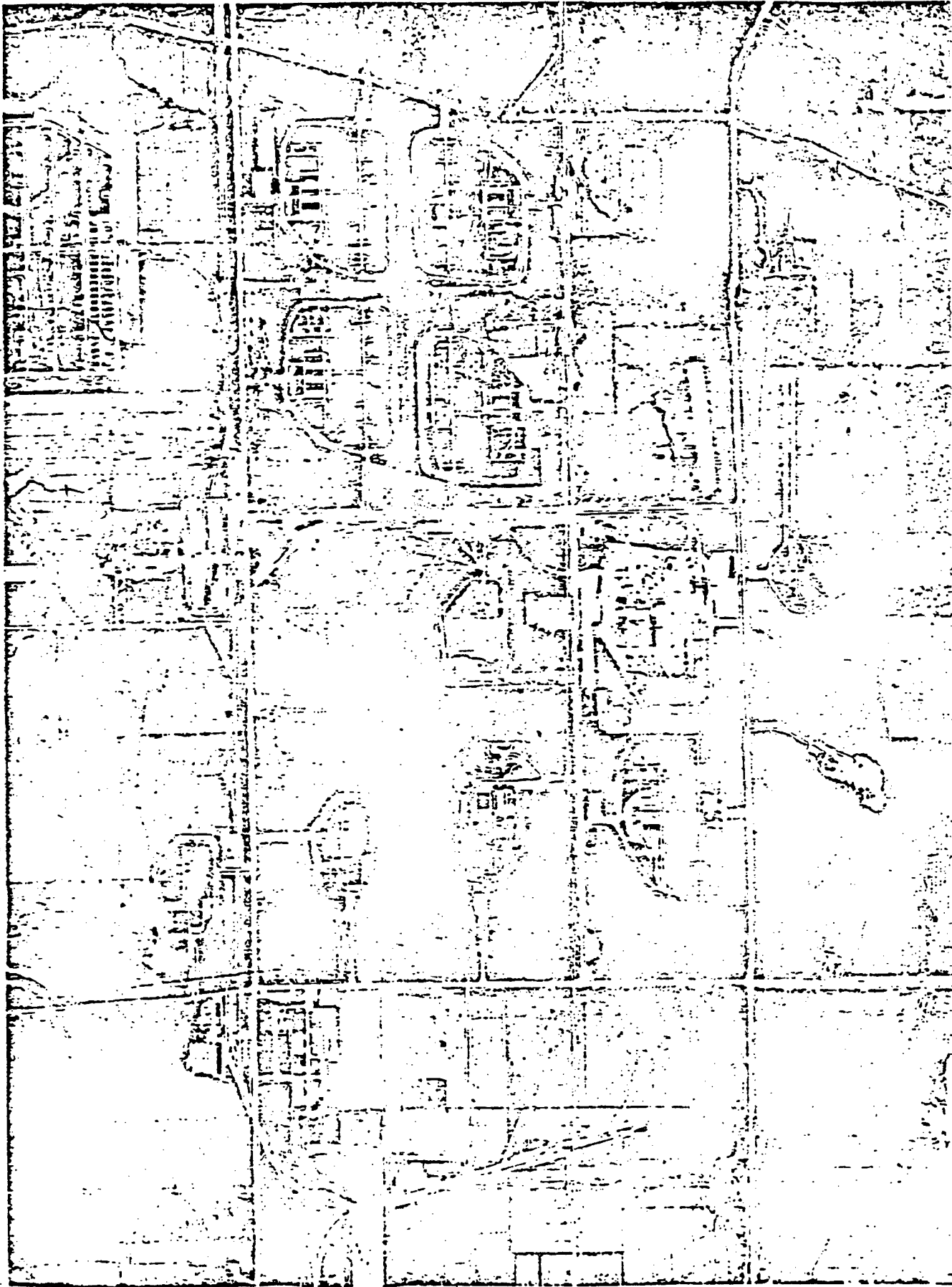

Figure . . . Aerial photo of Vigo Plant

were received, quarantined, housed, and bred. The T-800 area at Vigo, adjacent to Plant I, was the headquarters of the Technical Department. ___/

SPD Manufacturing Order No. SP-1 was placed with Vigo Plant on 20 June 1944. This called for 1,000,000 Mk I Type F bombs, for which CWS-120 funds in the amount of \$10,000,000 had been provided. This sum was to include the procurement, manufacturing, filling, packing and storing of the munitions. Vigo Plant then contracted with Electromaster, Inc., of Detroit, Michigan, for bomb bodies, fuzes, bursters and boosters, and with Unexcelled Manufacturing Company of Cranbury, New Jersey, for pellets of pentolite and tetryl for the bombs. Production of these items by the companies was begun in May 1945. ___/

Laboratory animals. Statistics maintained by the animal breeding unit at Camp Detrick show that between August 1943 and the end of December 1945, seventeen types of experimental animals were used in the studies conducted by that installation. The quantities were as follows: 598,504 white mice, 32,339 guinea pigs, 16,178 rats, 5,222

___/Ltr (S), CO VP to C SPD, 19 Oct 44, sub: Operating Directives for Vigo Plant. SPCYA. In VP Tech Dept (461-TD). Also memo (TS), C Filling Br Plant No. VP for C Plant No. 1 VP, 11 Nov 44, sub: Tentative Operating Instructions for the Filling, Bonding, and Inspection Operations of the Type F Munition. SPCZA 635.10/9. In VP Tech Dept (635.10).

___/Annual Report for FY 45, C SPD to C Contl Div OC CWS, 4 Jun 45.

rabbits, 4,578 hamsters, 399 cotton rats, 225 frogs, 166 monkeys, 98 brown mice, 75 wistar rats, 48 canaries, 34 dogs, 30 sheep, 25 ferrets, 11 cats, 5 pigs, and 2 roosters.

The principal sources of these animals were the Jackson Memorial Laboratory at Bar Harbor, Maine; Bagg Research Laboratory, Westchester, New York; and the Army Medical College, Washington, D. C.

Due to the scarcity of animals, the urgent need for them and the shortness of time, no steps were taken to improve the strain of animals used in quantity and no attempt was made at selection. This resulted in occasional lack of uniformity of results when working with mice, guinea pigs and rats, but could not be helped since the raising of a single breed under controls could not be effected.

When agent-treated animals died or were dispatched at the conclusion of experiments, they were autoclaved, placed in cartons and incinerated.

Between 15 February 1944 and 15 June 1945, approximately 4,000 animals were autopsied in the laboratories at Camp Detrick. An average of three to five tissues were taken from each of these animals, and from each of these tissues, between two and three sections were made and variously stained for microscopic examination. It is

estimated that probably 25,000 slides were made in the course of
laboratory operations.

 MPR B Div Path Br (18 Jun 45).

SECURITY, INTELLIGENCE, AND TRAINING

Security. Violation of AR 380-5 was considered to be the most serious crime that could be committed at Camp Detrick. Military personnel arriving at the camp were at once given two forms, one a statement of security to read, beginning, "This is a classified exempted station," and the other, an agreement not to reveal information on operations at Camp Detrick, which had to be signed. Civilian personnel received these two forms and in addition were required to sign a consent for medical treatment and hospitalization and for burial in event of death (these forms are in Appendix G).

More detailed instructions on the special precautions in force at Camp Detrick were contained in sections of post regulations which were designated Secret. These instructions stated that the professional background of personnel at the station was to be concealed, that no person receiving special procedures was to donate blood to the Red Cross or to reveal the facts of his vaccination to unauthorized personnel, that the nature of materials or stores procured for Camp Detrick was to be concealed, and that personnel who became ill from biological agents while absent from the station were to communicate at once with the Post Surgeon for instructions for hospitalization. Additional instructions covered the secrecy classification

—/CD GO 4, 12 Jul 43, Post Regulations; superceded by CD GO 17, 6 Dec 44, Security Regulations. Sections X and XI of GO 17 are included in Appendix H .

of matters concerning biological warfare and the Chemical Warfare Service.

It was considered that accidents or illness of civilians which even remotely or presumptively might be connected with Camp Detrick would be disastrous because of the resultant publicity. For this reason, every precaution was taken to avoid danger and to safeguard all operations at the camp. These precautions are described in detail in later sections on construction and operation safety. Plans were made for the most extreme contingency that might occur, the disposition of the remains of civilian or military personnel in the event of death caused by a biological warfare agent. In March 1944, the Chief, Chemical Warfare Service, asked the Judge Advocate General of the Army for his opinion as to the legal authority to make secret disposition of such remains. It was decreed that by establishing a restricted military area at Camp Detrick, deceased personnel might be placed in a hermetically sealed metal casket and

CD GO 14, 16 Oct 44, was a commendation for three members of E Division (then, Operating Engineering Division) who were instrumental in saving property and post security as the result of an accident that occurred on 20 Sep 44. Large quantities of anthrax slurry were found overflowing from a reactor tank in pilot plant No. 2 through the air vent into the vent gas incinerator and out through the foundation of this latter unit. By throwing up a dirt barrier around the overflow, the three men prevented the material from running into a nearby storm sewer and from thence into the creek which flows through a number of dairy herd pastures in the vicinity of Frederick.

interred by military personnel in the area, without disclosing by certificate, report or statement the nature or cause of death. ___/

This was the basis for the consent which incoming personnel were required to sign before going to work. Although these preparations had to be made, there was, fortunately, no occasion for them to be put in practice. There were a number of illnesses due to handling biological agents at Camp Detrick but no fatalities. Nor were there any fatalities at Vigo Plant, Horn Island or Granite Peak, due partly to the precautions that were taken and also to the limited experimentation with viable agents, by comparison with that undertaken at Camp Detrick.

An important phase of security operations at Camp Detrick involved the nearby town of Frederick. Every effort was made to conceal the nature of the work being performed at Camp Detrick from the townspeople, although the opportunities for suspecting or even being informed of its nature were numerous. Construction workers lived in or visited the town while the camp was being built, post personnel on leave from the camp visited friends in Frederick or congregated in its bars, restaurants and theaters. To maintain a check on possible leakage through these sources, periodic security surveys in the town were conducted by intelligence personnel. In one such survey conducted in

___/Ltr (S), C CWS to JAG, 31 Mar 44, sub: Disposition of Remains of Civilian or Military Personnel In Event of Death Caused by Secret Poisonous Agent (SPCWL 161), and 1st Ind, C of Mil Affairs Div JAGD, 14 Jul 44 (SPJGA 44/5278). Copy in Hist. files. See also ltr (S), C Intel Div CD to C SPD, 31 Jul 45, sub: Burial Procedures. SPCWF-PLO-SAR.

May 1944, the intelligence agent "interviewed" a number of people who, it had been reported, had indicated they had knowledge of the activities going on at Camp Detrick. The agent summarized his findings as follows:

Throughout the entire survey this agent observed that little interest was taken by the townspeople of Frederick in the activities carried on at Camp Detrick. It was general knowledge among the townspeople that Camp Detrick is a secret chemical warfare installation and it is believed by them generally to be a research installation where a new secret gas or gases are being developed... However, it is this agent's opinion that anybody who really wanted to find out that bacteriological warfare activities are being conducted at Camp Detrick could easily do so by studying the background of the technician civilian employees employed there and by analyzing the type of material purchased by the post procurement in Frederick and the types of material which is shipped into Frederick by Railway Express.

Doubtless, there were townspeople who knew by inference and observation the work in which Camp Detrick was engaged, and having guessed, refused to conjecture further as a matter of rationalization. The physical composition of the camp itself was informative. It was originally contemplated that all research and development would be confined to the hangar that was part of Detrick Field, but subsequent

 Memo (S), Thomas A. Gregg SIC III SC for OinC CD, 15 May 44, sub: Security Survey, Frederick, Maryland, in Connection with Classified Activities at Camp Detrick, Maryland. SC III-90808. In Historical files.

Note: So well were security regulations maintained at Camp Detrick that the Special Services Officer at Camp Detrick, who had been on the post for a whole year but, of course, had not been allowed inside the restricted area, admitted to the intelligence agent that he had not been able to find out what activities were being carried on at the post.

expansion left this hangar far behind in a corner of the camp. The size of the camp could easily be discerned from Eraddock Heights, a nearby prominence, and the smoke stacks and special sewage arrangements of the camp could not be concealed. Numerous outside agencies must also have had some inkling of the work going on at Camp Detrick, since large shipments of items like corn steep liquor, pepticase, laboratory animals, autoclaves, microscopes, were made directly from the source to the camp and not through an intermediary neutral agency such as a large general hospital, with secret delivery.

The security blanket over the work being done at Camp Detrick inevitably worked many hardships on research and development. Industry, for example, was frequently not willing to release secret commercial processes unless their military necessity was established, nor could industry provide intelligent information for technicians at Camp Detrick when no hint of the kind of work to which the information was related could be given. Even within the Army, security regulations made for delays and difficulties since joint efforts or conferences between the services required that all participants, particularly their civilian and industrial consultants, be formally cleared.

Intelligence of enemy activities. Intelligence activities in biological warfare began with the appointment in the WRS of a director

 /Ltr (S), C PC Div to Tech Dir SPD, 1 Jun 45, sub: Information on Personnel Attending Clothing Meeting at OCMG. SPCYF.

12

of intelligence and information who made arrangements at once to obtain all available information dealing with biological warfare in the possession of G-2, GMI, MID of SGO, OSS and FBI. The meager amount of information obtained led to the conclusion that these agencies might not be properly alerted to manifestations of biological warfare, and, after consultations with the Office of the Secretary of War, intelligence instructions were sent by WD G-2 to all military attaches and to theater or area commanders in the British Isles, North Africa, Middle East, China-Burma-India, and the Pacific. When this alert failed to uncover further information, the director of intelligence for WRS himself went overseas to consult with intelligence authorities and with theater surgeons in the operational areas. One of the results upon his return was that WRS, with the approval of CSC, made certain recommendations to the Secretary of War designed to facilitate the collection and dissemination of biological intelligence. This involved the collection and laboratory examination of blood samples taken from prisoners of war, to determine whether these individuals had been immunized against biological agents which the enemy might possibly employ. / Also, an intelligence officer appointed by the Surgeon

./Memo (S), Dir WRS for Secy of War, 22 Apr 43, no sub; ltr (S), Secy of War to Dir WRS, 14 May 43, no sub; and memo (S), Dir R&D WRS for Dir WRS, 19 May 43, sub: Concerning Meeting on Blood Samples. Merck suggested that 20cc. per individual, to yield 10cc. of serum, would be sufficient; that samples from 5 to 10 percent of any given enemy unit, with special attention to drawing samples from officers, would be adequate; that the samples would be from prisoners in the large camps in the U.S. and in rear areas overseas;

General and Assistant Chief of Staff, G-2, was sent to the European theater and later to the North African, Middle East, SW Pacific, CBI, and Pacific theaters to instruct responsible officers and stimulate the collection of biological warfare intelligence.

Concurrently with these activities, WRS intelligence began a continuous survey of the press and periodicals of this country to detect any evidence of hysteria regarding epidemics which might spring up locally and to detect any leaks in security concerning our own activities. It was agreed that public speculation on the potentialities of biological warfare should be discouraged but without placing undue emphasis on the subject. As a result of the cooperation of the nation's press and radio, the general public did not become alarmed or unduly concerned over biological warfare at any time during the war. Possibly the single exception to public speculation concerning biological warfare was the appearance of a book, Japan's Secret Weapon, by Barclay Moon Newman, /

and it was suggested that the National Institute of Health be the receiving laboratory for blood specimens. By means of these samples it might be learned whether Japanese troops were being inoculated against yellow fever (a disease not occurring in the Far East) and whether either Japanese or German troops were being inoculated against typhus, anthrax, dysentery or botulism. It was also possible that improved methods of immunization developed by enemy scientists might be discovered. The Secretary of War agreed to Merck's recommendations and the SGO was directed to undertake the study. The results, however, proved negative. The British fared little better except that a number of their German prisoners of war were found to have cholera antibodies, with 16 sera in one group of 50 positive. However, these troops had probably come from the African theater or eastern front where such immunization was routine. See Report of Visit of Lt. Col. Oram C. Woolpert to ETO, 22 May-2 Jul 44, p. 4. In Hist files.

/ Current Publishing Co., New York, 1944.

which attempted to prove that the Japanese had already used biological warfare agents against our troops and would continue to do so on an increasing scale. The diseases which the author stated might be used by the Japanese included malaria, leprosy, kala-azar, lymphogranuloma inguinale, diphtheria, syphilis, yaws, tuberculosis, Japanese encephalitis, coccidioidomycosis, and cancer-producing chemicals. The author claimed that American research workers and officials refused to ^{take} the the problem seriously or to prepare adequate defenses or means of retaliation in kind.

The book was reviewed by the Technical Aide on the staff of WRS (Lt. Comdr. Sarles), who declared that the book was sensational to the point of being frantic and might therefore have great nuisance value. In the letter from Mr. Merck to Mr. Bundy, 3 June 1944, forwarding the review Mr. Merck declared that the book was

an inflammatory and emotional piece of writing and its publication is to be regretted. As agreed yesterday, it would not be wise to attempt to suppress the book even if this were possible, as this would only serve to attract attention to it. It is hoped it will prove a "dud" and if anything could be done towards assuring this, it would be highly desirable, for instance, if means were available to prevent reviews and all references to the book eliminated from newspapers, and above all, "digests" prevented. In any case, we should expect reactions to this book. The most unfavorable to our mind will be those which arcuse doubts. /

Few if any doubts were aroused by the book.

The directive from the Secretary of War in January 1944 which transferred the biological warfare program to the War Department carried an indorsement from ASF authorizing the Chemical Warfare

/ In files of H.H.Bundy, Sp Asst to SW.

Service to provide an intelligence unit for the collection, evaluation and integration of all pertinent information on biological warfare and to establish effective liaison with G-2, OSS, ONI, OSRD, NIRC, WRS, Joint New Weapons Committee, and New Developments Division of WDGS. The next month an Intelligence Branch was set up in the Special Projects Division, authorized to collect, record, evaluate and transmit such intelligence, maintain liaison with the agencies specified, clear personnel for work at SPD installations, and supervise security and counterintelligence at all SPD posts. The organization consisted of two officers in SPD, two each at Camp Detrick and Vigo Plant, and one each at Horn Island and Granite Peak.

A directive was issued by the War Department to alert theater commanders, telling them what to look for, what action to take, and what reports to make. This was sent to the commander in chief, STPA, and to the commanding generals of all theaters of operations, of the Eastern and Caribbean Defense Commands, Alaska Department, and to Separate Base Commands. A second directive was given the same distribution, with an additional copy going to the Northwest Service Command in this country. It described defensive measures against possible sabotage and recommended the appointment of a staff biological warfare officer, possibly the theater surgeon, as special adviser

to the commander. ___/

A medical officer was sent to G-2, ETOUSA, to stimulate the flow of biological warfare intelligence from that quarter, and a CWS officer enroute to the CBI theater was instructed to alert the Joint Intelligence Collecting Agency (JICA) and G-2 and CWS officers in NATOUSA and in CBI. In May 1944, the SGO liaison officer at Camp Detrick prepared an 8-page technical bulletin for staff medical officers in the overseas theaters containing information on likely diseases which might be encountered in the event of biological warfare. ___/ Chiefs of JICA in North African, Middle East and CBI theaters were given verbal indoctrination, as were military attaches in New Zealand, Teheran, Canada, Stockholm, Spain, Portugal, South Africa, China and Australia. CWS members of the ASF materiel collection teams, who had been previously briefed on what biological warfare materiel to look for, arrived in the ETO, NATO, SP, SWP, CP and CBI

___/Ltr (R), 14 Feb 44, sub: Biological Warfare. AG 381 (9 Feb 44) ~~CS-S-B-M.~~ Ltr (R), 28 Mar 44, sub: Defense Against Sabotage Methods of BW in a T/O. AG 361 (24 Feb 44) ~~P-S-E-M.~~ In Cml C Sch EA (F&A 461/829).

___/TB Med 45 (R), Notes on Certain Infectious Diseases, 20 May 44. Routes of infection, incubation period, onset and course of disease, clinical and laboratory diagnosis, and treatment were given for anthrax, botulism, brucellosis, coccidioidomycosis, equine encephalomyelitis, glanders, melioidosis, plague, psittacosis, Rift Valley fever, tularemia and typhus fever. The bulletins were printed and shipped overseas but were not widely distributed.

theaters in the summer of 1944 prepared to carry out this additional mission. The chief of CWS Intelligence attended the biological warfare school at Camp Detrick and went overseas to alert CWS officers in the Middle East and North African theaters. Trained officers were sent from Camp Detrick to the CEI and Pacific theaters to indoctrinate G-2, CMI and medical officers there, and made arrangements for interrogating medical personnel among Japanese prisoners of war and for obtaining blood samples. ___/

As a result of activities of the Intelligence Branch, SPD, the European Theater of Operations took steps to alert its entire command to the possibilities of biological warfare. An SOP for investigating and reporting suspected use of biological material by the enemy was set up. ___/ Sabotage methods were described and procedures outlined for interrogating captured saboteurs. By way of further implementation, the Chief Chemical Officer, ETOUSA, was charged with keeping his commanding officer advised on all matters pertaining to biological

___/Memo (S), Int Br SPD for Dir WRS, 5 Jul 44, sub: Collection and Dissemination of EW Intelligence with Suggestions for Improvement. Representative of indoctrinative material prepared for the Pacific theater was ltr 61 (S), OofCml O Hq USAFPOA, 18 Sep 44, sub: Bacteriological (Biological) Warfare, which had sections on detection, physical protection, decontamination, biological protection, types of agents, and training. In Cml C Sch EA (F&A 319.1/239-49). See Also History of Chemical Section, USAF Mid Pac, 7 December 1941-2 September 1945, Vol. IV, Annex IIIe.

___/Hq ETOUSA Operations Memorandum 2 (S), 1 Mar 45, sub: Biological Warfare. Amended changes on 16 Apr 45, 26 Apr 45 and 1 Mar 45.

warfare, except medical aspects, with providing protective equipment, preparing plans and directives, supervising biological warfare training, maintaining liaison with British biological warfare authorities in the theater, and cooperation with the Chief Surgeon and Assistant Chief of Staff, G-2. ___/

In contrast to the interest in biological warfare, intelligence activities and general preparations that were effected in the active theaters of operations, those of the Caribbean Defense Command were minimal. The assistant surgeon, CDC, was designated antibiological warfare officer, as an additional duty, and the required defense plan was prepared by each of the units in the command. ___/

In general, intelligence relations with the British and Canadian biological warfare organizations at Porton and Suffield were cordial, but on several occasions British Intelligence could not see eye to eye

___/Ltr (S), CG ETOUSA to C Cml O ETO, 14 Apr 44, sub: Responsibility with Respect to BW. AG 381 Op CTS. In SPD Hist. Record.

___/Ltr (S), Lt. Col. A. S. Behrman to Dir WRS, 8 Jan 44, sub: A BW Program for the Panama Canal. Ltr (R), Hq PCD to all units of the Department and the Panama Canal, 27 May 44, sub: Antibiological Warfare Plan, Panama Canal Department. In CDC S-381 (Plans for War). Plans for antibiological warfare in the CDC were "of minor importance. No more relative attention was given to this phase of defense of the Panama Canal than the War Department gave to the subject in general....ND directives were passed on by this command to the two subordinate commands, Panama Canal Department and Antilles Department, for action without comment....No comprehensive anti-BW plan for CDC was ever made." See undated report, Plans for Anti-Biological Warfare, in Historical Section, CDC.

with our efforts. They objected to our procedure of taking blood samples from prisoners of war, considering such action ill-founded. Later, they protested as unnecessary our plan to inoculate U.S. troops against botulinum toxin prior to the invasion of Normandy. Their experts, they reported, had not construed intelligence reports as we evidently had and did not foresee any danger from this agent. ___/

The two principal sources of biological warfare intelligence proved to be the Office of Strategic Services and Medical Intelligence Service, SGO. Other valuable sources were G-2 WD, FBI, ONI, G-2 ETOUSA, G-2 CWS, WRS, and the State Department. Material from these sources flowed into the Intelligence Branch, SPD, to form the basis for the Special Projects Periodic Intelligence Reports (SPPIR) which were prepared and sent to WRS, the Surgeon Generals of the Army and Navy, New Developments Division, Col. Paget (Great Britain), Dr. Maas (Canada), G-2 ETOUSA, G-2 WD, Chief of CWS, and OSS.

Prior to the invasion of Europe in June 1944, it was generally considered by most of the intelligence agencies that our enemies had made considerable preparations for biological warfare and were using it in the war of nerves as a threatened secret weapon. ___/ In the

___/Ltr (TS), H. L. Ismay, Offices of War Cabinet England to Field Marshall Sir John Dill, British Joint Staff Mission, 1 Apr 44, no sub, no file. In files of H. H. Bundy, Asst SW. Ltr (TS), Asst CofS to C CWS, 10 Aug 44, sub: British-US Liaison with Respect to BW. OPD 385.

___/See Technical Division Memorandum Report 616 (S), Possible Chemical Warfare Agents of the Axis Powers (26 Apr 43).

months following the invasion, trained biological warfare officers were attached to all major military operations, in the Pacific as well as in Europe, and sent into reoccupied and conquered territory to investigate enemy biological warfare activity. The findings of the Alsos Mission ___ were the first indication that the truth about enemy activities was considerably at variance with the intelligence reports, although not until early in 1945 was it generally agreed to be too late for Germany to use biological warfare as a tactical weapon against our forces. ___

In a comprehensive report prepared by the biological warfare team with the Alsos Mission, it was revealed that biological warfare activities in Germany had been conducted by third-rate personnel whose principal efforts had been directed to defensive measures against possible Allied use of biological agents and specifically against the many acts of sabotage against the German Army by guerilla fighters in Poland and Russia. ___ Although more than 70 potential sites of

___/ "Alsos" is the Greek equivalent of "grave", for Maj. Gen. Leslie R. Groves, head of the Manhattan Project. Intelligence Br SPD attached several of its officers to the Alsos team investigating biological warfare activities of the enemy. Members of the team were J.M. Barnes, RANMC; C. Henze, MC, AUS; W.J. Cromartie, MC, AUS; and J.W. Hofer, MC, USNR.

___/ SFPFR 4 (S), 15 Aug 44.

___/ Among the biological, chemical, and toxic agents used in individual acts of sabotage against German soldiers by the guerillas were arsenic, atropine, strychnine, scopolamine, typhoid bacilli, potassium cyanide, nicotine, mustard gas, aconitine, morphine, botulinum toxin, curare, sodium sulfate, typhus, dysentery, glanders, cholera, anthrax, and paratyphoid. Int Rpt B-C-H-H-205 (S), A Review of German Activities in the Field of Biological Warfare, MIS, Alsos Mission (12 Sep 45), pp. 82-88. In CD Tech Lib.

research were visited, including 16 universities, 10 medical institutes, 5 veterinary institutes, 10 commercial firms, 2 chemical warfare installations, and 4 concentration camps in which medical research had been conducted, little evidence could be found that studies of biological warfare had been effectively pursued. It was learned that Hitler had decreed that only defensive aspects be studied. The only high ranking Nazi to take an active interest in biological warfare was Himmler. His Waffen SS established a laboratory near Posen, Poland, in 1943, where it was intended to perform offensive experiments using human subjects. However, the laboratory had to be abandoned before it could be completed, and a new laboratory in Geraburg, Thuringen, was still being built when Germany surrendered.

Defensive measures taken by the Germans consisted mainly in alerting agriculture, veterinary and public health officials to the dangers of biological attacks. The only large scale defensive measure was taken in 1942 when one million doses of plague were prepared and sent to the Stalingrad front when the Germans learned that the Russians had been immunized against plague. The vaccine was stored but never used.

The files of German intelligence on biological warfare, which were captured intact, gave extensive information on Russian and Polish efforts and were fairly complete on France. Information from

12

the United States and the United Kingdom, surprisingly enough, stopped completely after 1942, a tribute to our security precautions. ✓

Japanese activities were far better organized and more comprehensive than those of Germany. Japan seems to have started its program in 1936, when it began conducting biological warfare studies in an organization called the Boeki Kyusuibu, literally, Antiepidemic Water Supply Unit or Water Purification Department. Its principal wartime research was centered in a Defense Intelligence Institute at Pingfan, near Harbin in Manchuria. This Institute had 3,000 personnel at the peak of operations and reached the point of munitions development with glanders and anthrax as agents. ✓

Allied Intelligence appears to have been accurate in its reports on Japanese activities, for reports made in May 1945 of the existence of a Japanese bacillus bomb, its name literally translated as "disease

✓Memo (S); C Int Br SFD for Consultant to SWH, 20 Aug 45, sub: Final Resume of German BW Activities. WDSND 334 JWF 441.2. In NDD WDSS. See also Int Rpt B-C-H-H-305 (S), 12 Sep 45, and its resume in SPPIR 10 (S), 1 Sep 45.

✓Report on Scientific Intelligence Survey in Japan, Vol. V, Biological Warfare (S), GHQ USAF Pacific, 1 Nov 45. Also, Report on Japanese Biological Warfare Activities (S), Lt. Col. A. T. Thompson VC Camp Detrick, Md., 31 May 46. Both reports in CD Tech Lib.

General summary of intelligence reports is contained in Special Study, MIS, Biological Warfare Activities and Capabilities of Foreign Nations (S), 30 Mar 46. In CD Tech Lib.

frozen germ," were confirmed, and it appears that ^{other} experiments were made in the dissemination of typhoid, diphtheria and cholera. The Japanese denied, however, that the paper balloons that sailed across the Pacific to Western U.S. and Canada were pre-bacterial warfare experiments. ___/

Counterintelligence. The strictest secrecy was maintained in this country, Canada and the United Kingdom from the very beginning concerning the fact that work was being done in biological warfare. Stringent security measures were taken not only to prevent the enemy from obtaining information as to our efforts and results, but also to keep the public and the armed forces from becoming concerned over the possibility of biological warfare.

Counterintelligence control, intended to destroy the effectiveness of any possible enemy intelligence work, was a function of the Intelligence Branch, SPD, and was established at all the installations. Personnel in the project were investigated by the Provost Marshall General's Office, War Department G-2 or Office of Naval Information, and by the Federal Bureau of Investigation. Investigation and protection of scientists engaged in the project were arranged. Purchase and shipment of critical materials for the SPD centers were controlled, and reported leaks in security were investigated.

___/Inf & Int Ltr 6 (S), Hq ASF POA APO 958, 21 May 45.

As a result of our security measures, German intelligence files revealed that no information was received concerning our biological warfare work after 1942, and insofar as could be learned, Japan had no knowledge of our activities whatever.

The single counterintelligence operation of special interest was occasioned by the landing in Western United States, Canada and Mexico early in 1945 of paper balloons which were apparently released from Japan and carried by high altitude winds to this continent. The possibility of biological attack by these balloons, with human, animal or plant disease agents as possible pay loads, was at once recognized. The discovery that some of them carried incendiaries while many others were without material of any sort, led to the belief that the Japanese hoped to obtain information on their flight characteristics from our press, with a view to subsequent employment of the balloons as a biological carrier. However, not a word about them was permitted in the public press, and the work of detection and reporting by Intelligence officers was performed in strictest security to avoid alarming the public.

Soon after the first of the balloons was reported, the War Department advised the Chief, CWS, that he would be responsible for the

(revised)
mark page
⊕

/Ltr (S), AG to C CWS, 12 Feb 45, sub: Possible Introduction of Disease Producing Agents by Japanese Balloons. AG 729.2(7 Feb 45)OB-S-SPLINT. In NDD WDSS.

study of these balloons, in collaboration with the Surgeon General, and coordinate his work with the U.S. Public Health Service and the Department of Agriculture. The Chemical Warfare Service was to indoctrinate military personnel in the U.S., Panama, Hawaii, and Alaska to insure transmission of specimens that might be obtained from the balloons, and was to exchange technical information with Canada and Mexico. The Surgeon General was to instruct all its agencies to look for disease agents. Any specimens found were to be sent by air to the Office of the Chief, CWS. / The Chief, CWS, was also made responsible for the planning and execution of defensive and counter measures against the balloons or materials carried by the balloons, and was to coordinate these plans with the commanding generals of the Eastern and Western Defense Commands and the appropriate Service Commands. He was to be aided by the Surgeon General, the Service Commands, the directors of ASF staff divisions, director of ASF G-2, chiefs of the technical services, and such federal agencies as might be required. /

The Intelligence Branch, SPD, at once sent out teams of officers to each of the Service Commands to alert responsible officers, to

(insert)
minutes 12/8
④ Made of shellacked parchment-like paper, some of these balloons were as much as 33½ feet in diameter. When filled with hydrogen, they were capable of lifting 800 pounds.

/Ltr (S), AG to C CWS, 12 Mar 45, sub: Responsibility for Defensive and Counter Measures Against EAF Agents Introduced by Japanese Balloons. SPX 729.2(12 Mar 45)OB-S-SPINT-M. In NDD WDSS.

instruct in the collection of samples that might be obtained from material conveyed by the balloons, and to establish procedures for reporting further balloon incidents. The U.S. Public Health Service and Department of Agriculture alerted their reporting and detecting services. Emergency plant disease and insect pest surveys which had been instituted throughout the country by the Department of Agriculture at the request of FRS in 1942 were reviewed and rechecked in the light of this new emergency, and these activities were coordinated with similar steps being taken by Canadian authorities. ___/

When, in May 1945, five women and children in Oregon were killed while tampering with a charge fixed to one of these grounded balloons, the War Department decided to release information on them to the press and radio, in the hope of preventing further casualties. ___/ By that time, too, it had been learned that none of the captured balloons were carrying biological agent materials. Two months later it was reported that 187 balloons had been recovered, 44 of them carrying incendiary bombs, the rest apparently without any material whatever. ___/ Not until that September, one month after the surrender of Japan, was the

___/SPPIR 7 (S), 7 Feb 45.

___/Memo (S), C Int Br SPD, ^{by C SPD,} 11 May 45, sub: Summary No. 7 of Balloon Landings. SPD 730. Memo (S), C Int Br SPD for C SPD, 30 May 45, sub: Summary No. 8 of Balloon Landings. SPD 730.

___/Memo (S), C Int Br SPD for C SPD, 5 Jul 45, sub: Summary No. 9 of Balloon Landings. SPD 730.

program for defense against biological attack via the Japanese balloons cancelled. /

Training. A biological warfare school was begun at Camp Detrick in February 1944 to give selected ranking officers in the Army and Navy an understanding of the known technical facts and potentialities of germ warfare. Upon being graduated from the school, these officers were to alert the appropriate officers of their particular services to the dangers of biological warfare. As a secondary purpose of their training, they would constitute the nucleus of a teaching staff for any general program of biological warfare instruction that might later be adopted, when they would be required in all overseas theaters to train officers and units in biological warfare, prepared programs of instruction for lower echelons, prepare defensive plans, lend assistance in collecting and evaluating biological intelligence, and advise commanders with regard to biological warfare tactics. /

At the close of the war each major overseas theater of operations had a qualified biological warfare officer who had either been closely connected with the work of the Special Projects Division or was a graduate of the Special Projects School at Camp Detrick.

/ Memo (S), Asst C CWS for Fld Opns to CG 6th SvC, 14 Sep 45, sub: Decontamination Materials. SPCUK 730-Balloon.

/ The British had no school similar to that at Camp Detrick nor did they train special biological warfare officers. Also there was no British counterpart to the biological warfare intelligence network we had. On the purely informative level, instruction concerning biological warfare potentialities extended only to the highest echelons of British command, whereas we had prepared directives for all but troop level in the Chemical Warfare Service and in medical and intelligence and other related services. See Report on Visit of Lt.Col. Cram C. Woolpert to ETO, 22 May-2 Jul 44 (S), p. 5. In Hist files. w

Authority for the school was granted in January 1944 ___/ and the first course, with 60 students began on 14 February 1944. Five classes, the first of three weeks duration, the others of two weeks, were held between February and June 1944, graduating a total of 217 students. These included 70 Army medical officers from ASF, ACF and AAF, 115 CWS officers, and 32 Navy medical officers.

The faculty under the commandant of the school, who was also Deputy Chief, SPD, consisted of 35 instructors, largely drawn from the technical staff at Camp Detrick and from civilian consultants to SPD. ___/ Lectures and classroom demonstrations, with occasional use of laboratories and visits to the pilot plants, were the methods of instruction. The principal subjects taught in the five classes were:

Significance of BW and possible enemy tactics. . .	3 hours
Intelligence	3
Microbiology	5
Immunology	6
Agents	9
Production of agents	4
Munitions.	12
Food and water contamination	3
Methods of detection	2
Clinical and laboratory diagnosis.	3
Physical protection.	9
Epidemiological control.	14

In addition to these 73 scheduled hours, there were a number of lectures presented during each course by general officers and guest

___/Memo (S), Deputy CofS for CG ASF, 13 Jan 44, sub: Protection Against BW. 730-BW.

___/Appendix I contains a list of the faculty, as well as an outline of the 3 week and 2 week courses that were given.

speakers on such subjects as CWS organization, field requirements, and Allied biological warfare activities. Study periods were held six nights a week while each course was in progress. This was necessary because security made study or discussion in the barracks impossible and all notebooks and papers had to be locked up when not in use.

The first class began without any special text, use being made of standard bacteriological reference works in the technical library at Camp Detrick. By the third class, however, a "syllabus" had been prepared, being a mimeographed compilation of a number of the lectures which had been given to the two previous classes (Appendix J).

 A notebook kept by one of the students in the third class at the Special Projects School is in Historical files. Recorded in the notes is the unofficial class motto: We seek something which cannot be seen, smelt or felt, discovered by means which we do not have, and to be cured by something which we make from nothing, not later than yesterday. Class colors are reported as globigiti yellow and methylene blue, and the class yell is:

Brucellosis, Psittacosis
Pee! You! Bah!
Antibodies, Antitoxin
Rah! Rah! Rah!

The notes are otherwise in good order.

 While the SGO liaison officer at Camp Detrick prepared TB Med 45, Notes on Certain Infectious Diseases (20 May 44) for medical staff officers in overseas theaters, the staff of the SP School began work in Jun 44 on a manual for staff chemical officers in the theaters and for training purposes. This was a 25-page handbook entitled CWS Training Memo SPCYV (S), 10 Jan 45, sub: Instruction for Defense Against Biological Attack. A total of 2,355 copies were printed at Edgewood Arsenal in Jan 45, of which 727 were sent overseas and the remaining 1,306 were
(Appendix K).

In addition to the courses given by the Special Projects School, there were a number of training courses conducted by various divisions at Camp Detrick. Safety Division gave a one-day course in security, safety and sanitation which all individuals who were newly assigned to the Special Projects Division were required to attend. Twelve classes were held between April and November 1944, with a total attendance of approximately 315. The course continued to be given, with emphasis on general orientation and safety precautions, as long as the need existed. Engineering Division conducted a series of lectures on the operation and maintenance of its special equipment for new personnel, and seminars were held by the Chemistry Branch of B Division on the work of that section. In the seminars, electrophoresis was demonstrated and lectures given on the biochemistry, immunochemistry and clinical chemistry of various disease agents, on carbohydrate studies, spectrophotometry and microanalysis. /

distributed to OSG, Navy, UK, Canada, or stored. See Annual Report (S), C SPD to C Contl Div OC C&S, 4 Jan 45. This manual or memorandum was revised and 1,000 copies reprinted 31 Aug 46 as tentative TM (no number) (S), Instructions for Defense Against Biological Attack. In Oct 46, preparation of a more comprehensive tentative technical manual on biological warfare was begun by a member of Historical Branch, Cml C Sch. The 145-page manual (based on Vol. I of this history) was completed in Apr 47 as Tentative TM 3-216 (S Reg Doc), Military Biology and Defense Against Biological Warfare.

/Memo (S), C Lab Sec Chem Br CD for all members Chem Br, 8 Jun 45, sub: Chemistry Seminars. SPCYF.

At Vigo Plant, a 112-hour course in machine shop practice was given to all Engineering Division personnel and members of the Production Division were required to attend a five day course in general biology, operations and safety. / An instruction course of 20 hours in oxyacetylene and arc welding was also conducted by Vigo Engineering Division.

In January 1945, a course in chemical engineering was given by Dr. Odon S. Knight of Rose Polytechnic Institute in nearby Terre Haute. This was given under the auspices of the U.S. Office of Education, as a part of the Engineering Science War Training Program. Thirty-two officers and enlisted men attended the course, which was given two evenings a week for 16 weeks, beginning in January 1945. /

The Special Projects Division was also responsible for troop training at its various installations, in compliance with the Army Service Forces requirements in MTP 21-2. Military police and WAC personnel were given training in conformance with requirements, but troops in the CWS Detachment and in the Technical Detachment were given a minimum of training so as not to interfere with their normal duties. In general, this meant that these troops had to take the

/Ltr (S), C Prod Div VP to CO VP, 14 Feb 45, sub: Training Schedule, Production Division, Vigo, SPCYA 353.10/2. In Hq VP.

/Ltr, CO VP to Dr. Odon S. Knight, 10 May 45, no sub. In Hq VP (353).

compulsory hour of orientation each week, but little else. ___/

3

___/Ltr (TS), CO CD to C CWS, att SPD, 20 Oct 44, sub: Training (SPCYF 353) and 1st Ind, C SPD, 7 Nov 44. ASF Manual #4, sec I, par 3d, 20 Sep 44, sub: Military Training, and WD Cir 360, sec III, par 6, 5 Sep 44, sub: Training, were quoted as authorities for SPD training program.

OPERATIONAL SAFETY AND PROTECTION

Plant safety supervision. While the design of closed system manufacturing processes and provision for disposal of vent gases, pilot plant and laboratory wastes and provision of ventilated air in buildings in the restricted area at Camp Detrick ensured a degree of operational safety to the working personnel, many other measures had to be taken to establish the maximum degree of protection possible for those engaged in handling viable and virulent agents. The welfare of all personnel in the restricted area was the province of Safety Division.

Functions of the S Division were divided between a biological protection branch, which was responsible for personnel inspection, first aid, and immunization, and an operational control branch, responsible for inspection of operational processes in the pilot plants and laboratories and for providing methods of detection, decontamination, and treatment of classified materials which might escape and infect personnel at Camp Detrick or in the surrounding community.

S Division was activated on 27 September 1943 and began at once to compile safety regulations for the conduct of all personnel working in the restricted area, covering operations in the pilot plants, laboratories, animal rooms, shower and dressing rooms, in handling munitions and conducting field tests. The degree of safety control which was developed as operations at Camp Detrick expanded doubtlessly

prevented many infections, through the constant survey of safety practices by S Division, its training program and use of posters, its system of first aid and inspection of personnel, and its immunization program. Many of its practices, testing devices, and techniques are directly applicable to industry and to medicine, and all its experience proved applicable to operation at the Vigo Plant.

Personnel inspection and first aid. Safety regulations required all workers leaving a contaminated area to take a shower. Strict supervision was maintained over the removal of items from these areas, and large autoclaves were installed at the plant entrances for decontaminating items that were to be removed. First aid rooms were maintained in each of the pilot plants and in many of the laboratories, offices and shops. Personnel of the first aid rooms inspected all individuals entering or leaving the buildings, principally for breaks in the skin which might serve as a route of entry for microorganisms.

Immunization. A vaccination routine called "special procedures" was instituted by the biological protection branch of S Division. The object of special procedures was to protect all individuals working with the various agents, determine the most efficacious methods for immunization, and determine the effectiveness of the various

preparations available. ___/ Because there were no standard vaccines in existence for some of the agents under investigation at Camp Detrick and only experimental vaccines for other agents, many of the special procedures were of necessity experimental and it was necessary to obtain permission from the Surgeon Generals of the Army and Navy before unproved materials could be used. Nevertheless, the purpose of immunization of personnel was for their protection and not for collecting data to evaluate procedures which might be of use in general medical practice or be used in the field for immunizing troops.

Special procedures for each individual requiring protection were planned on a master schedule covering a three month period. Records were kept for each person of blood samples taken, injection and skin tests given, and titers obtained, and this information was recorded as the special procedures received by that individual while at Camp Detrick. Thus, individuals ^{who} were definitely going to be exposed to botulinum toxin poisoning, for example, were given the course of injections and serum antitoxic determinations were performed on them each month. If the amount of antitoxin in the blood fell below a critical level, a booster injection of toxoid was given. Individuals who were classified as potentially exposed to the toxin were immunized

___/Ltr (S), CO CD to Post Surgeon CD, 22 Jan 44, sub: Immunization.
SFCYF 400.12. In Hq CD (720.3).

by an initial series of toxoid injections and given booster injections every six months, regardless of the antitoxic titer. Where no immunization procedure was available for an agent, complete information on the determination of skin sensitivity and serum antibody levels were obtained at various intervals on all personnel exposed to these agents. ___/

These procedures underwent considerable modification in the two years of wartime operations at Camp Detrick as new agents were introduced for investigation at Camp Detrick, new biological materials became available, and as laboratory research provided new lines of approach to the problems of immunization.

The first problem of the special procedures group in S Division was to provide a vaccine for protection against anthrax. The use of a killed vegetative anthrax vaccine was authorized in November 1943,

___/Sp Rpt 15, Immunological Protection of Personnel Against B.W. Agents (Oct 46), p. 2.

A few individuals refused to undergo immunization, and when explanations of its importance was of no avail, they were assigned to work where they would not be exposed to pathogenic agents.

Because of the emotional reaction of certain individuals to immunization, a syringe filled with 1:1000 dilution epinephrine hydrochloride was on hand at all times. No immediate reactions to the injections other than syncope occurred, although three individuals developed peripheral nerve disturbances subsequent to injections, with symptoms of numbness and muscular weakness in the hands and arms. Sp Rpt 15, pp. 92-93.

since vaccines of living spore suspensions which are used to immunize animals were considered dangerous to humans. The vegetative vaccine contained 150 to 200 million cells per ml., and 1/10 ml. was injected on three occasions at weekly intervals. Two hundred and five individuals had been given the vaccine when its use was discontinued in July 1944 because no evidence of its value had been demonstrated either by animal protection or serological methods. ___/ In the absence of a satisfactory vaccine for anthrax, an investigation was made of the sulfonamide drugs in the hope of obtaining a method of prophylaxis against known massive exposure to anthrax. Mice and rabbits could not be used as test animals because of their high susceptibility to anthrax infection and because of the toxicity of sulfonamides for them, but satisfactory results were obtained with monkeys which were less susceptible and in which sulfadiazine blood levels could be controlled more easily. Although sulfadiazine appeared to be valuable in preventing anthrax infection in these animals, the results were not verified in humans.

Personnel who were exposed to botulinum poisoning were originally immunized with a fluid type A toxoid, prepared in the Department of Health laboratories at Jamaica Plain, Mass. It was found that a series of four injections of 1.0 ml. each of fluid toxoid at two week

___/Sp Rpt 15, p. 67.

intervals provided over 70 percent of those taking them with a protective antitoxin titer within two months after starting the series. Titers reached their maximum at five months in the average individual, at which time they were 0.02 unit per ml. of serum. This was designated as the protective level and it was believed, on the basis of animal studies, that at that level a 150 pound man should be protected against approximately 60 million guinea pig MLD's of type A botulinum toxin. Booster injections were required every five or six months with the fluid toxoid. Reactions to the toxoid were similar to those to tetanus toxoid. ___/ However, as a result of studies at Camp Detrick, an alum precipitated toxoid was prepared which had greater antigenicity than the liquid toxoid and therefore required fewer injections. While the new type A toxoid (AP321) failed as an antigen in humans and the type B toxoid (AP5511) was too slow, a combination of these toxoids, produced late in 1944 as K23 1.A, proved successful. Satisfactory levels, especially with respect to the B component, were achieved with two 1.0 ml. injections eight weeks apart. ___/

Immunization of personnel in the brucellosis project was begun in May 1944 with a vaccine obtained through the National Academy of Sciences from Dr. I. F. Huddleson of the Central Brucella Research

___/Sp Rpt 11, Immunization of Man with Fluid Type A "X" Toxoid (1 May 45).

___/Sp Rpt 15, p. 10.

Station, Michigan State College. Preliminary skin tests were given using Brucellergen skin test antigen, with plate and tube agglutinations run at frequent intervals. Production of an area of erythema and edema measuring 20 mm. or greater in diameter was regarded as a positive test. No individual, however, with a known history of brucellosis or skin sensitivity was given either Brucellergen or the vaccine. The exact nature of Huddleson's vaccine or its method or preparation were not made known to Camp Detrick. Vaccination with it consisted of two intradermal injections of 0.1 ml. five days apart. A total of 648 individuals working on the project were given the skin test with Brucellergen and 676 were vaccinated. /

Immunization for tularemia was started in January 1944 with a prophylactic vaccine obtained from Dr. Lee Foshay of the University of Cincinnati. Use of the phenol-inactivated vaccine required a skin sensitivity test and in certain cases an agglutinin titer determination prior to the first injection, because of the systemic reaction of many individuals to the vaccine. Vaccination consisted of three injections of 0.5 ml. each. By April 1945, quantity lots of the vaccine were being prepared at Camp Detrick, and in that same month immunization was begun using a new acetone-extracted vaccine which showed promise of causing fewer systemic reactions. Altogether, 743 individuals were

/Sp Rpt 15, pp. 31-34.

given the Foshay-type vaccine and 66 the acetone-extracted vaccine. ___/

Special procedures in the case of psittacosis were not initiated until April 1945, when a vaccine prepared at Camp Detrick was pronounced ready for trial. However, those engaged in the preparation of the vaccine, as well as other workers in the "Si" project, had previously been inoculated with a vaccine received from Dr. Karl F. Meyer of the Hooper Foundation. A total of 193 individuals were given one or more injections of Meyer's psittacosis vaccine, an ether-extracted preparation from infected yolk sacs. A schedule of inoculations was set up and vaccinations started with the Detrick vaccine but definite results did not become available before the end of the war because usable vaccine was always in short supply. ___/

There were no vaccines available for immunization against glanders, melioidosis, or coccidioidal granuloma, the remaining agents studied at some length at Camp Detrick. Skin sensitivity tests were performed with organisms of coccidioidal granuloma and serological data were obtained from personnel exposed to glanders and melioidosis at stated intervals. ___/

___/Sp Rpt 15, p. 55; Sp Rpt 56, Studies on the Development of Biological Defense Against "UL" (1 Jan 46), pp. 123-26.

___/Sp Rpt 15, pp. 69-70.

___/Sp Rpt 15, pp. 72, 83.

Detection of agents in the plants and laboratories. Since the slightest leak in the process equipment of the pilot plants or in operations in the laboratories was a source of danger not only to the immediate working personnel but also to the community at large, S Division personnel were in constant circulation with swab and test tube, checking for leaks and alert for gross flaws. The criteria established for the development of methods of detection required that the method be selective for a particular agent, be as rapid as possible, detect small numbers of organisms, provide for neutralization of the bacteriostatic action of disinfectants used in decontamination, and permit large numbers of samples to be analyzed routinely.

Studies in the detection of the anthrax bacillus and its simulant, B. globigii, led to the establishment of the blood agar plate method as superior to animal inoculation. Contamination of surfaces by anthrax organisms was detected by the use of swabs moistened with saturated sodium thiosulfate solution, brushed across blood agar plates. Detection of organisms in liquid effluents was best accomplished with a meat mash medium, rather than Brewer's thioglycollate medium which was first used. Attempts to develop differential media for the anthrax bacillus and its various pseudo organisms (B. subtilis, B. anthracoides,

B. cereus, etc.) were not satisfactory. ___/

Efforts to use a complement fixation test for the detection of botulinum toxin, and attempts at agglutination of the botulinum antibody absorbed on various dead bacteria, were uniformly unsuccessful. The problem in the case of brucellosis organisms was that of detecting small numbers of them in the presence of their common contaminants. A selective medium which appeared especially favorable to the growth of *Brucella* and unfavorable to their contaminants was tryptose agar with brilliant green. ___/ Results in detection studies of tularemia indicated that plating methods were most successful where contamination was heavy, but in the event of light contamination where tularensis colonies were concealed by various nonpathogens, animal inoculation methods were superior. ___/

For detecting purposes, it was found that the organisms of both glanders and melioidosis grew best on crystal violet glycerol agar,

___/Sp Rpt 58, Detection of Biological Agents (Jul 46), pp. 3-7. See also Sp Rpt 19, Control of Anthrax in a Biological Warfare Installation (Oct 46). In this report on safety problems connected with the production of anthrax are sections on liquid effluent disposal, air contamination, pilot plant safety control, laboratory safety control, discharge of agent from exposure chambers, and medical problems in control of anthrax.

___/Sp Rpt 58, pp. 8-10.

___/Sp Rpt 58, pp. 19-21.

as it provided detection of small numbers of organisms even in grossly contaminated samples. The Strauss reaction in animals did not prove to be a more efficient method and usually required more time than the culture method. ___/ Detection of Coccidioides immitis was effected with .05 percent copper sulfate in a basal medium of 1 percent dextrose, 1 percent peptone and 2 percent agar. Swabs used to collect samples were first moistened with Dobell's solution, the plates were streaked and then incubated at 37° C. for three to four days. The plates were then examined for the characteristic white velvety colony of immitis. The guinea pig was used for confirmatory tests, a Strauss reaction appearing in seven days to three weeks. ___/

While these methods of detection produced fairly accurate results, efforts to devise the rapid methods of detection which were desired met with meager success. It appeared that rapid detection would have to be based on a knowledge of the metabolism of each agent, for only with precise knowledge of the vitamins, amino acids, carbon sources, inorganic salts, and so on, required by each organism could it be grown and identified in a relatively short incubation period. A further knowledge of the compounds which inhibit one species but not another was required to permit rapid growth of the agent involved and inhibit

___/Sp Rpt 58, pp. 14-18.

___/Sp Rpt 58, pp. 11-13.

undesirable organisms overgrowing the pathogen.

Experiments in the use of radioactive phosphorus (P32) as a tracer for aerosol discharges in the pilot plants, in an effort to reduce the time required for detection, produced favorable results. However, the use of P32 was more practicable in the laboratory than in the pilot plant where the concentration in reactors estimated to give adequate detection required greater amounts of phosphorus than could be obtained for detection purposes of that nature.

In another effort to develop an immediate and specific method for the detection of biological warfare agents, an attempt was made to produce anaphylaxis in guinea pigs with bacterial antigens dispersed as clouds. This had been done with ricin in actively sensitized guinea pigs, both in cloud chambers and in the field. ___/ It was learned that guinea pigs could be actively sensitized to anthrax and brucellosis, but the results were not marked nor were they regular. Only negative results were obtained with tularemia and glanders. ___/

Decontamination procedures. S Division was responsible for the effectiveness of decontamination procedures but not for the operations

___/M. Heidelberger and E. A. Kabat, "Immunochemical Studies on 'W'," CSRD Report 4651 (S) (2 Feb 45), p. 7.

___/Sp Rpt 17, Studies on Bacterial Anaphylaxis in Guinea Pigs by the Respiratory and Intravenous Routes (Oct 45).

themselves. The principal experiments it conducted in decontamination were concerned with anthrax. Cloud chambers, it was learned, could be virtually sterilized in 30 minutes when sprayed with 5 percent calcium hypochlorite from the 3-gallon decontaminating apparatus. There was little apparent difference between oiled and unoled surface^s in the collection and retention of organisms or in the decontamination of such surfaces. Plans to oil the walls and floors of laboratories and offices were therefore abandoned.

Tests on the decontamination of munitions showed that formalin was superior to hypochlorite in stability and in lack of corrosiveness. The various mercurials and tincture of iodine appeared to be satisfactory for disinfecting cuts on the skin. Subsequent tests revealed that only Mercresin among the mercurials had a truly bactericidal effect; the other mercurials were merely bacteriostats.

Dakin's solution, an effective sporicide in vitro, corroded metal and lost its sporicidal power in vitro. Neither it nor tincture of iodine were effective against experimental cutaneous anthrax. /

 /Sp Rpt 19, passim.

Air treatment testing. The types of air purification devices and air samplers used at Camp Detrick were influenced by the fact that two types of air had to be tested, that of pilot plant and laboratory process air, which was in small volume but highly contaminated, and pilot plant and laboratory exhaust ventilation air, which was in large volume but relatively low in contamination.

Equipment used for the removal of contamination from effluent air included electromatic filters in the pilot plant and laboratory exhaust systems, which operated by electrostatic precipitation of air-borne particles; air washers in gas chamber and certain laboratory exhaust systems, which drew the air through a fine spray, air incinerators used in the pilot plants and laboratories for waste process air, in which air was drawn through an oil-spray furnace at 1000° F.; and paper filters, where air was drawn through Airmat filters, a Kleenex-like material. These last were used in the inlet vent systems of the pilot plants and laboratories only to reduce likelihood of inborne contamination and not as a safety measure.

Air sampling devices included agar impingers (slit samplers, sieve samplers and open plates), which were found to have poor sampling efficiency since they were not quantitative, but were useful in spot checking; cotton impingers, which were poor for clouds of low concentration; and bubbler samplers, particularly the Polin Aeroscope

bubbler. ✓

In a series of tests conducted with the various types of air filter equipment, the results that were obtained with the several air samplers showed that the electrostatic filter averaged 65 percent efficiency, ✓ the air washers were about 75 percent effective, the air incinerators were 100 percent effective, and the paper filters averaged 40 percent efficiency, depending upon atmospheric conditions and other uncontrollable variables. ✓

✓ R. B. Bourdillon, O. M. Lidwell, and J. C. Thomas, "A Slit Sampler for Collecting and Counting Air-borne Bacteria," Journal of Hygiene, 41 (1941), 197-224.

E. G. DuBuy and L. R. Crisp, "A Sieve Device for Sampling Air-borne Organisms," Public Health Report, 59 (1944), 829-32.

S. M. Wheeler, G. E. Foley, and T. D. Jones, "A Bubbler Pump Method for Quantitative Estimation of Bacteria in the Air," Science, 94 (1941), 445.

L. P. Rettger, "A New Improved Method of Enumerating Air Bacteria," Journal of Medical Research, 22 (1910), 461-68.

H. G. DuBuy, A. Hollaender, and M. Lackey, "A Comparative Study of Sampling Devices for Air-borne Micro-organisms," Supplement No. 184 (1945).

K. R. May, "The Cascade Impactor," Journal of Scientific Instruments (Brit), 22 (1945), 187.

L. S. Sonkin, "Modified Cascade Impactor," Journal of Industrial Hygiene and Toxicology, 28 (1946), 269.

✓ Sp Rpt 70, The Performance of an Electrostatic Filter for Removing Air-borne Bacteria (May 46).

✓ MTR, Safety Div (Dec 44), pp. 25-28; (Jan 45), pp. 31-32; (Apr 45), p. 34; (Nov 43), pp. 9-11; (Mar 45), pp. 31-32.

Sewage treatment. In S Division tests of the sewage tanks containing treated liquid wastes from the anthrax pilot plant, positive results were obtained with considerable frequency. However, since neither the anthrax bacillus nor Escherichia coli were among the contaminants found in the supposedly sterile material, it was concluded that either sampling techniques or incomplete sterilization must be at fault. By installing bleeders at dead ends in the tank piping, such as at the gauges, better steam sterilization was obtained with resulting negative tests. The occasional leaks that were found in the retention tube and raw sewage pumps in the sewage treatment plants proved the value of constant inspection tests and led to corrective measures.

Laundry treatment. Determination of the factors necessary to ensure complete sterility of the clothing discarded at the end of each day by the plant and laboratory workers was a responsibility of S Division operational control. It was learned that complete sterilization of clothing and shoes could be accomplished in the autoclave at 240° F. for one hour. Because wet clothing was considerably more difficult to sterilize, the time was prolonged.

Shipment clearance: S Division approval was required before any new process involving possible hazard to personnel or property could be adopted and before any new equipment was subjected to use with

actual toxic agents. Representative of this phase of safety control was the packing of toxic biological agents for shipment out of Camp Detrick. A packing case which was developed when it became necessary to ship a quantity of botulinum toxin to Horn Island for field tests consisted of a welded metal box with a flanged top bolted on and sealed with a rubber gasket. The metal box was then enclosed in a wooden box with an inch and a half of sawdust packing on all sides. It proved entirely satisfactory for the purpose, arriving at Horn Island in good condition.

Laboratory techniques. In the course of its laboratory safety control work, S Division learned that many ordinary laboratory techniques, such, for example, as blowing out pipettes by mouth, pouring, and vigorous agitation of dilution blanks, were not safe when working with highly infectious agents. By means of high speed photographic studies, it was shown that these operations may set up dangerous aerosol suspensions of the agents in the laboratory. ___/

The cleaning of laboratory glassware with the usual materials, concentrated sulfuric acid saturated with potassium or sodium dichromate, was not considered suitable in biological laboratory practice

___/K. R. Johansson and D. H. Ferris, "Photography of Airborne Particles During Bacteriological Plating Operations," Journal of Infectious Diseases, 78 (May-Jun 46), 238-52.

because of the difficulty of ridding glassware of dichromate after cleaning and because of the toxicity of dichromate for living cells and enzymes. Instead, it was recommended that 10 percent nitrate or 1 to 5 percent trisodium phosphate be used for this purpose. ___/

Insect and rodent control. The normal incidence of the insect and rodent populations in the environs of Camp Detrick constituted a potential health hazard both to the camp personnel and to the surrounding community. As natural vectors of certain of the disease agents being studied in the laboratories, these populations also presented a threat to the security of the installation. An epidemic or even a few cases of anthrax, melioidosis, or tularemia, all of which may be transmitted by rodents, might well have proved disastrous to the secrecy under which the work at Camp Detrick was conducted. There was evidence, too, that in continuous war weather the common housefly infestation at Camp Detrick might prove dangerous to the camp and community. Adjacent dairy farms were considered breeding sources of an immense fly population. For these reasons, the camp maintained rigid control over both insect and rodent pests and attempted to enlist the help of the U.S. Public Health Service

___/R. J. Henry and E. C. Smith, "Use of Sulfuric Acid-Dichromate Mixture in Cleaning Glassware," Science, 104 (1 Nov 46), 426-27.

in eliminating off-reservation sources of infestation. /

ACCIDENTS AND

Laboratory infections. In spite of the control operations of S Division, the physical and chemical protection studies of PC Division, and the biological protection studies of B Division, a certain number of infections among the plant and laboratory workers was, of course, inevitable. Yet, with almost 4,000 people engaged in the operations at Camp Detrick, ^{and other installations} there were only 60 cases of proven infection among them, in addition to 190 cases of accidental exposure to various agents in unknown concentrations. These latter cases received immediate prophylaxis and none of them developed infection. The general health of the command, as indicated by hospital admission and sick call visits, did not differ significantly from health at other Army installations in the area. Between 1 and 2 percent of the command were hospitalized at all times for various minor illnesses and an additional 1 to 1.5 percent were hospitalized elsewhere for more chronic diseases or for surgical operations which could not be performed at Camp Detrick.

/Ltr (TS), C SPD to Liaison Off USPHS 3d SvC, 25 May 44, no sub. SPCYF 040 (725.11/25 May 44). This ltr was referred to USPHS District Office for inspection and necessary action, per ltr USPHS FSA to C SPD, 27 May 44.

The station hospital that was activated at Camp Detrick in April 1943 was uniquely favored in its opportunity to study the ^{onset} inception, course, and therapeutics of many diseases, some of which were rarely seen in the Eastern United States, some not known at all in this country, and still others which might be considered exotic to medical practice anywhere. The opportunity was also unique in that complete vital statistics could be obtained for all personnel engaged to work in the laboratories and pilot plants before they began their hazardous tasks. The conditions under which disease might occur were under constant study by S Division as well as the workers themselves, thus presenting an unusual opportunity for determining actual modes of infection. In addition, many of the patients were skilled technicians and were therefore able to furnish the hospital staff with far more precise information than lay patients. ✓

There is some indication in the early history of the station hospital that these special advantages were either overlooked or discounted. The hospital was staffed by SGO personnel, none of whom were specialists in the clinical aspects of the disease agents under investigation. At the height of activities when the greatest number of cases were hospitalized, there was no first rate internal medicine specialist on the post. Nurses at the hospital were not informed of the nature of the installation. There does not even appear to have been any pre-planning of hospital procedures upon admission of patients

who were known to have been handling highly pathogenic agents. In October 1944, three patients were admitted to the hospital after exposure to an anthrax aerosol, yet anthrax was not suspected and no effort was made to isolate the organism. The high fever and lung lesions observed in these patients appeared to later investigators to indicate that these laboratory workers might have had respiratory anthrax, a relatively rare form of the disease. ___/

With subsequent changes in personnel, advantage was taken of the special circumstances present at Camp Detrick. Closer liaison was set up with the technical divisions. Members of these divisions were consulted and the laboratories of B Division, superior in many respects to the hospital laboratories, were called on for aid. Bacteriological and serological studies of hospitalized cases were carried out in a special laboratory by members of S Division. A laboratory, plant, or field accident report form was prepared in order to record the complete circumstances of all accidents involving dangerous agents as they occurred (Appendix L), and a standing operating procedure, Hospital Procedures at a BW Installation, outlined in some detail hospital practice in cases of anthrax, botulism, tularemia, brucellosis, glanders and melioidosis, psittacosis,

___/Classified Undiagnosed Diseases (a report in files of Station Hospital, CD); MTR, S Div (Jul 45); memo (S), Medical Off VP to CO VP, 27 Mar 45, sub: Report on TD of Medical Officer at Camp Detrick. In Hq Vigo. SPCYA.

coccidiomycosis, and Japanese B encephalitis (Appendix M). In March 1945, the chief medical officer of the Vigo Plant visited the station hospital at Camp Detrick to study the hospital procedure that had evolved as the result of cumulative experience, particularly with reference to the study and treatment of anthrax cases. ___/

In the 28 months of wartime operations at Camp Detrick, there were 25 cases of cutaneous anthrax, 7 cases of brucellosis infection, 19 cases of clinical or subclinical tularemia, 2 cases of meningopneumonitis psittacosis and 1 case of classical psittacosis, 1 case of cutaneous and 1 case of pulmonary coccidioidal granuloma, and 4 cases of glanders, a total of 60 cases of infection. In the six months after 1 September 1945, there were an additional 10 cases of brucellosis, 7 of tularemia and 2 of glanders. ___/ The history of most of these cases is reported at the end of the chapters on the individual agents.

There was not a single case of botulinum poisoning, in spite of the extensive investigation made of the organism and toxin. Brucellosis caused the greatest time loss per case, averaging 177 days; glanders was next with 121 days per case; followed by

___/Meno (S), Medical Off VP to CO VP, 27 Mar 45, sub: Report on TD of Medical Officer at Camp Detrick. SPCYA. In Hq VP.

___/Sp Rpt 72, Accidental Laboratory Infections at a Biological Warfare Station (Jul 46).

coccidioidomycosis with 98 days, tularemia, 71 days, and anthrax 25 days per case.

In addition to the 60 cases of actual infection, there were 190 cases of accidental exposure to agents being studied at Camp Detrick, none of which, however, developed infection. There were 142 cases of exposure to anthrax organisms, of which 129 were given immediate treatment with sulfadiazine and 13 were untreated; 25 cases of exposure to botulinum toxin, of which 13 were treated with toxoid and 12 were untreated; 15 cases of exposure to brucellosis, treated and untreated; 3 to tularemia, 3 to glanders or melioidosis, and 2 to psittacosis, both treated and untreated. ✓

Safety control at Visc Plant. The Safety Division at Vigo Plant consisted of a medical branch, industrial safety branch, and agent control branch. The operation of this division was, in general, similar to that at Camp Detrick in controlling safety factors with respect to the working personnel and the operation of the laboratories and production plants. The industrial safety branch had no precise counterpart at Camp Detrick, but it was set up at Vigo Plant to control ordinary industrial hazards and ordinary industrial hygiene, apart from the special controls connected with handling biological agents.

✓ LTR, S Div (Jul 45), pp. 29-41.

When actual manufacture of anthrax was begun in the plant, Safety Division planned to use sheep as control animals, placing them in 13 locations in a circle around the rim of the restricted area, with six to twelve sheep at each station.

First aid equipment and aid personnel were located at three sites in the 1,100 area and at one in the 1,200 area to provide emergency treatment in accident cases. Personnel entering the plants areas were stripped and given thorough physical inspections before going to work and upon leaving each evening.

To facilitate the detection of leaks in production plant equipment, drawings were made of every foot of process piping and each possible point of leakage in the piping was numbered on both drawing and the equipment itself. When a positive swab was at any time reported to the engineers, they were able to locate it quickly by reference to the drawing.

Formaldehyde was successfully used to decontaminate an entire building involving more than 300,000 cubic feet. This was believed to have been the largest decontamination operation of that kind ever undertaken. It was found that formaldehyde could readily be disseminated from outside into the building and it proved an effective decontaminant. Previous trials with hypochlorite showed that it was corrosive and was difficult to spray, while ethylene oxide did not appear to be as effective a decontaminant as formaldehyde.

The air sieve samplers developed at the US Public Health Institute and improved by Camp Detrick were found satisfactory for testing effluent air in the Vigo production plants. ___/

___/Interv CES Hist Off with Capt Thompson, Safety Div, Vigo Plant,
13 Jul 45.

DEFENSE AGAINST BIOLOGICAL AGENTS

~~Biological~~ Physical, and chemical protection. The field for investigation of biological protection was well defined, for it had to keep pace with offensive developments. As each agent with potential offensive possibilities was examined, an effort was made to find a biological preventive for it and to develop chemotherapy or other treatment for the effects it produced. While S Division concentrated its efforts on the immediate protection of the workers at Camp Detrick and the community of Frederick from these offensive agents, B Division was engaged in the basic biological and medical research to determine the essential factors in detection, diagnosis, pathogenesis, immunization, and treatment for these agents.

The objectives of PC Division (in T-521), in devising physical and chemical protection against the biological warfare agents which were being studied, were not so evident. Neither the weapons nor tactics of biological warfare had been determined. The potentialities of aerial bombs, small bore ammunition, shrapnel, aerial sprays and dusts, terrain contamination, and sabotage presented an enormous field against which a considerable degree of physical and chemical protection of troops would have to be provided.

In order to limit the range of studies for the sake of achieving quick results, the efforts of PC Division were of necessity confined to obvious hazards. It had to be assumed that individuals and groups would in most instances be exposed to biological agents by breathing the organisms

or by skin or conjunctival contact. The possibility of ingesting pathogens by drinking or eating would have to be prevented by detection methods, with protection based on principles of public health and epidemiology. Studies in PC Division were therefore concentrated on the development of masks, clothing, and decontamination procedures. The investigation began with a survey of the defensive possibilities of conveniently available materials, those which had already been devised for protection against chemical warfare agents.

Biological masks. Testing of standard and experimental Army and Navy gas masks was begun in September 1943 to determine their efficiency against biological agents under simulated field conditions. In order to establish conditions in the laboratory and field tests which would be more critical than those which would normally be attained in the field, the masks were subjected to aerosols of 90 percent single spore particles at concentrations of approximately 3×10^5 (300,000) spores per liter of air.

Preliminary experiments were carried out using a tent as a test chamber. Later gas mask, hood, and outlet valve tests were conducted in a special chamber constructed from a plexiglass hollow sphere which was designed to expose only the individual's head to the agent cloud. In still later tests of masks and clothing, a 25,000 liter chamber was used. In the tent chamber, aerosols of B. globigii spore mud diluted with sterile distilled water were produced by compressed air capillary atomizers under 30 pounds pressure. Binks nozzles produced an aerosol containing from 91.8 to 96.7 percent single spore particles. The atomizer was used three to

ten minutes prior to the entrance of the test subjects into the chamber. Every effort was made to keep the men in the tests free from contamination prior to exposure to the test cloud. The nostrils and mask of each man were cultured before each test by a wet cotton swab inoculated onto an agar plate. In the event B. globigii was recovered from the nares or mask of any man, the mask worn by him in the particular test was not considered.

Each man, clad in ^{standard} issue one-piece herringbone twill coveralls with ^{plastic over} issue helmet and a ^{gloved} mask without carrier, was exposed to the cloud for fifteen minutes. Cotton impingers were used to determine the spore concentration in the chamber. Following exposure, the men came into the open air away from the test chamber and fifteen minutes later smears were taken on sterile wet cotton swabs from the face outside the facepiece, the face inside the facepiece, the nose, and mouth. Mouth cultures were abandoned when experience proved them impractical. ✓

As the tests progressed, special collecting devices were fabricated, in an effort to secure more accurate and comparable data. These included glass nose impingers (51.5 percent efficient), rubber stopper nose impingers (43.5 percent efficient), an eye-dropper rubber bulb for the nose impinger (41.5 percent efficient), a mouth impinger consisting of the mouthpiece from a basal metabolism apparatus (75 percent efficient). The most satisfactory collecting device, however, was a nose cartridge impinger which had a collecting efficiency of approximately 50 percent for B. globigii spores. It consisted of a 1-inch diameter brass cylinder 3/4-inch long, packed with 250 mg. of absorbent cotton, and offered a resistance of about 60 mm. of water when subjected to an air flow of 25 liters per minute, the

maximum resistance consistent with comfort. The number of specific organisms present in these impingers was the criterion for measurement. Results were relative only, since not all types of organisms could be collected by the types of impingers used.

A mask sampling device was invented to sample air under the facepiece, independent of the respiration of the subject. This device was necessary to estimate leakages at high work rates when the resistance imposed by the cotton nose collector was so great that high work rates could be maintained only over short periods of time. Cultures from the hoses of the masks were made by means of fixed cotton impingers inserted into the hose through the deflectors for a distance of three inches. At the end of the tests, facepieces, hoses, and canisters were decontaminated by washing with a 40 percent solution of alkaline chlorox. Clothing and helmets were autoclaved at 15 pounds pressure for twenty minutes.

In view of the proven efficiency of the canister in laboratory tests, the facepiece and outlet valve of the gas mask were considered responsible for the lack of protection against spores which was demonstrated in the early tests, even though hose leaks were demonstrated in 25 percent of twenty masks tested. In general, the tests indicated that the CWS masks existing in 1943 gave poor protection against simulated biological agents. Though resin wool exhaust filters or flannel snouts over the exhaust filter on the mask definitely reduced leakage at this site, they did not raise the

The low bacterial counts which were obtained from cotton collectors after test subjects wore masks which had been previously heavily contaminated, removed, and replaced on the face without intervening decontamination suggested that as an emergency measure in the event of a biological attack in the field, the mask should be put on as soon as possible and worn even though it had been exposed to

degree of protection significantly. It was believed that hoods over the masks would be even more effective and Quartermaster Corps and CWS supplied hoods made of Oxford type IV wind-resistant cloth and two layers of 5 ounce poplin. They increased the protection offered by the mask, but because they did not cover the outlet valve on the mask, a high degree of leakage persisted. The CWS laboratory at Massachusetts Institute of Technology developed an impermeable hood (EL4RS) and a permeable type (EL4R12) which did cover the outlet valve and these provided the basis for the successful biological masks which were finally developed late in 1945. /

Outlet valves. The routine method of measuring valve leakage in CWS gas masks ^{and} is a static test based on the amount of water displaced by air leaking through the outlet valve when the valve is subjected to a constant negative pressure of 25 mm. of water. This gives a true indication of gas leakage since the gas concentration is unchanged in the passage of air through the valve. With a cloud of spores, however, some would be removed by impaction on their way through the valve. In the event of exposure to a biological cloud at a concentration of 500,000 spores per liter, it was postulated, leakage of the magnitude acceptable in this static test would permit 1,500 organisms to enter the mask per minute. For this reason, a

/ Sp Rpt 37, The Development of Gas Masks and Hoods for Protection Against Biological Warfare Agents (Feb 46).

The masks developed at the end of the war are described in Vol. 1, Military Biology and Biological Warfare, ch. 5.

dynamic test for outlet valve leakage was required in which conditions of breathing had to be employed or simulated, with the outlet valve exposed to bacterial clouds moving at wind speeds comparable to those likely to be encountered in the field.

The first tests were made with humans in February 1944. Consistent results were obtained with the brass cylinder nose collector, previously described, but in order to eliminate some of the variable with humans, use was also made of a breather pump and manikin head. With this device it was found that as the leakage collector was moved to a point closer to the back of the outlet valve, the degree of leakage increased. An apparatus of plaster of Paris and ground glass joints was next constructed to sample all the air back of the outlet valve. Assessment of experimental outlet valves was based on the use of these three test methods.

When none of the four standard outlet valves used in Army and Navy canisters in 1943 proved acceptable, the CWS laboratories at M.I.T. was requested to develop a special filter for the M3 outlet valve which was to be used with the biological mask. The result was the E4 filter, made of a resin wool packing and fitted in a cylinder which was adaptable only to the M3 valve. / When leakage still persisted with this filter, it was

/ More than 2,000,000 E4 filters were procured by June 1945. Three-quarters of them shipped to ETO, Leyte, CBI, and POA and the remainder were put in storage or sent to Camp Detrick for further development. An additional 450,00 were scheduled for completion in July and these would be held in storage. See Annual Report for FY 1945, C SPD to C Control Div OC CWS, 4 Jun 45.

recommended that the M1 outlet valve cloth cover previously developed replace the E4 filter, since that the the most practical method found up to that time of protecting this vital zone in the mask. / In the leak-proof service mask developed after the war, however, both the M1 cover and E4 filter for the outlet valve were eliminated. /

Canisters. The purpose of the canister study undertaken at Camp Detrick in April 1943 was to devise methods for testing Army and Navy canisters for penetration by simulant biological agents and to correlate the results with those obtained in standard CWS tests. The chamber used for these tests was jointly designed by PC Division and E Division at Camp Detrick, the Naval Research Laboratory at Anacosta, and the H.K. Ferguson Company, and the agents used were B. sterrimus, B. nizer, B. globisii, and S. marcascens, obtained from the University of Wisconsin.

The method devised for canister penetration was to produce an aerosol of organisms, determine the number in the cloud before it passed through the canister and the number in the ambient cloud after canister passage. Three test procedures were used: a constant flow of 32 liters per minute through the canister, an alternating flow using the breather pump, and

/ Sp Rpt 31, Testing and Development of Outlet Valves (Nov 45), p. 54.

/ Vol. 1, ch. 5.

/ 16

breathing by a human subject. The first method was most severe and provided test conditions considerably more exacting than those which might be expected in the field.

The filter papers used in Army canisters, particularly the M11 model, were found most effective against the test agents. Discrepancies in effectiveness were usually due to faulty assembly of the canisters. Navy canisters appeared to be less efficient because of the poor quality filter paper and the fact that the paper was wrapped in a spiral form in the canister, making it difficult to obtain a perfect seal around the edges. Both Army and Navy canisters provided better protection against the simulated agents than 23 of 24 German and Japanese canisters which were available for tests.

In correlation studies between D.O.P. / and biological agent penetration of the canisters, it was shown that at 32 liters per minute the following D.O.P. penetration percentages assured excellent canisters for filtration of agents of about 1 micron in size: U.S. Army M11, 0.001 percent; U.S. Navy ND-B2, 0.003 percent; U.S. Army M10A1, 0.01 percent. These specifications could readily be met by manufacturers of the canisters.

The development of a special canister designated E10R2 for biological warfare agents resulted in a model comparable to the M11, but because it could not be used for protection against chemical warfare agents, ^{the latter were not} _{was simulated}

/ Gas mask canisters are ^{routinely} tested for penetration with di-octyl-phthylate, a liquid smoke.

No completely satisfactory method for the decontamination of canisters was found. When autoclaved, the canisters retained their original efficiency in filtering biological agents but no longer afforded protection against most chemical warfare agents. /

Protective clothing. Prior to the studies at Camp Detrick in the development of clothing for protection against micro-organisms, the only groups at all interested in the subject had been hospital workers who had investigated hospital masks for use during surgical operations and, to a limited extent, workers in the fermentation industries.

Considerable time was spent in developing test methods of determining the permeability of cloth samples because such studies were without precedent. The cloth filtration test apparatus that proved most satisfactory because it simulated actual wearing conditions was a large metal manifold with twelve sampling units which was installed in a cloud chamber in which aerosols of B. globigii spores, B. prodigiosus, B. subtilis, or E. coli could be produced. By drawing a vacuum at a low flow rate through the material in the sampling units and plating the agents that penetrated the cloth, differential rates of permeability could be determined. By means of this apparatus it was apparent that Oxford type IV cotton cloth, with a

/ Sp Rpt 30, Laboratory Testing of Canisters (Oct 45), pp. 1-3.

filtration efficiency of 92 percent, was the best textile for biological protective clothing. / Herringbone twill suits which were standard issue in the field afforded limited protection by excluding approximately 50 percent of the organisms to which the body would be exposed without the clothing. The wearing of underwear under this suit increased protection by excluding up to 90 percent of organisms.

The relative protection afforded by wet and dry clothing against B. globigii spores was determined by covering the hands of subjects with herringbone twill cotton cloth. Just prior to exposure, one hand was saturated with water. After exposure, the hands were washed with sterile water and swabbed dry. Dilutions were made of the wash water and swabs and the plated samples counted after incubation. No significant difference in results were observed.

To determine the effects of decontamination processes on various textiles, samples were treated and then tested for tensile strength and air permeability and inspected for apparent deterioration. Wool serge was badly damaged by calcium and sodium hypochlorite and by autoclaving, but was safely decontaminated with low concentrations of ethylene oxide. Autoclaving, followed by laundering, did not impair the serviceability of cotton clothing. The use of alkaline hypochlorites with 1.5 percent chlorine

/ Sp Rpt 34, Protective Clothing for Use in Biological Warfare
(Dec 45), pp. 6, 8, 15, 27-28.

content was safe on such material. /

It was concluded at the end of the test program that the standard issue clothing in the Army provided a certain amount of protection against biological agents as they would most likely be encountered in the field, but the clothing was not entirely adequate. Since the physical comfort of protective clothing was shown to be important, a certain amount of protection necessarily had to be sacrificed. The problem of supply was a limiting factor in the case of the material selected as most suitable for biological protection, Oxford type IV water-repellent, wind-resistant cotton cloth. Only a small quantity of this type of cloth could be produced in this country with existing facilities. A number of uniforms made of this material were obtained for plant workers at Camp Detrick and the suit was designated as the SFD Work Uniform. /

An impermeable ventilated suit made of Neoprene-bonded nylon cloth was developed for especially hazardous work at the Vigo Plant. Tests indicated that the suit was safe and comfortable to wear and provided 100 percent protection against B. globigii spores. /

/ Sp Rpt 33, The Effects Produced on Cotton and Woolen Fabrics by Certain Decontaminating Procedures (Oct 45), pp. 18-19.

/ MPR, PC Div (31 Dec 44), p. 35; MPR, PC Div (30 Apr 45), p. 33.

/ Sp Rpt 34, pp. 43-46.

Bactericidal properties of impregnated cloth. Because Oxford type IV cotton cloth was not available, whereas large stocks of CC_2 -impregnated clothing were already on hand in the field as a part of CWS readiness for gas warfare, series of tests were run to evaluate this clothing for its biological protective properties.

The apparatus used in preliminary impregnated clothing tests consisted of a plastic cloud chamber and a glass nebulizer fitted with a short reflux tube. Four liters of air per minute flowed through the nebulizer. A slight negative pressure was maintained in the chamber. Samples of clothing impregnated by both the M-1 and M-2 processes / were exposed for ten minutes to clouds of S. marcescens, E. coli, S. albus or S. aureus, removed and after suitable contact times, placed in diluents and plated.

On unimpregnated cloth, E. coli and S. marcescens survived one and a half hours with no decrease in numbers when the cloth was wet, but were sterile within twenty minutes when the cloth was dry. S. albus survived $1\frac{1}{2}$ hours without reduction on dry cloth and decreased approximately 90 percent on wet cloth within $1\frac{1}{2}$ hour. S. aureus was reduced approximately 50 percent on either wet or dry cloth within $1\frac{1}{2}$ hours. v

/ Components of the M-1 solution or solvent process are one part CC_2 (an active N-chloro compound), 10 percent $CaCO_3$ or 10 percent ZnO stabilizers (by weight of CC_2), 75 percent chlorinated paraffin binder, fifteen parts tetrachlorethane solvent, and vat dye. Components of the M-2 aqueous or suspension process are one part CC_2 , 10 percent ZnO (Army) or 25 percent ZnO (Navy) or 10 percent $CaCO_3$ (Navy), 75 percent chlorinated paraffin binder, 3.75 percent polyvinyl alcohol as emulsifying agent, fifteen parts water, vat dye, and small amounts of Daxtad II and Dupanol C as dispersing agents.

On impregnated cloths, S. marcescens and E. coli were killed almost immediately, and both S. albus and S. aureus were killed within 20 minutes when the cloths were wet. On dry cloth, S. marcescens and E. coli were killed within 10 minutes, and 50 to 70 percent of both S. albus and S. aureus survived after 1½ hours.

In tests of the sporocidal effects of the two impregnating processes on actual pathogens, samples of each kind of impregnated cloth were placed in bottles and infected with 0.1 cc. of a standard suspension of anthrax spores. The bottles were then placed in a 30° C. waterbath, after which 10 cc. of 1.2 percent sodium thiosulfate, to neutralize the activity of the chlorine, was added. The results obtained by plate counts and by mouse inoculation indicated that the aqueous process destroyed all anthrax organisms in 1 to 3 hours, the solvent process in 8 to 10 hours or more. No changes in the sporocidal properties of the cloths were found when the amounts of chlorinated paraffin binder were varied nor when mineral oil was substituted as a binder. Omission of stabilizers, however, resulted in a decrease in sporocidal properties. /

A final report of tests of CC₂-impregnated clothing revealed somewhat different conclusions. This report stated that impregnated clothing did not sterilize anthrax organisms but did act on the organisms to some degree after 30 minutes contact time. Sterilization of brucellosis organisms

/ MFR, DD Div (31 Jan 44), MPR, PC Div (30 Nov 44).

was still incomplete at the end of an hour, but was essentially complete against tularemia organisms in 15 minutes. It was concluded that self-sterilization of CC_2 cloth could not be counted on to prevent infection from occurring by passage of organisms through the clothing and impinging on the skin. /

In further tests, comparison was made of other N-chloro impregnites, including the hydantoin derivatives RH-195, RH-816, RH-851, RH-852, RH-855 and RH-856; the glycouril derivative S-461; the melamine derivative S-436; and the chlorinated anilides CC_2 and A-V, the British impregnite. / Of these, only RH-195 and S-461 improved the sporocidal properties of cloth, but when they were combined with one part to nine parts of CC_2 , these impregnites lost their enhanced qualities. Furthermore, RH-195 was unsuitable as a replacement for CC_2 in clothing due to its extreme instability and destructiveness to cloth, and S-461 was too active to be of practical value. /

Impregnated cloth stored for 96 hours at $75^{\circ} C.$ and 75 percent relative humidity, which was considered equivalent to 6 months storage under tropical conditions, resulted in marked loss of sporocidal action in the aqueous-impregnated cloth, but only slight loss in the solvent-impregnated cloth. Efforts made to prevent such aging and to restore the depleted

/ Sp Rpt 34, p. 19.

/ RH-195 or CC_1 is the basis of CWS shoe impregnite; S-461 is the basis of CWS M5 protective ointment.

/ MPR DD Div (31 Oct 44), MPR PC Div (30 Nov 44).

sporocidal properties were fruitless, nor could any correlation be made between reduction in chlorine content and loss of sporocidal properties in the cloth.

To determine the effect of hard wearing on the sporocidal properties, suits of coveralls were obtained from participants in field trials held at Camp LeJeune where the suits had been worn for three days in landing operations and for a week on the rifle range. Of the five suits tested, three had shown poor sporocidal properties before wearing. All five showed marked loss of properties after wearing. The suits were then reimpregnated by various methods and retested. While there was a reduction in the number of organisms on the uniform over an 8 hour period, a large number of viable organisms remained.

Impregnated clothing was laundered in Ivory soap and in Nacconol-NR, a synthetic detergent. After two washings in soap, sporocidal properties were greatly reduced, but after washing twenty-one times in Nacconol, they were greater than in unwashed clothing. As Nacconol possessed only slight bactericidal properties in itself, no explanation could be offered for these results. Nacconol and other synthetic detergents incorporated in the impregnating bath of both aqueous and solvent processes resulted in great improvement in sporocidal properties, particularly in the solvent process. It was found, almost without exception, that the shorter the wetting out time in washing tests, the higher the sporocidal action. Inclusion of detergents appeared to improve the absorbent quality of the cloth and hence its sporocidal efficiency.

The initial laundering tests were run under conditions approximating 100 percent relative humidity. When the humidity was lowered to 40 percent, it was found that sporocidal properties were greatly decreased. Humectants, including glycerine, sorbitol, ethylene glycol, TLL-7 and Mp-646 (commercial preparations), were added to the cloth in an effort to increase the moisture content at lower humidities, thereby increasing the sporocidal action. Incomplete results in this series of tests suggested that the humidity might be lowered to 70 percent without materially affecting sporocidal properties.

As a result of the clothing investigation, it was determined that no more practical method of impregnation had been found than standard aqueous impregnation and that clothing thus impregnated required relatively high atmospheric humidity for efficient bactericidal and sporocidal action. Vegetative organisms which were tested survived less than 20 minutes on wet impregnated cloth and their ability to survive on dry impregnated cloth depended on the ability of the individual organisms to withstand desiccation.

✓ MPR DD Div (30 Apr 44), MPR DD Div (31 May 44), MPR PC Div (31 Jan 45), MPR PC Div (31 Apr 45).

Ointments. It was believed that the Army-Navy M5 protective ointment developed for protection of the skin in chemical warfare might have disinfecting properties applicable to biological warfare. Samples of M5 ointment, as well as a number of disinfecting preparations made by various pharmaceutical houses, were obtained for testing. Anthrax spores were used in these tests because that agent was in production in the pilot plant and protection of laboratory personnel against it was of immediate concern. Furthermore, anthrax spores offered a severe test because of their high resistance to ordinary means of disinfection.

In vitro tests for bactericidal action were made by infecting the test substance with anthrax spores. After varying contact times, the active ingredient in the test preparation was neutralized by a chemical agent. Dilution plate counts were made and the rate of death of the spores was determined by counting the number of colonies appearing in the plates. To indicate the concentration of active ingredient necessary to kill anthrax spores in a given time, varying concentrations of the substances were tested against constant inoculi and contact times. In vivo tests were made by scarifying depilated areas on the bellies of mice by making about 20 light scratches with a needle, care being taken not to draw blood. The preparation being tested was then rubbed into this area, leaving a layer of substance comparable to that which would be used in protecting human skin. The area was then infected by depositing 0.01 cc. of an anthrax suspension and

spreading this over the protected area. Mice without protection were infected as controls.

The substances subjected to these tests were M5 ointment; iodine in alcoholic and aqueous solutions and in combination with M5 ointment; G4, an organic chlorine compound; xeroform; N.I.H. 66, a chemical warfare protective ointment; CC_2 paste, an organic chlorine compound; hyamine 1622, a quaternary ammonium chloride; phemerol, a solution containing hyamine; lanogin, a commercial antiseptic hand lotion; and iodoform.

The in vitro tests of M5 ointment against anthrax spores indicated that it was only slightly bactericidal. In vivo tests suggested it had some protective action against cutaneous infection in mice. In general, the skin protection tests with M5 ointment were unsatisfactory and its use could not be recommended for protection of troops against biological warfare agents in the field. None of the other substances appeared promising. Those found to be sporicidal proved too irritating for use on human skin. In retrospect, it was felt that anthrax spores were too severe a test organism for biological warfare disinfection. An in vitro test of M5 ointment against E. coli indicated that the ointment might be quite effective against less resistant forms of biological agents. /

/ Sp Rpt 32, Protective Ointments in BW (Sep 45), pp. 7, 10.

Decontamination^{entry} The object of the decontamination project of PC Division was to determine the effectiveness of possible decontaminating procedures against biological warfare agents in the field, laboratories and pilot plants at Camp Detrick and at Vigo Plant. It was stipulated that the ideal agent should be effective against vegetative and resistant spore forms, have a high vapor pressure or exist as a gas at ordinary temperatures act rapidly even at relatively low concentrations, have a density approaching that of air, not form readily explosive mixtures, not be unduly toxic for man and animals, not attack or corrode metals, paint, textiles, leather, rubber or ceramic surfaces, should have an action reasonably independent of humidity and temperature over wide ranges, and be available and cheap.

The investigation was begun with CWS materials, equipment and techniques which were already available for the decontamination of air, water, terrain, materiel, equipment, and personnel. These materials included bleach high test hypochlorite (ETH), sodium hypochlorite, caustic soda, the 1½-quart, 3-quart, and 400-gallon decontaminating apparatus, and screening smok Preliminary tests were made with anthrax spores and with B. globigii, which was even more resistant than anthrax to sterilization by heat and chemicals.

The first tests, on the decontamination of air in enclosed spaces, were carried out in the tent chamber used to test gas masks. In these tests as well as in later ones conducted in the large cloud chambers, a mist of sodium or calcium hypochlorite with 0.05-0.07 mg. chlorine per liter of air decontaminated 99.99 percent of an aerosol of B. globigii spores within 5 minutes. Hypochlorite mists, however, were corrosive, left a permanent

residue, and were irritating. /

Mists or vapors of propylene and triethylene glycols, which it was hoped might be used to decontaminate air in the pilot plants, were found capable of sterilizing aerosols of E. coli and S. marcescens but not B. globigii. The use of triethylene glycol vapor for decontaminating cloud chambers in which a dynamic cloud of meningopneumonitis virus or psittacosis virus had simultaneously or subsequently been developed, resulted in a reduction of concentration of organisms but not in complete decontamination. Formaldehyde gas was uniformly effective but was difficult to generate for decontamination purposes.

Extensive tests were also made with ethylene oxide, a gas at ordinary temperatures and pressures, widely used as an insecticide. It appeared to have many advantages as a gaseous disinfectant or decontaminant over sulfur dioxide or formaldehyde. Carboxide, a noninflammable mixture of ethylene oxide and carbon dioxide, might be used where the oxide presented a fire hazard. In gaseous form, carboxide appeared to be particularly useful for decontaminating shoes, gas masks, clothing and laboratory equipment, for it has little or no deleterious action on these articles. / *Ethylene*

/ Sp Rpt 35, Decontamination in Biological Warfare (Jun 46), pp. 1, 2, 40.

/ Sp Rpt 22, Disinfection of Clouds of Meningopneumonitis Virus and "Si" with Triethylene Glycol Vapor (Oct 45).

/ Sp Rpt 80, Ethylene Oxide: A Gaseous Disinfectant (Feb 47), pp. 41-45.

oxide vapor showed considerable decontaminating activity against aerosols of B. globigii spores but the activity decreased with increasing relative humidity. Ethylene imine was many times more effective but would not stand up in storage for any length of time. /

Of the standard CWS screening smokes examined for possible decontamination of biological agent aerosols in the field, oil smoke and WP smoke were found inactive against B. globigii spore clouds, but FS and HC smokes were quite effective in chamber tests. Field tests were not made.

Hypochlorite mists which would decontaminate the air of an enclosed space would not decontaminate surfaces within that space unless the surface were actually wetted by the mist. Metal, wood, cloth and tile when wetted by the mist were effectively sterilized within 15 minutes. However, because hypochlorite could not be used in the pilot plants, formaldehyde gas became the agent of choice, despite certain difficulties in its use. Sterilization was not effected with low humidities and low temperatures; both had to be high for rapid and complete sterilization. The problem of producing large volumes of formaldehyde gas with a high humidity was solved by utilizing the M2 smoke generator, substituting formaldehyde for the fuel oil in the apparatus. With 80 percent relative humidity and 32° C., 1 ml. formalin per cubic foot of space almost completely decontaminated cloth, metal and / Sp Rpt 35, p. 40.

tile surfaces heavily contaminated with B. globigii spores. Ethylene oxide in the form of carboxide showed little promise against spores on surfaces, but ethylene imine, epichlor-hydrin and epibrom-hydrin showed considerable surface decontaminating activity. /

An investigation of soil decontamination revealed that the standard 6 to 7 percent solution of bleach ^{against chemical agents} suspension was not sufficient to kill spores, since the hypochlorite was inactivated by organic matter in the soil before marked bactericidal effect could be exerted. A 10 percent solution of sodium hydroxide or 20 percent suspension or slurry of hypochlorite was necessary to decontaminate soil effectively.

The process of superchlorination, followed by dechlorination, in which a residual chlorine of 10 ppm is reached, was recommended for treating water suspected of contamination with biological agents. Sewage presented an added problem in that organic matter present inactivated the chlorine. Once the necessary residual chlorine concentration was reached, however, decontamination could be considered effected. HTH and Halazons were capable of decontaminating water heavily contaminated with B. globigii within an hour. /

/ Sp Rpt 35, p. 2.

/ Sp Rpt 35, pp. 3, 4.

Decontamination of personnel involved careful removal of clothing, followed by washing. The hands of test subjects were treated with various soaps and germicides such as cresol, Roccal, and mercuric chloride, after which counts were made of remaining bacterial flora. The tests confirmed the value of the surgical practice of merely washing the hands thoroughly with a good soap. The use of special germicide preparations was unnecessary. Vegetative organisms (E. coli) were removed more rapidly and more thoroughly than spore forms (B. globigii) in all of the techniques which were examined.

Clothing autoclaved in the field autoclave at 124° C. and 23 psi was completely decontaminated in 45 minutes. It could also be sterilized by boiling in water for 15 minutes. B. globigii spores were 99 percent destroyed by laundering in the Quartermaster fixed laundry. Carboxide gas destroyed all anthrax and B. globigii spores on clothing in 16 hours at 15-23 psi. Five 20 ml. ampules of methyl bromide (in the Quartermaster delousing kit) sterilized B. globigii spores in 12 hours. Rinsing in plain water removed 95 percent of the spores. Soaking clothing in sodium hypochlorite solution containing 1.5 gms. available chlorine per 100 ml. resulted in complete decontamination in 5 minutes. Six hours in bright sunlight failed to reduce greatly the concentration of anthrax spores on clothing.

In preliminary studies for further decontamination investigations, a review was made of the literature on surface active agents (wetting agents, detergents, and emulsifying agents are types with important industrial uses) as a potential source of materials useful for decontamination and also

in other types of laboratory investigations, due to the potent biological activities of many of these synthetic agents. /

Perhaps the largest decontamination project carried out at Camp Detrick was occasioned by the end of the war when all work on anthrax was brought to a close and it became necessary to remove every trace of the agent from the laboratory rooms, laboratory equipment, pilot plant rooms and equipment, ventilation air ducts and liquid effluent processing plants. Where possible, flowing steam under 15 psi for 6 hours was used, followed by flushing 5 percent NaOH solution through the equipment. External surfaces were sprayed with a water solution of calcium hypochlorite containing 15,000 ppm of available chlorine. This procedure was repeated on two successive days.

Laboratory equipment that could be autoclaved was sterilized at 20 psi for 1 hour. Large equipment, such as refrigerators and incubators were decontaminated with hypochlorite. Delicate laboratory instruments were exposed to carboxide under 20 psi for 6 hours. Furniture, telephone and office equipment were decontaminated by setting up a formalin vapor in the room by means of a smoke generator. The room was sealed for 24 hours when the formalin concentration reached 1 ml. per cubic foot of air space.

/ Sp Rpt 33, Surface Active Agents: Literature Review of Their General Properties and Biological Activity (Apr 47).

There were 3 inches of contaminated sludge in the liquid effluent storage tanks. This was pumped into batch-type treatment tanks and destroyed, and the storage and treatment tanks were then decontaminated with formalin vapor. /

/ Sp Rpt 66, Removal of Bacillus anthracis from Contaminated Buildings and Equipment (18 Feb 46).

Biological protection. The principal studies of B Division in the pathogenesis of the biological agents under investigation at Camp Detrick and in immunization and treatment for their effects are presented in the chapters on the individual agents. This section will be concerned with some mention of the discipline of method in B Division and with certain of the studies which cannot be conveniently reported in the chapters on agents.

In the course of the successive projects undertaken by B Division, beginning with the studies on anthrax and continuing with brucellosis, tularemia, psittacosis and the others, a high degree of cooperation and interdependence evolved in the various branches of the division. The operation of this organization in the "H" project is described in the chapter on anthrax (Chart 5, p. 28), and shows the close connections that existed between the cloud chamber section, chemistry branch, pathology branch, bacteriology and serology branch, the nutrition unit, physiology and pharmacology branch, and clinical medicine branch.

Two sets of studies, by the bacteriology and pharmacology groups in B Division, were made on streptomycin. In a study conducted by the former group on factors influencing the activity of streptomycin in the body, it was believed that the data which had been obtained in vitro might give an indication as to whether or not an infection by a particular strain would be amenable to therapy and also as to the blood level required for effective therapy. / In a later study it was reported that streptomycin appears to be antagonized by the constituents of certain standard media and those of serum and plasma. As much as 75 percent loss of streptomycin had been observed, possibly due to adsorption into the constituents of these environments. /

A study of streptomycin by the pharmacology branch of B Division was carried out in a variety of animal species before and during a series of experiments designed to test the therapeutic effectiveness of this antibiotic in specific bacterial infections. In all cases, whole blood with an oxalate anticoagulant was used in performing the determinations. Methods were devised for assaying streptomycin in body fluids, particularly in blood and urine, to aid in the investigation of the absorption, excretion and activity of the drug in man and laboratory animals. One method was

/ S. Berkman, R.J. Henry, and R.D. Housewright, "Studies on Streptomycin. I. Factors Influencing the Activity of Streptomycin," Journal of Bacteriology, 53 (May 1947), 567-74.

/ R.J. Henry, Sam Berkman, and R.D. Housewright, "Studies on Streptomycin. II. Inactivation of Streptomycin Upon Standing in Certain Culture Media and Human Serum," Journal of Pharmacology and Experimental Therapeutics, 89 (May 1947), 42-45.

based on the relationship between the diameter of the zone of inhibition and the amount of streptomycin diffusing into an agar plate seeded with a sensitive strain of B. subtilis. As determined in clinical studies of tularemia and brucellosis infection in man, it appeared that subcutaneous administration might be the route of choice over intramuscular administration, due to slower absorption and less fluctuation of blood levels during therapy. / Microtechniques for assay, were devised for detecting traces of streptomycin and other antibiotics in blood and tissue extracts, proved useful where only small amounts of blood can be obtained, as in mice, guinea pigs, hamsters, or infants. /

In further studies of streptomycin, it was learned that maximum blood levels in man and animals following injection of the drug appeared in from 15 to 60 minutes. Such blood levels could not be achieved by oral administration of streptomycin. Also, it seemed apparent that in man storage of the drug is established somewhere in the body so that it con-

/ J. Forgacs, G.B. Kornegay, and T.F. Henley, "Studies on Streptomycin. I. Assay in Body Fluids," Journal of Laboratory and Clinical Medicine, 31 (May 1946), 514-22. Originally reported in Sp Rpt 41, An Assay Method for Streptomycin and Its Application to In Vivo Studies of the Antibiotic (Nov 45). See also W.E. Nelson, J. Forgacs, and J.L. Kucera, "Alteration of the Distribution and Excretion of Streptomycin," Proceedings of the Society for Experimental Biology and Medicine, 64 (1947), 20-21.

/ J. Forgacs and J.L. Kucera, "Studies on Streptomycin. III. Micro-techniques for Assay," Journal of Laboratory and Clinical Medicine, 31 (Dec 1946), 1355-63.

tinues to be excreted long after cessation of therapy. /

The development of streptothrycin as a useful antibiotic was still in the preliminary stage at the end of 1945 and B Division was content to make only a series of confirmatory tests of the toxicity of this substance for laboratory animals. The unevenness of the crude product which was available at that stage of its development was demonstrated in the varying toxicities for mice of the four lots examined by B Division. Following subcutaneous injection of 50 to 300 units every 3 hours for 5 days in mice, the manifestations of its toxicity were ruffling of coats, anorexia, lowered body temperature, cyanosis, blindness, tremors, ataxia, and convulsions. Amounts of streptothrycin which were considered to be therapeutically effective against a variety of agents resulted in the deaths of experimental animals and could not, therefore, be used in human treatment. /

/ G.B. Kornegay, J. Forgacs, and T.F. Henley, "Studies on Streptomycin. II. Blood Levels and Urinary Excretion in Man and Animals," Journal of Laboratory and Clinical Medicine, 31 (May 1946), 523-34.

/ Sp Rpt 68, Preliminary Studies in Streptothrycin Toxicity (1 Dec 45).

Although the problems of nutrition of micro-organisms was originally the special province of the offensive development divisions at Camp Detrick the increasing importance of this subject to B Division workers finally resulted in the establishment of a nutrition unit of their own. The single special report on the subject, however, was based on work done for the pilot plant branch, but is reported here as a matter of convenience.

It became apparent to pilot plant workers that the amino acid, mineral and vitamin balance of culture media played an important role not only in the yield and virulence of organisms produced but also probably on their drying and storage characteristics. Because of the unavailability and excessive cost of these elements of media, their use in more or less pure form was not practical in large scale production and a number of studies were made to find culture materials that were available and reasonable in cost and whose chemistry contained the necessary elements. The result was a series of charts showing the amino acid, vitamin, and inorganic element composition of 23 different biological materials used in the culture of biological warfare agents, including pepticase, Walker's distillers solubles paste, marmite, corn steep liquor, plasmolyzed yeast, bacto-tryptose, bacto-peptone, Brewers yeast, soy bean meal, Seagram-Calvert distillers syrup, and casein, among others. Of these, marmite which was used by the British in the production of anthrax was not available in this country, and pepticase was very expensive. Corn steep liquor and several of the peptones proved acceptable substitutes.

The following were the amino acids, vitamins, and inorganic elements present in the various basal media and listed as essential in one degree or another to the culture of the biological agents being investigated at Camp Detrick: /

Amino acids

Arginine
Cystine
Glutamic acid
Isolucine
Leucine
Lysine
Methionine
Phenylalanine
Threonine
Tryptophane
Valine

Vitamins

Biotin
Folic acid
Nicotinic acid
Pantothenic acid
Pyridoxine
Riboflavin
Thiamine

Inorganic elements

Ash
Cl⁻
Ca⁺⁺
Mg⁺⁺
Cu⁺⁺
Zn⁺⁺
P
Fe⁺⁺⁺
K
Na
SO₄
H

/ Sp Rpt 76, Amino Acid, Mineral, and Vitamin Content of Some Biological Materials Used for the Cultivation of BW Agents (Aug 46).

Additional references on nutrition are Manual of Methods for Pure Culture Study of Bacteria, Society of American Bacteriologists (9th ed.; Geneva, N.Y., Biotech Publications, 1944); F.W. Tanner, Bacteriology (New York, 1938), ch. 13, "Nutrition of Bacteria."

See also TM 8-227, Methods for Laboratory Technicians (Oct 46), pp. 290-307.

The biochemists, physical chemists, and organic chemists engaged in biological protection research in B Division were principally responsible for clinical and laboratory analyses of the micro-organisms being investigated, of available chemotherapeutic agents, and similar studies. Isolation of antigenic material from the organisms of anthrax and tularemia and from botulinum toxin, preparation of the inflammatory factor in anthrax and the pure toxin of the botulinus bacillus, all made possible by the acquisition of a cold room and a Tiselius electrophoresis apparatus, were signal studies performed by this group. Other investigations included development of a micro method for determination of zinc in toxic smokes, spectrophotometric examination of botulinum toxin to determine its nucleic acid and protein components and contaminants, chemical analyses for phosphorus, nitrogen and nucleic acid as characteristics of botulinum toxin fractions, determinations of copper and iron in bacteriological media, and like studies for the biological protection group, the nutritionists, and the pilot plant group. /

The work done by this section on the disintegration of bacteria by ultrasonic waves was made possible when Dr. Leslie A. Chambers of the University of Pennsylvania, inventor of the device, became a consultant to B Division. An isolated series of experiments performed by the chemists

/ MPR L Br (31 Dec 43), MPR B Div (Nov 44, Feb 45, Mar 45).

which did not lead to hoped for results was the investigation of a number of new antimalarial drugs for possible use against biological agents.

ANTHRAX
(Bacillus anthracis)

Code letter "N"

General. On the basis of actual experience with anthrax in the pilot plant at Camp Detrick and experimental data obtained at Vigo Plant, it was proved that anthrax organisms could be produced in great quantities. They could be grown in 5,000 gallon vessels on a corn steep liquor base with a count of 10 billion spores per ml. Before the end of the war a better production medium was found in peptone-glucose broth, yielding twice the population and three times the virulence. The stability of the organisms in storage was proved. The loss of agent observed in dispersion was ascribed to inefficiency of the munitions rather than to any inherent liability of the organism. Studies of the ratio of explosive force to quantity of agent yielded valuable and useful information. An efficient munition was developed and proven by the British. /

The anthrax bacillus was the first micro-organism selected by WRS for study of its potentialities as an agent of biological warfare. After preliminary investigations at Cornell University and the Public Health Research Institute of New York City, WRS authorized the Chemical Warfare Service to undertake final development of the agent. In November 1943, the work of producing, evaluating and disseminating anthrax as an offensive

/ Monthly Notes No. 8, Biology Section, Porton (1 Oct 44).
In CD Tech Lib (PBS Acc.No. 8)

biological warfare agent became a project of the animal research, munitions, and pilot plant branches of OD Division, Camp Detrick. Their objectives were to produce large quantities of a virulent strain of anthrax in a resistant form, capable of survival under the conditions required for subsequent harvesting, storage and dissemination. /

Selection of strain. The initial problem was to secure a strain of anthrax that offered the greatest promise from the standpoint of its ultimate use in war. Two strains were available: one from the British, designated M-36 Vollum strain, / the other from the WRS workers at Cornell and designated by them as N-99. It was approximately equal in virulence to M-36. The British strain was received in a lyophilized marmite-molasses medium. When it was grown out on nutrient agar at Camp Detrick, five variant colony types were observed. These were designated as V1, V2, and GV (granular Vollum), which were twice as virulent as M-36, and R1 and R2 (rough strain), one-half as virulent as M-36. From the V1 strain, a pilot plant strain (PPI) and another designated #42 were developed. The GV strain, after persistent culture, yielded a new one designated #55. In final tests, strain #42 was found preferable to any other, being three times as virulent as either V1 or even PPI.

/ Sp Rpt 9, Development of N for Offensive Use in Biological Warfare (Jul 44); Sp Rpt 28, Laboratory Branch Report on the B.W. Agent "N" (1 Jan 46).

/ M-36 refers to successive passage through 36 monkeys, an accepted method of increasing virulence. M-36 was almost two and a half times as virulent as the standard British Vollum strain.

Virulence of the various strains was tested, usually, by placing guinea pigs or rats in a cloud of agent set up in either the British or American cloud chamber. Respiratory virulence of anthrax was considered a more precise and more rigid test of general virulence than cutaneous or intestinal inoculation.

Early difficulties in maintaining selected strains were overcome when corn steep liquor / as a medium was abandoned and the organisms were grown in pepticase-plasmolyzed yeast, placed in test tubes, and desiccated at room temperature. Desiccation was achieved by slow drying of the agent material over calcium chloride and white phosphorus with the application of vacuum. Such stock cultures could be held for long periods, possibly as much as two years, since spores did not change as they would on agar, and transfer was not needed to maintain viability. Attempts to increase the mutation rate of anthrax spores by ultraviolet irradiation were abandoned when the spores apparently lost virulence and even viability under irradiation. Only slow growth without mutations could be expected from such treatment.

/ A byproduct in the manufacture of corn starch, obtained by concentrating the water in which the grain is steeped before removal of the starch. Its use was found to reduce virulence by three times.

Anthrax simulant. Because of the hazards in handling anthrax spores, many of the problems of producing, disseminating, and providing protection against these organisms were conducted with Bacillus globigii, a nonpathogenic spore former whose cultural and other characteristics were very similar to Bacillus anthracis. A number of experiments were carried out with B. globigii to determine certain of its specific properties. It was learned that the different strains of B. globigii varied widely in their morphological and sporulating characteristics, indicating the importance of the selection of a pure and stable strain of the simulant for studies on physiological factors common to it and anthrax. /

The British and Canadian used B. anthracis as an anthrax simulant.

/ A.E. Hayward, J.A. Marchetta, and R.S. Hutton, "Strain Variation as a Factor in the Sporulating Properties of the So-called Bacillus Globigii," Journal of Bacteriology, 52 (Jul 1946), 51-54.

Nutrition. In the absence of prior experience, experiments in quantity production of anthrax were begun in the laboratory, with facilities and equipment common to bacteriological and chemical laboratories. Contributory phases in these studies included investigations of ^{culture apparatus, assay methods,} aeration, ^{continuous culture, preservation against contaminants,} ~~culture vessels,~~ toxicity of metals, and especially, evaluation of nutrients. A satisfactory medium for production required that the yield be large, virulent, stable, and free of inert impurities. Preliminary tests indicated that such basal substances as corn steep liquor, yeast products, peptones from milk or meat, and molasses could be employed. The British had selected a medium composed of yeast autolysate (marmite), molasses, and phosphate buffer. This gave excellent results, but marmite was not available in the United States. However, using substances which could readily be obtained, a large number of media were developed by various workers for the growth of anthrax spores in the laboratory or pilot plant, only a few of which were generally used.

The first production lots of anthrax spores were grown on² corn steep liquor base, which provided many of the necessary materials for good spore formation. To get a more critical evaluation of the nutritional requirements of anthrax when corn steep liquor failed, a basic study was undertaken which showed that among the well-known vitamins, only thiamin hydrochloride was required by the organism; that its amino acid requirements were complex but could be satisfied with a mixture of amino acids derived from casein; glucose was a satisfactory energy source, provided adequate buffering with potassium phosphate was maintained to prevent development of an

acid reaction; and certain inorganic substances, particularly iron, magnesium, manganese, potassium phosphate, salts of calcium, and sodium bicarbonate, were required for maximum yields but might, in some instances, be harmful if present in excess. /

On the basis of the nutrition studies and tests of various formulas in the laboratory and in Pilot Plant No. 2, the following medium for initial seed was recommended for use at Vigo Plant:

<u>Base</u>	<u>Buffer</u>	<u>Salts</u>
1% pepticase	0.03 M K_2HPO_4	0.00004 M $FeSO_4$
0.2% plasmolyzed yeast	0.03 M KH_2PO_4	0.002 M $HgSO_4$
0.4% cerelese		0.001 M $MnSO_4$
		0.01% calcium carbonate

Recommended media for the production cycle at Vigo were: /

2.5% corn steep liquor and 0.1 gamma¹ thiamine hydrochloride ~~growth~~

or

1% corn steep liquor, 0.6% cerelese, 0.5% pepticase, 0.075% plasmolyzed yeast, and 0.01% $CaCO_3$

or

0.6% pepticase	0.5% K_2HPO_4	0.02% $CaCl_2 \cdot 6H_2O$
0.6% peptone	0.4% KH_2PO_4	0.001% $FeSO_4 \cdot 7H_2O$
0.8% cerelese		0.005% $MgSO_4 \cdot 7H_2O$
0.6% distiller's solubles paste		0.003% $MnSO_4 \cdot 4H_2O$
0.25% plasmolyzed yeast		

/ Report, Nutrition of "N", read by Dr. C.R. Brewer at meeting of Tech Dept, 23 Feb 45. In CD Tech Lib. See also Sp Rpt 28, part II. The Nutrition and Stability of "N".

/ Operating Procedure Recommended to the Vigo Plant for Production of "N" (13 May 45). In CD Tech Lib (N-Misc-15).

In devising the third formula for plant production to replace the use of corn steep liquor, which had proved unsatisfactory in the pilot plant, the nutritionists found that pepticase; / when used with a yeast product in the presence of glucose, phosphate buffer and other essential salts, provided the necessary amino acids. Peptones from meat digests could substitute at least partially for the expensive pepticase in laboratory media. This formula yielded 1 to 3 billion spores per ml. which were of uniform high virulence by respiratory test on guinea pigs. /

/ A product of Sheffield Farms produced by digestion of acid-precipitated casein with 2.5% commercial trypsin for 6 to 10 days. Cerelese is a commercial glucose.

/ Sp Rpt 28, pp. 26-27. Refinements of the formula, particularly in the balance of mineral components, were effected later. See C.R. Brewer, W.G. McCullough, R.C. Mills, W.G. Roessler, E.J. Herbst, and A.F. Howe, "Studies on the Nutritional Requirements of Bacillus anthracis," Archives of Biochemistry, 10 (May 1946), 67-75; C.R. Brewer, W.G. McCullough, R.C. Mills, W.G. Roessler, and E.J. Herbst, "Application of Nutritional Studies for Development of Practical Culture Media for Bacillus anthracis," Archives of Biochemistry, 10 (May 1946), 77-80.

Laboratory production. Among the methods explored for laboratory production of anthrax spores were cultivation on solid surfaces, / culture in embryonated eggs, and growth in liquid culture with forced aeration or constant circulation over surfaces exposed to air. Growth and virulence of spores produced by these methods were determined by microscopic observation of the degree of sporulation, plate counts of heat-shocked aliquots to determine yields, and animal inoculation to test virulence. Of the three methods, employment of aerated liquid cultures seemed most adaptable to large scale operations.

The first acceptable production of anthrax was achieved with the development of a liquid medium which yielded a billion or more spores per ml. in about 36 hours at 34° C. when aerated with 1/3 to 2/3 volume of air per volume of medium per minute. Aeration was accomplished either by forcing air through the culture or by incubating the cultures in a mechanical shaker. / A suspension of spores or vegetative cells were inoculated into the distiller's solubles medium. After reaching maximum growth in 36 hours, with approximately 95 percent sporulation, the cultures were then autolyzed for 24 hours at 45 to 47° C. and heat-shocked at 65° C. for 30 minutes.

/ Surface growth was obtained on nutrient agar and on cellophane overlying solid substrates such as hominy grits or a mixture of asbestos and wheat bran saturated with a nutrient solution.

/ The shaker method had the advantage of greater reproducibility for small scale experimental cultures, but the forced aeration method appeared better adapted for plant work.

Pilot plant production. Because of the urgency of the anthrax project, the laboratories and pilot plants began their operations almost simultaneously. As a result, many operations in the plant were not well conceived or proved in the laboratory prior to plant trials. With little or no precedence in industry for the undertaking, preliminary trials were necessarily largely empirical. Only experience in operation could determine whether or not the system that had been designed and constructed for plant production would work. The two pilot plants constructed in the airplane hangar at Camp Detrick were the scene of these trials. Fundamental problems of anthrax production common to plant and laboratory were to be investigated in Plant No. 1 and small scale mass production would then be attempted in Plant No. 2.

In essence, the plant production of anthrax both at Camp Detrick and later at Vigo Plant was simply the inoculation of successively larger vessels of media, with concentration of the grown material. First a pre-catalyst tank was inoculated with a laboratory culture. When growth in the pre-catalyst tank had reached its maximum, this culture was in turn used as inoculum for the catalyst tank, a larger vessel. The contents of the catalyst tank were next used to inoculate a reactor tank, largest of the three. / Harvesting of the maximum amount of inert material produced in the reactor tank was then accomplished by concentration, a process

/ The names "pre-catalyst," "catalyst," and "reactor" were borrowed from the distilling industry to cloak the actual functioning of the tanks. More properly, they were plant culture or pre-seed, seed and fermenter tanks.

involving either settling, evaporation or centrifugation, or a combination of these.

Operations in anthrax production began January 1944 in Pilot Plant No. 1, with 230-gallon reactors fed by 15-gallon catalyts. A strain of N-99 was used, in a medium of 0.25 percent corn steep liquor and 1.5 percent pepticase. Of a total of 89 reactor tanks put in production in the first series of trials, 64 were contaminated with undesirable bacteria and operations were halted while engineering changes were made to eliminate sites in the equipment found difficult or impossible to decontaminate. In a second series of trials, during which 2.5 percent corn steep liquor and 2.0 gamma thiamine hydrochloride per ml. was used as the basal medium, contamination was still the principal production problem; of 456 tanks set, 252 became contaminated and were discarded.

From September to December 1944, studies were made to discover the sources of spoilage and to learn the cause of erratic yields even in pure cultures. The method of decontaminating tanks and lines was improved, the scheme of the plant was further simplified, and improved seeding techniques were developed to secure more uniform cultures. Batch results improved: of 53 tanks set in January, only 12 were contaminated; only 1 of 32 were discarded in March; and all 78 tanks set in April 1945 were free of contamination.

Pilot Plant No. 2 went into production in June 1944. It contained two 3,400-gallon reactor tanks and one of 10,000-gallon capacity, fed by 230-gallon catalyst and 10-gallon pre-catalyst tanks. In contrast to the methods employed in the laboratory and in Plant No. 1 where media were prepared and sterilized in batches, in Plant No. 2 the medium was prepared continuously, heated quickly, held for a short time in retention tubes, and then introduced into the tanks.

While Plant No. 2 provided valuable data for Vigo operations, as a production unit it was not considered a success because of the high incidence of tank contamination. /

/ Sp Rpt 29, Pilot Plant Branch Report on the B.W. Agent "N" (1 Jan 46).

Large scale production. Vigo Plant was obtained by the Chemical Warfare Service for mass production of all biological warfare agents which were sufficiently developed to justify employment against the enemy in the event such warfare was started. Actually, only anthrax reached that stage, but before its production began the war was over. However, before all operations came to a halt, Vigo Plant had been proved and its personnel trained in production operations with the anthrax simulant, B. globigii. In a trial run in June and July 1945, the plant proved itself capable of producing 8,000 pounds of the simulant in a single run, under satisfactory conditions of procedure and with maximum safety to operating personnel.

On the basis of the trial run with the anthrax simulant, a productive cycle for the processing of anthrax was evolved. It will be described in the following paragraphs as an actual operation.

Corn steep liquor (code letter "L"), sulfuric acid, and caustic soda in tank lots came into the plant area by rail and were transferred to the tank farm. These materials were piped into the adjacent slurry preparation building, filtered, and mixed in holding tanks. Pepticase (code letters "HT") was then added and the material was sterilized by heating to about 280° F. for 30 minutes in the heat exchanger. Before being discharged from the heat exchanger, the material was quickly cooled to 95° F. With the addition of thiamin, buffers, salts, and anti-foam to the sterilized mixture, the basal medium was complete and it was then called slurry. This slurry was then piped to the huge catalyst and reactor tanks in nearby buildings as the raw material for mass production.

In the catalyst building, slurry in 30-gallon lots was piped into the 50-gallon pre-catalyst tanks and measured quantities of sterile steam and air were added. Seed cultures of anthrax, prepared in adjoining laboratories, / were then introduced into these tanks and, under controlled temperature, aeration and time of culture, the batch was induced to grow. The inoculum in the pre-catalyst tanks was then released into catalyst tanks directly below. These tanks were of 1,000-gallon capacity, each filled with 600 gallons of slurry. Growth temperature in the catalyst tanks was maintained by automatically controlled circulation of water at 45 psi around the tanks. Material in the tanks was sampled from time to time by means of a rubber valve in the side of the tank, to determine the concentration of agent growth.

From the catalyst tanks, the new lot of inoculum was pumped into the 20,000-gallon reactor tanks in the reactor building. In the pre-catalyst and catalyst tanks, only the vegetative form of the agent was permitted to grow. In the reactor tanks, the growth period was extended and the organisms permitted to sporulate. During this period, internal pressure in the reactors was maintained by the admission of steam from time to time, to prevent possible collapse of the tanks. Electronic devices indicated the extent of foaming and warned when additional anti-foam was to be introduced, to prevent possible waste of slurry by escape

/ Seed cultures were grown in a Hot Room kept at 95° F. and stored in a Cold Room maintained at 34° F. until they were ready to be used.

through vents. Blow cases and sump pumps in each of the process building disposed of waste from the tanks and waste water and debris collecting outside the tanks was pumped to the sewage disposal system.

The completely sporulated slurry in the reactor tanks was pumped to the separation building for final processing. Four decanters of 20,000-gallon capacity each served to store the slurry. Within these, the initial separation of the organisms from the mother liquor took place by means of settling. At the end of 6 hours, the clear supernatant fluid was drawn from the decanters and the remaining material, now called sludge, was pumped into two 6,000-gallon storage tanks. Concern for the sterility of the product was relaxed at this point. The nutrient liquor had, for the most part, been separated from the organisms at supernatant, the organisms were no longer in the vegetative phase, and acid added to the slurry in the decanters, all created unfavorable conditions for the growth of contaminants and at the same time inhibited further growth within the sludge. Temperature control was therefore no longer important and the sludge could be maintained at room temperature.

The anthrax sludge in the settling tanks was next pumped along at a constant rate to eight banks of Dorr thickeners. These machines consist of two tanks to a bank, coupled by piping. The sludge passed from one to the other of the tanks and in the process the heavier material sank in response to gravity, thus permitting still more supernatant to be drawn off. The material emerging from this process was known as mud, but it was still not concentrated sufficiently to serve as an end product.

A portion of the mud was pumped into Sharples centrifuges. Twenty-four of these machines converted the Dorr-thickened mud into a clay-like product. The centrifuges were installed in chambers adjoining the Dorr machines, three to a chamber, and each chamber was controlled by an operation outside. After centrifugation, the operator, clad in protective clothing and masked, entered the chamber, removed the centrifuge bowl with its residue clay, and carried it to a ventilated room accessible only through an air-lock. Within this room, which was specially ventilated to provide a flow of air away from the centrifuge bowls, another operator clad like the first removed the clay from the bowls and dropped it into a tank beneath the floor of the room. / This clay, however, was too thick for a munition filling and was therefore blended in the tank with less-concentrated mud from the Dorr thickeners.

The blended material was then pumped into three storage tanks of 1,000-gallon capacity each in the adjoining munitions filling building, and from these tanks the material was fed to the filling machines. Here also, bomb cases which had been previously tested under 800 psi for body weakness and sterilized, were conveyed to the filling machines. After filling with the agent material, the exteriors of the bombs were decontaminated in a hypochlorite bath. The bombs were then stored for

/ This manual centrifuge separation process was considered highly undesirable from a safety standpoint. At the end of the simulant agent trial runs, this process, the air effluent system and the sewage disposal system at Vigo Plant were believed to be the principal weak points in the production system which required further improvement.

two days and closely examined for leakage. Minute quantities of fluorescein had been added to the agent mixture just before it went into the bomb and leakage could be detected by means of the fluorescein with ultraviolet light.

The entire production cycle at Vigo Plant was controlled from a record office where, on a bulletin board, was posted the status of all operations. By this means, an observer could learn at a glance the current operations of each pre-catalyst, catalyst or reactor tank. The status record described the lot number of the material in the tanks, the time it began each step in the process, sampling results, age, condition, and time of disposition to the bomb-filling machines. /

/ Ltr (S), CO VP to C SPD Att Tech Dir, 28 Oct 44, sub: Proposed Process Operations for Plant No. 1, Vigo Plant. SPCYA 635.1.
Ltr (S), Tech Dir SPD to CO VP, 18 Nov 44, same sub and file.
See also Standing Operating Procedures, Plant No. 1, Vigo Plant, CWS (TS), 5 Dec 44, in Hq VP (Doc.No. P1-S1); Operating Procedures Recommended to the Vigo Plant for Production of "N" (TS), 18 May 45 (directive Tech Dir SPD to C Tech Dept VP), in Hq VP (SPCYP 319.2); Standing Operating Procedures, Prod Div, VP (S), 28 Jun 45, in Hq VP (Doc.No. YA-17).

Harvesting. The objective of harvesting studies carried out in the laboratories and pilot plants at Camp Detrick was to collect the greatest number of spores possible in the shortest time and in the smallest volume. Specifically, 400 billion spores per cubic centimeter of material was deemed a reasonable goal.

The method of harvesting adopted, as described in the previous section, consisted of acid-precipitating the completed culture, allowing the spores to settle as a slurry and concentrating the organisms by means of a Sharples centrifuge. This was accomplished by using air pressure to force the sedimented spores into settling tanks where they were acidified to pH₄. The supernatant was then decanted off and the remaining mud forced, again by air pressure, into a Dorr continuous settler which automatically decanted residual supernatant as it was formed. Further concentration was effected by centrifugation, or could also be accomplished by vacuum evaporation under 50° C. maximum temperature. At the same time, the acidity of the mud was neutralized with sodium hydroxide to pH7.5.

The aim of a 40x10⁹ count of viable spores, however, could be obtained only by batch harvesting. It could not be accomplished by continuous centrifugation, which gave consistent counts of around 20 to 30x10⁹. Batch harvesting was a dangerous process for operating personnel and its output was relatively small. It was not considered practicable either on a laboratory or plant scale. The vacuum evaporator method of harvesting was a safer method and although the laboratory obtained the desired accuracy using this equipment, the same results could not be reached in the pilot

plant, principally due, it was believed, to unsatisfactory equipment. /

Storage. Studies were made to determine the conditions under which anthrax organisms could be stored, both in bulk and in munitions, for the longest time and with the least diminution of virulence and viability. Initial strains of the anthrax bacillus which had been selected for development were cultured in gas washing bottles, harvested and prepared for storage by one or more of the following methods: as acid precipitates, acid precipitated and neutralized, suspended in distilled water, suspended in buffer solution, dried with acetone, preserved with chemical agents (merthiolate, Zephiran, phenol), and untreated controls. Samples of pilot plant product were obtained, sealed with gelatin in 100 cc. Pyrex test tubes or in metal tubes coated with bomb lacquer, and variously stored under the following conditions: at temperatures from 1° to 45° C., with the three chemical preservatives, at various pH levels, in a lyophilized state, and as untreated controls. At intervals, specimens of the laboratory and pilot plant products were taken and tested for virulence and viability. The ^{accepted} standard for storage of biological

/ Certain of the pilot plant experiences with harvesting illuminated its special problems. It was found difficult to determine the height of the supernatant in the continuous settlers because of the closed system. This was solved by keeping a continuous balance, based upon the centrifugable solids, between the incoming and outgoing mud and the supernatant. It was found that soluble iron in the feeder lines cut down the spore count. Replacement with stainless steel pipes and porcelain-lined vessels would have overcome that problem. No solution was found to the problem created by the caking of mud which clogged the exit ports of the continuous autoinjector centrifuges. Experience with both the batch centrifuge and the autoinjector centrifuge was unsatisfactory. The first was hazardous to personnel; caking mud in the second impeded the effluent.

agents was survival for more than six months with less than 75 percent loss of viability.

Laboratory samples were found to store most satisfactorily with 1 percent phenol. / After six months, these samples were 80 percent viable, as compared with 44 percent for untreated samples. Pilot plant samples stored with 1 percent phenol and at temperatures from 1° to 26° C. retained a viability of 67 percent after six months. Untreated samples at those temperatures showed only 47 percent viability. Viability decreased with temperatures above 26° C. The most satisfactory pH seemed to be above 7.5, and Pyrex test tubes and lacquered metal tubes proved equally satisfactory as storage vehicles. All other storage methods were found less satisfactory. /

/ Because phenol was later routinely used in the process of preserving anthrax spores in muds, a method had to be found for determining the amounts of phenol in such bacterial preparations. A way to separate almost 100 percent of the phenol in mud samples containing 1.0 percent to 0.1 percent phenol. Sp Rpt 77, A Method for the Determination of Phenol in Bacteriological Materials (Aug 46), pp. 3-4.

/ Sp Rpt 28, Laboratory Branch Report on the B.W. Agent "N" (1 Jan 46), pp. 162-84.

Dissemination. Initial objectives in dissemination which were common to all biological warfare agents were established from experience with pathogens and simulants at field trials in England and Canada. The most important of these objectives was to determine the number of infecting units required per milliliter of bomb filling and then to produce a strain culture that would achieve this infective force. British and Canadian experience with anthrax indicated that vegetative organisms should be available in orders of magnitudes of 4×10^{10} per ml., a requirement based upon the relationship between bomb filling and effective Ct produced at 50 and 100 yards downwind. The pilot plants at Camp Detrick were fully capable of producing spore organisms of this magnitude.

Actual dissemination of anthrax was never accomplished in the United States, although small quantities of anthrax were used at Granite Peak Installation for the purpose of testing the longevity of the spores as ground contaminants, with inconclusive results. However, extensive field tests were conducted at Camp Detrick and Horn Island during the war with the anthrax simulant, B. globigii. The simulant mud received from the pilot plant was processed into a dry powder with the aid of acetone and an air-jet grinder. It was filled, either in the dry state or suspended in distilled water, in the CWS M47, M70, and M74 bombs, the British Mark I 4-pound bomb, shot-gun shell bombs, and gas expulsion bombs.

The bombs were exploded statically and sampling devices arranged about the point of explosion picked up portions of the resulting cloud. By use of plate counts and the British gas slide rule, the efficiency

of the munitions was determined. Most satisfactory of the munitions tested with simulant anthrax were the M74, the British Mark I, and the shot-gun shell. The S.D.F. or standard dispersion figure, which on the gas slide rule was 5, was achieved or slightly bettered by each of these munitions, but since 5 was the minimum constant, the objectives were not accomplished in the degree hoped for. /

/ Sp Rpt 44, Munitions for Biological Warfare (Dec 45), pp. 17-53, 64, 71-80.

Pathogenicity. Incidental to the measurement of virulence of artificially produced anthrax spores were the studies conducted by A Division to determine the quantity or dosage required to infect animals of different species, the effect on pathogenesis of the several portals of entry, mode of infection, and effects of coagents on anthrax infection. /

Various species of animals were exposed to anthrax alone or with coagents, by subcutaneous hypodermic inoculation, cutaneous application, respiratorially in the cloud chambers, and per rectum and per vagina by enema and douching. The most successful method of inducing anthrax infection was by the subcutaneous route, although this had little application to the potential offensive use of the agent in the field.

The guinea pig was most susceptible to infection by the respiratory route, as well as by other routes. The monkey, rabbit, hamster, and mouse were also susceptible by this route, but dogs, rats and swine were resistant. Improvement of strains in the course of the anthrax program resulted in a four⁶-fold increase in virulence by the respiratory route. Respiratory exposure to mixed aerosols of metallic salts and anthrax spores in concentrations which would have no lethal effect if used separately, caused fatal anthrax infections in mice, guinea pigs and rats. Inhalation of heavy metals, such as cadmium chromate and cadmium chloride,

/ Sp Rpt 23, part I. Factors Related to the Pathogenesis of N;
MPR A Div (Feb 44, Aug 44, Jan 45, Mar 45).

and anthrax spores were many times more lethal than spores alone. Mercur salts appeared more toxic than cadmium salts, but copper and zinc less so. All deaths following exposure to chemical-anthrax clouds were found due to anthrax, the chemical-biological synergism attributed to chemical inactivation of the enzyme system. /

In studies of the cutaneous route of infection, anthrax was also made many times more infective by the use of coagents. Experiments were made on normal, mechanically scarified, and chemically injured skin to which spores were applied in aqueous suspension. Results were confirmed by exposure of control animals to clouds of comparable Ct dosages in the spray chamber. While normal skin was apparently refractory to spores, even slight alteration of the skin by scarification or burning allowed penetration by comparatively small numbers of spores. Infectiveness of the spores was vastly increased by the use of coagent chemicals to depress the surface tension of the skin. Tergitol, a wetting agent, resulted in a tenfold increase in virulence, cadmium chromate almost one hundredfold. Attempts to increase susceptibility with phosgene, mustard and the nitrogen mustards were not as satisfactory as with the metallic salts.

/ G.A. Young, Jr., M.R. Zelle, and R.E. Lincoln, "Respiratory Pathogenicity of Bacillus anthracis Spores. I. Methods of Study and Observations on Pathogenesis," Journal of Infectious Diseases, 79 (Nov-Dec 1946), 233-46.

M.R. Zelle, R.E. Lincoln, and G.A. Young, Jr., "Respiratory Pathogenicity of Bacillus anthracis Spores. II. Genetic Variation in Respiratory Pathogenicity and Invasiveness of Colonial Variants of B. anthracis," same, 247-53.

R.E. Lincoln, M.R. Zelle, C.I. Randles, J.L. Roberts, and G.A. Young, Jr., "Respiratory Pathogenicity of Bacillus anthracis Spores. III. Changes in Pathogenicity due to Nutritional Modification," same, 256-65.

G.A. Young, Jr., and R.M. Zelle, "Respiratory Pathogenicity of Bacillus anthracis Spores. IV. Chemical-Biological Synergisms," same. 266-71.

Examination by Young and Zelle of pathological specimens of lung from rats, monkeys, guinea pigs and dogs exposed to respiratory doses of anthrax / indicated that invasion of the host occurred through the lymphatic system. Upon inhalation, the spores were apparently carried to the alveoli or air cells of the lungs. There the organisms germinated and elaborated a permeable substance which enabled them to pass through the alveolar wall into the lymph stream and from thence by way of the bronchial lymph nodes into the blood stream. At organs where the blood stream is slowed, as in the liver and spleen, the organisms multiplied enormously until, at the point of death, they were found throughout the blood stream and interstitially in the lung tissue. In explanation of the mechanism of death, it was suggested that anthrax infection results in a disturbance of the carbohydrate metabolism of the host. This disturbance increases progressively, becoming most marked shortly before death. The most obvious carbohydrate disturbance in anthrax-infected animals is in the hydrolysis of liver glycogen to glucose. It was believed that the mode of action of coagents in lowering resistance to anthrax infections was due to the inhibition or oxidation of glutathione and related substances by the coagents, resulting in a disturbance of carbo-

/ Lethal respiratory exposure values (LRE50) used in these studies referred to the number of spores per liter of cloud, multiplied by 10^{-4} , which caused 50 percent mortality among animals exposed to the cloud for 5 minutes. Each test was based on 16 animals observed for 7 days.

hydrate metabolism preparatory to that of the infection itself. /

Although anthrax death had been attributed, prior to the Detrick work, to purely mechanical means such as capillary obstruction, studies by Cromartie, Watson and Bloom of B Division indicated rather that it was through a disturbance of the normal physiological processes of the host that pathogenic bacteria produced disease and death. Their studies revealed that there was no relationship between the number of anthrax organisms per ml. of blood and the death of the animal, thereby discounting the mechanical obstruction theory. Rather, a disturbance of carbohydrate metabolism as evidenced by hyperglycemia was constantly associated with fatal anthrax infection in rabbits, this observation confirming the results observed by the A Division group. /

/ Sp Rpt 28, p. 147, and op. cit.

/ W.L. Bloom, W.J. McGhee, W.J. Cromartie, and D.W. Watson, "Studies on Infection with B. Anthracis. VI. Physiological Changes in Experimental Animals During the Course of Infection with B. anthracis," Journal of Infectious Diseases, 80 (Mar-Apr 1947), 137-44.

Kendall on intravenous injection of iodized spore vaccines of N-99 strain in rabbits was abandoned when the vaccines consistently produced a febrile reaction and anemia after the second injection, caused death in a high proportion of animals, led to the development of liver lesions, and failed to stimulate any active immunity against anthrax. /

In November 1943, the workers at Camp Detrick received their directive "to develop immunity against 'N' through analysis and investigation of various antigens and through serological studies." They at once began to prepare a number of experimental vaccines, including a killed vegetative form, a whole culture of anthrax grown in extract of embryo tissue, a washed culture grown in embryo extract, two vaccines made from whole inactivated embryo extract, one from the polypeptide (a component of the anthrax capsule) derived from E. subtilis, and a number of others prepared from the yolk, membrane, and embryonic fluid of anthrax-infected chick embryos. The results were unrewarding, for none of the vaccines were effective antigens for stimulating the production of an adequate immunity against anthrax even in naturally resistant animals. / Thus, after more than a year of intensive study,

/ Forrest C. Kendall, "Studies with Iodized Spore Vaccines of N-99 in Rabbits" (31 Jan 44). In CD Tech Lib.

/ Sp Rpt 6, Immunization Against N (Feb 45), p. 5.

no immunizing vaccine had been prepared nor had any information been obtained to indicate that any of the investigators were on the right track. A study of encapsulated suspension vaccines by WRS workers had proved fruitless, and their work on the use of extracts of the gelatinous edema from anthrax lesions failed to produce results, perhaps because too few organisms remained following extraction. /

Meanwhile, another attack on the problem of anthrax immunization was being made at Camp Detrick and suddenly it began to show promise. Convinced that if an antigen was to be found that could be used to immunize man, then the mechanism of infection must first be examined, this group, headed by Cromartie and Watson, took as their point of departure the work that had been done on anthrax by Bail and his colleagues in 1905. Bail had demonstrated substances in the edema fluid from anthrax lesions which he termed "aggressins." The efficacy of these substances as immunizing agents had not been adequately demonstrated, but if the mechanism of infection was to be analyzed, these "aggressins" merited renewed investigation.

The new path proved profitable. It was learned that when anthrax multiplies in normal tissue, a diffusible substance is elaborated which damages tissue, apparently by capillary destruction, with the formation of inflammatory edema and areas of hemorrhage. It seemed apparent that bacteria-free extracts of anthrax lesions contained a substance which, when injected intradermally in animals, brought about changes comparable

/ Julianelle, Wilson, and Kerr, "Progress Report on MW Studies" (19 Apr 44). In CD Tech Lib.

Defensive research. Concurrent with the efforts of OD Division to produce strains of anthrax of high virulence were the efforts of DD Division to devise adequate defenses against infection by these strains. The work of the latter was centered around the development of an effective vaccine for human protection.

Vaccination of animals against anthrax infection had been achieved by the use of living spore suspensions after the method of Pasteur, but such vaccines were not applicable to man because of the danger that the living spores might produce an active and perhaps fatal infection. In general, examination of the literature indicated that active immunization was brought about only in the presence of living organisms; conventional methods for the preparation of dead spore or vegetative vaccine had failed to prove useful; the mechanism of death by anthrax was explained on the basis of capillary obstruction and asphyxiation or by oxygen depletion due to organism competition, but no evidence to support either of these concepts was available.

Prior to the initiation of work at Camp Detrick, preliminary studies on immunization against anthrax had been carried out by Kendall and Julianelle under contract with WRS. Kendall had investigated commercial antisera, with discouraging results. Julianelle had presented preliminary findings on antigenic differences between vegetative, spore, and capsule forms of anthrax, without drawing conclusions, and had reported encouraging results with penicillin therapy. / A study undertaken by

/ WRS Progress Report MM-1, Studies on Immunization Against "N" (13 May 43). See also Proceedings of Conference on N Immunization Held at National Academy of Sciences, 3 Sep 1943 (Doc.No. S42-N Misc). In CD Tech Lib (Acc.No. 5).

to those described in anthrax infection. This extract from anthrax lesions was termed the "tissue damaging factor" or TDF. Repeated intradermal injections of TDF in rabbits, guinea pigs and mice appeared to increase markedly the resistance of these susceptible animals to anthrax infection and also to modify the appearance of the local lesions associated with infection. Less edema, negligible hemorrhage, fewer organisms, more inflammatory cells, and increased phagocytosis of anthrax organisms at the site of injection were observed in animals given TDF, suggesting that this substance established an unfavorable environment for the multiplication of anthrax organisms when they were subsequently introduced into the animals. / TDF apparently contained both destructive and modifying factors in its composition and might therefore be a possible source of the protective antigen which B Division sought. /

/ W.J. Cromartie, W.L. Bloem, and D.W. Watson, "Studies on Infection with *Bacillus anthracis*. I. A Histopathological Study of Skin Lesions Produced by *B. anthracis* in Susceptible and Resistant Animal Species," Journal of Infectious Diseases, 80 (Jan-Feb 1947), 1-13.

/ To continue their tests, a method was found for producing large amounts of sterile TDF extract. An inoculum of 1.0 ml. of an anthrax spore suspension, diluted ten to two in broth, was injected intracutaneously into the flanks and abdomens of rabbits. Lesions which developed in 43 to 96 hours were excised, cut into strips, and immediately frozen in CO₂ ice. The lesion material was then partially thawed and ground, an equal volume of cold 0.85 percent NaCl solution added, and the suspension allowed to extract at 5° C. for 24 hours with frequent agitation. Extraction was accomplished by filtering through large Buchner funnels and the crude filtrate was then freed from anthrax organisms by passage through a pressure Berkefeld filter. The residual clear filtrate was TDF. Sterility tests were made by injecting each of six mice with 0.5 ml. subcutaneously and plating 1.0 ml. of the material with beef extract agar. Yields of between 200 and 300 grams could be obtained from each rabbit and approximately 400 ml. of extract containing 1 percent protein could be produced from this amount of tissue. See MPR B Div (Mar 44).

An investigation of the nature and characteristics of the TDF extract showed that its antigenic value was destroyed by heating at 57° C. for 1/2 hour, that it was nondialyzable, was not destroyed by 1 percent formalin, and that while guinea pigs and mice showed increased protection when injected with TDF, immunized rabbits resisted respiratory challenges of as much as 20 to 30 respiratory MLD. As a result of these findings, TDF was presumed to be protein in nature and isolation of the proteins could therefore probably be effected by standard methods. / Further study of the physical and chemical properties of the antigenic extract, with a view to formulating an isolation technique, revealed that no rapid quantitative method for estimation of the antigen was available. A 3-week immunization course, with three injections of 1 ml. each, and subsequent testing of rabbits was the quickest means. As additional properties of the antigen, it was learned that TDF was stable at pH ranges from 2.5 to 11.0, with the exception of pH 3.5 to 4.0 where it was relatively unstable; it was destroyed by trypsin at pH 8.8 at 37° C. for 72 hours; it could not be extracted by diethylene glycol or trichloroacetic acid; the antigen was relatively stable to the action of cold ether, acetone, and alcohol. These results confirmed the protein nature of the antigen and indicated that it was relatively unstable to chemicals usually employed in isolation techniques, but stable if the procedures were accomplished in the cold room.

/ MPR B Div (Feb 44). W.J. Cromartie, D.W. Watson, F.L. Bloch, and R.J. Heckly, "Studies on Infection with Bacillus anthracis. II. The Immunological and Tissue Damaging Properties of Extracts Prepared from Lesions of B. anthracis Infection," Journal of Infectious Diseases, 80 (Jan-Feb 1947), 14-27.

In the attempt to isolate the protective antigen in TDF, use was made of a Tiselius electrophoresis apparatus to follow the fractionation of TDF and identify its components. It was demonstrated that in addition to normal serum proteins (d^2 , $d^2 \beta$ and γ globulins) and a Q component, TDF contained a highly acidic fraction which could be almost completely removed by calcium phosphate adsorption and purified. When this fraction was injected in small quantities into the skin of man or rabbits, it produced an inflammatory reaction comparable to that of the whole TDF. It was at first supposed that this fraction contained all the immunizing antigen of TDF, but subsequent tests proved that the inflammatory portion did not protect animals against anthrax infection and that all the immunizing antigen was present in the noninflammatory supernatant. It was therefore possible to divide TDF into two fractions, the inflammatory factor and an immunizing antigen. /

With the removal of the inflammatory factor from TDF, deemed advisable because of its acidic nature and affinity for other proteins, further fractionation of the remaining material was accomplished by alcohol precipitation at low temperatures. The yield was a pure component which electrophoretic analysis showed to be composed of beta and gamma globulin

/ D.W. Watson, W.J. Cromartie, W.L. Bloom, R.J. Heckly, W.J. McGhee, and N. Weissman, "Studies on Infection with Bacillus anthracis. V. The Isolation of an Inflammatory Factor from Crude Extracts of Lesions of B. anthracis Infection and Its Biological and Chemical Relationship to Glutamyl Polypeptide," Journal of Infectious Diseases, 80 (Mar-Apr 1947), 121-136.

/ D.W. Watson, W.J. Cromartie, W.L. Bloom, G. Kegeles, and R.J. Heckly, "Studies on Infection with Bacillus anthracis. III. Chemical and Immunological Properties of the Protective Antigen in Crude Extracts of Skin Lesions of B. anthracis," Journal of Infectious Diseases, 80 (Jan-Feb 1947), 28-40.

It was at this point that the wartime study of TDF came to an end. New methods of fractionating gamma globulins, recently developed at the University of Wisconsin, could not be applied before the program was curtailed. Although an antigen from TDF had not been successfully isolated in pure form, many of its properties had been discovered and considerable promise was held for future efforts. It was agreed that TDF appeared to contain a protective antigen capable of solidly protecting animals against large challenges of anthrax. However, because the material was obtained from rabbits and therefore contained rabbit serum, it was not utilized in humans because of the danger of rabbit sensitization. It was believed, nevertheless, that had the enemy employed anthrax in combat, TDF could have been used as a protective antigen. /

While the work on TDF was still in progress, another aspect of the problem of developing a protective antigen was under development in a study of the host-parasite relationship in anthrax infection, in an effort to determine the mechanism by which anthrax invades its host. Preliminary observations of this relationship had been made by WRS workers / and Cromartie and Watson continued the line of study.

/ Though produced in rabbits, TDF was considered practical for large-scale production, its processing being simple and inexpensive. A yield of 50 ml. or 160 immunizing doses could be obtained from a single rabbit, and in the lyophilized state, the vaccine is readily shipped and does not lose potency for at least one year when stored at 7° C. In the opinion of Dr. Rolla S. Dyer of the USPHS, rabbit sensitization was not a serious detriment to the use of this vaccine. He recommended that the vaccine be given to humans if tests in animals showed definite production of immunity. See informal statement from Dr. Dyer to Dr. Dack, C Safety Div, 20 Jan 45, in files of B Div CD.

/ J. Victor and L. Julianelle, "The Pathological Effects of Virulent and Avirulent 'N' in Susceptible, Resistant, and Immunized Hosts" (23 Nov 44). In CD Tech Lib (Acc.No. 11).

The literature revealed that although the anthrax organism germinated in all classes of animals, only certain species, particularly the guinea pig, mouse and rabbit, were susceptible to anthrax, while others, including the dog, hog, pigeon and chicken, were resistant. Resistance could be altered by varying the body temperature of resistant species, and the resistance of the rat could be lowered by fatigue. It was known that the serum of certain species was highly anthracidal, and it was this that had given Bail his "aggressor" theory. It had been shown that the leucocytes contained the anthracide. A phagocytic theory proposed that natural immunity to anthrax resided in the capacity of the leucocyte to phagocytize the anthrax organism.

An interesting feature of the anthrax lesions in resistant animals examined by the pathologists at Camp Detrick was the relative abundance of leucocytes, without phagocytosis. Yet, after four hours the bacilli in the relatively resistant species began to disintegrate and die. Observations made in the response of both susceptible and resistant species to anthrax infection suggested that resistance was associated with infiltration of the local lesion with leucocytes. In the presence of these leucocytes, anthrax organisms underwent a degenerative change, indicating that substances appeared during the course of infection to produce these changes.

It became further apparent that resistance to anthrax infection was similar pathologically in the immune and in the resistant animal. This evidence indicated that a knowledge of natural resistance to anthrax was essential for the production and interpretation of anthrax immunity.

Upon re-examining the observations made up to that point, it seemed that when anthrax invades the tissues, it is confronted with factors of natural resistance which causes a dissociation of the organisms. This dissociation involves production of an adaptive anabolic enzyme which is responsible for the production of the inflammatory factor. The protective antigen extracted from the tissues (TDF) is the anabolic enzyme. Antibodies developed in the actively immune animal prevent invasion of the anthrax organism by blocking the anabolic enzyme responsible for the production of the inflammatory factor. In the absence of the inflammatory factor, the organisms are disposed of by the natural resistance factors of the host.

Apparently a protective antigen for anthrax infection could be produced only in the animal body where the organism had a natural substrate for growth and was at the same time confronted by the natural resistance of the host. This was the basis for a working hypothesis derived for the production of protective antigen in vitro, based on the dissociation of the anthrax organism when confronted with a factor or factors of natural resistance. Isolation of these factors and their application to the anthrax organism might, it was felt, lead to production of antigen.

The anthracidal factor was isolated from many tissues, including the pancreas and thymus, from the leucocytes of several animals, and from rabbit serum. Calf thymus proved to be the best source. Examination of the factor revealed that it was inhibited by the inflammatory factor of

anthrax and glutamyl polypeptide. It was shown not to be ribonucleare or lysozyme. Electrophoretic analysis showed it to be basic in character which explained its inactivation by the acidic inflammatory factor and glutamyl polypeptide. When tested for its therapeutic value in anthrax-infected mice, it proved to be nontoxic and showed considerable activity in vivo. The exact role of this substance in anthrax infection could not, however, be determined, and it did not prove possible to produce an antigen in its presence in-vitro. /

In the preliminary observations made by the pathologists, the anatomical changes seen in anthrax lesions did not satisfactorily explain the marked functional changes evidenced by the clinical picture of the disease in the host. Some mechanism appeared to be present which, although it altered vital tissue function, was not associated with anatomical changes demonstrated by usual histological methods. The physiology group set to work to investigate the clinical picture and mechanism of death, and more specifically, to examine the problem of the altered physiology in anthrax infection.

A differential count showed that specific components of the blood altered characteristically as the infection progressed. The appearance

/ Sp Rpt 7, Observation on "N" Infection. I. Host Parasite Interrelationships in "N" Infection (Feb 45).

W.L. Bloom, D.W. Watson, W.J. Cromartie, and M. Freed, "Studies on Infection with Bacillus anthracis. IV. Preparation and Characterization of an Anthracidal Substance from Various Animal Tissues," Journal of Infectious Diseases, 80 (Jan-Feb 1947), 41-52.

N. Weissman and L.H. Graf, "Studies on Infection with Bacillus anthracis. VII. A Comparison of the Antibacterial Effects of Calf Thymus Histone and a Quarternary Ammonium Cationic Detergent on B. anthracis," Journal of Infectious Diseases, 80 (Mar-Apr 1947), 145-153.

of blasts, myelocytes and immature polymorphonuclear leucocytes showed a marked change 24 hours after infection and this persisted throughout the course of infection. The change occurred in both immune and nonimmune rabbits even before a positive blood culture was noted. It was also observed that although a bacteremia occurred occasionally in the immune rabbit, it was promptly eradicated. / The most consistent change noted in infected rabbits was a hyperglycemia or excess sugar in the blood in the preterminal animal. This was significant, since glucose tolerance tests were known to potentiate the hyperglycemia early in the infection. Lactic and pyruvic acid levels carried out concomitantly indicated no change, indicating the lack of anoxia and suggesting the inability of the animals to phosphorylate glucose. / The liver was rapidly depleted of glycogen, but muscle glycogen, with few exceptions, remained fairly constant. Adrenalin could therefore be precluded, since it was known that this produced a marked decrease in muscle glycogen with a rise in lactic acid.

While these studies were in progress, the inflammatory factor had been isolated and identified in the urine of infected rabbits. Since it was well known that calcium played an important role in the phosphorylation of adenylic acid to adenosine triphosphate, and adenosine triphosphate is required in the phosphorylation of glucose to glucose-6-phosphate

/ These physiological findings appeared to refute the literature on anthrax death which explained its mechanism on the basis of capillary obstruction and asphyxiation or oxygen depletion due to organism competition.

/ A function of carbohydrate metabolism.

it was concluded that a marked change in ionizable calcium, which might be brought about by the inflammatory factor, would also bring about the physiological changes leading to the death of the host. There was evidence in the literature that magnesium acted in a similar way to produce magnesium death. If this was so, then possibly animals treated with calcium would show resistance, while those treated with magnesium would become more susceptible. In the experiments that followed, calcium prolonged life and magnesium increased susceptibility in every instance. /

These studies in defense against anthrax infection indicated many points of attack for subsequent investigation but at their conclusion the mechanism of death had yet to be demonstrated and a vaccine had not been found.

/ W.L. Bloom, W.J. McGhee, W.J. Cromartie, and D.W. Watson, "Studies on Infection with *Bacillus anthracis*. VI. Physiological Changes in Experimental Animals During the Course of Infection with *B. anthracis*," Journal of Infectious Diseases, 30 (Mar-Apr 1947), 137-144.

The seven studies in this series were first reported in Sp Rpt 73, Studies on Infection with "N" (Aug 46), pp. 5-112.

The work on immunization and therapy for anthrax infection was, perhaps, the most exhaustive study undertaken by B Division in its wartime operations and its work on all subsequent agents was based on the closely integrated organization that was developed for this study. The integration of the work on anthrax may be illustrated by the chart on the following page and by this précis of the work accomplished:

Bacteriology: Bacteriological techniques were employed to maintain pure cultures, were used in titration and in estimations of challenge dosages. This branch prepared vegetative anthrax vaccines which were found to give no active immunity.

Serology: The serologists could discover no correlation between active immunity and serological findings. Animals with high precipitin, agglutinin and complement fixation titers were not necessarily immune.

Pathology: The pathologists conducted studies in the host-parasite relationship in anthrax infection and in natural resistance to anthrax infection. In the former studies, a substance was found in the tissues of infected animals which the pathologists called TDF. In studies of natural resistance, it was believed that such resistance was based on the presence of an anthracidal factor, probably excreted from the leucocytes. Precipitation of this factor by Ca^{++} gave the pathologists an inflammatory factor which had the power of neutralizing the anthracidal factor. Since the anthracidal factor in leucocytes was shown to be capable of killing large numbers of anthrax organisms in vitro and the inflammatory factor from TDF was shown to be capable of neutralizing this anthracidal substance in vitro, it was postulated that the inflammatory factor was a possible logical mechanism by which anthrax invades the susceptible host or is overcome by the resistant host. This suggested a hypothesis for the possible production of a protective antigen in vitro.

Chemistry: By fractionation, the TDF isolated by the pathologists was found to contain a protein antigen and an inflammatory factor similar to that found in the anthracidal factor. It was learned that TDF and the inflammatory factor both damage normal tissue like living anthrax organisms. Both factors, therefore, might possess the basis for a protective antigen which would make active immunity against anthrax infection in man possible.

Physiology: The principal changes observed in anthrax-infected rabbits are hyperglycemia and liver glycogen depletion. It was possible that Ca ++, used to extract the inflammatory factor from the anthracidal factor in natural resistance, might also be a basis for the development of therapy. It was found that Mg ++, on the other hand, tended to increase susceptibility in rabbits to anthrax infection, and it was possible that the presence of this substance in infected animals might be a clue to the mechanism of death by anthrax. Similarly, the presence of an anthracidal factor in the blood of animals infected with anthrax held possibilities for further therapeutic study.

Pharmacology: While these other studies were in progress, the pharmacologists investigated the use of streptomycin, penicillin, and sulfadiazine as therapy for anthrax infection and found them to be effective in that descending order. Streptomycin could not be used in treating humans because of its systemic reactions and the agent of choice was therefore penicillin in cases of accidental laboratory infection.

Chart 5

INTEGRATION OF THE FUNDAMENTAL SCIENCES IN ANTHRAX
STUDIES IN B DIVISION

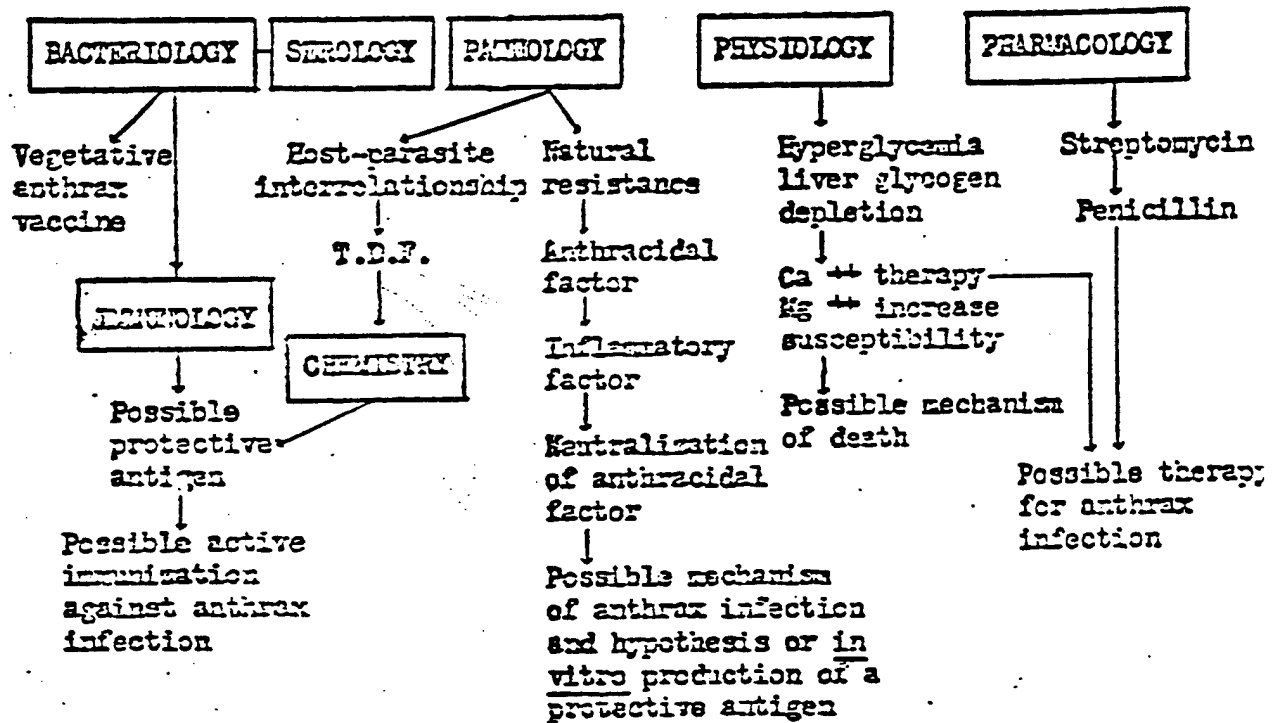

Anthrax therapy. While a large part of the work of B Division was concentrated on of immunization for anthrax, another group was conducting studies to evaluate the efficiency of sulfadiazine, penicillin and streptomycin as therapeutic agents for anthrax infection. Streptomycin proved to be highly effective, penicillin somewhat less so, and sulfadiazine of a much lower order of efficiency.

Consistently fatal infections could be produced in the mouse by injection of relatively small doses of anthrax organisms, but in these experiments, as a rigorous test of the agents, large doses were used and the disease allowed to become well established before therapy was initiated. In two separate experiments, survival rates of 79 percent to 92 percent were obtained with streptomycin dosages of 800 to 1600 units daily per mouse. On a kilogram basis, this dosage was within the limits used in man in the treatment of other infectious diseases. Penicillin was moderately effective; survival rates varied from 43 to 58 percent with doses ranging from 625 to 10,000 units per day. Sulfadiazine, in amounts considered optimal in the treatment of other infections, was only slightly effective against anthrax infection, with a 5 percent maximum survival rate. The life of infected animals was prolonged but few survived.

Anthrax bacilli in large numbers were found in 96 percent of infected untreated animals which died. Only 43 percent of infected-treated animals revealed anthrax bacilli and in these the number of organisms was considerably diminished by comparison with untreated animals. In treated animals which died, a large percentage was negative to culture, suggesting

that in these the actual infection was halted and the mice died of irreversible physiological changes resulting from the infection. The edema contained a great deal of the inflammatory factor, and in view of the absence of living organisms, this was considered evidence of the importance of the factor as a cause of death. /

In a later study with monkeys, it was learned that sulfadiazine blood levels of 5.0 to 10.0 mg. per 100 ml. prevented infection and/or death, with a mortality rate of 7 percent for treated animals as compared with 85 percent for untreated animals. Survivors could not be re-infected. Penicillin treatment started 1 hour after infection of mice or rabbits by subcutaneous injection of anthrax bacilli protected 90 to 100 percent of the animals. Therapy beginning 43 hours after inoculation seldom protected more than 5 to 10 percent. /

/ E.S. Miller, E.B. Scott, H.A. Noe, S.H. Madin, and T.F. Henley, "Chemotherapy of Experimental Anthrax Infections," Journal of Immunology, 53 (Aug 1946), 371-79. Originally reported in Sp Rpt 73, pp. 113-20.

/ F.M. Schabel, H.R. Reames, and R.D. Housewright, "The Use of Sulfadiazine and Penicillin for Treatment of Experimental Anthrax," Journal of Infectious Diseases, 79 (Sep-Oct 1946), 141-47.

A series of studies were conducted by members of S Division for the work on penicillin therapy on the production and use of penicillinase. Penicillinase was used by B Division workers to inhibit the action of penicillin in blood drawn from animals which had been infected with anthrax and were under penicillin treatment. By using penicillinase, it was possible to recover organisms in blood cultures contaminated by penicillin, thereby preventing false negative results. /

/ R.D. Housewright and R.J. Henry, "Studies on Penicillinase. I. The Production, Partial Purification, and Practical Application of Penicillinase," Journal of Biological Chemistry, 167 (Feb 1947), 553-61.

R.J. Henry and R.D. Housewright, "Studies on Penicillinase. II. Manometric Method of Assaying Penicillinase and Penicillin, Kinetics of the Penicillin-Penicillinase Reaction, and the Effects of Inhibitors on Penicillinase," Journal of Biological Chemistry, 167 (Feb 1947), 559-71.

R.D. Housewright and R.J. Henry, "Studies on Penicillinase. III. The Effect of Antipenicillinase on Penicillin-resistant Organisms," Journal of Bacteriology, 53 (Feb 1947), 241-47.

Laboratory infection. In the 18 months of laboratory and pilot plant work with Bacillus anthracis at Camp Detrick, there were 25 cases of cutaneous anthrax.

Nearly all patients had solitary lesions, located for the most part on the hands, wrists, face, neck or arms. In five patients, infection occurred at sites of known trauma: a cigarette burn on the face, abrasions on the fingers, and in a hangnail. In all but three cases, there were no symptoms of malaise prior to the appearance of the lesion. Subsequently, symptoms of headache, malaise and joint pains were experienced in varying degrees by 20 of the patients.

In spite of the treatment, which was initiated as soon as a diagnosis was made, every lesion passed through its typical cycle of gross pathologic changes. All patients were treated with penicillin, in total dosages ranging from 1 to over 4 million units. The plan of therapy was to give 60,000 units intramuscularly in each of five doses, followed by 30,000 units every 3 hours, by the same route. This therapy was continued until the edema had begun to recede, cultures from lesions were negative, systemic symptoms had subsided, and lesions were drying. In addition to penicillin, acetylsalicylic acid (aspirin) was given for symptomatic relief. The duration of hospitalization for these patients was from 4 to 45 days. All recovered uneventfully. /

/ H.V. Ellingson, P.J. Kadull, H.L. Bookwalter, and C. Howe, "Cutaneous Anthrax. Report of Twenty-five Cases," Journal of American Medical Association, 131 (3 Aug 1946), 1105-08.

Although streptomycin had been proved most efficacious in the treatment of anthrax in laboratory animals, it was not used to treat these patients because it was itself still in the experimental stage of development. The crude product available was highly toxic to laboratory mice and this precluded its use in humans. /

On the basis of the laboratory studies of anthrax, the incidence of infection in laboratory workers, and the course of infection in hospitalized cases, the chief of S Division expressed his opinion that anthrax might not be the hazardous organism it was thought to be. Its value as an agent of war was a problem of dosage and of trauma. It was not an especially dangerous agent to handle in the laboratory, but its use in the field with a coagent, to ensure trauma in exposed personnel, might make it exceedingly effective. /

6
/ See p.204 (~~Defense Against Biological Attack~~)

/ Interv CWS Hist Off with Dr. G. M. Dack, Chief of S Div, Tech Dept, CD, 20 Jun 45.

BOTULISM
(Botulinum toxin produced by Clostridium botulinum)

Code letter "X"

General. A satisfactory method was found for producing Type A botulinum toxin in high concentrations and large quantity on a pilot plant scale. Although it was not tried, little difficulty was anticipated in adapting these methods to large scale production.

When it appeared possible to top ranking officials early in 1944 that Germany might be tempted to employ botulinum toxin in a cross-channel attack on our massed invasion forces, the Surgeon General of the Army undertook the procurement, storage and issue of the botulinum toxoid which had been developed by the efforts of WBS and Camp Detrick research. The toxoid was first manufactured at Camp Detrick and later, under the supervision of the Surgeon General's Office, in commercial biological firm

From the very beginning of the project, it was felt that any understanding of the pathogenesis, of means of increasing the yield, of maintaining stability of a munition in storage and dispersion, was necessarily limited by the lack of knowledge as to what botulinum toxin actually is. This was the basis for the work undertaken to isolate and purify the toxin from the culture medium. The end of the war came soon after this task was accomplished, so that the work reported in this history was all done before this basic information became available. /

/ Memo (S), H.H. Bundy for Secy of War, 23 Feb 44, sub: Re Biological Warfare. In OSW.

/ Sp Rpt 50, Development of "X" for Offensive Use in Biological Warfare (10 Nov 45), p. 1.

Selection of strain. The initial problem was to select the one of the five known types of Clostridium botulinum which would yield the greatest amount of the most potent toxin. Type A was responsible for most cases of botulism in the United States, while Type B was more common in Europe. Types C and D appear to be ineffective against man, and Type E, although toxic to man, is less so than Types A or B.

Studies of all five types of the botulinum bacillus were made during the course of the program, but the major effort was directed to Type A. Type A was not only most toxic, but it was considered likely that the Germans and Japanese would devote their greatest attention to preparing a defense against Type B, with which they were more familiar by reason of its greater incidence in their countries. After preliminary trials, the Hall strain of Type A and the Nevin strain of Type B were chosen for study because of their consistently high titer yields. Four types of colonies were developed from the Hall strain, differing in appearance, media requirements and toxicity. The colony designated strain #57 was isolated and recommended for production in the pilot plant because it appeared to possess the greatest toxicity, killing all test mice in less than 17 hours.

Sp Rpt 21, Studies of Toxin and Toxoid Production of "X", Types C and D (1 Oct 45).

The minimum amount of toxin required to kill a mouse in a given period is called the minimum lethal dose or MLD. To determine the relative toxicity of several specimens of culture, a concept borrowed from chemistry is used. The reaction of blood to a culture is considered an index of its toxicity, and the measure of this reaction is called its titer. A high titer therefore signifies a high concentration of toxin in the bacterial culture which produces it

Botulinum toxin simulant. Radioactive phosphorus (P32) was used in S. Division operational safety tests and in a few preliminary munition studies as a simulant for the toxin.

Nutrition. Stocks of strain #57 were maintained in cultures of beef heart infusion broth containing chopped meat. After an initial growth period of 24 hours at 34° C., the cultures were stored at room temperature. When required, colonies were obtained from this stock, inoculated in sterile meat tubes, incubated for 24 hours, then transferred into a corn steep liquor-peptidase-cereulose broth medium for production growth.

Studies of the basic nutritional requirements of strain #57 suggested replacement of the peptidase medium with a supplemented casein hydrolyzate base. Casein proved superior to peptidase for it produced toxin for 24 hours longer than the original basal medium. / The new medium consisted of 0.3 percent casein, 1 percent alkaline-treated corn steep liquor, and 0.5 percent cereulose. This was used in laboratory production and recommended with modifications to the pilot plant.

The ^{basal} acid-hydrolyzed casein medium actually used in pilot plant production consisted of 0.5 ml. acid-hydrolyzed vitamin-free casein, 0.5 ml. glucose, 0.1 ml. tryptophane, 0.01 ml. salts B, 0.1 ml. phosphate buffer, and 0.1 ml. sodium thioglycollate. To this the vitamins biotin, thiamine, choline, pyridoxine, and folic acid were added. /

/ Sp Rpt 50, pp. 134-36.

/ C. Lamanna and C. Lewis, "An Observation of Apparent Substitution of Pantothenate by Thiamine and Choline," Journal of Bacteriology, 51 (Mar 1946), 398-99.

Another practical liquid medium which was developed for the production of highly toxic cultures of the Hall strain of Type A C. botulinum was composed, on a liter basis, of 20 grams of powdered milk, 6 grams of commercial glucose (cerelose), and 4 grams of clarified corn steep liquor. This solution was adjusted to pH 7.4 to 7.6, sterilized for 20 minutes at 120° C., and inoculated with 2 to 5 percent by volume of an actively growing culture from stock. Incubated at 34° C. for 24 to 48 hours, this medium yielded 500,000 to 1,000,000 MLD of toxin per ml. of culture.

/ K.H. Lewis and E.V. Hill, "Practical Media and Control Measures for Producing Highly Toxic Cultures of Clostridium Botulinum, Type A," Journal of Bacteriology, 53 (Feb 1947), 213-30.

Laboratory production. The optimum cultural temperature for both laboratory and plant growth of Clostridium botulinum was 37° C. under anaerobic conditions. An initial pH between 6.7 and 7.4 was best for the pepticase medium and 7.2 (slightly alkaline) for the casein medium.

Pilot plant production. The production cycle for botulinum toxin was worked out in Plant No. 1 and No. 2 and was similar to that described for anthrax production.

Stock cultures of strain #57 were maintained by monthly transfers in meat mash cultures. Two 15 ml. portions were inoculated from stock, incubated at 34° C. for 18 hours, then transferred into 1,500 ml. of regular plant medium. Further incubation was continued for 16 to 20 hours and this batch was then used to inoculate the catalyst tanks, containing 8 to 10 gallons of medium. There it was incubated at 94° F. for 18 hours. Gas production by the agent helped to maintain an anaerobic condition of growth, and a pressure of 5 to 10 psi was permitted to develop in the tanks. Further growth in the reactor tanks was induced under similar conditions of temperature, time and pressure.

Achievement of maximum toxin in the reactors was indicated by the increase of acidity from the original pH of 7.4-7.8 to a pH of 5.6-6.2 and by autolysis (self-digestion) of the cells. When the acidity of the batch then went down to pH 6.0-6.2, the toxin was collected. Control measures during the period of growth included determination of media and tank sterility, macroscopic and microscopic observations of growth, acidity determination, and toxicity assays.

Two engineering changes were made in pilot plant operations as a result of preliminary trials. The sensitivity of the toxin-producing organisms was such that introducing inoculum from the catalyst tanks into the bottom of the reactor tanks, instead of the top, appreciably increased growth of the final batch. It was also found that mechanical mixing of the medium in the reactor before inoculation permitted a more even rate of growth at all depths. /

Harvesting. The separation of the toxin from the remainder of the culture was related to the time of growth. The most useful method for determining the time of maximum toxin appeared to be by recording the changes of pH during growth.

Precipitation of the toxin with a strong acid (either hydrochloric or sulfuric acid) was found to be the most satisfactory method of harvesting the soluble toxin from the culture medium in both laboratory and pilot plant production. / Sedimentation and centrifugation were used to obtain a concentrated mud from the flocculent material resulting from precipitation. The thick mud that was formed was itself adequately concentrated for use in munitions. Filtration was not successfully accomplished, and pilot plant drying of the toxin was not attempted.

/ Sp Rpt 50, pp. 136-42.

/ The published literature disclosed that the Japanese had established a method of separating the toxin from the mother liquor by precipitating with zinc chloride and then removing the zinc from the toxin as zinc sulfide. Precipitating the material at the iso-electric point by adding acid, however, was found by Camp Detrick to produce a toxin of superior quality.

Storage. A number of interdependent variables influenced the mud form of toxin in storage, among them being time, temperature, pH, heavy metals, inorganic salts, and toxin purity. Some salts maintained toxicity, especially at alkaline pH values. Lyophilization of the product was tried, with poor results. The best results obtained was storage of the acid toxin mud for over two months when kept in glass containers at temperatures below 15° C. In general, the storage characteristics of the mud toxin were poor and investigation proved inconclusive.

Preliminary evidence indicated that the purified crystalline botulinum toxin was considerably more stable than the mud form of toxin.

Dissemination. In laboratory studies made to determine necessary characteristics for the dissemination of the toxin, ~~it was found that if~~ the toxin was considered ~~from the point of view of its use as a liquid and as a dry powder, for~~ ~~infection by the respiratory route and by sabotage or contamination of~~ the ground. It was found that if an acid mud slurry was to be used in a munition, adjustment of the slurry to a pH of 5.9 was desirable. Ball milling was found impractical for rendering the mud to a dry powder particle size suitable for inhalation. Large, uneconomical losses of toxin resulted from this process and use of a whirlwind mixer proved more practicable.

In a series of tests with the mud form of toxin at Horn Island, it was substantially shown that the 4-pound Mark I British Bomb filled with 12.15 percent toxin slurry would probably not be a lethally efficient

weapon. / Guinea pigs used in tests with one, two and four bombs were killed by the contamination of their coats with the toxin. No toxin could be detected in their lungs. The mechanism of action of the toxin on the coats of the animals could not be determined. / When twelve and thirteen of the 4-pound bombs were simultaneously detonated, only one of thirty animals was killed, apparently by primary inhalation.

Although it was found possible to contaminate turf with botulinum toxin in quantities that would produce a toxemia and even ocular lesions in mice, the palpable superiority of other biological agents and the known difficulty of infection man by the respiratory route, which was essential if botulinum toxin was to be considered as a war agent, rendered more elaborate field tests superfluous. Interest in the dissemination values of this agent were revived, however, with the development of the crystalline toxin.

/ MTR HI (Sep 44), further entitled, "Combined Report, 6 Oct 1944."

/ MTR HI (Jan 45), pp. 5-7.

/ MTR, HI (Apr 45), p. 3.

Purification of Type A toxin. The outstanding accomplishment of the "X" project was the discovery of two methods whereby the toxin elaborated by C. botulinum during cultural growth could be concentrated, separated from extraneous material, and crystallized. Aside from the primary implication in this ultimate concentration of the most powerful poison in nature, the discovery was of the utmost benefit to the project. It permitted the assembly of information on the exact chemical and physical properties of the toxin, it became possible to increase immeasurably the payload of an "X" munition by reducing the extraneous matter in the filling, and it made it possible to prepare immunizing toxoids of increased efficiency.

Both A Division and B Division at Camp Detrick worked on the problem of purifying the toxin. A Division, under Dr. Carl Lamanna, sought to purify the toxin in order to increase its efficiency as a filling for munitions. B Division, under 1st Lt. Adolph Abrams, CWS, was engaged on the problem in the hope of securing a better toxoid for biological defense. Lamanna achieved his crystallization by the chloroform agitation method in May 1945. Three months later, Abrams succeeded in isolating the toxin by a more classical procedure.

The purification method according to Lamanna consisted essentially of acid precipitating the culture, extracting the acid mud with a sodium chloride-acetate buffer, shaking this solution with chloroform, precipitating at a new iso-electric point, and fractionating at controlled pH values from the sodium chloride-acetate buffer mixture with ammonium

sulphate. Crystallization was then accomplished by supersaturation, using several methods. /

The original precipitation with acid rendered the toxin a pure protein. The sodium acetate apparently brought it back into solution as a salt, free of bacterial cells and other materials precipitated with the toxin by the acid. Crystallization, which would permit fractionation of its constituents, now became possible.

Abrams' method consisted of acid precipitation and acetate buffer resolution extended according to the usual methods of alcohol and salt fractionation of proteins. Saturated Na_2SO_4 (sodium sulfate) and $(\text{NH}_4)_2\text{SO}_4$ (ammonium sulfate) were selected as fractionating agents. The sodium sulfate fractionation was carried out at pH 6.3 or under slightly acid conditions. Impurities were removed by precipitation at pH 4.7 to 5.0. By repeating these procedures at increasingly greater concentration of toxin, it was possible to obtain the purified and crystalline end product. /

- / C. Lamanna, O.E. McElroy, and H.W. Eklund, "The Purification and Crystallization of Clostridium botulinum Type A Toxin," Science, 103 (17 May 1945), 613-14. First reported in Sp Rpt 50.
- C. Lamanna, H.W. Eklund, and O.E. McElroy, "Botulinum Toxin (Type A); Including a Study of Shaking with Chloroform as a Step in the Isolation Procedure," Journal of Bacteriology, 52 (Jul 1945), 1-13.
- / A. Abrams, G. Kegeles, and G.A. Hottle, "The Purification of Toxin from Clostridium Botulinum Type A," Journal of Biological Chemistry, 164 (Jul 1945), 63-79. First reported in Sp Rpt 51, The Purification of "XA" Toxin (1 Sep 45).

Studies of the nature and composition of the crystalline toxin revealed that it was a protein and therefore probably incapable of synthetic reproduction. It had the solubility properties of a globulin, insoluble in water and alcohol but susceptible to solution with a neutral salt. Its amino acid composition and molecular weight were estimated. The protein was free from carbohydrate, halogens, iron, manganese, and magnesium. In addition to carbon, hydrogen, oxygen, nitrogen, and sulfur, the toxin molecule contained some phosphorus and a negligible amount of ash. Nineteen amino acids were found in it. The pure toxin could be detoxified with ketene, carbon monoxide, and ethylene. No explanation for the extreme toxicity of the substance could be given from the analytical data. /

Possible means of applying the laboratory methods of purifying Type A toxin to large scale production were explored. Acetate extraction of acid mud and purification by the chloroform shaking method were considered distinctly feasible for large scale operations. The chief unsolved problems of mass production appeared to be in developing means

/ F.W. Putnam, C. Lamanna, and D.G. Sharp, "Molecular Weight and Homogeneity of Crystalline Botulinus A Toxin," Journal of Biological Chemistry, 165 (Oct 1946), 735-6. Also reported in Sp Rpt 5
142-96, and in Sp Rpt 82, The Elemental and Amino Acid Composition of Crystalline Clostridium botulinum Type A Toxin (Jul 47), pp. 1, 5.

G. Kegeles, "The Molecular Size and Shape of Botulinus Toxin," Journal of American Chemical Society, 68 (1946), 1670. First reported in Sp Rpt 62, Physicochemical Properties of XA Toxin (15 Nov 45).

for simplifying the procedure and increasing the yield of the pure crystalline product. /

Pathogenicity In animal studies with acid-precipitated Type A toxin (the mud form of toxin), it was found that the agent was most toxic by the intraperitoneal route. The subcutaneous route was half as effective. Healthy skin offered a good barrier to the toxin, but a burn, abrasion or laceration increased the rate of absorption from the area until it approached the effectiveness of the subcutaneous and intraperitoneal routes. This was more true of nebulized than of powdered toxin. Experiments with the oral route were not consistent.

The application of this information to man is difficult since no data as to his relative susceptibility exist. /

To determine the toxicity of the pure toxin, it was necessary to abandon the MLD as a statement of absolute potency and substitute an LD50 measure, based on a statistically valid titration. / The MLD of the pure toxin was estimated at approximately 0.00005 gamma; the LD50 at 0.000032 gamma. Thus, for the 20-gram white mouse there appeared to be 32 billion intraperitoneal LD50's per gram of dry toxin. If it is

/ Sp Rpt 50, pp. 252-65.

/ Sp Rpt 50, pp. 252-61.

/ MLD refers to intraperitoneal injection into 20-gram (= 2 g.) white mice of the least amount of material killing all mice tested within 4 days. (J. Bact., 52, Jul 46, p. 1 fn. and 12) LD50 refers to the least amount of material injected intraperitoneally which will kill exactly 50 percent of mice tested. See also²⁴ fn., p. 255.

assumed that the average person weighs 75 kg. and is of the same order of susceptibility, as the mouse, only 3,750 times more toxin or 0.12 gamma, would be required for one human LD50. The mere tasting of spoiled foods with as little toxin as this might logically cause death. ✓

In a study of the ultimate toxicity of the pure toxin for ^{the} monkey, it was shown that approximately 300 LD50 mouse doses would kill a 1 kg. animal. This would mean that less than 0.01 gamma (one-thousandth part of a milligram) of pure toxin would produce death in the monkey, or, if man had the same susceptibility, 0.75 gamma would kill a 75 kg. man.

The potency of the pure toxin indicated that the isolation procedure resulted in about a 240-fold purification.

By means of fractional precipitation and electrophoretic analysis, Type B toxin was found to have the same general chemical properties as Type A toxin and to contain approximately 2.5×10^6 mouse LD50 per milligram, or 25 billion intraperitoneal LD50's per gram of toxin.

In an effort to localize the action of the poison, studies were conducted on the physiology of botulinum toxin. It was shown that the action of botulinum toxin in the body probably occurs at the myoneural junction, producing its effect on the end plate, the series of discs

✓ J. Bact., 52 (Jul 46), p. 12. In food containing one million mouse MLD per ml., a not impossible figure, it was estimated that 0.0037 ml. of such food would be fatal to man. See Sp Rpt 50, p. 192.

which are the terminus of motor nerve-fibrils in muscular tissue. The effect is apparently due to a specific destructive chemical reaction between a component of the end plate and the protein molecule of the toxin. In more general terms, it was evident that botulinum poisoning causes a peripheral circulatory failure due to vasoparalysis and this vasoparalysis in turn is due to an effect of the toxin on the central nervous system.

Despite many similarities, there appeared to be a fundamental difference between botulinum poisoning and curare poisoning, since acetylcholine and nicotine did not respond as they did in curare poisoning. Prostigmine had little effect on botulinum poisoning, and the long period of recovery and degree of irreversibility of botulinum poisoning in the end plate suggested that future improvements in clinical treatment might prove discouraging. /

/ A.C. Guyton and M.A. MacDonald, "Physiology of Botulinus Toxin," Archives of Neurology and Psychiatry, 57 (May 1947), 578-92.
First reported in Sp Rpt 26, The Physiology of "X" Toxin (1 Nov 45).

Defensive research. Defensive aspects of the "X" project were centered almost entirely in the production of a toxoid for immunizing military personnel against the agent of botulism. The work on toxoid production was begun in March 1943 by the Harvard group under J.H. Mueller. Camp Detrick set up its defense project in September 1943. Since five types of botulinum toxin were known, the problem involved development of toxoids against each of the types. The work started with a Type A toxoid; toxoids for Types B and E were studied later. Toxoids for Types C and D were not considered because these toxins had not been found to cause human disease.

Preliminary studies were still being made at Camp Detrick when an urgent demand was received for immediate large scale production of the Type A toxoid. An effort was made to apply the Harvard procedure to quick production. This consisted of purifying the toxin by acid precipitation and detoxifying the redissolved toxin with formalin. When, in early production runs, use of this procedure resulted in 50 to 90 percent losses of toxin, the workers at Camp Detrick overcame this loss by reversing the procedure. Satisfactory results were obtained by first detoxifying the toxin in the culture media and then purifying the toxoid by alum precipitation. / By July 1944, all demands for the toxoid had been met and further production was discontinued. Subsequent studies were directed to improving the toxoid as an immunizing agent, based on isolation of the

/ Sp Rpt 4, Development of Materials and Procedures for Protection Against "X" (30 Oct 44).

Type A toxin. These studies led to the purification and crystallization of the toxin.

The methods and techniques used for the early emergency production of botulinum toxoid were largely adapted from those used by the laboratories preparing tetanus toxoid for the Army. Five-gallon bottles were used as culture vessels. The basic medium consisted of 4 percent charcoal-treated pepticase, 0.75 percent alkali-treated corn steep liquor, tap water, and sterile dextrose solution, making 16 liters of material. This medium was inoculated with 300 ml. of seed culture. Immediately at the end of the growth period, 0.6 percent formaldehyde was introduced into the bottles, this large amount of disinfectant ensuring sterility of the entire process without requiring special techniques. / The culture was allowed to stand in contact with the formaldehyde for 2 days before being clarified through paper pulp. The detoxified toxin was then mixed in a 100-gallon stainless steel tank, to ensure uniformity of product and expedite safe testing of the lot. The safety test was based on the fact that 5 ml. toxoid was harmless to guinea pigs. Mandler filter candles were used to obtain bacteria-free toxoid and alum precipitation removed the excess formaldehyde. The final toxoid had the appearance of a fine white flocculent precipitate which sedimented rapidly leaving a water-clear supernate. It was stable at room temperature and therefore required no special refrigeration for storage. /

/ Formaldehyde was the most effective agent found for detoxifying the botulinum toxin, but how this chemical acts to alter the toxin could not be established.

/ C. Nigg, G.A. Hottle, L.L. Coriell, A.S. Rosenwald, ^{and} G.F. Beveridge, "Studies on Botulinum Toxoid, Types A and B. I. Production of Alum Precipitated Toxoids," Journal of Immunology, 55 (Mar 1947), 245-54. ;

A total of 81 days elapsed between preparation of a lot and testing of the end product. This included a growth period of 4 days, a detoxification period of 28 days, safety test period of 15 days, alum precipitation process period of 6 days, and a period of 28 days for determining the antigenicity of the product in mice. Mice were injected with graded doses of the alum-precipitated toxoid and 21 days later were injected with a constant amount of toxin. This made it possible to determine the dilution of toxoid which would induce protection in half the mice receiving the challenge dose and was therefore a satisfactory quantitative method for comparing different lots of toxoid and method of purifying the toxoid. / Prior to this mouse test, antigenicity tests of Types A and B toxoids were made with guinea pigs. On the basis of guinea pig serum antitoxin levels and challenge immunity, a serum level of 0.02 unit per cc. was thought to provide adequate immunity for man, probably capable of protecting a 150-pound man against at least 60 million Type A guinea pig MLD's. / Studies in the effectiveness of the Type A toxoid as immunity against respiratory challenge established the fact that 0.8 unit injected intraperitoneally protected a 400-gram guinea pig against 640 mouse MLD administered by the respiratory route. The animals were found to have approximately 0.008 unit of antitoxin per ml. of serum at

/ G.A. Hottle, C. Nigg, and J.A. Lichty, "Studies on Botulinum Toxoids, Types A and B. II. Methods for Determining Antigenicity in Animals," Journal of Immunology, 55 (Mar 1947), 255-62. First reported in Sp Rpt 43, Development of Materials and Procedures for Protection Against "X" (1 Oct 45).

/ Sp Rpt 4, p. 18.

the time of this challenge. Guinea pigs retaining as little as 0.002 unit of antitoxin per ml. of serum withstood 1,600 mouse MLD per kg. of body weight. If man reacted similarly, he could withstand at least 3.75 grams of toxin or five times the estimated respiratory MLD, with a serum titer of 0.002 unit antitoxin per ml. /

Formaldehyde was also used to detoxify the purified crystalline toxin. The most active toxoid preparation was 2,400 times more active antigenetically than crude toxoid (alum-precipitated) on the basis of nitrogen content. /

/ An attempt to use the "L plus" dose of toxin as a criterion of antigenicity gave inconclusive results. The Linsted plus dose is the smallest amount of toxin which will kill a 250-gram guinea pig in 4 days when mixed and injected with one unit of antitoxin. Theoretically, this method should work well with botulinum toxoid since it measures the combining power of the toxin with antitoxin in the animal body, but perhaps due to the method of processing the toxoid it was not satisfactory.

/ G.A. Hottle and A.Abrams, "Detoxification of Crystalline Botulinum Type A Toxin," Journal of Immunology, 55 (Feb 1947), 183-87.

Concern in this country over possible use of botulinum toxin against our armed forces had its inception with the report in May 1941 that the Germans were working with the toxin in laboratories near Paris. Our Intelligence agencies continued to report rumors that this toxin was being prepared as a secret weapon, and in the Fall of 1943 as American troops began to mass in Great Britain preparatory to the invasion, our apprehension mounted. This was the basis for the urgent demand that Camp Detrick begin immediate large scale production of Types A and B toxoids. British authorities, on the basis of their own studies with the toxin, were not inclined to believe botulism presented a threat, despite rumors of the planned attack. / Nevertheless, this country continued to be concerned and in meetings between members of the Joint Chiefs of Staff and the Committee on New Weapons and Equipment, it was agreed that "Y" might be a powerful weapon of attack and quite within the bounds of possibility. /

The Surgeon General of the Army was solicited for his opinion as to the advisability of inoculating American forces in Great Britain against botulism. He declared that such mass inoculation depended on the likelihood of the enemy using the toxin as an offensive agent and the tactical employment that was made of the agent, both of which considerations were

/ See ltr (S), CO CD to C CWS, 27 Dec 43, no sub. SPCYF 400.12.

/ Encl, "Possible Use of X By the Enemy" to ltr (S), Col. J.H. Defandorf Hq ETOUSA CWS APO 887 to C CWS, 11 Feb 44. In CD Tech Lib (Doc. T-70).

/ JCS Report 908-3 (JCS 625/1), Implications of Recent Intelligence Regarding Alleged German Secret Weapon (6 Jan 44), pp. 9-17. See also memo (S), H.H. Bundy for SW, 23 Feb 44, sub: Re Biological Warfare, in files of OSW.

beyond his ability to decide. He further said that optimism as to the protective value of our toxoids in humans under combat exposure was not warranted at that time. The Chief of the Chemical Warfare Service informed Canadian authorities that we were nevertheless going to proceed with the manufacture of the toxoids. /

That was in May 1944. Four months later, Special Projects Division reported that as of 31 August 1944 a total of 1,138,000 units of Type A toxoid (alum-precipitated) made at Camp Detrick had been shipped overseas and 184,000 units were in storage at Gilliland, while an additional 411,000 units were being readied for shipment to storage. No Type B toxoid had been shipped overseas, but 564,000 units were ready at Camp Detrick and an additional 142,000 units were in process. / At 3 cc. per man, the 1,138,000 units of Type A toxoid overseas was sufficient for approximately 300,000 men. /

/ Ltr (S), C CWS to Dr. Otto Maas Dir CW and Smoke Canadian Army, 12 May 44, no sub. In OC CWS (092-Canadian).

/ When processing of all lots of toxoid were completed by 1 Sep 44, approximately 6,500 liters of Type A toxoid and 3,900 liters of Type B toxoid were on hand. Later, approximately 2,200 liters of each of the XA and XB toxoids were processed in order to prepare 4,400 liters of bivalent XAB toxoid. After prolonged efforts with the strains of Types C, D and E which were available, it was found that the toxicities of their cultures did not reach the high values of XA or XB and development work on toxoids for these three was discontinued.

/ Memo (S), C SPD for Asst C CWS for Materiel, 11 Sep 44, sub: X Toxoid.

BRUCELLOSIS
(Brucella suis)

Code letters "US"

General. The consideration which dictated the choice of Br. suis for special study was its known infectivity for man and, more particularly, its relative ease of cultivation over other Brucella, for this species is capable of growth, even on primary isolation from infected animals, without increased carbon dioxide in its environment.

Prior to the initiation of studies at Camp Detrick in May 1944, the literature on brucellosis indicated some possibility of its usefulness as a biological warfare agent. Because morbidity statistics for the disease were notoriously incomplete, it was impossible to deduce reliable estimates of the proportion of frank clinical cases to latent infections. Detailed serological studies made on occupational groups, however, showed conclusively that veterinarians, slaughterhouse employees and farm workers exposed to infective material did become infected with Br. abortus. Laboratories in the United States and abroad where brucellosis was studied offered additional evidence on infectivity. In from 4 to 20 years, seven centers of research in the U.S. had 66 cases; five institutions abroad had 53 cases. The literature also described 44 cases of fatal undulant fever. Upon examination, however, only seven of these were uncomplicated deaths directly attributable to specific organisms.

As a result of studies at Camp Detrick, a simple medium was found for pilot plant production of Br. suis, without deterioration of virulence

or loss of yield. Constituents of the medium are cheap and available in quantity. Some experimentation on Br. abortus and Br. melitensis was begun before the end of the war but without definite results.

Selection of strain. Four strains of Br. suis were obtained from Michigan State University, Army Medical School and the Department of Agriculture and were designated S₁, S₂, S₃, and S₄. Subcutaneous inoculations of graded doses into groups of guinea pigs indicated that S₁ (Huddleson's 1772-A) was of superior value on the basis of high parenteral virulence and characteristic cultural behavior. Although derived from a single colony, prolonged experience with S₁, from May 1920 when it was first isolated to September 1945 when wartime studies at Camp Detrick came to an end, failed to show any appreciable genetic or colonial variation in this strain when carried in serial transfer. /

Preliminary studies were made with two virulent melitensis strains of the Brucella organism, designated US-M₁ and US-M₂. These strains appeared to be very ineffective for man but decidedly less virulent for guinea pigs than Br. suis. Respiratory virulence was only one-half or one-third that of S₁, the melitensis strains requiring 100 to 110 cells to infect 50 percent of the guinea pigs exposed to them. Production media for these strains appeared to be similar to those for Br. suis, as were their storage characteristics. /

/ Sp Rpt 67, Development of Defensive Measures Against "US" (Sep 45), pp. 3-4.

/ Sp Rpt 20, The Present Status of the Offensive Development of "Us" (Sep 45), pp. 140-41.

Simulant. The nonpathogenic bacterium, Serratia marcescens, was most frequently used in laboratory and field studies as the simulant for the vegetative pathogens of brucellosis and tularemia. Studies made to obtain maximal quantities of the material with maximum survival during dehydration and storage resulted in the production of cell counts of 5×10^{12} per gram of dried material and 100 percent survival. / Egg cultures of S. marcescens were prepared and tested in the field. On the basis of one successful trial out of four, it appeared that this simulant, and possibly similar vegetative organisms, could be dispersed in a frozen state from the British 4-pound Mark I bomb. /

In a series of studies to develop the most suitable means for preserving vegetative organisms over long periods of time and under conditions normally unfavorable to maximum survival in this type of organism, S. marcescens was chosen for the tests because of its sensitivity to drying. Yet it was learned that spray drying appeared to be a practical method for large scale operations with vegetative organisms, provided equipment could be designed which would produce powders of low moisture content. Even better results were obtained by lyophilization of S. marcescens.

/ H.B. Naylor and P.A. Smith, "Factors Affecting the Viability of Serratia Marcescens During Dehydration and Storage," Journal of Bacteriology, 52 (Nov 1946), 565-73.

/ Sp Rpt 3, Use of Embryonated Eggs for Offensive Biological Warfare (Aug 44). This report summarized studies on the application of egg techniques for mass production of vaccines, virus agents, and nonsporulating bacteria such as S. marcescens.

Lyophilization of suspensions of the nonpathogen resulted in viable cell counts of 1×10^{12} per gram, with survivals of 80 to 100 percent consistently. When sealed under vacuum, the dry material showed little loss of viability for several weeks. /

On two occasions, personnel exposed to aerosols of this supposedly nonpathogenic bacterium were made ill. The exposures took place during experiments on the evaluation of the efficiency of equipment designed to remove bacteria from the air. Symptoms of those made ill were substernal oppression associated with coughing, fever and generalized aching. The syndrome was suggestive of a febrile reaction due to some pyogen in the aerosol rather than an infectious process, due to the early appearance of symptoms after exposure and their short duration. Symptoms had appeared within $2\frac{1}{2}$ to 4 hours and cleared up in 6 to 11 hours

/ Sp Rpt 61, Drying of *Serratia marcescens* (19 Nov 45), pp. 36-37.

/ Tom F. Paine, "Illness in Man Following Inhalation of *Serratia marcescens*," Journal of Infectious Diseases, 79 (Nov-Dec 1946), 226-32.

Nutrition. Examination of the nutritional requirements of Br. suis in February 1945 led to the use of a medium composed of 2 percent tryptose (Difco 15 tryptose peptone) and 0.5 percent sodium chloride. Subsequent studies indicated that maximum yields and stability were obtained by adding 0.1 µg thiamine hydrochloride, 1 percent glucose, and 4 ppm iron salts to the tryptose-sodium chloride base. The presence of 1 percent glucose was required for maximum growth and greatly enhanced viability of the Brucella cells in storage. This enriched medium increased yields from about 10×10^9 to 70 to 80 $\times 10^9$ cells per ml. Even better results were obtained when tryptose was later replaced by 2.0 percent pepticase plus 0.12 percent plasmolyzed yeast. /

/ W.G. McCullough, R.C. Mills, E.J. Herbst, W.G. Roessler, and C.R. Brewer, "Studies on the Nutritional Requirements of Brucella Suis," Journal of Bacteriology, 53 (Jan 1947), 5-15.

Laboratory production. Satisfactory production of S₁ organisms was achieved in 5-gallon lots in a Pyrex carboy apparatus. Inoculum for initial production consisted of the surface growth wash off a 48-hour tryptose agar slant which was introduced into a 100-ml. dilute tryptose saline medium (0.1 percent Eacto-tryptose and 0.5 percent NaCl). This gave a 1 percent inoculum which was then introduced into a medium of 15 liters of 2 percent Eacto-tryptose, 0.5 percent NaCl and 5 µg percent thiamine hydrochloride, with maintenance of pH between 6.8 and 6.9, aeration at the rate of 1 liter per minute and temperature at 37° C. A layer of melted lard three-eighths inch deep (one-half pound per 5 gallons of medium) acted as an antifoam and air baffle.

Under these conditions, organism counts of 1 to 2 x 10¹⁰ per ml. were obtained in 65 hours. The average yield was 1.36 x 10¹⁰ per ml. for 300 gallons of agent material which were produced. Only 4 of 53 batches contained contaminants. There were no variants in colonial forms and virulence of the end product was equivalent to results obtained on agar slant cultures. The minimal infective dose for 50 percent of the animals tested was of the order of five organisms when injected subcutaneously. /

/ H.N. Glassman and S. Elberg, "The Growth of Brucella in Aerated Liquid Cultures," Journal of Bacteriology, 52 (Oct 1946), 423-30.

In laboratory production it was found that the amount of inoculum, within certain limits, did not affect the quantity of maximum yield but did affect its rate of attainment. Differences in age of the inoculum resulted in no observable constant deviation in growth, and limited storage did not alter the usefulness of the strain adversely. Because Br. suis is aerobic, the amount of air and its dispersion through the culture proved to be important. A filter was adapted which secured the dispersion of great numbers of air bubbles throughout the material. It was found that air equal to one-fifteenth of the total volume of culture was required every minute for maximum growth.

An investigation of culture in embryonated eggs was made, primarily in an attempt to produce vaccines from yolk sac extracts of infected eggs, but also as a possible means of laboratory and large scale production of organisms. Br. suis could be produced in quantity in this manner but tank production was regarded as more efficient for pilot plant operations.

✓ Sp Rpt 20, pp. 51-52.

Pilot plant production. Plant operations (in Bldg. 431) were terminated in September 1945 after only two and a half months of production, but in that time it was demonstrated that the agent of brucellosis could be grown on a commercial scale for use as a biological agent. As a result of control and safety regulations during this period of operation, not a single case of infection occurred among personnel working in the plant.

A cyclic culture system of pilot plant production was accomplished by adaptation of the serial transfer principle, with continuous and simultaneous addition of fresh medium and withdrawal of final product, ^(Figure). The production cycle commenced with a stock culture of Br. suis from the spleen of fourth guinea pig passage in a medium of fortified tryptose agar to which 5.0 ml. of sterile tryptose-saline diluent was added. From the agar slant, growth was continued in stock suspension tubes. Both the stock culture and the stock suspension tube materials were transferred to a 2-liter florence flask and incubated 24 hours at 37° C. in a medium of 300 ml. of fortified tryptose broth. The culture was then transferred to another 2-liter florence flask, this one with a seeding adapter which permitted introduction of the material to one of the eight catalyst tanks. After incubating and being shaken for 20 to 24 hours at 37° C. in the second florence flask, the material was then emptied into one of

✓ P. Gerhardt, "Brucella Suis in Aerated Broth Culture. III. Continuous Culture Studies," Journal of Bacteriology, 52 (Sep 1946), 283-92.

✓ The fortified tryptose broth consisted of 2 percent bacto-tryptose broth, 0.5 percent sodium chloride, 0.1 percent glucose, 0.1 µg thiamine hydrochloride per ml., and distilled water. See P. Gerhardt and L. L. Gee, "Brucella Suis in Aerated Broth Culture. I. Preliminary Studies on Growth Assays, Inoculum, and Growth Characteristics in an Improved Medium," Journal of Bacteriology, 52 (Sep 1946), 261-69.

SECRET

PILOT PLANT CYCLE FOR THE PRODUCTION OF U₃

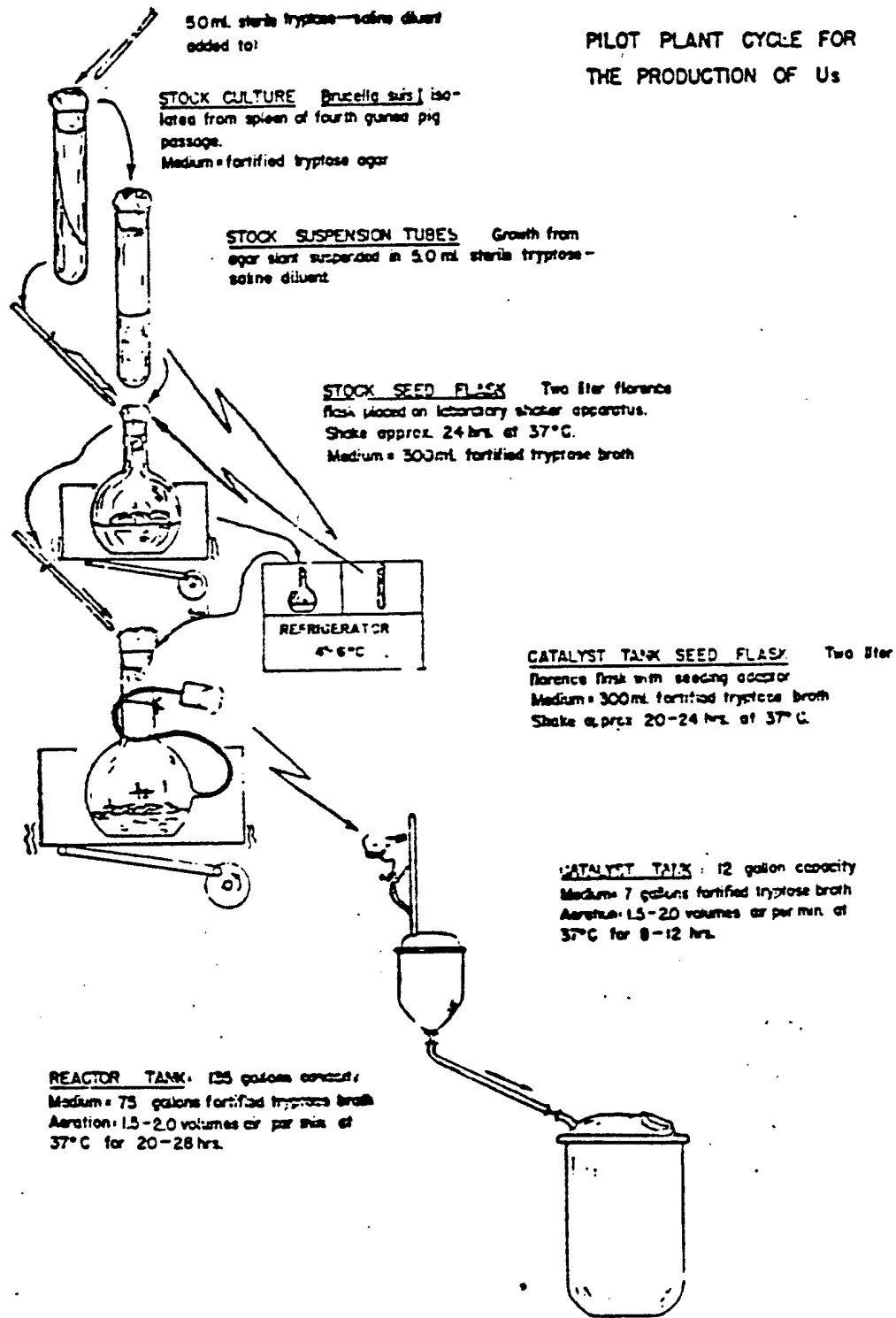

FIGURE 10

the eight catalyst tanks. Each of these tanks was of 12-gallon capacity but contained just 7 gallons of fortified tryptose medium. After aerating at the rate of 1.5 to 2 volumes per minute and incubating at 37° C. for 8-12 hours in the catalyst tanks, the material was transferred as inoculum to the reactor tanks. / These eight tanks were of 135-gallon capacity each, but contained only 75 gallons of medium. / Here the culture was similarly aerated and incubated for 20 to 28 hours, or until it reached full growth.

The use of lard and tributyl citrate were found to provide some retarding effect on the foaming in the reactor tanks. Tyrothricin in the amount of 0.025 mg. per cc. was found effective in inhibiting the sporulating aerobic organism that contaminated early production lots.

The average plant yield in these operations was approximately 35 to 40 x 10⁹ organisms per ml., which was acceptable as filling for munitions.

/ Sparger aeration or the bubbling of air through deep quantities of culture was required for Br. suis growth. L.L. Gee and P. Gerhardt, "Brucella Suis in Aerated Broth Culture. II. Aeration Studies," Journal of Bacteriology, 52 (Sep 1946), 271-31.

/ The reactor medium was composed of 2.5 percent bacto-tryptose broth, 1.0 percent dextrose (cerelose), 0.1 ug/ml. thiamine hydrochloride, 10 ppm Fe as FeSO₄·7H₂O, 75 gallons of tap water, with pH between 6.7 and 7.0 and lard as needed. See Sp Rpt 20, p. 74.

Harvesting. Three 500-gallon tanks for gravimetric separation, three types of centrifuges, a vacuum evaporator, and an Oliver filter were used to harvest the yield.

Efforts to separate the agent material from its broth culture by means of flocculation or iso-electric precipitation were not successful. Although the use of the Sharples supercentrifuge in the latter method appeared valuable, its hazards with living cultures ruled it out.

The least hazardous method of concentrating the broth culture to a suitable consistency which was finally evolved and recommended for pilot plant use consisted of filtration through preformed beds of filter-cel, a Johns-Manville diatomaceous earth. The apparatus consisted of a cover from a desiccator jar sitting on a 10-inch Buchner funnel. This in turn was set into a 5-gallon glass carboy through a rubber stopper. A feed tube fed the culture onto the filter bed in the Buchner funnel and the filtrate seeped into the carboy. A cotton air filter in the desiccator cover prevented formation of vacuum above the filter bed, and another between the vacuum pump and filtrate reservoir prevented dissemination of the agent into the atmosphere. The entire system could be autoclaved. At the end of filtration, the agent material was harvested from the surface of the bed by scraping. By means of this apparatus, over 2,500 grams of concentrated bacterial paste, having an average count of 1×10^{12} organisms per gram, were produced for use in vaccines and storage and field test studies. /

/ A.M. Kaplan and S. Elberg; "Concentration of *Brucella Suis* from Broth Culture," Journal of Bacteriology, 52 (Nov 1945), 513-17.

Storage. In the absence of large scale refrigeration facilities and the lack of a munition suitable for dispersion of the agent in dry powder form, studies of the finished product at Camp Detrick were confined mainly to storage characteristics of liquid cultures.

Samples for storage were placed in erlenmeyer flasks stoppered with tin foil or parafilm or were stored in Mark I bombs with lacquered inner surfaces. Results were encouraging. At refrigerator temperature, the greatest loss after 30 days was 7 percent; at 60 days the mother liquor retained 35 percent of its original viability. After 6 months of storage at room temperature, more than 25 percent of the original material was viable and fully virulent, thus meeting the accepted standard for storage. Dextrin, ascorbic acid, gelatin, and marmite were tested as preservatives. After 60 days only a 50 percent drop occurred in dextrin-treated slurry, despite a temperature of 36° C. for 10 days. No preservative, however, was found capable of protecting the organisms at 37° C.

Some preliminary data were accumulated to indicate that this vegetative agent was susceptible to lyophilization. When stored for a period of 90 days, the dry material was still sufficiently effective to warrant its use in a munition. /

/ Sp Rpt 20, pp. 84-87.

Dissemination. Field trials with Br. suis, at which Camp Detrick personnel were present, were held at the Suffield Experimental Station in December 1944 and again in January and June 1945. Up to that time, the only previous field trials with a pathogenic organisms had been the pioneer British trials with anthrax.

Two types of bombs, the Mark I and the shot-gun shell, were fired statically during the Canadian trials and the resulting clouds sampled by means of impingers and animals stationed on arcs of 50 and 100 yards from the site of the bomb-burst. Bomb fillings consisted of 320 ml. of agent slurry, stabilized with dextrin. Peak Ct's of 200 and 300 infective doses were obtained throughout the entire width of the cloud and up to both the 50 and 100 yard lines. The organism was found stable in cloud form either with or without protective coatings furnished by gum arabic, gelatin, or dextrin, and it was possible to predict the morbidity^{rate} of the cloud on exposed animals. From 10 to 35 percent of the organisms were recovered from the clouds, more than sufficient to cause animal infection. /

A suspension of Br. suis made at Camp Detrick and sent to Canada for the trials was reported completely noninfective for the test animals. A sample was returned for study, but upon examination no explanation

/ Sp Rpt 20, pp. 120-23.

could be found for its failure in the tests. /

A few studies were made of the transmission of brucellosis by canaries. The results, which were both negative and faulty, did not permit any conclusions to be drawn. /

Pathogenicity. The S₁ strain selected for study demonstrated such high virulence as a potential offensive agent that additional efforts to increase its infectiousness were not considered necessary. A strain which will infect guinea pigs with 10 organisms or less may be considered highly virulent. Six organisms of S₁ proved sufficient to establish infection in guinea pigs.

One of the first problems which presented itself in physiological studies of the agent was the necessity of developing a rapid virulence test. This was important since the organism does not produce death readily in any of the laboratory animals and the disease has a long incubation period and slow onset, making ordinary assays of virulence time consuming. The usual method of testing was by subcutaneous injection in guinea pigs with a known number of organisms, varying from 5 to 500,

/ Sp Rpt 34, Report on the Infectivity of a *Brucella suis* Suspension from the Suffield Experiment Station, Alberta, Canada (May 47), pp. 8-9.

/ Sp Rpt 20, pp. 131-35.

and sacrificing the animals after 30 days, using postmortem cultural, pathological and serological examinations to disclose the presence and severity of the infection. To permit rapid assay of strains, media and final product, the mouse-mucin test was developed. An investigation was made of several laboratory animals to determine in which of them death could be produced by a moderate number of organisms. Hamsters, cotton rats and mice were inoculated with S₁ intracerebrally, intraperitoneally, intracutaneously and subcutaneously. In general, the hamster resembled the guinea pig and 10 million organisms injected intraperitoneally did not cause death. The cotton rat was very resistant, the relatively enormous dose of 620 million organisms being required to produce an infection, demonstrable at 37 days. The mouse proved equally unreliable as an index because of the number of organisms found in individual mice varied so much that extent and rapidity of invasion could not be measured. / Nevertheless, an accurate and rapid test for virulence was developed, using the death of mice as an end point. This test involved intraperitoneal inoculation of mice with a mixture of organisms in gastric mucin. The test, involving a comparison between dilutions of standard suspensions of the brucellosis strain and the unknown suspension to be tested, was used repeatedly and found to give constant results if precautions were used in its application. Approximately 14 million organisms were required to kill half the mice during the test period of 10 days. /

/ Sp Rpt 20, pp. 136-39.

/ Sp Rpt 20, pp. 124-23.

Despite the lack of evidence in the literature, it was established at Camp Detrick that brucellosis might be acquired via the respiratory tract. / Although the organism is nonsporulating, studies revealed that it compared well with the most favorable sporulating organisms tested in British spray trials. This was an unexpected finding since vegetative organisms had previously been considered useless for spray due to their fragility. Actually, the agent appeared to possess a high degree of virulence for guinea pigs and monkeys when disseminated as an air-borne cloud. While no quantitative data exist for man, the rather high incidence of laboratory infection at Camp Detrick supported the view that unprotected man would respond to exposure in proportion to his respiratory capacity.

It appeared from cloud chamber tests that from 100 to 300 organisms by the respiratory route were sufficient to infect guinea pigs, and the ID50 (intra-dermal or subcutaneous injection) was below 100 organisms. In one experiment, ten of twelve mice were infected by approximately 400 organisms, indicating that their infectivity by the respiratory route was similar to that of the guinea pig.

The lesions in guinea pigs following respiratory exposure to brucellosis organisms were very similar to those produced by subcutaneous inoculation. The spleen is enlarged and congested, with occasional necrosis and abscesses. The liver contains small granulomas. The lymph nodes at the site of invasion are enlarged, inflamed and often abscessed.

/ MPR A Div (Jan 45), MPR B Div (May 45).

Defensive research. The study of immunization and therapy for brucellosis began at Camp Detrick in July 1944. Protection of friendly troops required the development of both an immunizing agent and specific therapy, but in spite of all efforts neither objective had been achieved at the end of the war.

Development of a suitable antigen capable of inducing active immunity in susceptible hosts, it was believed, might be based on the use of a living strain of virulent Brucella, a method widely used to protect cattle, or on the use of a killed vaccine, which, if effective, might be less dangerous for man. Huddleson had found a strain, A-19, which conferred good immunity on cattle. In 1942, he performed tests with a water soluble extract of A-19 cells which was found to provide 90 percent protection of guinea pigs, with 65 percent infection among controls.

A criterion of immunity had first to be established by experimentation. It was determined that the protection of guinea pigs against infective doses of Brucella would permit accurate evaluation of the required degree of antigenicity. Guinea pigs were chosen because they are difficult to immunize. They are susceptible to infection in low doses, are difficult to protect, but they don't die as a result of the infection. The choice of guinea pigs, however, proved a handicap in the work on immunity because a single vaccine could not be assayed in them in less than 10 weeks.

Because it was known that Brucella organisms grow only intracellularly in the spleen, lymph nodes, etc., in the host, an attempt was made to grow the organisms in vivo to secure the antigenic component. From infections of embryonated chick eggs, eleven general groups of egg vaccines were developed for study. Results indicated that the older egg embryos (up to

10 days) from which vaccines were ether-extracted at a pH between 5.4 and 6.3 appeared to give the best results. Temperature and time of extraction did not appear to affect results. These vaccines were tested on mice. Very small amounts were sufficient to protect the mice against infection and lethal challenge. However, this merely emphasized the fact that mice are easy to protect against brucellosis, for the same results could not be obtained with guinea pigs. Agar-grown vaccines, ether-killed, and ether-killed suspensions of cells fragmented by sonic disintegration, were also tried on mice but proved inferior in protection to the yolk sac preparations. /

The ability to protect mice was used as a test of human susceptibility. Death occurred in mice subjected to 1×10^9 organisms. When mixed with mucin, which was irritant, 1×10^8 organisms were sufficient to produce death. Organisms of the A-19 strain in the amount of 10×10^{10} did not kill mice, but at 10×10^{11} they did. Organisms of the S₁ strain in the amount of 10×10^9 were lethal and also reproduced themselves in the mouse.

Studies in the difference of response in mice to lethal and infecting doses of Brucella organisms indicated that the serum of the animal had a bactericidal effect; that the serum would protect against a challenge

/ Sp Rpt 67, Development of Defensive Measures Against "US"
(1 Oct 45), pp. 17-23.

dose which, to reach a maximum lethal effect, required incubation in the animal, this protection resulting from the bactericidal effect of the serum; and finally, that the serum did not protect against a challenge of a size great enough to cause death without organism reproduction. /
Immunization studies came to a close at this point.

Therapeutic investigations were undertaken to determine a satisfactory treatment for an established infection and to discover a preventive which could be administered to troops exposed to *Brucella* organisms when dispersed as an agent of war. The fact that death is not a characteristic of the disease made it necessary to establish macroscopic and microscopic pathological changes, the presence of recoverable organisms in the tissues and serological findings as criteria of the efficacy of the drugs to be studied. Normalcy was set as the goal, so far as these criteria were concerned, in treating animals from the beginning of infection. Animals treated after the establishment of a well-developed infection were required to show a complete absence of recoverable organisms or histological changes, except healing lesions.

Antimalarial drugs, antibiotics and the sulfonamides were tested in vivo and in vitro, since a number of these agents had already proved

/ Sp Rpt. 67, pp. 24-45.

/ A new sensitive medium was devised for the direct isolation of Br. suis organisms from the feces of experimentally infected animals. It consisted of Difco tryptose agar, 0.025 mg. tyrothricin, and 0.0125 mg. sodium azide per ml. medium, and permitted satisfactory inhibition of normal fecal flora contaminants at the same time that it ensured good growth of Br. suis. See S. Elberg, E.P. Edwards, and R.W. Swanson, "A Selective Medium for the Isolation of *Brucella suis*," American Journal of Public Health, 36 (Jun 1946), 650-52.

effective against similar gram negative pathogens. Results were generally unsatisfactory. None of the drugs could be shown to be useful for the treatment either of experimental or natural (accidental) infections of animals or humans. Sulfadiazine was partially successful in the treatment of guinea pigs and commercially prepared antisera gave some promise of enhancing the effect of the sulfadiazine. ✓

At the conclusion of these studies, it appeared that the only possibility of protection against brucellosis was in Huddleson's vaccine. His method of production was not known to the Army, but he had made quantities of the vaccine available to the workers at Camp Detrick. The vaccine seemed to offer somewhat better immunity than any of the products that were prepared at Camp Detrick.

The fact that the organism is of the intercellular type would indicate that a tremendous amount of any therapeutic agent would be needed. This means that either a far greater amount of drug than has ever been used before would have to be administered or else a combination of a highly protective antiserum with a chemotherapeutic agent (~~see p. 47~~). ✓

✓ Sp Rpt 67, pp. 46-63.

In the summer of 1947, Dr. Huddleson announced that sulfadiazine had been made effective as treatment for brucellosis. On the supposition that inactive antibodies in the patients' blood somehow neutralized the drug, Dr. Huddleson gave his patients transfusions of whole blood containing active antibodies. When sulfadiazine was then administered, it produced favorable results. Reported in Time (1 Sep 47).

✓ A few attempts, without results, have been made to develop an antimetabolite approach to the problem, by interfering with the nutrition of the Brucella organism through the use of antivitamin.

Laboratory infection. There were 17 cases of infection due to Br. suis or Br. melitensis at Camp Detrick, all of whom had been given a Brucella vaccine as a routine special procedure prior to infection. A number of these were not due to laboratory accidents, in that the portal of entry was not established. One of the patients was working on infected animals, but may have acquired the disease from infected dust. Another was working with the cloud chamber. A third was a kitchen worker and had no contact with the living organisms experimentally since the glassware he handled was supposed to be sterile. /

The clinical picture presented by almost all patients on admission to the hospital was that of acute and moderately severe febrile illness. Chief among the nonpathognomic symptoms were fatigue and dull intermittent aches and pains in the muscles or joints. Headache, chills, nausea and occasional vomiting were other symptoms among the patients. Physical examination disclosed no other abnormalities other than fever and prostration. Diagnosis was based on the clinical course of the disease, the development of high Brucella agglutinin titers, and, in most cases, isolation of the etiologic agent from the blood.

There was no indication that treatment with sulfadiazine, strepto-

/ This was considered significant, since the literature indicated that laboratory infections usually occurred as the result of a cut either with a blade or needle, or by swallowing organisms while pipetting. A whole class of students at the University of Michigan had been infected with drinking water from a fountain remotely joined to a contaminated source.

mycin / or a combination of penicillin and sulfadiazine altered the natural course of the disease in any way. Symptomatic therapy was apparently most efficacious. Acetylsalicylic acid administered every 4 hours resulted in a sharp drop in fever and a coincidental decrease in malaise, muscular aching and headache. The shortest illness was 4 months, with apparently complete recovery. The longest illness was 12 months, with occasional symptoms appearing after that period of time. Two years after the occurrence of the first case, almost all patients appeared recovered. One, however, had had more than ten febrile episodes since the onset of illness and three patients reported mild occasional symptoms.

- / Although several million units of streptomycin were administered, it was suggested that the lack of results obtained might have been due to the use of the antibiotic in insufficient quantities. At that time, however, there was no laboratory evidence of the value of streptomycin. The crude product was toxic, as was evident from the fact that the patient's fever subsided when the treatment was halted. The use of streptomycin in this case was the subject of some criticism at Camp Detrick. It was felt that laboratory workers who were exposed to the dangers of infection by their normal duties should be immune from untried chemical therapy when they were stricken.
- / C. Howe, E.S. Miller, E.H. Kelly, H.L. Bookwalter, and H.V. Ellingson, "Acute Brucellosis Among Laboratory Workers," New England Journal of Medicine, 236 (15 May 1947), 741-47. First reported in Sp Rpt 67, pp. 63-71.

GLANDERS AND MELIOIDOSIS
(Pfeifferella mallei and Pfeifferella whitmorei)

Code letters "LA" and "Hi"

General. The ease of cultivation of the organisms of glanders and melioidosis, their resistance to attenuation of virulence, and the inherent difficulty of detection and diagnosis of the diseases recommended these agents for consideration as potentially valuable biological agents.

The work was begun at Camp Detrick in April 1944. It was confined principally to studies of the inherent stability of the organisms and development of adequate methods for ensuring maximum survival. Little work was done on development of methods for mass production or on dispersion in the field. Perhaps the most significant aspect of these agents is their ability to survive and even proliferate under the most adverse conditions. Growth of the agents in plain tap water was not thought possible. It is now obvious from a biological warfare standpoint that if either agent were introduced into a water supply, devastating results might occur. If the water supply contained a small amount of nutrient matter such as might be expected from vegetative decay, the agents would not only survive for a long period of time but might actually increase in numbers.

The literature revealed that although only a few hundred cases of human infection with glanders had ever been reported, the disease produced is seriously incapacitating and highly fatal. Since studies of these two Pfeifferella organisms had been curtailed in recent years and since no satisfactory means of therapy or prophylaxis had ever been devised, the

importance of further investigation was apparent.

Selection of strains. The first strains of the agent of glanders, designated as 2MP, 3MP and 3PP, were obtained from the Army Veterinary School. These were stock cultures used in the production of commercial mallein, their virulence maintained by periodic passage through guinea pigs. In October 1944, three superior strains of glanders, C3, C4 and C5, and two strains of melioidosis, W294 and W295, (C for China and W for Whitmore) were received through the chief of the Veterinary Corps from the CBL theater. The glanders strains were from the type culture collection of the China Natural Epidemic Prevention Bureau. The melioidosis strains were from old laboratory stock cultures from the School of Tropical Medicine, Calcutta India. The latter were reported to be avirulent and the record of the source had been lost. However, they were the only strain of melioidosis that could be obtained for the work at Camp Detrick. Strain W294 was found to be highly virulent and fairly satisfactory for laboratory use, but strain W295 proved avirulent, as reported.

Two additional strains of glanders were later received, one designated C6, source unknown, from the CBI theater, and the other, designated C7, from the Army Veterinary School and reported to have been isolated from a fatal human case of glanders in 1944.

Three strains of glanders (C3, C4 and C7) and one strain of melioidosis (W294) proved quite virulent for experimental animals. The species

29
20

tested, in order of susceptibility, were hamsters, ferrets, guinea pigs, mice, rats and monkeys. Rabbits and chick embryos were susceptible to melioidosis but resistant to glanders. Hamsters were uniformly highly susceptible to both agents and were therefore adopted as the routine experimental animal. Parenteral inoculation in hamsters gave MLD values of 20 and 15 organisms and LD50 values of 12 and 6 organisms for glanders and melioidosis, respectively.

The strains of glanders and melioidosis selected for study proved indistinguishable morphologically by ordinary staining methods. The melioidosis organism was the slightly larger, measuring 1.5 to 4 micra by 0.4 to 0.6 micra. The so-called filaments of these organisms described in the literature appeared more often to be long chains of closely tied bacilli. Glanders organisms stained with Sudan Black B dye showed that intracellular fat bodies were present, and it was concluded that the granular staining of this organism is due to the presence of these bodies which are not stained by ordinary methods.

Cross agglutination, complement fixation, agglutination absorption, and "H" and "OH" agglutination tests were used to demonstrate the serological relationships between the various strains. Attempts to increase the specificity of serological reactions between the two types of organisms were unsuccessful. Studies on variations of the agglutination technique proved that the resuspension method gave comparable results more rapidly than the standard incubation technique. In the rapid test, a 2-hour incubation at 37° C., followed by centrifugation at 2,000 rpm for 5 to 10 minutes, was substituted for 24-hour incubation at 37° C. in the

routine test.

Agglutination titers indicated a close antigenic relationship between the C4 strain of glanders and the W294 strain of melioidosis. From the results of cross agglutination titrations, it appeared that C3, C4 and C7 were almost identical, whereas C5, C6, 2MP, 3MP and 3PP were similar serologically and belonged to a separate group. Moreover, strains C3, C4 and C7 were more closely related serologically to the melioidosis strains than they were to other glanders strains. /

/ Sp Rpt 53, Comprehensive Report on Pathogenesis of "LA" and "HI"
(1 Nov 45), pp. 6-11, 15-17, 24.

Nutrition. The organisms of both glanders and melioidosis were found to grow slowly but profusely on any of several simple media, but a glycerinated nutrient agar or broth was accepted as standard. This consisted of 0.3 percent beef extract, 1.0 percent bacto-peptone, 0.5 percent sodium chloride, 1.5 percent bacto-agar, and 4.0 percent glycerine. The alternate standard medium was Luhr's modification of Long's synthetic medium: 0.3 percent NaH_2PO_4 , 0.4 percent KH_2PO_4 , 0.06 percent MgSO_4 , 0.25 percent sodium citrate, 0.5 percent asparagin, 2.0 percent glycerine, and 0.0001 percent ferrous ammonium sulfate. /

Laboratory production. While melioidosis colonies grew well in 24 hours, glanders colonies required 48 hours incubation. Optimum growth was attained at 37° C., with temperatures permitting growth ranging between 22° and 40° C. Aeration or oxygenation greatly enhanced the rapidity of growth and the yield. Colonial variants of both agents were frequently observed. The variants obtained from the strains under study did not breed true.

A few studies were made of large scale production aspects of glanders and melioidosis prior to the conclusion of the project in October 1945. Two media were recommended as a result of these tests:
/ Sp Rpt 53, p. 14

2 percent pepticase broth fortified with ferrous sulfate, thiamin chloride and 4 percent glycerine; and 2 percent tryptose broth fortified with ferrous sulfate, thiamin chloride, yeast extract and 4 percent glycerine. Production of a slurry or mud form of agent promised the most satisfactory storage conditions. /

Storage. In general, the organisms of melioidosis proved more stable than those of glanders and their virulence was less affected by storage. Both agents proved quite stable, surviving for 16 weeks in slurries or in peat moss mud when stored at room temperature. No noticeable loss of virulence was found in slurry suspensions of melioidosis organisms after 20 weeks. The virulence of glanders organisms declined somewhat after 20 weeks. This was indicated by the prolonged death time in hamsters and by a change from an acute to a chronic form of disease in the animals.

The concentration of agent permitting maximum survival was that which would allow some further growth. The optimal conditions for survival were found to be a light inoculum of approximately 5×10^7 organisms per ml. when stored at 20° to 25° C. in glycerinated nutrient broth, gelatin diluent, synthetic medium, or enriched peat moss.

/ Sp Rpt 53, pp. 155-60.

Both organisms survived well for relatively long periods in ordinary tap water. Glanders organisms survive in tap water for 4 weeks and melioidosis for at least 8 weeks. When a small amount of nutrient matter was present in the water, the organisms actually proliferated.

All organisms died rapidly after drying at room temperature. On the other hand, both organisms reacted well to lyophilization, the best menstruum, permitting some further growth, being 50 percent normal rabbit serum in standard broth. Glanders organisms survived after storage in frozen embryonated eggs for 14 months, but the percentage of survival was low. /

Dissemination. Both agents can probably be dispersed in the field as aerosol clouds. Cloud chamber studies indicated that 8 to 10 percent of glanders organisms and 10 to 30 percent of melioidosis organisms were recoverable after spraying. Studies of the infectivity of such aerosol clouds in hamsters gave LD50 values of 160 and 70 organisms, respectively, for glanders and melioidosis. /

/ Sp Rpt 53, pp. 161-69.

/ Sp Rpt 53, pp. 169-71.

Pathogenicity. Hamsters were uniformly susceptible to both glanders and melioidosis, developing acute, fulminating infections. Guinea pigs varied markedly in susceptibility so that it was necessary to use large groups in experimental work to obtain satisfactory results. It was believed that had freshly isolated strains of the two organisms been available, they might have proved more pathogenic for some of the animal species than the strains tested in this work.

Chick embryo fluids supported heavy growth of both agents, but only melioidosis is pathogenic for the embryo.

The mechanism of the pathogenesis is essentially one of vascular and lymphatic spread of the infection from the initial focus, producing widespread lesions in the liver, spleen, and lungs. There is an early bacteremia, and many animals probably die of a terminal septicemia. The typical lesion of both infections is a small white necrotic area of semisolid consistency. It is composed of necrotic tissue cells with dense infiltration of polymorphonuclear and large mononuclear leucocytes, many of which contain phagocytized organisms. Glanders and melioidosis lesions were indistinguishable grossly and microscopically. The organisms spread from the initial focus via the lymphatic and vascular systems, producing miliary lesions comparable in distribution to those seen in miliary tuberculosis. /

/ Sp Rpt 53, pp. 45-59.

Defensive research. Attempts to produce passive immunity in laboratory animals were unsuccessful. High titred immune rabbit sera and convalescent human sera gave no evidence of affording passive protection to hamsters against either glanders or melioidosis. These sera, as well as normal human sera, actually increased the susceptibility of the animals to the diseases. Large numbers of antigens were tested in an attempt to actively immunize hamsters against glanders and melioidosis. No highly effective antigen was found, but three antigens gave moderate protection against small challenge doses. A glanders suspension in sodium sulfadiazine, a glanders urea extract (Farase), and an avirulent living melioidosis antigen were found capable of protecting about 50 percent of the animals in each test against a challenge dose of 2 to 5 MLD.

Strong Schwartzman reactions were produced with glanders and melioidosis filtrates, with complete reactions between the two agents. These reactions were blocked when immune rabbit sera were given previous to injection of the provocative antigen. However, the blocking was not specific for either of the two agents.

Bacterial anaphylaxis was produced in passively sensitized guinea pigs using either killed organisms or nonprotein chemical fractions of glanders and melioidosis organisms as shocking antigens. Complete cross reactions between these agents occurred. Nonprotein chemical fractions of the two types of organisms were found to be very similar chemically. Both were water soluble and could be broken down into soluble carbohydrates and insoluble lipoidal components. The fractions reacted to high titre in complement fixation tests with known positive sera and produced anaphylaxis.

Guinea pigs chronically infected with glanders or melioidosis showed a high degree of sensitivity to mallein skin tests. The sensitivity did not appear, however, until between 28 and 45 days after inoculation. The skin test titre was higher in guinea pigs infected with glanders, but pigs infected with melioidosis reaction to dilutions of mallein up to 1:200. Guinea pigs which spontaneously recovered from the infection slowly lost their skin sensitivity.

Skin tests with 0.1 ml. of a 1:10,000 dilution of mallein in cases of human glanders infection were made. The technique of the test is similar to the tuberculin test and reaction reaches its peak after 36 to 48 hours. Four of six human cases gave positive reactions. The only systemic effect observed followed an injection of 0.2 ml. of the 1:10,000 mallein. Skin tests on 33 normal humans showed a small percentage of slight reactions. These skin reactions were less than 5 mm. in diameter after 48 hours. On the basis of these studies, it was arbitrarily decided that a positive test must show an area of erythema at least 8 mm. in diameter in 48 hours.

In the general immunological picture presented by the phenomena of glanders and melioidosis infections, the complete lack of correlation between complement fixing and agglutinating antibody titres and immunity to infection suggested that the circulating antibodies for these two diseases were more closely related to sensitivity than to protective immunity. The anaphylaxis in guinea pigs passively sensitized with rabbit antisera seemed to substantiate this. The marked skin sensitivity and

relatively poor immunity developed in both infections suggested a parallelism to the balance between sensitivity and immunity in tuberculosis.

Prior to the research studies on glanders at Camp Detrick, no chemotherapy was known for this disease. Mallein had been employed in therapy for both the human and animal disease but in view of the spontaneous retrogressions found in the chronic form of the disease, the results had been difficult to evaluate. Prompt and radical surgical measures had been the most reliable means of treating the chronic disease.

Studies were made of the sulfonamides, penicillin, streptomycin and streptothricin, in vitro and in vivo, to determine their relative values. Because of heavy pellicle formation, in vitro methods of testing the drugs were not applicable to melioidosis. On the other hand, in vitro studies showed several of the sulfa drugs and streptomycin to be effective against glanders. Sodium sulfadiazine proved to be an efficient drug for both treatment and prophylaxis in the two diseases, treatment being effected in hamsters, ferrets, guinea pigs and man. Sulfadiazine gave 100 percent cures of experimental acute glanders and melioidosis in hamsters when the drug was given for 20 days. It also gave 100 percent cures of experimental acute glanders in a small series of ferrets when given in large doses for 7 days, but evidences of drug complications were observed. Prophylaxis with sulfadiazine in small doses given at the time

/ Sp Rpt 53, pp. 80-136.

of exposure ^{to glanders} would probably provide adequate protection in most cases. The drug arrested subacute melioidosis infection in guinea pigs, but definite cure was not demonstrated.

Streptomycin and penicillin were shown to be useless in the treatment of experimental acute glanders and melioidosis in hamsters. /

Efforts to prepare a complement fixation antigen which would differentiate between glanders and melioidosis in cases of infection were unsuccessful. In an evaluation of the three serological tests for the detection of glanders and melioidosis, it was concluded that the complement fixation test is the most specific for the genus but does not differentiate between the two species. The agglutination test proved more sensitive but less specific than the complement fixation test. If the normal agglutination titres were previously determined, an early progressive rise in titre might be diagnostic of the disease, before the complement fixation test becomes positive. The precipitation test is neither specific nor sensitive and is the least valuable of the three tests.

A practical method of detection for field use was developed, the materials required to conduct one complete test being as follows:

1. 180-ml. Pyrex milk dilution bottle containing dehydrated agar (2.3 gm. B-1 nutrient agar, 0.5 gm. B-118 bacto-agar and 0.5 gm. sodium chloride)
2. 10-ml. vial containing 3.5 ml. glycerine and 0.5 ml. 1:1,000 crystal violet in glycerine

/ Sp Rpt 53, pp. 67-80.

3. Six capillary pipettes containing a 1:10 dilution of immune rabbit serum packed in a corked Wasserman tube
4. Ten ml. vial of normal saline
5. Sealed cork-stoppered test tubes containing 1 ml. of 2 percent peptone water
6. Micro slides
7. Sterile swabs
8. Wire loop
9. Five petri dishes
10. Alcohol lamp
11. One pair forceps
12. One pair scissors
13. Lead or glass wax pencils

Procedure: Empty the glycerine vial into the dehydrated medium and add 100 ml. tap water. Bring the suspension to a boil to dissolve the agar. (With crystal violet present in the medium, ordinary clear glassware, dehydrated media, and ordinary tap water may be used without autoclaving. Bringing the medium to a boil kills vegetative cells and spore forms are inhibited by the crystal violet so that no contaminant colonies appear on the plates.) Pour plates. Streak plates with swabs containing suspected contamination and spread out with loop. Incubate plates for 24 to 48 hours. The colonies that appear may be identified by typical morphology colony appearance, and slide agglutination. Identification is confirmed by inoculation into adult male hamsters or guinea pigs. Fatal infections with specific lesions or a positive Straus reaction / confirms the presence of glanders or melioidosis. This procedure should provide positive diagnosis in any biological warfare use of these agents. /

/ Sp Rpt 53, pp. 25, 28-31.

/ Sp Rpt 53, pp. 61-64.

A number of studies were made of decontaminating agents for the organisms of glanders and melioidosis. Using comparatively large amounts of inoculum to serve as a vigorous test, 1:2,000 dilutions of Roccal and hypochlorite containing 500 ppm of available chlorine were found to be the most effective of common disinfectants for decontamination purposes. Both organisms were killed by moist heat in 10 minutes at 55° to 60° C. Ten percent dilution of 7 percent tincture of iodine, 1 percent mercuric chloride in 35 percent alcohol, and 1 percent potassium permanganate in 1 percent hydrochloric acid were also highly effective decontaminating agents. Phenol was much less effective and lysol was almost useless. /

Laboratory infection. It appeared significant that although animal studies showed the melioidosis strain #294 to be more virulent than any of the glanders strains being studied, nevertheless all six cases of human infection in the course of the "LA" and "Hi" projects at Camp Detrick appeared to be due to glanders. Symptoms in all cases indicated a respiratory route of infection. These ranged from generalized aches and pains, temperature elevation and undue fatigue to sudden onset of dizziness, nausea, blurring of vision, backache and chills. Significant serological responses, positive reaction to commercial mallein, and persistent leukopenia and relative lymphocytosis were among the striking laboratory findings.

The six cases of laboratory infections with glanders presented an opportunity to evaluate serological tests as a means of diagnosing glanders

in man. All cases showed that a definite rise in the agglutination titre occurred in from 2 to 3 weeks, followed by a progressive rise to a titre of 1:2,500 to 1:5,000. At this point, the titres leveled off, followed by a steady decrease which approached the normal value after 6 months or more. Five of the six cases developed positive complement fixing antibodies. The complement fixation test became positive in about 4 to 6 weeks and, like the agglutination test, reached its peak rapidly and fell off gradually after the patient recovered. The highest complement fixation titre observed was 1:640. /

Skin tests with 0.1 ml. of a 1:10,000 dilution of mallein were made on all six cases. Four of the cases gave positive skin reactions, reaching the reaction peak after 36 to 48 hours. Skin tests on 33 normal humans showed erythema of less than 5 mm. in diameter after 48 hours.

The final diagnosis in all six cases, who were of both sexes but all in the same age group, rested primarily on the specific serology, and in five out of the six, on the positive skin test with commercial mallein. All six cases were characterized by the history of probable laboratory exposure to both P. mallei and P. pseudomallei (P. whitmori).

/ Agglutination and complement fixation tests were performed on approximately 400 samples of sera from patients hospitalized at Camp Detrick with glanders, brucellosis, tularemia, anthrax, infectious mononucleosis, and atypical pneumonia. It was shown that 97 to 98 percent of normal individuals have agglutinins for both glanders and melioidosis. The highest agglutination titre obtained with normal serum was 1:320. The complement fixation test gave negative results with all normal sera tested.

This probability was most pronounced in the last two patients whose courses were remarkably parallel. In no case was P. mallei isolated from blood or sputum.

All patients were treated with sulfadiazine, on the basis of successful animal experimentation at the time of admission of the first two patients. / Two patients were not treated with sulfadiazine until after correct diagnosis had been established during their convalescence. In the other four, sulfadiazine was given for 20 days, on the basis of experimental chemotherapy in the laboratories, beginning in the acute stage of disease when diagnosis of glanders appeared probable. In two cases, sulfa therapy showed clear cut results. In the other cases it was difficult to assess the effect of the drug on the course of disease although all cases recovered. None of the six has had any demonstrable residual disability or sign of persistent active disease and there have been no frank relapses. /

/ Two cases of acute melioidosis infections in U.S. Navy personnel on Guam were reported in August 1945. Both cases were treated with penicillin and both were fatal within 7 days.

/ C. Howe and W.R. Miller, "Human Glanders: Report of Six Cases," Annals of Internal Medicine, 26 (Jan 1947), 93-115. First reported in Sp Rpt 53, pp. 136-54.

TULAREMIA
(Pasteurella tularensis)

Code letters "UL"

General. The principal investigative studies on the production of organisms of tularemia had been completed by WRS workers when the Special Projects Division assumed the study of this agent. As a result, work with tularemia at Camp Detrick was directed to approach as nearly as possible in the laboratory the conditions of plant operation and to improve certain basic procedures such as the assay method, which had not been satisfactorily examined elsewhere.

Studies in the development of the agent of tularemia for offensive use in biological warfare, made by WRS and Camp Detrick personnel, are described in special reports and in articles submitted for open publication. These studies indicate that production of the agent in artificial media in large quantity and with good maintenance of virulence can probably be accomplished without difficulty. Tularemia organisms were not produced on a pilot plant scale at Camp Detrick, although preparatory studies were made.

Selection of strain. The highly virulent Schu strain was the principal one used at Camp Detrick, although a total of 28 strains / were made available. Of the four strains examined at some length, the

/ Listed in T.L. Snyder, R.A. Penfield, F.B. Engley, Jr., and J.C. Creasy, "Cultivation of Bacterium tularensis in Peptone Media," Proceedings of Society for Experimental Biology and Medicine, 63 (1945), 25-30.

Schu, Chur, and FO-38 were obtained from Dr. Lee Foshay / and strain NIH-38 was obtained from the National Institute of Health.

Strain cultures were routinely maintained on dextrose cysteine blood agar slants and transferred every 3 weeks with interval storage at 6° C. Virulence was maintained by mouse or rabbit passage every 2 or 3 months. MLD for mice was determined by intraperitoneal injection of 0.5 ml. of serial tenfold dilution of a 24-hour saline suspension. LD50 was a dilution of a standard suspension, 1 ml. of which killed 50 percent of the test animals. Untreated mice generally died within 6 days. Mice surviving 10 days were considered noninfected.

The simulant for P. tularensis was S. roseum, a vegetative nonpathogen.

/ These were the strains used in the microscopy study reported by H.T. Eigelsbach, L.A. Chambers, and L.L. Coriell, "Electron Microscopy of Bacterium Tularensis," Journal of Bacteriology, 52 (Aug 1946), 179-35. First reported in Sp Rpt 56, Studies on the Development of Biological Defense Against "UL" (1 Jan 46), pp. 51-55.

Nutrition. Both liquid and solid basal media were devised for the laboratory production of Pasteurella tularensis (also known as Bacterium tularensis). The first successful fluid medium, reportedly permitting production of 2.25×10^{17} to 9×10^{17} mouse lethal doses / per day, consisted of 0.5 percent bacto-peptone, 1.0 percent sodium chloride, and 0.1 percent glucose. / Another liquid medium was later devised which, it was believed, could also be used in large scale production by deep tank culture. One constituent of the medium, bacto-peptone, is relatively expensive, however, and a cheaper nitrogen source is required. This medium consisted of 2 percent Difco bacto-peptone, / 1 percent sodium chloride, 0.1 percent glucose, and 0.1 percent cysteine hydrochloride. Luxuriant growths were obtained with this medium, with yields of 2×10^8 to 9×10^8 per ml. in 24 to 48 hours at 37° C. in stationary cultures, and approximately 5×10^9 organisms per ml. under forced aeration of 0.1 to 3.0 volumes per minute. /

Studies with solid media indicated that a hydrogen ion concentration of pH 6.8 to 7.0 was optimum, but that this factor was not critical. The most satisfactory basal solid medium devised consisted of 1.0 percent

- / The minimum lethal dose for mice by the intraperitoneal route was reported to be approximately one cell.
- / Sp Rpt 1, Development of UL for Offensive Use in Biological Warfare (30 Jun 44), pp. 17-13.
- / A product supplied by Digestive Ferments Company which could be made available at the rate of 3,000 pounds per day.
- / T.L. Snyder, R.A. Penfield, F.B. Engley, Jr., and J. C. Creasy, "Cultivation of Bacterium tularensis in Peptone Media," Proceedings of Society for Experimental Biology and Medicine, 63 (1945), 26-30. First reported in Sp Rpt 57, Additional Studies on the Development of "UL" as an Offensive Biological Warfare Agent (1 Dec 45), pp. 62-63. 2

hydrolyzed vitamin-free casein, 0.5 percent glucose, 0.01 percent K_2HPO_4 , 0.1 percent cysteine hydrochloride, and 1.0 percent sodium chloride. Red blood cell extract and thiamine hydrochloride were then added. Ten ml. of medium were placed in each 180-ml. Pyrex bottle, autoclaved, inoculated with 10^6 washed cells per ml. and incubated at $37^\circ C.$ with continuous shaking. /

Laboratory production. The most important factor regulating growth in peptone media was the size of the inoculum, and it was shown that inocula of less than 1 percent were not reliable. This was attributed to the sensitivity of the organism to oxygen tension or oxidation-reduction potential. Metals such as tank iron, stainless steel and aluminum had no appreciable effect on growth or virulence when present in proportions likely to be encountered in large scale production. / No pilot plant production of P. tularensis was undertaken, however.

The method for estimating growth of agent in cultures was based on measurement of turbidity and on enumeration of the colonies on the surface of solid media. A dilution plate counting method was developed for the first time for use with this organism. /

/ D.J. O'Kane, "The Substitution of Thiamine for the Labile Fraction of Red Blood Cell Extract in the Growth of Bacterium Tularensis," Journal of Bacteriology, 51 (Apr 1946), 559-60.

/ T.L. Snyder, F.B. Engley, Jr., R.A. Penfield, and J.C. Creasy, "A Dilution Plate Counting Method for Certain Strains of Bacterium Tularensis," Journal of Bacteriology, 52 (Aug 1946), 241-42.

An investigation was made of the cultivation of the tularemia organism in embryonated eggs, as a source of material for vaccine production. The organisms multiplied abundantly in the tissues and fluid of the embryonated egg, and the virulence of the organism for chick embryos was enhanced on serial passage, but the percentage of organisms surviving in cold storage after 3 months was relatively small. This phase of the project was therefore abandoned. /

Harvesting. Although centrifugation provided the most efficient and practical means of separating the organisms from the mother liquor, producing concentrations of 2×10^{12} viable cells per ml., this method was considered too hazardous for either laboratory or possible plant production. The agent aerosol produced by industrial type centrifuges was particularly dangerous in the case of P. tularensis because of the extreme infectiousness of even small doses and the fact that the disease may be acquired by any portal of entry. The incidence of tularemia among workers was higher than any other agent that had been studied at Camp Detrick up to that time.

Filtration proved almost as satisfactory a method of harvesting as centrifugation and considerably superior to acid-precipitation. The

/ C.M. Downs, L.L. Coriell, S.S. Chapman, and A. Klauber, "The Cultivation of Bacterium Tularensis in Embryonated Eggs," Journal of Bacteriology, 53 (Jan 1947), 89-100.

only filter medium with a porosity small enough to separate the organisms from the peptone broth was filter-cel. This did not prove deleterious to the stability or preservation of the organisms. The filtration rate of 7 gallons per hour per square foot of filter surface can probably be directly applied to large scale filters. In large scale laboratory filtration of tularemia organisms, 96 percent recovery with a concentration ratio of 11.5 to 1 was achieved. This greatly exceeds the requirements for a munition, assuming no marked loss on storage and dispersion. The practicability of centrifugation as an alternate method of harvesting depends upon reduction of the operational hazards of large scale centrifuges. /

Storage. The problem of storage of tularemia agent material did not reach a satisfactory stage of development. Survival in a moist state at room temperature was very low. The best survival occurred in liquid peptone broth culture or in embryonated eggs at icebox temperatures. Even then, however, the stability of the agent did not meet military requirements for a munition filling. Ordinary drying did not appear feasible, although 25 percent survival was obtained after 4 months storage in vacuo at 10° C. The stability of lyophilized material alone held some promise and may be further improved to meet requirements.

/ Sp Rpt 57, pp. 81, 87-88, 97.

Survival experiments on soil tested under moist and dry conditions showed that although 100 million organisms per gram of soil were present immediately after inoculation of the soil, few or none survived at the end of one week. This was determined when only one of a group of mice died after inoculation with material from dry dirt. None of the mice died after inoculation with wet soil material. In this experiment it was believed that extremely hot weather may have been a factor in the death of the organisms.

Lake and tap water containing 100 million organisms per ml. and tested after one week showed no survival of virulent organisms where the water was stored under southern exposure. Stored on the north, tap water and lake water contained approximately 10 mouse MLD per ml. after one week. Stored in a refrigerator at 4° to 6° C., the waters contained approximately 10 million mouse MLD per ml., indicating the ability of this organism to survive better at low rather than high temperatures. /

/ Sp Rpt 57, p. 131.

Dissemination. The dispersibility of wet agent material was studied in the cloud chamber. Recovery proved somewhat less than that of other vegetative agents even when drying was prevented by the use of glycerol.

It was possible that lyophilized material may be adapted for successful dispersion. Lyophilized filtered material appeared promising in that the addition of diatomaceous earth promoted the formation of a fine powder which gave a persistent cloud after milk shaking. This did not occur with lyophilized centrifugate material.

Tularemia organisms can be sprayed from liquid suspensions as an aerosol. Although the percentage of recovery is lower than that of other gram-negative, nonsporulating bacteria, the high infectivity rate and low LD50 may nonetheless make P. tularensis a highly potential biological warfare agent. /

/ Sp Rpt 57, p. 161.

Pathogenicity. The introduction of a single cell of P. tularensis under the skin of a susceptible animal invariably proved fatal. Mice, rabbits, guinea pigs and hamsters seemed equally susceptible when challenged either subcutaneously or intracutaneously. The respiratory dose was 11 organisms for guinea pigs, 1 to 2 organisms for mice, and 1,000 to 10,000 for rats. /

Studies on the ability of the organism to penetrate intact skin and the respiratory tract were incomplete, but there were indications that dosages might be at least as low as those for any other biological agent under consideration at Camp Detrick. Mice, guinea pigs and rabbits became infected upon ingestion of contaminated water or of carrots which had been planted in contaminated soil, although the dosages they received could not be measured under the conditions of the experiment. Water which originally contained 100 million organisms per ml. was infective for 72 hours after inoculation. Carrots growing in soil watered with a spray containing 2 billion organisms per ml. was infective for 50 percent of the animals 72 hours after inoculation. As nearly as could be determined, this soil contained approximately 120 million organisms per gram. /

The clinical picture in monkeys infected with tularemia was high fever, weakness, prostration, weight loss, local ulceration and regional

/ Sp Rpt 56, pp. 23, 30.

/ MPR Univ of Kansas (Sep 44). In CD Tech Lib (UL Acc.No. 9)

lymphadenopathy. All challenged animals developed subcutaneous induration and edema near the umbilicus, a usual tularemia phenomenon, with the skin becoming hemorrhagic, necrotic, or ulcerative. The spleen was enlarged two or three times normal size and the kidneys, adrenal glands, and livers were swollen. All animals that died had bacteremia. /

Defensive research. The extreme ease with which tularemia infection is acquired and the high infection rates among butchers, laboratory workers and hunters made it necessary to provide better methods of protection against this agent than those known prior to the war. Although tularemia is of minor importance as a cause of death in man, like brucellosis, it has considerable social and economic importance as a cause of prolonged morbidity and disability and would therefore be very effective as a casualty agent against troops.

Pursuant to a WRS directive of 1 November 1943, defensive studies on tularemia were begun by workers at the University of Cincinnati and at Camp Detrick. A vaccine had been developed at the University and its improvement was the special task of that group. Camp Detrick workers were directed to accumulate data on all other phases of therapy, including the development of an effective vaccine.

Preliminary experiments at the University of Cincinnati with heat-killed and formalinized suspensions of tularemia organisms demonstrated

that vaccines made by these methods, from either virulent or avirulent strains, provoked severe and extensive constitutional and local reactions upon initial injection into normal individuals. Doses which could be tolerated were so small that several months of daily injections were required to produce agglutinin titers of 1:320, the minimum response. The use of such a vaccine was adequate for protecting a few laboratory workers, but was highly impracticable for large scale use.

Specifications for an acceptable vaccine against tularemia were established as follows: It should be capable of subcutaneous administration, being well absorbed and not producing sterile abscesses. The toxicity upon initial injection must be diminished to a degree to permit a three-injection scheme of administration. The three doses must contain enough bacteria of sufficient antigenicity to confer protection. Such doses must provoke no constitutional reactions or severe local reactions. The mode of preparation must be readily and reliably reproducible.

Dr. Foshay's vaccine which, to some degree, satisfied these criteria had been developed and reported in October 1942. / It consisted of a suspension of virulent P. tularensis grown on a solid medium of gelatin hydrolyzate and treated with nitrous acid, washed, neutralized and resuspended in 0.1 percent formalinized saline. The vaccine was given clinical

/ L. Foshay and W.H. Hesselbrock, "Vaccine Prophylaxis Against Tularemia in Man," American Journal of Public Health, 32 (1942), 1131-45

trial in man with encouraging results, but failed to protect the highly susceptible guinea pig, rabbit, and mouse. The vaccine was subsequently improved by being phenolized. The result was a simple product which could be made in almost any quantity desired with a minimum of handling and risk. Even this, however, frequently caused a sensitization, and after a series of injections resulted in local or systemic reactions.

While the improved phenolized vaccine was shown to protect laboratory animals against challenge doses, an acetone-extracted vaccine developed at Camp Detrick and used in special procedures appeared to be just as effective as the formalinized and phenolized vaccines and did not cause severe local reactions in hypersensitive humans. It was produced in a 24-hour Snyder's peptone broth culture with 25 percent acetone added and the material allowed to stand overnight at 4° C. The material was then centrifuged twice and resuspended first in 50 percent and then in 100 percent acetone in saline. After a third centrifugation, the material was decanted and dried over vacuum. When resuspended in 0.1 percent formalinized saline, it was ready for use. / Its effectiveness either for man or for laboratory animals, however, was not fully demonstrated.

The most satisfactory therapeutic agent for tularemia infection appeared to be streptomycin. It was shown to be effective in treating established tularemia infections in experimental animals and in laboratory workers infected in the course of their work. The drug is effective in

/ Sp Rpt 56, pp. 78, 187. Studies conducted at the Univ of Kansas under contract, supplementing the work at Camp Detrick, indicated that acetone-extracted cell vaccines protected rabbits, that passive protection of mice with immune serum could not be accomplished,

man at dosages less than one-seventh the amount that has been safely tried in other human diseases. Streptomycin appeared to be a true specific for tularemia, with marked symptomatic and clinical improvement observed within 12 hours after beginning treatment. /

In the course of devising methods of detection for tularemia, the most satisfactory antigen found for routine agglutination tests was a formalinized saline suspension of washed whole organisms made from strain NH-38. / In addition, a medium was prepared which gave quick and abundant growth of tularemia organisms for their rapid detection. This was the DCBA medium, in which colonies could be obtained with an inoculum of as few as one or two organisms. With the addition of 500 units of penicillin and 50 mgm. percent sulfadiazine, many of the common contaminants of such agar cultures were inhibited without destruction of the tularemia organisms. The medium was applicable to sputum, exudates from local lesions and pus. For blood cultures, specimens should be taken at the time of chills or on a rising fever curve and guinea pigs

that laboratory animals were readily infected by ingestion of UL contaminated water and vegetables thrust in contaminated soil, and that results on storage of UL organisms were discouraging. Final Report, Univ of Kansas, 1 Mar 44 to 30 Jun 45. In CD Tech Lib (UL Acc.No. 44).

/ Sp Rpt 56, p. 171.

/ Sp Rpt 56, p. 160.

or rabbits, rather than mice, should be used for confirmatory tests. /

The most effective disinfectant for laboratory decontamination was phenol in 5 percent solution. Tincture of iodine was recommended as a skin disinfectant. Bleaching powder, $\text{Ca}(\text{OCl})_2$, it was reported, would be most effective for field decontamination. /

Laboratory infection. In the period between December 1943 and October 1945, a total of 26 persons contracted tularemia in the laboratories while doing experimental work. In the cases of 7 of these laboratory workers which were reported in the literature, tularemic pneumonia developed in 2 of them, typhoidal tularemia without demonstrable visceral lesions developed in 4 patients, and one had a mild ulceroglandular infection. All patients had been immunized with the Foshay vaccine through special procedures prior to their illness. Organisms were isolated from two patients only.

The predominant symptoms were headache, fatigue, muscular pains, and in those with definite pulmonary involvement, unproductive cough. There were no physical signs of illness other than fever and prostration except in the two patients with pulmonary consolidation. The sharp fall in serum agglutination for *P. tularensis* shortly after onset of febrile
/ Sp Rpt 56, pp. 55-59.

/ Sp Rpt 56, pp. 59-61.

illness was diagnostic. It was believed by Dr. Foshay that due to prophylactic vaccination, these cases exhibited a distinctly milder form of the disease than that observed in unvaccinated persons.

Four patients were treated with streptomycin in the early stage of illness and three were treated late in convalescence. In five cases, total dosages were 5,600,000 and 5,800,000 units, given in approximately one week. In two patients treated shortly after onset of acute illness, fever and symptoms subsided within 24 to 48 hours. Patients treated late in convalescence displayed no clearcut response to this therapy. Side effects of streptomycin of both immediate and prolonged pain at the site of injection were reported by all patients. In two patients, a macular cutaneous eruption or rash appeared, at which time administration of the drug was discontinued as this was considered a sign of streptomycin toxicity.

Complete recovery from symptoms required from 3 weeks to 3 months for those treated in early stages of illness, 5 to 14 months for those treated late in convalescence. Residual fatigue after recovery was common in all patients. /

/ C. Howe, L.L. Coriell, H.L. Bockwalter, and H.V. Ellingson, "Streptomycin Treatment in Tularemia," Journal of American Medical Association, 132 (23 Sep 1946), 195-200.

First reported in Sp Rpt 56, pp. 122-30.

PSITTACOSIS
(filtrable virus)

Code letters "Si"

General. As the program at Camp Detrick was expanded after the work on anthrax and botulinum toxin had got well under way, it was felt that the biological warfare potentialities of some virus agent or agents should be investigated. The psittacosis group of viruses was selected as most promising because it was known they could be grown to high titer, were comparatively stable, were capable of infecting at considerable distances by avian vectors, and because they produced a severe illness in man. One strain of virus in this group, the Borg strain, isolated in Louisiana, had caused a small epidemic during which the virus had passed through six consecutive person-to-person transfers and had been fatal to 3 out of 19 patients acquiring the infection.

After preliminary studies with several virus simulants, work on the psittacosis strains, including the Borg variety, was begun in September 1944.

Selection of strains. Representative strains of all known psittacosis viruses were obtained prior to or during the development of the project. Dr. Karl F. Meyer furnished two psittacine strains, 65C and Gleason, and a pigeon ornithosis strain, P207. Dr. M. D. Eaton provided the Cal-10 strain of meningopneumonitis virus, the S-F strain (isolated in human cases only), a strain of Baker's feline pneumonitis virus, and the 12 XN strain of hamster pneumonitis virus. The Borg strain was

obtained from Dr. Rolla E. Dyer of the National Institute of Health. The mouse pneumonitis virus was furnished by Dr. Clara Nigg. Strains of the Greb mouse pneumonitis virus and the feline pneumonitis virus were also obtained from Dr. D. L. Davis of the National Institute of Health. A strain of lymphogranuloma venereum virus was furnished by the Army Medical School.

Simulants. Advantage was taken of the fact that the mouse pneumonitis virus and the meningopneumonitis virus (Cal 10 strain) are apparently nonpathogenic for man under ordinary laboratory conditions. These, therefore, were used as simulants for the virulent strains wherever practicable.

Laboratory production. Only recently, since the end of the war, has it appeared possible to grow a virus agent on anything but living tissue. For the first time, according to published reports, the virus of tobacco mosaic has been reproduced on synthetic media. The wartime studies on production of the psittacosis viruses were all based on the use of living matter for laboratory and pilot plant reproduction.

Since viruses had not been cultivated in artificial media, there appeared to be only three methods of producing these agents in quantity: cultivation in tissue cultures, in living animals, and in embryonated eggs. The latter method was most practicable and was the technique used in commercial laboratories. / Seed cultures of the 6BC strain

/ Sp Rpt 65, The Offensive Phase of the "SI" Project (15 Nov 45), pp. 9-20.

were prepared by injecting 8-day-old embryonated eggs by the yolk sac route with 0.25 ml. of a 10^{-6} dilution in nutrient broth of infected yolk sacs. These embryos died on the fourth day and the yolk sacs were harvested and made into a 10 percent suspension in broth by shaking for one-half hour at 0° C. To this suspension of agent material, 25 mg. percent sodium sulfadiazine and 125 units ml. of streptomycin were added as a safeguard against possible contaminants. / The use of these same inhibitory agents also proved effective in the storage of 10 percent yolk sac seed cultures when sealed in glass vials and stored in a CO_2 icebox. /

In addition to the egg technique, it was also learned at Camp Detrick that the psittacosis viruses could be readily grown in roller tube tissue cultures using a nutrient fluid consisting of serum ultrafiltrate and Simm's solution. The virus growth was then precipitated with alum and recovered in a viable form by redissolving in broth containing sodium citrate. /

- / H.R. Morgan and R.W. Wiseman, "Use of Bacteriostatic Agents in Preparation of Seed Cultures of Psittacosis Virus," Proceedings of Society for Experimental Biology and Medicine, 62 (1945), 130.
- / Sp Rpt 40, Studies of the Virus Agents of the "Si" Group (1 Nov 45), pp. 75-73.
- / H.R. Morgan and R.W. Wiseman, "Growth of Psittacosis Virus in Roller Tube Tissue Culture; Use in a Vaccine," Journal of Infectious Diseases, 79 (Sep-Oct 1946), 131-33.

Pilot plant production. The pilot plant in Building T-434 was designed for the production of biological agents requiring embryonated eggs as the culture medium. Embryonated eggs were inoculated under sterile conditions with standardized inoculum, incubated for a definite period at approximately 99° F., and the whole egg harvested under sterile conditions. Inoculation was performed with 2-ml. automatic syringes using 0.25 ml. of inoculum per egg. A 54,000-egg capacity Smith commercial incubator was used to incubate the inoculated eggs. The proper incubation period was determined by means of egg candler.

Actually, no pathogenic agent material was produced in this pilot plant, but through production runs with the virus simulants it was determined that virus pathogens could probably be produced in the system safely after certain engineering changes had been made. It appeared that although the pipes, tanks, dispersing equipment and breaking cabinet in the production system could all be completely decontaminated and maintained in a sterile condition, yet it did not seem possible to obtain absolutely noncontaminated final product. Contamination in the process of inoculating the eggs could be eliminated, perhaps, but contamination of the culture from the egg shell surface remained. It was suggested that spraying the eggs with chlorine in water or iodine in alcohol just prior to harvesting might yield a sterile surface. There yet remained the fact that the eggs as received at Camp Detrick were

naturally contaminated to a small extent. It was believed to be almost impossible to eliminate this type of contamination with the large scale harvesting procedure that was devised. /

Harvesting. It was possible to harvest the agent material formed in the egg embryos by one of three methods: hand breaking, followed by mechanical dispersion; breaking in a suspended basket centrifuge, followed by mechanical dispersion; and by two-stage grinding in a carborundum-type colloid mill. Only the hand breaking method was used at Camp Detrick, with mechanical dispersion provided by a colloid mill and a homogenizer in series. All units of this system were made of stainless steel and were connected together by arc welding. Suitable cooled holding tanks were spaced between the various units of the harvesting apparatus to permit uniform flow. The system was cleaned with water and boiling sodium hydroxide and sterilized by flowing steam. /

There was some experimental evidence to indicate that for biological warfare purposes it might be practical to harvest all eggs dying of specific infection, as well as survivors, on the peak day of the death curve, instead of harvesting the dead daily as is done in commercial

/ Sp Rpt 65, pp. 83-107, 126-27. Standing operating procedures for operations in Bldg T-434 are appended to this report, pp. 151-64.

/ Sp Rpt 65, pp. 100-107.

vaccine production. /

Storage. Storage characteristics of various virus strains tested appeared entirely satisfactory for their possible use as a munition filling. Studies with the Cal-10 strain of meningopneumonitis virus in slurry showed it could be stored at dry ice box temperature or -40° C. for 183 days. The virus in vacuum-desiccated preparations was also quite stable for as much as 154 days at -40° C. The Cal-10 strain deteriorated markedly, however, at refrigerator temperature (0° C.), at room temperature (25° C.), and at incubator temperature (36° C.). It was most stable when stored in sealed glass ampules.

The 6BC psittacosis virus in slurry and in lyophilized preparations was stable for as long as 6 months when stored at -40° C. The strain survived in soil for 3 days at room temperature, but became almost completely inactive in one week. /

/ Sp Rpt 40, pp. 75-76.

/ Sp Rpt 65, pp. 123-29.

Dissemination. Because the stability of the virus agents under study appeared to be poor except at low temperatures, it appeared that use of these agents in the field would present special difficulties. It was not believed that a true aerosol could be secured with egg material in any munition available at Camp Detrick when these studies were made. Tests of the survival of egg material in soil produced encouraging results and it was believed that this method of dispersion might have some importance.

Pathogenicity. In a series of cloud chamber studies it was shown that the three strains of psittacosis available (Borg, Gleason, and 6BC) were more infective by the respiratory route in mice than were those of tularemia, melioidosis, brucellosis, or glanders. The Borg strain was more lethal than tularemia or melioidosis, and the Gleason strain was more lethal than glanders. The Borg and 6BC-strains were only slightly less stable than the organism of brucellosis and more stable than those of melioidosis, glanders, and tularemia. Both as an infective and as a lethal agent of biological warfare, the Borg strain of psittacosis was superior to the other four agents with which it was compared. /

/ Sp Rpt 45, Cloud Chamber Studies. II. Comparative Data on Infective Agents and Simulants. Final Report (Feb 46), pp. 74-81.

Immunization. An examination of the literature prior to beginning defensive studies indicated that the situation with respect to the prevention and treatment of psittacosis was not satisfactory. Because it was known that recovery from the infection was accompanied by enhanced resistance, immunization with live virus given intramuscularly had been tried on a small scale. Such immunization, however, was considered dangerous. Mice had been protected against intraperitoneal challenge by preparations of killed virus, but no protection against respiratory challenge had ever been demonstrated. Treatment had not advanced even as far as prophylaxis. Convalescent and hyperimmune sera had been used therapeutically, with poor results. The sulfonamide drugs had received clinical trial against a number of different strains without notable success. Recently, however, penicillin had been found effective in mice against the pigeon ornithosis virus. /

As a result of B Division studies at Camp Detrick, a psittacosis vaccine was developed from the 6BC strain which gave definite protection against small challenges by the respiratory route. This vaccine was prepared from infected yolk sacs under a procedure which involved lyophilization prior to ether extraction. A neutralizing antiserum was prepared by injecting this toxic preparation into rabbits. A toxoid was prepared by treating the preparation with 0.1 percent formalin. Antiserum and toxoid for the meningopneumonitis virus was similarly prepared using the Cal-10 strain.

/ Sp Rpt 40, passim. This report contains the material reported in subsequent footnotes of published articles.

Vaccines prepared from 6BC were extremely rich in elementary bodies and comparatively free from egg protein, with the immunizing potency of the vaccines apparently related to their elementary body content. Three intraperitoneal injections of 0.5 ml. each in mice protected 75 percent or more of the animals against intraabdominal challenges of from 10,000 to 1,000,000 LD50 of the virus. A similar course of injections conferred slight but definite protection against small challenges of from 1 to 10 MLD by the respiratory and intracerebral routes. /

It was learned that neutralizing sera prepared from the 6BC strain gave some protection against the toxin of the Cal-10 meningopneumonitis virus. Mice immunized with Cal-10 vaccines were solidly immune to intraperitoneal challenges with 6BC, thus emphasizing a point of fundamental importance in the field of immunity, namely, the degree of cross protection as determined by heterologous challenge. Yet no explanation could be offered for the fact that mice immunized with Cal-10 vaccine showed virtually no sign of immunity when challenged in the cloud chamber with 6BC. It was therefore concluded that the effectiveness of any vaccine prepared from a single strain against challenge with a heterologous strain must be considered doubtful.

/ J.C. Wagner, G. Meiklejohn, L.C. Kingland, and E.W. Hickish, "Psittacosis Vaccines Prepared from Chick Embryo Tissues," Journal of Immunology, 54 (Sep 1946), 35-46.

Experiments in mice indicated that live virus produced a more solid immunity than killed (formalinized) virus, but again did not protect against challenge with other strains.

A second type of vaccine was prepared at Camp Detrick by use of the roller tube tissue culture technique. Cultures were made using 8 to 10 day old chick embryos from which the eyes, beaks, and legs were removed before the tissues were cut into fragments. This tissue was placed in test tubes and a nutrient fluid of two parts Simms' solution, one part serum ultrafiltrate added. The tissues were then allowed to grow for 48 hours at 37° C., at which time the original nutrient fluid was replaced with nutrient fluid containing a dilute suspension of psittacosis-infected yolk sacs. The fluids were changed in the tubes every 48 hours for 15 days, producing large amounts of tissue culture fluids. Tissue culture vaccines were prepared by the addition of 0.1 percent formalin. While these vaccines overcame the disadvantage of yolk sac vaccines, in that they introduced smaller amounts of foreign protein with the immunizing injection, they did not provide as high a degree of protection as the yolk sac vaccines. /

On the basis of results obtained by intraperitoneal and intracerebral challenge, it was apparent that the vaccines prepared at Camp Detrick were more potent than any produced up to that time.

/ H.R. Morgan and R.W. Wiseman, "Growth of Psittacosis Virus in Roller Tube Tissue Culture; Use in a Vaccine," Journal of Infectious Diseases, 79 (Sep-Oct 1945), 131-33.

Therapy. The results obtained in studies of chemoprophylaxis and chemotherapy for the psittacosis group of viruses offered considerably more promise even than immunization. It was learned that all ten strains under study are susceptible in chick embryos and mice to penicillin. Certain strains, including the two classical psittacosis strains, 6BC and Gleason, the Greb strain, the 12 IN strain, and the lymphogranuloma venereum virus, were also found to be susceptible to sulfadiazine. / Data concerning the effectiveness of penicillin in humans infected with psittacosis viruses are limited but promising.

In continuing studies, to determine the effect of penicillin and sulfadiazine on the growth of the virus in tissue cultures and embryonated eggs, it was shown that penicillin definitely inhibits or retards the multiplication of the virus. The sodium salt of sulfadiazine also had a marked inhibitory action on the growth of virus in eggs, delaying or preventing deaths of infected chick embryos. This was surprising, since previous clinical observations had suggested that the sulfonamides had no effect in human psittacosis infections. When these studies were repeated with mice, oral sulfadiazine therapy resulted in survival of

/ G. Meiklejohn, J.C. Wagner, and G.W. Beveridge, "Studies on the Chemotherapy of Viruses in the Psittacosis-Lymphogranuloma Group. I. Effect of Penicillin and Sulfadiazine on Ten Strains in Chick Embryos," Journal of Immunology, 54 (Sep 1946), 1-8.

R.W. Wiseman, G. Meiklejohn, D.B. Lackman, J.C. Wagner, and G.W. Beveridge, "Studies on the Chemotherapy of Viruses in the Psittacosis-Lymphogranuloma Group. II. Effect of Penicillin and Sulfadiazine on Seven Strains of Mice," Journal of Immunology, 54 (Sep 1946), 9-16.

all mice infected by intravenous, intraperitoneal, and respiratory routes, while oral penicillin caused definite delays in death and even survival of mice.

In neither tissue cultures, embryonated eggs, nor mice did streptomycin or p-amino benzoic acid as therapeutic agents produce significant effects on the course of 6BC strain infections. /

Repeated oral administration at 2-hour intervals of 6,000 units per kg. of penicillin in combination with activated charcoal and bicarbonate of soda in water, as absorbent and antacid, was found to provide a minimum blood level of 0.5 units per ml. of penicillin in five of six dogs. It was believed that maintenance of the desired level of penicillin could be established in man easily and efficiently by oral dosage, although a preliminary parenteral injection might be made to establish an initial high level quickly. /

/ R.L. Early and H.R. Morgan, "Studies on the Chemotherapy of Viruses in the Psittacosis-Lymphogranuloma Group. III. Effect of Certain Chemotherapeutic Agents on the Growth of Psittacosis Virus (6BC Strain) in Tissue Cultures and Eggs," Journal of Immunology, 53 (Jun 1945), 151-56.

R.L. Early and H.R. Morgan, "Studies on the Chemotherapy of Viruses in the Psittacosis-Lymphogranuloma Group. IV. Effect of Certain Chemotherapeutic Agents on Psittacosis Virus (6BC Strain) Infections in Mice," Journal of Immunology, 53 (Jul 1945), 251-57.

/ Sp Rpt 60, Observations on Penicillin Relative to Prophylaxis and Therapy of "Si" Infections (1 Sep 45), pp. 17-13.

Detection. A method was devised for ready detection of the psittacosis virus in contaminated animal secretions and excretions. This became possible when it was learned that virus from ground intestine containing feces could be successfully isolated by use of a diluent broth containing 50 mg./ml. sodium sulfadiazine and 250 mg./ml. streptomycin. / Virus organisms were also isolated from the lung, liver, spleen, kidney, bladder, urine, and peritoneal washings, in addition to the intestine of mice infected with psittacosis virus. In each case, the virus was detected upon intracerebral injection in mice.

Although a skin test for the demonstration of infection by a number of the psittacosis strains under investigation was devised, it could not be used as a test for infection with a specific virus since there was no observed difference in animal reactions to either homologous or heterologous antigens. The animal reactions of erythema and induration at the site of intracutaneous injection merely indicated a psittacine-like infection. /

/ Isolation of virus from the intestine raised the question of the possible excretion of virus by this route in mice, as was known to be the case in parrots. These results pointed to a possible danger of infection by contact with infected mice, and at the same time presented a new potential for dissemination of these virus organisms.

/ H.R. Morgan, "Use of Yolk Sac Antigens for Skin Tests in Rabbits Infected with the Virus of Meningopneumonitis," Journal of Immunology, 54 (Sep 1945), 103-106.

Decontamination. Triethylene glycol vapor concentrations well in excess of saturation intensity were found to have positive disinfectant value when relative humidity was between 35 and 45 percent and when the viruses (Cal-10 and 6BC) were contained in a dynamic cloud sprayed from a suspension in broth. The degree of disinfection was measured by the reduction of virus concentration in samplers following release of the glycol vapor and also by reduction of infective response in mice, based on counts of focal lesions on lung surfaces. Yet even under these restrictive conditions, it was shown that enough virus escaped disinfection to induce distinct infection in exposed mice. Triethylene glycol had, therefore, only limited value for the disinfection of infective aerosols in the laboratory. /

More effective decontamination of the laboratory was achieved by the use of phenol, hypochlorite, or G.I. Germicide. Ethyl alcohol and tincture of iodine had limited use as decontaminating agents in the preparation of eggs for inoculation and for surface disinfection after inoculation. Formalin, acetone, and chloroform were effective against the virus in relatively low concentrations and might be used as inactivating agents in vaccine production. /

/ T. Rosebury, G. Meiklejohn, L.C. Kingsland, and M.H. Boldt, "Disinfection of Clouds of Meningopneumonitis and Psittacosis Viruses with Triethylene Glycol Vapor," Journal of Experimental Medicine, 85 (1 Jan 1947), 65-76.

/ Sp Rpt 65, p. 58.

Laboratory infection. A case of acute pneumonitis occurred in a laboratory worker (Dr. Rosebury) at Camp Detrick in May 1945. Clinical diagnosis of psittacosis was confirmed by isolation of the virus from the sputum and by a rise in complement-fixation antibody titer in the serum. The cause of infection was leakage from a pinhole flaw in the base of an ampule of frozen 68C virus suspension, a small pool of the material collecting in the palm of the hand of the patient.

Twelve days after this incident, the worker reported to the station hospital complaining of malaise, severe dull headache, epigastric distress, anorexia, and mild cough without chest pain. A tentative diagnosis of psittacosis was made on the basis of symptomatology and a history of exposure to the virus. The virus was isolated from sputum taken on the third day of illness, and on the fourth day treatment with intramuscular penicillin at the rate of 50,000 units every 3 hours (400,000 units per day) was instituted. On the fifth day, because of a possibility of infection with P. whittori, since the patient had also been working with that agent, sulfadiazine at the rate of 1 gram every 4 hours (6 grams per day) was also instituted.

A total of 3,900,000 units of penicillin and 48 grams of sulfadiazine were administered through the fourteenth day of illness and the patient was released on the seventeenth day of the disease, his chest X-rays showing almost complete resolution of the pulmonary lesion. The antibiotic-chemotherapeutic treatment had been based on experiments against infection with the 68C strain in mice and chick embryos. Recovery was considered dramatic. *L. M. Rosebury*

✓ T. Rosebury, H.V. Ellingson, G. Meiklejohn, and F. Schabel,
"A Laboratory Infection with Psittacosis Virus Treated with
Penicillin and Sulfadiazine, and Experimental Data Bearing on
the Mode of Infection," Journal of Infectious Diseases, 80
(Jan-Feb 1947), 64-77. First reported in Sp Rpt 24, A Labora-
tory Infection with "Si" Successfully Treated with Penicillin
and Sulfadiazine, and Experimental Data Bearing on the Mode
of Infection (Mar 46).

COCCIDIOIDAL GRANULOMA
(Coccidioides immitis)

Code letters "OC"

General. The suggestion that Coccidioides immitis be investigated as a possible biological warfare agent was made to WRS by the Office of Strategic Services in April 1943 and laboratory studies were begun in September. As a result of WRS efforts, principally at Stanford University, more than 600 times as many spores were being produced per petri dish in April 1944 as were produced in October 1943 and the limits of productive capacity by laboratory methods were being rapidly approached. /

The research program on this agent was initiated at Camp Detrick in January 1945, following transfer of the project from Stanford University. The five laboratories, three animal rooms, service room and storage area in Building T-433 were turned over to the new project, with A and B Divisions sharing the work that was to be done. A Division undertook the study of nutrition for growth of the material on solid and liquid media, of the virulence of the agent, its stability, and the effects of various disinfectants on its viability. B Division began work on detection, vaccines, and chemotherapy.

When the project was terminated on 15 August 1945 it had been learned that quantity production of "OC" spores was technically a simple matter

/ Ltr (S), Dr. Stanley Lovell, Stanford U., to Lt. J.A. Hamilton, CD, 23 Jun 44, sub: Coccidioides Immitis, Introduction, Military Feasibility. In CD Tech Lib (Doc.No. FF3, OC Acc.No. 3).

/ Ltr (S), Dr. R.E. Dyer Dir NIE to Tech Dir SPD, 16 Dec 44, no sub. (SPD 221) said that the "OC" project could safely be conducted at Camp Detrick without danger to the surrounding community. "As a matter of fact," said Dr. Dyer, "your protection of the community is much better than ours at this Institute." 34
7.

although such production, because of the high infectivity of the spores, required unique controls.

Selection of strain. The strain of Coccidioides immitis used in the studies at Camp Detrick was Stanford University No. 46, obtained from Captain A.R. Lack, Jr., who had been working with this agent prior to the war and later under WRS contract.

Yeast cells were used in a few instances as a simulant for this pathogenic fungus, but most studies were conducted with the agent itself.

Nutrition. Three satisfactory media were developed for growth of the agent material. The liquid synthetic medium consisted of 0.08 M ammonium acetate, 0.11 M glucose, 0.008 M $MgSO_4$, 0.015 M K_2HPO_4 , 0.015 M KH_2PO_4 , and 2 ppm Zn. The liquid natural medium consisted of 1 percent peptone, 2 percent glucose, 0.008 M $MgSO_4$, 0.015 M K_2HPO_4 , 0.015 M KH_2PO_4 , 2 ppm Zn, and 0.1 percent plasmolyzed yeast. Coccidioides immitis could also be grown on a solid medium consisting of soybean infusion and 1 percent Brewer's yeast (SbY₁), to which ammonium chloride, sodium acetate, KH_2PO_4 , K_2HPO_4 , magnesium sulfate, and distilled water were added. /

/ W.G. Roessler, E.J. Herbst, W.G. McCullough, R.C. Mills, and C.R. Brewer, "Studies with Coccidioides immitis. I. Submerged Growth in Liquid Mediums," Journal of Infectious Diseases, 79 (Jul-Aug 1946), 12-2

/ Sp Rpt 49, Studies on the Nutrition, Growth, and Virulence of "OC" (23 Dec 45), pp. 25-26.

Laboratory production. It was found that Coccidioides immitis did not require preformed vitamins or other growth factors for satisfactory proliferation or virulence. Maximum yields of spore were obtained in submerged aerated liquid cultures with a 10-day incubation period. About 95 percent of the total growth in high yielding cultures consisted of spores, and about 45 percent of this growth consisted of single spores. Yields in excess of 250×10^6 per ml. of material were obtained with liquid synthetic media and in excess of 300×10^6 viable fragments in liquid natural media.

When grown on solid media, agent material was completely sporulated in a period of 7 days, with 92 percent degree of sporulation by direct chamber counts. The optimal temperature for growth in this medium was 39° C.

No attempt was made to grow the agent on a large scale, although studies of nutritional requirements for pilot plant production indicated that there were no serious obstacles to the production of large quantities of "OC" spores. It was estimated that large scale production could be achieved within a period of 60 to 90 days on the basis of the procedures that had been worked out. Required equipment was largely standard and could be immediately obtained on priority if production became necessary.

Storage. Investigations of "OC" made prior to these wartime studies indicated that the dry spores could be stored for years without appreciable deterioration. No biological variations had been observed in the organism following repeated culture, repeated animal passage, storage, change of culture media, or any of the modifications which often change the virulence of bacteria.

Studies at Camp Detrick showed that "OC" cultures could be stored satisfactorily at 5° C. for periods up to two months in the media in which they are grown. Exposure to a temperature of 46° C. for 2 hours did not affect the viability of the organisms, but 50 percent agent in dilute suspension was destroyed by a 10-minute exposure to a temperature of 48° C. At temperatures of 51° C. and above, all agent was completely destroyed in an hour or less. /

/ J. Infect. Dis., 79 (Jul-Aug 1946), 12-22.

Dispersion. Spores of this organism are light and fluffy and do not pack or consolidate under pressure or even when prepared for dissemination by extracting the water from thick suspensions. There was reason to believe that this agent material could be easily dispersed by dropping from planes in frangible containers.

Because endemic areas of the disease are known to exist in the hot arid regions of Southwestern United States, laboratory tests were made to determine the susceptibility of the agent to heat under both storage and dispersion conditions. Liquid grown material diluted to give a final count of 177 spores per ml. and exposed to 45° C. in a water bath for 1 hour resulted in only 14 percent survival. Material grown on solid media when diluted to give a count of 163 spores per ml. and exposed to the same temperature for the same length of time, showed a survival of 20 percent. No explanation was offered for these somewhat contradictory results. The performance of the agent under both storage and potential dispersion conditions was not considered satisfactory on the basis of these tests. ✓

✓ Sp Rpt 49, pp. 30-32.

Pathogenicity. The extreme infectivity of Coccidioides immitis was recognized by all who had worked with it in the laboratory, the severity of infection varying with the number of spores inhaled.

From preliminary data obtained in cloud chamber exposures carried out in the British-type chamber at Camp Detrick, it was shown that 75 to 100 percent infection resulted when guinea pigs were exposed to cloud concentrations (Ct's) of from 0.0025 to 0.05. All 16 guinea pigs in one test were infected by breathing approximately 1,350 viable fragments, chiefly spores, of the culture. At these concentrations, no difference in respiratory virulence could be attributed to growths of culture in liquid as opposed to solid media or to the ratio of spores to mycelial fragments in the suspensions.

The organism produced an atypical bronchopneumonia when introduced by inhalation. Acute systemic infections resulting in death seldom occurred. The usual infection resembled disseminated tuberculosis, with primary lesions appearing in the skin or lungs, followed by progressive lesions of the skin, joints, lymph nodes, larynx, adrenals, or meninges.

Immunization. A review of the literature made before beginning work on the defensive aspects of coccidioidal granuloma, revealed that detection of the organism of the disease was difficult and time-taking, that there was no established chemotherapy for the disease and no available vaccine. A skin test with an antigen, coccidioidin, was known but its usefulness was limited by the fact that a positive reaction might indicate either that the patient had previously been infected and was presently free of infection or that he was presently infected.

Preliminary investigations of immunization for the disease were not rewarding. Efforts made to isolate the antigenic material in the skin test coccidioidin were futile. Complement fixation tests that were made on the sera of two suspected human cases and one sheep did not reveal the presence of any complement fixing antibodies. While precipitation tests indicated that specific antibodies were present in the sheep serum, human sera showed only slight results. It was admitted that the mildness of the disease in the human cases and the paucity of cases for clinical study prevented any conclusions from being drawn with regard to either of the serological tests. ✓

Chemotherapy. Experiments in chemotherapy for coccidioidal granuloma were equally inconclusive and meager as to results. Streptomycin did not result in inhibition of growing cultures in synthetic liquid media. In

✓ Sp Rpt 48, Investigations Concerned with Defense Against "OC"
(17 Dec 45), pp. 9-12, 21-25.

fact, streptomycin appeared to stimulate growth of the organisms. Streptothrycin, on the other hand, did appear to be inhibitory. One unit of streptothrycin per ml. of culture caused a significant reduction in growth and 10 units per ml. almost completely prevented growth. Cultures grown in the presence of streptothrycin exhibited an abnormal morphology, with clumping, failure of septation, and nonsporulation. Neither of these antibiotics were tried in vivo before the project came to a close. /

Detection. A procedure was devised for relatively quick detection and identification of immitis organisms. It was learned that readily identifiable spherules of Coccidicoides immitis could be isolated from cultures prepared in guinea pig embryo tissues when suspended in Simm's physiological salt solution and Simm's ox serum ultrafiltrate, diluted 1:2, and buffered with physiological salt solution and rabbit serum. There was some evidence that an antigenic material found in these cultures might be made available for immunological study. /

A synthetic agar made by solidifying the liquid synthetic medium proved of some value in the isolation of organisms from sputum.

/ W.G. Roessler, E.J. Herbst, W.G. McCullough, R.C. Mills, and C.R. Brewer, "Studies with Coccidicoides immitis. II. In Vitro Effects of Streptothrycin and Streptomycin," Journal of Infectious Diseases, 79 (Jul-Aug 1945), 23-26. First reported in Sp Rpt #2, pp. 12-20.

/ Sp Rpt 48, pp. 4-7.

Decontamination. Triphenylmethane and its water soluble dye derivatives were found to be potent fungicides for use against this organism. /

Laboratory infection. In spite of the high infectivity of this fungous organism, only one case of infection occurred among the laboratory workers engaged in the project. The primary focus and the portal of entry in this case was the skin and the consequent infection resulted in a 6-week period of hospitalization for the individual. In the absence of specific therapy, supportive measures alone were administered.

/ Sp Rpt 48, pp. 20-21.

NEURO-TROPIC ENCEPHALITIDES

Code letters "NT"

General. Preliminary studies were begun in June 1945 on the group of viruses known as the neuro-tropic encephalitides. In the next two and a half months, when the work was brought to a close by the end of the war, investigations had only been made of materials and procedures for protection against infection with Japanese Type B encephalitis (code letters "AN").

The virus used was the Nakayama strain of Japanese Type B encephalitis, obtained from the Army Medical School in the form of infected allantoic fluid. In the studies centered on the preparation of an egg tissue vaccine, it was learned that the AN virus could be readily cultivated in embryonated eggs. Maximum growth of the virus was obtained throughout the tissues of the embryonated egg by intraembryonic inoculation.

Suspensions of infected embryos or membranes in nutrient broth were used as inoculums. After a number of passages, this fluid was injected into 8 or 9 day old eggs and the infected eggs incubated at 35° C. for 72 to 96 hours before harvest. In harvesting the eggs, the allantoic fluid was first withdrawn by a syringe and the remaining contents poured into a sterile Petri dish. Almost without exception, the virus content of egg tissues was greatest in the embryo, with decreasing amounts found

in the chorioallantoic membrane, the yolk sac, and the allantoic fluid, indicating a definite tropism of this virus for embryo tissues.

In the infection of mice with the virus, it appeared that the intravenous route of inoculation had certain advantages over intracerebral or intraperitoneal routes and might be of use in chemotherapeutic studies with the agent. It was shown that the virus in clear fluids could be inactivated by ultraviolet radiation, which might be useful in the preparation of complement fixing antigens and vaccines.

It was at this point, in September 1945, that these preliminary studies were terminated. /

/ Sp Rpt 55, Development of Materials and Procedures for Protection Against the "NT" Group of Viruses (1 Nov 45). Parts of this report were published by H.R. Morgan, R.L. Farly, and M.E. McClain, "Studies on the Cultivation of Japanese B Encephalitis Virus in Eggs," Journal of Infectious Diseases, 79 (Nov-Dec 1946), 276-31.

SHELLFISH (MUSSEL) POISONING

Code letters "SS"

General. The project on shellfish poison was undertaken by a research group at the George Williams Hooper Foundation, University of California, under the direction of Dr. Hermann Sommer. Their work consisted principally of the collection of large amounts of paralytic shellfish poison, to be used in the chemical studies made by Dr. Byron Riegel at Northwestern University. In addition to the crustaceans collected for Dr. Riegel by the California group, samples were also received from the California Public Health Laboratory and the U.S. Food and Drug Administration, and data was obtained from the Department of National Health of Canada.

The collecting of shellfish poison was begun in July 1944. Early in 1946, the California group, in conjunction with the U.S. Fish and Wildlife Service, established a testing laboratory of their own. A total of 4.3 tons of raw material was worked in this laboratory, and from this amount of material, a theoretical poison content of 213 million MU / was extracted. When received at Evanston, Illinois, however, only 50 percent of this poison extract could be demonstrated.

Although efforts were made to collect the poison from its source, the plankton Gonyaulax catenella, this did not appear to be profitable. A method was therefore devised for extracting it from mussels, in the

/ MU or mouse unit is that amount in 1 ml. which will kill a 20-gram mouse on intraperitoneal injection in approximately 15 minutes.

livers of which considerable amounts were stored. Mussel livers were collected in acid alcohol, ground, and filled in bottle for shipment. In the laboratory, diatomaceous earth was used to remove the bulk of the pigments and colloids from the poison solution and base-exchange silicates and active carbon were then used to remove the poison from the solution. The resulting product was a poison hydrochloride. Elution of the poison was achieved with a solution of quinine dihydrochloride. /

The pure mussel poison was an all-or-none agent. Intravenous injection in mice resulted in death in 45 to 80 seconds or complete recovery in 2 minutes. Two MU by intranasal instillation was fatal to most mice. Rats and guinea pigs were as susceptible to the poison as were mice.

On the basis of known clinical cases, where humans have consumed the poison accidentally, it is presumed that the consumption of 20,000 MU of mussel poison may be dangerous for man and that 40,000 MU may be considered the minimum lethal dose.

It was learned by the California group that paralytic salamander

/ The steps and materials used in processing mussel poison were, more precisely, extraction of raw material with 50 percent acid alcohol, filtration through Hyflo-Supercel and Hyflo-Supercel carbon columns, adsorption on a Hyflo-Lloyd's reagent, elution with quinine, and precipitation by helianthate or Norit carbon column filtration.

poison which was obtained from the skin of adult salamanders behaved in all respects exactly like mussel poison. From 1,000 to 3,000 MU could be extracted from the skin of each animal. The poison could also be obtained from their eggs. Its action on mice and its solubility and stability were similar to mussel poison. /

No work was done on these paralytic poisons at Camp Detrick during the war, but when the contract project came to a close in December 1946, the program was transferred as a continuing postwar study to the Maryland laboratories.

/ Final Report, Project on Shellfish Poison, 1 Jul 1944-31 Dec 1946
(31 Jan 47). In CD Tech Lib (Acc.No. 36).

PLAGUE
(Pasteurella pestis)

Code letters "LE"

General. The study of the offensive possibilities and defenses against the organism of Asiatic plague was a project of the U.S. Navy, conducted by the U.S. Navy Medical Research Unit No. 1 at Berkeley, California. It was begun under the auspices of WRS in April 1943 and in July 1944 the project was taken over by the Navy Bureau of Medicine and Surgery and continued to the end of the war.

By November 1944 the unit at Berkeley had progressed sufficiently in its studies of the nutrition and laboratory production of plague organisms to request the assistance of Vigo Plant personnel in making plans for small scale pilot plant production. It was contemplated that an avirulent strain of plague, #122, would be used in these operations, and that the process production would be limited to the use of 250 cc. pre-catalysts, 5 gallon catalysts, and 50 gallon reactors. /

/ Ltr (TS), CO US Navy Unit Berkeley Calif to CO VP, 9 Nov 44, no sub. Classified Navy Doc. No. 464. In files Hq VP.

RINDERPEST
(filtrable virus)

Code letters "R" or "GIR-1"

General. Under the direction of the Joint United States-Canadian Commission, / conduct of the rinderpest experiments on Grosse Ile in the lower St. Lawrence River was assigned to six officers of the U.S. Army Veterinary Corps, one from the U.S. Navy Medical Corps, and two Canadian scientists, together with a corps of technicians from both countries. The island was acquired early in 1942 and the first experiments began shortly thereafter. In July 1942, the Chief of the Chemical Warfare Service was authorized by ASF to execute recommendations made by the survey committee of the Commission as to the degree of participation in the project of CWS personnel and funds. /

The objectives of the project were, first, to prepare in quantity a tissue vaccine for rinderpest according to known methods in order to provide as soon as possible means for surrounding an epizootic, should it occur, with a ring of immunized animals, and second, to investigate the possibility of developing an efficient vaccine which could be pro-

/ Members of the Commission, appointed by the U.S. Secretary of War and the Canadian Minister of National Defense, were:

J. Craigie, Dept of Immunol & Bact, University of Toronto
R.E. Dyer, Dir, National Institute of Health, USPHS
E.B. Fred, Dean, Graduate School, University of Wisconsin
R.A. Kelser, Chief, Veterinary Division, SGO
C.A. Mitchell, Animal Diseases Res Inst, Dept of Agri, Canada
E.G.P. Murray, Dept of Eact, McGill University
G.B. Reed, Dept of Bact, Queen's University
H.W. Schoening, Bur of Animal Industry, U.S. Dept of Agriculture

/ Ltr (S), CG ASF to C CWS, 29 Jul 42, no sub. CWS 710/4. In OC CMC.

duced more economically than known vaccines.

At the conclusion of the project, an avianized vaccine which was capable of rapid large scale production had been developed, tested, and found to be entirely adequate for the protection of both native and European breeds of cattle against rinderpest. /

Selection of strain. The rinderpest virus used in all experiments at Grosse Ile was an African bovine strain. It was received as infected dried lung tissue in sealed ampules. When administered to calves, it induced a disease that was clinically characteristic of rinderpest after an incubation period of from 46 to 72 hours. The animals died after 6 to 10 days of illness.

The breeds of calves, which were obtained locally or at the Montreal stockyards for use in these experiments, included Holstein-Friesians, Jerseys, Ayrshires, Herefords, Red Polls, Shorthorns, and Guernseys. All were equally susceptible to the African bovine strain of the disease.

Safety precautions. Except at the Gross Ile laboratory, rinderpest is nonexistent in the Western Hemisphere. Every precaution had therefore to be taken to prevent the escape of the highly contagious virus from the isolation quarters on the island where it was being handled. Ten

/ American Journal of Veterinary Research, VII (Apr 1946), Foreword, pp. 133-34.

/ R.E. Shope, H.J. Griffiths, and D.L. Jenkins, "Rinderpest. I. The Cultivation of Rinderpest Virus in the Developing Hen's Egg," Am. J. Vet. Res., VII (Apr 1946), pp. 135-36. ✓

completely isolated units were constructed in the main laboratory to contain infected animals, each with an anteroom equipped with a shower bath for the use of the animal attendant. Attendants wore rubber gloves, boots, and coveralls while in the room with an infected animal. No bedding was provided for the animals, and they were allowed no hay. The animals were maintained on a diet of commercial grain dairy ration mixed with dried beet and ground alfalfa. Animals were autopsied in the isolation unit in which they were maintained and final disposal of the carcasses was by incineration. Manure and sewage from the isolation units were decontaminated for 30 minutes at 80° C. in two 1,000-gallon steam sterilizing pits. After removal of an animal from an isolation unit, the room was decontaminated with scalding water. The boots, gloves and coveralls worn by attendants were soaked for an hour in scalding water each time after leaving an infected animal. /

Production of Inactivated Bovine Tissue Vaccines. Two chemically inactivated antirinderpest vaccines, prepared from virus-infected tissues of sick cattle, had been developed prior to the GIR project. As the work began, it was proposed to produce at once at least 100,000 doses of the chloroform-inactivated vaccine, since it appeared to be somewhat superior to the formalin-inactivated vaccine.

The chloroform-inactivated vaccine, which had been used to control rinderpest in the Philippines with considerable success, consisted of a

/ Ibid, pp. 136-37.

50 percent suspension in physiologic salt solution of finely ground infected spleen, lymph nodes, and liver, inactivated with 0.75 percent chloroform. A single injection of 25 cc. of the vaccine was sufficient to give immunity and three doses of 15 to 20 cc. administered subcutaneous at weekly intervals solidly immunized cattle or carabaos against rinderpest. /

In producing the vaccine at Grosse Ile, calves were inoculated subcutaneously either with egg culture virus or with bovine splenic virus and killed by stunning and bleeding on the second or third day of fever. The organs saved for vaccine production were the lymph nodes, spleen, and lungs, which contained sufficient virus to infect experimental calves when prepared as a 1:10,000 suspension in physiologic salt solution. These organs were minced in a meat chopper, making approximately 3 quarts of material per animal. This material could be maintained without loss of titer or virulence for at least 7 months when stored at minus 5° F. When it was to be made into vaccine, the material was thawed, 0.85 percent sterile salt solution was added, and the mixture ground in a colloid mill. Chloroform was added to the finished suspension just before it was drawn off from the mill. The vaccine was then filled in 9-liter Pyrex serum bottles, put in refrigerators (at - 2° C.), and shaken daily for the next four days. Each batch of vaccine was cultured aerobically on horse-blood agar and anaerobically in Brewer's thioglycolate

/ R.A. Kelsner, S. Youngberg, and T. Topacio, "An Improved Vaccine for Immunization Against Rinderpest," J. Am. Vet. Med. Assoc., 74 (1929), 23

medium to determine its bacteriologic sterility.

Final storage of the vaccine was in 500-cc. serum bottles capped with vaccine-type rubber stoppers and stored at refrigerator temperature. This type of vaccine was known to have been stored with full retention of its potency for one year, but tests at Grosse Ile were limited to periods of 15 weeks, with good results. When stored at 38° C., however, it was learned that the immunizing capacity of the vaccine was lost after 8 days.

Tests of the potency of the Grosse Ile product indicated that a single injection of the vaccine was adequate to confer protection, although 20 cc. was recommended for use in the field in order to overcome any possible loss of potency in transportation. / From the first 132 ✓ calves used to produce the vaccine, the yield of usable tissue per animal averaged 1,368 grams. On the basis of 10 cc. of vaccine as an ✓ immunizing dose, this came to 684 doses per animal. /

The shortcomings of both the chemically inactivated vaccines were the fact that the yield of vaccine from an individual animal was small and the titer of virus in the organs used to prepare the vaccine was not impressively high. In addition, there was danger of including animal bacterial pathogens in a vaccine prepared from bovine tissues.

/ R.V.L. Walker, H.J. Griffiths, R.E. Shope, F.D. Maurer, and D.L. ✓
Jenkins, "Rinderpest. III. Immunization Experiments with Inacti-
vated Bovine Tissue Vaccines," AMST. J. Vet. Res., VII (Apr 1946), 157-

/ F.D. Maurer, R.V.L. Walker, R.E. Shope, H.J. Griffiths, and D.L.
Jenkins, "Rinderpest. V. Attempts to Prepare an Effective Rinder-
pest Vaccine from Inactivated Egg-Cultivated Virus," AMST. J. Vet.
Res., VII (Apr 1946), 164.

Production of Inactivated Egg-Cultivated Virus. In order to effect economy of production, obtain a safer vaccine and make large quantities of vaccine more readily available, an effort was made to substitute egg-grown virus for that of infected bovine tissue. It was learned that rinderpest virus could be cultivated for 11 serial passages on the chorioallantoic membranes of embryonating hens' eggs. / Further experiment showed that chick embryos could be infected by inoculation of virus into the yolk sac with titrations indicating a virus content of one minimal infective calf dose per 0.1 mg. of embryo. This titer was comparable to that of spleen or lymph nodes from infected calves. On this basis, then, an average egg would yield approximately seven doses of vaccine and 100 eggs would produce the equivalent vaccine obtained from a single calf. /

Inoculation in 7-day old embryonated eggs, with 4 days' incubation before harvesting, appeared to result in the largest amount of infected material which could be used in vaccine production. The minimal infective dose for inoculating the embryonated eggs was approximately 0.5 mg. of a tenfold dilution of fifteenth membrane-passage virus. /

This egg-propagated virus, unfortunately, was found to be ineffectiv

/ Amer. J. Vet. Res., VII (Apr 1946), sec. I, pp. 137-39.

/ R.E. Shope, F.D. Maurer, D.L. Jenkins, H.J. Griffiths, and J.A. Baker, "Rinderpest. IV. Infection of the Embryos and the Fluids of Developing Hens' Eggs," Amer. J. Vet. Res., VII (Apr 1946), 153-60.

/ Rinderpest virus of direct bovine origin could not be transmitted indefinitely in series in eggs by yolk sac inoculation alone, but could be transmitted in this manner in extended series only when it was subjected to a preliminary series of chorioallantoic membrane passages. Immunologic evidence indicated (8 to 12) that direct bovine virus and this egg-cultivated virus were identical.

in immunizing cattle against rinderpest after inactivation with either chloroform or formalin. It was believed that the failure of the inactivated egg virus vaccine to immunize might be due to the presence of interfering embryo or egg proteins in the preparations, and not to any lack of immunizing potency of the virus they contained. / It was necessary to devise some other method for obtaining an effective egg-grown rinderpest vaccine.

Production of Vaccine from an Attenuated Virus Strain. It had been observed that when the bovine strain of rinderpest was transferred to growth in eggs, the virus gradually lost its capacity to kill and eventually reached a stage in which it no longer made calves seriously ill. If the virus itself could be shown to confer an immunity against the disease when thus attenuated, it might prove a solution to the problem of finding a new vaccine. In a series of tests, rinderpest virus which had undergone 67th, 68th, and 71st serial passages in eggs via the yolk sac route reached a point where it was almost completely innocuous for its natural host, yet still retained its ability to immunize against fully virulent bovine-passage virus. The immunity was effective within 10 days. /

This was a "live" attenuated virus vaccine and for that reason could be expected to give adequate protection during an epizootic more rapidly

/ Amer. J. Vet. Res., VII (Apr 1946), sec. V, pp. 165-69.

/ D.L. Jenkins and R.E. Shope, "Rinderpest. VII. The Attenuation of Rinderpest Virus for Cattle by Cultivation in Embryonating Eggs," Amer. J. Vet. Res., VII (Apr 1946), 174-78.

than would inactivated bovine tissue vaccine. However, because it was a "live" vaccine, it was necessary to make certain that its immunizing character was fixed by this egg transference and that the mild symptoms it produced in vaccinated animals could not be transmitted to other animals by contact.

To learn whether the attenuated character of the virus was fixed or would revert to its original bovine pathogenicity by repeated blood passages, five calves were inoculated in series from an original immunize animal. All blood-passage animals were found to be immune when challenge with virus and only after a sixth direct blood passage did the attenuated virus regain its original virulence. The experiment demonstrated that the blood of animals inoculated with attenuated virus contained rinderpest virus of the same mild type as that in egg cultures, and that the vaccine would be perfectly safe to use in the field. The mild symptoms which occasionally resulted from administration of the vaccine were not transmitted by close and intimate contact. / Development of a production cycle was started at once.

In the production of seed virus, cultivation was started from 20 percent suspensions of infected spleen in broth or physiologic saline solution which were placed on the choricallantoic membrane of 10-day embryonated eggs in 0.2-cc. amounts and incubated for 72 hours at 38° C. Infected membranes from the 10th to the 15th passage level, in a vehicle

/ M.W. Hale and R.V.L. Walker, "Rinderpest. XIII. The Production of Rinderpest Vaccine from an Attenuated Strain of Virus," Am. J. Vet. Res., VII (Apr 1946), 199-200.

Therapy. The results obtained in studies of chemoprophylaxis and chemotherapy for the psittacosis group of viruses offered considerably more promise even than immunization. It was learned that all ten strains under study are susceptible in chick embryos and mice to penicillin. Certain strains, including the two classical psittacosis strains, 6BC and Gleason, the Greb strain, the 12 EN strain, and the lymphogranuloma venereum virus, were also found to be susceptible to sulfadiazine. / Data concerning the effectiveness of penicillin in humans infected with psittacosis viruses are limited but promising.

In continuing studies, to determine the effect of penicillin and sulfadiazine on the growth of the virus in tissue cultures and embryonated eggs, it was shown that penicillin definitely inhibits or retards the multiplication of the virus. The sodium salt of sulfadiazine also had a marked inhibitory action on the growth of virus in eggs, delaying or preventing deaths of infected chick embryos. This was surprising, since previous clinical observations had suggested that the sulfonamides had no effect in human psittacosis infections. When these studies were repeated with mice, oral sulfadiazine therapy resulted in survival of

/ G. Meiklejohn, J.C. Wagner, and G.W. Beveridge, "Studies on the Chemotherapy of Viruses in the Psittacosis-Lymphogranuloma Group. I. Effect of Penicillin and Sulfadiazine on Ten Strains in Chick Embryos," Journal of Immunology, 54 (Sep 1946), 1-8.

R.W. Wiseman, G. Meiklejohn, D.B. Lackman, J.C. Wagner, and G.W. Beveridge, "Studies on the Chemotherapy of Viruses in the Psittacosis-Lymphogranuloma Group. II. Effect of Penicillin and Sulfadiazine on Seven Strains of Mice," Journal of Immunology, 54 (Sep 1946), 9-13.

all mice infected by intravenous, intraperitoneal, and respiratory routes, while oral penicillin caused definite delays in death and even survival of mice.

In neither tissue cultures, embryonated eggs, nor mice did streptomycin or p-amino benzoic acid as therapeutic agents produce significant effects on the course of 6BC strain infections. /

Repeated oral administration at 2-hour intervals of 6,000 units per kg. of penicillin in combination with activated charcoal and bicarbonate of soda in water, as absorbent and antacid, was found to provide a minimum blood level of 0.5 units per ml. of penicillin in five of six dogs. It was believed that maintenance of the desired level of penicillin could be established in man easily and efficiently by oral dosage, although a preliminary parenteral injection might be made to establish an initial high level quickly. /

/ R.L. Early and H.R. Morgan, "Studies on the Chemotherapy of Viruses in the Psittacosis-Lymphogranuloma Group. III. Effect of Certain Chemotherapeutic Agents on the Growth of Psittacosis Virus (6BC Strain) in Tissue Cultures and Eggs," Journal of Immunology, 53 (Jun 1945), 151-56.

R.L. Early and H.R. Morgan, "Studies on the Chemotherapy of Viruses in the Psittacosis-Lymphogranuloma Group. IV. Effect of Certain Chemotherapeutic Agents on Psittacosis Virus (6BC Strain) Infections in Mice," Journal of Immunology, 53 (Jul 1945), 251-57.

/ Sp Rpt 60, Observations on Penicillin Relative to Prophylaxis and Therapy of "Si" Infections (1 Sep 45), pp. 17-18.

Detection. A method was devised for ready detection of the psittacosis virus in contaminated animal secretions and excretions. This became possible when it was learned that virus from ground intestine containing feces could be successfully isolated by use of a diluent broth containing 50 mg./ml. sodium sulfadiazine and 250 mg./ml. streptomycin. / Virus organisms were also isolated from the lung, liver, spleen, kidney, bladder, urine, and peritoneal washings, in addition to the intestine of mice infected with psittacosis virus. In each case, the virus was detected upon intracerebral injection in mice.

Although a skin test for the demonstration of infection by a number of the psittacosis strains under investigation was devised, it could not be used as a test for infection with a specific virus since there was no observed difference in animal reactions to either homologous or heterologous antigens. The animal reactions of erythema and induration at the site of intracutaneous injection merely indicated a psittacine-like infection. /

/ Isolation of virus from the intestine raised the question of the possible excretion of virus by this route in mice, as was known to be the case in parrots. These results pointed to a possible danger of infection by contact with infected mice, and at the same time presented a new potential for dissemination of these virus organisms.

/ H.R. Morgan, "Use of Yolk Sac Antigens for Skin Tests in Rabbits Infected with the Virus of Meningoepneumonitis," Journal of Immunology, 54 (Sep 1945), 103-106.

Decontamination. Triethylene glycol vapor concentrations well in excess of saturation intensity were found to have positive disinfectant value when relative humidity was between 35 and 45 percent and when the viruses (Cal-10 and 6BC) were contained in a dynamic cloud sprayed from a suspension in broth. The degree of disinfection was measured by the reduction of virus concentration in samplers following release of the glycol vapor and also by reduction of infective response in mice, based on counts of focal lesions on lung surfaces. Yet even under these restrictive conditions, it was shown that enough virus escaped disinfection to induce distinct infection in exposed mice. Triethylene glycol had, therefore, only limited value for the disinfection of infective aerosols in the laboratory. /

More effective decontamination of the laboratory was achieved by the use of phenol, hypochlorite, or G.I. Germicide. Ethyl alcohol and tincture of iodine had limited use as decontaminating agents in the preparation of eggs for inoculation and for surface disinfection after inoculation. Formalin, acetone, and chloroform were effective against the virus in relatively low concentrations and might be used as inactivating agents in vaccine production. /

/ T. Rosebury, G. Meiklejohn, L.C. Kingsland, and M.H. Boldt, "Disinfection of Clouds of Meningopneumonitis and Psittacosis Viruses with Triethylene Glycol Vapor," Journal of Experimental Medicine, 85 (1 Jan 1947), 65-76.

/ Sp Rpt 65, p. 53.

Laboratory infection. A case of acute pneumonitis occurred in a laboratory worker (Dr. Rosebury) at Camp Detrick in May 1945. Clinical diagnosis of psittacosis was confirmed by isolation of the virus from the sputum and by a rise in complement-fixation antibody titer in the serum. The cause of infection was leakage from a pinhole flaw in the base of an ampule of frozen 6BC virus suspension, a small pool of the material collecting in the palm of the hand of the patient.

Twelve days after this incident, the worker reported to the station hospital complaining of malaise, severe dull headache, epigastric distress, anorexia, and mild cough without chest pain. A tentative diagnosis of psittacosis was made on the basis of symptomatology and a history of exposure to the virus. The virus was isolated from sputum taken on the third day of illness, and on the fourth day treatment with intramuscular penicillin at the rate of 50,000 units every 3 hours (400,000 units per day) was instituted. On the fifth day, because of a possibility of infection with P. whitxori, since the patient had also been working with that agent, sulfadiazine at the rate of 1 gram every 4 hours (6 grams per day) was also instituted.

A total of 3,900,000 units of penicillin and 48 grams of sulfadiazine were administered through the fourteenth day of illness and the patient was released on the seventeenth day of the disease, his chest X-rays showing almost complete resolution of the pulmonary lesion. The antibiotic-chemotherapeutic treatment had been based on experiments against infection with the 6BC strain in mice and chick embryos. Recovery was considered dramatic. *Complete*

✓ T. Rosebury, H.V. Ellingson, G. Meiklejohn, and F. Schabel,
"A Laboratory Infection with Psittacosis Virus Treated with
Penicillin and Sulfadiazine, and Experimental Data Bearing on
the Mode of Infection," Journal of Infectious Diseases, 80
(Jan-Feb 1947), 64-77. First reported in Sp Rpt 24, A Labora-
tory Infection with "SI" Successfully Treated with Penicillin
and Sulfadiazine, and Experimental Data Bearing on the Mode
of Infection (Mar 46).

COCCIDIOIDAL GRANULOMA
(Coccidioides immitis)

Code letters "OC"

General. The suggestion that Coccidioides immitis be investigated as a possible biological warfare agent was made to WRS by the Office of Strategic Services in April 1943 and laboratory studies were begun in September. As a result of WRS efforts, principally at Stanford University more than 600 times as many spores were being produced per petri dish in April 1944 as were produced in October 1943 and the limits of productive capacity by laboratory methods were being rapidly approached. /

The research program on this agent was initiated at Camp Detrick in January 1945, following transfer of the project from Stanford University. The five laboratories, three animal rooms, service room and storage area in Building T-433 were turned over to the new project, with A and B Divisions sharing the work that was to be done. A Division undertook the study of nutrition for growth of the material on solid and liquid media, of the virulence of the agent, its stability, and the effects of various disinfectants on its viability. B Division began work on detection, vaccines, and chemotherapy.

When the project was terminated on 15 August 1945 it had been learned that quantity production of "OC" spores was technically a simple matter

/ Ltr (S), Dr. Stanley Lovell, Stanford U., to Lt. J.A. Hamilton, CD, 23 Jun 44, sub: Coccidioides Immitis, Introduction, Military Feasibility. In CD Tech Lib (Doc.No. FF3, CC Acc.No. 3).

/ Ltr (S), Dr. R.E. Dyer Dir NIE to Tech Dir SPD, 16 Dec 44, no sub. (SPD 321) said that the "OC" project could safely be conducted at Camp Detrick without danger to the surrounding community. "As a matter of fact," said Dr. Dyer, "your protection of the community is much better than ours at this Institute."

of mixed allantoic and amniotic fluids, were then injected directly into the yolk sac of 7-day embryonated eggs in 0.5-cc. amounts, the eggs incubated for 96 hours at 38° C. and then chilled for 40 minutes at minus 20° C. When a total of 20 or more transfers had been made by way of the yolk sac, the egg fluids were tested to determine the degree of attenuation of the virus. This was acceptable when calves which received 1 cc. of the mixed egg fluids subcutaneously did not become clinically ill within 14 days and were subsequently immune to challenge with 100 minimal infective doses of bovine-passage virus. When necessary, more yolk sac passages were made to bring about the required degree of attenuation and then the seed virus of mixed egg fluids was promptly frozen after harvesting. It remained viable for at least a year at a temperature of minus 20° C.

Frozen egg fluids from the 30th to the 50th yolk sac passage were used to prepare supplies of fresh seed virus for actual vaccine production. Seven-day embryonated eggs were injected with 0.5 cc. of the stored fluids by way of the yolk sac and incubated for 72 hours at 38° C. At the end of this time, dead or abnormal embryos were discarded and the remaining eggs frozen for 40 minutes at minus 20° C. The fluids were then harvested with a 30-cc. Luer syringe and a 19-gauge needle, from 5 to 7 cc. of clear mixed fluids being obtained from each egg. Since 0.5 cc. of seed was required for the injection of each egg to be used for vaccine, the seed fluids were diluted 1:10 with physiologic saline solution and thoroughly mixed prior to injection. Eggs were then inoculated in lots of approximately 300, incubated for 96 hours, chilled, and harvested.

✓ over

1 - 3

✓ It was later discovered that the chick could be satisfactorily substituted for the calf when it was desired to determine either the presence or concentration of rinderpest virus propagated in eggs. The susceptibility of chicks to avianized virus was equal to that of calves. (Rabbits, guinea pigs, and mice were infected and developed neutralizing antibodies when given large amounts of natural and lapinized forms of virus but these antibodies were not formed when the animals were given avianized virus.) Chicks exhibited neutralizing antibodies 21 days after inoculation. See J.A. Baker and A.S. Greig, "Rinderpest. XII. The Successful Use of Young Chicks to Measure the Concentration of Rinderpest Virus Propagated in Eggs," Am. J. Vet. Res., VII (Apr 1946), 196-98.

The fluids were suctioned off and the embryos removed with sterile forceps. The two components were then milled together in an Eppenbach colloid mill, the vaccine drawn off in 9-liter bottles, and refrigerated for one or two hours. The vaccine was finally distributed in 20-cc. amount in 60-cc. serum bottles by means of a dispensing burette assembly, shell frozen by rotation in a bath of dry ice and alcohol, and placed in a freezer until ready to be dried. Drying from the frozen state was accomplished by sublimation under high vacuum (lyophilization).

In spite of all precautions, it was almost impossible to obtain a completely sterile product from each lot of eggs. In an emergency where vaccine was urgently required in large amounts, however, it was believed that a slight amount of contamination with nonpathogenic organisms would not be detrimental to the vaccine. / Despite the description of the production cycle, attenuated virus could be prepared in tremendous quantities on very short notice.

Immunization. Since the vaccine was dried from 20-cc. amounts in 60 cc. vials, it was convenient to reconstitute the dried material with distilled water to 60 cc. It was believed that doses of less than 0.5 cc. were probably not practicable to administer to bovine animals in large numbers. Thus the dilution recommended for standard use was equal to 1 cc. of a dilution of 1:6 or 16 times the amount actually required to produce an immunity. The reaction of individual calves to / Op. cit., pp. 202-11.

sec. XIII,

the avianized vaccine was so slight as to go almost unnoticed in most animals unless body temperatures were recorded twice daily. The immune response was prompt, most animals demonstrating neutralizing antibodies within 10 days.

The dried vaccine, packed in vacuum, maintained its potency for as long as 15 months when stored at temperatures between 2° and 5° C. The dried vaccine did not remain potent for long periods at high atmospheric temperatures. It rapidly lost its ability to immunize after being reconstituted from the dry state and must therefore be administered within 12 hours. It appeared that the only satisfactory method of determining the potency of the dried vaccine was to challenge immunized animals after a 14-day period with fully virulent material. /

Survival of Rinderpest Virus. With the development of a vaccine based on the use of live virus, it became important to examine the environmental requirements for reproduction and survival of the rinderpest virus. An investigation was therefore made to determine the optimum hydrogen ion concentration and optimum buffer salt concentration for survival. It was learned that the stability of a 1.0 percent suspension

/ M.W. Hale, R.V.L. Walker, F.D. Maurer, J.A. Baker, and D.L. Jenkins, "Rinderpest. XIV. Immunization Experiments with Attenuated Rinderpest Vaccine Including Some Observation on the Keeping Qualities and Potency Tests," Am. J. Vet. Res., VII (Apr 1946), 212-21

of rinderpest virus varied considerably at 36° F., depending upon the pH and salt concentrations of several suspending mediums. Optimum conditions appeared to be achieved with an M/10 phosphate buffer at pH 7.

Pathogenicity. The course of rinderpest disease in cattle infected with the bovine-passage virus at Grosse Ile included abrupt febrile rises, sudden and complete anorexia, ^{persistent diarrhea,} early prostration, and death. Of 19 calves infected, 16 died of rinderpest in from 6 to 9 days after inoculation and the other 3 eventually recovered. The mortality rate for the virus from which the avianized vaccine was prepared was therefore something over 80 percent. /

The immature bovine animals being tested under experimental conditions at Grosse Ile frequently died before the classic clinical symptoms of the disease developed. In some cases, there were no characteristic lesions at autopsy. Severe leucopenia was the most marked morphological change observed in the blood of these animals and might be characterized as an aid in diagnosis of rinderpest in young bovine animals. /

/ F.D. Maurer, "Rinderpest. XI. The Survival of Rinderpest Virus in Various Mediums," Am. J. Vet. Res., VII (Apr 1946), 193-95. ✓

/ Am. J. Vet. Res., VII (Apr 1946), sec. VII, p. 174.

/ T.O. Robey and M.W. Hale, "Rinderpest. XV. Morphological Changes in the Blood of Young Cattle During Rinderpest and After Vaccination with Attenuated Virus Vaccine," Am. J. Vet. Res., VII (Apr 1946), 222-27.

In serial transfers of bovine tissue virus in embryonated eggs, it was observed that rinderpest virus apparently had no constant and dependable lethal effect upon the embryos, although many infected embryos succumbed. The precise role of the virus in causing these deaths was not thoroughly studied. Yet chick embryos could be heavily infected with virus and still survive and present a normal appearance grossly. /

In virus-infected chick embryos which were allowed to hatch, the virus persisted in the brains and solid viscera of the chicks for at least 5 days but disappeared sometime before the chicks reached 8 days of age. The failure to demonstrate virus in the blood of chicks suggested that the infection was not septicemic but rather that the virus was in intimate association with fixed tissue cells in the organs or brain. Baby chicks, however, could not be infected with rinderpest by any route, suggesting that neither chicks nor birds in general need be considered in the transmission of the disease. /

/ Am. J. Vet. Res., VII (Apr 1946), sec. IV, p. 155.

/ R.E. Shope and H.J. Griffiths, "Rinderpest, VI. The Persistence of Virus in Chicks Hatched from Infected Eggs," Am. J. Vet. Res., VII (Apr 1946), 170-73. /

Rinderpest virus can be made to show definite signs of illness in rabbits, but only by the use of a new method was serial passage of rinderpest in rabbits accomplished. This consisted of alternating passages between calves and rabbits, in order to keep the virus content above the threshold of infection for rabbits. When this was done, the rabbits regularly showed a sharp rise in temperature 36 to 48 hours after inoculation, increased respiration, anorexia, and signs of malaise. Prompt recovery followed the return of a normal temperature. /

Guinea pigs were also examined in studies to find a test animal to substitute for calves in making potency tests of egg vaccines. Although no definite signs of illness were shown by guinea pigs, the production of neutralizing antibodies indicated that infection did occur in the guinea pig. It was concluded that like the rabbit, the guinea pig could be included in the list of laboratory animals susceptible to the virus of rinderpest. /

/ J.A. Baker, "Rinderpest. VIII. Rinderpest Infection in Rabbits," Am. J. Vet. Res., VII (Apr 1946), 179-82. ✓

/ J.A. Baker, J. Terrence, A.S. Greig, "Rinderpest. X. The Response of Guinea Pigs to the Virus of Rinderpest," Am. J. Vet. Res., VII (Apr 1946), 189-92. /

Serology and Detection. Although previous infection of calves by rinderpest virus can be detected by both neutralization and complement fixation tests, for purposes of diagnosis the neutralization test appears preferable. The test was as follows: in an outbreak of an infectious disease among cattle where rinderpest was suspected, an animal showing acute signs should be killed and a 10 percent suspension of the spleen prepared in physiologic salt solution by maceration. After sedimentation a 1:10 and 1:100 dilution of the supernatant should be made with physiologic salt solution. When mixed with equal amounts of immune sera, the virus in these dilutions should be neutralized, as indicated when subcutaneous injections of the dilutions in calves fail to cause illness of the animals. /

The ability to produce a marked thermal reaction in rabbits with rinderpest virus made that laboratory animal useful to show the neutralizing ability of serums from cattle immune to rinderpest as the result either of recovery from the disease or of vaccination. /

Before the Grosse Ile project came to a close, a satisfactory complement fixation test for rinderpest had been developed which permitted complement-fixing antibodies to be demonstrated regularly in the serum

/ R.V.L. Walker, J.A. Baker, and D.L. Jenkins, "Rinderpest. II. Certain Immunity Reactions," Am. J. Vet. Res., VII (Apr 1946), 142-44.

/ D.L. Jenkins and R.V.L. Walker, "Rinderpest. IX. Neutralization Tests in Rabbits as a Measure of the Immune Responses in Calves to Vaccination against Rinderpest," Am. J. Vet. Res., VII (Apr 1946), 133-38.

of vaccinated animals beginning approximately 14 days after vaccination and persisting for 5 to 6 months. The antigen developed for the test consisted of the mixed allantoic and amniotic fluids from 11-day infected eggs which were harvested after 96 hours' incubation and stored at minus 20° C. In making the test, 18 to 22 hours at 4° to 7° C. was required for fixation of the complement by the antigen and the antibody. The test proved of great value in measuring the virus content of eggs used for vaccine production and seed virus for egg inoculation. /

/ H.K. Cooper, "Rinderpest. XVI. Complement Fixation Test for Rinderpest," Am. J. Vet. Res., VII (Apr 1946), 228-37. ✓

NEWCASTLE DISEASE AND FOWL PLAGUE
(filtrable viruses)

Code letters "OE"

General. The project established to investigate fowl plague and a new pseudoplague in this country identified as Newcastle disease was supported by the Chemical Warfare Service but, like the rinderpest project was administered by the Joint United States-Canadian Commission. The work was performed at the ~~Huntington Laboratory~~, ^{Harvard University,} from July 1943 to December 1945.

Fowl plague was unknown in this country, although it was well known in Europe. Suddenly in 1944 occurrences of a similar plaguelike infection were reported in widely separated areas previously not known to be infected. Outbreaks of an atypical fowl pest were reported not only on the European continent but, for the first time, in the Western Hemisphere, in California, New Jersey, New York, Massachusetts, and Connecticut. Distinguished from true fowl plague by certain clinicopathologic differences, the new infection was identified definitely as Newcastle disease. This disease had been first reported in 1926 as a highly diffusible and fatal infection of poultry in the Dutch East Indies, and soon after, in England. Traffic in live birds, contact with the offal, exudates, and excreta of infected birds, and dissemination by wild birds appeared to be the major factors in the spread of the disease.

The degree of dissemination of the new disease in this country and the virulence of certain of its strains indicated that either in the event of a series of natural outbreaks or in the event of use of the agent

as an instrument of war, spread of the disease might result in the depletion of a prime source of food in the nation. / The relatively high tenacity of the disease favored direct as well as indirect dissemination. It was therefore important that adequate diagnostic facilities and comprehensive control measures be made available as quickly as possible. /

When the wartime program came to an end, both living-modified and killed virus vaccines had been prepared from embryonating chicken eggs to provide protection for our flocks against Newcastle disease.

Selection of strains. One strain of fowl plague, the DEI (Dutch East Indies), and eleven strains of Newcastle disease were available for the studies conducted at Harvard. Four strains of Newcastle disease were European and the other seven were North American. The first strain received was the Hertfordshire E virus, from the Ministry of Agriculture and Fisheries, Surrey, England, which arrived as pieces of infected chicken liver and spleen suspended in 50 percent glycerol-saline. This had been originally isolated from the 1933 outbreak in England and had been passed in fowl at intervals of three months in the Ministry labora-

- / Although identified positively only in chickens and turkeys, the reported host range of Newcastle disease is apparently quite broad and includes guinea fowl, ducks, geese, pigeons, pheasants, partridges, crows, sparrows, and martins, as well as unidentified species of free-flying birds.
- / C.A. Brandly, H.E. Moses, E.E. Jones, and E.L. Jungherr, "Epidemiology of Newcastle Disease of Poultry," Am. J. Vet. Res., VII (Jul 1946), 243-49.

tories. Two Milano strains and a Perugia strain were supplied by the Italian Veterinary Institutes of those cities in June 1945 and forwarded through U.S. Army channels.

Three strains of Newcastle disease virus were received from California the 11919 strain being isolated from lyophilized chicken lung and, like the RO and C strains, obtained from cases of "pneumoencephalitis". Strains KD and H came from New Jersey in the form of dried chicken brain tissue, obtained following an outbreak of the disease. Strain 4F was obtained in an outbreak of spontaneous infection among laboratory stock birds at Harvard during March 1945. The seventh strain, designated New York, was forwarded by Dr. E.W. Schoening of the U.S. Bureau of Animal Industry.

Tissues from glycerol suspensions were washed in sterile physiologic saline or 1 percent tryptone broth, ground finely, suspended in broth, centrifuged, and the supernatant fluid then drawn off ready for use. Lyophilized organ material was suspended in a similar manner in distilled water. Organ tissues collected from laboratory stock were either suspended or diluted prior to use. All tissues were kept stored in the frozen state, at minus 65° to minus 68° C. /

/ E.L. Jungherr, E.E. Tyzzer, C.A. Brandly, and H.E. Moses, "The Comparative Pathology of Fowl Plague and Newcastle Disease," Am. J. Vet. Res., VII (Jul 1946), 250.

C.A. Brandly, H.E. Moses, E.L. Jungherr, and E.E. Jones, "The Isolation and Identification of Newcastle Disease Virus," Am. J. Vet. Res., VII (Jul 1946), 290.

C.A. Brandly, H.E. Moses, E.E. Jones, and E.L. Jungherr, "Immunization of Chickens Against Newcastle Disease," Am. J. Vet. Res., VII (Jul 1946), 308.

Pathogenicity. In studies of the clinical course of fowl plague at the Harvard laboratories, the earliest evidence of disease was usually observed within 18 to 30 hours after inoculation with 100 minimal lethal doses of fully virulent virus. Death occurred within the next 24 to 48 hours. The first evidence of disease shown by the White Leghorns used in the studies was a decrease in sensitivity to sensory stimuli. Succeeding symptoms of fowl plague were pronounced general malaise, conspicuous congestion of comb and wattles, excessive thirst, stupor, and voice changes. The birds would frequently fall asleep while drinking and let the water run from the mouth. Their voices changed from a shrill quality to a weak squawk, and this was often the forerunner of terminal convulsive seizures.

The incubation period in Newcastle disease ranged from less than 24 hours to 15 days in inoculated chickens and from 6 to 13 days in birds exposed by contact. In acute experimental cases, initial dullness developed rapidly into marked depression accompanied by progressive weakness. Diarrhea often appeared early, with rapidly developing dehydration. Advanced debility or complete prostration usually preceded death, which ensued after a course of 24 to 48 hours.

Subacute or chronic cases of experimental Newcastle disease were more common with American strains than with European strains. With prolongation of the disease in these instances, emaciation and symptoms of peripheral and central nervous system derangement increased. Even after almost complete paresis and prostration, muscle spasms often remained prominent. /

/ "Comparative Pathology...", Am. J. Vet. Res., VII (Jul 1946), pp. 250-52. 265-66.

Comparative pathology. Prior to the identification of the new fowl disease in this country with the infection reported in England as Newcastle disease, it had been called a respiratory nervous disorder of chickens or avian pneumoencephalitis in California, and elsewhere, atypical fowl pest. Despite its marked similarity to fowl plague, the essential pathologic picture was found to develop along different lines which permitted separation of fowl plague and Newcastle disease on pathologic grounds.

In fowl plague, the basic microscopic pathology was found to consist of multiple focal necrosis in the visceral organs and the central nervous system. In both subacute and chronic cases, the visceral and nervous changes were accompanied by secondary inflammatory reactions leading, in the brain, to meningoencephalitis.

In Newcastle disease, the basic microscopic pathology was found to be necrotizing in character in the abdominal viscera and proliferative in the lung and central nervous system. The proliferative processes, predominant in American strains, resulted in the lung in interstitial pneumonia complicated by respiratory tract infection, and in the central nervous system in primary encephalomyelitis.

European strains of Newcastle disease virus were predominantly enterotropic, American strains neurotropic or pneumotropic, depending upon whether the avenue of infection was parenteral or intratracheal. The comparative pathology of the two diseases, with due regard to the usual modifying factors, was considered to be specific for these diseases.

In the absence of virologic diagnosis, recognition by pathologic means might serve to identify the causative agent. /

Isolation of Newcastle disease virus. The results of prolonged study in the isolation and identification of Newcastle disease virus tended to confirm the difficulties and irregularities which had been encountered by others in attempting to isolate this virus from field cases of known or suspected Newcastle disease.

Although actual isolation of the virus was not accomplished, a number of criteria were delineated for establishing the identity of the various American strains of the disease with the original Hertfordshire strain. These included infectivity for and isolation in embryonating chicken embryos and chickens, course of disease and pathology in embryos and chickens, pH stability range, hemagglutinative activity for chicken cells and cells from certain other species, cross-neutralization and agglutination inhibition of the virus strains by their respective immune serums, and cross-immunity among vaccinated and recovered chickens.

It was learned that the fowl plague virus, because of its more rapid growth, was recoverable from mixtures with Newcastle virus merely

/ "Comparative Pathology...", Am. J. Vet. Res., VII (Jul 1946), pp. 283-87.

by serial passage via the allantoic chamber in eggs at 20 to 24 hour intervals. After three to five such series of passages, the latter agent was absent or present only in the low dilutions or in the undiluted tissues or fluids of the egg.

The demonstration that fowl plague virus may clump the red cells of a number of animal species, including the horse and cat, both of which were not agglutinated by Newcastle disease virus, provided an additional differential feature. It was also shown, for the first time, that Newcastle virus-infected allantoic-amniotic fluids were lethal to young white mice via the cerebral route. /

/ "Isolation and Identification...", Am. J. Vet. Res., VII (Jul 1946), pp. 303-05.

Immunization against Newcastle disease. Prior to these wartime studies, efforts to develop a satisfactory method of active immunization against Newcastle disease had yielded negative or generally poor results. The Harvard experiments, however, resulted in the development of several successful killed virus vaccines and a living modified virus vaccine.

The minimal permissible titer of virus strains selected for the production of vaccines with maximum immunogenic activity was standardized at 10^{-7} . The strains used in the preparation of vaccines included the Hertfordshire E strain, the RO, C, 11914, KD, H, 4F, New York, and the Perugia and Milan strains. Lots of 10-day eggs were inoculated via the allantoic chamber with 10^3 m.l.d.'s of virus, incubated from 48 to 96 hours, the allantoic-amniotic fluids collected and diluted to 10^{-6} , and this material used as inoculum through 15 serial passages. Concentrations of 0.2 to 0.5 percent formalin were then used to destroy the infectivity of the virus-infected tissues for use as a vaccine. /

For ultraviolet-inactivated virus vaccine production, the E, RO, and 11914 strains were used in the form of finely ground infected embryo tissue suspended in 9 parts of infected allantoic-amniotic fluid. Satisfactory vaccines were then obtained by inactivating this material with short wave length (1600 to 1800A) irradiation with a Hanovia coil tube made available by the National Institute of Health. While the ultraviolet-inactivated virus vaccine was comparable in protective values to

/ "Immunization...", Am. J. Vet. Res., VII (Jul 1946), pp. 308-11.

the formalin-inactivated product, it demonstrated no superior advantages.

The production of living modified virus vaccines was based on the isolation of Newcastle virus variants which were virtually apathogenic for chickens, yet fully pathogenic for chicken embryos and which at the same time engendered an immunity of substantial persistence. Such a modified virus vaccine, if found, might be used to augment the immunity produced by inactivated virus vaccines or even be used for primary immunization. It was learned that the KH, H, LF, and New York strains of Newcastle virus after three or more egg passages revealed considerable loss of chicken pathogenicity, with sometimes as much as 10^9 embryo m.l.d.'s failing to produce clinical infection. These viruses in the form of unprocessed or lyophilized allantoic-~~amniotic~~ fluids, could be used for vaccine production. /

The intravenous route of inoculation, with 1.0 cc. or 0.1 cc. quantities of formalized allantoic-~~amniotic~~ fluid vaccines, yielded the highest degrees of protection in susceptible chickens. Serum titers of 10^2 or more were demonstrable 7 days after inoculation. However, intramuscular inoculation appeared to provide an earlier protection, by about one day, and this route was suggested for use in an emergency.

/ "Immunization...", Am. J. Vet. Res., VII (Jul 1946), pp. 311-12, 323-24.

/ Ibid, pp. 313-14, 328.

The duration of the immunity established in chickens by the killed virus vaccines varied greatly. In some cases good immunity was present up to 4 months; in other cases, only slight immunity was demonstrable after 3 weeks following inoculation. Experiments gave some evidence that the living modified virus vaccine provided a substantial immunity which might persist for periods of several months to four years.

Storage tests with vaccines composed of 20 percent formalin-inactivated embryo pulp, 40 percent allantoic-amniotic fluid, and 40 percent buffer, when stored at 6° C. at pH 5 to pH 9, showed that the material was maintained for as long as 471 days. /

The preparation of vaccines for fowl plague was similar to that for Newcastle disease. Their characteristics and specificity for the disease of fowl plague were analogous to the formalin-inactivated virus vaccines in Newcastle disease. /

/ ^{Ibid} ~~Op. cit.~~, pp. 319-20, 325, 328, 331.

/ ^{Ibid} ~~Op. cit.~~, p. 311.

Passive protection and specific immunization. A special problem was raised by the application of egg-propagated vaccines to the immunization of animals, such as in rinderpest, Newcastle disease, and fowl plague. The passive protection afforded the progeny of immune mothers during early life, modifying the immunity response to concurrent, specific antigenic stimuli, presented the possibility that the use of eggs from hens immune to certain infections might lead to difficulties in producing specific vaccines and to a reduction of their efficacy.

The experiments which were carried out tended to confirm previous studies of this problem. The demonstrable antiviral activity or titer of yolks from eggs laid by Newcastle-immune hens was, with few exceptions, ten to a hundredfold lower than the serum titers of these hens. The result was an interference with the normal active immunity response of young chicks to vaccination. It appeared, nevertheless, that embryonating eggs from Newcastle-immune hens may be satisfactory for production of the specific vaccine provided the yolk, yolk sac, and albumen are excluded as vaccine materials. It was possible that the continued use of eggs from immune hens for virus propagation might lead to undesirable modifications of the virus. /

/ C.A. Brandly, H.E. Moses, and E.L. Jungherr, "Transmission of Antiviral Activity via the Egg and the Role of Congenital Passive Immunity to Newcastle Disease in Chickens," Am. J. Vet. Res., VII (Jul 1946), pp. 340-42.

BROWN SPOT OF RICE
(Helminthosporium oryzae)

Code letter "E"

General. Biological studies in crop-destroying agents were suggested to the Chemical Warfare Service as early as March 1942, when it was reported that investigations of the agents of late blight of potatoes, rice fungus, wheat rusts, rubber leaf blight, and plant growth inhibitors might prove profitable. / At a conference between biologists of the National Research Council and the United States Department of Agriculture in May 1942, several rice pathogens were considered as potential biological warfare agents, one of which was Helminthosporium oryzae, the organism causing brown spot of rice. Preliminary studies were made by a group in the U.S.D.A. working at Beltsville, Maryland, under Dr. Freeman Weiss. Laboratory and greenhouse studies of the pathogen were begun by Dr. E. C. Tullis of the U.S.D.A. at Beaumont, Texas, early in 1943, and in October of that year authorization was obtained to begin studies of the agent at Camp Detrick. / Because neither facilities nor personnel were available at Camp Detrick, however, full time efforts were not begun until February 1944.

/ Memo (S), Lt. L.F. Ney to C Tech Div OC CWS, 26 Mar 42, sub: Biological Warfare. In CD Tech Lib (EW Gen.Acc.No. 8). CWS 710.17.

/ Memo (S), C CWS to CO CD, 12 Oct 1943, sub: Proj Spec CD-0 Div-Lab Br. CWS 400.1141.

The principal objective in the studies of the agents designated as "E" and "IR" was to develop, by means of laboratory, greenhouse, field, and pilot plant studies, methods for large scale production and utilization of such agents in a form adaptable to offensive use in establishing infections of epiphytotic proportions in Japanese rice fields. Although the studies conducted at Beaumont, Texas, and Camp Detrick indicated that large scale production of these particular agents was feasible, extensive application of the findings was not made. The organisms were limited in their usefulness by their special environmental needs and the chemical agents in the LN group, which were also under development, gave promise of being considerable more effective when applied to rice crops. Studies in these fungous agents were terminated at the end of the war because it was considered that little information of practical value, either for peace or war, could reasonably be expected. /

Selection of strains. Original isolations of "E" for routine use in laboratory studies and pilot plant production were made from several sources including leaf spots from naturally infected rice growing in the field in Texas and from plants grown from disease seed in the field at Camp Detrick. /

- / Sp Rpt 2, Characteristics of Some B.W. Agents for Plants (Aug 44), pp. 20-23. See also Final Report on Investigation of Fungous Agents Pathogenic to Rice, with Supplementary Notes on Factors Affecting the Pathogenicity of *Sclerotium rolfsii* (1945)
- / Sp Rpt 47, Development of E as an Agent for Biological Warfare (Jul 46), p. 43.

2. CD
Lip
M. C.
M. C.

Nutrition and laboratory production. Since infection with brown spot of rice is initiated by two forms of the organism, its spores and mycelial fragments, production of both forms were studied. It was learned that spores could be produced on agar substrates of potato-dextrose in liquid cultures, and on grain substrates. Mycelia could be produced in aerated liquid cultures of molasses and peptone.

Initial studies indicated that on a medium of potato-dextrose agar, yields of 85,000 spores per square cm. of agar slant were obtained after 15 days. With suspensions of spores obtained from these slant cultures as inoculum, abundant production of spores could be obtained on sterilized moist grains, particularly rye, oats, and sorghum, with sorghum the best medium, giving yields of more than 6 million spores per gram of dry grain after 14 days. Nevertheless, rye was recommended for mass production of spores since it did not become gummy during sterilization and packing.

Mycelial fragments were produced readily in an aerated liquid medium of 10 percent black strap molasses and $\frac{1}{2}$ percent peptone or pepticase. After sterilization at 15 psi for 20 minutes and then cooling, the 3-liter bottles of medium were inoculated with approximately 2 ml. of an aqueous suspension of conidia. / During the incubation period of 6 days at 27° to 31° C., the cultures were aerated with sterile air. The mycelia were collected in a Buchner funnel and the filter cake dried at 40° C. for 24 hours. The material was then ground to produce a dust and

/ Asexual reproductive spores formed by segmentation of the mycelium.

mixed with a limestone filler before use. /

Pilot plant production. Large scale production studies of plant pathogens were carried out in Pilot Plant No. 3, Building T-325, a large one-story air-conditioned building of tile and concrete construction. Its equipment included four large autoclaves, two steam-heated ribbon mixers for steeping grains, a 125-gallon slurry cooker for sterilizing liquid media for the reactors, three incubation cabinets and rotating and fixed drums for production of agent material on solid substrates, nine reactors for production of agents in liquid media, a drying cabinet, and miscellaneous grinding and mixing machines for final processing of the agent material. /

In the production of either mycelial or spore forms on solid substrates, cereal grains were usually employed as the substrate, although potatoes and peanut hulls supplemented with cornmeal could also be used. Prior to inoculation, the grain was steeped to a moisture content of 100 percent, then autoclaved and cooled. Following inoculation with a spore suspension, the grain substrate was spread out in shallow trays and the material allowed to sporulate in the open, or was incubated in large cabinets.

/ Sp Rpt 47, pp. 8-15, 56-57.

/ Sp. Rpt 38, A Pilot Plant for the Production of Plant Pathogens (Nov 45).

The second technique used in the pilot plant involved production of mycelia in aerated liquids. One-hundred-gallon tanks were used to hold the molasses-pepticase medium. After being sterilized and cooled, the tanks were then inoculated with spores or actively growing minced mycelia. / The liquid medium was then aerated at the rate of 0.3 to 0.4 volumes of sterile air per minute for 6 to 7 days, when maximum growth of the mycelial material was reached. /

The greatest problem in pilot plant work with fungous material was occasioned by contamination of the substrates with undesirable bacteria and fungi. Part of this was believed due to superficial disintegration of the plant flooring which resulted in stirring up contaminating dusts. Other sources of contamination of liquid culture processes were partially eliminated by the installation of piping systems which avoided pockets or connections where contaminants might resist sterilization. Contamination by air-borne organisms was reduced by stringent sanitary measures, air filters, actual sterilization of small rooms, and the use of preliminary protected growth periods in closed containers.

/ W.W. Dorrell and R.M. Page, "The Use of Fragmented Mycelial Inoculum in the Culture of Fungi," Journal of Bacteriology, 53 (Mar 1947), 360-6

/ Sp Rpt 47, pp. 95-141.

Harvesting. The separation of spores from cultures grown on grain substrates was accomplished by washing and shaking with water, by dry brushing, or when separation was not required, the substrate and agent were processed together. When water was used, the spore suspension was concentrated by settling overnight at 10° C., to prevent germination. After the spores had settled, the supernatant liquid was decanted and the spores from the concentrated suspension collected by filtration in a Buchner funnel and coarse filter paper. The spores were then over-dried for 24 hours at 40° to 42° C. Yields of 5 million spores per gram of dry substrate were obtained on rye, the best medium.

Mycelia were best harvested by washing, drying, and vacuum filtration. After filtering, the mycelial material was dried at 40° C. to a moisture level of 4 to 6 percent. The result was a yield of 10 to 15 pounds of mycelial agent per 100-gallon tank. This dried material was then easily ground to a dust form which represented the final product. /

Storage. Spores retained their viability for many months when stored under cool dry conditions. At the end of 100 days, 81 percent of a spore lot stored at 2° C. were still viable. Mycelia were somewhat less resistant to loss of viability under prolonged storage.

The virulence of cultures of "E" used as inocula was maintained for a period of 943 days without transfer. The laboratory grown organism:

/ Sp Rpt 47, pp. 92-94.

will survive through a winter and will withstand freezing at minus 40° C. for a period of 60 hours.

Dissemination. Both spores and mycelia were more effective when applied to plants in dust form than as aqueous suspensions. Preliminary trials with the SS bomb showed that a single plane could contaminate 8 square miles with a spore concentration of 100 mg. per square mile or more. / In a series of trials made in July 1944 with the SPD Mark 2 bomb, the results indicated that pattern size and concentration could be predicted from any given particle size if the wind speeds and heights of bomb opening were known. This bomb appeared to be completely successful for the purpose for which it was designed.

Pathogenicity. Greenhouse trials showed that the age and variety of rice had little effect on susceptibility to infection. Although both spores and mycelial fragments proved highly infective, on a weight for weight basis spores were five to ten times more effective. A 10-hour period of high moisture after inoculation was required for the establishment of an infection at 20° to 30° C. Rice was susceptible to leaf infection at all stages of its development. /

/ Sp Rpt 47, p. 166.

/ A.F. Sherf, R.M. Page, E.C. Tullis, and T.L. Morgan, "Studies of Factors Affecting the Infectivity of *Helminthosporium Oryzae*," Phytopathology, XXVII (May 1947), 281-90. See also Sp Rpt 47, pp. 164-65.

It was observed that secondary spread of the disease was brought about by the conidia, the banana-shaped reproductive bodies which are produced in large numbers on the leaves and heads of infected rice plants. The primary function of conidia appeared to be connected with the spread of the fungus rather than with its persistence. Since conidia retained their viability only in low temperatures, it was apparent that the warm moist climates of many rice growing regions would be unfavorable for the survival of conidia. /

/ R.M. Page, A.F. Sherf, and T.L. Morgan, "The Effect of Temperature and Relative Humidity on the Longevity of the Conidia of *Helminthosporium Oryzae*," Mycologia, LXXIX (Mar-Apr 1947), 153-64.

RICE BLAST
(Piricularia oryzae)

Code letters "IR"

General. Studies on rice blast were initiated in November 1943 as a WRS project under the direction of Dr. E. C. Tullis at the Texas Agricultural Experiment Station at Beaumont. Dr. Tullis had observed the ravages of this disease in Arkansas where it annually caused great destruction in plantings of Japanese rice varieties. Barley, corn, rye and wheat in the seedling stage of development were also known to be susceptible to infection by this fungus. The importance of the pathogen in Japan was described as follows: "There is no doubt that the blast disease of the rice plant caused by Piricularia oryzae is the most important and destructive enemy of farming in Japan....The disease is widely distributed throughout the Empire, causing great damage every year." /

The success achieved in preliminary studies of "IR" at the Texas station led to approval of a CWS project for its development as a biological warfare agent at Camp Detrick. The project was initiated in March 1944 and before it came to a close, production and processing techniques developed in the laboratory had been successfully applied on a pilot plant scale. However, the soil and climate at Camp Detrick made field studies of "IR" inconclusive. Similar studies were not

/ Quoted in Sp Rpt 39, Development of IR as a Biological Warfare Agent (Nov 1945), p. 1.

conducted on a large scale elsewhere in view of the development of the LN series of compounds.

Selection of strains. Two field isolates of "IR" were obtained from Dr. Tullis and used in the production studies at Camp Detrick. The first, designated P-1, was isolated in September 1943 from dead rice stubble obtained from an old rice field in Arkansas. The other, designated P-63, was obtained from Cody rice in Arkansas in 1944.

Nutrition and laboratory production. A 2 percent rice polish agar was the best medium for sporulation of the agent and was used for perpetuation of stock cultures. The organism was found to require only thiamin and biotin among the vitamins for growth and sporulation, in addition to a number of amino acids, purines, pyrimidines, and carbohydrates.

A liquid medium for producing mycelium as inoculum consisted of 2 percent black strap molasses and 0.2 percent peptone, but tests did not indicate that mycelia could be used either for seeding cultures or as a final form of agent, and mycelial production was not therefore attempted in the pilot plant.

In the production of spores, a solid substrate containing equal parts of oats and Hegari sorghum, or corn alone, with water content of 54 percent was used. The optimum amount of spore inoculum for seeding this substrate was 10,000 spores per gram dry weight. Incubation for the best sporulation varied from 5 to 10 days. Forced aeration was required in closed vessels

with grain substrates unless the infested substrate was transferred to open vessels for the latter part of the incubation period. Use of semi-open vessels for the entire incubation period was not possible since air-borne contaminants overran the substrate and prevented development of the slow-growing agent material. /

Pilot plant production. The preparation in the pilot plant of a grain substrate which was completely free of contamination and was not lumpy was achieved by presoaking the grain in hot water at 80° C. and by autoclaving the presoaked grain at least twice on successive days.

Seed cultures for pilot plant production were inoculated with 10 ml. of a spore suspension containing 200,000 spores per ml. The cultures were aerated for 7 days and were harvested by vigorous agitation in cold water as the spore suspension was siphoned off. Each culture flask yielded enough spores for 160 pounds of pilot plant substrate. The substrate of oats and sorghum, which had been steeped at 80° C. for 2 hours to a moisture content of 100 percent and then sterilized in the autoclave, was poured out on trays and inoculated by spray with an atomizer over the surface of each tray. The material was then incubated at 85 to 90 percent relative humidity and 77° to 81° F. for 9 to 10 days.

/ Sp Rpt 39, pp. 10-16.

Harvesting. After reaching maximum growth, the spores were separated from the grain substrate either by washing with water, by filtering, or by drying and then brushing them loose with an adapted grain polisher. In harvesting the spores with water, concentration of the spore suspension was effected by settling, centrifuging, or filtering. The latter method was successfully applied in both the laboratory and the pilot plant. Yields of as much as 30 million spores per gram of dry substrate were obtained in pilot plant operations, but the average was closer to 20 million spores per gram. /

Storage. Apparently insoluble was the problem of maintaining the stability of rice blast cultures. The instability of the organism was believed to be due to the impurity of the original culture and the tendency for the nonsporulating type of organisms to displace the sporulating type. The latter type was recovered by re-isolation from infected plants or by mycelial transfers from stock cultures.

The loss of viability of spores incurred during processing and after storage was largely overcome by improvements in techniques and by the addition of black neutral peat as a filler with the spores. The thermal death point for wet spores appeared to be 52° to 54° C. and for dry spores, 64° to 66° C. Properly processed spores were found to survive satisfactorily in transit if kept dry and cool.

/ Sp Rpt 39, pp. 67-113.

Dissemination. It appeared that rice blast spores in the dry state would be the only feasible form in which to disseminate them effectively and production spores were therefore processed in a dust form for use either as a dust or resuspended in water. The SS bomb appeared practical for dissemination of the agent in this dust form.

In greenhouse tests conducted at Camp Detrick, considerable difficulty was encountered in establishing infection on rice plants inoculated with aqueous suspensions of the conidia of this organism due to the high surface tension of the droplets on the waxy surface of rice leaves. Free moisture on the leaves rolled off, removing the conidia before it could germinate and infect the plant. A solution of agent containing 0.05 percent sodium oleate and 0.25 percent gelatin proved to be an effective spreader-sticker combination for use with the inoculum. /

Because high humidity and the presence of free moisture on the leaves of infected plants were essential for secondary spread and establishment of infection, the field studies carried out in Texas were not entirely satisfactory. Plants were never exposed to as much as 12 to 14 hours of free moisture at any one time, which was necessary for the initiation of infection, nor was there continuous wet weather for periods greater than 24 hours, the conditions required for optimum secondary spread of the disease. Showers followed by sunshine resulted in drying of the leaves, thereby destroying the agent material on them. /

/ A.L. Andersen and B.W. Henry, "The Use of Wetting and Adhesive Agents to Increase the Effectiveness of Conidial Suspensions for Plant Inoculations," Phytopathology, XXXVI (Dec 1946), 1056-57.

/ A.L. Andersen, B.W. Henry, and E.C. Tullis, "Factors Affecting Infectivity, Spread, and Persistence of *Piricularia oryzae* Cav.," Phytopathology, XXXVII (Feb 1947), 94-110. See also Sp Rpt 39,

Pathogenicity. Rice, barley, corn, rye, and wheat are all susceptible to rice blast infection under greenhouse conditions. Air temperatures above 21° C. were necessary to initiate the infection on rice plants. Plants growing in cool soil between 15° and 20° C. were less susceptible to infection than those in wet soils at the same temperatures, but at soil temperatures between 30° and 35° C. there was no difference.

A heavy rain within 8 to 10 hours after initial application of the agent materially reduced the amount of infection when a dust inoculum was used and to a lesser degree when the inoculum was a spore suspension. High humidity and continuous wetting for a 16 to 24 hour period resulted in maximum infection. A minimum period of about 6 days after inoculation was necessary for lesions to develop to the stage where they produced spores, which, in turn, might serve as inocula for secondary infections. High humidity and presence of free moisture on the leaves resulted in maximum spore production with secondary spread between the sixth and twelfth days. Under such conditions, a 15-hour exposure was not sufficient to allow secondary infection to any significant degree, but a 21½-hour period of continuous wetting resulted in spread and establishment of a high degree of infection.

No evident antagonism was noted between the agents of brown spot of rice and rice blast when grown together on rice polish agar or when their spores were allowed to germinate together. However, when these two rice agents were applied together on plants, the organisms of brown spot of rice tended to inhibit rice blast infections. /

/ Sp Rpt 39, pp. 114-31, and Sp Rpt 2, Characteristics of Some B.W. Agents for Plants (Aug 44), pp. 15-19.

LATE BLIGHT OF POTATO
(Phytophthora infestans)

Code letters "LO"

General. The dependence of Germany on the potato for a large portion of its total nourishment was a factor in the selection of "LO" for study in the biological warfare program. From a defensive standpoint, the investigation was also justified by the vast American and Allied investments in the crop.

Preliminary experiments with the agent of late blight were conducted under WRS auspices at the Maine Agricultural Experiment Station at Orono, the New Jersey Agricultural Experiment Station at Brunswick, and at the U.S. Department of Agriculture station at Beltsville, Maryland. The project was assigned to Camp Detrick in January 1944. The studies carried out on "LO" at these stations indicated that the agent was extremely destructive but that its use as an agent of war was limited by its apparent instability in storage and the special climatic requirements demanded for initiation of the plant infection. It was not determined whether or not large scale production of Phytophthora infestans was feasible. ✓

- ✓ R. Bonde and S.F. Snieszke, "Summary of Data Obtained in Maine Pertaining to the WRS Late Blight Project," WRS Report LO-2 (1943).
In CD Tech Lib (LO Acc.No. 4).
Sp Rpt 2, Characteristics of Some B.W. Agents for Plants (Aug 44),
pp. 9-14.

Laboratory production. Solid media examined for laboratory production of "LJ" included extracted legume seeds; cereal grains, particularly wheat and rye, mixed with peanut hulls; various legume seeds, such as the navy bean, mixed with peanut hulls; preformed pellets of ground potatoes, peanut hulls and pulverized peat, bound with raw egg albumin. A liquid medium was made from water extracts of germinated wheat and malted rye with the addition of dextrose. The addition of 0.1 to 0.5 percent agar to this liquid medium considerably increased its yield.

All media were sterilized for 20 to 30 minutes at 15 to 17 pounds pressure in an autoclave prior to inoculation. The inoculum was a suspension of sporangia or mycelium, prepared by washing sporangia from cultures 3 to 20 days old grown on peanut hull-grain mixtures in 250-ml. erlenmeyer flasks in sterile distilled water at 20° C. The use of an inoculum containing at least 10,000 spores per ml. produced good fungus growth in about 9 days at 20° C. /

Navy beans and preformed pellets appeared to be the best vehicles of the fungous agent. Preformed pellets inoculated with Ph. infestans became covered with a dense growth of mycelia and sporangia, with the interior of the pellets thoroughly ramified by the fungus. The easily permeated seed coat of the navy bean made that legume a good vehicle.

/ Sp Rpt 54, A Comprehensive Report on Investigations Concerned with the Development of Phytophthora infestans as a Potential Agent for Biological Warfare (Oct 45), pp. 2-12, 14.

The surface of the bean carried residual sporangia and sporangiophores from the culture, while inside the seed became filled with mycelia. The seeds were infected on a peanut hull-navy bean medium and in 8 to 10 days the fungus had permeated the seed. /

Little or no work was done on pilot plant production of this fungus, except in studies of the use of normal living potato tubers when infected with sporangia for the propagation and dissemination of the agent. It was learned that live tubers could be infected easily on a large scale. /

Storage. Sporangia of the fungus retained their viability best when stored in undisturbed cultures rather than as harvested agent. Mycelium could be stored successfully in water, in liquid media, or in soil slurry for at least 30 days and in dextrose solution for at least 52 days.

The fungus lived for more than 3 months without loss of viability in pellets partially dried and stored at 20° C. Infested navy beans survived at least 30 months at 20° C. when cultured on a peanut hull-bean medium. Under suitable conditions, sporangiospores emerged from navy bean seed and produced sporangia from which infection was initiated.

/ Sp Rpt 54, pp. 86-88, 103.

/ Sp Rpt 54, pp. 109-111.

Dissemination. Extensive greenhouse tests were made at Camp Detrick on the infection of potato plants with various forms of the agent. Uniform good results were obtained under the controlled conditions. Field experiments ^{were} carried out at Orono and Presque Isle, Maine, and in New Jersey. Only the experiments in Maine in 1943 were successful due to the prevalence of ideal conditions for this organism.

Pathogenicity. Inocula in the form of sporangia, mycelium, infected tubers, preformed pellets, and infested navy bean seed were all capable of initiating infection, but only under suitable environmental conditions. The optimum conditions for infection were free moisture on the plants, high humidity, and cool temperature. These were considered highly restrictive for employment of this agent in the field. /

SOUTHERN BLIGHT
(Sclerotium rolfsii)

Code letter "C"

General. With the German potato and sugar beet crops in mind, as well as certain staples of the Japanese, study of the biological warfare possibilities of "C" was begun by WRS in 1942. The project was assigned to WRS workers at the Department of Agriculture station at Beltsville, Maryland. Continuation of the investigation was authorized for Camp Detrick in October 1943.

The crops tested for infection by Sclerotium rolfsii at Camp Detrick were those commonly grown in Japan (rice, cereal grains, soybeans, and sweet potatoes) and those grown in Central Europe (Irish potatoes, sugar beets, and grains). Media and cultural methods were devised for production of the fungus and infestation of inert carriers. Large scale production of agent-infested seeds for offensive use did not present any major problems and the agent material, it was learned, could be stored for periods of at least 12 months in a cool dry atmosphere with little loss of vigor.

The investigation of the agent was abandoned shortly after the war. By then it had been learned that the principal Japanese crops, rice, cereals, and sweet potatoes, were all too resistant to permit effective use of the agent in any conceivable circumstance. /

/ A final report from the Beltsville group stated that brown spot of rice, rice blast, Southern blight, and Rhizoctonia salani were all

Selection of strain. Following tests on the four strains of Sclerotium rolfsii available for study at Camp Detrick, one designated as "C" was chosen because of its vigorous growth, high virulence and effectiveness against the widest variety of plants.

Although as many as five passages were made with the four original strains, in no case could any re-isolate of any strain be identified by new morphological characteristics nor could their virulence be increased. All strains were found to be quite stable, with no change in cultural characteristics observed in over a year.

Laboratory production. It was found that the organism of Southern blight seldom produced spores of any type, either in artificial culture or in nature. The work at Camp Detrick, therefore, was originally directed to the production of sclerotia and mycelia of the fungus. In addition to sclerotial and mycelial material, the agent was also made up as an infested seed and as pellets of infested bran. Later, production of sclerotial and mycelial pellets was abandoned when field trials proved these forms to be less effective than infested seeds.

incapable of serious destruction to rice plants when inoculum of the seed or pellet type were dropped on plants between sprouting and planting time (first month). A 50 percent reduction in the crop was possible when the soil was heavily inoculated before the seed was sown or seedlings transplanted in it. Under very favorable environmental conditions, however, any of these agents might cause a basal leaf-sheath rot in growing rice plants, resulting in appreciable stunting of growth. Rice growing in submerged soil would be less readily infected than that in dry soil.

F. Weiss, Div of Mycology & Disease Survey, U.S.D.A., Final Report on Investigations of Fungous Agents Pathogenic to Rice, with Supplementary Notes on Factors Affecting the Pathogenicity of Sclerotium rolfsii (15 Jul 44). In CD Tech Lib (Acc.Nos. C10 and C25).

Sclerotia was produced in a 10:3 mixture of cornmeal and peanut hulls with 75 percent water. Separation of the sclerotia from the mass of medium was accomplished by breaking the bond between the agent material and medium, separating the sclerotia from larger particles by use of a 16-mesh screen, and separation of finer trash by fanning. Mycelial production required culture on a carrier substrate such as grass seed or bean pellets which were allowed to become thoroughly infested with the hyphae. These infested particles after being dried then served as carrier of the mycelial inoculum.

For infested seed production, the mycelial form of agent was inoculated in wheat seed. Water content of the wheat seed had to be held at a minimum of 35 percent to prevent production of sclerotia and to keep from destroying the seeds when they were autoclaved. The best temperature for growth of mycelia was between 30° and 35° C. during the 10 to 12 day incubation period. After removal from the culture chamber, the infested seed was harvested by drying rapidly at 45° C. Control during production was maintained by agar plate tests to determine the vigor of growth of the agent and by tests on 6-day old cowpea plants to determine the infectivity of infested wheat seeds. /

/ Sp Rpt 27, The Development of "C" for Offensive Use in Biological Warfare (A Comprehensive Report of Investigations Conducted at Camp Detrick by C Division, Sep 1943-Nov 1945) (Nov 1945), pp. 47-50.

Pilot plant production. In early pilot plant production of the sclerotial form of agent, a 10:3 peanut hull-cornmeal mixture was used, with 30 parts of water added and the whole placed in shallow trays and sterilized. Ten percent dry weight of infested wheat kernels were then mixed in as inoculum and the culture was incubated at 77° to 81° F. for 10 to 14 days. Processing was accomplished either by a flotation method with the sclerotia separated from the substrate by differences in specific gravity or a dry screening method whereby the material was dried for 24 hours at 40° C. and the sclerotia separated by passage over shaking screens. The latter was the more reliable method. Control of sclerotial production was maintained by moisture determinations on substrates and by viability and vigor tests on the sclerotia. The yield obtained was 50 percent of the mass of material or an estimated 655 pounds of agent per month in a plant the size of Pilot Plant No. 3.

Subsequent pilot plant studies indicated that the fungus agent was better produced in the form of cereal grains infested with mycelia of the fungus. Grain, preferably wheat, was steeped to a moisture content of 55 percent, autoclaved, cooled, spread on shallow metal trays, and then inoculated with freshly prepared infested grain, the amount of inoculum representing 5 percent of the dry substrate. After 4 to 5 days of incubation at 25° to 27° C., the mycelia had infected all the grain and it was then dried at 40° C. for 24 hours to a moisture content of 8 to 10 percent. As a control on the vigor of the grown material, it was determin

that any infested kernel which produced a colony of fungus 15 mm. or more in diameter in 24 hours on water agar was satisfactory. It was estimated that 27,000 pounds of infested seeds per month could be produced in Pilot Plant No. 3.

It was learned that the inoculated grain could not be more than 5 or 6 inches deep in the tray containers or the heat of growth inside the mass would reduce the viability and vigor of the agent. Suitable agent material could also be produced by piling inoculated grain on a clean concrete floor to a depth of 5 inches and raking the mass daily to dissipate the heat. Forced aeration of the grain was not necessary for maximum growth. /

Storage. Infested seeds were maintained in cool dry storage for as much as 12 months with little loss of vigor. High humidity and high temperatures caused serious reductions in vigor very quickly.

Discernation. For those plants against which Sclerotium rolfsii is effective, application of the agent just prior to a warm wet period of the growing season was considered to be most effective for maximum results. It should be made early in the season, just before or immediately after the crops have been planted. The inoculum may remain dormant in / Sp Rpt 27, pp. 90-91.

soil for at least 3 weeks without loss of vigor.

No definite recommendations as to application rates could be made, but preliminary tests suggested that 16 pounds of agent material per acre would be suitable for sugar beets if disseminated under suitable conditions. Even 48 pounds per acre, however, proved ineffective against large numbers of common garden plants. It was believed that distribution by aircraft over wide areas given to the production of susceptible crops would be the only practical means for disseminating sufficiently large quantities of agent material.

These were the results of large scale tests of Southern blight conducted on rice crops at Baton Rouge, Louisiana, and Beaumont, Texas; on soybeans and sweet potatoes at Griffin, Georgia, and Raleigh, North Carolina; and on Irish potatoes at Presque Isle, Maine, and Three Rivers, Wisconsin.

Pathogenicity. In the large scale tests, cereals proved noticeably resistant to Southern blight. Cereal grains, rice, and sweet potatoes were so highly resistant that the agent was of no value even in the seedling stage of their growth. On the other hand, root crops, such as sugar beets and carrots, were very susceptible, their roots serving as an excellent source of food for the fungus. The soil immediately surrounding the root for several inches in all directions was often filled with the mycelia and sclerotia, facilitating spread of the agent from plant to plant. Irish potatoes and lettuce were also highly susceptible, with

soybeans and field beans intermediate in susceptibility.

It was observed that the susceptibility to disease decreased in most crop plants with age. However, sugar beets and carrots were more or less susceptible at all stages of growth. The fungus of Southern blight was found capable of growing and attacking plant seeds in soil too dry to support growth of a plant or even permit germination of the seeds. It is known that sugar beets are so susceptible to this agent that the fungus may remain in the soil in mild climates from 3 to 5 years before a reduction of its sclerotial material will permit successful growing of sugar beets again.

In field and greenhouse trials, infested wheat seeds were found more effective in initiating infections than either sclerotia, which usually failed to germinate in the soil, or pellets, which rapidly became covered with soil fungous contaminants.

An observable difference in the course of disease was noted in comparative studies of seedlings and older plants. On greenhouse seedlings symptoms of blight were similar for all crops. The agent attacked the host at or near the soil line and caused complete decay of that section of the stem. Wilting of the plant did not usually take place until the plant had fallen over. On both seedlings and older plants in the field, however, the plant usually wilted first and fell over later, and the point of attack, except in wet weather, was usually several millimeters below the soil surface. The attack on older plants was usually limited

to the region of the stem near the soil line.

A study of growth conditions was made using constant temperature water baths and plants 5 to 6 days old. A plant was recorded as dead when the fungus had destroyed the base of the stem to such an extent that it no longer supported the plant. Under these conditions, poor growth of the fungus was recorded at temperatures below 26° C. and above 36° C. Maximum growth was obtained at approximately 30° C. in a 48-hour period.

/ Sp Rpt 27, pp. 99-105, 139-140; Sp Rpt 2, pp. 2-8; F. Weiss,
Final Report....

CHEMICAL PLANT GROWTH REGULATORS

Code letters "LN"

General. In April 1944, the project for the development of chemical agents to destroy or reduce the value of crop plants was activated at Camp Detrick, to be carried out by the Plant Research Branch, ODD. Related projects were undertaken at Beltsville, Maryland, under Dr. J. W. Mitchell of the U.S. Department of Agriculture, and at Ohio State University under Dr. M. S. Newman. The objectives of these investigations were to discover new chemicals which might be effective against plants and to determine the amounts of chemical required and the most feasible methods for its application for the destruction of crop plants.

A total of 1,053 different chemical compounds were examined and tested at Camp Detrick. Of these, 226 compounds were synthesized at Ohio State University and most of the rest were prepared at Camp Detrick. Of all compounds tested, the halogenated phenoxy acetic acids and their functional derivatives appeared to be best suited for military purposes.

It was demonstrated in aerial field trials held at Bushnell, Florida, between February and April 1945 that complete destruction or severe injury could be accomplished against any herbaceous broadleaf crop with relative

/Special Projects Division, CWS, "Plant Growth Regulators," Science, 103 (19 Apr 1946), 463-70.

H.E. Thompson, C.P. Swanson, and A.G. Norman, "New Growth-regulating Compounds. I. Summary of Growth-inhibitory Activities of Some Organic Compounds as Determined by Three Tests," Botanical Gazette, 107 (Jun 1946), 467-507.

M.S. Newman, W. Fones, and M. Renoll, "New Compounds as Plant Growth Regulators," Journal of American Chemical Society, 69 (Mar 1947), 715-23.

small amounts of selected LN agents sprayed from standard ELO chemical spray tanks mounted on tactical aircraft. / A recommendation for tactical use of the new crop agents was made to the General Staff in May 1945.

No thoroughly successful approach was made as a result of wartime studies for the destruction of cereal crops by chemical agents, although several compounds appeared promising.

Selection of agents. The studies made at Camp Detrick and under contract in the chemical plant growth regulators were developed from the base laid by many workers on the plant effects produced by hetero-auxin, naphthalene acetic acid, and similar or related compounds. Of the 1,058 compounds examined, only a few were studied at any length. They include:

LN-2	Para monochlorophenoxyacetic acid
LN-8	2,4-Dichlorophenoxyacetic acid
LN-14	2,4,5-Trichlorophenoxyacetic acid
LN-32	2-methyl-4-chlorophenoxyacetic acid
LN-33	isopropyl phenyl carbamate
LN-44	ethyl ester of LN-3
LN-143	normal butyl ester of LN-8
LN-155	allyl ester of LN-2
LN-379	chloride of LN-14

/ Sp Rpt 12, Crop Destruction by Aerial Sprays. Preliminary Trials (26 Apr 45).

In the tests to determine the relative effectiveness of compounds being examined as crop-destroying agents, the common reference material used was 2,4-dichlorophenoxyacetic acid (hereafter, 2,4-D). With inhibition of growth due to the use of 2,4-D designated as 100 percent, comparative results were obtained by subjecting germinating corn seed to 20 ml. of aqueous solution of each compound to be tested, / and kidney-bean plants to 0.02 ml. of an aqueous solution and 0.01 ml. of an oil solution of the compound being tested.

Production. No compound tested surpassed 2,4-D in general effectiveness against a wide variety of crops and as a result, large quantities of this agent were produced for the numerous greenhouse and field trials which were subsequently carried out. A commercial grade of the compound, purified through the ammonium or alkali metal salt by several recrystallizations from aqueous and alcoholic solutions, was prepared for the Special Projects Division by the Dow Chemical Company of Midland, Michigan and the Sherwin-Williams Company.

LN-3, the wartime designation of 2,4-dichlorophenoxyacetic acid, was prepared in bulk as an acid solid (VKA), as an ammonium salt (VKS), and as a liquid (VKL). Vegetable Killer Acid, a granular powder, was

/ The ability of 2,4-D to inhibit the elongation of the primary root of germinating corn seed provided a bio-assay method for determining unknown low concentrations of 2,4-D. C.P. Swanson, "A Simple Bio-assay Method for the Determination of Low Concentrations of 2,4-Dichlorophenoxyacetic Acid in Aqueous Solutions," Botanical Gazette, 107 (Jun 1946), 507-09.

packaged in paraffined-fiber cartons containing 200 pounds of agent, sufficient to make 500 gallons of 5-percent solution. Vegetable Killer Liquid was prepared on the basis of 24 gallons of tributyl phosphate / per 100 pounds of VKA, or in smaller quantities, 0.95 quart per pound of VKA. The final volume amounted to 31.75 gallons, containing 33.8 percent agent by weight or 3.15 pounds of agent per gallon. When prepared in 55-gallon drums, 170 pounds of VKA were dissolved in 40 gallons of tributyl phosphate, to give a volume of 53 gallons of material weighing 495 pounds. / When VKL was ready to be used, it was diluted with diesel fuel oil to make ^{330 gallons of} a 5-percent solution of active agent.

Dissemination. The first dispersion tests were made using the M10 airplane spray tank, which held approximately 30 gallons of material. The plants used in these trials were kidney-beans, soybeans, sweet potatoes, oats, rice, and corn. On the basis of the tests, it appeared that the best oil spray was one containing 2.9 percent VKA dissolved in tributyl phosphate and diesel oil, and the best aqueous spray was one containing 2.9 percent VKS in water. /

/ W.B. Ennis, Jr., H.E. Thompson, and H.H. Smith, "Tributyl Phosphate as a Solvent for Preparing Concentrated and Oil-miscible Solutions of 2,4-Dichlorophenoxyacetic Acid and Similar Substances," Science, 103 (19 Apr 1945), 476.

/ Ltr (S), Tech Dir SPD to C Tech Dept VP, 23 Apr 45, sub: Preparation of VKA. In VP Tech Dept (SPCYF 613.34).

/ Sp Rpt 12, p. 2.

Three trials were conducted at Granite Peak Installation in June, July and September 1945. In the first, M16 cluster adapters were tested as possible agent containers. They proved unsatisfactory due to mechanical difficulties which appeared to be constitutional, and no assessment of the effectiveness of the dispersed material could be made. In the second series of trials, the SPD Mark 2 bomb, adapted from the M10A1 cluster container, was examined. The results with this bomb indicated that pattern size and concentration per unit area could be predicted for any given particle size if the wind speed and height of cluster opening were known. / The bomb was considered entirely successful for the purpose for which it had been designed. The third series of trials resulted in little information due to faulty fuses and indeterminate variations in particle sizes of the material used.

/ The formula developed by Dr. H.C. Weingartner of Division 10, NDRC, for determining the proper height of burst of VKA-loaded clusters, in order to obtain the desired ground pattern, was: $h = \frac{645}{V} \times \frac{59.7}{0.533}$; with h = height of burst above the ground in feet, and V = mean wind from ground to height of burst in feet per second. The ground pattern obtained with this formula was 645 yards long downwind and 150 yards wide. The formula assumed a charge of 100 pounds of material per cluster, to give uniform coverage of five pounds of agent per acre. See ltr (S), Asst Tech Dir for MIA SPD to Cinc GPI, 29 Jun 45, sub: Formula for Determining Proper Height of Burst of VKA Loaded Clusters (in VP Tech Dept, SPCXF 618.34). See also MTR GPI (Jul 45), pp. 1-2.

Aerial spray trials were held at Terre Haute, Indiana, and at
Beaumont, Texas, using 550-gallon bomb-bay tanks in B-25's. These tanks
were found to be suitable for the dispersion of crop-destroying solutions.
While no other growth regulating compound proved superior to VKA in
these tests, it was learned that the oil miscibility of esters of certain
phenoxy acids, such as LN-44, made them very effective and under some
circumstances might replace VKA with advantage. /

/ Sp Rpt 25, Crop Destruction by Aerial Sprays. Field Trials 1945.
Vigo Plant, CWS, Terre Haute, Indiana, and Beaumont Texas. April-
October 1945 (Oct 45).

Toxicity of phenoxycetic acids.

Stem curvature, epinasty (downward curvature of leaves), proliferation of various plant parts, and formation of gall-like growths were found to be common responses of plants to single drops or spray applications of 2,4-D. When the compound was brought into contact with aerial portions of plants, it apparently entered by penetration of the cuticle, epidermal layer, and underlying cells of the leaves and then made its way rapidly to the stems. Experiments that were made supported the theory of upward movement of growth regulators in the xylem and possible downward movement in the phloem. / The leaves of young soybeans absorbed maximum amounts of 2,4-D within 6 hours after application. / The effect of 2,4-D was shown to be systemic in nature, rather than local, even in relatively low concentrations, and in this respect it differed from other growth-regulating compounds. /

As a result of greenhouse and field trials, it was learned that a 3 percent solution of LN-8 (one pound per ten gallons of solution) in oil or water would severely injure or kill most broadleaf crops. A 5 percent solution was required for plants in the mature stages of growth. Concentrations up to 15 percent had relatively little effect on any of

- / The phloem is the part of the conductive tissue which conveys the elaborated food materials from the leaves down to the stem. The xylem is the trachea tissue of plants in which water is conveyed from the roots up the stem and also furnishes mechanical support to the plant.
- / R.J. Weaver and H.R. DeRose, "Absorption and Translocation of 2,4-Dichlorophenoxyacetic Acid," Botanical Gazette, 107 (Jun 1946), 509-21.
- / C.P. Swanson, "Histological Responses of the Kidney Bean to Aqueous Sprays of 2,4-Dichlorophenoxyacetic Acid," Botanical Gazette, 107 (Jun 1946), 522-31.

the cereal crops. No spread, as the secondary infections of fungi, was possible with chemical compounds, the agent affecting only those plants it falls on. For soil contamination, applications ^{at the rate} of 5 pounds of LN-8 in granular pellet form per acre effectively killed young plants, but was ineffective against older plants. No completely satisfactory method for destroying cereal crops was found, although the carbamates as a class showed promise against cereals in their early stages of growth. A spray of ammonium sulfamate at the rate of 5 pounds per acre stopped all yields of rice but only when applied at the heading stage. /

Treatment of cabbage, soybean, tomato, sweet potato, and sugar beet plants with an aqueous spray of ammonium 2,4-dichlorophenoxyacetate at various stages of growth indicated that the immature plants only were severely inhibited or killed by the agent. / Similar results were obtained when young vegetative red kidney bean, soybean, cowpea, wheat, and corn plants were grown in nutrient-solution cultures / which contained various concentrations of 2,4-D, the agent proving toxic to all plants, with the cereals slightly more resistant than the broadleaved crop plants. From these studies it appeared that when 2,4-D was pre-

- / J.W. Mitchell, "Results of Field and Greenhouse Experiments Concerning Effectiveness of LN Compounds," WRS Progress Report No. LN-1 (1 Jul 44-1 Jan 45).
- / R.J. Weaver, C.P. Swanson, W.B. Ennis, Jr., and F.T. Boyd, "Effect of Plant Growth-regulators in Relation to Stages of Development of Certain Dicotyledonous Plants," Botanical Gazette, 107 (Jun 1946), 563-68.
- / This was Hoagland's standard nutrient solution containing chemicals in the following concentrations: 0.005 M monopotassium acid phosphate, 0.001 M ammonium dihydrogen phosphate, 0.005 M calcium nitrate, 0.005 M magnesium sulphate, 0.00012 M ferric citrate, and minor elements, in distilled water to pH 6.0-6.2 with sodium

sented in nutrient cultures, it caused greater inhibition to growth of plants than was caused by equal or larger amounts of 2,4-D when applied as soil treatment. /

Irish potatoes could be killed or severely injured only by applications of LN-14. When applied to the vegetative portions of the plants in aqueous or oil sprays or to the soil, it caused pronounced stunting and distortion of vegetative growth, with marked reduction in yield and quality of tubers. LN-8 and LN-32 in oil solutions caused some reduction in yield but in aqueous solutions had no effect on either top growth or yield when applied at rates which would kill or inhibit the usual broad-leaf weeds. /

Studies made on the effect of 2,4-D upon germination and seedling development of twenty-two cereal and broadleaf crops showed that this agent inhibited germination in every case, decreased the growth of young seedlings, and caused abnormalities in the anatomy of seedlings. Notable was the lack of specificity of 2,4-D in its inhibition of germination. /

- / D.L. Taylor, "Observations on the Growth of Certain Plants in Nutrient Solutions Containing Synthetic Growth-regulating Substances. I. Some Effects of 2,4-Dichlorophenoxyacetic Acid. II. The Influence of Presentation Time," Botanical Gazette, 107 (Jun 1946), 597-619.
- / W.B. Ennis, Jr., C.P. Swanson, R.W. Allard, and F.T. Boyd, "Effects of Certain Growth-regulating Compounds on Irish Potatoes," Botanical Gazette, 107 (Jun 1946), 563-74.
- / R.W. Allard, H.R. DeRose, and C.P. Swanson, "Some Effects of Plant Growth-regulators on Seed Germination and Seedling Development," Botanical Gazette, 107 (Jun 1946), 575-83.

In quantitative studies of aqueous 2,4-D, it was shown that volume rates of 10 to 20 ml. per square yard were the most effective when applied to young kidney-bean plants. Sprays of relatively large droplet size, with average diameters between 250 and 561 μ , were more effective than small droplet sprays. Maximum deposition and retention resulted under these conditions. Both larger and smaller volume rates were less effective than 10 to 20 ml. per square yard. /

Since it had been shown that it took several hours for plants to absorb maximum amounts of 2,4-D sprays, tests were made to determine to what extent rainfall would remove the agent and reduce its effectiveness. When 2,4-D was applied in oil solution, an immediate heavy rain caused no diminution in plant response, but when it was applied in aqueous solution there was a slight decrease in response. /

Before tributyl phosphate was accepted as the most effective co-solvent for increasing the concentration of 2,4-D in aqueous or oil solutions, an investigation was made of Carbowax, a polyethylene glycol. It was found that Carbowax enhanced the action of 2,4-D on kidney-bean plants but failed to do so on soybean plants, and it was therefore abandoned. /

- / H.H. Smith, "Quantitative Aspects of Aqueous-spray Applications of 2,4-Dichlorophenoxyacetic Acid for Herbicidal Purposes," Botanical Gazette, 107 (Jun 1946), 544-51.
- / R.J. Weaver, C.R. Minarik, and F.T. Boyd, "Influence of Rainfall on the Effectiveness of 2,4-Dichlorophenoxyacetic Acid Sprayed for Herbicidal Purposes," Botanical Gazette, 107 (Jun 1946), 540-44.
- / W.E. Fennie, Jr., and F.T. Boyd, "The Response of Kidney-bean and Soybean Plants to Aqueous-spray Applications of 2,4-Dichlorophenoxyacetic Acid with and without Carbowax," Botanical Gazette, 107 (Jun 1946), 552-59.

The most satisfactory preparation for the dispersion of 2,4-D either for herbicidal purposes or as a crop-destroying agent was a mixture of the agent in tributyl phosphate and oil, the co-solvent fixing the largest quantities of agent in solution and the oil enhancing the inhibitory effect of the agent, probably because of its low rate of evaporation and its power of penetration of leaf cuticle. It was also demonstrated that tributyl phosphate itself had an inhibitory effect on plant growth and acted synergistically with 2,4-D to increase the action of the agent compound. /

Since 2,4-D might be used as a soil contaminant as well as a spray against growing crops, studies were made to determine the persistence of the agent in soils and their subsequent effect on crops planted in such soils. 2,4-D was nonpersistent. In greenhouse trials, high rates of 2,4-D disappeared in 8 weeks as a result of leaching due to rainfall or inactivation. In the field, it did not persist for more than 80 days and in some instances had almost completely disappeared in 63 days. LN-32, however, was sufficiently active in soil after 63 days to be toxic to soybeans and LN-14 was only slightly less active. / In comparative tests of ammonium 2,4-dichlorophenoxyacetate on plants grown in soil cultures and in nutrient-solution cultures, approximately four to five

- / ¹⁻⁴Fn, p. 416; C.P. Swanson, "Two Methods for the Determination of the Herbicidal Effectiveness of Plant Growth-regulating Substances in Oil Solution on Broadleaf Plants," Botanical Gazette, 107 (Jun 1946), 560-62.
- / H.R. DeRose, "Persistence of Some Plant Growth-regulators When Applied to the Soil in Herbicidal Treatments," Botanical Gazette, 107 (Jun 1946), 583-89.

times as much inhibition of growth occurred in solution cultures as in soil cultures, apparently due to the retention or inactivation of the agent by organic or colloid components of the soil. /

A special study was made of 2,4-D to determine its possible toxicity for man. Experimental animals were administered the compound orally, parenterally, and by inhalation. It was apparent that 2,4-D is a relatively nontoxic compound for mice, guinea pigs, rats, rabbits, and monkeys, all of which reacted similarly to the material. In large doses, 2,4-D is a gastric irritant but is not lethal. It was presumed on the basis of the experiments that a 75 kg. man could tolerate a dosage of 15 grams or an oral volume of 28 milligrams of agent. / Elsewhere, it was estimated that a 75 kg. man could tolerate 18 grams of agent and that 52 grams might be a lethal dose, except that man could not ingest and retain this amount of agent. It also appeared that 2,4-D is nontoxic by inhalation and is not readily absorbed by the skin. /

- / D.L. Taylor, "Observations on the Growth of Certain Plants in Nutrient Solutions Containing Synthetic Growth-regulating Substances. IV. The Amount of Growth in Soil and Solution Cultures Treated with Equal Weights of Ammonium 2,4-Dichlorophenoxyacetate," Botanical Gazette, 107 (Jun 1946), 630-32.
- / E.V. Hill and H. Carlisle, "Toxicity of 2,4-Dichlorophenoxyacetic Acid for Experimental Animals," Journal of Industrial Hygiene and Toxicology, 29 (Mar 1947), 85-95.
- / Sp Rpt 10, Toxicity of LM-8 (2,4-Dichlorophenoxyacetic Acid) for Experimental Animals (Apr 1947)

Toxicity of isopropylphenylcarbamate. Unlike the halogenated phenox-
acetic acid series which do not injure cereals greatly, isopropylphenyl-
carbamate (LN-33 or IPC) appeared to be a highly selective herbicide for
certain cereals, particularly when applied to the soil rather than to
the plants themselves. In greenhouse studies, LN-33 severely stunted
or killed seedling oats, wheat, corn, barley, and rice, and was particula
effective against oats and barley. It was also highly effective against
field-grown oats and rye when applied at seeding time or to seedling
plants, completely prevented the germination of buckwheat, and killed
field-grown winter rye. It was ineffective as an inhibitor of growth
in such broadleaf plants as soybeans, kidney beans, radishes, turnips,
and sugar beets. /

The low solubility of LN-33 in water made aqueous sprays impractical
and the agent was entirely insoluble in oil. However, it could be
dissolved in tributyl phosphate and this solution was oil miscible. It
could not be shown that oil sprays produced any of the effects seen in
soil treatment, except on winter rye.

It had been shown that in greenhouse studies, 2,4-D inhibited germin-
ation and decreased the growth of young seedlings not only of broadleaf
plants but of cereal plants as well. The behavior of LN-33 was quite

/ R.W. Allard, W.B. Ennis, Jr., H.R. DeRose, and R.J. Weaver, "The
Action of Isopropylphenylcarbamate Upon Plants," Botanical
Gazette, 107 (Jun 1946), 589-96.

W.B. Ennis, Jr., "Some Effects of O-Isopropyl N-Phenyl Carbamate
Upon Cereals," Science, 105 (24 Jan 1947), 95.

CHEMICAL DEFOLIANTS

General. The objectives of the defoliation project carried out by C Division were to determine the effectiveness of certain chemical agent in solution for marking, defoliating, or increasing the inflammability of forest vegetation and to ascertain techniques of distribution from tactical aircraft using standard chemical tanks. As a result of the investigation, discoloration and defoliation of forest vegetation by two chemical compounds was successfully accomplished. It was determined, however, that leaf discoloration occurred too slowly to be of general tactical value in target marking, and that the inflammability of treated foliage was not enhanced by either of the chemical compounds selected.

Selection of agents. Preliminary static trials were held at the AAF Tactical Center at Orlando, Florida, in March and April 1944. Saturated solutions of ammonium thiocyanate, zinc chloride, sodium nitrite, sodium arsenite, sodium fluoride, and dinitro-ortho-cresol in oil were compared in these tests. The first two solutions proved to be the best agents for causing rapid leaf discoloration and defoliation, with ammonium thiocyanate slightly superior because it turned leaves a bright red within 48 hours whereas zinc chloride acted in 2 to 3 days, turning leaves to a yellowish brown color. Defoliation was initiated 3 to 4 days after treatment and was complete in approximately 10 days. Recovery of trees, marked by the appearance of new leaf buds, required 3 weeks or more after

treatment. /

Dissemination. Aerial spray trials, using the standard M10 airplane spray tank, were conducted at Marathon Key, Florida, at Lake George, Florida, and at Orlando, Florida, between March and September 1944. On the basis of these trials, a one-third saturated solution of thiocyanate was sufficient to produce a satisfactory color intensity for target marking and a one-third saturated thiocyanate or 0.37 percent zinc chloride solution was sufficient to produce fully effective defoliation. Eight tanks of thiocyanate solution simultaneously detonated at 50 feet above the treetops produced a visible swath 110 to 130 yards wide. Twelve tanks of solution produced a swath between 150 and 200 yards wide.

/ Sp Rpt 13, Marking and Defoliation of Forest Vegetation (May 45), pp. 7-8.

/ Sp Rpt 13, pp. 38-41. Also reported in AAF Board Project 3690 B470.6, "Marking and Defoliation of Tropical Vegetation (18 Dec 44).

MUNITIONS DEVELOPMENT

Objectives of the program. Development of an immediately usable munition took precedence over proposals to begin fundamental studies in search of the best possible munition because of the apparent urgency of attaining means of retaliation in the event of enemy use of biological agents. The objectives of M Division, therefore, were to survey all existing munitions with respect to their adaptability to biological warfare, develop sampling methods and devices for assessment of the munition study meteorological conditions influencing the behavior of biological agent clouds, and finally, develop munitions which would be specifically adapted to biological warfare. The initial objectives of M Division were necessarily based on the only available experience, that of the British. The British had a 4-pound light case bomb which they reported ready for production. They had also developed a burster-type 30-pound bomb which appeared promising in early trials, and had described the preparation of a linseed-meal tablet inoculated with anthrax, which might be used to infect enemy herds. /

Preliminary investigations at Camp Detrick were influenced by the fact that there was no immediate immunization available for our troops against the agents of anthrax and botulism. These were believed to be the agents which would be first used against us and therefore the agents

/ P. Fildes, Organization of B.W. in the United Kingdom (no date).
In CD Tech Lib (EW Gen, Acc.No. 35).

with which we would retaliate. This circumstance precluded consideration of close-range weapons, for fear of infecting friendly troops, and attention was therefore focussed on aerial munitions, bombs, and spray tanks. The use of the spray tank for delivering viable agents was believed to be of doubtful value, because of the danger of contamination to the plane, with subsequent infection of crew and ground force members. For that reason, the major part of the early work was centered on the development of suitable aerial bombs. The spray tank later proved useful for the dissemination of crop-destroying agents.

Dispersion factors. The form of the bomb filling was an important factor in the development of a suitable munition. It was recognized that dry powder forms of agents would generate many more hazards in filling and handling than would wet, solid, or slurry forms. Furthermore, the Chemical Warfare Service had accumulated considerable information on the dispersal of liquid chemicals in cloud or aerosol form. The possible application of this experience to biological munitions could not be ignored and favored the development of wet forms of agents. In cloud chamber and field trials, however, the apparent similarity was found to be superficial. Neither the degree of fineness nor the concentration of aerosol organisms that were required to ensure infection by inhalation could be compared to chemical experience.

It was believed that a powerful explosive blast would be necessary to produce a true aerosol, and there was much doubt whether the delicate living organisms would survive it. Most important of all differences

between gas and germs was that of the effective particle size. British workers were very much impressed by the minute quantities of biological material necessary to produce infection. In terms of chemical efficiency as it was understood in the Chemical Warfare Service, -that is, the weight of agent in relation to weight of munition - the possibilities in biological munitions therefore appeared tremendous.

The early experiments made at Camp Detrick with the 100-pound M47A2 chemical bomb served to illustrate the great difference between dispersion factors in chemical and potential biological munitions. Since ordinary fog particles have a diameter of 10 to 1,000 microns, it was presumed that a munition affording this degree of dispersion might be satisfactory for the dissemination of biological particles. The M47A2 was known to disperse an appreciable amount of a charge of mustard in droplets not more than ten times this range in diameter. Then it was learned that particles even as small as 10 microns in diameter would not pass the nasal barriers and enter the lungs of either man or animals. The largest particle size capable of entering the lungs was found to be not over 4 microns, and the more probable size was between 1 and 3 microns. / In order to disperse the mustard filling in the M47A2 into particles averaging 2 microns, each

/ Studies were made at the University of Chicago Toxicity Laboratories of the distribution of particles in the respiratory tract when human subjects were exposed to clouds of calcium phosphate ($\text{Ca}_3/\text{PO}_4/2$). In the particle range 1-2-5 microns, 10 to 25 percent of the particles were retained in the nose, 25 to 45 percent in the lung, and 65 to 30 percent were exhaled. It thus appeared that the actual respiratory dose might be less than half the calculated inhaled dose in terms of the whole respiratory tract, and as little as a quarter of the inhaled dose in terms of the lungs alone. This factor had therefore to be considered along with the respiratory surface defenses in comparing dosage values obtained by inhalation with those obtained by other routes of inoculation. See reports UCTC-NDRC 9:411-25 (10 Feb 45) p. 9; NDRC 9:411-25 (10 Feb 45) p. 1; NDRC 9:411-NIS:17 (15 Oct 45) p. 9. Also published as H.D. Lambell and S. Clow, "Filtration of Air-borne Particles Through the Human Nose," Journal of Industrial Hygiene and Toxicology, 29 (1948), 269-77.

cubic centimeter of filling would be required to furnish 250,000,000,000 fragments as compared to the 2,000 fragments which the bomb normally produced. Nevertheless, by September 1945 biological bombs approaching this performance were being made and tested. /

SPD Mark I bomb. The first successful munition study began with an examination of the British light case 4-pound HE/Chemical Type F bomb which had been modified to carry a biological filling. The bomb had an overall length of 21.4 inches and a maximum outside diameter of 1.69 inches. It consisted of a welded tube of 22-gauge sheet steel, closed at the tail end by a press-fit cap and at the other end by a burster adapter which connected the fuze with the axial burster. The fuze portion of the casing was hexagonal stock, to permit clustering 106 of the bombs in the British #14 cluster adapter. This adapter was designed to permit a string of individually dropped bombs to be exploded in rapid succession in the air, each bomb being set off by the blast of its predecessor. The total capacity of the bomb was 400 cc., but the recommended filling was 320 cc. or 0.725 pound, which was 17.6 percent of the total bomb weight. The weight ratio of the pentolite explosive to filling was 1:3.

As the result of tests of the bomb at Camp Detrick, a number of changes were suggested, including the fuze construction, safety of the fuze, protective coating for the interior, and end seals, in order to provide a satisfactory bomb for mass production methods. So many minor

/ Sp Rpt 44, Munitions for Biological Warfare (Dec 45), pp. 4-10.

alterations were made in the original that the new bomb was designated the SPD Mark I.

Actual tests of the SPD Mark I with pathogenic filling were never made, but tests with simulant agents revealed a number of fundamental deficiencies in the munition. The British estimated that its bomb when filled with anthrax spores would produce a cloud effective against a man one mile distant. Accumulated evidence at Camp Detrick, however, indicated that the effective range of the cloud produced by a cluster of these bombs would fall far short of that estimate.

The fact that the bomb functioned by explosion of a burster charge appeared to be a basic flaw in a biological munition. In the first place fragmentation of a liquid agent by means of detonation is not considered thermodynamically efficient. The greater the amount of explosive, the finer the dispersion, but also the greater the destruction of agent by heat, pressure, and toxic gases. Furthermore, the more explosive, the less filling.

It was found that the size of the cloud produced by detonation of the SPD Mark I was not proportional to the amount of explosive, nor was cloud size at the instant of burst appreciably increased even by doubling the amount of explosive. Because aerosol stability is limited by cloud concentration, a large cloud is necessary for dispersion of a large quantity of agent. It was calculated that the size of cloud issued at burst by the SPD Mark I would accommodate only about 20 cc. of the 320 cc. of agent filling.

Additional sources of dissatisfaction with the SPD Mark I bomb were its crater loss, the corrosion and breakage which made storage and handling unsafe, the relatively small payload, and the failure of the fuze to function on any but smooth terrain. Thus the bomb was not considered altogether a success. Nevertheless, it was an adequate bomb and it was the most practical munition that could be devised in the time permitted. Because it could be filled safely, clustered (110 in a modified M10A1 adapter), shipped, and dropped with effective results, the SPD Mark I went into production and was being procured in quantity as an anthrax vehicle at the end of the war. /

Other burster-type munitions. In addition to the tests made with the 100-pound M47A2 bomb, which originally was a chemical munition and later converted to a gasoline-filled incendiary, a number of other CWS munitions were examined as possible viable-agent vehicles. These included the 6-pound M69, an oil incendiary bomb; the 10-pound M74, a propellant-type bomb with a white phosphorus-gel gasoline filling; the 10-pound M77, an EC smoke bomb; and the 115-pound M70, a chemical bomb.

Attempts to disperse B. globigii slurries in the M47A2 bomb had not been successful and, because of the large size of the bomb, loading difficulties, its instability in flight, and poor efficiency, work with this bomb was abandoned. / Even with the modifications made in the

/ Sp Rpt 44, pp. 17-53.

/ Sp Rpt 44, p. 56.

M74 and M77 bombs, they proved ^{only} half as efficient as the SPD Mark I, but they represented a reserve type which could be used in the event of an emergency. / The heavy wall of the M70 bomb made it entirely useless for the dispersion of viable agents. /

The failure of the M69 and related bombs to produce an aerosol directly from liquid agents led to experiments with bursting-type canister ejected from these bombs. Slurry-filled hand grenades released from the bombs appeared promising, but ejection of three grenades at uniform heights could not be achieved. A single canister was tried, and, fitted with an aerial burster, was fired from the M69. Again, it proved difficult to obtain the required low muzzle velocity of canister burst with the inertia fuse containing a delay train in this munition, and its development did not go beyond the preliminary stage. /

Gas-expulsion bomb. In order to avoid the deleterious effect of explosion on viable agents in bombs, an effort was made to eject the agents by means of gas or air pressure. A gas-expulsion bomb was devised by building a compartment of 300 cc. capacity in the nose of the 10-pound M74 bomb casing. The compartment's seal was punctured by a spring-operate striker pin and compressed gas in the compartment pushed the dry agent out past crossed vanes, thus producing a dispersed cloud. Two types of

/ Sp Rpt 44, p. 64.

/ Sp Rpt 44, p. 66.

/ Sp Rpt 44, p. 68.

the modified M74 were developed and designated "GXS" for Gas Expulsion Solid and "GXL" for Gas Expulsion Liquid.

In spite of its high efficiency with dry and semi-dry agents and its absence of heat at burst, the gas-expulsion bomb had serious limitations. It did not disperse liquid agents well; the gas compartment constituted a hazard because it could not readily be made bullet-proof; a heavy compartment was required to store the gas under pressure, thus reducing the payload; slow leakage of gas under pressure could not be easily detected; and finally, construction problems were more complicated than were desirable. /

SS bomb. Perhaps the most promising munition developed by H Divisi was the SS bomb, devised on the basis of an analysis of the shortcomings of the SPD Mark I bomb. It had been shown that increasing the size of the bomb enormously did not increase the relative size of the agent cloud. On the contrary, it appeared that the smaller the bomb, the larger the burst-cloud relative to the amount of agent filling. An efficient biological munition seemed therefore to lie in the development of a small bomb which could be used in great numbers. High velocity propulsion of the agent also appeared necessary if an aerosol was to be produced with satisfactory particle size and concentration. The result was the SS bomb / Sp Rpt 44, pp. 85-89.

which functioned on impact in much the same manner as a miniature mortar shell.

The SS bomb consisted of a primed 10-gauge cement-coated shell casing into which a 1-3/4-inch drawn aluminum vial containing 240 grams of either liquid or dry agent was inserted. The explosive was 2 grams of Bulls-eye powder. The entire bomb was about 6 inches in length and 1-1/2 inches in diameter. The bomb functioned when released from its cluster by the successive action of a safety pin, firing pin, primer, and the Bulls-eye powder. There was no crater loss with the bomb and tactically it was possible to produce with it either dilute clouds over a wide area or a concentrated cloud in a small area. A nose piece of hexagonal stock, a modification of the M16 cluster, permitted clustering 110 SS bombs. The M10A1 cluster adapter accommodated 330 of the bombs, holding a total of 18 liters of agent material.

By September 1945 sufficient data had been accumulated on the SS bomb to indicate that in principle at least the munition was highly satisfactory and might prove effective in the field. /

SPD Mark 2 bomb. The fact that the chemical plant growth-regulators were liquids suggested the use of the airplane spray tank for their dispersal. However, effective spraying required hazardous low-altitude flight over the target site. Also, the tanks were best adapted to light

/ Sp Rpt 44, pp. 71-80.

short-range bombers or fighters. It was believed that heavy bombers, capable of extended flight and high altitude bombing, would be required if Japanese rice crops were to be attacked. Work was therefore centered on the development of a device to carry the crop-destroying chemicals in heavy bombers. No existing munition seemed entirely suitable. The 100-pound M47A2 and 115-pound M70 bombs, as well as the M16 and M10A1 aimable cluster adapters, were considered and the adapters selected as most promising. While Division 10, NDRC, undertook the development work on the M16 adapter, M Division concentrated on the M10A1.

The SPD Mark 2 bomb that evolved was simply a container made of 26-gauge sheet steel which was fitted in the M10A1 adapter. The complete bomb weighed 91 pounds empty and had a capacity of 3.5 cubic feet which accommodated 192 pounds of VX agent. The Mark 2 was detonated by primacord and a T39E1 nose fuze. Functional tests at Granite Peak indicated dependable performance, and its payload was considerably higher than that of other bomb types considered. /

Coagent bomb. An effort was made to produce a munition capable of simultaneous dispersion of a biological agent and a chemical coagent. Cloud chamber studies had shown that cadmium, either as oxide, chloride, or chromate, was a profound irritant in itself and at the same time greatly enhanced the infectiveness of anthrax organisms. When the mixture of

/ Sp Rpt 44, pp. 92-94.

viable agent and chemical coagent could not be affected, attention was turned to the use of separate bombs in clusters, in order to secure a cloud of coagent in close proximity to the cloud of organisms. The 10-pound M77 smoke bomb, with cadmium substituted for the zinc in the HC smoke mixture, offered most promise. Trials were held with the bomb at Horn Island. It appeared that the cadmium smoke precipitated the cloud of simulated agent, but the findings were not conclusive. Although no proof was attempted, the solution appeared to be the creation of successive clouds, using both the M77 and the SPD Mark I bombs. /

Miscellaneous devices. Among miscellaneous munitions and devices investigated by H Division were darts coated with botulinum toxin and anthrax-inoculated linseed meal biscuits. Suggestions that were made but not tested included the impregnation of small bore ammunition, leaflets, and paper money, and the use of a low melting wax film for sabotage purpose

More extensive were the series of tests carried out in Canada and at Horn Island on the possible use of insects as vectors of disease. The Canadian group in biological warfare found that the fruit fly might be a practical vehicle and on the basis of their findings, a program for combined United States-Canadian studies of insect vectors was arranged. / Large populations of Musca domestica, the common housefly, / and Aedes sollicitans, the salt marsh mosquito, were present on Horn Island,

/ Sp Rpt 44, pp. 96-98; MPR, Horn Island (Jun 45).

/ Memo (S), Lt. Col. A.T. Thompson for Tech Dir SPD, 26 Dec 44, sub: Conference on Joint Insect Vector Program. SPCIF 092.

/ Almost 2,500,000 adult flies were reared at Horn Island for the studies. Female adults were fed on evaporated or powdered milk for egg production and the eggs grown in lots of 10 to 15 thousand in a larval medium of yeast and ground alfalfa seed. 44

Drosophila (fruit fly) species were imported, and screw worms and wool maggots were available from the experimental animals on the island.

The studies began when, after field shoots with botulinum toxin, large numbers of mosquitoes were collected on the island and examined for signs of contamination. No evidence of either internal or external contamination could be found in any of the insects. / In a series of studies to test the recovery of biological agents from insects after release of agent clouds, Shigella alkalescens was used as the simulated agent. Definite evidence was found that both fruit flies and house flies transmitted S. alkalescens to fermented food for 4 days after exposure of the insects, and contaminated flies were found as many as 7 days after their exposure to the agent. Contaminated insects were collected at ranges from 50 to 200 yards from the source of contamination. /

Although considerable data were accumulated on insect vectors in the 10 months of these studies, they did not permit any conclusions to be drawn as to the effectiveness of insects as disease vectors. /

/ MTR Horn Island, Sep 44, Entomol Br, Append I.

/ MTR Horn Island, Mar 45, Pt II, pp. 14, 16.

/ MTR Horn Island, May 45, Pt II, pp. 1-16.

Bomb filling preparations. The types of fillings which have been prepared for biological munitions include granular (VKA), pulverulent (spore material), aqueous suspension (vegetative agents as aerosols), nonaqueous solution (VAL), and nonaqueous suspension (anthrax spores and ricin, as developed by the Canadians).

Since early trial filling operations were concerned with the agent of anthrax, all efforts were bent to develop a suitable pulverulent material. The agent material, which was received from the tank reactors as a slurry was centrifuged and collected as a mud containing about 30 percent solids. After mixing with acetone in a Waring blender and filtering on a Buchner funnel with the aid of a vacuum pump, the material remaining on the filter was washed with acetone and the excess acetone removed by filtration. The residue was permitted to dry at room temperature for 24 to 36 hours, resulting in 6 to 10 percent loss of moisture, and the dried material was then pulverized and ready for filling.

The objective of drying and grinding operations was to achieve a degree of fineness of a mass mean diameter of 5 microns. The test materials were B. globigii, the anthrax simulant, and peat, which was to be the filler for sporulating agents. The agent material would adhere to the individual particles of peat, and the peat when dispersed would thus act as a carrier in the aerosol cloud. Equipment investigated as grinding instruments of these two test materials included a Wiley mill, a Bantam mikro-pulverizer, a laboratory-size ball-mill, and a 30-gallon blending mill which was borrowed from Edgewood Arsenal. None of these proved satisfactory. Ball-milling B. globigii resulted in a high loss of viability.

47

The Bantan pulverizer killed between 30 and 50 percent of the organisms as a result of the heat generated when the hammers came in contact with the screens. Grinding operations were not successful until an air-jet grinder, the Whirlwind Mixer made by the Mansfield-Webster Corporation of New York, was obtained. The machine consisted of a cylindrical chamber into which air was blown under high pressure at a 45° angle by means of seven symmetrically arranged jets. As a constant stream of agent material was fed into this chamber, the high velocity of air speed within the chamber set up a micro-turbulence which pulverized the material. The pulverized material was collected in a container, while exhaust air was filtered and then passed on to an air incinerator.

The particle size of material pulverized in the Whirlwind Mixer was less than 5 microns for the spore agent and less than 20 microns for the peat. Pulverization of E. globosii could be achieved at the rate of almost 35 pound per hour without loss of viability of the material. Pulverization of vegetative cells was not carried out. As will be seen in the next chapter, they reacted better to spray drying.

As originally installed, compressed air from the jets operated at 75 psi. By modifying the air-jet orifices in the pulverizing chamber, it was possible to increase the pressure to 100 psi, resulting in increased feed flow and smaller particle size. The volume of air fed into the chamber was also increased, from 100 cfm to 160 cfm, and with a final increase in pressure to 125 psi, productivity with the Whirlwind Mixer was increased threefold. With later modifications it became possible to dry and grind E. globosii slurry with a 10 percent solids content. Instea

of using a dry feeding apparatus with a Venturi jet, the machine was fitted with a modified atomizer jet. Liquid slurry was fed to the jet by suction. A method was improvised for heating the air passing into the chamber, evaporating as much as seven pounds of moisture in an hour's run under a temperature of 110° F. A gas-fired heating unit was later built to heat the compressed air to 375° F. The result was the conversion of simulant agent slurry into a mud form ready to be filled, all in a single operation.

These studies were limited to trials with B. globigii spores and it was not learned whether the methods would be equally effective in preparing anthrax spores, botulinum toxin, or vegetative cells for filling in munitions. /

While sporulating agents, it appeared, might safely be rendered into a finely divided state by pulverizing, it was believed that grinding non-sporulating agents would destroy them entirely. A method of spray drying such agents was devised and tests were conducted with both B. globigii and S. marcescens. The solution or slurry of agent material was sprayed in fine droplets into a chamber of rapidly moving hot dry air. The drying was accomplished in a matter of a few seconds and the dry powder collected by means of a cyclone air separator or with some type of filter.

The material obtained by spray drying had a moisture content of from 3 to 10 percent, with a mass median diameter of the particles ranging from 2 to 3 microns. The viability of B. globigii spores after drying was

/ Sp Rpt 44, pp. 162-79.

almost 100 percent; that of S. narcescens cells between 23 and 57 percent. The spray drier tests were considered successful both from a production and safety standpoint. /

Similar results with spray drying were obtained earlier in a study conducted at the University of Notre Dame. The material used in their work was typhus rickettsia grown in yolk sac and diluted in skim milk. It was learned that suspensions of the rickettsia could be spray dried at 300° F. or higher with a minimum loss of one-half the toxicity. The dried material would then keep for at least 30 days at refrigerator temperature. The powder could be readily resuspended in water or might be dispersed in its dry form. /

Machine-loading of munitions. An examination of existing methods used by the Chemical Warfare Service, Ordnance, and by industry in handling and loading toxic materials did not reveal any procedure that would permit safe and practical application to biological munitions. It was therefore necessary to devise an entirely new procedure for filling such munitions. In this case, vacuum-loading the SPD Mark I bomb. This was done by compressing 1/4-inch neoprene rubber discs of approximately 35 durometer hardness inside the metal tail-cup of the bomb with a thin metal ring which was press fitted into the cup. The disc was pierced with

/ Sp Rpt 75, An Experimental Spray Drier for B.W. Agents (Aug 45), pp. 14

/ J.A. Reyniers and P.C. Trexler, Final Report, Summary Report on Preservation of Rickettsia in the A-system (1 Jun 45)(S).

the filling needle for loading and when the needle was withdrawn, the rubber disc closed tightly over the puncture due to internal compression of the rubber. An additional tail-cup was welded over the rubber diaphragm after filling, to provide additional safety in rough-handling tests.

It was learned that finely divided dry material could be made to flow from the agent supply container into the munition through a hypodermic needle as large as 9/16-inch outside diameter at almost the same rate of flow as liquids. This was accomplished by agitating and mixing the dry material with air under vacuum. An electrical conductivity indicator was developed for the vacuum-loading machine to show when the bomb was full during operations with liquid material. The filling machine was capable of handling approximately 200 bombs per hour, each to a total fill of 320 cc., plus or minus 2 cc. The entire operation was completely automatic.

The experimental design for the machine for loading the SPD Mark I bomb was turned over to E Division for final design and production for the Vigo Plant. It was believed that the principles developed for liquid loading of bombs would be equally applicable to ampule loading and dry material loading. ✓

✓ Sp Rpt 44, pp. 189-97.

Explosive studies. A number of experiments were made by M Division to determine the effects of explosives on viable agents. A comparison of effects on sporulated bacteria and yeast cells was made using the M47A2, an axial burster bomb, and the M67 and M69, which are base-ejection bombs. When sporulated B. globigii was substituted for yeast cells in all three munitions, higher viable counts were obtained, indicating the pronounced destructive effect of detonation on yeast or vegetative cells. /

The effect of the gas generated by an exploding SPD Mark I bomb with a penthalite burster was determined by feeding the gas through a nebulized cloud of anthrax spores. In two separate experiments it was shown that the explosion-produced gas destroyed approximately 39 percent of the anthrax spores. / On the other hand, the gas generated by E.C. powder when allowed to burn unconfined was fed through a cloud of nebulized anthrax with negligible effects on the viability of the spores, indicating that it might be a suitable powder for use with such base-ejection bombs as the M67, M69, M74, and M77. /

The heat generated by an exploding munition was believed destructive to biological agents. Tests with B. globigii indicated that this organism could withstand one second exposures to a temperature of 100° C., but suffered 85 percent destruction at 200° C. and was almost completely destroyed at 300° C. / To determine the effect of brisance on viable

/ MPR M Div, Oct 43, p. 4.

/ MPR M Div, Aug 44, p. 5.

/ MPR M Div, Sep 44, p. 9.

/ MPR M Div, Oct 44, p. 7.

organisms, a small amount of B. globigii slurry was placed in the bottom of a one-ton mustard container. An SPD Mark I bomb was suspended 16 inches above the slurry, the container closed, and the bomb fired. High destruction of agent resulted in every instance. An experiment was next made to compare the shock effect of an exploding munition on cultures of vegetative and sporulated cells. Three 3-inch steel nipples were filled with a slurry of Serratia marcescens, a nonsporeformer and three other nipples were filled with a slurry of sporeforming B. globigii. The nipples were capped top and bottom and placed near an SPD Mark I bomb in the one-ton container, the container was closed, and the bomb fired. The average loss of the sporulated material was 7 percent as against a loss of 47 percent of the nonsporulating material, indicating the susceptibility of vegetative organisms to destruction by pressure shock.

In order to learn the relative destruction caused by different explosives in the SPD Mark I burster, bombs were fired with burster compositions of pentolite and Bulls-eye powder. Five times as many viable B. globigii organisms were recovered from the bomb casing opened by Bulls-eye powder as that by pentolite. /

/ MPR M Div, Apr 45, p. 9.

Sampling devices. To test the effectiveness of dispersion by munit not only in the test chamber but more particularly in the field, devices for sampling the clouds at burst had to be developed. Certain criteria were established for these sampling devices. They had to be small and compact and convenient for field handling. They should be 90 to 100 per cent efficient, and be adaptable for use with any agent. They should be able to sample both high and low concentrations of agent at any reasonable wind speed. When immersed in a wash, they should release the impinged agent as rapidly as it was originally impinged. Finally, their design must facilitate laboratory analysis of their contents.

Early samplers were of two types, one instantaneous and the other a continuous sampler. The instantaneous sampler was a 1 liter evacuated ampule containing 50 ml. of sterile water. It was set up on a stake in the field so that the drawn-out ampule tip was 5 feet above the ground. At the desired moment, an electric squib released the trigger of a mouse trap which in turn released the spring trap wire that snapped off the sealed tip of the ampule. Approximately 1 liter of agent cloud was inspired in 1 to 2 seconds. Sterile cotton plugs were inserted into the ampule mouth, the water and inspired cloud were thoroughly mixed by shaking, and the ampule was then sent to the laboratory for analysis.

The continuous sampler consisted of a cotton-filled test tube which had been drawn out at one end. The tube was closed with a rubber stopper containing a glass tube inserted so that its end pressed against the cotton. The drawn-out end of the test tube was connected by rubber hose

to an evacuated cylinder. A mouse trap was used to squeeze the hose together until the appropriate moment, when a squib activated the trap trigger and released the hose, permitting suction. (Later the squib was replaced by electromagnetic activation of the trap trigger.) Air containing agent spores was sucked through the cotton and the spores were thus impinged, this continuing until the suction was turned off. Since the rate and time of inspiration were known, the concentration of cloud could be calculated by determining the number of spores filtered out. This was done by diluting and plating the material trapped in the cotton.

A Cascade impactor utilized the continuous sampler and by means of sticky resinous-treated slides placed in the inspired air stream, impinged representative samples of the cloud as it passed over them. It was useful in determining particle sizes of captured organisms. The Cotrell precipitator was an electrical device which precipitated charged particles from air drawn through it by neutralizing their charges. While the precipitator was fairly efficient at removing anthrax or B. globigii spores passing through it, it destroyed approximately 45 percent of the inspired material.

As field studies progressed, the instantaneous sampler, a Porton impinger, and the Cascade impactor were abandoned because of their inconvenience for field use. The Cotrell precipitator was discarded because of its destruction of agent. The continuous cotton sampler was routinely used, being small, easily transported and mounted, and convenient for analysis and reloading. It sampled all types of spore clouds at any concentration and at any rate, but it was not entirely efficient in the collection of vegetative agent samples. /

/ Sp Rpt 44, pp. 114-22.

Sampling procedure. Preparatory to the static firing of test munitions, samplers were set up on wooden stakes approximately 5 feet above the ground at various distances downwind from the burst site. In early tests at Camp Detrick, the stakes were set out on a rectangular grid 8 rows wide by 16 rows deep, with 10 yard intervals between the stakes, making a total of 128 sampling stations. For airplane drops, as well as static firing, a larger grid was constructed with sampling stakes placed in concentric circles about the firing point or target site at distances of 100, 200, and 300 yards. The circular grid permitted tests being made with the wind from any direction.

At first, 150-liter evacuated cylinders were used to operate the continuous samplers in the grids. These were replaced by electrically-driven vacuum pumps which could be individually or collectively operated from a central control station. This grid set up was used both at Camp Detrick and at Granite Peak Installation. /

/ Sp Rpt 44, pp. 109-11; Ibid., pp. 122-35 has Standard Operating Procedures for Field Testing BW Bombs at Camp Detrick; Standing Operating Procedure, Granite Peak Installation, is contained in Appendix N , this history.

456

RESTRICTED

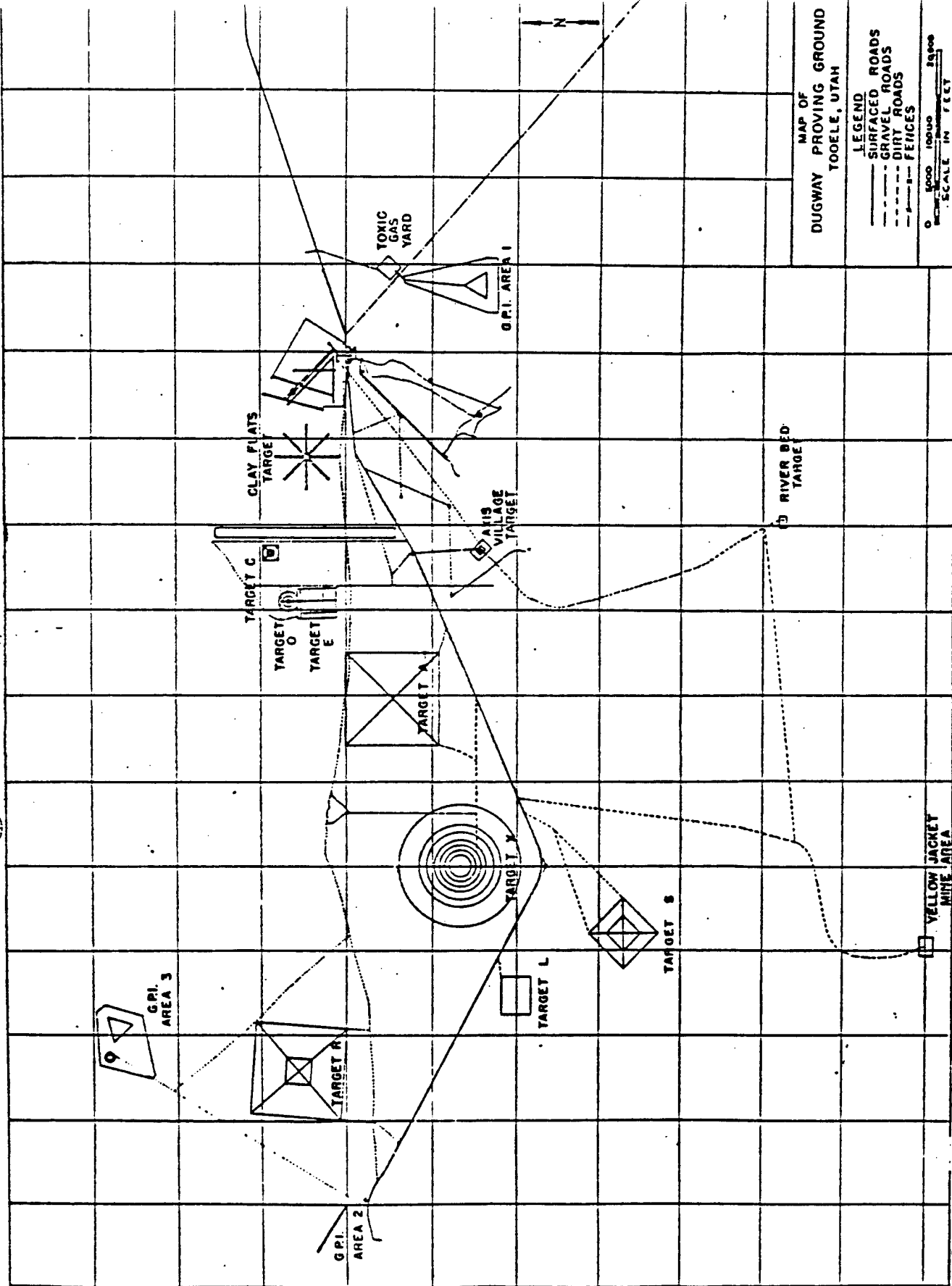

MAP OF
DUGWAY PROVING GROUND
TOOELE, UTAH

LEGEND
 — SURFACED ROADS
 - - GRAVE ROADS
 - - - DIRT ROADS
 - - - - FENCES

0 500 1000 1500 2000
SCALE IN FEET

Sheet 11 Grid 110 6-4

Photo No. 1565

45

SPECIAL DEVICES AND SPECIAL STUDIES

British cloud chamber. The first precise studies in the dispersion of biological agents in aerosol form were carried out in a cloud chamber developed at the Porton chemical warfare station in England. The machine operated as a closed system, in which a constant vacuum as well as constant flow of air was maintained, and the British used it to study their so-called "hot" agents, "Us", "UL", "OC", and "Hi".

The machine was designed as a simple method of measuring particulate clouds where a dry cloud was required which necessitated controlling the relative humidity. It consisted of a tube approximately 32 inches long and 2 inches in diameter. This carried the cloud and provided a suitable place for exposing animals and for sampling concentrations. A rotary pump delivered not less than 224 liters of air per minute through the tube. A nebulizer with its own source of air flow, to which the agent material suspension was attached, furnished 10 liters of air per minute.

As the aerosol from the nebulizer passed into the tube, it was met by approximately 20 liters of extremely dry air. By the time the cloud reached the end of the tube, it was completely dry and all particles in it were air-borne. As the cloud continued through the system, it passed through a filter of resin-treated marine wool which removed all air-borne particles. Two additional filters, similar to those in the gas mask, acted as further impingers. Then the air was dried by passing through two large containers half filled with silica gel and the circuit was complete.

The machine permitted exposure of two animals at a time. To expose an animal to the aerosol cloud, its nose was inserted through a rubber diaphragm and the animal allowed to inhale the cloud as it passed through the tube at that point. In this way, only the nose of the animal became contaminated. To determine the concentration of agent in the tube, liquid impinged samples were taken from the cloud at a point near the end of the tube and directly opposite the point of animal exposure. / The British cloud chamber was used in studies of all the virulent agents experimented with at Camp Detrick and found to be completely safe in operation.

American cloud chamber. A more elaborate and, it was believed, a more versatile cloud chamber was developed at Camp Detrick, originally for work on botulinum toxin. This consisted of a modified standard 26-inch by 11-inch autoclave with a volume of 70 liters. An aerosol of bacteria or bacterial toxin was set up in this chamber by atomization from liquid suspension. / The agent cloud entered at the top of the chamber and escaped through two vacuum lines. The main exhaust line at the rear of the chamber permitted removal of 80 percent of the cloud. A second exhaust line was used to sample the cloud. At the end of an exposure, the chamber was emptied by opening the vacuum exhaust valve and diluting the cloud with clean air from the room. The contaminated air was then exhausted ..

/ Porton Reports BDP No. 20 and No. 32.

/ Sp Rpt 8, A Preliminary Report on the Design and Performance of Atomizers in Relation to EW Cloud Chamber Studies (Feb 45).

through the incinerator to ensure complete destruction of the active agent.

A second autoclave-type chamber was constructed for work with anthrax and differed from the first in that it had two Pyrex glass windows through which the animals and cloud could be observed. It was decontaminated with steam. A third modified autoclave-type chamber, of rectangular shape, measuring 24 x 24 x 36, was used for special cloud studies of anthrax. In all chambers, small animals might be put in free or in 16-compartment holding cages. These chambers were located in Building T-243.

The principal difference between the British and American chambers was the fact that the autoclave-type chambers permitted total exposure of animals. With the British spray apparatus, the noses ^{alone} of one or two guinea pigs were exposed. With the Detrick apparatus, up to 100 mice or 50 guinea pigs, rats, or hamsters could be exposed at a time. The autoclave-type chamber more nearly simulated field conditions than the British, since restrained animals became excited and hyperventilated. Furthermore, the Detrick chambers were readily adaptable to studies of metallic and chemical co-agents, as British chambers were not. One shortcoming of the American cloud chamber had to be accepted: certain experimental animals obtained lethal gastro-intestinal doses by licking their contaminated fur. This was so in the case of the mouse, but not for the guinea pig. Also, the contaminated coats of animals were a source of danger to handling personnel and in this respect the British chamber was definitely superior, particularly in experiments with "hot" agents. /

/ Sp Rpt 16, Report on the Development, Operation, and Experimental Use of the American Autoclave Type B.W. Chamber (1 Oct 45), pp. 34-37.

A month before the end of the war, the first of two Reyniers "SP-4-B Germ Free Units" was installed in Building T-429. These commercially designed chambers were used for quantitative cloud studies of such highly infectious agents as psittacosis and meningopneumonitis viruses, brucellosis, tularemia, and melioidosis. Studies were also made using this type chamber on the employment of a dye as a tracer in infective clouds, in demonstrations of respiratory anaphylaxis with glanders and melioidosis, and in tests of the air-disinfecting properties of triethylene glycol when psittacosis strains were used in the chamber. /

Perhaps the most interesting series of studies carried out in the cloud chambers at Camp Detrick were those based on a comparison of the various agents under study to determine which of them was most infective, most lethal, and most stable. The agents in the order of decreasing infectivity by the respiratory route, together with the animal species used in each case, were:

- Borg strain of psittacosis (mice)
- Gleason strain of psittacosis (mice)
- 6BC strain of psittacosis (mice)
- Tularemia (mice)
- Melioidosis (hamsters)
- Brucellosis (mice)
- Brucellosis (guinea pigs)
- Glanders (hamsters)

The agents in the order of decreasing lethality by the respiratory route were:

/ Sp Rpt 18, Cloud Chamber Studies. I. Methods Developed at Camp Detrick (5 Division) for Production and Study of Clouds of Highly Infective Agents (15 Oct 45), p. 73.

Borg strain of psittacosis (mice)
Tularemia (mice)
Melicoidosis (hamsters)
Gleason strain of psittacosis (mice)
Glanders (hamsters)
6BC strain of psittacosis (mice)

The agents in order of decreasing stability according to atomization data were:

Brucellosis
Borg strain of psittacosis
6BC strain of psittacosis
Melicoidosis
Glanders
Cal 10 strain of psittacosis
Tularemia

It was admitted that whether stability of organisms to atomization bore any relationship to stability to dispersion in the field was not known. Like the determinations made as to the infectibility of laboratory animal these results could only be considered experimental data until verified under actual field conditions. It was suggested that stability data base on atomization might be more directly related to natural means of dissemination, as by sneezing or coughing, than to the more artificial means contemplated in the use of the agents in biological warfare.

On the basis of these studies, it seemed apparent that a highly infective but very unstable agent might have less value than one that was more stable although less infective. The agents, therefore, in order of decreasing stability-infectivity, -that is, infectivity in biological warfare— were:

Borg strain of psittacosis (mice)
6BC strain of psittacosis (mice)
Brucellosis (mice)
Melicoidosis (hamsters)
Brucellosis (guinea pigs)
Glanders (hamsters)
Tularemia (mice)

#6

The agents in order of decreasing stability-lethality, --that is, lethality in biological warfare-- were:

Borg strain of psittacosis (mice)
Meloidosis (hamsters)
Glanders (hamsters)
Tularemia (mice)
6BC strain of psittacosis (mice) /

Bacteriological laboratory studies. Among miscellaneous studies made at Camp Detrick in the course of the work was one reported by the chief of A Division in explanation of the nature of the Ziehl-Neelsen stain, to account for the beading of cells when stained with carbol-fuchsin. / Another was on plate counting methods. The degree of precision attained with dilution plate counting methods of enumerating viable bacteria was not as great as could be desired. Sources of variation in counts were listed as the presence of clumps in original suspensions, errors in preparing dilute suspensions, errors in measuring aliquots of suspensions into plates, distribution of organisms in aliquots, and factors influencing the development of cells into visible colonies. Where precision studies were demanded, it was recommended that the number of plates used be increased from three to nine or even eighteen, and that where permitted, prepared and dried plates should be used, inoculated with 0.1 ml. aliquots delivered by 1 ml. serological pipettes, with the inoculum

/ Sp Rpt 45, Cloud Chamber Studies. II. Comparative Data on Infective Agents and Simulants. Final Report (Feb 46), pp. 74-81.

/ C. Lamanna, "The Nature of the Acid-fast Stain," Journal of Bacteriology, 52 (Jul 1946), 99-103.

spread with a sterile glass rod. This method, however, would probably not be practical in routine practice where economy and manipulative convenience suggested use of standard plating methods. /

Studies were made by S Division on several laboratory techniques, and these have been reported in chapter of this history. /
(pp. 167-68)

- / Sp Rpt 85, The Relative Errors of Bacteriological Plate Counting Methods (Jun 47).
- / K.R. Johansson and D.E. Ferris, "Photography of Airborne Particles During Bacteriological Plating Operations," Journal of Infectious Diseases, 78 (May-Jun 1946), 238-52; R.J. Henry and E.C. Smith, "Use of Sulfuric Acid-Dichromate Mixture in Cleaning Glassware," Science, 104 (1 Nov 1945), 426-27.

Chemical laboratory studies. The Chemistry Branch of B Division served two main functions in the studies being carried out at Camp Detrick. It supplied trained personnel to the various projects within the division to undertake chemical aspects of the experiments in progress, and it maintained a laboratory section of its own to supply clinical chemistry, spectrophotometrical, electrophoretic, microanalytical, and other routine chemical analyses. The branch prepared a report compiling a number of the techniques which it devised and adapted for special problems created by the work at Camp Detrick. These included its spectrophotometric studies of biological compounds, its determinations of the presence of hexosamine and carbohydrate in biological substances, the development of a simple lyophilization apparatus, and an ultrafiltration apparatus. /

Tiselius electrophoresis apparatus. The apparatus is essentially an analyzing device which allows the investigator to distinguish between substances of different electrical charge and at the same time indicates the relative quantity of each component of the mixture. It proved valuable in the study of proteins and other substances of high molecular weight derived from bacteria or from natural products with antibacterial activity. Proteins and similar combinative substances will not yield information as to their composition by any known classical chemical procedure, and many of the problems in the purification of antigens, toxins, and other bio-

/ Sp Rpt 63, Techniques Utilized in the Characterization of Naturally Occurring Substances of Bacterial and Animal Origin (Mar 46).

logically active compounds required such analysis.

At Camp Detrick, the electrophoresis apparatus was called on to furnish analyses in connection with the purification of types A and B botulinum toxin, purification of the tissue destroying factor obtained from anthrax-infected animals, of anthracidal factors from various sources of tularemia antigen; examination of serum from monkeys infected with brucellosis, from anthrax-infected rabbits; and purification of antigens from glanders and melioidosis infections and of biologically active substances from hog mucin in connection with anthrax studies.

Sonic disintegrator. The sonic disintegrator works by setting up sound waves with a frequency of approximately 10,000 waves per second in a fluid medium. Bacteria and other cells in the medium are broken into fine bits and the various chemical constituents of the cells can then be removed from the cell bodies. The instrument was used principally to disintegrate bacteria for the purpose of obtaining antigenic proteins from their elementary bodies. These antigens might then be examined as the basis for the development of experimental vaccines.

Lyophilizing apparatus. This was simply an apparatus to remove water from biological agent material in the frozen state, as a means of preserving the agent over a period of time. The apparatus devised was capable of handling 2,500 ml. of material at a time. By means of lyophilization, the virulence and viability of a number of pathogenic and nonpathogenic bacteria could be preserved for months and in some cases for a year or more. /

/ R.J. Heckly, "A Simple Lyophilizing Apparatus for Laboratory Use," Journal of Immunology, 55 (Jan 1947), 91-95. 46

Nerve stimulation recorder. To make studies of the paralyzing effect of botulinum toxin, an apparatus was designed which recorded in very slow motion the the change in electrical response of muscle after nerve stimulation. In this way neuro-muscular damage caused by botulism could be observed.

An electrical clock on the apparatus excited a solenoid (a tubular coil for the production of a magnetic field) every minute, which in turn opened the shutter of the camera. Simultaneously with the opening of the shutter, the electrical stimulator was excited, acting on the nerve of the subject. The electrical response of the muscle was picked up by an amplifier and recorded on the screen of the oscilloscope where it was photographed. The shutter of the camera opened for 1/16 second and a minute later the cycle began again. /

Respiration recorder. This apparatus was devised to record accurately the respiration of small laboratory animals, to determine tidal airs, respiratory volumes, and rates of breathing of the different animals used in field trials and in cloud chamber studies.

Two bottles half filled with water were placed at different levels so that the water flowed from the upper to the lower bottle. The bottles were connected by rubber tubing at both air and water levels. The displacing of the water caused air in the top of the lower bottle to flow past an outlet in the air line to which the nose of the animal was fixed and into the upper bottle. The respiration of the animal made the pressure

/ A.C. Guyton, "A Versatile Square Wave Nerve Stimulator," Review of Scientific Instruments, 17 (Dec 1946), 553-56. Originally reported in Sp Rpt 69, pp. 2-13. dl

within the system rise and fall slightly, causing a bellows to compress and dilate. The bellows pressed against several layers of paper and tin-foil arranged to form a variable condenser. The varying capacity of the condenser was recorded by a special instrument on the screen of the oscillograph and the record on the screen was then photographed. /

Electrical particulate counter. The electronic recorder was designed to count the number of particles suspended in an aerosol and to estimate the size of the particles. It operated by means of a vacuum line which pulled air through a small adapter which reacted with each particle encountered to create a small amount of electrostatic electricity. This impulse was then amplified more than one million times and was recorded on either an oscilloscope screen or a magnetic counter. The apparatus was reported to be ideally suited for the rapid study of cloud concentrations and particle sizes from one minute to the next. Clouds with concentrations from a few particles per liter to a theoretical upper limit of several million particles per liter might, it was stated, be studied.

/ Sp Rpt 23, Measurement of the Respiratory Volumes of Laboratory Animals (Oct 45). Also reported in Sp Rpt 69, pp. 14-29.

/ Sp Rpt 59, Electronic Counting and Size Determination of Particles in Aerosols (Dec 45).

47

Photography. Almost all equipment used by the photographic section at Camp Detrick was standard items issued by the Signal Corps. A photomicrographic camera, however, was obtained from salvage at Edgewood Arsenal, repaired, and used until it could be replaced with a new instrument. Leicas, 16 mm. motion picture cameras, Speed Graphics, and 8 x 10 view cameras were in constant use and with these a wide variety of lenses, from wide angle to telephoto. Adapters for the Leica lenses made it possible to use these on the Speed Graphics for photomacrography. Photomicrography, photomacrography, microfilming, photostating, preparation of slides, and motion pictures were the principal efforts of this section. Field photography of munitions experiments required as many as four cameras in operation at a time, to record the rise, drift, and spread of the agent clouds. Slow motion films were made in tests of bombs and fuzes. Occasional combinations of photography and electronic recording were required. Large numbers of pictures were taken of laboratory equipment, instruments, protective equipment and devices, laboratory specimens, clinical cases, and other material suitable for illustrating the subsequently published articles on the work that was done at Camp Detrick.

When a speedlamp and multiframe lamp could not be procured from commercial sources, the parts were assembled and the lamps constructed by a member of the section. With the aid of these lamps, aerosol particles invisible to the naked eye could be photographed. It was learned that particles as small as one micron could be shot in the air when the proper lenses, focus, lights, film and developing technique were combined. These lamps made possible the study of aerosols which are accidentally produced in certain laboratory procedures. The lamps also proved useful for showing

burst patterns of munitions and rapidly moving, barely visible cloud formations.

Micrometeorological instruments. A Chemical Warfare Meteorology Experimental Station was maintained at Camp Detrick from 1 March to 31 July 1946. Due to the danger and inconvenience of manually read instruments when used in the field during viable agent tests, the instrument research section of this Station turned all its efforts to the application of recording and remotely controlled weather instruments. These included apparatus for the measurement of temperature gradients, wind structure at horizontal, longitudinal, and vertical levels, and air flow at micrometeorological levels. /

Meteorological studies which were carried out at Camp Detrick in the course of field experiments with biological agents did not progress beyond preliminary considerations. / They were to be a postwar project, following the development of adequate and safe instrumentation.

/ Sp Rpt 74, Micrometeorological Instruments (Aug 46).

/ Sp Rpt 44, Munitions for Biological Warfare (Dec 45), pp. 205-21.

TERMINATION OF WARTIME ACTIVITIES

The end of the war. The program for the fiscal year 1945, comprising almost 200 separate projects, had come to an end and the program for 1946 a continuation of these projects, had just begun when the surrender of Japan was announced. For the next six months, operations at all Special Projects Division installations were more or less suspended. On an administrative level, decisions had to be made as to the future of biological warfare research in the Army. After some delay, it was decided that Camp Detrick must continue its research activities. The production plant at Vigo was retained for the Chemical Warfare Service, but would be maintained only in a standby condition. Horn Island was abandoned, and the Granite Peak Installation was closed and turned over to Dugway Proving Ground for surveillance.

While reorganization plans for the project program and conduct of postwar operations were being prepared for Camp Detrick, the chiefs of the divisions, branches and sections, and the groups of workers under them, began the preparation of final reports on the work they had done, based on the material recorded in their notebooks and in the monthly progress reports. At the same time, they were also engaged in writing up their wartime experiments in the form of articles, which were to be submitted to various scientific and technical publications as soon as classification restrictions on the subject material were relaxed.

Accomplishments. Shortly after the war summaries of the work of the Special Projects Division began to appear, as well as tentative conclusions concerning the implications of biological warfare, based on the successes attained in the wartime program. In a memorandum in September 1945 for the Secretary of War from ASF, positive accomplishments of the program were reported as: ✓

- 1 The design and construction of pilot plants and the construction of a large-scale production plant for the production of highly pathogenic agents.
- 2 The development of methods for mass production of virulent anthrax organisms as bomb filling.
- 3 The development of methods for mass production of virulent brucellosis organisms as bomb filling.
- 4 The standardization and production of the British-designed Mark I 4-pound bomb for the dispersal of anthrax organisms. Modification of existing design and production of a cluster adapter and container for this munition.
- 5 The development and field testing of a new type of bomb, the SS bomb which holds promise of being more efficient for the dispersal of certain biological agents than the British Mark I 4-pound bomb.
- 6 The development of methods for the field testing of biological munition.
- 7 The development of methods for pilot plant and large scale production of biological agents pathogenic to rice and other agricultural crops.
- 8 Procedures for large-scale use of chemicals to destroy crops. New chemicals which are nonpoisonous to man and animals have been discovered and their use thoroughly proven in extensive field trials.

✓ Memo (S), ACoFS ASF for SW, 13 Sep 45, sub: Research and Development in Biological Warfare. JWH 441.2 WDSND 334.

9 Methods have been developed for the defoliation of forest and jungle areas using easily available chemicals which are nonpoisonous to man and animals.

10 Great advances have been made in studying the pathogenesis of micro-organisms, particularly with respect to air-borne infectious agents.

11 Great advances have been made in the development of methods for the safe handling of highly pathogenic micro-organisms and for their detection. For example, the new infectious disease laboratory of the National Institute of Health at Bethesda, Maryland, is being designed and built on the basis of information obtained in the laboratories and pilot plants at Camp Detrick.

12 Effective toxoids for the immunization of man and animals against type A and type B botulinum toxins were developed and produced prior to the invasion of the Normandy Peninsula.

13 Great advance has been made in the study of immunity to anthrax, tularemia, and brucellosis and in producing immunizing agents against these pathogens.

14 Important advances have been made in the therapy of infectious diseases which might be used in biological warfare. For example, the treatment of anthrax with penicillin, of tularemia with streptomycin, and of glanders with sulfadiazine.

Great advances have been made in the design and manufacture of gas masks and protective clothing and in the development of methods of decontamination.

Accomplishments of the biological warfare program which possessed special values for peacetime research and development and which would be reported in open literature included:

1 Fundamental contributions made regarding nutrition and conditions of growth of micro-organisms, as well as safe procedures for quantity production of them.

2 Methods developed for accurate detection of small numbers or minute quantities of micro-organisms.

3 Many contributions made to the knowledge of control of air-borne diseases.

4 Significant contributions made to the knowledge concerning the development of immunity against certain infectious diseases of humans and animals.

✓ See Gen. Williams, "Laboratory Against Death," Weekly International Correspondence (1954)

- 5 Important advances achieved in the treatment of certain infectious diseases of humans and animals.
- 6 Special photographic techniques applied to the study of air-borne micro-organisms, promoting the development of safe laboratory techniques for handling pathogenic organisms.
- 7 Information secured on the effectiveness of over 1,000 different chemical agents on living plants, which will be of great value to agriculture.
- 8 Studies on the production and control of certain diseases in plants, which will also be of great potential value to agriculture.

A summary history of the wartime activities of this country in the field of biological warfare was reported in a secret document prepared by Mr. George W. Merck for the Secretary of War in October 1945, / and a brief resume of this report became the first War Department release infor the general public of the fact that the Army had been engaged in the stud of biological warfare throughout the war. / The same report was also th basis of a speech by Mr. Merck before the George Westinghouse Educational Foundation Forum in May 1946. The speech, like the release, emphasized the principal accomplishment of the program from an essentially nonmilita standpoint: /

- / Activities of the United States in the Field of Biological Warfare, A Report to the Secretary of War by George W. Merck, Special Consultant on Biological Warfare (S), 30 Oct 45? In CD-Tech Lib.
- / WD Bureau of Public Relations, for release at 7:30 P.M. EST, January 3, 1946, sub: Biological Warfare. See Appendix .
- / Reported in Science, 103 (31 May 1946), 662-63. See also George W. Merck, "Peacetime Implications of Biological Warfare," Chemical and Engineering News, 24 (25 May 1946), 1346-49.

Methods and facilities for the mass production of pathogenic microorganisms and their products were developed.

Methods for the rapid and accurate detection of minute quantities of disease-producing agents were elaborated.

Significant contributions were made to the knowledge of the properties and behavior of air-borne, disease-producing agents.

A pure, crystallin, bacterial toxin was isolated and studied for the first time.

Vaccines for the protection of chickens against two highly fatal diseases known as Newcastle disease and Fowl Plague.

Large-scale tests of a vaccine for the protection of cattle against rinderpest, a fatal Oriental disease, were made.

Extensive studies were made on the production and control of diseases which might affect crops of economic importance.

Information was obtained regarding the effect of more than 1,000 different chemical agents on living plants.

Implications. The potentialities of biological warfare, so long asserted by the Chemical Warfare Service, were, by reason of these accomplishments, no longer a matter of serious doubt. However, they remained potentialities only, for the agents and munitions that had been developed could not be tested against human subjects and their possible effectiveness as an instrument of war could not be confirmed. In a letter to the Chief, Chemical Warfare Service, the director of the Special Projects Division offered his conclusions as to the nature and practicability of such warfare in the light of the wartime studies: /

/ Memo (S), C SPD for C CWS, 15 Nov 45, sub: Information on EW of Interest to the Equipment and Review Board. SPD 730-EW.

Biological warfare, through sabotage, can be developed in a short time by any progressive nation. The activity would be difficult to detect since it can be conducted under the guise of legitimate research.

Sabotage will succeed only in proportion to the breakdown of public health measures in the country attacked.

Open large scale biological warfare can be developed only by nations with sizable resources in scientific personnel and industrial facilities. However, investment for significant development will be less than for other forms of warfare.

For a given casualty effect, the weight of a biological agent or munition is expected to be very much less than that of a chemical warfare agent or high explosive.

The Japanese balloon was well-adapted to spread biological warfare agents, particularly for serious epidemics of livestock. The balloon incidents prove that the U.S. and Canada are open to this form of attack from the Asiatic mainland.

Use of aerial bombs and spray for crop destruction is practical and can be greatly extended.

In a report prepared by former officials of the ^{United States} biological warfare program it was declared that the development of agents for biological warfare was possible in many countries, large and small, without vast expenditures of money or the construction of huge production facilities. It was quite probable that research directed toward enhancing the virulence of known pathogens would result in the production of varieties much more virulent than those now known. It would be difficult to control research and development work in the field of biological warfare, as compared with that of atomic warfare. /

/ G.W. Merck, E.B. Fred, I.L. Baldwin, and W.B. Sarles, "Implications of Biological Warfare," The United States and the United Nations Report Series No. 5, The International Control of Atomic Energy (Dept of State, Pubn. 2661: USGPO, 1946), pp. 65-71.

47

Evaluations of the program. In a report on a visit to the Biological Section of the Porton Experimental Station in May 1944, the chief of the Technical Department at Camp Detrick furnished a number of instances which tend to indicate that although we accomplished much with our almost unlimited personnel and funds and with the finest facilities obtainable, we were probably not as original in our thinking as the British, nor were we as realistic in our approach to the problem. Certainly we were not quite as handicapped by lack of precedence at the outset of our work as were the British, for we had their experience to draw on and they gave it to us freely. Counterbalancing this, however, was the fact that our investigations were on a far larger scale than those of our allies. Their work was conducted with only a handful of people. In its fourth year of work, the Biological Section at Porton under Dr. Paul Fildes was comprised of only 45 people, including 15 officer-civilians (four of which were being supplied by SPD), 20 enlisted technicians, and 10 female helpers. / In contrast, the year-old SPD had more than 1,500 people at Camp Detrick and Horn Island the two installations operating in May 1944, and this figure was to be more than doubled in the next year.

The British considered, perhaps out of reluctant envy, that the great size of the project at Camp Detrick was not necessarily favorable to research and might even be a handicap. They were probably right in declaring that, as a result of its size, the experienced research people at Camp Detrick,

/ Report on Visit of Lt.Col. Oram C. Woolpert to ETO, 22 May-2 Jul 44, p. 2. In Hist files.

as heads of the divisions, were too tied up with administrative work to spend enough time in the laboratories. /

There appeared to be some justice in the complaint of Dr. Fildes in May 1944 "that there has been a certain amount of duplication of effort in the several countries; that we in the States have not taken full account of their fundamental studies and have attacked de novo problems which they had brought to a satisfactory state of solution." / This was perhaps true to some extent in the case of anthrax and botulinum toxin. When the biological warfare program was begun in Great Britain in 1940, the Government wanted an offensive weapon ready for retaliation within six months. Anthrax was selected by Dr. Fildes and his group as the most likely agent, although it was understood that it was not the most disabling of biological agents, because of its hardiness, the fact that it killed animals with regularity, was stable, could be produced in quantity, and because dissemination was not an impossible problem. Working entirely by empirical methods and without precedent, the British learned that anthrax organisms could be readily produced and effectively dispersed. Their initial successes were particularly encouraging and they went on to develop an anthrax meal cake for use against domestic animals and the 4-pound bomb, both of which were

/ Interv GWS Hist Off with Dr. David Henderson, Bio Sec, Porton Exper Sta, 11 Jun 45. Dr. Henderson who had worked at Porton with Dr. Fildes came to Camp Detrick in August 1944, not as British liaison but to work in our laboratories.

/ Report on Visit..., p. 3.

46

quick if not entirely satisfactory answers to the demand for an offensive weapon. / The Porton group learned early, however, that anthrax was not the superior agent we held it to be, and it was our tremendous outlay in time and effort on repetitive studies of anthrax which Dr. Fildes deplored. They worked on it just long enough to provide themselves with the necessary groundwork for research on other agents, and it was in the light of their field experience with anthrax that the British first saw the possibility of brucellosis and began its study.

The work of the British on botulinum toxin convinced them, as it failed to convince us, that there was no necessity of inoculating our invasion troops against the toxin. The British therefore had no stocks of botulinum toxoid available for D-Day, while we had sufficient for 100,000 of our troops and the Canadians had supplies for all of their forces. The chief of the Technical Department admitted the sound judgement of the British decision and stated that we ourselves had not demonstrated that botulinum toxin would be an effective agent for aerial dissemination. /

- / The British themselves prepared several million of the anthrax-infected cakes, but having no facilities for biological bomb production, ordered 500,000 of the Mark I bombs from Vigo Plant.
- / Dr. Henderson said that except for the work of Watson and Bloom, which presented a new view of the host-parasite relationship, all the immunological work on anthrax done at Camp Detrick was along classical lines. See interview, op. cit.
- / Although the toxin had not proved an effective aerosol, the British had shown that it may be very effective as a contaminant of small ammunition and shrapnel. They did not believe, however, that the enemy would use the agent in this manner. Report on Visit..., pp. 6, 2. 4

Although the British were somewhat critical of our interest in repeat the fundamental work which they had done on anthrax, they were eager for us to continue production studies, munition design, and field trials of the agent, since they did not have the facilities. In a letter to the chief of Special Projects Division in October 1945, Dr. W.J. Nungester of A Divi suggested that perhaps the British had been allowed too much voice in these matters. It was Dr. Nungester's opinion that "the two big sour notes at Detrick were the time and money wasted in the study of M and our slowness in accepting or even adequately trying unconventional modes of dissemination such as use of insects, refrigerated munitions and other ideas not yet born

Controversy over the extent of the investigations of anthrax had been raised at the 18 July 1944 meeting of the Technical Department (see fn. p.), when Lt. D. W. Watson and Lt. L. C. Kingland were reprimanded for becoming emotional in an attempt to show that typhus and psittacosis had greater possibilities than anthrax and botulinum toxin as biological warfare agents. The Special Projects Division, however, was committed to the study of the latter agents and had to await authorization for any broadening of the program.

The work of the Special Projects Division, in general, was subjected to the same criticisms after the war that were leveled at much of the

/ Ltr (S), Dr. W.J. Nungester to C SPD, 23 Oct 45, no sub. SPD 730-BW.

26

military research and development efforts between 1941 and 1945. In spite of the great volume of work performed and the number of scientific papers prepared for publication, it was generally agreed that the speed of development and quality of work in SPD had been seriously limited by the war emergency nature of the project, by the drastic security restrictions, procurement difficulties, unfamiliarity of personnel with the work that was to be done, scarcity of competent enlisted personnel, differing viewpoints regarding the relative importance of various phases of the work, attempts to subject the research and development program to a military system, and inadequate information both from the literature and from those in possession of facts regarding the status of biological warfare activities and related matters. It was felt that such progress as had been made was attributable chiefly to the ingenuity and enthusiasm of both officers and enlisted men who were directly concerned with the work. They persisted, with few exceptions, in the face of hazards, difficulties, and discouragements which might have completely demoralized less able personnel. /

Publication. The question of publication first came up in November 1943. The research workers at Camp Detrick were informed that manuscripts which were received by the Technical Director, SPD, would be subjected to review by the Intelligence Branch, SPD, and forwarded to Information Branch OC C7S, for transmittal to the Review Board, WD Bureau of Public Relations. A manuscript which cleared all these agencies might then be submitted to a scientific periodical for publication. / There is no record that any manuscript reporting on work performed at Camp Detrick during the war achieved publication in this manner.

Except through the medium of secret technical reports with limited circulation, the strict security classification of all work in biological warfare prevented any publication whatever. Even those findings which were, from the ordinary point of view of security, innocuous and of general interest only, but which might be identified with the program at Camp Detrick had to be withheld. Yet despite the veritable ban on publication, certain papers reportedly appeared before the end of the war, "surprisingly similar to studies carried out at Camp Detrick," written by personnel who had been associated with the project. Security could not be absolute when personnel were constantly being transferred or separated from the service. It therefore was necessary to find some means of protecting the scientists working in the Special Projects Division, not only as to their findings but also as to the priority of their findings, since publication of research was an accepted privilege of the scientist and constituted one of the chief means

/ Memo for file, C SPD, 1 Nov 43, sub: Note for Publication File.
SPCYF 000.7. In SPD OC Cml C.

46

of his professional advancement. /

A new mechanism was proposed whereby manuscripts would be submitted through the DEF Committee and the Advisory Committee on Scientific Publications of the National Research Council, after which they would be filed in the archives of the National Academy of Sciences. In this manner, it was hoped, priority and authorship would be protected, and the manuscripts would be ready for release as soon as classification of the material was relaxed. The suggestion was embodied in a report to the USBW Committee in May 1945 but was not accepted because it would not, it was felt, protect the workers as intended. There was nothing to prevent those who had been engaged in the work at Camp Detrick from utilizing their special information in connection with their work upon return to peacetime pursuits, either in further research or in publication, even though officially they would be unable to disclose the source of their information and ideas.

Another plan for publication was submitted just as the war ended in the Pacific. Under this arrangement publication was to be accomplished through a governmental agency such as the National Academy of Sciences,

/ The problem became evident in Oct 1944 when the Joint Sub-Committee on Publication, Committee on Medical Research, OSRD, with the approval of Joint Security Control, granted permission to three research workers in Philadelphia to publish a paper on the treatment of human anthrax with penicillin. Although this subject material pointed straight at Camp Detrick and therefore had a top secret classification, the writers were not connected with the project in any way and publication was allowed on the basis of a similar study in Lancet in 1941. See memo (S), Lt. Comdr. W.B. Sarles for Dr. A.N. Richards, Chrm, Com on Med Res, 15 Nov 44, no sub., and memo for file, 23 Nov 44, sub: Report of Conversation between Sarles and A.N. Richards. In files of G.W. Werck.

/ Memo for file, Dr. W.J. Nungester, 27 Nov 44, sub: Suggested Outline for Study of Publication Problem. In files Tech Dir CD.

without disclosure of the association of the War Department with the work and with no reference to individual authorship. The policy would be clear with our British and Canadian allies to protect special joint interests. A secret file would be maintained to indicate the source and authorship of each paper, and the papers would be release when security policies were altered to permit such disclosure. Adoption of this proposal, it was believed, would protect the priorities and personal interests of the responsible research workers without sacrificing security and at the same time, it would stimulate the morale of all associated with the project, encourage the preparation of further reports, and facilitate the organization and prosecution of a postwar program. /

Not a single paper from Camp Detrick had been published when the war ended, although the subject had been under intermittent discussion for almost two years. Also, no effort had been made to utilize the mechanisms either of the National Defense Research Committee or of the National Academy of Sciences, both of which had special publication committees, in order to obtain priorities for the papers of workers associated with Camp Detrick. This was due largely to the rigid security classification of all work concerned with biological warfare, and it was agreed that a new classification policy on the subject material would have to be sought before adoption of any plan for publication could be considered. /

/ Ltr (S), C Tech Dept CD to C SPD, 23 Aug 45, sub: Publication of Research. SPCRF 000.72.

/ 2d ind, C Tech Dept CD, 29 Aug 45, on ltr (S), above.

Early in September 1945, therefore, the Chief, CWS, wrote to the Commanding General, ASF, that revision of existing security classification was urgently needed. Immediate release of material and information on a new vaccine for rinderpest was necessary so UNRRA in China could have it. The U.S. Department of Agriculture wanted all information available on the chemical plant growth-regulating compounds. It was desirable to transmit other valuable findings to responsible medical, veterinary, public health, and agricultural authorities. In addition, publication rights must be granted on as wide a basis as possible in order to attract qualified scientific workers into this specialized field of research for postwar work, and limited publicity should be permitted in order to give the public sufficient information to make them aware of the program and to approve it. A proposed reclassification on matters concerning biological warfare was outlined as a basis on which War Department policy might be established and by which manuscripts prepared at Camp Detrick and elsewhere might be judged. / In a Joint Chiefs of Staff memorandum of policy dated 19 November 1945, the new classification went into effect, substantially as proposed (see Appendix P). /

Just one month prior to the establishment of the new classification, word was received that restrictions would be relaxed and all prospective authors in the SPD were advised to prepare their manuscripts with utmost dispatch. The manuscripts would be forwarded through the Technical Director, CD, to SPD, OC CWS, for submission to the President's Committee on Public

/ Ltr (S), C CWS to CG ASF thru SGO, 11 Sep 45, sub: Classification of Matter Concerning Biological Warfare. SPCWV 730 and WDSND 334 JNW 441.

/ Appendix P contains the original JSC policy of 7 Sep 44, an interpretation by the C Int Br SPD on 25 Jan 45, and the revised JSC policy of 19 Nov 45. ↓

tion of War Research and would be reviewed and released in the near future. Between October 1945 and 30 June 1947, a total of 156 papers were approved at Camp Detrick. By the latter date 121 had been published, 15 had been accepted by various journals, and 20 had been submitted for publication. Seventeen of the 121 papers published were those on rinderpest, in which the Canadians collaborated. In addition, there were 28 papers approved and presented at scientific meetings. / Indicative of the wide range of research in SPD were the fields of knowledge covered by these papers, including bacteriology, physiology, pathology, clinical medicine, preventive medicine, biochemistry, neurology, veterinary medicine, mycology, phytopathology, botany, public health, industrial hygiene, instrumentation, chemical engineering, chemistry, and agriculture.

/ Ltr, C SPD to Tech Dir CD, 5 Oct 45, sub: Preparation of Manuscripts for Publication. SPCYF 000.7.

/ Ltr, C Ed & Info Br R&D Dept CD to All Concerned, 15 Jul 47: sub: Bi-Monthly Report of Papers from Camp Detrick which have been Approved for Publication and for Presentation at Scientific Meetings. CMICD.
See bibliography for list of papers published or presented at meetings.
p. 535 ff.

Newspaper and periodical publicity. The subject of biological warfare was undeniably sensational, even more sensational than was the legendary "dew of death," lewisite, after the last war. It was not even exceeded in public interest by the atomic bomb, which required a degree of astronomical imagination for appreciation. Biological warfare is being waged against each one of us continuously and goes on internally all our lives. The appeal was to the viscera, and with the first War Department release, the periodicals gave tongue.

The day after the War Department issued the first release on the wartime investigation of biological warfare, / the Navy Department held a press conference and reported that its Naval Research Unit at Berkeley, California, had used fifth^{ly} convicts from San Quentin in its bubonic plague experiments. / A week later the first of the Sunday supplements on the terror of biological warfare appeared, / and Waldemar Kaempffert, science editor of the New York Times, declared the subject could not be ignored by the new United Nations Organization. / The writer was in the Panama Canal Zone when the first news-worthy stories of botulinum toxin went out on the wires. In a UP dispatch with a London dateline, it was reported

- / "U.S. Was Prepared to Combat Axis in Poison Germ Warfare," New York Times, January 4, 1946, p. 1.
- / "Convicts Aid Germ Battle," Oakland, California, Tribune, January 5, 1946, p. 1.
- / "The Black Death Returns," Washington Times-Herald, January 13, 1946, sec D, p. 3.
- / "Bacterial Warfare Poses a Problem," New York Times, January 13, 1946, sec E, p. 9.

that "British scientists in close touch with the United States Chemical Warfare Service said American bacteriologists had prepared a deadly germ - believed to be the virus that causes infantile paralysis- in powder form. One thousand millionth of an ounce of this powder would be enough to infect a man..." / Just four months later, Gerald Wendt, editorial director of Science Illustrated, was quoted as saying that "a new, innocuous looking crystalline toxin...is so powerful that an inch-cube of it, rough an ounce, could kill every person living in the United States and Canada, silently and swiftly." "...One gram is enough to kill 7,000,000 human beings, and an ounce is enough to kill 150,000,000." /

The next newsbreak of consequence occurred in May 1947 when a manuscript on the potentialities of some thirty diseases as agents of biological warfare, prepared in 1942 by a Columbia University bacteriologist and biochemist and submitted to the National Research Council at that time, was published by the Journal of Immunology. / Although the article contained no information derived from the wartime studies, it enumerated the types of diseases which might have war application and, of course, many of the organisms of these diseases had been investigated by the Special Projects Division. The newspapers made full reports on the journal article. /

- / "U.S. Reportedly Develops Potent New Germ Weapon," Panama Canal Zone Panama-American, May 30, 1946, p. 1.
- / "Ounce of New Super-Poison Held Able to Wipe Out U.S., Canada," New York Times, September 19, 1946, p. 1.
- / Theodor Rosebury, Elvin A. Kabat, and Martin H. Boldt, "Bacterial Warfare: A Critical Analysis of the Available Agents, Their Possible Military Applications, and the Means for Protection Against Them," Journal of Immunology, 56 (May 1947), 7-95.
- / "Scientists See U.S. Very Vulnerable to Germ Warfare," New York Times, May 19, 1947, p. 1; "1942 Report on Germ War Lists 30 Diseases Without a Defense," New York Herald-Tribune, May 19, 1947, p. 1.

With the War Department release, the newspaper accounts, and Mr. War published speeches to draw on, and by tapping the scientific journals and other special sources available to it, the periodical literature began to report its findings in biological warfare research. / Next, the journal ists, supplying imagination to the known facts, retold the story in vivid word pictures. Their theme, in general, insisted that "biological warfar using scourges of disease and famine as weapons, is as dreadful as the atomic bomb and far more difficult to control." / The socially-conscicu New Masses and Nation scolded. "...This research," said the former, "als is of bewildering peacetime value to humanity...yet...at present the military censorship guards these lifesaving secrets behind machine-guns. The only beneficial discoveries so far disclosed are of use to poultry an cattle!" /

A short story in Collier's, based on a theoretical application of a principle of biology, symbiosis, was by far the cleverest of the journali attempts. For comparable use of atomic principles in fiction, it would b necessary to go to Amazing Stories. /

/ "Disease Warfare Not New," "Biological Warfare," "International Effect "Harmful Effects Persist," Science News Letter, 49 (12 Jan 1946), pp. 16-21:

"Armies of Germs," Newsweek, 14 (14 Jan 1946), pp. 75-76.

"'Better' than the Bomb," Time, XLVII (3 Jun 1946), p. 42.

"Planned Pestilence," Time, XLVIII (12 Aug 1946), p. 56.

"Death in Convenient Bottles," Time, XLVIX (26 May 1947), p. 81.

"Nazi Try Germ Warfare," Science News Letter, 51 (8 Mar 1947), p. 133.

"Deadly Chain Reaction; Spreading of Disease Can Be Used as a Weapon," Science News Letter, 51 (31 May 1947), p. 342.

"Germ Warfare Advances More Potent than A-Bomb," Science News Letter, 52 (30 Aug 1947), p. 136.

(cont'd)

- ✓ Gerard Piel, "BW," Life, 21 (18 Nov 1946), pp. 118-30.
Sidney Shallett, "The Deadliest War," Collier's, (15 Jun 1946), pp.
John W. Campbell, Jr., "The Real Big Three," Pic, (Feb 1947), pp. 82.
"Germs-New War Terror," Look, 11 (7 Jan 1947), pp. 52-53.
- ✓ Dyson Carter, "Biological Warfare: New Ways of Killing," New Masses,
LX (3 Sep 1946), pp. 3-6.
L. Engel, "Scope of Biological Warfare," Nation, 165 (26 Jul 1947),
pp. 93-95.
- ✓ William F. Jenkins, "Symbiosis," Collier's, 119 (14 Jun 1947), pp. 14-

POSTWAR OPERATIONS

Reconversion. Three days before the Japanese announced their acceptance of the Potsdam terms, directives were issued to the Chief, CWS, for bringing an end to the work of the Special Projects Division as soon as possible, "in order to promote the rapid and orderly completion of the wartime program of research, development and production in this field." Cancellation of procurement contracts, deactivation of Horn Island, and termination of research contracts with agencies outside the War Department were to be carried out as quickly as possible. All plans for future research and development at Camp Detrick and Granite Peak Installation were to be abandoned at once, and all projects under investigation must be closed out at the earliest date consistent with the preparation of final reports. / However, as plans were being made to continue research in many of the laboratories of the services, the Chemical Warfare Service urged retention of its laboratories at Camp Detrick as a part of the peacetime CWS research establishment. On 23 August 1945 the Chief of the Service informed ASF that all construction in SPD had been stopped, that purchases to support Vigo production had been cancelled, Horn Island had been declared excess, and Granite Peak recommended for inactive status. But he requested that Vigo Plant be retained for the CWS and placed on temporary inactive status, and that Camp Detrick be retained for continue

/ Memo (S), CG ASF for CofS, 11 Aug 45, sub: Research and Development in Biological Warfare. WDSND 334 JNW 441.2. This was in accordance with memo (S), Deputy CofS WDCS for CGs AAF, AGS, and ASF, 1 May 45, sub: War Department Policy on Research and Development. WDCSA 400. 112 (30 Mar 45)

research on a peacetime basis. / It was also recommended that the organization for joint Anglo-American and Canadian American research collaboration in biological warfare which had been in effect during the war be continued.

The request for retention of Camp Detrick and Vigo Plant was granted in a memorandum from the Secretary of War to the Chief of Staff on 13 September 1945, which directed that plans for peacetime research in biological warfare be prepared by the Chief, CWS. The plan for conversion was reported on 12 October 1945 to ASF, the Surgeon General, and the Navy Department's Bureau of Ordnance and Bureau of Medicine and Surgery. / Although the participating agencies demurred to the proposal that control of the postwar program remain in the hands of the Chemical Warfare Service the War Department declared that the Service would continue to conduct the work, with the collaboration of the Surgeon General. / In the same memorandum that made the Chemical Warfare Service responsible for the biological warfare program, it was directed that the USBW Committee be dissolved and its function as the directing agency of biological warfare research be transferred to the New Developments Division in the War Department.

- / Memo (S), C CWS for CG ASF att. Lt.Gen. LeRoy Lutes, 23 Aug 45, sub: Present Status of the Program in Biological Warfare. SPCWV 730.
- / Ltr (S), C CWS to CG ASF, 27 Aug 45, sub: Continued Collaboration with United Kingdom in Biological Warfare Research and Development. SPCWV 730.
- / Ltr (S), C CWS to CG ASF, 12 Oct 45, sub: Recommended Peacetime Program of Research and Development in Biological Warfare. SPCWV 730. Also 1st ind, TSG, 19 Oct 45; 2d ind, C Navy Dept BuMed, 7 Nov 45; 3d ind, C Navy Dept BuOrd, 13 Nov 45.
- / Memo (S), Asst DCofS for Dir NDD WDSS, 5 Nov 45, sub: United States Biological Warfare Committee. WDSND 334 JNW 441.2

ment Special Staff. /

In a revised organization plan for postwar research, the Chief, CWS proposed that personnel for Camp Detrick be authorized as follows:

	<u>CWS</u>	<u>SvC</u>	<u>Navy</u>	
Officers	20	27	15	
Enlisted men	35	28	60	
Civilians	<u>496</u>	<u>271</u>	<u>50</u>	
	551	326	125	= 1,002

In addition to active Navy participation in the program, approximating 25 percent of its wartime strength, the Office of the Surgeon General was urged to provide personnel to supervise the medical defensive research in the program. An estimated budget of \$2,746,000 was proposed for the fiscal year 1947. To recommend policy for the general program of work to be carried out, it was proposed that an advisory committee (later, Coordinating Committee for Biological Warfare) be established, composed of members from the four participating agencies and representatives of the National Academy of Sciences, U.S. Public Health Service, and U.S. Department of Agriculture. This committee would also review budgets, appointments, project plans, and research contracts, and assure liaison with related services, agencies and institutions. /

/ Memo (S), SW for CofS, 30 Oct 45, no sub (WDSND 334 JNW 441.2), said that the work of this special committee was about concluded and future supervision should be undertaken by the NDD, WDSS.

/ Ltr (S), C CWS to Dir NDD WDSS, 14 Dec 45, sub: Revised Recommendations for Peacetime Organization of Research and Development in Biological Warfare. SPCBL 730.

The proposed program was approved in principle by New Developments Division, the Deputy Chief of Staff, and the Director of Plans and Operations, ASF, and the Chief, CWS was directed to take the necessary action to implement the new program. The initiation and cancellation of all research projects were to be submitted for approval to Plans and Operations and this agency would also settle any controversy arising within the Coordinating Committee on Biological Warfare. /

With the first announcement by the Chemical Warfare Service that it would seek to continue research in biological warfare, the Bureau of Medicine and Surgery, Navy Department, gave prompt assurance that it too was vitally interested and would cooperate fully. / When, in March 1946, the new program got under way, the Navy had its full complement already at work at Camp Detrick. /

The Coordinating Committee in Biological Warfare, to direct the program at Camp Detrick, had been formed and was composed of the following members:

- / Memo (S), Dir NDD WDSS for CG ASF, 29 Jan 46, sub: Research and Development in Biological Warfare (WDSND 441.2), and 1st ind, Plans & Opns ASF to C CWS, 14 Feb 46.
- / Ltr (S), C BuMed & Surg USN to Dir NDD WDSS, 5 Nov 45, sub: Interest of Bureau of Medicine and Surgery in Research and Development in Bacteriological Warfare. BUMED-Y-MK Serial 002107(SC). In NDD WDSS. This letter also urged that official announcement should be made of the fact that this country was carrying on investigations in BW during the war, no word of which had yet been made public.
- / Ltr (S) Secy of Navy to Special Distribution List, 29 Mar 46, sub: Naval Participation in the Army Program of Bacteriological Warfare Research.

SGO - Col. Roger G. Prentiss, MC, SGO
BuMed - Capt. O. L. Burton, MC, USN
BuOrd - Comdr. Levering Smith, USN, R&D Div, BuOrd
U.S. Public Health Service - Dr. Rolla E. Dyer, Dir, National
Institute of Health
U.S. Department of Agriculture - Dr. W. V. Lambert, Asst Admin
of Agricultural Research Administration
National Academy of Sciences - Dr. William A. Hagen, Cornell
University

Deactivation of Horn Island and Granite Peak Installation. On Horn Island at the close of the war were 12 CWS officers and 83 enlisted men, as well as a contingent of 1 naval officer and 19 ratings. On 25 September 1945 the naval unit returned to the Great Lakes Naval Station, its mission completed. A month later, after sending all laboratory equipment and remaining supplies to Camp Detrick, the last of the CWS personnel turned the island installation and surplus property valued at approximate \$448,000 over to the Corps of Engineers for disposal and returned to Camp Detrick. / The installation was formally deactivated on 18 November 1945.

At Granite Peak, Utah, there were 98 men in the CWS unit and 60 in the Navy unit when the war ended. By the end of October both units had departed, after closing up the buildings and turning over the care of the installation to Dugway Proving Ground. / Tentative plans were made to conduct large-scale field tests of biological agents and munitions at

/ Ltr, TAG to CG 4th S&C, C CWS, and C CE, 1 Oct 45, sub: Disposal of Horn Island Installation, CWS. AG 602(23 Sep 45)OB-I-SP:WOC.

/ Teletype directive, Mob Div ASF to CO DPG, 1 Oct 45.

Granite Peak for several months in each year, but during the rest of the year the site would be deserted, its minor maintenance expenses borne by the neighboring CWS installation.

Demobilization of Vigo Plant. The day after Japan surrendered, a Steering Committee was appointed at Vigo Plant to expedite demobilization planning, direct the disposition of supplies and equipment on hand, cancel purchase contracts, and dispose of excess personnel as quickly as their services were no longer required to reduce the plant to standby status. In the month that followed, all purchase contracts, numbering almost 600 orders for materials, were cancelled or transferred to appropriate CWS procurement districts. Then the shipment of excess equipment and materials at the station began. Three carloads of coal were returned to the Commercial Barge Lines and all surplus diesel oil was turned over to the Quartermaster Corps. On October 5 the fires in the main boilers of the Vigo Plant were pulled.

The fact that pathogens had not been used in the trial operations made it unnecessary to decontaminate the plant and facilitated closing it down. All experimental animals at Vigo were shipped to the Medical Division.

✓ CWS plans to retain Vigo Plant were reported in ltr (C), C CWS to C CE, 18 Aug 45, sub: Production Facilities at Vigo Plant Placed in Inactive Status (SPCIV 635) and ltr (C), C SPD to CO VP, 21 Aug 45, same sub (SPCIV 635). Not until November 1945, following recommendations of the Steering Committee, USBWC, was official confirmation received, in memo (S), C Industrial Activities Div, Office of Under Secy of War for CG ASF, 8 Nov 45, sub: Disposition of Vigo Plant.

✓ Among the larger of the procurement contracts of SFD transferred
(contd)

Fr. (cont'd)

to the New York or Chicago Chemical Warfare Procurement Districts for termination were:

To NYCWPD-Contract	12-083-CWS-8	Sponge Rubber Products Co., Shelton, Conn.	\$ 12,827
	12-083-CWS-9	Commercial Solvents Corp., Terre Haute and New York	13,365
	12-083-CWS-13	Unexcelled Manufacturing Co., Cranbury, NJ	209,434
	12-083-CWS-16	E.I. duPont de Nemours, Wilmington, Del.	15,000
	12-083-CWS-18	Buflovac Equipment Div, Blaw-Knox Co., Buffalo, N.Y.	21,308
	12-083-CWS-20	Ohio Apex, Inc., Nitro, W. Va.	36,750
To CCWPD-Contract	12-083-CWS-5	Electromaster, Inc., Detroit, Mich.	4,356,020
	12-083-CWS-24	Sherwin-Williams Co., (unavailable Chicago, Ill.	

at Edgewood Arsenal, to Department of Agriculture tests stations, or in the case of overage animals, were disposed of. Three carloads of machine shop equipment were sent to Camp Detrick and remaining shop equipment turned over to the Engineers for disposal. All but 70 military vehicles were returned to Ordnance. A carload of sulfuric acid, 16,000 gallons of caustic, and 20,000 pounds of bleach were sent to the Memphis ASF Depot; primacord on hand was returned to the Ensign-Bickford Company, and 765,000 detonators and two carloads of blankets and beds were returned to the Quartermaster. All stocks of tributyl phosphate remaining were made into VML and shipped to the Desert GWS Depot, and approximately 20,000 Mark I bombs were sent to Camp Detrick for storage. Donations of excess plant equipment were made to the Armour Research Foundation of Illinois Institute of Technology, Emory University at Atlanta, Purdue University, Rose Polytechnic Institute at Terre Haute, the University of Michigan, University of Colorado, and the U.S. Penitentiary at Terre Haute. At the end of October almost \$800,000 worth of equipment had been declared excess. The equipment removed from Vigo Plant required 18 boxcars. /

Personnel at Vigo Plant were progressively reduced from 967 Army officers and enlisted men, 326 Navy officers and enlisted and 202 civilians in August 1945 to 151 Army officers and enlisted men and 140 civilians by the end of December 1945. The naval unit had been inactivated on 3

/ History of Demobilization, 14 August 1945-31 December 1945, Vigo Plant, GWS, pp. 21-59. In Hist files.

November 1945. It was believed that when standby status had been achieved five officers, four enlisted men, and 50 civilians would be all that was required to keep the plant in good order. /

In spite of the efforts of Vigo Plant personnel, the installation had not been completely converted to a standby condition in accordance with standard Army procedures by 31 December 1945, the original target date. However, the work was to continue until it could be reported that the Army criterion had been met, that is, that the inoperative plant was in such condition that it could be made ready for proof testing operation within 30 days.

In a report made to the chief of the Special Projects Division on 30 November 1945, the Steering Committee at Vigo Plant recommended that the manufacturing plant area be held in a standby condition for a minimum of five years. It was not believed that any of its special machinery or plant processing equipment would become obsolete in that time. The remainder of the plant, except for rail and highway rights of way, should be disposed of as surplus. The agent manufacturing plant itself, said the report, could not be sold or leased to a civilian concern, even were the Chemical Warfare Service willing, because of the amount of secret construction. Only a small part of the facilities were readily convertible to the manufacture of commercial products, such as penicillin or streptomycin, and the type of equipment suitable for this purpose at Vigo was not critical elsewhere.

/ Ibid., p. 59.

Reorganization of Camp Detrick. Less than a week after V-J Day work schedules at Camp Detrick were reduced to 25 percent of their war-time heights by cutting down the number of hours worked each day and by eliminating work on Saturday afternoons. Under this plan, the projects in progress were to be closed out by 30 November 1945 and work would then proceed along the lines to be recommended for the postwar program. In addition to the completion of laboratory studies and preparation of final reports, field trials which were scheduled would also be run off by that termination date. These included tests with brucellosis organisms and the SS bomb at Suffield in Canada, dispersion bomb tests with VKA at Dugway Proving Ground, woodland defoliation studies being made with AGF and AAF personnel at Fort Knox, Kentucky, and airstrip vegetation control studies being made in conjunction with the AAF at Eglin Field, Florida. /

The reorganization of Camp Detrick for postwar research was largely a matter of reducing its forces, its research program, and of consolidating its organization for efficient administration. The basic organization remained virtually unchanged for, even in reduced circumstances, all its functions remained necessary. However, many of the functions were telescoped and the number of personnel assigned to purely administrative functions was minimal. In the Technical Department, Animal Research (A)

/ Memo (S), C CNS for CG ASF att Lt.Gen. LeRoy Lutes, 23 Aug 45, sub: Present Status of the Program in Biological Warfare. SPCWV 730.

Division was redesignated as Pilot Plants (P) Division, and Biological Research (B) Division became Medical-Veterinary (M-V) Division. / The Special Projects Division as a function in the Office of the Chief, Chemical Corps, / was abolished when Camp Detrick became the only remaining installation conducting biological warfare research. (See Chart 6 for wartime organization of Camp Detrick, Chart 7 for postwar organization and Chart 8 for the position of Camp Detrick in the postwar Chemical Corps.)

There were a total of 2,273 people at Camp Detrick when the war ended:

Army officers	245
Army enlisted	1,457
Navy officers	87
Navy enlisted	475
Civilians	9

Four months later, on 31 December 1945, personnel had been reduced to a total of 865 people (see Chart 4, p.76).

Army officers	134
Army enlisted	302
Navy officers	33
Navy enlisted	109
Civilians	287

In the months that followed, military personnel continued to be replaced by civilians at a rapid rate, largely effected as wartime personnel were separated from the services and resumed their work in the laboratories as civilians. (See Chart 9 for postwar personnel strength summaries.)

/ CD GO 24, 31 Oct 46, and CD GO 2, 19 Mar 47.

/ The Chemical Warfare Service was redesignated as the Chemical Corps per WD GO 99, 6 Sep 46.

CHART NO.

APPROVED:	WALTER T. HICK Colonel, C. A. B. Commanding
	P. W. WOLFE Lt. Colonel, C. A. B. Chief, Special Projects Division
	W. J. TOLAN Major General, U. S. A. Chief, Chemical Warfare Service
	Date of Last Revision 11 Sept. 48

ORGANIZATION SERVICE
CRACK PLANTS DIVISION
D. A. F. S. 100.000
W. J. TOLAN, Chief

ORGANIZATION SERVICE. With respect to S. V., complete research and development on mechanical and biological methods of defense, and on the production of agents and methods for retaliatory employment to offset perfect weapons. Develop procedures through engineering and pilot plant studies; develop safety measures for the protection of personnel on the post and in surrounding communities; develop toxic inspection procedures for production plants; perform all service training necessary to successful accomplishment of technical studies.

REPORT OF PERSONNEL		Per	Alleg	Att.
OFFICERS:		Count		
Colonels		5		
Lt. Colonels		15		
Majors		40		
Captains		103		
1st Lieutenants		87		
2nd Lieutenants		81		
TOTAL		272		
ENLISTED:				
W or 1st Sgt		26		
S Sgt or 1st Sgt		40		
Sgt or 1st Sgt		80		
Plt or 1st Sgt		201		
Plt		26		
Plt		56		
Plt		59		
TOTAL		589		
PL OFFICERS:				
Captains		1		
1st Lieutenants		1		
2nd Lieutenants		1		
TOTAL		3		
ENLISTED:				
W or 1st Sgt		3		
S Sgt		3		
S Sgt or 1st Sgt		11		
Sgt or 1st Sgt		27		
Plt or 1st Sgt		37		
Plt		51		
Plt		59		
TOTAL		192		
PL OFFICERS:				
Captains, 1st Lt		46		
2nd Lt		15		
Enlisted, 1st Lt		128		
Enlisted, 2nd Lt		117		
TOTAL OFFICERS		97		
TOTAL ENLISTED		293		

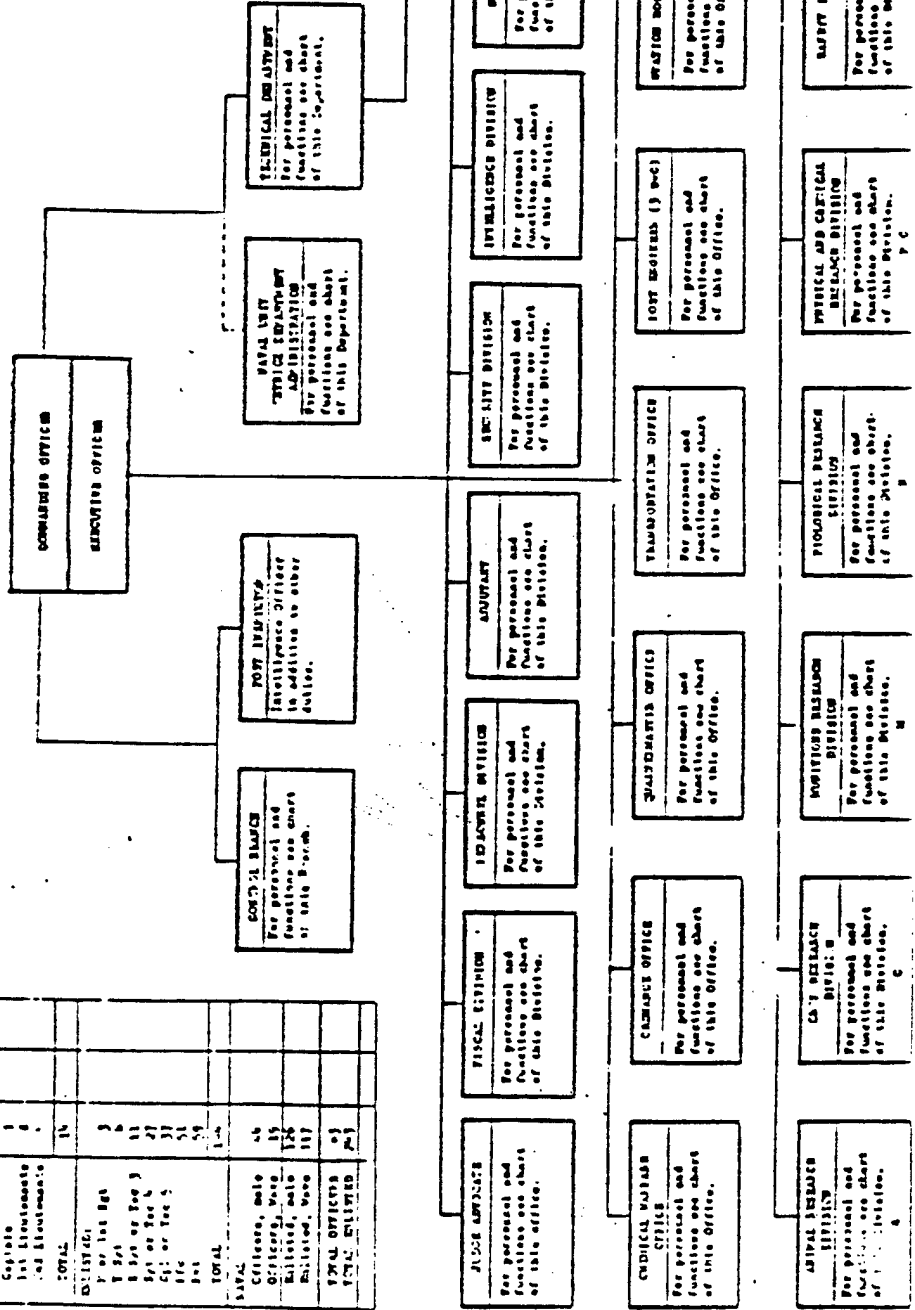

U.S. DEPARTMENT OF ARMY
CHEMICAL CORPS

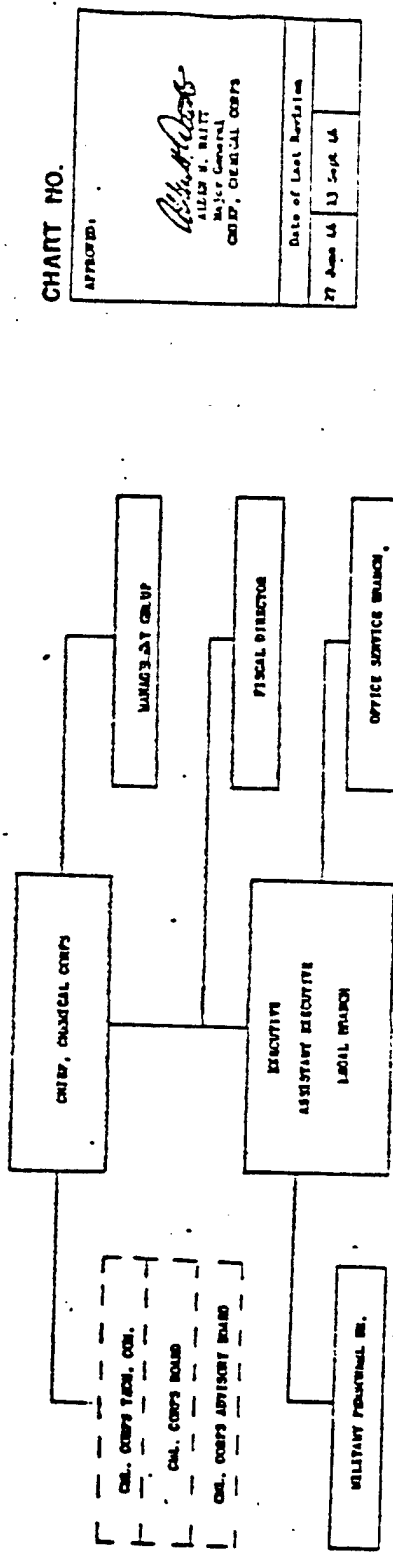

CHART NO.

APPROVED:

[Signature]
 Major General
 CHIEF, CHEMICAL CORPS

Date of Last Revision
 27 June 64 13 Sept 64

Chart 5

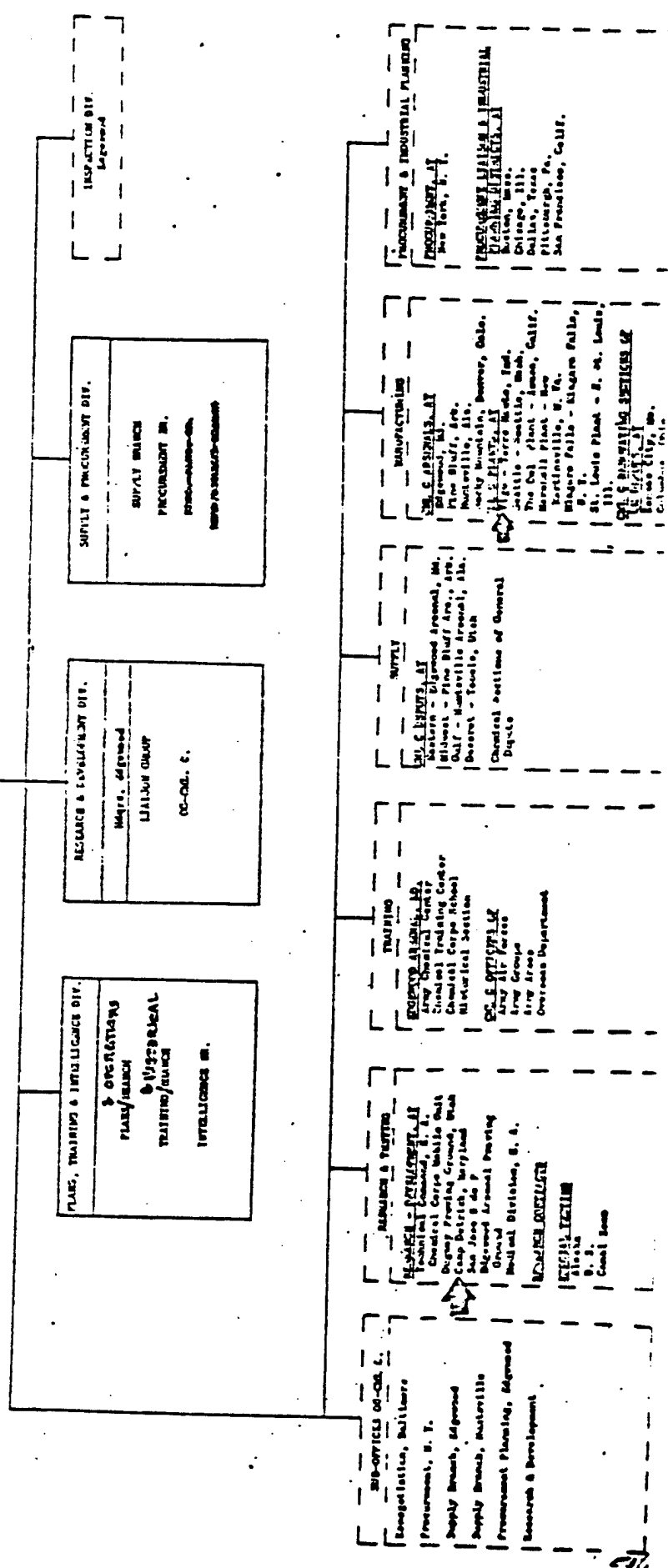

- SUB-OFFICES OF CH. C.
 - Negotiation, Baltimore
 - Procurement, Ft. T.
 - Supply Branch, Agnew
 - Supply Branch, Mullville
 - Procurement Planning, Agnew
 - Research & Development
- RESEARCH & TRAINING
 - RESEARCH - TRAINING CENTER
 - Technical Center, Ft. T.
 - Chemical Corps Mobile Unit
 - Chemical Training Center
 - Chemical Corps School
 - Chemical Corps School
 - Chemical Section
 - SPECIAL INSTITUTE
 - Agnew
 - Agnew
 - Agnew
 - Agnew
 - Agnew
- TRAINING
 - ARMY CHEMICAL CENTER
 - Army Chemical Center
 - Chemical Training Center
 - Chemical Corps School
 - Chemical Section
 - SPECIAL INSTITUTE
 - Agnew
 - Agnew
 - Agnew
 - Agnew
 - Agnew
- SUPPLY
 - CH. C. BRANCH, AT
 - Agnew
 - Agnew
 - Agnew
 - Agnew
 - Agnew
 - CH. C. BRANCH, AT
 - Agnew
 - Agnew
 - Agnew
 - Agnew
 - Agnew
- MANUFACTURING & INDUSTRIAL PLANNING
 - MANUFACTURING
 - Agnew
 - Agnew
 - Agnew
 - Agnew
 - Agnew
 - INDUSTRIAL PLANNING
 - Agnew
 - Agnew
 - Agnew
 - Agnew
 - Agnew

PERSONNEL AT CAMP DETRICK

Postwar Operations

	Chemical Corps			Second Army			Navy Department			Total
	Off	EM	Civ	Off	EM	Civ	Off	EM	Civ	
<u>1946</u>										
JAN	75	72	221	25	33	217	25	90		
FEB	50	24	249	23	11	223	17	91		
MAR	37	20	391	15	7	201	14	77		
APR	30	18	374	13	13	191	13	69		
MAY	29	16	303	13	7	281	10	60		
JUN	14	14	416	14	10	190	6	55	27	
JUL	13	11	455	14	7	191	6	43	28	753
AUG	8	9	440	11	6	159	5	47	53	738
SEP	13	9	497	9	5	154	5	46	53	731
OCT	10	8	482	9	5	151	5	46	53	709
NOV	9	7	441	11	5	132	5	49	52	711
DEC	10	6	452	9	8	123	4	49	52	713
<u>1947</u>										
JAN	9	12	465	9	10	129	4	49	52	739
FEB	9	13	474	9	11	133	4	51	52	761
MAR	9	11	477	9	10	167	5	50	52	793
APR	8	10	431	7	11	173	3	56	52	831
MAY	13	52	482	7	12	164	2	57	52	841
JUN	14	53	435	7	9	123	2	57	52	807
JUL	14	75	435	6	10	123	2	55	52	822

Source: Daily Personnel Strength Reports, Hq CD

*Not included are the 3 EAC officers at Camp Detrick in Jan 47.
Two departed in Feb and the remaining EAC officer left in May 47.

Postwar project programs. With the termination of the war, the original budget of the Special Projects Division for the fiscal year 1946 which had been estimated at \$2,340,000, was revised to \$933,000, as follows:

Project C1	Agents.....	\$119,000
C2	Pilot plant development.....	45,250
C3	Munitions.....	77,000
C4	Biological defense.....	44,500
C5	Chemical-physical defense.....	49,600
C6	Biological safety.....	54,334
C7	Engineering research.....	58,000
C8	Operational maintenance & repair.	266,000
C9	Granite Peak Installation.....	20,000
C10	Vigo Plant.....	5,000
C11	Research contracts.....	194,316
		<u>\$933,000</u>

In contrast with this budget for the reconversion period, that estimated for the fiscal year 1947 was as follows:

Research and development		
	Civilians and consultants.....	\$1,091,000
	Project expenses.....	614,000
	Research contracts.....	153,000
Housekeeping expenses		
	Camp Detrick.....	254,000
	Vigo Plant (standby).....	250,000
Engineer funds		
	Cyclone fence at Vigo Plant.....	110,000
	Permanent civilian quarters at Detrick..	274,000
		<u>\$2,746,000</u>

Included in the 1946 budget, but not indicated above, was a Corps of Engineers appropriation for that year for \$328,470, made available for the erection of a new cloud chamber at Camp Detrick. The erection of this large-scale test chamber, it was believed, would eliminate the need for a proving ground such as that at Horn Island and would reduce activity at

Granite Peak Installation by half. In addition, it would allow more rapid progress in fundamental studies, and more important, would eliminate the hazards in field tests for humans, wild life and vegetation which were accepted in time of war but would not be permitted in peacetime. /

There were ten research contracts with universities, Government laboratories, and institutions in the original budget for fiscal year 194

Bureau of Plant Industry, U.S.D.A.	
Investigation of agents destructive to rice crops.....	\$ 5,000
Study of plant growth-regulating compounds.....	15,000
Northwestern University, Department of Chemistry	
Studies of mussel poisoning.....	20,000
University of California, Hooper Foundation	
Studies of toxic substance produced by mussels.....	3,500
Harvard University	
Studies in fowl plague and Newcastle disease.....	65,000
Stanford University School of Medicine	
Studies in the production of <u>Coccidioides immitis</u>	12,125
University of Cincinnati	
Studies in tularemia.....	10,100
University of Kansas	
Studies in tularemia.....	8,000
University of Notre Dame	
Study of methods for production of rickettsia.....	13,100
Ohio State University	
Studies of plant growth-regulating substances.....	11,450
	<u>\$163,275</u>

/ Memo (S), C SPD for Proc Plan Br, Proc Div, OC CWS, 16 Nov 45, no sub. SPD 600.12-CD.

In the revised budget for fiscal year 1946, the latter five contracts had been terminated and Project CII for research contracts was itemized as follows:

Bureau of Plant Industry, U.S.D.A., Beltsville, Md.....	\$ 7,750
Bureau of Animal Husbandry, U.S.D.A., Beaumont, Texas.....	2,500
Northwestern University (Dr. Gucker).....	33,000
Northwestern University (Dr. Reigel).....	42,000
University of California, Hooper Foundation.....	5,400
Harvard University.....	32,500
Office of Secretary of War - University of Chicago.....	8,666
Iowa State College.....	7,500
National Academy of Sciences.....	5,000
War Supplies, Ltd.....	<u>50,000</u>
	\$194,316

The fiscal budget for 1947 contained an appropriation for \$153,000 for research contracts.

The project program for the fiscal year 1946, a continuation of that of the previous year, had just begun when the war ended. The program consisted of approximately 182 different projects which could be grouped in seven main categories, as follows:

Laboratory series - concerned with studies of strains, characteristic culture media, pathogenesis, and methods of harvesting, concentrating, purifying, and stabilizing selected biological agents.

Production series - concerned with devising means for laboratory and pilot plant production, for process control, and for packaging and storing the agents.

Munitions series - concerned with development of sampling methods and devices; studies of effects of temperature, pressure and meteorology on selected agents; development of munitions and other dispersion devices; field testing; and development of tactical doctrine.

Biological defense series - concerned with investigation of protection or immunization against the agents and protective devices for safeguarding laboratory personnel and the surrounding community.

Mechanical defense series - concerned with the detection and destruction of air-borne agents

Safety series - concerned with development of laboratory tests for the detection and control of agents and with the development of prophylactic and therapeutic agents to counteract biological agents.

Medical studies - concerned with toxicity studies, development of analytical and assay methods, and with studies of chemotherapy.

As a result of the completion of certain projects, the consolidation of numbers of small projects into a single group, and abandoning those projects which had purely wartime military application, it was possible in the 1947 project program to reduce the total number of projects to 67 separate studies. The more orderly and compact program of research for

postwar investigation appeared as follows: /

- C1 - Screening of bacteria, viruses, fungi, protozoan, and helminth parasites for potential biological warfare agents.
Studies of arthropods as biological agent vectors.
Laboratory development of selected agents.
Development of biological defensive measures against selected agent
Clinical studies of diseases encountered in biological warfare rese
- C2 - Development of pilot plant equipment for production and processing of selected agents.
Studies on the production and processing of selected agents.
- C3 - Screening, development, production, and protection against plant inhibitors and defoliant.
- C4 - Development of aerosol munitions, surface-contaminating munitions, guided missiles, small arms, and sabotage methods.
Design of methods for filling biological warfare munitions.
Surveillance studies of munitions.
Tactical employment of munitions.
- C5 - Decontamination materials and methods.
- C6 - Protective clothing development.
Development of masks, canisters, and hoods.
- C7 - Studies of biological warfare occupational hazards.
- C8 - Nutrition of potential agents.
Cloud chamber studies
Studies of the special physiology, pathology, and pharmacology of biological warfare diseases.
Study of chemical methods in biological warfare research.
Study of meteorological factors incident to biological warfare.

(S)

/ Research and Development Projects, 1947, R&D Dept, CWS, Camp Detrick, Md. Report in files Tech Dept CD.

The project program for the fiscal year 1948, reported in Research and Development Projects, 1948 (TS), Cml C, Biological Division, Camp Detrick, Md., was essentially the same as that for 1947.

The most significant difference between the wartime and postwar programs of research was the lack of emphasis in the new program on specific organisms. While studies with anthrax, botulinum toxin, brucellosis, tularemia and other agents would continue, principally in an effort to improve virulence, stability and yield, more attention would be given to agents previously considered only briefly, such as those of the dysentery group, certain of the rickettsias and viruses, and diseases uncommon to different geographical areas. Primary emphasis in postwar research, however, was to be on munitions development. Perfection and standardization would be sought for the small bombs developed during the war. The development of new bomb types as well as war heads for guided missiles was also projected in the new program. A series of studies were to be devoted to investigating the possibility of dispersing agents by means of insects. Defensive aspects of biological warfare, from the standpoint of personnel safety as well as generally applicable medical, physical and biological protection, would necessarily be continued on the same high level maintained during the war.

✓ Costs of the postwar program of research are given below, p.91.

In pursuing postwar research, close cooperative liaison was to be maintained with associated services, including the offices of the Surgeon Generals of the Army and Navy, Ordnance, appropriate General and Special Staff divisions, and the U.S. Public Health Service, U.S. Department of Agriculture, and National Institute of Health. Information and technical personnel would continue to be exchanged with Great Britain and Canada on projects of special joint interest.

The training and indoctrination in biological warfare defense which was a part of the wartime program was to be continued. At the Chemical Corps School, Army Chemical Center, a schedule of 15 hours of biological warfare indoctrination was included in the basic regular course and 40 hours of instruction in the advanced regular course for Chemical Corps Reserve officers, for selected officers of other branches of the Army, and Navy Reserve officers. The first advanced course began on 2 June 1947; the first basic course on 9 July 1947. The text used in both courses was the tentative Technical Manual 3-216, Military Biology and Defense Against Biological Warfare. /

/ See above, p. 147 (246).

The degree of instruction given in these two courses was in considerable contrast to the amount of information that British service personnel got on biological warfare, as represented by a 4-page leaflet, Biological Warfare, Information for Service Personnel, which contained a brief historical background of the subject, a comparison of biological and chemical agents, possible methods of dispersion, effects on the human body, methods of defense, respirators, vaccines, and notes on offensive aspects of biological warfare. Leaflet appended to Intel Rpt #1, A, London Rpt. No. R1101-47 (S), ~~REF 3510~~, ~~REF 304~~, 22 Feb 47, (2). In Hist file

(copy: 201 to be made for Service Rpt.)

GUIDE TO FOOTNOTES

Footnote citations are given in accordance with the form recommended by the Historical Division, War Department Special Staff. For example:

"Ltr (S), Adm FSA to Dir WRS, 26 Aug 42, sub: Biological Warfare. In WRS NDD WEGS (WDSHD 334 JNW 441.2),"

refers to a secret letter from the Administrator of the Federal Security Agency to Mr. Merck, Director of War Research Service, which may be found in the WRS files now in the New Developments Division, War Department General Staff, in the Pentagon, under letter file WDSHD 334 JNW 441.2. In some instances files of special wartime agencies referred to in the footnotes have been transferred to other agencies since the footnote was first made. The Bibliographical Notes gives the latest disposition known of all files relative to biological warfare.

Abbreviations used in the footnotes may, for the most part, be found in the Dictionary of United States Army Terms and AR 850-150. Abbreviations which are peculiar to this history are as follows:

- Acc - accession; documents and reports received by the technical library at Camp Detrick were given accession numbers.
- ACC - Army Chemical Center, formerly Edgewood Arsenal, at Edgewood, Maryland.
- Bumed - Bureau of Medicine and Surgery, Navy Department.
- Buord - Bureau of Ordnance, Navy Department.
- Chl C Sch - Chemical Corps School at the Army Chemical Center.
- BW - Biological warfare

CD - Camp Detrick, SPD.

CD 322(2) - A correspondence file in the office of the Technical Director, Camp Detrick.

CD Tech Lib - The Technical Library at Camp Detrick.

Hist files - Files of the Historical Section, Plans, Training and Intelligence Division, OC Cml C. These files are located in the Historical Section at the Army Chemical Center, Edgewood, Maryland.

EA - Edgewood Arsenal, Maryland, now Army Chemical Center.

F&A - Files and Analysis Section, Library, Chemical Corps School; these letters precede file numbers of reports and documents in this library's files.

FSA - Federal Security Administration.

GPI - Granite Peak Installation, SPD.

HI - Horn Island, SPD.

IOM - Interoffice memorandum.

M&R - Mail and Records Section, Headquarters, Vigo Plant. Similar to F&A, above.

MPR - Monthly Progress Report.

MTR - Monthly Technical Report; similar to MPR - a change in name only..

NAS - National Academy of Sciences.

NDRC - National Defense Research Committee.

NIH - National Institute of Health.

NRC - National Research Council.

OinC - Officer-in-Charge.

OSRD - Office of Scientific Research and Development.

PES - Porton Experimental Station, Biology Section; code letters of reports from that station.

R&D - Research and development.

SPD - Special Projects Division.

TD - Technical Department.

USDA - United States Department of Agriculture.

USPHS - United States Public Health Service.

VP - Vigo Plant, SPD.

WRS - War Research Service.

When agents, materials, or operations of the biological warfare program are referred to in correspondence and reports, they are usually indicated by code letters. Although the use of these code letters has been reduced to a minimum in the preparation of this history, they are nevertheless listed here for reference. In the case of biological agents, the code letters may refer either to the disease itself or to the organisms causing the disease.

AN - Japanese Type B encephalitis

AU - Mass culture of spores

C - Southern blight

E - Brown spot of rice

GER 1 - Rinderpest (also R)

Ei - Kelicidosis

HL - Shizella alkalescens

HO - Cholera

II - Rice diseases

IR - Rice blast

INK B - Production of anthrax at Vigo Plant (unauthorized code letter)

LA - Glanders

LE - Plague

LN - Plant growth-regulating compounds (also RR)

LN 8 - 2,4-dichlorophenoxyacetic acid (or 2,4-D)

LN 33 - Isopropyl phenyl carbamate (or IPC)

LO - Late blight of potatoes

LT - Blood studies by the Office of the Surgeon General
MN - Immunisation for anthrax
N - Anthrax
Nc - Newcastle disease
NT - Neurotropic encephalitides
OC -- Coccidioidomycosis (coccidioidal granuloma)
OE - Fowl plague and Newcastle disease
OO - Foot and mouth disease
R - Rinderpest (also GIR 1)
RI - Preservation of rickettsia
RR - Plant growth-regulating substances (also LN)
SI - Psittacosis
SS - Mussel poison or poisoning
UL - Tularemia
US - Brucellosis
VIA - Granular powder form of 2,4-dichlorophenoxyacetic acid
VKL - 2,4-D in tributyl phosphate and oil
VKS - Ammonium salt of 2,4-D
WYE -- Plan to acquire Vigo Plant for Special Projects Division
X - Botulinum toxin or botulism
Y - Dysentery
YE - Typhus fever .

BIBLIOGRAPHICAL NOTE

The Technical Library at Camp Detrick is the repository of all technical reports of the Special Projects Division, including both periodical progress reports and final special reports, and also contains all reports received from WRS research laboratories and other U.S. agencies engaged in the biological warfare program. Monthly progress reports from SPD installations began in August 1943 when the first report of the Operations Division at Camp Detrick was filed. Thereafter monthly reports were received from each of the technical divisions at Camp Detrick and from Horn Island, Vigo Plant and the Granite Peak Installation as each station was activated. Progress reports are on file from the Porton Experimental Station in England and from Grosse Ile and Suffield in Canada.

The Technical Director's files at Camp Detrick contain correspondence incidental to operations and administration of all biological warfare research and development at SPD installations, with the consulting specialist to SPD, reports of the WRS antibiological warfare program, and correspondence between WRS and the Chemical Warfare Service.

The files of the Special Projects Division in the Office of the Chief, Chemical Corps, contain all intelligence correspondence and all reports and directives associated with biological warfare intelligence. Files relating to Chemical Warfare Service activities in biological warfare were removed from the Army Chemical Center at Edgewood, Maryland, and are

presently located either at Camp Detrick (Technical Library) or in the Office of the Chief, Chemical Corps. Correspondence and directives of the Chief, Special Projects Division, for SPD installations and higher echelons and correspondence between the Chief, Chemical Warfare Service and outside agencies are also located in these files.

New Developments Division, WDSS, in the Pentagon, has many of the G-2 reports concerning biological warfare, reports and documents of the USBW Committee, the Joint New Weapons and Equipment (BARCELONA) Committee, and all correspondence of WRS.

The Office of the Secretary of War, in the Pentagon, is in possession of the files of the Special Assistant Secretary of War, Harvey H. Bundy. These files contain correspondence and memoranda between Mr. Bundy and WRS, the National Academy of Sciences, and the Secretary of War.

The National Academy of Sciences, 2101 Constitution Avenue, Washington D. C., has in its files an outline history of WRS, records of the National Research Council relating to biological warfare, and reports and correspondence of the WEC, ABC, and DEF Committees and other agencies of the Academy.

The files of the Federal Security Agency contain information on the financing, personnel and administration of WRS.

The publications of personnel connected with the Special Projects Division may be found in reprint form in the Technical Department, Camp Detrick; at the Welch Memorial Library, Johns Hopkins University, Wolf and

Monument Streets, Baltimore, and in the case of non-medical periodicals,
in the Technical Library, Army Chemical Center, or Enoch Pratt Public
Library, Baltimore.

BIBLIOGRAPHY

STANDARD TEXTS

- G.S. Wilson and A.A. Miles, Topley and Wilson's Principles of Bacteriology and Immunology (Baltimore, 1946)
- W.N.C. Topley and G.S. Wilson, The Principles of Bacteriology and Immunol (2d ed.; Baltimore, 1936)
- A.J. Salle, Fundamental Principles of Bacteriology (New York, 1943)
- Bryan and Bryan, Principles and Practice of Bacteriology (College Outline Series, New York, 1943)
- Hans Zinsser and Stanhope Bayne-Jones, A Textbook of Bacteriology (8th ed New York, 1939)
- Manual of Methods for Pure Culture Study of Bacteria, Society of American Bacteriologists (9th ed.; Geneva, N.Y., 1944)
- F.W. Tanner, Bacteriology (New York, 1938)
- H. Zinsser, J.F. Enders, and L.D. Fothergill, Immunity: Principles and Application in Medicine and Public Health (5th ed.; New York, 1939)
- William Bond, A Textbook of Pathology (4th ed.; Philadelphia, 1943)
- Park and Williams, Pathogenic Organisms (11th ed., Philadelphia, 1939)
- Thomas G. Hull, Diseases Transmitted from Animals to Man (Baltimore, 1941)
- David Perla and Jessie Karmorston, Natural Resistance and Clinical Medicine (Boston, 1941)
- Frederick P. Gay, et al., Agents of Disease and Host Resistance (Baltimore, 1935)
- Russell L. Cecil, ed., Textbook of Medicine by American Authors (6th ed.; Philadelphia, 1943)
- Kilton J. Roseneau, Preventive Medicine and Hygiene (6th ed.; New York, 1935)

- G.C. Dunham, Military Preventive Medicine (3d.ed.; Harrisburg, Pa., 1935)
- I.F. Huddleson, Brucellosis (New York, 1944)
- G.M. Dack, Food Poisoning (Chicago, 1943)
- E.B. Wilson, The Cell (New York, 1900)
- Charles E. Skinner, Molds, Yeasts, and Actinomycetes (New York, 1947)
- W.A. Hagan, The Infectious Diseases of Domestic Animals (Ithaca, N.Y., 19
- A.F. Skull, Principles of Animal Biology (New York, 1941)
- F.D. Heald, Manual of Plant Diseases (New York, 1946)
- F.L. Stevens, Plant Disease Fungi (New York, 1946)
- F.T. Bennett, Outlines of Fungal and Plant Diseases (New York, 1944)
- I.E. Melhus and George C. Kent, Elements of Plant Pathology (New York, 19

HISTORICAL AND POPULAR

F.R. Packard, History of Medicine in the United States (New York, 1931)

E.W. Goodal, A Short History of the Epidemic Infectious Diseases (London, 1934)

J.S. Simmons, T.F. Whayne, G.W. Anderson, and H.M. Horack, Global Epidemiology: A Geography of Disease and Sanitation (Philadelphia, 1944)

W.H. Holmes, Bacillary and Rickettsial Infections: Black Death to White Plague (New York, 1940)

M. Greenwood, Epidemic and Crowd Diseases (London, 1935)

British Ministry of Health, Report on the Pandemic of Influenza, 1918-1919 (London, 1920)

C. Creighton, Epidemics in Britain (Cambridge, England, 1891)

J.F.C. Hecker, The Epidemics of the Middle Ages (London, 1844)

Daniel Defoe, Journal of the Plague Year (Everyman ed.; London and New York, 1908)

A. Hirsch, Handbook of Geographical and Historical Pathology (London, 1888)

E.C. Large, The Advance of the Fungi (New York, 1940)

F. Sherwood Taylor, The Conquest of Bacteria (New York, 1942)

Joseph W. Bigger, Man Against Microbe (London, 1939)

Stanhope Bayne-Jones, Man and Microbes (Baltimore, 1932)

Justina Hill, Germs and the Man (New York, 1940)

Hans Zinsser, Rats, Lice and History (Boston, 1935)

F.C. Jean, et al, Man and His Biological World (New York, 1934)

S. Epstein and B. Williams, Miracles from Microbes: The Road to Streptomycin (New Brunswick, N.J., 1946)

CAMP DETRICK SPECIAL REPORTS*

1. Development of UL for Offensive Use in Biological Warfare (30 Jun 1944) (T. L. Snyder, Animal Research Br, ODD) (46 pp.)
2. Characteristics of Some B.V. Agents for Plants (Aug 1944) (A. G. Norman) (26 pp.)
3. Use of Embryonated Eggs for Offensive Biological Warfare (Aug 1944) (V. Sprague, Animal Research Br, ODD) (35 pp.)
4. Development of Materials and Procedures for Protection Against "X" (30 Oct 1944) (G. A. Hottle, J. A. Lichty Jr., and C. Nigg) (21 pp.)
5. Pilot Plant Construction and Operation (Oct 1944) (Top Secret) (E. H. Foster, M. E. Tyler and G. B. Achorn) (39 pp.)
6. Immunization Against "N" (Feb 1945?) (A. M. Gorelick, L. C. Kingsland, C. O. Seward, J. C. Wagner, C. D. Moelchert and D. M. Chapman) (16 pp.)
7. Observations on "N" Infection. I. Host Parasite Interrelationships in "N" Infection (Feb 1945?) (W. J. Cromartie, D. W. Watson and W. L. Bloom) (12 pp.)
8. A Preliminary Report on the Design and Performance of Atomizers in Relation to BW Cloud Chamber Studies (Feb 1945?) (T. Rosebury, F. Olson, J. Aaron, C. Franzen and W. Ogden of B Div) (27 pp.)
9. Development of "N" for Offensive Use in Biological Warfare (Jul 1944) (personnel of Animal Research, Munitions and Pilot Plant Branches, ODD) (145 pp.)
10. Toxicity of IN-8 (2-4 Dichlorophenoxyacetic Acid) for Experimental Animals (Apr 1945) (H. N. Carlisle, E. V. Hill and K. H. Lewis) (13 pp.)
11. Immunization of Man with Fluid Type A "N" Toxoid (1 May 1945) (G. M. Dack, J. B. Wilson, H. R. Reames, P. Kadull, R. D. Housewright and personnel of S Div) (14 pp.)

*All reports are Secret unless otherwise specified.

12. Crop Destruction by Aerial Sprays. Preliminary Trials (26 Apr 1945) (H. H. Smith and A. G. Norman) (30 pp.)
13. Marking and Defoliation of Forest Vegetation (May 1945) (A. G. Norman, R. J. Weaver and D. L. Taylor) (41 pp.)
14. Effect of VKA and VKS on Natural Vegetation. Preliminary Trials. (17 Jun 1945) (J. B. Carpenter) (20 pp.)
- ✓ 15. Immunological Protection of Personnel Against B.W. Agents (Oct 1946?) (H. R. Reames and P. J. Kadull) (93 pp.)
16. Report on the Development, Operation, and Experimental Use of the American Autoclave Type B.W. Chamber (1 Oct 1945) (G. A. Young Jr. and N. A. Johnson) (41 pp.)
17. Studies on Bacterial Anaphylaxis in Guinea Pigs by the Respiratory and Intravenous Routes (Oct 1945?) (W. A. Turner, M. E. Boldt, T. Rosebury and E. A. Kabat) (10 pp.)
18. Cloud Chamber Studies. I. Methods Developed at Camp Detrick for Production and Study of Clouds of Highly Infective Agents (15 Oct 1945) (T. Rosebury and personnel of the Cloud Chamber Project, B Div) (77pp.)
19. Control of Anthrax in a Biological Warfare Installation (Oct 1946?) (A. G. Wedum) (90 pp.)
20. Present Status of the Offensive Development of "US" (Sep 1945) (S. S. Elberg and personnel of A and B Divs) (156 pp.)
21. Studies of Toxin and Toxoid Production of "Y", Types C and D (1 Oct 1945) (M. D. Bailly) (27 pp.)
22. Disinfection of Clouds of Meningopneumonitis Virus and "Si" in Triethylene Glycol Vapor (Oct 1945) (T. Rosebury, G. Meiklejohn, L. Kingsland and M. E. Boldt) (16 pp.)
23. Measurement of the Respiratory Volumes of Laboratory Animals (Oct 1945) (A. C. Guyton) (8 pp.)
- ✓ 24. A Laboratory Infection with "Si" Successfully Treated with Penicillin and Sulfadiazine, and Experimental Data Bearing on the Mode of Infection (Mar 1946?) (T. Rosebury, H. V. Ellingson and G. Meiklejohn) (15 pp.)

25. Crop Destruction by Aerial Sprays. Field Trials 1945. Vigo Plant CWS, Terre Haute, Indiana, and Beaumont, Texas. April-October 1945 (Oct 1945?) (C. Swanson, C. Minarik, R. M. Acker and A. G. Norman) (44 pp.)
26. The Physiology of "X" Toxin (1 Nov 1945) (A. C. Guyton and M. A. McDonald) (23 pp.)
27. The Development of "C" for Offensive Use in Biological Warfare (Nov 1945?) (W. M. Epps, W. E. Dorrell, A. G. Norman and personnel of C Div) (146 pp.)
28. Laboratory Branch Report on the B.W. Agent "W" (Spores of Bacillus anthracis) (1 Jan 1946) (G. A. Young Jr., C. R. Brewer, R. E. Lincoln, H. N. Carlisle, W. I. Jensen and M. R. Zelle) (198 pp.)
29. Pilot Plant Branch Report on the B.W. Agent "W" (Spores of B. anthracis) (1 Jan 1946) (compiled by J. L. Roberts, Chief, Pilot Plant Br) (247 pp.)
30. Laboratory Testing of Canisters (15 Oct 1945) (E. Wetter) (103 pp.)
31. Testing and Developing of Outlet Valves (23 Nov 1945) (A. E. Tempel Jr.) (61 pp.)
32. Protective Ointments in BW (9 Sep 1945) (H. Tatlock, C. W. Botts and B. M. Swanson) (10 pp.)
33. The Effects Produced on Cotton and Woolen Fabrics by Certain Decontaminating Procedures (15 Oct 1945) (D. D. Gagliardi) (20 pp.)
34. Protective Clothing for Use in Biological Warfare (5 Dec 1945) (personnel of PC Div) (64 pp.)
- ✓ 35. Decontamination in Biological Warfare (15 Jun 1946) (N. A. Johnson) (110 pp.)
36. A Study of Particle Size and Aggregate Distribution in Aerosols of B. globigii (15 Nov 1945) (C. E. Farnsworth) (38 pp.)
37. The Development of Gas Masks and Hoods for Protection Against Biological Warfare Agents (28 Feb 1946) (R. Porter) (47 pp.)

38. A Pilot Plant for the Production of Plant Pathogens (Nov 1945) (W. W. Dorrell and E. Cherry) (65 pp.)
39. Development of IR as a Biological Warfare Agent (Nov 1945?) (personnel of C Div) (148 pp.)
40. Studies of the Virus Agents of the "Si" Group (1 Nov 1945) (G. Meiklejohn and personnel of the "Si" Project) (87 pp.)
41. An Assay Method for Streptomycin and Its Application to In Vivo Studies of the Antibiotic (Nov 1945) (staff of the Pharmacology Br, B Div) (27 pp.)
42. Engineering, Construction, Operation, Maintenance and Development in Restricted Areas (15 Nov 1945) (J. F. Matousek, C. E. Follman, A. Sierzec, J. J. Hicks, H. Peters, E. Franzel and T. Antoskiw of the Engineering Div) (in 20 sections)

Section I.	General
Section II.	Black Maria
Section III.	Plant I Area II
Section IV.	Pilot Plant II
Section V.	Pilot Plant T-63
Section VI.	Process Air for Plants I, II, and T-63
Section VII.	Pilot Plant III and Area
Section VIII.	Pilot Plant IV and Area
Section IX.	Liquid Contamination in Restricted Area; Incinerators; Water Distribution System
Section X.	Ventilation of Contaminated Buildings in the Restricted Area
Section XI.	Decontamination of Plant Equipment
Section XII.	Rotometers vs. Orifices
Section XIII.	Gaskets
Section XIV.	Sampling Adapters
Section XV.	Catalyst Feeders
Section XVI.	Shaft Seals
Section XVII.	Dura-seal
Section XVIII.	Liquid Level Gauge
Section XIX.	Hills-McCanna Diaphragms
Section XX.	Effect of Temperature and Hypochlorite on Paint

43. Development of Materials and Procedures for Protection Against "X" (1 Oct 1945) (G. A. Hottle and personnel of the X Project) (52 pp.)

44. Munitions for Biological Warfare. A Comprehensive Report of Investigations Conducted at Camp Detrick (Dec 1945?) (Top Secret) (H. G. Tanner and personnel of Munitions Div) (276 pp.)
45. Cloud Chamber Studies. II. Comparative Data on Infective Agents and Simulants. Final Report (Feb 1946) (T. Rosebury and personnel of the Cloud Chamber Project, B Div) (84 pp.)
46. (unassigned; original report included in Special Report No. 63)
47. The Development of E as an Agent for Biological Warfare (Jul 1946) (R. M. Page, A. F. Sherf, W. W. Dorrell, M. M. Mills, F. W. Leaver and J. W. Marck) (178 pp.)
48. Investigations Concerned with Defense Against "CC" (17 Dec 1945) (T. G. Metcalf, W. H. Rogers, C. Lewis, J. T. Clymer and C. E. Venzke) (23 pp.)
49. Studies on the Nutrition, Growth, and Virulence of "CC" (23 Dec 1945) (C. E. Venzke, C. R. Brewer, W. G. Roessler, E. J. Herbst and G. C. Broadwater) (32 pp.)
50. Development of "FX" for Offensive Use in Biological Warfare (10 Nov 1945) (personnel of A Div) (288 pp.)
51. The Purification of "XA" Toxin (1 Sep 1945) (A. Abrams, G. Kegeles, G. A. Hottle and personnel of the X Project) (24 pp.)
52. (unassigned; original report given Special Report No. 62)
53. Comprehensive Report of Pathogenesis of "LA" and "HI" (1 Nov 1945) (W. R. Miller, B Div) (185 pp.)
54. A Comprehensive Report on Investigations Concerned with the Development of *Phytophthora infestans* as a Potential Agent for Biological Warfare (Oct 1945) (S. F. Snieszko, E. P. Lowe, J. B. Carpenter and A. G. Norman) (160 pp.)
55. Development of Materials and Procedures for Protection Against the "NT" Group of Viruses (1 Nov 1945) (H. P. Morgan and personnel of the NT Project) (12 pp.)
56. Studies on the Development of Biological Defense Against "UL" (1 Jan 1946) (L. Coriell, C. M. Downs and personnel of the UL Project) (206 pp.)

57. Additional Studies on the Development of "U1" as an Offensive Biological Warfare Agent (1 Dec 1945) (T. L. Snyder and personnel of the Laboratory Br, A Div) (166 pp.)
58. Detection of Biological Warfare Agents (Jul 1946) (G. M. Dack, J. B. Wilson, H. R. Reames and F. R. Smith) (21 pp.)
59. Electronic Counting and Size Determination of Particles in Aerosols (Dec 1945) (A. C. Guyton) (11 pp.)
60. Observations on Penicillin Relative to Prophylaxis and Therapy of "Si" Infection (1 Sep 1945) (P. Steinglass, G. B. Kornegay, D. D. Deane, D. B. Lachman, T. F. Henley of Pharmacology Section, B Div) (20 pp.)
61. Drying of Serratia marcescens (19 Nov 1945) (H. B. Naylor) (38 pp.)
62. Physicochemical Properties of XA Toxin (15 Nov 1945) (C. Kegeles) (4 pp.)
63. Techniques Utilized in the Characterization of Naturally Occurring Substances of Bacterial and Animal Origin (Mar 1946) (D. W. Watson and N. Weissman) (28 pp.)
64. Destruction of Tropical Crops with Growth-inhibiting Agents (Aug 1946) (H. K. Smith) (51 pp.)
65. The Offensive Phase of the "Si" Project (15 Nov 1945) (V. Sprague, W. L. Denman, T. Lewandowski, D. E. Drukenmiller Jr. and personnel of A and B Divs) (167 pp.)
66. Removal of Bacillus Anthracis from Contaminated Buildings and Equipment (18 Feb 1946) (no author) (12 pp.)
67. Development of Defensive Measures Against "US" (1 Oct 1945) (S. S. Elberg, A. N. Gorelick and personnel of the "US" Project) (84 pp.)
68. Preliminary Studies on Streptothricin Toxicity (1 Dec 1945) (J. Forgacs, T. F. Henley, G. B. Kornegay and personnel of Pharmacology Br, B Div) (7 pp.)
69. Incidental Physiological and Physical Studies and Design of Physiological Apparatus (1 Oct 1945) (A. C. Guyton and M. A. MacDonald) (29 pp.)

70. The Performance of an Electrostatic Filter in Removing Airborne Bacteria (Serratia marcescens, test organism) (May 1946) (J. J. Jezeski) (9 pp.)
71. Physiology of UL (report still incomplete in Aug 1947)
72. Accidental Laboratory Infection at a Biological Warfare Station (Jul 1946) (H. V. Ellingson) (5 pp.)
73. Studies on Infection with "M" (Aug 1946) (D. W. Watson and others) (125 pp.)
74. Micrometeorological Instruments (Aug 1946) (Restricted) (C. J. Hlad Jr.) (15 pp.)
75. An Experimental Spray Eriar for B.W. Agents (Aug 1946) (E. J. Schantz) (22 pp.)
76. Amino Acid, Mineral and Vitamin Content of Some Biological Materials Used for the Cultivation of BW Agents (Aug 1946) (E. H. Bormor and E. J. Schantz) (12 pp.)
77. A Method for the Determination of Phenol in Bacteriological Materials (Aug 1946) (E. J. Schantz and J. P. Crispell) (5 pp.)
78. Observations on the Permanent Effects of Aerial Plant Growth Inhibitory Sprays Upon Natural Vegetation (Aug 1946) (A. S. Newman and W. B. Ennis Jr.) (19 pp.)
79. Crop Destruction by Chemical Agents (report still incomplete in Aug 1947)
80. Ethylene Oxide: A Gaseous Disinfectant (Feb 1947) (C. R. Phillips) (52 pp.)
81. Sewage Decontamination at Camp Detrick (The Process, Its Failure, Detection of Failure, and Recommendations) (Mar 1947) (no author) (7 pp.)
82. The Elemental and Amino Acid Composition of Crystalline Clostridium botulinum Type A Toxin (Jul 1947) (H. J. Buehler, E. J. Schantz and C. Lananna) (13 pp.)
83. Surface Active Agents: Literature Review of Their General Properties and Biological Activity (Apr 1947) (H. N. Glassman and F. W. Putnam) (Unclassified report) (133 pp.)

84. Report on the Infectivity of a Brucella suis Suspension from the Suffield Experimental Station, Alberta, Canada (May 1947) (A. N. Gorelick, C. O'Bryan and E. H. Kelly) (10 pp.)
85. The Relative Errors of Bacteriological Plate Counting Methods (Jun 1947) (T. L. Snyder) (21 pp.)

ANTHRAX

C.R. Brewer, W.G. McCullough, R.C. Mills, W.G. Roessler, E.J. Herbst, and A.F. Howe, "Studies on the Nutritional Requirements of *Bacillus Anthracis*," Arch. Biochem., 10 (May 1946), 65-75.

C.R. Brewer, W.G. McCullough, R.C. Mills, W.G. Roessler, and E.J. Herbst, "Application of Nutritional Studies for Development of Practical Culture Media for *Bacillus Anthracis*," Arch. Biochem., 10 (May 1946), 77-80.

H.V. Ellingson, P.J. Kadull, H.L. Bookwalter, and C. Howe, "Cutaneous Anthrax. Report of Twenty-five Cases," J.A.M.A., 131 (3 Aug 1946), 1195-1200.

E.S. Miller, E.B. Scott, H.A. Noe, S.H. Madin, and T.E. Henley, "Chemotherapy of Experimental Anthrax Infections," J. Immunol., 53 (Aug 1946) 37.

F.M. Schabel, Jr., H.R. Peanes, and R.D. Housewright, "The Use of Sulfadiazine and Penicillin for Treatment of Experimental Anthrax," J. Infect. Dis., 79 (Sep-Oct 1946), 141-47.

G.A. Young, Jr., M.R. Zelle, and R.E. Lincoln, "Respiratory Pathogenicity of *Bacillus Anthracis* Spores. I. Methods of Study and Observations on Pathogenesis," J. Infect. Dis., 79 (Nov-Dec 1946), 233-46.

M.R. Zelle, R.E. Lincoln, and G.A. Young, Jr., "Respiratory Pathogenicity of *Bacillus Anthracis* Spores. II. Genetic Variation in Respiratory Pathogenicity and Invasiveness of Colonial Variants of *B. Anthracis*," J. Infect. Dis., 79 (Nov-Dec 1946), 247-53.

R.E. Lincoln, M.R. Zelle, C.I. Randles, J.L. Roberts, and G.A. Young, Jr., "Respiratory Pathogenicity of *Bacillus Anthracis* Spores. III. Changes in Pathogenicity Due to Nutritional Modifications," J. Infect. Dis., 79 (Nov-Dec 1946), 254-65.

G.A. Young, Jr., and M.R. Zelle, "Respiratory Pathogenicity of *Bacillus Anthracis* Spores. IV. Chemical-Biological Synergisms," J. Infect. Dis., 79 (Nov-Dec 1946), 266-71.

W.J. Cromartie, W.L. Bloom, and D.W. Watson, "Studies on Infection with *Bacillus Anthracis*. I. A Histopathological Study of Skin Lesions Produced by *B. anthracis* in Susceptible and Resistant Animal Species," J. Infect. Dis., 80 (Jan-Feb 1947), 1-13.

W.J. Cromartie, D.W. Watson, W.L. Bloom, and R.J. Heckly, "Studies on Infection with *Bacillus Anthracis*. II. The Immunological and Tissue Damage Properties of Extracts Prepared from Lesions of *B. anthracis* Infection," J. Infect. Dis., 80 (Jan-Feb 1947), 14-27.

D.W. Watson, W.J. Cromartie, W.L. Bloom, G. Kegeles, and R.J. Heckly, "Studies on Infection with *Bacillus Anthracis*. III. Chemical and Immunological Properties of the Protective Antigen in Crude Extracts of Skin Lesions of *B. anthracis*," J. Infect. Dis., 80 (Jan-Feb 1947), 28-40.

W.L. Bloom, D.W. Watson, W.J. Cromartie, and M. Freed, "Studies on Infection with Bacillus Anthracis. IV. Preparation and Characterization of an Anthracidal Substance from Various Animal Tissues," J. Infect. Dis., 80 (Jan-Feb 1947), 41-52.

W.D. Watson, W.J. Cromartie, W.L. Bloom, R.J. Heckly, W.J. McGhee, and N. Weissman, "Studies on Infection with Bacillus Anthracis. V. The Isolation of An Inflammatory Factor from Crude Extracts of Lesions of B. anthracis Infection and Its Biological and Chemical Relationship to Glutaryl Polypeptide," J. Infect. Dis., 80 (Mar-Apr 1947), 121-36.

W.L. Bloom, W.J. McGhee, W.J. Cromartie, and D.W. Watson, "Studies on Infection with Bacillus Anthracis. VI. Physiological Changes in Experimental Animals During the Course of Infection with B. anthracis," J. Infect. Dis. 80 (Mar-Apr 1947), 137-44.

N. Weissman and L.E. Graf, "Studies on Infection with Bacillus Anthracis. VII. A Comparison of the Antibacterial Effects of Calf Thymus Histone and a Quarternary Ammonium Cationic Detergent on B. anthracis," J. Infect. Dis. 80 (Mar-Apr 1947), 145-53.

R.D. Housewright, S. Berkman, and R.J. Henry, "The Relative Effectiveness of Purified Penicillin Fractions Against Bacillus anthracis in Vitro and in Vivo," submitted to J. Immunol.

BOTULISM

C. Lamanna, O.E. McElroy, and H.W. Eklund, "The Purification and Crystallization of Clostridium Botulinum Type A Toxin," Science, 103 (17 May 1946) 613-14.

A. Abrams, G. Kegeles, and G.A. Hottle, "The Purification of Toxin from Clostridium botulinum Type A," J. Bio. Chem., 164 (Jul 1946), 63-79.

C. Lamanna, H.W. Eklund, and O.E. McElroy, "Botulinus Toxin (Type A); Including a Study of Shaking with Chloroform as a Step in the Isolation Procedure," J. Bact., 52 (Jul 1946), 1-13.

G. Kegeles, "The Molecular Size and Shape of Botulinus Toxin," J. Am. Chem. Soc., 63 (1946), 1670.

F.W. Putnam, C. Lamanna, and D.G. Sharp, "Molecular Weight and Homogeneity of Crystalline Botulinus A Toxin," J. Bio. Chem., 165 (Oct 1946), 735-36.

G.A. Hottle and A. Abrams, "Detoxification of Purified Botulinum Type A Toxin," J. Immunol., 55 (Feb 1947), 133-37.

C. Nigg, G.A. Hottle, L.L. Coriell, A.S. Rosenwald, and G.W. Beveridge, "Studies on Botulinum Toxoid, Types A and B. I. Production of Alum Precipitated Toxoids," J. Immunol., 55 (Mar 1947), 245-54.

G.A. Hottle, C. Nigg, and J.A. Lichty, "Studies on Botulinum Toxoid, Types A and B. II. Methods for Determining Antigenicity in Animals," J. Immunol., 55 (Mar 1947), 255-62.

H. Reames, P. Kadull, R.D. Housewright, and J. Wilson, "Studies on Botulinum Toxoids, Types A and B. III. Immunization of Man," J. Immunol., 55 (Apr 1947), 263-72.

K.H. Lewis and E.V. Hill, "Practical Media and Control Measures for Producing Highly Toxic Cultures of Clostridium Botulinum, Type A," J. Bact., 53 (Feb 1947), 213-30.

A. Guyton and W. MacDonald, "The Physiology of Botulinus Toxin," Arch. Neurol. & Psychiatry, 57 (May 1947), 576-92.

C. Lamanna and C. Lewis, "An Observation of Apparent Substitution of Pantothenate by Thiamine and Choline," J. Bact., 51 (Mar 1946), 393-99.

H.J. Bushler, E.J. Schantz, and C. Lamanna, "The Elemental and Amino Acid Composition of Crystalline Clostridium Botulinum Type A Toxin," submitted to J. Bio. Chem.

BRUCELLOSIS

S. Elberg, E.P. Edwards, and R.W. Swanson, "A Selective Medium for the Isolation of *Brucella suis*," Amer. J. Pub. Health, 36 (Jun 1946), 650-52.

A.M. Kaplan and S. Elberg, "Concentration of *Brucella suis* from Broth Culture," J. Bact., 52 (Nov 1946), 513-17.

H.N. Glassman and S. Elberg, "Growth of *Brucella* in Aerated Liquid Cultures," J. Bact., 52 (Oct 1946), 423-30.

P. Gerhardt and L.L. Gee, "*Brucella Suis* in Aerated Broth Culture. I. Preliminary Studies on Growth Assays, Inoculum, and Growth Characteristics in an Improved Medium," J. Bact., 52 (Sep 1946), 261-69.

L.J. Gee and P. Gerhardt, "*Brucella Suis* in Aerated Broth Culture. II. Aeration Studies," J. Bact., 52 (Sep 1946), 271-81.

P. Gerhardt, "*Brucella Suis* in Aerated Broth Culture. III. Continuous Culture Studies," J. Bact., 52 (Sep 1946), 283-92.

W.G. McCullough, R.C. Mills, E.J. Herbst, W.G. Roessler, and C.R. Brewer, "Studies on the Nutritional Requirements of *Brucella Suis*," J. Bact., 53 (Jan 1947), 5-15.

C. Howe, "Acute Brucellosis Among Laboratory Workers," New. Eng. J. Med., 236 (15 May 1947), 1-7.

G. Spencer and E. Kelly, "The Use of the Mouse in *Brucella* Research," dormant.

H.N. Glassman and S.S. Elberg, "Viability of *Brucella suis* on Storage in Liquid Culture," Am. J. Vet. Res.

H.N. Glassman and S.S. Elberg, "Improved Yields of *Brucella* in Aerated Liquid Cultures," Proc. Soc. Exper. Bio. Med.

TULAREMIA

- D.J. O'Kane, "The Substitution of Thiamine for the Labile Fraction of Red Blood Cell Extract in the Growth of Bacterium Tularensis," J. Bact., 51 (Apr 1946), 559-60.
- T.L. Snyder, F.B. Engley, Jr., R.A. Penfield, and J.C. Creasy, "A Dilutic Plate Counting Method for Certain Strains of Bacterium Tularensis," J. Bact. 52 (Aug 1946), 241-42.
- H.T. Eigelsbach, L.A. Chambers, and L.L. Coriell, "Electron Microscopy of Bacterium Tularensis," J. Bact., 52 (Aug 1946), 179-85.
- C. Howe, L.L. Coriell, H.L. Bookwalter, and H.V. Ellingson, "Streptomycin Treatment in Tularemia," J.A.M.A., 132 (23 Sep 1946), 195-200.
- T.L. Snyder, R.A. Penfield, F.B. Engley, Jr., and J.C. Creasy, "Cultivation of Bacterium tularensis in Peptone Media," Proc. Soc. Exper. Bio. & Med., 63 (1946), 26-30.
- C.M. Downs, L.L. Coriell, S.S. Chapman, and A. Klauber, "The Cultivation of Bacterium Tularensis in Embryonated Eggs," J. Bact., 53 (Jan 1947), 89.
- ① C.M. Downs, L.L. Coriell, G. Pinchot, E. Maunroe, A. Klauber, S.S. Chapman and B. Owen, "Studies on Tularemia. I. The Comparative Susceptibility of Various Laboratory Animals to Bacterium Tularensis," J. Immunol., 55 (Jul 1947)
- ② C.M. Downs, L.L. Coriell, H.T. Eigelsbach, K.F. Plitt, G.B. Pinchot, and B.J. Owen, "Studies on Tularemia. II. Immunization of White Rats," J. Immunol. 55 (Jul 1947)
- ③ L.L. Coriell, C.M. Downs, and M.P. Clapp, "Studies on Tularemia. III. Immunization of Mice," J. Immunol., 55 (Jul 1947)
- ④ S.S. Chapman, C.M. Downs, L.L. Coriell, and S.F. Kowal, "Streptomycin Studies in Tularemia. I. The Effect of Streptomycin and Streptothricin on Bacterium Tularensis in Vitro and in Vivo (Mouse)," submitted to J. Immunol.
- R. Penfield and T. Snyder, "Lyophilization of Bacterium Tularensis," submitted to J. Bact.
- C.M. Downs, L.L. Coriell, G.B. Pinchot, E. Maunroe, A. Klauber, S.S. Chapman, and B.J. Owen, "The Comparative Susceptibility of Various Laboratory Animals to Bacterium Tularensis," submitted to J. Infect. Dis.
- ⑤ S.S. Chapman, L.L. Coriell, and S.F. Kowal, "Streptomycin Studies in Tularemia. II. Streptomycin Therapy in White Rats," submitted to J. Infect. Dis.

③ S.S. Chapman, L.L. Coriell, and W.E. Nelson, "Streptomycin Studies in Tularemia. III. Streptomycin Therapy in Monkeys," submitted to J. Infect Dis.

④ L.L. Coriell, E.O. King, and W.G. Smith, "Studies on Tularemia. IV. Observations on Tularemia in Normal and Vaccinated Monkeys," submitted to J. Immunol.

PSITTACOSIS

- G. Meiklejohn, J.C. Wagner, and G.W. Beveridge, "Studies on the Chemotherapy of Viruses in the Psittacosis-Lymphogranuloma Group. I. Effect of Penicillin and Sulfadiazine on Ten Strains in Chick Embryos," J. Immunol. 54 (Sep 1946), 1-3.
- R.W. Wiseman, G. Meiklejohn, D.B. Lackman, J.C. Wagner, and G.W. Beveridge "Studies on the Chemotherapy of Viruses in the Psittacosis-Lymphogranuloma Group. II. Effect of Penicillin and Sulfadiazine on Seven Strains in Mice" J. Immunol., 54 (Sep 1946), 9-16.
- R.L. Early and H.R. Morgan, "Studies on the Chemotherapy of Viruses in the Psittacosis-Lymphogranuloma Group. III. Effect of Certain Chemotherapeutic Agents on the Growth of Psittacosis Virus (6BC Strain) in Tissue Cultures and Eggs," J. Immunol., 53 (Jun 1946), 151-56.
- R.L. Early and H.R. Morgan, "Studies on the Chemotherapy of Viruses in the Psittacosis-Lymphogranuloma Venereum Group. IV. Effect of Certain Chemotherapeutic Agents on Psittacosis Virus (6BC Strain) Infections in Mice," J. Immunol., 53 (Jul 1946), 251-57.
- H.R. Morgan and R.W. Wiseman, "Use of Bacteriostatic Agents in the Preparation of Seed Cultures of Psittacosis Virus," Proc. Soc. Exper. Biol. & Med., 62 (1946), 130.
- J.C. Wagner, G. Meiklejohn, L.C. Kingland, and H.T. Hickish, "Psittacosis Vaccines Prepared from Chick Embryo Tissues," J. Immunol., 54 (Sep 1946) 35-45.
- H.R. Morgan and R.W. Wiseman, "Growth of Psittacosis Virus in Roller Tube Tissue Culture; Use in a Vaccine," J. Infect. Dis., 79 (Sep-Oct 1946), 131.
- H.R. Morgan, "Use of Yolk Sac Antigens for Skin Tests in Rabbits Infected with the Virus of Meningopneumonitis," J. Immunol., 54 (Sep 1946), 103-106
- T. Rosebury, G. Meiklejohn, L.C. Kingland, and M.H. Boldt, "Disinfection of Clouds of Meningopneumonitis and Psittacosis Viruses with Triethylene Glycol Vapor," J. Exper. Med., 85 (1 Jan 1947), 65-70.
- T. Rosebury, H.V. Ellingson, and G. Meiklejohn, "A Laboratory Infection with Psittacosis Virus Treated with Penicillin and Sulfadiazine, and Experimental Data Bearing on the Mode of Infection," J. Infect. Dis., 60 (Jan-Feb 1947), 64-77.

COCCIDIOIDAL GRANULOMA

W.G. Roessler, E.J. Herbst, W.G. McCullough, R.C. Mills, and C.R. Brewer,
"Studies with *Coccidioides Immitis*. I. Submerged Growth in Liquid Mediums
J. Infect. Dis., 79 (Jul-Aug 1946), 12-22.

W.G. Roessler, E.J. Herbst, W.G. McCullough, R.C. Mills, and C.R. Brewer,
"Studies with *Coccidioides Immitis*. II. In Vitro Effects of Streptothricin
and Streptomycin," J. Infect. Dis., 79 (Jul-Aug 1946), 23, 26.

GLANDERS AND MELIOIDOSIS

W.R. Miller and C. Howe, "Human Glanders. Report of Six Cases," Annals I Med., 26 (Jan 1947), 93-115.

J. Hink, W.R. Miller, and W. Tanner, "Non-protein Fractions from *Malleomyces mallei* and *Malleomyces pseudomallei*," submitted to J. Bio. Chem.

H. Tanner, M. Boldt, T. Rosebury, and E. Kabat, "Studies of Bacterial Anaphylaxis in Guinea Pigs by the Respiratory and Intravenous Routes," submitted to J. Immunol.

NEUROTROPIC ENCEPHALITIDES

H.R. Morgan, R.L. Early, and M.E. McClain, "Studies on the Cultivation of Japanese B Encephalitis Virus in Eggs," J. Infect. Dis., 79 (Nov-Dec 1946), 275-31.

H.R. Morgan, R.L. Early, and M.E. McClain, "Use of the Intravenous Route in the Infection of Mice with Japanese B Encephalitis Virus," submitted Proc. Soc. Exper. Bio. Med.

RINDERPEST

- R.E. Shope, H.J. Griffiths, and D.L. Jenkins, "Rinderpest. I. The Cultivation of Rinderpest Virus in the Developing Hen's Egg," Am. J. Vet. Res. VII (Apr 1946), 135-41.
- R.V.L. Walker, J.A. Baker, and D.L. Jenkins, "Rinderpest. II. Certain Immunity Reactions," Am. J. Vet. Res., VII (Apr 1946), 142-44.
- R.V.L. Walker, H.J. Griffiths, R.E. Shope, F.D. Maurer, and D.L. Jenkins, "Rinderpest. III. Immunization Experiments with Inactivated Bovine Tissue Vaccines," Am. J. Vet. Res., VII (Apr 1946), 145-51.
- R.E. Shope, F.D. Maurer, D.L. Jenkins, H.J. Griffiths, and J.A. Baker, "Rinderpest. IV. Infection of the Embryos and the Fluids of Developing Hens' Eggs," Am. J. Vet. Res., VII (Apr 1946), 152-63.
- F.D. Maurer, R.V.L. Walker, R.E. Shope, H.J. Griffiths, and D.L. Jenkins, "Rinderpest. V. Attempts to Prepare an Effective Rinderpest Vaccine from Inactivated Egg-cultivated Virus," Am. J. Vet. Res., VII (Apr 1946), 164-70.
- R.E. Shope and H.J. Griffiths, "Rinderpest. VI. The Persistence of Virus in Chicks Hatched from Infected Eggs," Am. J. Vet. Res., VII (Apr 1946), 170-73.
- D.L. Jenkins and R.E. Shope, "Rinderpest. VII. The Attenuation of Rinderpest Virus for Cattle by Cultivation in Embryonating Eggs," Am. J. Vet. Res. VII (Apr 1946), 174-76.
- J.A. Baker, "Rinderpest. VIII. Rinderpest Infection in Rabbits," Am. J. Vet. Res.; VII (Apr 1946), 179-82.
- D.L. Jenkins and R.V.L. Walker, "Rinderpest. IX. Neutralization Tests in Rabbits as a Measure of the Immune Responses in Calves to Vaccination against Rinderpest," Am. J. Vet. Res., VII (Apr 1946), 183-88.
- J.A. Baker, J. Terrence, and A.S. Greig, "Rinderpest. X. The Response of Guinea Pigs to the Virus of Rinderpest," Am. J. Vet. Res., VII (Apr 1946) 189-92.
- F.D. Maurer, "Rinderpest. XI. The Survival of Rinderpest in Various Mediums," Am. J. Vet. Res., VII (Apr 1946), 193-95.
- J.A. Baker and A.S. Greig, "Rinderpest. XII. The Successful Use of Young Chicks to Measure the Concentration of Rinderpest Virus Propagated in Egg," Am. J. Vet. Res., VII (Apr 1946), 196-98.
- M.W. Hale and R.V.L. Walker, "Rinderpest. XIII. The Production of Rinderpest Vaccine from an Attenuated Strain of Virus," Am. J. Vet. Res., VII (Apr 1946), 199-211.

M.W. Hale, R.V.L. Walker, F.D. Maurer, J.A. Baker, and D.L. Jenkins, "Rinderpest. XIV. Immunization Experiments with Attenuated Rinderpest Vaccine Including Some Observations on the Keeping Qualities and Potency Tests," Am. J. Vet. Res., VII (Apr 1946), 212-21.

T.O. Robey and M.W. Hale, "Rinderpest. XV. Morphological Changes in the Blood of Young Cattle During Rinderpest and After Vaccination with Attenuated Virus Vaccine," Am. J. Vet. Res., VII (Apr 1946), 222-27.

H.K. Cooper, "Rinderpest. XVI. Complement Fixation Test for Rinderpest," Am. J. Vet. Res., VII (Apr 1946), 228-37.

NEWCASTLE DISEASE AND FOWL PLAGUE

C.A. Brandly, H.E. Moses, E.L. Jungherr, and E.E. Jones, "Epizootiology of Newcastle Disease of Poultry," Am. J. Vet. Res., VII (Jul 1946), 243-4

E.L. Jungherr, E.E. Tyzzer, C.A. Brandly, and H.E. Moses, "The Comparative Pathology of Fowl Plague and Newcastle Disease," Am. J. Vet. Res., VII (Jul 1946), 250-83.

C.A. Brandly, H.E. Moses, E.L. Jungherr, and E.E. Jones, "Isolation and Identification of Newcastle Disease Virus," Am. J. Vet. Res., VII (Jul 1946), 289-306.

C.A. Brandly, H.E. Moses, E.E. Jones, and E.L. Jungherr, "Immunization of Chickens Against Newcastle Disease," Am. J. Vet. Res., VII (Jul 1946) 307-32.

C.A. Brandly, H.E. Moses, and E.L. Jungherr, "Transmission of Antiviral Activity via the Egg and the Role of Congenital Passive Immunity to Newcastle Disease in Chickens," Am. J. Vet. Res., VII (Jul 1946), 333-42.

C.A. Brandly, H.E. Moses, E.L. Jungherr, E.E. Jones, and E.E. Tyzzer, "Newcastle Disease and Fowl Plague Investigations in the War Research Program," J. A. V. M. A., 103 (1946), 369-71.

H.E. Moses, M.S. Brandly, and E.E. Jones, "The pH Stability of the Virus of Newcastle Disease and Fowl Plague," Science (dormant)

PLANT PATHOGENS

R.M. Page, A.F. Sherf, and T.L. Morgan, "The Effect of Temperature and Relative Humidity on the Longevity of the Conidia of *Helminthosporium oryzae*," Mycologia, XXXIX (Mar-Apr 1947), 158-64.

A.F. Sherf, R.M. Page, E.C. Tullis, and T.L. Morgan, "Studies on Factors Affecting the Infectivity of *Helminthosporium oryzae*," Phytopathology, XXXVII (May 1947), 231-90.

A.L. Andersen and E.W. Henry, "The Use of Wetting and Adhesive Agents to Increase the Effectiveness of Conidial Suspensions for Plant Inoculation," Phytopathology, XXXVI (Dec 1946), 1056-57.

A.L. Andersen, E.W. Henry, and E.C. Tullis, "Factors Affecting Infectivity Spread, and Persistence of *Piricularia oryzae* Cav.," Phytopathology, XXXVII (Feb 1947), 94-110.

W.W. Borrell and R.M. Page, "The Use of Fragmented Mycelial Inoculum in the Culture of Fungi," J. Bact., 53 (Mar 1947), 360-61.

W. Epps, J. Paterson, and I. Freeman, "The Effect of Soil Temperature on the Infectivity of *Sclerotium rolfsii* (SACC)," Phytopathology (dormant)

S.F. Snieszko, J.B. Carpenter, E.P. Lowe, and J.G. Jakob, "Improved Methods for the Cultivation and Storage of *Phytophthora infestans*," Phytopathology (dormant)

F.W. Leaver, J. Leal, and C.R. Brewer, "Nutritional Studies on *Piricularia oryzae*," J. Bact. (dormant)

PLANT GROWTH REGULATORS

SPD, CWS, "Plant Growth Regulators," Science, 103 (19 Apr 1946), 469-70.

W.B. Ennis, H.E. Thompson, and H.H. Smith, "Tributyl Phosphate as a Solvent for Preparing Concentrated and Oil-miscible Solutions of 2,4-Dichlorophenoxyacetic Acid and Similar Substances," Science, 103 (19 Apr 1946), 47

W.B. Ennis, Jr., "Some Effects of O-Isopropyl N-Phenyl Carbamate Upon Cereals," Science, 105 (24 Jan 1947), 95.

E.V. Hill and H. Carlisle, "Toxicity of 2,4 Dichlorophenoxyacetic Acid for Experimental Animals," J. Ind. Hyg. Tox., 29 (Mar 1947), 85-95.

E.W. Surber, C.E. Minarik, and W.B. Ennis, Jr., "The Control of Aquatic Plants with Phenoxyacetic Compounds," Progressive Fish-Culturist (Jul 1947) 143-50.

H.S. Newman, W. Fones, M. Renoll, "New Compounds as Plant Growth Regulator" J. Am. Chem. Soc., 69 (Mar 1947), 713-23.

H.E. Thompson, C.P. Swanson, and A.G. Norman, "New Growth-regulating Compounds. I. Summary of Growth-inhibitory Activities of Some Organic Compounds as Determined by Three Tests," Botanical Gazette, 107 (Jun 1946) 476-507.

C.P. Swanson, "A Simple Bio-assay Method for the Determination of Low Concentrations of 2,4-Dichlorophenoxyacetic Acid in Aqueous Solutions," Bot. Gaz., 107 (Jun 1946), 507-09.

R.J. Weaver and H.R. DeRose, "Absorption and Translocation of 2,4-Dichlorophenoxyacetic Acid," Bot. Gaz., 107 (Jun 1946), 509-21.

C.P. Swanson, "Histological Responses of the Kidney Bean to Aqueous Sprays of 2,4-Dichlorophenoxyacetic Acid," Bot. Gaz., 107 (Jun 1946), 522-31.

R.J. Weaver, "Effect of Spray Applications of 2,4-Dichlorophenoxyacetic Acid on Subsequent Growth of Various Parts of Red Kidney Bean and Soybean Plants," Bot. Gaz., 107 (Jun 1946), 532-39.

R.J. Weaver, C.E. Minarik, and F.T. Boyd, "Influence of Rainfall on the Effectiveness of 2,4-Dichlorophenoxyacetic Acid Sprayed for Herbicidal Purposes," Bot. Gaz., 107 (Jun 1946), 540-44.

H.H. Smith, "Quantitative Aspects of Aqueous-spray Applications of 2,4-Dichlorophenoxyacetic Acid for Herbicidal Purposes," Bot. Gaz., 107 (Jun 1946) 544-51.

W.B. Ennis, Jr., and F.T. Boyd, "The Response of Kidney-bean and Soybean Plants to Aqueous-spray Applications of 2,4-Dichlorophenoxyacetic Acid With and Without Carbowax," Bot. Gaz., 107 (Jun 1946), 552-59.

C.P. Swanson, "Two Methods for the Determination of the Herbicidal Effectiveness of Plant Growth-regulating Substances in Oil Solution on Broadleaf Plants," Bot. Gaz., 107 (Jun 1946), 560-62.

R.J. Weaver, C.P. Swanson, W.B. Ennis, Jr., and F.T. Boyd, "Effect of Plant Growth-regulators in Relation to Stages of Development of Certain Dicotyledonous Plants," Bot. Gaz., 107 (Jun 1946), 563-68.

W.B. Ennis, Jr., C.P. Swanson, R.W. Allard, and F.T. Boyd, "Effects of Certain Growth-regulating Compounds on Irish Potatoes," Bot. Gaz., 107 (Jun 1946), 568-74.

R.W. Allard, H. R. DeRose, and C.P. Swanson, "Some Effects of Plant Growth regulators on Seed Germination and Seedling Development," Bot. Gaz., 107 (Jun 1946), 575-83.

H.R. DeRose, "Persistence of Some Plant Growth-regulators When Applied to the Soil in Herbicidal Treatments," Bot. Gaz., 107 (Jun 1946), 583-89.

R.W. Allard, W.B. Ennis, Jr., H.R. DeRose, and R.J. Weaver, "The Action of Isopropylphenylcarbamate Upon Plants," Bot. Gaz., 107 (Jun 1946), 589-

D.L. Taylor, "Observations on the Growth of Certain Plants in Nutrient Solutions Containing Synthetic Growth-regulating Substances. I. Some Effects of 2,4-Dichlorophenoxyacetic Acid," Bot. Gaz., 107 (Jun 1946), 597-611.

D.L. Taylor, "Observations on the Growth of Certain Plants in Nutrient Solutions Containing Synthetic Growth-regulating Substances. II. The Influence of Presentation Time," Bot. Gaz., 107 (Jun 1946), 611-19.

D.L. Taylor, "Observations on the Growth of Certain Plants in Nutrient Solutions Containing Synthetic Growth-regulating Substances. III. The Relative Toxicity of Isopropylphenylcarbamate and Some Phenoxyacetic Acid Derivatives to Some Cereals," Bot. Gaz., 107 (Jun 1946), 620-29.

D.L. Taylor, "Observations on the Growth of Certain Plants in Nutrient Solutions Containing Synthetic Growth-regulating Substances. IV. The Amount of Growth in Soil and Solution Cultures Treated with Equal Weights of Ammonium 2,4-Dichlorophenoxyacetate," Bot. Gaz., 107 (Jun 1946), 630-32.

D. Ready and V.Q. Grant, "A Rapid Sensitive Method for the Determination of Low Concentrations of 2,4-Dichlorophenoxyacetic Acid in Aqueous Solutions," Botanical Gazette (dormant)

ANTIBIOTICS

J. Forgacs, G.B. Kornegay, and T.F. Henley, "Studies on Streptomycin. I. Assay in Body Fluids," J. Lab. Clin. Med., 31 (May 1945), 514-22.

G.B. Kornegay, J. Forgacs, and T.F. Henley, "Studies on Streptomycin. II. Blood Levels and Urinary Excretion in Man and Animals," J. Lab. Clin. Med. 31 (May 1945), 523-34.

J. Forgacs and J.L. Kucera, "Studies on Streptomycin. III. Microtechnics for Assay," J. Lab. Clin. Med., 31 (Dec 1946), 1355-63.

S. Berkman, R.J. Henry, and R.D. Housewright, "Studies on Streptomycin. I. Factors Influencing the Activity of Streptomycin," J. Bact., 53 (May 1946), 567-74.

R.J. Henry, S. Berkman, and R.D. Housewright, "Studies on Streptomycin. I. Inactivation of Streptomycin upon Standing in Certain Culture Media and Human Serum," J. Pharm. Exper. Ther., 89 (May 1947), 42-45.

W.E. Nelson, J. Forgacs, and J.L. Kucera, "Alteration of the Distribution and Excretion of Streptomycin," Proc. Soc. Exper. Biol. Med., 64 (Jan 1947), 20-21.

R.D. Housewright and R.J. Henry, "Studies on Penicillinase. I. Production, Partial Purification, and Practical Application of Penicillinase," J. Bio. Chem., 167 (Feb 1947), 553-57.

R.J. Henry and R.D. Housewright, "Studies on Penicillinase. II. Manometric Method of Assaying Penicillinase and Penicillin, Kinetics of the Penicillinase Reaction and the Effects of Inhibitors on Penicillinase," J. Bio. Chem., 167 (Feb 1947), 559-71.

R.D. Housewright and R.J. Henry, "Studies on Penicillinase. III. The Effect of Antipenicillinase on Penicillin-resistant Organisms," J. Bact., 53 (Feb 1947), 241-47.

R.J. Henry and R.D. Housewright, "Studies on Penicillinase. IV. The Effect of Various Inhibitors on the Activity of Penicillinase," J. Bio. Chem., (dormant).

P. Steinglass and T. Henley, "The Distribution of Penicillin in Embryonated Eggs," submitted to J. Pharm. Exper. Ther. (dormant)

MISCELLANEOUS

- K.R. Johansson and D.H. Ferris, "Photography of Airborne Particles During Bacteriological Plating Operations," J. Infect. Dis., 70 (May-Jun 1946), 238-52.
- A. Guyton, "Electronic Counting and Size Determination of Particles in Aerosols," J. Ind. Hyg. Tox., (Jul 1946).
- A.C. Guyton, "A Versatile Square Wave Nerve Stimulator," Rev. Sci. Instruments, 17 (Dec 1946), 553-56.
- R.J. Heckly, "A Simple Lyophilizing Apparatus for Laboratory Use," J. Immunol., 55 (Jan 1947), 91-95.
- R.J. Henry and E.C. Smith, "Use of Sulfuric Acid-Dichromate Mixture in Cleaning Glassware," Science, 104 (1 Nov 1946), 426-27.
- C. Lazanna, "The Nature of the Acid Fast Stain," J. Bact., 52 (Jul 1946), 99-103.
- A.E. Hayward, J.A. Marchetta, and R.S. Hutton, "Strain Variation as a Factor in the Sporulating Properties of *Bacillus globigii*," J. Bact., 52 (Jul 1946), 51-54.
- H.E. Naylor and P.A. Smith, "Factors Affecting the Viability of *Serratia marcescens* During Dehydration and Storage," J. Bact., 52 (Nov 1946), 565-70.
- T.F. Paine, "Illness in Man Following the Inhalation of *Serratia marcescens*," J. Infect. Dis., 79 (Nov-Dec 1946), 226-32.
- J. Baker, "Rickettsial Infection in Canadian Voles," J. Exper. Med. (Jul 1946).
- M.S. Newman, "Methods," J. Am. Chem. Soc. (Mar 1947).
- A. Guyton, "Measurement of the Respiratory Volumes of Laboratory Animals," submitted to Am. J. Physiol.
- A. Guyton, "Analysis of Respiratory Patterns in Laboratory Animals," submitted to Am. J. Physiol.
- A. Guyton, "High Speed Recording of Blood Pressure, Respiratory Pressures and Mechanical Stress with a Capacity Recorder," submitted to Am. J. Physiol.
- A. Guyton and M. MacDonald, "Apparatus for Recording Extremely Slowly Changing Action Potentials on Kotion Picture Film," submitted to Review Sci. Instr.

R.S. Hutton and A.E. Hayward, "Disinfection of Large Rooms with Formaldehyde," submitted to Ind. Eng. Chem.

T. Rosebury, M. Boldt, F. Olson, et al., "Quantitative Experimental Study of Air-borne Infection with Special Reference to Highly Infective Agents: Equipment, Methods, and Basic Data," submitted to Bact. Monographs.

D. Boroff, L. Tripp, and B. Dembeck, "Specific Aggregation of Streptococcal Proteins Adsorbed on Oil Droplets," submitted to J. Immunol.

E.H. Lennette, "Immunity in Viral Diseases," submitted to Cyclopedia Med.

F.T. Gucker, H. B. Pickard, C.T. O'Konski, and J.N. Pitts, Jr., "A Photo-electronic Counter for Colloidal Particles," submitted to J. Am. Chem. Soc.

F.W. Putnam, "The Interactions of Proteins and Synthetic Detergents," Advances in Protein Chemistry (dormant)

PAPERS PRESENTED AT SCIENTIFIC MEETINGS

"Chemotherapy of Experimental Anthrax Infections," E. Miller, E. Scott, H. Noe, S. Madin, and T. Henley (Society of American Bacteriologists, Detroit, 21-24 May 1946).

"The Nutritional Requirements of *Bacillus anthracis*," C. Brewer, W. McCullough, R. Mills, W. Roessler, E. Herbst, and A. Howe (Society of American Bacteriologists, Detroit, 21-24 May 1946).

"Nutritional Studies with *Clostridium botulinum*, Toxin Types A and B," W. Roessler and C. Brewer (Society of American Bacteriologists, Detroit, 21-24 May 1946).

"The Amino Acid Composition of Crystalline Botulinus (Type A) Toxin," H. Buehler, D. Bornor, E. Schantz, and C. Lamanna (Society of American Bacteriologists, Detroit, 21-24 May 1946).

"Physical Chemical Properties of Crystalline Botulinus A Toxin," F.W. Putnam (Federation of American Societies for Experimental Biology, Chicago, 19-22 May 1947).

"Aeration in the Cultivation of *Brucella suis*," P. Gerhardt and L. Gee (Society of American Bacteriologists, Detroit, 21-24 May 1946).

"The Comparative Susceptibility of Various Animals to *B. tularensis*," C. Downs, L. Coriell, G. Pinchot, F. Maumenee, A. Klauber, S. Chapman, and B. Owens (Federation of American Societies for Experimental Biology, Atlantic City, 11-16 Mar 1946).

"Observations on the Cultivation of *Bacterium tularensis* in Embryonated Eggs," L. Coriell, C. Downs, E. Smadel, A. Klauber, and R. Dorion (American Association of Pathologists and Bacteriologists, Chicago, 8-9 Mar 1946).

"Studies on the Bacteriostatic and Bactericidal Action of Streptomycin on *Bacterium tularensis*," S. Chapman, C. Downs, and S. Koval (Society of American Bacteriologists, Detroit, 21-24 May 1946).

"Studies on Streptomycin Therapy of Experimental Tularemia in White Mice," S. Chapman, L. Coriell, S. Koval, W. Nelson, and C. Downs (Society of American Bacteriologists, Detroit, 21-24 May 1946).

"The Immunization of White Rats Against Tularemia," L. Coriell, C. Downs, H. Eigelsbach, G. Pinchot, B. Owen, B. Hamilton, and G. Spencer, (Society of American Bacteriologists, Detroit, 21-24 May 1946).

"Electron Microscopy of *Bacterium tularensis*," H. Eigelsbach, L. Chambers, and L. Coriell (Society of American Bacteriologists, Detroit, 21-24 May 46)

"Plating Media Requirements for Certain Strains of Bacterium tularense," F. Engley and T. Snyder (Society of American Bacteriologists, Detroit, 21-24 May 1946).

"Living Bacterium tularense," L. Chambers (Society of American Bacteriologists, Detroit, 21-24 May 1946).

⑥ "Streptomycin in Experimental Brucellosis," E.H. Kelly (Society of American Bacteriologists, Philadelphia, 12-16 May 1947).

"Psittacosis Vaccines Prepared from Chick Embryo Tissues," J. Wagner, G. Weiklejohn, L. Kingsland, and A. Hickish (Society of American Bacteriologists, Detroit, 21-24 May 1946).

"The Chemotherapy of Experimental Psittacosis Infection (Strain 6BC) in Mice," R. Early and H. Morgan (Society of American Bacteriologists, Detroit, 21-24 May 1946).

"The Nutrition of Coccidioides immitis in Submerged Culture," W. Roessler, E. Herbst, W. McCullough, R. Mills, and C. Brewer (Society of American Bacteriologists, Detroit, 21-24 May 1946).

"The Interference Phenomenon Within the Psittacosis-LGV Group of Viruses O.J. Golub (American Association of Immunologists, Chicago, 13-22 May 1946).

"Nutritional Research with Pathogenic Micro-organisms," C. Brewer (Society of American Bacteriologists, Baltimore, May 1946).

"Specific Aggregation of Streptococcal Proteins Adsorbed on Oil Droplets D.A. Boroff and L.M. Tripp, Jr. (Society of American Bacteriologists, Philadelphia, 12-16 May 1947).

"Alteration of the Distribution and Excretion of Streptomycin," W.E. Nelson, J. Forgas, and J.L. Kucera (Sectional meeting of Society of Experimental Biology and Medicine, Washington, D.C., 5 Dec 1946).

"Studies on the Adsorption of Streptomycin and its Antagonism by Salt," S. Berkman, R.J. Henry, R.D. Housewright, and J.E. Henry (Society of American Bacteriologists, Philadelphia, 12-16 May 1947).

"On the Mode of Action of Streptomycin," J.E. Henry, R.J. Henry, R.D. Housewright, and S. Berkman (Society of American Bacteriologists, Philadelphia, 12-16 May 1947).

"Some Quantitative Aspects of Aqueous Spray Applications of 2,4-Dichloro phenoxyacetic Acid for Herbicidal Purposes," H. Smith (Society of American Bacteriologists, Detroit, 21-24 May 1946).

"Effect of Soil Micro-organisms on the Persistence of Plant Growth-regulators in Soil," A.S. Newman and A.G. Norman (Society of American Bacteriologists, Philadelphia, 12-16 May 1947).

"Application of Plant Growth Regulators," A.G. Norman (Pennsylvania State College Chapter of Sigma Xi, 26 Mar 1947).

"A Photoelectronic Counter for Colloidal Particles," F.T. Gucker, Jr., E.E. Pickard, C.T. O'Konski, and J.H. Pitts, Jr., (American Chemical Society, Atlantic City, May 1947).

ADDITIONAL TECHNICAL JOURNAL LITERATURE

W.H. Kellogg, "Epidemic of Pneumonic Plague," Am. J. Pub. Health, 10 (1920), 599.

E.O. Jordan, "The Influenza Epidemic of 1918," J.A.M.A., 89 (1927), 1603-06, 1689-93, 1779-83.

K.F. Meyer, B. Eddie, and I.M. Stevens, "Recent Studies on Psittacosis," Am. J. Pub. Health, 25 (1935), 571.

K.F. Meyer and J.C. Geiger, "The Increasing Importance of Brucellosis as an Occupational Hazard," J.A.V.M.A., 86 (Mar 1935), 280-86.

K.F. Meyer and B. Eddie, "Laboratory Infections Due to Brucella," J. Infect Dis.

K.F. Meyer, "The Ecology of Psittacosis and Ornithosis," Medicine, 21 (Feb 1942), 175-206.

K.F. Meyer, "The Ecology of Plague," Medicine, 21 (Feb 1942), 143-74.

D.M. Goldstein and S. Louis, "Primary Pulmonary Coccidioidomycosis: Report of Epidemic of 75 Cases," War Medicine, 4 (Sep 1943), 299

A.P. Long, "Immunization in the United States Army," Am. J. Pub. Health, 34 (1944), 27-33.

Leon A. Fox, "Bacterial Warfare: the Use of Biologic Agents in Warfare," Mil. Surg., 72 (Mar 1933), 139-207. Reprinted in Mil. Surg., 90 (May 1942), 563-79.

Le Bourdelles, "La Guerre Bacteriologique et la Defense Passive Anti-microbienne," Le Bulletin Medicale, 53 (11 Mar 1939), 179-85.

Editorial, "Bacteriological Warfare," Medical Record, 155 (15 Apr 1942),

Ernest C. Faust, "Some Biological Relationships," Am. Scientist, 33 (Jan 1945), 13-32.

Selman A. Waksman, "The Microbe-Friend and Enemy of Man," Chem. Eng. News 24 (25 May 1946), 1372-74.

George N. Merck, "Peacetime Implications of Biological Warfare," Chem. Eng. News, 24 (25 May 1946), 1345-49.

T. Rosebury, E.A. Kabat, and W.H. Boldt, "Bacterial Warfare: A Critical Analysis of the Available Agents, Their Possible Military Applications, and the Means for Protection Against Them," J. Immunol., 56 (May 1947), 7-9.

PERIODICAL LITERATURE

"U.S. Was Prepared to Combat Axis in Poison Germ Warfare," New York Times, January 4, 1946, p. 1.

"Convicts Aid Germ Battle," Oakland, California, Tribune, January 5, 1946, p. 1.

"The Black Death Returns," Washington Times-Herald, January 13, 1946, sec D, p. 3.

"Bacterial Warfare Poses a Problem," New York Times, January 13, 1946, sec E, p. 9.

"U.S. Reportedly Develops Potent New Germ Weapon," Panama Canal Zone Panama-American, May 30, 1946, p. 1.

"Ounce of New Super-Poison Held Able to Wipe Out U.S., Canada," New York Times, September 19, 1946, p. 1.

"Scientists See U.S. Very Vulnerable to Germ Warfare," New York Times, May 19, 1947, p. 1.

"'42 Report on Germ War Lists 30 Diseases Without a Defense," New York Herald Tribune, May 19, 1947, p. 1.

Wickham Steed, "Aerial Warfare: Secret German Plans," Nineteenth Century and After, 116 (Jul 1934), 1-15. Ibid., Aug 1934, 331-36; Sep 1934, 337-39.

"Invisible Weapon," Time, XXXIX (9 Mar 1942), 22.

"Disease Warfare Not New," "Biological Warfare," "International Effects," and "Harmful Effects Persist," Science News Letter, 49 (12 Jan 1946), 18-21.

"Armies of Germs," Newsweek, XLVII (14 Jan 1946), 75-76.

"'Better' than the Bomb," Time, XLVII (3 Jun 1946), 63.

"Planned Pestilence," Time, XLVIII (12 Aug 1946), 56.

"Death in Convenient Bottles," Time, XLIX (26 May 1947), 57.

"Nazi Try at Germ Warfare," Science News Letter, 51 (8 Mar 1947), 156.

"Deadly Chain Reaction; Spreading of Disease Can Be Used as a Weapon," Science News Letter, 51 (31 May 1947), 342.

"Germ Warfare Advances More Potent than A-Bomb," Science News Letter, 52 (30 Aug 1947), 136.

UNCLASSIFIED

Gerard Piel, "BH," Life, 21 (18 Nov 1946), 118-30.

Sidney Shallett, "The Deadliest War," Collier's, 117 (15 Jun 1946), 11.

John W. Campbell, Jr., "The Real Big Three," Pic, (Feb 1947), 82-84.

"Germs-New War Terror," Look, 11 (7 Jan 1947), 52-53.

Dyson Carter, "Biological Warfare: New Ways of Killing," New Masses, LX (3 Sep 1946), 3-6.

L. Engel, "Scope of Biological Warfare," Nation, 165 (26 Jul 1947), 93-95.

"Germ Warfare: Its Threat for the Future," New Republic, 114 (10 Jun 1946), 821.

Greer Williams, "Laboratory Against Death," Hearst's International-Cosmopolitan, (Feb 1947)

William F. Jenkins, "Symbiosis," Collier's, 119 (14 Jun 1947), 14-15.

UNCLASSIFIED

UNCLASSIFIED

HISTORICAL REPORTS IN THE MILITARY DEVELOPMENT OF BIOLOGICAL WARFARE

Edgewood Arsenal Mechanical Division Progress Report 442 (24 Sep 1924).
In EA Tech Lib.

Technical Study 10 (S), Bacteriological Warfare Possibilities (28 Aug
1939). In CD Tech Lib.

OC CWS Progress Report 54 (S), Biological and Bacteriological Warfare
(15 Aug 1941). In CD Tech Lib.

Technical Study 58 (S), Biological Warfare: An Annotated Bibliography
(19 Jan 1942). In CD Tech Lib.

Technical Division Memorandum Report 616 (S), Possible Chemical Warfare
Agents of the Axis Powers (26 Apr 1943). In EA Tech Lib.

USBWC Report (TS), Development of the Biological Warfare Program of the
United States (15 Nov 1944). In Hist files.

Dr. Paul Fildes, Organization of B.W. in the United Kingdom (1945?).
In CD Tech Lib.

Activities of the United States in the Field of Biological Warfare. A
Report to the Secretary of War by George W. Merck, Special Consultant on
Biological Warfare (S)(30 Oct 1945?). In CD Tech Lib.

G.W. Merck, E.B. Fred, I.L. Baldwin, and W.B. Sarles, "Implications of
Biological Warfare," The United States and the United Nations Report Seri
No. 5, The International Control of Atomic Energy (Dept of State Pubn 266
USGPO, 1946), pp. 65-71.

UNCLASSIFIED

UNCLASSIFIED

WAR DEPARTMENT AND SERVICE MANUALS

FM 3-25, Chemical Laboratory Company

FM 3-70, Chemical Decontamination Company

FM 21-10, Military Sanitation and First Aid

FM 21-40, Defense Against Chemical Attack

TM 3-215, Military Chemistry and Chemical Agents

Tentative TM 3-216 (S Reg Doc), Military Biology and Defense Against Biological Warfare, Apr 47

TM 3-220, Decontamination

TM 3-290, Miscellaneous Gas Protective Equipment

TM 3-350, Gasproof Shelters

TM 8-227, Methods for Laboratory Technicians

TM 8-235, Treatment of Casualties from Chemical Agents

TM 8-450, Animal Diseases

TB-Med 45, Notes on Certain Infectious Diseases (R), 20 May 44

GHS Tng Memo SPCYV (S), Instruction for Defense Against Biological Attack, 10 Jan 45

Tentative TM (no number)(S), Instructions for Defense Against Biological Attack, 31 Aug 46

UNCLASSIFIED

56



DEPARTMENT OF THE ARMY
US ARMY RESEARCH, DEVELOPMENT AND ENGINEERING COMMAND
EDGEWOOD CHEMICAL BIOLOGICAL CENTER
5183 BLACKHAWK ROAD
ABERDEEN PROVING GROUND, MD 21010-5424

REPLY TO
ATTENTION OF

RDCB-DPS-RS

30 MAR 2015

MEMORANDUM THRU Director, Edgewood Chemical Biological Center, (RDCB-D, Mr. Joseph L. Corriveau), 5183 Blackhawk Road, Aberdeen Proving Ground, MD 21010-5424

FOR Office of the Chief Counsel, US Army Research, Development and Engineering Command (RDECOM), (AMSRD-CCF/Ms. Kelly Knapp), 3071 Aberdeen Boulevard, Aberdeen Proving Ground, MD 21005-5424

SUBJECT: Operations Security/Freedom of Information Act (FOIA) Review Request

1. The purpose of this memorandum is to recommend the release of information in regard to RDECOM FOIA Request, FA-14-0021.
2. The Edgewood Chemical Biological Center (ECBC) received RDECOM FOIA Tasker #FA-14-0021 from Ms. Kelly Knapp, the RDECOM FOIA Officer.
3. The document, History of the Chemical Warfare Service in World War II, Volume II – July 1940 – August 1945, dated Nov 1947 was reviewed by Subject Matter Experts from ECBC who deemed this document is suitable for a distribution change with the Defense Technical Information Center to be released publically.
4. The point of contact is Mr. Ronald L. Stafford, ECBC Security Specialist, (410) 436-1999 or ronald.l.stafford.civ@mail.mil.

RONALD L. STAFFORD
Security Manager