



This is a digital copy of a book that was preserved for generations on library shelves before it was carefully scanned by Google as part of a project to make the world's books discoverable online.

It has survived long enough for the copyright to expire and the book to enter the public domain. A public domain book is one that was never subject to copyright or whose legal copyright term has expired. Whether a book is in the public domain may vary country to country. Public domain books are our gateways to the past, representing a wealth of history, culture and knowledge that's often difficult to discover.

Marks, notations and other marginalia present in the original volume will appear in this file - a reminder of this book's long journey from the publisher to a library and finally to you.

Usage guidelines

Google is proud to partner with libraries to digitize public domain materials and make them widely accessible. Public domain books belong to the public and we are merely their custodians. Nevertheless, this work is expensive, so in order to keep providing this resource, we have taken steps to prevent abuse by commercial parties, including placing technical restrictions on automated querying.

We also ask that you:

- + *Make non-commercial use of the files* We designed Google Book Search for use by individuals, and we request that you use these files for personal, non-commercial purposes.
- + *Refrain from automated querying* Do not send automated queries of any sort to Google's system: If you are conducting research on machine translation, optical character recognition or other areas where access to a large amount of text is helpful, please contact us. We encourage the use of public domain materials for these purposes and may be able to help.
- + *Maintain attribution* The Google "watermark" you see on each file is essential for informing people about this project and helping them find additional materials through Google Book Search. Please do not remove it.
- + *Keep it legal* Whatever your use, remember that you are responsible for ensuring that what you are doing is legal. Do not assume that just because we believe a book is in the public domain for users in the United States, that the work is also in the public domain for users in other countries. Whether a book is still in copyright varies from country to country, and we can't offer guidance on whether any specific use of any specific book is allowed. Please do not assume that a book's appearance in Google Book Search means it can be used in any manner anywhere in the world. Copyright infringement liability can be quite severe.

About Google Book Search

Google's mission is to organize the world's information and to make it universally accessible and useful. Google Book Search helps readers discover the world's books while helping authors and publishers reach new audiences. You can search through the full text of this book on the web at <http://books.google.com/>

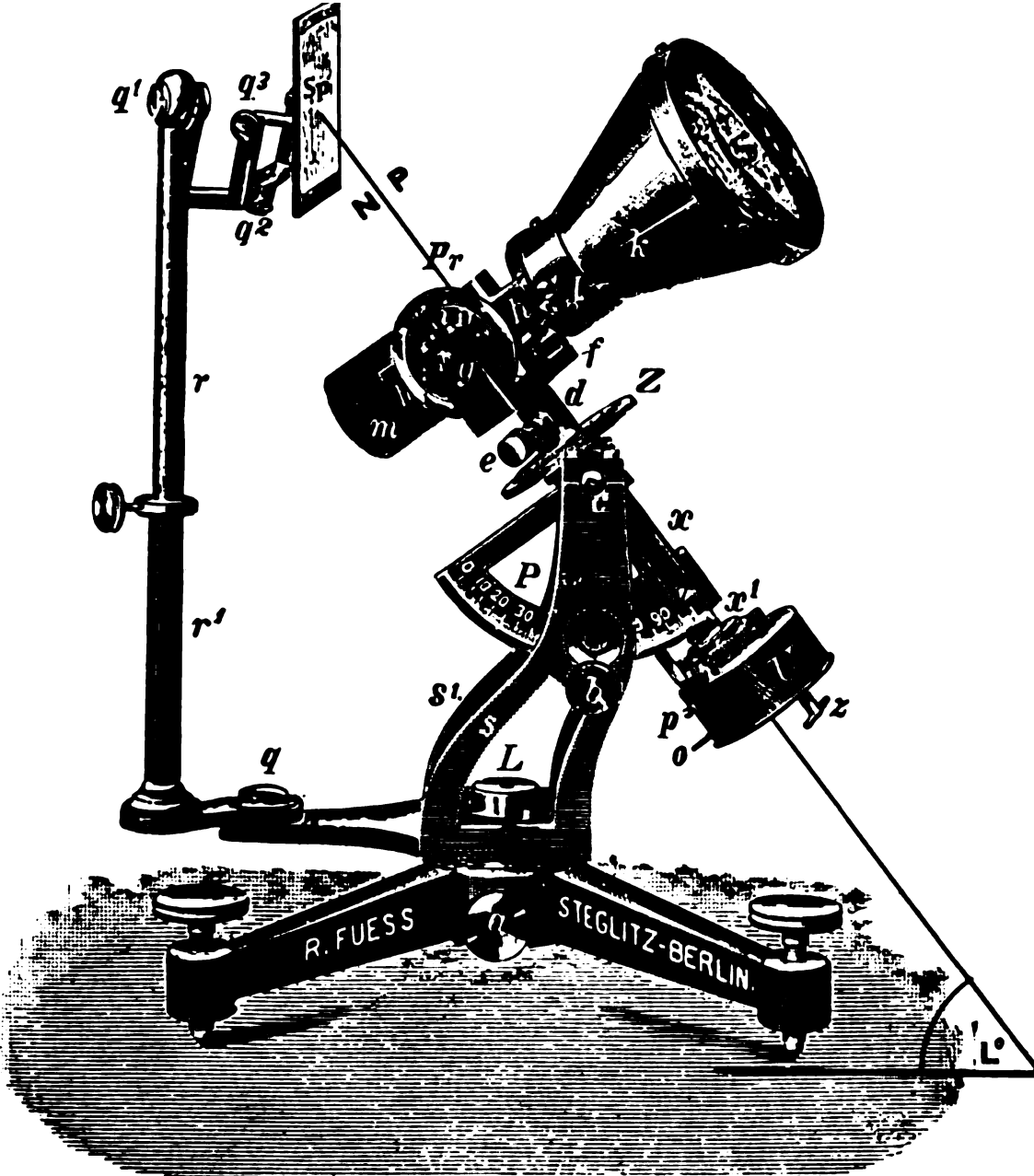

Optic projection

Simon Henry Gage, Henry Phelps Gage

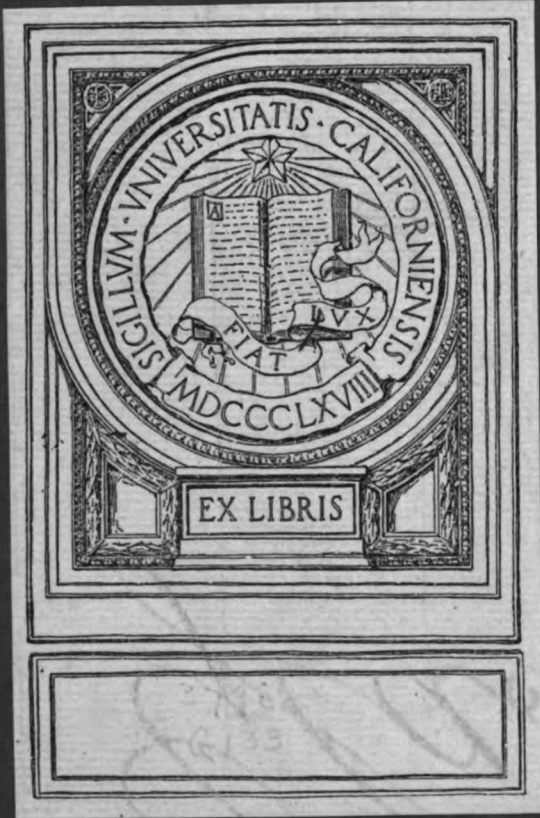

EX LIBRIS

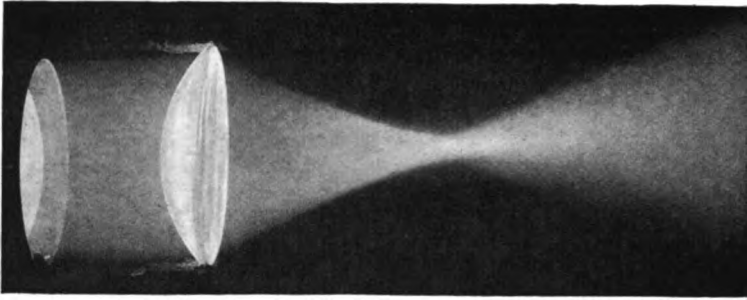

FIG. 323. PLANO-CONVEX LENS WITH LEAST ABERRATION, §809

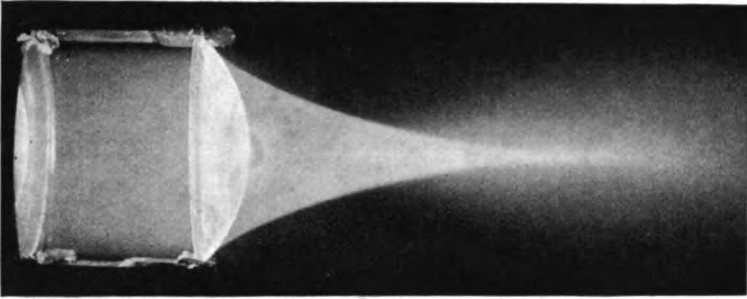

FIG. 322. PLANO-CONVEX LENS WITH GREATEST ABERRATION, §809

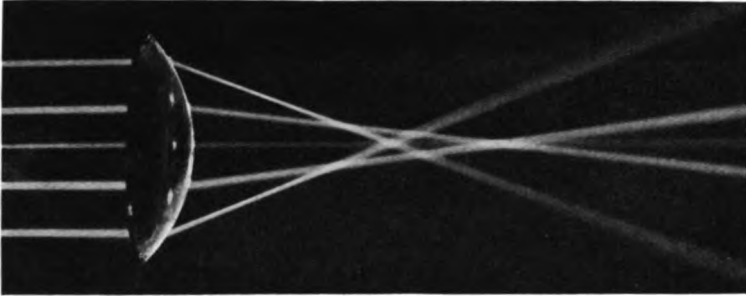

FIG. 320. CROSSING OF LIGHT RAYS WITH GREATEST ABERRATION, §809

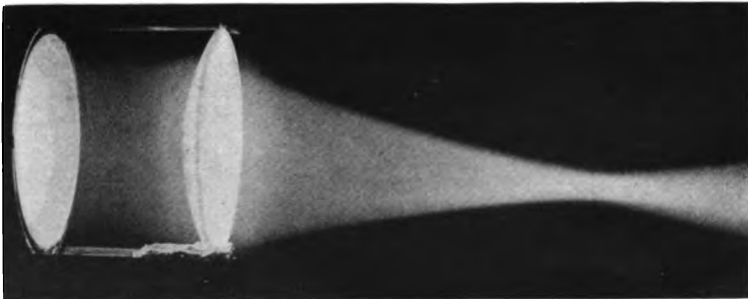
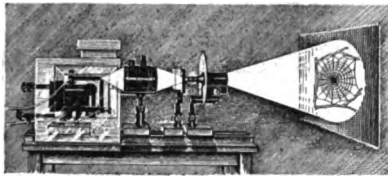

FIG. 323A. LIGHT CONE WITH THE RADIANT ABOVE THE OPTIC AXIS, §57

OPTIC PROJECTION

PRINCIPLES, INSTALLATION AND USE
— OF THE —
MAGIC LANTERN
PROJECTION MICROSCOPE
REFLECTING LANTERN
MOVING PICTURE MACHINE



FULLY ILLUSTRATED WITH PLATES AND WITH
OVER 400 TEXT-FIGURES

By SIMON HENRY GAGE
Professor of Histology and Embryology, Emeritus, Cornell University

AND

HENRY PHELPS GAGE, Ph.D.

UNIV
CALIF

ITHACA, NEW YORK
COMSTOCK PUBLISHING COMPANY
1914

Q. 126
G3

COPYRIGHT 1914
COMSTOCK PUBLISHING CO.,
ITHACA, N. Y.

TO THE
LIBRARY OF

PRESS OF W. F. HUMPHREY, GENEVA, N. Y.

47.
TO

JACOB GOULD SCHURMAN

IN GRATEFUL RECOGNITION OF HIS ABLE AND
DEVOTED SERVICE TO CORNELL UNIVERSITY, OF
HIS BREADTH OF SYMPATHY FOR ALL ART AND
ALL SCIENCE, AND OF THE ENCOURAGEMENT
AND SUPPORT WHICH HAVE MADE THE PRESENT
WORK POSSIBLE, THIS VOLUME IS DEDICATED.

295710

PREFACE

OUR aim in the preparation of this work on Optic Projection has been to explain the underlying principles on which the art depends, and to give such simple and explicit directions that any intelligent person can succeed in all the fields of projection; and our hope is that the book will serve to make more general this graphic art by means of which many persons can be appealed to at the same time and in the most striking manner. Furthermore we believe that this art has great, undeveloped possibilities for giving pleasure, arousing interest and kindling enthusiasm, in that it provides for the rapid demonstration of maps, diagrams and pictures of all kinds, the structure and development of animals and plants, many of the actual phenomena of physics and chemistry, and finally scenes from nature and from life, even with their natural motions and colors.

The authors have received most generous aid from many individuals and many manufacturers; and most loyal service from those who have helped to put the book in its present actual form.

Manufacturers have not only answered our numerous questions, but have put at our disposal valuable apparatus for experiment. They have also loaned us electrotypes of their apparatus.

We feel especially indebted to the Department of Physics of Cornell University for the help given by different members of the staff, and for the use of a research room and apparatus for the numerous photometric and other determinations required. Professor George S. Moler of that department read over the manuscript, and gave us many valuable hints derived from his experience of over 40 years with all kinds of projection apparatus.

While we have both joined in the preparation of the entire work, each holds himself especially responsible for certain chapters as follows:

The senior author for 10 chapters (I-V, VII-X and XII).

The junior author for 5 chapters (VI, XI, XIII-XV).

SIMON HENRY GAGE,
HENRY PHELPS GAGE.

October 4, 1914.

CONTENTS

Introduction pp. 3-7

CHAPTER I

Magic Lantern with Direct Current

Fig. 1-38; § 1-99, pp. 9-67
Apparatus and material for Ch. I, § 1; Works of reference, § 2; Magic
Lanterns, § 3-19; Perfection and brilliancy of the screen image, § 20;
Suggestions for the lecturer or demonstrator, § 21-25; Suggestions to the
operator, § 26-41; Projection of horizontal objects with a vertical objec-
tive, § 42; Projection with multiple lanterns, § 43-46; Moving slides for
single lanterns, § 47-49; Stereoscopic screen images, § 50; Centering the
parts of the magic lantern, §51-54; Correct separation of the parts, § 55-
56; Optical test for centering, § 57-58; Centering the vertical objective,
§ 59-60; Troubles with the magic lantern, § 61-93; Breaking of conden-
ser lenses, § 94-97; Examples of American magic lanterns, § 99, fig. 32-
38; Summary of Ch. I, § 99,.

CHAPTER II

Magic Lantern with Alternating Current

Fig. 39-40; § 100-119, pp. 68-77
Apparatus and material required, § 100; Comparison of direct and alternat-
ing current, § 102-103; Installation with alternating current, § 104-113;
Use of the magic lantern with alternating current, § 114-115; Troubles
with alternating current lanterns, § 116-118; Summary of Ch. II, § 119.

CHAPTER III

Magic Lantern for Use on the House Electric Lighting System

Fig. 41-55; § 120-148, pp. 78-99
Apparatus and material, § 120; Magic lantern with small current for home
and laboratory, § 122-126; Arc lamps for the house circuit, § 127-131;
Turning the arc lamp on and off, § 132-135; Magic lantern with mazda
lamp, §136-139; Magic lanterns with Nernst lamp, § 140-146; Troubles
in Ch. III, § 147; Summary of Ch. III, § 148.

CHAPTER IV

Magic Lantern with the Lime Light

Fig. 56-63; § 150-186.....pp. 100-118
 Apparatus and material, § 150; Lime light with oxygen and hydrogen, § 152-158; Management of the lime light lantern, § 159-173; The lime light with oxygen and illuminating gas, § 174-176; The lime light with oxygen and ether vapors, § 177-179; Troubles with the lime light, § 180-185; Summary of Chapter IV, § 186.

CHAPTER V

Magic Lantern with a Petroleum Lamp, with Gas, Acetylene, and Alcohol Lamps

Fig. 64-73; § 190-224.....pp. 119-137
 Apparatus and material, § 190; Oil and gas lamps, § 192-195; Magic lantern with kerosene lamp, § 196-202; Lantern with mantle gas lamps, § 203-207; Lantern with acetylene lamp, § 208-213; Lantern with alcohol lamp and mantle, § 214-219; Troubles in Ch. V, § 220-223; Summary of Ch. V, § 224.

CHAPTER VI

Magic Lantern with Sunlight; Heliostats

Fig. 74-87; § 230-265.....pp. 138-165
 Apparatus and material for Ch. VI, § 230; Light from the sun, and heliostats, § 232-233; Installation and use of heliostats, § 234-238, 239-248; Heliostats for the southern hemisphere, § 249-255; Condenser for sunlight, § 256-258; Conduct of an exhibition with sunlight, § 259-262; Troubles with sunlight, § 263-264; Summary of Ch. VI, § 265.

CHAPTER VII

Projection of Images of Opaque Objects

Fig. 88-111; § 270-297.....pp. 166-199
 Apparatus and material for Ch. VII, § 270; Images of opaque objects, § 272; Comparison of the projection of opaque and transparent objects, § 273-280; Combined projections, § 281-282; Opaque projection demonstrations, § 283-292; Erect images with opaque projection, § 293-295; Troubles with opaque projections, § 296; Summary of Ch. VII, § 297.

CHAPTER VIII

Preparation of Lantern Slides

- Fig. 112-120; § 310-340..... pp. 200-220
 Apparatus and material for Ch. VIII, § 310; Sizes of lantern slides, and necessary condensers, § 312-314; Making lantern slides direct, § 315-324; Photographic lantern slides, marking, mounting and coloring them, § 325-337; Storing lantern slides, § 338; Troubles in making lantern slides, § 339; Summary of Ch. VIII, § 340.

CHAPTER IX

The Projection Microscope

- Fig. 121-178; § 350-441..... pp. 221-318
 Apparatus and references, § 350-351; General on micro-projection, § 352-354; Objectives, amplifiers, oculars, visibility of objects, diopter, § 355-359; Room and screen, § 360; Arc lamp and wiring, fine adjustment, condenser, water-cell stage, mechanical stage, § 361-369; Blackening apparatus, § 370-371; Hoods for objectives and shield for stray light, § 372-373; Centering the projection microscope, § 374-376; Table of candle power, § 377; Use of the projection microscope, § 379-390; Magnification of screen images, § 391-392; Projection with an ordinary microscope, § 393-396; Projection of horizontal objects with a vertical microscope, § 397; Sample objects for micro-projection, § 399; Conduct of an exhibition, § 400; Demonstration with high powers, § 401-411; Alternating current for micro-projection, § 412-416; Micro-projection with the house-current, § 417-418; Micro-projection with sunlight, § 419-421; Micro-projection with lime light, § 422-423; Home-made projection apparatus, § 424-431; Combined micro-projection and lantern slide projection, § 432; Projection microscopes on the market, § 433-434; Troubles in micro-projection, § 435-440; Summary of Ch. IX, § 441.

CHAPTER X

Drawing and Photography with Projection Apparatus

- Fig. 179-220; § 450-549..... pp. 319-389
 Apparatus and material, § 450; Drawing with projection apparatus, general, § 452; Room for drawing, § 453-455; Projection apparatus for drawing, § 456-460; Light for drawing, § 461-463; Drawing with the magic lantern, § 464-468; Drawing with the reflecting lantern, § 469-470; Drawing with a photographic camera, § 471; Drawing with the projection microscope, § 472-485; Drawing with the house current, § 486-491; Microscope to use with the house current, § 492-503; Avoidance of heat,

§ 504; Stray light, § 505-506; Magnification of drawings, § 507-508; 509-510; Drawings for models, § 511; Erect images in the drawings, § 512-516; 517-526; Drawings for publication with projection apparatus, § 527-530; Drawings and their lettering, § 531; Photography with projection apparatus, § 532-547; Troubles met in Ch. X, § 548; Summary of Ch. X, § 549.

CHAPTER XI

Moving Pictures

Fig. 221-236; § 550-599.....pp. 390-438⁸
 Apparatus and material, § 550; Introduction, § 552; Auditorium, screen and operating room, § 553-557; Current, lamps and moving picture machine, § 558-574; Installation of a moving picture outfit, § 575; Optics of moving picture projection, § 576-578; Magic lantern with the moving picture machine, § 579; Management of the lamp, moving picture machine mechanism, § 580-589; flicker, § 590-592; General precautions, § 593; Splicing films, § 594; Winding and rewinding, § 595; Danger of fire, § 596; Conduct of an exhibition, § 597; Home projectors and advertising magic lanterns, § 598; Troubles with moving pictures, § 599; Summary of Ch. XI, § 599¹.

CHAPTER XII

Projection Rooms and Screens

Fig. 237-251; § 600-642.....pp. 439-473
 Apparatus and material for Ch. XII, § 600; Suitable room for projection, and its lighting, § 602-611; Position of the projection apparatus in the room, § 612-620; Screen for the image, § 621-628; 629-632; Size of screens and screen images, § 633-640; Troubles with rooms and screens, § 641; Summary of Ch. XII, § 642.

CHAPTER XIII

Electric Currents and their Measurement; Arc Lamps, Wiring and Control; Candle-Power of Arc Lamps for Projection

Fig. 252-308; § 650-782.....pp. 474-571
 Apparatus and material for Ch. XIII, § 650; Electric currents, kinds and comparison, § 652-653; Electric units, § 654-661; Electric measurements and apparatus, § 662-671; 672-674; Power factor, cycle, frequency, § 675-677; Special dynamo for arc lamps, § 678-680; Current rectifiers, § 681-683; 135 and 25 cycle currents for projection, § 684-685; Wiring for arc lamp from dynamo back to dynamo, § 686; Amperages for different purposes, short circuit, ground, insulation of wires, § 687-690;

Regulations for wiring, § 691-692; 693-700; Polarity tests for direct current, § 701-703; Wiring the three-wire automatic lamp, § 704; Wiring for alternating current, § 705-710; Switches, circuit breakers and fuses § 711-722; Resistors or rheostats, § 723-735; Reactors, inductors, choke-coils, etc., § 736-738; Transformer, § 739; The electric arc, § 740-743; The use of ballast (rheostats, etc.), § 744-748; The arc lamp, light and heat from, § 749-752; Carbons and their position, § 753; Table showing size and wear of carbons, § 753a; Candle power of arc lamps, § 754-762; Candle power, and energy required, § 763-768; Distribution of light intensity in different directions, § 769-771; Intrinsic brilliancy of the crater, § 773; Visible and invisible radiation, § 774; Radiant efficiency of arc lamps, § 775-776; Energy required for moving picture projection, § 779-781; Effect of opacity in the film, § 782.

CHAPTER XIV

Optics of Projection

Fig. 309-349; § 790-865..... pp. 572-620
 Reflection and refraction, § 792-801; Lenses, § 802-808; Spherical and chromatic aberration in lenses, § 809-810; Image formation with the magic lantern, § 811-817; Focus of Condenser and objective, § 818; Types of condensers, § 819-821; Image formation with moving pictures, § 822-832; Image formation with the projection microscope, § 833-838; Light losses, § 839-843; Energy losses, § 844-854; Effect of aperture, § 855-856; Brightness of the screen image, § 857; Microscopic image and aperture, § 858-863; Koehler method of illumination, § 864-865.

CHAPTER XV

Uses of Projection in Physics; Normal and Defective Vision

Fig. 350-402; § 875-932..... pp. 621-672
 Apparatus and material for Ch. XV, § 875; Introduction, § 877-878; Experiments with polarized light, § 879-884; Projection of spectra, § 885-900; Absorption spectra, § 901-902; Emission spectra, § 903-905; Ultra-violet light, photography, § 906-908; Abbe diffraction theory, § 909-911; Dark ground illumination, striae, § 912-915; Normal vision and eye defects, § 916-932.

Appendix. Brief Historical Statement on the Origin and Development of Projection Apparatus 673
Projection Apparatus and Accessories in the Open Market; Manufacturers 688
Bibliography on Projector 693
Index of names and subjects 705

INTRODUCTION

IN THE following pages, Projection Apparatus of various forms and with various sources of light have been considered from a three-fold standpoint:

- (1) The standpoint of the actual user of the apparatus.
- (2) The standpoint of the manufacturer.
- (3) The standpoint of the student for whom an understanding of the principles involved is of fundamental importance.

From the first and second standpoints simple "rule of thumb" would answer, and in many cases has answered to bring about fairly good results. For example, the toy magic lanterns so much in evidence at Christmas time, are almost exact copies of the first magic lantern shown by Walgenstein in 1665. The only striking difference is that instead of a candle or lamp without a chimney such as he used, there is now a small petroleum lamp with a glass chimney.

But for adapting projection apparatus to new conditions and applying it to new uses with the greatest efficiency, the user and the manufacturer must comprehend the fundamental optical and mechanical principles involved. In a word, to make good projection apparatus and to produce good projection in the different fields, the manufacturer and the user must know the principles, and then they must build and must use the apparatus in accordance with those principles.

Besides the optical and mechanical principles involved in the apparatus, it seems to the authors that the physiology of vision should have prime consideration, because, after all, it is not only the possibility of producing a brilliant screen image that must be thought of, but also the possibility that the observer get a satisfactory impression of that image. With the magic lantern and arc light it is very easy to get screen images as brilliant as daylight scenes in nature. These brilliant images are best seen when the eyes of the observers are adapted to daylight vision. If now, as is

possible with modern combined apparatus, the brilliant screen image of the transparency is replaced by a relatively dim image projected by the opaque lantern, it will appear exceedingly dim until the eyes can be adjusted to twilight vision. If the operation is reversed after the eyes are adapted to dim light, the brilliant screen image of the transparency will dazzle the eyes.

It is then, not only the dead machine that must be considered, but also the living machine—the eye. It is for the eye that all the work is done, and perfection can be gained only by understanding the workings of the two machines, and adapting the dead machine to the physiologic laws governing the living machine.

Our aim in writing this book then has been to show how good results can be most easily and certainly obtained in all the forms of projection by obeying the laws of physiology as well as those of optics and mechanics.

Naturally, most users of projection apparatus will employ that which is regularly manufactured, but in many institutions not all of the desired apparatus can be afforded. Furthermore, every one who is to do any special work in projection must be capable of combining and adapting apparatus for those special needs. Hence, we have indicated how home-made apparatus can be got up, and how apparatus designed for one purpose can be utilized for other purposes. We have done this for two reasons, first, because we feel sure that a great gain in efficiency can be made in teaching by the use of the magic lantern, the projection microscope and other forms of projection apparatus, and secondly, because the construction or adaptation of projection apparatus gives one an intimate and working knowledge which more than pays for all the time and trouble.

In examining the apparatus of many different makers we have been impressed with the general excellence of the apparatus and also with certain general defects.

The defects seem to us almost wholly due to the fact that the manufacturers of apparatus and the users of the same are not intimately enough associated, and, therefore, are not so mutually helpful as seems desirable.

The manufacturer naturally advertises the possibilities of his apparatus as if he expected it to be used under the most favorable conditions, and operated by men skilled in the use of optical instruments, and the results to be judged by persons of experience who do not expect the impossible.

For example, if one reads the statements concerning the projection of pictures in books, photographs, postal cards and actual objects, the impression would be very strong that the screen pictures so produced were every bit as satisfactory as those of lantern slides, and just as easily produced. In speaking with many individuals we have found the belief is very general that with the new apparatus nothing is simpler than to get good screen images of objects, pictures, etc., with all their natural colors, and that the expense of lantern slides can be wholly done away with. But we have yet to find the actual user of such apparatus who found his sanguine expectations fully realized.

Modern opaque projection is marvelous in its accomplishments, but what is gained in the use of actual objects, books, etc., is lost in the relative dimness of the screen image, in the expense and difficulty of managing the apparatus, and in the large electric current needed to give even tolerable screen images.

Judging from our observations the manufacturers have not fully realized the lack of optical and mechanical knowledge and instinct in many users of projection apparatus. Naturally, the user of the apparatus wants results, and he wants the apparatus to give the results without trouble.

Perhaps the most striking, as also it seems to us the most easily obviated defect, is, that with many parts of the apparatus, it is just as possible to insert them in the wrong position as in the right position. For example, in most of the apparatus we have examined the condenser is so mounted that it can be put with either end facing the arc lamp. So with many other parts, they can be put in a wrong position just as easily as in a right position.

In our opinion there are five fundamental rules in the production of projection apparatus that the manufacturers should follow:

1. The optical parts should be arranged on one longitudinal axis and fixed in that position, except that the projection objective must be movable along the axis for focusing.
2. The radiant or source of light should be adjustable in every direction to insure proper centering of the light along the optic axis, and to insure the proper relative position of the source of light and the condenser.
3. The object carrier for lantern slides is preferably fixed in one position; but the stage of the microscope and the object holder of most other kinds of apparatus should be movable along the longitudinal axis so that the object can be put in the cone of light where it will be fully and most brilliantly lighted.
4. The parts should be constructed so that either (a) it makes no difference how they are placed or (b) so that they cannot be put together wrong. (See footnotes to 4-5, p. 7).
5. Every part of the apparatus should be dull black to avoid reflections.

Of course for experimental apparatus the more adjustable each part is the greater are its possibilities, but for apparatus to use for definite purposes we believe that no unnecessary adjustments should be possible.

The custom followed by many manufacturers of sending an illustrated pamphlet giving instructions for installing and using their apparatus, is wholly commendable. In addition it would be advisable in some cases to attach tags to the different parts, stating their purpose and connections (fig. 45).

All of the apparatus and all of the experiments discussed in this book have been personally tested or observed by us to make sure that they will work; and we have tried to give directions and methods which are intelligible, and which will most easily produce the desired results.

Finally, the authors of this book most earnestly advise any one who is to use projection apparatus to go to some place where the facilities are abundant, and where there is someone skillful in using them. This will give him a standard of what can be accom-

plished and what can reasonably be expected. The learner will find that in such a place the apparatus, the room, the screen and the light are all adapted to the purpose to be served.

Good projection, like any other skilled operation, requires knowledge, facilities and experience.

There is a very trenchant expression used in shops and in laboratories which seems to us to cover the ground. It is: "Fool Proof."

From the testimony of many who are especially skilled in machinery and in the use of apparatus, and from our own personal experience, the "fool proof" construction of apparatus is not only necessary for the careless and unskilled, but much appreciated by the most skilled and careful. When one is absorbed in the principles and complexities which some experiment is meant to elucidate, it is a great advantage to have the apparatus which is to be used so constructed that it will go together in the right way with the least conscious effort on the part of the user. The user ought not to be compelled to make a special study of the apparatus every time it is assembled. It is the business of the manufacturer to put thought into the construction of the apparatus, and it is the user's business to work out problems with it.

From time immemorial it has been the habit of mankind to make tools, implements and more elaborate apparatus with smooth and glistening surfaces, bright colors often being added to heighten the effect. The microscope and other optical apparatus naturally followed the fashion.

While to many workers in optics there early came the fundamental appreciation that the clearest images were possible only when absolutely no light reached the eye except from the image field, still polished brass and nickel finish persisted, and the dazzling reflections when bright lights were used, often overwhelmed the image which it was the sole purpose of the apparatus to make visible.

During the last few years the knowledge of the best conditions for clear images has asserted itself more and more, and the mirror surfaces of optical apparatus have gradually disappeared. At first the dull black apparatus was prepared only for the few who could demand and pay for a special finish. The advantage of the dull finish of optical apparatus is so apparent when once seen and used that now it is becoming very common.

The great advantage of such dull black, non-reflecting surfaces for the outside as well as for the inside of optical instruments became apparent to the senior author by the accident of a laboratory fire (1900) during which the lacquer of his best microscope was blackened by the dense smoke.

The ordinary point of view ten to fifteen years ago that optical apparatus should of course have a bright brass or nickel finish is well illustrated by this incident: The senior author was having, by special contract, a microscope with all its accessories made dull black. A visitor, interested in optical goods, going through the factory noticed this lone, black microscope among the brilliant array and asked: "When are you going to bury that one?"

CHAPTER I

THE MAGIC LANTERN WITH DIRECT CURRENT ARC LAMP AND ITS USE.

§ 1. Apparatus and Material for Chapter I:

Suitable projection room with screen (Ch. XII); Magic lantern (§ 3-19); Arc lamp, automatic or hand-feed, with fine adjustments, lamp-house and wiring for current up to 25 amperes (fig. 3); Cored carbons adapted to the current (§ 753a); Rheostat; Lantern table (Ch. XII); Double-pole, knife switch (§ 8); Ammeter (§ 7); Incandescent lamp or flashlight (§ 14-15); Gloves with asbestos patches (§ 27); Lantern slides; Opera-glasses (§ 38); Testing incandescent lamp (§ 61, fig. 21); Fuses; Extra condenser lenses to replace cracked ones (§ 94); Screw driver and pliers.

§ 2. Historical Summary and Works of Reference:

For a historical summary of the invention and use of the Magic Lantern, see the Appendix.

The reader will find many good hints in the following works on Projection. For the full titles, see the Bibliography.

R. C. Bayley.—Modern Magic Lanterns and their Management.

H. Fourtier.—La Pratique des Projections.

Hassack and Rosenberg.—Die Projektionsapparate.

T. C. Hepworth.—The Book of the Lantern.

R. Neuhauss.—Lehrbuch der Projektion.

C. G. Norton.—The Lantern and How to Use It.

F. P. Wimmer.—Praxis der Makro—und Mikro-Projektion.

Lewis Wright.—Optical Projection.

The latest information and many useful hints may be found in the catalogues of the manufacturers (see Appendix).

MAGIC LANTERN

§ 3. The Magic Lantern as the standard for projection apparatus.—The magic lantern may be taken as the standard example of projection apparatus, for it is in the most common use and is the simplest instrument for image projection.

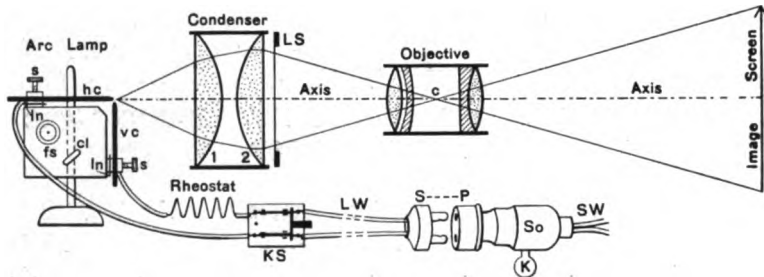

FIG. 1. SIMPLEST FORM OF MODERN MAGIC LANTERN WITH ARC LAMP

It consists of an arc lamp with suitable connections to the current supply, a rheostat and a table switch; a double condenser, lantern-slide holder and projection objective.

Arc Lamp This is a mechanism for holding and feeding the carbons.

hc Horizontal (upper) and

vc Vertical (lower) carbons.

ss Set screws for holding the carbons in place.

In In Insulation between the carbon holders, and the rest of the lamp to prevent a short circuit.

fs Feeding mechanism for moving the carbons.

cl Clamp for fixing the lamp in any position on its vertical support.

SW Supply wires to the lamp socket or wall receptacle.

So Lamp socket.

K Key of the socket switch.

S-P Separable attachment plug.

LW Supply wires from the cap of the attachment plug to the table switch.

KS Double-pole knife switch on the table for turning the current off and on the arc lamp.

Rheostat for controlling the current. It is inserted in one wire.

Condenser In this simple form it is composed of two plano-convex lenses with the convexities facing each other.

1 2 The two elements of the condenser.

LS Lantern slide close to the plane face of the 2d condenser lens.

Axis Axis The straight line passing from the source of light along the optic axis of the condenser and the objective to the image screen.

Objective The projection objective for giving a clear image of the lantern slide on the screen.

c The center of the objective where the rays from the condenser should cross.

Image Screen The white screen upon which the image of the lantern slide is projected by the objective.

If the principles governing the magic lantern are mastered, and one gains skill in handling it, the more difficult forms of projection will offer no great obstacles.

§ 4. **Standard source of light.**—With all forms of present day projection the direct current arc light is taken as the standard because, next to the sun, it is the most perfect light source available. In many places it is to be had during the entire twenty-four hours, and is the safest and most easily managed light capable of furnishing sufficient illumination for use with all kinds of apparatus, from the simplest magic lantern to the moving picture machine and the compound microscope.

MAGIC LANTERN WITH DIRECT CURRENT ARC LIGHT

Except the projection table, the room and screen, (for which see § 424 and Ch. XII,) the essential elements of a magic lantern and their arrangement are shown in fig. 1, 2, 3. They are as follows:

§ 5. **Wires for the electric current.**—There must be two wires for carrying the current extending from the main line to the electric lamp. One wire, the positive (+), conveys the current to the upper carbon of the lamp, and the other, the negative (—), conveys the current from the lower carbon back to the main line (fig. 1, 2) (see also Ch. XIII).

§ 6. **Rheostat.**—This device must be placed in the circuit along either the positive or the negative wire, it makes no difference which. In figures 1 and 2 it is placed in the negative wire. It serves as a balance, and limits the amount of current passing through the lamp (§ 744-748).

§ 7. **Ammeter.**—This indicates the amount of current flowing. It is not necessary, like the rheostat, but is very desirable, for with the information it gives, the operator can determine whether any defects in the brightness of the screen image are due to the lack of current, or whether something else is at fault (see Troubles. § 61-95.)

The ammeter is placed along one wire the same as the rheostat (fig. 1, 2).

In case no ammeter is used the rheostat can be calibrated and marked when the apparatus is installed (see § 729).

§ 8. **Double-pole switch.**—It is important to have a double-pole switch near the lamp. By its means the operator can at any time turn the current on or off the lamp. When the switch is open no current can reach the lamp (fig. 1-3).

§ 9. **Arc Lamp; automatic type.**—The lamp is needed to hold the carbons, and to provide a mechanism for moving them toward each other as they burn away (see § 12). The lamp may be of the **automatic type** in which there is a magnetic release or motor for the mechanism, so that the carbons are brought nearer together whenever the arc gets too long. If it is properly designed and constructed, the lamp will burn continuously as long as the switch is closed, and the carbons last. There should also be a hand-feed mechanism in these arc lamps, so that slight modifications may be made by hand when necessary; furthermore, there must be arrangements for moving one or both carbons separately to correct any irregularity in the wasting away of the carbons.

§ 10. **Fine adjustments.**—There must be adjusting screws by means of which the lamp can be slightly raised or lowered, or moved to the right or to the left, to enable the operator to keep the crater of the positive carbon exactly in the axis. This is to compensate for the slight change in position of the crater as the carbons burn away (fig. 3).

§ 11. **Arc lamp, hand-feed type.**—In this form of arc lamp the operator must work the mechanism by hand. The carbons usually have to be moved nearer together every four or five minutes. As with the automatic type, one or both carbons should be movable independently, and there should be fine adjustments (§ 9, 10).

§ 12. **Carbon Terminals.**—As a light source for projection, carbon terminals or electrodes are used in the arc lamp. With a direct current the carbons burn away unequally, the upper, positive carbon, wasting about twice as fast as the lower, negative carbon. If the carbons are of equal size and quality, the mechanism of the lamp must move the upper carbon about twice as fast as the lower one. Sometimes a lamp with equal motion for the upper and lower

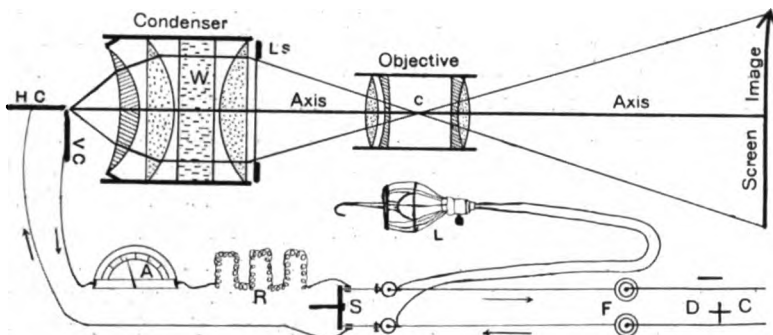

FIG. 2. MAGIC LANTERN WITH TRIPLE CONDENSER AND WATER-CELL.

H C, V C Horizontal or upper and vertical or lower carbon of an arc lamp. The upper carbon furnishes the light.

D + C Supply wires for the electric current. The positive wire (+) goes to the upper carbon (*H C*), and the negative wire (—) comes from the lower carbon (*V C*). The arrows indicate the direction of the electric current.

F Fuses where the supply wires for the lamp connect with the main line.

L Incandescent lamp with wire guard. It is connected with the supply wires before the table switch (*S*) and the resistor (*R*), hence it can be used while the arc lamp is running or when it is turned off (See also fig. 4).

S Double-pole, knife switch for turning the current on or off the arc lamp.

R Rheostat for controlling the current. It is inserted in one wire.

A Ammeter to indicate the amount of current being used. It is inserted in one wire.

Condenser This consists of a meniscus next the arc light, and of two plano-convex lenses with a water-cell between them. The lenses must be arranged as here indicated.

W Water-cell placed between the plano-convex lenses of the condenser. It absorbs much of the radiant heat.

L S Lantern slide close to the condenser.

Axis Axis The straight line passing from the source of light along the optic axis of the condenser and the objective to the screen.

Objective Projection objective serving to give a clear image of the lantern slide on the screen.

C Center of the objective where the rays from the condenser should cross.

Screen Image The image of the lantern slide formed by the objective on the white screen.

carbons is used and the upper carbon is enough larger than the lower one, so that the two shorten at the same rate.

In our experience it is more satisfactory to have both carbons with soft cores, but some advocate and use a large soft-cored carbon above and a smaller solid carbon below (fig. 299).

§ 13. **Lamp-house.**—This is a metal box in which the arc lamp is enclosed. It should be of good size, and be well ventilated by means of openings at the bottom, and a flue at the top. There should be one or more large doors, so that the lamp can be reached for changing the carbons and making any necessary adjustments. Opposite the crater at the end of the positive carbon there should be a window about 2 to 3 cm. (2 in.) square so that the ends of the carbons can be observed when the lamp is burning without opening the door. This window should be provided with a combination of red and green, or red and blue glass, or with smoky mica or with deeply tinted glass so that the eyes will not be injured when looking at the crater (fig. 133, 147).

§ 14. **Incandescent lamp.**—If experiments are to be made it is desirable to have an incandescent lamp with wire guard to use in connection with the lantern. It should have a flexible cord of sufficient length so that it can be carried to any desired position. This lamp must be connected with the supply wires before the rheostat is inserted; then it will burn brightly while the arc lamp is going. By consulting fig. 2, it will be seen that the two wires for this lamp are connected one with each of the supply wires. That is the incandescent lamp is not connected with one wire like the rheostat and the ammeter but with both wires.

§ 15. **Electric flash-light.**—An electric flash-light is a great convenience about a lantern; and is almost a necessity when an incandescent light (fig. 1, 2) is absent. It should lock, so that it will burn continuously; then carbons may be changed by its light and other corrections made. It is an absolutely safe light also.

§ 16. **Incandescent lamp to burn when the arc lamp is turned off.**—To avoid the great darkness in the room when the arc lamp is turned out, it is advantageous to have an incandescent lamp connected with the line, as indicated in fig. 4.

§ 17. **Condenser.**—This collects the light from the arc lamp and directs it through the objective. In passing from the condenser to the objective it passes through the lantern slide or other object whose image is to be projected (fig. 1, 2 4).

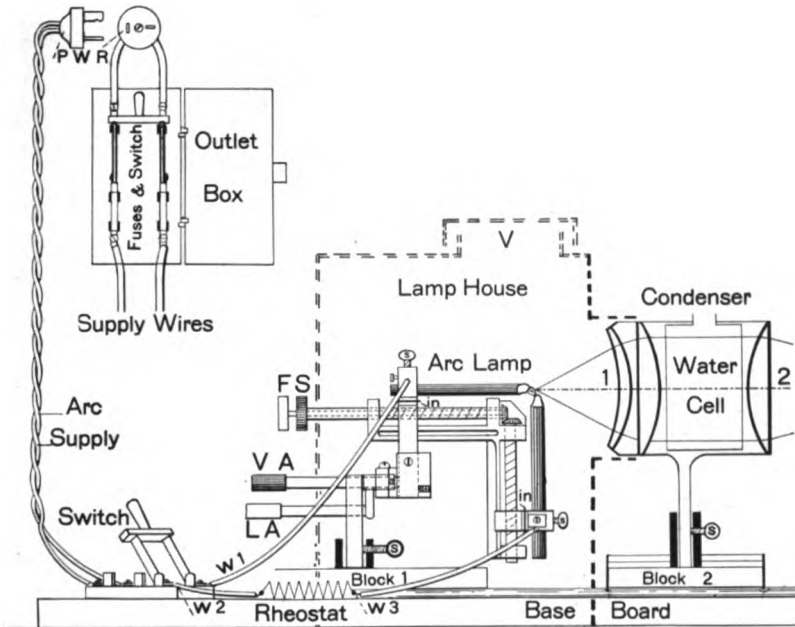

FIG. 3. ARC LAMP FOR PROJECTION, WITH WIRING, SWITCHES AND FUSES

Supply Wires The conductors from the supply to the outlet box.

Outlet Box. An iron box receiving the supply wires at one end and giving exit to them from the other.

Fuses & Switch Two cartridge fuses in the circuit and a double-pole knife switch beyond the fuses. The fuses are present to avoid accident in case of a short circuit and the switch to turn the current on or off as desired.

PWR Polarized wall receptacle. This is composed of two parts as shown, the part on the wall to receive the supply wires from the outlet box, and the cap to connect with the table switch. The metal connections of the cap with the receptacle are in planes at right angles so that the cap can be put in place only in one way, hence the polarity is always the same.

Arc Supply The wires connecting the cap of the wall receptacle and the table switch.

Switch The double-pole, knife switch for turning the current on and off the arc lamp.

W1 The wire extending from the switch to the upper carbon of the arc lamp.

W2 The wire extending from the switch to the rheostat.

W3 The wire extending from the rheostat to the lower carbon of the arc lamp.

Rheostat This is for controlling the current. It is inserted in *one wire*.

Arc Lamp The mechanism for holding and feeding the carbons.

F S Feeding screws for moving the carbons closer together or farther apart. The carbons can be moved separately or both at once.

V A Fine adjustment screw for moving the carbons up or down.

L A Fine adjustment screw for moving the carbons to the right or left.

in in Insulation between the carbon holders and the rest of the lamp. This is to prevent the current from leaving the carbons and making a short circuit through the metal part of the lamp.

s s Set screws for holding the carbons in place.

Lamp-House The metal box enclosing the arc lamp. The feeding screws (F S) and the fine adjustments (V A, L A) should project through the wall of the lamp-house.

Condenser A condenser composed of three lenses with a water-cell in the parallel beam between the plano-convex lenses.

1 The first element of the triple condenser is composed of a meniscus lens next the arc lamp, and a plano-convex lens next the water-cell.

2 The second element of this condenser is a plano-convex lens. The convex surfaces of the plano-convex lenses face each other as in the double condenser (fig. 1).

Block 1. The block supporting the arc lamp. It is movable back and forth along the track on the base-board. The socket and set screws permit the adjustment of the lamp.

Block 2. The block holding the condenser. It is movable along the track on the base-board. The socket and set screw (S) enable one to adjust the position of the condenser.

Base Board The board on which all the parts of the projection apparatus rest (see fig. 158-159).

The condenser is of two or of three lenses. If of three lenses the first lens, which is nearest the arc lamp, is usually of meniscus form, with the concavity next the lamp. The second lens is a plano-convex, as is also the third (fig. 2). If the condenser is of two lenses both are usually plano-convex with the convex surfaces facing each other and the plane faces looking toward the radiant and toward the lantern slide (fig. 1).

The two condensers appear alike in form and relation of the lenses except that in the three-lens type a meniscus has been added.

In the three-lens type the meniscus and first plano-convex together render the diverging light from the lamp parallel, and the third lens or second element renders this parallel beam converging, bringing it to a focus at the center of the projection objective when the condenser and objective are properly proportioned to each other (fig. 1-2).

With the two-lens condenser the usual practice is to bring the condenser closer to the lamp than the focal length of the first lens.

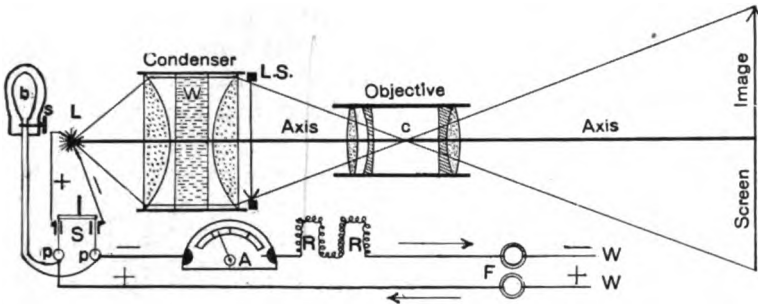

FIG. 4. MAGIC LANTERN WITH INCANDESCENT LAMP IN THE CIRCUIT AFTER THE RHEOSTAT (Compare fig. 2).

- W W* Supply wires.
 - F F* Fuses in the supply wires (see fig. 3).
 - R R* Rheostat for controlling the current.
 - A* Ammeter for indicating the amount of current.
 - p p* The two binding posts of the knife switch. The two wires of the incandescent lamp are connected at these points.
 - b s* The incandescent bulb and the key switch of the lamp socket. From the connections of the supply wires to the incandescent lamp it will shine whenever the socket key is closed whether the knife switch to the arc lamp is opened or closed. When the arc lamp is burning the incandescent lamp will be very dim and when the arc lamp is out it will shine with full brilliance.
 - S* The table, knife switch.
 - L* The source of light.
- The +’s, -’s and arrows indicate the polarity and course of the electric current.
- Condenser* A two-lens condenser with water-cell (*W*).
 - L S* Lantern slide.
 - Axis* The principal optic axis of the condenser and of the objective.
 - Objective* The objective for projecting an image of the lantern slide upon a screen.
 - Screen Image.* The image projected on the screen by the objective.

This gives a somewhat diverging beam between the two lenses. The second lens brings this diverging beam to a focus beyond its own principal focus.

This condenser is sometimes placed so that the crater of the arc lamp is at the principal focus of the first lens and the center of the projection objective at the focus of the second lens, as in fig. 2.

Whatever the form of the condenser, the lenses must be so mounted that there is freedom for expansion; and they must be so arranged that the proper lens is next the radiant (see fig. 2, 3, 36 B).

§ 18. **Water-cell.** This is a vessel of water with parallel, glass sides, placed in the beam of light from the lamp, before the light reaches the lantern slide or other object. The water-cell absorbs most of the radiant heat from the lamp and thus protects the objects from over-heating (fig. 2-3).

The water-cell is especially needed for opaque lantern slides like those of dark scenes or colored slides made by the Autochrome process. It sometimes happens that in an exhibition as many as 10 to 30 per cent. of the slides are cracked by the heat, if no water-cell is used.

Unfortunately the water-cell is oftener absent than present in magic lanterns. (For a further discussion of the avoidance of heat see § 364, § 854).

§ 19. **Projection objective.**—This forms an image of the lantern slide upon the screen. If the instrument is in proper adjustment the objective will transmit to the screen the rays of light from the condenser which pass through the lantern slide or other semi-transparent object. These rays reflected from the screen to the eye give rise to a picture with all the gradations of light and shade and color of the lantern slide or other object used (see fig. 1, 2, and § 811).

PERFECTION AND BRILLIANCY OF THE SCREEN IMAGE

§ 20. The quality of the screen image depends upon:

1. **The accurate centering along one axis** of the source of light, the condenser, and the projection objective (fig. 1, 2).
2. The amount and intensity of the light used.
3. The excellence of the condenser.
4. The aperture and perfection of the objective.
5. The proper proportion of the objective and the condenser to each other and to the size of the room. (See fig. 1, 2,

§ 634-636).

6. The perfection and transparency of the lantern slides or other objects imaged on the screen.
7. The accuracy of the focus of the image on the screen.
8. The reflecting qualities of the screen (see § 621).

9. The darkness of the projection room (see §608).
10. The proper adjustment of the eyes of the spectators to either daylight or twilight vision (§ 281).

USE OF A MAGIC LANTERN FOR EXHIBITIONS AND FOR DEMONSTRATIONS

SUGGESTIONS TO THE LECTURER OR DEMONSTRATOR:

§ 21. **Order of the lantern slides.**—The lecturer or demonstrator should have his slides in the exact order in which they are to be shown. They should not only be in the exact order of exhibition, but they should all be in the same relative position so that the operator can insert them correctly without the trouble of looking at them individually.

§ 22. **Duplication of lantern slides.**—It frequently happens that the same slide, for example, of a map or some other general subject, should be shown at two or more stages of a lecture. There is always difficulty in doing this unless the operator is carefully instructed, and the slide is marked to be repeated, and a slip of paper inserted in the pile of slides at the proper level. With a small audience, and for an informal talk the difficulty is, perhaps, not great; but for a large audience and anything like a formal presentation, the repetition of the same slide almost always causes confusion and delay.

To avoid this confusion, one can have duplicate lantern slides. Then the slides can be put exactly in order, and no confusion is possible.

If a person has ever exhibited lantern slides for a friend, and one or more of the slides had to be shown two or three times, he can understand the troubles of the operator when the same slide must be shown more than once, and will agree that it is better to have the slide duplicated.

§ 23. **Marking or "spotting" lantern slides.**—In order that lantern slides may be inserted in the carrier by the operator correctly, and without hesitation or worry, the slides must be marked or "spotted" in some conspicuous way (fig. 7, 8, 13).

If the slides are not marked, and the correct position must be determined for each individual slide during the exhibition, even the most expert operator is liable to make mistakes, especially when the slides are shown rapidly.

§ 24. Inspection of the room and lantern by the lecturer.—It is highly desirable that the lecturer make himself acquainted with the room in which he is to speak, and inspect the lantern himself before the lecture hour. If the operator is with him it gives opportunity to establish pleasant relations, and to stimulate the operator to make the best exhibition possible. It also gives opportunity and time to make any slight changes necessary to insure a good exhibition. Foresight is always more satisfactory in its results than hindsight.

§ 25. Directions for the operator.—The lecturer should instruct the operator how he wishes the slides shown. There must be some signal for changing the slides. Preferably the signaling device is some form of electric signal on the operator's table, then he can see or hear it, but the audience will not be distracted by it, as when the lecturer has to speak to the operator, or hammer on the floor with the pointer, etc. (For signaling devices see the list of apparatus in the appendix).

The lecturer should direct the operator to light the lantern before the room lights are extinguished, and give ample warning. The operator should also be told to leave the lantern burning until the room lights are turned on.

SUGGESTIONS TO THE OPERATOR

§ 26. Testing the lantern.—Before every exhibition or demonstration the operator should make sure that the lantern is in good working order. This is only fair to the speaker who depends upon his illustrations which he has taken so much trouble and expense to prepare. If the slides are not well shown it injures the effect of the lecture or demonstration and makes it difficult or impossible for the speaker to make clear the subject he is treating. It also disquiets the audience; and *should make the operator uncomfortable.*

In testing the lantern the following points should be especially looked to:

(A) That there is voltage in the supply line. This is easily determined by turning on the incandescent lamp (fig. 2), or by trying to light the arc lamp.

(B) That the arc lamp is in working order and has carbons long enough to last during the exhibition. By closing the switch and bringing the carbons in contact and slightly separating them the arc light should be established almost instantly (see also § 30). It takes a certain amount of experience to tell whether the carbons are long enough to last during the exhibition. If there is any doubt, put a new pair in position.

From the high temperature of the carbons, and the lamp generally, after the current has been on some time, it is not easy to put in new carbons in the midst of a demonstration. It also makes an embarrassing break in the exercises (see § 27).

§ 27. **Gloves with asbestos patches.**—In spite of all precautions it is sometimes necessary to work about the arc lamp after it has been running, and is therefore very hot. By the use of suitable pliers or tongs one can usually manage to do the things necessary; but for certainty and rapidity one always needs to be able to use the hands directly. This is rendered possible by the use of gloves with asbestos patches in the places which come in direct contact with the hot metal or carbons. The gauntlet form of gloves is best for then the wrists also are protected.

The asbestos patches may be of asbestos cloth, or preferably of quilted asbestos paper. The asbestos cloth is very thick and clumsy. The asbestos paper of about half a millimeter thickness ($\frac{1}{30}$ in.) quilted between thin cotton or linen cloth answers well. The quilting stitches should be long and extend obliquely in two directions (fig. 5). The object of the quilting is to overcome the weakness and easy tearing of the asbestos paper.

For most work a patch on the thumb and index finger is sufficient but as it is often convenient to grasp a hot carbon between the index and middle finger, it is well to have a patch on the middle finger also (fig. 5).

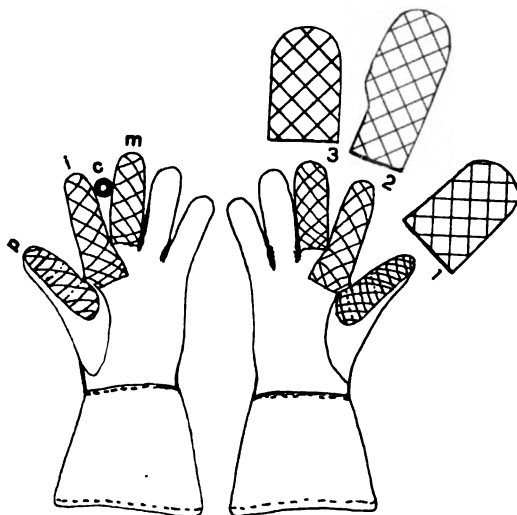

FIG. 5. GLOVES WITH ASBESTOS PATCHES, PALM SIDE UP.

Left glove. *p. i. m.* The pollex or thumb (*p*), the index or fore finger (*i*), and the medius or middle finger (*m*), have the patches on the palmar surface and sides.

c Carbon held pincer-like between the index and medius.

Right glove. The asbestos patches are as in the left. Above the corresponding digits (1, 2, 3) are patterns of suitable patches drawn to the same scale as the gloves.

With the hands protected by such gloves, one can grasp the hot carbons within two or three centimeters (1 in.) of the hot tips with entire safety. The asbestos being a non-conductor of electricity as well as of heat, makes it safe also to work about the lantern when the current is on (§ 27a).

§ 27a. Old leather gloves answer very well if one does not wish to sacrifice a new pair. New cloth gloves with gauntlets can be had for 20 cents. These answer fairly, but are not so good as the leather gloves, and there is no danger of the leather gloves being motheaten or catching fire. It is easier to sew the patches on the cloth gloves, however.

Asbestos mittens are to be had of dealers in chemicals and chemical apparatus. They are of asbestos cloth but are so thick and clumsy that they are not adapted for working about the lantern.

§ 28. See if the lantern is centered.—Make sure that the different elements of the lantern are centered along one longitudinal axis (fig. 1, 2). Then and then only will a perfect screen image be produced. If the apparatus was installed correctly in the beginning the only part liable to be out of line is the crater of the positive carbon. In burning the carbons frequently so wear away that the crater is at one side of the axis. Slight decentering of the crater can be easily corrected by using the fine adjustment designed for the purpose (§ 10, fig. 3, see also *Troubles* § 79).

§ 29. Slide-carrier.—Be sure that the slide-carrier works properly and easily. The “push-through” form (fig. 6), is very convenient, for while one slide is on exhibition the one previously shown can be removed and another put in place, and it can be instantly put in front of the condenser when the lecturer signals.

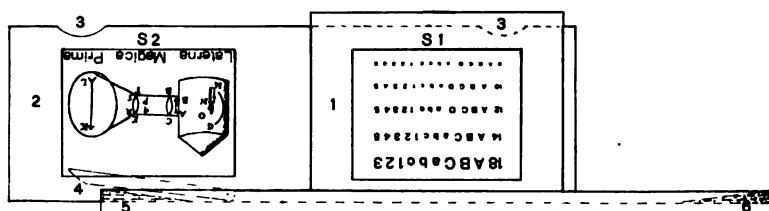

FIG. 6. “PUSH-THROUGH” OR DOUBLE SLIDE-CARRIER.

1 The frame which remains in one position in front of the condenser and serves as a container and guide for the “push-through” part.

2 The movable slide-holder or “push-through” part of the carrier. It moves easily to the right and to the left. It contains two slides in the proper position for an erect image on a vertical opaque screen (see fig. 7, 8).

3 3 Notches in the movable part to enable one to grasp the slide easily.

4 Elevator serving to lift the slide when at either end. In some forms the elevator lifts the entire slide from the middle instead of tilting one end.

5 6 Inclined planes at each end. These raise the elevator when the carrier is moved to either end of the base.

S 1 Lantern slide in the carrier in front of the condenser.

S 2 Lantern slide in the carrier at the left end. It is of the first magic lantern (1665) and is in position to be removed or to be pushed to the right for exhibition.

§ 30. To start the arc light.—Turn on the current by closing the switch (fig. 1-4). If the lamp is of the *automatic type* the

magnetic release will allow the carbons to come in contact and separate slightly so that the arc will be of the correct length.

If the lamp is of the *hand-feed type* the operator must start it by bringing the carbons in contact and then separating them a short distance (3 to 4 mm.; $\frac{1}{8}$ in.). This is done by turning the feed screws by hand (fig. 3, F. S.).

§ 31. Managing the arc lamp during the exhibition.—For an *automatic lamp*, the operator has only to close the switch to start, and to open the switch to stop the lamp. The automatic mechanism is supposed to keep the lamp burning in the best manner. From the uneven burning of the carbons it is sometimes necessary to make slight adjustments by hand even with automatic lamps. This is easily accomplished by turning the proper screws present for the purpose (fig. 3, F. S., L. A., V. A.).

For the hand-feed lamp the operator must bring the carbons closer together every four to five minutes or oftener by turning the feed screws. If this is not done the distance between the carbons soon becomes too great for the current to pass, and the lamp will go out. Allowing the lamp to go out when it should not is one of the things for the operator to avoid.

§ 32. Amount of current to use.—This depends upon the kind of arc lamp used (Ch. XIII), the screen distance, and the character of the lantern slides. For dark lantern slides or long distances more current must be used than for clear lantern slides and short distances.

For a screen distance up to 10 meters (33 ft.) and a right-angled arc lamp (fig. 1-3) one will rarely need more than 12 amperes. For a screen distance of 15 to 25 meters (50 to 80 ft.), 15 or at most 20 amperes should suffice. If more than 20 amperes are needed to give the proper brilliancy to the screen images something is wrong with the slides, the room, or the lantern itself, or more probably with the management of the lantern. (See under Ammeter § 7).

§ 33. When to light the lamp.—The room should never be totally dark during an exhibition. The incandescent lamp men-

tioned above (§ 16) will avoid this; and furthermore, the operator should start the arc lamp before the lecturer turns off the room lights (§ 25).

§ 34. **When to put the lamp out.**—The operator should not turn out the arc lamp until the lecturer turns on the room lights. The intervals of total darkness so common in exhibitions can be avoided by keeping in mind the suggestions in this and the previous section.

It is also a good plan for the operator to remove the last slide when the lecturer is through with it, and show a blank disc of light. This will inform the lecturer that all the slides have been exhibited and give him the hint to turn on the room lights.

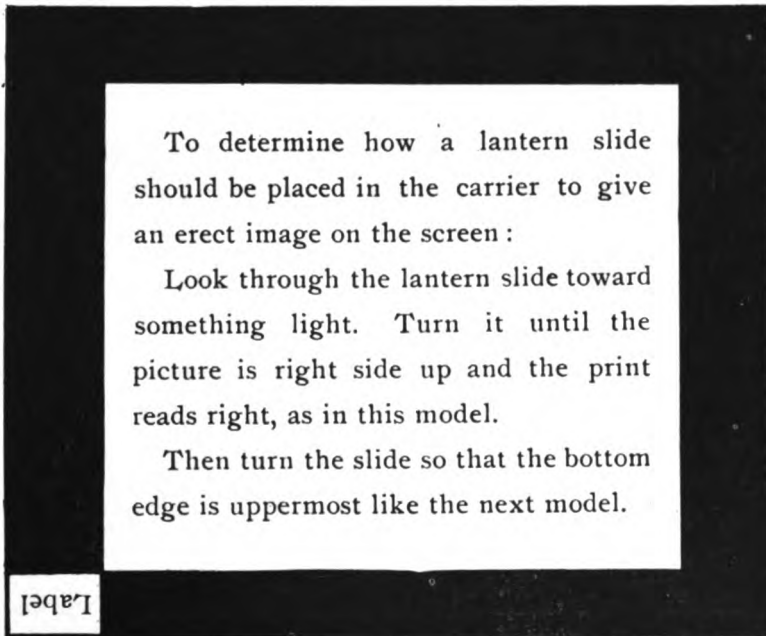

FIG. 7. STANDARD AMERICAN LANTERN SLIDE, FULL SIZE, WITH DIRECTIONS FOR INSERTING IT IN THE CARRIER SO THAT THE SCREEN IMAGE WILL BE ERECT.

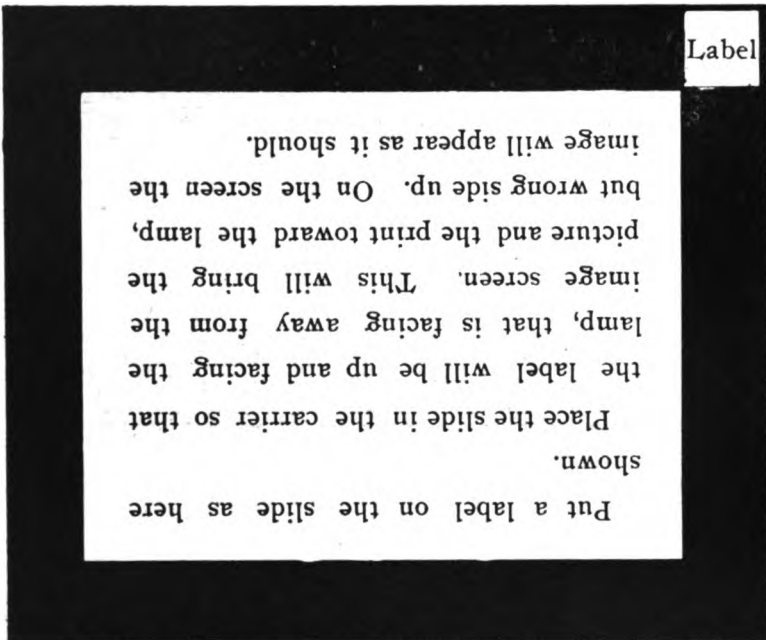

FIG. 8. STANDARD AMERICAN LANTERN SLIDE, FULL SIZE, WITH DIRECTIONS FOR MARKING IT, AND INSERTING IT IN THE CARRIER SO THAT THE SCREEN IMAGE WILL BE ERECT.

§ 35. **Correct position of the lantern slide in the carrier.**—In order that the image on the screen may be right side up and like the original in every way, the lantern slide must be put into the carrier in the following manner to counterbalance the inverting effect of the projection objective (fig. 1).

1. A lantern slide with any printing upon it must have the side which reads correctly face the lamp, if the screen is of ordinary form.

If the screen is translucent like ground glass and the picture is viewed from the back of the screen, then the printing must face the screen, not the lamp.

2. In all cases the slide must be put into the holder with the bottom edge up (fig. 6, 8).

10 CENTIMETER RULE

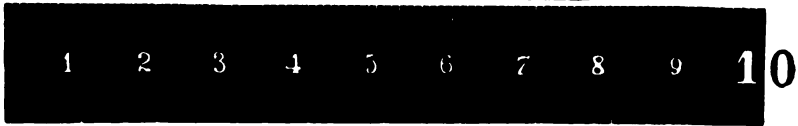

The upper edge is in millimeters, the lower in centimeters.

FIG. 9. SCREEN IMAGE OF A LANTERN SLIDE CORRECTLY INSERTED IN THE CARRIER (FIG. 6-8).

The upper edge is in millimeters, the lower in centimeters.

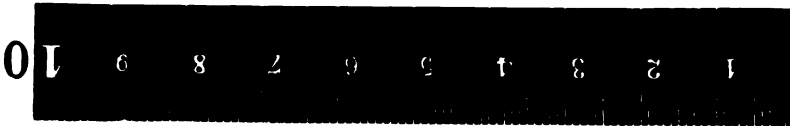

10 CENTIMETER RULE

FIG. 10. LANTERN SLIDE IMAGE, WRONG EDGE UP.

10 CENTIMETER RULE



The upper edge is in millimeters, the lower in centimeters.

FIG. 11. LANTERN SLIDE IMAGE, FACING IN THE WRONG DIRECTION.

The upper edge is in millimeters, the lower in centimeters.



10 CENTIMETER RULE

FIG. 12. LANTERN SLIDE IMAGE, WRONG EDGE UP AND FACING IN THE WRONG DIRECTION.

FIGURES 9-10-11-12. LANTERN SLIDES OF A METRIC RULE FULL SIZE.

The figures show the image as it appears on an opaque vertical screen in each of the four possible ways of inserting the slide in the carrier.

For a translucent screen, or when a mirror is used, the slide in fig. 11 would appear erect.

3. In the slide-changer of the Spencer Lens Co.'s magic lanterns (Delineascopes), the slide is laid flat, with the face up, i. e., so it will be toward the condenser when ready for projection. The edge which is to be uppermost in the ordinary vertical carrier, is toward the screen. Now when this slide-changer is used it turns the slide up in the vertical position so that it is in precisely the same position as with the ordinary slide carrier.

§ 36. Possible ways of inserting American lantern slides in the slide-carrier.—The standard American lantern slide is oblong (10 x 8.2 cm.; 4 x 3¼ in.), and the carriers are constructed to receive them lengthwise. While they would never be inserted with the short edge up, they can be inserted with either long edge up, and facing in either direction. This gives four possible positions in the carrier, only one of which is correct. That is, there are three wrong ways of inserting the slide in the carrier with the corresponding wrong images on the screen. It is not very uncommon for an audience to see all possible images of the same slide, and occasionally the wrong ones repeated once or twice. This is as inexcusable as it is unnecessary (fig. 10-12).

§ 37. Possible ways of inserting the square English lantern slides.—These slides are 8.3 x 8.3 cm. (3¼ x 3¼ in.), and being square they may be put into the carrier with any of the four edges up, and of course with either face toward the lamp. This gives eight possible ways of insertion, seven of which are wrong. Square slides must have two "spots," (see fig. 13).

§ 38. Focusing the image on the screen.—When the lantern slide is in the correct position before the condenser (fig. 1-2) the objective must be at such a distance from the slide that the screen image will be sharp, and show clearly the printed matter and all the details of the picture. With the usual magic lantern the objective is nearly in the right position all of the time. But for any necessary final focusing there is a rack and pinion on the objective, or it is mounted in a tube with spiral movement. By turning the milled head of the pinion, or by turning the objective



FIG. 13. SQUARE ENGLISH LANTERN SLIDE FULL SIZE.

This figure shows the method of "spotting" or marking by the English Photographic Club. That is, there are two marks on the upper front margin of the slide. Two marks are necessary for square slides, while a single one answers for oblong slides.

The picture on the lantern slide is of a retouching frame to hold the slides while being colored.

in its spiral casing the image may be made perfectly sharp, provided that the light is good and the objective also good. With an imperfectly corrected objective the margins of the screen image are liable to be lacking in sharpness although the middle may be good.

It may be necessary to focus slightly for each individual slide, but ordinarily if one slide is in perfect focus those following will also give good images.

If the screen distance is small (three to five meters; 10 to 16 feet) it may be necessary to focus slightly for each slide if the sharpest

images are desired. When, however, the screen distance is 10 meters (30 ft.) or over, it is not usually necessary to focus for each slide.

If the screen distance is very great (20 meters; 65 ft. or more) the operator cannot tell by his eye alone when the screen image is perfectly sharp. In such a case he must have an assistant stand near the screen to tell him when the image is sharp, or he can use good opera-glasses and determine for himself.

When the focus is once found for these long distances it is well to mark in some way the exact position of the objective; then in future the operator can be sure of good screen images in the same position provided the lantern has not been moved.

§ 39. Hints on running the lantern for a demonstration lecture.

—It frequently happens that in a demonstration lecture, slides are to be shown at several different times. Ordinarily the arc lamp is turned out during the intervals; but to make sure that the desired slide can be shown without delay, the arc lamp can be left burning all the time, and to avoid lighting the screen a mask can be put in front of the objective (fig. 14). A "push-through" carrier (fig. 6) should be used, and the next slide to be shown put in one of the compartments. The other compartment is left vacant, and this empty compartment is put in front of the condenser. If the slide were left in position all the time it might become over heated and break.

Whenever the slide is called for it is pushed into position and the mask turned aside. This will bring the picture on the screen almost instantly.

A mask or shield for the objective is much more important for the slow starting lights like the Nernst, than for the arc (§ 146, 169, 202, 217).

§ 40. Collecting and arranging the lantern slides at the close of an exhibition.—After the exhibition is over be sure to remove the last lantern slide from the slide-carrier. It not infrequently happens that the last slide is left in the carrier, and the lecturer's set is thus rendered incomplete.

It should be a part of regular routine to look in the slide carrier at the close of every exhibition to make sure that the last lantern slide has been removed.

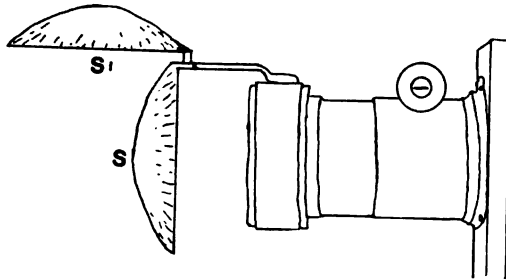

FIG. 14. SHIELD FOR THE OBJECTIVE IN INTERMITTENT PROJECTION WITH SLOW-LIGHTING RADIANTS.

S^1 Shield raised to allow the light to pass from the objective to the screen.
 S Shield down in front of the objective to cut off the light from the screen.
 The shield should be of a concave form and in front of the objective a short distance to avoid heating. It should be made of metal or asbestos and be hinged so that it can be easily turned up or down.

This is also the best time to arrange the slides in the box or a pile exactly as they were at the beginning of the exhibition; then the set will be ready for use at the next lecture or demonstration.

§ 41. **Lantern slides permanently fixed in individual carriers.**—Originally lantern slides were mounted in wooden frames. Each slide then had its own carrier, which was inserted in a special opening for it next the condenser (fig. 15, 32). This method of mounting slides still prevails for some purposes. If one wishes to use them in the ordinary lantern the common slide-carrier (fig. 6) is removed entirely; then each slide in its carrier is inserted in order during the exhibition. This method of mounting is admirable for a small collection of slides, as the wooden frame protects them, but for a large collection they take too much space and are too expensive.

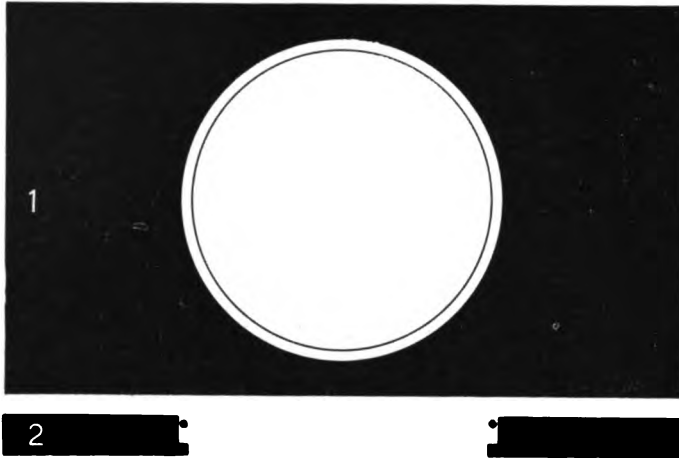

FIG. 15. LANTERN SLIDE IN PERMANENT WOODEN CARRIER; ONE-HALF SIZE.

- 1 Face view of the carrier and its slide.
- 2 Sectional view of the carrier, showing the shelf on which the slide rests, and the wire spring above.

The slide is usually cut in circular form, and fitted into a circular opening in the frame. A hole of the desired size is first made in the middle of the carrier, but not going clear through; then a slightly smaller hole goes entirely through. This leaves a narrow shelf for supporting the slide. Above the slide is placed a cover-glass, and then a wire spring to hold the glass in position.

PROJECTION OF HORIZONTAL OBJECTS

§ 42. The ordinary magic lantern is in a horizontal position (fig. 1), but the lantern slide must then be vertical. Objects in liquids, and some other objects cannot be put in a vertical position, hence the necessity of a rearrangement of the lantern parts so that the object may be placed horizontally. This is accomplished by placing the second or terminal part of the condenser, in a horizontal position, and the projection objective is made vertical. By means of a plane mirror in the path of the beam of light from the first part of the condenser, the light is reflected vertically upward. The object is placed horizontally just above the second element of the condenser. The vertical projection objective would give a picture

on the ceiling above, but by means of another mirror at 45 degrees or a prism this vertically directed light is reflected horizontally to the ordinary vertical screen (fig. 16, § 42a). (For projection with the vertical microscope see § 397).

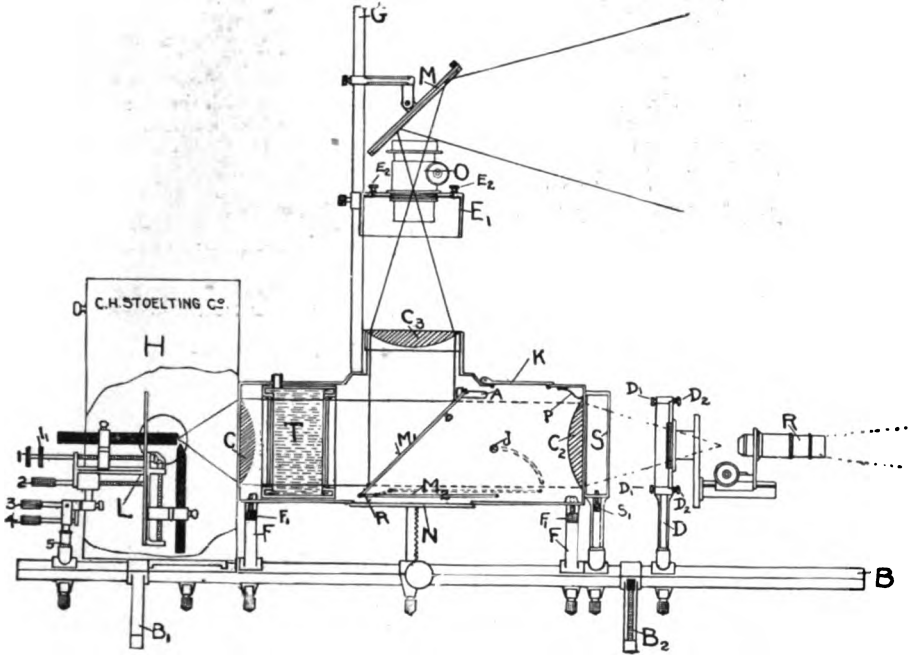

FIG. 16. ARRANGEMENT OF THE MAGIC LANTERN FOR HORIZONTAL OBJECTS.

(Cut loaned by C. H. Stoelting Co.).

- Commencing at the left the parts are:
- L Hand-feed lamp with right-angled carbons.
 - H Lamp-house cut away to show the lamp within.
 - 1 2 Adjusting screws to move the carbons.
 - 3 4 Screws for centering the crater.
 - 5 Adjusting screw for moving the lamp toward and from the condenser.
 - C The plano-convex lens of the condenser next the radiant. It here gives a parallel beam.
 - T Water-cell in the path of the parallel beam.

§ 42a. In England and America this is often called *vertical projection* from the position of the objective; in Germany it is called *horizontal projection* from the position of the object.

- M*₁ 45 degree mirror to reflect the parallel beam vertically.
*C*₃ Second element of the condenser in a horizontal position. The lantern slide is put just above it.
O Projection objective in a vertical position for opaque projection.
M 45 degree mirror above the objective to reflect the light horizontally to the screen.
G Vertical support for the condenser, objective and mirror.
E Lantern front holding the objective.
*E*₂ Set screws for holding the objective in position when once centered.
M Mirror in horizontal position. When raised 45° it serves to reflect the horizontal beam down upon an opaque object.
*C*₂ Second element of the condenser used in projection with the microscope or lantern objective with the object in the ordinary vertical position.
S Opening for the lantern slide carrier.
*D*₁ Objective and its holder.
O Projection objective for lantern slides.
FFF Supports of the condenser, etc.
N Platform on which opaque objects are placed.
*B*_{1,2} Legs or supports of the prismatic rod serving as an optical bench.

PROJECTION WITH MULTIPLE LANTERNS

In the period before the common use of the moving picture machine, when the pictorial effect was dependent wholly on the magic lantern, two and even more lanterns were run simultaneously i. e., both were going all the time.

§ 43. Composition of multiple lanterns.—

1. Each lantern must be complete in itself.
2. The size of image of each lantern must be exactly the same.
3. The lanterns must be so placed and so inclined toward each other that the light discs on the screen exactly coincide. They are now usually placed one above the other (fig. 17).

§ 44. Wiring for multiple lanterns.—Each lantern must have its own electric lamp. When the supply is 110 volts or less each lamp must be separately wired, and each lamp must also have its own rheostat and double-pole knife switch (fig. 2, 3).

In case the supply is 220 volts, each lamp may be separately wired as just described; or both lamps may be put in series, i. e., along one wire, on one system of wiring, and use but a single rheostat.

§ 45. Use of multiple lanterns.—By the use of two lanterns there is not shown first one slide and then another simply, but one

slide seems to melt into the other, hence the name "dissolving views." This is brought about by a shutter gradually uncovering one objective and at the same time obscuring the other; or, as in the figure here shown (fig. 17), by the closing of the iris diaphragm of one objective while the other opens.

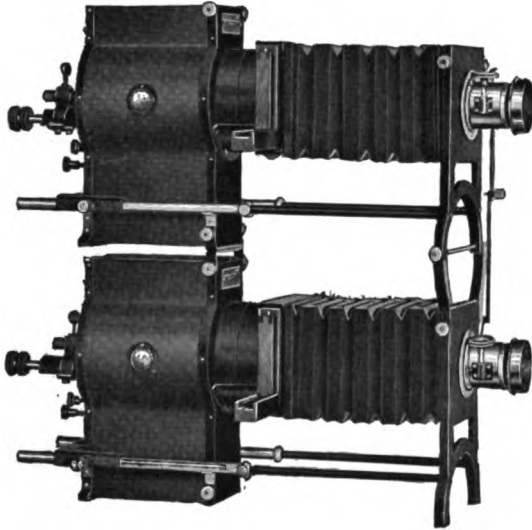

FIG. 17. MULTIPLE LANTERN FOR DISSOLVING VIEWS.

(Cut loaned by the Bausch & Lomb Optical Company).

Each lantern must have its own arc lamp and rheostat. For dissolving one picture into another the iris diaphragm of one objective is opened gradually while the other is gradually closed. This is accomplished by pulling up or down on the rod connecting the two iris diaphragms in the objectives.

Some lecture rooms are supplied with double lanterns, not so much for the dissolving effect, as for the rapid passage from one slide to another. In most cases the "push-through" carrier with a single lantern will accomplish this as effectively.

§ 46. **Multiple lanterns for "effects."**—Formerly certain "effects" or striking appearances were produced by the use of two or more lanterns which were in operation and projected their light

upon the screen at the same time. For example, to show falling snow, in one of the lanterns is a slide showing a landscape, city street, etc., in another is a black band with irregular perforations of minute size which give the appearance of snow-flakes. If now the light in the lanterns is properly regulated, and the black perforated band is moved *up* over the face of the condenser, the snow-flakes will appear to fall either gently or rapidly in the landscape or street as one moves the band slowly or rapidly. One can give the appearance of a driving storm by tilting the black band, for this will make the flakes seem to fall obliquely.

For rain effects the black band should have slit-like perforations.

MOVING SLIDES FOR SINGLE LANTERNS

§ 47. **"Effects" with single lanterns.**—The appearance of movement may also be produced in a single lantern. For this two slides must be superposed, and one moved over the other. By this means various combinations of designs may be made, and also appearances of relative movement. Here, naturally, the two slides must be close together, or one will be too much out of focus. Special slide carriers are constructed for showing these single-lantern "effects."

For simple experiments use a single slide-carrier. The slides should have no cover-glass, but may be varnished. Then one slide is put in place as for an ordinary exhibition, and another is inserted over it and pushed by the fingers into different positions to show various combinations. For this experiment the bellows between the slide-carrier and the objective should be removed to give freedom to the hands in making the various changes necessary.

§ 48. **"Slip-slides" for optical deceptions.**—Slides with lines at various angles, etc., are used to demonstrate these. The lines can be shown separately, and then by pushing one slide over the other one can get various combinations. For suggestions as to slides the reader is referred to works on physiology and experimental psychology under "optical deceptions."

§ 49. Most of the "effects" produced by the movement of two slides over each other, and the use of multiple lanterns are so far

exceeded in every way by the moving picture that it is hardly worth while to go to the trouble to get together the apparatus and slides to show these small "effects" when such wonderful ones are shown daily in every moving picture theater.

The moving picture was originally invented to illustrate scientific facts; and the indications now are that it is to become a great factor in education by its striking portrayal of the processes of nature. (See Ch. XI).

STEREOSCOPIC SCREEN IMAGES

§ 50. For a stereoscopic screen image the same fundamental law must be observed as for any other stereoscopic effect. That is, there must be two slightly different images corresponding with the image seen by the left eye and that seen by the right eye. These images must be projected on the screen so that they nearly coincide, then by some means the left eye sees its left-eye image, but not the right-eye image; and the right eye sees the right-eye image, but not the left-eye image. The two images are then combined in the brain and the stereoscopic effect follows as with ordinary naked eye binocular vision or when using a stereoscope.

With the magic lantern this effect has been produced in three principal ways:

(1) *By the aid of prism spectacles.*—Lantern slides of a stereoscopic pair are projected on the screen so that they nearly coincide by the use of two lanterns. When this is done some people can get the stereoscopic effect by looking at the pictures with the naked eye, but for most people it is necessary to look through prism spectacles so that the right eye shall see only one image and the left eye only one.

(2) *By the aid of polarized light and Nicol-prism spectacles.*—According to this method two lanterns are used and two lantern slides, making a stereoscopic pair. For one lantern there is used a Nicol-prism or a glass pile and the projection is made with the ordinary polarized light. A similar prism or pile is used for the other lantern, but the extraordinary polarized light is used for projecting its image. These two images are projected so that they

nearly coincide upon the screen. The screen is covered with silver foil to prevent the depolarization of the reflected light. Now to look at the screen image and to make it possible for each eye to see only its own image, the observer must wear polarizing or analyzing spectacles with the prisms or piles corresponding with the one supplying the light for its own image. For example, if the right eye image is made by extraordinary polarized light, then the right eye of the observer must have its prism spectacle so that it transmits the extraordinary polarized light, but extinguishes the ordinary polarized light which produces the left eye image. And the left eye must have its prism so that it will receive the polarized light from its image, but extinguishes that from the right eye image. Each eye then sees its own image, but not the one for the other eye, and the conditions for stereoscopic vision are fulfilled.

(3) *The two-color method.*—For this method two complementary colors are selected—usually red and green.

(A) With two lanterns there are projected the two images of a stereoscopic pair so that they nearly coincide. There is put somewhere in the path of the beam of one lantern a plate of red glass and in that of the other lantern a plate of green glass. The observer must have spectacles or viewing glasses of corresponding colors. Then with one eye he sees the red image and with the other the green image. The combination of these colored images by the brain gives a stereoscopic image in black and white.

(B) With a single lantern the two-color stereoscopic effect can be produced as follows: The two pictures of a stereoscopic pair are printed by one of the color processes so that one is a red picture and one a green picture. These two are placed together so that they nearly coincide, then they are projected by *one lantern*. With the naked eye the pictures look like any two-color picture where the colors do not register, and such a screen picture is anything but satisfactory; but now if spectacles or viewing glasses of corresponding colors are held before the eyes, one eye sees the green picture and one eye the red picture and the stereoscopic effect comes out very strikingly.

The simplest way to determine which color to put in front of the right and which in front of the left eye is to try first one color then

the other. In general it will be found that if the red parts are at the right then the red glass must be over the right eye and similarly for the green. Presumably if one used the wrong color then there should be a pseudoscopic effect, convex objects looking concave, etc.; but this effect is difficult to obtain.

It is seen that in all these methods the observer must be supplied with some means by which only one of the projected images is seen by one eye, the other by the other eye. Stereoscopic projection is necessarily, therefore, expensive.

For most people any good lantern slide shows perspective and relief sufficiently.

CENTERING THE VARIOUS PARTS OF THE LANTERN AND SEPARATING THEM THE PROPER DISTANCE

§ 51. **Centering.**—By this is meant the arrangement of the source of light, the condenser and the projection objective so that the source of light, and the principal optic axis of the condenser and of the objective shall be in one straight line, and each lens be perpendicular to that straight line (fig. 1-4).

When the different elements are once centered along one straight line the objective and the condenser should be fixed in position so that they cannot be raised or lowered or turned sidewise. If the source of light gets slightly out of center by the burning of the carbons, it may be recentered by bringing the carbons nearer together or by regulating the position by the fine adjustments of the lamp.

In the right-angled arc lamp the upper carbon, which furnishes the light, is constantly in the optic axis. With oblique carbons (fig. 39) the source of light constantly shifts with the burning away of the carbons; and with the direct current lamp the source of light gradually rises above the axis. With the alternating current and V-arranged carbons one source shifts above and one below the axis, or one to the right and one to the left depending upon the arrangement of the V. In centering the lamp one should start with the carbons in contact and take the point of contact to center from.

Remember that one should never change the position of the condenser or of the objective to compensate for the lack of centering of the source of light.

§ 52. Mechanical method of centering.—This is the method most satisfactory for both manufacturer and user in getting the various parts properly aligned.

Generally some form of track (optical bench) is used on which the various parts are placed and along which they can slide. The straight line or axis to which all parts are to be centered is at a selected, definite position above the base-board or table supporting the track (fig. 3, 40).

The first thing, then, is to decide upon the distance the axis is to be above the base-board or table.

For all work upon centering, the bellows between the condenser and the objective should be removed so that the faces of all parts can be seen.

The position of the common axis may be determined by some part of the apparatus, such as the condenser. Or one can decide upon some convenient level which will give sufficient room for the arc lamp and its carbons, and then adjust all parts to this level. A good way to get all at the proper height is to make a measure or gauge of wood just the height of the axis. If this is a board which just fits between the tracks, and has a peg indicating the middle point between the tracks it will help to get the parts perpendicular to the axis as well as at the right level. If the wooden gauge is carefully made it will enable one to center the parts to within one or two mm. ($\frac{1}{16}$ to $\frac{1}{24}$ inch). Very slight variations from perfect mechanical centering can be compensated for by using the fine adjustment screws of the arc lamp.

§ 53. Getting the center of the lens faces.—This can be done by using a rule in millimeters or $\frac{1}{16}$ th's inch. Or it can be done by pressing some white paper against the lens face and creasing it around the edges with the finger. The center of this circle of paper can then be found as shown in fig. 18. If the center is marked and the paper then put over the lens face one will have a guide to center by.

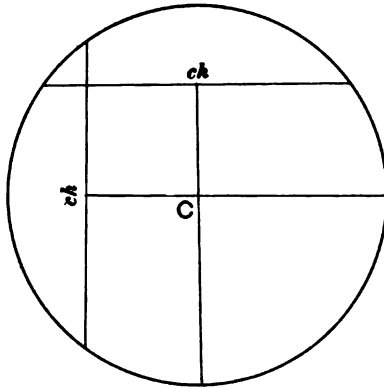

FIG. 18. FIGURE SHOWING HOW TO FIND THE CENTER OF A CIRCLE.

Draw two chords (*ch ch*) and erect perpendiculars at their middle points. Where these perpendiculars cross is the center of the circle (*C*).

As stated above, when once centered, the objective and condenser should be fixed in position.

§ 54. **Avoidance of obliquity.**—Not only must all the parts be at the same level and in one straight line, but the lenses must be perpendicular to that straight line and not oblique. Then the straight line or common axis passing from the crater of the upper carbon to the screen will coincide with the principal axis of the condenser and the projection objective, and the arrangement for perfect projection will be realized (fig. 1-4, 26).

One can usually tell when the parts are in line and not oblique by sighting along them with the eye, or by the use of a straight edge like a T-square. To make sure by measurement one can put the optical bench or base-board (fig. 158, 159), on a level table and next a smooth wall. Then by measuring horizontally the central points can be determined exactly as their height was determined (§ 52).

CORRECT DISTANCE APART OF THE DIFFERENT ELEMENTS

§ 55. **Radiant and condenser.**—With the three-lens condenser the radiant is at the right distance when it is at the principal focus of the first element of the condenser (fig. 2). This will give a

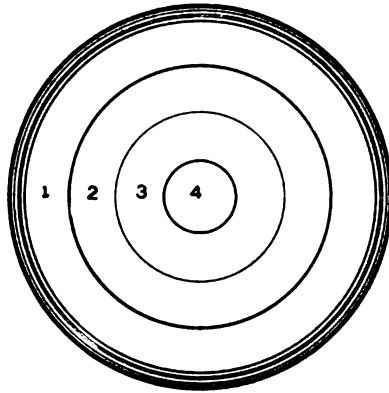

FIG. 19. CONCENTRIC CIRCLES ON THE FACE OF THE CONDENSER, SHOWING THE SIZE OF THE CIRCLE OF LIGHT WITH VARIOUS POSITIONS OF THE RADIANT.

When the radiant is at the proper distance, the entire face of the condenser is illuminated (1).

As the radiant and condenser are separated the part illuminated becomes smaller and smaller (2-4). (See also fig. 20).

cylinder of approximately parallel rays between the two elements of the condenser, and will fully light the face of the second element. One can determine this easily by putting a sheet of white paper over the face of the condenser which is toward the objective. If the radiant is in the right place the entire face will be light. If the radiant is too far off, only a part of the face will be illuminated (fig. 19). If the radiant is too close the face will be lighted, but the light will be diverging between the condenser lenses. In this case a part of the light falls outside the second element and is lost. There is liable also to be a defective screen image (fig. 28). One can get the condenser at the right distance from the lamp by first separating the lamp and condenser a considerable distance and then gradually bringing them closer and closer together until the condenser face is just filled with light. Sometimes the radiant is put nearer than the principal focal distance on purpose, so as to correct in part for the lack of proper proportion between the condenser and the objective (§ 56).

With the two-lens condenser used for lantern slides the lamp is usually closer than the principal focal distance of the first lens, this makes the beam between the lenses diverging, hence it is best to have the two lenses as close together as possible to avoid loss of light (fig. 1).

With this condenser and diverging light between the lenses the only rule that can be given is to adjust the distance between the lamp and the condenser until the best light is obtained on the screen. If this brings the crater of the arc lamp within 8 to 10 cm. (4 in.) of the first lens, then it will be necessary to substitute longer focus lenses for either the first or the second condenser lens or for both. In general, the first lens should be of about 15 cm. (6 in.) focus and the second lens should have a somewhat shorter focal length than the projection objective. For example, if the projection objective is of 38 cm. (15 in.) focus, the second lens of the condenser in the two-lens form should be of about 25-30 cm. (10-12 in.) focus. This will bring the diverging cone to a focus near the center of the objective.

§ 56. Condenser and projection objective.—If the projection objective and the condenser are properly proportioned the condenser will focus the light near the center of the projection objective when the lantern slide is in focus on the screen (fig. 1, 2).

If the condenser is of so short a focus that the light from the condenser comes to a focus before reaching the objective the field is restricted and bordered by a red margin (fig. 29).

If, on the other hand, the condenser is of too long a focus for the objective the light will not come to a focus by the time it reaches the center of the objective (fig. 28). In this case the field will be restricted and bordered by blue.

OPTICAL TEST FOR CENTERING

§ 57. Optical test for centering the radiant and the condenser.—If these are properly centered along one line, and the two are separated a considerable distance when the lamp is burning, the light spot on the face of the condenser looking toward the objective

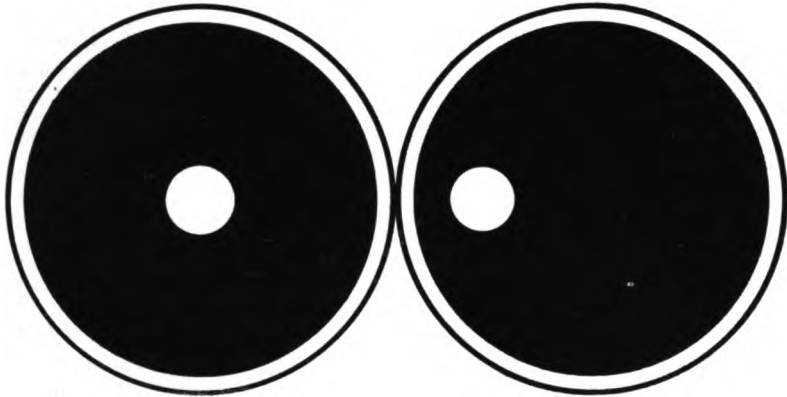

FIG. 20 A. CONDENSER FACE WITH THE SPOT OF LIGHT IN THE MIDDLE, SHOWING THAT THE LAMP AND CONDENSER ARE ON THE SAME AXIS.

FIG. 20 B. CONDENSER FACE WITH THE SPOT OF LIGHT OUT OF THE CENTER. THIS SHOWS THAT THE CONDENSER AND LAMP ARE NOT ON ONE AXIS.

To get the appearance here shown the lamp must be pulled back considerably beyond the principal focus of the first element of the condenser.

will appear in the center (fig. 20). This can be easily seen by holding a piece of paper against the condenser face. In case the two are not properly aligned, the white spot on the paper will appear outside the center, at the right or left, above or below. On account of the inverting effect of lenses the arc light will be too far from the center in just the opposite direction from the spot of light. For example, in figure 20B the light spot is too far to the left, consequently the crater of the positive carbon must be too far to the right. One should change it to the left by the adjusting screws until the circle of light appears exactly in the middle (fig. 20A).

§ 58. **Optical test for centering the condenser and the objective.**—After the condenser and the radiant are properly centered, and the radiant put at the principal focus of the condenser one can tell whether the objective is on the same axis by looking at both ends of the objective when it is at the proper distance from the condenser (fig. 1-2).

If the objective is in line with the lamp and the condenser the spot of light from the condenser can be seen in the middle of the

first lens of the objective. The light should strike the middle of the first lens and leave through the middle of the last lens of the objective (fig. 1).

If it is not centered the cone of light will strike at one side of the center and leave at one side. If it is greatly out of center the cone of light may fall wholly outside the objective; this frequently occurs in micro-projection.

To center the objective it should be moved up or down, to the right or to the left, until the cone of light strikes it exactly in the center and leaves the center. No change of the lamp or the condenser should be made, for that would spoil the centering of those two elements. After the objective is centered, it should be fixed firmly in position. Any slight variation from the center by the irregular burning of the carbons, can be corrected by the fine adjusting screws of the lamp (fig. 3, L. A.; V. A.).

CENTERING THE OBJECTIVE IN A VERTICAL POSITION

§ 59. When the objective must be made vertical in projecting horizontal objects, the radiant and the condenser should first be centered as described above (§ 55). Then the second element of the condenser should be removed and placed in a horizontal position with the convex face downward, and the flat face upward toward the objective. A plane mirror at 45 degrees is placed in the path of the beam of light from the first element of the condenser. The light will be directed vertically upward. The horizontal condenser lens must be moved until it receives this vertical cylinder of light and continues the central or axial ray in a vertical direction. One can tell when this is the condition by pulling the arc lamp back from the condenser until a small circle of light appears on the horizontal condenser lens (fig. 20A, B.). If it is centered the spot of light will be in the middle. If it is not in the middle move the upper lens until it is, but do not change the position of the lamp. When the horizontal lens is centered, move the arc lamp up toward the condenser until the horizontal lens is filled with light (§ 55).

§ 60. **Centering the vertical objective.**—After the horizontally placed condenser lens is centered the objective is placed in a vertical position over it and moved sidewise until the cone of light enters the middle of the first face and leaves the middle of the last face of the objective. One proceeds exactly as for centering it in the horizontal position (§ 55, 58). Just over the objective is placed a 45 degree mirror silvered on the face, or a right-angled prism, to direct the vertical rays horizontally to the screen (fig. 16). The lower mirror may be an ordinary glass mirror silvered on the back, but the mirror over the objective must be silvered on the face to avoid a duplication of the image.

TROUBLES: HOW TO AVOID AND HOW TO OVERCOME THEM

THE LAMP CANNOT BE STARTED

§ 61. This may be because there is no voltage in the main line. The presence of current is easily determined by using the testing incandescent lamp (fig. 21). An incandescent lamp in the circuit as shown in fig. 2 or 4 will show whether the current extends to the lamp switch.

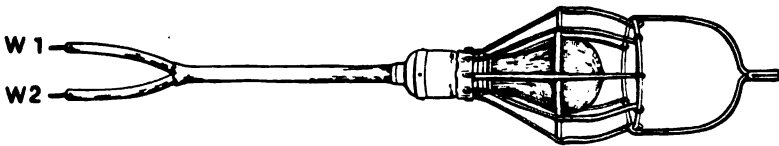

FIG. 21. TESTING INCANDESCENT LAMP.

W_1 , W_2 . The two supply wires for the lamp.
For this testing lamp a socket without key switch is best. It is also wise to have the lamp protected by a wire guard. The wires at W_1 , W_2 should be exposed only a short distance as shown.

To test with the lamp put the naked ends of the wires W_1 , W_2 upon metallic parts of the circuit to be tested being sure to make contact with both conductors of the circuit. For example, the two wires or the two blades of a knife switch, etc. If there is voltage in the line at that point the lamp will light up.

§ 62. The connections in the arc lamp may not be good, that is, the set screws holding the connecting wires may have become

loosened, or a wire may have become wholly separated from its connections.

§ 63. A fuse may have burned out somewhere along the line. Commencing with the fuse nearest the lamp, take each fuse out and examine it. Use the testing incandescent lamp also.

§ 64. A fuse plug may not be screwed in tightly enough to make good contact. Occasionally some one puts a piece of paper or wood in the fuse socket, thus preventing metallic contact. Such obstructions should be looked for and removed; then the fuse plug can be made to produce metallic contact.

§ 65. The switches may not be properly closed, and hence the circuit is not complete.

§ 66. The carbons may be so short that they cannot be brought in contact, and thus the circuit cannot be completed. Put in new ones.

§ 67. The range of the lamp movement may be at its limit, so that the carbons cannot be approximated. This must be corrected by turning the screws back and then setting the carbons by hand, if long enough, or by putting in new carbons.

§ 68. If one uses an automatic arc lamp, it may be that the mechanism does not work. Before looking elsewhere for the trouble, one should try the hand-feed device present in all automatic lamps and make sure that the carbons are brought in contact and then slightly separated to establish the arc.

§ 69. Of course, if one uses a hand-feed lamp it will not start until one brings the carbons in contact by the proper device for the purpose. As soon as the carbons touch there will be a flash of light; then the carbons should be slightly separated.

§ 70. There may be a short circuit in the lamp itself due to a burning out of the insulation. This may be detected by opening the double-pole knife switch slowly. If there is a big spark when the switch finally opens, a short circuit in the lamp is strongly indicated.

Unless one has considerable knowledge of arc lamps it is advisable to get an electrician to repair the lamp.

Short circuiting in the lamp is a rare trouble and less liable to occur than almost anything else.

GOING OUT OF THE LAMP

§ 71. This may be due to the stopping of the dynamo.

§ 72. A fuse may burn out somewhere along the line.

§ 73. Some connection may burn out or one or both wires may be disconnected.

§ 74. The carbons may have burned off so that the interval between the ends is too great for the current to pass. This is a very common cause, and is, of course, easily remedied by the use of the feeding screws of the lamp to bring them closer together. If the carbons are so short that they cannot be brought together, new carbons must be inserted. Always open the table switch before putting in new carbons.

Sometimes the screw holding the lower carbon is not set up enough and the carbon falls down. If this is the trouble open the table switch and replace the lower carbon in its proper position and tighten well the set screw holding it.

Always look at the carbons first in case the lamp goes out unexpectedly (see also above § 66-67, 70 and all the causes for no current § 61-70).

NOT ENOUGH CURRENT

§ 75. There may not be enough in the line.

§ 76. The line may be grounded. Test for this with the testing incandescent by touching one of the terminal wires of the incandescent to some metal object connected with the ground, like the metal tube enclosing the wires, a water or gas pipe or radiator, and the other to one of the exposed metal parts of the conductors, first on one side and then on the other. If there is a connection of either wire with the ground the testing lamp will light when its two wires are connected, one with the radiator, etc., and the other with

the line wire which is not grounded. In some cases one wire is purposely grounded. In such cases great care must be taken not to ground the other wire (see also fig, 266-267 § 68g).

§ 77. There may be too much resistance in the circuit. Open the rheostat wider, if it is adjustable (fig. 281), keeping an eye on the ammeter to see when the current is of the desired amperage.

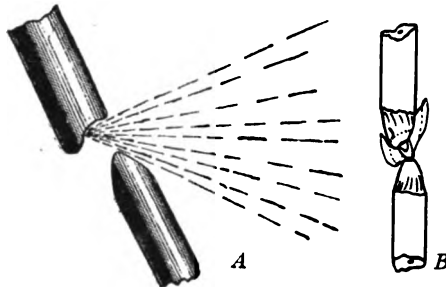

FIG. 22. INCLINED AND VERTICAL CARBONS IN THE CORRECT RELATIVE POSITION.

The upper carbon is positive and supplies the light in both cases.

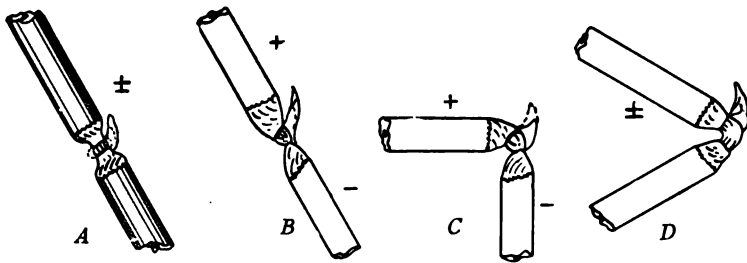

FIG. 23. CARBONS IN THE CORRECT RELATIVE POSITION FOR BOTH DIRECT AND ALTERNATING CURRENTS.

- A Inclined carbons in the correct position for alternating current.
- B Inclined carbons in the correct position for direct current.
- C Carbons at right angles in the correct position for either direct or alternating current. Direct current is indicated.
- D Carbons arranged in a V-shaped position. For this position alternating current only is employed; and the crater on each carbon contributes to the light. The V may be either in a vertical or in a horizontal plane. The vertical arrangement is the more common.

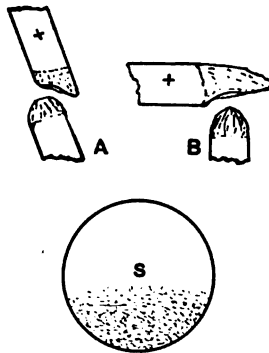

FIG. 24. CARBONS IN BAD POSITION; THE UPPER CARBON CUTTING OFF THE LIGHT FROM THE UPPER PART OF THE CONDENSER, AND HENCE CASTING A SHADOW ON THE LOWER PART OF THE SCREEN.

A Carbons at an inclination of about 25 degrees, with the upper or positive carbon too far forward.

B Carbons at right angles, with the upper carbon too far forward.

S Screen image of the condenser face. As the upper carbon is in the way, the upper part of the condenser is partly in shadow, and hence the screen image will be shaded on its lower part due to the inverting action of the objective.

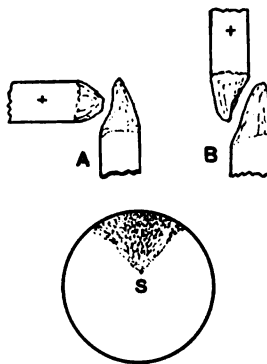

FIG. 25. CARBONS IN BAD RELATIVE POSITION, THE LOWER OR NEGATIVE CARBON EXTENDING UP IN FRONT OF THE POSITIVE CARBON.

A Carbons at right angles, with the lower carbon too high.

B Both carbons vertical, but the lower or negative one standing in front of the upper one.

S Screen image of the condenser face. As the condenser is not well lighted on its *lower part* due to the shading action by the lower carbon, the screen image will be shaded correspondingly on its *upper part* due to the inverting action of the objective.

IRREGULAR OR INSUFFICIENT LIGHT ON THE SCREEN

§ 78. There may be an insufficient current flowing through the lamp. Consult the ammeter (§ 7, 75-77).

§ 79. **Improper relative position of the carbons.**—Look at them occasionally through the window in the lamp house. They should be in the relative position shown in fig. 23. If they are in a wrong position (fig. 24, 25), one cannot expect to get a good screen light.

It sometimes happens that one or both of the carbons has no soft core, although the hole in the carbon is present. In such a case the crater is liable to jump around as with a solid carbon. Easily corrected by substituting a properly cored carbon.

§ 80. **Wrong polarity of the supply wires.**—As stated above (§ 5) the positive supply wire should be connected with the lamp so that the current passes along the upper carbon and from its tip over to the lower carbon, whence by means of the negative wire, it passes back to the generator or dynamo. In case the wires were reversed in position, the lower carbon would be positive and the bright crater would be on it. This would give a poor light, for the crater would not face the condenser, and as this carbon would burn away more rapidly than the upper carbon the upper one would soon be in the position shown in fig. 24B. There would then be a double reason for a poor screen image, viz., the crater would not face the condenser, and the upper carbon would act as a shield to cut the light off the condenser. To determine whether the wires are connected to the lamp properly, insert carbons, turn on the current, and let the lamp burn a minute or two. Then turn off the lamp and watch the hot ends of the carbons. The positive one will remain red hot longest. (See also Ch. XIII, § 701-703 for determining the polarity). In case the lower carbon remains glowing longer than the upper, the polarity is wrong (fig. 271).

Open the switch and remove both wires from their binding posts and insert them in the reverse position. Then repeat the experiment and the upper carbon should remain glowing longest.

After one has had some experience it is easy to tell whether or not the wires are properly connected by watching the carbons through

the lamp-house window when the lamp is burning. The upper carbon should always be considerably brighter than the lower one.

When one has found the correct polarity it is wise to mark the positive wire red and the negative wire black. It is also a good plan to mark the positive switch connections *plus* with red and the negative connections *minus* with black. But one must not forget that the polarity is liable to be changed by the changing of the wires in the main line when repairs are made, so one must be on the alert to detect polarity change.

§ 81. **Non-registering of the direct current ammeter.**—In first installing an ammeter if the hand does not register on the dial when the current is turned on and the arc lamp started, either the instrument is out of order, or more likely the wires are wrongly connected. Remember that the ammeter must be inserted in *one wire*, then if it does not register when the lamp is burning the wires were inserted wrong. Turn off the current and reverse the wires in the binding posts of the ammeter. If now the wires are properly connected both to the ammeter and the arc lamp, the polarity in both will be changed by a change in polarity in the main line, and the wires must be changed around in the binding posts in the ammeter and in the arc lamp to get the polarity correct in both. As the lamp and the ammeter are wholly independent instruments, the polarity may be correct in both or wrong in both, or correct in one and wrong in the other. (See also Ch. XIII, 702a for ammeter which can be used with both alternating and direct current).

DEFECTIVE OPTICAL RESULTS

§ 82. There may be direct light falling on the screen from some window or some lighted lamp in the room. This will make the disc of light, or the lantern picture on that part of the screen receiving the adventitious light, look faded or gray instead of brilliant. It will look as if that part of the screen were not so brilliantly illuminated, when, in fact, more light may be falling on it. To be effective the light must reach the screen from the lantern and from no other source.

SHADOWS AND RESTRICTION IN THE DISC OF LIGHT ON THE SCREEN

§ 83. The radiant, i. e., the crater of the upper carbon (fig. 27) may be outside the main axis (above, below, to the right or to the left of it). If sufficiently outside the center there will be only an elliptical light area present. On the side toward which the crater is displaced there will be a blue crescent or spot, and on the opposite side a dark crescent, bordered, in extreme cases, by red. Remedy: get the crater back in the axis.

§ 84. The condenser may be out of center.—This will give the same defective light on the screen as when the light source is off

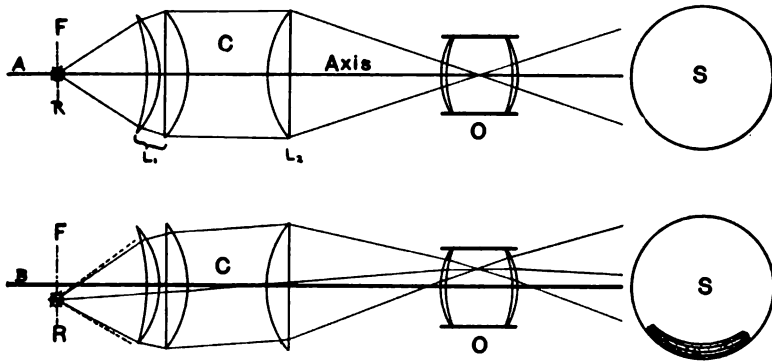

FIG. 26 (A). DIAGRAM OF A MAGIC LANTERN AND A SCREEN IMAGE WHEN ALL THE PARTS ARE IN CORRECT PROPORTION AND ON ONE AXIS.

Axis The common axis passing from the radiant along the principal axis of the condenser and the objective to the screen.

C Condenser of three lenses, the first element (L_1) composed of a meniscus and a plano-convex; the second element (L_2), is a plano-convex. The convex surfaces face each other as usual.

F Principal focal distance of the condenser.

O Projection objective.

R Radiant giving the light.

S The screen fully and perfectly lighted.

FIG. 27 (B). DIAGRAM SHOWING THE EFFECT OF HAVING THE RADIANT BELOW THE AXIS.

There appears a blue shadow on the lower part of the screen (S).

Whenever the radiant is off the axis the dark blue shadow will be on the corresponding side of the screen. In this case the radiant would have to be raised to get rid of the shadow. If the shadow were on the left it would be necessary to move the radiant to the right and so on.

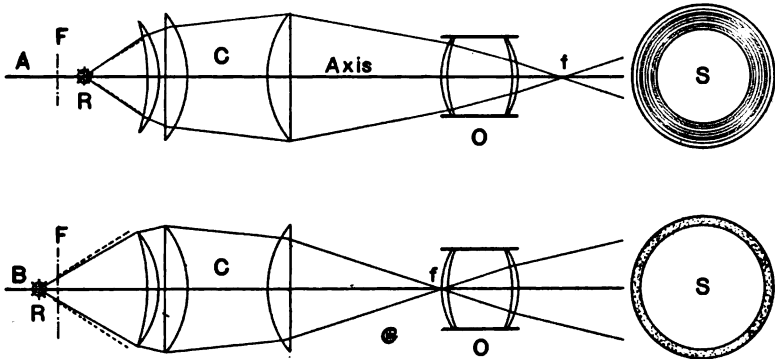

FIG. 28 (A). DIAGRAM SHOWING THE EFFECT ON THE SCREEN IMAGE WHEN THE RADIANT IS TOO NEAR THE CONDENSER.

In this case the conjugate focus of the condenser (f) is considerably farther off, i. e., beyond the objective, the screen image is made smaller, and the light disc on the screen is bordered with blue. With some condensers there is a dark or blue disc in the center also. (Lettering as in fig. 26).

FIG. 29 (B). DIAGRAM SHOWING THE EFFECT ON THE SCREEN IMAGE WHEN THE RADIANT IS BEYOND THE PRINCIPAL FOCUS OF THE CONDENSER.

This brings the conjugate focus of the condenser (f) nearer the condenser, and in this case just before the light reaches the objective. It narrows the screen image and the light disc is bordered with red. (Lettering as in fig. 26).

the axis, but the blue spot or disc will be on the side away from which the condenser is displaced, being just the reverse of the position when the light source is off the axis (§ 83).

If the condenser is too high the blue spot or disc will be on the lower part of the screen; and if the condenser is too low the blue edge will appear on the upper part of the screen; if to the right the blue disc will be at the left, etc. That is the condenser inverts the position (fig. 27).

The condenser should be correctly centered once for all and firmly fixed in position so that it need never be changed.

§ 85. **The projection objective may be off the main axis.**—The effect will be the same as when the source of light is off the axis. This is due to the fact that while the condenser inverts the rays,

they are re-inverted or erected by the objective. If the condenser and source of light are on one axis and the objective off that axis, it must be recentered; but as stated above (§ 54) when the objective and condenser are once centered they should be fixed in position, then the only element of the lantern to become decentered is the crater of the arc lamp, i. e., the source of light. The fine adjustment screws of the lamp will enable one to center the light. By limiting the changes to one element, viz., the source of light, corrections can be made quickly and accurately. If one tries to get the light centered by changing two or all three of the elements it leads only to chaos.

§ 86. For the effects of spherical aberration and for a ghost, a white or black spot in the center of the field, see also § 828.

§ 87. The radiant (i. e., crater of the upper carbon) may be too close to the condenser. This will give a restricted field with a blue margin or there may be a blue circle in the center of the disc (fig. 29, 30).

§ 88. The radiant may be too far from the condenser. This will produce a restricted screen disc with the edge bordered with red (fig. 29). It is easily corrected by bringing the radiant and condenser closer together.

§ 89. The condenser may be of too short focus, so that the light comes to a focus before reaching the objective when the lantern slide is in focus (see § 56, fig. 29, 30). Correct the defect by using a lens of longer focus for the second element of the condenser. It may be less satisfactorily compensated for by putting the radiant nearer the condenser.

§ 90. The condenser may be of too long a focus (see § 56, fig. 28). Correct by using a shorter focus condenser. It may also be compensated for in part by removing the radiant farther from the condenser, but this lessens the available light.

§ 91. There may be dirt, mist or opacities on some of the glass surfaces. This is easily remedied by cleaning the glass.

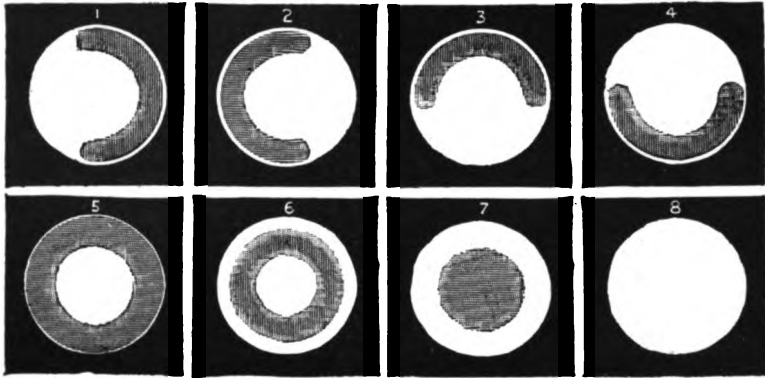

FIG. 30. ARRANGEMENT AND CENTERING OF THE RADIANT.
(From the catalogue of Fuess).

- (1) The Radiant, i. e., the crater is too far to the right.
- (2) The crater is too far to the left.
- (3) The crater is too high.
- (4) The crater is too low.
- (5) The crater is too far from the lamp condenser.
- (6-7) The crater is too near the condenser.
- (8) The crater is in the correct position.

One of the condenser lenses may be cracked. If a new lens cannot be inserted, but the cracked one must be used at the time, rotate it around until the crack is least noticeable.

There may be strings or wires hanging down in the path of the beam of light. They will give sharp shadows on the screen. Remove them.

§ 92. **Defective or too opaque lantern slide.**—The lantern slides may be cracked, producing a dark streak through the picture. There may be dirt or mist on one or more of the glass surfaces.

The slide may be too opaque. There is a tendency to make lantern slides so opaque that only the most powerful radiants can give anything like satisfactory screen images. This is a great mistake. Lantern slides properly made are very transparent and show all the delicate shading, from the densest to pure transparency (clear glass). Probably 99 slides are too dense where one is not dense enough. The opacity of the slides made by the autochrome

or starch process is one of their great drawbacks. Only powerful radiants give satisfactory screen images.

§ 93. **Shadow on the screen with water-cell.** In case the water in the water cell has evaporated in part there will be a very disagreeable shadow on the lower part of the screen (fig. 31). It is on the lower part of the screen although it is the upper part of the water cell that will be empty. This is due to the inverting action of the objective.

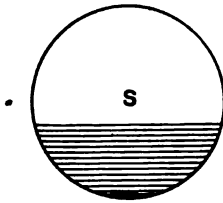

FIG. 31. SHADOW ON THE LOWER PART OF THE SCREEN WHEN THE WATER-CELL IS BUT PARTLY FILLED.

S Screen image with shadow on the lower side. The water is of course present in the lower part of the water cell, and absent from the upper part; but, owing to the inversion produced by the objective, the screen image shows the shadow on the lower part.

Occasionally the water is entirely absent from the water-cell. Then there will be a very poor screen image, the entire screen being affected by the obscurities on the dry surfaces of the water-cell.

BREAKING OF CONDENSER LENSES

§ 94. It is usually the lens next the radiant that cracks or becomes shattered. This is due to the too rapid heating or cooling of the condenser lens, or to the mounting, which may be too rigid to allow of free expansion of the lens as it becomes hot.

Condenser lenses are especially liable to break: (1) When too heavy currents are used; (2) when the lamp-house is not well and evenly ventilated; (3) when currents of cold air strike the hot condenser; (4) when the lens mounting is not provided with ventilating openings for free circulation of air between the lenses;

(5) when the lens next the radiant is of such a focus that the lamp must be put very close to it.

§ 95. **Unequal heating.**—Breakage often occurs from unequal heating of the lens. This is perhaps as common with large flame sources such as the kerosene flame, the alco-radiant or Welsbach mantle gas flame as with the electric arc. With the electric arc, if the crater is too close to the lens the thick central part of the lens expands rapidly before the edge is heated enough to expand with the middle part. Separating the lamp and condenser somewhat, for a few minutes after starting the lamp would give the condenser a chance to expand uniformly.

§ 96. **Mounting of the lenses.**—This may not give the lenses sufficient freedom of expansion. In all forms of condensers as now constructed there is almost invariably provision for this expansion, and for free circulation of air between the lenses. The lens next the radiant is usually held by a few obliquely extending springs, (fig. 36 B), thus giving the greatest freedom. To prevent breakage some operators avoid all direct contact of the condenser with the metal mounting by the use of asbestos paper. Others think that a heavy metal ring around the edge of the condenser will lessen breakage by preventing the too rapid cooling.

The final solution of condenser breakage will come when the glass makers produce heat-resisting, optical glass.

§ 97. **Breakage due to reversing the ends of the condenser.**—That is, the condenser lens which should be next the projection objective is put next the lamp. The lens which should be next the lamp is specially mounted for expansion (§ 96). Furthermore, the condenser is not designed optically in most cases so that it will give equally good results if reversed. In the magic lantern the lens next the objective has frequently a longer focus than the one next the radiant, so that a reversal injures the optical effect as well as endangers the condenser.

If the makers of projection apparatus would so construct their condenser mountings that they could not be reversed, they would be doing a friendly service to many.

§ 98. If the lantern table is on a concrete floor which is damp the operator is liable to get a shock unless he stands on a mat or board or other insulating material, provided some part of the circuit is grounded (see § 689).

SOME EXAMPLES OF AMERICAN MAGIC LANTERNS FOR THE DIRECT CURRENT ARC LAMP

§ 99. The following examples of American Magic Lanterns are introduced to give the reader some notion of the lanterns on the market which can be obtained at any time and at a very moderate cost.

In subsequent chapters will be found pictures of lanterns for the different forms of radiants, and for two or more kinds of projection (combination apparatus).

In the appendix at the end of the book will be found the addresses of some of the great manufacturers in all countries with the prices for the different complete outfits for the various forms of projection.

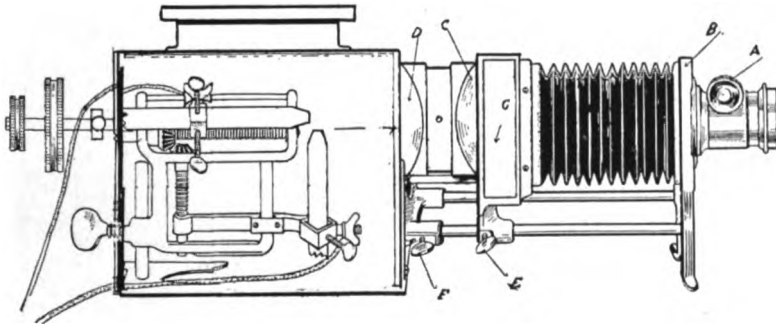

FIG. 32. MAGIC LANTERN IN OUTLINE TO SHOW THE PARTS.
(Cut loaned by Williams, Brown & Earle).

At the left, the side of the lamp-house is removed to show the hand-feed, right-angled arc lamp with the supply-wires and the carbons in position.

C D The condenser composed of two plano-convex lenses. In the space (*o*) a water-cell may be inserted,

G The oblong opening, just in front of the condenser, into which the slide carrier is inserted.

A The projection objective fastened to the end piece *B*, which also holds the bellows.

E F Set screws serving to fix the apparatus on the guide rods.

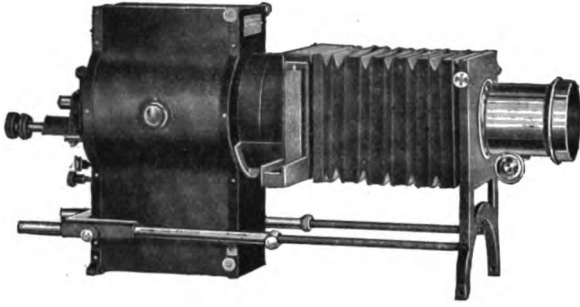

FIG. 33. SIMPLE MAGIC LANTERN WITH A TWO-LENS CONDENSER.
(*Model C, Balopticon; Cut loaned by the Bausch & Lomb Optical Co.*)

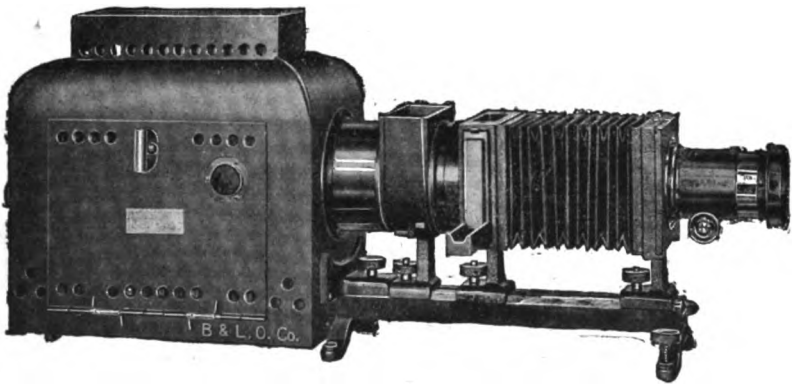

FIG. 34. MAGIC LANTERN OF THE LATHE-BED TYPE WITH A THREE-LENS CONDENSER AND WATER-CELL.
(*Model D, Balopticon; Cut loaned by the Bausch & Lomb Optical Co.*)

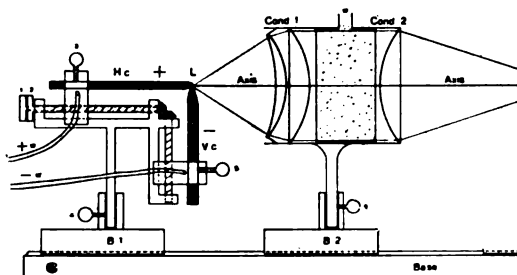

FIG. 35. SECTIONAL VIEW OF AN ARC LAMP AND A TRIPLE-LENS CONDENSER WITH WATER-CELL.

- + W Wire going to the positive carbon.
 — W Wire from the negative carbon.
 Hc Horizontal or upper carbon; it is positive.
 Vc Vertical or lower carbon; it is negative.
 L The crater of the positive carbon; it is the source of light.
 Cond 1 The first element of the triple-lens condenser. The meniscus is always placed with the concavity next the source of light.
 Cond 2 The second element of the triple-lens condenser. It is a plano-convex lens and should be of the same focus as the projection objective. The different lenses should be in the position shown in this diagram. Between the two convex lenses in the parallel beam of light is placed the water-cell.
 B, B₂ Blocks supporting the arc lamp and the condenser.
 Base The base-board with the track along which the different parts move (see fig. 40).
 Axis The principal optic axis of the condenser and continuous with that of the projection objective.

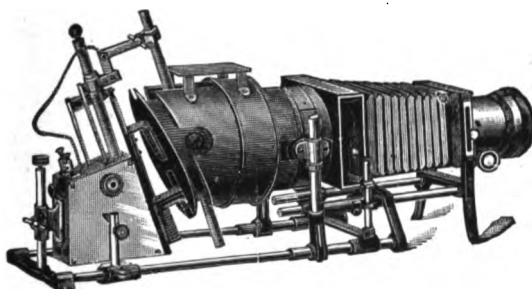

FIG. 36 A. MAGIC LANTERN WITH AN AUTOMATIC LAMP AND INCLINED CARBONS.

(Cut loaned by P. Keller & Co., successors to the J. B. Colt Co.).

This lantern is very widely used. It has a two-lens condenser (see fig. 1). Its main defect is that every part, lamp, condenser lantern-slide holder and objective can be separately raised or lowered.

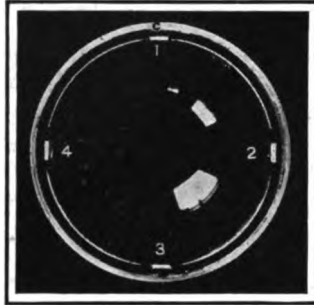

FIG. 36 B. CONDENSER LENS NEXT THE RADIANT IN ITS MOUNT.

This is a picture of the end of the condenser next the radiant of the lantern shown in fig. 36 A.

The lens is held in place by four thin metal supports, fastened at one end to the condenser mount, and hooked over the edge of the condenser at the other. The lens is considerably smaller than the condenser mount, thus giving abundant room for expansion.

1, 2, 3, 4. The four thin metal strips for holding the lens in position. They are white where they hook over the edge of the lens.

c End view of the metal tube supporting the condenser.

(The white spots in the condenser face are mirror images of the windows near where the picture was taken).

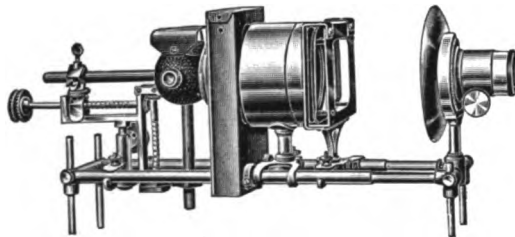

FIG. 37. MAGIC LANTERN WITH TWO-LENS CONDENSER, AND HAND-FEED ARC LAMP.

(Portable Sciopticon. Cut loaned by the McIntosh Stereopticon Co.).

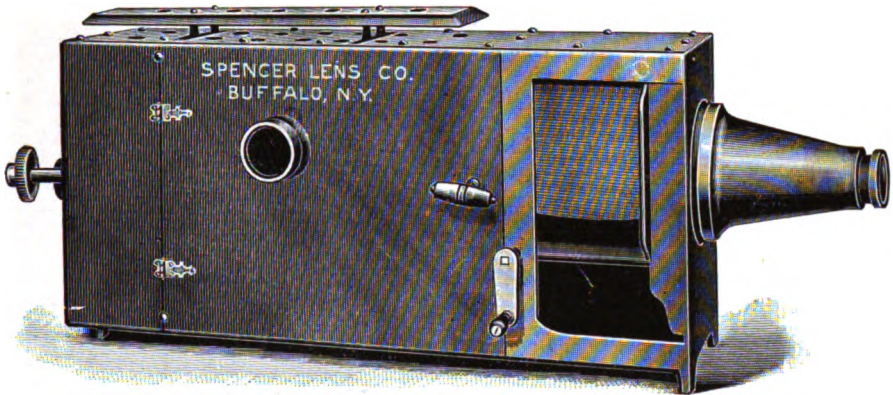

FIG. 38 A. SIMPLE MAGIC LANTERN WITH TWO-LENS CONDENSER AND A HAND-FEED ARC LAMP WITH RIGHT-ANGLED CARBONS AND WATER-CELL.

(Model 2, Delineascope. Cut loaned by the Spencer Lens Co.).

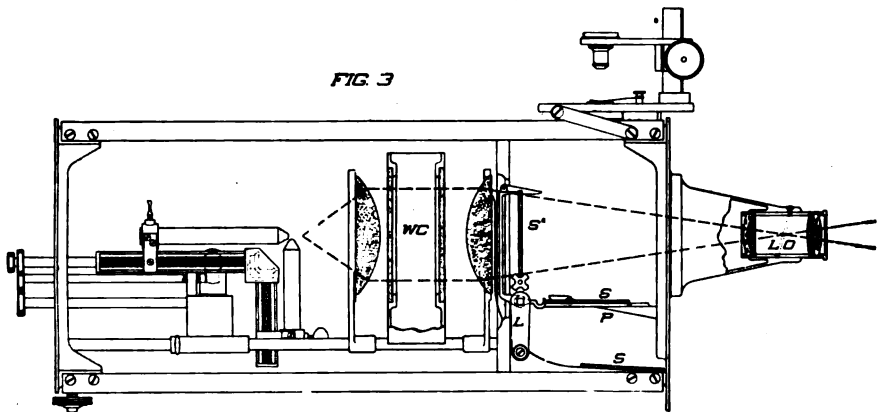

FIG. 38 B. DETAILS OF MODEL 2, DELINEASCOPE.
(Cut loaned by the Spencer Lens Co.).

The entire instrument is in one metal box.

At the left is the right-angled arc lamp with the feeding and fine adjustment screws.

The condenser is of the two-lens type with a water cell (*W C*) between the lenses.

S P S' The slide-carrier is a flat frame on which the slides are laid and turned to a vertical position by the crank *L*.

S When the crank *L* turns a slide into position the one already in position is released and it falls down the curved incline to *S* where it can be removed.

L O The projection objective. Its conical holder is hinged so that it can be readily turned aside to give place to the projection microscope, which, in the figure, is turned over on the top of the lantern box.

§ 99₁. Summary of Chapter I:

Do

1. Connect both supply wires to the arc lamp as indicated in fig. 3, i. e., connect the positive wire with the binding post of the upper carbon and the negative wire with the binding post of the lower carbon.

Make sure of the polarity (§ 80).

2. Always use a rheostat or other balancing device with an arc lamp (§ 6).

3. Insert the rheostat along *one wire* (fig. 1-4).

4. Insert the ammeter along *one wire* (fig. 2, 4).

5. Always have a double-pole switch on the lantern table (fig. 1-3).

6. Insert the switch along both wires, and before the rheostat, so that all the apparatus on the lantern table has no current when the switch is open (fig. 3).

7. Always open the switch before changing any of the wires.

Do Not

1. Do not connect the negative wire to the upper carbon and thus make the polarity wrong.

2. Never try to use an arc lamp without a balancing device—(rheostat, etc.).

3. Do not connect both wires with the binding posts of the rheostat, but *insert it in one wire*.

4. Do not connect the ammeter with both wires. *Insert it in one wire*.

5. Do not try to get along without a double-pole table switch.

6. Do not insert the switch along one wire, but connect it with both wires. Do not put the switch after the rheostat, etc., but before.

7. Never change wires on the apparatus until the current is turned off by opening the switch.

8. Open the switch before inserting or changing carbons.

9. Center the parts of the lantern when it is first installed (§ 51-60).

10. When the condenser and objective are once centered they should be fixed in position (§ 51).

11. Use the fine adjustments on the arc lamp (fig. 3) for centering the light on the screen after the first centering. Look at the carbons through the lamp-house window occasionally to make sure that they are in the correct relative position (§ 79).

12. Make sure that the arc lamp and condenser, the condenser and objective are separated the right distance (§ 55-56).

13. For the triple condenser select a condenser lens to go next the lantern slide which shall be of approximately the same focus as the projection objective, then the light from the condenser will cross at the center of the objective (fig. 1-2).

8. Do not try to insert carbons when the current is on. Open the switch.

9-10. After the parts of the lantern are once centered, never change the position of the condenser or objective for centering.

11. Do not fail to keep the light centered by the use of the fine adjustments on the lamp and by keeping the carbons in the correct relative position.

12. Do not try to use the lantern when the arc lamp and condenser are too near together or too far apart.

The same for the condenser and objective.

13. Do not try to use an objective with a condenser that does not cross its rays at the center of the objective. Objective and condenser should have the same focal length approximately.

14. Make sure that the condenser is arranged with the proper lens next the radiant. If a three-lens condenser, the meniscus should face the source of light; if a two-lens condenser, it is the lens in a special mounting (fig. 36 B), or if there is no special mounting, it is the one of shorter focus usually, i. e., of 15 to 19 cm. (6-7½ in.), while the one next the objective is often of longer focus.

15. Mark or "spot" the lantern slides so that they may be inserted in the lantern correctly (§ 23, fig. 7, 8, 13) and arrange the slides as desired before the exhibition (§ 21).

16. Make sure that everything is in working order, the room properly darkened, and the proper amount of current available (10 to 15 amperes).

17. Light the arc lamp before the room lights are turned off (§ 33).

18. Keep the arc lamp burning until the room lights are turned on (§ 34).

19. After the last slide, show simply a lighted screen (§ 34).

14. Do not reverse the ends of the condenser and thus have the wrong lens next the light and the wrong one next the objective.

15. Do not try to exhibit slides that are not in order and not marked for insertion in the carrier.

16. Do not attempt an exhibition unless the room is properly darkened, and the apparatus in working order.

17. Do not let the room get dark, but turn on the arc lamp before the room lights are out.

18. Do not turn out the arc lamp until the room lights are turned on.

19. Do not keep the last slide in the holder too long, but show a light screen to indicate that the last slide has been shown.

20. Study the "Troubles," their causes and remedies (§ 62-98).

21. Focus the screen image sharply, using opera-glasses, if necessary (§ 38).

20. Do not fail to study the "Troubles" and their remedies.

21. Do not let the screen image appear vague and out of focus. Do not forget the aid opera-glasses will give, if the screen distance is great.

CHAPTER II.

THE MAGIC LANTERN WITH AN ALTERNATING CURRENT ARC LAMP AND ITS USE

§ 100. Apparatus and Material for Chapter II:

Suitable room with screen (Ch. XII); Magic lantern with lantern table (§ 102); Arc lamp for alternating current with suitable carbons (§ 108); Alternating current supply; Rheostat, choke-coil or other balancing device (§ 105-106); Ammeter for alternating current (§ 111); Incandescent lamp; flash-light, gloves with asbestos patches, testing lamp, fuses, extra condenser lenses, screw driver, pliers, opera-glasses, lantern slides as in Ch. I (§ 1).

§ 101. For the historical development of the alternating current arc lamp see the Appendix; and for the character and advantages and disadvantages of alternating current see § 652-653, and modern works on the subject.

The same books of reference given in § 2, Ch. I, are available for this chapter.

COMPARISON OF ALTERNATING AND DIRECT ELECTRIC CURRENTS AND LANTERNS

§ 102. A magic lantern for alternating current may be precisely like one for direct current, the only essential difference being that the arc lamp must be of the hand-feed type and the mechanism for feeding the carbons gives equal movement to the upper and to the lower one, both carbons being of the same size.

One would never use an alternating current with the magic lantern if direct current were available. It frequently happens, however, that the lighting system of a place is of the alternating current type, and no direct current is available. In such a case one must make the best of it, or use a motor-generator set or a rectifier (see § 682-683).

The objections to an alternating current for the arc lamp in projection are: (1) The lamp is noisy; (2) It requires about two and one-half times as much current for the same effective light.

That is, if 10 to 12 amperes of direct current give satisfactory illumination in a given case, it would require from 25 to 30 amperes of alternating current to give the same brilliancy of screen image. Naturally also the heating with the larger alternating current is greater than with the smaller direct current (see also § 768).

§ 103. The difference between direct and alternating current is, in general terms, this: the direct current has a constant polarity and one carbon is always positive; while the alternating current has an alternation of polarity, as the current flows in one direction for an instant and then in the opposite direction. The result is that each carbon is positive half the time and negative half the time, hence both carbons have brilliant craters from which light for the screen image might be obtained. Sometimes an effort is made to utilize the light from both craters by the arrangement of the carbons in the form of a V, the apex of the V pointing toward the condenser (fig. 23D).

INSTALLATION OF A MAGIC LANTERN WITH AN ALTERNATING CURRENT ARC LIGHT

§ 104. **Wiring from the supply to the lantern.**—This is precisely as for the direct current lamp. If the lantern is to be used for experimental purposes it is advantageous to have an incandescent lamp inserted in the circuit as shown in fig. 2.

§ 105. **Rheostat or other regulating device.**—There must be introduced along one of the supply wires to the lantern some form of balancing device. This may be in the form of a rheostat like that used for the direct current (§ 6); an inductor or choke-coil, a transformer, or a mercury arc rectifier may be used. For the special advantages and disadvantages of the different balancing devices (see § 736-738).

§ 106. **Wiring the lamp.**—For the alternating current it makes no difference which supply wire is connected with the upper carbon, as each carbon has an approximately equally brilliant crater.

But in installing a magic lantern for either current, it must never be forgotten that the arc lamp must not be connected with the main line without some form of rheostat or regulating device in the circuit (fig. 3, 40, and § 744).

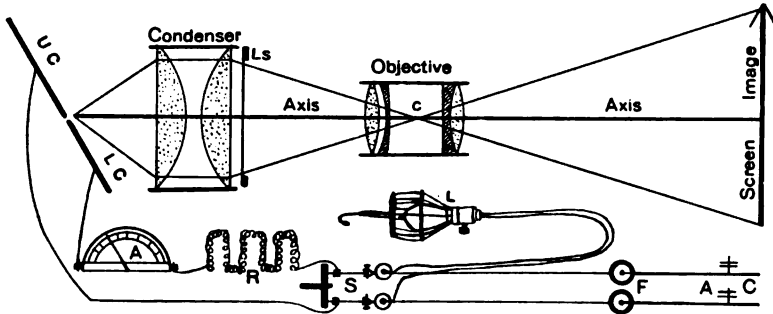

FIG. 39. MAGIC LANTERN WITH INCLINED CARBONS.

U C, L C The upper and the lower carbon. Only the carbons of the arc lamp are shown.

A C Alternating current supply wires.

F Fuses at the outlet box (see fig. 40).

L Incandescent lamp for use in working around the magic lantern.

S Double-pole, knife switch.

R Rheostat in one wire.

A Ammeter for indicating the amount of current.

Condenser A two-lens condenser. The light is shown as a parallel beam between the lenses. It is usually diverging (see fig. 1).

L S Lantern slide next the condenser.

Axis Axis The principal optic axis of the condenser and the projection objective.

Objective The projection objective for forming the screen image.

c Center of the projection objective. The objective and condenser should be so related that the light from the condenser crosses at the center when the image is in focus on the screen.

Screen Image The image of the lantern slide on the screen.

§ 107. **Double-pole table switch.**—This is especially necessary when using an alternating current, because with it the current can be turned completely off the lamp whenever desired. Any changes in the carbons or in the lamp mechanism can then be made with safety, as the lamp is completely cut off from the electric supply, which would not be the case if a single-pole switch were used. The shock from an alternating current supply of 110 volts is much

more disagreeable than from a direct current supply of the same voltage.

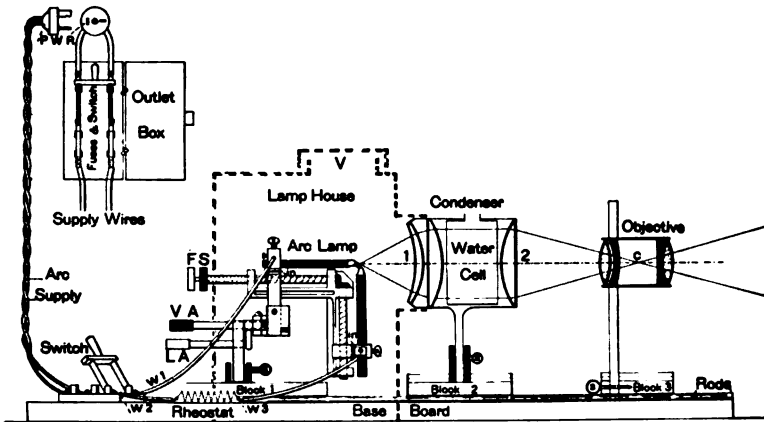

FIG. 40. MAGIC LANTERN SHOWING THE WIRING AND THE RELATION OF THE PARTS.

Supply Wires Wires from the electric supply to the outlet box.

Outlet box The iron box receiving the supply wires and containing fuses of the cartridge form, a double-pole knife switch and the wires extending to the wall receptacle.

P W R Polarized wall receptacle from which is taken the current to supply the arc lamp of the magic lantern. As this receptacle is polarized the cap can be put on but one way, and hence the polarity will always be the same if the current is direct. With alternating current this form of connection is also good.

Arc Supply The wires extending from the wall receptacle to the table switch and the arc lamp.

Switch The double-pole, knife switch on the lantern table.

W₁ The wire extending from the switch to the upper carbon.

W₂ W₃ Wire from the table switch through the rheostat to the lower carbon.

Arc Lamp Hand-feed, right-angle carbon arc lamp.

F S Feeding screws for the carbons.

V A Fine adjustment for moving the source of light vertically.

L A Fine adjustment for moving the source of light laterally.

in in Insulation between the carbon holder and the rest of the arc lamp so that the current will keep to the carbons instead of short circuiting through the lamp.

s s Set screws for holding the carbons in place, etc.

Lamp-House The metal box enclosing the arc lamp. The feeding and fine adjustment screws project through the back end of the lamp-house.

V Ventilator of the lamp-house.

Condenser The three-lens condenser.

Water Cell The vessel of water in the path of the beam.

1 The first element of the condenser consisting in a meniscus lens next the arc lamp and a plano-convex lens.

2 Plano-convex lens toward the lantern slide. The lenses of this condenser should be arranged as here shown.

Objective The projection objective.

c The optic center where the rays from the condenser should cross when the objective is in focus.

Base Board The board bearing the track and the blocks for supporting the different parts.

Block 1, Block 2, Block 3 The blocks supporting the arc lamp, condenser and objective.

Rods The rods or tubes on the base-board and serving as a track for the blocks to move upon.

§ 108. **Arc lamps for alternating current.**—These are almost invariably of the hand-feed type. Lamps are made to hold the carbons: (1) at right angles (fig. 1-3); (2) inclined backward 30 degrees (fig. 23, 39); (3) converging in the form of a V (fig. 23 D); or (4) even in a vertical position (fig. 22). Each form is best adapted to some special purpose.

With carbons of the same size and composition both carbons burn away at the same rate, and therefore must be fed forward at the same rate. If the carbons are of different size or material, then the mechanism must be adjusted to move the two at a rate which shall hold the ends at the same level.

§ 109. **Fine adjustments for the lamp.**—As indicated for the direct current arc lamp (§ 10), there should be some means of moving one or both carbons separately to compensate for any unequal burning. There must also be some means of raising and lowering the lamp and moving it sidewise so that any slight variations of the source of light from the axis may be corrected (§ 10, fig. 3).

§ 110. **Lamp-House.**—There should be a well ventilated metal lamp-house of good size and with large doors, so that all the apparatus within can be easily got at. There should also be a good sized window (say 5 cm., 2 in. square) glazed with smoky mica or a combination of green and red glass or some smoked glass of sufficient depth of tint for the protection of the eyes. This window

should be opposite the craters of the electrodes, so that the position of the carbons can be readily seen (fig. 133, 145).

§ 111. **Ammeter for alternating current.**—The ammeter serves the same purpose for the alternating as for the direct current; that is, it indicates the amount of current (§ 7). The construction for the alternating current is somewhat different, so that the one for direct current cannot be used for alternating. On the other hand excellent ammeters are now constructed which can be used for both alternating and direct currents (§ 664, 702a).

§ 112. **Mechanical centering in a horizontal axis.**—This is done precisely as for the direct current lantern (§ 51, fig. 1, 2 and 40).

§ 113. **Amount of current necessary.**—In general it requires from two and one-half to three times as many amperes of alternating current to get the same brilliancy of image as of the direct current (see § 755-768). Then for a screen distance of 10 meters (30 feet) one should have a current of about 25-30 amperes; and for a distance of 15 to 25 meters (50-75 ft.) one should use from 30 to 45 amperes. If one can be satisfied with less brilliant screen images, of course the amount of current may be somewhat less.

For a further discussion of the comparative merits of direct and alternating currents, and means of changing alternating to direct current see Ch. XIII, § 755-756, 682-683.

USE OF THE MAGIC LANTERN WITH ALTERNATING CURRENT FOR EXHIBITIONS AND LECTURE DEMONSTRATIONS

§ 114. The suggestions for the lecturer are as in Chapter I (§ 21-40).

§ 115. **Suggestions for the operator.**—These are the same as when using the direct current arc lamp (§ 26-42), except that in using the alternating current arc lamp more care is required to get good results.

(1) The carbons must be properly proportioned to each other. If they are of the same composition they should be of the same size. If one is solid and the other cored, the solid one is smaller (§ 753a).

(2) As there are two sources of light it is necessary to take special pains to focus the lantern slide very sharply on the screen, or, when the carbons burn away so that the sources of light are relatively far apart, the image on the screen will appear partly double like print that has slipped on the press, or like color printing when the impressions do not register, thus giving two partly superimposed images, especially if the carbons are arranged like a V.

If the image is sharply focused and the carbons kept close together this trouble will be avoided.

(3) The carbons must not be allowed to burn away too far before they are fed up, or the lantern will become very noisy. The carbons should be kept about three mm. ($\frac{1}{8}$ in.) apart. This will involve feeding them toward each other every five minutes (see also § 131, 753a).

A pair of gloves with asbestos patches (fig. 5) should be at hand when working about the alternating current lamp.

Practically all of the magic lanterns found in the open market may be used with an alternating lighting system, provided a lamp designed for the alternating current is used (§ 102, fig. 3).

TROUBLES WITH A MAGIC LANTERN WITH ALTERNATING CURRENT ARC LAMP

§ 116. **Noisy arc.**—There is no way of entirely obviating the noise in an arc lamp with alternating current. It may be kept at a minimum by using carbons of the proper size for the amperage used (§ 753a) and by keeping them relatively close together. As the carbons burn away, increasing the length of the arc, the noise increases. If a heavy current (much amperage) is used the noise becomes very loud and disagreeable.

The noise is also increased if there is any loose part around the rheostat or lamp which can vibrate in unison with the alternations of the current.

§ 117. **Managing the arc lamp.**—Practically all of the arc lamps used for the magic lantern with alternating current are of the hand-feed type, hence besides all the other things the operator

must see to it that the carbons are brought toward each other occasionally by turning the proper screws. With moderate currents the lamp will run from five to ten minutes without feeding, but the greater the amount of current the oftener must the carbons be fed together. As stated above, the noise increases with the length of the arc; therefore the carbons should be brought nearer together every two to four minutes.

§ 118. **Shadows on the screen.**—All the defects indicated under “troubles” in chapter I (§ 83) for the direct current light are liable to appear when using alternating current. This is somewhat complicated by the presence of an equally brilliant crater on both the upper and the lower carbons. As with direct current, there is less trouble with right-angled carbons than with vertical or inclined ones. With right-angled carbons the defect is greatest when the lower carbon is too high, thus shading the upper carbon, as in fig. 25 A (for the shadows see fig. 24-25, 27-29). As with the direct current, the greater the aperture of the projection objective, the less marked is the screen defect of a slight mal-position of the carbons. (See also Ch. III, § 127, Ch. IX, § 417, and Ch. X, § 488 for the arc lamp with small carbons to be used on the house lighting system).

§ 119. Summary of Chapter II:

Do

1. Connect *both* supply wires with the lamp; and remember that with the alternating current lamp it makes no difference which supply wire goes to the binding post of the upper and which to the post for the lower carbon (§ 106).

2. Insert a rheostat or other balancing device along *one* of the supply wires (fig. 3).

3. Insert the ammeter along one wire (fig. 2).

4. Install a double-pole switch before the rheostat (fig. 3).

5. If the lantern table is on a concrete floor, use a board or insulating mat to stand on and thus avoid possibility of a shock if the metal part of the lantern is touched (§ 98, 689).

6. Feed the carbons nearer together every three to five minutes so that the lamp will not be noisy or go out or give double screen images.

Do Not

1. Do not fail to connect both supply wires to the arc lamp.

2. Never try to use an arc lamp without a rheostat or balance. Do not connect the rheostat with both, but with a single wire.

3. Do not connect the ammeter with both supply wires, but with *one*.

4. Do not install a lantern without a double-pole, table switch which will cut off the current from all the apparatus on the lantern table (fig. 40).

5. Do not stand directly on a moist concrete floor when operating a magic lantern with an alternating current lamp.

6. Do not let the lamp go too long before feeding up the carbons.

7. Focus the screen image with special care when using alternating current lest the two sources of light produce a doubling of the screen image.

8. Use opera-glasses, if necessary, for focusing sharply a distant screen image (§ 38).

9. Look out for shadows on the screen. Center carefully and remove all causes for shadows (§ 83-93).

10. Study the "Troubles" in § 116-118, and 62-98.

7. Do not forget the greater need for accurate focusing with an alternating current lamp, on account of the double source of light.

8. Do not forget the advantage in using opera-glasses for focusing if the screen distance is great.

9. Do not permit any defect in the management of the lantern, suspended strings, etc., to give shadows on the screen.

10. Do not neglect any of the causes for "Troubles."

CHAPTER III.

MAGIC LANTERN TO BE USED ON THE HOUSE ELECTRIC LIGHTING SYSTEM

§ 120. Apparatus and Material for Chapter III:

Suitable room and screen (Ch. XII); Magic lantern with lamp-house and lantern table; Arc lamp for small carbons (§ 127); Rheostat (§ 129); Flexible cable for connecting the lamp and rheostat with the house lighting system (fig. 40); Separable plugs and extension plugs (fig. 40-50); Polarized plugs (fig. 48-49); Nernst lamps (fig. 54-55); Objective shield (fig. 14); Concentrated filament, Mazda lamps (§ 136); Flash-light; testing lamp, screw drivers and pliers; lantern slides, etc., as in Ch. I.

§ 121. For the historical summary of the use of the house, electric lighting system for the magic lantern, see the Appendix.

For works of reference see § 2. Consult also the Microscopical Journals, and the catalogues of manufacturers of projection apparatus.

MAGIC LANTERN WITH SMALL CURRENT ELECTRIC LIGHTS FOR LABORATORY AND HOME USE

§ 122. For public exhibitions and large lecture rooms special electric wiring and large current arc lamps are necessary, as described in Ch. I, II and XIII. For small audiences as in laboratories and for home use, where less than 100 people are usually present, very satisfactory results may be obtained by means of lighting apparatus drawing current from the ordinary house lighting system; and the electric current may be direct or alternating.

§ 123. **Kinds of lamps to be used with small currents.**—There are three forms of lamps which have been successful for use with the magic lantern drawing current from an ordinary lighting system:

(1) An arc lamp of small size using small carbons, i. e. carbons of 6 to 8 mm. ($\frac{1}{4}$ to $\frac{5}{16}$ in.) in diameter. A large arc lamp is equally available if it has long clamping screws, bushings or

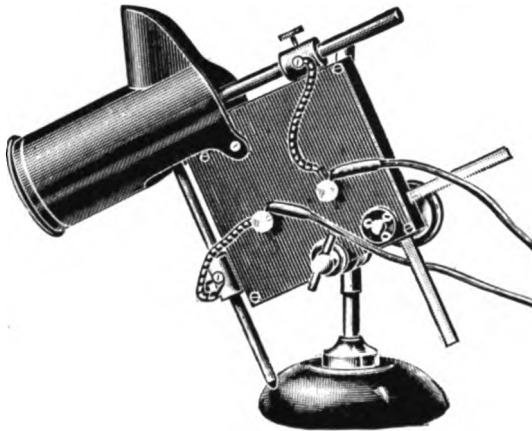

FIG. 41. THE LILIPUT ARC LAMP OF LEITZ.

This lamp was designed to use with the Edinger drawing apparatus and with the condenser for dark ground illumination, etc. Both carbons are moved equally by means of the rack and pinion movement. For direct current the horizontal or positive carbon is larger than the vertical or negative carbon in the proportion of 8 to 6.

The condensing lens in the tube is mounted in a telescoping sleeve. When the sleeve is in, the lens is at its principal focal distance from the crater, and gives a parallel beam of light. When the sleeve is pulled out more or less the condenser gives a converging beam of light.

For use with the magic lantern the tube and special condenser are removed, as shown in fig. 47.

adapters for the small carbons. Such carbons require from three to six amperes of current for the best effect (fig. 41-44).

- (2) A Nernst lamp with one or more filaments (fig. 54-55).
- (3) A Mazda lamp with concentrated filament (fig. 52).

The arc lamp is permanent. One has simply to renew the carbons when they are burned out.

If alternating current is used, carbons 150 mm. (6 in.) long and 8 mm. ($\frac{5}{16}$ in.) in diameter last about three hours.

If direct current is used the upper carbon is 8 mm. ($\frac{5}{16}$ in.) and the lower carbon 6 mm. ($\frac{1}{4}$ in.) in diameter. Both are 150 mm. (6 in.) long, and they last about three hours (§ 753a).

The Nernst and Mazda lamps are fragile and must be handled carefully. They have a working life of 500 hours, more or less, then a new lamp must be obtained.

§ 124. **Room for projection.**—Any room may be used at night, and this makes these magic lanterns especially adapted for the home.

In the daytime, of course, the room where they are used must have shutters or curtains so that it can be darkened.

§ 125. **Screen for the image.**—The screen need not be over three or four meters square (9-12 feet). For many purposes a large sheet of cardboard, 72 x 120 cm. (28 x 44 in.) makes the best possible screen (see Ch. XII).

For home use a white wall or a well stretched sheet will serve. If the screen is to be used frequently in the same place in the laboratory or home it is desirable to use a white wall or a regularly painted screen (see § 621-630).

§ 126. **The magic lantern and its support.**—Any of the good modern forms of magic lantern can be used. Special small and compact lanterns have been constructed for this purpose, and they are excellent and cheap (see prices in the appendix) (fig. 51-52).

For a lantern support any table of sufficient height may be used. A pile of books or an empty box on an ordinary table will serve to raise the lantern sufficiently.

ARC LAMPS FOR THE HOUSE CIRCUIT

§ 127. Small arc lamps, using small carbons only, are convenient; but the ordinary large arc lamp can be used if the screws for clamping the carbons are long enough, or by means of bushings or adapters for the small carbons (for wiring and rheostat, see § 128-129).

The small carbon arc lamps are easily managed, and the amount of light they give (see § 756) much more than offsets the attention they require over the other lamps used on the house circuit.

If a lamp must be purchased for use on the house circuit, one of small size is preferable. They are designed for the small carbons only. They are nearly always of the hand-feed type, but when direct current is available there are automatic lamps to be had. The Thompson automatic arc lamp, and the Bausch & Lomb

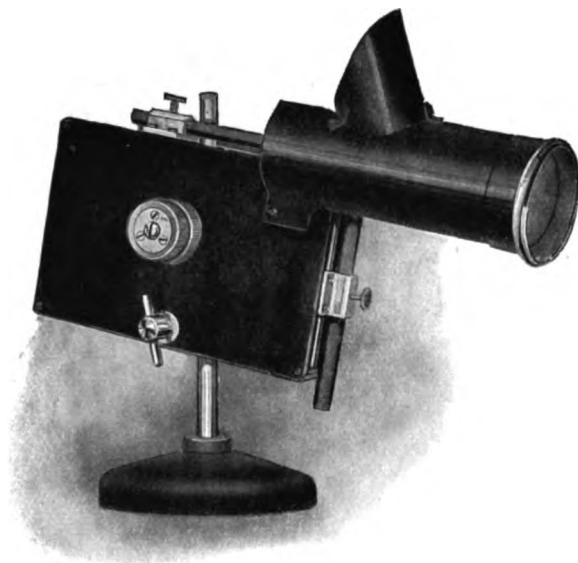

FIG. 42. THE SMALL ARC LAMP OF THE SPENCER LENS CO.

With this small arc lamp the two carbons may be moved separately or together, as the carbon movement is like that of the larger lamps, i. e., one shaft within the other, and the corresponding milled heads are placed close together, so that either can be turned separately or both together.

It is arranged for giving parallel or converging light. When used with the magic lantern the special condenser and its tube are removed (fig. 47).

automatic lamp are so adjusted, or may be so adjusted if desired, that they will work with currents ranging from 5 to 25 amperes (fig. 41-44).

The small lamps (from their size, called "Liliput or baby" arc lamps) are largely used for darkground illumination and ultra-microscopy and for drawing. For these purposes they have a tube attached with a condensing lens (fig. 41). For use with the magic lantern the tube and condensing lens are removed (fig. 1).

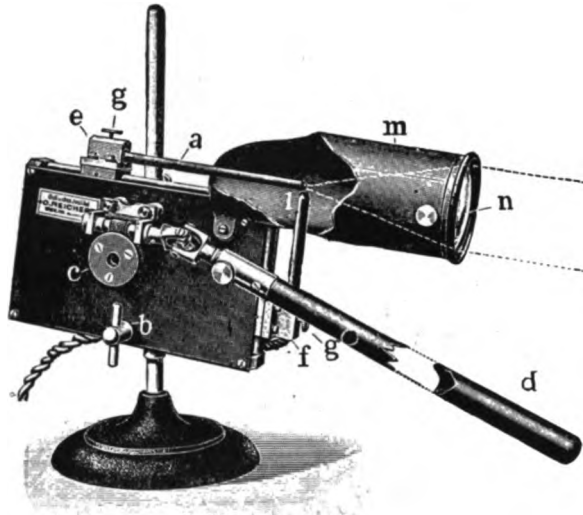

FIG. 43. THE SMALL ARC LAMP OF REICHERT.

This is arranged in the figure for giving a parallel beam of light from the small condenser; and the mechanism for feeding the carbons can be actuated at a distance by means of a Hooke's joint and rod.

- a* The horizontal or positive carbon.
- b* Clamp for holding the lamp to the upright at any desired height.
- c* Milled head of the feeding mechanism for the carbons.
- d* Rod extending from the Hooke's joint.
- e, f, g.* Holders and clamping screws for the carbons.
- l* Terminal points of the carbons where the arc is formed.
- m* The tube holding the condensing lens. It is cut away on one side to show the carbons.
- n* The condensing lens in the end of the tube. It is at the principal focal distance from the crater and the diverging beam is made parallel; by pulling it to the right the beam will be converging.

WIRING AND CONNECTING THE ARC LAMP WITH THE HOUSE CIRCUIT

§ 128. **Wiring.**—The wiring is in principle exactly as for the large current arc lamp (fig. 1, 2, 45).

One end of a double, flexible cable of sufficient length (2 meters, 6 ft. at least) is connected with a separable attachment plug (fig. 49). The two wires near the other end of the cable are separated for a short distance, and one wire is cut. The cut ends of this wire

are then inserted into the binding posts of the rheostat (fig. 45). This puts the rheostat along one supply wire (in series).

The cut ends of the cable are then connected with the binding posts of the arc lamp (fig. 45). For polarity see § 701.

§ 129. **Rheostat or other balancing device.**—As with the arc lamp for heavy currents, those to be used on the house circuit must also have a balancing device of some sort like a rheostat. It must be in *one wire* (fig. 45).

Never try to use an arc lamp on any circuit without a rheostat or other balancing device. If one is not used the fuses will be burned out.

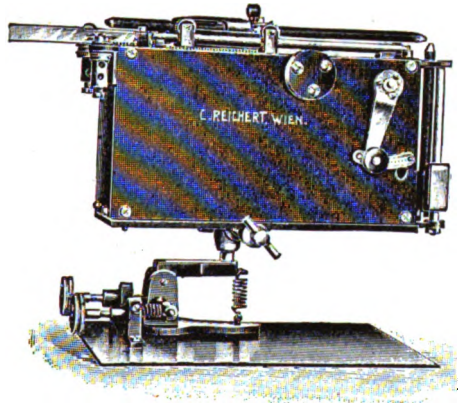

FIG. 44. REICHERT'S AUTOMATIC ARC LAMP FOR USE ON THE HOUSE LIGHTING SYSTEM IF DIRECT CURRENT IS AVAILABLE.

At the bottom are screws for fine adjustment, laterally or vertically.

§ 128a. In modern wiring for incandescent lamps each group of not over 16, or in special cases not over 32, lamp sockets must be protected by a fuse or cut-out. The wire must be equivalent to a copper wire No. 14 or No. 18 B. & S. gauge, and the fuse or cut-out must be for not over 10 amperes (usually 6 amperes) for a 110 volt circuit. This is sufficient for the small arc lamp.

In the older constructions where only one to three lamps were on a single line, very weak fuses were used which would melt if over two or three amperes were drawn from the line. Naturally, on a house circuit thus wired and fused, the fuses would be burned out if one tried to use the small arc lamp upon it, for that rarely draws less than four amperes and often as many as six.

In using the arc lamp on the house circuit it is therefore necessary to make sure that the wiring and fuses are of sufficient capacity for the current needed.

The rheostat needed for the small-current, arc lamp is small and inexpensive. It need not be adjustable. One has only to be certain that it will not deliver a current above five or six amperes.

In purchasing a rheostat for the house circuit, tell the manufacturer the kind of current (direct or alternating) and the voltage (110 or 220). If one does not know the character and voltage of his house circuit the information can be obtained at the office of the company furnishing the current.

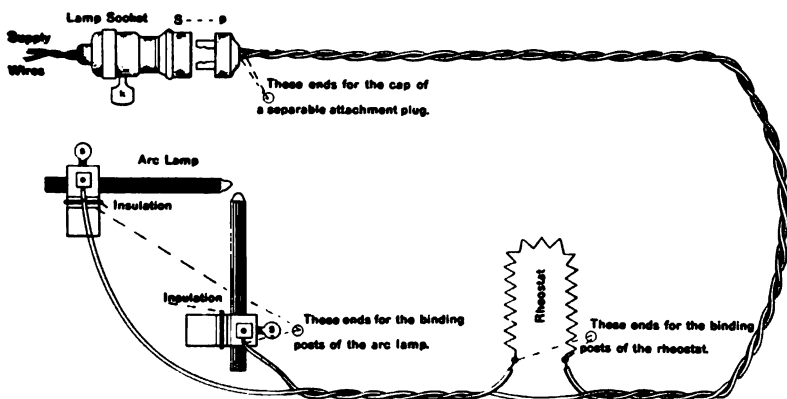

FIG. 45. WIRING AND CONNECTIONS OF THE ARC LAMP USED ON THE HOUSE LIGHTING SYSTEM.

§ 130. **Polarity with the arc lamp.**—With alternating current both wires are the same (see § 103 and 653), but with direct current one of the wires is positive and one negative, and the positive wire must be connected with the binding post for the upper carbon. The most practical ways of determining the polarity are described in Ch. I, § 80; Ch. XIII, § 702.

In case the lower carbon shows the brightest crater it is positive and hence the polarity wrong. If the separable attachment plug is of the polarized form, separate the two parts thus turning off the current. Then reverse the position of the wires in the binding posts of the lamp. This will connect the positive wire with the upper carbon as it should be. A simple way, if non-polarized plugs

are used (fig. 49B), is to leave the wires as they are in the lamp, but pull the separable plug apart and turn it half way round. This will reverse the position of the connections so that the polarity will be found correct on lighting the lamp again.

When the correct polarity has been obtained at one particular lamp socket it is well to make a straight line with a glass pencil, a pen or a brush across the socket, and the two parts of the separable plug, then the correct connections can be made with that socket at any time without trouble.

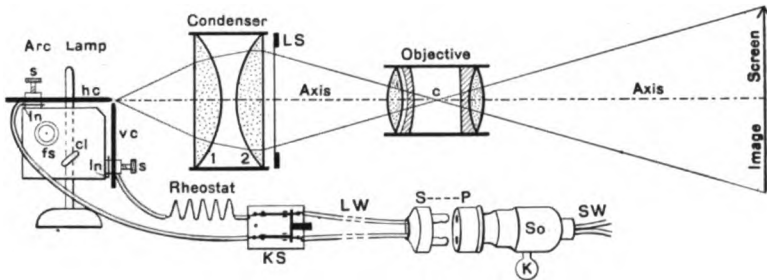

FIG. 46. THE MAGIC LANTERN FOR USE ON THE HOUSE LIGHTING SYSTEM.

- SW* Supply wires to the lamp socket (So).
- So, K* The lamp socket with the key switch.
- S—P* Separable attachment plug. The cap has been removed to show the metal prongs serving to make the contact.
- L W* Wires connecting the cap of the separable plug with the knife switch. (*K S*). As shown in fig. 45, 47, the knife switch is more frequently omitted.
- K S* Double-pole knife switch for opening and closing the circuit.
- Rheostat* For controlling the current. It is in one wire.
- Arc Lamp* This is one of the small forms.
- s s* Set screws for holding the carbons in place.
- h c* Horizontal or upper carbon.
- v c* Vertical or lower carbon.
- In In* Insulation between the carbon holders and the rest of the lamp to compel the current to follow the carbons, and not to short circuit.
- fs fs* Feeding screws for moving the carbons.
- cl cl* Clamp to fix the lamp at any desired position on the vertical rod.
- Condenser* The two-lens condenser for illuminating the lantern slide.
- 1 2* The two plano-convex lenses with their curved surfaces facing each other.
- L S* Lantern slide close to the condenser.
- Axis Axis* The principal optic axis of the condenser and the objective.
- Objective* The projection objective for giving the screen image.
- Image Screen* The white screen on which the image is projected.

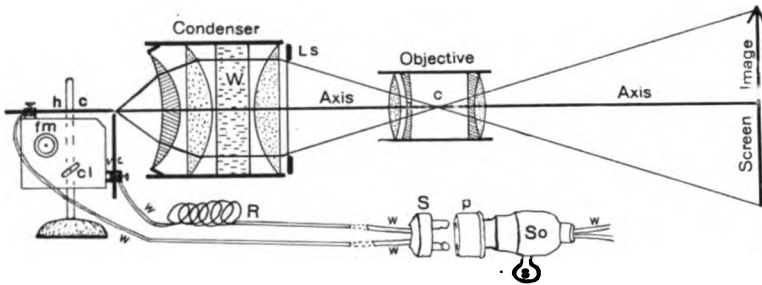

FIG. 47. THE MAGIC LANTERN WITH A THREE-LENS CONDENSER AND A WATER-CELL FOR USE ON THE HOUSE LIGHTING SYSTEM.

This is the same as fig. 46 except that no double-pole knife switch is used, and there is a triple-lens condenser and water-cell in place of a double-lens condenser.

It is well also, when one has the lamp properly connected, to turn off the current by opening the separable plug, and then paint the positive wire red where it is inserted into the binding post for the upper carbon. The negative wire can be painted black also. If

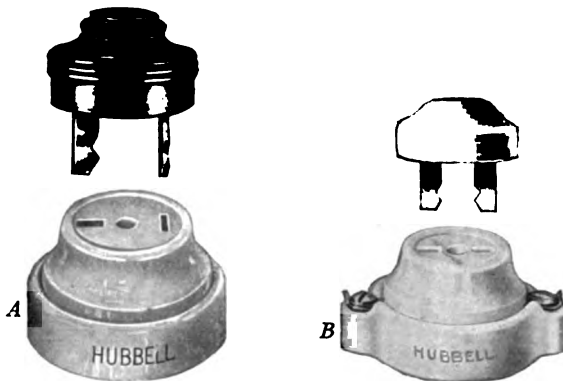

FIG. 48. WALL RECEPTACLES WITH SEPARABLE CAP.
(Cuts loaned by H. Hubbell, Inc.).

A Wall receptacle with the connecting prongs polarized so that the cap can be put on only one way, thus avoiding change of polarity with direct current.

B Wall receptacle in which the cap can be put in place either way around. Either form can be used with both direct and alternating current.

these precautions are taken, it will be very simple to connect up the lamp correctly at any time.

"Polarized attachment and extension plugs" are made (fig. 48A, 49A). These can only be put together one way. They are very convenient for direct current connections; they are also equally adapted for alternating current.

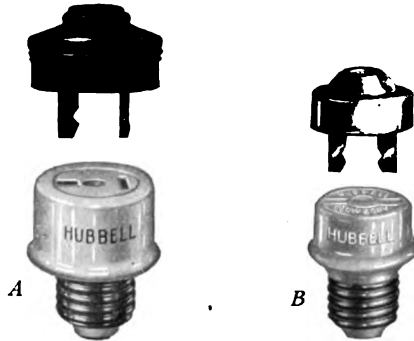

FIG. 49. SEPARABLE ATTACHMENT PLUGS.
(Cuts loaned by H. Hubbell, Inc.).

A Polarized, separable plug for a lamp socket. The metal prongs are in planes at right angles and hence can be inserted in only one way, thus avoiding change of polarity with direct current.

B Non-polarized attachment plug. The connection can be made either way around as the prongs are in the same plane.



FIG. 50. SEPARABLE EXTENSION CONNECTOR.
(Cut loaned by H. Hubbell, Inc.).

This is to enable one to extend the line by joining separate cables. These extension connectors can be had with polarized or non-polarized prongs to the cap.

§ 131. **Carbons for small currents; feeding the carbons.**—For the small currents used with the house circuit, the carbons should be small. For alternating current of five to six amperes, 8 mm. carbons answer well. For three to four amperes the carbons should not be over 6 mm. in diameter.

For direct current the two carbons must be of different size if the feeding mechanism of the lamp moves the carbons equally. With an equal feeding mechanism, the upper or positive carbon can be 7 mm., the lower one 5 mm., or the upper 8 mm. and the lower one 6 mm.

One could use carbons of the same diameter for direct current, but it would be necessary to feed the upper or positive one more rapidly than the lower one on account of the unequal rate of burning, otherwise the correct relative position of the carbons would not be maintained (fig. 24-25). On a 110 volt, direct current circuit, the lamp will burn about six minutes without going out. The carbons should be fed up every three to five minutes.

For alternating current of 110 volts, the small lamps will burn from eight to ten minutes, sometimes longer. It is well to feed the carbons every five to seven minutes.

In case a choke-coil is used (Ch. XIII, § 736), the lamp burns more quietly and will burn longer without being fed. If a step-down transformer is used, then the right-angled lamp will not burn so long—only one to two minutes—while a lamp with inclined carbons will burn three minutes, because it takes a higher voltage to maintain the right-angled than the inclined carbon arc (see Ch. XIII, § 753, 768).

TURNING THE ARC LAMP ON AND OFF

§ 132. **Lighting the small arc lamp.**—For this, make sure that the carbons are *not in contact*. Now turn the switch for the room lights and the snap switch in the socket where the separable attachment plug for the lamp wiring is screwed in. Feed the carbons together until they touch. There should be a flash of light. Separate the carbons two or three millimeters as soon as the flash is seen and the arc will be established and the light will be at full brilliance. Sometimes it is necessary to keep the carbons almost in contact for a half minute or so, until the tips are well heated, before the arc will burn. If on separating the carbons the light goes out, they must be brought together again as at first.

§ 133. **Turning off the small arc lamp.**—The snap or key switch in the usual incandescent lamp socket is designed to break the circuit where, at most, two amperes are used. These key switches, if used to interrupt a relatively large current, like that used for the small arc lamp, are liable to start an arc within the socket. If such an arc is started, the socket will be short circuited, resulting either in the burning out of a fuse, the burning out of the socket or something more serious.

The liability of a socket to arc is much greater with direct than with alternating current. The liability to arc is also much greater if the key switch is turned slowly than when it is turned quickly.

By observing the following directions the current may be turned off with perfect safety:

(1) Turn off the current by separating the carbons until the lamp goes out, then the key switch may be used, or a plug or extension pulled apart.

(2) Turn off the current by pulling the separable plug or the separable extension apart (fig. 49-50).

(3) Make use of a knife- or snap-switch (fig. 1, 2, 40).

(4) Do not turn off the current by the key switch in the bulb socket. When the lamp is out, it is safe to turn the key switch in the socket.

(5) Do not unscrew a plug to turn off the light, for the break in the circuit is so slow that an arc will almost certainly be formed.

§ 134. **What to do in case the key switch is used and an arc is formed in the socket:**

(1) Turn the key on again as quickly as possible.

(2) If the arc lamp is still burning after turning on the key switch, turn the lamp off by method 1 to 3 (§ 133).

(3) Go to the nearest room switch and turn off the current.

In case a fuse is blown out—which is almost sure to occur if an arc is formed in the socket—or if the lamp socket is burned out, it is wise to call in an electrician to make the necessary repairs. This, of course, assumes that the user has not the technical knowledge necessary to make the corrections himself. It is further

assumed that if he had possessed the technical knowledge no mistakes, and hence no accident would have happened.

§ 135. **Use of the small arc lamp for demonstrations and exhibitions.**—The centering of the apparatus to one axis, and using the correctly proportioned condenser and projection objective, the lighting and putting out the lamp, arrangement and insertion of lantern slides, etc., are all exactly as described in Ch. I, II (§ 26-41, 52, 112).

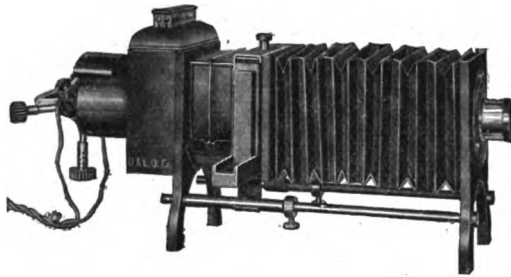

FIG. 51. MAGIC LANTERN WITH SMALL ARC LAMP.
(*Balopticon B.*; Cut loaned by the Bausch & Lomb Optical Co.).

MAGIC LANTERN WITH A MAZDA, CONCENTRATED FILAMENT INCANDESCENT LAMP

§ 136. Next to the arc lamp the Mazda concentrated filament lamp is perhaps the best electric light at present available. They are as simple to use as an ordinary incandescent bulb. No rheostat is necessary. The lamp is on a stand by which it may be raised and lowered and brought the proper distance from the condenser (fig. 52-53).

§ 137. **Connections with the house circuit.**—This is made by a double flexible cable, one end of which is connected with a separable plug, and the other with the lamp socket of the Mazda lamp. As no rheostat is used, and as the light is turned on and off exactly as for any incandescent bulb, this light is absolutely simple in use. It gives a light sufficient for a small room, where not over 50 to 100 people are to watch the exhibition.

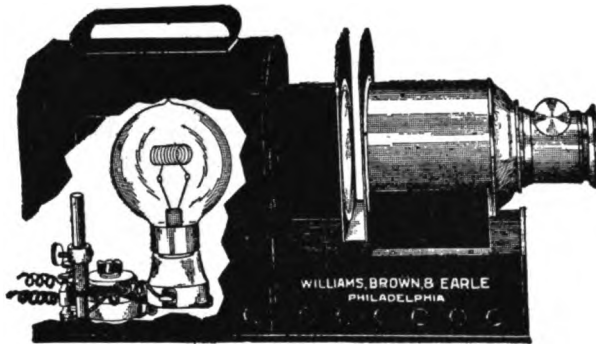

FIG. 52. SIMPLE MAGIC LANTERN WITH INCANDESCENT LAMP AS RADIANT.

(Cut loaned by Williams, Brown & Earle).

This is known as the "Society Incandescent Lantern No. 3 G." It is especially designed for use with permanently mounted lantern slides (fig. 15).

§ 138. **Centering and distance from the condenser.**—The centering along one axis is as with the arc lamp (§ 51).

In general the concentrated filament should be at the principal focal distance from the condenser. One can determine the best position by the use of a good lantern slide and changing the distance of light and condenser until the best position is found. It is well to mark that position for future use.

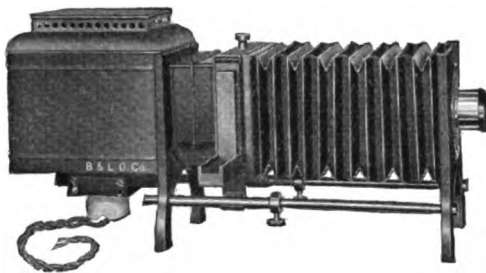

FIG. 53. MAGIC LANTERN WITH MAZDA LAMP.

(Balopticon B.; Cut loaned by the Bausch & Lomb Optical Co.).

This lantern can be used with the small arc lamp on the house lighting system, with the Mazda incandescent lamp or with acetylene.

§139. **Management of an exhibition with the Mazda lamp.**—The exhibition should be managed as for the arc light (§ 26-41).

One must remember that with this relatively weak light only a small screen image should be attempted, and that the room must be relatively darker than for the arc light. In brilliancy the screen images will be more like that of the old lanternists with their weak lights. Clear lantern slides are especially desirable. The very opaque lantern slides sometimes met with can only be well shown by a large arc lamp.

MAGIC LANTERN WITH A NERNST AUTOMATIC LAMP

§ 140. This is also an excellent lamp to use with a magic lantern in a small room. Some forms are automatic in starting when the current is turned on, and some have to be specially heated. The automatic form is to be preferred, for it is no more trouble to run than an ordinary incandescent lamp. It takes some time, usually one to three minutes, for the glowers to come to full brilliancy after the current is turned on. They are made for the lantern with one, two, three and four filaments or glowers. The single glower approximates most closely to the arc lamp in the smallness of the source of light. Of course, with the multiple glower lamps a greater amount of light is given off, but they make an extended source. Whether the lamp has one or more filaments it can be attached directly to the house lighting system through any incandescent bulb socket as described for the Mazda lamp (§ 137).

§ 141. **Rheostat or ballast for the Nernst lamp.**—This lamp like the arc lamp is always used with a balancing device, but unlike the arc lamp, the ballast is an integral part of the lamp as purchased, and not a separate apparatus as with the arc light (fig. 54, 55 and 1).

The glowers and the ballast must be adapted to each other and both must be adapted to the line voltage.

The ballasts, which are enclosed in a vacuum glass, as with an incandescent bulb, sometimes burn out. The filaments will not then glow when the current is turned on. If a ballast burns out it must be replaced by a perfect one.

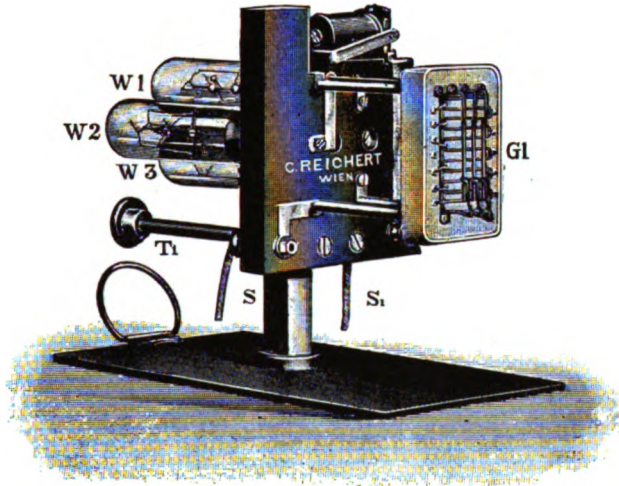

FIG. 54. NERNST LAMP FOR THE MAGIC LANTERN (REICHERT).

This is on a support and has a rack and pinion for raising and lowering the lamp. It is automatic.

G The three filaments or glowers with this lamp.

*S S*₁ The two supply wires from the house circuit.

*T*₁ Pinion and milled head of the rack work.

*W*₁, *W*₂, *W*₃ The three ballast tubes.

§ 142. **Centering and distance from the condenser with the Nernst lamp.**—The lamp must be centered with the condenser and objective as described in Ch. I (§ 51+). It must have some form of support with means of raising and lowering the lamp. The distance of the lamp from the condenser which gives the best illumination can be determined as follows: Light the lamp, put a good lantern slide in the lantern, then move the lamp up toward the condenser, shifting it back and forth until the best screen image is produced. In general, it will be found that this results when the glower is at about the principal focal distance from the condenser. When the best position is found the place should be clearly marked, then the lamp can be put in this position quickly at any time.

§ 143. **Connecting the lamp with the house circuit; alternating current.**—This is done by means of a flexible conductor connected

with the lamp at one end, and a separable plug at the other (fig. 49A). The plug is of standard size and can be screwed into the socket or receptacle of any incandescent lamp.

To light the lamp turn the key switch of the socket as for an incandescent lamp, and in a minute or longer the glower or glowers will attain their full brilliancy, and one can use the lamp as long as desired without further attention.



FIG. 55. NERNST LAMP OR SCHWANN-LIGHT.
(Cut loaned by the Chas. Besler Co.).

If one uses a three or four glower lamp drawing about four amperes of current there might be a short circuit in the incandescent lamp socket if the snap switch were turned off slowly. If that is used, turn it as quickly as possible (see § 133). Pulling the separable attachment plug apart will avoid all danger (§ 133).

§ 144. **Nernst lamp and direct current.**—If one has a direct current lighting system, then the Nernst lamp must be adapted to that, and must be connected properly as with the direct current arc lamp. The two connections with the lamp are marked, plus (+) and minus (—); or positive (P) and negative (N); and the corre-

sponding wires must be attached to these lamp binding posts or connections, or the lamp will soon burn out. Unfortunately, one cannot tell by simple observation when the wires are connected properly, as for the arc lamp; but he must determine the polarity of the wires before connecting them with the lamp (see Ch. XIII, § 701-703).

§ 145. Marking the wires and attachments after determining the polarity with the direct current system.—When the polarity of the wires is determined, if one is to use the same place for current repeatedly, it is a good plan to mark the position of the socket and the two parts of the separable plug by a straight line of colored paint when all are in position. Then it will be easy to connect up the parts correctly at any future time. Then if the positive wire has its insulation material colored red, at least at the lamp end, it will enable one to connect up with that particular socket correctly at any future time. It is also a convenience to have polarized separable plugs (fig. 49A), then the two parts of the plug cannot be reversed if they should become separated. On the other hand, if the attached part is left in place and the cap or removable part pulled off, one can make the connection correctly at any time without trouble, as it cannot be put together wrong.

Unfortunately, one cannot be sure that a separable plug and the lead wires connected to the lamp properly for one incandescent socket will be so for any other, and one must determine the polarity for each socket.

An alternating current is more satisfactory for the Nernst lamp than a direct current, for with the alternating current one does not have to trouble about the polarity of the two wires, since both are alike.

§ 146. Management of an exhibition with the Nernst light.—This is precisely as for any other magic lantern radiant except that the lamp must be started three to four minutes before it is needed, for it may take that time to get good illumination. Furthermore, it is better to leave the light burning during the entire lecture, so that there will be no delays. The light can be shut off the screen during the intervals with the objective shield (fig. 14).

§ 147. **Troubles with the magic lantern on the house lighting system.**—With the arc lamp these are the same as those indicated in Ch. I, § 62-98; Ch. II, § 116-118. See also § 128a for fuses. There is also the danger of starting an arc in the incandescent socket from which the current is drawn unless the precautions given in § 133 for turning out the light are observed.

For all the lights the management of the exhibition, centering of apparatus, etc., are the same as for the lanterns in Ch. I, II.

The most striking difficulty will probably be the comparatively dim screen pictures as compared with the brilliant screen images given by the large current arc lamp.

The room must be darker and the screen picture smaller with these lights.

The Mazda lamp may go out on account of the breakage of some of the connections within the bulb. If this happens the only thing to do is to use a new lamp. It is wise to have several on hand.

With the Nernst lamp also some of the connections are liable to break, or the ballast may burn out, or the glower be broken. Usually only the defective parts must be renewed, and not an entirely new lamp obtained.

§ 148. Summary of Chapter III:

Do

1. Find out the kind of current used in the house lighting system and the voltage (alternating or direct current; voltage 110 or 220).

2. Wire the small arc lamp exactly as the large arc lamp is wired (fig. 40).

3. Always use a rheostat or some other balancing device with the arc lamp (§ 129).

4. Use small carbons for the arc lamp on the house circuit (§ 131).

5. Make sure of the polarity if direct current is used (§ 701-703).

6. Follow carefully the directions for lighting the arc lamp (§ 132).

7. Be very careful to turn off the arc lamp by one of the safe methods (§ 133).

8. Make the room darker for the small arc lamp than for the large one, and have a smaller screen picture (§ 139).

Do Not

1. Do not try to use an arc lamp on the house circuit without knowing the kind of current and the voltage.

2. Do not wire the small lamp differently from the large lamp except that smaller wire can be used.

3. Never use the arc lamp without a proper balancing device.

4. Do not use large carbons for the lamp on the house circuit, they would not heat enough to give a good light.

5. Do not worry about the polarity if alternating current is used. If direct current is used the polarity must be attended to so that the upper carbon is positive.

6. Do not have the carbons in contact when turning on the current.

7. Do not turn off the arc lamp by the socket switch.

8. Do not expect so much of the small as of the large current arc lamp. Do not have the room too light for the small lamp.

Do

1. Wire for the Mazda lamp exactly as for any incandescent bulb lamp.

2. Turn the lamp on and off by the key switch as for any incandescent lamp.

3. As this light is relatively dim, make the room dark and project a small picture.

It is also wise to have one or more extra bulbs in case one burns out.

4. Turn the lamp on and off whenever desired as it gives full brilliancy in an instant.

Do Not

1. Do not use a rheostat with a Mazda lamp.

2. Do not take any more trouble with the concentrated filament Mazda than for any bulb lamp.

3. Do not try to make too large a screen picture; and do not have the room as light as for the arc lamp.

4. Do not let the lamp burn all the time during an intermittent exhibition any more than with the arc lamp.

Do

1. Find out the kind of current and the voltage wherever a Nernst lamp is to be used.

2. Purchase a Nernst lamp adapted to the current with which it must be used.

3. A special rheostat or ballast forms a part of every Nernst lamp for projection.

Do Not

1. Do not use a Nernst lamp with a current and voltage for which it was not constructed.

2. Do not purchase a Nernst lamp for direct current if it must be used on an alternating current line.

3. Do not insert a separate rheostat in the wiring for a Nernst lamp.

4. Wire the Nernst lamp just as the arc lamp is wired except that no separate rheostat is inserted. Wire the Nernst lamp for alternating current just as a Mazda incandescent lamp is wired.

5. Wire the Nernst lamp for direct current with the positive wire in the binding post marked + or P, i. e., the same as a direct current arc lamp is wired, except that no separate rheostat is included (§ 141).

6. Determine the polarity of the supply wires with precision and care (§ 701-703).

7. Let the Nernst lamp burn during the entire exhibition, as it takes from one to three minutes for the light to reach full brilliancy.

8. Shut the light off the screen when not needed, by the objective shield (fig. 14).

9. Handle the Nernst lamp carefully, as it is easily injured.

10. Manage the exhibition with a Nernst lamp as with any other light, remembering the need of a dark room and a screen picture of moderate size for this relatively weak light.

4. Do not worry about polarity in wiring the Nernst lamp for an alternating current system.

5. For a direct current circuit, do not put the positive wire in the negative binding post of the Nernst lamp.

6. Do not neglect the polarity of the two wires on a direct current circuit.

7. Do not turn the Nernst lamp out during an exhibition for it takes too long to light it.

8. Do not forget to use the objective shield for shutting the light off the screen when it is not needed.

9. Do not handle the Nernst lamp roughly. It is delicate.

10. Do not expect too much of a Nernst lamp with the magic lantern. One cannot have the room so light, nor project such large screen pictures, nor use such dark lantern slides as with the arc lamp.

CHAPTER IV

THE MAGIC LANTERN WITH THE LIME LIGHT AND ITS USE

§ 150. Apparatus and material for Chapter IV:

Suitable room with screen (Ch. XII); Magic lantern with a suitable lamp-house and a lime-light burner (fig. 56-59); Cylinders of compressed Oxygen and Hydrogen (§ 154-155); Lime or other refractory substance for giving the light (§ 153, 157); Oxygen generator and ether saturator (§ 177-179); Objective shield (fig. 14, 62, § 169); Tubes for making the connections (§ 159, 159a); Flash-light, screw drivers and pliers, asbestos-patch gloves (fig. 61); lantern slides, etc.; Matches or gas lighters (§ 160).

§ 151. For the discovery that oxygen and hydrogen burning together give a very hot flame, and that dazzling light is produced by directing the flame against lime, etc., and the application to the magic lantern, see the Appendix.

For works of reference see Chapter I, § 2.

THE LIME LIGHT FOR THE MAGIC LANTERN

§ 152. The Magic Lantern used with the lime light is in every way like the standard magic lantern with the direct current arc lamp with the single difference of the source of light.

§ 153. **The lime light.**—This is one of the most brilliant available lights for projection purposes. It is produced by directing the exceedingly hot flame of hydrogen burning in oxygen against a piece of unslaked lime. The oxy-hydrogen flame in itself is not brilliant, but the heated lime gives a light of dazzling brilliancy from a very small area; hence it is especially well adapted for projection with the magic lantern and the projection microscope.

If the candle-power of a lime light is compared with the other lights used for projection it will be seen that it stands third, sunlight being first and the arc light second.

Hydrogen is not always used, but illuminating gas, the vapor of alcohol, ether or gasoline sometimes takes its place.

Unslaked lime is not the only refractory substance which gives great incandescence. Zirconium discs and discs made of the mix-

ture of thorium and cerium such as is used in Welsbach mantles have been employed. Nothing gives a more brilliant incandescence than the unslaked lime, but it deteriorates rapidly by absorbing moisture when exposed to the air. This is not the case with zircon and thorium; the discs of these may be used over and over, sometimes hundreds of times, while with the limes one usually has to put a new one in place every time the lantern is used (§ 153a).

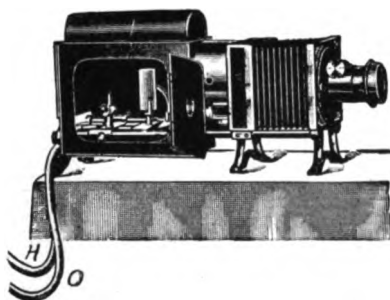

FIG. 56. MAGIC LANTERN WITH THE LIME LIGHT.

(From the Catalogue of the Enterprise Opt. Mfg. Co.)

The door of the lamp-house is open, showing the burner with the lime in position.

H The hydrogen supply tube, extending to the burner.

O The oxygen supply tube, extending to the burner.

§ 154. **Oxygen gas in steel cylinders.**—This is now a great article of commerce. Nearly every large drug store keeps one or more of them in stock for the use of physicians. The steel cylinders for containing oxygen were formerly large and contained oxygen under a pressure of about 17 atmospheres (250 pounds per square inch). Such cylinders are still used; but at the present

§ 153a. There has lately been introduced a substitute for limes, known as Guil Pastils. These are rather soft white cylinders of a substance giving great brilliancy when used in place of lime. The Guil pastil is put into the holder so that the end is heated, hence the lamp should be in the form shown in fig. 57 K, not as in fig. 56 or 59 L. The Guil pastil serves for 10 to 20 exhibitions. It is composed mostly of a zirconium compound and is not hurt by exposure to the air. It should be heated up gradually as directed for the limes (§ 162).—*Moving Picture World*, June 13, 1914, p. 1539.

time smaller cylinders with the gas at a much higher pressure (100 to 120 atmospheres) are employed (see also § 156). In using the gas it is drawn off through a reducing valve by which it can be delivered at any pressure desired, and of course in any volume desired.

One should never try to use the gas without drawing it through the reducing valve. The cylinders have special junctions for the reducing valve, so that it is easy to make the connections.

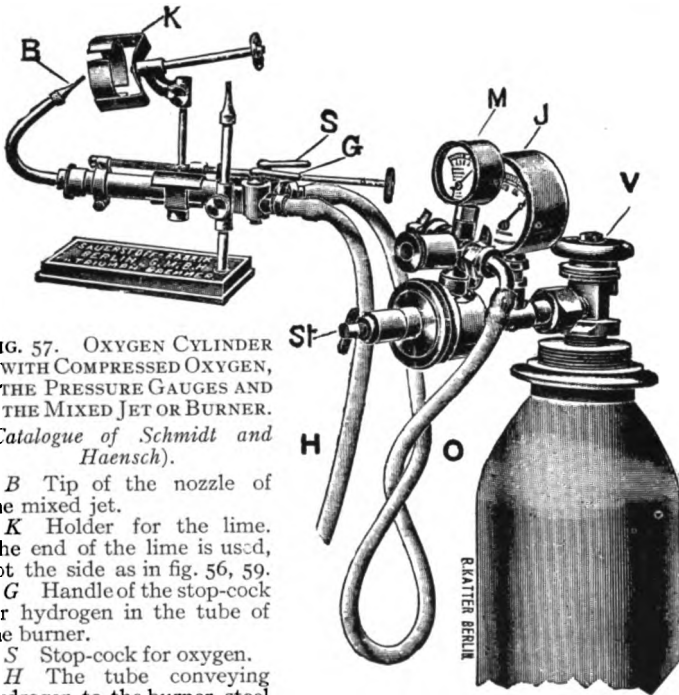

FIG. 57. OXYGEN CYLINDER WITH COMPRESSED OXYGEN, THE PRESSURE GAUGES AND THE MIXED JET OR BURNER. (*Catalogue of Schmidt and Haensch*).

B Tip of the nozzle of the mixed jet.

K Holder for the lime. The end of the lime is used, not the side as in fig. 56, 59.

G Handle of the stop-cock for hydrogen in the tube of the burner.

S Stop-cock for oxygen.

H The tube conveying hydrogen to the burner, steel cylinder not shown.

O Tube conveying oxygen from the steel cylinder to the burner.

J The high pressure gauge giving the number of atmospheres under which the gas in the cylinder is compressed.

M The low pressure gauge to show the pressure of the gas after it has passed the pressure reducing valve (*St.*).

St. The handle of the valve serving to open the pressure reducing apparatus.

V The valve of the cylinder. This must be opened to allow the compressed gas to escape into the tube passing to the reducing valve and to the high pressure gauge. It must be closed after every exhibition.

In Great Britain and on the Continent oxygen cylinders are, by common usage, painted black, and the screw threads are right-handed.

Hydrogen cylinders are painted red, and their screw threads are left-handed.

In the United States of America this uniformity of color and distinction of screw threads is not always found.

§ 155. Hydrogen in steel cylinders.—Hydrogen gas is also compressed in steel cylinders, and forms an article of commerce. It must also be drawn off through a pressure reducing valve.

Every precaution should be taken to avoid mixing the two gases in large quantities. Safety lies in mixing the gases only at the moment of exit from the two tubes of the blow-through jet or in the small mixing chamber of the mixed jet.

§ 156. Pressure gauges for gas cylinders.—While a pressure reducing valve is a practical necessity, the pressure gauges are highly desirable.

The one beyond the pressure reducing valve is a low pressure gauge and may indicate the pressure in millimeters of mercury or in centimeters of water (or, of course, in inches of water or mercury). This shows the pressure under which the gas is actually being used.

The gauge next the cylinder registers the full pressure within. The figures on the dial usually represent atmospheres of pressure, one atmosphere being 760 mm. of mercury. The special purpose of this gauge is to enable one to determine the amount of gas in the cylinder at any given time, hence it is sometimes called a "capacity meter" or a "finimeter."

If the pressure gauge does not indicate directly the atmospheric pressure, it may give the number of pounds per square inch or the number of kilograms per square centimeter. To change these to atmospheres one can use the approximate values: 15 lbs. per square inch = 1 atmosphere; or 1 kilo per square centimeter = 1 atmosphere (§ 156a).

§ 156a. The exact values are:

One atmosphere equals 14.73 pounds per square inch.

One atmosphere equals 1.033 kilograms per square centimeter.

For example, suppose the pressure gauge indicates 1800 lbs. per square inch, then it would be under a pressure of $1800 \div 15 = 120$ atmospheres.

If the pressure gauge should read 100 kilograms per square centimeter, then it would be under approximately 100 atmospheres pressure.

From Boyle's law of the relation between the volume of a gas and the pressure to which it is subjected it is known that if one starts with a cylinder holding five liters of oxygen or hydrogen, or indeed of any other gas, under one atmosphere pressure, it will hold twice as much under two atmospheres, etc., so that a cylinder of five liters capacity at one atmosphere, will hold 500 liters at 100 atmospheres pressure. Now to determine the amount of gas present in a given cylinder with the high pressure gauge one must know the capacity of the cylinder under the ordinary atmospheric pressure, and multiply this amount by the number of atmospheres of pressure indicated on the gauge. For example, if the capacity of the cylinder is 10 liters at one atmosphere (often called no pressure) and the high pressure gauge indicates that the gas in the cylinder is under a pressure of 25 atmospheres, then the amount of gas is $10 \times 25 = 250$ liters of gas; and so in like manner with any other pressure. For example, in England, the cylinders are filled under 120 atmospheres pressure; this would give in the above case $10 \times 120 = 1200$ liters to the full cylinder.

On the Continent, the filling pressure is often 100 atmospheres and the cylinder of the same capacity would then contain $10 \times 100 = 1000$ liters of the gas.

The practical application of this knowledge is to determine in a given case whether there is sufficient of the gases present for the exhibition. Authors differ somewhat in estimating the amount of gas used per hour with the lime light lantern. A conservative estimate would be, for oxygen, 85 liters (about three cubic feet) and, for hydrogen, something over twice that volume, as, in practice, there is an excess of hydrogen (§ 161).

§ 157. **Limes.**—The masses of unslaked lime (calcium oxid) used for the lime light are usually cylindrical in form. For some

burners they are placed on a pin or axle, and then must have a corresponding central hole. With other burners they are pressed into place between surrounding springs, somewhat as a lamp chimney is put on its burner (fig. 57, 59).

The limes are sealed hermetically in glass tubes, or are packed in powdered unslaked lime, in air-tight tin cans, to prevent the access of moisture.

If moisture reaches the limes they will slake and become powdery and useless for the light. To avoid any moisture reaching them they should not be removed from their protective covering until a few minutes before they are to be used.

§ 158. **Lamp for the lime light.**—This consists of a burner or jet for conducting the two gases, oxygen and hydrogen, to a point where they can be mixed and burned; and a device for holding the lime in a proper position, and raising, lowering, rotating and adjusting the lime with reference to the burner.

There are two principal forms of burner or jet:

(1) *The blow-through jet.*—In this a stream of oxygen is blown into a flame of hydrogen on the principle of the gas or alcohol blow-pipe (fig. 58).

(2) *Mixed jet.*—In this form the two gases (oxygen and hydrogen) meet and mix in a common chamber just before the nozzle

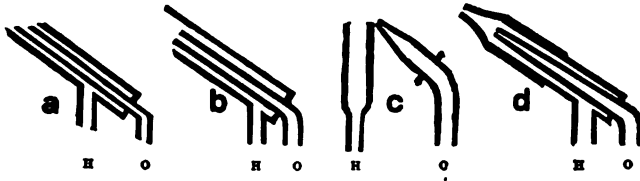

FIG. 58. FORMS OF BLOW-THROUGH JETS (*Lewis Wright*).

The form *c* shows best that the principle is that of a blowpipe.

The form *d* approaches the mixed jet somewhat.

With all of them the hydrogen, or hydrogen substitute (illuminating gas, ether or gasoline vapor) passes out from the supply through the tube marked *H* at the left. The oxygen is then blown through the flame from the tube at the right marked *O*. Not so much light can be got with these jets as with the mixed jet, but for illuminating gas or ether vapor, etc., this form, especially *a*, *b*, *c* is safer in the hands of amateurs than the mixed jet.

opens; then the mixed gases burn on emergence from the nozzle (fig. 59). This form of jet gives the greater amount of light but the two gases should be under considerable pressure. The tip of the nozzle (fig. 59 N) makes an angle of 40 or 45 degrees with the lime. This gives a source of light above the tip of the nozzle, and hence there is free passage for the light to the condenser.

The blow-through jet is usually 10 to 15 mm. ($\frac{1}{2}$ inch) from the lime while for the mixed jet the nozzle is within about 3 mm. ($\frac{1}{8}$ inch) of the lime.

MANAGEMENT OF THE LIME LIGHT

§ 159. Connecting the gases with the burner.—This is accomplished by means of rubber tubes of thick walls, and the ends of the tubes should be tied or wired to the supply pipes and to the burner (§ 159a).

It is a great advantage to have the two parts of conducting tubes of the burner of the same color as the gas tanks, viz., red for hydrogen and black for oxygen, then there will be less liability to error in connecting the gas supply.

It is only while using the gas that the cylinder valve (fig. 57 V) should be opened. And in opening it care should be taken to open slowly so that the sudden rush of the compressed gas may not injure the pressure gauges or the reducing valve.

When through with the cylinder at any time the cylinder valve V should be closed.

The pressure of the two gases should be about equal. This can be arranged by the pressure reducing valve. Set this to give the desired pressure, which ordinarily is equal to a column of water about 28 to 50 cm. high (11 to 22 inches) or 2 to 4 cm. of mercury ($\frac{3}{4}$ to $1\frac{1}{2}$ in. Hg) a pressure of .03 to .06 kilos per sq. cm. (.4 to .8 lbs. per sq. in.).

§ 160. Lighting the jet.—Turn on the hydrogen slightly and light it with a match or a cerium-iron gas lighter, then continue to

§ 159a. Flexible metallic tubes.—There is now available flexible metallic tubing with rubber connections at the ends to use in place of rubber tubes for conducting gases (fig. 60).

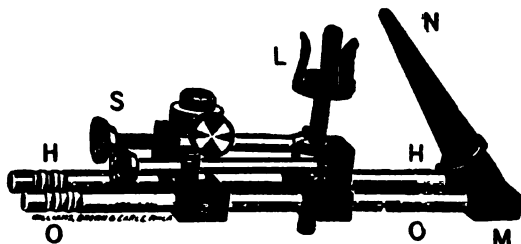

FIG. 59. MIXED BURNER OR JET FOR THE LIME LIGHT.

(From the Catalogue of Williams Brown & Earle).

H H The metal tube of the burner conveying the hydrogen to the mixing chamber (*M*). It should be painted red to correspond with the color of the hydrogen cylinder of compressed gas.

O O The metal tube conveying oxygen to the mixing chamber (*M*). It should be painted black to correspond with the color of the oxygen cylinder of compressed gas.

M The common chamber into which open the oxygen and hydrogen tubes. Here the gases mix before passing out through the nozzle (*N*).

N The nozzle or outlet tube from the mixing chamber. It is at an inclination of about 40 to 45 degrees with the vertically standing lime face; and when the burner is in action the nozzle and lime are about 3 mm. ($\frac{1}{8}$ th in.) apart.

L The support and springs for holding the lime.

S The milled heads of the pinions by which the lime is rotated or raised and lowered. The lime support slides back and forth on the supply tubes *O* and *H* so that the lime may be withdrawn from or made to approach the tip of the nozzle (*N*).

open the stop-cock until the flame is from 8 to 15 cm. (3–6 in.) long. Then turn on the oxygen slowly until the flame just commences to hiss. After the lamp has been going some minutes the operator can slightly increase or decrease the oxygen until the most brilliant light is obtained. One must learn by experience. The flame will become very small as the oxygen is turned on, and this small, intensely hot flame heats a very small part of the lime, hence the source of light is very small, something like the crater of the positive carbon in the direct current arc lamp.

Caution.—Always turn on the hydrogen first and light it before turning on the oxygen.

Never turn on the oxygen first, and never until the hydrogen has been lighted, and then turn it on slowly.

If both were turned on before lighting the hydrogen, there would be a greater or less explosion. This might not be very dangerous,

but it has a dangerous sound; and the purpose of the exhibition is to instruct or entertain, not to scare the audience. To insure the correct use of the gases it is a good plan to have the stop-cock handles of the two gases so different that one can tell by feeling which one is being turned on.

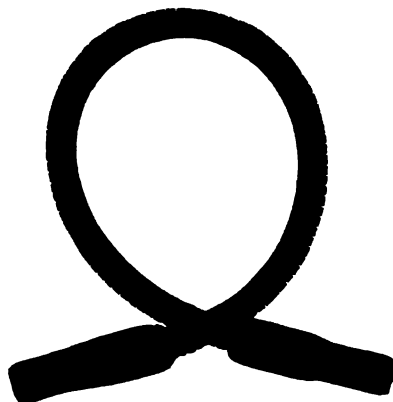

FIG. 60. FLEXIBLE METALLIC TUBING WITH RUBBER CONNECTORS AT THE ENDS.

(Cut loaned by the Pennsylvania Metallic Tubing Co.).

§ 161. **Regulating the flame.**—Theoretically the proportion of the two gases should be their combining quantities (H_2 , O); but experience has shown that better results are gained when the hydrogen is in excess. When the oxygen is in exactly the combining proportion there is liable to be a snap and the light goes out. If there is an excess of hydrogen this does not happen. As stated above, the oxygen should be added until the flame just begins to hiss.

§ 162. **Putting a lime in position.**—A fresh lime from the box should be put in position in the burner (fig. 59 L) before lighting the hydrogen, but the lime should at first be 3 to 5 cm. (1 to 2 in.) distant from the tip of the nozzle (fig. 59 N), and it should be rotated, raised and lowered until it is warmed. If the full heat of the O-H flame were directed against one point of the cold lime for too long a time the lime would be liable to break. After it is well

warmed up the lime is not liable to break. Some operators warm the lime by means of the hydrogen flame only. When the lime is warm the oxygen is turned on slowly until the most brilliant light is obtained.

§ 163. **Arranging the lime and the burner; rotating the lime.**—After warming the lime for half a minute or so it should be gradually brought toward the nozzle until it is only about 5 mm. ($\frac{1}{4}$ inch) distant. If now one watches the disc of light on the screen and slowly moves the lime slightly closer to and farther from the tip of the nozzle it is easy to tell when one gets the most light. It is to be remembered that the best light is not practically instantaneous, as with the arc lamp, but is produced after the lime has been half a minute or so in one position.

§ 164. **Changing the position of the lime.**—The intense heat of the oxy-hydrogen jet makes a little pit in the surface of the lime. In about two minutes this pit gets so deep that the light is greatly

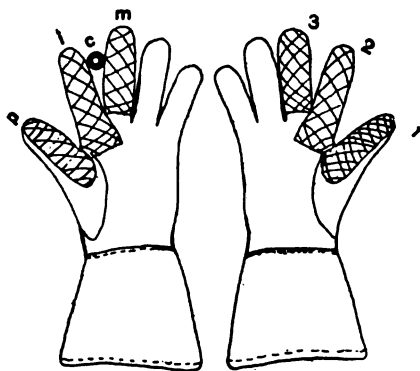

FIG. 61. GLOVES WITH ASBESTOS PATCHES ON THE THUMB, INDEX AND MIDDLE FINGERS FOR USE IN WORKING ABOUT THE HOT LIME-LIGHT LANTERN.

Right hand, palm up: *p*, Pollex or thumb; *i*, Index or fore finger; *m*, Medius or middle finger; *c*, the index and medius used as pincers to grasp a hot lime or a hot carbon.

Left hand, palm up: *1, 2, 3* The first, second and third digits, but numbered instead of named.

lessened, and one must move the lime a little so that a new surface may be acted upon.

In practically all the modern burners there is a screw mechanism for rotating the limes and for raising and lowering them (fig. 59 S). With a little experience one learns by the looks of the screen light when to turn the lime. If the limes must be handled, use tongs or asbestos-patch gloves (fig. 61).

§ 165. **Turning out the light.**—Always turn off the oxygen first, then the hydrogen. Never turn off the hydrogen until after the oxygen is turned off.

Perhaps it will help to remember the order by keeping in mind that (1) the Hydrogen is the *first to come and the last to go*. (2) And the Oxygen, like the best in human nature, is *last to come and first to go*.

MANAGEMENT OF THE LIME LIGHT MAGIC LANTERN FOR AN EXHIBITION OR DEMONSTRATION

§ 166. **Preparation for an Exhibition.**—Before the exhibition the operator should see that everything is in perfect order and readiness. The gas cylinders should be connected with the burner, and a perfect, fresh lime should be in position in the burner. The box of limes should also be at hand in case anything goes wrong with the one in the burner.

§ 167. **To start the light.**—It takes much longer than for the arc lamp. It is usually about half a minute before the brightest light possible is produced, and one must not forget the precaution to warm the lime before subjecting one spot to the full power of the O-H jet.

Light up as directed above (§ 160).

If there is a snap and the light goes out, turn off the oxygen, and relight the hydrogen. Turn on the oxygen slowly until the best light is obtained (§ 160).

§ 168. **To put out the light.**—*Turn off the oxygen first, then the hydrogen* (§ 165).

§ 169. **Shield for cutting off the light from the screen.**—As it takes considerable time to start the lamp after it has been put out it is not so easy to use the lime light intermittently as the arc lamp, hence in a lecture or demonstration in which the lantern slides are to be shown at several different times, it is best to leave the lamp burning all the time. But the screen should not be lighted all the time, and to avoid this the objective shield (fig. 62) may be used.

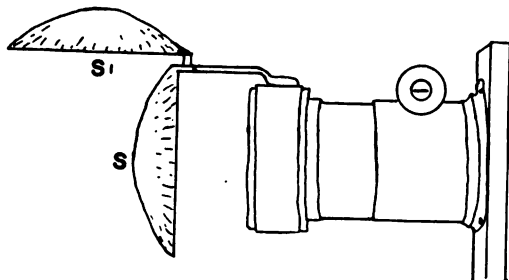

FIG. 62. SHIELD FOR THE OBJECTIVE IN INTERMITTENT PROJECTION, WHEN SLOW-LIGHTING RADIANTS ARE USED.

S¹ Shield up to allow the light to pass from the objective to the screen.

S Shield down to cut the light off from the screen. This shield is especially desirable when slides are to be shown at intervals, as in a demonstration lecture with the lime light, a Nernst light, a kerosene light, or an alcohol light (§ 169).

Sometimes also to avoid using so much gas and burning out the lime too quickly there are regulating valves, by which only a small amount of the two gases is allowed to pass, without changing the relative proportions. When these valves are opened again the full amount needed and in the original proportions is allowed to flow again. Even in this case there should be a shield before the objective to avoid lighting the screen.

§ 170. **Proper lighting for the screen.**—The light on the screen should be uniformly brilliant. This can be attained by following the directions for centering and getting the proper distance of the lamp from the condenser exactly as with the direct current arc lamp (§ 51-57).

If there are shadows on the screen make the proper change in the position of the lamp, etc., as indicated in fig. 27-30, § 83-93.

If everything has been put in perfect order before the exhibition the changes required during the exhibition should be very slight.

§ 171. **Arrangement of lantern slides, their insertion and focusing.**—Follow the directions in Ch. I, § 21-23; 35-41.

§ 172. **Lighting the room.**—As the lime light gives only about $\frac{1}{8}$ to $\frac{1}{6}$ as much light as the arc lamp the room must be darker if the same brilliant contrast is desired. One can determine by a little experiment with the set of slides to be exhibited at any time how dark to have the room. The more transparent the lantern slides, the lighter can the room be. Many lantern slides are altogether too opaque, and require a dark room, no matter what light is used in the lantern.

§ 173. **Avoidance of intervals of total darkness in the room.**—This can be accomplished by leaving the lantern on all the time and by using the objective shield (fig. 62). If that device is not used, then the operator should not turn out the lime light until the room lights are turned on. And whenever the lantern is to be used, the lecturer must give two or three minutes warning to the operator before turning off the room lights.

THE LIME LIGHT WITH OXYGEN AND ILLUMINATING GAS

§ 174. Frequently the lime light is produced with illuminating gas drawn from the house supply, and with oxygen gas in a steel cylinder (§ 154).

If illuminating gas is used instead of hydrogen it is to be remembered that the pressure as drawn from the house supply is very slight, i. e., about equal to a column of water from 5 to 12 cm. high (2 to 5 in.) or only about $\frac{1}{2}$ the pressure of the hydrogen and oxygen when these gases are drawn from steel cylinders (§ 154).

The oxygen is used at a much higher pressure than the house gas, and many operators use for this combination the "blow-through jet" (fig. 58). Mixed jets are also constructed for this combination, but the "blow-through" is considered safer. The user of this form of apparatus would do well to get the combination found best by the manufacturers of his apparatus.

§ 175. **For lighting the lamp.**—Whatever form of burner is used turn on the illuminating gas first and light it; then turn on the oxygen until the flame is made much smaller, as with hydrogen. For warming and arranging the lime and its distance from the nozzle of the jet see § 158, 162-164.

§ 176. **Putting out the lamp.**—Turn off the oxygen first, then the illuminating gas.

Remember that oxygen is always *on last*, and *off first*.

LIME LIGHT WITH OXYGEN GENERATOR AND ETHER SATURATOR

§ 177. **Oxygen generator.**—There has recently been perfected a method of preparing sodium peroxide so that it gives off oxygen gas when water is added, somewhat as calcium carbide gives off acetylene gas when put in water. This substance gives about 300 times its volume of oxygen, and serves very well for an oxygen supply when used in a proper generator.

§ 178. **Hydrogen substitute.**—The substitute for hydrogen with this outfit is sulfuric ether or gasoline. But ether and gasoline should never be mixed.

§ 179. **Use of the apparatus.**—There must be a burner and lime holder as for the oxy-hydrogen lime light. The sodium peroxide (Oxone, oxodium, oxylithe are trade names) is put into the generator and the oxygen gas conducted over to the ether saturator. In the saturator, the stream of oxygen from the generator is divided, one stream of the oxygen going directly to the burner through one tube, and another part going through the ether chamber of the saturator and becoming loaded with ether vapor. This oxygen-

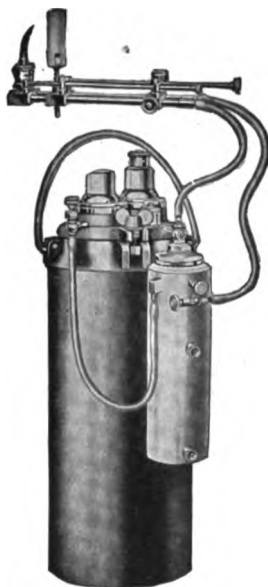

FIG. 63. PORTABLE OXYGEN GENERATOR AND ETHER SATURATOR.

(Cut loaned by the Edison Manufacturing Co.).

ether vapor is inflammable and takes the place of hydrogen or coal gas. The pure oxygen mixed with it just before it emerges from the burner gives the necessary intensity to the flame.

In using this outfit it is necessary to follow very precisely the directions of the manufacturers to avoid accidents. In particular, one must be sure to turn on the *oxygen-ether* first and light it; then turn on the pure oxygen until the light is best. In turning the light out: *Turn off the oxygen first*, then after a moment, turn off the oxygen-ether supply.

The oxygen produced from one charge of $3\frac{1}{2}$ pounds of the sodium peroxide (oxone) gives about 6.6 cubic feet of oxygen gas, enough to last from two to three hours for the magic lantern. One filling of the ether saturator requires about one pound of sulfuric ether and will supply the ether vapor for the charge of oxone. It is said by the manufacturers that if used economically the single charge of oxone and ether will supply a double lantern for an entertainment lasting an hour or an hour and a half.

TROUBLES WITH THE LIME LIGHT

§ 180. **Snapping out of the light.**—This is usually due to an excess of oxygen. The oxygen should always be less than the hydrogen or any of its substitutes, i. e., illuminating gas, ether or gasoline vapor, acetylene gas. To invert the statement, the hydrogen or its substitutes, i. e., the inflammable gas or vapor should be in excess of the actual combining proportions. If the lime is too close to the burner tip the light will snap out.

In case the light snaps out, at once turn off the oxygen. Light the hydrogen and slowly turn on the oxygen again until a satisfactory flame is obtained. Be sure the lime is not too close to the burner tip.

§ 181. **Going out of the light.**—This may be due (1) to a lack of one or of both the gases used, that is, the supply may be exhausted. Look at the capacity meter.

- (2) Some of the valves may be clogged.
- (3) A rubber tube may have split or come off at the connection.

(4) A lime may have broken so that there is nothing for the hot flame to make incandescent.

Remedy.—Turn off the gases the first thing; oxygen first then the hydrogen or other gas. One can then investigate each of the possible causes for the going out of the lamp. The broken lime and the split or separated rubber tube can be most easily detected and corrected, and consequently should be looked for first.

§ 182. **Irregular light or shadows on the screen.**—The fault may lie in any of the following, to name which is to suggest a remedy:

(1) The lime may be too deeply pitted where the flame strikes it. Change the position of the lime (§ 164).

(2) The lime may be in bad position, too high or too low, too far from or too close to the burner tip.

(3) The incandescent spot may not be centered on the axis, i. e., be too high or too low; too far to the right or to the left with the resulting shadows as with the crater of the arc lamp (fig. 27-30).

(4) The light may be too close to or too far from the condenser.

(5) The nozzle of the burner may be in the way and cast a shadow. If so, it must be lowered or the distance from the lime or the angle changed (see also § 82-91).

§ 183. **Roaring or hissing of the burner.**—A slight hissing sound is usually heard when the right amount of oxygen is being used. But when the roaring becomes annoying its cause must be found and remedied. It may be due to: (1) The inside of the nozzle tube may be rough.

(2) The lime may not be the right distance from the tip of the nozzle.

(3) The pitting of the lime may be too great.

(4) There may be too great a supply of the gases for the bore of the nozzle.

§ 184. **Cracking of the lime.**—This is usually due to a sudden heating of the lime. If it is warmed gradually by rotating it at first at some distance and then closer to the flame the breaking is usually avoided. If broken, the lime should be removed from the

holder and a new one put in place. This should then be gradually warmed (§ 162).

SPECIAL PRECAUTIONS IN USING THE LIME LIGHT

§ 185. Remember that hydrogen and all the substitutes used for it, illuminating gas, ether and gasoline, are very inflammable.

Oxygen with hydrogen and also with the other substances forms an explosive compound. Hence, the greatest care must be taken to avoid mixing these gases except in the mixer of the burner (fig. 59). Hence also in filling any part of the apparatus and in working about it there should be no open flames or glowing parts to ignite any accidentally escaping hydrogen, gasoline, ether, etc. Fill the apparatus by daylight, or use an electric light or an electric flash-light if the work must be done in a dark place. In this way no chance for igniting the gases will occur. Naturally one should not smoke when filling the apparatus.

It is economical to buy the best apparatus throughout. The makers adapt the burners and all other parts to give the best results in the safest manner, therefore, unless one is an expert in such matters it is safer to take the outfit assembled and recommended by some reliable manufacturer.

The makers send out with their apparatus very precise directions for using it with safety, and it is the height of wisdom to follow their directions faithfully.

§ 186. Summary of Chapter IV:

Do

1. Use gas cylinders which are plainly marked Oxygen and Hydrogen, and have right-handed screws for the oxygen and left-handed screws for the hydrogen (§ 154). Be sure that there is plenty of gas in each (§ 156).

2. Connect the cylinders with the burner by means of rubber or metallic tubing, colored to correspond with the cylinders (O or H) (§ 154, 159, 159a).

3. In starting the burner, turn on the hydrogen or its substitute first and light it, then turn on the oxygen slowly (§ 160).

4. Heat up the lime slowly by having it at some distance from the flame (§ 162).

5. Turn the lime occasionally so that the pit will not get too deep (§ 164).

6. In putting out the lamp, turn off the oxygen first, then the hydrogen after a moment.

7. If the light snaps out, turn off the oxygen then the hydrogen. Turn on the hydrogen, light it and then turn on the oxygen slowly as in (3).

Do Not

1. Do not use gas cylinders which are not plainly marked. Do not start an exhibition unless there is plenty of gas.

2. Do not be careless in connecting the cylinders with the gas burner.

3. Do not turn on the oxygen first. Oxygen is *last on, first off*.

4. Do not turn the full heat of the O-H flame against a cold lime which is close up to it.

5. Do not let the lime stay too long in one position. Rotate it occasionally.

6. Do not turn off the hydrogen first, but turn off the oxygen first. Oxygen is *on last, off first*.

7. Do not leave the gases turned on if the light snaps out. Oxygen off first, then Hydrogen.

8. After the exhibition is over remove the lime or it will slake in the holder.

9. Conduct the exhibition exactly as with an electric lantern (Ch. I, § 21-40).

10. As the hydrogen or its substitute is inflammable, and the oxygen is a perfect supporter of combustion, follow the directions given by the manufacturers of a special apparatus intelligently and exactly.

8. Do not leave the lime in the holder to slake after the lecture.

9. Do not spare any pains in conducting an exhibition with the lime-light magic lantern. More care and skill are necessary than with the electric light lantern.

10. Do not take any chances when dealing with the oxy-hydrogen lantern. Do things in the right order, and do not neglect the directions of the manufacturers.

CHAPTER V

MAGIC LANTERN WITH PETROLEUM LAMP; VERTICAL AND REFLEX MANTLE GAS LAMPS; ACETYLENE LAMP; ALCOHOL LAMP WITH MANTLE

§ 190. Apparatus and Material for Chapter V:

Suitable projection room with screen; Magic lantern with lamp and chimney for petroleum (fig. 65-67); High grade petroleum for burning in the lamp; Gas burners for vertical and reflex mantles (fig. 68-69); Illuminating gas supply; Acetylene burner and reflector, (fig. 70); Acetylene gas supply (house supply, prestolite tank of compressed acetylene in acetone or an acetylene generator); Special alcohol lamp with mantle (fig. 72-73); Strong alcohol (95%) ethyl, methyl or denatured. The magic lantern for all but the oil lamp must have a lamp-house into which the burner can be placed. There must be lantern slides, screw drivers, pliers and matches or safety lighters (§ 160), for all of them.

§ 191. **Historical development and references to literature.**—For the history see the Appendix, and for general works of reference see the list of books in the first chapter (§ 2).

The directions sent out by the manufacturers of these light sources should be studied carefully and followed exactly unless one has technical knowledge on the subject.

OIL AND GAS LAMPS

§ 192. **Early sources of light.**—For a long time after the invention of projection apparatus there were but two sources of light known:

(1) The sun, which has ever remained the most brilliant source of light available, and

(2) Some form of torch, candle, or oil lamp.

The first oil lamps burned animal or vegetable oil and had no lamp chimney.

After the discovery and proper refinement of petroleum, that became and has remained the oil most used for illumination.

If one reads the early works on projection it seems astonishing that the workers of those times were able to produce screen images

which showed general form and details with anything like satisfaction to large audiences. But screens as large as four meters square (12 ft. sq.) were used with the petroleum light.

When the feeble lights discussed in this chapter are compared with the powerful electric arc light giving from 1,000 to 5,000 candle-power it would seem that the results of earlier times must have been very unsatisfactory.

But the older lanternists gave very successful exhibitions. They did this by observing with scrupulous care the requirements for projection with their appliances.

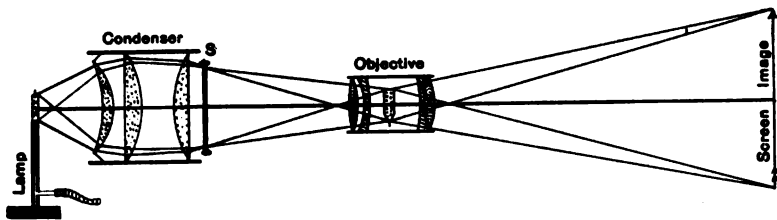

FIG. 64. MAGIC LANTERN WITH LARGE LIGHT SOURCE.

Lamp Illuminating gas lamp with Welsbach mantle.

Condenser Triple-lens condenser without water-cell.

S Lantern slide.

Objective Projection objective with inverted image of the luminous mantle between the lenses.

Screen Image The image of the lantern slide on the white screen.

§ 193. Requirements for projection with a feeble light:

(A) The lantern slides must be very transparent; and the old, hand-painted slides were very transparent.

(B) The room must be very dark. There must be no stray light from the windows or from the apparatus; the only light must be that issuing from the lantern objective and reflected from the screen.

(C) The management of the lantern must be the best possible, so that all the available light may be utilized for producing the screen image.

(D) The projection objective must be of large aperture so that as much as possible of the light issuing from the large source (lamp

flame or incandescent mantle), may be utilized in making the screen image. This is of fundamental importance (fig. 64, 90).

(E) Use of twilight vision.—It is astonishing how dim a picture can be clearly seen after one's twilight vision has become fully established. According to careful investigations the sensitiveness of the eye may be increased from 35 to 2500 times by the adaptation to dim light (§ 281).

The old lanternists used to advise that the exhibition should not begin until the audience had been in the darkened room for half an hour "to get," as they said, "the sunlight out of their eyes." We would say to "get the twilight vision well established."

§ 194. **Time required for lighting up.**—The gas light and the acetylene light are quickly established, but the petroleum and the alcohol lights require several minutes to get up the best illumination. These two should then burn during the entire time of an exhibition. If the lecturer cannot arrange to have all the slides continuously, but must have them at intervals during the lecture, the operator should make use of an objective shield (fig. 14, 62), and leave the lights on all the time.

§ 195. **Rehearsals.**—As these lights are more difficult to manage and the results are less satisfactory than with the more powerful radiants, so much the more should the operator rehearse before the lecture and make sure that everything is in as nearly perfect order as human skill can make it.

THE MAGIC LANTERN WITH A PETROLEUM LAMP

§ 196. The petroleum lamps now used as radiants for projection have two, three or four wicks. The wicks are wide (about five cm., two in.) and are placed edgewise to the condenser. If more than two wicks are used the two outer ones are inclined inward (fig. 66).

Sometimes instead of being ranked side by side, the different wicks are arranged like the lines forming the letter W, but there is no advantage in this.

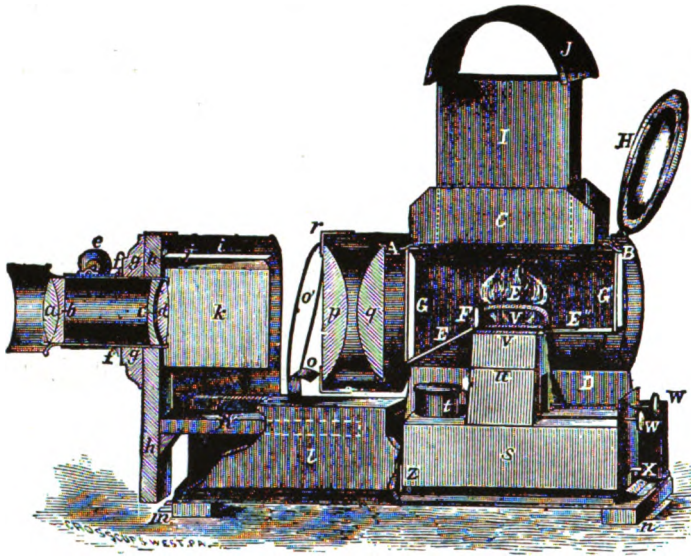

FIG. 65. MARCY'S MAGIC LANTERN OR "SCIOPTICON" WITH A MULTIPLE-WICK, PETROLEUM LAMP.

(From *Dolbear's Art of Projecting*).

a-b, c-d The lenses of the projection objective.

p-q The condenser lenses.

Z S The oil reservoir of the lamp.

E The flames of the lamp with their edges toward the condenser.

G-G Two glass plates at opposite ends of the lamp-house to allow the light to pass to the condenser, and so that the reflector *H* can return the backward extending light.

C I J The chimney and ventilator of the lamp-house.

W W At the right, the milled heads for turning the lamp-wicks up or down.

There is a common reservoir and a common chimney, but each wick has a separate burner and a separate mechanism for raising and lowering the wick.

§ 197. **Chimney and reflector.**—There is a common chimney. This is usually of metal with a window on opposite sides, and with either a telescoping extension or a segment which can be put on top

for getting the best draught when the lamp is turned up full height.

The reflector is a concave mirror placed with its center of curvature coinciding with the flame. This serves to reflect the backward extending light to a focus on the flame again, and from thence it passes onward to the condenser with the rays passing directly from the flame to the condenser.

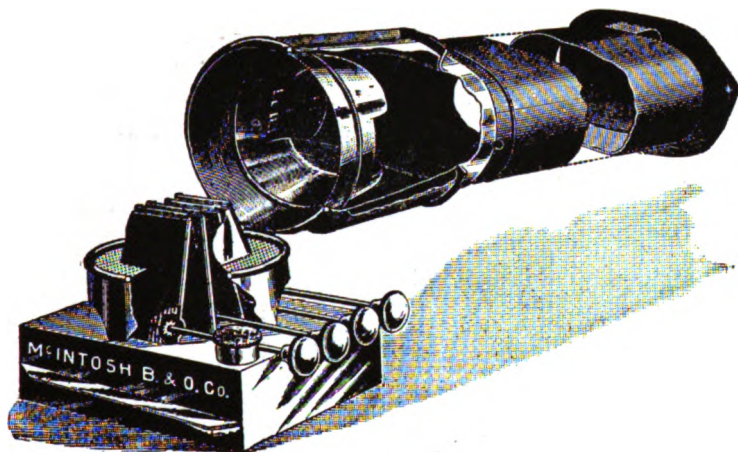

FIG. 66. MULTIPLE-WICK, PETROLEUM LAMP FOR THE MAGIC LANTERN.
(From the Catalogue of the McIntosh Battery and Optical Company, 1889).

This figure shows that there is a single oil reservoir but four separate wicks, each with a mechanism for turning the wick up or down. It also shows clearly the inclination toward each other of the separate wick holders, and finally that the lamp has a single chimney.

The openings in the metal chimney for the reflector and the condenser must be covered with glass or with clear mica or the lamp will smoke.

§ 198. **Management of the lamp.**—Before an exhibition the reservoir is filled nearly full with good petroleum (kerosene oil). The wicks must be carefully trimmed until the flame burns without tails. One must be careful in preparing the lamp not to get any oil on the outside, for when the lamp gets hot this oil is sure to smell badly.

Light the wicks and turn them up moderately and allow them to burn for five or ten minutes before the exhibition. This is to get the apparatus warmed up. One cannot get the best light from a petroleum lamp instantly, but only after it has become warm. Finally turn up each wick as high as possible without having it smoke. The central wicks can usually be turned higher than the marginal ones. When the wicks are at their full height the chimney, if adjustable, must also be at its full height to give the best draught.

After the exhibition is over the lamp-wicks are turned down, the small flames blown out, and then the unused oil poured into a container, the wicks taken out and carefully dried between blotting

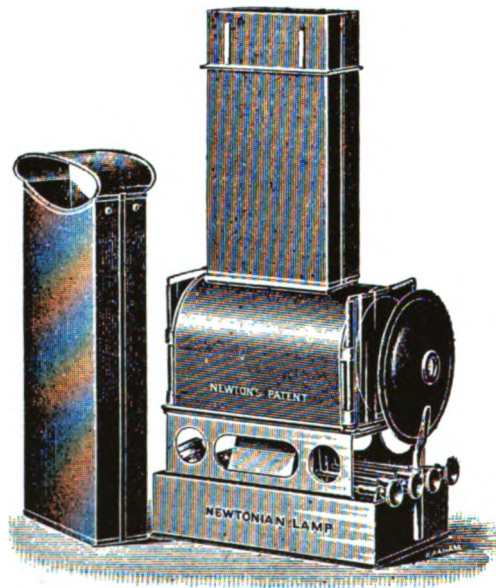

FIG. 67. NEWTON'S FOUR-WICKED, PETROLEUM LAMP FOR THE MAGIC LANTERN.

(From Catalogue No. 4 of Newton & Co.).

The chimney is in two segments. For the maximum light after the lamp is warmed up, the top segment is added.

papers. If the lamp is kept perfectly clean, and no oil is allowed to remain on the outside, the disagreeable smell of partly oxidized oil will be avoided.

§ 199. **Amount of oil used.**—It takes about half a liter (one pint) of kerosene per hour for the best lamps.

§ 200. **Candle-power and size of screen.**—The candle-power of the best petroleum lamps is not much above 100. While the older lanternists used large screens (4 meters, 12 ft. square) it is better to use, with this light, screens of small size, 2 to 3 meters square (6–9 ft.), and to keep in mind the requirements for good images with these feeble lights (§ 193).

§ 201. **Relative position of lamp and condenser.**—In general, the middle of the flame should be in the axis of the condenser and it should be at about the principal focal distance of the first element of the condenser from it (fig. 64). One must get the best possible position at any one time by experiment, i. e., by moving the light a little closer or farther away than the focus of the condenser. For the two-lens condenser the lamp must be closer than for the three-lens condenser (§ 17, 55).

§ 202. The management of an exhibition is as described in Chapter I, § 21–41, and above, § 193–194.

MAGIC LANTERN WITH A MANTLE GAS LAMP

§ 203. **Gas and gas lamps.**—The illuminating gas may be drawn from the house lighting supply.

The lamps are of two kinds, the vertical and the inverted or reflex form (fig. 68–69). The burner is of the Bunsen type. It heats the mantle to incandescence. While there is a very brilliant light and a great deal of it, the source is very large, and cannot be utilized so completely as the small source of the electric arc lamp (see fig. 1, 64).

§ 204. **Position of the incandescent mantle.**—As this is the source of illumination, the middle of the face next the condenser should be on the horizontal axis (fig. 64).

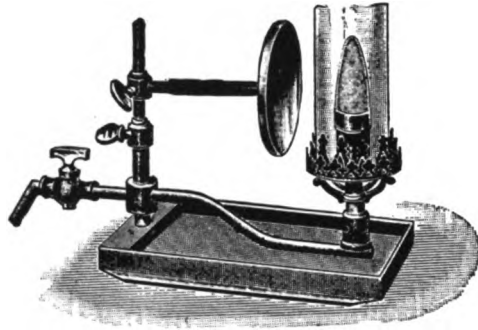

FIG. 68. UPRIGHT GAS BURNER WITH WELSBACH MANTLE AND CONCAVE REFLECTOR FOR THE MAGIC LANTERN.

(From Max Kohl, A. G., Price List No. 50, Vol. I).

The distance from the condenser giving the best light must be determined by experiment, as with other extended sources. But, in general, it will be found to be at about the principal focal distance from the first element of the condenser, as with the arc lamp, but closer for the two-lens than for the three-lens condenser § (55).

§ 205. **Reflector.**—As with the petroleum light, a concave reflector is sometimes used behind the mantle to reflect back to the mantle and thence to the condenser the light which passes backward from the mantle. This is not always used, but it would increase the light somewhat (§ 210).

§ 206. **Connecting the gas supply with the lamp.**—Use for this a perfect rubber tube or one of the flexible metallic tubes (fig. 60), and secure the

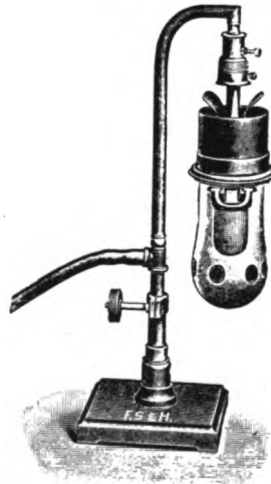

FIG. 69. INVERTED GAS BURNER WITH WELSBACH MANTLE FOR THE MAGIC LANTERN.

(From Schmidt und Haench's Catalogue, No. IV, Projektions-Apparate, 1910).

ends to their connections by tying a string tightly around them, if rubber tubes are used. If the supply is at a considerable distance there should be a stop-cock at the lamp to regulate the amount of gas, and to turn it off completely if desired. At the end of the exhibition the gas must be turned off at the source of supply.

§ 207. **The management of the exhibition is simple**, and should follow the general lines laid down in Chapter I (§ 21-41). It is not wise to try to use a screen more than two to three meters square (6-9 ft.), and one must keep in mind the requirements for feeble lights (§ 193).

THE MAGIC LANTERN WITH AN ACETYLENE LAMP

§ 208. **Source of acetylene.**—This may be from a house supply, a special generator, or from a tank or cylinder of acetylene dissolved in acetone under pressure (prestone tank).

§ 209. **Acetylene lamp.**—The burners now used are in pairs. Two jets set at an angle give a fused, flat flame. For the magic lantern the lamp has from one to four of these twin burners in a line. Behind the burner is a concave reflector returning the backward reflected light to the burner and from thence on to the condenser, so that as much of the light as possible is utilized for the screen image (fig. 70).

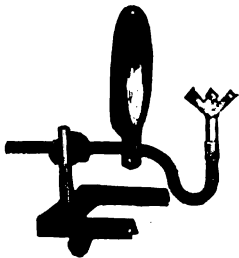

FIG. 70. DOUBLE-JET ACETYLENE LAMP WITH REFLECTOR FOR THE MAGIC LANTERN.

(Cut loaned by the Bausch & Lomb Optical Company).

§ 210. **Position of the concave mirror.**—If a concave mirror is used to save the light extending away from the screen, its center of curvature should coincide with the flame of a single burner, or its center should be at the middle flame, if there are several burners in a row.

The acetylene flame is very transparent, so that a mirror behind the burner will increase the light nearly the theoretical amount (75%), while with nearly

opaque sources, such as the incandescent mantle light or the petroleum flame, a mirror placed behind the light does not increase the brilliancy so much.

§ 211. **Position of the acetylene lamp.**—This should be so that the middle point of the flame is on the axis (fig. 64) and it should be at a distance from the condenser of about the principal focal length of the first element of the condenser and the middle flame of the burner. For the best position in practice one must experiment while looking at the screen image or disc of light, and arrange the lamp to give the best effect (§ 17, 55).

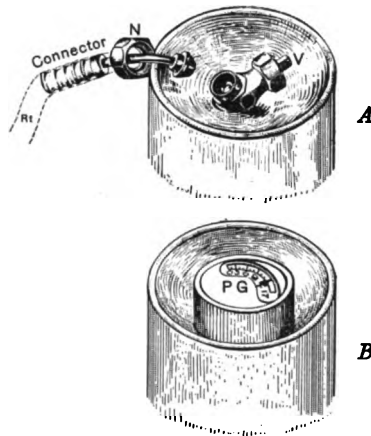

FIG. 71. UPPER AND LOWER ENDS OF A PRESTOLITE TANK USED WITH THE MAGIC LANTERN.

FIG. 71A. UPPER END OF THE PRESTOLITE TANK.

V Outlet valve. It is opened and closed by a special wrench.

Connector The metal connector for joining the gas supply and the acetylene burner.

Rt Rubber or flexible metal tube extending from the connector to the burner.

N Nut for holding the conical part of the connector in gas-tight union with the hollow cone of the tank-valve. This valve must be set gas-tight before opening the outlet valve (*V*).

FIG. 71B. LOWER END OF THE PRESTOLITE TANK SHOWING THE PRESSURE GAUGE.

PG Pressure gauge indicating the pressure of the gas within the tank. The pressure is given in atmospheres or in pounds per square inch or in both.

§ 212. **Connecting the burner to the gas supply.**—For this a heavy and perfect rubber tube or a flexible metallic tube (fig. 6o) should be used and the connections with the supply and with the burner should be tied unless special fittings are present.

As with illuminating gas, the best light is obtained when the correct amount of gas is delivered at the tip of the burner. If too much gas is flowing the jets will blow, and if too little, there will not be light enough.

If a tank of compressed acetylene in acetone is used (fig. 71 A), the adjustments must be made at the valve on the cylinder. If one turned this on full head and tried to regulate by the stop-cock at the burner the pressure accumulating in the rubber tube would probably blow the tube from its connections or burst it (§ 212a).

§ 212a. **Prestolite tanks supplying acetylene for the Magic Lantern.**—A steel cylinder is packed with asbestos and this is saturated with acetone. Acetylene gas is then pumped into the cylinder and is dissolved by the acetone.

The tanks are charged under a pressure of approximately 15 atmospheres at 18½ degrees centigrade (65° F.) this is 15.82 kilos per square centimeter or 225 lbs. to the square inch.

The tanks are of various sizes, and their holding capacities, under 15 atmospheres pressure, are as follows:

- "A" contains 70 cubic feet of gas, (1982 liters), cost. \$25.00
- "B" contains 40 cubic feet of gas, (1132.6 liters), cost. \$18.00
- "E" contains 30 cubic feet of gas, (849.5 liters), cost. \$15.00
- Motor-cycle tank contains 10 cubic feet of gas, (283 liters), cost. \$ 8.00

The burner for a magic lantern requires from one to two cubic feet of acetylene gas per hour. The motor-cycle tank full of gas will then supply light, for from five to ten hours. It costs less than \$1.00 to have the tank recharged, hence, the cost of gas per hour is from 10 to 20 cents.

It is of importance to know at any given time whether there is gas enough to last for an exhibition or for a number of exhibitions. As shown with the lime light the cylinders are supplied with a gauge showing the pressure of the gas within the cylinder, and from Boyle's law that the amount of a gas in a given space depends on the pressure, it is easy to determine at any time the amount of gas available. It is only necessary to know the capacity of the cylinder under ordinary atmospheric pressure and to multiply that volume by the number of atmospheres indicated on the pressure gauge (see also § 156).

For example, the gauge of a motor-cycle tank (fig. 71 B), shows that the pressure is 12 atmospheres, how many cubic feet of acetylene gas are available?

As the tank under 15 atmospheres holds 10 cubic feet of gas its capacity at atmospheric pressure must be $10 \div 15 = \frac{2}{3}$ of a cubic foot. If it holds $\frac{2}{3}$ of a cubic foot under one atmosphere, under 12 atmospheres pressure it will hold $\frac{2}{3}$ multiplied by 12 = 8 cubic feet.

The tank will then supply gas for four or for eight hours of continuous light depending upon the capacity of the burner.

§ 213. The management of an exhibition is as for the direct current arc lamp, keeping in mind the general statements in this chapter (Ch. I, § 21-40; § 193).

THE MAGIC LANTERN WITH ALCOHOL LAMP AND MANTLE

§ 214. An alcohol flame burning in the air, is very hot. This has been taken advantage of to heat a mantle to incandescence in the same way that illuminating gas with a Bunsen burner heats a mantle to incandescence.

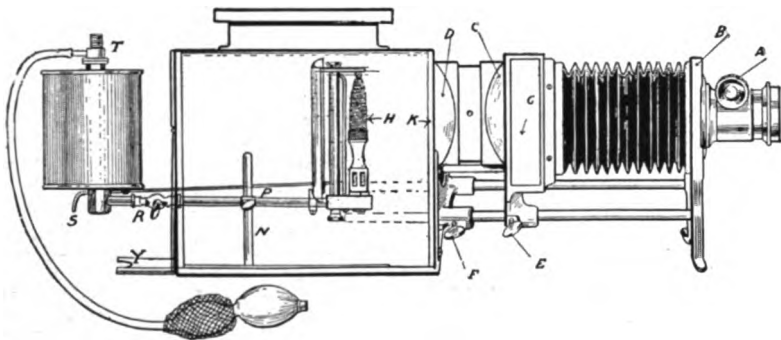

FIG. 72. MAGIC LANTERN WITH THE ALCO-RADIANT.
(Cut loaned by Williams, Brown & Earle).
For the details see fig. 32 and 73.

For the best results the alcohol is vaporized, and the vapor burning in a special burner gives the Bunsen flame necessary to heat the mantle.

The light is as intense or more intense than gas light with a mantle.

§ 215. **Alcohol supply and burner.**—There must be a reservoir for alcohol (95% ethyl, methyl, or denatured). This is connected with the burner by means of a metal tube with a stop-cock. In use the reservoir is filled over half full, but must always have an air space above. Connected with this air space is a force-pump by which the alcohol is put under pressure.

§ 216. **Lighting the lamp.**—(1) Place the lamp in a metal tray; put a mantle in position over the burner, and burn it off as for a new gas mantle.

(2) Place the heater or torch in position under the burner (fig. 73 L). Wet the torch well with strong alcohol, using a pipette. Sometimes the torch is saturated with alcohol by pouring the alcohol upon it from a bottle before it is put in place under the burner. This is usually wasteful, as some alcohol is almost sure to be spilled.

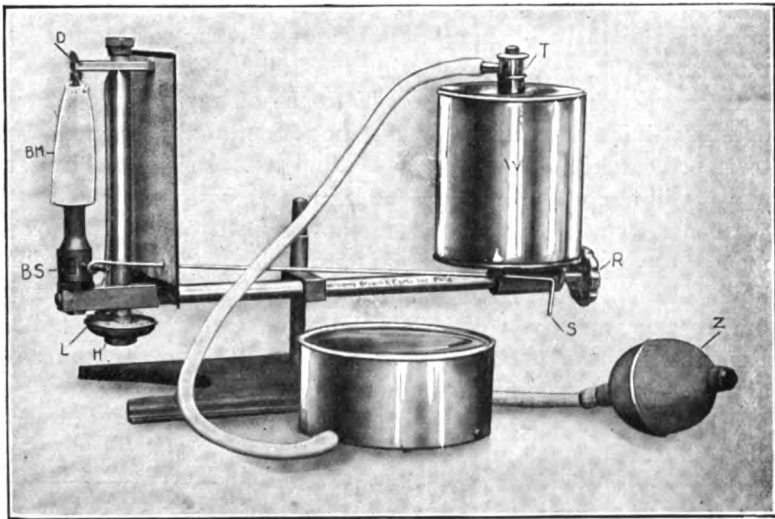

FIG. 73. ALCO-RADIANT, SHOWING THE PARTS.
(Cut loaned by Williams, Brown & Earle).

- BM The mantle.
- BS The gas burner for the volatilized alcohol.
- LH The heater to start the volatilization.
- S The handle for opening and closing the air valve of the burner.
- R Valve for turning on and off the alcohol supply.
- W The tank holding the alcohol supply.
- T Connection for the pressure tube.
- Z Rubber bulb for forcing air into the alcohol reservoir. The round object in the course of the rubber tube is an air reservoir to make the pressure steady.

(3) When the torch is in place and wet with alcohol, open the stop-cock from the supply tank (fig. 73 R), and then light the torch. The alcohol flame will heat the burner and stand-pipe, and the alcohol in the stand-pipe will be vaporized and pass over through the small pipe to the burner where it will catch fire and burn. Open the air intake partly. In using the lamp this air intake must be regulated as for a Bunsen burner, the more pressure the more the valve must be opened.

Soon the mantle should begin to glow brightly from the burning vapor in the burner. When this occurs commence to put pressure on the alcohol tank (fig. 73 W). This is done by connecting the pressure apparatus by means of the rubber tube to the alcohol tank, at T, (fig. 73), and squeezing the bulb.

In case the first burning off of the torch does not start the lamp one must burn it off again, but do not add the alcohol until the torch or heater is out, and then use a pipette. Relight the heater and it will almost surely start the lamp.

Do not connect the pressure apparatus until the mantle commences to glow. If pressure were on the alcohol tank at first the liquid alcohol would be forced over from the stand-pipe into the burner and would run down on the torch and upon the table. Remember that alcohol is very inflammable and also very unmanageable when it is on fire, so be exceedingly careful.

(4) As soon as the mantle begins to glow brilliantly considerable pressure can be put on the alcohol tank. The greater the pressure the wider must the air-intake at the burner be opened and the more brilliant will be the light; but as the pressure increases the lamp roars more loudly until, when the pressure is considerable, it roars like a young blast furnace. By watching the results one can avoid the excessive noise, and still get a brilliant light.

§ 217. **Management of the exhibition.**—This is in general like any other magic lantern, but as the light depends largely on the pressure regulation, one must be careful to keep up the proper amount of pressure during the entire time. Do not expect too much of this light. It gives fairly good lantern-slide images for a screen from two to three meters (six to nine ft.) square. As the

source is large, one needs a good projection objective of large aperture (see § 855).

§ 218. **Putting out the lamp.**—As this lamp is difficult to light it should be kept burning during the entire exhibition. One can shut the light from the screen by the objective shield (fig. 62).

At the close of the exhibition, take the lamp from the lamp-house, remove the rubber tube from the pressure apparatus to the tank to relieve all pressure on the alcohol. Close the supply valve so that no more alcohol can pass over to the stand-pipe. Close the air-intake of the burner. Use a sponge well wet with water and apply it to the burner as near the mantle as possible without touching the mantle. The sponge will naturally rest against the small conducting pipe and the stand-pipe in this operation. This cools the burner and the stand-pipe and stops the vaporization of the alcohol. The flame then goes out as with any gas burner when the supply of gas is cut off.

§ 219. **Precautions.**—Remember that alcohol is very inflammable, therefore special care should be exercised that none of it overflows from the reservoir or leaks from poor joints. It is perfectly safe in burning through the burner, but any alcohol outside the lamp is dangerous, for if it catches fire it cannot be extinguished unless one has plenty of sand or non-inflammable dust to throw on it and smother the flame, or one of the modern chemical fire extinguishers.

TROUBLES IN CHAPTER V

§ 220. The prime difficulty with these relatively weak lights is the dim screen pictures. That is, they will be dim in comparison with the bright pictures obtainable with the direct current arc light.

Remember the conditions requisite for screen images with weak lights (§ 193).

§ 221. **Smoking of the petroleum lamp or of the acetylene burner.**—This shows that the wicks are not properly trimmed or that they are turned up too high for the height of the chimney.

With the acetylene flame if too much gas is turned on the flame will smoke and roar.

§ 222. The image of the lamp flame may show on the screen. This is because the objective is too far from the condenser or the lamp flame is not in the proper position with reference to the condenser. Try removing the lamp farther from the condenser or bringing it nearer. When it is in the correct position its image will not appear on the screen.

§ 223. Roaring of the alco-radiant lamp. If the roaring is excessive it shows that the pressure on the alcohol reservoir is too great. This can be remedied by ceasing to pump the air in till the noise is within reasonable bounds.

§ 224. Summary of Chapter V:**Do**

1. For these relatively weak sources of light use a good screen, and make the room dark (§ 193).

2. Use transparent lantern slides.

3. The objective to select is one of large aperture for these large sources (§ 217, 855).

4. Have perfect containers for liquids and gases so that none can escape into the room.

5. For the petroleum light and the alco-radiant use the objective shield (fig. 62) as it takes so long to get a good light.

6. Follow carefully the directions sent with the apparatus by the manufacturers.

7. Do your part with great care and even these weak lights will give good projection within their range of possibility, i. e., for a screen two to three meters (six to nine feet) square.

Do Not

1. Do not try to give an exhibition with these weak lights in a room with much stray light, and do not use a dirty screen.

2. Do not try to use opaque lantern slides.

3. Do not use an objective of small aperture with these large sources.

4. Do not use leaky containers for the gases or liquids used in this chapter. They are all dangerous when out of their proper containers.

5. Do not turn off the alco-radiant or the petroleum light during the exhibition; it takes too long to start them.

6. Do not fail to read carefully and follow strictly the directions sent out by the manufacturers.

7. Do not expect too much of these weak sources, but give them a chance to do their best.

Do

1. Use a good quality of petroleum (kerosene).
2. Keep the lamp clean, and the wicks properly trimmed.
3. Use a chimney of the proper height for the flame.
4. Turn the flame up as high as possible without having it smoke.
5. The edge of the flames should face the condenser, the middle flame being in the axis.

Do Not

1. Do not use poor oil, it will not give a good light, and may explode.
2. Do not let the lamp get dirty or the wicks burn with tails. Clean and trim.
3. Do not use a low chimney for a large, high flame.
4. Do not turn the wicks up till they smoke. Stop just before that.
5. Do not have the face of the flame, but the edge toward the condenser.

Do

1. For gas use the best kind of mantles.
2. Make the connections with rubber tubing of good thickness and quality or flexible metallic tubing (fig. 60).

Do Not

1. Do not use mantles of poor quality, or that are broken.
2. Do not make connections with thin or used up rubber tubing.

Do

1. For acetylene use a proper burner and reflector, that is, one which is made by a reliable house that has proved its safety and excellence.
2. Use a safe gas supply, such as a house supply or a prestolite tank is best.

Do Not

1. Do not use an untried lamp and general outfit for the acetylene light. Acetylene is a good servant but a cruel master.
2. Do not try to use a make-shift gas generator. The smell will be disagreeable and the escaping gas possibly dangerous

3. Use thick and good quality rubber tubing or flexible metallic tubing (fig. 6o) to make the connections.

4. Study carefully the directions for the use of the acetylene outfit with the magic lantern sent out by the manufacturers.

5. Use perfect burners with the gas turned on sufficiently, but not enough to blow.

6. Keep all naked lights away from an acetylene supply. Use an electric torch light if a light must be used.

3. Do not use poor rubber tubing for connections.

4. Do not neglect the careful study of the directions for using the acetylene outfit with the magic lantern.

5. Do not try to use broken burners, and do not turn the gas on until it blows.

6. Never let any naked lights come near an acetylene gas supply.

Do

1. For the alcohol light, follow with care the directions accompanying your alco-radiant lamp. Alcohol is dangerous stuff and should not be trifled with.

Do Not

1. Do not fail to follow with scrupulous care the directions of the manufacturers of the lamp you use.

CHAPTER VI

THE MAGIC LANTERN WITH SUNLIGHT: HELIOSTATS

§ 230. Apparatus and material for Chapter VI:

Suitable room for projection, preferably one with southern exposure; Screen of proper size; Porte-Lumière or hand-regulated heliostat; Heliostat with clock-work for regulation; Condenser for bringing the parallel rays of sunlight to a focus (plano-convex or achromatic combination); Slide-carrier and projection objective.

See also Ch. I, § 1.

§ 231. Historical.

For the history of the magic lantern and all other projection apparatus with sunlight, see the Appendix.

For Foucault's clock-driven heliostat see his: *Recueil des Travaux Scientifiques*, 1878, pp. 427-433.

For the Heliostat of Mayer, using a lens and prisms, see *Amer. Journal of Science*, IV Ser. Vol. IV, (1897), pp. 306-308.

For the Heliostats of Fuess, see C. Leiss, *Die Optischen Instrumente der Firma R. Fuess*, 1899, pp. 284-305. For Heliostats like fig. 82, see *Ambrohn's Handbuch Astron. Instr.* p. 649, fig. 637.

Dolbear.—*Art of Projecting*.

LIGHT FROM THE SUN

§ 232. The limitless supply of light from the sun would be used in preference to any artificial source if it were only always available. In many regions it is available during most of the year, and will no doubt be much more utilized as time goes on. Its use is strongly recommended in sunny regions.

The sun is the brightest known source of light. Its intrinsic brilliancy is, in round numbers, 421,000 candle-power per square centimeter (2,720,000 candle-power per sq. inch). (See § 232a).

Sunlight also serves as the standard for color values.

§ 232a. **The intrinsic brilliancy of the sun.**—The intrinsic brilliancy of a source can be determined if its area and its candle-power are known. With the sun it is inconvenient to make the reckoning in these terms as both the candle-power and distance are so enormous. The light from the sun near the zenith in clear weather amounts to 288,000 meter candles, that is, the sunlight is as powerful as the illumination due to 288,000 standard candles at a distance of one meter. (A. Arrhenius—*Lehrbuch der kosmischen Physik*).

§ 233. **Heliostat.**—From the rotation of the earth on its axis from west to east the sun *seems* to move over the face of the sky

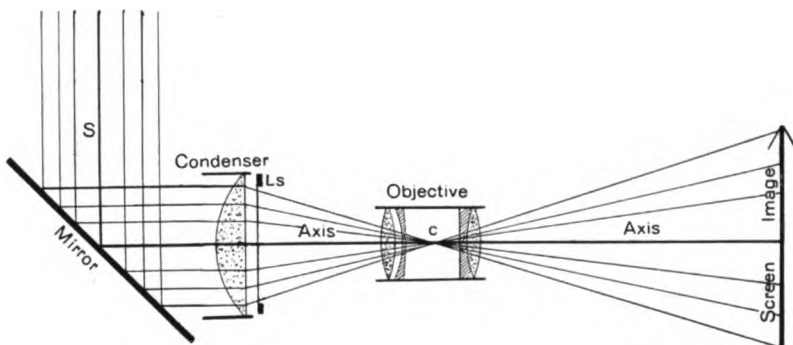

FIG. 74. MAGIC LANTERN WITH SUNLIGHT.

S Sunlight.

Mirror The plane mirror serving to direct the sunlight horizontally into the condenser.

Condenser The single plano-convex lens serving to converge the parallel beam of sunlight. (Compare the second element of the condenser in fig. 2).

Ls Lantern slide.

Objective The projection objective for projecting an image upon the white screen. The projection objective and the condenser should be of approximately the same focus.

c Center of the projection objective where the rays from the condenser should cross.

Axis Axis The principal optic axis of the condenser and of the projection objective.

Screen Image The image of the lantern slide upon the white screen.

The apparent diameter of the sun's disc is $32'36''$ in midwinter and $31'32''$ in midsummer, or it averages $32'04''$ (Abbot, *The Sun*, p. 3; Ball's *Astronomy*, p. 127).

The apparent area of the sun's disc at a distance of one meter is determined as follows: Its diameter is $32'04''$ or $.5343^\circ$. One centimeter at a distance of one meter subtends an angle of $.573^\circ$, hence at one meter the sun's disc would appear to have a diameter of $\frac{.5343^\circ}{.573} = .933$ centimeters. The area of such a

circle is $\frac{.933^2}{4} \times \pi = .684$ square centimeters.

The intrinsic brilliancy is then, $\frac{\text{Candle-power}}{\text{Area}} = \frac{288,000}{.684} =$ in round numbers, 421,000 candle-power per square centimeter or 2,720,000 candle-power per square inch.

from east to west. In order that the sun's rays may shine in one place continuously it is necessary to counterbalance in some way the apparent motion of the sun.

If one holds a plane mirror in the hands, it is possible to keep a spot of sunlight on one place indefinitely by making slight changes in the position of the mirror to correspond with the changes in apparent position of the sun. This is possible from the law of reflection: "The angle of incidence and the angle of reflection are equal." (See fig. 80 and Chap. XIV, § 794).

A heliostat is then simply a mechanism for holding the mirror so that the sun's rays may be reflected in a constant direction. As this seems to make the sun stand still, the name is appropriate. It was given by the original inventor, s'Gravesande, 1742 (fig. 77).

There are three principal forms of heliostats:

(1) The hand-regulated heliostat or *porte-lumière* with one mirror and a double movement up and down, and on the axis, so that it may be made to follow accurately the sun's apparent motion (fig. 75).

(2) A heliostat with one mirror, in which the movements of the mirror are brought about by clock-work (fig. 77-79).

(3) A Heliostat with two mirrors. One mirror is attached to the *end* or *side* of the clock-shaft. The other mirror is not connected with the clock-work. The second mirror serves to reflect the beam from the movable mirror in the desired direction, and is set by hand, once for all, at the beginning of the experiment.

The clock-shaft rotates once in 24 hours with the single mirror heliostats (fig. 77-79), and also with the two mirror heliostat with the mirror at the end of the clock-shaft (fig. 81).

When the mirror is attached parallel to the clock-shaft (fig. 82), the clock-shaft rotates once in 48 hours (fig. 82, A, B, C).

INSTALLATION AND USE OF A HAND-REGULATED HELIOSTAT OR PORTE-LUMIÈRE

§ 234. The hand-regulated heliostat or *porte-lumière* consists of a plane mirror so mounted that it can move on two axes. The mirror should be about 15 x 30 cm. (6 x 12 in.) in size and sup-

ported by a framework. This frame should be hinged so that it can be moved from the horizontal up to the vertical position. It must also be so mounted that it can be rotated around at right angles to the hinge motion.

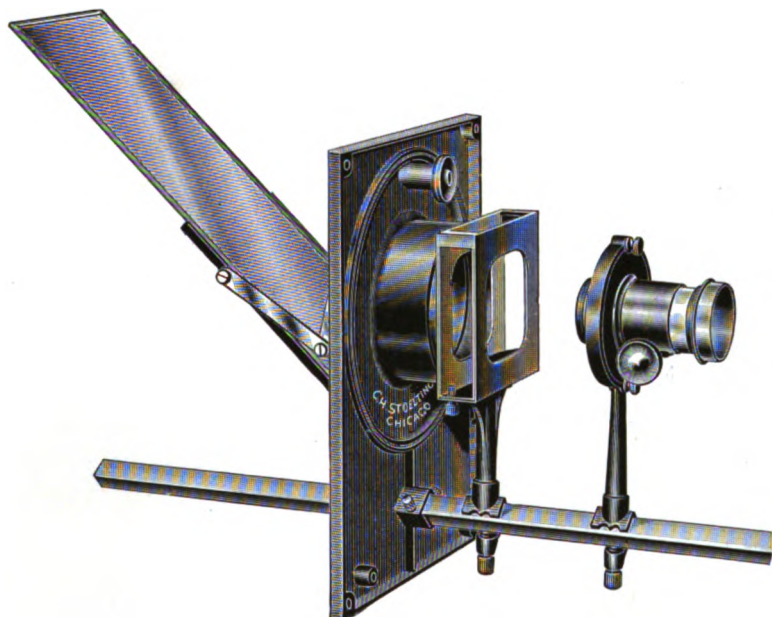

FIG. 75. PORTE-LUMIÈRE WITH PLANO-CONVEX LENS AND PROJECTION OBJECTIVE.

(Cut loaned by the C. H. Staeling Co.).

The mirror for the reflection of the sunlight into the condenser is moved as necessary by the milled head just above the condenser.

The two movements are made by hand as often as needed while one is using the apparatus. In the original forms of Cuff and Adams (1744-1746, fig. 75a), and in some modern forms, there are two handles or milled heads extending into the projection room; with one of them the operator can raise or lower the mirror on its hinges, and by the other he can rotate it on the other axis. In the form here shown there is but one handle. This serves as a crank

to turn the mirror around in a circle on its axis, and as a screw by means of which it is raised or lowered on its hinges (fig. 75).

§ 235. **Setting up the hand-regulated heliostat.**—The apparatus must be so placed that it receives the full sunshine on the mirror.

In the forenoon an eastern exposure can be used, and in the afternoon a western one; or a southern one nearly all day. In practice a person will naturally use the window best adapted to his particular needs if he has a choice.

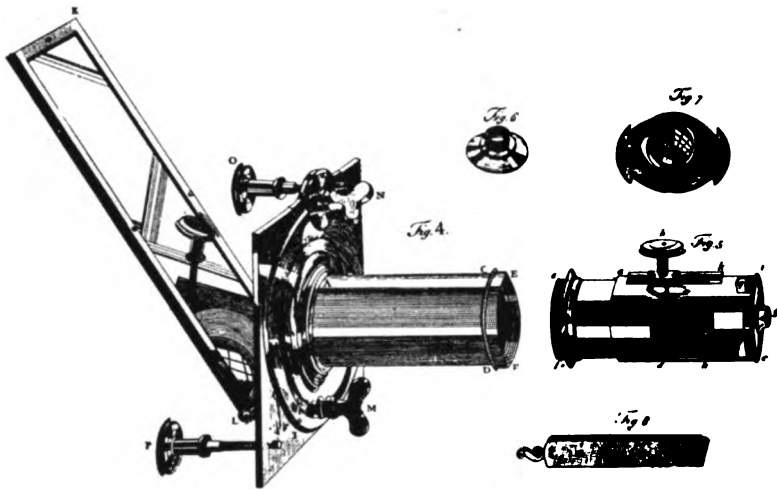

London: Printed for S. Adlard by the Author, 1771, Street No. 1771.

FIG. 75a. SOLAR, PROJECTION MICROSCOPE OF ADAMS, WITH PORTE-LUMIÈRE.

(From Adams' *Essays*, 1771, Pl. VI.)

Fig. 4 shows the movable mirror (*K-L*) placed outside the shutter in the sun, *O-P*, screws in the square plate to fasten the instrument in the shutter; *M-N*; thumb screws by which the mirror is turned to hold the sun's rays in the right direction. The large tube, *A-C-D*, contains the condenser and receives the shorter tube, fig. 5. Fig. 5 shows the tube into which the objectives are fixed. If for large objects the lens (fig. 6) is screwed into the end, *g*, for smaller objects, the objectives are arranged in a piece (fig. 8) sliding into the opening at *q*. Notches along the objective slider indicate when the lens is centered. The specimen to be examined is inserted at *h*. For high powers the substage condenser shown at fig. 7 is put in the tube between *d-h*. At *b* is a rack and pinion for focusing the object.

§ 236. **Darkening the room.**—The room is darkened in the usual way with curtains or shutters. The window where the apparatus is to be placed must be darkened by a shutter or a curtain with a hole in it, through which the instrument may be extended out into the sunshine and through which the sunshine can be reflected into the room.

The window frame must either be raised entire or one of the panes must be hinged so that it can be opened when desired. One can use the heliostat within the room utilizing the sunlight passing through the window glass, but this is far less satisfactory than having the heliostat out in the free air where the sun shines directly upon it.

Finally it must be possible to close the openings completely so that the room may be made as dark as desired.

§ 237. **Operation of the apparatus.**—In starting work at any time the mirror is inclined on its hinges and rotated until the sun shines upon it, and then until the light is reflected into the condenser. Finally some further slight changes may be necessary to get the light accurately centered so that it will pass from the condenser along the common axis to the objective and thence to the screen (fig. 74). By changing the position of the mirror slightly every three to five minutes to compensate for the apparent motion of the sun, the light will continue to pass through the magic lantern to the screen.

§ 238. **Adjustments necessary for the different windows.**—

(A) *For a southern exposure*—For this exposure it is desirable to have the entire outfit in a north and south direction with the objective pointing toward the north. In the morning the mirror is turned on its hinges to about 45° and then rotated toward the east until it receives the light of the sun (fig. 76). It must then be turned slightly by one or both of its possible movements until the light is reflected in the desired direction. As the sun continues to rise in the sky the mirror must be rotated on the axis from the east toward the west to follow the apparent movement of the sun. As the sun gets higher and higher the mirror must be turned on its

hinges more and more until at noon it will be nearly horizontal (fig. 76). In the afternoon, as the sun moves toward the west, the mirror must be rotated to follow it. At the same time it must be turned more and more on its hinges until late in the afternoon, it will be at the same angle as in the morning, and rotated as far toward the west as it was toward the east in the earlier part of the day (fig. 76).

(B) *For an eastern exposure*—In this position, the axis of the entire instrument is preferably east and west with the objective pointing westward. The earlier the time the more nearly hori-

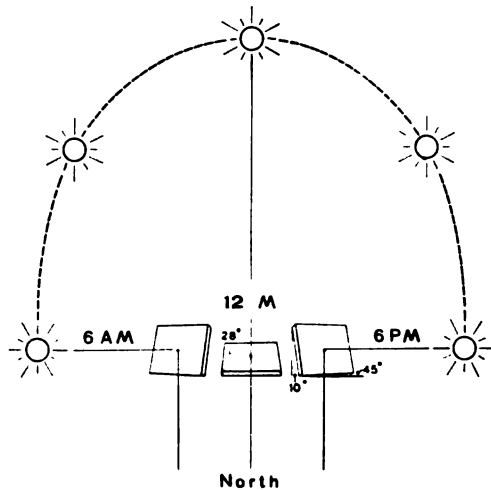

FIG. 76. DIAGRAM SHOWING THE POSITION OF THE MIRROR NECESSARY TO REFLECT THE SUNLIGHT DIRECTLY NORTH AT THREE DIFFERENT PERIODS OF THE DAY—(6 A. M.; 12 M.; 6 P. M.).

The diagram is for the latitude of Ithaca and at the season of the equinox when the sun seems to rise directly in the east and set directly in the west. In the morning the mirror is turned toward the east at an angle of 45° and inclined about 10° toward the south. In the evening it is turned similarly toward the west and south.

At noon the mirror is raised on its hinges about 28° above the horizontal. At all intermediate points the mirror must be set accordingly: that is, so that it will reflect the sun directly north.

The diagram also shows the apparent course of the sun from sunrise to sunset.

zontal must the mirror be. As the sun gets higher and higher the mirror must be raised more and more on its hinges; and as the sun seems to move toward the south as well as upward, the mirror must be rotated on its axis toward the south.

(C) *For a western exposure*—If a western exposure is used, the entire instrument should be placed pointing east and west if possible. The mirror will be raised on its hinges and turned southward early in the afternoon. As the sun sinks toward the west the mirror will be made more and more nearly horizontal, and as the sun seems to move toward the north as well as toward the west, the mirror will finally be nearly horizontal on its hinges and rotated somewhat northward.

These movements of the mirror become intelligible if one observes the position of the sun in the different periods of the day. By consulting fig 86, 87, it is also clear that the mirror must have different positions owing to the declination or position of the sun with reference to the horizon at different times of the year.

HELIOSTATS DRIVEN BY CLOCK-WORK

§ 239. **Types of clock-driven heliostats.**—A fundamental character of all heliostats is that the clock-work rotates a shaft corresponding with the post carrying the hour hand of an ordinary clock, and that it is this shaft which directly or indirectly gives motion to the mirror.

This shaft must be made parallel with the earth's axis wherever the instrument is used.

(A) *Single-mirror type.*—This is so constructed that the clock-work gives a double motion to the mirror something as one can give a double motion to a mirror held in the hands, i. e., an up and down motion and a motion of rotation on the axis (fig. 77-79).

(B) *Double-mirror type.*—In this type one mirror is fixed at the *end*, or the *side* of the clock-shaft. The second mirror is not moved by the clock-work, but is set by hand at the beginning of each experiment (fig. 81-84).

As one might conclude, the second or two-mirror type is of simpler construction and therefore correspondingly inexpensive.

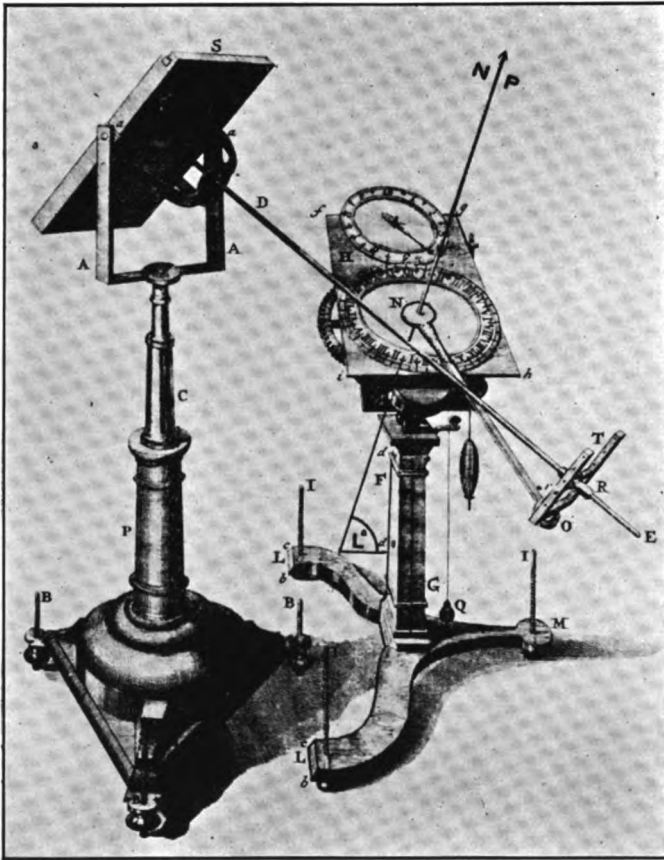

FIG. 77. ONE-MIRROR HELIOSTAT OF S'GRAVESANDE.

(From his: *Elementa Mathematica Physices, Tomus II, Tabula LXXXIII*).

This picture is a facsimile except that the clock-shaft has been extended above and below.

B B Base of the mirror support with leveling screws.

P Hollow cylinder in which the mirror support *C* can rotate.

C The pillar with mirror fork at the upper end.

S Plane mirror.

D E Shaft at right angles to the mirror and extending to the fork at the end of the clock-hand (*N O*).

L L M Foot of the support for the clock-work.

I I I The leveling screws of the support.

G F Column supporting the clock-work.
N P L° The clock-shaft. It is parallel with the earth's axis and hence points toward the celestial north pole. The angle L° at the lower end is equal to the latitude of the place where the heliostat is used.
T R Fork where the movement of the clock-hand (*N O*) is transferred to the shaft actuating the mirror (*D E S*).
f g Plate bearing the clock-work. It must be elevated sufficiently to make the angle of the clock-shaft equal to the latitude of the place (see fig. 85).

It answers very well for all the work required by the photographer and the projectionist.

§ 240. **How to make the clock-shaft parallel with the earth's axis at any given place.**—For this it is necessary to know two things:

- (1) One must know the north and south direction.
- (2) One must know the latitude of the place.

The first information can be gained by referring to the pole star. Buildings are often set due north and south, and thus serve as guides; or one might use a compass. If a magnetic needle is used it must not be forgotten that there is a certain variation from the true north and south line assumed by the compass needle, and for accurate observations it is necessary to know the magnetic variation at any given place and to correct for it.

For the latitude, a good map like that issued by the U. S. geological survey will give the information. The geological survey maps also give the magnetic variation.

Making the clock-shaft parallel with the earth's axis is easily accomplished if one knows the latitude and the north and south direction. As a general statement all that is necessary is to make the clock-shaft point toward the north star or more accurately, toward the celestial north pole.

By referring to fig. 85 it is evident that this is brought about by putting the instrument due north and south and then elevating the clock-shaft above the level or horizontal line an amount equal to the latitude of the place.

For example, if an experiment with the heliostat is to be made in one of the buildings of Cornell University at Ithaca with, in round numbers, a latitude of 42.5 degrees, the instrument is set on a level place and due north and south, then the free end of the

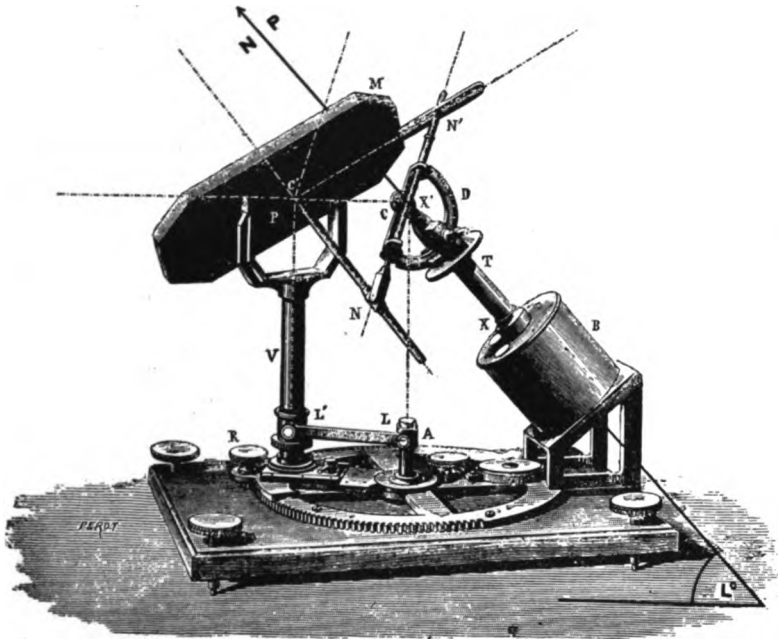

FIG. 78. ONE-MIRROR HELIOSTAT OF FOUCAULT.
(From his *Recueil des Travaux Scientifiques*).

Modified by extending the clock-shaft above and below.

B Clock-work.

T The clock-shaft.

C The upper end of the clock-shaft.

N P Continuation of the clock-shaft above the mirror (*M*).

L° The angle above the horizontal to make the clock-shaft parallel with the earth's axis. It equals the latitude of the place where the heliostat is used (see fig. 85).

D Divided semicircle to enable one to set the instrument according to the sun's declination.

N¹ N, N C¹ Connections between the clock-work and the mirror.

clock-shaft is raised above the level 42.5 degrees. If now one were to sight along the clock-shaft it would be found pointing directly toward the north star.

As seen from the diagram, fig. 85, it will then also be parallel with the earth's axis.

Sometimes the co-latitude and the vertical line are used instead of the horizontal line and the latitude. This brings about the same result, for if the clock-shaft is vertical to start with, it must be tipped over toward the north from the vertical an amount equal to the co-latitude. That is, in Ithaca, it must be inclined 47.5 degrees from the vertical.

In general the clock-shaft must be inclined upward from the horizontal, a number of degrees corresponding with the latitude at the place of observation or it must be inclined downward toward the north from the vertical position a number of degrees corresponding with the co-latitude. The sum of the latitude and the co-latitude in every case equals 90 degrees. (See fig. 85 and its explanation).

INSTALLATION OF A SINGLE-MIRROR HELIOSTAT

§ 241. Setting up the heliostat.—

1. In the first place the instrument must be leveled and arranged accurately in a north and south direction.
2. The clock-shaft must next be elevated to an angle corresponding with the latitude of the place where it is to be used (§ 240) so that it will point toward the north star. It will then be parallel with the earth's axis (fig. 85).
3. To give the proper angle to the mirror, depending on the declination of the sun, and to get also the correct local time, loosen the clamp holding the clock-arm (fig. 79 c) and turn the clock-arm toward the sun until the light shines through both sights along the line q-p. Then clamp the set screw at c.
4. To get the spot of light in the desired place, loosen the clamp-screws in the position arm F-B and below H in the rotating collar and then raise or lower the shaft o, fig. 79 and rotate the position arm around the column A till the light is reflected where it is wanted, then tighten the clamping screws and the clock-work should cause the mirror to move so that it will reflect the beam of light in the same place so long as the sun shines on the mirror.

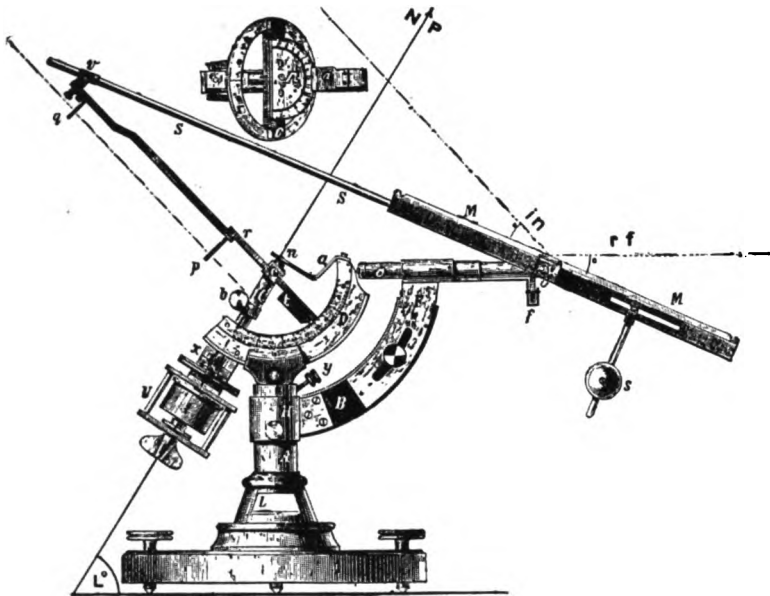

FIG. 79. UNIVERSAL, ONE-MIRROR HELIOSTAT.

(From the Catalogue of R. Fuess).

Modified by extending the clock-shaft above and below and by adding the abbreviations *in* and *rf* for the incident and reflected ray on the mirror (*M*).

This heliostat is called universal for it is adjustable so that it can be used in any latitude and at any season of the year. See fig. 80 and § 241 for further explanation.

The dials showing the time and declination may be used for setting the heliostat, but one can get the apparatus set accurately by trial as just described. If the time and declination scales are to be used one must consult a nautical almanac for the sun's declination for the given date, and an accurate clock for the time of day.

§ 242. For centering the magic lantern when a heliostat is used the same general principles must be followed as with the arc light magic lantern (Ch. I, § 51-57, fig. 1, 74).

To center the light one must be able to adjust the mirror by hand after it has been set to follow the sun. This is provided for in all

forms of single-mirror heliostats. In fig. 79, for example, the position arm B-F can be raised or lowered and the entire arm can be rotated around the column A. When the light is accurately directed, all the clamps can be tightened and the clock-work should cause the mirror to hold the light constantly in position. It will be found much easier to center the light on one axis if the heliostat is at about the same level as the condenser and objective. This position can be secured by raising the heliostat or the lantern, whichever is more convenient, provided the two are not on the same level to start with.

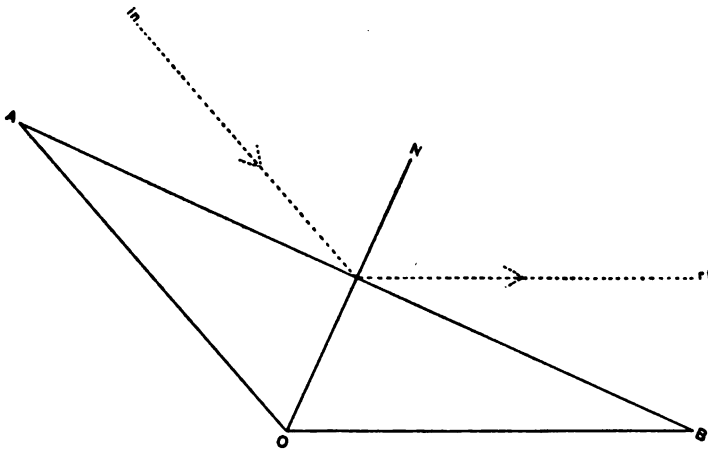

FIG. 80. PRINCIPLE OF THE UNIVERSAL HELIOSTAT SHOWN IN FIG. 79.

- OA* The clock arm pointing directly towards the sun.
OB The position arm, pointing in the direction in which it is desired to reflect the light.
in The incident light parallel to *OA*.
rf The reflected light.
AB The mirror. The mirror is perpendicular to the plane passing through *A*, *O* and *B*.
ON Perpendicular to the mirror *AB*.

In order to prove that incident light parallel to *AO* will be reflected from the mirror parallel to *OB* it is necessary to prove that *AO*, *OB* and *ON* are in the same plane and that *ON* bisects the angle *AOB*. The mirror being perpendicular to the plane containing *A*, *O* and *B* and the line *ON* perpendicular to *AB* must also be in this same plane. The triangle *AOB* is isosceles by construction, as *AO* and *OB* are made equal, hence the perpendicular to the base must bisect the vertex angle.

INSTALLATION AND USE OF TWO-MIRROR HELIOSTATS

§ 243. **Heliostat with the mirror at the end of the clock-shaft.**—

Place the heliostat in a position either inside a room or outside a window where the full light of the sun can fall upon the movable mirror. The stand supporting the clock-work, etc., must be made level, and set in a north and south direction (fig. 81).

Elevate the clock-shaft above the level to an angle equal to the latitude of the place where it is to be used. One can use a good protractor for this. The clock-shaft will then point toward the north star, and be parallel with the earth's axis (fig. 85).

This form of heliostat often has the clock-shaft in a fixed position for cheapness of construction (fig. 81). If such a heliostat is purchased, the manufacturer must know the latitude of the place where it is to be used, then he will give the proper inclination to the clock-shaft so that when the instrument is arranged in a north and south line the shaft will point toward the north star.

§ 244. **Arranging the movable mirror.**—The mirror is fixed to the end of the shaft by a collar which permits it to rotate around the shaft. It is also held in a kind of fork, which permits the mirror to be raised and lowered in a way similar to the hinge movement of the porte-lumière (fig. 75).

For setting this mirror so that the clock-work will cause it to throw a beam of light in one direction continuously, it is necessary first of all to set the mirror for the local time. This is done by the use of a perforated screen admitting a narrow pencil of light from the sun. This screen is so placed that the pencil of light falls upon the mirror. The mirror is then turned by loosening the clamp (fig. 81 c) and rotating it on the shaft, and by tipping it in the fork until the pencil of light is reflected back along its path through the hole again.

Then the clamp is tightened and the screen removed. The mirror is now tipped in the fork until the light is reflected from it directly in line with the clock-shaft, i. e., directly toward the north star (fig. 81 N. P.). The easiest way to do this is to take a piece of white cardboard with parallel black lines on it and place it

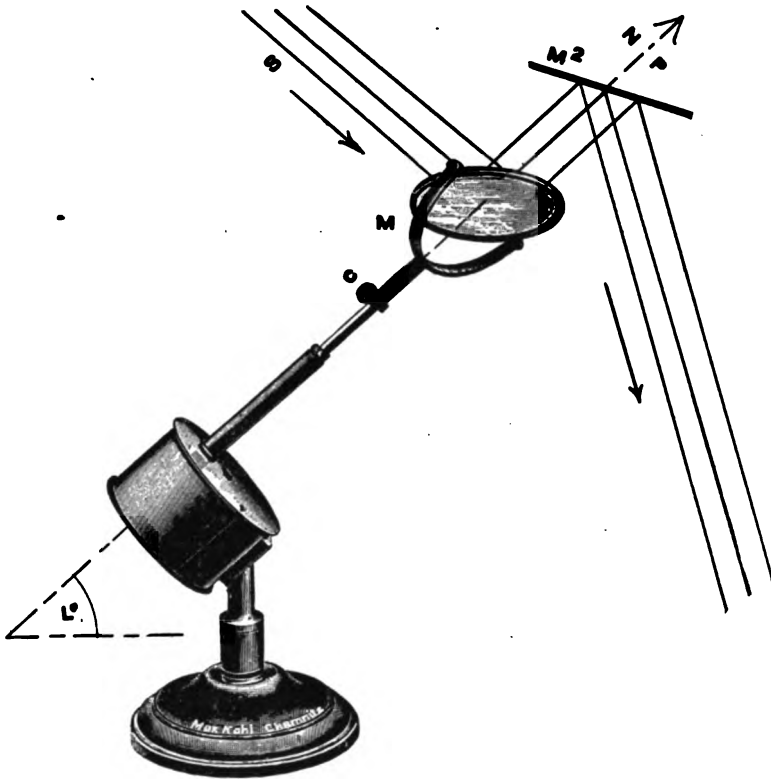

FIG. 81. TWO-MIRROR HELIOSTAT WITH THE MOVABLE MIRROR AT THE END OF THE CLOCK-SHAFT.

(From the Catalogue of Mux Kohl).

The figure has been modified by extending the clock-shaft and by adding the second mirror and the light rays. This heliostat is usually fixed for a given latitude, hence in ordering one, the latitude of the place should be given. It could be made adjustable for latitude, but that would naturally increase the cost.

N-P, L° The clock-shaft pointing to the celestial north pole above, and indicating the angle corresponding with the latitude below.

c Clamp to hold the mirror (*M*) to the revolving clock-shaft.

M Movable mirror. It is adjusted in the fork and on the clock-shaft until the reflected rays proceed parallel with the earth's axis, hence also parallel with the clock-shaft.

M² The fixed mirror to be set by hand in the beginning.

S and the Arrows. The sun's rays.

parallel with the clock-shaft. When the beam of light from the mirror extends out parallel with these lines, as indicated by the streak of light, the mirror will be in the correct position.

§ 245. **Arranging the second mirror.**—For getting the light in a desired direction, a second mirror is used in the path of the beam extending directly northward, from the first mirror, and so arranged that the light is reflected as desired (fig. 81 M²).

§ 246. **Heliostat with the mirror parallel with the clock-shaft.**—With the other heliostats described in this chapter, the clock-work rotates the shaft once in 24 hours, but with this form, the rotation is once in 48 hours, i. e., half the rate of rotation of the earth. The clock-shaft is somewhat extended and the mirror is fixed directly to the shaft and parallel with it. The mirror is therefore in a plane which if extended would cut the celestial north pole (fig. 82).

Light reflected from this mirror may be made to take any direction in a circle.

§ 247. **Setting up the heliostat with the mirror parallel with the clock-shaft.**—The heliostat is placed in a proper position for receiving the sunlight. The support is made level, and the instrument set north and south. The clock-shaft is then elevated from the horizontal until it is at an angle equal to the latitude of the place where it is to be used. As the mirror in this form may be set to reflect the light anywhere in a circle, it is best to loosen the clamp of the clock-shaft and rotate the mirror until it receives the full light of the sun and reflects it in a convenient direction. Then clamp the shaft to the clock-work and the mirror will follow the sun.

§ 248. **Arranging the second mirror.**—The second mirror is now placed so that it will receive the beam from the movable mirror, and then it is turned, raised, or lowered on its stand, until the light extends in the desired direction. It should continue to hold the light in one place so long as the sun shines on the movable mirror (fig. 82). One must make sure that the position of the second mirror is such that it will not shade the heliostat mirror as the sun moves toward the west.

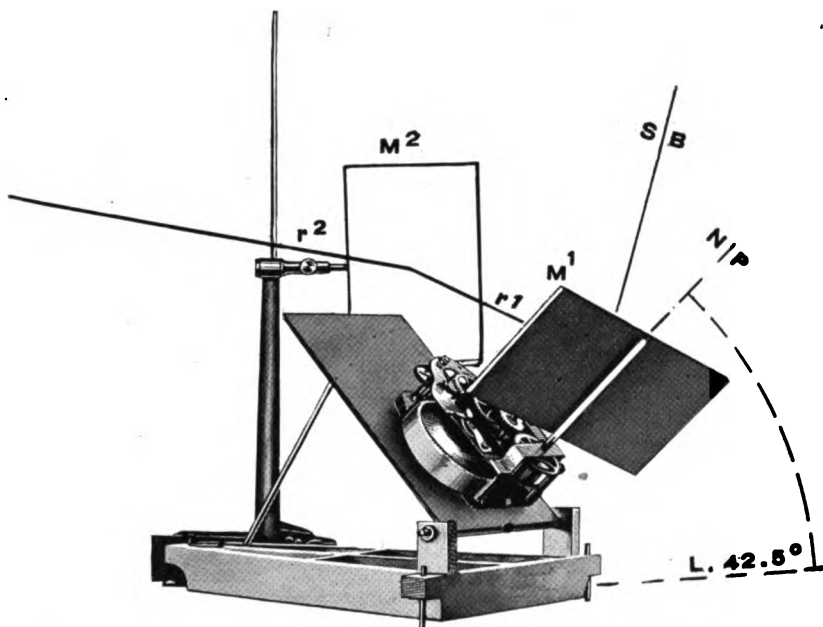

FIG. 82. TWO-MIRROR HELIOSTAT WITH THE MOVABLE MIRROR ATTACHED PARALLEL TO THE CLOCK-SHAFT.

This heliostat is adjustable for latitude and can be used anywhere in the northern hemisphere, and by reversing the motion, in the southern hemisphere (§ 253).

C Clock-work mounted on a hinged plate.

*M*¹ Rotating mirror attached to the side of the clock-shaft. From this arrangement its plane would pass through the celestial north pole if extended.

*To get this picture, the heliostat was set in the west window of Stimson Hall at 2:30 P. M., May 20, 1912, and the mirrors arranged to receive and reflect a small beam of sunlight as indicated. A black cord was extended from the small hole in the shutter to the point on the first mirror receiving the sunbeam, and from thence to the second mirror along the path of the sunbeam; and from the second mirror to a point on the screen receiving the sunbeam. The apparatus was then photographed. To make the course of the sunbeam very sharp for this cut its course was traced on the photograph by a right line pen. The clock-shaft was also extended above and below and an arc of a circle added between the clock-shaft and the horizon to indicate the angle of elevation of the clock-shaft, corresponding with the latitude of Ithaca (42.5° North Latitude).

*M*² The fixed mirror. This is adjusted at the beginning of the experiment to reflect the light in the desired place and usually needs no attention during the experiment.

N P Continuation of the clock-shaft pointing toward the north pole.

L 42.5° The angle made by the clock-shaft, and the horizon at Ithaca, New York, U. S. A. It indicates the latitude of that place, and the elevation of the clock-shaft to make it point toward the celestial north pole.

S B Sunbeam admitted through a hole in the shutter. It strikes the first mirror and is reflected to the second mirror, and from it in any desired direction.

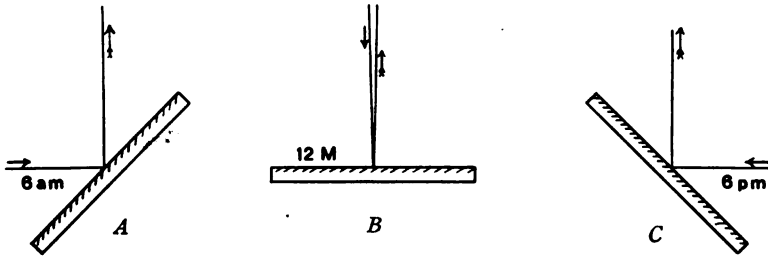

FIG. 82 A, B, C. DIAGRAMS SHOWING THE POSITION OF THE FIRST MIRROR OF THE HELIOSTAT (Fig. 82) AT DIFFERENT TIMES OF THE DAY TO REFLECT THE SUNLIGHT CONSTANTLY IN THE SAME DIRECTION.

The eye is supposed to be looking along the axis of the clock-shaft. It is to be noted that between 6 A. M. and 6 P. M. (12 hours) the mirror has turned through an angle of 90°, and at this rate it takes 48 hours for the mirror to make a complete revolution of 360°.

The arrows indicate the direction of the light before and after reflection from the mirror.

A Position of the mirror at 6 A. M.

B Position of the mirror at 12 M.

C Position of the mirror at 6 P. M.

At intermediate periods the mirror will be in correspondingly intermediate positions to reflect the sun constantly in the same direction, that is, the mirror must follow the sun.

This is one of the easiest heliostats to manage, as one needs to know only the latitude and the north and south direction. The arrangement of the two mirrors can be easily made at any time and in any place by trial.

HELIOSTATS IN THE SOUTHERN HEMISPHERE

§ 249. Up to the present, the discussion has been with reference to heliostats in the northern hemisphere. For those to be used in the southern hemisphere certain modifications are necessary as seen from the following considerations:

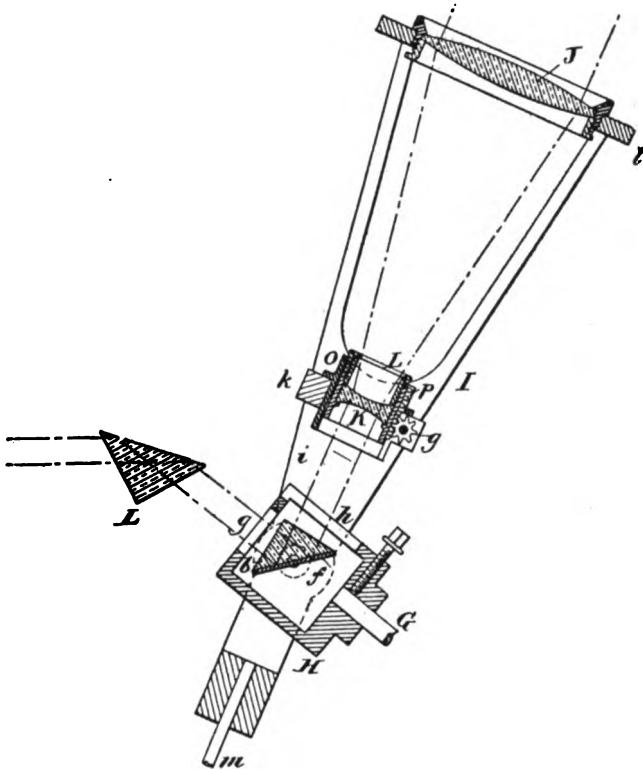

FIG. 83. LENS AND PRISM HELIOSTAT OF ALFRED M. MAYER.
 (From the American Journal of Science, Vol. 154, 1897).

This heliostat is in principle like the two-mirror heliostat with the movable mirror attached to the end of the clock-shaft (fig. 81).

J Biconvex lens about 10 cm. (4 in.) in diameter to receive the sun's rays and render them convergent.

K Concave lens to render the converging beam parallel.

g Rack and pinion movement to change the position of the concave lens and thus increase or diminish the size of the beam.

f Right-angled prism receiving the parallel bundle from *K* and reflecting it to a fixed prism (*L*) or to a mirror, by which it is reflected in any desired direction.

The two lenses *J* *K* and the prism *f*, are all on one common axis and are rotated by the clock-shaft *G*, and thus made to follow the sun like the mirror on the end of the clock-shaft in figure 81. The clock-shaft *G* must be at an elevation corresponding to the latitude of the place (see also fig. 84).

§ 250. If one were looking at the north pole of the earth from a position along the earth's axis, the direction of the earth's rotation would appear in a direction opposite to the hands of a clock or watch. To compensate for this, a mirror to hold a spot of sunlight in one position would need to be rotated around an axis parallel with that of the earth, but in an opposite direction to the earth's rotation, that is in the clockwise direction.

§ 251. At the equator, the clock-shaft must be horizontal in order to be parallel with the earth's axis. The clock-shaft must be turned from east to west. This can be accomplished either by a clock-work located at the southern end of the shaft turning in the clockwise direction as in fig. 77-79, or by a clock-work located at the northern end of the shaft turning in a counter-clockwise direction.

§ 252. At the north pole of the earth, the axis of rotation of the shaft would be vertical and the direction of rotation as seen from above, would be clockwise.

At the south pole the axis would also be vertical and the direction of rotation would be clockwise as seen from below—i. e., from the north—or counter-clockwise as seen from above.

§ 253. A heliostat constructed for the southern hemisphere would be exactly similar to one for the northern hemisphere except that the clock-shaft must rotate in the counter-clockwise direction, that is, from right to left.

§ 254. **Setting up a heliostat in the southern hemisphere.**—If a heliostat is properly constructed for the southern hemisphere it is set up at any given south latitude by arranging the instrument due north and south with the free end of the clock-shaft pointing south. Then the clock-shaft would be elevated above the horizon a number of degrees corresponding with the south latitude. This would make the clock-shaft parallel with the earth's axis and it would point toward the celestial south pole (fig. 85). Indeed, the entire procedure for getting the light in the desired direction, the use of the condenser and projection objective, etc., is exactly as for the northern hemisphere.

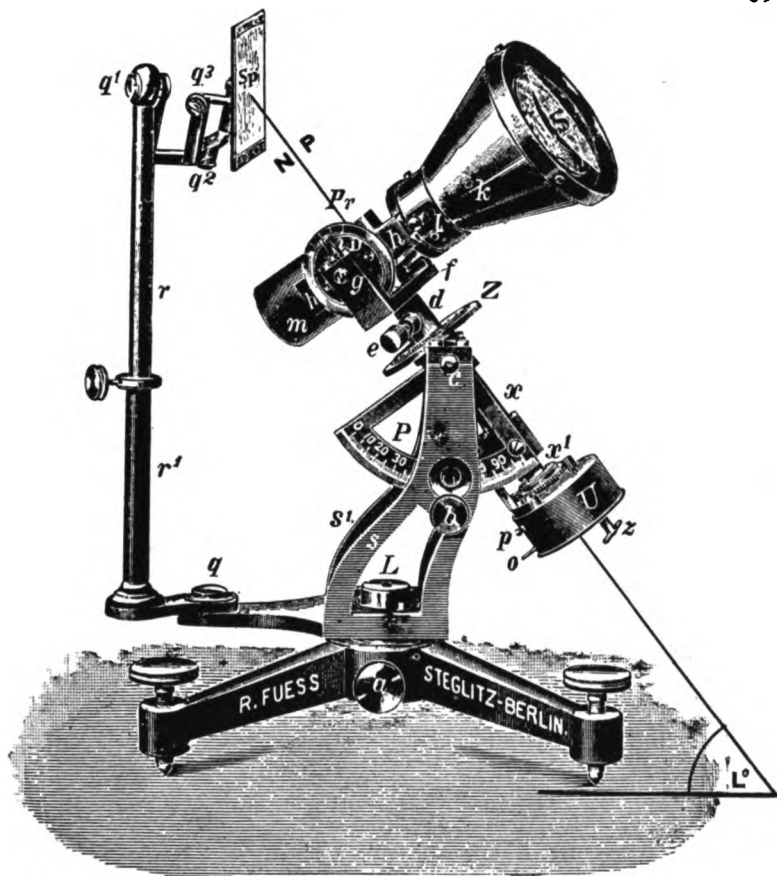

FIG. 84. LENS AND PRISM HELIOSTAT OF ALFRED M. MAYER.
 (From the Catalogue of Optical Instruments by R. Fuess).

The figure has been modified by extending the clock-shaft above and below. As here shown the instrument is suitable for any latitude. It uses a mirror instead of a second prism as in the original of Mayer (fig. 83).

U Clock-work.

N P, L° The clock-shaft extended to indicate the direction of the celestial north pole above, and below the angle of elevation corresponding to the latitude of the place where the instrument is used.

P D Z Three divided scales; *P* for the latitude, *D* for the Sun's declination, *Z* for the time of day.

S, k and Pr. The convex and the concave lens, and the prism as shown in fig. 83.

Sp Mirror to take the place of the prism (*L*) in fig. 83.

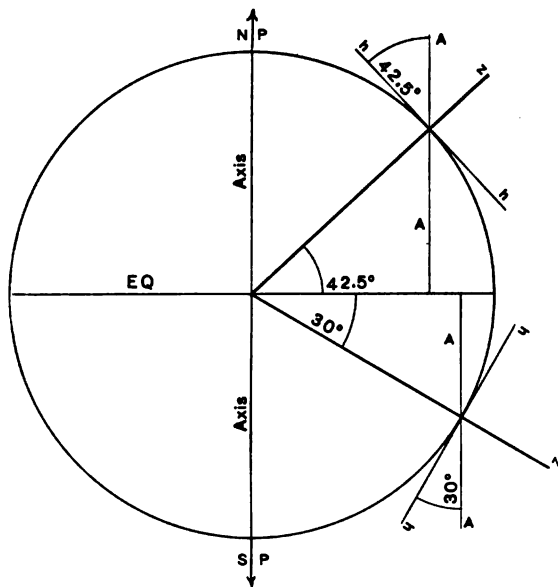

FIG. 85. DIAGRAM SHOWING THAT THE ELEVATION OF THE CLOCK-SHAFT AT AN ANGLE EQUAL TO THE LATITUDE OF A PLACE WILL MAKE THE CLOCK-SHAFT PARALLEL WITH THE EARTH'S AXIS.

EQ Equator of the earth.

Axis Axis The earth's axis with the north pole of the earth above and the south pole below.

NP The earth's north pole.

SP The earth's south pole.

42.5° Latitude of Ithaca, New York, U. S. A.

h h Horizontal lines, that is, tangents to the earth's surface at the two latitudes shown (42.5° north, 30° south).

Z Zenith.

AA Clock-shaft elevated from the horizon an amount equal to the latitude. If continued toward the equator the clock-shaft would meet the plane of the equator at right angles, hence it is parallel with the earth's axis and points toward the celestial poles.

Ah Latitude (42.5° north and 30° south).

AZ Co-latitude (47.5° north, 60° south).

§ 255. Finally, a heliostat constructed for the northern hemisphere would work equally well for the southern hemisphere if it were attached to the ceiling (i. e. wrong side up) instead of being on a table or window-sill right side up, for this change in position would make the clock-shaft rotate in the counter-clockwise direction, as seen from above.

CONDENSER FOR SUNLIGHT

§ 256. As sunlight is composed of practically parallel rays, the condenser consists of a single plano-convex lens with the convexity receiving the light (fig. 74); or one may use an achromatic combination (fig. 324).

The condition is practically like the ordinary condenser after the light has been rendered parallel by the first element of the condenser (fig. 3). Having parallel rays to start with, only the second element of the condenser is needed.

§ 257. **Increasing the illumination.**—The greatest difference between the use of sunlight and the arc light for projection appears when one wishes to increase the illumination. With the arc lamp one simply uses more current, and this increases the candle-power and makes the screen image more brilliant. With the same size condenser and picture the illumination of the screen with the arc light is directly proportional to the illumination of the condenser face.

With sunlight, the illumination of the condenser face is a constant quantity except for haze, etc. As all the light which strikes the screen must pass through the condenser, the screen illumination can be increased with sunlight only by using a condenser of larger diameter and correspondingly greater focal length. And for this one must have heliostat mirrors of sufficient size to fill the condenser with light.

§ 258. **The water-cell with sunlight.**—This light is accompanied by so much radiant heat that it is desirable to use a water-cell with the apparatus, and thus reduce the liability of over-heating lantern slides or other specimens used for projection (see § 848 for the discussion of the need of a water-cell).

CONDUCT OF AN EXHIBITION WITH SUNLIGHT

§ 259. The general principles given in Ch. I, § 21-41 are applicable.

§ 260. **Lighting of the room.**—Sunlight is sufficiently powerful so that the room used need not be very dark for showing lantern

slides. Care must be taken to have no direct light fall on the screen except that from the lantern, but the room can have sufficient diffused light to take notes comfortably (see also Ch. XII, § 605-608).

§ 261. **Size of the room and the screen.**—By using a condenser of proper size and of a focal length adapted to the projection objective, there is no practical limit to the possibilities of projection with sunlight.

§ 262. **Turning on and off the light.**—For shutting out the sunlight one can use a metal shield between the mirror and the condenser or one can use the objective shield (fig. 14 and 62). The first method is preferable, for there will be less heating of the apparatus.

TROUBLES

§ 263. **The troubles with sunlight are:**

1. The difficulty of keeping the beam of sunlight in a constant direction. With the porte-lumière one must be constantly on the alert to make the slight adjustments of the mirror necessary.
2. The clock-driven heliostats, if well made and regulated accurately, should give no trouble when they are properly set up.

If a person is fortunate enough to live near an astronomical observatory and can get the help of the astronomer in charge he can learn to overcome difficulties that seem to be insurmountable when working alone. The apparatus of an observatory is also of first rate quality, and it helps any worker to know what good apparatus looks like.

§ 264. **Lack of sunlight.**—This is the one great trouble. Of course it is not available at night anywhere. And in the most thickly populated regions where projection apparatus is used there is liable to be so much cloudy weather that sunlight is not available even in the daytime during much of the year. Smoke also obscures the sun when clouds are absent.

Fortunately, in many parts of America the sun can be counted on in the daytime; and for those parts the use of sunlight for projection of all kinds is strongly recommended.

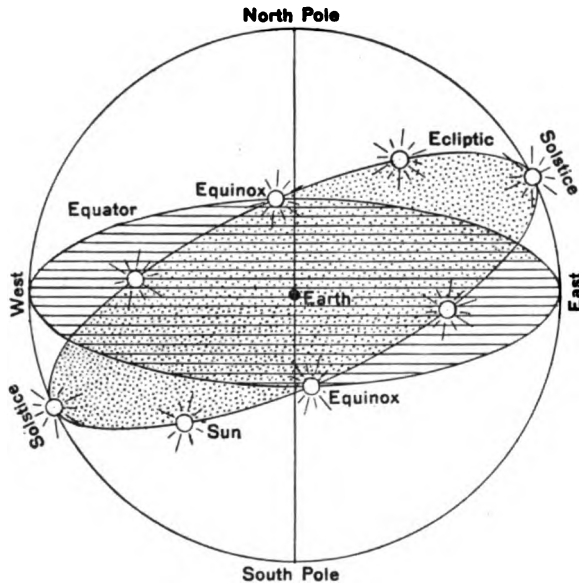

FIG. 86. DIAGRAM OF THE CELESTIAL SPHERE WITH THE PLANES OF THE CELESTIAL EQUATOR AND OF THE ECLIPTIC; AND WITH THE APPARENT POSITION OF THE SUN AT DIFFERENT SEASONS.

Earth This is shown as a small black sphere at the center.

North Pole, South Pole The two poles of the celestial sphere. They are at an infinite distance from the earth.

West, East East and west points of the celestial sphere. The plane of the celestial equator touches these points.

Equator The plane of the celestial equator (shaded in lines) dividing the celestial sphere into a northern and a southern hemisphere. A plane at right angles to this traversing the north and south poles would divide it into an eastern and western hemisphere.

Ecliptic The plane (shaded in dots) around the outer edge of which the sun seems to move during the year. It is inclined to the equator at an angle of $23^{\circ} 27'$.

Equinox When the sun appears at the equator the days and nights are of equal length (March 21, Vernal or Spring Equinox, and Sept. 23, Autumnal or Fall Equinox).

Solstice The point on the Ecliptic the farthest north or south of the Equator. (Summer Solstice, when north of the equator, June 22; Winter Solstice, when south of the equator, Dec. 22).

(See also fig. 87).

§ 265. Summary of Chapter VI:

Do

1. Utilize sunlight when that is available, for it is the brightest light to be had on our planet (§ 232).

2. For sunlight some sort of a heliostat is necessary to counterbalance the rotation of the earth, and make the sun shine in one place continuously (§ 233).

3. Two motions to the mirror are necessary, an up and down motion and a rotary motion at right angles to this (§ 233).

4. If a clock-driven heliostat is used, the instrument must be set up so that the shaft of the clock shall point toward the celestial pole and thus be parallel with the earth's axis (§ 239-241).

5. To make the shaft parallel to the earth's axis raise it from the horizontal an amount equal to the latitude of the place where it is to be used (§ 240).

6. The two-mirror heliostat is simplest and least expensive (§ 239).

Do Not

1. Do not use artificial light in a region where bright sunlight is constantly available.

2. If a porte-lumière is used to keep the sun shining in one place, do not forget to adjust the mirror frequently. Remember that the earth never stops rotating.

3-4. For a clock-driven heliostat do not forget that the shaft moving the mirror must point toward the north pole (or south pole, if south of the equator).

5. Do not forget to elevate the clock-shaft an amount equal to the latitude of the place.

6-7. Do not put the second mirror of the heliostat so that the sun cannot shine on the first mirror.

7. One mirror is attached to the shaft and is driven by the clock-work. The other mirror is set by hand at the beginning of the experiment (§ 239, 248).

8. As the rays of sunlight are practically parallel, only one element of the condenser is needed, viz., the one next the lantern slide (fig. 74, § 256).

9. To increase the illumination use a larger mirror and condenser (§ 257).

10. To turn the light on and off, use a metal shield (§ 262).

11. Use a heliostat designed for the hemisphere where you are to work (§249-255).

8. Do not use a condenser with two or three lenses for sunlight as for a near light source, use only one lens or an achromatic combination designed for parallel light (fig. 74).

9. One cannot increase the illumination without increasing the size of the mirror and condenser.

10. Do not use inflammable shields to block the light. Use a metal shield between the mirror and condenser.

11. Do not try to use a heliostat in the southern hemisphere which was constructed for use in the northern hemisphere.

CHAPTER VII

PROJECTION OF IMAGES OF OPAQUE OBJECTS

§ 270. Apparatus and material for Chapter VII:

Suitable projection room with screen (§ 286); Lantern with projection objective of large aperture and with suitable radiant and condenser (§ 275, 277, 279, 294-296); Suitable objects for projection (§ 285).

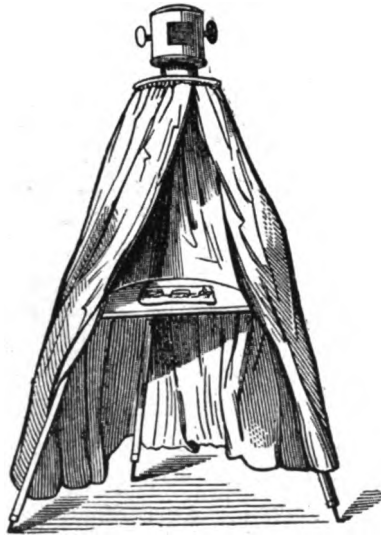

FIG. 88. CAMERA FOR DRAWING LANDSCAPES.
(From the Catalogue of Queen & Co., 1880).

The dark room is made of opaque cloth over a tripod. The 45° mirror at the top rotates to take in any desired part of the surrounding country and an objective projects the image down upon the horizontal drawing shelf.

If there is to be combined projection, a tinted glass to make the lantern-slide image as dim as the opaque image (§ 282).

See also the outfit given in § 1, Ch. I.

§ 271. **Historical development.** See appendix.

References to literature: See the books referred to in Ch. I, § 2, also the special catalogues and directions furnished by the manufacturers of Opaque Lanterns and combined projection apparatus.

PROJECTION OF IMAGES OF OPAQUE OBJECTS

§ 272. All of the images seen on a white screen within a dark room were originally of opaque objects. These objects were brilliantly illuminated by the sun, and the light reflected from them

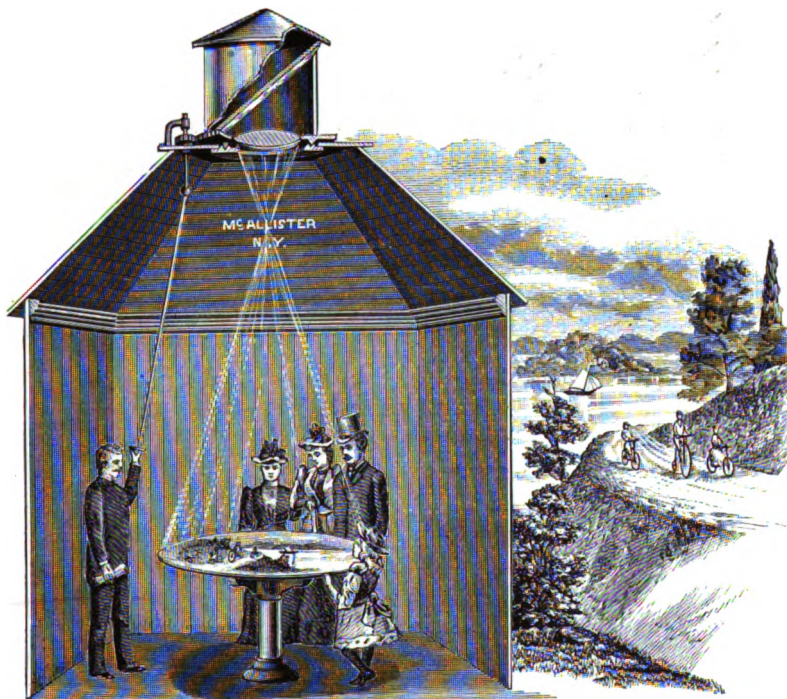

FIG. 89. CAMERA FOR EXHIBITING SURROUNDING LANDSCAPES.
(From the Catalogue of McAllister).

In a kind of cupola at the top is situated a plane mirror and beneath that a projection objective. The cupola rotates, thus enabling the operator to bring any desired scene upon the horizontal screen within the room. Such cameras were once common at fairs and in parks.

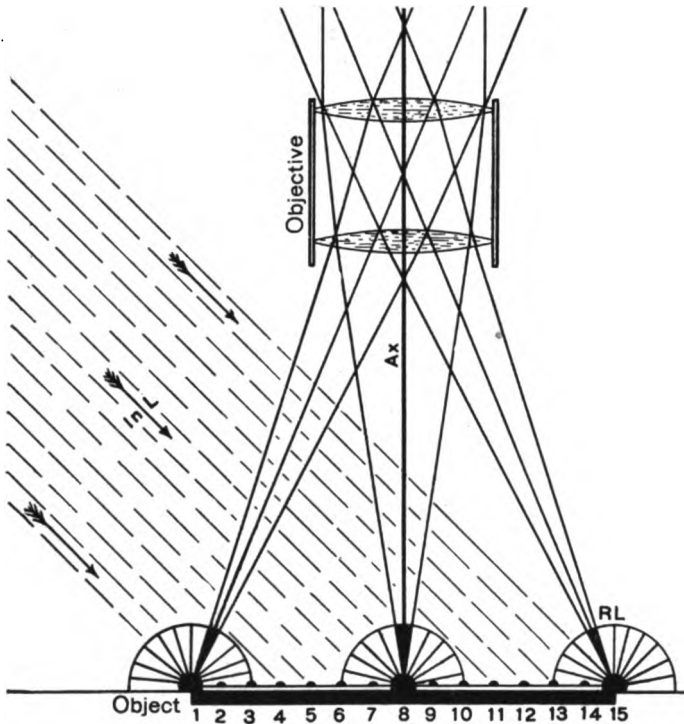

FIG. 90. DIAGRAM SHOWING OPAQUE PROJECTION.

In both these diagrams (fig. 90-91) the same amount of light illuminates the object, and the objects are of the same size, and the objectives have the same aperture.

Fig. 90. Opaque projection In. L. Incident light of parallel rays impinging upon a picture in white and black.

Object. The opaque object in black and white the size of a lantern slide.

1-15 The beams of light illuminating the object. The light must of course fall upon the surface facing the projection objective.

RL Reflected light. From each point on the surface of the opaque object the light falling upon it is reflected nearly equally throughout the entire hemisphere.

Ax Axial beam on the principal optic axis of the objective.

Objective The projection objective. Its aperture is such that it receives and transmits about 20° of the 180° reflected from each point.

From the formula given in § 857a such an objective transmits to form the screen image approximately 3% of the light reflected from the opaque object.

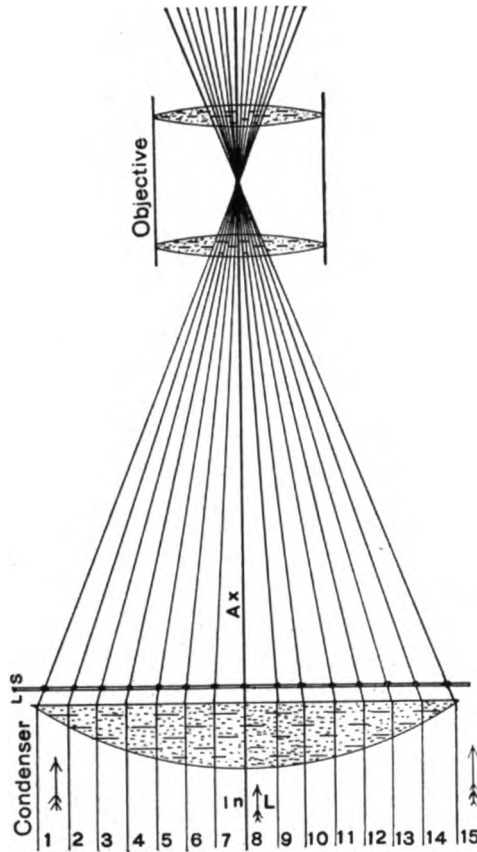

FIG. 91. TRANSPARENCY PROJECTION.

In L Incident light. This is supposed to be exactly the same as that striking the face of the opaque object. In this case it traverses the condenser lens, passes through the transparency, and the objective, and passes on to the screen with very little loss.

1-15 Parallel beams of light reaching the condenser and passing onward.

Condenser A plano-convex lens to render parallel rays converging.

L S Transparent lantern slide.

Ax The principal optic axis.

Objective The projection objective. Its aperture is the same as in fig. 90, but is much larger than necessary for the transparency.

passing through a hole, or later a lens, in the wall of a dark room sufficed to produce the picture on the white wall or screen.

Later it was found that it was possible to illuminate objects sufficiently with artificial light to get screen pictures; and still later transparencies were used (§ 272a).

Every one who looks at the picture of a landscape, etc., depicted on the ground glass of a photographic camera sees inverted images like those originally observed in darkened rooms on translucent screens.

CONDITIONS FOR OPAQUE PROJECTION: COMPARISON OF PROJECTION WITH OPAQUE AND TRANSPARENT OBJECTS

§ 273. In order to deal intelligently and successfully with opaque projection it is necessary to comprehend in the very beginning the difference in the conditions for obtaining a screen image of an opaque object, and for a screen image of a transparency (lantern slide, moving picture film or microscopic specimen).

With a transparent or semi-transparent object, the light comes from behind and traverses the object, and goes on with practically no variation in direction to the projection objective. As the light reaching the lantern slide or transparency is directed by the condenser (fig. 91), the light which illuminates the transparency passes on and enters the projection objective and therefore serves for the production of the screen image (fig. 1-2).

With the opaque object, on the other hand, all the light which produces the screen image must be reflected from the surface of the object, and the light which illuminates the object must strike its

§ 272a. In the early days of opaque projection with artificial light the whole face of a man was sometimes shown; this, of course, required very large lenses.

This is what Hepworth says concerning these exhibitions: "At one time a large instrument of this type was made for casting the image of a human face on the screen, the lenses being of immense size. . . . It was, of course, fitted with a reversing (erecting) lens (fig. 208), so that the face should appear right way up. The owner of this face, by the way, suffered tortures during the short time of exhibition, for the powerful lime lights close to and on each side of his head, were so hot that they blistered his skin. He was made to smile at the audience, and then to drink their good health in a glass of wine, a refreshment which the poor man really needed after his grilling." (P. 246).

face instead of traversing it,—that is, it must extend in the opposite direction from that used with the transparency.

The light falling upon the face of the opaque object must then be reflected from each point. But unlike the transparent object, in which practically all of the light illuminating each point of the object goes directly to the projection objective (fig. 91), with the opaque object, each point reflects the light irregularly and in all directions within the entire hemisphere (180 degrees, fig. 90). This being the case, only a part of the light reflected from each point can get into the projection objective, all the rest falling outside the objective. Of course, the larger and closer the objective, the more of the light will be received; hence, in selecting an objective for opaque projection, keep in mind that the greater the diameter of the lenses the more light from each point can be received, and consequently the more brilliant will be the screen picture.

It is assumed in this discussion, and in the accompanying diagrams (fig. 90-91), that the opaque object is black and white and that it and the transparent lantern slide are of the same size; that both are lighted by a similar beam of parallel light rays, and that none of the light is lost by absorption.

§ 274. Relative amount of light for the images with transparencies and opaque objects.—If, for example, as in the diagram, the projection objective can receive but 20 degrees of the hemisphere of light from each point, then 160 degrees will fall outside the objective and not aid at all in the formation of the screen image. If the objective could take in all of the light from each point, the opaque object would give as brilliant a screen image as the lantern slide, but the actual proportion of light represented by the angle of twenty degrees is only three per cent. of that represented by 180 degrees. As only three per cent. of the light from each point helps in the formation of the screen image of the opaque object, the opaque object can give a screen picture only three per cent. as bright as the transparency where practically all of the light helps to form the screen image (fig. 90-91).

In practice, how great a proportion of light serves for the screen image and how much is absorbed or lost depends upon the opacity

of the lantern slide and the reflecting qualities of the opaque object (see § 274a).

§ 275. **Aperture of the projection objective for transparencies and for opaque objects.**—By comparing figures 90–91 it will be seen that for a transparency, relatively small aperture for the projection objective is sufficient. This also shows that if one were to use the same objective for both transparencies and for opaque objects, that the difference in brightness would be enormously exaggerated, if one used only the necessary aperture for the transparencies. If one used the proper objective for the opaque object, it would answer well for the transparency, but only a part of the aperture would be utilized. As the large aperture makes the objective very expensive, one wastes money by having the large aperture for transparencies. In the best practice, an objective of moderate aperture is used for transparencies, and one of relatively very large aperture for opaque projection.

§ 276. As will be shown later (Ch. XIV, § 857a), with a given object and a given illumination, the brilliancy of the screen image depends upon the aperture of the objective and its distance from the screen. The larger the diameter of the lenses of an objective

§ 274a. **Light flux getting through the objective with opaque projection.**—It will be shown in § 857a that the light received from a perfectly white, perfectly diffusing surface is

$$\frac{\pi B}{2} \int_0^{\theta} \sin 2\theta \, d2\theta = \frac{\pi B}{2} (1 - \cos 2\theta)$$

$= \frac{I}{20,000} (1 - \cos 2\theta)$ lumens per square centimeter of the white reflecting surface, where I is the intensity of illumination of the surface measured in meter candles, and θ is the half angle of light subtended by the objective, or 2θ is the angle of light subtended by the objective. The light received by the surface is $I/10,000$ lumens and the proportion of light received by the surface which strikes the objective is then $\frac{1 - \cos 2\theta}{2}$

In this problem the angle of light subtended by the objective is 20° , i. e. $2\theta = 20^\circ$. The proportion of light received by the objective is then $(1 - \cos 20^\circ)/2 = (1 - .9397)/2 = .0603/2 = .0302$ or about 3%.

of given focus, the greater will be the brightness. With the same objective, the greater the distance of the objective from the screen, the less will be the brightness

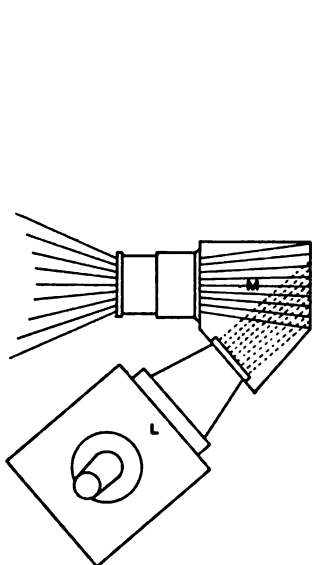

FIG. 92. CHADBURN'S OPAQUE LANTERN WITH ONE SOURCE OF LIGHT.
(From Chadwick, Hepworth and Wright).

L Source of light shining directly upon the opaque object.
M Beam of light from the opaque object to the objective and to the screen.

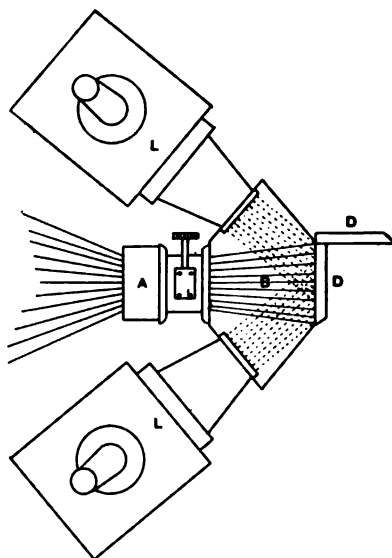

FIG. 93. CHADBURN'S OPAQUE LANTERN WITH TWO SOURCES OF LIGHT.
(From Chadwick, Hepworth and Wright).

This form requires two sources of light and two condensers. The light is projected directly upon the object and from the object it extends out through the objective to the screen. This method is still often employed.

The same lantern, connected in the usual way, was employed for transparency projection (fig. 1).

L-L Source of light and condenser arranged to send the light directly to the opaque object.

D-D Hinged door for the support of the book, picture or other object. When the door is closed, the light from both sources shines directly upon the opaque object.

B Beam of light from the object to the objective.

A Objective of large aperture for projecting the image of the opaque object upon the screen.

§ 277. **Brilliant screen images of opaque objects.**—It is intelligible from the above discussion and the diagrams that to produce a brilliant screen image of an opaque object five things are necessary:

1. The light for illuminating the opaque object must be very brilliant, like sunlight or the electric arc light.
2. The opaque object must be capable of reflecting most of the light illuminating it, or must be on a white background.
3. The projection objective must have lenses of large diameter.
4. The distance of the objective from the screen must not be too great.
5. Besides the above, the projection room must be dark or the screen image will not have sufficient contrast.

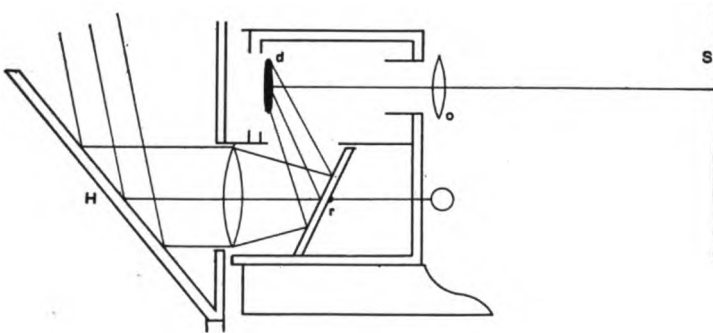

FIG. 94. DOLBEAR'S OPAQUE PROJECTOR WITH SUNLIGHT.

(From Dolbear's *Art of Projecting*.)

H Heliostat, porte-lumière or simply a plane mirror to direct the sunlight through the bi-convex condenser.

r Movable mirror to reflect the sunlight upon the opaque object at *d*. The handle for changing the inclination of the mirror is seen at the right.

d Opaque object with the light from the mirror (*r*) illuminating it.

o Projection objective.

S Screen for the image.

§ 278. **Position of the radiant.**—The radiant or source of light for illuminating opaque objects for projection may have either of two positions:

1. It may be in front of the object so that the light emitted shines directly on it. This is the original device and gives the greatest amount of light (fig. 92-93); or the radiant may be tilted (fig. 105, 111).
2. The second method is to have the light not in front, but a mirror reflects the light from the radiant upon the opaque object (fig. 94, 95). This is usually a more convenient arrangement than the above, but a certain amount of the light (between 10% and 25%) is lost when reflected from a mirror.

§ 279. **Use of a condenser or concave reflector with opaque projection.**—This is frequently employed for the object is often at a considerable distance from the radiant, and too small a part of the light from the radiant would be available but for the help of the condenser.

In most cases only the first element of the condenser is used. This projects upon the object or the mirror a cylinder of parallel rays (fig. 90, 103). Sometimes also a converging lens of long focus is put in the path of the parallel cylinder to concentrate it more or less, depending upon the size of the object to be shown. Instead of a condenser, there is sometimes used a reflector (fig. 95, 96) behind the radiant.

§ 280. **Darkness of the projection room.**—Owing to the difficulty of obtaining a sufficiently brilliant screen image it is necessary to have the projection room very dark.

COMBINATION LANTERN SLIDE AND OPAQUE PROJECTION

§ 281. **Daylight and twilight vision.**—Nearly all modern apparatus giving opaque projection also gives transparency projection with a slight change. These two kinds of projection are mutually antagonistic for the adjustments of the eyes of the spectators. For transparency projection the image is so brilliant that the eyes are adjusted for daylight vision in large part, while for the opaque projection the image is so dim that the eyes should be adjusted for twilight or night vision.

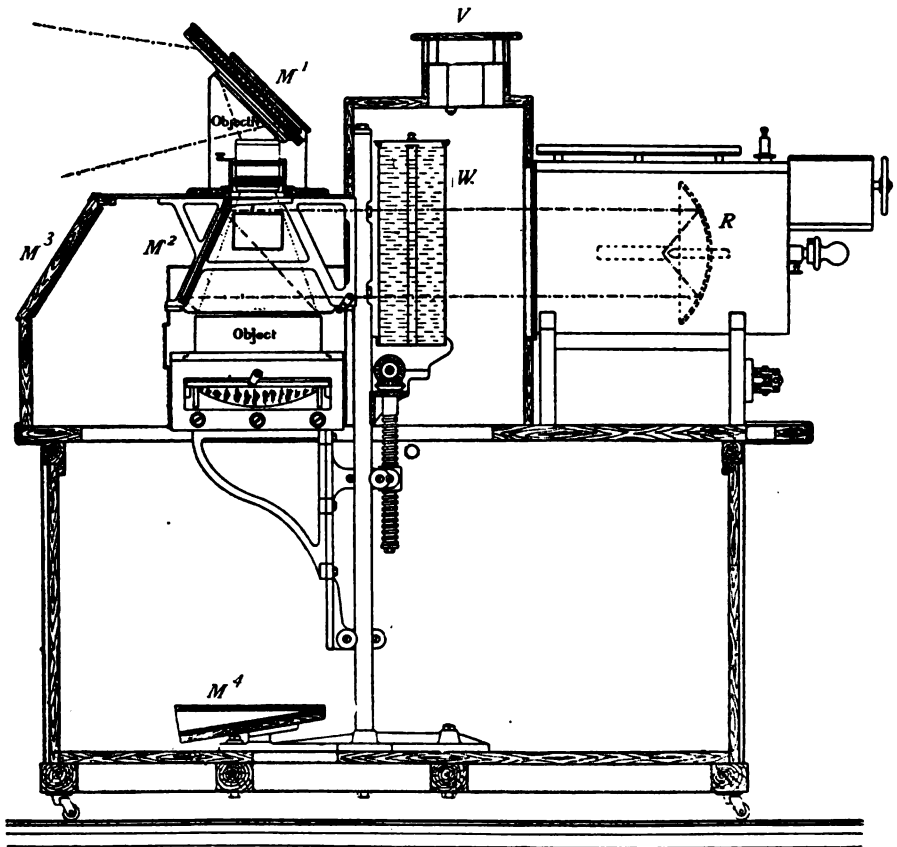

FIG. 95. ZEISS EPIDIASCOPE FOR OPAQUE AND FOR TRANSPARENT OBJECTS
IN A HORIZONTAL POSITION.
(*Zeiss' Special Catalogue*).

As shown in this figure the apparatus is set up for opaque objects. For transparent objects M^2 (mirror 2) is removed when the light striking M^3 is reflected to M^4 and thence up through the object to M^1 and to the screen.

Commencing at the right: R Parabolic reflector, which projects the light from the crater through (W) the water-cell to M^3 the mirror which is at the proper angle for reflecting the light down upon the opaque object. From the opaque object the light is irregularly reflected through the objective to M^1 . M^1 serves to reflect the rays from the objective to the screen.

V Ventilator. M^3 and M^4 are mirrors for use in reflecting the light through horizontal transparent objects.

This apparatus is designed to project opaque objects as large as 22 centimeters in diameter, at a magnification of five to ten with a 30 ampere current. For a smaller object one may magnify as high as 25 diameters. With a 50 ampere current and a larger reflector the magnification may be from 14 up to 37 diameters.

In this instrument the carbons are horizontal and in the optic axis. The parabolic reflector (*R*) serves to direct the light in a parallel beam along the line of the optic axis.

It takes considerable time for the eyes to adjust themselves, hence, if one passes quickly from opaque projection to lantern slides the screen images are dazzling. On the other hand in passing from lantern-slide images to opaque images, the eyes being adjusted for daylight vision, the screen images seem exceedingly dim at first, although the screen image may be as brilliant as it is possible to obtain with the best apparatus. After the eyes gain their twilight vision the images on the screen appear much brighter, as if the light had been greatly increased. As old observers put it: "It is necessary to get the brilliant sunshine out of the eyes before the relatively dim screen images are satisfactory."

§ 282. Dim and brilliant light in combined projection.—This difficulty can be avoided in two ways:

1. In showing lantern slides, the current may be lessened until the light forming the image of the transparency is of about the same intensity as is that of the opaque object with the full current.
2. A neutral tinted glass of the proper shade can be put in the path of the beam going to the lantern slide, to tone down the brilliancy (§ 282a).

§ 282a. In 1908–1909 this difficulty was in part overcome by Mr. A. O. Potter by putting a tinted glass of the proper light reducing power in the path of the beam going to the lantern slide. This reduces the image of the transparency to the same dimness as the opaque object, hence one can pass from one to the other without any adjustment of the eyes.

If only lantern slides are to be shown, the tinted glass can be removed and the full light employed.

Some combined lanterns, as those of the Bausch & Lomb Optical Co., and perhaps others, are now regularly supplied with the light reducing glass for the magic lantern part.

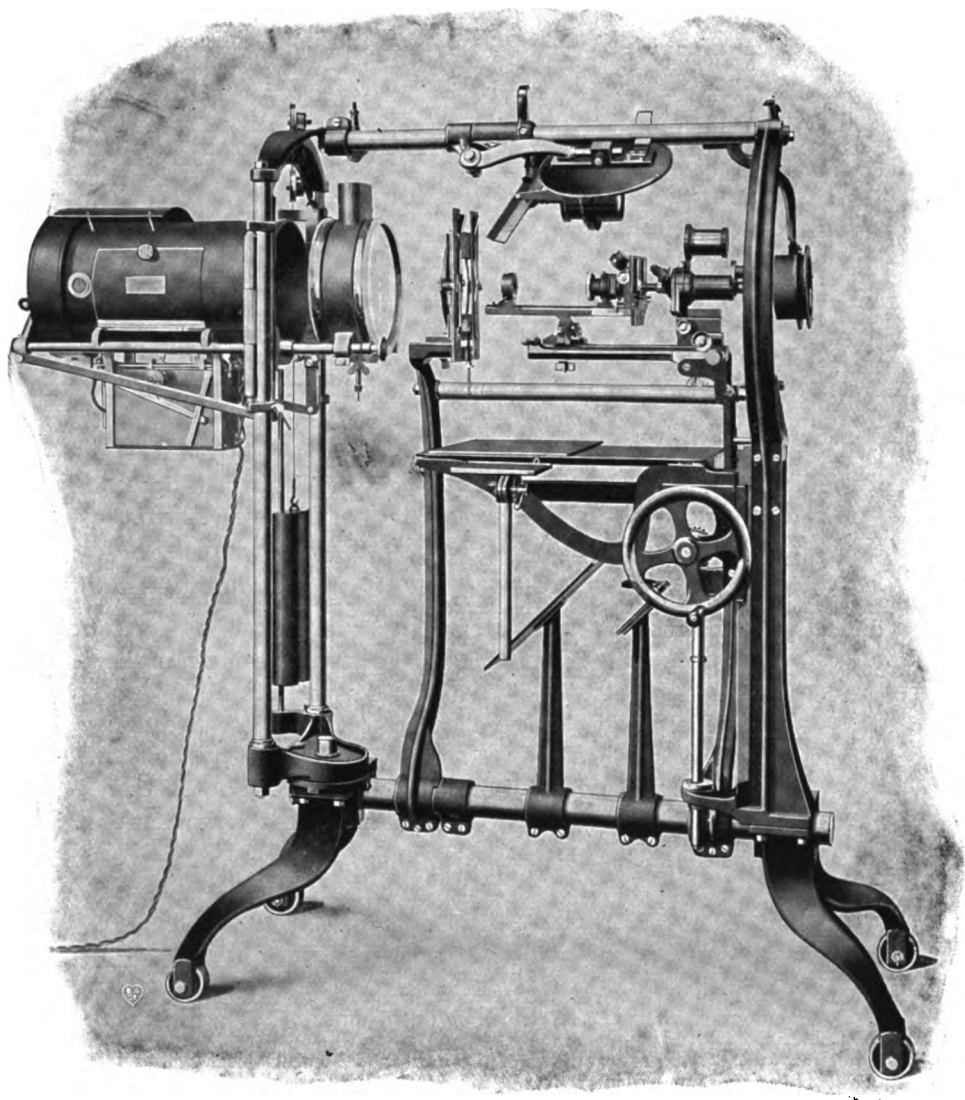

FIG. 96. UNIVERSAL PROJECTION APPARATUS WITH THE PROJECTION MICROSCOPE IN POSITION.
(Cut loaned by E. Leitz).

This apparatus is designed for all kinds of projection, and with the objects either in a vertical or in a horizontal position. When the object is in a vertical position the illuminating device (arc lamp with parabolic reflector) sends the light horizontally through the specimen, apparatus and to the screen as would be the case in the figure here shown.

If the object is in a horizontal position the lamp and reflector remain in a horizontal position and the light is reflected by a mirror upon the opaque object; or for vertical opaque objects the radiant is turned sidewise.

For transparencies in a horizontal position the lamp and reflector are lowered to the level of one of the mirrors below, and this mirror reflects the horizontal beam up through the transparent object whence it passes to the projector and the screen.

The entire apparatus is covered by a dark curtain (compare fig. 95).

USE OF OPAQUE PROJECTION FOR EXHIBITIONS AND FOR DEMONSTRATIONS

§ 283. **Testing the lantern.**—The directions given in Chapter I, § 26 are applicable here.

§ 284. **Size of objects for opaque projection.**—The size of object which can be shown with an opaque projector varies greatly. The smallest size is usually larger than a lantern slide. The lantern-slide opening is rarely greater than 6.5 x 7.5 cm. (2.6 x 3 in.), while the smallest picture usually shown in the opaque lantern is rarely less than postal card size (8 x 12.5 cm., 3 x 5 in.). From this minimum the size ranges all the way up to 50 cm. (20 in.) square.

Of course the radiant and condenser must vary accordingly (see fig. 107).

§ 285. **Objects for opaque projection.**—The best of all are dull white objects, like marble figures, or black print on white paper, pictures in black and white. Colored pictures in which the bright colors of the spectrum like red, yellow and green, are predominant, give good images. Metallic objects with polished surfaces give good images. Among these the works of a watch or small clock show well; also coins and medals. Bright metallic objects show best on a dark ground.

Objects and pictures which are very light-absorbing naturally will not give good screen images, no matter how brilliant the light or good the apparatus. If the outlines of such objects are what is

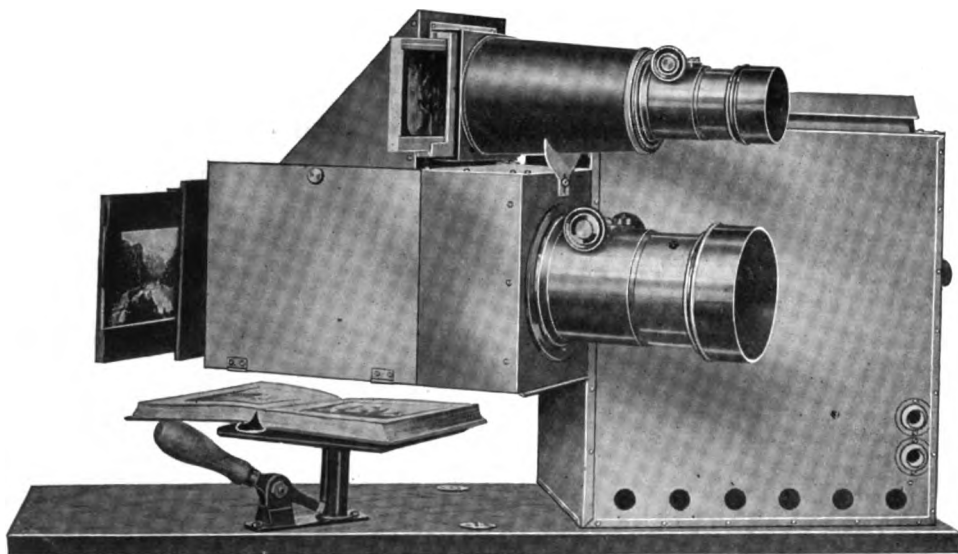

FIG. 97. THOMPSON'S REFLECTOSCOPE, MODEL G-2, 1913.
(Cut loaned by A. T. Thompson & Co.).

As here shown the instrument is ready for opaque and for transparency projection.

There are additional attachments by which microscopic projection can be done with either a horizontal or a vertical microscope. There is also an arrangement for placing the magic lantern objective in a vertical position, and thus projecting horizontal objects.

Commencing at the right: The lamp-house with arc lamp and condenser. This is at an angle so that opaque objects in a vertical position are lighted directly as in Chadburn's opaque lantern (fig. 92). In this case the screen picture has the rights and lefts reversed.

Above is the magic lantern objective for transparencies.

Below is the large aperture, long focus projection objective for opaque objects. The objective is inserted in the dark chamber containing mirrors for reflecting the light upward for transparency projection, or downward for the opaque objects in a horizontal position.

Above is shown a lantern slide in the carrier and below a book in a horizontal and a picture in a vertical position.

With the opaque object in a horizontal position the light is reflected from a mirror down upon the object, the light from the opaque object is then reflected, in part, back to the same mirror and from the mirror out through the projection objective to the screen. The screen image in this case will be erect in every way if properly placed on the holder.

wanted very good results can be obtained by using a white background. They will appear like silhouettes, but almost no details will show.

§ 286. **Screens for opaque projection.**—On the whole no screen is so satisfactory as a white one of the best quality (see § 621).

If the room is narrow, so that all the spectators are included in about 30 degrees, the metallic screen answers fairly well. If the room is wide, those on the sides near the screen will get only a very dim screen image from the metallic screen. With the white screen it is practically as good in one place as in another, for the reflection is about equal throughout the entire 180 degrees (§ 622, 630).

For darkening the room see § 280 and § 608.

§ 287. **Magnification of the picture and size of screen image.**—For lantern slides the magnification can be 30 to 60, with resulting brilliant pictures; but with opaque projection one can rarely magnify more than six to ten times and get good results.

If the area to be shown is relatively small and the illuminating beam is made converging and a powerful radiant (50 amperes) is used, the magnification may be carried up to 25 or 37 diameters (Zeiss, p. 6) or perhaps more.

The screen image should not exceed 2 x 2, or 3 x 3 meters (8 x 10 feet), (Zeiss, p. 6).

§ 288. **Screen distance.**—In opaque projection, the screen images are usually not magnified so much as lantern-slide images and the screen distance is usually from three to ten meters. The correct magnification (six to ten) is obtained by using an objective of the proper focal length, i. e., for a magnification of six and a screen distance of three meters there should be an objective of 50 cm. or 20 in. If the magnification is to be 10 and the screen distance three meters then the objective should have a focus of 30 cm. or 12 inches. For the discussion relating to magnification, screen distance, and focus of the objective see § 392a.

Sometimes it is necessary to project at a screen distance of 15 to 20 meters (50 to 70 feet). As the magnification of the screen image must not usually exceed six to ten, a very long focus projection

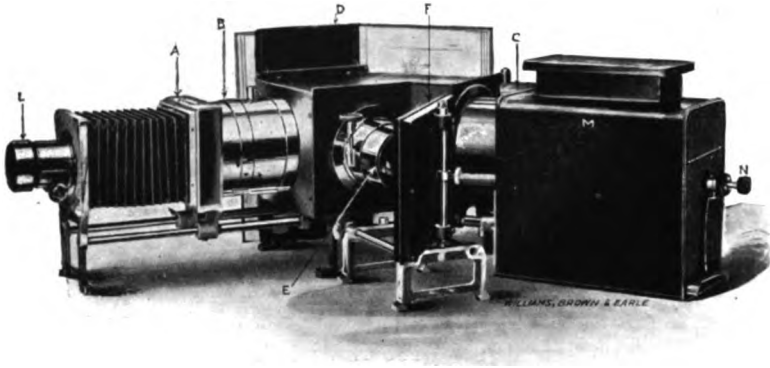

FIG. 98. THE NEW REFLECTING LANTERN OF WILLIAMS BROWN & EARLE
(No. 3 BR 15).

(Cut loaned by Williams Brown & Earle).

This is a combination projector for lantern slides and for opaque objects. Commencing at the right:

N Arc lamp in the lamp-house with the feeding screws extending beyond the lamp-house.

M Lamp-house of metal with the ventilator at the top.

C First element of the condenser for giving approximately parallel rays.

D The opaque object in position. The light from the lamp shines directly upon it and is reflected outward toward the projection objective (*E*).

E Projection objective for opaque objects.

F Mirror for reflecting the image of the opaque object to the screen and for correcting the right to left inversion.

B Water-cell and second element of the condenser for transparency projection.

A Opening for the lantern-slide carrier.

L Projection objective for lantern slides.

For lantern-slide projection a mirror at *C* is brought into position to reflect the light out along the optic axis of *B* and *L*.

objective must be used for such a screen distance. (For a magnification of six and a 15 meter screen distance, an objective of 250 cm. (100 inches) is necessary).

§ 289. **Arc lamp and amount of current.**—If one wishes to use more than 25 amperes, the arc lamp should be hand-feed. Up to 25 amperes, the right-angled carbons work well. Beyond that amount the inclined or vertical carbons are more satisfactory for

the right-angled arc goes out easily from the magnetic blow when the current is above 25 to 30 amperes. Of course, in opaque projection, where the most powerful light available is demanded, alternating current is far less satisfactory than direct current; still with skillful application of the light available even alternating

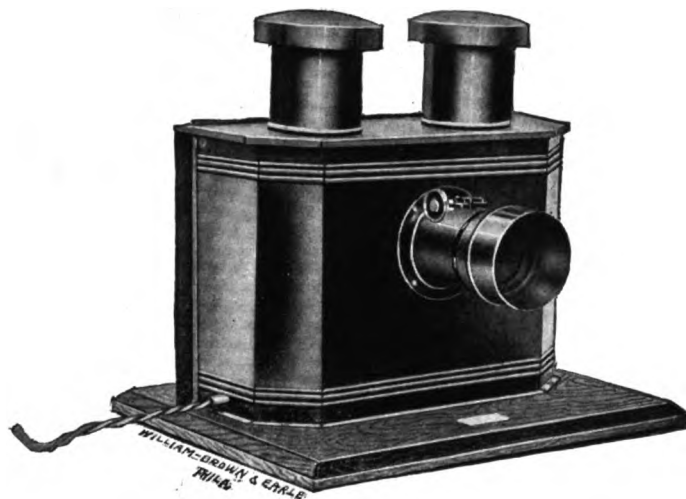

FIG. 99. THE INDEPENDENCE POST-CARD PROJECTOR.

(Cut loaned by Williams Brown & Earle).

This is in principle exactly like Chadburn's opaque lantern with two lamps (fig. 93). In this projector the lamps are usually of the incandescent form, and connection is made with the house-electric lighting system.

current radiants give fairly good opaque projection (see Ch. XIII, § 753a for size of carbons with different currents, etc.).

For favorable objects and good conditions one must use not less than 20 to 25 amperes of direct current for successful screen pictures of opaque objects. Those with most experience in the work use 40 to 50 amperes.

For alternating current satisfactory results can hardly be obtained with less than 40 amperes, and 60 to 80 are better.



FIG. 100. HOME BALOPTICON FOR OPAQUE OBJECTS.
(Cut loaned by the Bausch & Lomb Optical Co.).

In this instrument there is used a small arc light for attachment to the house lighting system. The rheostat is shown at the left.

The object is horizontal and the lamp shines in part directly upon the object and in part the light is reflected upon the object by a mirror. From the object light is reflected to a mirror above the arc light, and from the mirror directed out through the objective to the screen. The projected mirror image appears erect on the screen.

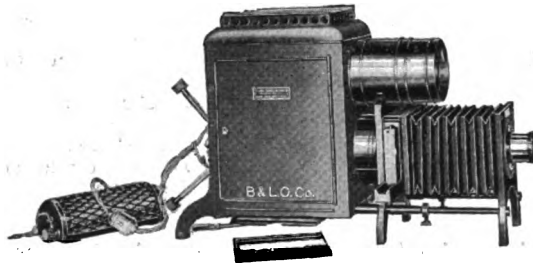

FIG. 101. HOME BALOPTICON FOR LANTERN SLIDES AND OPAQUE OBJECTS.

(Cut loaned by the Bausch & Lomb Optical Co.).

The opaque projection is precisely as in fig. 100. For lantern-slide projection the mirror in front of the arc lamp is turned up out of the way and the light passes on to the condenser, lantern slide and objective as in ordinary lantern-slide projection (fig. 1).

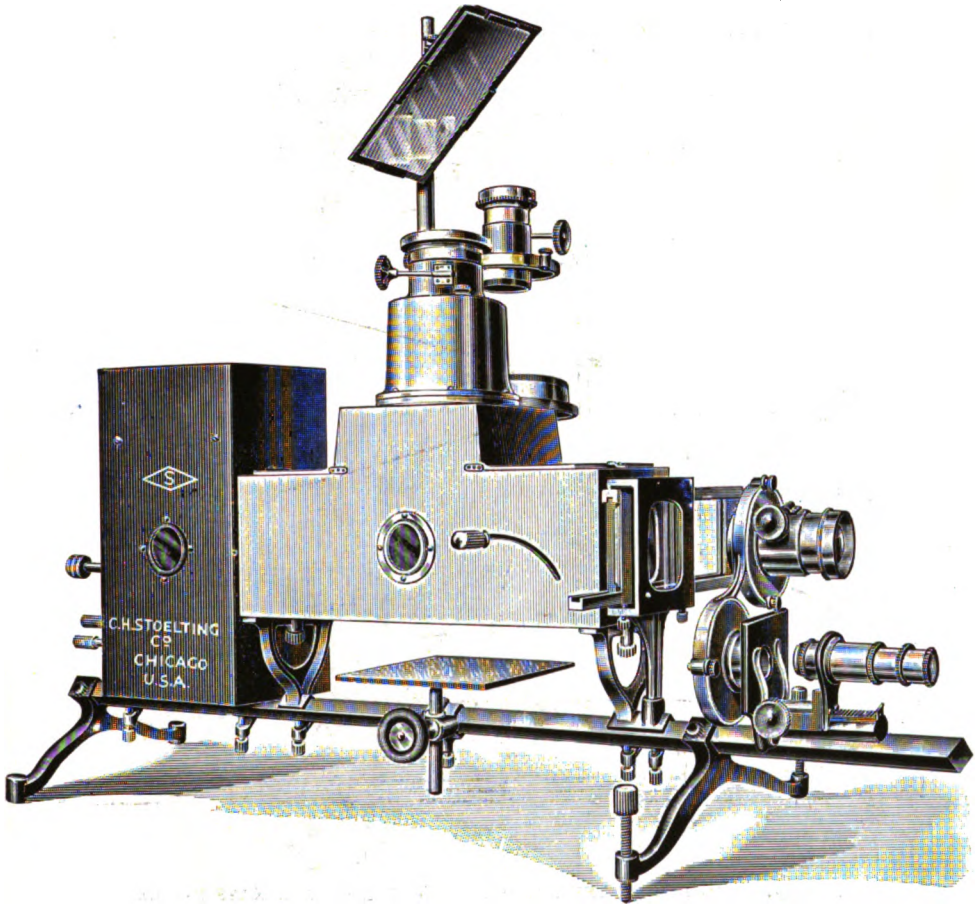

FIG. 102. UNIVERSAL PROJECTOSCOPE.
(Cut loaned by C. H. Stoebling Company).

This instrument as shown in the picture is designed to project:
(1) Lantern slides and other transparencies in the usual vertical position or in a horizontal position.
(2) Opaque objects.
(3) Microscopic objects. For this the lantern-slide objective is turned back and the microscope turned up in place.

§ 290. **Precaution for heavy currents.**—The lamps for heavy currents are mostly of the hand-feed type and burn large carbons. When starting the lamp it is much safer to make sure that the carbons are separated before closing the knife switch. Then one can use the feeding screws and bring the carbons together to strike the arc, and separate them a short distance immediately. If the

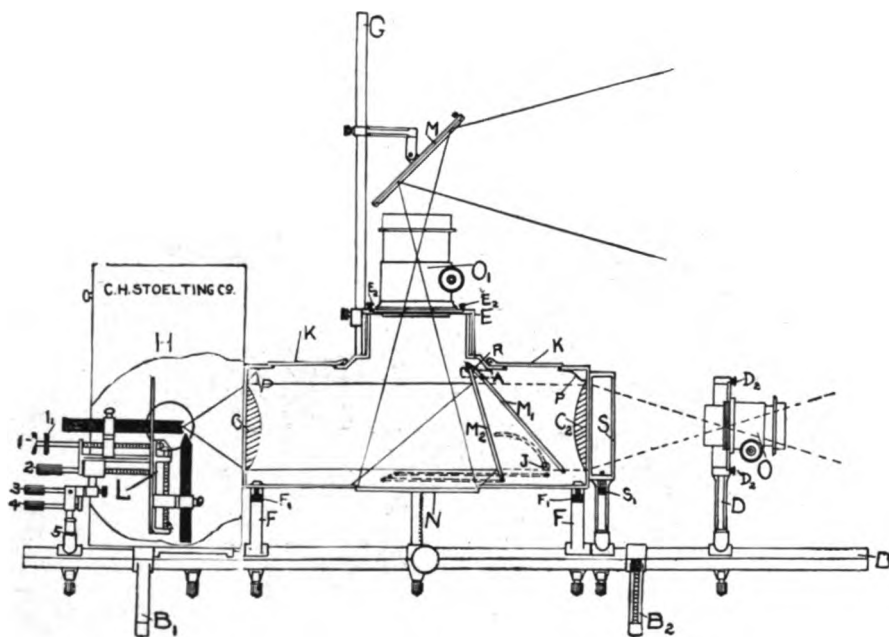

FIG. 103. DIAGRAM OF THE PARTS AND COURSE OF THE RAYS IN THE UNIVERSAL PROJECTOSCOPE FOR OPAQUE AND LANTERN-SLIDE PROJECTION.

(Cut loaned by the C. H. Stoelting Company).

The instrument is here arranged for the projection of opaque objects. The mirror, M_1 , reflects the parallel beam from the first element of the condenser (C), down on the horizontally placed object. The large aperture projection objective directly above, and the 45° mirror beyond, project the image upon the screen.

Ordinary lantern-slide projection is shown by the broken lines, (for a detailed description of all the parts see fig. 16).

carbons are in contact after striking the arc, so much current flows that there is danger of blowing the fuses or burning out some connection. Be sure that the fuses and wiring are adapted to the current (fig. 3, § 691).

§ 291. **Illuminating the entire opaque object.**—For illuminating opaque objects, Zeiss uses the principle of the search-light. That is, the two carbons are horizontal, the positive one has its crater facing the concave mirror (fig. 95, 96). This mirror then reflects the light toward the object. Depending upon its position, it can

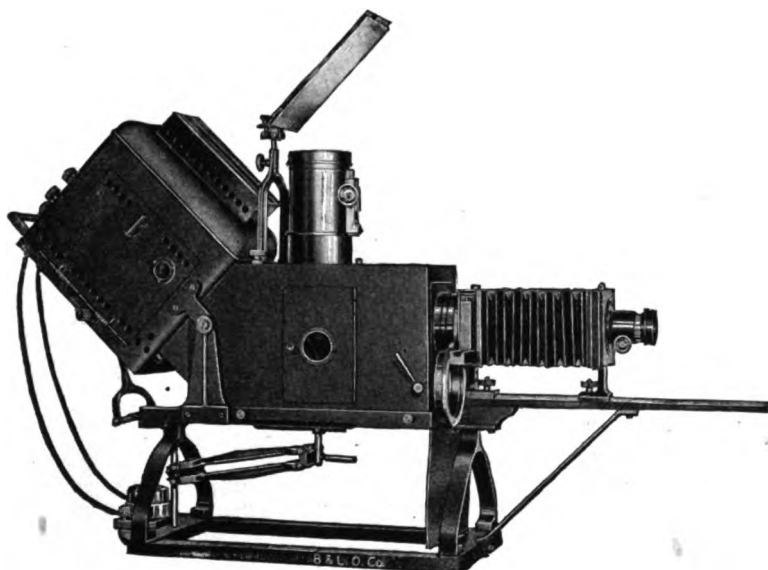

FIG. 104. NEW MODEL CONVERTIBLE BALOPTICON IN POSITION FOR OPAQUE PROJECTION.

(Cut loaned by the Bausch & Lomb Optical Co.).

In the new (1913) models of projectors by the Bausch & Lomb Optical Company provision is made in each case to place the object in a horizontal position and then to illuminate it either by a mirror (fig. 105a) or preferably by tilting the radiant and first element of the condenser (fig. 105), so that the light from the lamp is projected directly upon the object. From the object a part of the light extends out through the vertically placed projection objective to the mirror and from the mirror to the screen. The mirror gives correct images on the screen.

direct a parallel beam, a converging or a diverging beam (see also Ch. XIII–XIV on radiants and lighting).

If a condenser is used, its size must be adapted to the size of the object, that is, the diameter of the cylinder of light must be some-

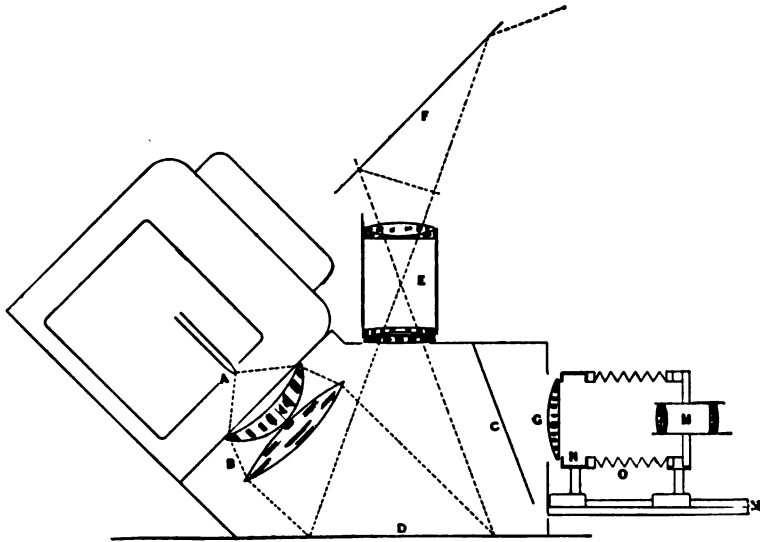

FIG. 105. DIAGRAM SHOWING THE OPTICAL PARTS AND THE COURSE OF THE RAYS IN THE CONVERTIBLE BALOPTICON IN OPAQUE PROJECTION.

(Cut loaned by the Bausch & Lomb Optical Co.).

The lamp-house, radiant and first element of the condenser are so inclined upward that the light from the condenser falls directly upon the opaque object.

- A Upper carbon of the arc lamp furnishing the light.
- B First element of the condenser to render the diverging light parallel. The lens beyond the meniscus is double-convex instead of plano-convex as in fig. 3.
- D Position of the opaque object. Objects as large as 20 x 20 cm. (8 x 8 inches) can be illuminated and projected.
- E Large aperture projection objective in a vertical position.
- F Mirror beyond the objective to reflect the image to the screen and correct the inversion.
- C Mirror. It serves to increase the illumination of the opaque object by reflecting back upon it some of the scattered light.
- G Second element of the condenser for lantern-slide projection (fig. 3).
- H Projection objective for lantern slides.
- O Bellows.
- M Lathe bed on which slide the objective, etc.

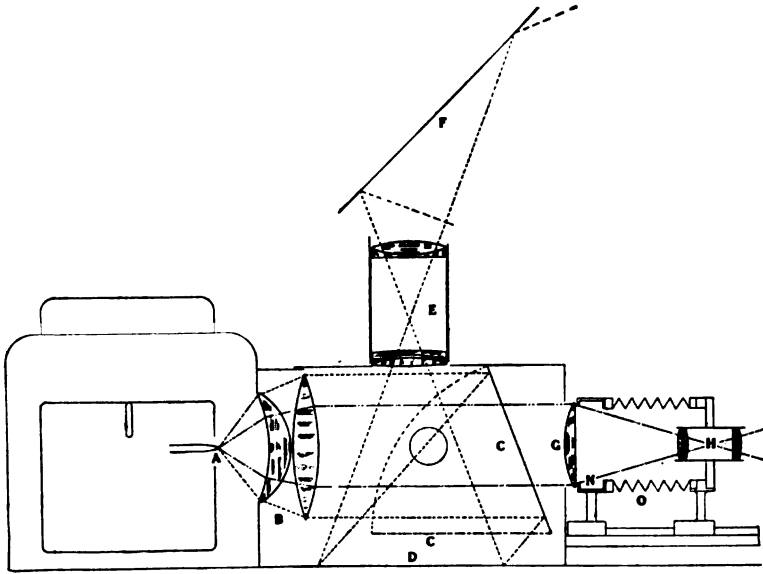

FIG. 105a. DIAGRAM SHOWING THE COURSE OF THE LIGHT RAYS FOR TRANSPARENCY AND OPAQUE PROJECTION WITH THE RADIANT HORIZONTAL.
(Cut loaned by the Bausch & Lomb Optical Co.).

- A Upper carbon of the arc lamp.
- B The first element of the condenser (fig. 3).
- C C Mirror horizontal when using lantern slides and inclined for opaque projection.
- D Horizontal surface for opaque objects (20 x 20 cm., 8 x 8 in.).
- E Projection objective for opaque objects.
- F Mirror for reflecting the light to the screen and correcting the inversion.
- G Second element of the condenser for lantern slides.
- H Projection objective for lantern slides.
- N Support for condenser and bellows.
- O Bellows.
- M Lathe bed on which move the various supports.

what greater than the diagonal measuring the size of the picture, as for lantern slides (see § 314, fig. 114). A diverging beam could be used by pushing the radiant within the focal distance, and a converging by separating farther than the focal distance. Sometimes there is no condenser but the radiant shines directly upon the object (fig. 99, 100, 107).

§ 292. **Avoidance of shadows.**—With solid objects there will be very heavy shadows unless the light is evenly distributed. With a single lamp this is not easily accomplished, and if no mirror is used practically impossible. It is better to use two lamps, one on each side, as in the original apparatus of Chadburn (fig. 93). The two lamps have the further advantage of doubling the light. Two arc lamps are used in the large opaque lantern of the Bausch & Lomb Opt. Co. (fig. 107).

In the Spencer Lens Co.'s opaque lantern, plane mirrors line a part of the projection chamber where the object is placed, and much of the light lost by absorption without this arrangement is reflected back upon the object. This also helps to obviate the shadows when one lamp is used (fig. 111).

ERECT IMAGES WITH OPAQUE OBJECTS

§ 293. **Inversion of the image with an opaque object.**—Besides being upside down the image of an opaque object on an ordinary white screen has the rights and lefts reversed.

§ 294. **How to get an erect image with the object in a vertical position.**—Put the opaque object in the vertical position upside down. Point the objective at right angles to the screen, use a mirror at 45 degrees, or use a 45 degree prism to direct the image-forming rays upon the vertical opaque screen (fig. 95, 111). If the inversion of the rights and lefts is unimportant, put the object upside down in the vertical holder and point the objective directly toward the screen (fig. 97, 109).

If a translucent screen like ground glass is used the image will be erect in every way if it is put upside down in the holder and the objective pointed directly toward the screen.

§ 295. **How to get an erect image of an opaque object in a horizontal position.**—Place the opaque object with its upper edge away from the screen. The objective is usually in a vertical position so that the image would appear on the ceiling above the instrument. The mirror or prism used to direct the image forming rays upon the vertical screen corrects also the mirror image, and

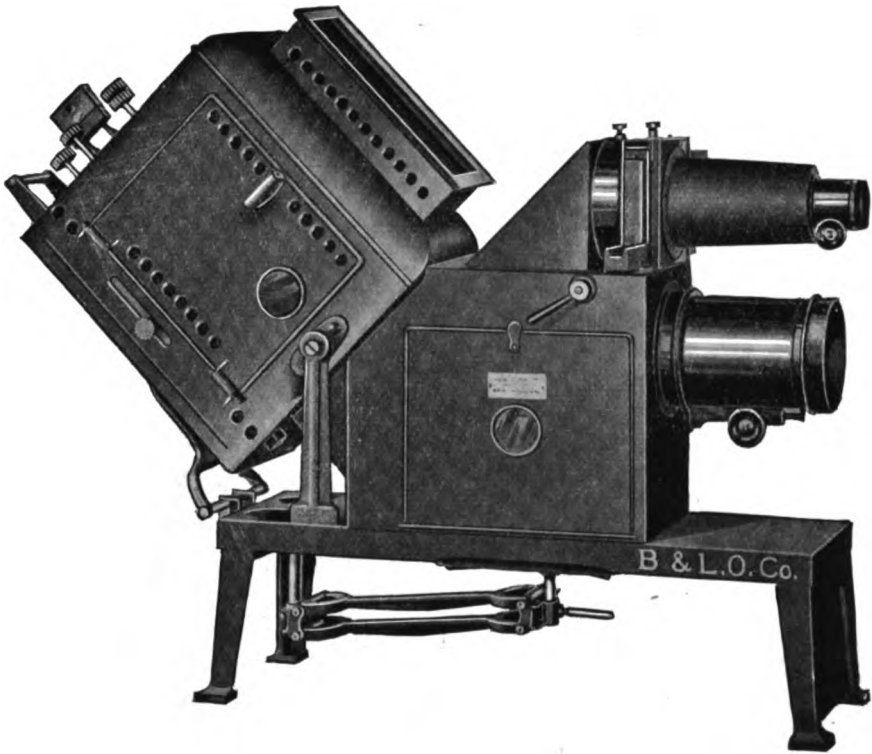

FIG. 106. NEW MODEL UNIVERSAL BALOPTICON IN POSITION FOR OPAQUE PROJECTION.
(Cut loaned by the Bausch & Lomb Optical Co.).

Opaque objects are placed in a horizontal position and the lamp-house, lamp and first element of the condenser are inclined as in fig. 105. The light from the opaque object is reflected upward to the right face of an inclined mirror and from the mirror reflected out through the projection objective, giving an erect screen image.

When used for lantern slides the lamp-house is horizontal and the horizontal light is reflected upward by the left face of the mirror to the mirror at the left of the lantern-slide attachment. This second mirror reflects the light horizontally through the lantern slide.

the object will be erect in every way (fig. 95-111). (See also the discussion of the reflecting lantern of Thompson in which a mirror image is projected, and hence appears erect on the screen (fig. 97, 100). If a translucent screen is used with the object in a hori-

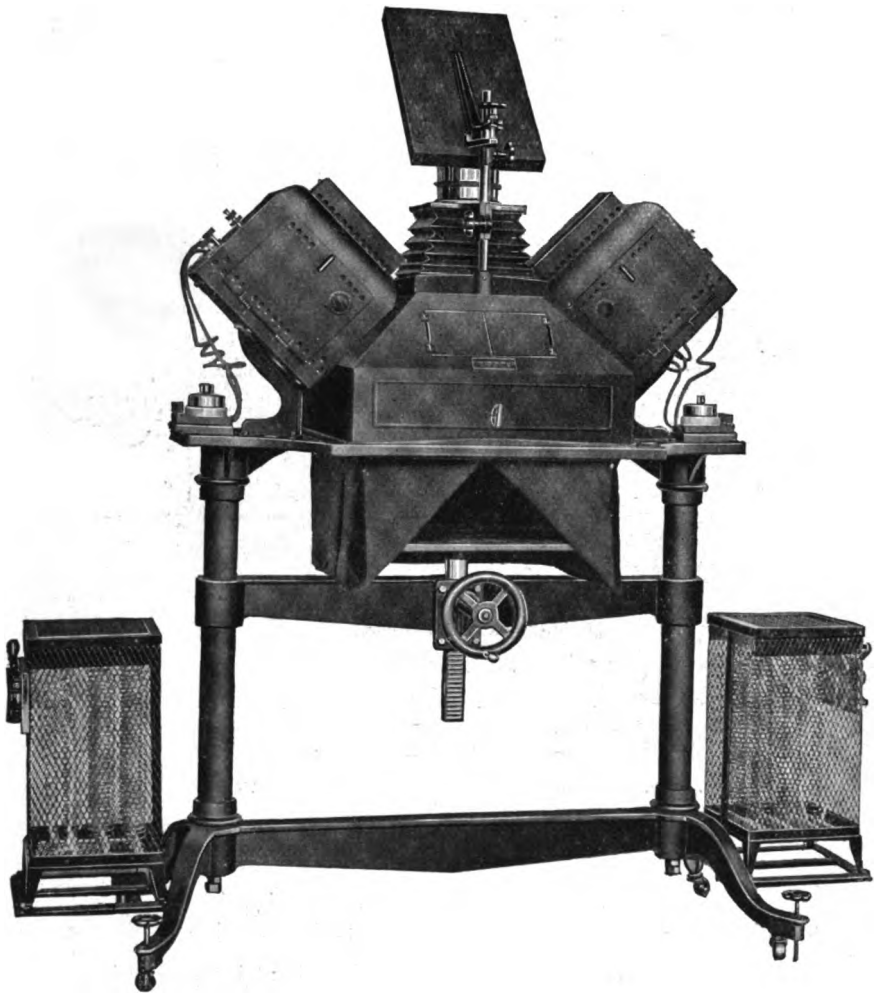

FIG. 107. BALOPTICON FOR THE PROJECTION OF LARGE OPAQUE OBJECTS.
(Cut loaned by the Bausch & Lomb Optical Co.).

This opaque projector is especially designed to show large objects and large surfaces (20 inches, 50 cm. square). To avoid shadows in projecting machines and other solid objects, and to supply the needed illumination there are two 25 ampere lamps tilted to throw their light directly upon the two opposite sides of the object. Each lamp has its own rheostat and table switch.

The projection objective is of the Tessar Ic series of very large aperture (114 mm., $4\frac{1}{8}$ in., in diameter and 50 cm. $19\frac{3}{4}$ in. equivalent focus). The focusing is accomplished by a screw which raises or lowers the table supporting the object.

This instrument enables one to demonstrate to an audience the workings of a machine like a cash register, or a quarto size page of illustrations or print. With the vertical objective and a mirror to reflect the light to the screen the image will be erect. The reflecting mirror is silvered on the front to avoid the doubling of the image.

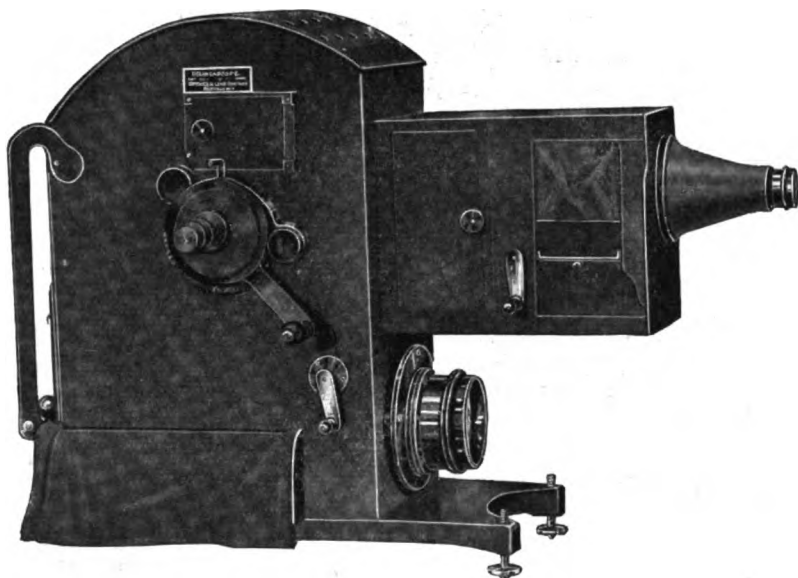

FIG. 108. MODEL 5 DELINEASCOPE FOR OPAQUE AND LANTERN-SLIDE PROJECTION.

(Cut loaned by the Spencer Lens Co.).

With the arc lamp and the first element of the condenser in a horizontal position the light extends directly to the right through the lantern slide or other object and the projection objective, or projection microscope, or it may be reflected upward through the vertical projection microscope (fig. 175).

For opaque projection, the arc lamp and first element of the condenser are, by means of the crank, rotated within the lamp-house to the right position to direct the light upon an opaque object in a vertical or in a horizontal position as desired.

If the object is in a horizontal position the light from it is reflected to a mirror and from the mirror out through the large projection objective. It will appear correct in the screen image. The vertical object will have the rights and lefts inverted. Objects or surfaces 15 x 23 cm. (6 x 9 in.) can be projected with this instrument.

zontal position the image will only be erect with the screen at right angles to the axis of the objective, no mirror or prism being used. If a mirror or prism is used to project upon a vertical screen then a translucent screen will give a mirror image, but an opaque screen an erect image.

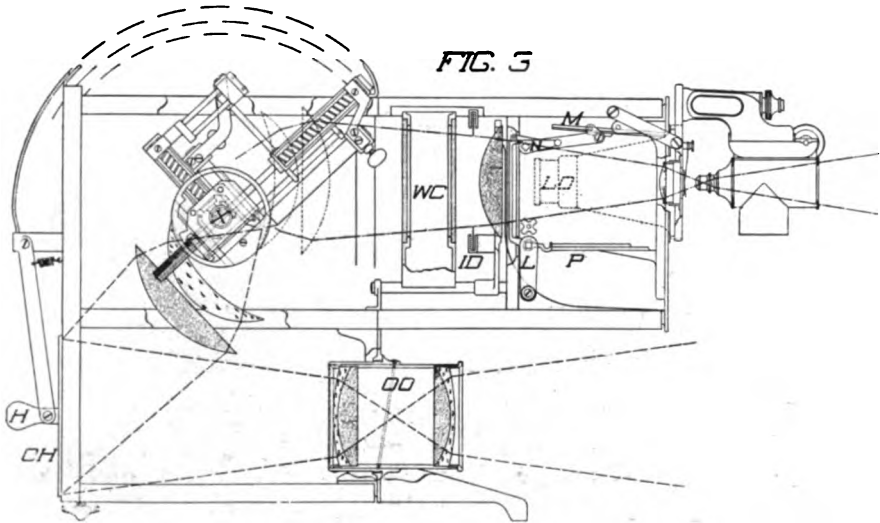

FIG. 109. DIAGRAM SHOWING THE PARTS AND COURSE OF THE RAYS IN MODEL 4-5 DELINEASCOPE.

(Cut loaned by the Spencer Lens Co.).

This diagram shows the arc lamp and first element of the condenser in position to illuminate a vertical object in opaque projection. Above is shown in outline the course of the rays for the projection microscope or the magic lantern.

Commencing at the left:

OH The object holder for objects 15 x 23 cm., 6 x 9 in.

H Handle for operating the object holder.

X The horizontal axis on which rotates the arc lamp and the first element of the condenser.

OO The large projection objective for opaque objects.

WC Water-cell for removing the radiant heat.

ID Large iris diaphragm.

L Lantern slide, and crank for turning the slide up in the vertical position in front of the condenser behind the objective.

P Platform on which is laid the lantern slide.

LO Lantern-slide objective turned to one side to allow the microscope to get to the horizontal position.

M Mirror to reflect the horizontal beam of light through the vertical microscope.

§ 296. Troubles:

1. The one great trouble will be a dim screen image. This cannot be wholly avoided. It can be made tolerably good: (1) by having the room very dark; (2) by using a powerful radiant; (3) by having a projection objective of large aperture; (4) by magnifying the screen image very moderately (5 to 10 diameters).

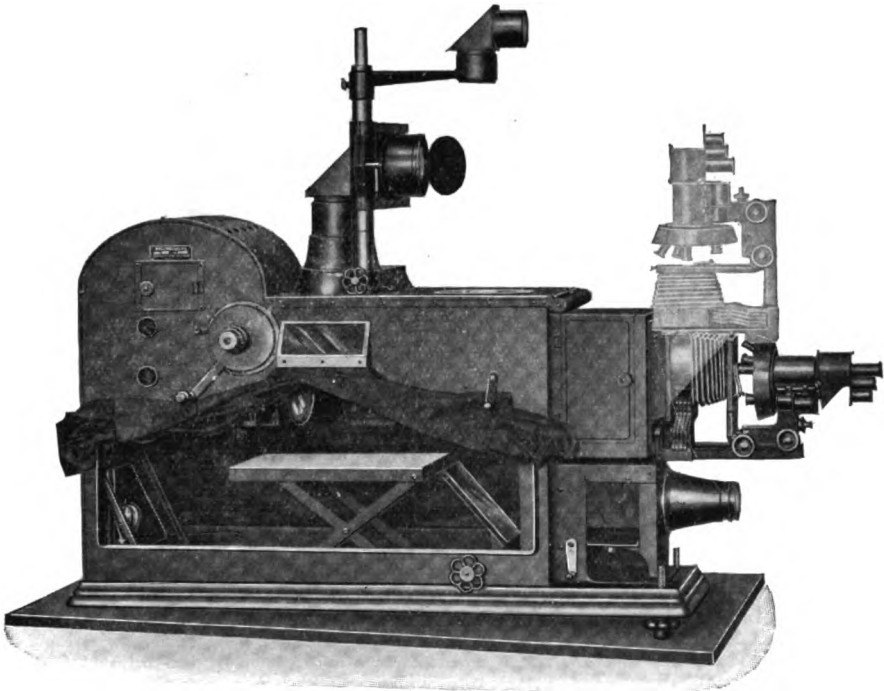

FIG. 110. MODEL 8 DELINEASCOPE FOR ALL KINDS OF PROJECTION.
(Cut loaned by the Spencer Lens Co.).

In this instrument there is provision for lantern-slide projection with the slides or other objects in a vertical or in a horizontal position.

It provides for opaque objects in a horizontal position and lighted directly by the radiant (fig. 111), and for objects in museum jars in a vertical or horizontal position.

Finally it provides for micro-projection with the objects in a vertical position or in a horizontal position, and for the drawing of objects on a horizontal or on a vertical surface.

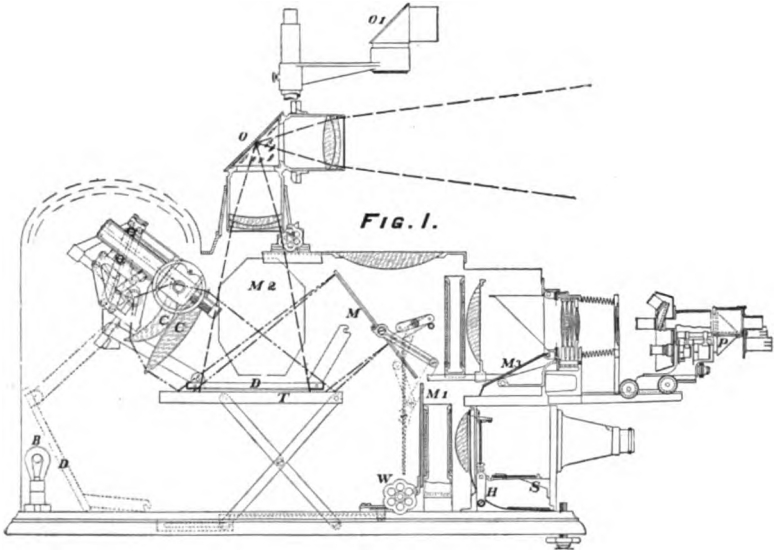

FIG. 111. DIAGRAM OF MODEL 8 DELINEASCOPE SHOWING THE POSITION OF THE RADIANT AND THE COURSE OF THE LIGHT RAYS FOR OPAQUE PROJECTION WITH THE OBJECT IN A HORIZONTAL POSITION.

(Cut loaned by the Spencer Lens Co.).

- T* Table for opaque objects.
W Wheel by which the table is raised and lowered.
D Diaphragm above the table for flattening out the page of a book.
B Incandescent bulb which always gives light for the interior of the machine.
C Condensing lenses in front of the arc.
O Large objective for opaque projection.
O₁ Smaller objective for vertical projection.
M Mirror for throwing light downward for the lantern-slide compartment or upward through the vertical attachment.
M₁ Mirror for reflecting a perpendicular beam of light out through the lantern-slide compartment; shown thrown up against the water-cell in this figure (see fig. 177)
M₂ Mirror used in connection with projection of the vertical side of an object.
M₃ Mirror which assumes a position at 45° when the microscope is used perpendicularly.
P Prism which is thrown into the prism box when the microscope is used in a perpendicular position.
S Shelf upon which the lantern slide is placed previous to throwing it up into the optical axis by the handle.
H Handle of the lever for raising the slide into position.

2. If the amperage is to exceed 25 or 30, it is better to use an arc lamp with inclined or vertical carbons, not those at right angles for the magnetic blow puts the right-angled arc out too easily.
3. Do not have the carbons in contact with a hand-feed lamp when the current is turned on. Feed them together after the current is on, then they can be separated properly immediately after the arc is struck.
4. Inverted screen image. The object not properly placed on the support, or no erecting mirror or prism is used.
5. No detail in the screen image. The object may be too light-absorbing, or the light may not be sufficient.

(See Troubles in Ch. I.).

§ 297. Summary of Chapter VII:

Do

1. Select an objective of large aperture for opaque projection (§ 275).

2. Use a light of great brilliance like sunlight or the arc light (§ 274, 277).

3. Make the screen image only six to ten times as large as the object (§ 287).

4. Make the projection room very dark (§ 280).

5. Use a very white screen or under some conditions a metallic screen (§ 286, 621).

6. From 25 to 50 amperes of direct current are needed to give good opaque projection (§ 289).

7. If lantern slides and opaque objects are projected at the same exhibition, use a neutral tint (smoky) glass to make the lantern-slide image as dim as the image of the opaque object (§ 282).

8. Use a condenser for opaque objects somewhat larger than the object (see fig. 114).

Do Not

1. Do not undertake opaque projection with an objective of small aperture.

2. Do not expect good opaque projection unless from 20 to 50 amperes of direct current, or greater amperages of alternating current are available.

3. Do not try to magnify the object too much.

4. Do not try to project in a light room. It must be *dark*.

5. Do not be satisfied with a dirty, non-reflecting screen. It must be *white*.

6. Do not expect brilliant screen images with a weak light.

7. Do not pass quickly from the dim pictures of opaque objects to the brilliant pictures of transparencies. Dim the transparencies down to the opaque images.

8. Do not use a small condenser for a large object.

9. Use two radiants or mirrors for avoiding shadows with solid objects (§ 292).

10. Select objects which reflect well for opaque projection (§ 285).

11. If very light-absorbing objects must be projected, use a white background (§ 285).

12. Use a hand-feed arc lamp for opaque projection (§ 289, 290).

13. Make sure that the wiring is adapted to the heavy currents needed for opaque projection (§ 290).

14. Use carbons of the proper size for the current drawn (§ 290, 753a).

15. Make the images erect by placing the object up-side down for the vertical position, or with the upper edge away from the screen for the horizontally placed objects (§ 293-294).

16. Use a mirror or prism to avoid a mirror image on a vertical, opaque screen (§ 293-295).

9. Do not light solid objects so that there will be deep shadows. Use two radiants, or mirrors, or arrange so that the light strikes the object directly, not obliquely.

10. Do not select badly reflecting objects for opaque projection.

11. Do not use a black background on which to place dark objects.

12. Do not use an automatic right-angle carbon arc lamp for the heavy currents needed for opaque projection.

13. Do not run any risks by using the heavy currents on wiring not adapted to it.

14. Do not use small carbons for big currents.

15. Do not get the images wrong side up on the screen.

16. And do not expect too much in opaque projection. Know the principles involved; study fig. 90-91.

CHAPTER VIII

PREPARATION OF LANTERN SLIDES

§ 310. Apparatus and Material for Chapter VIII:

A photographic dark room; Camera with suitable objectives and plate holders (fig. 116-119); Lantern-slide plates, negative plates of various kinds; Chemicals for developing, etc.; Colors and brushes for tinting the slides; A retouching frame (fig. 113); Cover-glasses and binding strips and mats for the slides; Markers and labels for the slides; Cabinet for the slides (fig. 120).

§ 311. For the historical development of lantern slides see the works referred to in Ch. I, § 2, and for photographic lantern slides, *The Journal of the Royal Society of Arts*, Vol. LIX (1911), pp. 255-257.

For making and coloring lantern slides see the works in Ch. I, § 2, and Lambert, *Lantern-slide making and coloring*.

The Photo-Mineature series No. 9, *Lantern Slides*, and No. 83, *Coloring Lantern Slides*.

SIZE OF LANTERN SLIDES

§ 312. Modern lantern slides are of several standard sizes as follows: (See § 312a).

A. American slides.—These are oblong plates 82.5 x 102 mm. ($3\frac{1}{4}$ x 4 inches). They are designed to go into the lantern-slide carrier with the long side horizontal (§ 35).

B. British slides.—These are square, being 82.5 x 82.5 mm. ($3\frac{1}{4}$ x $3\frac{1}{4}$ inches) (§ 37).

C. French slides.—These are, following the recommendations of the French Congress of Photography for 1889, 85 x 100 mm. ($3\frac{1}{32}$ x $3\frac{15}{16}$ inches). That is, the standard is practically like the American, and French slides can be used in American lantern-slide carriers.

D. German slides.—In Germanic countries, slides of 85 x 100 mm. are much used, but the German standard is often given as 90 x 120 mm. ($3\frac{9}{16}$ x $4\frac{3}{4}$ inches). Those of 130 x 180 mm. are likewise employed.

E. Italian slides.—In Italy the sizes are 85 x 85 mm., 85 x 100 mm. and 90 x 120 mm., that is, the British (B), the French and American (A, C) and German (D) sizes.

In all countries those of larger and smaller sizes than the above standards are used for special purposes; and provision is made

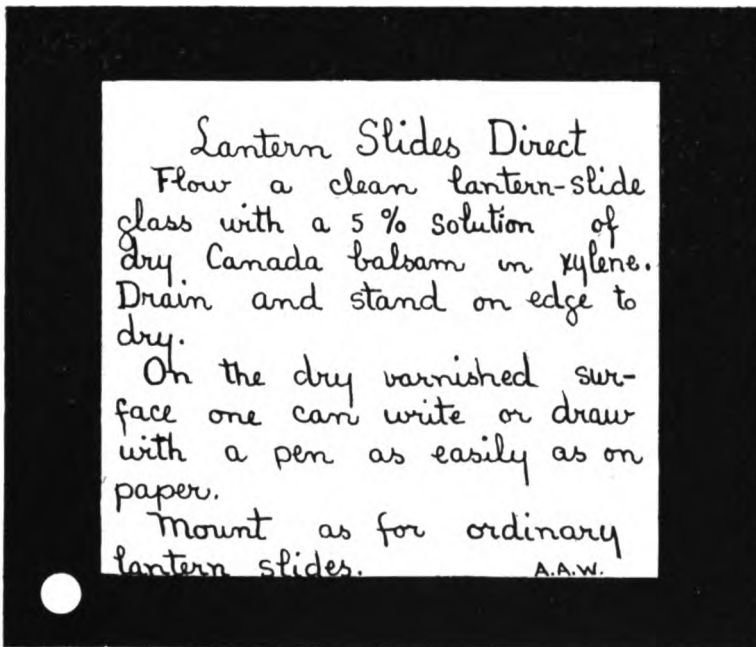

FIG. 112. AN AMERICAN LANTERN SLIDE, FULL SIZE, WITH INSTRUCTIONS FOR MAKING LANTERN SLIDES DIRECT. THE SLIDE IS PROPERLY "SPOTTED."

everywhere for the square British slides of 82.5 x 82.5 mm. and also for the oblong form of 82 or 85 x 100 mm. of the French and American manufacturers.

Any oblong form has the advantage that it is always put into the carrier with its long side horizontal and therefore requires only one mark or spot to indicate how it shall be inserted for an erect

image (fig. 6-8, 112). For a square form two marks are needed (fig. 13, 113).

§ 313. **Actual size of the free opening with lantern slides.**—The sizes given above are the measurements from the extreme edges of the plates. The actual size of the picture to be projected is always less, as part of the slide is covered when inserted in the carrier. The mat between the slide and its cover, and the binding around the edge lessen the size a variable amount. It requires from 5 to 10 mm. all around the edge for the binding and the part covered by the slide-carrier. This leaves a clear opening in the lantern slide of that much less. The smaller the slide to start with the less will be the proportionate amount of clear space left after the mounting of the slide.

The free opening of the American slides is rarely greater than 70 x 75 mm. and much more frequently the free opening is considerably less.

§ 314. **Diameter of the condenser required for different sized lantern slides.**—The final element of the condenser next the lantern slide (fig. 1, 2, 114) must be somewhat greater in diameter than the diagonal of the free opening of the lantern slide to be projected.

The accompanying figures show the British, French and American, and German standard sizes of lantern slides with the minimum diameter of the condenser which should be used with them (fig. 114).

§ 312a. There is some confusion as to the exact outside measurement of lantern slides. For example, the exact size of the British square slides is $3\frac{1}{4} \times 3\frac{1}{4}$ inches (82.5 x 82.5 mm.) In the two French works consulted (Trutat, p. 311, and Fourtier, tome ii, p. 18) the British size is given as 80 x 80 mm.

In Italy the size is given as 85 x 85 mm. In the German work of Wimmer the exact size is given (82.5 x 82.5 mm.). Neuhauss speaks of slides 85 x 85 mm. (p. 27).

The standard French slides are given as 85 x 100 mm. This is one of the standard sizes in Germany and Italy. Hence, it is concluded that the standard British slide is meant whenever 80 x 80, 82.5 x 82.5, or 85. x 85. mm. slides are mentioned. Also that the standard French and American slide of $3\frac{1}{4} \times 4$ inches (82.5 x 100 mm.) is meant whenever slides of 85 x 100 mm. are mentioned.

§ 315. **Making lantern slides.**—In the use of the lantern at the present day, one will find occasion to make lantern slides by all of the different ways that have ever been devised. That is, they may be drawn or painted wholly by hand; made partly by photography



FIG. 113. BRITISH LANTERN SLIDE OF FULL SIZE WITH TWO "SPOTS."

The "spots" are on the upper corners in the English slides.

The picture shown on the slide is of a retouching stand suitable for use in coloring slides.

S The slide.

R A reflector to throw the light up through the slide. This may be a mirror or simply white paper.

and then hand-colored; made wholly by photography, or transparent natural objects may be used.

Natural objects of the right transparency may be mounted on glass slides and used in the lantern. For example, seaweeds, thin leaves, skeletonized leaves, large wings of insects; crystals on

glass, thin sections of wood or animal organs mounted on glass, fibers of wood, thin cloth, spiders' webs, etc., etc.

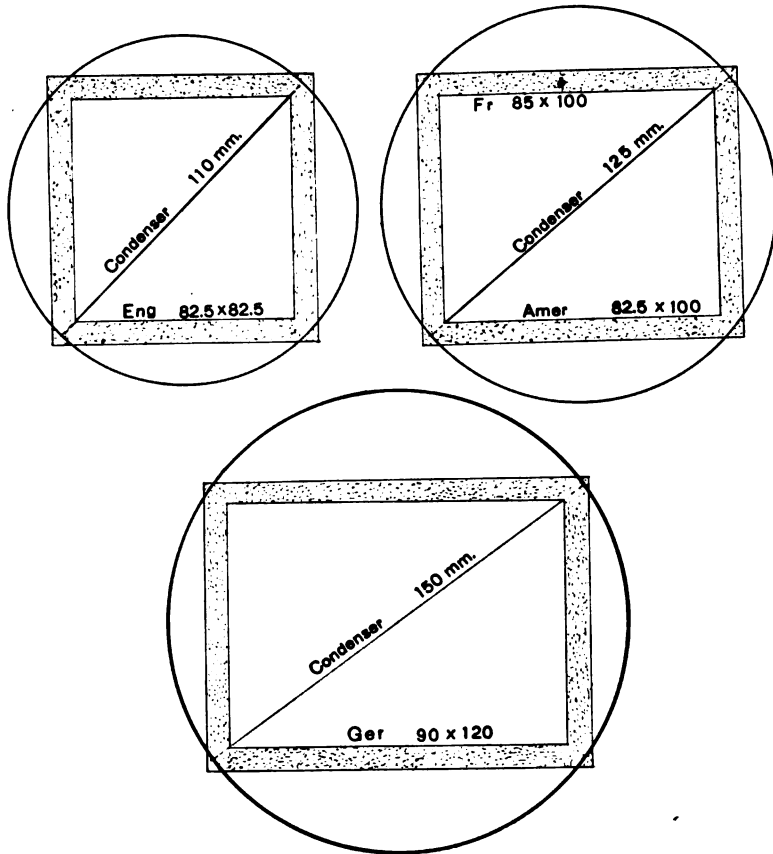

FIG. 114. STANDARD BRITISH, FRENCH, AMERICAN AND GERMAN LANTERN SLIDES WITH THE CONDENSER NECESSARY TO FULLY ILLUMINATE THEM. (ABOUT HALF NATURAL SIZE).

§ 316. **Hand-made lantern slides.**—Practically no one now makes the beautiful hand-painted lantern slides of former times; but for outline diagrams, for tables and for short statements, it is easier and cheaper to make the slides direct than to first make a

diagram or table, etc., and then have a photographic lantern slide made.

In preparing these slides direct, a device of the artists of earlier times who painted lantern slides, is used. That is, the slide is cleaned carefully and then coated with a thin solution of some hard varnish or with gelatin (fig. 112, § 317). After the varnish has thoroughly dried one can use a pen or a brush upon the varnished surface with the same facility as upon paper. The hand-made slide is then mounted as usual and can, of course, be used indefinitely.

If they are for a special occasion—as in projecting election returns, games, etc.—the slides are used without a cover-glass. They may be easily cleaned off with turpentine or xylene and used over and over.

§ 317. Coating the lantern-slide glass with varnish.—One of the best varnishes for this purpose is composed of 5% dry Canada balsam or gum dammar in xylene or in turpentine; or 10% natural Canada balsam in xylene or toluene. Or one can take some good, varnish, especially Valspar, one part and xylene, toluene, gasoline or turpentine nine parts. All of these thin solutions should be allowed to stand until they are clear, and only the clear part used. If one is in haste it is possible to filter the thin varnish through filter paper.

For coating the glass, the best way is to hold the clean glass flat by grasping the edges with the thumb and fingers. Then varnish is poured on, and the glass tilted slightly until the whole surface is covered. The excess is poured off one corner back into the bottle. Then the glass is stood on edge to dry. In a warm dry room 15–20 minutes will suffice for varnish in xylene or toluene. If turpentine is used it may require half a day or more. When the varnish is once dry the glass can be used at any time.

As it is not easy to tell which side has been varnished, a slight mark in one corner of the varnished surface with a glass pencil or pen will enable one to tell quickly and with certainty.

§ 318. Coating the lantern-slide glass with 10% gelatin.—For this, some clear gelatin is made into a 10% solution in hot water,

and filtered through filter paper. The slides are coated with the gelatin as described for the varnish. When the gelatin is dry the surface receives a pen or brush well. Gelatin slides are not so satisfactory as the varnished slides.

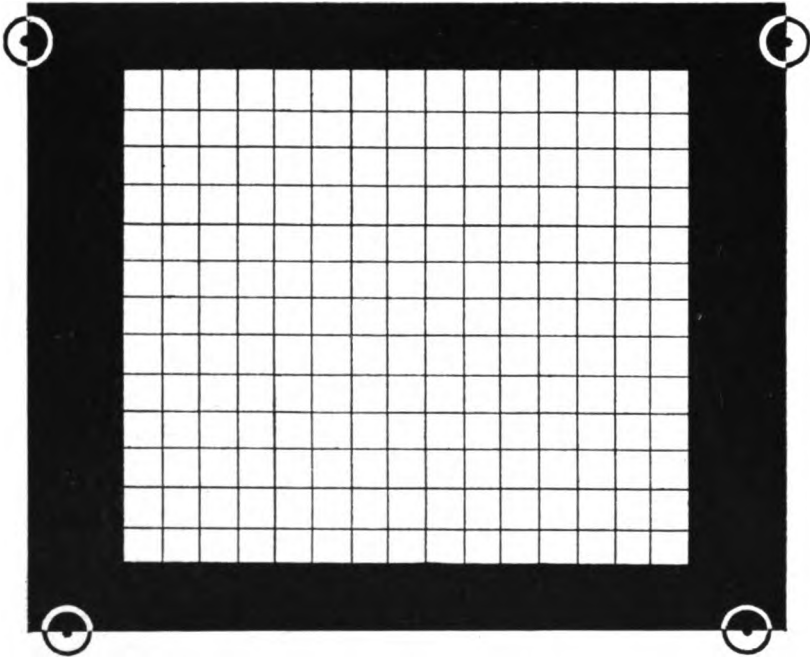

FIG. 115. AMERICAN LANTERN SLIDE OF FULL SIZE WITH GUIDE LINES FOR MAKING SLIDES DIRECT.

The thumb tacks at the four corners are to hold the slide firmly in position while writing or drawing upon it. The lined area represents about the maximum size of opening projected in ordinary work (65 x 75 mm.), ($2\frac{1}{2}$ x $2\frac{7}{8}$ in.).

§ 319. **Inks and pens.**—One can use any ink and any pen on the varnished or gelatinized slides.

For making tables, etc., it is best to use water-proof India ink and a fine pen, a crow-quill, steel pen is excellent.

§ 320. **Drawing diagrams on varnished slides.**—One can draw freehand on these varnished slides as well as upon paper. For

those not especially skillful, it is probably better to draw the sketch first and then trace the sketch on glass as follows: Place the lantern-slide glass on the drawing, varnish side up, and arrange it as desired. Select very thin glass for this, so that the drawing surface will be near the picture to be traced. Now with a pen or brush trace the outlines. One can also use colored inks if desired.

§ 321. **Guide for table making and for writing.**—For making lantern-slide tables or written matter direct on the slide it is best for most workers to have a guide which shall show the maximum size which can be projected (fig. 115). If one has no special guide, cross-section paper or catalogue cards will serve well.

To hold the glass in position while writing or making diagrams, thumb tacks at the corners are efficient (fig. 115).

§ 322. **Ink and pen to use on unvarnished glass.**—For temporary use, as in reporting games, etc., the glass is cleaned and then the fingers rubbed over it. Now with a ball-pointed pen one can write upon the glass. The lines will be coarse, but that will not matter. One can write with an ordinary pen also, but not so surely as with a ball-pointed pen (§ 322a).

The ink can be of almost any kind. The black India ink gives the sharpest images.

A special ink called "glassine" has recently been put on the market. It is in six colors, white, black, red, green, blue and violet. The ink is thick and with it one can write on untreated glass with any pen, although a ball-pointed pen is here also an advantage (§ 322b). The ink is easily washed off with water so that the same glass slide can be used over and over.

§ 322a. The writers are indebted to Dr. E. M. Chamot for the suggestion to use the ball-pointed pens on the unvarnished glass, also the advantage of rubbing the fingers or palm over the cleaned glass to prevent the ink from spreading.

According to Lewis Wright, p. 412, one can write on glass well if the glass is licked, and the thin coating of saliva so spread upon the glass is allowed to dry. The ink will not spread, and the saliva-coated glass takes the pen well.

§ 322b. **"Glassine announcement slide ink."**—This ink is made by the Thaddeus Davids Co., 127 William St., N. Y., and is supplied in 1 oz. (30 cc.) bottles, the full set of six colors costing \$1.00. See the *Moving Picture World*, March, 1914.

§ 323. **Smoked glass.**—For some purposes nothing is better than smoked glass slides. On these one can write or draw with a sharp point either before or during the exhibition. If one takes the precaution to commence writing on the lower edge of the slide and on the face looking toward the condenser the writing or diagram will appear right side up on the screen (see § 35 for proper position of lantern slides in the holder).

Smoked slides must be handled carefully or the surface will be spoiled.

§ 324. **Thin sheets of mica or of gelatin.**—On a sheet of mica, of gelatin or of non-inflammable cellulose one can write or draw with a pen or brush, using any colored ink. India ink is best for outlines and for written words, letters, or numerals.

As these sheets are very thin it is best to put a slide made upon one of them between two glasses, so that the sheet will be held flat and be protected. (For other methods of hand-made slides see Dolbear, pp. 29-32).

PHOTOGRAPHIC LANTERN SLIDES

§ 325. Nearly all of the lantern slides now used are made wholly or in part by photography.

Negative.—First, there is made a negative of the object to be represented in the lantern slide. This negative may be on any size of plate, but the picture should be, if convenient, of the proper size for a lantern slide. That is, its outside dimensions must not exceed 75 x 70 mm. (3 x 2.8 in.).

This negative should be very sharp and free from defects. Any lack of sharpness or any defects will come out with distressing prominence when the picture is magnified by the lantern. One must then use a good objective in making the picture, or if the objective is not particularly good a very small diaphragm is used. If it is desired that print shall be read easily by all in the room, the lantern slide should not have the letters smaller than six point type (see fig. 216 for sizes of type).

§ 326. **Printing the lantern slide from the negative.**—If the picture on the negative is of the proper size for a lantern slide, it is put into a printing frame exactly as for printing with paper. Then in the dark room a lantern-slide plate is put with its sensitive side next the negative and arranged so that the picture will be straight on the lantern slide. The cover of the printing frame is put on and held in place by the hands or by the springs. The exposure may be in diffused daylight, or about 30 cm. from any good artificial light (incandescent bulb, Welsbach gas light, kerosene lamp).

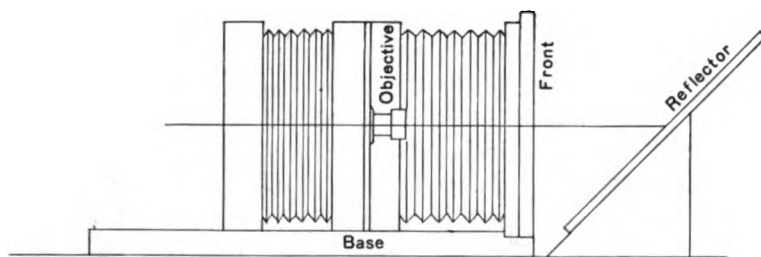

FIG. 116. CAMERA FOR MAKING LANTERN SLIDES BY MEANS OF AN OBJECTIVE.

Base The base of the camera resting on the table.

Objective The photographic objective in the middle segment of the camera. The objective is shown as if the enclosing bellows were transparent.

Front The front of the camera where the negative is placed.

Reflector A white sheet of paper or cardboard placed on a shelf at 45°. This reflector serves to illuminate the negative.

By varying the relative distances of ground glass, objective and negative, the lantern slide can be larger or smaller or of the same size as the corresponding part of the negative.

The exposure required varies with the negative, but it is less than for most developing papers.

§ 327. **Developing the lantern slide.**—Any good developer may be used, but as a rule the directions given in the box of plates are the best to use with that brand of plate. One should develop until the picture appears clearly. The temptation is to develop too much and thus make the slide too opaque. Black, like printed letters, should be opaque in the correct lantern slide, but there should be all gradations from that to clear glass in the whites.

Any one who can make a good negative and a good paper print from it can make a good lantern slide. The lantern slide is a positive and the lights and shades should appear as in the object when one looks through the slide toward the light. These lantern slides are small transparencies, and some of them make beautiful ornaments when used as transparencies in a window.

There is more danger of getting the slides too opaque than not opaque enough. The beginner should try each lantern slide with

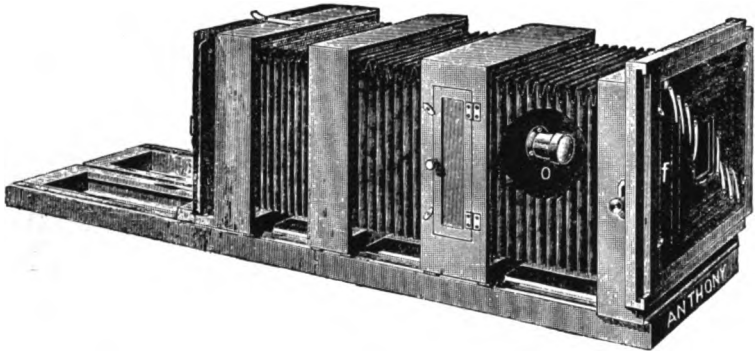

FIG. 117. COPYING, ENLARGING OR REDUCING CAMERA.
(From the Catalogue of Anthony & Co.).

O The objective. The bellows have been cut away to show it.
f Front of the camera with frames or "kits" for negatives of various sizes. For making enlargements with this camera the objective can be placed in the front.

a moderate light in the lantern. If the picture on the screen is brilliant and shows all the details with the moderate light, it will, of course, give a more brilliant picture with the electric light of 3000 to 4000 candle-power. If the slide is too opaque, it will not come out well with the moderate light and, while the powerful electric light may show it fairly well, so much radiation will be absorbed and transformed into heat that the slide is liable to break if left in the lantern a considerable time. The more transparent slides allow the radiant energy to pass through them and naturally they are not so greatly heated.

§ 328. **Negatives as lantern slides.**—Many objects appear equally well and equally clearly when projected from a negative as from a positive or transparency. That is, there will be white lines and white letters, etc., on a black background. This was a favorite method of illustrating in the older works on physics and projection. For examples, look at the pictures in Dolbear's Art of

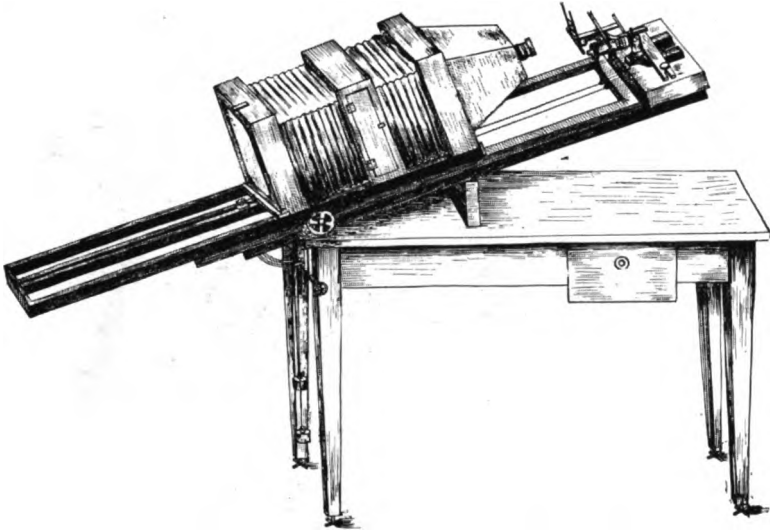

FIG. 118. PHOTOGRAPHIC CAMERA UPON A BASEBOARD HINGED TO A TABLE.

(From *The Microscope*).

This is one of the copying, enlarging and reducing cameras. The objective may be at the end, in a cone, or in the middle segment. For lantern-slide making it is in the middle segment and the negative at the end, the whole camera being directed upward toward the sky.

By reversing the position of the camera, and placing the hinged board in a vertical position, objects in liquids and any object in a horizontal position can be photographed.

NOTE.—The arrangement shown in fig. 118 with a baseboard hinged to the table, and with a camera which could be placed pointing upward or downward was devised by the senior author in 1878 especially for photographing objects in liquids or objects which must remain in an inclined or horizontal position. The baseboard carrying the camera can be fixed in any position from the horizontal to the vertical. (*Proc. Amer. Assoc. Adv. Sc. Vol. XXVIII (1879), p. 489; Science, Vol. III, p. 443, and Vol. IV, p. 5 (1884).*)

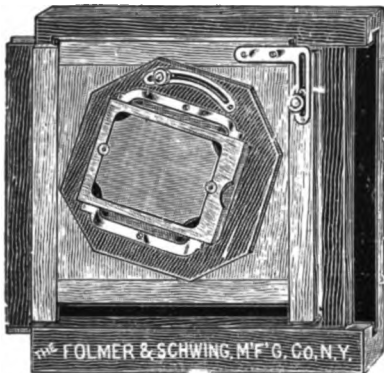

B

Projecting, Deschanel's Physics, etc., and fig. 141, 190, 211, 214.

There is one serious drawback to such lantern slides. The background being nearly opaque stops the light and other radiant energy from the lamp, and the great heat developed is liable to crack the slides (see § 18, 845).



A

FIG. 119. FOLMER & SCHWING'S TILTING CAMERA AND ADJUSTABLE BACK.

(From the Catalogue of Folmer & Schwing. Cut loaned by the Eastman Kodak Co.).

A Tilting camera for making lantern slides or other transparencies with an objective, or for photographing objects in a horizontal or inclined position.

B Adjustable back for the tilting camera. The adjustments are to the right or left, up or down and enable one to center accurately any desired part of the negative or other object to be photographed. The rotary motion of the back enables one to get the lines on the negative or object exactly parallel with the edge of the lantern slide.

§ 329. **Printing lantern slides by the aid of a camera.**—Unless the negatives from which lantern slides are to be made have the part to be shown of exactly the size of a lantern slide, the transparency or positive cannot be printed by contact. Then one can use a photographic camera and print the transparency as follows: The negative is put in a suitable opening or in the proper “kit” or frame in the end of a copying camera (fig. 116–119), and the objective in the second segment. The picture or film side of the negative must face the objective. Then the end of the camera holding the negative is elevated sufficiently to get a sky background through the window; or the camera is left level and a large piece of cardboard or white blotting paper is set at an angle of about 45 degrees out of a window and the camera pointed toward it. In either case the entire lantern slide will be evenly illuminated and a good print can be obtained.

Now focus the picture of the negative sharply on the ground glass of the camera and get it of the proper size by pulling out or closing up the bellows.

Print the positive by putting a lantern-slide plate in the plate holder in the usual manner and exposing it. Then develop as usual.

It is to be noted that the film surface of the negative and the sensitive surface of the lantern-slide plate face each other by this method exactly as for contact printing (§ 329a).

§ 330. **Camera for lantern slides.**—If one is to make many lantern slides it is a great convenience to have available a special

§ 329a. **White prints on a black ground.**—By using an ordinary negative giving black lines on a white ground one can get white lines or a white picture on a black ground by applying the method just given for printing lantern slides by means of a camera and an objective. Place the negative in position, but with the film side facing away from, not toward the objective as for an ordinary lantern slide. Use a lantern slide or any other kind of plate and make the picture just as for the lantern slide. The glass picture thus produced will be a positive like a lantern slide but it will have all the parts reversed exactly like a negative. If now this picture is used as a negative and printed with cyco, velox, argo, haloid or any other printing paper the picture will appear white on a dark ground.

Of course, any lantern slide can be used for making prints, but the picture will be reversed in every way, the lights and darks, the printing, etc. To prevent the inversion of the printing one can use an objective and camera as described in Ch. X, § 512.

camera known as a "copying, enlarging, and reducing camera" (fig. 116-119). As seen from the picture, the objective is placed in the middle segment if lantern slides are to be made from negatives, and the negative is placed in the proper sized frame or "kit" at the end of the camera. No light then reaches the negative except on the face looking toward the light, hence there will be no trouble from reflections.

In the best form of these cameras there is a "back with revolving, rising and vertical sliding lantern-slide attachment" for printing and for making the negatives (fig. 119). The picture can be got on the plate in the exact position desired, i. e., lines of print, etc., exactly parallel with the edge of the plate. By means of a camera one can print lantern slides from the negatives before they are dry. This is sometimes a great convenience.

§ 331. Printing lantern slides by artificial light.—With contact printing one can use daylight or any convenient artificial light—petroleum, gas, acetylene or electric. For printing with the camera, however, it is not so easy to get the negative evenly illuminated. A good way to evenly illuminate the negative is to use a 45 degree cardboard reflector illuminated with one or two incandescent lights, preferably with frosted bulbs in a horizontal position. Mantle gas lights serve well for illuminating the cardboard. The negative is set vertically some distance from the cardboard.

The time for printing lantern slides by contact or by the aid of a camera will vary with the negative as for paper prints; much depends on the intensity of the light and on the rapidity of the plates used.

To give an example of the time required in a given case the following table is added:

The same objective with a diaphragm opening of F/8 was used for all, and the same negative was used in each case. All the plates were from the same box and the same developer was used for all, so that the only variable was the light.

1. Sky background, diffused light 10 seconds.
2. Cardboard at 45 degrees, under the sky 15 seconds.

3. Cardboard at 45 degrees, lighted by a 40 watt mazda lamp above the cardboard 30 seconds.
4. Cardboard at 45 degrees with a 16 candle-power frosted bulb above the cardboard 120 seconds.

For contact printing with the same negative, 30 cm. (12 in.) from the light, if artificial, the following times sufficed: Diffused daylight, 2 sec.; Mazda, 40 watt lamp, 1 sec.; Frosted bulb, 16 c.p. lamp, 10 sec.; Petroleum lamp, 10 sec.; Gas mantle, 5 sec.

§ 332. Rapid preparation of lantern slides.—It occasionally happens that one needs a lantern slide at very short notice. In such a case, the negative can be taken and fixed in the hypo, rinsed in water, and put into the camera and a lantern slide exposed (§ 329). Then the negative can be washed as usual. The lantern slide is then developed and fixed, and washed a few minutes in water. It is then placed a few moments in 95% alcohol or denatured alcohol for dehydration. After removal from the alcohol it is dried in a draught or in the current of an electric fan. Negatives can be quickly dried in the same way. One can then make contact prints.

§ 333. Typewritten lantern slides.—It frequently happens that one desires to project some statement or some table. This can be written as stated above (§ 316, 321), or the statement or table can be made neatly with a typewriter, using a black ribbon. Then this can be used just as any other printed matter and a photographic lantern slide made from it.

If in a great hurry one can use the negative form of lantern slide and dry quickly (§ 332). This will give white letters on a black ground (§ 329a). (For film slides see § 333a).

§ 333a. Film lantern slides.—There has been recently introduced by the Eastman Kodak Co., a method of producing lantern slides on celluloid films, comparable to film negatives. The celluloid film is quite thick. There must be a negative as for glass lantern slides. The film is used in place of a lantern-slide plate. The printing is like printing cyco, velox or other paper. When the lantern-slide film is dry, after being developed and washed like a film negative, it is varnished and placed between two pieces of paper with the proper opening for the picture.

Naturally, these film slides are very light and are not fragile. Unfortunately the substance of which the film is composed is inflammable, and therefore the

§ 334. **Mounting lantern slides.**—In the original method, which is still followed to a certain extent, each slide was mounted in a wooden frame—that is, each slide had its own carrier which was put in place when it was to be shown (fig. 15).

For teaching and for many other purposes glass lantern slides are not now put in separate wooden frames, but are covered with a clear glass (cover-glass) of the same size and the two bound together by adhesive paper. They are far less bulky in this way of mounting, although they are not as well protected as in the earlier form.

In mounting them the slides are thoroughly dried, then some form of opaque mat or mask is put over the picture on the picture side of the transparency or negative. There are on the market masks or mats of various shapes and sizes of opening. These may be used or masks may be made by using strips of black paper.

When the mat is in place a cover-glass of exactly the same size as the lantern slide is thoroughly cleaned and placed over the picture surface of the slide. Then a narrow strip of adhesive paper is put all around the edge. This holds the slide and the cover in position, and prevents the sharp edges of the glass from cutting the fingers when handling the slides. The mat not only cuts out any part which is not to be shown, but it separates the cover-glass slightly from the picture and prevents rubbing or other injury to it. The size and shape of the opening in the mat to give the best effect depends upon the picture or other matter on the lantern slide. The mat is a kind of frame and like any other frame it should be suited in form and size to the object to be shown.

§ 335. **Marking or "spotting" the mounted slides.**—As pointed out in Chapter I (§ 23) each slide should have some kind of

Kodak Company recommend that the film slides be used only with a magic lantern having a water-cell (fig. 2, 3).

Furthermore, even if non-inflammable film were used, it would not do to leave those slides in a lantern without a water-cell too long for the heat would make the celluloid buckle and get out of shape or char it, although of course it would not be set on fire.

The lightness and small space required for such slides are of great advantage, but their limitations are so great that for the general, and rough usage of ordinary lantern slides they are not so well adapted as glass slides.

mark on it so that the operator can put it into the lantern correctly without closely inspecting each slide.

Unfortunately there is no general system of marking slides. The method recommended by the British Photographic Club (Bayley, p. 78) is to put two white spots on the upper edge of the slide (fig. 113). Two spots are necessary for the square slides, but for oblong slides one "spot" or mark is sufficient (fig. 112).

In America it is common to have the mark or spot on the lower left hand corner of the slide (§ 112), then when the slides are in a pile for inserting in the lantern the spot will be turned upward (fig. 8) as it must be to give an erect screen image. In the British method of "spotting" the slides would have the spots on the lower edge when piled up ready for insertion in the lantern.

§ 336. **Coloring lantern slides.**—Photographic lantern slides have been colored from their first production. To do this in the best manner possible requires considerable practise and natural artistic ability, but any one can color lantern slides sufficiently well to add to clearness in teaching—for example, veins blue, arteries red, etc. All that is needed is a small artist's brush and some of the desired color.

Transparent colors in sets are on the market (see Appendix), or one can employ the aqueous stains used in histology. It takes some experience to get the right dilution of the color and to put it on neatly with the brush. The slide should be held over some white paper in a light place so that it is possible to see exactly what is being done. The frame for holding slides is a convenience (fig. 113).

If one wishes to become expert it will be a great help to study the works of reference given at the head of this chapter, for they give many valuable hints.

One very important thing for the beginner to do is to test every slide that is colored in the lantern to make sure that the colors look right in the screen image. Sometimes a slide that looks well to the naked eye in daylight will not look well when projected on the screen. It is, of course, the screen image that must be satisfactory.

The early lantern slides were mostly colored with transparent oil colors, and then when entirely dry, the slide was mounted in Canada balsam, and a cover-glass put on exactly as microscopic

specimens are now mounted. This gave a very transparent and vivid picture.

§ 337. **Labeling lantern slides.**—Besides the mark or spot as guide to inserting the slides in the carrier, every lantern slide should have a label stating what it is, and if copied from some book or periodical it should give the name of the publication from which derived and the number of the figure.

Slides are also numbered for convenience in arrangement at the time of an exhibition. Some workers simply number the slides and have no label. This is, of course, feasible for a small collection to be used by one individual, but the slides are practically useless for any one else unless they are labeled.

Sometimes slides are numbered, and a catalogue kept with corresponding numbers and a description of the slide. For one unfamiliar with the collection the numbers and the cards are not easy to put together. Then one is liable to have more than one series, and the series are liable to get mixed. With a label on each slide, the collection can be made use of by any one.

§ 338. **Storing lantern slides.**—The problem of storing a large collection of lantern slides is a serious one. A still more serious problem is to find the slides needed for a given lecture or demonstration.

A common method of storing is to have a cabinet like that used for the card catalogue of libraries, and to put the slides in the drawers as the catalogue cards are filed.

One can use name cards to designate groups of slides as they are used to group catalogue cards.

In order to store and make them most easily available for use, Professor George S. Moler of the department of Physics in Cornell University has devised a cabinet which holds the slides in a single vertical layer, so that when any holder is pulled out the slides are all exhibited, and one can see exactly what the slides are and select those desired.

This seems to the writers of this book, by all odds, the most practical cabinet yet devised for safely storing slides and making them available with the least trouble and the least waste of time (fig. 120).

§ 339. **Troubles in making lantern slides.**—These are the troubles liable to be met in photography. They must be overcome by following intelligently the directions for photographic work in general and for lantern-slide making in particular. Study the directions coming with the lantern-slide plates used.

In making written slides or diagrams on varnished slides the pen will not work well, and the ink will crawl if the varnish is not dry.

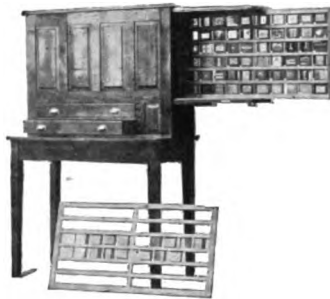

FIG. 120. THE MOLER SECTIONAL LANTERN-SLIDE CABINET.

(Cut loaned by G. S. Moler).

This cabinet holds 1200 lantern slides. It consists of a box with twenty vertical, sliding frames, each frame holding 60 slides.

In the picture the cabinet is shown on a table. One of the frames is entirely removed and leans against the table leg. One frame is pulled out for examining the slides stored in it.

In coloring lantern slides one must learn to use colors which give the correct effect with the artificial light used in projection. A tint which does not seem right by daylight may give exactly the desired effect by lamp-light. This is why the advice is given to test the work frequently in the lantern.

Remember that there is more danger of getting the lantern slides too opaque than not opaque enough.

Sometimes when being exhibited a lantern slide shows a mist or fog spreading over it. This may partly or wholly disappear. This is a real fog, and comes from the moisture in the slide, or its mounting. If the slides are thoroughly dried before they are put into the lantern this fog does not appear.

§ 340. Summary of Chapter VIII:

Do

1. Use the standard size of lantern slides in the country where you live (§ 312).

2. Make the lantern slides with moderate intensity, then they can be used with all lanterns, no matter what the source of light (§ 327).

3. Make the picture small enough so that all desired parts can be projected (§ 334).

4. Take pains in mounting the slides so that the frame will appear suited to the subject (§ 334).

5. In making slides direct on the varnished glass, write finely, neatly and clearly (§ 316).

6. Printed or written matter on the slide should be large enough to be read by all in the room (§ 325).

7. Mark or spot the lantern slides so that they can be inserted in the holder without hesitation (§ 335).

8. Label every lantern slide so that any one can tell what it is (§ 337).

9. Store the lantern slides so that they can be found quickly (§ 338).

Do Not

1. Do not use odd sized pieces of glass to make lantern slides on.

2. Do not make the lantern slides so opaque that only the best electric lanterns can exhibit them.

3. Do not make the picture on the slide too large to be exhibited.

4. Do not mount the slides in a slovenly, inartistic manner.

5. Do not use flourishes in writing on the varnished slides.

6. Do not reduce the written or printed matter so that it cannot be read in the screen image.

7. Do not leave the slides unmarked and expect every chance operator to insert them properly at railroad speed.

8. Do not leave the lantern slides unlabeled, for no one else can make the best use of them.

9. Do not store the slides in a miscellaneous heap.

CHAPTER IX

THE PROJECTION MICROSCOPE AND ITS USE

§ 350. Apparatus and Material for Chapter IX:

Suitable room with screen, for projection; Projection Microscope; Sunlight or the electric arc light; Specimens suitable for projection (§ 399); Tools etc., as for Ch. I.

REFERENCES AND HISTORY

§ 351. For the history of the origin and development of the projection microscope, refer to the appendix at the end of the book. In this history will be given many references to the original sources of information upon the subject.

For works dealing with modern micro-projection, the reader is advised to consult the works given in § 2 of Ch. I. He is especially advised to consult the catalogues of Zeiss and the other modern makers of projection apparatus, for in them he will find directions and suggestions for making the best use of the most modern instruments. His attention is also especially called to the Journal of the Royal Microscopical Society and to the *Zeitschrift für wissenschaftliche Mikroskopie*. See also the *Zeitschrift für Instrumentenkunde*, the *English Mechanic* and the *Scientific American* with its Supplement. In every volume of these periodicals there are almost always articles bearing directly on the problems involved in Projection.

GENERAL CONSIDERATION OF THE PROJECTION MICROSCOPE

§ 352. **Similarity of all projection apparatus.**—All devices for projection are fundamentally alike in giving images of brilliantly lighted objects. These images are projected upon some reflecting surface or screen in a dark room. The projection microscope simply gives images of greater enlargement than the other forms of apparatus. It imperceptibly merges into the magic lantern, as the magic lantern merges into the camera obscura. (Compare fig. 121-122).

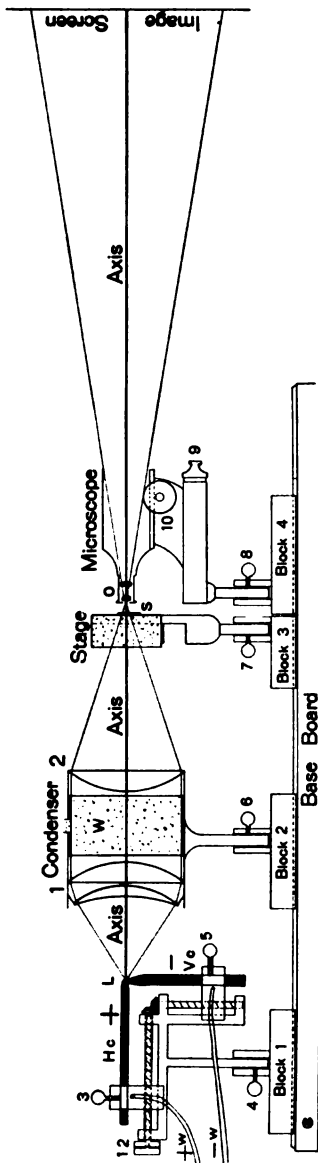

FIG. 121. PROJECTION MICROSCOPE.

- 1, 2 Feeding screws of the arc lamp.
 3 Set screw for the upper carbon.
 4 Set screw for holding the stem of the arc lamp in the socket on block 1.
 5 Set screw for the lower carbon.
Hc+ The horizontal, upper carbon. It must be made positive (+).
L The source of light, i. e., the crater of the upper carbon.
Vc- The vertical or lower carbon. It is negative (-).

Axis, Axis, Axis The principal optic axis from the positive crater of the arc lamp extending through the condenser, the stage water-cell, and the microscope to the screen.

1 *Condenser 2* The triple condenser for receiving and concentrating the light from the crater of the arc lamp.

1 The first element of the condenser which renders the diverging light parallel. It consists of a meniscus next the light and a plano-convex lens (compare fig. 105, III).

2 The second element of the condenser which concentrates the parallel beam.

W Water-cell between the two plano-convex lenses in the parallel beam of light.

As a projection microscope uses objectives of shorter focus and smaller diameter than the magic lantern, greater care must be exercised in getting all the elements, radiant, condenser and projection objective, centered along one continuous line or axis, and in having the different elements the right distance apart.

Micro-projection is simply a refinement of ordinary magic lantern projection. If one understands the principles, and has mechanical skill to apply them, there is no great difficulty in micro-projection. But if ordinary magic lantern projection is unsatisfactory in untrained hands, micro-projection in such hands is intolerable.

This is, however, such a powerful aid to the teacher and the lecturer that the time necessary to learn to use it properly is not to be counted. With micro-projection the beauties of structure and

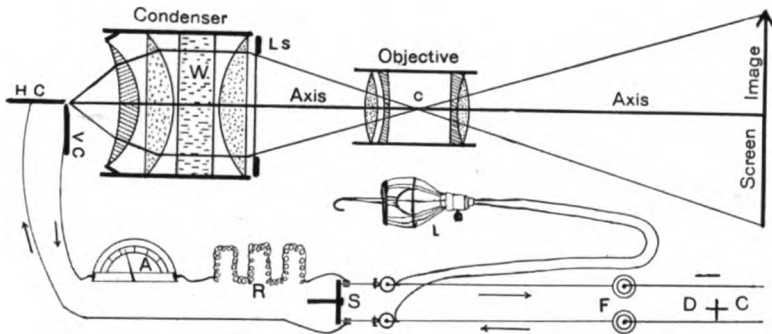

FIG. 122. MAGIC LANTERN FOR COMPARISON WITH THE PROJECTION MICROSCOPE (See fig. 2).

form are made visible to an entire audience with all their color, delicacy and exquisite perfection.

Furthermore, the teacher or lecturer can indicate on the screen the special points to be noted, and feel confident that his auditors see the special features and do not get confused by the mass of details, as when looking into a microscope. Often too, the most interesting and important structures in a specimen are not so striking as some less important detail, and the important points are likely to be missed unless pointed out.

§ 353. **Limitation of the Projection Microscope.**—Perfect and useful as the projection microscope is, it is limited in its powers. One can show with full satisfaction to a large audience (200 to 1000) only those details which an experienced observer can see by

looking directly into a compound microscope supplied with a low ocular and a 16 mm. objective. For a small audience near the screen higher powers are satisfactory (see § 401).

§ 354. **Size of specimens for projection.**—To meet the requirements of teaching and demonstration the modern scientific man and public lecturer should be able to commence with the projection microscope where the magic lantern leaves off, and carry the projection to the smallest size adapted to micro-projection; that is, from a specimen 60 mm. in diameter to one of half a millimeter or less in size. This requires an opening in the stage slightly larger than the largest specimen, that is, at least 65 mm. in diameter.

CHARACTER AND RANGE OF PROJECTION OBJECTIVES FOR DEMONSTRATION TO LARGE CLASSES

§ 355. Objectives from 125 mm. to 4 mm. equivalent focus are especially useful in micro-projection. The powers of 125, 100, 75, 50, and 25 mm. equivalent focus, and in some cases those of 20 and 16 mm., are constructed on the plan of photographic objectives (fig. 123). *These are always to be used without an ocular, and their iris diaphragms are wide open.*

At the present time the low objectives used in ordinary microscopic observation are also used in projection. The field is not flat, as with the micro-planar and other forms of photo-micrographic objectives, but they are much cheaper and the screen images are very brilliant. Formerly many of the objectives used in projection were made especially for that purpose. They gave very brilliant, flat fields over a narrow angle, but they were neither satisfactory for ordinary microscopic observation nor for photography.

Most of the projection with the microscope is, however, accomplished with objectives of about the following range: 50 mm., 16 mm., and 8 mm. With these in a triple nose-piece or revolver, the projection microscope can accomplish great things, especially if assisted occasionally by amplifiers. For an audience of 250 to 500 and a screen distance from 7.5 to 10 meters (25 to 33 ft.) the magnifications will range from about 150 to 3000 diameters (§ 391).

For a larger audience and a correspondingly larger room the screen distance might be made 15 to 20 meters (50 to 65 ft.), and the magnification raised from 250 at the lower limit up to about 5,000 diameters at the upper limit. The smaller room enables one to get more brilliant screen images, and to use a wider range of objects (see table of magnifications § 391). In the smaller room the screen should be at least 4 meters (12-13 feet) square, and in the larger room 5-6 meters (15-20 feet) square.

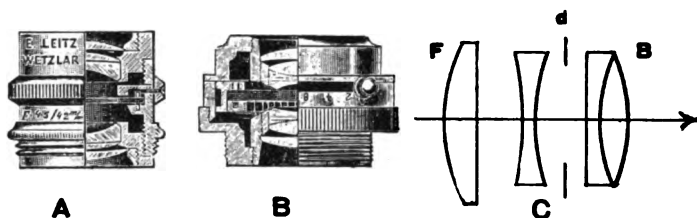

FIG. 123. DIAGRAMS SHOWING THE CONSTRUCTION OF OBJECTIVES FOR MICRO-PROJECTION AND FOR PHOTOGRAPHY.

(From the Catalogues of Zeiss, Leitz, and the Bausch & Lomb Optical Co.).

A Microsummar of Leitz.

B Microplanar of Zeiss.

C Microtessar of the Bausch & Lomb Optical Co.

When used for micro-projection the diaphragm is wide open and no ocular is employed.

In the diagram of the Microtessar, *F* represents the front lens, *d* the diaphragm, and *B* the back combination of the objective. The arrow indicates the direction of the light.

In articles and books upon projection, it is advocated sometimes, that oil or water immersion objectives as high as 1.5 or 2 mm. should be used for class demonstration.

There is no doubt that brilliant images with short screen distances can be obtained with high power objectives, but such projection is only applicable for small numbers; and if fine details are to be seen, the observer must be very close to the screen. Furthermore, no screen image in its finest details is equal to that which one gets in looking directly into a compound microscope. (For high power projection see § 401).

If it is high magnification that is desired, it is vastly better to use lower objectives with an amplifier (§ 356, fig. 126). The lower

objective with larger lenses admits much more light, hence the screen image will be brighter. For example, suppose it were desired to obtain the magnification which is given by a 2 mm. objective, it would be much better to use a 4 mm. objective and an amplifier doubling the size of the real image. This would make the screen image of the same magnification as the 2 mm. would give, and it would be far brighter and show a larger field. In like manner and for the same reason, it is better to use an 8 mm. objective and an amplifier, than a 4 mm. objective without the amplifier (but see § 401).

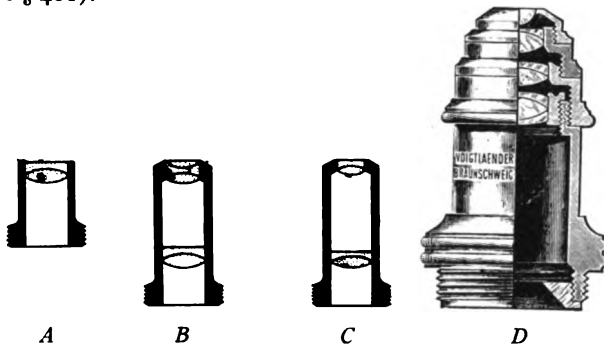

FIG. 124. FIGURES SHOWING THE GENERAL CONSTRUCTION OF MICROSCOPE OBJECTIVES.

A Low power objective of a single combination (50–30 mm. equivalent focus).

B, C Medium power objectives with two combinations (25–12 mm. equivalent focus). Sometimes the front combination is composed of two and sometimes of three lenses as shown.

D High power objective (8 to 2 mm. equivalent focus). Usually the front combination is of a single lens, the others of two or three lenses as shown. Many high power objectives have but three combinations.

(*D* is from Voigtländer's Catalogue).

The writers have found that in projection for actual class demonstrations, objectives of higher power than 4 mm. are unsatisfactory. We believe also that the purpose of class-room projection is not the demonstration and study of minute details which require that the observer should be close to the screen image, but the general outlines and broad features which can be seen clearly at a distance when suitably magnified.

The fresh blood corpuscles of man, for example, are about 7.5μ in diameter. To see these as discs on a screen at a distance of 10 meters would require a magnification of 4,000 and preferably of 8,000 diameters. With such a high magnification the sharpness of the outline, and the distinction between the corpuscles and the medium in which they float is almost lost, and there is nothing but a vague haze with shadowy outlines. If one goes up closer to the screen to see the images well, one will be sorely disappointed, for they are vague in outline and wholly unsatisfactory as compared with the appearance gained by looking directly into a microscope (§ 355a).

✓ § 355a. **Visibility of objects or their magnified images.**—It has been found by careful observation and experiment that the most sensitive part of the eye is in the fovea centralis or yellow spot; and that in order to see two points, by the fovea, as separate, they must be far enough apart so that the visual angle is one minute. If the visual angle is less than one minute, two points appear to most eyes as one.

The question now is, how far separated must the parts of an object be in millimeters or inches in order that the form of the object can be distinguished. To answer this it is necessary to know the actual length of the one minute of arc when the eye is at different distances.

To determine the length of one minute of arc in any case, the eye is considered to be at the center of a circle and the object at the circumference, and no matter how great the visual distance, the object must subtend one minute of the arc of the circle of which the visual distance is the radius in order to have its parts distinguishable.

To determine the actual length in millimeters or inches of one minute of arc in any circle, it is only necessary to remember that the circumference of a circle is 6.2832 times its radius and that it is divided into 360 degrees or 21,600 minutes (fig. 125).

If, now, the radius of the circle, or the distance of the eye from the object is 1 meter, the circumference of the circle will be 6.2832 meters or 6,283.2 millimeters. As there are 21,600 minutes in the circumference, the length of one minute is $6,283.2 \text{ mm.} \div 21,600 = .2908 \text{ mm.}$ or approximately .3 mm. That is, with the eye at one meter distance, the parts of an object should be separated .3 mm. to be seen as distinct points.

For the standard distance of distinct vision (25 cm.), used in microscopic magnification, the object must be $\frac{1}{4}$ th this size or .075 mm.; and for a distance of 10 meters it must be 10 times as great or 3 millimeters, and for 6 meters, the distance used for testing vision, it must be $.3 \times 6 = 1.8 \text{ mm.}$

A greater separation of the points is desirable for the most accurate determination, but those given above are the minimum for most observers.

Now to apply the above to the magnification necessary for a screen image of the human blood corpuscle which has a size of 7.5μ (.0075 millimeters; .000295 inch). To give the necessary sized screen image of .3 mm.; .075 mm. and 3 mm. at distances of 1 meter, $\frac{1}{4}$ th meter, and 10 meters, it is only necessary to divide the size of the screen image in each case by the size of the object (7.5μ or .0075 mm.).

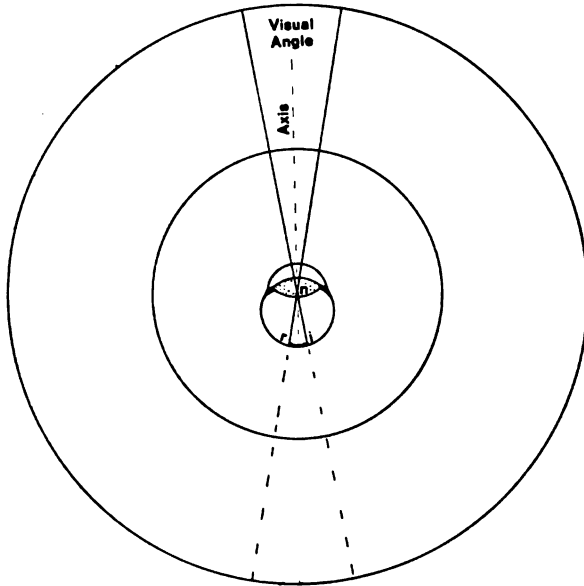

FIG. 125. DIAGRAM SHOWING VISUAL ANGLE.

The nodal point or optic center of the eye is placed at the center of the circle, and the rays from the extremities of the object which cross at this nodal point show the visual angle.

It is clearly seen from the diagram that the object must increase in length in direct proportion to its distance from the eye if the visual angle remains constant.

Visual Angle The angle between the lines extending from the extremities of the visible object and crossing at the nodal point (*n*) of the eye.

Axis The straight line extending along the principal optic axis of the eye to the visible object on one side and to the retina on the other side of the nodal point (*n*).

n Nodal point or optic center of the eye.

ri Retinal image. The size of the retinal image of a given object depends upon the visual angle and the visual angle depends upon the distance of the object from the nodal point.

For 1 meter ($.3 \text{ mm.} \div .0075 = 400$ diameters magnification).

For $\frac{1}{4}$ meter ($.075 \div .0075 = 100$ diameters magnification).

For 10 meters ($3 \div .0075 = 4,000$ diameters magnification).

For anything like a satisfactory view of the corpuscles, it would be desirable to double these magnifications.

§ 356. **Amplifiers.**—An amplifier is a concave lens or combination producing divergence instead of convergence of light rays, hence placing an amplifier in the path of the image-forming rays from the objective produces a larger image (fig. 126), and there is little loss in light. It should be made as great in diameter as the large tube (fig. 121) of the microscope will receive to avoid cutting down the field, and should be mounted in a short tube which can be easily slipped into a cloth-lined collar screwed into the end of the microscope tube (fig. 133).

The amplifiers most generally useful are of -5 and -10 diopters. The average increase in magnification given by the -5 diopter amplifier is 1.7 and that given by the -10 diopter is 2.5 (see § 356a).

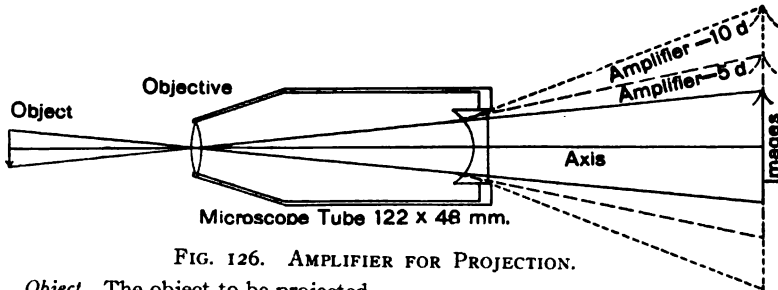

FIG. 126. AMPLIFIER FOR PROJECTION.

Object The object to be projected.

Objective The projection objective.

Axis Optic axis of the apparatus.

Amplifier The concave lens diverging the rays from the objective and thus increasing the screen image.

Images The ones with broken lines show the images with a -5 diopter and a -10 diopter lens. The full lines show the image which the objective alone would give.

The microscope tube is 122 mm. (4.8 in.) long and 48 mm. (1.9 in.) in diameter.

§ 356a, 403a. **Diopter, Diopre, Dioptry.**—For spectacle lenses especially, this is the unit of strength. It is the strength of a lens of 1 meter principal focus.

As the focal length of a lens varies inversely as its power, the focal length of a lens of 2 diopters is one-half as great as the standard, hence it has a focal length of $\frac{1}{2}$ meter; and one of 10 diopters has a focal length of $\frac{1}{10}$ meter and so on.

For lenses having a strength less than the standard of 1 meter the focal length will also be inversely as the power, and hence a $\frac{1}{2}$ diopter lens will have a focus of 2 meters and a $\frac{1}{10}$ th diopter lens has a focus of 10 meters. In general, the less the dioptre or strength the longer is the focus, and the greater the dioptre or strength the shorter is the principal focus.

Convex lenses with a real principal focus are indicated by the plus sign (+).

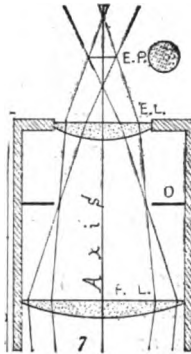

FIG. 127. HUYGENIAN OCULAR IN SECTION.
(From *The Microscope*).

F. L. Field lens. This aids the objective in forming a real image.

D Diaphragm in the ocular. It is at this level that the real image is formed in ordinary microscopic observation.

E. L. The eye lens. In projection this acts like an objective and projects upon the screen an image of the real image (see fig. 207).

Axis The optic axis of the microscope.

E. P. Eye-point or Ramsden's circle.

§ 357. **Projection oculars.**—Any ocular may be used for projection. The lower powers, $\times 2$, $\times 3$, $\times 4$, $\times 6$, (§ 357a) are better than the higher powers, for they cut down the field less, there is less loss of light, and there is not an inordinate magnification.

Concave lenses having a virtual focus are indicated by the minus sign (—).

If the dioptry of a lens is given, to find the principal focus: divide 1 meter by the dioptry. For example, the dioptry of the amplifiers mentioned above (§ 356) is —5 for one and —10 for the other. Their foci are then $\frac{1 \text{ meter}}{-5}$

$\frac{1 \text{ meter}}{-10}$. That is, they are concave lenses of $\frac{1}{5}$ and $\frac{1}{10}$ of a meter focus.

On the other hand, to find the dioptry of a lens whose principal focus is known, divide 1 meter by the principal focus and the result will represent the dioptry of the given lens. Taking the same case as before where the amplifiers have principal foci of $\frac{1}{5}$ and $\frac{1}{10}$ meter, $\frac{1}{\frac{1}{5}} = 5$; $\frac{1}{\frac{1}{10}} = 10$. As the lenses are

known to be concave, the minus sign is placed before the dioptry: —5, —10 diopters.

The increase in magnification given by the amplifiers, —5, —10 was found to average 1.7 for the —5 and 2.5 for the —10. The average was obtained by considering all the screen distances and all the different objectives shown in the table, § 391. See also § 392a.

In using the ordinary oculars a small tube must be screwed into the large microscope tube as for ordinary observation (fig. 147, 197).

Special oculars have been designed for projection. Some, like those of Zeiss (fig. 128) give sharp brilliant images, but the field is very small. Williams, Brown and Earle have a very large pro-

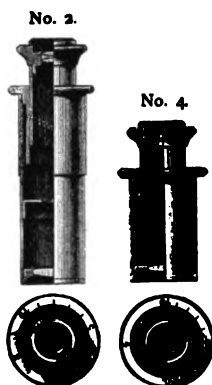

FIG. 128. PROJECTION OCULARS OF ZEISS.
(From Zeiss' Catalogue, No. 30).

A section has been removed to show the construction. Both are of the negative form.

The eye lens is in a smaller tube with spiral movement to enable the operator to focus the image of the diaphragm of the ocular sharply on the screen. Below are shown in face view the upper ends of the oculars with their graduated circles. By noting the position in any experiment it is easy to set the position exactly the same if the experiment is to be repeated.

No. 2, No. 4 These numbers indicate that the ocular magnifies the image two or four times (see § 391).

jection ocular of the Huygenian form which magnifies about twice.

On account of the loss of light and the restriction of the field of view, the writers of this book do not advocate the use of oculars for ordinary micro-projection, but see § 401.

§ 357a. **Designation of oculars.**—At the present time an ocular is usually designated by the increase in magnification it gives a microscopic image when the microscope is used in the ordinary way. For example, if the objective alone would give an image 10 times as long as the object, then an ocular $\times 2$ should double that size, thus giving an image magnified 20 times, and an ocular $\times 4$, an image magnified 40 times and so on.

§ 358. **Micrometer ocular for demonstration.**—It is so difficult for most students to understand the workings of the ocular micrometer, that it is of great help to them to use a micrometer ocular like fig. 130 to 131 on the projection microscope, then the object and micrometer lines can be projected together by suitably adjusting the eye-lens of the ocular. A stage micrometer might also be used as object and the students shown, all together, how to determine the ocular micrometer valuation (see Gage, *The Microscope*).

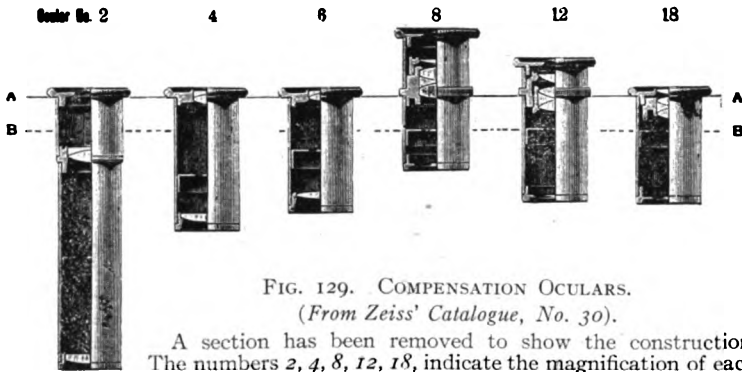

FIG. 129. COMPENSATION OCULARS.
(From Zeiss' Catalogue, No. 30).

A section has been removed to show the construction. The numbers 2, 4, 8, 12, 18, indicate the magnification of each ocular (see § 357a, 391a).

§ 359. **Substage condensers.**—The writers believe, from their experience and experiments in photometry under the different conditions, that it is better to use for illumination only the large condenser (fig. 121).

The use of a substage condenser is for either one of two purposes: (1) to enable the position of the object and the projection objective

The average increase in magnification given by the different oculars with the different objectives and screen distances shown in the table (§ 377) is as follows:

Projection ocular	x2	gives a magnification of	1.99
"	x4	" " " "	3.69
Compensation "	x2	" " " "	2.05
"	x4	" " " "	4.21
Huygenian "	x4	" " " "	4.21

From these figures it is seen that the increase in magnification for projection work can be closely enough approximated by multiplying the image given by the objective alone by the number designating the ocular, i. e., 2 or 4.

If very precise results are desired, one must use a stage micrometer and proceed as described in § 391a.

to be different from what it would be with the main condenser only; or (2) to make the aperture of the illuminating cone correspond with that of the objective.

The positional reason (1) can only have weight when combined apparatus is used, that is, when a magic lantern objective as well as microscopic objectives are used without changing the distance between the main condenser of the microscope or the magic lantern objective.

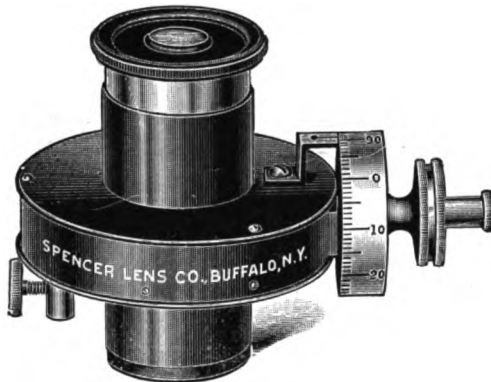

FIG. 130. OCULAR MICROMETER WITH MOVABLE SCALE.
(Cut loaned by the Spencer Lens Co.).

This is a Huygenian ocular with a 5 mm. scale divided into twenty $\frac{1}{4}$ mm. intervals. The pitch of the screw moving the scale is $\frac{1}{4}$ mm., therefore one complete revolution of the drum moves the scale one interval or $\frac{1}{4}$ mm. The drum is divided into 100 graduations thus enabling one to measure 100th of an interval on the micrometer scale. This ocular micrometer combines the advantages of the ocular micrometer with fixed scale and the filar micrometer. To complete the measurement of an object not exactly between any two micrometer lines the drum need be revolved only partly around.

With reference to the aperture (2) it is one of the fundamental laws of microscopic vision that the brilliancy and clearness of details depend largely upon the aperture of the light which illuminates the object, and which passes through the objective to form the retinal or the screen image. As the numerical aperture of objectives varies greatly it is necessary, if the clearest and most brilliant images are to be produced, to light the object with a numerical aperture equal to that of the objective. Where substage condensers are used arrangements must be made for this.

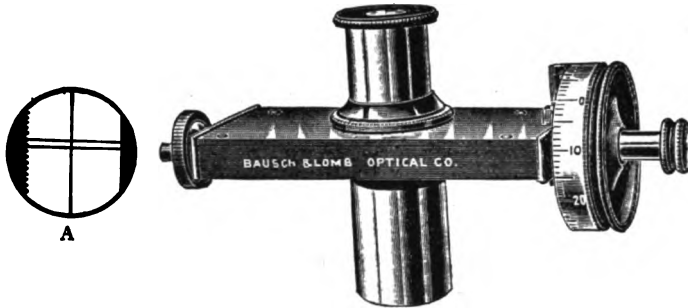

FIG. 131. FILAR MICROMETER OCULAR.
(Cut loaned by the Bausch & Lomb Optical Co.).

This filar micrometer ocular is of the Ramsden type and consists of a positive ocular with a movable hair line and two reference lines at right angles to each other as shown in *A*. The movable line must be carried over the entire length of the object to be measured by rotating the drum.

A Field of the filar micrometer showing the movable and the cross lines, and the comb. The teeth serve to measure the total revolutions of the drum.

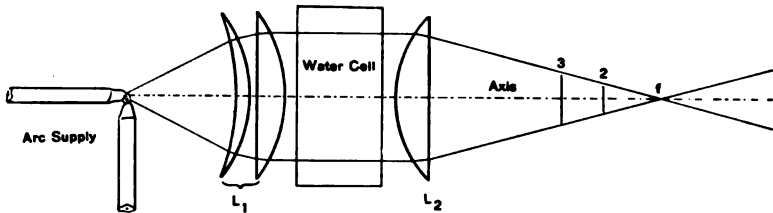

FIG. 132. ILLUMINATING OBJECTS OF VARIOUS SIZES IN MICRO-PROJECTION WITH THE MAIN CONDENSER ONLY.

The object must be put in the cone of light at a point where it will be fully illuminated.

For high powers it will be at or very near the focus (f). For larger objects and low powers the object is at 2 or 3, or even closer to the condenser face.

Arc Supply The right-angled carbons of the arc lamp.

L_1, L_2 The first and second elements of the triple condenser.

Water-Cell The water-cell for absorbing radiant heat. It is in the parallel beam between the first and second elements of the condenser.

Axis The principal optic axis on which all the parts are centered.

If only the main condenser is used (fig. 121), the cone of light from the condenser must be sufficient to fill the aperture of the projection objective. This requires that the second element of the

main condenser (fig. 132 L_2) have a focus of 150 to 200 mm. (6 to 8 inches). With such a main condenser one can do successful projection with objectives from 125 to 4 mm. focus. The aperture will not be completely filled in the 8, 6 and 4 mm. objectives, but brilliant screen images are obtained even with them for a 7.5 meter (25 ft.) screen and 12 amperes of direct current. One can also use a -5 diopter amplifier when good specimens are projected. (For the position of the objective and specimen see § 376).

With a substage condenser there is a great loss of light from reflection and absorption so that the increased aperture hardly compensates for it, and the increased detail is lost for the observers are too far from the screen to see them (see § 359a).

For special demonstrations and for drawing where the observers are very close to the screen, the substage condenser and also an ocular are advantageous, and for fine details, necessary (see § 401, 477).

SUITABLE ROOM AND SCREEN FOR MICRO-PROJECTION

§ 360. From the small size of the objective for micro-projection the image on the screen cannot be made as bright as with the magic lantern, hence it is necessary in micro-projection to have a room that can be made very dark; and the devices for cutting out stray light,—bellows, objective hood and shield—must be efficient (fig. 133, 139).

§ 359a. 1. Wright, p. 212, says: "The iris of the substage condenser is opened or closed until the best effect is produced." This can mean only that not the whole cone of light is used in some cases.

2. To determine the amount of aperture of the objective used in projection, take a thick piece of smoked mica or combine brown and blue, or deep red and blue, or red and green glass and put them over the front of the objective to soften the light. Or one might hold one of these light softeners just in front of the eye. Then in any given case look along the microscope tube directly toward the light, and the aperture of the objective actually filled by the entering cone of light can be seen. If the entire aperture is used, the back lens of the objective will be filled with light; if only a part of the aperture, then there will be a central brilliant circle and a dark zone of glass surrounding it (fig. 151).

It must be remembered too that the large specimen cooler (fig. 121, 134) cannot be used with a substage condenser; and in our opinion this overbalances any advantage that the substage condenser might yield for demonstrations to large classes.

The screen must be as reflecting as possible. Nothing has ever yet exceeded in satisfactory quality a smooth, dull, white, wall. For a full discussion of screens see Ch. XII, § 621.

MICRO-PROJECTION WITH THE DIRECT CURRENT ARC LAMP AS THE LIGHT SOURCE

§ 361. **Arc lamp and wiring for the same.**—The direct current arc light is the only fully satisfactory artificial light known at present for micro-projection. Hence it will be taken as the standard, as with the magic lantern (Ch. I). Furthermore, as the upper carbon is always made positive and hence is the source of light, this carbon is made horizontal and the crater faces the condenser and is in the optic axis. That is, for micro-projection we take the right-angled arc lamp as the standard (fig. 3, 121).

The wiring, rheostat and ammeter are as with the direct current magic lantern radiant, (figs. 2, 3, 133). The rheostat should be an adjustable one. The ammeter can be omitted, but it is more important than with the magic lantern, for the conditions of micro-projection must be made as nearly perfect as possible. With the ammeter one can tell instantly whether the proper amount of current is flowing. If there is sufficient current the light should be satisfactory, or if it is not satisfactory it will be due to some fault in optical adjustment. The ammeter is urged upon all users of the projection microscope because the tendency is to run in more and more current if the projection is unsatisfactory, hoping by pure brute strength, so to speak, to overcome difficulties due to improper adjustment. In case one cannot afford an ammeter, then the next best thing is, when installing the apparatus, to measure the current flowing through the arc with the different settings of the adjustable rheostat, and to mark these values on the rheostat dial. One can then set the rheostat at the proper amperage for the given projection; but as the voltage on the line is subject to variation, one cannot be sure that the proper current is flowing at any given moment unless an ammeter is present to indicate the amount. With many lighting circuits, the fluctuations in voltage are very small, and one can be reasonably sure of getting the current indi-

cated on the dial of the rheostat. When current is drawn from an overloaded power line, however, the voltage fluctuations are often so great that an ammeter, as well as an adjustable rheostat, is a necessity.

§ 362. **Fine adjustment for the arc lamp.**—For micro-projection it is absolutely necessary to have fine adjustments on the arc lamp so that the position of the crater can be changed slightly during an exhibition. In the burning of the carbons there is a slight shift in position of the crater even with soft-cored carbons. The crater may be in perfect alignment to start with, and by the shifting as the carbon burns away it may get far enough outside the longitudinal axis on which the apparatus is placed to spoil the light on the screen. This is emphatically true for high powers (16 mm. and higher). If now there are fine adjustments on the lamp (fig. 3, 146), by which the crater can be slightly raised or lowered or turned toward the right or left, compensation for this shifting can be made, and the most brilliant part of the crater kept strictly in the axis where it must be to give satisfactory illumination. Furthermore, it is necessary to have an independent adjustment for one or both of the carbons, so that one or both carbons may be moved independently. This is because the carbons are liable to wear away somewhat unequally, and some one of the mal-positions shown in fig. 24, 25 would occur if the carbons were not adjustable.

§ 363. **Condenser.**—The triple form with a meniscus next the radiant (fig. 121, 132) is very satisfactory for micro-projection, although many use the double form (fig. 146) with success. As the objectives used for projection with the microscope are of short focus and rather large aperture the final element of the condenser used to bring the light to a focus should not be of too great focal length. A focus of 150–200 mm. (6–8 in.) is a good average for the condenser with the objectives usually employed (125 to 4 mm., § 355). See § 401 for condenser with substage condenser.

§ 364. **Water-Cell to prevent overheating.**—For micro-projection a water-cell in connection with the large condenser is a necessity. It absorbs most of the radiant energy in the infra-red part

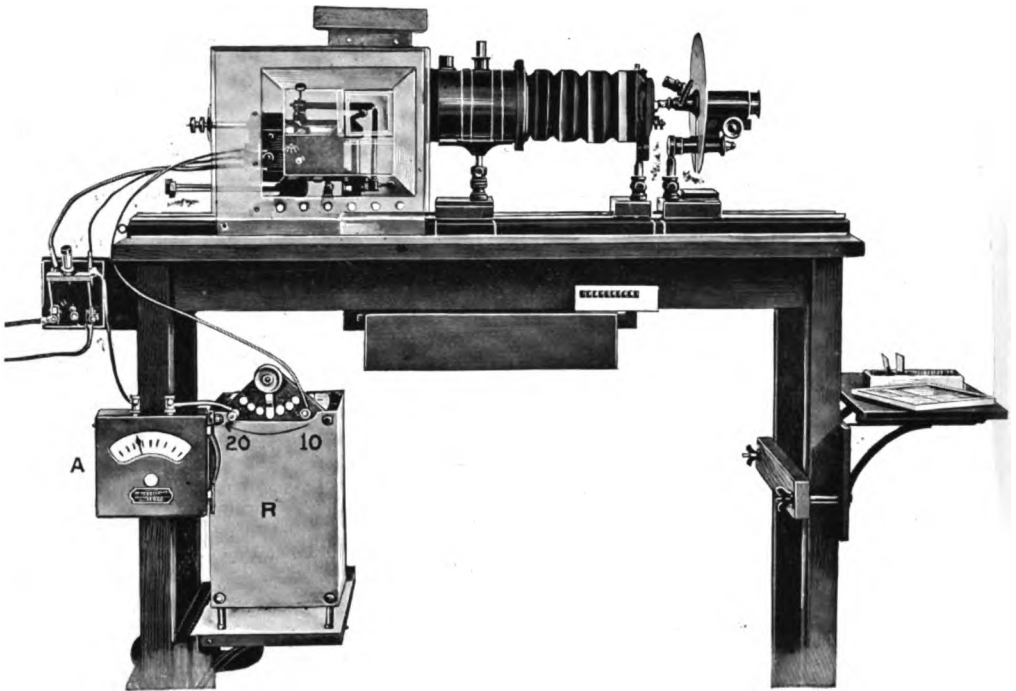

FIG. 133. PROJECTION MICROSCOPE WITH AMPLIFIER.

This picture shows the projection microscope arranged for use in a lecture room.

Commencing at the left:

The supply wires to the table switch.

A The ammeter to indicate the amount of current. It is along one wire (in series).

R The adjustable rheostat. It is along one wire.

10-20 These figures indicate that the rheostat is adjustable; the lowest current allowed to flow being 10 amperes and the highest 20 amperes. The arrow indicates the direction to turn the knob to increase the current.

The arc lamp in the lamp-house. This is the three-wire, automatic arc lamp of the Bausch & Lomb Optical Co.

The wiring is shown to be:

One wire from the negative pole of the switch to the pole for the lower carbon.

One wire passes from the positive pole of the switch to the middle binding post of the motor mechanism of the automatic lamp. The current for the motor does not traverse the rheostat.

One wire passes from the positive pole of the switch to the ammeter, to the rheostat and from the rheostat to the positive (+) binding screw of the arc lamp.

The metal lamp-house is semi-transparent as it was in position during only a part of the exposure for the photograph.

The condenser and water-cell are connected to the stage by a bellows to exclude stray light.

The microscope shows the objectives on a revolving nose-piece and behind them a metal shield to keep stray light from the screen.

An amplifier is shown in place, at the end of the large tube of the microscope.

The arc lamp, condenser, stage and microscope are each on an independent block which moves along the optical bench on the single baseboard. The vertical white lines on the baseboard indicate the position of the various blocks for the optical combination here shown.

On the front legs of the table is the adjustable drawing shelf upon which are demonstration preparations.

The scale of this picture is shown by the 10 centimeter rule just above the table drawer at the right.

of the spectrum and thus helps to avoid the overheating which would result if all of this energy remained. The best position of the water-cell is between the first and second elements of the condenser, where the rays are practically parallel (fig. 121). For further discussion of the avoidance of heating the specimens, see § 852.

§ 365. **Stage for specimens.**—The stage should be of ample size, and should have an opening sufficiently large for the largest specimens to be used in micro-projection, that is, not less than 65 mm. ($2\frac{1}{2}$ in.) square.

§ 366. **Mechanical stage.**—If serial sections are to be used with the apparatus then the stage should be supplied with a mechanical stage of great range, that is about 50 x 65 mm. This is about the maximum range for the sections mounted on slides 50 x 75 mm. (2 x 3 in.) (fig. 135, 136).

§ 367. **Stage cooling device.**—While the large water-cell in connection with the condenser absorbs practically all the long waves of radiant energy that can be absorbed by water, it is very desirable, and for many specimens necessary, to have some device for carrying off the heat developed in the specimen itself by the absorbed light. The most practical stage cooling device is a stage water-cell. The one found very efficient and satisfactory in every way is shown in fig. 121, 134. The specimen rests directly against the glass side of the water-cell and is cooled by conduction. Many

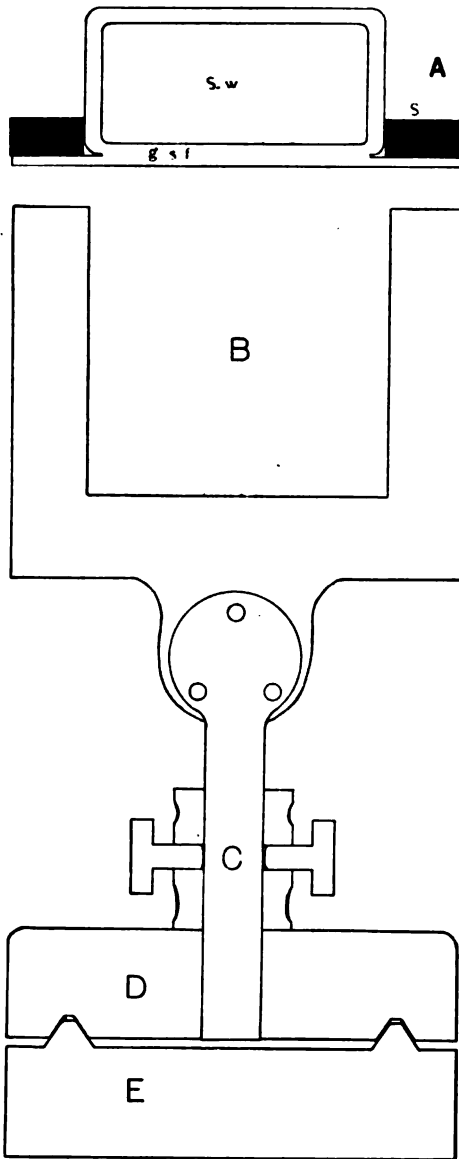

FIG. 134. FACE VIEW OF THE STAGE OF THE PROJECTION MICROSCOPE AND SECTIONAL VIEW OF THE STAGE WATER-CELL.

(About half size).

(From *The Microscope*, Ninth Edition, 1904).

A Sectional view of the stage with the stage water-cell.

S Metal part of the stage in section.

S.w. Stage water-cell.

gsf Glass front of the stage water-cell. The microscopic specimen rests directly upon the glass front, and heat from the specimen is conveyed away by conduction.

B Face view of the metal part of the stage of the projection microscope (fig. 121), and the optic bench. In this case the base (E) with V's is of cast iron as is also the block (D). Both were prepared on a lathe (Compare fig. 158, 159).

E End view of the guide piece with V's.

D Apparatus block.

C Post of the stage in the block socket. Two set screws hold the post in place. It is better to use but a single screw for this.

The stage proper has a very large opening, and the water-cell inserted in this opening permits of the demonstration of specimens up to 65 mm. in diameter.

specimens like those of the nervous system stained with Weigert's hematoxylin, or by the Golgi method absorb a great deal of the light

falling upon them, and hence, following the law of the conservation of energy, all this absorbed light is transformed into heat. The darker the specimen the more light is absorbed, and the quicker it will be spoiled by overheating. The stage water-cell against which the specimen rests conducts this heat away, in part, and makes it possible to exhibit the specimen a longer time (see § 852).

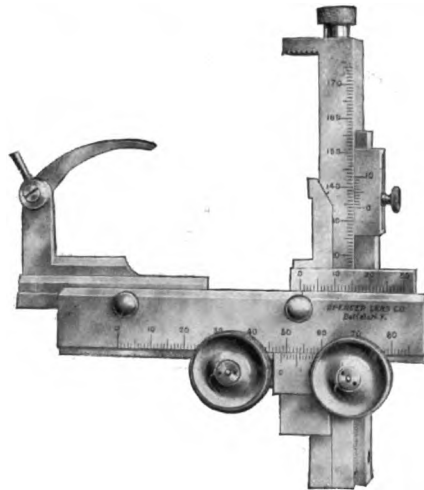

FIG. 135. MECHANICAL STAGE OF GREAT RANGE.
(Cut loaned by the Spencer Lens Co.)

This can be clamped to any rectangular microscope stage and as no part of the clamp extends above the stage the full range of 85 by 65 mm. is available and slides 50 x 75 mm. (2 x 3 inches) can be examined to the edges. This is of the greatest convenience in examining serial sections, and also in projecting them on the screen.

§ 368. **Microscope-tube, and focusing device.**—If a tube for receiving the objective is used it should be a large one, (fig. 121, 145). The small tubes used on most microscopes, and on all when using an ocular, cut down the field too greatly (fig. 137, 147). The tube should be short, that is, about 9 to 10 cm. (4 in.) long, and 4 to 5 cm. (2 in.) in diameter. There should be coarse and fine adjustments as for the ordinary microscope (fig. 121).

§ 369. **Mounting of objectives of low power.**—For the lowest powers (125 to 75 mm. equivalent focus) it is better to have no tube at all, but to have a black shield about 15 cm. (6 in.) in diam-

eter into the center of which is screwed the objective (fig. 138), then the field is not at all restricted. The low power objectives can be focused easily by moving their supports back and forth along the optical bench by hand (fig. 158-159).

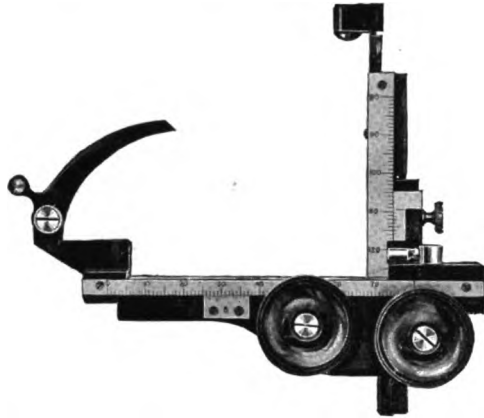

FIG. 136. MECHANICAL STAGE OF WIDE RANGE.
(Cut loaned by the Bausch & Lomb Optical Co.).

This mechanical stage can be attached to any microscope with square stage, and it permits the use of large slides. The right to left scale is 80 mm. and the front to back one 58 mm. The actual range available depends on the size of the stage of the microscope.

BLACKENED APPARATUS

§ 370. The light necessary for micro-projection is so dazzling that it should be kept strictly within the projection apparatus by means of a proper lamp-house and bellows, so that the only light which finally reaches the screen is that which passes through the projection objective. But this ideal condition cannot be wholly realized in practice, hence the necessity of making the outside of the entire apparatus, from lamp-house to microscope tube, dull black. Then any escaping light will not be reflected from polished surfaces and scatter light into the room, on the one hand, or blind the eyes of the operator and annoy the auditors on the other. Projection apparatus found in institutions, in many cases, have a finish of polished brass or nickel. If the operator cannot focus

properly and has ill success in general, there is no wonder, as he has blinding reflections constantly in his eyes. With a dull black finish for all outside surfaces, if the apparatus is properly built, this defect will be abolished. Polished black finish will not answer, for it reflects almost perfectly. The finish must be dull, dead, or lusterless, then the light will be mostly absorbed, and so small a part reflected that no inconvenience is produced.

§ 371. **Blackening the interior of projection apparatus.**—As with the exterior of projection apparatus, so the interior of all the parts should be dull black to avoid internal reflections and consequent confusion. This is especially true of the objective mountings, the tube of the microscope and the amplifier tube. Lewis

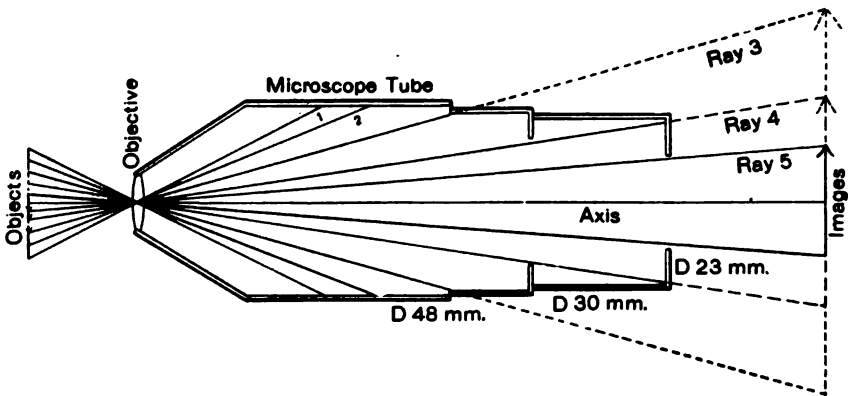

FIG. 137. DIAGRAM TO SHOW THE SIZE OF IMAGE WITH THE SAME OBJECTIVE AND DIFFERENT LENGTH AND DIAMETER OF MICROSCOPE TUBE.

Objects The different lengths of object shown.

Objective The projection objective.

Microscope Tube Microscope tubes with diameters of 48, 30 and 23 millimeters.

1, 2 Rays which are stopped by the largest tube.

Ray 3 The marginal ray allowed to pass by the largest (48 mm.) tube.

Ray 4 The extreme marginal ray allowed to pass by the 30 mm. tube.

Ray 5 The marginal ray allowed to pass the 23 mm. tube.

Axis The optic axis.

Images The one in full lines is for the smallest tube. The others in broken lines for the tubes of larger size.

By tracing back to the specimen it is seen that the larger tubes show correspondingly more of the object, the projection objective remaining the same.

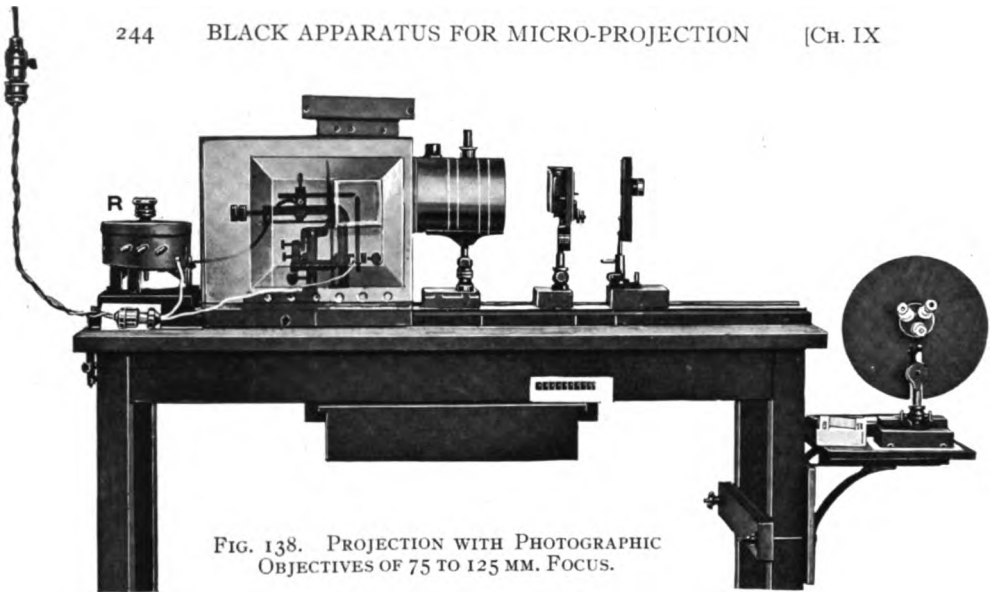

FIG. 138. PROJECTION WITH PHOTOGRAPHIC OBJECTIVES OF 75 TO 125 MM. FOCUS.

Commencing at the left:

The supply in this case is from the house circuit for a current of five amperes.

There is first a separable attachment plug in the lamp socket. On the table is a separable extension. This is to serve as a safe switch for turning the current on and off.

R Small rheostat for five ampere currents. It is in series, along one wire. In this case it is the positive wire, if direct current is used, and goes to the binding post of the upper or horizontal carbon.

The other wire extends between the binding post of the arc lamp and the separable extension.

The arc lamp with small carbons, in the metal lamp-house. The lamp-house appears transparent as it was in place during only a part of the exposure.

Following the lamp-house is the triple condenser and water-cell (fig. 122).

The stage with the stage water-cell and the mechanical stage of great range (fig. 121, 135).

Support for the photographic projection objective.

All the parts are supported by posts and blocks and all move independently on the baseboard with track. The vertical white lines on the baseboard indicate the proper relative positions of the different blocks.

At the extreme right is shown the adjustable drawing shelf attached to the legs of the table. On this shelf is the projection microscope with three objectives in the revolving nose-piece.

The shield behind the objectives is to prevent stray light from reaching the screen. Demonstration preparations are also shown in the slide box on the shelf.

The projection table with the drawer for holding apparatus is shown with the legs partly removed. The entire table drawn to scale is shown in fig. 182. In this picture the scale is shown by the 10 centimeter rule just above the drawer at the right.

Wright (p. 194) in speaking of the necessity of a dull finish in the interior of objectives says: "I may add here that some really good lenses [objectives] when used with brilliant light such as projection demands, give a "mist" over the image purely from flare, or reflection in the lens mount, and which is removed by careful blackening."

Finally, there may be a bright spot or "ghost" in the screen image from the internal reflections of a shiny microscope tube, especially if the tube is small. If an ocular is used this ghost usually disappears. It can also be avoided by having the interior of the microscope tube a dull black (§ 371a).

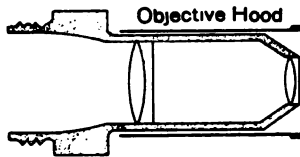

FIG. 139. PROJECTION OBJECTIVE WITH BLACK METAL HOOD.

§ 372. **Hoods for projection objectives.**—Usually the ends of objectives are tapering and finished in polished nickel, making them veritable mirrors. As the image of the source of light spreads more or less beyond the opening of the front lens upon this mirror surface the dazzling light is reflected into the face of the operator, and also more or less around the room. The operator is likely to be so blinded by the reflections that he cannot see to focus properly.

§ 371a. When necessary, a person can give polished surfaces a dull finish himself. A camel's hair artist's brush should be employed for the finer work. For the dull finish, dead-black japalac thinned somewhat with xylene (xylol of the Germans) toluene or turpentine answers well.

Dull black may be prepared by adding to thin shellac varnish plenty of good, dry lamp-black. After thorough shaking, this should be filtered through gauze to take out any coarse particles. If the shellac is too thick the resulting finish is more or less shiny, but if the proper mixture is used the surface will be very dull, but not so smooth as the japalac.

As the black surface wears off by use, the bright surfaces underneath are exposed, and occasionally one should go over the apparatus and reblacken all bright spots.

The light scattered in the room is liable also, if the room is finished in a light tint, to diminish the brilliancy of the screen image by lessening the contrast.

To avoid the troubles just considered, the objective should have a perforated hood over its front. The perforation should be of the diameter of the front lens. The free surface of the hood over the front of the objective should be perfectly flat, and should be finished in dull black (fig. 139-140). Such a hood is also of the greatest use in enabling one to center the light (§ 375, 372a).

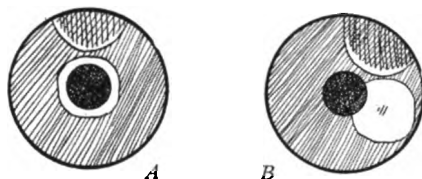

FIG. 140. END VIEW OF A HOODED OBJECTIVE SHOWING THE LIGHT CENTERED AND OFF CENTER.

In *A* the image of the crater is directly over the opening in the hood and therefore gives the greatest light for projection.

In *B* the crater image is at the right and only a small amount of light enters the objective.

In both *A* and *B* the negative or lower carbon is shown by cross lines. It is above owing to the inverting action of the condenser.

§ 373. Light shield beyond the objective.—There should be a flat or concave shield beyond the objective to prevent any stray light reaching the screen from the apparatus except what passes through the objective (see fig. 133, 138).

CENTERING THE PARTS OF THE PROJECTION MICROSCOPE ON ONE LONGITUDINAL AXIS

§ 374. For micro-projection it is absolutely necessary that all the parts or elements should be on one straight longitudinal axis like beads on a rod. With the large lenses used in magic lantern

§ 372a. If one does not have the metal-hooded objectives (fig. 139), ordinary, nickel-plated objectives can be greatly improved by painting the bright surfaces with dull black (§ 371a). The objectionable reflections can also be prevented by tying black velvet or blackened asbestos paper around the objectives.

objectives a slight variation from perfect alignment would do no particular harm, but the lenses are so small in micro-projection objectives that a very slight displacement from the axis would throw the light outside the objective and spoil the projection.

The fundamental principles and precise directions for centering projection apparatus are given in Ch. I. § 51-58.

§ 375. Final centering of the projection objective.—After the lamp and condenser are centered as nearly as possible and are at the right distance apart (§ 55, 56, 376), move the stage up toward the condenser so that there is plenty of room between it and the objective. Use some dust or smoke to find where the cone of light from the condenser comes to a focus (fig. 132, 323).

Now move the microscope on its mounting toward the condenser. If the objective is centered, then the point of light at the focus will enter the front lens through the hole in the objective hood (fig. 140). If it is not centered then it will appear at one side or even entirely outside the objective. Use the fine adjusting screws of the arc lamp and change the position of the image of the crater sufficiently to direct the cone of light into the front lens of the objective. In case the objective is greatly out of center it may be found necessary to change the position of the entire microscope.

§ 376. Distance of the objective from the condenser.—The objective should be at a distance which will bring the crossing point of the rays in the cone from the condenser within the objective, as for the magic lantern objective (fig. 122). As the center of the objective is but slightly beyond the front lens, the following method has been found to give excellent results. The objective is drawn up toward the condenser until the image of the crater is shown within the opening upon the black hood in front of the objective (fig. 140). As the image is inverted the lower or negative carbon will appear above in the image. If now the stage with a specimen is moved up toward the objective until the microscopic object on the stage is in focus, the image on the screen will be very brilliant.

One should make slight adjustments toward and away from the condenser to get the most brilliant image. It will be found that

the greatest brilliancy is when there is a slight yellowish tinge to the light. It will be pure white if one moves the stage and objective slightly nearer the condenser, but it will not be so brilliant. Guiding marks should be made on the apparatus at the best position for the different objectives used (fig. 133, 138).

§ 377. Table of Candle-Power and Current with Direct Current Arc and Right-Angled Carbons:

Size of Carbons	Amperes	Candle-Power
6 mm.	2	200
6 mm.	3	400
6 mm.	4	650
6 mm.	5	900
8 mm.	7.5	1,500
11 mm.	10	2,200
11 mm.	12.5	2,900
11 mm.	15	3,700
11 mm.	17.5	4,500
13 mm.	20	5,400
13 mm.	25	7,500
15 mm.	30	9,500

§ 378. **Increase in size of the crater with increase of amperage.**—As the size of the crater and hence its image increases with the increased amperage, the gain for actual micro-projection is not so great as would appear, for the larger crater image will be larger than the lenses of objectives of high power, hence, much light is wasted (fig. 141).

The heating is also much increased by the higher amperage. It has been found by experience with everything in the best possible condition that 12 amperes is sufficient for most micro-projection. A current above 20 amperes is a pure waste, as well as a source of danger to the specimens and apparatus by overheating. The light given by 10 amperes properly utilized yields far better results than that from 20 amperes only partly utilized. For the candle-power with different amperages see § 377.

USE OF THE PROJECTION MICROSCOPE

§ 379. **Objectives in a revolving nose-piece.**—For most projection a battery of three objectives would be sufficient. These should be: (1) a low power objective to show entire specimens (one of 40 to 50 mm. focus is good); (2) an intermediate objective of 16 to 18 mm. focus; and (3) a high power, that is, one of 10 to 4 mm. equivalent focus (§ 355).

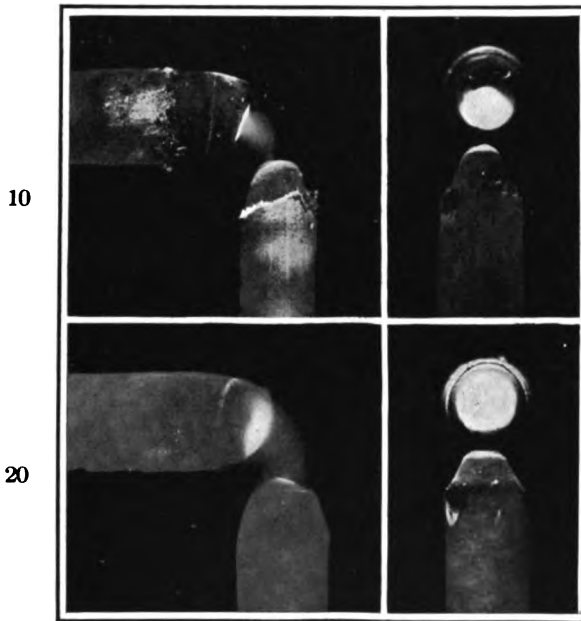

FIG. 141. SIDE AND FRONT VIEWS OF THE CRATER AND CARBONS BURNING WITH 10 AND WITH 20 AMPERES OF DIRECT CURRENT (Natural size).

This picture is to show the increase in size of the crater with the larger current. (See also fig. 292-293).

(In making the photographs, the lamp was burning with the amperage indicated, and an instantaneous exposure was made with a diaphragm of F/32. The current was then turned off and the carbons exposed 90 seconds with a diaphragm of F/8. This brought out the carbons, and gives the appearance gained by the eye when suitably screened and looking at the burning lamp.)

The three objectives selected should be in a revolving nose-piece (fig. 142) so that one can pass quickly from one power to another. The lecturer and operator must always keep in mind that for an audience giving their entire attention, a delay of even a quarter of a minute seems a very long time, hence every precaution should be taken to avoid delays.

§ 380. **Preparation of the carbons for an exhibition.**—The carbons supplied for projection are soft-cored, and sharpened somewhat like a lead pencil. This end form is unlike that assumed

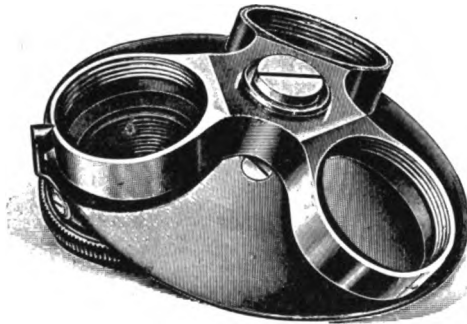

FIG. 142. TRIPLE NOSE-PIECE OR REVOLVER FOR QUICKLY CHANGING OBJECTIVES.

(From the Catalogue of Viogtländer und Sohn).

in the actual use of the carbons (fig. 141), and until the carbons have burned for some time, one will not get the best light from them. Hence it is wise to get the carbons formed by burning them in the lamp for five minutes or so before using them for a lecture or an exhibition.

Soft-cored carbons are a necessity for micro-projection, for the crater remains more uniform and it does not wander around the end of the carbons and thus get out of line of the general axis so frequently as would be the case with solid carbons (§ 380a).

§ 380a. **Cored and solid carbons.**—Some workers with the projection microscope use a large, cored carbon above (i. e., for the positive) and a solid carbon for the negative one. For example, in a projection outfit from Zeiss the upper carbon was 19 mm. in diameter and soft-cored. The lower or nega-

§ 381. **Screen image of the carbons.**—One of the good ways of learning to get the carbons in the correct relative position is to study their image on the screen. For this use an objective of 50 or 100 mm. focus. By moving the objective somewhat beyond the focus of the condenser an image of the burning carbons will be projected on the screen and one can tell the exact appearance of the crater and the relative position of the carbons. The glowing upper carbon ought to show the crater well and appear to face directly toward the observer. As this is an image of the real image of the carbons formed by the condenser the screen image will appear right side up. If the negative or lower carbon is not in the correct position it will shade the image (see fig. 24, 25).

§ 382. **Centering the light and getting the objective at the correct distance from the condenser for an exhibition.**—In using any of the objectives on the revolving nose-piece it is always to be kept in mind that the centering is most easily accomplished by drawing the objective toward the condenser until the image of the crater and the tip of the negative carbon appear in the opening and upon the objective hood (fig. 140).

Now if this image is not so that the brightest part is over the opening in the objective hood, use the fine adjustment of the arc lamp and get the image of the crater directly in the opening. The screen image will then be evenly and brilliantly lighted. In case one side is more brilliantly illuminated than the other, one can make the illumination even by the fine adjustments of the arc lamp (fig. 3, 146).

One can sometimes improve the illumination slightly by looking at the screen image and moving the microscope slightly nearer or farther from the condenser, but as a rule, when the image of the

tive carbon was 13 mm. in diameter and solid. In Ewon's lamp the upper or positive carbon is cored and 18 mm. in diameter; the lower carbon is 12 mm. in diameter and solid.

Experience leads us to recommend cored carbons below as well as above. For the size of carbons for different amperages see § 377, 753a.

For alternating current both carbons are of the same size, and most workers recommend that they be cored.

crater and the negative carbon are most sharply defined on the objective hood the light on the screen will be the best attainable.

Occasionally, during an exhibition, it will be necessary to use the fine adjustments on the arc lamp (fig. 146) to get the crater back in exact alignment as the crater changes position slightly on the wearing away of the carbons. As the carbons sometimes wear away unevenly it is necessary to have a mechanism by which one carbon can be moved without affecting the other, otherwise there would result some one of the malpositions shown in fig. 24, 25.

§ 383. Specimens for projection.—The specimens giving the best images with the projection microscope are those which are best for ordinary observation, that is those with the most definite outlines and sharpest details. They must, of course, be more or less transparent. For staining, any color which gives definite details can be used, but one must remember that the red colors are transparent to the longer, visible waves of light and hence red-colored objects can remain on exhibition much longer than hematoxylin, osmic acid or other dark stained objects which are more opaque to the long waves in the red end of the spectrum (fig. 307).

No matter how large the water-cell or the cooling stage, a thick, darkly stained specimen will be spoiled after a time by the transformation of the absorbed light into heat (§ 852).

§ 384. Masks for microscopic slides.—The light used in projection is of necessity so brilliant that the scattered light from the microscopic glass slide is very liable to dazzle the eyes of the operator when he looks at the slide in arranging it for the projection of the object or objects thereon. If one has a series for example, it is very difficult to select with ease and certainty just the sections that are to be shown with this scattered light in the eyes. It must always be remembered, too, that a very short time seems long to a waiting audience; and that it lessens their confidence in the lecturer to have too much blundering in showing the specimens he wishes them to see.

All this difficulty can be easily avoided by properly masking the preparations to be shown (fig. 143, 148).

§ 385. **Kind and color of paper for the masks.**—The best paper to use is one that allows only a moderate amount of light to pass, and that cuts out the green-blue end of the spectrum.

The color found best for this is an aqueous solution of the microscopic stain known as "Orange G." For the quality of paper, a white linen bond paper of moderate weight is used. It is stained by soaking it a few minutes (10–30) in a saturated aqueous solution of the "Orange G." It is then hung up to dry.

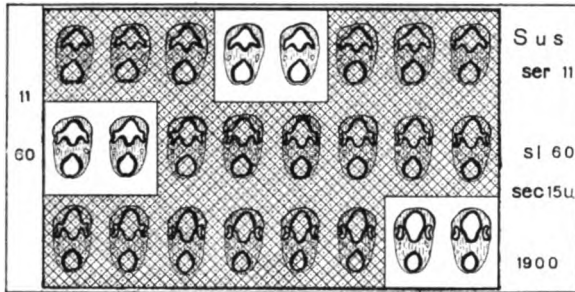

FIG. 143. SLIDE OF SERIAL SECTIONS WITH MASK.

The sections to be demonstrated are left uncovered.

Sus (*Sus scrofa*, the pig).

Ser. 11 This shows that the slide is from the 11th series of pig embryos.

sl 60. The 60th slide of series 11.

Sec 15 μ This indicates that the sections of this embryo were cut 15 microns (.015 mm., .00058 in.) thick.

1900 The year in which the series was prepared.

11 60 At the left; series 11, slide 60.

Paper thus colored allows a moderate amount of light to pass, and allows practically all of the long waves of red and infra-red to pass, so that it will not burn very quickly in the focus of the condenser. If black paper were used it would burn almost instantly in the focus. Of the many yellows and oranges tried for masks the "Orange G" proved most satisfactory.

§ 386. **How to employ the masks.**—The paper is cut of the right size for the slide and then square or round holes are made in it to give a clear field for the different objects to be shown on the slide, then it is pasted on the *cover-glass* (fig. 143). It is put on

the cover-glass and not on the slide for the reason that if it were put on the slide it would almost entirely overcome the good effect of the stage cooling cell, as it would hold the slide away from the glass surface, so that the heat could not be carried off by conduction. If it is on the cover-glass, the slide can then rest directly against the stage water-cell.

If one ever wishes to remove the mask it is easily done by putting a piece of wet blotting paper upon it till thoroughly softened. It can then be peeled off, and the cover-glass cleaned with a wet cloth.

§ 387. **Field of view in the screen image.**—Except with objectives corrected in the manner of photographic objectives the screen image will not be equally sharp over the entire field where the large tube and where no tube is used (fig. 138, 145). To obviate this, oculars may be used, or iris diaphragms to cut off the outer margin which is not sharp. This margin also shows color from the chromatic aberration of the condenser. But demonstrations in histology and embryology, at least, depend largely in their effectiveness upon the *relations of parts shown in a large field*. The part to be shown with greatest distinctness is brought into the middle of the field as with ordinary microscopic observation.

The importance of a large field in which the relation of parts can be shown, can be illustrated by a simple experiment. For example, let a well known friend cover his face with a mask having only eye-holes, or with a hole to show a part of the cheek or forehead. It would be hard to recognize him from that limited view alone.

§ 388. **Objectives needed for different sizes of field.**—In fig. 144 there is given a graphic representation of different sizes of field or object which one might wish to project, and the objective or objectives with which it can be done. It will be seen that the larger the field the longer must be the focus of the projection objective. In this figure it is assumed that no ocular is used and that the field is not restricted by the tube of the microscope, hence for the largest fields the objective must be mounted in a shield without tube (fig. 138). In fig. 137 is shown how the field may be cut down by using microscope tubes of different diameter. See also the table of magnification and field (§ 391).

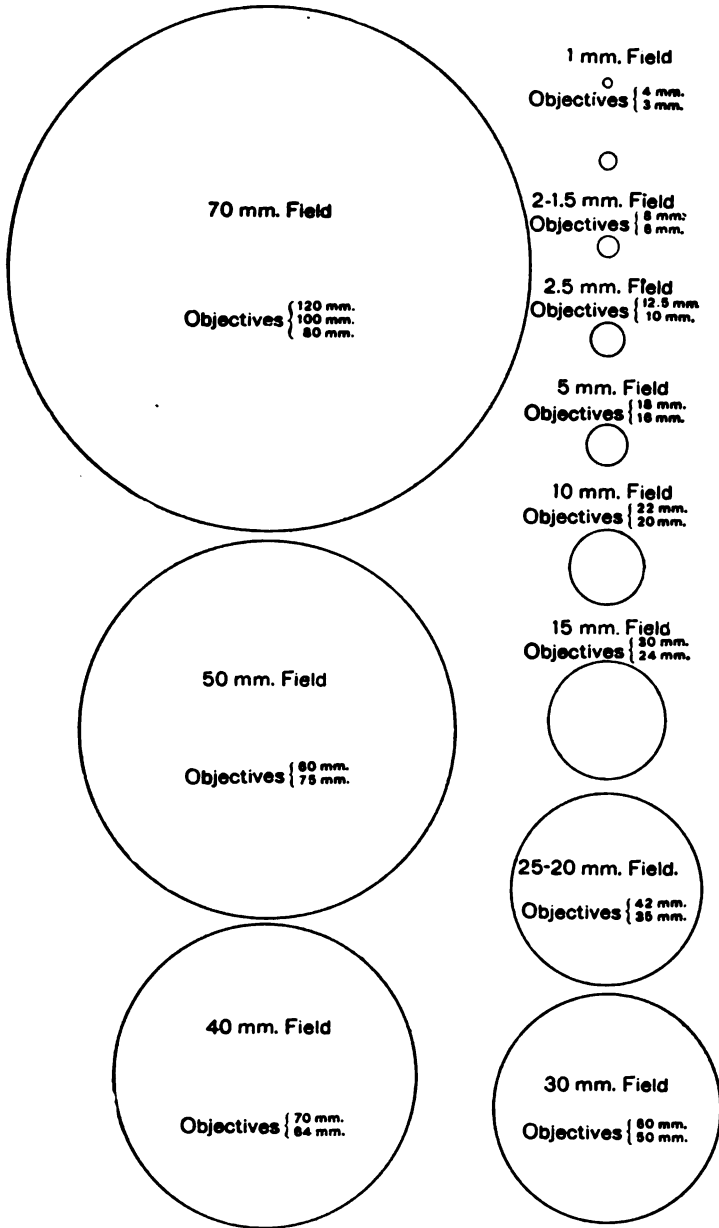

FIG. 144. SIZES OF FIELD AND OBJECTIVES NECESSARY TO PROJECT OBJECTS OF THESE SIZES.

§ 389. **Sharpness of the screen image.**—It is a mistake to think that it is necessary that the screen image should be photographically sharp. As well said by Lewis Wright, p. 191: "A certain breadth or coarseness of line is a positive advantage in the image to be viewed many feet [meters] away." Of course, the image should be focused as sharply as possible, but a line or structure that appears perfectly distinct at a considerable distance may appear indistinct when the observer is close to the screen. If the operator is at a considerable distance (15 to 20 meters, 50 to 65 ft.) from the screen, he will find good opera-glasses a help in getting the screen images properly focused.

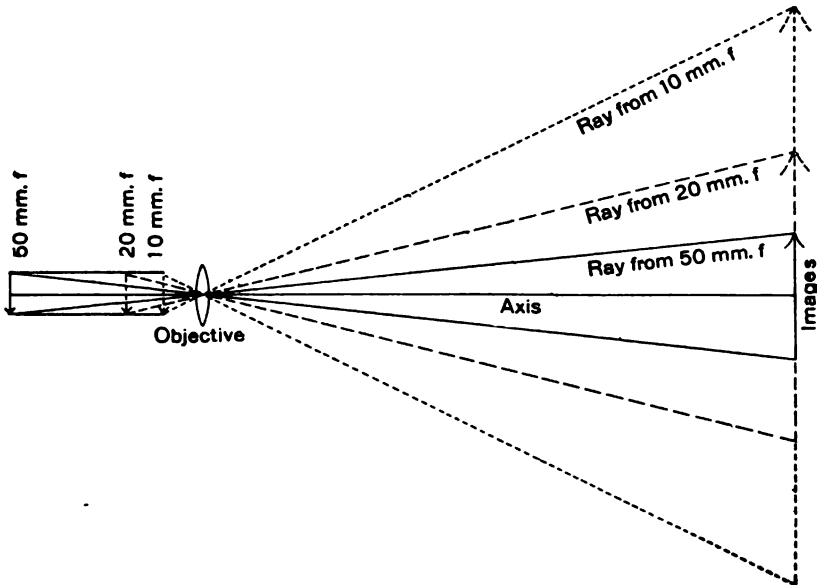

FIG. 144a. DIAGRAM TO SHOW THE POSITIONS OF THE SAME OBJECT AND THE SIZE OF THE SCREEN IMAGE FOR OBJECTIVES OF 50, 20 AND 10 MM. FOCUS.

In this figure it is assumed that the object in each case is practically at the principal focal distance from the objective and that the screen distance is the same for all. As the size of the image varies inversely with the distance of the object from the objective it is seen that the screen must be larger for an objective of short than for one of long focus in accordance with the general law of the relative size of the object and image (§ 392a).

Any one can get a pretty correct idea of the screen image and the details visible at different distances by putting the first page of a newspaper up in a well lighted place and then moving back from it. Close up, the ordinary print can be read, farther away the ordinary headlines, and still farther the title of the newspaper or some gigantic headline. Meantime the ordinary print and the ordinary headlines have merged into a gray haze.

§ 390. **Position of the object on the stage.**—For many microscopic specimens it makes no difference how the specimen is placed upon the stage, except that for high powers the cover-glass must be next the objective. If a specimen must have a given part, end or border at the top in the screen image, then with an objective only or an objective and an amplifier, the object must be put on the stage so that the part is down which is to appear at the top in the screen image. With an objective and ocular the object should be placed on the stage as the image is to appear on the screen. For getting the screen image exactly like the object see § 36, 512.

§ 391. **Magnification and Screen Image of Various Objectives as Found by Actual Measurement** (see § 391a).

Objective	Field of Objective	5 M. (16 ft.) Screen Distance		7.5 M. (25 ft.) Screen Distance		10 M. (33 ft.) Screen Distance	
		Magnification	Screen Image of Field	Magnification	Screen Image of Field	Magnification	Screen Image of Field
NO TUBE (Fig. 138)							
125 mm.	55 mm.	39	2.25 M.	61	3.56 M.	80.6	4.50 M.
100 "	50 "	48	2.70 "	74	3.16 "	98.4	4.20 "
70 "	50 "	72	3.50 "	107	5.10 "	143	7.10 "
60 "	42 "	85	3.15 "	123	3.70 "	168	5.20 "
50 "	38 "	101	3.30 "	147	4.50 "	202	6.10 "
35 "	26 "	142	3.50 "	210	5.10 "	285	7.60 "
30 "	20 "	167	3.30 "	250	4.90 "	330	6.70 "
20 "	11 "	253	2.85 "	370	4.20 "	495	5.40 "

LARGE TUBE (Fig. 121)

Objective	Field of Objective	5 M. (16 ft.) Screen Distance		7.5 M. (25 ft.) Screen distance		10 M. (33 ft.) Screen Distance	
		Magni- fication	Screen Image of Field	Magni- fication	Screen Image of Field	Magni- fication	Screen Image of Field
No TUBE (Fig. 138)							
70 mm.	31 mm.	72	1.85 M.	107	3.34 M.	143	4.26 M.
60 "	25 "	85	2.10 "	127	3.00 "	168	4.10 "
50 "	22 "	101	2.30 "	155	3.50 "	205	4.50 "
35 "	14 "	142	2.35 "	218	3.00 "	285	4.45 "
30 "	12 "	167	2.00 "	250	3.35 "	330	4.10 "
20 "	8 "	253	2.10 "	380	3.00 "	500	4.10 "
16 "	5.75 "	322	1.75 "	488	2.85 "	650	3.73 "
12.5 "	4.5 "	385	1.80 "	590	2.65 "	750	3.38 "
10 "	3.7 "	454	1.75 "	700	2.59 "	900	3.33 "
8 "	2.5 "	640	1.80 "	940	2.35 "	1280	3.20 "
6 "	2.18 "	760	1.80 "	1120	2.44 "	1460	3.18 "
4 "	1.42 "	1080	1.70 "	1600	2.27 "	2180	3.10 "
2 "	0.42 "	2600	1.10 "	3820	1.70 "	5080	2.00 "

MAGNIFICATION AND SCREEN IMAGE OF VARIOUS OBJECTIVES AS FOUND BY ACTUAL MEASUREMENT.

First is given the magnification of the objective only, using the large tube of the microscope (fig. 121); then are given the magnification, etc., with amplifiers (fig. 126) and with oculars. With the latter the draw-tube is in place (fig. 147, 172, § 391a).

Objective	Amplifier	Ocular	Micro- scope Field	5 M. (16 ft.) Screen Distance		7.5 M. (25 ft.) Screen Distance		10 M. (33 ft.) Screen Distance	
				Magni- fication	Screen Image of Field	Magni- fication	Screen Image of Field	Magni- fication	Screen Image of Field
16 mm.			5.75 mm.	322	1.75 M.	488	2.85 M.	650	3.78 M.
" "	- 5d		4.2 "	550	2.30 "	820	3.56 "	1100	4.85 "
" "	-10d		4.2 "	800	3.20 "	1160	5.00 "	1650	6.89 "
" "		Proj. x2	1.45 "	640	.95 "	950	1.40 "	1320	1.91 "
" "		" x4	1.32 "	1170	1.70 "	1900	2.65 "	2610	3.50 "
" "		Comp. x2	2.35 "	650	1.55 "	1000	2.35 "	1350	3.10 "
" "		" x4	1.60 "	1320	2.35 "	2000	3.40 "	2880	4.60 "
" "		Huyg. x4	1.60 "	1310	2.25 "	2250	3.35 "	2700	4.45 "
12.5 mm.			4.5 mm.	385	1.80 M.	590	2.67 M.	750	3.40 M.
" "	- 5d		3.5 "	650	2.30 "	990	3.60 "	1280	4.85 "
" "	-10d		3.5 "	910	3.30 "	1430	5.20 "	1900	6.50 "
" "		Proj. x2	1.25 "	730	.95 "	1075	1.35 "	1450	1.86 "
" "		" x4	1.25 "	1300	.70 "	2000	2.45 "	2700	3.30 "
" "		Comp. x2	2.00 "	750	.50 "	1150	2.30 "	1550	3.05 "
" "		" x4	1.50 "	1520	2.35 "	2350	3.50 "	3200	4.75 "
" "		Huyg. x4	1.40 "	1520	2.25 "	2350	3.37 "	3150	4.45 "

Objective	Amplifier	Ocular	Microscope Field	5 M. (16 ft.) Screen Distance		7.5 M. (25 ft.) Screen Distance		10 M. (33 ft.) Screen Distance			
				Magnification	Screen Image of Field	Magnification	Screen Image of Field	Magnification	Screen Image of Field		
10 mm.	- 5d -10d	Proj. x2 " x4 Comp. x2 " x4 Huyg. x4	3.70 mm.	454	1.75 M.	700	2.52 M.	900	3.65 M.		
" "			2.70 "	766	2.20 "	1115	3.40 "	1540	4.70 "		
" "			2.70 "	1100	3.20 "	1630	4.50 "	2225	6.50 "		
" "			1.05 "	870	.95 "	1300	1.40 "	1750	1.90 "		
" "			1.05 "	1600	1.70 "	2330	2.40 "	3100	3.30 "		
" "			1.70 "	870	1.50 "	1330	2.25 "	1780	3.05 "		
" "			1.25 "	1820	2.35 "	2720	3.50 "	3680	4.70 "		
" "			1.25 "	1800	2.25 "	2700	3.30 "	3680	4.55 "		
8 mm.			- 5d -10d	Proj. x2 " x4 Comp. x2 " x4 Huyg. x4	2.5 mm.	640	1.80 M.	940	2.55 M.	1280	3.31 M.
" "					1.80 "	1120	2.30 "	1650	3.24 "	2250	4.36 "
" "	1.80 "	1600			3.20 "	2430	4.35 "	3250	6.00 "		
" "	0.7 "	1280			.90 "	1960	1.40 "	2610	1.89 "		
" "	0.7 "	2360			1.70 "	3521	2.35 "	4820	3.35 "		
" "	1.10 "	1380			1.50 "	2030	2.25 "	2770	3.18 "		
" "	0.82 "	2750			2.30 "	4120	3.60 "	5560	4.90 "		
" "	0.78 "	2750			2.25 "	4050	3.35 "	5560	4.50 "		
6 mm.	- 5d -10d	Proj. x2 " x4 Comp. x2 " x4 Huyg. x4			2.18 mm.	760	1.80 M.	1120	2.50 M.	1460	3.50 M.
" "					1.7 "	1270	2.25 "	1950	3.30 "	2570	4.50 "
" "			1.7 "	1850	3.25 "	2760	4.95 "	3700	6.50 "		
" "			0.60 "	1500	.95 "	2250	1.41 "	3100	1.91 "		
" "			0.60 "	2720	1.65 "	4200	2.55 "	5700	3.37 "		
" "			0.93 "	1550	1.50 "	2400	2.30 "	3200	3.05 "		
" "			0.70 "	3120	2.35 "	4800	3.55 "	6500	4.75 "		
" "			0.67 "	3100	2.25 "	4700	3.37 "	6500	4.50 "		
4 mm.			- 5d -10d	Proj. x2 " x4 Comp. x2 " x4 Huyg. x4	1.42 mm.	1080	1.70 M.	1600	2.40 M.	2180	3.10 M.
" "					1.05 "	1910	2.30 "	2720	3.20 "	3800	4.30 "
" "	1.05 "	2750			3.25 "	4160	4.50 "	5650	6.50 "		
" "	0.40 "	2250			.92 "	3460	1.40 "	4500	1.90 "		
" "	0.40 "	4120			1.65 "	6800	2.75 "	9000	3.60 "		
" "	0.62 "	2350			1.50 "	3500	2.28 "	4830	3.10 "		
" "	0.47 "	4820			2.37 "	7200	3.60 "	9800	4.80 "		
" "	0.45 "	4770			2.25 "	7100	3.37 "	9820	4.50 "		
2 mm.	- 5d -10d	Proj. x2 " x4 Comp. x2 " x4 Huyg. x4			0.42 mm.	2600	1.10 M.	3820	1.70 M.	5080	2.00 M.
" "					0.42 "	4440	1.95 "	6560	2.85 "	8900	3.65 "
" "			0.42 "	7220	2.60 "	9480	4.50 "	12550	7.00 "		
" "			0.185 "	4940	0.93 "	7400	1.40 "	10500	2.37 "		
" "			0.18 "	9160	1.67 "	13800	2.50 "	18750	3.70 "		
" "			0.28 "	5120	1.50 "	6666	2.28 "	10600	3.00 "		
" "			0.215 "	10500	2.20 "	16150	3.35 "	21250	5.00 "		
" "			0.20 "	10750	2.20 "	15500	3.45 "	21000	5.10 "		

Objective	Amplifier	Ocular	Microscope Field	2.5 M. (8 ft.) Screen Distance	
				Magnification	Screen Image of Field
2 mm.			0.42 mm.	1300	0.56 M.
" "	- 5d		0.42 "	2130	0.97 "
" "	-10d		0.42 "	3080	1.38 "
" "		Proj. x2	0.185 "	2350	0.44 "
" "		" x4	0.18 "	4400	0.78 "
" "		Comp. x2	0.28 "	2440	0.71 "
" "		" x4	0.215 "	5000	1.10 "
" "		Huyg. x4	0.20 "	4960	1.10 "

§ 391a. In preparing this table the apparatus shown in fig. 121, 138 was used. The second element of the condenser giving the cone of light, had a focus of 30.3 cm. (8 in.), and the stage was moved up in the light cone (fig. 132) to give the largest and brightest field possible for the given objective. No sub-stage condenser was used except for the 2 mm. oil immersion.

A stage micrometer in millimeters, tenths and one-hundredths was used as object. The screen image of one or more of the micrometer divisions was measured with a metric rule and the magnification obtained by dividing the size of the image by the known size of the object. For example: if the micrometer is in one-tenth millimeters (0.1 mm.) and the screen image of two spaces (0.2 mm.) measures 20 centimeters or 200 mm. the magnification of the screen image must be 200 divided by 0.2 = 1000. That is, the image is one thousand times the size of the object, therefore, the magnification of the projection apparatus in that case is 1000. The size of the field of the projection apparatus is found by the use of the micrometer as follows: The micrometer is arranged on the stage so that the image shows one of the lines on one edge of the field (the circle of light). Then one simply counts the spaces to the other edge of the field. For example, suppose that it requires 14 of the 0.1 mm. spaces, then the size of the field is 1.4 mm. and an object larger than this cannot be projected entire with this objective.

To get the size of the screen image of this field a tape measure or meter stick is used and the diameter of the circle of light on the screen is measured.

This method of finding the size of the field of the projection apparatus, the magnification and the size of the screen image, depends upon direct observation and is applicable to any projection outfit whether an objective only or an objective and an amplifier or an objective and an ocular are used (see also § 392a). The amplifiers used had a free opening of 36 mm. ($1\frac{1}{8}$ in.), and were placed at the end of the large tube (fig. 133) at a distance of about 11 cm. ($4\frac{1}{4}$ in.) from the objective.

§ 392. Magnification and Screen Image of Various Objectives as Found by Calculation (see § 392a).

Objective	Field of Objective	5 M. (16 ft.) Screen Distance		7.5 M. (25 ft.) Screen Distance		10 M. (33 ft.) Screen Distance	
		Magnification	Screen Image of Field	Magnification	Screen Image of Field	Magnification	Screen Image of Field
No TUBE (Fig. 138)							
125 mm.	90 mm.	40.0	3.60 M.	60	5.40 M.	80	7.20 M.
	55 "		2.20 "		3.30 "		4.40 "
100 "	75 "	50.0	3.75 "	75	5.62 "	100	7.50 "
	50 "		2.50 "		3.75 "		5.00 "
70 "	50 "	71.5	3.57 "	107	5.35 "	138	6.90 "
60 "	42 "	83.4	3.50 "	125	5.25 "	166	7.00 "
50 "	38 "	100.0	3.80 "	150	5.70 "	200	7.60 "
35 "	26 "	143.0	3.72 "	214	5.56 "	286	7.43 "
30 "	20 "	166.6	3.34 "	250	5.00 "	333	6.66 "
20 "	11 "	250.0	2.75 "	375	4.13 "	500	5.50 "
LARGE TUBE (Fig. 121)							
70 mm.	31 mm.	71.5	2.22 M.	107	3.34 M.	138	4.27 M.
60 "	25 "	83.4	2.08 "	125	3.12 "	166	4.16 "
50 "	22 "	100.0	2.20 "	150	3.30 "	200	4.40 "
25 "	14 "	143.0	2.00 "	214	3.00 "	286	4.00 "
30 "	12 "	166.6	2.00 "	250	3.00 "	333	4.00 "
25 "	8 "	250.0	2.00 "	375	3.00 "	500	4.00 "
16 "	5.75 "	312.5	1.79 "	468	2.69 "	625	3.59 "
12.5 "	4.50 "	400.0	1.80 "	600	2.70 "	800	3.60 "
10 "	3.70 "	500.0	1.85 "	750	2.78 "	1000	3.70 "
8 "	2.50 "	625.0	1.56 "	937	2.34 "	1250	3.12 "
6 "	2.18 "	833.3	1.82 "	1250	2.72 "	1666	3.63 "
4 "	1.42 "	1250.0	1.77 "	1875	2.66 "	2500	3.55 "
2 "	0.42 "	2500.0	1.05 "	3750	1.57 "	5000	2.69 "

§ 392a. This table was derived by calculation from the optical law that: *The size of the image is to the size of the object as the distance of the image is to the distance of the object from the center of the projecting lens or objective (fig. 209).* In each case the objective's principal focus is marked upon it by the maker, and the distance of the screen from the objective is known. Referring to the diagram (fig. 121) it is seen that the focus of the objective represents approximately the distance of the object from the center of the objective when the screen distance is relatively great. The focus of the objective and the screen distance being known their ratio is easily found. For example, with the 20 mm. objective and a 5 meter screen distance, the object will be 20 mm. from the center of the objective (fig. 209) and the screen image is 5 meters (5000 mm.) distant, then the ratio is 250 to 1 (5000/20) and it follows from the optical law given above, that the magnification in this case is 250.

The field in each case was determined by the use of a stage micrometer as with § 391a. From fig. 209 it is evident that the screen image of the entire

MICRO-PROJECTION WITH AN ORDINARY MICROSCOPE

§ 393. **Magic lantern with optical bench and ordinary microscope.**—If one has a magic lantern with an optical bench, the bellows and lantern-slide objective may be removed and an ordinary microscope put in place. The microscope is made horizontal and firmly clamped to a suitable block (fig. 145, 187). This block should be furnished with cleats or grooved so that it will slide on the rods or guides of the magic lantern, and be of sufficient height to put the objective and tube of the microscope in the optic axis. The mirror and the substage condenser may be removed or turned aside and the object lighted by the cone directly from the large condenser as in fig. 145 or the condenser and ocular may be left in place (fig. 187).

field is magnified, hence to get the size of the screen image, the size of the field is multiplied by the magnification of the apparatus in any given case. In the case of the 20 mm. objective the entire field measures 8 mm., hence its screen image, with a magnification of 250, should be $8 \times 250 = 2000$ mm. or 2 M.

If one compares the tables obtained by actual measurement and that obtained by calculation it will be seen that they do not exactly agree. This is due to two things: first, the rated focus of the objective is only an approximation, and second, the measurement of the diameter of the screen image is not very exact from the difficulty of deciding just where to begin and where to leave off in measuring to get the magnification and for determining the size of the field or the screen image of the field.

The table of calculated values is only for the objective without the use of amplifiers or oculars.

If one knows the magnification of the objective for a given screen distance the magnification obtained when using an amplifier or an ocular with the objective may be obtained approximately as follows:

For —5d amplifier multiply the magnification of the objective only, by	1.70
For —10d amplifier multiply the magnification by	2.50
For x2 projection ocular multiply the magnification by	2.00
For x4 projection ocular multiply the magnification by	3.70
For x2 compensation ocular multiply the magnification by	2.05
For x4 compensation ocular multiply the magnification by	4.20
For x4 Huygenian ocular multiply the magnification by	4.20

As the field of the projection apparatus is cut down by the use of an amplifier or an ocular one must determine the size of the field by the use of a micrometer as with the objective alone. The screen image can then be calculated by multiplying the observed size of the field by the magnification of the combined objective and ocular or amplifier. It will be seen that the objective with an ocular x2 or x4 does not give a magnification exactly twice or four times as great as the objective alone. The oculars are rated for the ordinary distance of distinct vision (254 mm., 10 in.) and the relation does not hold strictly for the much greater screen distances (§ 357a).

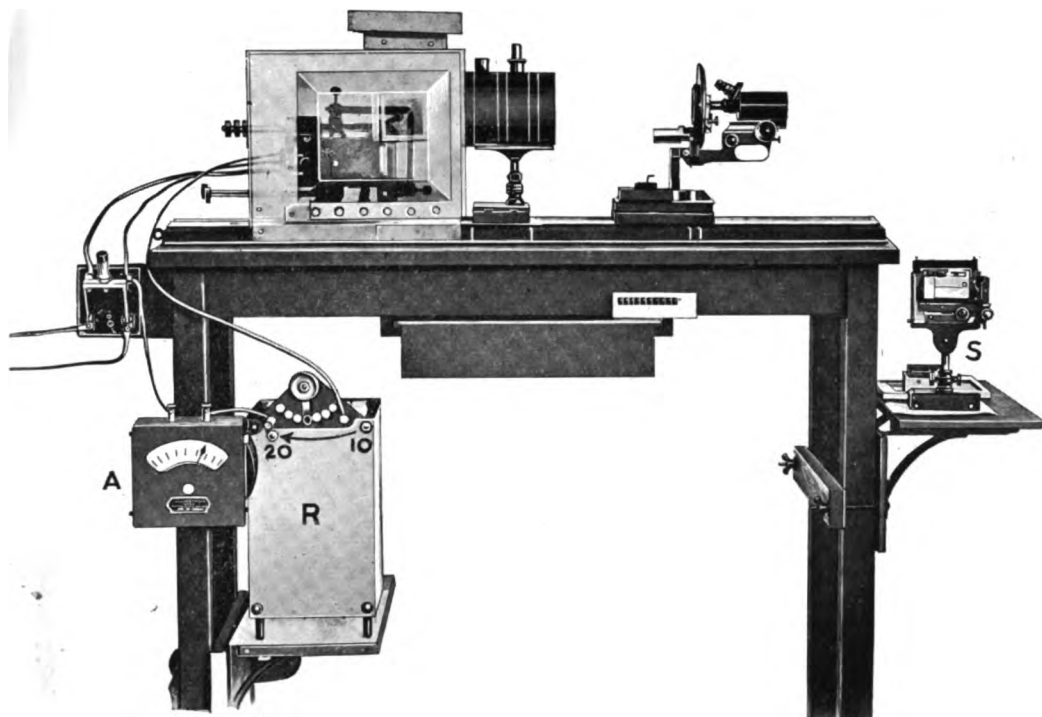

FIG. 145. ORDINARY MICROSCOPE FOR PROJECTION.

This figure is to show how an ordinary microscope can be used for projection if one has an arc lamp and condenser.

Commencing at the left:

The supply wires coming to the table switch.

From the negative pole of the switch one wire proceeds to the negative binding post of the arc lamp, i. e., to the one for the lower carbon.

From the positive pole of the switch extend two wires for the automatic lamp of the Bausch & Lomb Optical Co. One wire goes to the binding post of the automatic mechanism (the middle post). This means that the automatic mechanism receives current which does not go through the rheostat. The other wire from the positive pole of the switch goes to the ammeter (*A*), and from the ammeter to the rheostat (*R*), and from the rheostat to the positive binding post for the arc lamp, i. e., for the upper carbon.

The arc lamp is shown through the metal lamp-house. The lamp-house appears transparent as it was left in position during only a part of the exposure.

Following the lamp-house is the triple condenser and water-cell.

The microscope is bent over in a horizontal position to bring the axis of the objective in line.

The microscope is clamped to a block which raises it to the right level.

As here shown the substage condenser and mirror have been removed, and also the draw-tube and ocular (see fig. 147, 192 for the ordinary microscope with substage condenser, draw-tube and ocular in position).

The lamp, condenser and microscope are on independent blocks and can be moved to any desired position on the baseboard.

A The ammeter to indicate the amount of current.

R Adjustable rheostat. This rheostat is adjustable between 10 and 20 amperes. The arrow indicates the direction of increase in current.

S Adjustable drawing shelf attached to the front legs of the table. In this picture the shelf supports the stage of the projection microscope (fig. 121), and a box of demonstration specimens.

The scale of the picture is indicated by the 10 cm. rule just above the table drawer at the right.

If the tube of the microscope is large it is an advantage, but with the small tube one can do much. If the ocular is not to be used, then it is better to remove the draw-tube so that only the main tube remains. One should be sure that the interior of the tube is dull black (§ 370).

§ 394. Magic lantern with rods, and an ordinary microscope.—

If the magic lantern has the simple construction with rods and feet (fig. 32, 33, 36) an ordinary microscope can be used with it as follows: Remove the rods, bellows and projection objective, and support the arc lamp and the condenser on a block which will lift them high enough so that the microscope in a horizontal position will be in the optic axis. Place all on a baseboard with guides (fig. 146). Clamp the microscope to a suitable block with grooves or cleats to enable one to move the block accurately along the guides. When properly centered this form of apparatus works well.

§ 394a. For a water-cell one of the plane-sided glass boxes found on the market can be used, or a cell can be prepared in the laboratory as follows: Select some good plane and clear glass. For the ends of the box make two strips about 2½ cm. (1 in.) wide and about 10 cm. (4 in.) long. For the sides use two sheets about 10 cm. (4 in.) wide and 11 cm. (4½ in.) long; and for the bottom a rather thick sheet or strip about 11 cm. (4½ in.) long and 3 cm. (1¼ in.) wide. The pieces of glass are then put together by placing the bottom on a level table and the other pieces in position and held in place by a string or by narrow strips of gummed paper.

The joints are then gone over carefully with an artist's brush dipped in Ripolin white paint or Valspar varnish. Each coat should be allowed to dry thoroughly before adding the next, that is, for two to five days. Finally one can add water to see if the joints are all tight. If not, dry the glass box and then add more of the Ripolin paint or Valspar varnish.

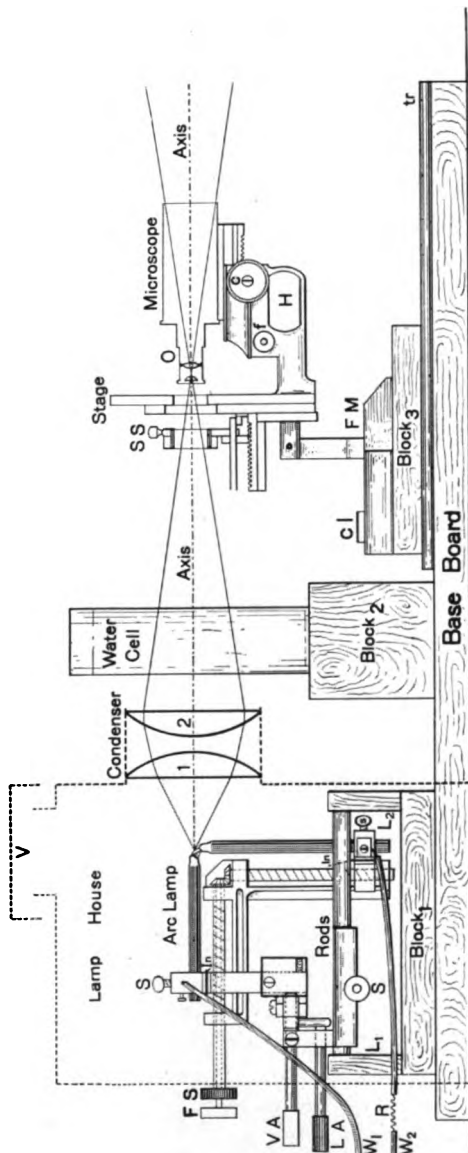

FIG. 146. USE OF THE SIMPLE MAGIC LANTERN CONDENSER AND LAMP AND AN ORDINARY MICROSCOPE FOR PROJECTION.

This is a magic lantern with iron legs and rods for the support and guidance of the parts (fig. 33). The slide-carrier bellows and lantern objective with the guide rods have been removed, leaving only the condenser, arc lamp and lamp-house. The short tubes for the lamp are supported at the left by the ordinary legs of the apparatus. In front a support of wood is used when necessary. As the whole lamp and condenser would be too low for the axis of the microscope it is raised on a block (Block₂) to the proper height. There is a base-board on which all the apparatus is placed, and at the left there is a track made of rods or tubes as in fig. 158, 159 on which the block supporting the microscope can be moved back and forth in line of the axis. For a water-cell, a glass box made as described in § 394a is set on a block in the path of the cone from the condenser.

Commencing at the left:
Arc lamp The hand-feed, right-angle carbon arc lamp.
s. s Set screws.

This is also an excellent method of making small glass boxes for experimental work where water is the liquid medium. Such boxes also have been used continuously for months for observing the growth of aquatic plants. If one side is made of cover-glass, then high powers of the microscope can be used to study the growth on the inside face of the cover-glass.

We are indebted to Prof. Romyn Hitchcock for the method of making water-cells by the aid of Ripolin paint.

- F. S.* Feeding screws for the carbons.
V. A. Vertical fine adjustment for centering the crater.
L. A. Lateral fine adjustment for centering the crater.
W₁ Supply wire to the upper carbon.
W₂ Supply wire from the lower carbon through the rheostat (*R*).
R Rheostat in the wire from the lower carbon.
Rods The short tubes or rods supporting the lamp.
L₁, L₂ The left and right supports or legs of the lamp-rods.
Block₁ The block on the baseboard to elevate the arc lamp and condenser to the axis of the microscope.
Lamp-House The metal enclosure of the arc lamp.
V Ventilator of the lamp-house.
Condenser The two-lens condenser. It is supported by the front end of the lamp-house.
1, 2 The two plano-convex lenses forming the condenser.
Water-cell The glass vessel with plane sides filled with water and placed in the path of the cone of light from the condenser to absorb the radiant heat.
Microscope An ordinary microscope turned in the horizontal position. The draw-tube and ocular have been removed, also the substage condenser.
Stage The stage of the microscope.
SS The substage condenser sleeve. The condenser has been removed.
Axis, Axis The principal optic axis of the condenser and the microscope.
O Objective.
H Handle for carrying the microscope.
c, f Coarse and fine focusing adjustments.
cl Clamp for holding the microscope to the block.
FM Foot of the microscope.
Block₂ The wooden block supporting the water-cell.
Block₃ The block to which the microscope is clamped. It moves back and forth on the track (*tr*).
tr The rods on the baseboard serving for a track.
Base Board The board on which all the apparatus is placed.

§ 395. **Stray light, and a water-cell.**—For a water-cell, any glass vessel with plane sides can be used, and it can be put between the condenser and the stage of the microscope instead of between the lenses of the condenser as in fig. 4, 167. For cutting off stray light one can use a black cardboard shield, or a black disc may be perforated and hung on the end of the tube of the microscope beyond the focusing mechanism. For bellows between the condenser and stage, use a sheet of asbestos paper.

§ 396. The directions for using the ordinary microscope in projection are precisely as for the special microscope shown in fig. 121, and discussed in the first part of this chapter. As there is no stage-cooling device one must be careful not to overheat the specimens.

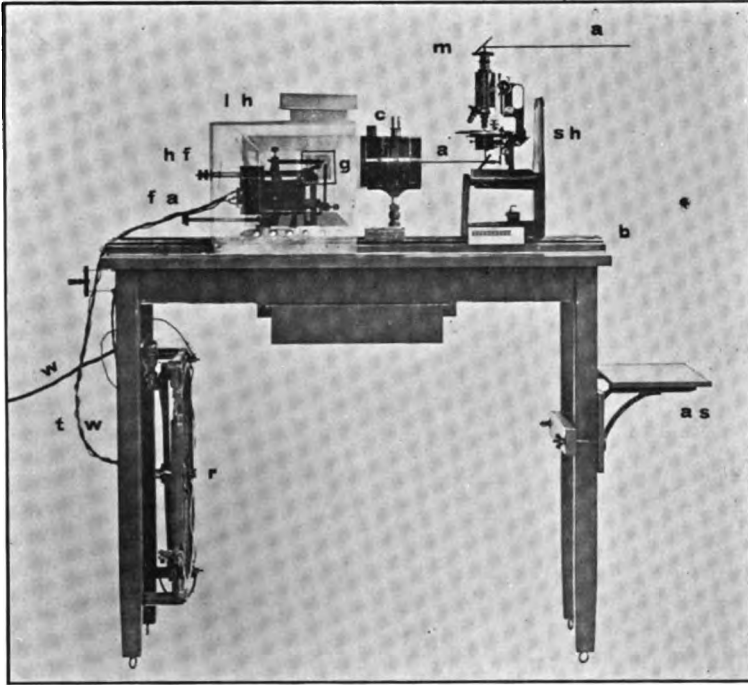

FIG. 147. PROJECTION WITH THE MICROSCOPE IN A VERTICAL POSITION.

- W* Supply wires from the outlet box (fig. 3).
r Rheostat of the theater-dimmer type.
tw Wires to the arc lamp from the switch.
fa Fine adjustment screws projecting behind the lamp-house.
hf Hand-feed screws for the carbons of the arc lamp.
lh Lamp-house. It is of sheet iron, but was left in position only a part of the time, hence it appears transparent.
g Observation window opposite the crater.
C Triple condenser with water-cell (fig. 121).
aa Principal optic axis. The mirror of the microscope reflects the light vertically along this axis and through the microscope, then the mirror or prism over the ocular reflects it horizontally again.
m Mirror or prism over the ocular to reflect the light horizontally to the screen.
sh Shield to cut off stray light.
b Baseboard with track for an optical bench.
as Adjustable shelf for drawing.

PROJECTION OF HORIZONTAL OBJECTS

§ 397. As with the magic lantern, so with the projection microscope some objects must be left in a horizontal position for projection. This requires that the microscope be in a vertical position. As the light source is for giving light in a horizontal direction (fig. 121), it is necessary to use a mirror or prism to reflect the horizontal light upward through the vertical microscope and then another mirror or prism above the microscope to reflect the vertical light horizontally to the screen. This is shown in fig. 147, 175.

The ordinary mirror of the microscope serves very well for making the light vertical, but for reflecting it horizontally to the screen a prism or a plane mirror silvered on the face is best, as it gives a single image, not a double image as would the ordinary glass mirror silvered on the back.

§ 398. **Avoidance of stray light with a vertical microscope.**— This is easily accomplished by using a vertical piece of blackened cardboard just beyond the microscope as shown in fig. 147. If light escapes from the sides one can use pieces of black cardboard or asbestos to enclose the microscope more completely. Ordinarily, however, the single black shield beyond the microscope will answer.

§ 399. **Sample Objects Suitable for Projection with the Different Objectives** (see also §399a).

PHOTOGRAPHIC TYPE OF OBJECTIVES (Micro-Planars, etc.)
No Tube (fig. 138)

Object	Size of Object	Objective	Magnification with:—		
			5 Meter Screen	7.5 Meter Screen	10 Meter Screen
Brain Section	55 to 90 mm.	125 mm.	39	61	80.6
Cerebellum and Brain Stem	50 to 75 mm.	100 mm.	48	74	98.4
Longitudinal Section of 40 mm. Embryo.	35 to 50 mm.	70 mm.	72	107	143
Section of Eye	25 to 40 mm.	60 mm.	85	123	168
Section of Injected Kidney	20 to 35 mm.	50 mm.	101	147	202
36 Hour Chick Entire	15 to 25 mm.	35 mm.	142	210	285
Transsection of Human Esophagus	10 to 20 mm.	30 mm.	167	250	330
Appendix (Homo) . . .	5 to 11 mm.	20 mm.	253	370	495

Large Tube (fig. 121)

Object	Size of Object	Objective	Magnification with:—		
			5 Meter Screen	7.5 Meter Screen	10 Meter Screen
Pyloric Stomach	20 to 30 mm.	70 mm.	72	107	143
Medulla and Olives	15 to 25 mm.	60 mm.	85	127	168
Scalp	12 to 22 mm.	50 mm.	101	155	205
Human Spinal Cord	10 to 14 mm.	35 mm.	142	218	285
Thyroid	8 to 12 mm.	30 mm.	167	250	330
Adrenal	5 to 8 mm.	20 mm.	253	380	500

ORDINARY MICROSCOPIC OBJECTIVES

Large Tube (fig. 121)

Section of Lung or Artery	4 to 5 mm.	16 mm.	322	488	650
Neural Plate of Amblystoma	2 to 4.5 mm.	12.5 mm.	385	590	750
Transection of Trachea	2 to 3.7 mm.	10 mm.	454	700	900
Striated Muscle Longi and Transections	1 to 2.5 mm.	8 mm.	640	940	1280
Nerve Cells in Spinal Cord	1 to 2 mm.	6 mm.	760	1120	1460
Goblet Cells of Intestine, Mucicarmin Stain	1 to 1.2 mm.	4 mm.	1080	1600	2180
Silvered Endothelium	0.2 to 0.4 mm.	2 mm.	2600	3820	5080

§ 399a. The preparations listed in the above table are simply examples of objects which can be shown entire with the different objectives without oculars. In practice any good microscopic preparation and many living things can be shown with the projection microscope.

For the complete understanding of any specimen it is necessary to see it as a whole and then by using higher and still higher powers (§ 391) to get views of finer and finer details.

In demonstrating the finer details one can show but a very small specimen or a small part of a large specimen. For large specimens it is a great advantage to have objectives of different powers on a revolving nose-piece so that it takes only a moment to turn from one to the other. If only the large condenser is used (fig. 121) the objective remains practically stationary, but the specimen must be on a movable stage so that it can be farther from the objective or nearer to it depending upon the focal length of the objective (fig. 132).

If one uses substage condensers the stage remains stationary and a long focus substage condenser is used for low powers and a short one for high powers and the objective is placed at approximately its focal distance from the object.

It must be remembered that many living things are soon destroyed by the intense light necessary for projection. While the circulation of the blood seems an ideal demonstration with the projection microscope it is found in practise to be a very poor way to demonstrate it. If this is tried the microscope in a vertical position (fig. 147) is convenient. The screen distance should not be very great (3 to 5 meters, 10 to 16 ft.). In the author's experience the demonstration of blood circulation under a microscope is vastly superior to anything that can be done with a projection microscope.

CONDUCT OF AN EXHIBITION OR DEMONSTRATION WITH THE PROJECTION MICROSCOPE

§ 400. What is said in Ch. I, § 21-40 is entirely applicable to the projection microscope by substituting microscopic specimens for the lantern slides. Only from the greater difficulty and precision demanded in using the projection microscope, it is imperative that the operator be prepared, hence the greater necessity of making certain that everything is in absolute order before the lecture begins.

If any of the projection objectives (i. e., those of 125 to 20 mm. focus) have iris diaphragms, open these as widely as possible. *Never try to project with the iris of the objective partly closed.*

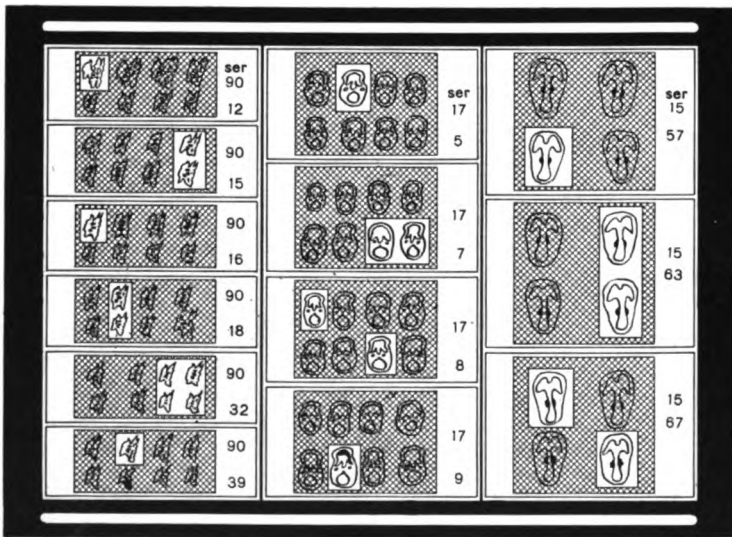

FIG. 148. SLIDE-TRAY WITH MASKED PREPARATIONS TO BE USED IN PROJECTION. (About ¼ size).

Three series are here represented on different sized slides.

The sections to be shown are not covered with the masking paper. The numeral on the side give the number of the series (ser. 90, ser. 17, ser. 15). On each slide is also the number of the slide in the series as ser. 15, slide 57, 63, 67, etc.

An experiment with the iris partly closed and then wide open will show the necessity of observing this rule.

The microscopic slides should be in order and properly masked (§ 384) and marked in some way so that the operator can tell which edge up they should be placed on the stage.

It is also a great advantage to have marked on the microscopic specimen the objective or objectives that should be used in projecting it to bring out the structural details which it is desired to show.



FIG. 149. SLIDE BOX TO HOLD PREPARATIONS FOR DEMONSTRATION.
(Cut loaned by the Spencer Lens Company).

For ease in getting hold of the slides to be exhibited, either a shallow tray can be used or a slide box (fig. 148, 149). As with lantern slides, it is advantageous to have the microscopic specimens so placed that they can be grasped easily, and put on the stage as desired without hesitation.

Some teachers, including the senior author, have found it advantageous to manage the projection themselves, giving the explanations from the position of the lantern.

The best way to point out the parts in the screen image to be especially noted is to have a slender pointer about two meters (six feet) long, like the upper two-thirds of a bamboo fishing rod, and to hold this out in the beam of light. The shadow appears on the screen sharply, and one can point out details with the same clearness as by using a pointer on the screen. It is easier also, because the speaker does not get his eyes dazzled by looking into the light beam, as so often happens when standing near the screen in the usual lecture position.

SPECIAL DEMONSTRATIONS WITH HIGH POWERS

§ 401. **Substage condenser in projection.**—As indicated in § 359 the authors of this book believe that projection for large audiences and with low objectives is best accomplished without

substage condensers, and without oculars; but they realize that in laboratory work and for some special lectures to small classes it is of the highest advantage to be able to show pictures of photographic sharpness in all details. For this it is necessary to use, first of all, a substage condenser which will give a light cone of sufficient aperture for the details; and secondly there must be a proper screen, i. e., the screen must be very white and very smooth, but not shiny (§ 409, 621). White cardboard answers well. Finally there must be an ocular used, and the observers must be near enough the screen to see the fine points.

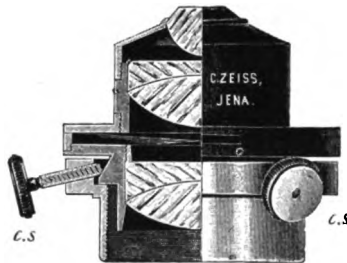

FIG. 150A. ACHROMATIC, SUBSTAGE CONDENSER WITH CENTERING SCREWS.
(From Zeiss' Catalogue).

There has been a segment of the condenser cut away to show the construction.

The centering screws (*c-s*, *c-s*) enable the operator to get the condenser in the optic axis of the microscope. The iris diaphragm for this condenser is between the lower and middle combinations, not below the condenser as with the Abbe form.

This form of condenser is especially desirable for projection and for photomicrography.

The substage condenser for micro-projection must either be of a special form to use with the main condenser of the apparatus or special means must be employed to utilize the light cone from the main condenser when the ordinary substage condenser is used.

This is because the substage condenser ordinarily used on microscopes is designed for approximately parallel beams of light, not for those markedly converging or diverging. By examining the figures of the light cone from the main condenser it will be seen

that the cone of light is converging to the focal point and diverging beyond that point (fig. 122, 132 and 320-323). If the converging cone is used the substage condenser brings it to a focus too soon and if the diverging cone, then the substage condenser brings it to a focus too far beyond it.

§ 402. **Methods of rendering converging or diverging light parallel.**—There are two principal ways of utilizing the light cone from the main condenser.

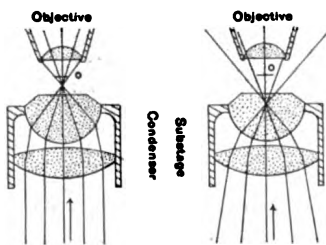

FIG. 150B. ABBE SUBSTAGE CONDENSER SHOWING PARALLEL AND CONVERGING INCIDENT LIGHT.

In this form of condenser the iris diaphragm is below both condenser lenses (compare fig. 150).

With parallel, incident light the condenser focuses the light just above the condenser, with converging light the focus is within the upper lens and the light is diverging on leaving the upper lens.

o, o Object.

Objective The front lens of the projection objective.

A. Rendering the converging cone of light approximately parallel by means of a concave lens. As it is desirable to use all the light in the cone, the concave lens is put in the cone where its diameter is slightly less than the diameter of the substage condenser, that is about 25 mm. (1 in.). The trial glasses used by the oculist are excellent for the purpose. A fork with stem is desirable, and this is placed in the socket for the mirror stem. This brings the fork carrying the spectacle lens near the substage condenser. Concave spectacle lenses of 10 to 20 diopters (100 to 50 mm., 4 to 2 in. focus) have been found excellent. The microscope for projection is so placed that the fork carrying the concave lens is about

$2\frac{1}{2}$ to 3 cm. (1 to $1\frac{1}{2}$ in.) from the focus of the converging cone. The concave lens will render the converging light approximately parallel, and this cylinder of light is small enough to enter the substage condenser. By a small manipulation of the screw of the substage condenser bringing it slightly nearer the specimen or slightly farther from it the most brilliant screen image can be produced. A slight change in the position of the substage condenser often works wonders.

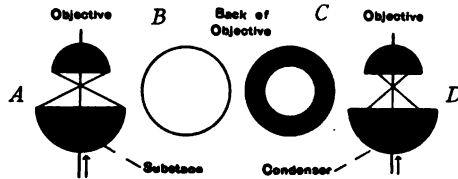

FIG. 151. RELATION OF THE APERTURE OF THE LIGHT FROM THE CONDENSER TO THE APERTURE OF THE OBJECTIVE.

(From Nelson, *Jour. Roy. Micr. Soc.*)

- A* The cone of light from the condenser just fills the aperture of the objective (*B*).
B Back lens of the objective entirely filled with light.
C The cone of light from the condenser is not great enough to fill the aperture of the objective (*D*).
D Back lens of the objective lighted by the condenser (*C*).
 The dark ring shows the aperture of the objective not lighted by the condenser.

B. Rendering the diverging cone of light approximately parallel by the use of a convex lens. If a convex lens is placed in the path of the diverging cone at its focal distance from the focus of the main condenser, the light will be rendered parallel. In order to have a cylinder of light of the right size to enter the substage condenser a convex lens of the proper focal length and diameter must be used. Trial lenses are excellent. Those of 10 and 20 diopters (100 and 50 mm., 4 to 2 in. focus) are excellent for the main condenser with a focus of 150 to 200 mm. (6 to 8 in.). The microscope must be put in such a position that the trial lens in the fork before the substage condenser shall be at its focal distance from the focus of the main condenser. The diverging cone of light will be made approxi-

mately parallel (fig. 153B), and by slight adjustments of the substage condenser brilliant images are produced.

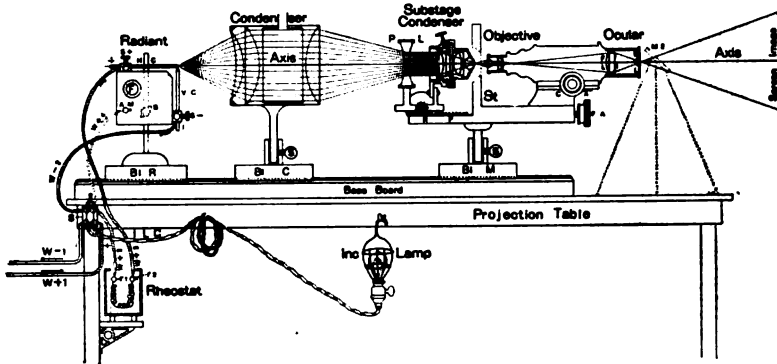

FIG. 152. MICROSCOPE FOR PROJECTION AND FOR DRAWING.

W - 1 The negative supply wire from the outlet box (fig. 3).

W + 1 The positive supply wire from the outlet box.

S Double-pole, knife switch.

W - 2 Wire from the switch to the binding post of the lower carbon.

W + 2 Wire from the knife switch to the rheostat.

W + 3 Wire from the rheostat to the upper carbon (+ *H - C*).

r1, r2 The two binding posts of the rheostat.

Rheostat The controlling device for the current.

ILC Incandescent lamp cord.

Inc. Lamp The incandescent lamp with a wire lamp guard.

This lamp is for use in working about the projection apparatus. It is connected to the supply wires at their connection with the switch so that the incandescent lamp will burn whether the knife switch is open or closed (see also fig. 2, 4).

Radiant The arc lamp.

S+, S- The set screws for the carbons.

HC, VC The horizontal or upper and the vertical or lower carbons.

Condenser The triple-lens condenser with water-cell in the parallel beam between the two plano-convex lenses.

Axis, Axis The optic axis of the condenser and the microscope.

Substage Condenser The achromatic condenser under the stage of the microscope.

P L The concave lens for making parallel the converging light from the large condenser before it enters the substage condenser.

St Stage of the microscope.

Objective The projection objective.

Ocular The ocular of the microscope used in projection.

M, The mirror or prism placed just beyond the ocular when it is desired to reflect the light downward.

Screen Image The image projected upon the white screen by the projection microscope.

- Bl. R* The block carrying the radiant on the optical bench.
Bl C The block carrying the condenser on the optical bench.
Bl M The block carrying the microscope on the optical bench.
Base Board The board bearing the track made of rods and serving as an optical bench.
Projection Table The table supporting the apparatus and holding it at the proper height for use.

The above method refers especially to high powers—objectives of 2 to 8 mm. equivalent focus. For powers lower than those just mentioned one can get better results by the use of a main condenser with a second element of 200 to 150 mm. focus and no substage condenser, or by adopting the method given below or in § 403.

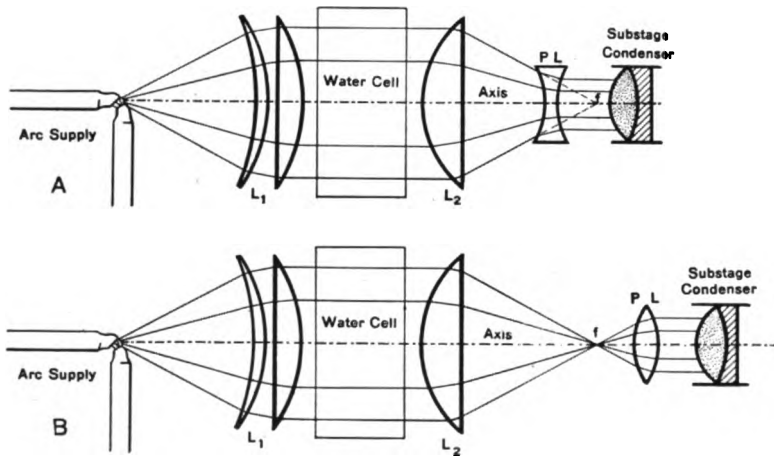

FIG. 153. DIAGRAMS TO SHOW METHODS OF PARALLELIZING THE CONE OF LIGHT FROM THE MAIN CONDENSER.

A Method of parallelizing the converging cone of light from the main condenser by means of a concave lens within the focus (f).

B Method of parallelizing the diverging cone of light from the main condenser by means of a convex lens beyond the focus (f).

Arc Supply The right-angled carbons of the arc lamp.

L_1, L_2 The first and second elements of the triple, main condenser.

Water Cell This is to remove the radiant heat.

Axis The principal axis on which all the parts are centered.

f The principal focus of the second element of the main condenser.

P. L. Parallelizing lens. Concave in *A*, Convex in *B*.

Substage Condenser This is the first or lowest element of the substage condenser of the achromatic form (fig. 150A). See also fig. 150 B. for the Abbe form of substage condenser.

Finally if one uses a main condenser with a focus of 30 or 38 cm. (12 to 15 in.) excellent results can be obtained with all powers (16 to 2 mm.) by so placing the microscope that the converging cone of the main condenser shall enter the substage condenser at a point where the light cone is of about the diameter of the substage condenser (fig. 154A-B). It may be necessary to raise or lower the substage condenser slightly to obtain the most brilliant screen image.

Fair results can also be obtained in this way by using main condensers of 15, 20 and 25 cm. (6, 8, 10 in.) focus, but much more

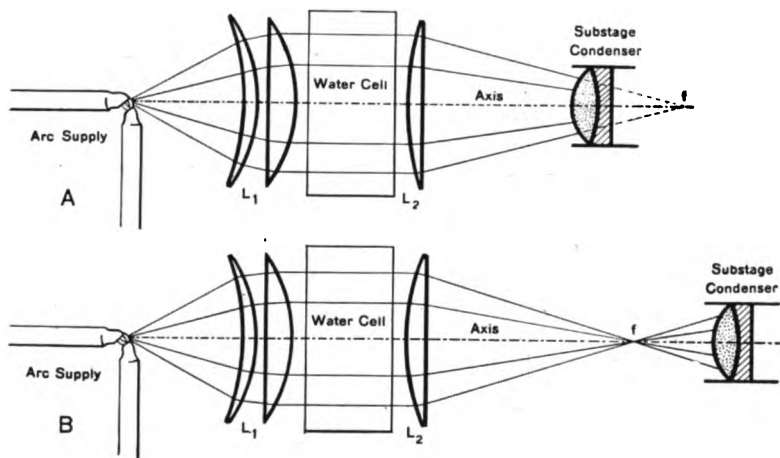

FIG. 154. DIAGRAMS TO SHOW THE POSITION OF THE SUBSTAGE CONDENSER WHEN NO PARALLELIZING LENS IS USED.

A The substage condenser is within the focus (f) at a point where the long, light cone is of about the same diameter as the substage condenser.

B The substage condenser is beyond the focus (f) of the long focus main condenser, at a point where the diverging cone is of about the same diameter as the substage condenser. This is the better position for the substage condenser of the ordinary microscope.

Arc Supply The right-angled carbons of the arc lamp.

L_1, L_2 The first and the second elements of the main condenser.

Water Cell This is to remove the radiant heat.

Axis The principal axis on which all the parts are centered.

f The principal focus of the second element of the main condenser. In both cases the focus is long as compared with fig. 153.

Substage Condenser This is the first or lowest element of the substage condenser. It is of the achromatic type (fig. 150 A). See figure 150 B for the Abbe form of substage condenser with parallel and with converging light.

brilliant pictures can be produced by using also a parallelizing lens as indicated in § 402 A.

If one has an optic bench apparatus (fig. 121, 158, 159) one can get good results with the condensers of all foci by placing the microscope so that a diverging cone of light enters the substage condenser (fig. 154B). It will then be necessary to lower the substage condenser slightly for the higher powers.

§ 403. Köhler method of using the substage condenser.—The general principle is shown in fig. 170. The microscope is moved toward the main condenser until the focus is at the iris diaphragm. One can tell when the main condenser is focused on the iris diaphragm in the same way as that in focusing on the black hood of the objective (§ 375) viz., by noting when the image of the crater and the tip of the lower carbon appear on the iris. After the image is focused on the iris diaphragm the iris is opened to admit the cone of light, and the substage condenser is raised or lowered slightly to get the most brilliant light. As one can see by the diagrams of light cones and the plates of the light rays and the light cones, the light is diverging beyond the focus so that diverging and not parallel light enters the substage condenser. As the condenser cannot focus diverging light at the same level that it would focus parallel light it may be necessary to lower the substage condenser somewhat to get the most brilliant image with high powers. Furthermore, if a concave lens of 10 to 20 diopters is put in the fork as described in § 402 A the image will be markedly brighter unless a very long focus main condenser is used (fig. 171). (See also Ch. XIV, § 864).

§ 404. Aperture of the substage condenser.—The purpose of the substage condenser in projection, as in direct observation with the microscope, is to increase the aperture of the illuminating cone. And as it is now one of the fundamental doctrines, that the resolution or making visible of minute details depends directly upon the aperture of the objective used, naturally as much as possible of the aperture of the objective is employed. For this, the substage condenser diaphragm should be wide open, so that the

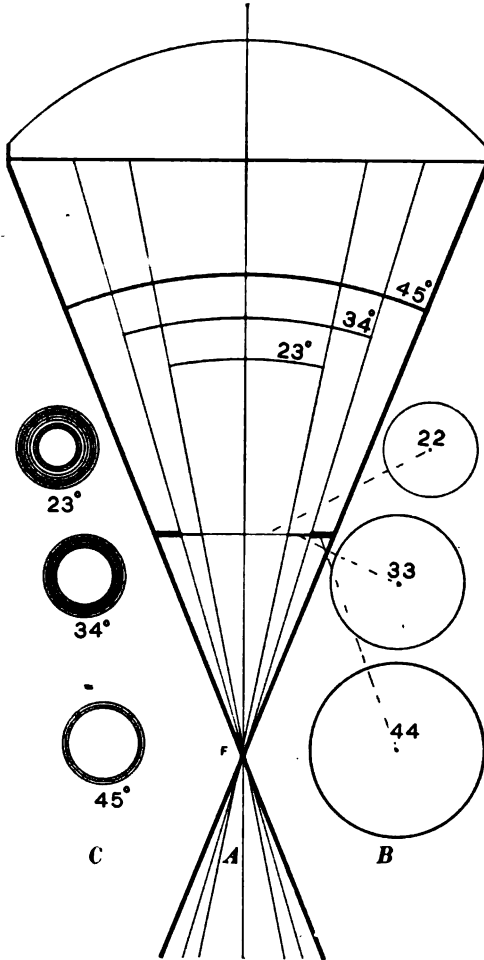

FIG. 155. THE EFFECT OF USING AN IRIS DIAPHRAGM IN THE CONE OF LIGHT FROM THE MAIN CONDENSER.

The second element of the condenser is shown at the top. The focus of the cone of light from the condenser is shown at *F*, the axis by *A*.

B At the right are shown in millimeters, three diameters of the cone of light with three different openings of the iris diaphragm (22, 33, 44 mm.)

C At the left are shown the apertures corresponding with these openings in the iris diaphragm (23° , 34° , 45°). The aperture of these openings is also shown above the circles.

One can see by this diagram what an enormous amount of light is lost by making the illuminating cone smaller.

entire beam of light from the lamp condenser may enter. Then, just as in ordinary observation, one can often make the contrast more striking by cutting down the aperture somewhat by closing more or less the substage condenser diaphragm. It must not be cut down too much, for that will render the image dim and defeat the very purpose of the substage condenser.

As a general statement, much more of the aperture of the objective can be used in projection than in ordinary direct observation in the microscope. Naturally, objectives of relatively large aperture give the more brilliant images (see § 855).

§ 405. Oculars to use in projection.—Generally speaking, only low powers are used (x_2 , x_4 , x_8). The lower the power the more brilliant the image. Compensation oculars have been found better than the Huygenian. A compensation ocular as high as x_{12} gives brilliant images for short screen distances.

One should not forget that the ocular, when used in projection, is really a second projection system, and hence the image will be erect on the screen (fig. 207).

§ 404a. Centering the substage condenser.—As the substage condenser becomes one of the optical elements in projection, its principal optic axis must be centered on the common axis of the entire apparatus.

It is assumed that the microscope without the substage condenser has been properly centered as directed in § 374-375.

To center the substage condenser, use the ocular and objective (x_4 ocular, 8, 10 or 16 mm. objective), remove the bellows if present (fig. 133), place a piece of white cardboard at about 45 degrees as shown in fig. 116, between the large condenser and the substage condenser, and light the cardboard well with a mazda lamp. This will give the light for the microscope.

Now put a preparation on the stage and focus the microscope as for ordinary observation. Remove the specimen and close the substage iris diaphragm nearly up. With a pocket magnifier examine the eye-point or Ramsden's disc (fig. 127 E P) beyond the ocular. This disc of light appears as if on the back lens of the objective. If the iris is properly made and the substage condenser is centered with the objective and ocular, the center of light will appear to be exactly in the middle of the back lens of the objective (fig. 151). If the substage is not in the optic axis then the disc of light will appear eccentric; and if the substage condenser is markedly off the center the spot of light will make a break in the black ring on one side as shown in fig. 30, 1-4. If it is only slightly off center, the disc of light will seem to be surrounded by a dark ring of unequal width. If the substage condenser is not found to be correctly centered, the centering screws (fig. 150) must be used to move it slightly until the disc of light is central as shown in fig. 151.

The Abbe condenser found on most microscopes has no centering screws. The makers center the instrument carefully and fix it in position. If it is found badly out of center it is best to return it to the makers for adjustment.

§ 406. **Range of objectives to use with a substage condenser.**—Objectives of 16, 12, 10, 8, 6, 4, 3, and 2 mm. equivalent focus are used with the substage condenser. For objectives of longer focus than 16 the substage condenser of the ordinary form is rarely used. Either a special long focus substage condenser is used or the ordinary one is turned aside and the cone of light from the large condenser used as directed above (§ 376).

§ 407. **Change in position of the substage condenser for different objectives and thickness of slides.**—For the highest powers

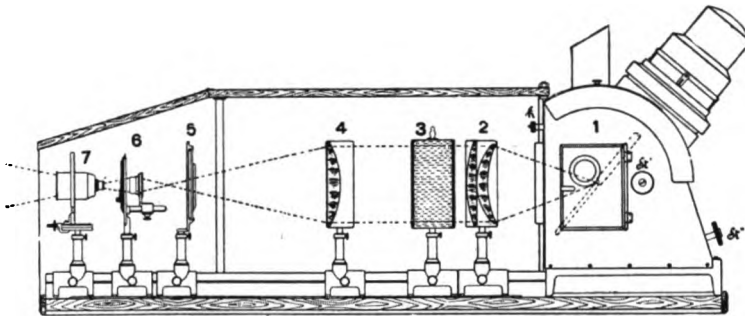

FIG. 156. PROJECTION MICROSCOPE OF ZEISS.

(From the 4th edition (1899) of Zeiss' catalogue of instruments and appliances for Photo-Micrography and Projection).

This projection apparatus, which in its main features was described in Zeiss microscope catalogue No. 28, (1889), and No. 29 (1891), consists of an optical bench on which all of the parts needed move separately so that any desired arrangement can be made for projection of large objects with low power or smaller objects with high powers.

Commencing at the right:

- 1 Arc lamp with inclined carbons, and with fine adjustments to center the source of light (crater of the positive carbon).
- 2 First element of the condenser consisting of a meniscus and a plano-convex lens, to render the light beam parallel.
- 3 Water-cell.
- 4 Second element of the condenser to converge the light-beam.
- 5 Iris diaphragm to cut down the light-cone if desirable.
- 6 Stage and substage condenser.
- 7 Projection objective and fine focusing device. In the figure no ocular is used.

This arrangement of the parts enables the user to employ a microscope with oculars or amplifiers, or the simple apparatus here shown, or photographic objectives.

(2-3 mm. oil or water immersion) and for the 3 and 4 mm. dry objectives the condenser is usually very close up to the slide, so that the object is practically in the focus of the beam of light.

For the 8, 10, 12, and 16 mm. objectives the substage condenser must be separated sufficiently from the specimen to light the whole field.

It will be found in practice that one must be more precise in keeping the substage condenser at just the right level for projection than for ordinary direct microscopic observation. Hence, it will be found that for a thin slide the condenser, even for high powers, may need to be separated slightly from the object, while if the slide on which the specimen is mounted is thick, the condenser may need to be as close to it as possible.

§ 408. **Screen distance for high power projection.**—This should not be excessive, for even in the darkest room the image will

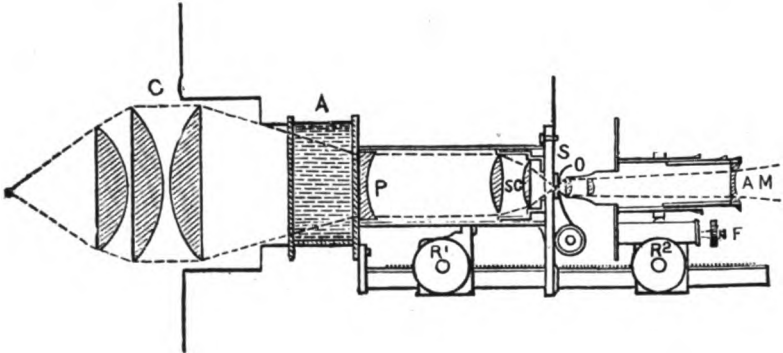

FIG. 157. LEWIS WRIGHT'S PROJECTION MICROSCOPE.

(From Wright's *Optical Projection*).

- C Condenser of three plano-convex lenses.
- A Alum cell for absorbing radiant heat.
- P Plano-concave lens of highly dispersive glass to aid in correcting the aberrations of the condenser and to render the light parallel.
- SC Substage condenser. For low powers but one lens is used.
- S Stage.
- O Object and objective.
- AM Amplifier.
- F Fine focusing adjustment.
- R₂ Rack and pinion, coarse focusing adjustment.
- R₁ Coarse adjustment for the substage condenser.

be too dim if the screen distance is over two or three meters (6 to 10 feet).

With objectives of 4, 6, 8, 10 mm. and lower powers, one can use a greater distance with satisfaction, but for the oil and water immersions, a distance of one to two meters (3 to 7 feet) gives the best results. This, of course, refers to minute details. If one simply wants size, the limit is much greater; but that is not scientific projection.

§ 409. **Kind of screen for high power projection.**—The principle enunciated by Goring and Pritchard must be kept in mind. *The whiter and smoother the screen, the more brilliant the image and the clearer the details.* Nothing has been found better by the writers than smooth, white bristolboard. This is also very easily procured, and when it becomes dirty or discolored, it can be cheaply replaced. We have also found white cardboard in sheets of 71 x 112 cm. (28 x 44 in.) good.

§ 410. **Specimens to project with high powers.**—These must have in a good degree the qualities of specimens giving clear images to the eye in direct, microscopic observation. That is, they should have definite outlines and contrasting colors; for example, well stained preparations of red and white blood corpuscles mounted in balsam and projected with the oil immersion objective.

Preparations of bacteria, well stained and mounted in balsam, may be projected with the oil immersion.

Thin histologic and embryologic sections, if well stained and mounted in balsam, answer well. The nuclei of cells show well, also the band of cilia in a ciliated epithelium, and the cells in mitotic division. Naturally, well prepared plant preparations have the advantage of very sharp outlines.

§ 411. **High powers with the vertical microscope.**—Any preparation which can be projected well with high powers may be used on the vertical microscope (§ 397). Of course, there is some loss of light in the double reflection required (fig. 147, 176), but if the screen is within two meters (6 ft.) distance and the observers few and close, results are fairly satisfactory. For example, if one has

water in which there are many large bacteria and infusoria, a most striking picture on the screen is made. For this projection a water immersion is excellent. An oil immersion may also be used and also a dry objective of 4 to 6 mm.

For securing a large field, the objective and amplifier are better than an objective and ocular (§ 355).

USE OF ALTERNATING ELECTRIC CURRENT WITH THE PROJECTION MICROSCOPE

§ 412. It is unfortunate that it should ever be necessary to use alternating current in micro-projection; but if that is all which can be obtained, much can be accomplished with it by skillful handling.

(For a discussion of the difference between direct and alternating current and the relative amount of light yielded by the two, also for the possibility of getting direct from alternating current by means of a motor-generator set, or by a "current rectifier," see Ch. XIII, § 681-683, 751-752).

§ 413. **Wiring the Arc Lamp.**—This is exactly as for the magic lantern, (fig. 3). And as with all arc lamp work there must always be present some form of regulating device like a rheostat or inductor (fig. 145, 197, § 748).

§ 414. **Arrangement of the carbons.**—For micro-projection the carbons should always be at right angles, and the light will then be almost wholly from the upper or horizontal carbon (fig. 191). As this is in the optic axis and looks directly toward the condenser it is the most satisfactory source of light available with this as with the direct current lamp for micro-projection. This is because the image of the crater of one carbon is as large as can be received by the projection objective.

It is especially necessary for micro-projection that the lamp have fine adjustments to keep the crater exactly centered (fig. 3, 146).

§ 415. **Amount of current necessary.**—As the alternating current gives less than one-third as much available light as the direct current one cannot project with such high powers nor produce so large screen images as with the direct current (fig. 302).

For example, with direct current of 10 amperes one can accomplish a great deal in micro-projection if the manipulation is skillful. To get equally brilliant results with alternating current would require 30 to 40 amperes of current. The heating is also excessive with the high amperages. (See Ch. XIII, § 768).

If alternating current must be used for projection with the microscope, one should not expect too much, but get as good results as possible by observing carefully the conditions giving good screen images, viz., apparatus in perfect order and alignment on one axis; a good screen and a dark room.

It is not wise, according to our experience, to try to use more than 25 amperes alternating current for micro-projection, and it is better as regards the specimens and apparatus, to be satisfied with the results which can be obtained with 15 to 20 amperes. An arc lamp with carbons at right angles is to be preferred.

§ 416. Centering the apparatus on one axis, separating the elements properly and the conduct of an exhibition are precisely as for the direct current light. The results, however, cannot be made as satisfactory, although, as stated above (§ 412), by care and skill much can be accomplished.

THE PROJECTION MICROSCOPE ON THE HOUSE ELECTRIC LIGHTING SYSTEM

§ 417. As with the magic lantern (§ 127), the small electric current (4 to 6 amperes) available from the regular house lighting system gives very gratifying results.

Small carbons (6-8 mm. diam.) are employed and either one of the small arc lamps especially designed for the purpose or an ordinary arc lamp with adapters or bushings can be used.

Of course the direct current is much more effective, but even with the alternating current, which is now so common in lighting systems, successful projection with the microscope can be done.

The small carbons form a minute crater, and thus approximate closely to a point source of light, which is the ideally perfect source from the optical standpoint. From our experience this is a

better source of light for the microscope than the lime light, and now electric lighting is so common that one can use almost any room in a house or laboratory at night for a projection room.

Of course one should not expect too much, but for small audiences—50 to 100—and with a moderate sized screen—2-3 meters—(6-10 ft.) astonishingly satisfactory micro-projection can be done.

§ 418. Hand-feed and automatic lamps for small currents.—Most of the small current lamps are of the hand-feed type whatever the form of the electric current (a. c. or d. c.) but some automatic ones have been constructed (fig. 44, 205). Large arc lamps may, by special arrangement, be so adjusted that they give good results automatically from 5 to 25 amperes (e. g. the automatic lamp of A. T. Thompson and of the Bausch and Lomb Optical Co., fig. 186, 187).

As for the usual lantern arc lamps, only those for the direct current have hitherto been constructed of the automatic form.

For a full discussion of the wiring and setting up of the apparatus see Ch. III and XIII, § 128 and fig. 3, 40, 45.

Do not forget that a rheostat or ballast of some kind must be used on every outfit where an arc lamp is employed (§ 129, 748).

Remember the precautions for turning on and off the current when using the house circuit (§ 133). For a further use of these small currents in drawing, see Ch. X, § 486.

MICRO-PROJECTION WITH SUNLIGHT

§ 419. This was the first light used for micro-projection and remains the best. If it were only available at all times it would be universally employed.

§ 420. Arrangement of the parts of the apparatus.—For the heliostat to keep the sunlight in a constant position one should consult Chapter VI.

After getting parallel light from the sun in a constant position, then one should use the proper condenser (fig. 74). The remainder of the apparatus is precisely as for the projection so far discussed and all the requirements of centering and arranging at the proper

distance from one another are as for the electric light described above.

As the spot of light must remain in exactly the same place to be received by the small lenses of the projection objective, it is necessary to regulate the hand heliostats oftener than for the magic lantern.

It may also be necessary to make slight corrections in the mirror of the clock-driven heliostat from time to time. The law is: The axial ray must correspond with the optic axis of the apparatus.

§ 421. **Use of a water-cell.**—The radiant energy of the sun is so great that a water-cell to remove as much of it as possible except the luminous part (§ 844) is as desirable as with the electric light. It is also desirable to have a specimen cooler (fig. 121).

PROJECTION MICROSCOPE WITH THE LIME LIGHT

§ 422. The management of the lime light for the projection microscope is exactly as for the magic lantern (see §163, 164), only more attention will be necessary to keep the best possible light all the time. The image of the luminous spot should be focused on the hood of the objective as for the electric arc. While there is not so much danger from overheating as with the electric light or sunlight, it is desirable to use a large water-cell. The stage cooler is also an advantage. For the correct form of a condenser see § 363.

As the intrinsic brilliancy of the lime light is less than that of sunlight or the electric light one must not expect so much of it as of them.

§ 423. Other sources of light are insufficient to give good micro-projection except in a very limited degree, and for some special purposes. See under drawing, Ch. X, § 463.

HOME-MADE PROJECTION APPARATUS

§ 424. **Projection table.**—For all kinds of projection the table should be of convenient height, so that the operator can stand during the exhibition. A height of 100 centimeters (40 inches) is suitable for most persons. The size of the top varies greatly with

the work to be done. For the work of micro-projection, drawing, etc., contemplated in this and the following chapter a table of the following dimensions has served admirably: Height, 100 centimeters (40 in.). Size of top 125 cm. (50 in.) long; 50 cm. (20 in.) wide. The legs are about 5 cm. (2 in.) square, and have large screw eyes in the lower ends for leveling. The table should be

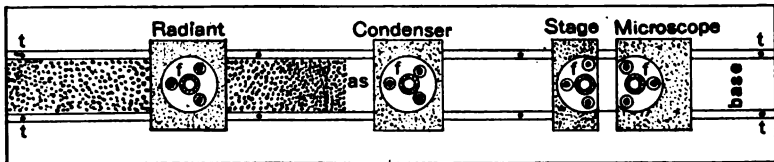

FIG. 158. HOME-MADE OPTICAL BENCH.

tttt The track of rods or tubes on the baseboard.

Radiant The block carrying the arc lamp.

as Asbestos paper between the track rods at the arc lamp end of the optical bench.

Condenser The block carrying the condenser.

Stage The block carrying the stage of the projection apparatus or the lantern-slide holder.

Microscope The block carrying the projection microscope or the lantern slide or other projection objective.

fff The railing flanges holding the sockets.

base The baseboard.

rigidly made so that there will be a minimum of vibration. If the table vibrates there is a disagreeable trembling of the screen image. (For pictures of such a table see fig. 133, 182).

Carrying out the precautions against reflections from light surfaces, the table is made dull black or brown. This is easily accomplished by using some dull black paint like "dead-black Japalac" or other dull black, or dull brown paint, thinned somewhat with turpentine.

The anilin black stain used for laboratory tables is also most excellent (§ 424a).

To the projection table should be fastened the rheostat, and the ammeter, if one is used; also the lamp switch and the incandescent lamp (fig. 133). Then the table can be moved from one place to

another and be ready for projection by connecting the supply wires for the lamp to the line at any outlet box (fig. 3).

§ 425. Lathe bed or optical bench for projection apparatus.—

For the projection microscope, and for general experimental purposes there is no form of projection outfit so suitable and flexible as the lathe-bed type. It is easily and cheaply constructed. Any teacher with a little ingenuity and the aid of a tin-smith, black-smith, plumber, and carpenter or cabinet-maker, can construct all except the optical parts. The optical parts can be obtained of dealers or manufacturers of microscopes and projection apparatus.

There is this further advantage in getting up a projection outfit, the person who does it will know enough to use it. He will not

§ 424a. Stain for laboratory tables.—During the last few years an excellent method of dying wood with anilin black has been devised. This black is lustreless, and it is indestructible. It can be removed only by scraping off the wood to a point deeper than the stain has penetrated.

It must be applied to unwaxed or unvarnished wood. If wax, paint or varnish has been used on the tables, that must be first removed by the use of caustic potash or soda or by scraping or planing. Two solutions are needed:

SOLUTION A

Copper sulphate	125 grams
Potassium chlorate or permanganate	125 grams
Water	1000 cc.

Boil these ingredients in an iron kettle until they are dissolved. Apply two coats of the hot solution. Let the first coat dry before applying the second.

SOLUTION B

Anilin Oil	120 cc.
Hydrochloric Acid	180 cc.
Water	1000 cc.

Mix these in a glass vessel putting in the water first. Apply two coats without heating, but allow the first coat to dry before adding the second.

When the second coat is dry, sandpaper the wood and dust off the excess chemicals. Then wash the wood well with water. When dry sandpaper the surface and then rub thoroughly with a mixture of equal parts turpentine and linseed oil. The wood may appear a dirty green at first but it will soon become ebony black. If the excess chemicals are not removed the table will crock. An occasional rubbing with linseed oil and turpentine or with turpentine alone will clean the surface. This is sometimes called the Danish method, Denmark black or finish. See Jour. Ap. Micr., Vol. I, p. 145; Bot. Zeit., Vol. 54, p. 326, Bot. Gazette, Vol. 24, p. 66, Dr. P. A. Fish, Jour. Ap. Micr., Vol. VI., pp. 211-212. The Anatomical Record, Vol. V. 1911, pp. 145-146. (Quoted from The Microscope, by Gage, 11th ed. 1911, pp. 282-283).

expect the apparatus to do the work of a machine, and also to supply all of the intelligence to enable it to do so.

§ 426. **Baseboard and track.**—For the lathe-bed carrying all the apparatus (fig. 121, 159) a flat board about 2 cm. ($\frac{7}{8}$ in.) thick is used for the base. The width and length can be made to suit the apparatus designed. The dimensions for that shown in fig. 158–159 are: Length 125 cm. (4 ft.); width 22.5 cm. ($8\frac{3}{4}$ in.).

The track which serves as a guide to the blocks bearing the different pieces of apparatus (fig. 121) is best made of two brass tubes or rods 12 mm. ($\frac{1}{2}$ in.) in diameter and the full length of the baseboard (§ 426a).

§ 427. **Fixing the track to the baseboard.**—For this, holes should be bored through the tubes or rods, being careful to have the holes parallel so that there will be no torsion or twist when the tubes are fastened to the board. If rods are used the screw holes must be countersunk. If tubes are used then the upper wall should have a larger hole than the lower and a slender screw driver used, (fig. 159 ts), then the screw head goes through the upper wall and presses against the lower side only.

One tube or rod is fixed firmly to the base, thus: With a straight edge like a T-square make a straight line on the baseboard where the track is to be laid and then fasten the one track accurately along this line so that it will be perfectly straight.

Now for the other track lay it as follows: Use apparatus blocks (§ 428) near the ends of the baseboard and put the loose rod in place. Press the block down firmly so that the loose track will be forced into the groove. Put screws in the end holes, but do not screw them down firmly. If there are intermediate holes as in fig. 158–159 move a block near the hole, press it down firmly and then put in a screw, but do not screw it in firmly.

§ 426a. For the rods, one can procure the thin, polished or nicked brass tubing used for railing, or the thick brass tubes used instead of iron tubing. The measurement given means the total diameter. Of course one can use any desired diameter by varying the size of the V-shaped notches in the apparatus blocks (fig. 158 A) or the position of the cleats (fig. 159). If brass tubing is employed for the track, the size known to the plumber is that of the bore, not the outside diameter. Tubing with $\frac{1}{4}$ th or $\frac{3}{8}$ th inch bore answers well. The outside diameters will be 10 and 13.5 mm. ($13/32$ and $17/32$ in.) respectively.

This will make a track along which the blocks will move freely. If both tracks were firmly fixed the blocks would have to be constructed with extreme precision or the blocks would bind. They would also bind if the tracks were not perfectly parallel at all points. The loose track gives slightly and thus compensates for any little irregularity of the track or apparatus block.

§ 428. **Apparatus blocks.**—These are shown in figures 158, 159. They must be sufficiently heavy so that the various pieces of apparatus they carry will be steady; and finally the sockets for receiving the stems of the apparatus must be on the blocks in a position so that the parts like the stage and the microscope can be brought sufficiently close together.

Size and weight of the different blocks for the apparatus figured (fig. 158, 159):

1. Arc lamp block. $12\frac{1}{2} \times 12\frac{1}{2}$ cm. (5 x 5 in.); weight 1 kilo. (2 lbs.), (fig. 158).
2. Condenser block. $12\frac{1}{2} \times 10$ cm. (5 x 4 in.); weight 2 kilos. ($4\frac{1}{2}$ lbs.), (fig. 158).
3. Stage block, $12\frac{1}{2} \times 6$ cm. (5 x 2 in.); weight, 1 kilo. (2 lbs.), (fig. 158).
4. Microscope block, $12\frac{1}{2} \times 10$ cm. (5 x 4 in.); weight, 2-3 kilos. (4-6 lbs.), (fig. 158).
5. Block for lantern-slide carrier, $12\frac{1}{2} \times 6$ cm. (5 x 2 in.); weight $\frac{1}{2}$ kilo. (1 lb.), (fig. 158).
6. Block for lantern objective, or a photographic objective, (fig. 158), $12\frac{1}{2} \times 10$ cm. (5 x 4 in.); weight, 2 kilos. ($4\frac{1}{2}$ lbs.).
7. Block for horizontal microscope, $17 \times 12\frac{1}{2}$ cm. (7 x 5 in.), weight $2\frac{1}{2}$ kilos. ($5\frac{1}{2}$ lbs.), (fig. 145).

§ 429. **Construction of the apparatus blocks.**—If one has the facilities of a machine shop and foundry at his disposal these apparatus blocks may be made of cast iron, smoothed and grooved on a planer. In like manner the lathe bed with V's can be made (fig. 134). Lacking these facilities one can prepare blocks of wood which will answer almost perfectly as follows: Select some fine grained board 2 cm. to 2.5 cm. thick ($\frac{1}{8}$ to 1 in.), and cut it into

blocks of the required size for the special purpose. The blocks can be made as heavy as desired by adding sheets of lead (fig. 158A).

For the guides to follow the track, one can make V-shaped grooves, or more easily, strips of the proper thickness can be screwed to the block (fig. 159). One of the strips should be screwed tightly to the block, and the other should have screw holes through the strip considerably larger than the screws, then it will be possible to make slight changes in position to get an exact fit. When in the exact place desired the screws can be set firmly. As the large holes in the strips will be larger than the heads of the screws, metal washers should be employed (fig. 159).

§ 430. **Sockets for the stems of the apparatus.**—There is first screwed to the top of the block, a railing flange, and into this is screwed a short tube of the size to receive the stem or post of the

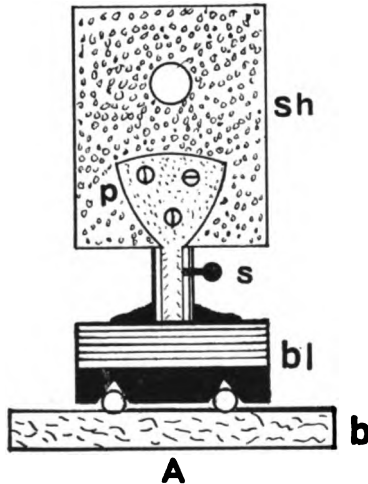

FIG. 158A. SHIELD FOR A PROJECTION OBJECTIVE.

This shows the method of supporting an objective in a shield. The shield is supported by a bolt with a fan shaped end (*p*).

The bolt or stem enters the socket and is held in place by a screw (*s*).

bl Apparatus block composed of lead sheets above and a block of wood below. The block of wood has V-shaped grooves for sliding along the track.

b Baseboard with track, end view.

apparatus. This tube has a set screw in the side to hold the post at any desired level (fig. 158F). In order to be able to perfect the centering of the apparatus, the screw holes in the flanges are made larger than the screws so that by loosening the screws the flange can be shifted slightly from side to side. If necessary one can use washers to increase the size of the screw heads, so that the holes in the flange can be quite large.

§ 431. **Wooden shields for holding objectives, etc.**—For holding projection objectives of low power, shields of thin board (1 to

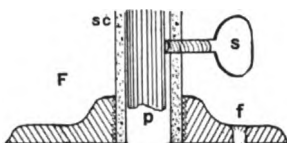

FIGURE 158F. SECTIONAL VIEW OF A RAILING FLANGE AND SOCKET.

- f* The flange in section. The screw holes are made large for centering.
s The set screw to hold the post in place.
p Post extending down into the socket. It is held at any desired height by the set screw (*s*).
sc Socket for receiving the post or stem of any piece of apparatus.

1½ cm., ½ in. thick) can be used, and a post or stem of iron made from a bolt by hammering out the end in the form of a fan (fig. 158A). To aid in centering, the screw holes in this post should also be larger than the screws.

MICROSCOPE AND LANTERN-SLIDE PROJECTION COMBINED

§ 432. With an outfit of the lathe-bed type (fig. 138), it is very simple to change from lantern-slide to micro-projection and the reverse. All that is necessary is to put the lantern-slide carrier next the condenser, and the lantern-slide projection objective on its block in position. The stage and the microscope must be set off the track on the table. The only difficulty is that the second element of the condenser for the micro-projection is of too short a focus for most lantern-slide projection. This can be overcome in

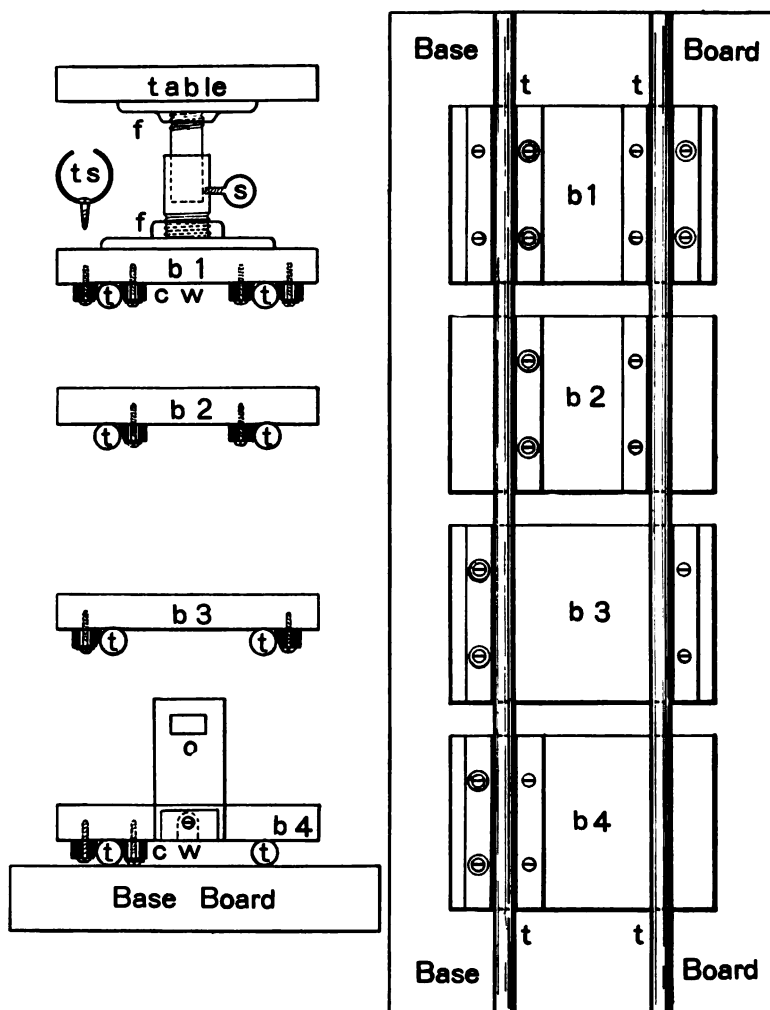

FIG. 159. HOME-MADE OPTICAL BENCH FOR ALL PURPOSES.

Base Board This is drawn at the right as if transparent to show the track and under side of the carrying blocks, and the various ways in which the guiding cleats can be applied.

|||| The tubular tracks on which the carrying blocks ride.

b 1 Block with four guiding cleats of wood. The screw holes in the inside cleat at the left and the outside one at the right are made large, and washers are used on the screws. This is to make accurate centering possible.

b 2 Block showing two guiding cleats between the tracks. Only one cleat has large screw holes for centering.

b 3 The third carrying block with the guide cleats on the outside of the track rods. Only one has large screw holes for centering.

b 4 The fourth carrying block with guide cleats at only one end, and with centering holes in one cleat.

At the left Sectional views of the carrying blocks.

In *b 1* is shown how to make a table for carrying apparatus along the optical bench, and at *1 s*, the method of screwing the track tubes to the baseboard.

In *b 4* is shown how to attach a shield with an opening for lantern slides (*O*).

two ways: (1) The arc lamp can be put closer to the condenser, thus making the beam between the elements diverging instead of parallel (fig. 1), or (2) a condenser lens of longer focus can be used for the lantern-slide projection. In much of the modern projection apparatus the condenser lenses are easily changed (see fig. 166).

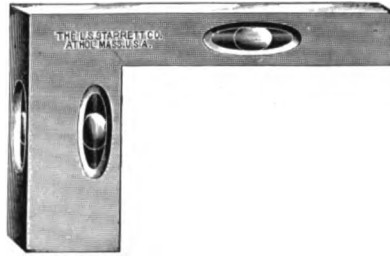

FIG. 160. UNIVERSAL LEVEL.
(Cut loaned by the L. S. Starrett Co.).

A level like this which serves for vertical and horizontal leveling is very convenient and essential for projection work.

The second method of combined projection is to have two complete lanterns side by side, one for micro-projection and one for lantern-slide work. In this case there should be a double-pole, double-throw switch; then one can turn either lantern off or on at will (fig. 162, 164).

Finally, in much of the modern apparatus special provision is made for combined projection (see fig. 164-176).

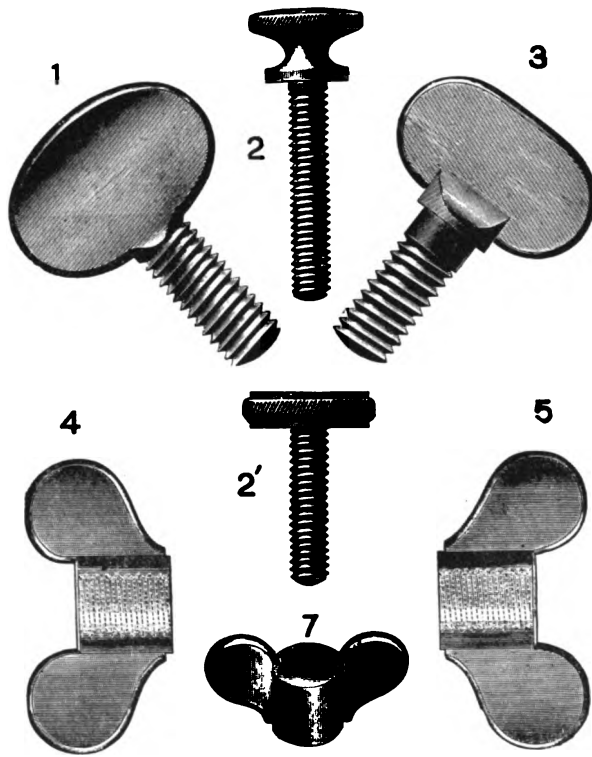

FIG. 161. THUMB SCREWS AND THUMB NUTS.
 (From the Catalogue of the Hartford Screw Company).

Thumb screws and thumb nuts are necessary if one is to construct home-made apparatus.

PROJECTION MICROSCOPES OBTAINABLE IN THE OPEN MARKET

§ 433. The projection microscope so far considered in this chapter was designed to give the range needed for modern micro-projection in a biologic or other laboratory, that is, for use with specimens slightly smaller than lantern slides (50 to 65 mm. in diameter) to those of 1 mm. or less (fig. 121, 147).

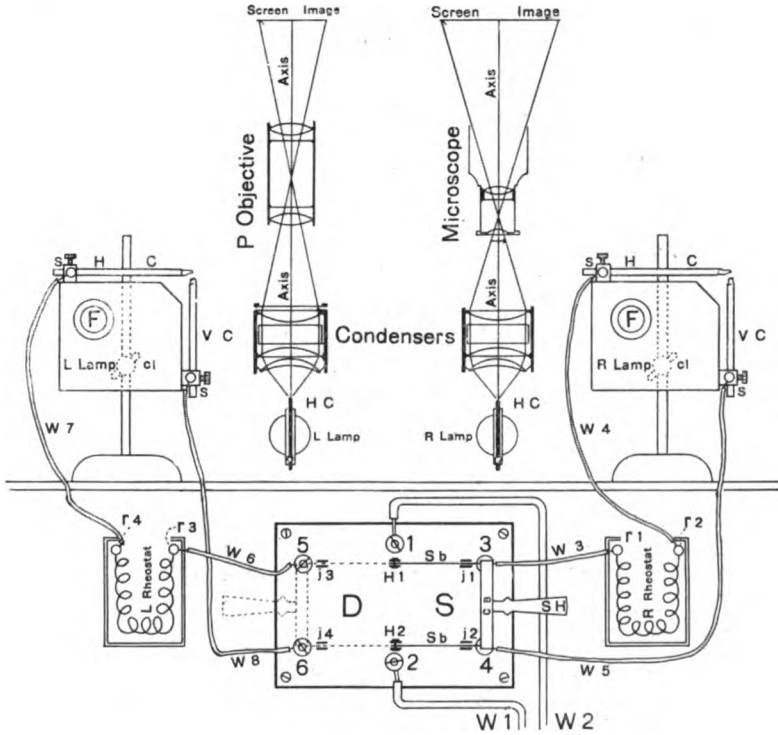

FIG. 162. COMBINED LANTERN-SLIDE AND MICRO-PROJECTION WITH TWO COMPLETE OUTFITS SIDE BY SIDE.

W1 W2 The supply wires from the outlet box (fig. 3).

D S Double-pole, double-throw knife switch.

1 Binding post of supply wire *W2*.

2 Binding post for supply wire *W1*.

3 Binding post for the wire (*W3*) from the switch to the rheostat at the right.

4 Binding post for the wire (*W5*) to the lower carbon of the arc lamp at the right.

5 Binding post on the switch for the wire (*W6*) to the rheostat at the left.

6 Binding post on the switch for the wire (*W8*) to the lower carbon of the arc lamp at the left.

H1, H2 Hinges for the switch blades.

j1, j2, j3, j4 Jaws for receiving the switch blades when the switch is closed.

SH Switch handle for opening and closing the switch. The switch is closed at the right. On the left the handle, bar and switch blades are shown with dotted lines.

- W 8* The wire to the left lamp, lower carbon.
W 6, W 7 Wire including the rheostat, passing to the upper carbon of the left arc lamp.
L Rheostat Rheostat for the left lamp.
r 3, r 4 The binding posts of the left rheostat.
L Lamp The left arc lamp.
F Feeding mechanism for the carbons.
cl Clamp for fixing the arc lamp in any vertical position on its standard.
s s Set screws for the carbons.
H C Horizontal or upper carbon.
V C Vertical or lower carbon.
R Rheostat Rheostat for the right arc lamp.
r 1, r 2 Binding posts for the rheostat.
W 3 W 4 Wire from the switch through the right rheostat to the upper carbon of the right arc lamp.
W 5 Wire to the lower carbon of the right lamp.
R Lamp The right lamp. It is exactly like the left one.
L Lamp, R Lamp The arc lamps for the two projectors.
Condensers The triple-lens condensers with water-cells for the two projectors.
Axis, Axis, Axis, Axis Principal optic axis in the two projectors.
P Objective The projection objective at the left.
Microscope The projection microscope at the right.
Screen Image, Screen Image The images formed on the screen by the two instruments.

NOTE.—In using these projectors it is only necessary to turn the switch handle over to the one desired and that lamp can be lighted. One can turn from one to the other at will.

A more economical arrangement would be to have a single rheostat inserted along either *W 1* or *W 2* before reaching the knife switch, then the single rheostat would serve for both lanterns.

With the two rheostats, as here shown, both lanterns could be run at the same time if there were two switch handles and double blades hinged at the center (*H 1, H 2*).

The projection microscopes in the open market rarely possess anything like this range. Very few will project an object as great as 25 mm. in diameter.

It seems to the writers of this book that the makers have unduly limited the range of their apparatus by a too rigid insistence on the use of substage condensers and projection oculars, and also by the effort to make combined apparatus. Combination always means compromise and more or less loss of individual efficiency.

It is certain, too, that most of them have not fully appreciated the necessity for dull black surfaces. The bright finish is probably to please the eye when the apparatus is not in operation. It certainly is not good for the eyes when the apparatus is in operation.

However, many opticians are coming to finish their apparatus in black, and all of them are ready to make modifications in their instruments which they are convinced will make them more effective and convenient for those who are to use them. But as many men have many minds it is not possible for the manufacturers to please every one in all particulars, hence the apparatus in the open market must represent a kind of average. While the authors realize the limitations mentioned above, it is a pleasure to be able to assert without reserve that the quality and design of the apparatus obtainable at the present time are excellent.

§ 434. As the projection microscopes most common in America are of German, English and home manufacture some examples are illustrated below.

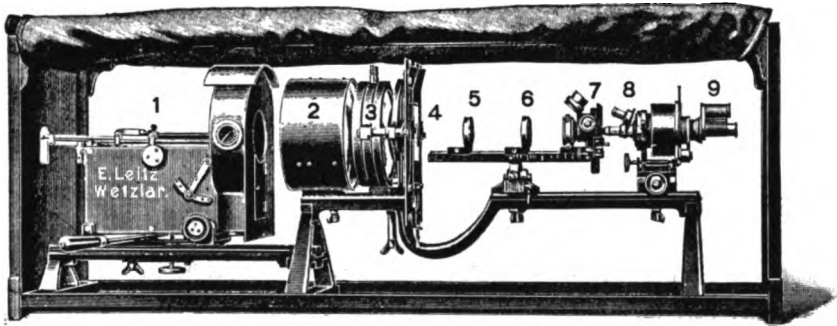

FIG. 163. LEITZ PROJECTION MICROSCOPE.
(From *Leitz Catalogue*).

- 1 Arc lamp.
- 2 Condenser next the arc lamp.
- 3 Water-cell.
- 4 The lantern-slide holder.
- 5 Iris diaphragm.
- 6 Biconcave, illuminating lens to give the light the right angle before it enters the substage condenser.
- 7 Stage and substage condensers, on a revolver for use with different powers.
- 8 Projection objectives on a revolving nose-piece.
- 9 Projection oculars on a revolver.

The enclosing curtain is turned over the top to uncover the parts. (See fig. 96 for the entire apparatus in its latest form, 1914).

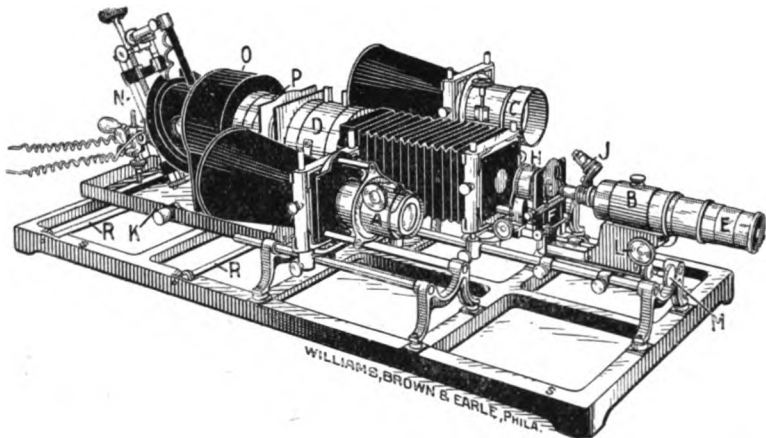

FIG. 164. PROJECTION MICROSCOPE, MAGIC LANTERN AND MEDIOSCOPE WITH SINGLE RADIANT.

(Cut loaned by Williams, Brown & Earle).

The arc lamp and condenser move laterally so that each instrument can be illuminated at will.

A The medioscope is an achromatic combination of large aperture for objects of large size, but smaller than lantern slides.

B Projection microscope with large projection ocular. It has a water-cell (*D*) in the path of the light. The arc lamp and condenser (*N O P*) are in place for micro-projection.

C Projection objective for lantern slides.

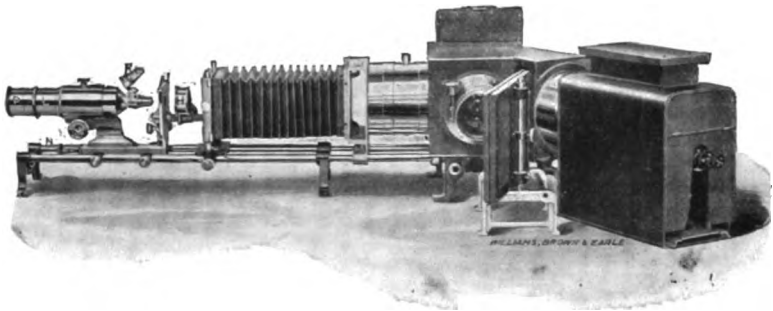

FIG. 165. NEW REFLECTING LANTERN WITH THE PROJECTION MICROSCOPE.

(Cut loaned by Williams, Brown & Earle).

This figure shows the new combined lantern of Williams, Brown & Earle with the projection microscope in position, the magic lantern objective having been

removed. For projection the mirror must be in place to reflect the light along the axis as for lantern slides. The change to the projection of opaque objects is almost instantaneous, but for lantern-slide projection the projection microscope must be removed and the lantern-slide objective put in place, but the apparatus is so constructed that this is easily accomplished.

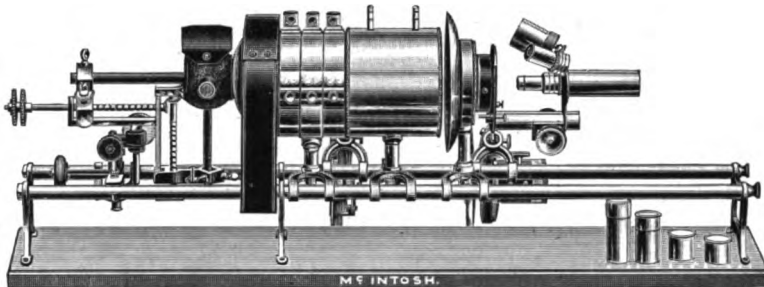

FIG. 166. IMPROVED, COLLEGE, BENCH LANTERN ARRANGED FOR MICRO-PROJECTION.

(Cut loaned by the McIntosh Stereopticon Co.).

The optical bench consists of a long baseboard with the two guide rods supported by three brackets.

As each part is independent it can be changed in position or entirely removed and other apparatus put in its place, thus giving great flexibility.

TROUBLES WITH THE PROJECTION MICROSCOPE

§ 435. The source of troubles with the projection microscope are mainly the same as with the magic lantern. These have been fully discussed at the end of Chapter I (§ 62-98). See § 128a for the blowing of fuses with the arc lamp on the house system.

The special troubles with the projection microscope are almost wholly due to the smallness of the lenses necessary for micro-projection; and as the foci of these lenses are relatively short, slight changes in the position of one of the elements of the apparatus, and slight deviations from the true axis produce correspondingly great effects. It is necessary to be more exact in micro-projection, but the great fundamental principles are exactly as for the magic lantern.

§ 436. **Insufficient illumination on the screen.**—Besides those given in Chapter I the following may be causes:

1. Too large a screen image may be attempted.

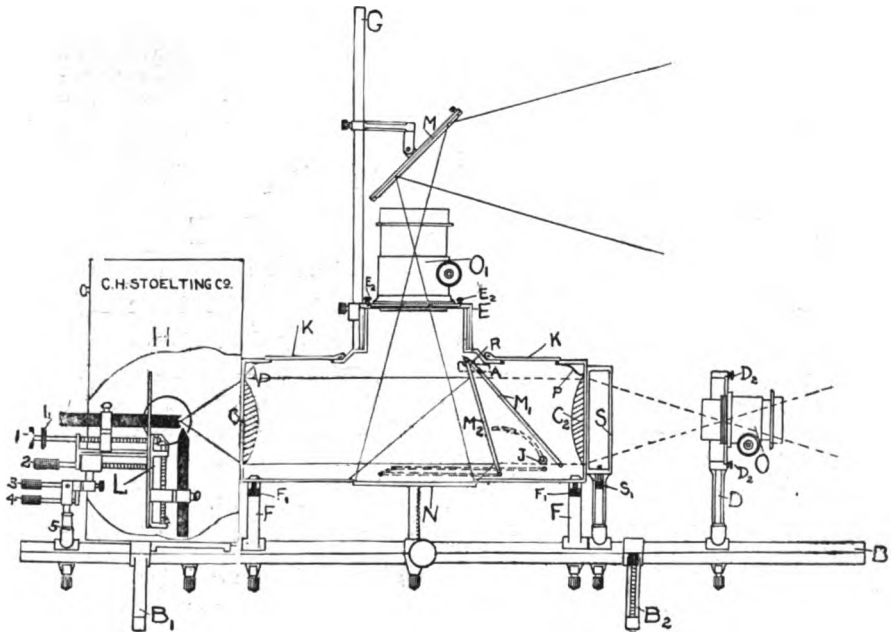

FIG. 167. UNIVERSAL PROJECTOSCOPE SHOWING THE ARRANGEMENT FOR HORIZONTAL TRANSPARENCIES AND FOR MICROSCOPIC PROJECTION.

(Cut loaned by the C. H. Stoelting Co.).

Commencing at the left:

- 1 Feeding screws for the carbons.
- 2 Fine adjustment for moving the arc lamp back and forth along the axis.
- 3-4 Fine adjustment screws for moving the arc vertically and laterally to keep the crater in the axis.
- LH Lamp and lamp-house.
- C First element of the two-lens condenser.
- F-F Supports.
- T Water-cell.
- M Mirror above the objective to reflect the light to the vertical screen.
- M₁, M₂ Mirror in position to reflect the horizontal beam directly upward.
- C₂, C₃ Second element of the two-lens condenser.
- R Projection microscope.
- B Optical bench on which slide the different pieces of apparatus.
- B₁, B₂ Supports of the optical bench. (See also fig. 16, 102).

2. The object may not be in the best position in the light cone (fig. 132).
3. The substage condenser, when that is used, may be a little too near or too far from the specimen. Slight changes in

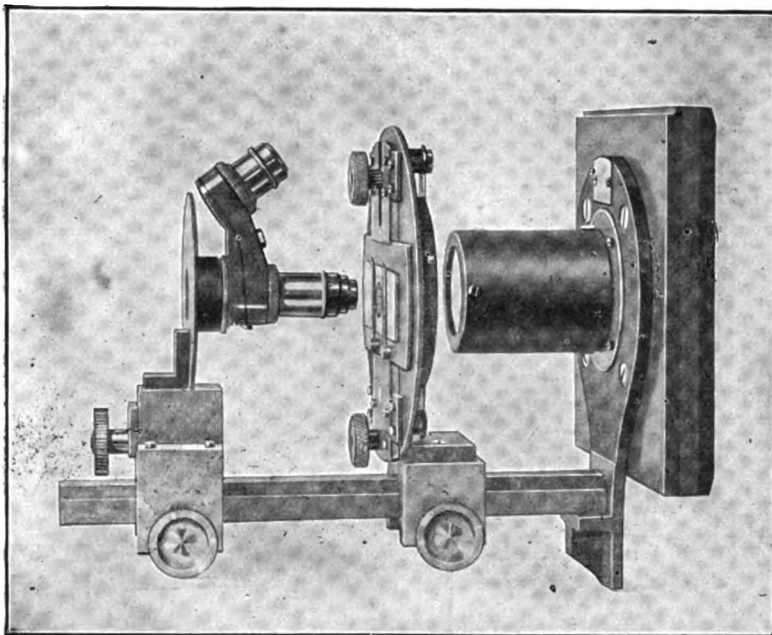

FIG. 168. THOMPSON'S PROJECTION MICROSCOPE.
(Cut loaned by the A. T. Thompson Co.).

The projection microscope with the substage condenser system is attached to the reflectoscope (fig. 97) in the position where vertical opaque objects are placed; this allows the direct beam of light to be utilized in micro-projection.

The stage and the objective holder are independent, and no ocular is used. This permits the projection of large objects with low powers or smaller objects with high powers. From the short tube employed, the field is not restricted.

its position often work wonders. The substage condenser may be too near to the large condenser or too far from it so that the light cone does not reach it in its most favorable position.

4. The room may not be dark enough or external light may fall directly on the screen from some window or open door.
5. Never forget the carbons. A slight mal-position or decentering of the crater may cause all the trouble.

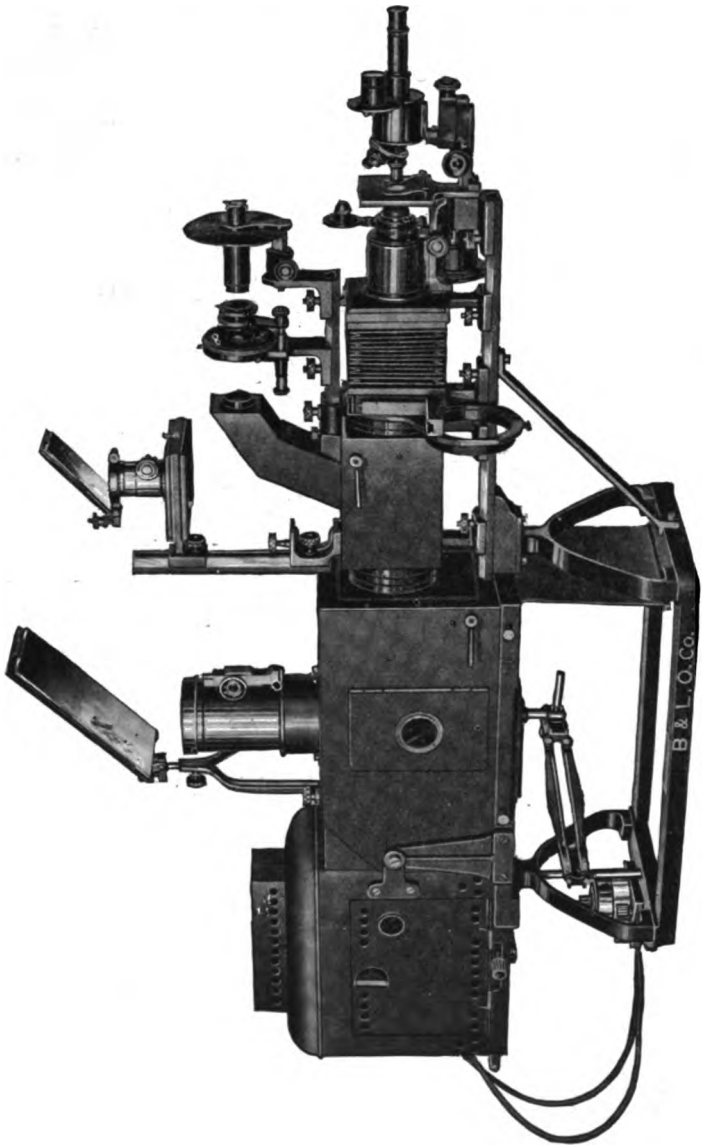

FIG. 169. NEW MODEL (1913) CONVERTIBLE BALOPTICON FOR ALL FORMS OF PROJECTION.
(Cut loaned by the Bausch & Lomb Optical Co.).

(Balance of descriptive matter on next page)

Commencing at the left:

Large, well ventilated, light-tight lamp-house. As shown in fig. 104, 105, the lamp-house with the lamp and first element of the condenser can be inclined to direct the light downward upon an opaque object.

Following the lamp-house is a dark box for opaque projection. The large projection objective with mirror is above and the table for the opaque objects below. Within the dark box is a mirror so inclined that it reflects part of the scattered light back upon the object (see also fig. 105). Opaque objects up to 20 cm. (8 in.) square can be projected.

Following the large objective for opaque projection is an objective for lantern-slide or other projection with the object in a horizontal position. Following this is the polarizing apparatus of glass plates (see § 880). The second element of the condenser serves for lantern-slide and for low power micro-projection, but for high powers this is turned out as here shown and a small double convex lens in the dark chamber near the first element of the condenser is swung into position and serves to project an image of the crater at the plane of the diaphragm of the substage condenser (fig. 170).

Just beyond the bellows are shown the projection microscope and the lantern-slide objective. These are so hinged parallel to the axis that the microscope can be turned laterally and thus bring the lantern-slide objective in position. In the picture the lantern-slide objective is swung aside and the projection microscope is in position.

The substage condensers for different objectives are shown on a revolving carrier, as are also the micro-projection objectives and the projection ocular and amplifier.

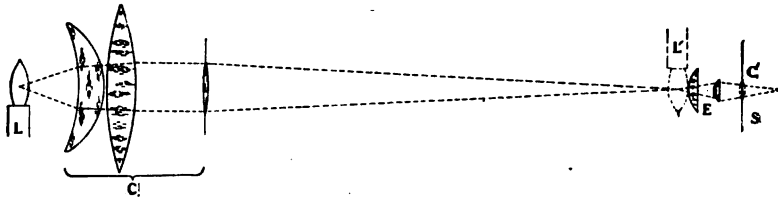

FIG. 170. DIAGRAM OF THE ILLUMINATING SYSTEM FOR HIGH POWER PROJECTION.

(Cut loaned by the Bausch & Lomb Optical Co.).

This is a modification of the Köhler system (§ 401-403), and consists of the first element of the triple condenser (meniscus and convex lens) to render the beam parallel. The small, convex lens near the condenser serves to project an image of the crater upon the plane of the diaphragm of the substage condenser. This is designed to fill the aperture of the substage condenser and, hence, of the high power objectives.

L The radiant.

C The meniscus and convex lens of the condenser and the small special convex lens for micro-projection.

L' Inverted image of the radiant.

E Substage condenser.

S The specimen.

C' Image of the small condensing lens in the plane of the specimen (*S*).

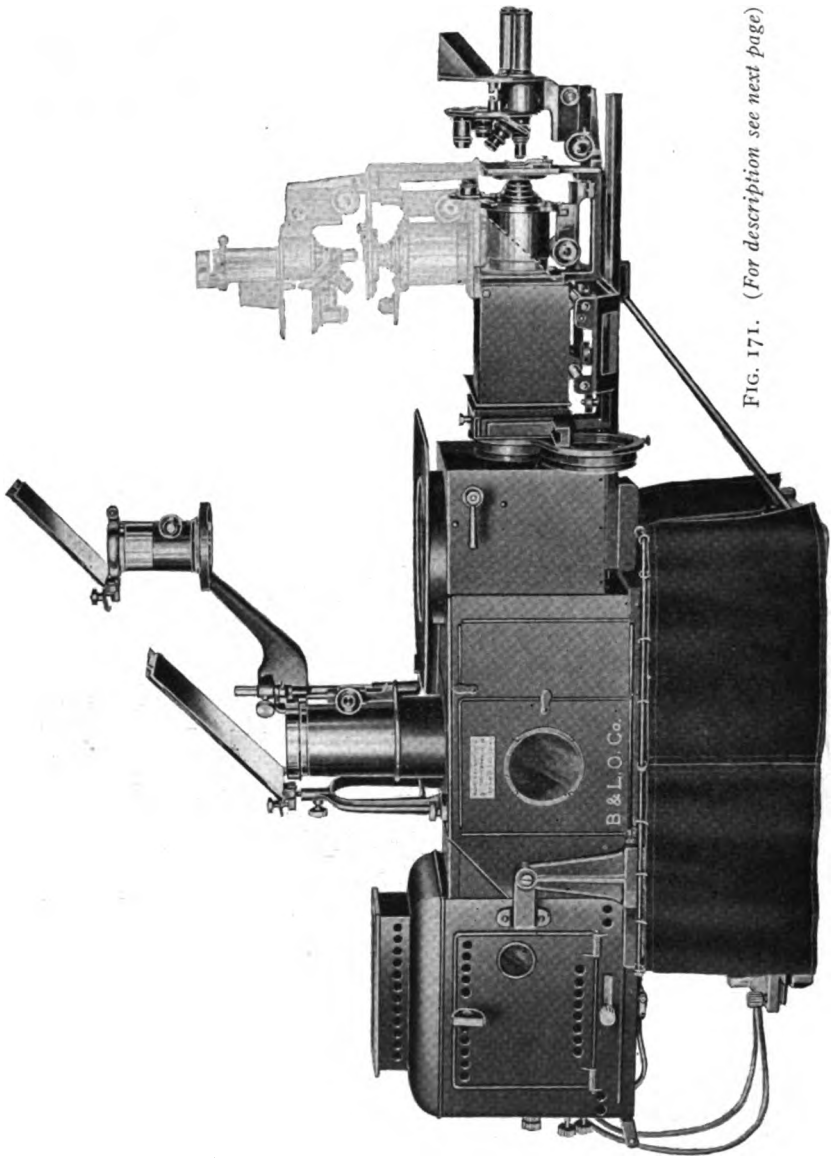

FIG. 171. (For description see next page)

FIG. 171. NEW STYLE CONVERTIBLE BALOPTICON FOR MICROSCOPE, LANTERN-SLIDE AND OPAQUE PROJECTION, AND FOR THE PROJECTION OF LARGE TRANSPARENTS IN A HORIZONTAL POSITION.

(Cut loaned by the Bausch & Lomb Optical Co.).

As shown in the picture, this instrument is designed for projecting all kinds of objects either in a vertical or in a horizontal position. For the large transparencies the object is placed on the broad plate beneath the objective. Immediately under the object is the condenser lens of 20 cm. (8 in.) diameter, thus making it possible to project X-Ray plates, brain sections, etc., 20 cm. (8 in.) in diameter. A mirror in the dark chamber directs the horizontal beam from the first element of the condenser vertically as in all projection of this kind.

For the large transparencies the projection objective is in a vertical position with mirror to reflect the light to a vertical screen and to overcome the left to right inversion.

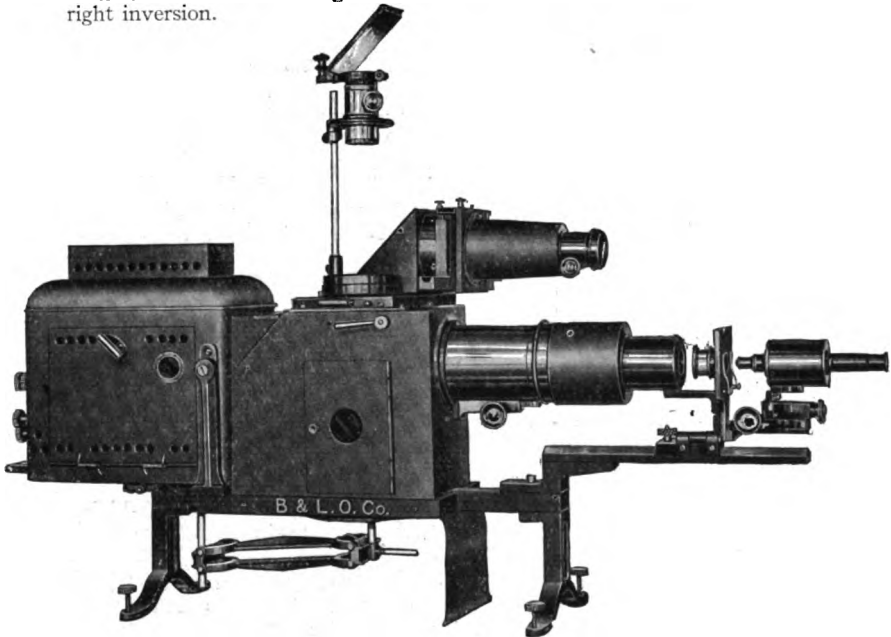

FIG. 172. UNIVERSAL BALOPTICON FOR OPAQUE OBJECTS, MICROSCOPIC OBJECTS AND FOR LANTERN SLIDES OR OTHER TRANSPARENT OBJECTS IN A VERTICAL OR A HORIZONTAL POSITION.

(Cut loaned by the Bausch & Lomb Optical Co.).

For the opaque projection and lantern slides in a vertical position see fig. 106.

For lantern slides or other transparent objects in a horizontal position the arrangement for vertical slides is pushed back, and this brings the condenser lens and plate for supporting horizontal objects over the opening. The same mirror is used for directing the beam of light upward as for the vertical slides.

For micro-projection the microscope is placed in line with the objective for opaque objects, the objective serving as a condenser. The light passes directly from the radiant through the first element of the condenser and the objective for opaque objects to the microscope. The microscope is so hinged that it can be turned aside and the other forms of projection quickly brought into use.

6. There may be mist on some of the glass surfaces as the water-cell, or some glass surface like the objective front may be dirty.

§ 437. **Unequal illumination of the screen.**—This is often due to the lack of centering of some element.

1. It is usually the crater of the upper carbon that gets out of the axis. It is easily corrected by means of the fine adjustments of the lamp (fig. 3).
2. There may be some less transparent part of the object over part of the field. One can easily determine this by moving the specimen slightly.
3. Part of the mask (§ 384, fig. 143, 148) may be in the field.



FIG. 173. BAUSCH & LOMB'S SIMPLEST FORM OF PROJECTION MICROSCOPE.
(Cut loaned by the Bausch & Lomb Optical Co.).

This is designed for low power projection and consists of an objective holder, rack and pinion focusing adjustment, stage and substage condenser for low powers. The whole is put in place of the projection objective for lantern slides. This simple outfit added to the magic lantern enables one to do very successful micro-projection.

§ 438. Hazy images may be due to direct light on the screen from some window, etc. Keep especially in mind also that internal reflections in the objective, the microscope tube or the amplifier tube will cause hazy images (§ 370, 371), also dirt or balsam on the front lens of the objective.

§ 439. Dark spots on the screen.—

1. They may be caused by air bubbles in the water-cell or in the stage cooler.

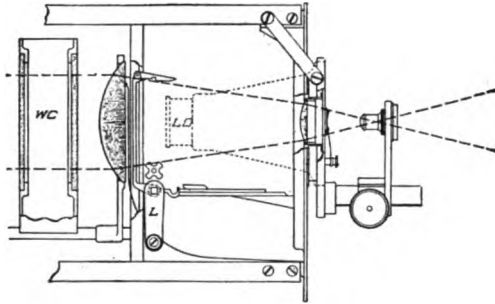

FIG. 174. SIMPLE ADDITION TO THE MAGIC LANTERN FOR MICRO-PROJECTION.

(Cut loaned by the Spencer Lens Co.).

This consists of a jointed frame by which the objective holder and focusing device can be brought down in position when the lantern-slide objective is turned aside. No microscope tube is used. This makes a very efficient and convenient addition to a magic lantern at moderate cost, and with it a great deal of projection can be successfully accomplished.

For lantern-slide projection the microscope is turned to the top of the lamp enclosure and the lantern-slide objective is turned on its hinge back into position in the optic axis.

2. They may be caused by dark spots or bubbles in the slide or specimen.
3. Dark spots on the condenser, amplifier or ocular may cause them.

§ 440. General conditions for good micro-projection.—With good specimens, clean glass surfaces, and all the elements on one axis, there should be no trouble in getting a good screen image on a suitable screen and in a well darkened room.

It would be of very great advantage for any man who aspires to use the projection microscope effectively, if he could see the room, apparatus, and exact method of work of some one who had mastered the art. Good projection will not do itself.

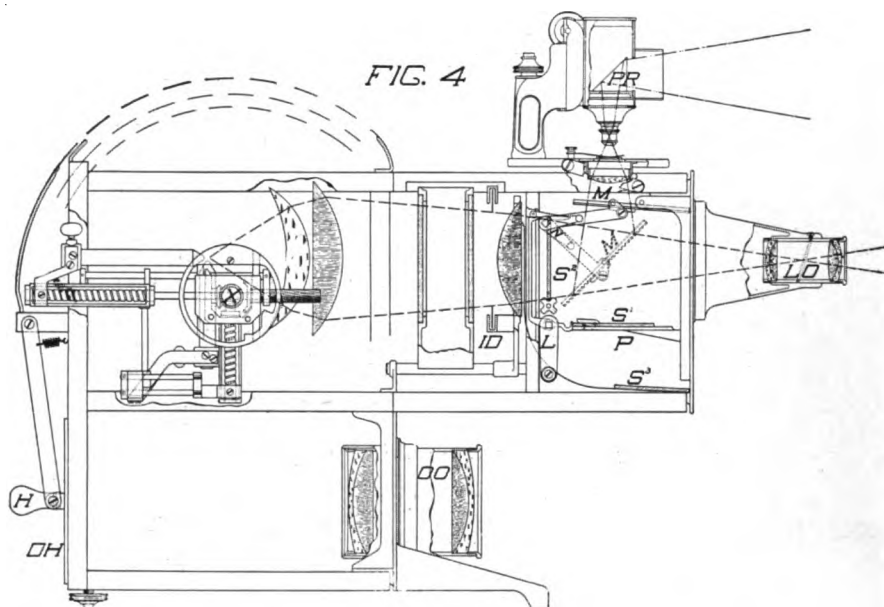

FIG. 175. MODEL 4-5 DELINEASCOPE WITH THE MICROSCOPE IN A VERTICAL POSITION FOR HORIZONTAL OBJECTS.
(Cut loaned by the Spencer Lens Co.).

This figure is to show the course of the rays for lantern slides in a vertical position and for microscopic objects in a horizontal position.

A mirror M reflects the light vertically through the horizontal specimen, and by means of a prism (PR) in the tube of the microscope the vertical light is made to extend out horizontally to the screen.

A joint in the microscope frame makes it possible to turn the microscope down in front of the instrument after turning the lantern-slide objective aside on its hinge. Then vertical objects can be projected in the usual manner, or by using the prism (PR) the image can be reflected down upon a horizontal drawing surface.

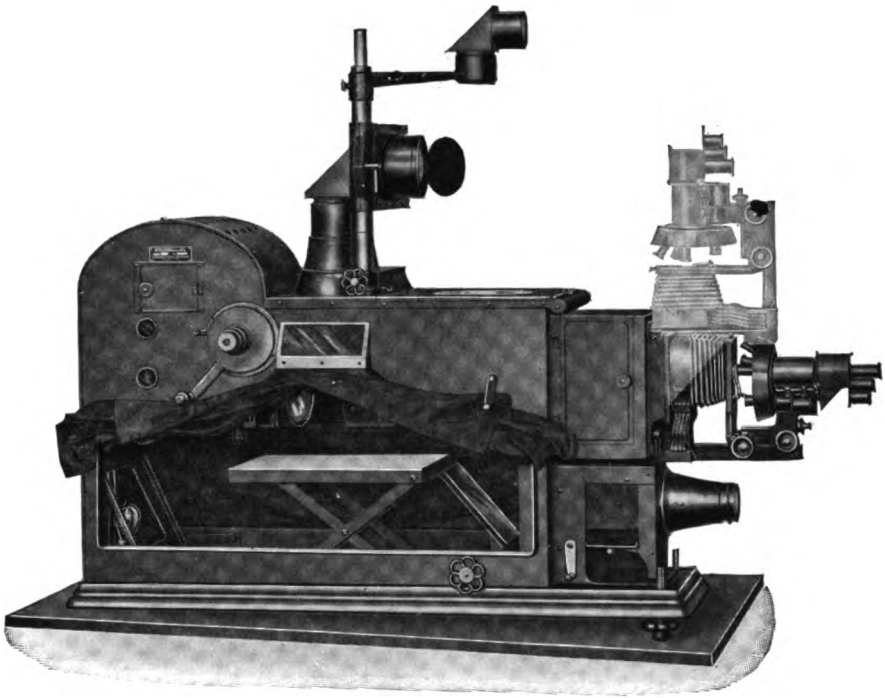

FIG. 176. MODEL 8 DELINEASCOPE SHOWING THE POSITION OF THE MICROSCOPIC ATTACHMENT FOR VERTICAL AND FOR HORIZONTAL OBJECTS.

(Cut loaned by the Spencer Lens Co.).

This projection microscopic attachment is designed to use with or without oculars or amplifiers, and for microscopic objectives of all foci from 125 mm. to the highest available. The substage condenser consists of several lenses which are easily turned in place or out of position. By making a suitable combination any object and any objective can be used. To enable the operator to get the object in the right position in the cone of light there is a rack and pinion movement moving microscope and stage toward or from the condenser. This is done by the lower milled head shown. The upper milled head is for the usual coarse adjustment and a micrometer screw is present for the fine adjustment (see also fig. 177).

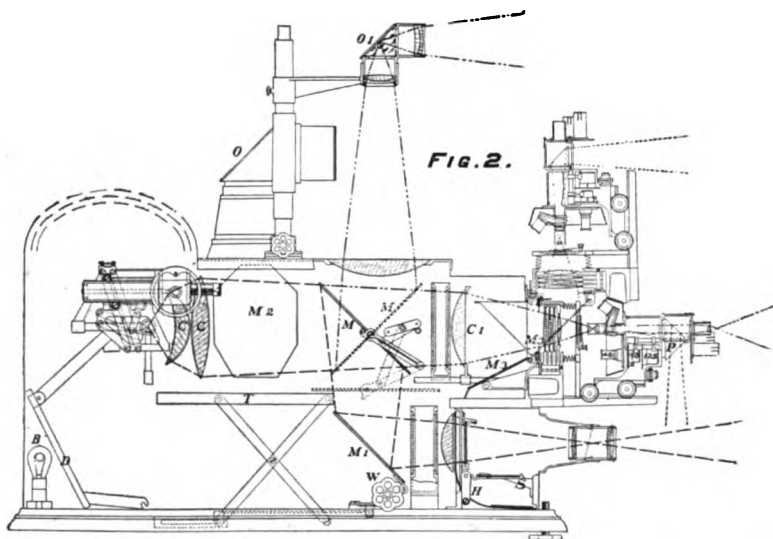

FIG. 177. DIAGRAM SHOWING THE COURSE OF THE RAYS FOR LANTERN SLIDES AND FOR MICROSCOPIC OBJECTS IN A VERTICAL AND IN A HORIZONTAL POSITION WITH MODEL 8 DELINEASCOPE.

(Cut loaned by the Spencer Lens Co.).

- T* Table for opaque objects.
- W* Wheel by which the table is raised and lowered.
- D* Diaphragm which may be used above the table.
- B* Bulb which always illuminates the interior of the machine.
- C* Condensing lenses in front of the arc.
- O* Large objective for opaque work.
- O₁* Smaller objectives for vertical attachment.
- M* Mirror for throwing light downward to the lantern slide.
- M₁* Mirror for throwing a perpendicular beam out through the lantern-slide compartment.
- M₂* Mirror used in connection with the projection of the vertical side of an object.
- M₃* Mirror which assumes a position of 45° when the microscope is used perpendicularly.
- P* Prism which is used in the prism chamber when the microscope is used perpendicularly or for drawing on a horizontal surface when the microscope is horizontal.
- S* Shelf upon which the lantern slide is placed previous to throwing it up into the optical axis by the handle.
- H* Handle of the lever for raising lantern slides into position.

§ 441. Summary of Chapter IX:

Do

1. Use actual objects in lectures and discussions as well as diagrams (§ 352).

2. Employ a projection microscope with equipment for specimens ranging from 60 mm. to less than 1 mm. in diameter (§ 354).

3. In demonstrating with the projection microscope use first a low power and show the relations of parts, then use higher powers to show details.

4. Use objectives without oculars from 125 mm. to 4 mm. focus (§ 355).

5. Oculars or amplifiers can be used with all the objectives on the microscope (fig. 138), but preferably with those not higher than 8 mm. focus.

6. Use a screen distance from 5 to 10 meters (16 to 33 feet).

7. It is better to use a microscope in the usual manner if very high powers, like the oil immersion, are to be used (§ 355).

8. If possible use a triple-lens condenser (§ 363).

Do Not

1. Do not stop with diagrams where actual specimens can be shown. Diagrams alone are liable to give false impressions.

2. Do not use projection apparatus with a narrow range of field or of powers.

3. Do not show minute details without first showing the object as a whole, so that relations can be clearly recognized.

4. Do not use oculars for projecting for large, class demonstrations. Oculars restrict the field too much.

5. Do not use oculars or amplifiers unless for special reasons.

6. Do not have the screen distance too great.

7. Do not try to make out the finest details by projection, but use a microscope in the ordinary way.

8. Do not use a poor condenser for micro-projection, the triple form, meniscus next the radiant, is best.

9. Make the room dark and use a perfectly white image-screen for micro-projection (§ 360).

10. Use only the direct current arc light for micro-projection, unless compelled to use alternating current (§ 412).

11. Use an ammeter and a variable rheostat or other balancing device and be very careful about the wiring (fig. 2-3 188).

12. The arc lamp must have fine adjustment screws to enable one to keep the arc centered on the objective front (§ 362).

13. Always use a water-cell in micro-projection with the arc lamp radiant (§ 364).

14. Use a mechanical stage for serial sections (§ 366).

15. Blacken the objective mounts, and all metal parts of the projection apparatus to avoid glare; make sure there are no shiny surfaces within the projection apparatus (§ 370-371).

9. Do not try to project with the microscope in a room that cannot be properly darkened or with a dirty screen.

10. Do not use alternating current if it is possible to obtain direct current.

11. Do not neglect the ammeter and the variable rheostat when installing a projection microscope.

12. Do not try to use an arc lamp without fine adjustments, otherwise the crater cannot be kept centered.

13. Do not project with the arc lamp without using a water-cell to absorb the radiant heat.

14. Do not try to show selected sections of a series without the help of a mechanical stage.

15. Do not leave the objective mounts with brilliant reflecting surfaces to dazzle the eyes of the operator, and do not leave shiny surfaces within the apparatus to give cross lights and make the image dim.

16. Use a hood on the objective to aid in centering the light and in placing the objective the right distance from the condenser (§ 372); a light shield beyond the objective to stop stray light is also an advantage (§ 373).

17. It is of the utmost importance that every part be accurately centered for micro-projection (§ 375), and that the parts should be separated from one another the right distance (§ 376, 382).

18. Remember that it is a pure waste to use too great an amperage (§ 378).

19. As the same object is to be shown entire and with magnified details and different objects require different magnifications, it is convenient to have two, three or four objectives of different powers in a revolving nose-piece (§ 379).

20. For exhibition purposes it is a great advantage to use carbons whose ends have been shaped by previous burning in the lamp (§ 380).

16. Do not forget the advantages of an objective hood for centering the light and preventing glare; and do not omit the light shield to cut off stray light.

17. Do not fail to have all parts accurately centered, and the correct distance apart.

18. Do not use a greater current than necessary.

19. Do not show all objects with the same objective, but have two or three on a revolving nose-piece so that different powers can be used with the minimum of trouble.

20. Do not forget to shape the ends of the carbons by burning them awhile in the arc lamp before any formal exhibition.

21. Be sure that the carbons are in the correct mutual position to give a good light. A screen image of the burning carbons often is of real help (§ 381).

22. Mask the preparations for exhibition (§ 384).

23. Remember the advantages of a large field for seeing the relation of parts (§ 387).

24. Remember that one can do good projection work with an ordinary microscope (§ 393).

25. For objects which must remain in a horizontal position, a vertical microscope must be used; this involves the use of two mirrors or of a mirror and a prism to reflect the light upward and then horizontally to the screen (§ 397).

26. Have everything in perfect order and adjustment whenever an exhibition of microscopic objects is to be made. Haphazard work will give only haphazard results (§ 400).

21. Do not omit the correct setting of the carbons. A good light cannot be produced with the carbons in the wrong mutual relation.

22. Do not exhibit specimens which are not properly masked. It is necessary to be able to work with certainty and rapidity in an exhibition.

23. Do not forget the importance of a large field so that the relations of parts can be seen.

24. Do not forget that one can do very good work by using an ordinary microscope in projection.

25. Do not try to use a horizontal microscope when one in a vertical position is called for.

26. Do not do haphazard projection.

27. For high powers like oil immersions, the screen distance must be short, the screen and light perfect, the room very dark and the spectators close to the screen (§ 401-410).

28. Remember the advantages of the small-carbon arc lamp for use on the house lighting system for drawing and for demonstrating to a few (§ 417).

29. Use sunlight when it is available (§ 419).

30. One can do excellent micro-projection by home-assembled apparatus (§ 424).

31. For passing from micro-projection to lantern-slide projection it must be remembered that the lantern-slide picture is much brighter with the same arc light. To avoid the great contrast, one would do well to use a tinted glass in the magic lantern to soften the light as for opaque and lantern-slide projection (§ 282).

32. Study faithfully the "troubles" with the magic lantern in Ch. I, and in this chapter (§ 435-439).

27. Do not try high power projection for a long screen distance, a light room or a poor screen, or anything else not in accordance with the most exacting work.

28. Do not forget the advantages of the small-carbon arc lamp on the house lighting system for drawing and demonstrations for a few persons.

29. Do not neglect the most brilliant light, i. e., sunlight, when it is available.

30. Do not refrain from micro-projection because you do not have an expensive special outfit. Home-made apparatus is often more effective and can be assembled by any one.

31. Do not forget the physiology of vision in passing from a dim to a brilliant light or the reverse.

32. Do not expect the apparatus to supply the brains.

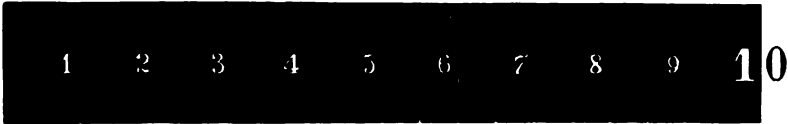

10 CENTIMETER RULE

THE UPPER EDGE IN MILLIMETERS, THE LOWER IN CENTIMETERS, AND HALF CENTIMETERS

THE METRIC SYSTEM

UNITS	THE MOST COMMONLY USED DIVISIONS AND MULTIPLES	
THE METER FOR LENGTH	}	Centimeter (cm.), 0.01 Meter; Millimeter (mm.), 0.001 Meter; Micron (μ), 0.001 Millimeter; the Micron is the unit in Micrometry.
THE GRAM FOR WEIGHT		Kilometer, 1000 Meters; used in measuring roads and other long distances.
THE LITER FOR CAPACITY		Milligram (mg.), 0.001 Gram. Kilogram, 1000 Grams, used for ordinary masses, like groceries, etc.
		Cubic Centimeter (cc.), 0.001 Liter. This is more common than the correct form, Milliliter.

Divisions of the Units are indicated by the Latin prefixes: deci, 0.1; centi, 0.01; milli, 0.001; micro, one millionth (0.000001) of any unit.
 Multiples are designated by the Greek prefixes; deka, 10 times; hecto, 100 times; kilo, 1000 times; myria, 10,000 times; mega, one million (1,000,000) times any unit.

TABLE OF METRIC AND ENGLISH MEASURES

Meter (M.) (unit of length) = 100 centimeters;	
1,000 millimeters, 1,000,000 microns (μ)	39.38 inches; 3.28 feet; 1.094 yard.
Centimeter (cm.) = .01 meter; 10 millimeters,	
10,000 microns (μ).	.3937 ($\frac{1}{25}$) inches
Millimeter (mm.) = .001 meter, .1 centimeter,	
1,000 microns (μ).	.03937 ($\frac{1}{25}$) inches
Micron (μ) = .001 millimeter (unit of measure in micrometry)	.000,039,37 inch 1/25000 inch
Liter (L.) (unit of capacity) = 1,000 cubic centimeters	(1 quart approx.)
Cubic Centimeter (cc.) = .001 liter	($\frac{1}{8}$ cubic inch approx.)
Gram (g.) (unit of weight)	15.43 grains.
Kilogram (Kg.) = 1,000 grams.	2.2046 (2 $\frac{1}{4}$) pounds.
Yard = 3 feet, 36 inches.	91.44 centimeters.
Foot = one-third yard, 12 inches	30.47 centimeters.
Inch = $\frac{1}{36}$ yard, $\frac{1}{12}$ foot.	2.54 centimeters.
.001 ($\frac{1}{1000}$) inch.	.0254 millimeters = 25.4 μ .
Fluid ounce = 8 fluidrachms.	29.57 (30) cubic centimeters.
Pound (Lb.) (avoirdupois) = 16 ounces.	453.6 grams.
Ounce (oz.) (avoirdupois) = 437 $\frac{1}{2}$ grains.	28.35 (30) grams.
Ounce (oz.) (Troy or apothecaries) = 480 grains	31.10 (30) grams.

CHAPTER X

DRAWING AND PHOTOGRAPHY BY THE AID OF PROJECTION APPARATUS.

§ 450. Apparatus and Material for Chapter X:

Room with electric current supply (§ 453); Arc lamp and rheostat or other regulating device (§ 462, 493); Water-cell (§ 504); Carbons of various sizes for small and large currents (§ 486, 488-9); Condenser suitable for the objects to be projected (§ 467, 533); Microscope with objectives and oculars and with a 45 degree mirror or a prism (§ 458-459, 493); Photographic objectives for projecting the images of large objects for use with negatives or lantern slides (§ 534); Movable drawing surface (§ 459-460); An opaque lantern (§ 469); A photographic camera with ground-glass focusing screen (§ 471); Metric measures; Transparent micrometer (§ 508+); Letters on tissue paper for drawings (§ 528+); Photographic paper, negatives and chemicals (§ 532, 547); See also the needs in Ch. I, (§ 1).

§ 451. For the history of drawing with projection apparatus see the Appendix, with its references to literature.

It will also be advantageous to consult the works given in Ch. I, § 2 and the catalogues of the manufacturers of projection and photographic apparatus. The Eastman Kodak Co. has published a very useful booklet on Enlarging. This deals, not with microscopic, but with the moderate enlargements up to 20 diameters with photographic objectives.

DRAWING WITH PROJECTION APPARATUS

§ 452. The aid which projection apparatus could give for getting accurate drawings was recognized from the beginning; and, indeed, this was considered one of its most important uses.

By the aid of projection apparatus accurate drawings can be made by any careful worker, although artistic perfection can be added only by those gifted of nature. Even for born artists it is helpful in getting the details of complex objects in due position and in correct proportion.

The range of possibility is great, for, by the aid of projection apparatus, one can draw the images produced by the objectives used with the magic lantern, photographic objectives, and microscopic objectives of all powers. The microscopic objectives may also be combined with amplifiers or with oculars for projecting the images to be drawn.

Drawing with projection apparatus has the advantage over drawing with the camera lucida that one can see the entire specimen in one field. More important still, the artist can use both eyes. There is entire freedom of head and eyes, the image remaining constantly in one place, regardless of the position of the draughtsman.

ROOM FOR DRAWING WITH PROJECTION APPARATUS

§ 453. Any room suitable for projection is also suitable for drawing with projection apparatus.

Any laboratory which can be made moderately dark in the day time is suitable for day work; and, of course, any room is suitable in the evening.

§ 454. **Special photographic and drawing room.**—Many laboratories have one or more photographic rooms which are also used for drawing. These are mostly separate rooms. Sometimes they are adjoining a laboratory, and sometimes they are like a ticket booth in a large railroad station, i. e., a room within a larger room (fig. 179). This is the plan adopted in the Wistar Institute (Anat. Record, 1907) and in the author's laboratory (Proc. Amer. Micr. Soc., 1906, p. 44-45). If these rooms are painted dull black within, stray light is absorbed, and it is much easier to get sharp pictures. In a black room the door can be left partly open and thus secure better ventilation.

As the radiant gives off much heat it is an advantage to have an electric fan in the room if one works several hours at a time. It is especially necessary in hot weather,—summer vacations when teachers have time for research.

§ 455. **A drawing room made with screens or curtains.**—If one has not a permanent room or booth in the laboratory, a fairly good

substitute can be made by means of opaque curtains enclosing one corner of a room. This would be something like the early drawing rooms or tents used by Kepler and others for sketching landscapes (fig. 88, 89). It is advantageous to have the cloth curtains rendered fire-proof by saturating them with a solution of sodium tungstate, or some other fire-proofing solution (see *Popular Science Monthly*, Vol. LXXXI, 1912, p. 397).

(Proceedings of the Amer. Assoc. Adv. Science, Vol. XLIII, 1894, p. 119.)

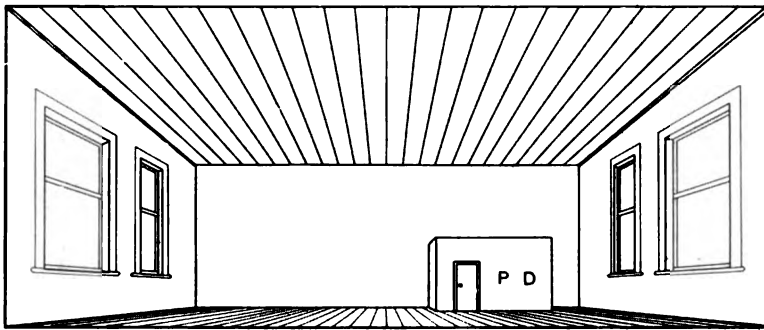

FIG. 179. PHOTOGRAPHIC AND DRAWING BOOTH (P D) IN A LARGE LABORATORY.

This booth contains water and electric supply for photography and for projection work including drawing, printing and photo-micrography.

PROJECTION APPARATUS FOR DRAWING

§ 456. The apparatus used for drawing may be the ordinary magic lantern (fig. 1-2), the projection microscope (fig. 121), the opaque lantern (fig. 92-111), or a photographic camera (fig. 117, 217).

§ 457. **Drawing on a vertical surface.**—For this, the only addition to any of the forms of projection apparatus is a vertical drawing-board, mounted so that it may be moved to a greater or less distance from the apparatus to get the desired size of image. Or one may use a fixed wall for the drawing surface and move the

apparatus back and forth to get the different sizes required. (For getting the picture like the object see § 512).

§ 458. **Drawing on a horizontal surface.**—From the earliest use of projection apparatus for drawing, it was the custom to draw the image on a vertical surface, or by means of a plane mirror to change the direction of the rays of light so that the image would fall on a horizontal surface. It was found also that when a plane mirror

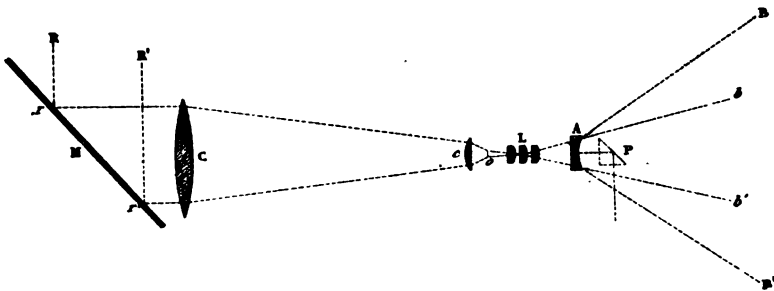

FIG. 180. PROJECTION MICROSCOPE FROM CHEVALIER (Planche 2).

M Mirror reflecting the sun's rays (RR' , rr') to the condenser (*C*); from the condenser they pass to the substage condenser (*c*) and are condensed upon the object (*o*).

L Achromatic objective.

A Amplifier composed of a plano-convex and a double concave lens; this amplifier makes the rays much more divergent, i. e., BB' instead of bb' .

P Right-angled prism acting as a 45 degree mirror to project the image down upon a horizontal surface for drawing.

was used, the image on the horizontal surface appeared erect. Sometimes the mirror was placed before the objective and changed the direction of the rays 90 degrees (fig. 89), and sometimes it was used to bend the rays downward after passing through the objective. With the microscope and magic lantern the mirror is usually beyond the objective (fig. 182, 193).

Reflecting prisms have been much employed with the microscope instead of mirrors (fig. 180, 192). They have the advantage of giving more perfect reflection and of avoiding doubling of the image, as occurs with a plane mirror silvered on the back.

§ 459. **Drawing table with attached 45 degree mirror.**—One of the simplest and most convenient arrangements for the magic lantern and the microscope is to have a large mirror attached to the drawing table. The table and mirror can then be moved toward or from the projection apparatus to aid in getting the desired magnification (fig. 182).

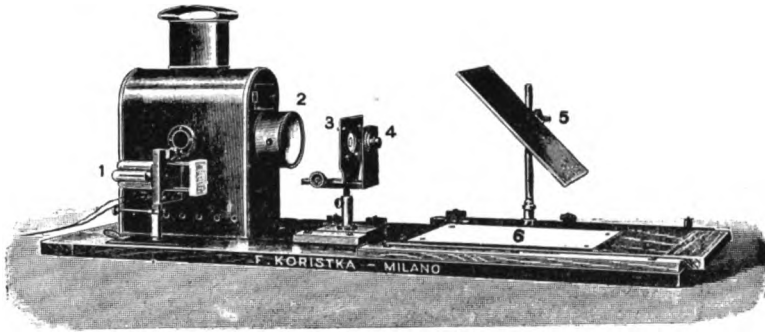

FIG. 181. KORISTKA'S SIMPLE DRAWING OUTFIT.
(From *Koristka's Microscope Catalogue*).

This drawing outfit can be connected with the house lighting system.

- 1 Nernst lamp for illumination.
- 2 Condenser connected with the lamp-house.
- 3 Stage of the microscope.
- 4 Projection objective.
- 5 45° mirror for reflecting the rays down upon the horizontal drawing surface.
- 6 Horizontal drawing surface. The drawing-board slides along the axis, thus making it possible to vary the distance and hence to increase or diminish the size of the drawing at pleasure.

When sitting down to draw, a convenient height for the table is 76 cm. ($2\frac{1}{2}$ ft.). The one shown in fig. 182 has a top 100 cm. long and 75 cm. wide (39 x 30 inches).

The plate glass mirror is 75 cm. long and 60 cm. wide ($2\frac{1}{2}$ x 2 ft.). It is permanently fixed at 45 degrees inclination; and to avoid the sharp angle at the base of the mirror it is raised from the table 10 to 15 cm. (4 to 6 in.).

The mirror itself is in a strong wooden frame, and it is supported by vertical and horizontal pieces, as shown in figure 182.

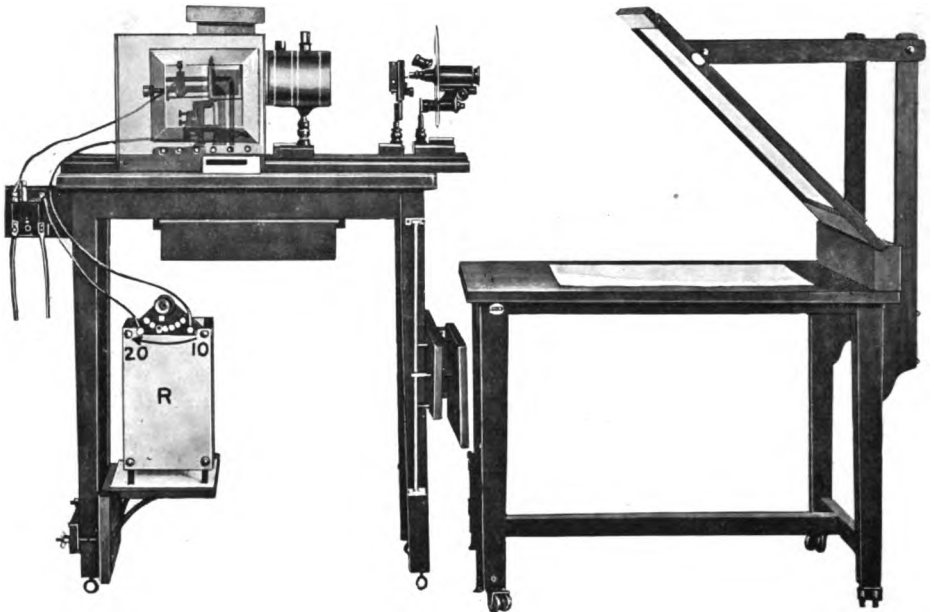

FIG. 182. DRAWING WITH PROJECTION APPARATUS AND A MOVABLE TABLE WITH 45° MIRROR.

Commencing at the left:

Supply wires to the table switch.

From one pole of the table switch a wire extends to the binding post of the upper carbon of the arc lamp.

From the other pole of the switch a wire extends to the rheostat (*R*) and from the rheostat to the binding post of the lower carbon.

Arc lamp within the lamp-house.

The metal lamp-house is shown as if transparent, as it was left in position during only a part of the time while the photograph was exposed.

Condenser and water-cell (fig. 121).

Stage of the microscope with stage water-cell.

Projection microscope with objectives in the revolving nose-piece, a shield to stop stray light and an amplifier in the end of the large tube.

The lamp, condenser, stage and microscope are on independent blocks and can be moved freely on the optical bench. The picture of the 10 centimeter rule under the door of the lamp-house gives the scale of the picture.

R Adjustable rheostat.

20-10 These numerals show the range of current which the rheostat permits. The arrow indicates the way to turn the knob to increase the current (see fig. 281, Ch. XIII).

On the legs at the left is a shelf for the rheostat.

The adjustable drawing shelf has an arrangement for moving up and down on metal ways which can be attached to any table, whatever the form of the

legs. The supporting brackets are so jointed that the shelf can be let down when the large drawing table needs to be brought up close to the projection table. This method of moving the drawing shelf and lowering it is due to Dr. B. F. Kingsbury.

As one must sit close to the table, there should be no vertical rail under the front edge to interfere with the knees of the artist. At this edge there is a strengthening piece flat against the top. On the other edge and at the ends are the usual vertical rails. To ensure the rigidity of the table, there are pieces passing across the ends between the legs and near the bottom, and a middle piece extending lengthwise between these end pieces, thus holding the table legs at the two ends, so that they cannot spread either side-wise or endwise (fig. 182).

The legs are 6 cm. ($2\frac{1}{4}$ in.) square, and smooth on the lower end so that the table can be moved easily, or casters may be used. The entire table is finished in dull black and all the corners rounded.

§ 460. Projection table with drawing shelf.—The simplest of all arrangements for drawing with the projection microscope and the magic lantern is a projection table with an adjustable shelf attached to the end (fig. 183, 187). For this arrangement the mirror or prism for reflecting the light downward must be close to the objective or to the end of the microscope.

As the shelf can be raised to the level of the table top or depressed about 50 cm. (20 in.), it is possible to get quite a range of magnification from the different image distances alone, using the same objective; but, of course, the upper range is not so great as with a separate drawing table. With the drawing shelf, however, one can get lower powers, as the image can be closer to the end of the objective. By using different objectives one can get all the range desired with either arrangement. The single table and adjustable shelf is, of course, much the cheaper.

If one uses the table and drawing shelf it is necessary that the apparatus be movable on the optical bench, so that the objective may be beyond the end of the table over the drawing shelf. This is easily accomplished with an optical bench like that shown in fig. 158-159. In case one desires a larger drawing surface than the

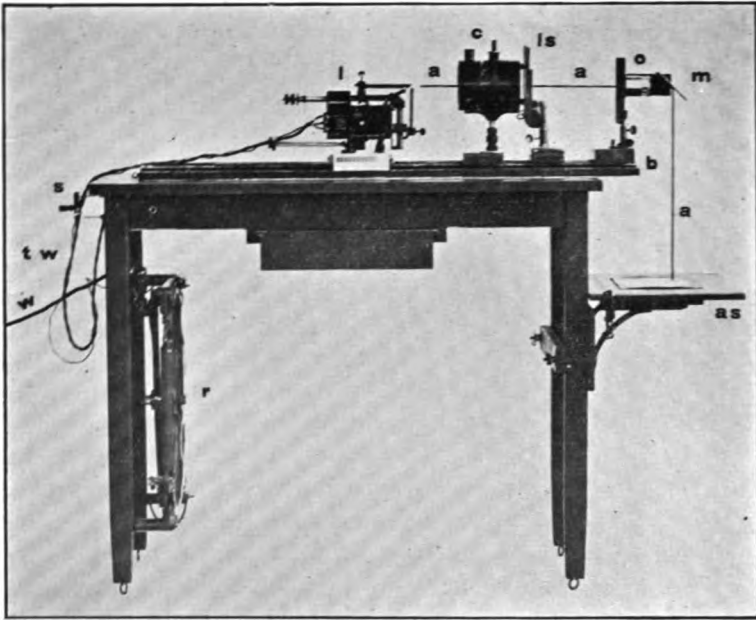

FIG. 183. ARRANGEMENT FOR DRAWING OBJECTS THE SIZE OF LANTERN SLIDES.

The illumination can be by the ordinary heavy lantern-slide current, or by the small current of the house lighting supply. The 5 ampere current is sufficient for drawing. If one wishes to draw on a horizontal surface, then a mirror is put beyond the objective. If the drawing is on a vertical surface, as for wall diagrams, then the mirror is removed.

w Supply wire cable from the outlet box (fig. 3).

lw Wires to the arc lamp.

s Table switch.

r Rheostat of the theater-dimmer type with a range of 5 to 35 amperes.

l Arc lamp.

a a a Axis.

c Condenser and water-cell.

ls Lantern-slide support.

o Projection objective for large objects.

m 45° mirror to reflect the light down upon the horizontal drawing shelf.

as Adjustable drawing shelf.

b Baseboard with track along which the carrying blocks can be moved independently.

attached shelf, a small drawing-board may be clamped to the shelf as shown in fig. 183.

The size of the projection table is the same as given above (§ 424). A convenient size for the drawing shelf is 50 cm. (20 in.) long, and 25 cm. (10 in.) wide.

In fig. 183 the legs of the table are square and straight and the shelf slides up and down on the legs, being clamped in any desired position by the thumb nuts.

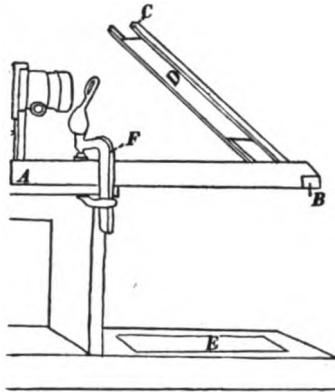

FIG. 184. DR. RILEY'S ATTACHMENT TO AN ORDINARY MAGIC LANTERN FOR DRAWING.

(*Science*, Vol. XXIX, 1909, p. 37-38).

- AB* Mirror support.
- CD* Mirror and mirror frame.
- F* Clamp for fastening the mirror support in position in front of the magic lantern objective.
- E* Drawing paper under the mirror.

In figure 182 is shown a neat and efficient arrangement designed by Dr. B. F. Kingsbury, in which the shelf is hinged so that it can be lowered out of the way when using the drawing table with attached 45 degree mirror. The guides for sliding the shelf up or down and clamping it in any desired position, are of metal and can be attached to any table whether the legs are square, tapering or of any other form.

RADIANTS FOR DRAWING APPARATUS

§ 461. **General.**—The best light for projection is naturally the best light for drawing with projection apparatus. One must always keep in mind that a rather dim light in a perfectly dark room, after one has been long enough in it to acquire twilight vision, may seem quite brilliant. The old observers with their very dim artificial lights understood this well, and did much with projection apparatus which at first sight would seem impossible to us.

The electric arc and other brilliant artificial lights are so common at the present that many have come to feel that they cannot see at all unless the object is flooded with light. But, excepting those who are night-blind, that is, have poor twilight vision, much can be done with the Welsbach mantle light, the alco-radiant mantle light, etc. Even a kerosene lamp of good quality is very serviceable, but one must always keep in mind that the dimmer the light-source, the darker must be the work-room, and the more care must be taken to avoid stray light. Too high powers should not be used with weak lights. *For high power drawing very brilliant light is necessary.*

§ 462. **Arc lamp with direct current.**—This is, of all the artificial sources, the most satisfactory for drawing, as for projection (fig. 3). With it the drawing room need not be very dark, and one can obtain sufficient light for the highest powers with which it is desirable to draw. Ordinarily a 5-10 ampere current is sufficient (see also § 485). If low amperages are used the apparatus is not so greatly heated as with higher amperages, and furthermore the specimens are less liable to injury from overheating.

The same lamp that is used for projection is suitable for drawing. There is some advantage in having an automatic arc lamp, then the artist will not have to bother about the lamp except to supply it with proper carbons, and to see that they are in proper position. With the hand-feed arc lamps the carbons must be brought closer together about every 3-5 minutes. It is a convenience if the artist

has some sort of device, like a Hooke's jointed rod, so that the lamp may be adjusted without getting up (see fig. 43).

For the arc lamp on the house circuit see Ch. III and § 486 below.

§ 463. Other radiants for drawing.—Any of the sources of light discussed in the first six chapters can be used for drawing. One must use the precautions given in those chapters for getting a good screen image by a proper alignment and separation of the elements of the apparatus, and by suiting the darkness of the room to the light.

DRAWING WITH THE MAGIC LANTERN

§ 464. Drawing wall diagrams.—The simplest form of projection for drawing is with the magic lantern. With it the preparation of wall diagrams is very easy (fig. 185).

If one has a lantern slide of the picture or object to be drawn it is put into the lantern as for ordinary projection. The drawing-board is then arranged at a distance to give the desired size, and then all the lines traced with a crayon, a brush or a coarse pen. One can use water colors or paints. For the black nothing is better than India ink.

If one has a smooth wall to which the drawing paper or cloth can be fastened, then the lantern can be moved closer or farther away to get the desired size.

If one has no lantern slide, then a negative may be made of the subject to be drawn, and the negative used in the lantern instead of the lantern slide. The negative should not be too dense or the lines will not come out clearly.

For making negatives to draw from, it is advantageous to use lantern-slide dry plates. These will be of the right size for the lantern and are more transparent than ordinary negatives.

For lettering diagrams nothing is more convenient than the large rubber type found in sets used in advertising and sign making.

§ 465. Getting the desired size.—Any desired size may be obtained by varying the distance between the drawing surface and the projection objective. Either the lantern or the drawing surface or both must be movable.

The size of the drawing can be varied without moving the lantern or the drawing surface by using an objective of longer focus for a smaller diagram, or of a shorter focus for a larger diagram (see also § 507).

§ 466. **Use of the magic lantern for small drawings.**—It frequently happens that a small drawing of some large object is needed for publication. This may be some natural object or a piece of apparatus. The object or piece of apparatus is placed in a good light and a small negative made on a lantern-slide plate, being careful not to make the negative too dense. After this is dry, it can be put into the lantern-slide carrier and projected upon the drawing paper, and the outlines accurately traced. Then with a pen and India ink one can ink in the lines and add any necessary shading free-hand, having the object or piece of apparatus in view so that it can be accurately done. The exact magnification or

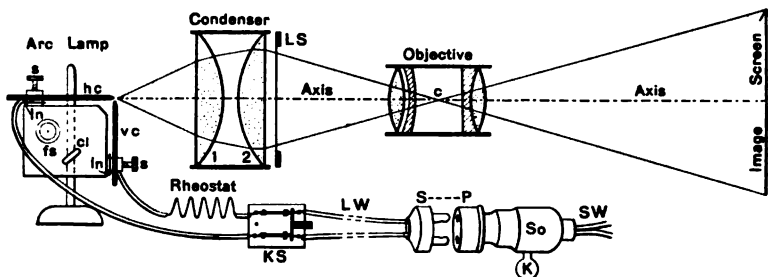

FIG. 185. SIMPLEST FORM OF MAGIC LANTERN WITH ARC LIGHT FOR USE IN DRAWING.

SW Supply wires.

So K Socket with its key switch.

S—P Separable attachment plug.

LW Wires extending from the cap of the plug to the knife switch.

KS Knife switch for turning the current on and off.

Rheostat The balancing device for regulating the current.

Arc Lamp The arc lamp with right-angled carbons.

Condenser The two-lens condenser with the first (1) and the second (2) elements.

LS Position of the lantern slide or other large object.

Objective with *c*, its center.

Axis Axis The principal optic axis of the condenser and the objective. The radiant must be centered on this axis.

Image Screen The drawing surface on which the image is projected.

reduction of the picture can be determined by photographing a metric or other measure (fig. 178) on the same plate with the object or piece of apparatus.

§ 467. Size of condenser necessary for making drawings.—

When lantern slides, or negatives made on lantern-slide plates or other plates of that size are used, the condenser of any magic lantern will answer. Sometimes, however, it is desired to make diagrams or drawings from negatives of larger size. There are two ways of accomplishing this:

(1) A lantern slide can be made from the large negative by the aid of a photographic objective as described in Ch. VIII, § 329. This can then be used in the ordinary lantern.

(2) If the large negative is to be used direct, then the condenser of the magic lantern must be of sufficient size to illuminate the negative. That is, the condenser must have a diameter a little greater than the diagonal of the negative to be illuminated and drawn (see fig. 114).

§ 468. Drawing on a horizontal surface by the aid of the magic lantern.—This is easily accomplished by using a 45 degree mirror or a prism beyond the objective (fig. 192).

One must be careful to put the negative or lantern slide in the carrier in such a way as to give an erect image (§ 512).

If the negative or lantern slide or other object is too dense, so that the light is relatively dim, the image will be duplicated when a mirror silvered on the back is used, therefore, one must use a prism or a mirror silvered on the face for these dark objects. For very transparent objects the image appears single even with a mirror silvered on the back, the silver image being so much brighter than the glass image that the latter does not show.

One can use the magic lantern and separate table with a 45 degree mirror (fig. 182) or the mirror can be fastened to the projection table as in Dr. Riley's device (fig. 184) or the mirror may be close to the objective, and the adjustable drawing shelf used (fig. 183).

DRAWING WITH THE EPISCOPE OR REFLECTING LANTERN

§ 469. If one has access to a lantern for opaque objects (Chap. VII), diagrams may be made from pictures in books and from suitable objects without the trouble of making a negative or a lantern slide. The object is put in position in the reflecting lantern and its image thrown upon the drawing surface. It can then be traced as for a lantern-slide image, and the details, shading and lettering added as described for diagrams made from lantern slides or from negatives (§464).

§ 470. **Drawing on a horizontal surface by the aid of the opaque lantern.**—If the apparatus is suitably arranged, the mirror will throw the image downward upon a horizontal surface instead of out horizontally. Then the tracing can be made as for a lantern slide (§ 468). There is one difficulty with the reflecting lantern in making drawings. If the object to be drawn is of some thickness, only a part of it will be in focus at any one time, hence it is not easy to get the parts in true perspective. (For erect images see § 514).

If one makes a small negative with a good objective, the perspective will be good and all the parts will be in focus.

When this negative is projected upon the drawing surface with an ordinary lantern, all the parts of the image will be in focus.

If one wishes drawings of flat objects, pictures in books, etc., the opaque lantern answers admirably, but heavy currents are required, and it is not so safe for inexperienced persons as the magic lantern with a small current and a negative or a lantern slide (see further in Ch. VII, § 290).

DRAWING WITH A PHOTOGRAPHIC CAMERA

§ 471. The drawing of enlargements or reductions of opaque objects with the photographic camera has been much practised. The object is put in a good light and arranged to show the desired aspect, then a photographic camera is directed toward it, and the bellows lengthened or shortened until the picture on the ground-glass focusing screen is of the desired size. Then the plate holder with a clear glass or a focusing screen of clear glass is used and over

it some tracing paper. By covering the head with a focusing cloth to shut out the surrounding light, one can trace the outlines of the object on the tracing paper, and transfer these to ordinary drawing paper, and proceed to ink them in and give the shading necessary free-hand.

With the magic lantern or with the opaque lantern the image is projected upon the drawing surface and regular drawing paper can be used to make the original pencil tracing upon, but with the camera one must use translucent paper for the tracing and then transfer it to the drawing paper. (To get an erect image with translucent paper see § 519).

DRAWING WITH THE PROJECTION MICROSCOPE

§ 472. **Range of objects.**—For drawing as for projection it is exceedingly desirable that the projection microscope should enable the investigator to commence where the magic lantern leaves off, and to carry the work to its utmost possibilities; that is, beginning with large specimens of 50 to 60 mm. (2 in.) in diameter requiring low objectives, and going on from this to the smallest objects visible and using the oil immersion objective at the other extreme.

To realize this ideal possibility one must have available for drawing some such outfit as that described in Ch. IX for projection; and in addition suitable arrangements for reflecting the image down upon a horizontal drawing surface. Fortunately, the additions are relatively simple and inexpensive.

Finally, for the widest usefulness in drawing there must be the possibility of using the ordinary house electric lighting system for an electric lamp with small carbons (see § 486).

§ 473. **Drawing large objects with low powers.**—For this it is necessary to have a stage with a large opening (fig. 134), and the objective must be mounted in a shield with no tube at all (fig. 138), or the tube must be short and of large diameter, so that the field is not restricted (fig. 137). Finally, there must be some means of increasing or diminishing the distance between the objective and the drawing surface to get the desired magnification.

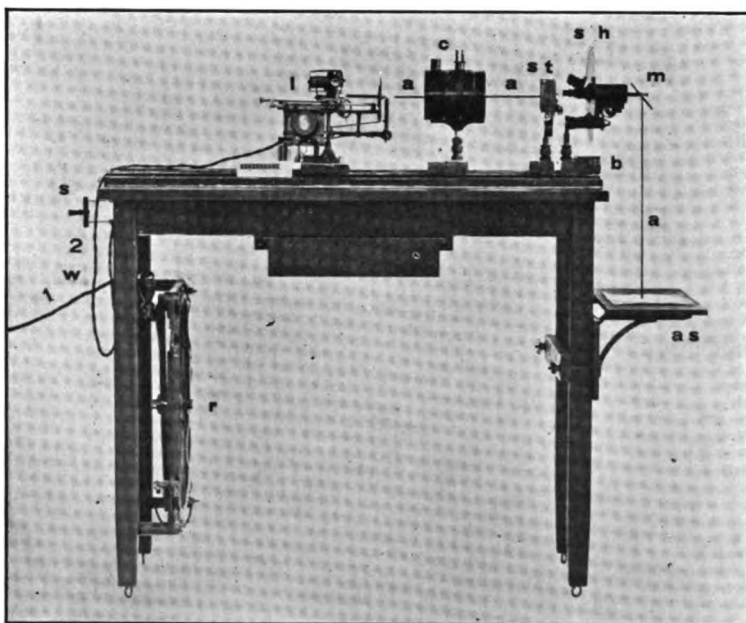

FIG. 186. APPARATUS FOR DRAWING WITH THE MICROSCOPE WITHOUT AN OCULAR OR SUBSTAGE CONDENSER.

The arc lamp is Mr. Albert T. Thompson's automatic lamp for direct current, 5-25 amperes. This is the first automatic arc lamp for right-angled carbons. By means of the optical bench carrying all the apparatus, the different parts are pulled forward so that the microscope tube and mirror project over the drawing shelf. This is adjustable up and down for varying the magnification.

The stage of the microscope (*st*) is independent and contains a large glass water-cell against which the specimen rests. It conducts away the heat from the specimen.

- a a a* Optic axis.
- b* Optical bench with track.
- c* Triple condenser with water-cell.
- l* Thompson's automatic arc lamp for 5-25 amperes direct current.
- m* Microscope without ocular. The 45° mirror reflects the light down upon the drawing surface.
- r* Adjustable rheostat.
- s* Double-pole knife switch (table switch).
- st* Stage with the stage water-cell for cooling the specimen. The stage is entirely separate from the microscope.
- sh* Shield 25 cm. in diameter to stop any stray light from the stage of the microscope.
- w1* Double cable supplying the electric current to the apparatus.
- w2* Flexible cables from the switch to the lamp.

§ 474. **Varying the drawing distance.**—The drawing distance is easily varied by means of a movable table like that figured (fig. 182), or by an adjustable shelf attached to the projection table (fig. 183).

Another way of varying the size of the drawing is to use higher or lower objectives, the drawing distance remaining the same (see § 507).

· § 475. **Lighting the object.**—For large objects and low powers the best way to illuminate the object is to use the main condenser only and to put the object in the cone of light where it is fully illuminated (fig. 132). If the drawing shelf is used this will involve moving the lamp and condenser toward the drawing-board; for the microscope must be beyond the end of the table, so that the image can be thrown down on the shelf, (fig. 186). The change in position of any part or parts is, of course, very easy with an optical bench (fig. 158–159).

§ 476. **Drawings with objectives of 16, 12, 10, and 8 mm.**—With objectives of this range without an ocular, one can draw objects varying from 5 to 2 mm. in diameter. For lighting, use the large condenser and focus the image of the crater on the hood of the objective (fig. 140), and then push the stage up toward the objective until the object is in focus, finishing the fine focusing with the micrometer screw of the microscope.

DRAWING WITH THE PROJECTION MICROSCOPE, INCLUDING AN OCULAR AND A SUBSTAGE CONDENSER.

§ 477. **Drawing fine details with high powers (8 to 2 mm. focus).**—As pointed out for the projection of images showing fine details (§ 401), it is necessary to use a substage condenser to get the necessary aperture of the lighting beam, and to use an ocular to compensate for objective defects. If one uses a water or an oil immersion objective the proper immersion fluid must be used between the cover-glass and the objective, as in ordinary microscopic work.

§ 478. **Parallelizing the converging beam of light.**—The substage condenser used for ordinary observation is designed for ap-

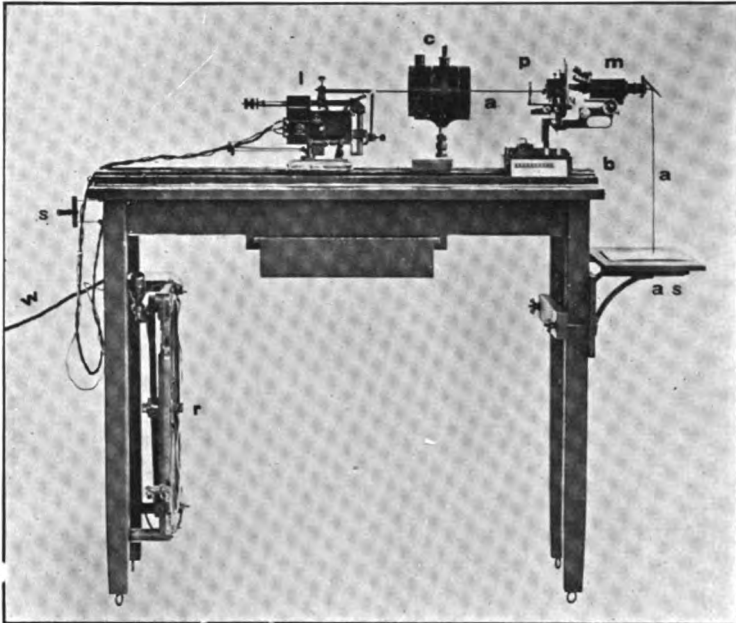

FIG. 187. AN ORDINARY MICROSCOPE USED WITH THE LAMP AND CONDENSER OF A MAGIC LANTERN FOR DRAWING OR PROJECTION.

- W* The supply cable from the outlet box (fig. 3).
s The table, knife switch.
r Rheostat of the theater-dimmer type.
l The automatic arc lamp. This is the three-wire automatic arc lamp of the Bausch & Lomb Optical Company for 5-25 amperes. (For the method of connecting the wires see § 704).
c Triple condenser with water-cell.
a a Principal optic axis.
p The concave parallelizing lens to render the converging cone from the condenser parallel or nearly so before entering the substage condenser of the microscope.
m The microscope in a horizontal position. If it is to be used for drawing there must be a prism or mirror beyond the ocular to reflect the light down on the drawing shelf.
b Baseboard with track serving as an optical bench.
a s Adjustable drawing shelf on the front of the projection table.

proximately parallel light (fig. 150 A. B.), hence it is necessary to render the converging cone of light from the main condenser approximately parallel. This is most easily accomplished by using

a plano-concave or double-concave lens. This is mounted in a fork-like holder and is set in the socket for the mirror stem of the microscope (fig. 152, 187). Then the microscope is pushed up toward the condenser until the parallel beam is of sufficient diameter to fill the substage condenser. The substage condenser diaphragm is opened to its full extent.

§ 479. **Concave lens to be employed.**—This depends upon the focus of the main condenser. If the focus is about 15 cm. (6 in.), use a concave lens of -16 to -20 diopters (§ 356). If the main condenser has a focus of 20 to 40 cm. (8 to 16 in.), use a concave lens of -8 to -12 diopters. The longer the focus of the main condenser the shallower can be the concavity of the parallelizing lens. Indeed, for objectives of 16, 12, 10, and 8 mm. focus a condenser lens of 25 to 38 cm. (10 to 15 inches) focus gives very good results, when the substage condenser is used without any parallelizing lens (fig. 154).

§ 480. **Position of the substage condenser; opening of the condenser diaphragm.**—As pointed out in Ch. IX (§ 407), the position of the substage condenser must be very precisely determined for different objectives and for different thickness of slides.

To begin with, the substage condenser diaphragm is opened to its full extent. Then in each case one must get the sharpest possible image by getting the best position of the substage condenser, and closing the diaphragm more or less. As a general statement, the diaphragm should be considerably wider open for drawing than for ordinary observation.

§ 481. **Oculars to employ for drawing.**—Those of $\times 2$, $\times 3$, $\times 4$, $\times 6$, $\times 8$, and $\times 12$ may be used. Naturally, the lower and medium powers give the more brilliant images as for direct observation. One will rarely need to use an ocular higher than $\times 8$.

§ 482. **Mirror or prism for reflecting the image-forming rays down upon the drawing surface.**—For high power drawing it is better to have the reflecting mirror or prism close to the ocular (fig. 192) rather than to have it distant, as with the drawing table in figure 182.

If a mirror is used it must be a perfect one and preferably slivered on the face to avoid duplicating the images. If it is silvered on the back the glass must be thin. A totally reflecting prism is best, but it is somewhat expensive, costing about twice as much as the mirror.

§ 483. **Avoidance of distortion.**—Whichever is used for reflecting, it should be fitted with a stop so that it will be at 45 degrees with the main axis, then the image-forming rays will be reflected directly downward and the image will not be distorted, provided of course, that the mirror or prism is directly above the drawing surface. If it were turned over to one side more or less, the image would be correspondingly distorted.

It is a good plan for one to become familiar with the distortions possible in drawing. For example, if the mirror or prism is not at 45 degrees with a horizontal microscope (fig. 182, 193), the spot of light on the drawing surface will not be circular but elliptic, the axis of the ellipse being parallel with the optic axis of the microscope. If the prism or mirror is not directly above, but turned to one side, then the spot of light will be elliptic and projected to one side of the axis of the microscope. If one is familiar with the possible distortions it will be easy to detect them; then they can be corrected. Naturally, a drawing should be accurate when finished.

§ 484. **Specimens suitable for drawing with high powers.**—Any object suitable for projection can have its image projected upon a drawing surface (see also § 410).

§ 485. **Amount of electric current required for drawing.**—If one has a direct current, 5 to 10 amperes will be sufficient for all drawing purposes. The specimens must usually be left for a considerable time in the focus or near the focus of the light beam, and hence are liable to overheating. The lower the amperage the less the danger from the overheating. Then it is not good for the eyes of the artist to have the light on the drawing surface too dazzling.

With alternating current, 6 to 15 amperes usually suffice.

Here, as in all other projection, skill is of more account than overwhelming electric currents.

PROJECTION DRAWING APPARATUS WITH THE RADIANT
CONNECTED WITH THE HOUSE LIGHTING SYSTEM.

§ 486. **General Statement.**—As shown in Chapter III (fig. 41-43), the arc lamps using small, cored carbons (6 to 8 mm. in diameter) and drawing from three to six amperes may be connected with any socket for an incandescent bulb of the house lighting system. The light so obtained is more powerful than the usual lime light. The carbons being small, the light approaches closely to the ideal point source. Consequently for all projection purposes, including drawing, this form of arc light is of the greatest importance and utility. Of course, for projection in a large hall it is insufficient, but for the relatively small screen pictures needed in drawing and for small classes, the results are very satisfactory.

§ 487. **Wiring, rheostat and connections for the arc lamp attached to the house lighting system.**—This is shown in fig. 188-189 and described in § 128-135. Remember and practice the advice given about turning the current on and off (§ 133), and the possibility of short circuiting and burning out the incandescent bulb socket. *Never use an arc lamp without a suitable rheostat or inductor.* (See § 129, also § 128a for fuses on the house system).

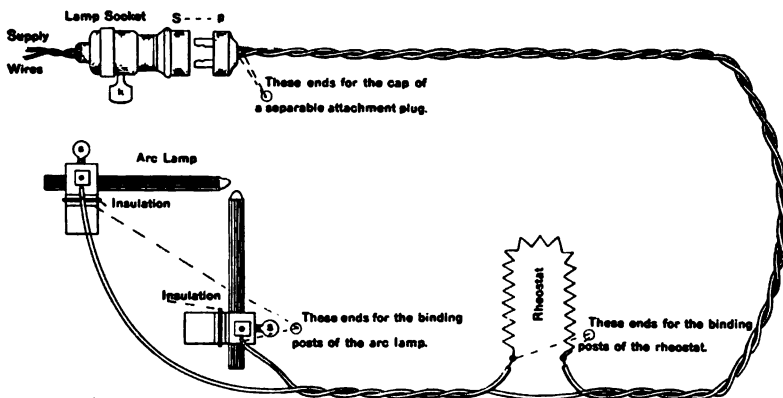

FIG. 188. WIRING AND CONNECTIONS OF THE ARC LAMP USED ON THE HOUSE LIGHTING SYSTEM (See fig. 45).

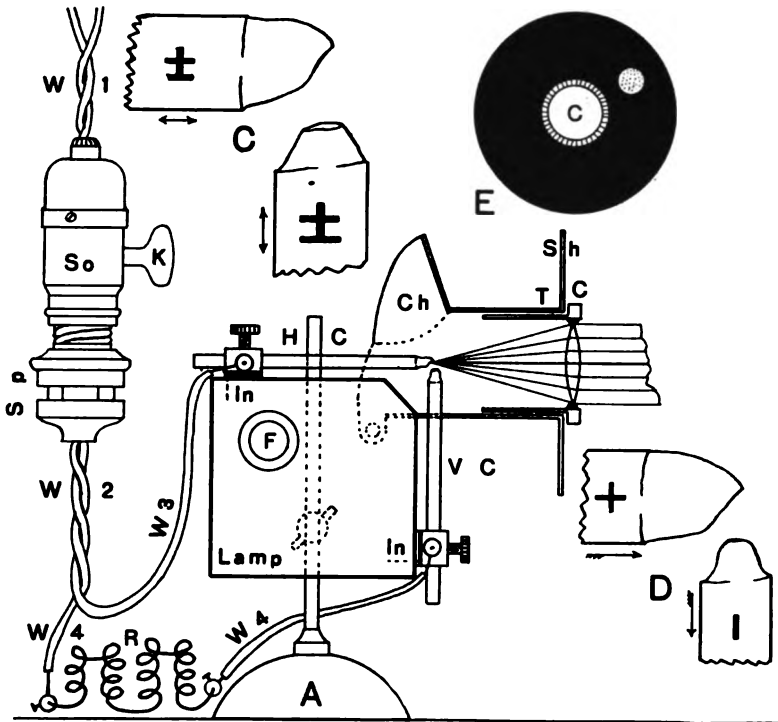

FIG. 189. SMALL ARC LAMP FOR DRAWING.

Commencing at the left:

W1 Supply wires

So Lamp socket.

K Key switch in the socket.

Sp Separable attachment plug.

W2 Wires to the arc lamp.

W3 Wire to the binding post of the upper carbon.

W4 Wire to the rheostat (*R*) and from the rheostat to the binding post of the lower carbon.

A Support of the arc lamp; the lamp can be raised or lowered on this support.

F Feeding screws for the carbons.

H C, V C The horizontal and the vertical carbons.

In In Insulation between the carbon holders and the remainder of the lamp. This prevents the current from taking any path away from the carbons.

Ch Chimney over the arc.

T C The tube and the condenser in the movable inner tube. The condenser is at its focal distance from the crater, and therefore the rays are made parallel.

S Shield to stop stray light and to aid in centering.

C Carbons with alternating current. They are of the same size.

D Carbons with direct current. The upper one is 8 mm. and the lower one 6 mm. in diameter.

E Shield or disc at the end of the condenser tube showing the opening of the condenser (*C*) and the spot of light at the right.

§ 488. **Arc lamp and small carbons.**—The form of arc lamp to use on the house circuit is not of particular importance. It may be very conveniently one of the small lamps shown in fig. 41-44, 201, 205, or it can be an ordinary arc lamp for greater currents, but supplied with long clamping screws, bushings or adapters for the small carbons (§ 127). The small lamps are generally of the hand-feed type and move the upper and the lower carbons equally.

§ 489. **Size of carbons for direct current.**—*A.*—The carbons found useful for direct current are as follows, all being of the soft-cored variety:

(1) Upper or positive carbon 7 mm. in diameter, lower or negative carbon 5 mm.

(2) Upper carbon 8 mm., lower 6 mm.

(3) Upper carbon 11 mm., lower 8 mm.

B.—The carbons for alternating current with an equal feed for the upper and the lower carbon, should be of the same size, and this size should not exceed 8 mm. in diameter for 5 to 6 amperes. If only three or four amperes are used, then it is better to have carbons not greater than 6 mm. in diameter.

§ 490. **Reason for using small carbons.**—In order to have the light steady and thus have the field continuously bright, the entire end of the upper carbon should be white hot.

If the carbon is so large that the crater covers only a part of the tip, the crater will wander about on the end of the carbon. Every change in the position of the crater changes the direction of the light beam. While the crater is in one position the entire field of a high power objective may be brilliantly illuminated; if the crater wanders to a new position, the field will be only partly or not at all illuminated. In such a case, one must constantly change the position of the mirror of the microscope to keep the field bright. If, however, the crater is nearly as large as the end of the carbon, it

will wander but little, if at all, and the light will be more constant.

§ 491. **Feeding the carbons together.**—If one has an alternating current to work with, the small arc lamp will burn about 10 minutes with 8 mm. carbons before going out. With the right-angle position the carbon giving the light remains constantly in the axis. With inclined carbons, it rises constantly above the axis. The carbons with the right-angle arc should be fed about every five to seven minutes to insure the best light.

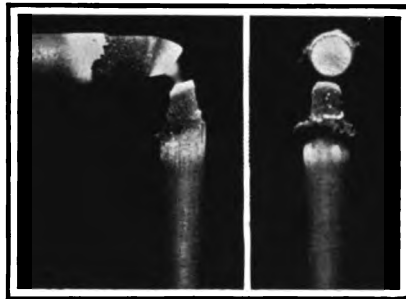

FIG. 190. SIDE AND FRONT VIEW OF SMALL CARBONS WITH FIVE AMPERES OF DIRECT CURRENT (Natural Size). Compare fig. 191.

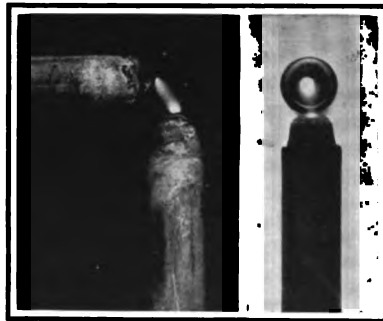

FIG. 191. SIDE AND FRONT VIEW OF SMALL CARBONS WITH FIVE AMPERES OF ALTERNATING CURRENT (Natural Size).

The crater is much smaller than with direct current (fig. 190).

If direct current is used, the lamp will burn for about six minutes and the carbons should be fed together every three to five minutes. (See fig. 205).

CONDENSER, STAGE AND MICROSCOPE FOR DRAWING WITH THE HOUSE LIGHTING SYSTEM

§ 492. **Drawing outfit.**—If one has a drawing outfit consisting of the projection apparatus shown in figure 182, all that is necessary to do is to place the arc lamp with its small carbons in the lamp-house and arrange it exactly as for projection.

The procedure is precisely as described above for the ordinary arc lamp on the usual special lantern lighting system (Ch. IX).

§ 493. **Small Current Outfit.**—This consists of an arc lamp using small carbons (6 to 8 mm. in diameter) and a rheostat or an inductor (fig. 197) not allowing over 5 to 6 amperes of current to flow. Instead of the usual large condenser (fig. 121), a small, single, convex lens is used. This is of 70 to 100 mm. (3 to 4 in.) focus, and 37 to 50 mm. (1½ to 2 in.) in diameter, and is placed in a tube extending straight out from the upper carbon. Usually, also, the lens is in a sliding tube, so that it may be varied in distance from the source of light. If it is at its focal distance from the light, the beam will be approximately parallel (fig. 189); if farther from the light, the beam will be converging.

§ 494. **Method of using the lamp with a special condenser.**—There are three methods of using this arc lamp and special condenser:

(1) The lamp can be put in line with the drawing microscope and a converging beam thrown directly on the specimen as for the large apparatus (fig. 132), the mirror and sometimes the substage condenser having been removed or turned aside.

(2) The mirror is removed from the microscope, but the substage condenser is left in position, and a parallel beam of light thrown directly into the substage condenser along the optic axis (fig. 201A).

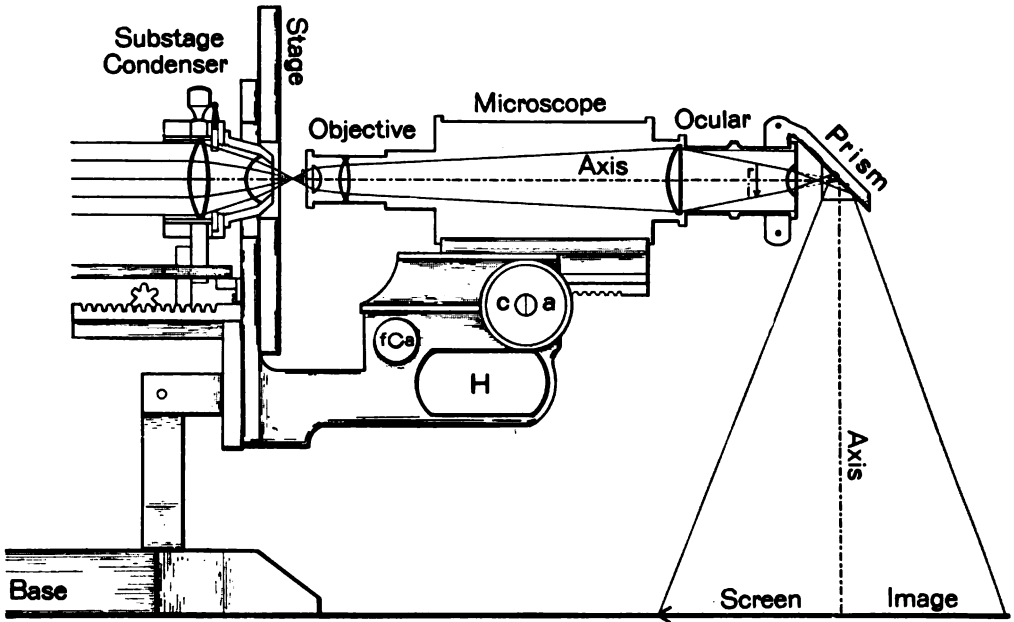

FIG. 192. DIAGRAM OF THE MICROSCOPE ARRANGED FOR DRAWING ON A HORIZONTAL SURFACE.

The light is from an arc lamp supplied by the house current (fig. 188, 189). A right-angled prism is used to reflect the rays down upon the drawing surface.

The designations are self explanatory except in the ocular *r i* means the real image formed by the objective and field lens (see fig. 207).

The adjustment screw heads at the side of the microscope are:

f a Fine adjustment.

c a Coarse adjustment.

H The handle in the pillar for carrying the microscope.

(3) From the difficulty of getting the small lamp and condenser in the optic axis without the use of an optical bench it has been found much easier to get the light upon the specimen and through the microscope by placing the arc lamp and its condenser at right angles to the microscope, and to use the regular microscope mirror for reflecting the beam through the substage condenser (fig. 193). If the substage condenser is not used, the mirror reflects the beam directly on the specimen, as for low power projection.

§ 495. **Microscope.**—Any modern microscope with a good sub-stage condenser can be used, provided it is supplied with a flexible pillar, so that the tube can be made horizontal; and provided also, that the fine adjusting mechanism will work when the tube is horizontal.

There must be a prism or mirror beyond the ocular to reflect the image-forming rays downward upon the drawing surface (fig. 192).

The discussion of avoidance of distortion, the proper objectives, oculars, etc., to use, which was given in the earlier part of this chapter apply here (§ 452, 483).

§ 496. **Position of the microscope for drawing.**—In the drawing outfits thus far devised, the microscope is placed in one of the following positions:

(1) In an inverted position with the objective pointing directly upward (as in the large Edinger apparatus, fig. 202).

(2) Inclined at 45 degrees (as in the small Edinger apparatus, fig. 204).

(3) In a horizontal position (fig. 192).

With the microscope in an inverted, vertical position, there should be no distortion of the image if the drawing surface is horizontal.

With the inclined microscope, the mirror used must be so inclined that it throws the image directly down upon the horizontal drawing surface, or the image will be distorted. It is not easy to tell just the inclination of the microscope, and therefore, the exact inclination to give the mirror, to make the axial ray perpendicular to the drawing surface. In the small Edinger apparatus (fig. 204), the directions are to make the inclination of the microscope 45 degrees and the inclination of the mirror $22\frac{1}{2}$ degrees. This arrangement will give a correct image. One may need to use a protractor to make sure that the inclination of the microscope and mirror are exactly correct.

With the horizontal microscope, the mirror or prism is so arranged that it is fixed at 45 degrees and therefore if put directly over the ocular of the horizontal microscope, will reflect the light perpendicularly upon the drawing surface, thus avoiding distortion (see § 483).

With the horizontal microscope, unless one uses a table with a drawing shelf (fig. 187), the microscope must be raised on a block or support of some kind and clamped to the block so that it will be rigid (fig. 193-194). A convenient height is 250 mm. (10 inches).

To vary the magnification slightly, the distance can be made greater by using an additional block, or it may be made less by raising the drawing surface. For a very convenient arrangement for changing the elevation of the microscope see fig. 198, 201C.

For obtaining the scale or magnification of the drawing see § 508-510.

§ 497. **Getting the light through the horizontal microscope with the plane mirror.**—The simplest method is to place the lamp



FIG. 193. DRAWING WITH THE MICROSCOPE IN A DARK ROOM.

In the arrangement here shown the light is from a small arc lamp drawing current from the house lighting system.

The supply cable and the lamp socket are shown, then the separable attachment plug and the supply wires with the rheostat inserted along one wire (fig. 188).

The arc lamp is at the level of the microscope mirror and at right angles with the microscope axis. The light from the arc lamp is reflected up to the sub-stage condenser by the mirror and passes on through the specimen and microscope as shown in fig. 192.

The shield between the lamp and drawing surface is to keep stray light from reaching the drawing surface. The shield is represented as transparent. It was left in place during only a part of the time of the exposure in making the photographic negative.

and the microscope at right angles. Use a level (fig. 160) and make sure that the condenser tube is horizontal, and the axis of the condenser at the same level as the center of the mirror. Place a disc of blackened asbestos or tin of about 12.5 cm. (5 in.) in diameter just behind the condenser as shown in fig. 193-198. This is easily done by making a hole of the proper size in the disc to go over the condenser tube (fig. 195). If now the current is turned on and the arc established the light will extend from the condenser to the plane mirror and be reflected by it, if it is set at 45 degrees, up into the substage condenser. From the lower face of the substage condenser a part of the light is reflected back to the mirror and from the mirror back toward the lamp, and is received by the black disc over the condenser tube. The mirror should then be turned until the spot of light enters the lamp condenser. The mirror will then be in position to reflect the light along the optic axis of the microscope.

If the microscope is in focus on the object, the light will traverse the objective and ocular and be reflected down upon the drawing surface by the mirror or prism beyond the ocular.

By changing the mirror slightly while watching the circle of light on the drawing surface, the best illumination can be obtained.

§ 498. Getting the light through the microscope with the concave mirror.—One proceeds exactly as described above, only the light reflected back to the black disc on the lamp condenser tube will be a crescent instead of a circle. The middle part of the crescent can be reflected into the lamp condenser and then the light will pass through the microscope and be reflected down upon the drawing paper, provided the microscope and the arc lamp are at right angles and at the proper level.

§ 499. Substage condenser.—Use the substage condenser with objectives of 16, 12, 10, 8, 6, 4, and 2 mm. focus. For objectives lower than the 16 mm. the substage condenser is turned aside.

With different objectives and slides of different thickness the substage condenser is changed somewhat in position to get the best light on the object and to light the entire field.

To start with, the substage condenser diaphragm should be opened widely. In some cases the picture can be made sharper by afterward closing the diaphragm somewhat.

For drawing, a skillful use of the substage condenser is very important. One must be more precise in its use than in ordinary microscopic observation.

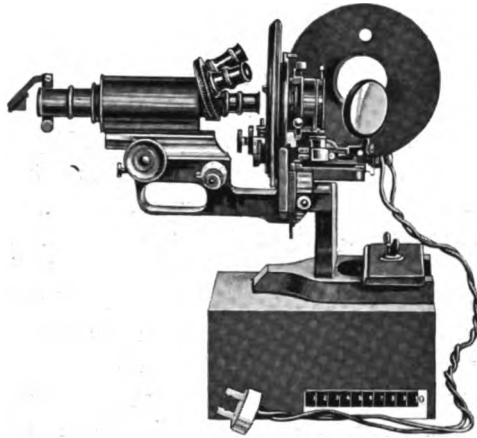

FIG. 194. DRAWING WITH A MICROSCOPE WITH THE ARC LAMP AT RIGHT ANGLES.

In this picture a prism is placed beyond the ocular to reflect the light downward (fig. 192). The arc lamp is on the back side of the microscope with the condenser facing the mirror. The spot of light on the shield or disc above the lamp shows that the light is not centered along the axis of the microscope. The mirror must be turned slightly until the light reflected back from the substage condenser and microscope mirror enters the condenser tube of the arc lamp (see fig. 195).

§ 500. **Plane mirror and substage condenser.**—Use the plane mirror and substage condenser for all objectives of 12, 10, 8, 6, 4, and 2 mm. equivalent focus.

§ 501. **Concave mirror and substage condenser.**—For the 16 to 18 mm. focus objectives use the substage condenser with the concave mirror. It may also be necessary to separate the condenser somewhat from the preparation to light the entire field.

§ 502. **Concave mirror without a substage condenser.**—For objectives of 20, 25, 30, 35, 40 and 50 mm. focus use the concave mirror without a substage condenser.

§ 503. **Immersion objective.**—For immersion objectives used in drawing do not forget to use the proper immersion liquid between the cover-glass and the objective; cedar oil for the oil immersions, and distilled water for the water immersions.



FIG. 195. SHIELD AT THE END OF THE ARC LAMP CONDENSER TUBE TO AID IN CENTERING THE LIGHT.

This disc is of blackened sheet iron, asbestos or cardboard and is 125 to 150 mm. in diameter. It is placed at the end of the lamp condenser tube. If the light is centered, then that reflected back from the substage condenser and microscope mirror will enter the lamp condenser (C). If the light is not centered there will be a round spot of light somewhere outside the lamp condenser. In that case the mirror must be turned slightly until the reflected light enters the lamp condenser.

If the plane mirror is used the spot of light will be nearly circular; with the concave mirror it will be crescentic.

C The lamp condenser.

I Spot of light outside the condenser showing that the light is off the center.

AVOIDANCE OF HEAT

§ 504. When the small currents from the house circuit are used the heat is not great enough to injure most specimens mounted in balsam. For live objects and objects mounted in glycerin or glycerin jelly, etc., it would be wise to place a water-cell in the beam before it reaches the microscope (see § 364, 394a, fig. 206).

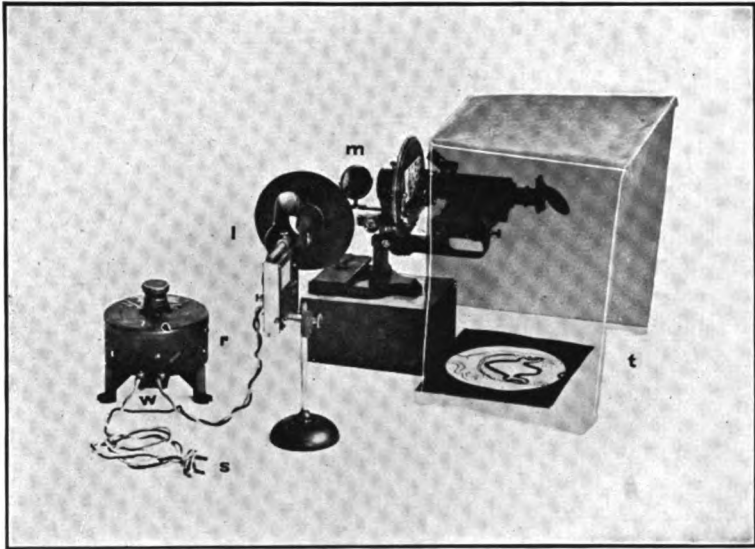

FIG. 196. DRAWING OUTFIT FOR THE HOUSE LIGHTING SYSTEM WITH A BLACK CLOTH TENT OVER THE MICROSCOPE.

This arrangement answers well for a moderately lighted room. Naturally the opening for drawing should face toward some dark furniture or the dark side of the room, not toward a window.

s Separable cap to attach to the separable plug in a socket of the house lighting system.

w r One of the supply wires cut and inserted into the binding posts of the rheostat (see fig. 188).

l Small arc lamp for supplying the illumination. It is at the level of the mirror and at right angles to the microscope.

m Mirror of the microscope.

t Cloth tent over the microscope. It appears semi-transparent as it was left in position during but part of the time when the photograph was taken.

SHIELDING THE DRAWING SURFACE FROM STRAY LIGHT

§ 505. **Shield for working in a dark room.**—If one works in a dark room all that is necessary to screen the drawing from stray light from the arc lamp, when the lamp is at right angles to the microscope, is a blackened cardboard shield (fig. 193).

If the lamp is in line with the microscope, it will be necessary to put a shield with a perforation for the light beam either before the beam reaches the microscope, or it may be put over the tube of the microscope so that it will shield the drawing surface.

§ 506. **Drawing in a light room.**—If this is necessary one should get in as shaded a part of the room as possible. To screen the drawing surface there are two ways:

(1) There may be a cloth for enclosing the drawing surface and the head of the artist. This is like the plan used in focusing a photographic camera (fig. 204).

(2) By means of cardboard, or of a wire frame and cloth curtains, a box or tent is built around the drawing surface enclosing also the microscope tube. The end of the box next the draughtsman is open sufficiently for him to see the image (fig. 196, 198). The drawing surface should look toward some dark furniture or a dark or shaded part of the room, and except for the most exacting work the surface will be sufficiently shaded. For the most exacting work, and for the greatest freedom from accessories, the evening or a dark room in the daytime offers the best facilities (§ 453).

HOW TO GET ANY DESIRED MAGNIFICATION IN A DRAWING

§ 507. The magnification can be varied by any of the following ways, or two or more of the ways may be combined.

- (a) By using a higher or lower objective.
- (b) By using an amplifier, of greater or less power, with the objective.
- (c) By using a higher or lower ocular with the objective.
- (d) By changing the distance of the drawing surface; the farther it is away in any given case the larger will be the image, and the nearer it is the smaller the image (§ 510a).

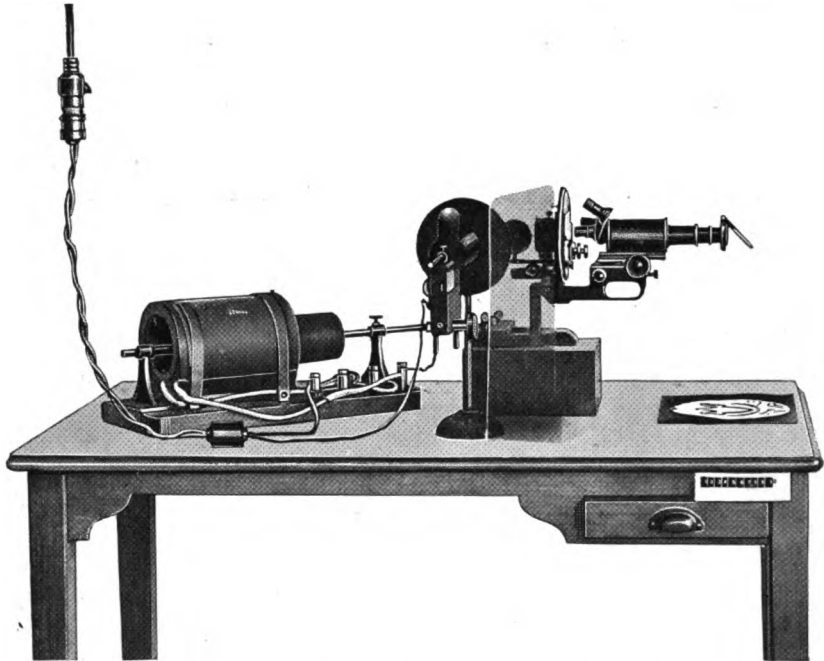

FIG. 197. DRAWING OUTFIT FOR THE HOUSE LIGHTING SYSTEM, USING AN INDUCTOR INSTEAD OF A RHEOSTAT (fig. 193).

Commencing at the left:

The supply wires to the lamp socket, and the supply wires from the separable attachment plug to the arc lamp.

One of the supply wires is connected directly with the arc lamp and one is cut and the two cut ends connected with the two poles of the inductor exactly as with a rheostat (fig. 188), and from the inductor the wire is continued to one of the binding posts of the arc lamp.

The inductor is only for alternating current (§ 736). The amperage can be varied by sliding the soft iron core in and out of the coil. The more the core is inserted the greater the inductance and hence the less the amount of current that is allowed to flow.

As shown in the picture, the core is only partly inserted and a medium current is allowed to flow.

If one uses alternating current this is a much more economical method of controlling the current than a rheostat (see § 736+) and a steadier light is produced.

The two most common changes are: (1) Using a higher or lower objective; and (2) Changing the distance of the drawing surface.

For slight variations in size the change in distance is by far the best and easiest change to make.

If one has a drawing table (fig. 182) it is very simple to push it farther from or closer to the projection apparatus.

If the drawing shelf is used it can be raised or lowered (fig. 183).

If the simple apparatus is used on an ordinary table the entire microscope can be raised for higher magnifications or for lower magnifications the drawing surface can be raised to bring it closer to the microscope tube (fig. 193-204), or the microscope can be lowered on its adjustable support (fig. 198).

DETERMINATION OF THE MAGNIFICATION OF A DRAWING

§ 508. For getting the magnification it is necessary to use for an object a transparent micrometer with known divisions upon it. For most of the work done a micrometer with heavy lines every half millimeter is satisfactory. These lines may be ruled on glass and filled with graphite, or they may be made by photography (see § 508a).

For example, if the micrometer used has half millimeter spaces, the image projected on the screen will be magnified more or less according to the distance of the screen and the objective used. The exact size of the image is easily measured on the drawing surface with a millimeter scale. Suppose that two of the half millimeter spaces were used as object, the object would be one millimeter in actual size. If the image of two spaces projected on the screen or drawing surface measured 25 millimeters then the magnification would be 25.

§ 508a. One can make a satisfactory micrometer for determining the magnification of drawings as follows: Make a negative of the millimeter scale (fig. 178, 211) making the picture exactly half the size of the original scale, then the spaces will be half millimeters. As the scale is black with light lines the negative will show dark lines with intervening clear spaces exactly as is a glass micrometer.

If so desired the micrometer lines may be covered with Canada balsam and a cover-glass applied as for microscopic specimens. (See *The Microscope*, § 354-5, p. 257). This would protect the lines and make the specimen more transparent. A lantern-slide plate is the best for making the negative, as it gives transparent lines.

Briefly stated, if one has an object of known size, then the size of the image divided by the size of the object will give the magnification in every case. In the example given above the object is 1 mm. and the image is 25 mm.: $25 \div 1 = 25$. Or, if one took a single space as object, that is, half a millimeter, then the image would measure 12.5 mm., and $12.5 \div .5 = 25$ as before (see § 510a).

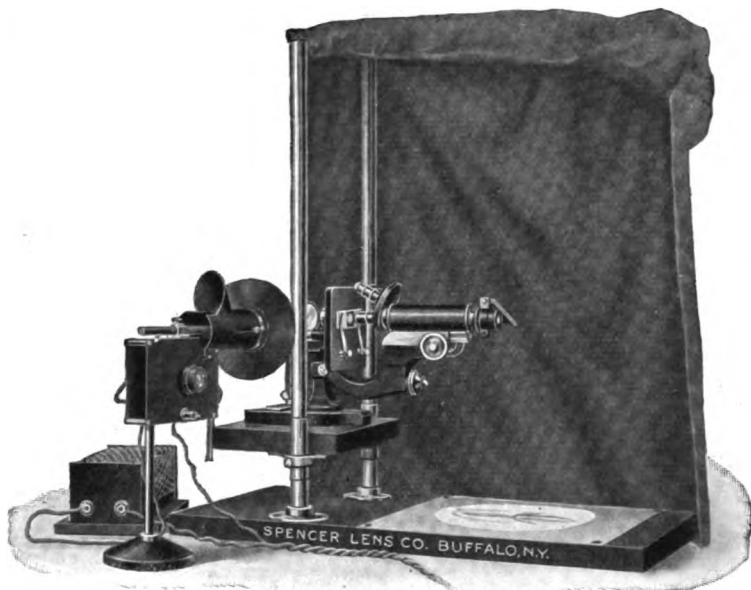

FIG. 198. SPENCER LENS COMPANY'S APPARATUS FOR DRAWING WITH THE MICROSCOPE.

(Cut loaned by the Spencer Lens Co.).

This consists of a small arc lamp with the proper wiring, rheostat and connections for the house electric supply. The lamp has all the adjustments, and the condenser tube is telescoping so that the beam of light may be parallel or converging.

The microscope is supported on an adjustable shelf which can be raised or lowered on the vertical rods, thus enabling one to get any desired magnification.

The vertical supports for the microscope shelf serve to carry a curved metal band to support the cloth curtains to shade the drawing surface. There are two curtains and they hang freely, thus avoiding all interference with the hands in drawing. If one desires, the arc lamp can be put in line with the microscope and the mirror turned aside.

For a reflector beyond the ocular a prism is used, thus avoiding any of the defects of a mirror.

MAGNIFICATION OF WALL DIAGRAMS, AND DRAWINGS MADE WITH THE OPAQUE LANTERN

§ 509. Scale of wall diagram.—Make the diagram any desired size as directed in § 457. Then remove the negative or lantern slide from the holder and insert a lantern slide or negative of the metric rule (fig. 178, 211). The image of the metric rule on the drawing surface will, of course, be magnified exactly as much as the diagram. By using a metric measure, one can find the magnification of the screen image exactly as described in § 508.

For wall diagrams, it is not usually very important to know the magnification. All that is necessary is to get it large enough to be seen well. But if one wishes to show the relative size of objects such as blood corpuscles of different animals, then the magnification must be known.

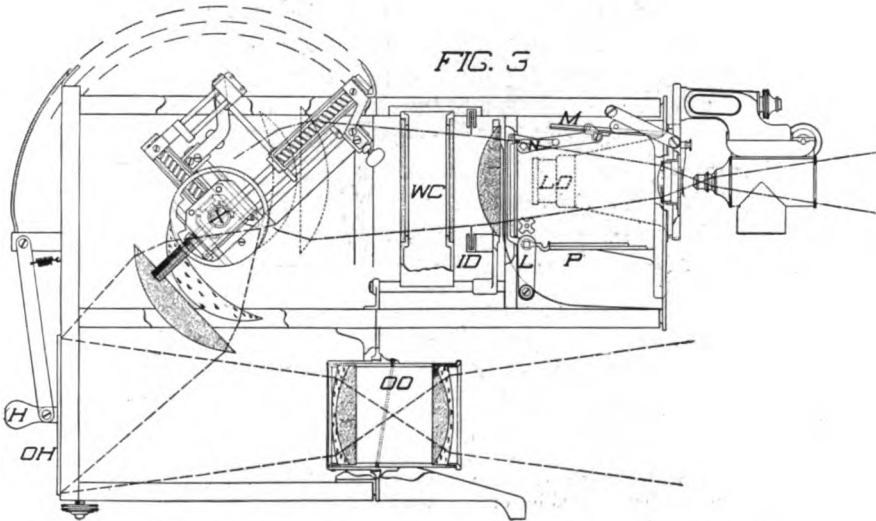

FIG. 199. MODEL 4-5 DELINEASCOPE WITH THE PROJECTION MICROSCOPE IN A HORIZONTAL POSITION.

(Cut loaned by the Spencer Lens Co.).

With the microscope in this position the image may be thrown down on a horizontal surface for drawing by pushing the totally reflecting prism up in the microscope tube to intercept the light (see fig. 109, 175).

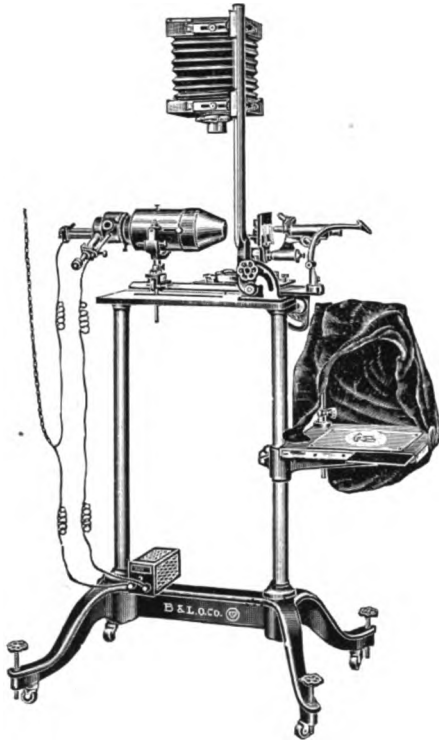

FIG. 200. COMBINED DRAWING AND PHOTO-MICROGRAPHIC APPARATUS OF THE BAUSCH & LOMB OPTICAL COMPANY FOR USE ON THE HOUSE LIGHTING SYSTEM.

(Cut loaned by the Bausch & Lomb Optical Co.).

This is a kind of universal apparatus serving for drawing with the microscope, projection with a microscope and with a magic lantern; opaque projection, and finally for photographing with all objectives and with the microscope.

It can be used in a horizontal, an inclined or a vertical position. For drawing with the microscope in a horizontal position there is an adjustable drawing shelf with a cloth tent for shutting out daylight in a light room.

The large condenser enables one to use the apparatus on specimens of all sizes up to lantern slides.

§ 510. **Scale of diagrams or drawings made with the opaque lantern.**—If one uses the episcopo or opaque lantern, or a photographic camera for drawing, it is very easy to get the exact magnification of the drawing by putting a metric rule upon some part of

the object, or beside it. It will be at the same scale of magnification or reduction as the drawing.

In practice some lines of the image of the scale are made beside the drawing. For example, suppose the image of one centimeter measured on the drawing was 10 centimeters long, one would know that the drawing is 10 times larger than the object. If the length of the centimeter on the drawing was only one-half centimeter long, then one would know that the drawing is only half as large as the object and so on (§ 508a, 510a).

DRAWINGS FOR MODELS

§ 511. **Drawings for models.**—These are made much more easily with projection apparatus than with the camera lucida or in any other way. The simple drawing outfit for use on the house circuit described above makes it possible for every laboratory and indeed every private worker to use this effective method, even if complete projection apparatus and heavy lantern currents are not available.

In making drawings for models several steps must be taken in order that the resulting model shall be anything like a true representation of the actual object.

(1) The object (embryo, etc.) should be photographed at a known magnification before it is sectioned.

(2) The sections should be made of a known thickness (10 μ , 15 μ , etc.).

§ 510a. **The general law for magnification and reduction.**—With a given object the size of the image depends directly upon the relative distance of the object and of the image from the center of the lens (fig. 185, 209, 210). If the image is farther from the center of the lens than the object then the image will be larger than the object; conversely if the image is nearer the center of the lens than the object then it will be smaller than the object.

For example, if the image is to be ten times as large as the object the image must be ten times as far from the center of the lens as the object.

Conversely, if the image is to be one-tenth as large as the object it must be formed only one-tenth as far from the lens as the object.

In lantern-slide and micro-projection, and in photo-micrography the image is much larger than the object and correspondingly more distant from the center of the lens. In ordinary portrait photography and in landscape photography the image is much smaller than the object, and consequently the image is much nearer the lens than the object (see also § 392a).

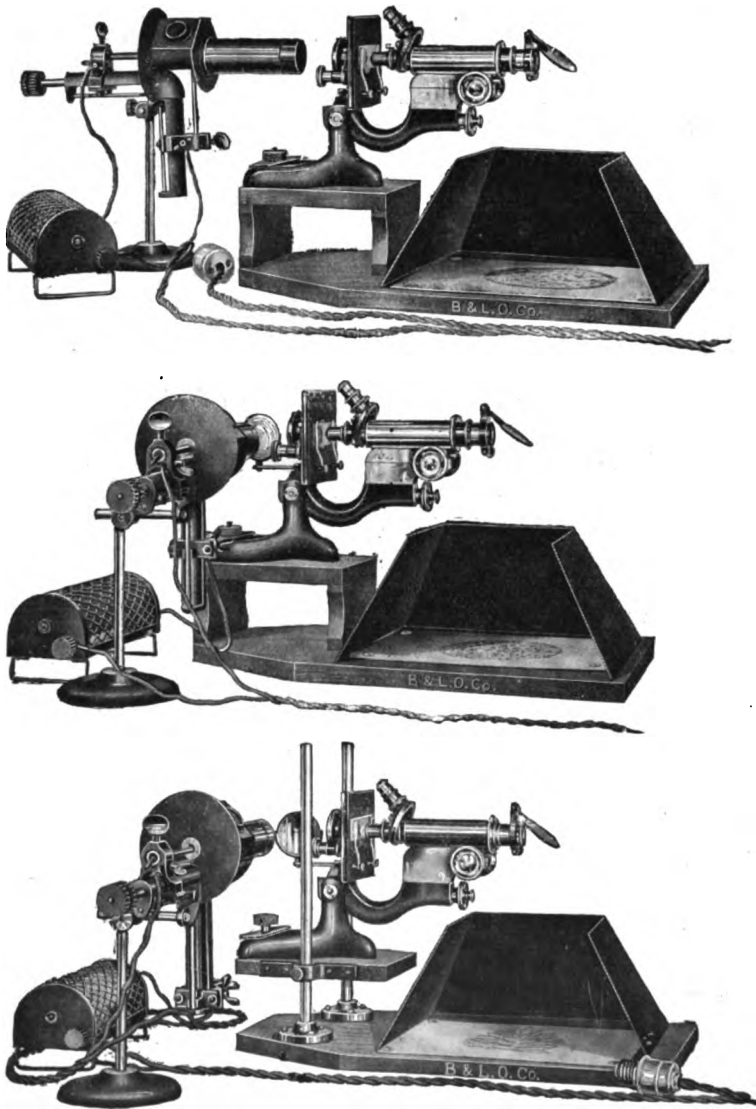

FIG. 201, A, B, C. SIMPLE DRAWING OUTFIT FOR THE MICROSCOPE.
(Cuts loaned by the Bausch & Lomb Optical Co.).

There is a hand-feed, right-angled arc lamp for small carbons, wiring and connections for the house circuit and a rheostat which will not permit over 6 amperes of current to flow. The lamp condenser is in a telescoping tube so that either a parallel or a converging beam of light can be obtained. To avoid stray light the drawing surface is enclosed by a metal box with one side removed.

A Drawing outfit with the lamp and microscope in line.

The microscope is supported on a block to give a drawing distance of 254 mm. (10 inches).

B Drawing outfit with the arc lamp at right angles to the microscope.

C Drawing outfit with the microscope on an adjustable platform and the arc lamp at right angles with the microscope.

(3) It must be decided in the beginning how much larger the model is to be than the original object.

(4) The objective and the drawing surface must be chosen and mutually arranged so that the desired magnification is attained (§ 509).

(5) The object must be placed on the stage of the microscope so that the image reflected down upon the drawing surface will be erect, that is, exactly like the object and not inverted in any way (see below § 512).

(6) Each drawing as it is made must be numbered to correspond with the number of the section: *This is very important.*

(7) It is desirable to make a duplicate set of drawings, for one set is used up in making the model, and one needs a set for reference.

The duplicate drawings are easily made by using thin carbon paper as in duplicating writing, or in typewriting.

(8) Marking the position of the apparatus. If all the drawings cannot be made at one time, then the objective, the ocular, if one is used, and the distance of the drawing surface from the tube of the microscope should be carefully measured or indicated by chalk marks, so that when working again exactly the same magnification can be used. It is well also to check up by using the stage micrometer again (§ 508). Pictures for models may also be made by photography, (see § 542).

ERECT IMAGES

§ 512. It has been known from the first use of projection apparatus that the projected image was inverted, and that this is true whether a simple aperture, a simple lens, or an objective of several

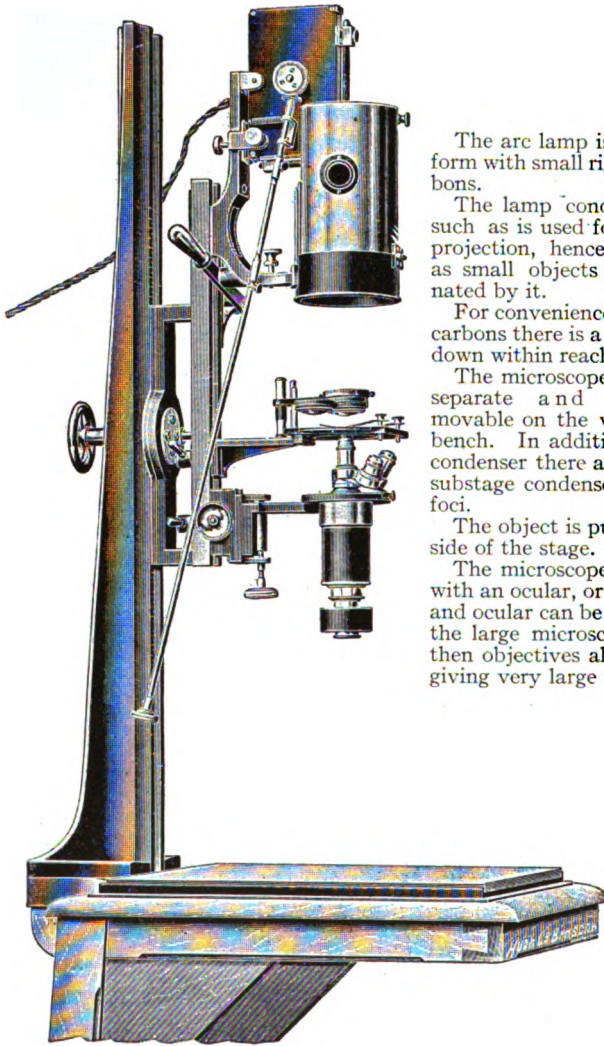

The arc lamp is of the Liliput form with small right-angled carbons.

The lamp condenser is large, such as is used for lantern-slide projection, hence large as well as small objects can be illuminated by it.

For convenience in feeding the carbons there is a rod extending down within reach of the artist.

The microscope and stage are separate and independently movable on the vertical optical bench. In addition to the lamp condenser there are two or more substage condensers of different foci.

The object is put on the upper side of the stage.

The microscope can be used with an ocular, or the draw tube and ocular can be removed from the large microscope tube, and then objectives alone used, thus giving very large fields.

FIG. 202. EDINGER'S VERTICAL DRAWING AND PHOTOGRAPHIC APPARATUS FOR USE ON THE HOUSE CIRCUIT.

(Cut loaned by Ernst Leitz).

lenses is used. The earliest workers also saw that an easy way to correct for this was to invert the object, then its image would appear in the natural position. But some objects do not admit of inversion, hence the effort to obtain erect images by some optical means.

The first and still the simplest method is by the use of a plane mirror with a horizontal screen (fig. 88, 89, 181, 204). The mirror might be put in the course of the beam before or after it has passed the objective. Figure 89 shows it before and figure 182 after traversing the objective.

It was demonstrated by Kepler (1611) and practically worked out by Scheiner (1619) that erect images could be produced by the use of two objectives in line. The first objective gives a real inverted image of the object, and the second gives a real, erect image of the inverted image (fig. 208). This is what occurs whenever an ocular is used with an objective in projecting with the microscope (fig. 207).

The principles for getting erect images with projection apparatus are very simple, but in practice it is a little puzzling to decide off-hand just how to arrange the object so that the screen image shall be erect and not show any of the inversions (fig. 212-214). This difficulty arises from the fact that in the different kinds of projection sometimes an opaque object is used, and sometimes a transparent object; sometimes an opaque and sometimes a translucent screen is employed; sometimes an objective only, and sometimes both an objective and an ocular are used for projecting the image; and finally, sometimes it is necessary to use a mirror or prism as well as an objective to get the image on the vertical or horizontal surface where it is to be seen or drawn.

The simplest and surest way to get the microscopic specimen on the stage of the projection microscope in a position which will give a correct image for drawing is the following:

1. The prepared microscopic specimen is placed on a piece of white paper so that it appears exactly as it should in the drawing, and the letters *a* and *k* are written on the cover-glass between the specimens (fig. 220).

2. The slide is then placed on the stage of the projection apparatus and its image thrown on the drawing surface. In case the specimen is wrongly placed to give an erect image the letters will show it, and the specimen can be rearranged until the images of the letters are correct in every way, then of course the images of the microscopic specimens will be erect in every way (see also § 517).

§ 513. **Erect images with opaque objects in a photographic camera with translucent screen.**—Place the object upside down in the holder. On the translucent screen it will be erect (fig. 211). If the object cannot be put upside down, the image will appear wrong side up on the translucent screen (fig. 212). It can be drawn

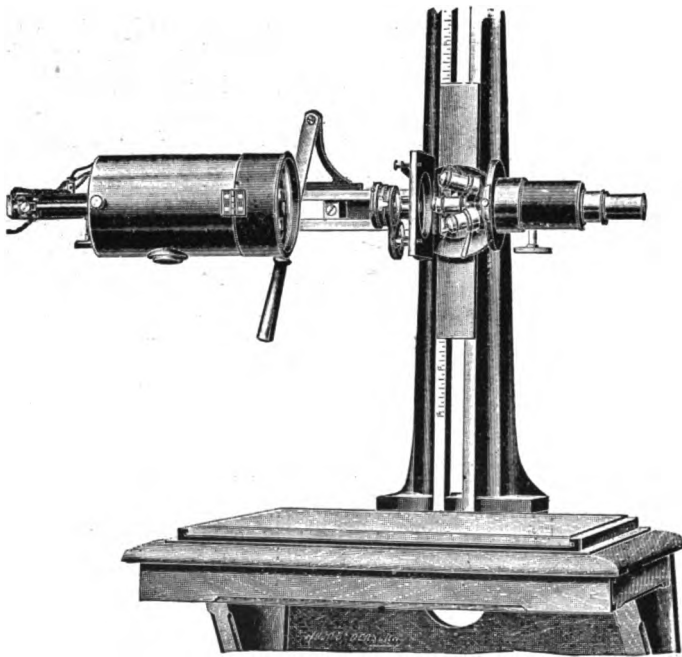

FIG. 203. LARGE EDINGER APPARATUS IN A HORIZONTAL POSITION FOR PROJECTION ON A VERTICAL SCREEN.

(Cut loaned by Ernst Leitz).

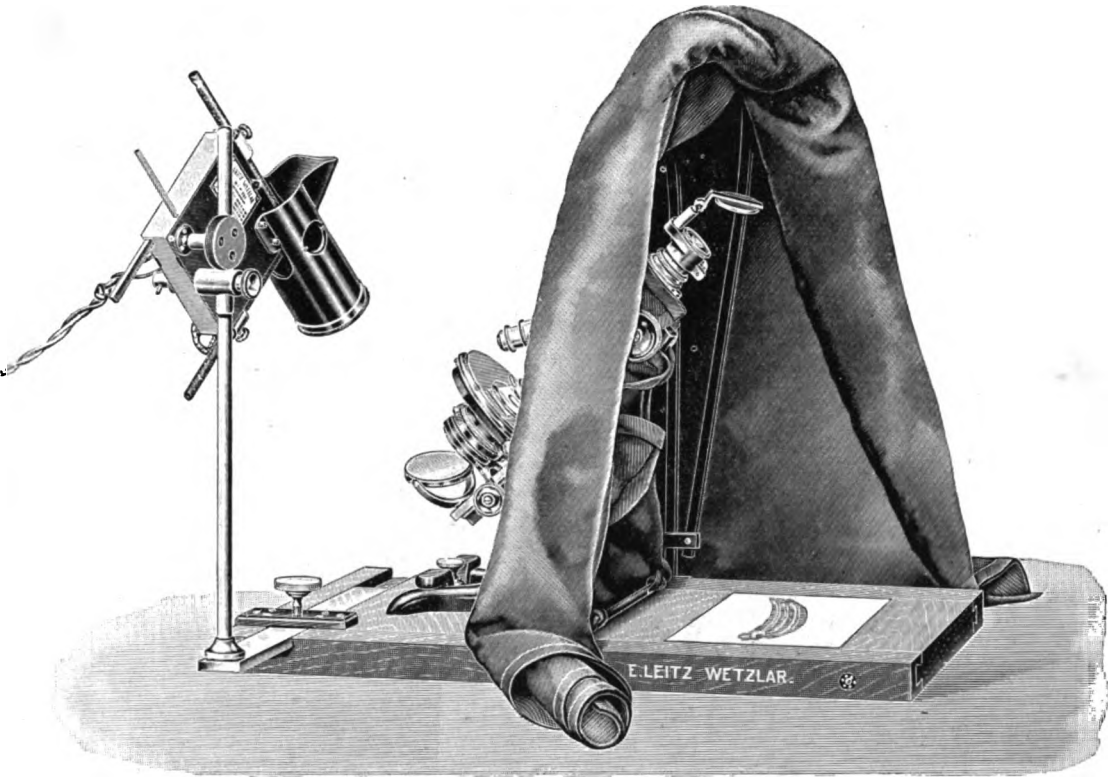

FIG. 204. EDINGER'S OUTFIT FOR DRAWING WITH AN ORDINARY MICROSCOPE AND SMALL ARC LAMP ON THE HOUSE LIGHTING SYSTEM.

(Cut loaned by Ernst Leitz).

This is the first form of the drawing outfits using the ordinary microscope and the small arc lamp on the house lighting circuit. It was demonstrated at the meeting of the Anatomische Gesellschaft at its Leipzig meeting, April, 1911.

The microscope is inclined to 45° and the mirror at an angle of 22.5° , thus directing the light vertically down upon the horizontal drawing surface.

For drawing in a light room a cloth tent is provided and is supported above and on the sides by metal arches. If it is very light one can pull the cloth over the head as in focusing a camera. In the evening or in a dark room the cloth can be opened widely to expose the drawing surface.

or traced in this position and the drawing turned right side up, when it will appear like fig. 211, that is, correct in every way.

§ 514. Erect images with the opaque lantern or episcopo.—

(A) The objective horizontal, the object and the drawing surface

vertical. The object is placed upside down in its vertical holder. The mirror reflecting the image upon the vertical drawing surface will give an erect image (fig. 211).

(B) The objective and the drawing surface horizontal, the object vertical. The artist with his back toward the apparatus: Place the object *right side up* in the vertical holder.

(C) Same as above, but with the artist facing the apparatus as with the drawing shelf in fig. 183. Place the object *wrong side up* in the vertical holder.

(D) Same, except that a vertical translucent screen is used. Place the object *wrong side up* in the vertical holder; do not use a

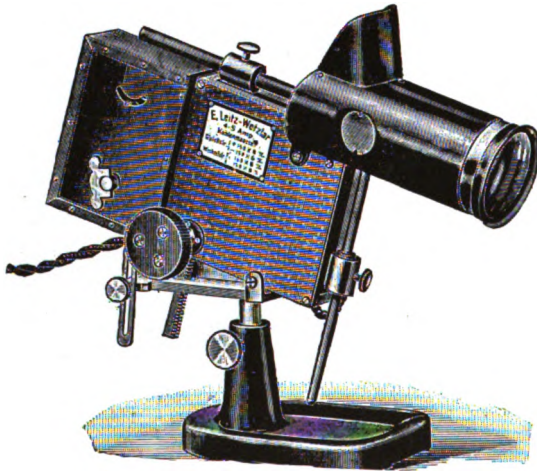

FIG. 205. SMALL ARC LAMP WITH CLOCK-WORK FOR FEEDING THE CARBONS.
(Cut loaned by Ernst Leitz).

This arc lamp for the house circuit has a clock-work which moves the carbons continuously. The arc must be started by hand as for a hand-feed lamp, but when once started the lamp will burn continuously provided the carbons burn off as fast as they are fed. If the carbons are too large the clock-work will feed them together faster than they burn away, and if too small the clock-work feeds the carbons too slowly and the lamp will go out.

The clock-work has a regulating device for speed and the lamp has the usual feed wheel for hand regulation.

This form of feeding mechanism is equally good for direct and for alternating current as the movement is entirely controlled by the clock-work. Such a lamp is especially useful for drawing and for photography.

mirror or prism with the objective, but point the objective directly toward the screen.

§ 515. **Erect images of horizontal objects with the episcope.**—Vertical drawing surface and vertical objective, horizontal object. The object is placed with its upper edge away from the drawing surface and the mirror reflecting the image to the vertical screen will make it erect (fig. 211).

§ 516. **Erect images on the drawing surface with the magic lantern.**—(A) With an opaque, vertical drawing surface. Place the transparency in the slide-carrier as described for lantern slides (fig. 7-8), i. e., with the object facing the light and wrong side up.

(B) For a translucent, vertical drawing surface. Place the object facing the objective and wrong side up.

(C) For an opaque horizontal screen. Place the object so that it faces the objective and the mirror or prism reflecting the rays downward will give an erect image (see B and C in § 514).

ERECT IMAGES WITH THE PROJECTION MICROSCOPE

§ 517. **Demonstration of the position of objects for erect images.**—The simplest way to determine how a specimen should be placed on the stage of the microscope to give an erect image on any

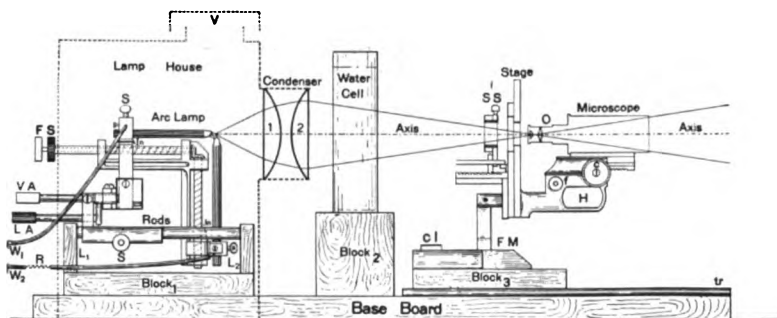

FIG. 206. MAGIC LANTERN ARC LAMP AND TWO-LENS CONDENSER USED IN MICRO-PROJECTION AND FOR DRAWING.

(See fig. 146 for full explanation).

kind or position of a screen is to use a specimen prepared as follows:

An ordinary microscopic slide is varnished as directed for lantern-slide glasses (Ch. VIII, § 317) and then the small letters *a* and *k* are written in the middle with a fine pen. These letters are selected because both in script and in printing they indicate clearly which side up they are and which way they face. With some letters it is not so easy to determine whether they have suffered an inversion or not.

A low power, 50 to 100 mm. focus objective, is good for projecting the image.

One could use a lantern slide with print upon it, or even a negative. For our experiments we used a lantern slide or negative of the metric measure (fig. 178, 211) so that cuts could be made for this book which were exactly like the images obtained on the screen with the transparency in different positions.

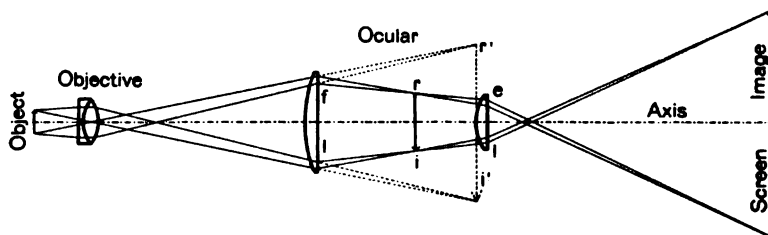

FIG. 207. DIAGRAM OF THE COURSE OF THE RAYS AND THE POSITION OF THE IMAGES WHEN AN OCULAR IS USED.

Object The object whose image is to be projected.

Objective The projection objective.

f' Field lens of the ocular. It acts with the objective to give a real, inverted image *r i*.

r i The real, inverted image of the object formed by the objective and the field lens of the ocular.

r' i' The inverted image of the object which would be formed by the objective if the ocular were absent.

e l Eye lens of the ocular. It acts like a second projection objective and gives a screen image of the real image (*r i*).

Axis The optic axis of all the lenses.

Screen Image The image projected by the eye lens. This image will be right side up, but the rights and lefts will be reversed on the ordinary opaque screen. If a translucent screen is used and the observer is behind it, the image will appear erect, and the rights and lefts will not be reversed.

It is a good plan to have a specially prepared microscopic slide or a lantern slide with print at hand whenever one is going to draw, then one can determine quickly and exactly how the specimen should be placed to give an erect image. A simpler method still is to write the letters, a, k, on the cover of the specimen to be drawn (§ 512, fig. 220).

POSITION OF THE OBJECT FOR ERECT IMAGES WITH THE PROJECTION
MICROSCOPE AND AN OBJECTIVE ONLY, OR WITH AN OBJECTIVE
AND AN AMPLIFIER

§ 518. **For an opaque vertical screen.**—Place the object on the stage as a lantern slide is placed in its carrier (§ 35), that is, with the specimen facing the light and the lower edge up. With a microscopic specimen this would bring the cover-glass next the stage and facing away from the objective instead of toward it, as in ordinary microscopic observation. In this case one must focus through the slide instead of through the cover-glass. This can, of course, be done with low, but not with high powers. (See drawing on a horizontal surface § 524).

With the specimen placed as directed, the image on the vertical opaque screen will appear erect in every way (fig. 211).

If one faces the light and looks at the specimen on the stage it will look like fig. 214 that is, like print seen through a sheet of paper wrong side up.

§ 519. **For a translucent vertical screen.**—If the screen is of ground-glass like that of a photographic camera, or if it is of tracing paper or other translucent substance supported by clear glass, the *object* should be placed on the stage so that it faces the objective, and is lower edge up.

When the observer looks at the *image* on the translucent screen, i. e., facing the light, the image will be erect like fig. 211.

When he faces the light and looks at the *object* on the stage it will appear like fig. 212, i. e., it is simply upside down.

POSITION OF THE OBJECT FOR ERECT IMAGES ON A HORIZONTAL SURFACE WITH AN OBJECTIVE OR WITH AN OBJECTIVE AND AN AMPLIFIER AND A 45 DEGREE MIRROR OR PRISM

§ 520. For an opaque horizontal screen.—(A) If for a drawing table and mirror (fig. 182), place the object on the stage so that it faces the objective and is right edge up. The image on the horizontal surface will appear erect when the observer looks at it facing away from the light.

The object on the stage will appear erect when the observer looks at it facing toward the light.



FIG. 208. KEPLER'S METHOD OF PRODUCING ERECT IMAGES BY MEANS OF TWO PROJECTION LENSES.

(From Scheiner's "Oculus", 1619).

(B) If the mirror is very close to the objective (fig. 183) the natural position for drawing is to sit facing the light. The object then is put in position facing the objective as before, but upside down. The image will appear erect on the drawing surface when the observer faces the light.

§ 521. **For a translucent, horizontal screen.**—In some of the old forms of sketching apparatus the image was reflected upward by a mirror or prism, and the artist drew on the upper surface.

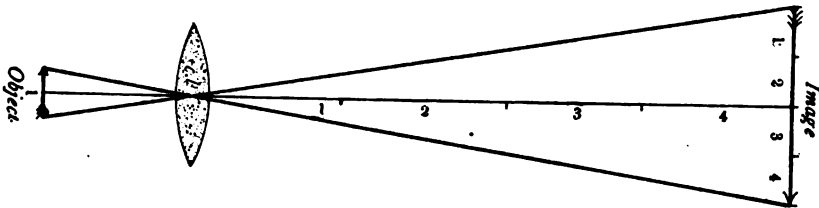

FIG. 209. DIAGRAM TO SHOW THAT THE SIZE OF THE IMAGE OF AN OBJECT DEPENDS UPON THE RELATIVE DISTANCE OF THE OBJECT AND IMAGE FROM THE CENTER OF THE PROJECTION LENS.

(From *The Microscope*).

In this figure the image is four times as far from the center of the lens (d) as the object, hence, from the law of similar triangles, the image must be four times as long as the object.

For such an arrangement, the object is put on the stage facing the light, but right edge up. The image will appear erect on the translucent screen when the observer faces the light and looks down upon the screen. For this experiment the mirror or prism must be on the lower side of the ocular (fig. 215).

POSITION OF THE OBJECT FOR AN ERECT IMAGE WITH AN OBJECTIVE AND AN OCULAR

§ 522. **For an opaque vertical screen.**—The object should face the light as with a lantern slide, but it must be right edge up. With a microscopic specimen the cover-glass will be next the stage as in § 518. On the screen the image will appear erect (fig. 211). The object on the stage will appear reversed like print seen in a mirror (fig. 213).

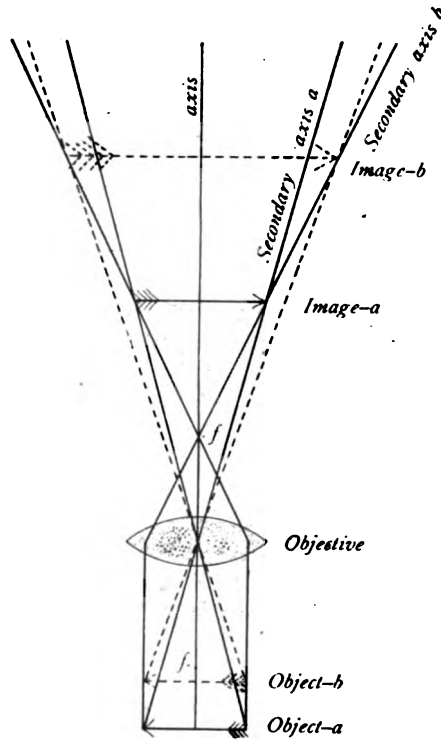

FIG. 210. DIAGRAM TO SHOW THAT THE SIZE OF THE IMAGE DEPENDS UPON THE DISTANCE OF THE OBJECT FROM THE CENTER OF THE LENS.
(From *The Microscope*).

The object at *Object-a* necessitates an image at *Image-a*; while if the same object is moved closer to the lens, as at *Object-b*, the image will move farther from the lens (*Image-b*) and be correspondingly larger.

f f The principal foci of the lens (objective).

axis The principal axis of the lens.

Secondary axis a, Secondary axis b Represent the secondary axes which mark the limit of the object and the two images.

With the object farther from the lens the secondary axes are in full lines, while for the object nearer the lens the secondary axes and the image are shown by broken lines.

§ 523. For a translucent vertical screen.—The object is put on the stage facing the objective and right edge up. The image will

10 CENTIMETER RULE

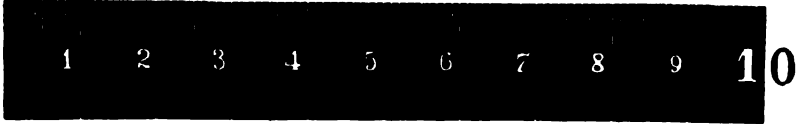

The upper edge is in millimeters, the lower in centimeters.

FIG. 211. CORRECT IMAGE.

The upper edge is in millimeters, the lower in centimeters.



10 CENTIMETER RULE

FIG. 212. INVERTED IMAGE.

10 CENTIMETER RULE

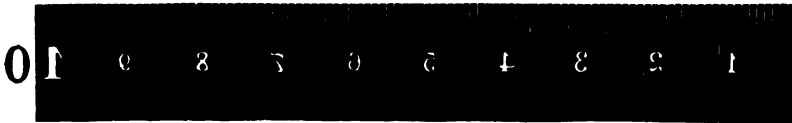

The upper edge is in millimeters, the lower in centimeters.

FIG. 213. MIRROR IMAGE.

The upper edge is in millimeters, the lower in centimeters.

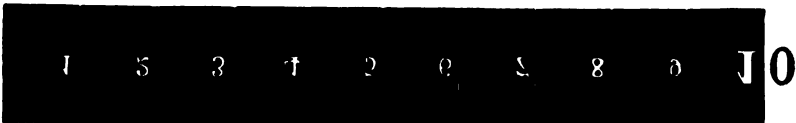

10 CENTIMETER RULE

FIG. 214. INVERTED MIRROR IMAGE.

FIG. 211-214. FIGURES OF A METRIC RULE, FULL SIZE, TO SHOW CORRECT, INVERTED, MIRROR AND INVERTED MIRROR IMAGES.

These representations of screen images show the result of placing the object in different positions or of using different means in projection. The determining factors for the position of the object for a correct screen image are:

- (1) Projection by an objective or by an objective and an amplifier (fig. 121, 126).
- (2) Projection by means of two lenses or of an objective and an ocular (fig. 207, 208).

(3) The use of a prism or of a mirror to change the direction of the rays on their way to the screen (fig. 192).

(4) The use of an opaque screen.

(5) The use of a translucent screen.

appear erect like fig. 211 when seen through the translucent screen and facing the light.

Facing the light, the object on the stage will also appear erect.

POSITION OF THE OBJECT FOR AN ERECT IMAGE WITH AN OBJECTIVE AND OCULAR, AND A 45 DEGREE MIRROR OR A TOTALLY REFLECTING PRISM

§ 524. For an opaque horizontal screen.—(A) For the drawing table and mirror (fig. 182), place the object on the stage so that it faces the objective and is with the lower edge up. The image will appear erect on the drawing surface when the observer faces away from the light.

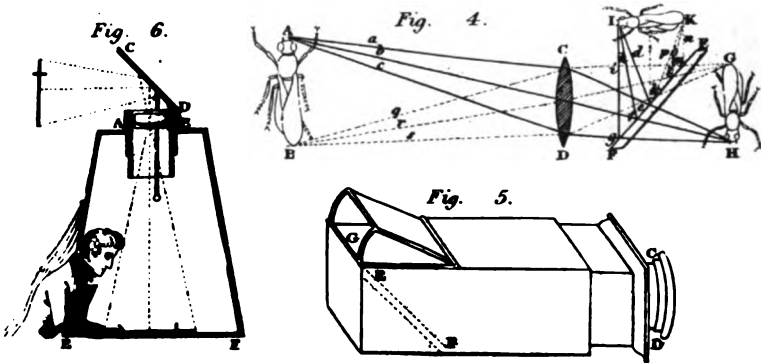

FIG. 215. EARLY METHODS OF DRAWING WITH PROJECTION APPARATUS.

In the picture at the left (Fig. 6) is shown a drawing tent or box with a 45° mirror and vertical objective by which an erect image is projected upon the drawing table as in figures 88-89. The artist sits outside, but has his head and bust within and the light is excluded by a cloth curtain over the back.

In Fig. 5 is shown a drawing box composed of an objective at the right (*CD*), a 45° mirror (*EF*), and a drawing surface (*G*) covered by a sloping roof of opaque material to keep out the light. With this instrument the artist simply introduces the hand and pencil. The picture will have the rights and lefts reversed as the drawing is made on the back of the drawing paper, not on the front as with Fig. 6.

Fig. 4 is to show the course of the rays from an object (*AB*), and its inverted image (*GH*). When the mirror (*EF*) is introduced the image (*IK*) is rendered horizontal.

If the observer faces the light the object on the stage will appear like a printed page upside down (fig. 212).

(B) For a drawing shelf, the mirror or prism being close to the ocular and the draughtsman sitting with his face toward the light (fig. 183, 187), the object is placed on the stage facing the objective and right edge up.

The image will be erect on the drawing surface (fig. 211).

The object on the stage will also appear erect (fig. 211).

§ 525. **For a translucent screen.**—For this the object is simply turned around so that it faces in the opposite direction in each case but remains the same edge up.

§ 526. **For erect images on a horizontal drawing surface with apparatus like Edinger's** (fig. 202).—In this case no mirror or prism is necessary. The position of the object on the stage for erect images is precisely the same as for a horizontal microscope and a vertical screen (§ 518).

This has the disadvantage of requiring one to turn the cover-glass away from the objective, which prohibits the use of high powers. If the cover-glass is turned toward the objective the drawing will be like a mirror image (fig. 213).

DRAWINGS FOR PUBLICATION BY THE AID OF PROJECTION APPARATUS

§ 527. Projection apparatus can give much assistance in producing the outlines and main details of drawings for publication. The outline drawings should be made on good drawing paper with a medium lead pencil. When the ink, air-brush, or crayon work is added for the finished drawing, the pencil lines will be covered or they may be erased. The finishing must be done free-hand and constant reference made to the actual specimen, to the image on the screen, or as looked at through a microscope. The finishing cannot be done successfully with the image of the specimen projected on the drawing paper as one cannot tell how the drawing looks with the image projected upon it. By means of a suitable screen the image may be cut off of part of the drawing surface while doing the finishing. By removing the screen the image can be

projected again upon the surface to make sure that all the details have been correctly drawn.

It is always desirable that drawings accompanying a scientific article should be at a definite enlargement or reduction, and that the scale of the drawing be definitely stated (See Style Brief, of the Wistar Institute, pp. 16-17).

If the drawings have been made without first doing this, then the magnification can be found by arranging the apparatus exactly as when the drawings were made and using a micrometer as directed in § 508.

A plan frequently followed is to have a few lines of the micrometer image drawn in one corner near the picture. Then any one can determine the scale of magnification or reduction (§ 510, 510a).

§ 528. Lettering the drawings.—After the drawings are finished the various parts can be lettered, or words can be written in where needed. Most workers, however, cannot letter neatly enough for publication. For such it is better to use printed words, letters or numerals.

It is assumed here that the drawings will be reproduced by some photo-engraving process; and for this the letters or words pasted on the drawing would best be printed on tissue paper, (§ 528a); Gothic type is best. By consulting fig. 216, one can select the proper size for the reduction to be made (§ 531).

§ 527a. Tracing pictures natural size on drawing paper.—It frequently happens in making the drawings for a book or for a scientific paper that pictures from other books or scientific papers are desired. Of course, if there are to be no modifications, the simplest method is to borrow an electrotype or to have the photo-engraver make a new cut; but sometimes only an outline is needed or modifications are desired.

If the picture is to be the same size as the one in the book or periodical it can be easily traced upon the drawing paper as follows: In place of a wooden shelf on the table (fig. 183, § 460) a piece of thick glass is placed on the brackets and an incandescent lamp of 40 or 60 watts, surrounded by a lamp shade of some kind, is turned so that it shines directly upward. It is then placed up close to the glass and the picture to be traced is placed on the glass, and over it the drawing paper. The light is so strong that it traverses the picture and the drawing paper and the picture is clearly seen on the upper side of the drawing paper. It can be traced almost as easily as if an image were projected upon the upper face. In tracing drawings for this book, Wattman's hot pressed paper and Reynold's bristolboard were used in making tracings in the way just described. Even if there is print on the opposite side of the page the tracing of the picture can be made successfully.

§ 529. **Fastening the letters to the drawing.**—The letters, numerals, or words are cut from the printed sheet, with pains to make straight edges and square corners. Then they are turned face downward and with a camel's hair brush of small size such as is used by artists, some freshly made starch paste is put on the back. As each word or letter is pasted, one uses fine forceps to pick it up and place it in the desired position, being sure that the letter or word is arranged properly. In the beginning it is well to use a try-square or some other instrument to make sure that the letter or word is arranged correctly. Then it is pressed down, using some tissue paper over the finger or some fine blotting paper, and pressing directly downward so as not to disarrange the letter or word by a lateral thrust.

§ 530. **White letters on a black back-ground.**—Sometimes it is necessary to use white letters or numerals on a black ground (e. g., see fig. 211-214). In the largest printing houses one might be able to get these, but they are easily made as follows:

The desired letters, numerals, abbreviations or words are printed on the white tissue paper as indicated above. A sheet of this printed tissue paper is used as a negative by putting a clean glass in the printing frame, placing the printed tissue paper face down on the glass, and then putting some Velox, Cyco, or other photographic paper in place and printing exactly as for any negative. The opaque letters will be in white, and the practically transparent tissue paper between the letters will give the black back-ground in the print.

§ 528a. (1) The authors are indebted to Mr. George C. Stanley, Ithaca's photo-engraver, for the suggestion to use tissue paper for the printed letters and words to be pasted on drawings for photo-engraving. The advantage of tissue paper is that there is no shadow around the edge of the letter or word. Where thick, ordinary white paper is used there is frequently left a black line due to the shadow, and this line must be cut out by the engraver or it will give a black line in the printed book.

(2) Starch paste for use in sticking on the letters and words should be freshly made. A good paste is made of dry laundry starch 5 grams, cold water 50 cc. These are put in a small vessel and gradually heated with constant stirring until the paste is formed. Mucilage and other adhesives make the tissue paper yellowish; and paste which has been made some time is liable to have fine lumps in it so that the letters are torn or distorted in pressing them down on the drawing.

Paper and developer should be of the contrast variety to give pure blacks and whites.

These letters, etc., are cut out and pasted on the drawing just as described above. The photographic paper being rather thick, there will be a white streak around the letter, etc., where cut out. This can easily be blackened after being stuck in place by the use of a pen or a fine brush, using India ink.

SIZE OF DRAWINGS AND THEIR LETTERING

§ 531. It is wise to make the drawings considerably larger than the desired picture. In reducing, the coarseness and some other infelicities of the drawing become less noticeable.

Of course if the drawing is made exactly the size of the desired cut, then it must look exactly as one desires it in the printed book; it is not liable to be improved by the process of photo-engraving. But if the drawing is to be reduced, then the lettering, etc., must be coarse enough in the drawing to give the proper appearance in the finished cut.

There is some confusion in the minds of the inexperienced as to the appearance of a picture half the size of the original. To the engraver half-size always means that any given line or part is just half the length of the original. That is, if any line of the original were 10 centimeters long, the finished cut would show the same line 5 centimeters long if it were reduced to half the original size. The appearance is well shown in the accompanying figure (fig. 216). In the upper half the letters and numerals are of full size; in the middle they are of half the original size; and below they are of one-fourth the original size. This picture will show one also about the size of type to use for the different reductions. The numerals on the left indicate the size of the type, as 24 point, 18 point, 12, 10, 8, and 6 point, respectively.

The lettering of pictures in books and periodicals should be proportioned to the size of the details of the cuts. It is distressing to have the letters and numerals on figures the most prominent feature. On the other hand, it is exasperating to have letters so minute that one needs a microscope to make them out. As

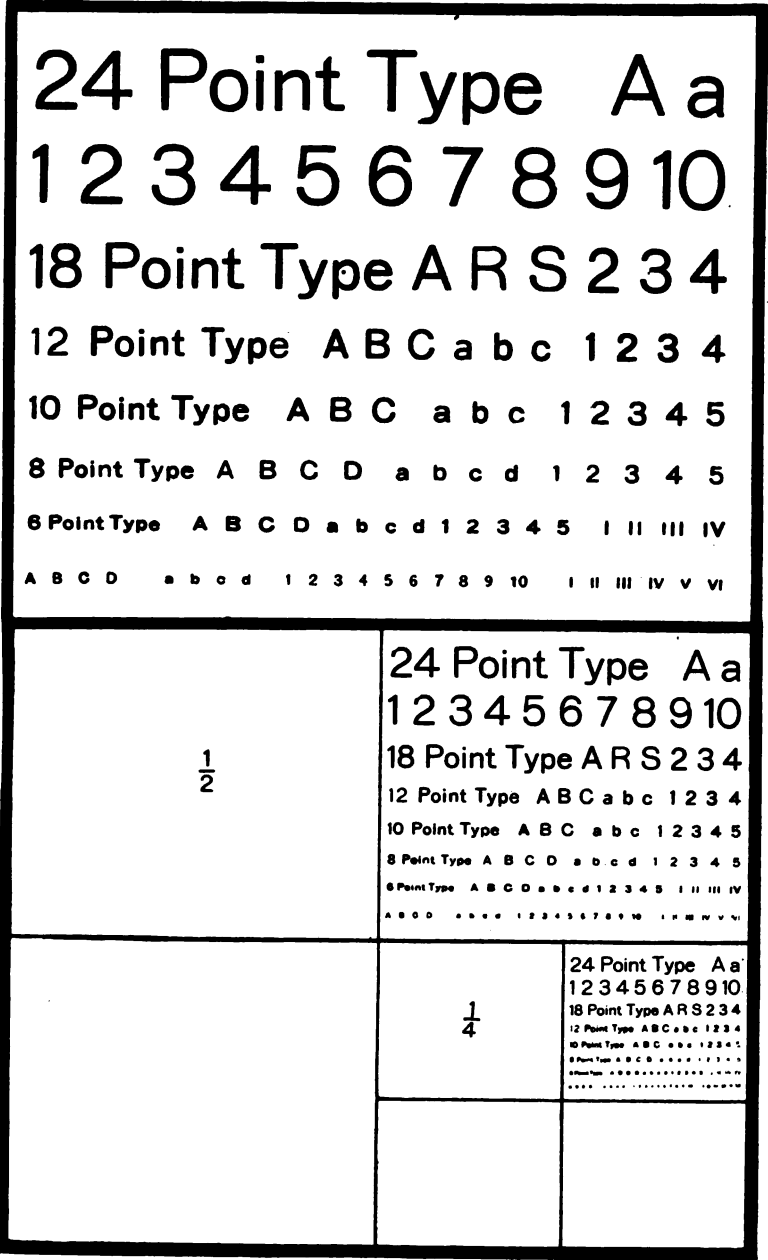

FIG. 216

FIG. 216. GOTHIC TYPE TO USE ON DRAWINGS AND THE APPEARANCE WHEN REDUCED.

In the upper half are shown letters and figures of full size with their designations by the printer, i. e., 24, 18, 12, 10, 8 and 6 point type.

In the lower half are shown the same reduced to one-half the length, and reduced to one-fourth the length.

shown by the numerals and letters in fig. 216, if the drawing is not to be reduced at all one can use 6, 8, or possibly 10 point type.

For one-half reduction (one-half off), the lettering should be with 10 or 12 point type. For one-fourth size ($\frac{3}{4}$ off), then the lettering should be with 12 or preferably with 18 point type.

PROJECTION APPARATUS FOR PHOTOGRAPHIC ENLARGEMENTS

§ 532. **Enlarged prints of negatives.**—There is great advantage in making pictures of large objects at a considerable distance so that the perspective will be correct and all levels in focus. It is also advantageous to make pictures of microscopic objects without undue enlargement, then there is greater sharpness of the object as a whole.

If now one wishes a large picture, any good negative can be printed by the aid of a photographic objective at almost any desired enlargement. This can be done with projection apparatus in a dark room by the following method: The management of the projection apparatus is as for drawing. The negative is placed in some kind of a holder and put in the cone of light from the main condenser where the part to be enlarged will be fully illuminated (fig. 132, 185). Care must be taken to so place the negative that an erect image will appear on the printing paper (§ 512).

§ 533. **Condenser required with negatives of different sizes.**—Remember that the diameter of the condenser must be somewhat greater than the diagonal of the part of the negative to be enlarged (§ 314 and fig. 114). For example, to use the whole of a lantern-slide negative (85 x 100 mm., $3\frac{1}{4}$ x 4 in.) the condenser should have a diameter of 14 cm. ($5\frac{1}{2}$ in.).

For a negative 100 x 125 mm. (4 x 5 in.), the condenser should be 18 cm. (7 in.) in diameter; for a negative 125 x 175 mm. (5 x 7 in.), the condenser should be 23 cm. (9 in.) in diameter and for a negative 200 x 250 mm. (8 x 10 in.), the condenser should be 35 centi-

meters (14 in.) in diameter. Of course, if only a part of the negative plate contains the picture to be enlarged then a smaller condenser in the given case will answer. The above figures are for the diagonal of the respective sizes. These condensers are usually of relatively long focus, especially those of the larger diameters, e. g., the 35 cm. lens ordinarily has a focus of 50 centimeters. The condensers most used for enlarging are usually of the double form, the convexities facing each other as for the magic lantern condenser (fig. 185).

§ 534. **Objectives to use for printing.**—It is necessary to use an objective which has been corrected for photography. The ordinary projection objective gives a good visual image, but not a good photographic image, hence it is better to use a photographic objective.

§ 535. In focusing, some white paper should be put into the printing frame or pinned in place and the image focused with care. The photographic paper when put in the same place will then give a sharp picture.

§ 536. **Photographic paper for printing with projection apparatus.**—If one has sunlight or the arc light the developing papers like Velox, Cyco, etc., are plenty rapid enough. If a weak light is all that is available, then Haloid or one of the more rapid bromide papers will be called for.

§ 537. **Holding the paper while printing.**—(A) If the pictures are of microscopic objects or other pictures of relatively small size (i. e., up to 30 x 35 cm.; 12 x 14 in.), a good method is to put a clear glass in a printing frame and press the printing paper down upon it just as one does for printing from a glass negative by contact. This holds the paper perfectly flat and ensures uniform sharpness. With the printing frame one can lay it flat if a mirror or prism is used, or it can stand on edge facing the objective if no mirror is used.

(B) If the printing paper is large the usual method is to have a board screen on a track. The picture is then got of the desired size by varying the distance between the board and the objective,

then the image is carefully focused by putting some white paper on the screen or by having a ground-glass in the middle of the screen. Then the objective is covered with a dark cap or with a cap containing ruby glass, and the photographic paper is fastened in place by thumb tacks or in some other way, care being taken to stretch it smooth.

§ 538. **Exposure.**—When the paper is in place the cap is removed from the objective and the projected image will print on the paper. The time necessary depends upon the magnification, the density of the negative, the intensity of the light and the sensitiveness of the paper used. It usually takes about one-fourth the time one would print by contact using a 16 candle-power frosted incandescent lamp. A good plan is to try a small piece of the paper and determine the correct exposure before printing on the large sheet. After the exposure the objective is covered with the cap and the paper is developed exactly as for contact printing.

§ 539. **Diaphragm of the objective.**—In printing, the diaphragm of the objective is wide open if the unmodified cone of light is used for illumination. This has one defect with the arc lamp. If there are any irregularities in the negative, such as minute scratches, etc., they would show in the print, whereas if the illumination were from an extended instead of a very small source like the crater of the arc lamp, the slight defects would show very much less.

To obviate this defect with the arc lamp one or more plates of ground-glass or of milk white glass are placed in the path of the beam before the negative. It must be put far enough from the negative so that the grain of the ground-glass will not show.

With the ground-glass or the milky glass in the beam the diaphragm of the objective can be closed as much as desired. The use of the ground-glass and the closure of the diaphragm will, of course, necessitate a longer exposure.

§ 540. **Avoidance of stray light.**—If one is to do considerable printing with the projection apparatus a light-tight lamp-house must be used and light-tight bellows between the condenser and the negative and objective. A special camera is most satisfactory.

For the occasional use of a laboratory the stray light can be excluded by means of asbestos paper. Sometimes the arc lamp is put on the outside of a partition, but that necessitates going out of the printing room to adjust the lamp. If direct current is available an automatic lamp is a great convenience.

PHOTOGRAPHING WITH PROJECTION APPARATUS

§ 541. Apparatus which will give good projection of microscopic specimens can, with slight modifications be used for photomicrography.

There are three possibilities:

- (1) Printing the image directly on a developing paper.
- (2) Exposing a dry plate directly to the image as for the paper.
- (3) Using a camera and plate holder.

§ 542. **Printing the projected image directly on a developing paper.**—With the apparatus set up exactly as for drawing one can expose a sheet of developing paper to the sharply focused image of the specimen as described for the enlargement of negatives (§ 532). The lights and shades will be reversed, but all the outlines and details will be present. This is a convenient method of getting an enlarged record of the specimen.

It is also a good method for making pictures for models (§ 511) especially when there are many details. With the cheap developing papers in rolls now obtainable the expense is not greater than for making drawings, and there is liable to be a gain in accuracy. The main draw-back is that but a single picture is made of each specimen for a single exposure, while in drawing it is as easy to make two or three as one, by using carbon paper (§ 511).

§ 543. **Exposing a dry plate directly to the image.**—A dry plate may be exposed as just described for the developing paper. The object must be so placed on the stage of the microscope that the image on the screen will be a mirror image of the specimen, that is, the rights and lefts will be reversed as they should be in a negative. The image is sharply focused, and the light cut off with a deep red glass so that the plate will not be affected.

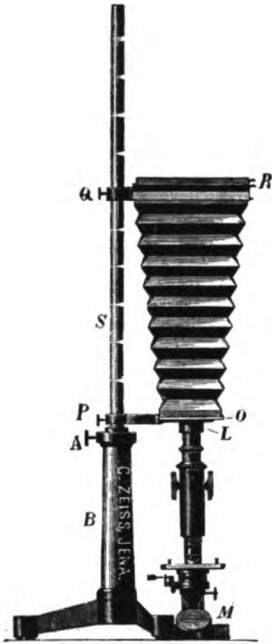

FIG. 217. VERTICAL PHOTO-MICROGRAPHIC CAMERA.
(From Zeiss' Photo-micro-graphic Catalogue).

A Set screw holding the rod (S) in any desired position.

P Q Set screws by which the bellows are held in place.

B Stand with tripod base in which the supporting rod (S) is held. This rod is now graduated in centimeters and is a ready means of determining the length of the camera.

M Mirror of the microscope.

L The sleeve serving to make a light-tight connection between the camera and microscope.

O The lower end of the camera.

R The upper end of the camera where the focusing screen and plate holder are situated.

The plate holder is then put in position, and the dark slide removed. The red glass is then removed for the short time necessary for the exposure ($\frac{1}{10}$ th sec., more or less) and then replaced. The dark slide is put back in the holder. The plate is developed and printed as usual.

When working with dry plates in this way great care is required to avoid stray light. Stray light which would not injure printing papers will fog a dry plate.

§ 544. Using a camera and plate holder.—

When exact results are required or much photo-micrography is to be undertaken, it is better to use a camera in connection with the projection apparatus (fig. 219).

The camera and projection apparatus are put on a long laboratory table, or the camera may be put on a second table and adjusted to the height of the projection microscope. The camera is connected with the projection microscope by means of a light-excluding sleeve such as that used by Zeiss with his photo-micrographic outfit (fig. 217-218).

The camera serves to exclude all stray light and to hold the plate holder in the correct position. The camera is supplied with a focusing screen which occupies exactly the same position as does the plate during exposure.

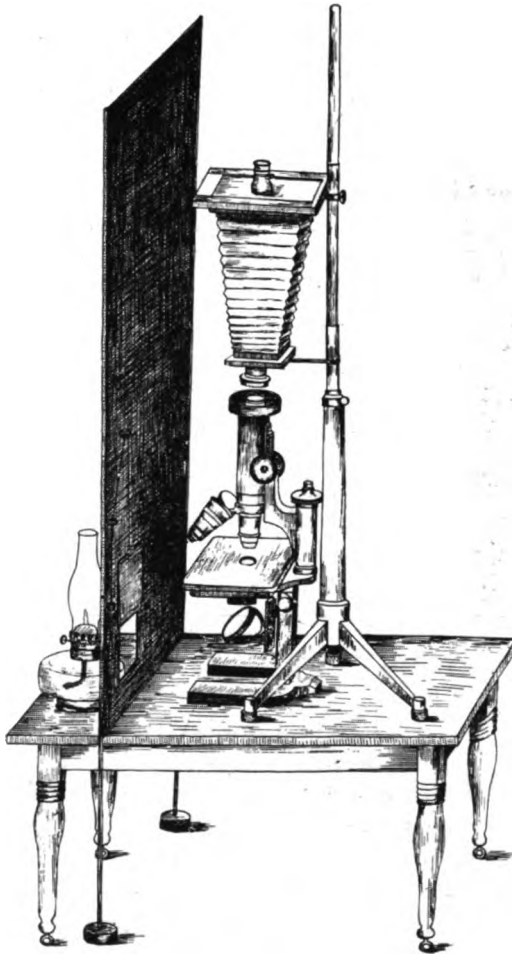

FIG. 217A. VERTICAL CAMERA WITH METAL SHIELD.

(From the Transactions of the Amer. Micr., Soc., Vol. XXIII, 1901).

The camera is on a low table and a shield of sheet zinc or roofing tin is on a stand between the source of light and the camera to protect the camera and the eyes of the operator. Opposite the light source is an opening with a shutter. The source of light in this case is a kerosene lamp.

§ 545. **Objectives to use.**—The micro-planars (fig. 123) or other short focus objectives of the photographic type are used without an ocular. They can be screwed into the nose-piece of the microscope or the microscope can be dispensed with and the objectives put into the end of the camera as with photographic objectives.

If one wishes to use the ordinary microscope objectives then an ocular of the projection type is of great advantage although Huygenian oculars will give good results. The apochromatic objectives, and the projection or compensation oculars to go with them, give the best results.

§ 546. **Making the negative.**—The image is first focused very sharply on the focusing screen. For lights of high intensity it will be necessary to soften the light in focusing so as not to injure the eyes. This can be done by putting a neutral tint glass plate or several thicknesses of ground-glass or one or more plates of milky glass in the path of the beam before the object.

The exposure and subsequent development and printing with the negative are as usual.

§ 547. **Photo-micrography with a vertical camera.**—If a vertical microscope is to be employed for photography, then it is best to use a vertical camera (fig. 217). A parallel beam of light is caused to fall upon the plane surface of the microscope mirror, and the mirror is turned to throw it directly up through the substage condenser upon the object. To get the parallel or approximately parallel beam one uses a condenser lens of very long focus (§ 479, fig. 154) or a parallelizing lens is used (fig. 153).

TROUBLES MET IN CHAPTER X

§ 548. The troubles liable to arise in the work of this chapter are those common to the preceding chapters. Those discussed in Chapter I and III are to be especially reviewed, as the source of light is most likely to be the electric arc. (See § 128a for the blowing of fuses).

(1) In drawing with the microscope with the small carbon arc lamp on the house lighting system, probably the trouble most

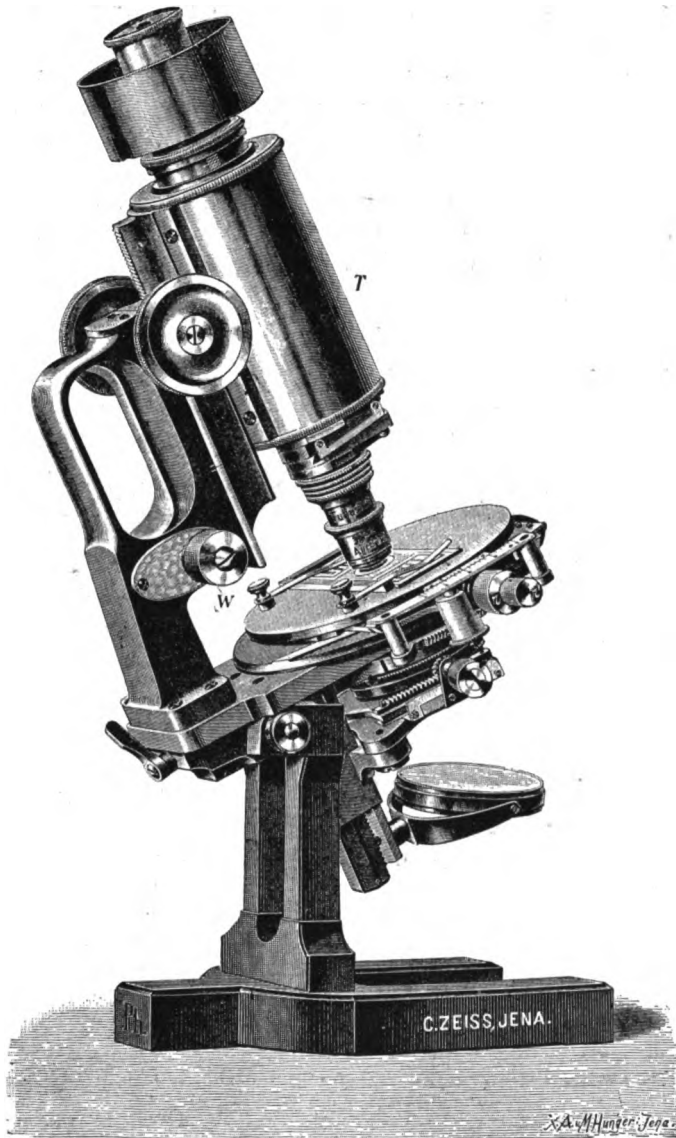

FIG. 218. THE ZEISS PHOTO-MICROGRAPHIC MICROSCOPE.

(From Zeiss' Catalogue).

This is the parent form of photo-micrographic stands with large tube (*T*), handle in the pillar and a special fine adjustment at the side (*W*). At the top is half of the light-excluding sleeve.

likely to arise is the lack of a brilliant picture on the drawing paper owing to the light in the room. Remember that to get a brilliant image the light must come to the eyes from the drawing surface only, and the drawing surface must receive no light except that from the specimen. The weaker the light and the greater the magnification the darker must the room be.

(2) In drawing from negatives or lantern slides remember that it is necessary to have a condenser somewhat larger than the diagonal of the object to be drawn (§ 314, 533).

(3) In drawing with the microscope where the substage condenser is used the condenser must be in the exact position to give the best results. If the slide is thick the condenser is a little higher



FIG. 219. MICRO-PROJECTION OUTFIT AND VERTICAL CAMERA ARRANGED FOR PHOTO-MICROGRAPHY.

(From *The Microscope*).

The apparatus is set up on a long table or on two tables placed end to end. The vertical camera (fig. 217) is placed horizontally and the bellows reversed. For illumination a petroleum lamp with large flat wick (38 mm., $1\frac{1}{2}$ in.) answers well.

Objects 50 to 60 mm. in diameter may be fully illuminated with the face of the flame, the lamp being 1 to 2 centimeters from the condenser. For powers of 100 to 150 diameters the flame is turned obliquely or edgewise, and placed 5 to 6 centimeters from the condenser. The position shown in the picture above is for high power work. No water-cell or specimen cooler is needed.

A light-tight connection is made with the large tube of the microscope by a double sleeve like that employed by Zeiss for the microscope. With low magnifications no ocular is used, and the objective is placed in the end of the camera. If one desires to make pictures of a size above the capacity of the photo-micrographic camera it is possible to use an ordinary camera, (fig. 117-119), then even quite large objects 50 to 60 mm. long, can be magnified considerably. The petroleum lamp has some advantages over daylight as the lamp gives an illumination of constant intensity. It is available during the entire 24 hours of the day, and in all seasons.

than for a slide which is thin. Attention to the substage condenser will make a great difference with one's success.

(4) The right-angled arc lamp should be used in drawing because if the microscope and lamp are properly arranged the source of light will remain in the axis no matter how long the lamp burns. If an inclined carbon lamp or one with both carbons in the vertical or horizontal position is used the source of light is constantly getting out of the axis from the burning away of the carbons, consequently they must be fed up more frequently to keep the source of light in the field.

(5) The picture will be distorted unless the axial ray strikes the drawing surface at right angles. Therefore, in using a prism or mirror for a horizontal surface the microscope must be horizontal and the mirror or prism at 45 degrees to reflect the axial ray vertically downward. If the mirror or prism is twisted over to one side the axial ray will not strike the surface at right angles and there will be distortion. If one has a micrometer in squares it is easy to determine whether the image is distorted or not.

(6) The image will be erect only when the object is properly placed on the stage.

(7) If a glass mirror silvered on the back is used, and the object is quite opaque the secondary image reflected from the face is

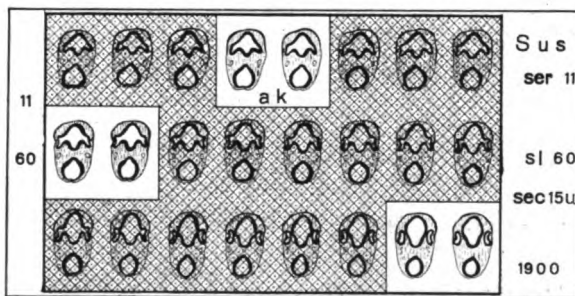

FIG. 220. SLIDE OF SERIAL SECTIONS WITH -a, k- ON THE COVER-GLASS TO ENABLE ONE TO DETERMINE WHEN THE IMAGE ON THE DRAWING SURFACE IS ERECT (See fig. 143, and § 512, 517).

liable to cause confusion. If the mirror is silvered on the face or if a prism is used there will be no doubling of the reflected image.

(8) Inverted images. One must follow carefully the directions or there is liable to be an inversion of the projected image (§ 512-526).

(9) In printing and photographing with projection apparatus the difficulties likely to be met with in photography are sure to come in. Knowledge of the principles underlying photographic processes will help one to overcome the troubles.

§ 549. Summary of Chapter X:

Do	Do Not
1. Have a suitable room or a suitable shield around the drawing to keep out stray light (§ 453-455).	1. Do not try to draw with the drawing surface flooded with stray light. Only the light from the specimen should reach the drawing surface.
2. Draw in the evening if a proper room is not available in the day time (§ 453).	2. Do not forget that it is dark in all rooms in the evening and, therefore, that is a good time to draw.
3. Use an arc lamp for light if possible (§ 461-462, 486-487).	3. Do not use a weak light for drawing if you can have an arc light.
4. Always use a rheostat with an arc lamp, large or small (§ 487, fig. 182, 185).	4. Never try to use an arc lamp, large or small, without a rheostat in series with it.
5. One can draw images projected by all forms of projection apparatus (§ 452).	5. Do not forget that it is possible to draw the images projected by any form of apparatus.

6. In drawing with any form of projection apparatus the axial ray must strike the drawing surface at right angles or the image will be distorted (§ 483).

7. Make sure that the mirror or prism reflects the rays upon the drawing surface so that the axial ray is at right angles to the surface (§482-483).

8. Use a condenser of sufficient diameter to fully light the object (§ 467, 533).

9. Get the desired size for the drawing by making the distance of the drawing surface greater or less, or by using a different optical system for the projection (§ 465, 507-508).

10. Take great pains to light as brilliantly as possible (§ 497, and Chapters I, II, and IX).

11. Take care to have the images on the drawing surface erect (§ 512-526).

12. In using projection apparatus for photography, remember the principles of good projection, and the requirements for good photography.

6. Do not draw distorted pictures; therefore do not have the axial ray strike the drawing surface obliquely.

7. Do not forget to incline the mirror used in drawing so that the axial ray will strike the drawing surface at right angles.

8. Do not try to project an object larger than the diameter of the condenser lenses used.

9. Do not neglect to give the scale at which every drawing is made.

10. Do not expect good light unless the conditions for it are met.

11. Do not draw inverted images.

12. Do not expect projection apparatus to give good photographs unless sharp, brilliant images are projected, and the photographic part is done correctly.

CHAPTER XI

MOVING PICTURES

§ 550. Apparatus and Material for Chapter XI:

A *competent* operator (§ 550a); Moving picture head, or mechanism; Rheostat for direct current, or rheostat, inductor or choke-coil, transformer, rectifier, motor-generator set for alternating current; Arc lamp and lamp-house; Condenser, assortment of different sized plano-convex lenses 14, 15, 16, 17, 19, 21, 23 cm. focus ($5\frac{1}{2}$, 6, $6\frac{1}{2}$, 7, $7\frac{1}{2}$, 8, 9 in. focus); meniscus lens, 23 cm. focus (9 in. focus); Projection objective, equivalent focus 11 to 15 cm. ($4\frac{1}{2}$ to 6 in.), preferably of 6.3 cm. ($2\frac{1}{2}$ in.) diameter, although 4.5 cm. ($1\frac{3}{4}$ in.) will answer; Moving picture films; Tools, asbestos gloves, pliers, screw driver, copper wire, pins, film cement; Supply of carbons.

For continuous use a special operating room separated from the auditorium by fireproof walls, all openings into the auditorium to have automatic shutters closing in case of fire, the room to be provided with a large flue connecting to the outside of the building.

§ 550a. *Competent operator.*—As no one can learn a difficult art from book directions alone without spending an undue amount of time, we strongly advise every one who wishes to be a moving picture operator or photographer to get the help of an expert. Every university and technical school worthy of the name now has laboratories in which the actual operations are learned by the students in repeated efforts under the direction of expert teachers. Books are helps, and often give an expert all that he needs to enable him to perform successfully some difficult or unfamiliar operation. But the living teacher and the actual experiment serve the beginner most effectively.

We strongly recommend the operator to possess the best works on Moving Pictures and projection in general, and to subscribe for one or more periodicals. By studying these he can keep himself informed of all the advances in his profession. In the long run, the "man who knows" is appreciated.

It was inevitable that with the exceedingly rapid development of the moving picture business many difficult operations, and the special form of acting requisite to the production and exhibition of a photo-play were undertaken by persons without adequate training and experience. It seems to the authors that it is highly creditable to human intelligence that the work has been so well done and that the improvement has been so constant and rapid. It seems to us, furthermore, that an important factor in the present creditable attainments which have already been reached, has been due to the high standards advocated by the *Moving Picture World* in all branches of the art. In particular the authors wish to commend the work of Mr. F. H. Richardson in his *Motion Picture Handbook* and in his weekly discussions and answers to questions in the projection department of the *Moving Picture World*.

§ 551. For the historical development of moving pictures see under History in the Appendix.

For works on moving pictures see: Cyclopedia of Motion Picture Work, 2 vols.; Hepworth, C. M., Animated Photography; Hopwood, Living Pictures; Jenkins, C. F., Handbook for Motion Pictures and Stereopticon Opera; Jenkins, C. F., Picture Ribbons; Richardson, F. H., Motion Picture Handbook, 2d ed.; Talbot, F. A., Moving Pictures; Hints to Operators by the Nicholas Power Company; Periodicals on Moving Pictures, e. g., the *Moving Picture World* and catalogues of manufacturers and dealers in moving picture outfits.

INTRODUCTION

§ 552. The steps that had to be taken in human experience and knowledge before it was possible to have moving pictures at all, were many; and the time between some of the steps was very long.

The first step was a knowledge of the physiology of vision, and especially a knowledge of the persistence of visual impressions. Primitive man knew that a glowing torch would make a circle of fire if it were whirled around rapidly enough. He knew also that he could see objects illuminated by an instantaneous flash of lightning.

From this power of seeing by an instantaneous illumination, and the persistence of the impression for a limited time after the light has gone, arise the possibility of having moving pictures. In a word, moving pictures are possible because we can see instantly, but we cannot stop seeing instantly.

To give views rapidly with proper illumination, involved the discovery of means for artificial light of great brilliancy, and of a machine by which the views could be lighted and moved along; and finally the long series of discoveries and inventions in optics and chemistry before photography was invented to make the production of the views cheap and accurate. It was another long step taken by Newton when he showed that white light in nature is composed of the rainbow colors. Furthermore, it was shown by him and contemporary and later physicists and physiologists that a mixture of less than the seven colors of the rainbow gave to the eye the appearance of white light. Even two complementary colors

as red and greenish blue, yellow and indigo blue, etc., give the appearance of white. With this information it became possible to add to the photographic black and white moving pictures, the element of color. This was accomplished by using isochromatic or panchromatic film, and taking the pictures through colored screens, the first picture through a red, the second through a green, the third through a violet screen and this constantly repeated throughout the whole scene. In exhibiting the picture there is a three-color screen used so that the picture exposed through the red screen is projected through a red screen, giving a red image, and the other colors in like manner. If the film is run through the machine three times as fast as the black and white film, then the brain mixes the colors of the successive pictures giving fairly true color values and black and white. Where only two screens are used—red and green—the process is the same, but the film has to be run through the machine only twice as fast as the black and white film as there are but two colors for the brain to combine. Naturally the combination of two colors gives a lower range of possibilities than the mixture of three colors, but even this is wonderful, as all will agree who have seen the colored moving pictures reproducing the gorgeous scenes of nature or the pageants of human splendor in all their form and movement and also with a fair approximation to the color effects.

So perfect have become the materials and processes used in photography, and the accessory mechanical appliances, and the artificial lights available, that now the scientist can register accurately the almost instantaneous movements of an insect's wing, the flight of a cannon ball, and the numberless actions everywhere in nature which are so rapid that the unaided eye cannot analyze them. On the other hand, the movements in the processes of nature which are so slow that one can only see what has been accomplished in an hour, a day or a year, can be hastened by the moving picture machine so that the actual changes can be made to appear as if they occurred in a brief time, and the actual movements which were too slow for the eye to recognize, are made to appear rapidly enough for the eye to follow them. In this way the

actual movements in a growing plant or an opening flower are revealed to the eye; and the great steps in the evolution of an egg to a complete animal, swimming, walking or flying, stand out with startling reality.

The last triumph is the combination of the phonograph and the moving picture machine so that both the eye and the ear are appealed to as in real life or in the theater with living actors. This combination was suggested by Muybridge, the first to analyze and then combine the movements of animals by photography and projection. That suggestion was made in 1888, but it is only now after 25 years that a fair degree of success has been obtained. It requires two operators, one for the moving picture machine and one for the phonograph. The phonograph is just behind the screen, while the moving picture apparatus is in the usual place at the back of the theater.

The screen is sufficiently transparent so that the phonograph operator can see the moving pictures, and the moving picture operator has telephonic connections with the phonograph so that he can hear accurately the sounds. He can, of course, see the moving pictures on the screen. The phonograph is made the master machine and the pictures must be made to follow the sounds. This is partly accomplished by a direct connection between the two machines, and partly by the intelligent coöperation of the two operators.

The first successful efforts in moving pictures were made by physicists and physiologists who desired to analyze the complex and rapid movements of men, animals, and machines. The purpose was wholly scientific, but it was early seen that herein lay the possibility of entertainment and general instruction.

The entertainment or amusement feature is, perhaps, now the predominant one; but the religious, educational, economic and scientific use of this powerful means for portraying action has never been lost sight of, and to-day is more prominent than ever.

Much has been said and written on the moral or social effect of the moving picture. The writers and their friends have visited moving picture theaters in many cities and in many lands to see

the kinds of scenes that were portrayed, and the kinds of people who crowded the theaters to see them. At the same time they have also visited the regular theaters to see actual human beings in the plays, and the kind of plays and the kind of people who were there to see them.

To some of us, at least, the actual stage and the screen-stage seem equally real. The screen-stage has the advantage of a boundless, and untrammled outlook of land and water, earth and sky in calm and sunshine and in the resistless action of storm or volcanic eruption.

In human life it can show actual scenes, commonplace or heroic; scenes like a royal coronation, or the barbarisms of war and riot, and on a scale impossible for a regular theater, and at an expense which makes them available for all mankind to see and enjoy, each according to his own knowledge, experience and capabilities.

That some of the scenes in moving picture theaters are neither inspiring nor uplifting, and that the order in which the scenes appear is sometimes unfortunate, must be admitted. But these and all other defects which have been pointed out are not inherent in the moving picture. They simply indicate human failings. They can be corrected and are being corrected all the time.

It is perfectly natural to think of the advantages to be gained by impressing moving pictures into the service of education. The striking scenes depicted by the moving picture are well adapted for arousing interest and giving the inspiration which lead to the careful and painstaking effort necessary for a true education. For example, in the development of a frog or a fish from the egg the moving picture shows the major changes but not the minor ones which are the really essential changes. No one would ever become an embryologist by looking at moving pictures of a developing animal or plant, and so with all the other subjects the study of which enters into an education.

There are a good many helps in education, but there is no way to become really educated in any subject without the continuous and concentrated study of details as well as of the subject as a whole, any more than a man can become a skilled mechanic by

simply visiting the best conducted machine shop in the world. Education is personal; everything gained has to be paid for to the last farthing in mental effort.

Moving pictures are the offspring of science through some of the finest minds that the world has known. It is simply for the finest art, the best science and the highest aspirations of mankind to take this powerful agent—their offspring—and put it to the real service of humanity. Let it do what it is so capable of doing in the church, in general and technical schools of all grades; in scientific, educational and philanthropic societies; in the theater, in the club, and finally in the home.

AUDITORIUM, SCREEN AND OPERATING ROOM

First, it is necessary to consider the room for projection, its arrangement for seats, lighting during and between exhibitions, the screen and the position of the machine.

§ 553. **Auditorium and screen.**—The auditorium should be arranged so that everyone in the room can get a good view of the screen, there should be a sufficient number of aisles and exits in order that the room can be filled or emptied quickly and without disturbance; and provision should be made for giving a sufficient illumination during the performance so that people can find seats or leave the room without difficulty.

The screen should be dead white and free from wrinkles. If simultaneous sound effects are to be produced it is an advantage to have the screen slightly translucent so that the pictures can be seen from behind. In a long narrow room one of the metallic screens is an advantage. These screens are very poor for those on the side when used in a wide room, as the picture appears very dim when seen from the side. When the hall is provided with a stage it is well to hang the screen quite a distance from the front of the stage so that it will be easier to avoid stray light and in order that the people in the front seats will not be too close to the picture. A dark border or frame to the screen is also an advantage. (For the size of screen and of the screen images see Ch. XII, § 633, 638–639).

§ 554. **Position of the machine.**—The machine should be located so that its optic axis is perpendicular to the screen or the pictures will be distorted. If the machine cannot face the screen directly it is better to have it in the middle of the room and pointing upward or downward, or to have it at the same height as the screen and pointing slightly to one side. The worst possible distortion occurs when the machine is pointed obliquely downward as it must be when placed in one side of a gallery.

§ 555. **Tent or booth for temporary operation.**—For a single performance the machine may be laid on a table in the middle of the auditorium just as with a magic lantern or it may be enclosed with a temporary booth or tent to enclose any stray light and to overcome the distracting effect of the machinery.

§ 556. **Permanent operating room.**—Permanent installation should include an operating room large enough so that the machine or machines can be operated without hinderance or loss of time from lack of sufficient space. This is very essential in any place where even a short delay is so disagreeable to the audience. The operating room should be easy to get to and it should be well ventilated. It should have a large flue at least 50 cm. (20 in.) in diameter, connecting with the outside of the building. All openings in the operating room should be provided with shutters which will close automatically in case of fire. The room should be provided with incandescent lamps and extension cords to use while working around the machine and finally there should be an electric fan and a chair for the operator. Every machine should be accessible from all sides. Film boxes should be placed where they can be easily reached. Sufficient tools for ordinary operation, a supply of carbons, pins, film cement, and extra condenser lenses should also be handy. A shop-room equipped for making repairs to the machines and for doing jobs of wiring should be near the operating room. It is not advisable to try to do such work in the operating room itself.

The operating room is to be at all times kept like a battle-ship in time of war, with the decks cleared for action, nothing there which is not actually required.

§ 557. **Construction of a modern operating room.**—For the construction of the operating room itself a good description is given by F. H. Richardson in the *Moving Picture World* of August 12, 1911, p. 372. See also Richardson's Handbook, pp. 65-93.

(1) "No operating room may have less than 50 square feet of floor surface, or be less than seven feet, in the clear, from floor to ceiling at any point.

(2) All operating rooms shall have a vent flue of not less than $1\frac{1}{2}$ square inches area to each square foot of floor area, same to extend from the ceiling, or a point near the ceiling, to the open air, above the roof if possible; provided, however, that no vent exceed 360 square inches in area.

(3) All operating rooms shall be of such fireproof construction as is approved by the National Board of Fire Underwriters or the City Fire Marshal.

(4) Every operating room shall have a door, opening outward, not less than 2 x 6 feet in size, provided with an appropriate spring to hold same shut.

(5) Every opening from operating room into auditorium, except door, shall be equipped with a metal shutter, sliding in grooves and semi-automatic in action. Same shall be so arranged that all shutters are held open by a single cotton master cord passing directly over front edge of upper magazine of each machine, just high enough to clear operator's head when standing. Shutters may close by their own weight or by force of a spring. If vent flue is provided with damper it shall be so weighted that it will normally stand open and shall only be held shut by cord attached by master shutter cord before mentioned.

(6) Front, sides, and top of every lamp-house shall be tightly enclosed, except for vent-holes, protected by wire gauze screen, but back of lamp-house may be open.

(7) All moving picture projection machines shall be equipped with approved upper and lower magazines, doors of which shall be closed when machine is running.

(8) All rheostats shall be located outside the operating room, but low voltage transformers (inductors, economizers, etc.), used to control the current may be located inside the room.

(9) No wire of less size than No. 6 B & S gauge shall be used in any projection arc circuit.

(10) Only link fuses, enclosed in suitable metal cabinet with spring door, shall be allowed in any operating room.

(11) All wires, except asbestos covered from outlet to lamps, shall be in conduits.

(12) All switches shall be enclosed (fig. 278).

(13) All carbon butts shall be deposited, immediately on removal from lamp, in metal can containing water.

(14) All films shall be kept in solderless metal case with approved spring-closing cover, or door.

(15) Smoking shall be absolutely prohibited inside the operating room.

(16) There shall be no reading matter inside any operating room. Reading matter to be construed to mean newspapers, novels, etc., but not including catalogues, or books of instruction, or magazines helpful to the operator in his work.

(17) Not to exceed one ounce of alcohol or one pint of lubricating oil shall be allowed in the operating room. Benzine, kerosene and like substances shall not be kept in any quantity in any theater.

(18) Machines may be motor driven.

(19) All machines shall be firmly and effectively anchored to the floor."

§ 558. Source of electric current.—Next to be considered is the source of current supply. If one is in a place where there is a good electric system in operation it is usually much better to buy the power than to try to run a special power plant. This is because of the greater certainty of the city power and the absence of responsibility. It is, however, perfectly feasible to generate power with a gasoline, oil, alcohol or steam engine. When this is done the power is somewhat cheaper but rather more trouble and without careful attention it is less certain than a regular supply. Independent generation of power in small units makes possible the direct connection of the arc to the generator without the use of a rheostat as will be explained later. (Ch. XIII, § 680, see also § 562).

§ 559. **Wiring.**—When the supply is decided upon, the wiring is next installed. This must be heavy enough to carry the greatest current which is to be used continuously in the lamp. It does not need to be designed for the rather high current which flows when the carbons are brought into contact, as any wiring can withstand a heavy overload for a few seconds without injury.

The wire which enters the lamp-house should be flexible cable, asbestos covered, and of a carrying capacity at least double the amount required for use at the arc (§ 694–695). This is on account of the high temperature within the lamp-house and consequent rapid deterioration of a small wire.

§ 560. **Fuses.**—Fuses should be used in every case and not circuit breakers. This is because a fuse will not “blow” instantly when current is drawn greater than its normal capacity (as when the arc is started) but if this overload is continued, it will melt and open the circuit. The circuit breaker, on the other hand, will open the circuit instantly at the same amperage whether the current is momentary or long continued.

§ 561. **Fire underwriters and special regulations.**—The wiring and installation must conform to the fire underwriters regulations and any special requirements of the city in which the theater is located. The wiring for moving picture machines is neither heavier nor more difficult to install than that required for other forms of projection, notably opaque projection, provision for 25 amperes direct current or 50 amperes alternating current usually being sufficient for small theaters.

For currents required in different cases; for the size of wire required for these currents and for fire underwriters regulations see Chapter XIII, § 691.

§ 562. **Rheostat or other ballast.**—As with all forms of arc lamp, the moving picture lamp requires some form of ballast or regulating device to control the current.

The simplest and cheapest device is of course the resistor or rheostat. When the electric supply is 110 volt direct current, a rheostat is generally used. A rotary motor-generator set or

“current saver” is sometimes used as a ballast with direct current and effects a considerable saving of power especially when the supply is 220 or 500 volts. (See Ch. XIII, § 744).

When the supply is alternating current the ballast may be in the form of a rheostat but reasons of economy exclude this form of ballast when the machine is used continuously. For continuous performance an inductor (choke-coil), a special transformer, a mercury arc rectifier or a motor-generator is used. (See Ch. XIII, § 682-683, 723-739).

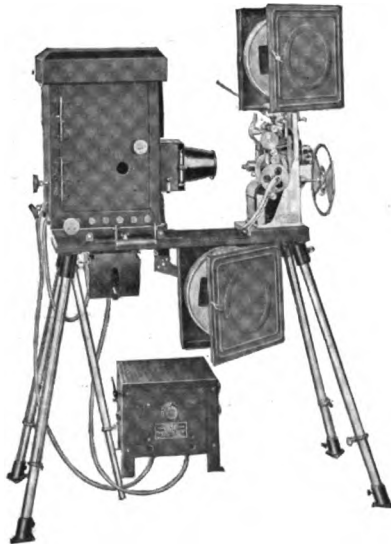

FIG. 221. EDISON KINETOSCOPE, PROVIDED WITH TWO-WING OUTSIDE SHUTTER.

(Cut loaned by the Edison Manufacturing Company).

When power is independently generated, a special dynamo can be connected directly to the arc lamp without ballast, the dynamo will be its own regulating device. (See Ch. XIII, § 680).

Whatever form of ballast is used, the quality and workmanship should be of the best or an endless amount of trouble may be expected. The rheostat or other ballast must conform to the underwriters regulations and must be satisfactory to the company

supplying the power. Some power companies object to the use of an inductor (choke-coil). In such cases a transformer can be used instead.

§ 563. **Stand or table.**—A stand or table is provided by the makers of the machine. The method used to set up the stand will be fairly obvious from the illustrations furnished by the makers of the particular machine used. Generally this stand is made of brass tubes. One maker provides a heavy iron pillar. With this make provision must be made to anchor this pillar firmly to the floor.

If the machine is to be installed permanently, it is often better to use a stand constructed of concrete or a very heavy wooden table instead of the light stand regularly supplied. A very slight motion of a rickety stand will cause an enormous movement of the picture on a screen 15 to 30 meters (50 to 100 feet) away.

§ 564. **Unpacking.**—The moving picture machines coming from the factory are very carefully packed. When removed from the box, it is advisable to take careful notes of just how the different parts are packed and to number the wooden cleats used to hold things in place, especially if the machine will need to be shipped away again.

Be careful in unpacking all parts, especially the lenses. Do not throw away any wrapping material until sure that no parts are missing.

§ 565. **The moving picture machine.**—When unpacked the moving picture machine will be found to consist of a stand and base-board, arc lamp, lamp-house, condenser, aperture plate, objective, shutter, film magazines, and mechanism for moving the film. There will also be an extra film reel and a rewinder (fig. 221-224).

§ 566. **The arc lamp.**—The arc lamp usually supplied with moving picture outfits is of the hand-feed type with inclined carbons. The handles for feeding the carbons and for slight up and down adjustments project backwards so they may be manipulated without opening the lamp-house. The good makes of arc lamp are adjustable so that the carbons can be held in the vertical or the

inclined position as desired and each carbon holder can be turned so that the upper carbon is inclined and the lower one is vertical. The right-angle arc can be used with the moving picture outfit if desired, but it should not be used with currents much above 25 amperes. Twenty-five amperes direct current will be found sufficient for all but the largest rooms.



FIG 222.. POWER'S CAMERAGRAPH NO. 6, SHOWING THE LAMP-HOUSE
IN POSITION

(Cut loaned by the Nicholas Power Co.).

§ 567. **Lamp-house.**—The arc lamp is enclosed by a metal house to protect the operator from being blinded by stray light and to protect the arc from air currents which might blow it out or otherwise interfere with its performance. The adjusting handles of the lamp project so that the lamp can be adjusted from time to time without opening the doors of the lamp-house.

The house should be provided with doors to enable the operator to change the carbons and should have a window of dark glass so

that the arc can be watched. This window should be of fairly large size and directly opposite the crater of the arc. The glass should be dark enough so that the eyes will not be tired by the too great brightness and yet light enough so that the whole of the hot carbon ends can be seen.

Another convenient way to observe the arc is to bore a fine hole in the side of the lamp-house away from the operator. This acts like a pinhole camera and an image of the arc is seen on the opposite wall. A sharper image of the arc can be formed by using a long focus lens over an opening in the wall of the lamp-house to focus an image of the arc upon the wall. A spectacle lens of about 25 cm. (10 in.) focus (4 diopters) will answer. The lens may be held by any convenient clamp but must be adjusted for distance to get the sharpest image, otherwise it is no improvement over the simple pinhole.

The lamp-house should be well ventilated as from $\frac{1}{2}$ to 2 kilowatts of power, .7 to 3 horsepower, is converted into heat. While the arc is going there must be some way for this heat to escape, otherwise everything inside would melt. One of the principal causes of condenser breakage is poor ventilation of the lamp-house. The best ventilation is secured by having holes permitting air circulation but no escape of light, at the top and near the bottom of the lamp-house. The back of the lamp-house is sometimes removed.

In many places the fire underwriters or the city, require that these ventilating holes be covered with fine wire gauze, to prevent sparks flying out. This requirement was invented by someone who had the mistaken idea that an arc lamp was a fiery volcano, vomiting out sparks and lava in all directions instead of a quiet, well behaved sort of thing. It is true that a minute spark sometimes does fly up, but it is so light that it cannot do any damage. Any small piece of the carbon tip which breaks off will fall to the bottom of the lamp-house where a suitable tray should be provided to catch it. This tray is also useful to hold the short pieces of hot carbon just taken out of the lamp when new carbons are put in.

§ 568. **Condenser.**—The condenser is usually in a box which is fastened to the lamp-house and moves with it. In front of the con-

denser is the lantern-slide carrier for use with the magic lantern, which is usually found in connection with moving pictures.



FIG. 223. NEW STYLE CONVERTIBLE BALOPTICON WITH POWER'S MOVING PICTURE ATTACHMENT.

(Cut loaned by the Bausch & Lomb Optical Co.).

The condenser is usually provided with two plano-convex lenses, each of 18 or 19 cm. focus (7 to 7½ in. focus).

The slide-carrier for the magic lantern usually found connected to the moving picture outfit is generally fastened to the lamp-house

directly in front of the condenser. This is not a good plan as it cuts down the light from the condenser, and as the opening is not round but a quadrangle it often leads to queer shadows on the screen. Some makers provide a stationary slide-carrier opposite the magic lantern objective so that the whole face of the condenser is free when it is opposite the moving picture objective; this is a better method than the above.

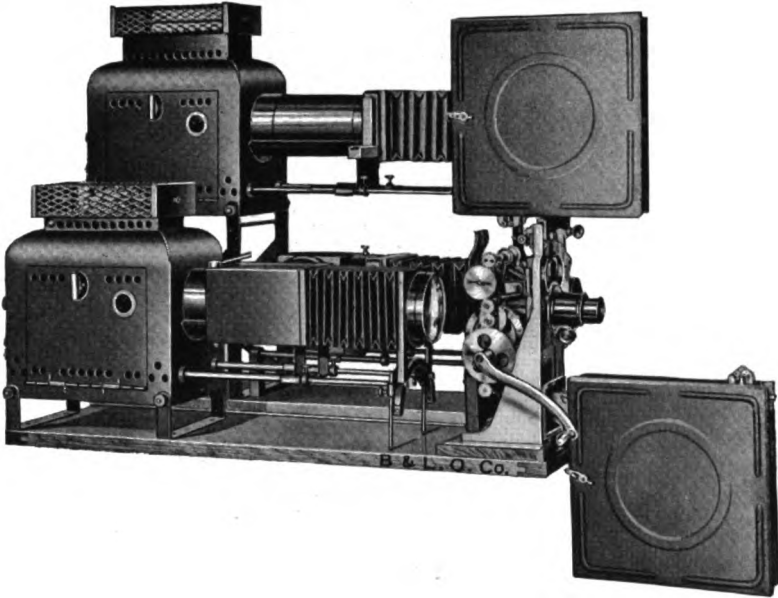

FIG. 224. DOUBLE DISSOLVING MODEL C BALOPTICON WITH EDISON MOVING PICTURE ATTACHMENT.

(Cut loaned by the Bausch & Lomb Optical Co.).

§ 569. **The moving picture head.**—This contains all of the elements of the moving picture machine except the arrangement for lighting. The moving picture head holds the objective and contains the film-moving mechanism and the aperture plate.

§ 570. **Aperture plate.**—Considered optically the aperture plate which serves as a frame for the picture on the film is the most important part of the moving picture head.

The standard aperture plate has an opening 23.08 mm. wide x 17.31 mm. high ($29/32$ in. x $87/128$ in.) with rounded corners. When the picture is in focus on the screen the edges of the aperture plate are also in focus at the same time (§ 570a).

§ 571. **The objective.**—The objective forms the image of the film picture upon the screen. It is in design exactly like an objective for the magic lantern but is of shorter focus.

It is better to have the lenses of large diameter (see § 830).

Moving picture objectives with lenses 45 mm. ($1\frac{3}{4}$ in.) and 65 mm. ($2\frac{1}{2}$ in.) in diameter are on the market. The objectives 45 mm. ($1\frac{3}{4}$ in.) in diameter will answer but those of 65 mm. ($2\frac{1}{2}$ in.) are to be preferred. The larger objectives will give with less trouble a screen image without shadows. (See § 829, 830).

One must select an objective of suitable focal length to give a proper sized screen image for the auditorium to be used. This is dealt with more fully in § 635. In most rooms a screen image of suitable size will be obtained with an objective of between 12.5 to 13.5 cm. focus (5 to $5\frac{1}{2}$ in.) when the moving picture machine is at the back of the room.

§ 572. **The film mechanism.**—This consists in the proper gears and sprocket wheels for moving the film, and for turning the shutter. The mechanism is complex; differs in different makes of machines, and no attempt will be made here to describe it in detail.

§ 573. The shutter which cuts off the light during the time when the film is in motion is located either just beyond the aperture plate and hence before the objective (fig. 225), or just beyond the objective (fig. 226, 227). When located between the aperture plate and the objective, it is called an inside shutter and when located beyond the objective it is called an outside shutter.

§ 570a. **Standard aperture.**—As there was some lack of uniformity in the size of the opening of the aperture plate, the Gundlach-Manhattan Optical Co. has selected a size for a standard as follows: The aperture has an opening of 23.08 mm. long and 17.31 mm. high ($29/32$ x $87/128$ inch). This standard has been adopted by the Nicholas Power Co., the Edison Co., and the Precision Machine Co. No doubt the other makers of machines will adopt the standard in due time. *Moving Picture World*, Vol. 20, April 11, p. 210, April 25, p. 512.

§ 574. The film magazines are large sheet iron boxes which hold the film reels. They are big enough to hold the standard 25 cm. (10 in.) reel and it is a convenience if they are large enough to hold the larger reels of 30 cm. (12 in.) diameter. The film magazines are fitted with fire traps to prevent any fire getting into the magazine if the film should start to burn.

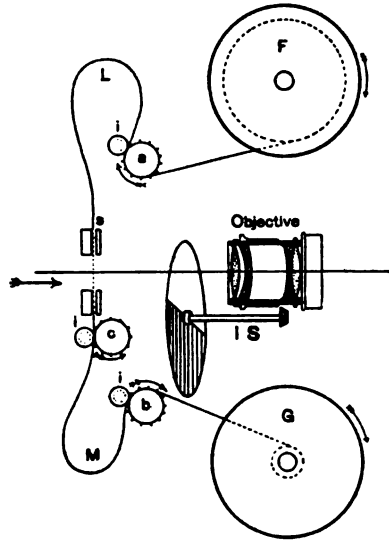

FIG. 225. MOVING PICTURE MECHANISM WITH INSIDE SHUTTER, I S.
For full explanation see Fig. 231.

INSTALLATION OF A MOVING PICTURE OUTFIT

§ 575. After the wiring to the operating room has been installed in accordance with the fire underwriters regulations and any special regulations of the city in which the work is done, all is ready to connect in the rheostat, transformer, or other regulating device (§ 728, 736) and to attach the wires to the arc lamp.

These connections are exactly like those for the magic lantern (fig. 3) when a rheostat or inductor (choke-coil) is used. When a transformer or mercury arc rectifier is used, the primary side is

connected to the line, and the secondary side is connected to the arc lamp. (See Ch. XIII, § 683, 739).

The switches should be in a convenient location, so that the current can be turned on or off without moving from the operating position.

As soon as the connections are made it is well to use an ammeter and to find what current the arc will draw with the different settings of the controlling lever of the rheostat or transformer. It is

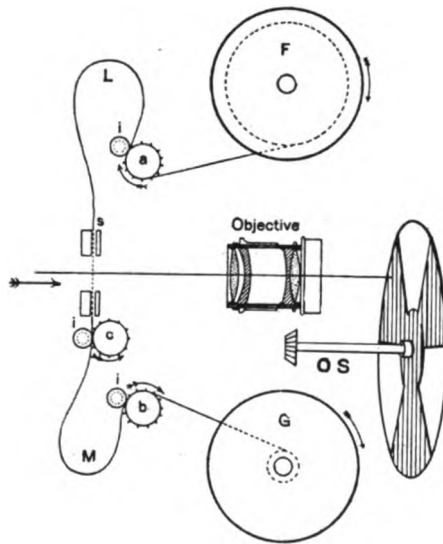

FIG. 226. MOVING PICTURE MECHANISM WITH OUTSIDE SHUTTER, O S.
For full explanation see Fig. 231.

a good thing also to use a voltmeter to determine the line voltage on open circuit, also the voltage across the line, between the arc terminals, across the rheostat or choke-coil, or if a transformer is used, the voltage given by the secondary both on open circuit and when the arc is running. The voltmeter or ammeter must be designed for the kind and amount of current for which it is to be used, that is, alternating or direct current. When a rectifier or a motor-generator is used it will be necessary to have both direct

current and alternating current instruments. (See Chap. XIII for using these instruments § 662-674).

OPTICS OF MOVING PICTURE PROJECTION

§ 576. For purposes of description the projection of the individual pictures of a film can be considered apart from the mechanism which moves the film.

The projection of the film picture has much in common with that of the ordinary lantern slide but it is somewhat more difficult.

A theoretical treatment of the proper method of lighting the film is found in § 825. Briefly stated it is this: Light from the arc is collected by the condenser so as to illuminate the film. This illumination must be very intense and at the same time must be evenly distributed over the entire area of the film. To secure this result with the ordinary large condensers ($4\frac{1}{2}$ in. in diameter) requires the condenser to be quite a distance away from the film, the crater of the arc to be of considerable size, and the projection objective to be of fairly large diameter.

Fig. 228 shows the optical arrangement most commonly used. Light from the arc is collected by the condenser upon the film at *s*, passing through the transparent parts of the film, it is bent by the objective in such a way as to form a sharp image of the film *s*, upon the screen.

Only one picture of the film is seen at a time, the rest being carried in the magazines or covered with shields. The picture to be shown is just in front of the opening of the aperture plate. Optically we are concerned only with the aperture plate and the short section of film behind it. It is this short section of film which must be evenly illuminated and projected upon the screen.

Beyond the film is the objective (fig. 229). The objective should be of good quality as it is the objective which determines the sharpness of the screen picture. Moreover, the objective must not be of too small diameter, for if it is too small there is danger that the screen image will not be evenly lighted although the illumination of the film may be perfectly even. The focal length

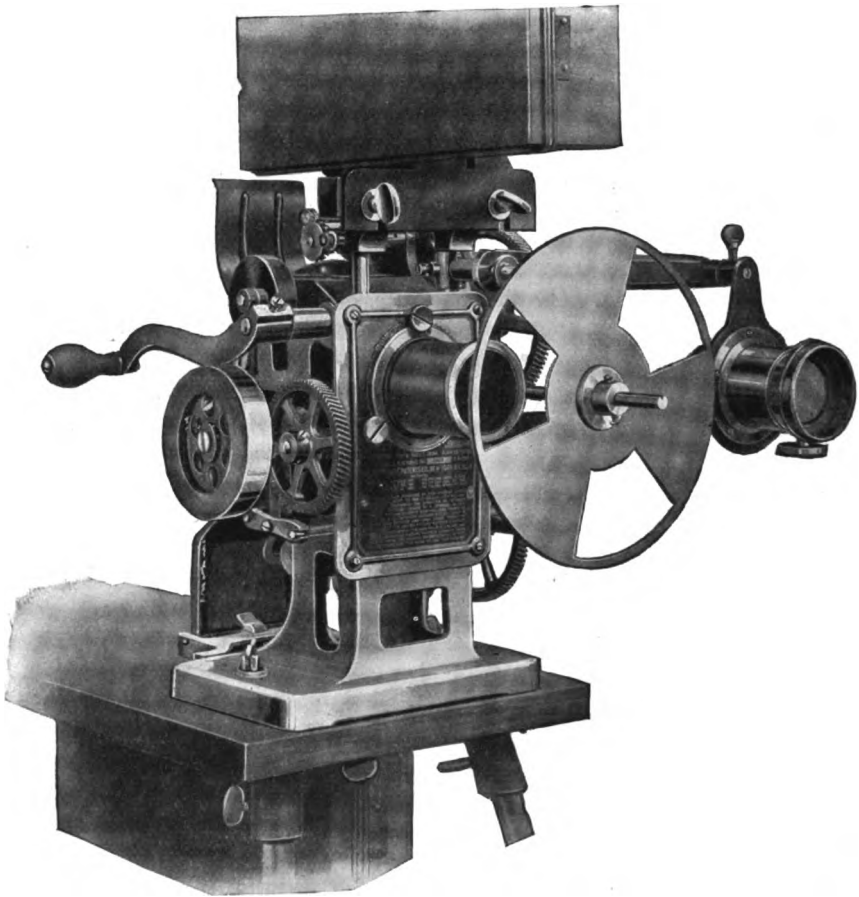
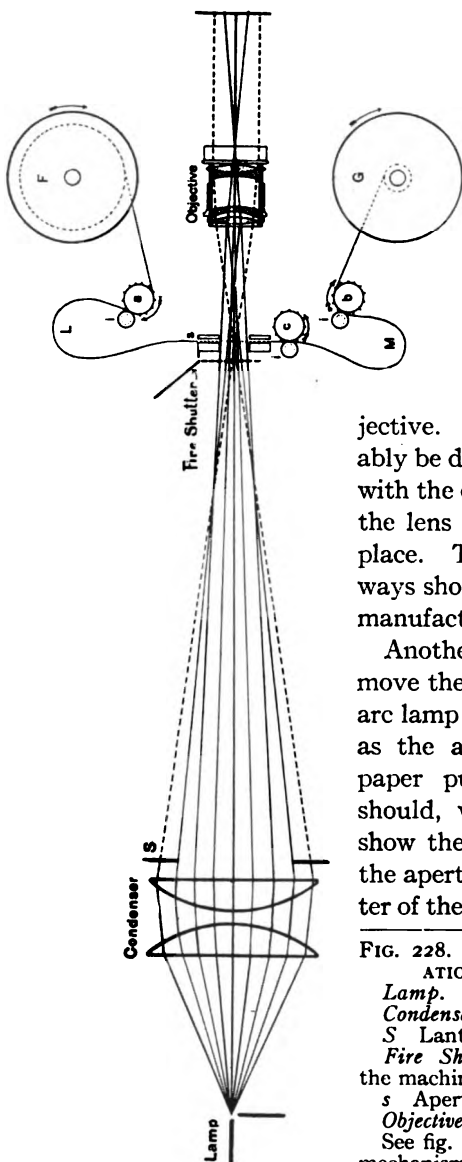

FIG. 227. MECHANISM OF POWER'S NO. 6 CAMERAGRAPH, SHOWING THE THREE-WING, OUTSIDE SHUTTER.
(Cut loaned by the Nicholas Power Company).

of the objective determines the size of the screen picture for a given screen distance.

§ 577. **Lining up the moving picture machine; Adjustment of the light.**—The machine being assembled on the board, the parts lined up mechanically as well as possible (§ 51+), the final steps to



get a good light on the screen must now be taken. The moving picture head as it comes from the factory should have the aperture plate and the center of the objective mount at the same height. If they are not, the aperture plate must be moved up or down until its center is on the same axial line as the objective.

The adjustment can probably be done with sufficient accuracy with the eye, when looking through the lens opening, the lens being in place. This is a matter which always should be looked after by the manufacturer.

Another method would be to remove the condensers and adjust the arc lamp to exactly the same height as the aperture plate. A piece of paper put in place of the lens should, when the arc is lighted, show the shadow of the center of the aperture plate in the exact center of the circular piece of paper.

FIG. 228. OPTICAL SYSTEM AND ILLUMINATION OF MOVING PICTURES.

Lamp.

Condenser.

S Lantern-slide holder.

Fire Shutter This is open only when the machine is running.

s Aperture plate.

Objective.

See fig. 231 for full explanation of the mechanism.

The center of the condenser and the center of the aperture plate are adjusted to the same height above the baseboard. This is attended to by the manufacturer, but if a head of one machine is used with the arc and condenser of another make, adjustment might have to be made. Make a spot with a pen or a wax pencil exactly in the center of the front lens of the condenser, measure the

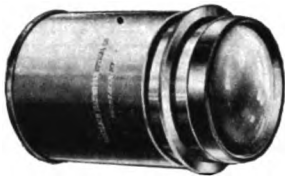

FIG. 229. LARGE DIAMETER PROJECTION OBJECTIVE FOR MOVING PICTURES. (Cut loaned by the Gundlach-Manhattan Optical Co.).

height of this above the baseboard. Make a similar mark on the aperture plate at the height of the middle of the opening and measure its distance above the baseboard. If the aperture plate is too low the head should not be screwed directly to the baseboard but should be lifted up sufficiently with a thin piece of board. If the aperture plate is too high, the front of the base-

board can be cut down or the lamp-house and condenser can be raised by using a piece of wood or asbestos board between the baseboard and the lamp-house fastenings.

After getting the objective, aperture plate, and condenser at the correct height, it only remains to get the arc at the right height. This is done from time to time by raising or lowering the arc lamp until the light spot falls exactly over the aperture plate.

The sidewise adjustment of the lamp-house is now made in the same way by measuring the distance from the edge of the baseboard to the center of the condenser and then to the center of the aperture plate. This measurement can be made by using a vertical board (§ 52).

When the same arc and condenser are used for both moving pictures and lantern slides, the lamp-house should be in the correct position when pulled on its lateral rods as near as possible to the operator. If it is not, stops can be fastened on the side rods to hold the lamp-house in the correct position.

§ 578. **Back and forth adjustment of the arc lamp and condenser.**—This is one of the most important and troublesome adjustments to make. There would be but little difficulty in getting an

even illumination of the film picture and the screen image if condensers were obtainable entirely free from spherical aberration, but this is not practical. No rule can be given as to the best position of the arc and condenser but the best position must be determined for each particular case. Some general hints can, however, be given.

First—The objective should be of large diameter. This will allow of a greater range of adjustment through which good illumination can be obtained (§ 829–830).

The lenses of the double-lens condenser (fig. 1) should be as near together as possible without actually touching. The convex sides of the condenser lenses should face each other, the plane sides should face the lamp and the objective.

The condenser lenses should be of fairly long focus, 18 to 19 cm. (7 to $7\frac{1}{2}$ in.).

If the condenser is as far away from the aperture plate as possible the illumination is usually more even, though less intense than when the condenser is close to the aperture plate.

When first setting up the machine, it is a great help to have a series of condenser lenses to try, say such a series as two lenses of 14 cm. focus, one each of 15, 16, 17 cm., two of 19 cm. focus, (two of $5\frac{1}{2}$ in., one each of 6, $6\frac{1}{2}$, 7 in., two of $7\frac{1}{2}$ in.). The two condenser lenses should be of the same focus, then only one kind of condenser lens will need to be kept in stock to supply breakage.

When the adjustment for distance is to be made, move the lamp-house with its condenser close to the aperture plate, fasten it in position, move the arc in the lamp-house nearer to and farther from the condenser until the best light is obtained on the screen. Note how this light appears and whether there are any ghosts or shadows. Then fasten the lamp-house and condenser slightly farther from the aperture plate and move the arc until the best light is again obtained. After repeating this, for every position of the condenser, the condenser is set at the distance which was found to be best. It may be necessary to try a different set of condenser lenses before the best possible result is obtained. This is a rather tedious process but is well worth while doing.

ADJUSTMENT OF THE MAGIC LANTERN ATTACHMENT FOR USE IN
CONNECTION WITH THE MOVING PICTURE MACHINE

§ 579. The adjustment of the arc lamp and condenser for the moving picture part is of much greater importance and is more difficult than that for the magic lantern attachment, hence, no attention should be paid to the projection of lantern slides until the projection of moving pictures is perfect.

In most outfits the lamp-house moves sidewise on some lateral rods. When pulled towards the operator the lamp is in line with the moving picture objective, and when pushed away from the operator until it hits a stop, it is in line with the lantern objective.

Push the lamp-house on these lateral rods until it is held by the stops. A lantern slide is put in the holder and the lantern objective support is loosened and the lantern objective moved sidewise until it is over the spot of light from the arc and moved back and forth until the image of the slide is in focus on the screen. If there are shadows on the screen not due to malposition of the carbons, use an objective with larger lenses.

If the lantern picture does not occupy the same place on the screen as the moving picture it may be the fault of the side adjustment of the slide-holder, or it may be due to faulty alignment of the arc lamp and moving picture head. If this should be the case move the lamp-house sidewise until the lantern-slide picture occupies the proper position on the screen. Then move the arc sidewise until the screen is well lighted and clamp it in position. When, now, the lamp-house is pulled into position in front of the moving picture objective the spot of light may not fall upon the aperture plate but to one side. If it is not in the right position do not alter the adjustment of the arc lamp but move the lamp-house as a whole to one side until the spot exactly covers the aperture plate. Then fasten the stop, so that the lamp-house will always occupy the same position when pulled toward the operator.

§ 580. **Management of the arc lamp.**—During an exhibition it is necessary to watch the arc lamp to see that it is burning properly. There are several ways of burning the arc which will give a good light:

The carbons may be at right angles (fig. 23 C).

The carbons may be inclined backwards about 30° (fig. 230 a).

The upper carbon may be inclined backward 45° , the lower carbon being vertical (fig. 230 c).

The carbons may come together in the form of a horizontal V with the point towards the condenser (fig. 23 D).

Both carbons may be vertical (fig. 230 b).

Whatever carbon setting is used, the arc must be held, so that the crater or craters face the condenser.

The form of the arc can be watched by observing it through the smoky glass window or by the pinhole or lens image on the wall (§ 567). When using alternating current the sound will give an indication as to whether the arc is of the right length.

Constant vigilance in watching the arc is one of the requirements for success in showing moving pictures. During an exhibition, *never let the arc go out.*

§ 581. **Supply of carbons for the arc lamp.**—A good supply of carbons should be provided and placed where they may easily be reached. The carbons are soft-cored and their size should be suited to the current used (see § 753a). Generally 16 mm. carbons ($\frac{5}{8}$ in.) are used, both being of the same size.

§ 582. **Position of the film in the machine.**—When a film is passing through the machine the rule for its position is the same as with the lantern slides, that is, the picture should appear correct when one looks through it toward the screen but it must be upside down. To accomplish this one should bear in mind that as the films are printed they will appear correct when one looks at the emulsion side just as with a lantern slide or an ordinary paper print. Therefore, the light is made to strike the emulsion side of the film.

§ 583. **Mechanism.**—Without going into the details of the special

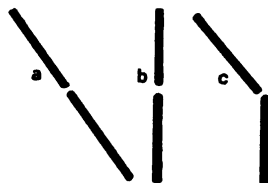

FIG. 230. POSITION OF CARBONS FOR MOVING PICTURE PROJECTION.

- a Inclined.
- b Vertical.
- c Upper carbon inclined, lower carbon vertical.

arrangements employed in the different makes of machine, the principle is simple, although the mechanical problems in working out these principles require much care.

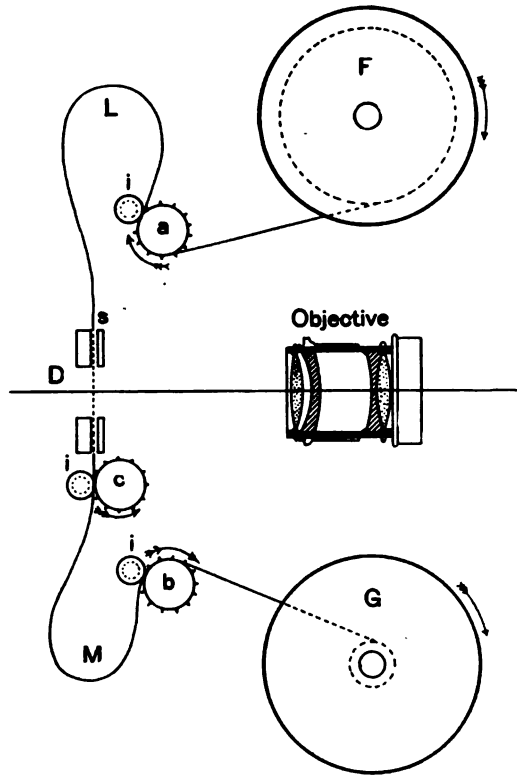

FIG. 231. FIGURE TO REPRESENT THE PRINCIPLE OF THE MOVING PICTURE MACHINE MECHANISM.

a b Sprocket wheels moving with uniform velocity.
c Intermittent sprocket wheel which jerks down the short section of film between *L* and *M*.

i Idlers to hold the film on the sprocket wheels.

D Gate which holds the film in place in front of the aperture plate.

F Upper film reel, unwinding.

G Lower film reel, winding up.

S Aperture plate.

Objective.

The essential part of the mechanism consists in three sprocket wheels, a, b, and c, (fig. 231), the two wheels a and b move continuously at the average rate at which the film is passing (30 cm., 1 foot, per second), and serve to unwind the film from the upper reel F and feed the film to the take-up reel G at a uniform rate. The sprocket wheel c, located between the other two, is intermittent in its movements, being stationary for about $\frac{5}{6}$ of the time and being in rapid motion for about $\frac{1}{6}$ of the time. The effect is, that after the film has been in position for exposure on the screen this sprocket wheel jerks the small section of film between L and M forward to the next picture. In fig. 232 is shown one form of mechanism for causing the intermittent movement of the sprocket wheel.

When the film is stationary it is projected on the screen by the objective, but during the short time when the film is in motion a shutter either before or behind the objective cuts off the light and prevents any blurring due to the movement of the picture.

The films are made in such a way that if the pictures are right side up, the later picture will be below the earlier ones, but as in passing through the machine the pictures are upside down, the later pictures are above and it is necessary to move the film downward to bring the pictures on the screen in due order.

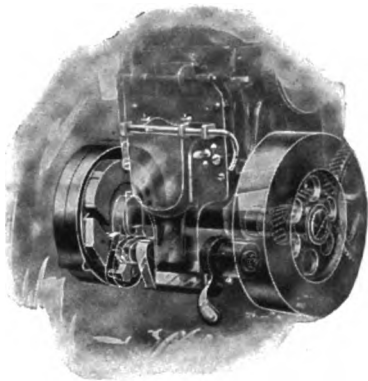

FIG. 232. INTERMITTENT MOVEMENT OF POWER'S NO. 6 CAMERAGRAPH. (Cut loaned by the Nicholas Power Company).

§ 584. **Threading the film in the machine.**—The film as wound on the reel usually is wound in the correct direction, so that the first pictures are on the outside. If this is not the case, the film must be rewound on another reel to reverse its direction. If the direction is correct the pictures will be upside down when the film is in the machine, that is, when the film is passing downward from F (fig. 231).

Next, it is necessary to get the film right side out, otherwise, everything will be reversed and appear as if seen in a mirror, an especially troublesome state of affairs when titles or letters are shown. The side of the film which has the emulsion appears rough, the other side is smooth and shiny. The film often has a tendency to curl, the emulsion being on the concave side. The film is turned so that the rough, emulsion side bearing the picture is toward the light. When it is wound correctly on the reel, and the emulsion side is turned so it will face the light as the film unwinds, the reel of film is put in the upper magazine. The end of the film is pushed through the opening in the magazine between the rollers of the fire-trap. This can best be done by using the index and middle fingers to hold the film.

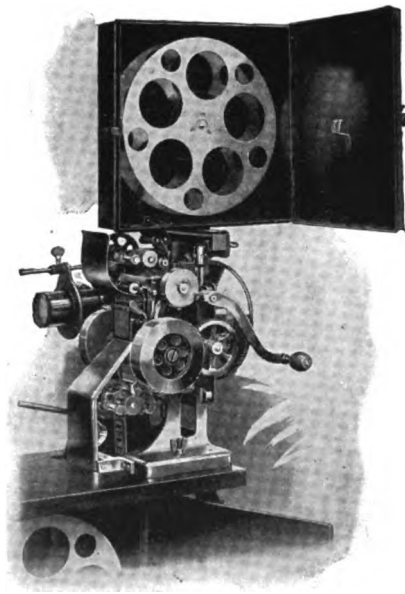

FIG. 233. EDISON KINETOSCOPE MECHANISM.

(Cut loaned by the Edison Manufacturing Company)

The magazine doors are open showing the film reels.
The film is in place ready to project.

The gate D is then opened and the idlers, iii are pushed away from the sprocket wheels a, b and c. A sufficient length of film is unrolled from F to reach to the take-up reel G and the film is put under the sprocket wheel a, so that the teeth fit into the holes at the edges of the film. Care must be taken that the film goes over or under the sprocket wheels in such a way that as the crank is turned forward all of the sprocket wheels tend to move the film in the same direction, otherwise they will tear it apart. The arrangement may differ in different machines.

After putting the film on the sprocket wheel a, so that the teeth pass through the holes of the film, the idler i, is pushed over to hold the film in place. This can be done with one of the fingers while holding the film in place with the thumb and forefinger. The film is then engaged with the lower sprocket wheel b, leaving an extra length of film to form the two loops L and M. This can best be determined by experience, it must be enough so that the intermittent sprocket will not jerk the film in two and not long enough so that the loops will strike any shields there may be to cover them.

The film is held against the intermittent sprocket c, so the loops L and M, are about equal in size and held straight on the tracks of the aperture plate when the gate D, is closed.

The end of the film is now pushed through the fire-trap opening in the lower magazine and fastened to the take-up reel G. This is accomplished by slipping the end under the spring on the spindle of the reel, in such a direction that the film will not be folded as the reel is turned. The reel is turned to insure the end of the film being well fastened. Fig. 233 shows a mechanism with the film in position and ready to operate as soon as the magazine doors are closed.

If the picture is not directly in front of the aperture plate but is above or below (misframed), it can be put in its proper position by a lever which lowers the mechanism and film without disturbing the position of the aperture plate and objective.

§ 585. **Direction of motion.**—The normal direction of motion to secure the proper sequence of events in the order in which they occurred is secured by moving the film downward, and results

from a right-hand rotation of the crank. If the crank is turned to the left the film will be pushed upward by the intermittent sprocket instead of being pulled downwards as it should be. This would most likely result in crumpling and breaking the film.

§ 586. **Operation and speed.**—After the machine is threaded the lamp is pulled toward the operator so that the light shines upon the aperture plate.

In starting the machine do not start with a jerk but start gradually (1-2 seconds), otherwise an unnecessary strain is put upon the gears. The crank is turned in a right-hand (clockwise) direction at such a speed that the film passes at the rate of 16 pictures per second. If the gearing is arranged so that the intermittent sprocket would move 16 times for each revolution of the crank, this would require 1 revolution per second or 10 revolutions of the crank every ten seconds. One should practice the speed for a while with no film in the machine, looking at the second hand of a watch and turning with a uniform speed until there are just 10 revolutions every time the second hand passes a ten second division. This should be practiced for some time until the proper speed can be maintained with certainty. After the film is in, the action in the scene will serve as a guide for the proper speed, as some films are improved by being shown at a slower or faster rate than they were taken, i. e., the standard given above.

See Richardson's Handbook, p. 219.

§ 587. **Automatic fire shutter.**—As the machine starts, the automatic fire shutter (fig. 228) opens and allows the light to fall upon the film. If the picture is not at the right height on the screen it can be "framed up" by moving a lever which raises or lowers the mechanism and film.

If an old machine is used that does not have an automatic fire shutter, one must be extremely careful never to allow the light to fall upon the film except when it is in motion, otherwise one or two seconds will suffice either to ruin the film if non-inflammable film is used or to start a conflagration if celluloid film is used. The danger from this source is so great that we strongly recommend

that a water-cell be used (§ 848) in cases where an automatic fire shutter is not provided; where a motor is used to drive the machine; for all experimental work and for every person running a moving picture machine who has not had abundant experience in operating. It is so easy to let the film stop for a second, or to have the film break leaving a tag end of film in the aperture plate, and wonder afterward what started the fire.

§ 588. Setting or "timing" the shutter.—The shutter should be mounted on the spindle used to turn it in such a way that it will cut off the light from the screen during the time when the film is in motion. If the shutter is not set exactly right in the beginning it is often a rather tedious job to correct its position, but by going at the matter systematically the difficulty is greatly lessened.

Shutters of the one-wing type can, of course, be set in only one way but shutters of the two- or three-wing types may have wings of different widths. In this case the widest wing is the one which should intercept the light while the film moves.

The easiest way to set the shutter would, of course, be to run the machine very slowly and watch the picture on the screen. If no shutter were used the picture would seem to jump up, and be replaced by a picture which comes up from below. When the shutter is in place, if the picture seems to jump up just before the light is out, the shutter is said to be too "late" and it must be loosened on its shaft and turned slightly forwards, that is, in the direction in which it is turning. The shutter is then fastened securely in position. If the picture jumps into place from below just after the light comes on, the shutter is said to be too "early" and it must be turned slightly backwards. That the shutter may be correctly set when it is turning rapidly as well as when it is moving slowly, it is well to hold the outside of the shutter or the shaft on which it turns with the finger so as to take up lost motion. When in rapid rotation all the lost motion is taken up on account of air friction.

§ 587a. With a two-lens condenser the water-cell can be put between the condenser and the aperture plate (fig. 206).

Running the machine slowly with a film in the machine is entirely practical provided the arc current is not extremely heavy, and provided a water-cell is used (See § 596, 779-782).

When no water-cell is at hand the machine must be run rapidly. In this case the rule for changing the position of the shutter is exactly the same but the motion of each individual picture cannot be seen. If one has a film which is nearly opaque, but has a few spots in it, as a period on a title for example, there is an effect known as "travel ghost" which is seen if no shutter is used or if the shutter is incorrectly timed. This is caused by the persistence of vision. As the white spot moves upward, it appears to be a streak instead of a spot. If, now, the shutter is too late, the light is not cut off until the spot starts to move upwards and a streak is seen above the spot. If the shutter is too early, the light is turned on while the spot is still moving upward and before it comes to rest; the streak is then seen below the spot.

If the shutter is too narrow the motion of the spot, both before and after the light is cut off and the streak will be seen both above and below the spot of light.

§ 589. Rule for setting or timing the shutter.—If the streak or travel ghost appears *above* the letters of the title, the shutter is too *late*, turn it slightly forward on the shaft.

If the streak or travel ghost appears *below* the letters of the title the shutter is too *early*, turn it slightly backwards on the shaft.

If the streak or travel ghost appears *both above and below* the letters of the title, the shutter blade is too *narrow*. Use a shutter with a wider blade.

§ 590. The best position of the shutter and the speed to prevent flicker.—The shutter may be placed in either of two positions; it may be just beyond the film and between it and the objective (inside shutter) or it may be placed beyond the objective (outside shutter). There is a difference in the effect produced depending on which of these positions is chosen (fig. 225-226).

With the inside shutter, when the machine is turned slowly the image of the shutter can be seen somewhat out of focus traveling from one side of the picture to the other.

With the outside shutter, beyond the objective, the wing of the shutter as it advances removes light from the whole of the picture, a phenomenon which tends to reduce flicker.

The diameter of the inside shutter is limited by the size of the mechanism, while the outside may be made as large as is desired.

As will be seen below, the diameter of the shutter has an effect on the light.

The picture should be entirely covered by the shutter before it commences to move, and it should not be uncovered until it has ceased to move. This requires that the wings of the shutter need to be about 3 cm. ($1\frac{1}{4}$ in.) wider than the theoretical $\frac{1}{6}$ th of the circumference of the circle.

The larger the circle the nearer to $\frac{1}{6}$ of the circle is the width of the shutter wing.

With a shutter of large diameter, the actual velocity is greater and the interruption of the light is more sudden, therefore a shutter of large diameter is to be preferred.

§ 591. **Flicker.**—The standard speed of the film is given as 18 meters (60 ft.) per minute, 30 cm. (1 ft.) per second. There being 16 films per 30 cm. (foot), this gives 16 pictures per second.

It is the general intention to run films at this speed though they are often run either faster or slower to get the best effects. The time during which one picture is shown ($\frac{1}{16}$ second) can be divided into 6 equal periods, during five of these periods the picture is stationary and during the 6th the film is moved and the next picture substituted.

One complete change will be called a cycle.

The films could be run through the machine with no shutter at all, the film being in place an instant and then moved and the next picture substituted by a quick movement. This will cause a spreading out of white patches into a vertical streak called travel ghost, and will also give a general gray appearance and lack of contrast to the screen image.

To avoid this appearance some kind of a shutter is used to obliterate the pictures while the film is in motion. The shutter can be either translucent or opaque.

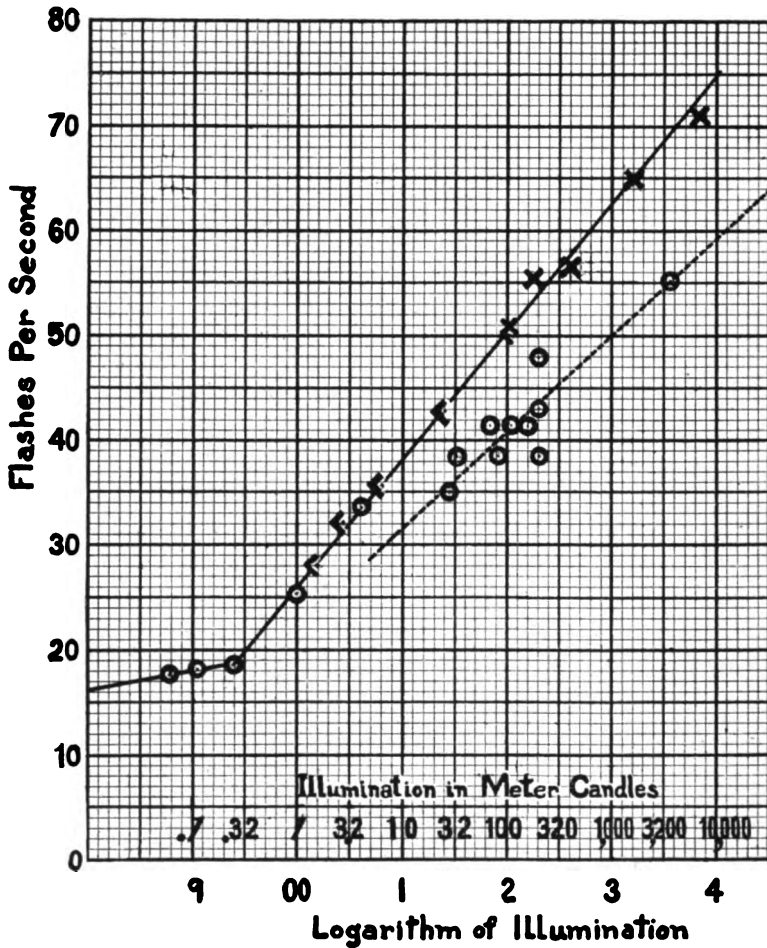

FIG. 234. THE RELATION BETWEEN THE ILLUMINATION OF THE SCREEN AND THE NUMBER OF FLASHES PER SECOND AT WHICH FLICKER JUST DISAPPEARS.

If the flashes are more frequent than indicated by the curve for a given illumination there will be no flicker, but if less frequent, flicker will be seen.

The solid line represents the observation of T. C. Porter and the dotted line represents some rough observations made by the authors.

If the shutter is translucent the appearance during the change of pictures is that of a screen lighted to a uniform gray. This kind of shutter is not much used in practice as it has the disadvantage of slightly illuminating the parts of the screen which should be absolutely black.

The opaque shutters were originally made to cover the picture during the time the picture was in motion, i. e., from $\frac{1}{2}$ to $\frac{1}{6}$ of the cycle, the rest of the cycle the screen was lighted, but this was found to give a very bad flicker.

Recently to get rid of the flicker the shutters have been made with 2 or 3 opaque wings.

With the one-wing shutter a cycle is made up with

1. Picture on the screen—screen light— $\frac{1}{2}$ to $\frac{5}{6}$ cycle.
2. Picture changed—screen dark— $\frac{1}{2}$ to $\frac{1}{6}$ cycle.

There are 16 cycles per second. The average transmission is $\frac{1}{2}$ to $\frac{5}{6}$ of the incident light.

It has been found that with a one-wing shutter the flicker is nearly as troublesome when the opaque part is $\frac{1}{6}$ as when it is $\frac{1}{2}$ of the shutter. To avoid this, extra dark wings are added to the shutter, the form with 3 wings being the best. With a three-wing shutter a cycle is made up of:

1. Picture on the screen—screen light— $\frac{1}{6}$ cycle.
2. Same picture on the screen but—screen dark— $\frac{1}{6}$ cycle.
3. Same picture on the screen but—screen light— $\frac{1}{6}$ cycle.
4. Same picture on the screen but—screen dark— $\frac{1}{6}$ cycle.
5. Same picture on the screen but—screen light— $\frac{1}{6}$ cycle.
6. Picture changed—screen dark— $\frac{1}{6}$ cycle.

The screen is dark $\frac{1}{2}$ and light $\frac{1}{2}$ of the time: Transmission of incident light, 50%.

Each picture is thrown on the screen three times before it is changed for the next. Thus, while there are 16 cycles per second; there will be 48 flashes per second.

At this speed, 48 flashes, flicker will altogether disappear (See § 592).

THEORY AND EXPERIMENTS ON FLICKER

§ 592. Experiments have been made to determine the speed at which flicker disappears, that is, the speed at which the eye is unable to distinguish between a continuous and an intermittent light.

These experiments show that at a certain speed the appearance of flicker disappears. This speed is practically the same for different people.

As the speed is increased the flicker disappears for the center of the field of vision before it does for the edge. Thus, the light on a screen may not appear to flicker when looked at directly but it may appear to flicker when looked at out of the "tail of the eye."

As the brightness of illumination is increased the appearance of flicker is increased and a higher speed is required for flicker to disappear. Thus, when showing a very dark film, the light may not appear to flicker at all, while with a very transparent film or no film at all the light may appear to flicker violently although the speed is the same.

If, instead of having the dark period and the light period equal, either the dark period or the light period is made less in proportion the flicker appears less violent, and it disappears entirely at a lower speed. This effect is, however, not very great.

Thus, the flicker with a shutter in which $\frac{1}{6}$ is light and $\frac{5}{6}$ is dark, is the same as one in which $\frac{5}{6}$ is light and $\frac{1}{6}$ is dark (§ 592a).

§ 592a. A formula to express these factors numerically was worked out by T. C. Porter of Eton College and published in the *Proceedings of the Royal Society*, Vol. 63, p. 347; Vol. 70, p. 313-329 (1902).

The constants have been recalculated.

Let f = number of light flashes per second at which flicker disappears when light and dark flashes are equal.

Let n = number of flashes per second; light and dark flashes are unequal.

w = angle of white space in disc.

$(360^\circ - w)$ = angle of dark space in disc.

I = intensity of illumination in meter candles.

b = constant depending on illumination.

From experimental data the formula comes out

$$f = 26 + 12.2 \log I$$

$$b = 12.04 + 2.378 \log I$$

$$n = f + b [\log w - \log (360^\circ - w) - 4.5106].$$

§ 592b. Table showing Speed at which flicker just disappears.—

FROM T. C. PORTER

Illumination meter candles	Logarithm of illumination	Flashes per second at which flicker just disappears
.0625	8.796-10	17.75
.111	9.046-10	18.08
.25	9.398-10	18.50
1.00	0.000	25.08
4.00	0.602	33.50
1.56	0.193	28.00
2.70	0.431	32.00
6.30	0.799	35.50
25.00	1.398	42.66
100.00	2.000	50.16
100.00	2.000	50.83
178.00	2.250	55.08
400.00	2.602	56.42
1600.00	3.204	65.00
6400.00	3.806	71.00

RESULTS FOUND BY THE AUTHORS WITH A MOVING PICTURE OUTFIT

32.00	1.500	36
100.00	2.000	41
1000.00	3.000	50
3200.00	3.500	54

The curves (fig. 234) are drawn to show the speed at which flicker disappears for equal light and dark flashes. There is not a great advantage as far as the speed at which flicker disappears in having the duration of the dark flash very short. The actual appearance of flicker is much less violent, however, when the dark section is narrow.

GENERAL PRECAUTIONS

§ 593. **Inspection of films.**—Before attempting to show films to an audience, it is well to inspect them carefully to see that they are in good condition and wound on the reel correctly.

Use the rewinder to roll the film from the new reel upon an empty reel. Turn the handle slowly with one hand while holding the edge of the film between the fingers of the other hand; do not touch the face of the film. When a patch is met in the film inspect it carefully to see that: (1) The same side of the film is on top. (2) The patch is made at the right place so there will not be a misframe,

i. e., see that the pictures are evenly spaced. (3) The sprocket holes match evenly. (4) That the patch is strong and no loose corners stick up.

If the patch is not good in all these particulars, it must be remedied.

There should be no torn sprocket holes or torn places in the film or bad scratches in the emulsion. If any such defects are found, they should be cut out and the film patched together again. Places may be found where the film broke and was pinned together. Remove the pin and cement the film.

When the whole film has been inspected in this way, rewind it, so that it will go through the machine correctly.

See that there is a "leader" or strip of blank film 1 to 2 meters (4 to 5 ft.) long to thread through the machine, so the entire title of the film may be shown. The part of the film used to thread the machine often becomes broken and a good "leader" saves the film itself from damage.

If there is time, it is well to run the film through the machine and watch the screen picture before showing it to an audience.

§ 594. **Splicing the film.**—When moving pictures are to be shown the operator will need to patch the film occasionally. Often a film breaks or an old splice comes in two. A splice is made by cementing the two ends of the film with "Film Cement."

Cut one end of the film, b, (fig. 235), exactly on the line between two pictures and scrape the back (shiny side) of the film with a sharp knife. There may be oil on the film. It must be removed; cement will not hold otherwise. Cut the other end of the film a, about 4 mm. ($\frac{1}{8}$ in.) longer than a dividing line between two pictures. Then scrape off the emulsion between the picture division and the ends of the film. This emulsion can be scraped off accurately to the line by holding a straight edge over the picture on a, and letting the end of the film project. Scrape the emulsion off and right down into the film stock. Scrape the corners as well as the middle, as the corners usually are the first to work loose. Film cement is then spread on the back of b, and the front of a, with a brush or stick, never use the fingers. Be sure to get plenty

of cement on the corners of the film. Then immediately press the two ends of the film together firmly for a few seconds, being careful not to push the ends of the film sidewise in doing so.

Several points must be carefully observed in order to get a splice which is satisfactory and durable.

1. Cut the film so that the dividing lines between two pictures come exactly together or there will be a "misframe" when the film is running through the machine.



FIG. 235A. EDISON FILM MENDER.

(Cut loaned by the Edison Manufacturing Company).

It has three gates or hinges—those on the sides clamp down and hold the film while the ends are cut and prepared and the cement is applied. The narrow middle clamp is then closed holding the ends of the film firmly in contact while the cement dries. The gauge shown at the left enables the operator to cut true edges on the film and scrape the proper width for the cementing.

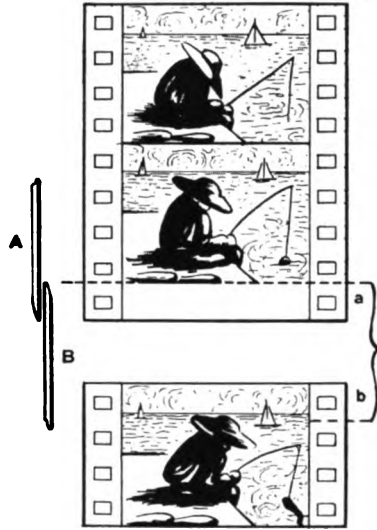

FIG. 235. METHOD OF PATCHING A MOVING PICTURE FILM.

One end of the film *B*, *b* is cut on the line between two pictures and the other end *A*, *a*, is cut a short distance beyond the line between two pictures. The film side of one and the shiny side of the other are scraped, cement is applied and the two ends are placed together so that the sprocket holes will match.

2. Scrape the film well, both the back side of *b*, and the emulsion side of *a*.

3. Apply the cement and work rapidly.

4. Be sure to hold the emulsion side of both films either up or down.

5. Get the film together so that the two parts of the film are in a straight line and not at an angle.

6. Get the sprocket holes together, so that they will match accurately.

7. Press the film firmly together without any sidewise motion.

It is well to practice on short pieces of scrap film until strong splices fitting together accurately can be made quickly.

There are two kinds of film cement, one which is good for celluloid films only, the other (NI cement) will work equally well on non-inflammable film and celluloid film.

For making permanent patches in a routine way there is a film mender (fig. 235A), consisting of a guide and a pressure clamp, so that the film may be accurately held while being cemented together.

All splices should be as far as possible made before beginning a performance. Any old splices which appear weak and likely to pull apart should be pulled apart and cemented together again.

With the greatest precaution a film will sometimes come apart during an exhibition. When this occurs the film is pinned together to be spliced permanently later. Be sure to remove pins and make permanent splices before attempting to run the film through the machine again.

WINDING AND REWINDING

§ 595. A device to wind the film from one reel to another is a part of any moving picture outfit.

While passing through the machine the film is always wound on the lower reel in the wrong direction for use, and it is necessary to rewind it, so that it will be right side out again.

While rewinding is the time to remove pins and splice permanently any breaks in the film which occurred during an exhibition.

In most moving picture theaters one film is rewound while the next film is being shown, the operator turning the moving picture crank with one hand and the rewinder with the other hand. When the rewinding is done this way very rapidly and the rewinder is fastened to the walls of a sheet iron booth a decidedly terrifying sound may be produced.

DANGER OF FIRE

§ 596. Before the introduction of non-inflammable films, all films were made by coating the emulsion upon celluloid. This is a nitrate (the trinitrate) of cellulose to which is added a certain amount of camphor. A more highly nitrated cellulose is called gun cotton.

There is sufficient oxygen in the nitrated cellulose to partially support combustion and it is the cause of the highly inflammable nature of celluloid. This was strikingly shown in some experiments made to ascertain the possible danger from an ignited film. A small reel of film was lighted and put under a tin box so that no air could get at it. A fire in ordinary combustibles, such as paper or wood, would soon be smothered, but the roll of film continued to decompose in the closed box. This shows that if a roll of film, even in a closed fire proof magazine, once catches fire it will continue to burn as long as there is anything left of it.

The gases given off from the film decomposing in a closed box are very disagreeable and will burn in contact with air if they are once lighted. If celluloid will burn so vigorously in a closed box, what would be the effect of a large reel of film lying uncoiled in a waste basket or on the floor should it once catch fire? This was the practice in the early days of the art of projecting moving pictures. Seven to ten meters (twenty or thirty feet) of film piled loosely, will be completely consumed in a few seconds, burning with a fierce flare while it lasts.

In view of this very evident danger, modern apparatus is designed to make it as safe as possible. To the good design of the machine must be added the coöperation of the operator to prevent a fire.

The fire shutter (fig. 228), automatically closes whenever the machine is not running. This shutter is placed in front of the film and prevents the light of the arc from striking it except when it is in motion. If the film should break, however, a tag end might remain in the aperture plate and be ignited, the fire shutter remaining open while the crank was being turned. To prevent this trouble the light should be instantly shut off whenever a film breaks.

The time required for igniting a film was examined. It was found that an ordinary film, partly black and partly transparent when held in the condenser focus would first curl and later burst into flame. The time required for each was noted, first with, then without a water-cell.

Image of arc	No water-cell		With water-cell	
	Curl	Burn	Curl	Burn
<i>20 Ampere D. C. Arc</i>				
Concentrated spot	1.3 sec.	2.6 sec.	5 sec.	10 sec.
Small spot	2 sec.	3.5 sec.	7 sec.	12 sec.
<i>24 Ampere A. C.</i>				
Concentrated spot	6 sec.	10 sec.	over 30 sec.	
<i>35 Ampere A. C.</i>				
Spot large enough to project picture, film dead black . . .	3 sec.	12 sec.	over 60 sec.	

With 35 amperes alternating current and the crater image large enough to project the full size of picture, the film curled in 3 seconds and burst into flame in 12 seconds. When a water-cell was used the film was merely slightly warped and not in the least injured after an indefinite exposure. With larger installations the water-cell could not be relied on to protect the film indefinitely, though it would much reduce the risk.

The data given in § 848 (fig. 342), shows the effects of the water-cell in reducing the radiant energy.

Examination was made of the probable security afforded by the fire-trap of a fire-proof film magazine. A short piece of film was put through the fire-trap of a film magazine. This fire-trap consists in a flat tube, the lower end of which is nearly closed by a pair of metal rollers. The flame would not follow the film through the metal tube. When, however, the film was pulled rapidly through the fire-trap it might or might not be extinguished by the rollers.

With the upper magazine, where the film hangs down, the rising flames heated the film to such an extent that when pulled upward through the fire-trap it continued to burn on the other side. When the film projecting from the lower magazine was ignited and pulled down through the fire-trap, it was extinguished just as a strip of

paper would be. The end of the film did not get as hot as that projecting from the upper magazine because the rising flames did not tend to play around the unburned part. It would seem, therefore, that the fire would probably not be carried into the lower magazine along with the film. Of course, with the upper magazine the film is going out of the opening in normal operation. What would be the effect of the sharp blaze from a meter or more (three feet) of loose film which would quickly unwind if the film broke can only be conjectured. It would be likely to get the magazine red hot and set the film inside on fire.

With these possibilities of risk in mind, one will naturally be very careful in handling the apparatus, so that nothing shall start to burn and to follow the precautions of keeping all of the films not in use inside of fire-proof boxes. The two films in use are: the film in the machine, and the film which has just been run through and is being rewound.

When non-inflammable film is used the above precautions are not necessary from the standpoint of fire risk, but the films might be spoiled. It is, however, a good plan to be careful even if non-inflammable films are used, so that habits of carelessness will not lead to accident should one of the celluloid films be included without the knowledge of its nature.

THE CONDUCT OF AN EXHIBITION

§ 597. Inspection of the plant.—Is the exhibition going to go smoothly, without hitches, or will the light be poor and go out, the film be out of focus, and break and everything go wrong? This depends largely upon the operator and a very careful inspection of all the apparatus before the exhibition begins.

The principle things to look out for are:

- (1) See that all wiring is in good shape, no binding posts loose, no wires almost burned out in the lamp.
- (2) See that the carbons in the lamp are long enough, that extra carbons are ready, that tools to change carbons are handy.
- (3) Burn the arc a little while till the carbon ends are properly shaped.

(4) See that the optical parts are clean, and free from dust. See that everything is in line and the light is even on the screen.

(5) See that the objective is in focus.

(6) See that the mechanism is oiled and in good order, no screws loose.

(7) See that the films are properly mended and that there are no misframes.

(8) See that the rolls of film are in the proper order.

The first reel of film is put in the magazine and the machine is threaded.

The arc is either pushed away from the operator so it will not shine on the moving picture head or else the dowser in front of the condenser is let down.

The arc lamp is lighted. When all is ready the crank of the machine is started, the arc lamp pulled toward the operator into position, the dowser is raised, and the house lights turned off all at the same time.

During the exhibition there should be but two things to watch.

1. The adjustment of the carbons. The carbons need occasional attention to keep a good light.

2. The action on the screen. The action on the screen should be very carefully followed. It will serve as a guide to the proper speed to turn the crank of the machine. The lighting of the picture and the focus of the objective may need attention occasionally as can be seen by watching the screen.

If the machine or the film is poor various mishaps may occur and require a short stop.

The most frequent is a misframe. This occurs when a patch has not been properly made and the pictures not properly matched. The difficulty is remedied by raising or lowering the framing lever. Note the place where the misframe occurs and remove it before the film is shown again.

The film may break. Turn off the light instantly, or push the lamp over to the lantern-slide side or lower the dowser. If a tag end of film is left in the aperture plate, it may catch fire if the light is not turned off. The film is now threaded through the machine

again and the ends pinned together in the lower film magazine. Splice permanently later.

When the end of the film is reached, turn up the house lights and put out the arc light, or push the lamp over to the lantern-slide side as the case may require. Turn the crank a few times until the film has all rolled into the lower film magazine.

The lower reel is taken out and put on the rewinder, the empty reel from the upper magazine put in its place and a new roll of film is put in the upper magazine.

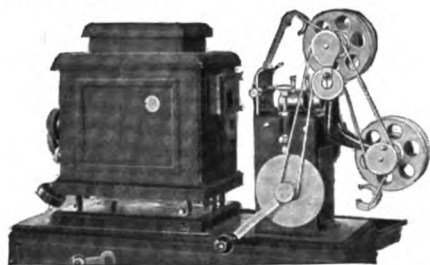

FIG. 236. THE EDISON HOME KINETOSCOPE.
(Cut loaned by Thomas A. Edison, Inc.).

At the end of the exhibition all of the films are rewound and put in the box to be kept until the next day or to be sent away.

§ 598. **Home projectors and advertising magic lanterns.**—In addition to the regular moving picture machines there have been two side-line developments. One of these is a relatively cheap moving picture machine with a small arc lamp for the house lighting system (§ 127) or some other form of radiant (Ch. IV, V). Some of these small instruments like the “Phantoscope” of Jenkins, take the standard size of motion picture film. Edison has put out another form, the “Home Kinetoscope,” (fig. 236). This does not project the ordinary size of moving picture, but very small pictures. Instead of one row of pictures on the film there are three rows. With the small pictures in three rows, a film 80 feet (24.38 meters) long contains as many pictures as 1000 feet (304.8 meters) of the ordinary moving picture film, and the mechanism is so arranged that the three rows are shown without a break.

The automatic magic lanterns are devised to show automatically a series of ordinary lantern slides. One of these instruments is called the "Advertigraph" by Williams, Brown & Earle and has a capacity of 24 lantern slides. Another form, designated a "Stereomotorgraph" by the Charles Besler Co., has a capacity of 52 lantern slides. These instruments are very effective for advertising and for exhibitions in museums.

TROUBLES

§ 599. There are two main troubles confronting the moving picture operator: A poor screen image, and fire in the operating room.

A poor screen image. This may be due to any one or a combination of the following:

(1) An operator with insufficient knowledge and experience. This is probably the most common cause.

(2) A poor projection apparatus.

(3) A bad light due to insufficient current or to a wrong relative position of the carbons.

(4) The parts of the projection apparatus not on one axis.

(5) The film may be poor; too dark or not sharp, or worn out, or badly perforated, or scratched, giving rainstorm appearances.

(6) The film may be wrong side up or wrong side out in the machine.

(7) There may be a "misframe" (§ 584, 597).

(8) The apparatus or the floor may vibrate, giving a jerky appearance on the screen.

(9) The shutter may not be in the right position or of the right design, hence flicker, travel ghost, etc.

(10) The general light in the room may be too great, hence, a gray picture without sufficient contrast. The same effect is produced by a single room light or the light from a door or window shining directly on the screen.

Fire in the operating room. This seems inexcusable, but may occur. To avoid loss of life and of property the operating room must be (1) truly fire-proof; (2) it must have a large flue leading

to the open air outside the building; (3) all the openings in the operating room must be closed by fire-proof shutters the instant a fire starts. In this way the smoke and gases will escape through the flue, and no one in the audience will know that anything is wrong.

From the standpoint of the operator, if a fire should start he should turn off the arc light and turn on the room lights as soon as possible. If there is a pail of water or a small fire extinguisher of the wet form in the room the water or the fire extinguisher can be used to good advantage to prevent the fire from spreading. The cooling effect will sometimes put out the film, although, as stated above exclusion of oxygen does no good for the celluloid contains enough oxygen to support combustion. The real way after all is to be so careful that a fire never starts. (See Richardson's Handbook, 2d edition, pp. 65-93).

§ 599¹. Summary of Chapter XI:

Do

1. Learn the principles, and perfect yourself in the practice under expert guidance, before you assume the responsibility of an independent operator.

2. Keep your operating room in perfect order.

3. Light the theater so that the lights cannot shine directly in the eyes of the spectators or upon the screen.

4. Have a perfect screen. If it is a painted screen, add a fresh coat occasionally.

5. Use direct current for the arc lamp if possible (Ch. XIII).

6. Inspect wiring and apparatus daily.

7. Keep the lenses of the condenser and of the objective clean, and in the right relative position.

8. Keep in mind the precautions (§ 593-594).

9. Learn to conduct the exhibition in the best possible manner.

10. Remember that it is far easier to avoid a fire than to put it out.

Do Not

1. Do not pretend to be a competent operator until you have the requisite knowledge and experience, and then never stop learning.

2. Do not have your operating room in disorder.

3. Do not install room lights so that they can glare in the eyes of the spectators or shine on the screen.

4. Do not project on a dirty screen.

5. Do not use alternating current for projection if you can use direct.

6. Do not neglect a careful daily inspection of wiring and apparatus.

7. Do not use dirty lenses or objectives.

8. Do not fail to study carefully the precautions (§ 593).

9. Do not neglect the directions for the conduct of an exhibition.

10. Never forget the danger from fire.

CHAPTER XII

PROJECTION ROOMS AND SCREENS

§ 600. Apparatus and Materials for Chapter XII:

1. Room which can be made entirely dark, or which can be partly lighted, depending on the kind of projection and the radiant.

2. If for exhibitions, the room should have plenty of aisles and exits, and there should always be lights (red lights) near the exits, and these lights should be independent of the projection circuit. The room should be well ventilated, and of a form found suitable for audiences, e. g., like a church, theater or university lecture room. The room should be tinted and decorated with light-absorbing colors (§ 604).

3. The lantern or other projection apparatus should be so placed that it does not interfere with the audience (§ 612-620).

4. Special room for the projection apparatus. If in a moving picture theater, there should be a fire-proof room for the apparatus. This should have a large ventilator extending through the roof or side of the building (§ 556-557).

5. Screen upon which the images are projected. This should receive the image at right angles to avoid distortion (fig. 241), and be of sufficient size for the room (§ 633).

§ 601. For the historical consideration of rooms and screens see under history in the Appendix. See also the works referred to in Chapter I, § 2, and the catalogues of manufacturers of projection apparatus and materials. Periodicals on moving pictures like the *Moving Picture World*; F. H. Richardson's *Motion Picture Handbook*; and F. A. Talbot's *Moving Pictures*.

§ 602. **Suitable room for projection.**—Any room which can be darkened may be used for projection, but to be satisfactory it should have the qualities of a good auditorium.

(1) There should be plenty of aisles and passages, so that the auditors can easily reach their seats.

(2) There should be plenty of exits, so that the room can be quickly and safely emptied.

(3) There should be plenty of fresh air.

(4) Each seat should have a good view of the stage and the screen.

(5) There should be enough diffuse light in the room so that people can find their way around easily and after gaining twilight vision, be able to take notes.

§ 603. **Form of the room.**—In general that shape of room which has been found most satisfactory for churches and theaters and for science lecture rooms in colleges and universities is well adapted for projection. As, however, the entire attention must be given to the images on the screen in the middle of the stage there is a tendency to make the rooms used especially for projection longer than they are wide. In a room which is approximately square, the spectators who sit at the sides of the room near the front do not have so good a view of the screen as those in the middle of the room and farther back.

With a long narrow room either the picture must be magnified excessively to enable those on the back seats to see the details, while for those on the front seats the pictures seem very coarse, or there must be a compromise so that only for those in the middle of the hall are the screen pictures of the most favorable size.

We strongly advise any person having the responsibility of planning a lecture hall for educational purposes or for exhibitions, to take advantage of human experience and see a considerable number of halls in various places, and get hints of what not to do as well as of what to do from those who have had experience. Then he can combine excellencies and avoid mistakes in planning his own building or room.

§ 604. **Tint and decoration of the room.**—In order to get the best possible results in projection, no light whatsoever should reach the eyes of the spectators except that reflected from the screen. With the moderate light available for the earliest users of the magic lantern it was advised that the walls and ceiling be made black so that, as they put it, "the room would be as sombre as possible." For some experiments in projection with polarized light, the spectroscope, and the highest power micro-projection such a room

would still be an advantage; but for ordinary magic lantern and moving picture exhibitions total darkening of the room is unnecessary and undesirable. But for all projection it is a great advantage *to prevent any light from falling upon the screen except that from the projection apparatus.* The room should therefore be tinted with some light-absorbing color. Nothing is better than the brownish color of natural wood, such as oak or pine. If natural wood is not used, the walls and ceilings can be tinted brownish or olive. For decorations, rich, dark red, orange, green, and blue may be used. Light orange, green, and blue reflect too much light but the dark, rich colors give the pleasing effect without making the room too light.

For mixing these tints, if oil colors are used, much turpentine should be employed to give a flat or dull finish, not a shiny or glossy one. If the finish is shiny it will act like a mirror and give an undesirable glare, and shine in the face of some of the auditors.

§ 605. **Light in the exhibition room.**—For magic lantern and moving picture exhibitions, the room should be light enough so that the spectators can easily find their way about; and after the twilight vision is established, the spectators should be able to take notes easily.

If the room is finished and decorated with light-absorbing colors and tints as indicated above, there is no danger of making the screen images gray and dull from reflections from the walls and ceiling. One has simply to guard against direct light shining on the screen from a window or from a lamp. (For lighting a black-board in a lecture room see fig. 240).

§ 606. **Lamps for general lighting.**—The lamps to give the needed light should be so arranged, and with such shades that: (1) They cannot shine directly in the eyes of the spectators; and (2) That they cannot send any of their rays directly upon the screen. This is best accomplished by placing the lights along the sides of the room or on the ceiling or both, and shading them so that none of their light can extend directly to the screen.

The arrangement sometimes used of a row of lights around the screen is bad; for, while no light can reach the screen from them,

the glare in the eyes of the spectators will detract from the effect.

If ceiling lights are used they should be placed close to the ceiling and on the side of the construction work (stringers, etc.) away from the screen. Then the light will extend obliquely downward and backward, but none of it will fall directly upon the screen.

Lights along the sides of the room can be placed behind the projecting construction work, or shaded so that the light cannot extend toward the screen.

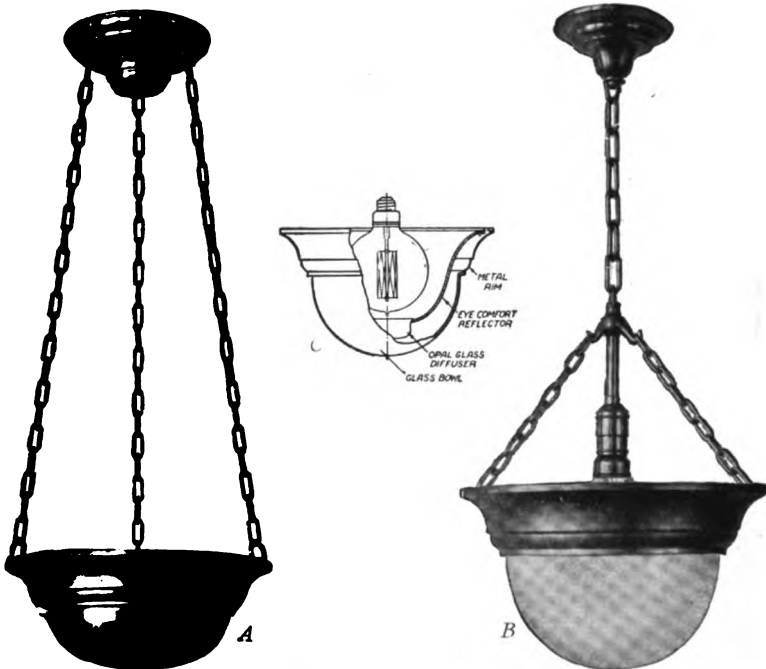

FIG. 237. METHODS OF INDIRECT LIGHTING.
(Cuts loaned by the National X-Ray Reflector Co.).

A Shows an opaque bowl containing the electric light. The light is reflected upward and is diffused throughout the room.

B and C Illustrate the indirect lighting where the bowl containing the electric light allows a certain amount of the light to extend downward. The light is also reflected upward as in A.

In C the bowl is cut away to show the electric bulb, the reflector for throwing the light upward, and the opal glass diffuser below to give the soft luminous effect of a very large source in the "luminous bowl."

The indirect or concealed light sources which have been recently developed answer all the requirements for suitably lighting a moving picture theater or, indeed, any other place where a soft light is required and the light should not shine directly in the eyes of the spectators (fig. 237 A, B, C).

It is also an advantage to have the screen in a kind of alcove 1 to 2 meters (3-6 ft.) deep and the walls on the sides, the floor and the ceiling dark brown or dark red or olive to absorb any light reflected upon them (606a).

For exhibitions, it also adds brilliancy to the picture to have a black border around the screen. It gives also the effect of a framed picture.

With such an arrangement of the lights in a suitably tinted room, no light will reach the screen directly to destroy the contrast and render the image vague. There can be sufficient diffused light in the room to enable one on entering to see the aisles and seats, and go about without stumbling. In a short time twilight vision will be established and it will then be possible to read or to take notes.

§ 607. Red lights near all exits. Fire escapes.—In public halls, and especially in moving picture theaters, it is an advantage, and often a requirement in city regulations, to have red lights near every exit so that the audience can see exactly where it is possible to get out of the hall.

The manager of every public hall should look to it every day that the fire escapes are in working order and before every exhibition that the doors or gates to the fire escapes are unlocked and easily opened.

§ 608. Relative darkness of the room for different kinds of projection.—The amount of diffuse light permissible in the pro-

§ 606a. While it is a great help to have a screen in a dark alcove, still the general light of the room, although none extends directly upon the screen, tends, if too great, to make the image less brilliant and definite. Every one who has studied astronomy at all with a telescope knows full well how the definiteness of the image of a nebula or dim star cluster diminishes when the moon rises and floods the heavens with its diffuse light. One can also see the effect of too much diffused light by observing a lighted clock face on a dark night, and the same face with the same light shining from it on a moonlight night or early in the evening twilight before complete darkness.

jection room depends entirely upon the brilliance of the screen image. In order to see the screen image clearly there must be strong contrast between it and surrounding objects. With transparent lantern slides and sunlight or the electric light to illuminate them one can see the screen images well in a room so light that everything in the room is visible provided no direct light reaches the screen except that from the projection apparatus. If the lantern slides are less transparent or the light used for projection less brilliant, then the room must be relatively darkened to give the needed contrast. Keeping the principle of contrast in mind, one readily understands that for some of the experiments in physics where the light on the screen is very dim, with kinemacolor moving pictures and with Lumière colored lantern slides, and with high power micro-projection, the room must be very dark in order to get the screen image clearly visible. In like manner if the source of light for projection is relatively weak, like the acetylene flame or some other less brilliant light than the electric arc, the room must be darker than with a more brilliant radiant.

§ 609. **Daylight and twilight vision.**—It has been known for time out of mind that with most people the eyes can adapt themselves to a dim light or to a bright light. If one goes into a dimly lighted room from full daylight the room will at first appear perfectly black, but in a few minutes objects can be seen fairly well, and within half an hour the room will appear comparatively light. On the other hand, in passing from a comparatively dark room to full sunlight the eyes are so dazzled at first that hardly anything can be seen, but soon the eyes become adapted to the bright light. It has been found by careful experiments on large numbers of people that the main adaptation of the eyes for bright light after being in a dark room requires only about 6 minutes, while the adaptation for a dim light after being in full daylight requires about 30 minutes, although after 10 minutes the eye is about 100 times as sensitive in a dark room as it is in full daylight. While the pupil expands normally in dim light, thus increasing the aperture of the eye, this is not the fundamental thing in adaptation, but there is some change in the retina which gives it greater sensitiveness.

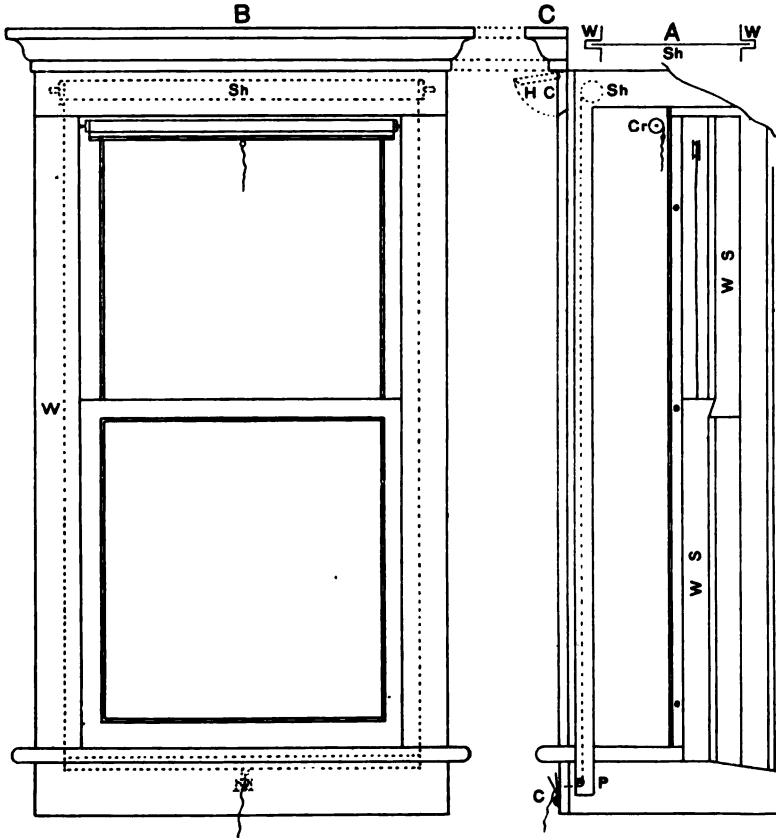

FIG. 238. FACE AND SECTIONAL VIEW OF WINDOW SHADES PLANNED FOR IN THE CONSTRUCTION OF THE BUILDING.

A Cross section showing the window shade (*Sh*) in the grooves (*W W*) at the sides.

B Face view of the window with the shade (*Sh*) shown by dotted lines.

C Sectional view of the window showing the window sashes (*W S*), the ordinary window curtains (*Cr*) close to the sash, and the window shade (*Sh*) considerably in front of the curtain, i. e., near the front of the window frame.

The coping over the window is shown by dotted lines as turned down. This exposes the shade roller so that it can be adjusted if it gets out of order.

The window shade is shown as drawn down, and the shade string goes over a pulley (*P*) and is caught in a fork-like holder (*C*) in front of the window frame.

Much of the projection at the present time requires daylight rather than twilight vision from the brilliancy of the screen images, but one should keep in mind that good screen images may be obtained by two methods (1) brilliant illumination and daylight vision; or (2) moderate illumination and twilight vision.

§ 610. **Method of darkening a room.**—As many rooms used for projection are well supplied with windows there must be some method of excluding daylight or other outside light. The two means usually employed are wood or metal shutters and opaque cloth curtains.

Shutters may be on hinges and swing sidewise, or they may be hung, and by means of pulleys raised and lowered. In many laboratories where the shutters are opened and closed several times during a lecture, there is a water or electric motor to move the shutters.

If curtains are used they should be of dark colored opaque cloth on a spring roller, so that they can be opened or closed as much or as little as desired. These are usually opened and closed by hand (fig. 238).

§ 611. **Excluding light at the window margins.**—As curtains are usually hung, there is a space admitting light at the top, bottom, and sides of the window. This can be avoided by having the edges of the curtain in a groove at the sides and bottom of the window frame, and having the curtain roller above the opening of the window frame (fig. 238). If one has the designing of the building, proper grooves can be planned for and put in when the window frames are made. If this has not been planned for in designing the building, then the light-excluding devices can be added afterwards. That is, a light-excluding shield can be put all around the window frame (fig. 239). This will, of course, cut down somewhat the opening of the window frame.

POSITION OF THE PROJECTION APPARATUS IN THE ROOM

§ 612. The best position for the projection apparatus in a lecture room or exhibition room is at the back of the room, where it is entirely free from the audience. This also gives the operator greater freedom (fig. 240).

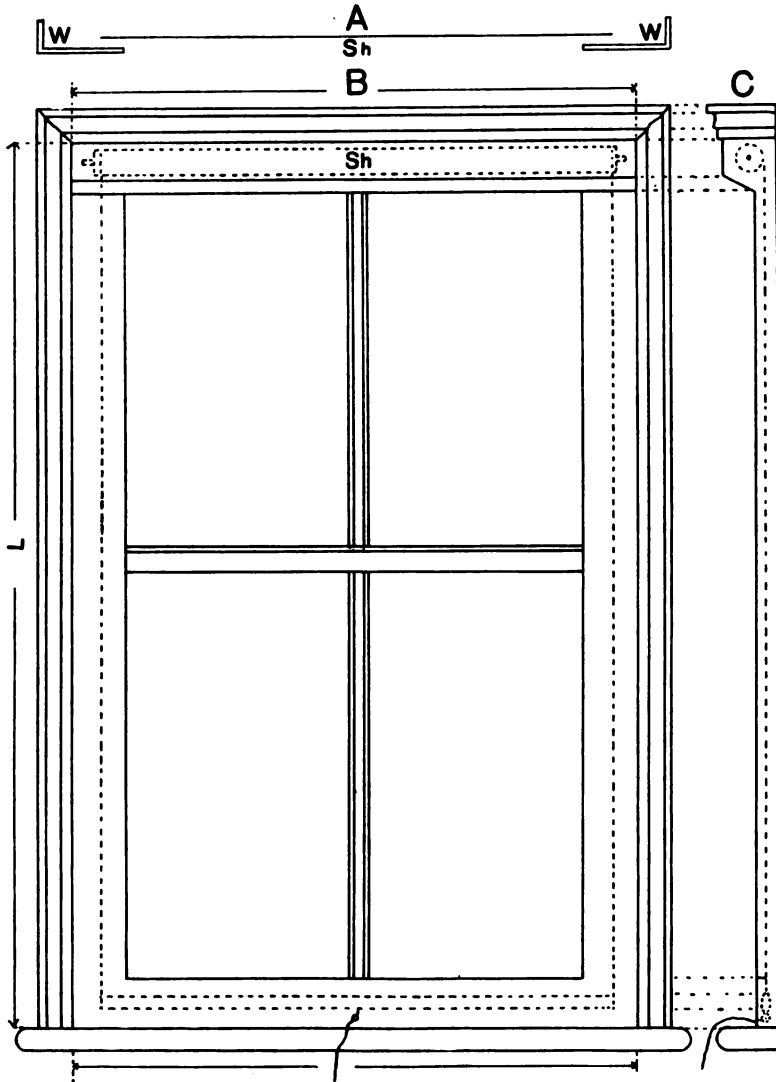

FIG. 239. FACE AND SECTIONAL VIEW OF A WINDOW SHOWING HOW THE LIGHT-EXCLUDING SHADE CAN BE INSTALLED AFTER THE BUILDING IS CONSTRUCTED.

A Cross section showing the window shade (*Sh*) behind the thin boards (*W W*) which serve to exclude the light at the top, sides and bottom of the shade.

B Face view of the window with the light-excluding shade (*Sh*) shown in dotted lines, (*L*) indicates the size of the window frame. The sash cuts this down somewhat and the thin board frame to cut out the light around the edge of the curtain cuts it down considerably more.

C Lateral view of the window with the shade in dotted lines. The light-excluding frame around the edge is in full lines in *B* and *C*.

§ 613. **Position of the projection apparatus with a level room.**—

In a level room, the projection apparatus at the back of the room must be at such a level that the projection beam goes over the heads of the spectators. This can be accomplished by building a platform, or by using a high table. In case the image is still not high enough on the screen, the lantern can be tilted slightly upward by putting a wedge under the end of the baseboard supporting it (fig. 240).

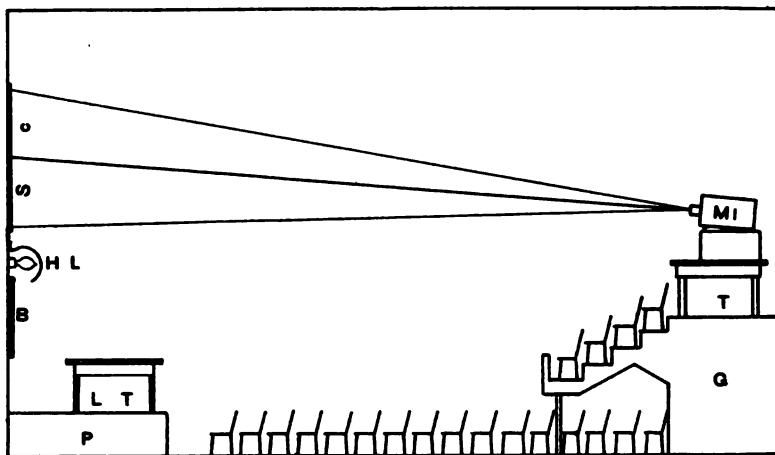

FIG. 240. SECTIONAL VIEW OF A LECTURE ROOM HAVING A GALLERY.

B Black-board. This is lighted by incandescent lamps behind a curved, metal shield (*H L*). This gives plenty of light for the black-board without in any way injuring the brilliancy of the screen image.

L T Lecturer's table on the platform (*P*).

MI The magic lantern in the gallery on its table and special support (*T*).

Sc Screen for the image above the black-board.

§ 614. **Level room with the apparatus near the screen.**—It is sometimes desirable to put the apparatus near the screen. Then provision must be made by removing some of the seats if the center aisle is not wide enough.

The apparatus must usually be raised somewhat also, and sometimes the objective inclined more or less upward. In case it is desired to have the apparatus very near the screen it must be pointed upward considerably and then the screen should be hinged at the bottom so that it can be inclined toward the lantern till it is perpendicular to the optic axis. The simplest way to fix the screen in any position, and to change the position is by means of ropes and pulleys at the top.

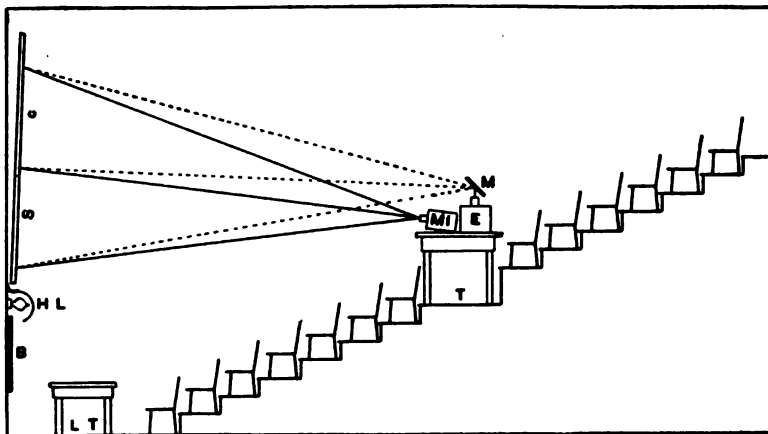

FIG. 241. LECTURE ROOM WITH RISING SEATS, AND THE LANTERN IN THE MIDDLE OF THE ROOM, NOT AT THE BACK.

B Black-board lighted by the hidden lights (*H L*) behind a curved metal shield.

L T Lecturer's table in front of the audience.

M I E The magic lantern (*M I*); its rays shown in full lines, and the episcopa or opaque lantern (*E*) with its rays shown extending from the mirror (*M*) in dotted lines.

S C The screen for receiving the image. As the magic lantern must be elevated the screen is tipped toward it to meet the axial ray at right angles.

For such a position of the magic lantern the projection objective must be of shorter focus to give the desired size of image than when the lantern is at the back of the room (§ 636).

The lantern should be fastened to a hinged board when it is elevated considerably (fig. 118, 242).

§ 615. **Magic lantern on the lecture table.**—Occasionally it is an advantage to have the magic lantern on the lecture table; then the lecturer can manipulate it himself.

There are three arrangements possible: (1) The lantern is pointed toward a screen at the side of the room (fig. 243). (2) It is pointed obliquely upward toward the screen in front of the audience. In this case the screen must be inclined toward the lantern as indicated above (§ 614). (3) Occasionally, for ease of manipulation, the lantern is pointed obliquely upward toward the audience and a plane mirror reflects the image-forming rays backward to the screen (fig. 244). If a mirror is used, the lantern slides must be inserted with their faces toward the objective.

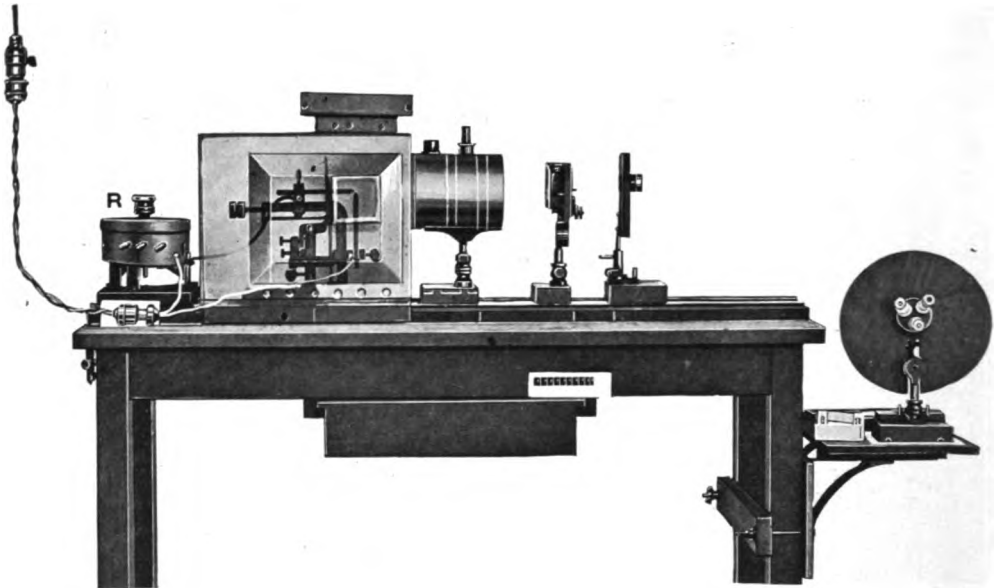

FIG. 242. MAGIC LANTERN TABLE WITH HINGED BASEBOARD.

Hinges connect the baseboard to the table at the left. By putting a block under the board at the right, it can be elevated to bring the screen picture higher up (fig. 118).

§ 616. **Projection with inclined seats or gallery.**—If the seats in the auditorium are raised after the manner of an amphitheater or if a gallery is present, in many cases the apparatus can go to the back of the room or in the gallery. This may make it necessary to point the projection apparatus somewhat downward towards the

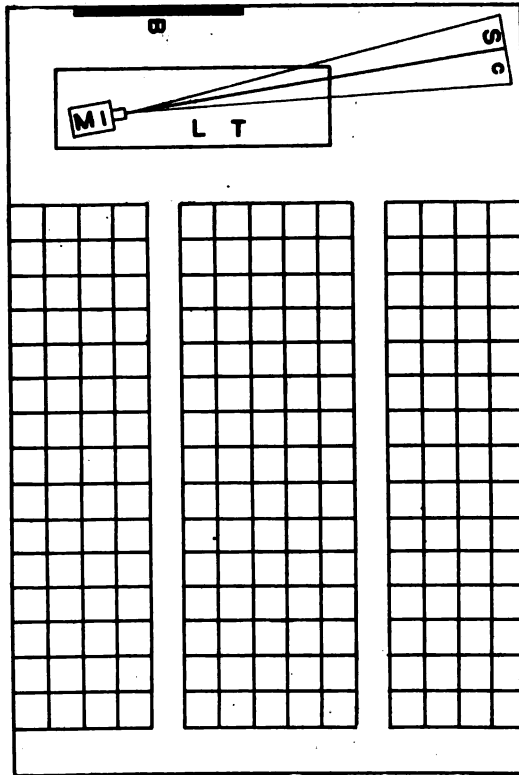

FIG. 243. GROUND PLAN OF A LECTURE ROOM WITH THE MAGIC LANTERN ON THE LECTURER'S TABLE AND THE SCREEN AT THE SIDE OF THE ROOM.

B Black-board.

Ml Magic lantern on the lecture table (*L T*) and pointing up to the screen (*Sc*) on the side of the room.

Sc The screen is shown tipped forward to avoid distortion.

Such a position of the lantern enables the lecturer to perform experiments or show lantern slides conveniently.

screen, but as the distance is usually considerable, the screen image will be good on a vertical screen. The position of the lantern should never be so high that the screen image will be distorted.

§ 617. **Apparatus in the middle of the auditorium with raised seats.**—If the apparatus cannot be at the back of the room in an amphitheater then a space or alcove must be made somewhere in the middle by omitting a certain number of seats. The machine is liable to be more or less distracting if in the middle of the room. but sometimes this cannot be avoided on account of distance or the form of the amphitheater (fig. 241).

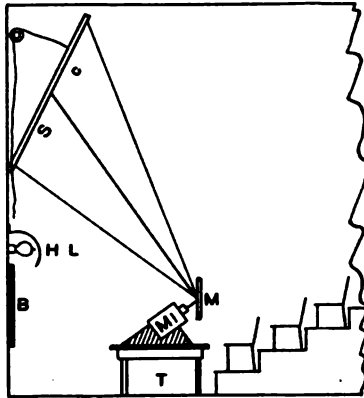

FIG. 244. PART OF A LECTURE ROOM WITH THE MAGIC LANTERN ON THE LECTURE TABLE DIRECTED TOWARD THE AUDIENCE AND A MIRROR TO REFLECT THE IMAGE ON THE SCREEN IN FRONT OF THE AUDIENCE.

B Black-board with hidden light behind the curved metal shield (*H L*).

M M Magic lantern pointing toward the audience. The mirror reflects the image back to the screen in front of the audience. The mirror also serves as a shield.

Sc The image screen. By means of the pulley and cord it is inclined on its hinges at the lower edge toward the mirror of the magic lantern. In this case it is not inclined sufficiently to meet the axial ray at right angles, hence there will be some distortion of the image and the upper edge will not be in sharp focus when the lower edge is.

T Lecturer's table. With such an arrangement the lecturer can demonstrate with the lantern conveniently, and still have the screen in front of the audience. If he uses lantern slides they must be put in the holder facing the objective, not the light or there would be a mirror image on the screen (fig. 213).

Occasionally when the seats are on a steep incline there is left a space through which the projection objective can send its beam to the curtain, the apparatus and operator being under the seats of the amphitheater.

§ 618. **Apparatus on one side of the room.**—Occasionally the apparatus is put on one side of the room and instead of projecting directly in front of the audience the projection is on one side of the room. The auditors simply turn in their seats to face the screen.

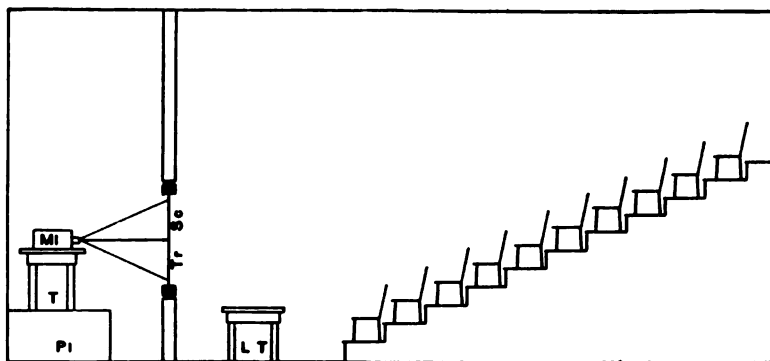

FIG. 245. SECTIONAL VIEW OF A LECTURE ROOM SHOWING THE POSITION OF THE PROJECTION APPARATUS WITH A TRANSLUCENT SCREEN.

MI Magic lantern or other projection apparatus on its table (*T*) and raised platform (*Pl*) in a room outside the lecture room.

L T Lecturer's table.

Tr Sc Translucent screen. The audience does not see the apparatus; only the screen image is visible.

Lantern slides must be inserted in the holder facing the objective, not the light, or the image will have the rights and lefts changed like fig. 213.

This is not so satisfactory as when the screen is directly in front (fig. 243).

§ 619. **Apparatus wholly without the room.**—Regardless of the form of the room, the apparatus may be placed in a room just back of the lecture table in front of the audience and a translucent screen employed. This arrangement has decided advantages, but a translucent screen is not so satisfactory as a white opaque screen (see fig. 245).

§ 620. **Special operating room.**—With the ordinary magic lantern and projection microscope the apparatus and operator are

usually in the general exhibition room, and there is no special boxing or enclosure of the apparatus. But in moving picture theaters, where there is some danger from the inflammability of the picture films, both the fire underwriters and the municipal regulations usually require some form of fire-proof operating room.

IMAGE SCREEN

§ 621. Next in importance to a suitable room for exhibitions with projection apparatus is a good screen upon which to project the image.

No one has ever more briefly and clearly stated the qualities of a good image screen than Goring & Pritchard: "*It should reflect the greatest possible quantity of light and absorb the least.*" "Every care should be taken to render the surface as smooth, white and opaque as it can be made" . . . "inasmuch as the brilliancy and perfectness of the picture will greatly depend on the whiteness, and the sharpness of its outline upon the smoothness of the screen." The screen should be dull white, never shiny.

§ 622. **Screens of plaster paris upon the wall.**—A screen fulfilling all the requirements just given is a wall coated with a smooth finish of pure, fine plaster of Paris.

§ 623. **Painted wall screen.**—While a plaster of Paris wall screen is perhaps the best, a smoothly plastered wall, if properly painted, gives almost as good results and is much cheaper. The wall, as stated, should be finished as smoothly as possible by the plasterers, then it is coated with pure linseed oil if porous, or with a mixture of equal parts of linseed oil and turpentine if the wall is hard and non-porous. When this is dry, the wall is painted with either white lead ground in oil and thinned with turpentine, or with "sanitary paint" thinned with turpentine. The sanitary paint has the advantage that it does not turn yellow with age, and that it is more easily cleaned with soap and water.

When the paint is properly thinned it should be strained through one or two layers of gauze (cheese cloth) to get out any lumps or coarse particles.

In spreading the paint on the wall one should use a soft brush and apply only the tip of the brush. This will give a smooth finish and if one uses plenty of paint there will be no joints, but the whole will appear like one uniform coat. Practical painters call this "flowing on the paint."

After one coat is well dried another can be put on until the wall is perfectly white. If plenty of turpentine is used the surface will be dull. It should not be glossy or shiny.

Whenever the surface becomes dirty it can be washed off with soap and water. If it is not up to standard whiteness after the washing and drying, put on another coat of the paint.

Sometimes hot glue, 15% to 20% in water, is used for sizing the wall. This answers well if the wall is perfectly dry and not subject to moisture. In general it is safer to use the linseed oil sizing.

In our experiments several white paints were used, but the pure white lead (sometimes called "flake white") and the non-lead containing paint called "sanitary paint" were found most satisfactory. The latter has the advantage over white lead that it does not yellow with age, and gives a very opaque and white surface which stands washing with soap and water very well.

§ 624. **Whitewashed wall screens.**—A smoothly plastered wall that has been carefully whitewashed with milk of lime gives a good, dull white surface for a projection screen. It rubs off rather easily and cannot be cleaned. Of course a fresh coat of whitewash will renew the screen. It is cheap as well as good. One should take pains to strain the whitewash, and to apply it smoothly so that a uniform surface will be produced.

We did not find a kalsomined wall satisfactory for projection. It is, or soon becomes, too yellow.

§ 625. **Painted cloth screens.**—A good screen can be made by stretching some smoothly woven, strong cotton cloth (strong muslin) upon a frame and painting it as for the wall (§ 623). The frame must be strong and the cloth stretched tight so that there will be no wrinkles, and it must not rest against anything.

One could paint directly on the cloth, but it is more satisfactory to size the cloth in some way first. One of the best methods is

to use white linseed oil, raw or boiled. The oil is put on with a soft brush like paint. It is well to make all the brush strokes in one direction, so that the lint or nap on the surface of the cloth will be smoothed down in one direction. After the linseed oil is dry the cloth is painted, preferably with sanitary paint and turpentine, although white lead thinned with turpentine answers well. One coat should be allowed to dry before adding another. It takes from one to two days for each coat to dry. The screen will be white and opaque with three to five coats. Care should be taken to strain the paint as for the walls (§ 623), then there will be no rough spots (§ 625a, 625b).

If the curtain gets grimy it can be wiped off with soap and water, and if necessary after it is dry, a fresh coat of the paint can be put on.

§ 626. Roller screens.—Cloth screens which have been painted as just described make excellent roller curtains, for the sizing and

§ 625a. Amounts of sizing oil and paint for a cloth screen.—For oil-sizing and painting a muslin screen the following times for drying in the summer, and the following amounts of oil and paint were used to make a perfect screen. For sizing, white raw linseed oil was used, and only one coat was applied.

For this it required 220 cubic centimeters of the linseed oil per square meter of cloth, or about one-tenth of this amount per square foot.

For painting, a preparation of sanitary paint known as "Artists' Scenic White," ready for use on screens was used, two coats were applied. It required 110 cc. of the paint for each square meter of surface.

It required about 36 hours for the raw oil sizing to dry; 24 hours was sufficient time for a coat of the white paint to dry. The finished screen was flexible and easily rolled.

For a screen 3 meters or 10 feet square it would require for sizing and painting about two quarts of linseed oil and about the same amount of the "Artists' Scenic White" or any other white paint for two coats of the paint.

§ 625b. The cloth may be sized by the use of white shellac. This is thinned about half with denatured alcohol and painted on the surface just as described for the oil size. It gives a good surface to paint on, but does not leave the curtain so flexible.

A hot 15% to 20% solution of white glue in water may also be used as described for the oil or shellac size. This has the advantage of pasting down the nap of the cloth and of giving a very good surface to paint on. It has the disadvantage of expanding and contracting greatly with different conditions of moisture. If the glue size is used the curtain should have at least one coat of paint on the back, so that the glue size cannot be so easily affected by moisture.

§ 625c. The authors wish to express their appreciation for information on paints and the painting of wall and cloth screens for projection, to Mr. A. E. Nash, Superintendent of the Cornell University paint shop.

painting leave the cloth flexible, and without liability of cracking and peeling. They are mounted on heavy spring rollers as ordinary window curtains are so commonly mounted, and can be rolled up when not in use.

§ 627. **White cloth screens without paint or other facing.**— White cloth such as a bed sheet has always been and still is used. The cloth should be as white as possible, and of good thickness. It is also advantageous to have the screen of one piece without seams. Bed sheets may be obtained in large dry goods houses about 3 meters square (10 ft. sq.) without seams. These make very good curtains when the folds are ironed out, and the sheet stretched to hold it flat. It is not easy to stretch a sheet so evenly that there will be no folds or wrinkles. Fortunately, a slight unevenness is not noticeable in the screen image. A screen which appears quite uneven to the naked eye in daylight may give very good screen images and appear perfectly smooth, when giving an exhibition.

Cloth screens have the disadvantage that they are not sufficiently opaque. If one goes behind the screen the image is almost as well seen as in looking at the face of the screen. This means that almost as much light traverses the screen as is reflected from the face. Naturally, it takes much more light for a brilliant screen image than with an opaque screen (§ 632).

For some purposes it is advantageous to be able to see the image on the back, then assistants behind the screen can make the appropriate noises to make the scene seem more real. For example, in a moving picture scene, sounds can be made to imitate the breaking of the waves on the shore, the clatter of horses hoofs on a pavement, etc., etc. Unless the assistant could see the image it would not be possible to suit the sound so accurately to the scene.

Sometimes so large a screen is needed that strips of white cloth are sewed together. If this must be done the seams should be very smooth. On such screens the seams show like lighter streaks on the image, as more light is reflected from the double thickness of

cloth. Behind the screen the seams show as black or dark streaks, as less light traverses the screen along the seam (§ 627a).

§ 628 **Paper screens.**—The suitability of white paper screens has been recognized for a long time. One of the best possible screens is a large sheet of white cardboard. As shown by photometric measurements, the reflections from a white cardboard are almost as great as from the standard surface of oxide of magnesium (§ 632). The white cardboard is especially suitable for the images of the high power projection microscope, and if it could be had in sufficiently large sheets it would make an almost perfect screen for large rooms. (In large paper stores one can get sheets 71 x 112 cm. (28 x 44 in.). The paper used for drawings by architects and engineers and 69 x 102 cm. (27 x 40 in.) in size is also excellent for screen purposes. It is not so easy to get a smooth surface as with the cardboard).

Finally, cloth is sometimes faced with paper to give a more opaque and perfect screen.

SCREENS WITH METALLIC SURFACES

§ 629 Dull white surfaces reflect almost equally throughout the whole hemisphere (fig. 248) and therefore the image appears almost equally brilliant in any position. Those near the axis of the projection apparatus in the middle of the room do not see the

§ 627a. **Screens for traveling exhibitions.**—When exhibitions must be given in school-houses and in halls where there is no lantern and no screen, the exhibitor must supply both. In traveling it is inconvenient to carry a roller screen, and usually the screen is folded so that it can be packed in a small space. This, of course, makes creases in the screen, and besides there is nothing to support it so that it will hang smooth and even.

For a traveling screen a heavy, seamless bed sheet is excellent. Bed sheets in one piece as large as needed are to be had. To hang these sheets there should be a strong cord along the upper edge either in a hem or in curtain rings. From the corners of the sheet should be strong cords by which the sheet can be stretched out smooth and held in position by passing the cords through screw eyes or attaching them to other fixed supports.

It is well also to have rings along all the edges to attach strings to, to pull the edges taut, and to support the curtain at the upper edge.

For temporary use, a sheet may be stretched and held in position by tying strings to the corners and by fastening the strings along the edges by safety pins.

image much more brilliantly illuminated than those at the side. Sir David Brewster in 1832 advocated and used the bright metallic surface on the back of looking glasses, which at that time was composed of mercury and tin. Later, surfaces covered with silver-leaf, silver particles or particles of aluminum have been tried. Last of all, plate glass has been ground on one side, and the smooth side silvered. The ground surface of the glass is turned toward the projection apparatus and facing the spectators who get the image reflected from the mat surface of the glass and transmitted from the mirror through the mat (§ 629a).

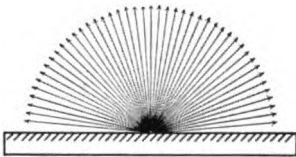

FIG. 246. DISTRIBUTION OF LIGHT REFLECTED FROM A WHITE SCREEN.

It is approximately uniform throughout the entire hemisphere.

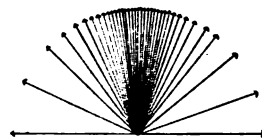

FIG. 247. DISTRIBUTION OF LIGHT FROM A SEMI-DIFFUSELY REFLECTING SCREEN.

The closeness of the arrows indicates the apparent brightness as seen from different directions.

§ 630. **Suitability of metallic screens.**—Metallic screens are not suitable for micro-projection, or, indeed, for any projection if fine details are to be studied close to the screen, but details which can be seen at a distance of 2 to 3 meters are very well brought out on the mirror screen, and other metallic screens. In comparing a mirror screen, an aluminum bronze screen and one of plaster of Paris or cardboard if the image was observed within the narrow angle of 15 degrees to the right or left of the axis, 30 in all, the mirror screen was brightest, the aluminum next, and finally the plaster of Paris or cardboard, the screens being in the field at the same time so that the comparison was under identical

§ 629a. The authors wish to acknowledge their indebtedness to The Motion Picture Screen Company of Shelbyville, Indiana, U. S. A., for their courtesy in sending a sample of their "Mirror Screen" for experiment; to the Bausch & Lomb Optical Company for the loan of the two metallic screens of Zeiss; to the J. H. Gentner Company of Newburgh, N. Y., for samples of Mirroroids; and to other screen manufacturers for courteous answers to inquiries.

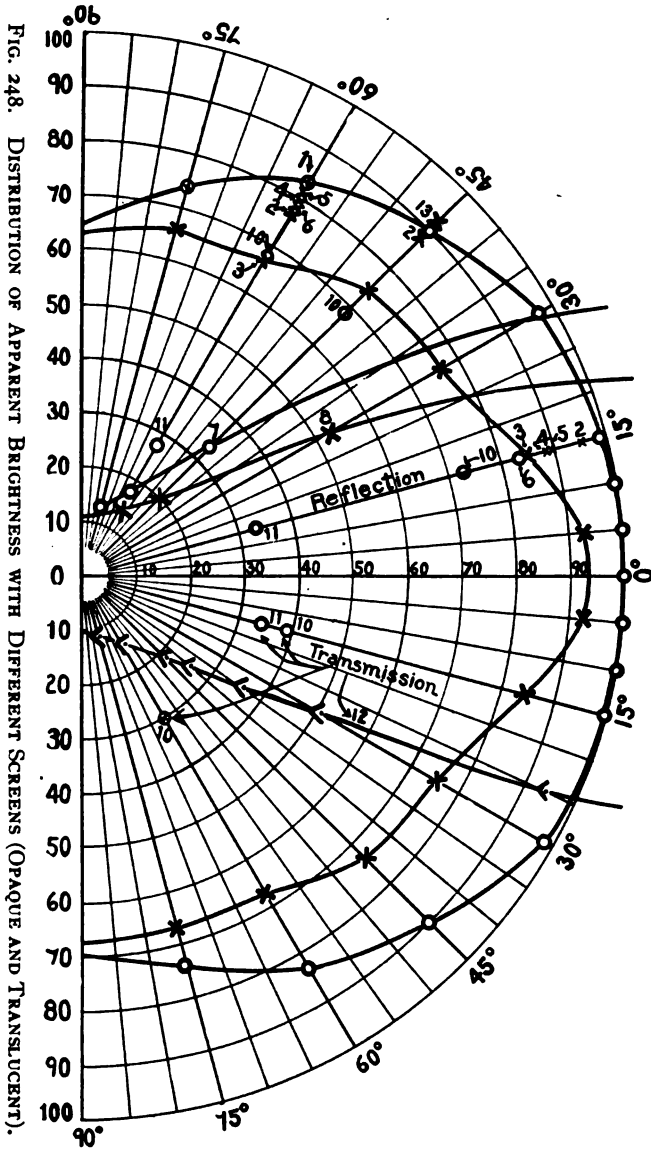

FIG. 248. DISTRIBUTION OF APPARENT BRIGHTNESS WITH DIFFERENT SCREENS (OPAQUE AND TRANSLUCENT).

On the curved surface of the diagram are given the degrees of inclination of the light. On the diameter, and on the radius at right angles to the diameter are given the percentage of apparent brightness. Magnesium oxide is taken as the standard and called 100%.

The data shown on the diagram are given in figures in the table, § 632.

Curve 1. Screen coated with magnesium oxide. It is to be noted that it is only in the central region that the full 100% of reflection occurs.

Points 2 2 2 2 Plaster of Paris screen.

Curve 3 Cardboard screen.

Points 4 4 Screen painted with white lead.

Points 5 5 Screen painted with Artists' Scenic White.

Points 6 6 Screen painted with zinc white.

Curve 7 Cardboard screen painted with aluminum.

Curve 8 Zeiss metallic screen.

For *9* see the table, § 632.

For the *Mirror Screen*, see the table, § 632.

Points 10 10 10 Reflection and transmission of a white muslin screen. Note its uniformity (§ 632).

Points 11 11 11 Reflection and transmission of white gauze (Griswoldville gauze, No. 10). With this screen more light is transmitted than reflected.

Point 12 Transmission of ground-glass.

Point 13 Reflection of bristolboard.

conditions. At an angle of 30° degrees and upward the metallic screens appeared almost black, and the white screens pure white.

§ 631. **Translucent screens.**—For the old phantasmagoria and for many appearances given by shadow pictures it is necessary to have a translucent screen like ground-glass or translucent cloth or paper. The paper or cloth is rendered as translucent as desired by the use of water, water and glycerine, or oil. Tracing cloth makes good translucent screens of moderate size.

With a translucent screen the apparatus is entirely out of sight behind the screen and only the picture shining through the screen is seen by the audience. This is not so good and effective a method of showing projection images as the opaque white screen or the metallic screen, for much more light is lost (fig. 248). It is still used in some institutions, as it entirely eliminates the projection apparatus and the operator from the auditorium (§ 631a).

The ground-glass screen is excellent, but this, like a metallic screen restricts the brilliant image to a rather narrow angle (see § 630, 632 and fig. 250). The ground surface should be fine or there is given the appearance of looking toward a bright light in a snow storm, this is especially marked if one is near the ground-glass and looking nearly along the axis.

The cloth screens were not so satisfactory as the ground-glass because the crossing threads make a kind of grating and one sees diffraction images; and if one is in direct line with the arc lamp the cloth acts almost as if it were transparent. The translucent mercerized paper used in making tracings is practically as good as ground-glass, but it is difficult to hold it smooth and even. The tracing cloth used by architects and engineers is good for a translucent screen.

There is a practical difficulty with all translucent screens. On account of the poor reflection, the operator cannot tell with the same certainty when the image is in focus as with a white, opaque screen.

§ 632. Table of the reflection of different screens compared with magnesium oxide.

No.		At 15°	At 45°	At 60°
1	Magnesium Oxide	100		83
2	Plaster of Paris	95.6	88.7	78
3	Cardboard	84.5		67
4	White Lead	88.5		79.4
5	Century Company's White	89.4		81
6	Zinc Paint	84.4		76.5
7	Aluminum Paint on Card	210		18
8	Zeiss Metallic Screen, smooth	136		14
9	Mirror Screen	200		
10	White Muslin, Reflection	73.4	69.1	66.9
	Transmission	39		30
11	Gauze, Reflection	33		27
	Transmission	35		
12	Ground-Glass, Transmission	300		14.2
13	Bristolboard, Reflection		91.5	

§ 631a. For example, in the anatomical institute at Munich. Here all the projection, whether with the magic lantern, the projection microscope or the opaque lantern, is upon a translucent screen; also in some of the lecture rooms in Holland.

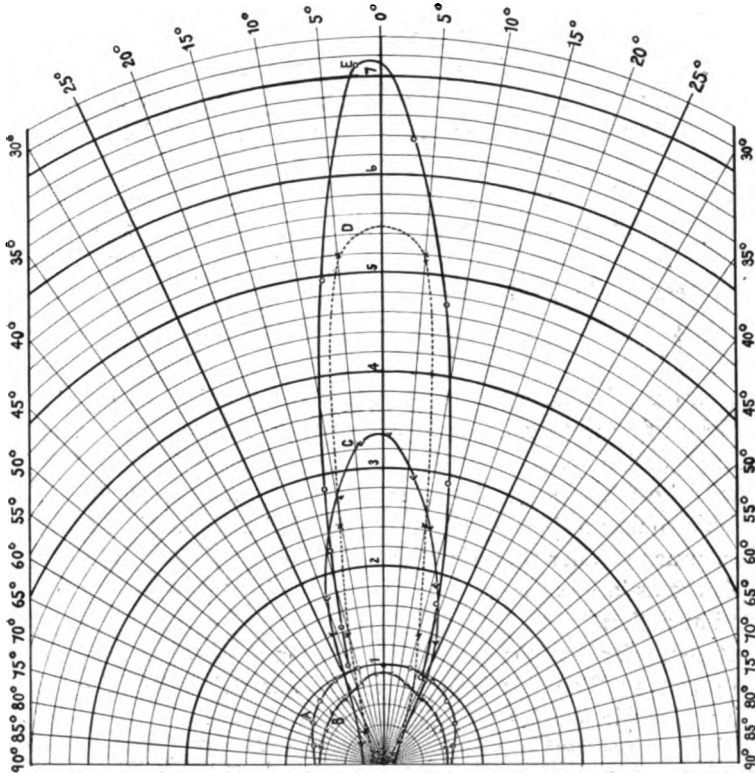

FIG. 249. DISTRIBUTION OF APPARENT BRIGHTNESS WITH DIFFERENT SCREENS WHEN VIEWED FROM DIFFERENT DIRECTIONS.

On the sides and curved surface are given the degrees of inclination of the reflected light.

The numbers along the central radius indicate the relative brightness of each screen, magnesium oxide being used as the standard and called 100%.

A Magnesium oxide screen. It gives the standard brightness of 100% and reflects nearly equally throughout the entire 180 degrees.

B White cardboard.

C Screen with aluminum bronze facing. This gives 3.2 times the brightness of magnesium oxide in the center, but it falls off rapidly at the sides.

E Mirror screen. This gives 7.1 times the brightness of magnesium oxide in the center.

It is to be noted in general that the mirror screens, (*C. E.*) give great intensity when seen near the center, and that this intense light is restricted to an angle of about 25 degrees. Farther to the side the light falls off rapidly, being in marked contrast with the white screens (*A B*).

SIZE OF SCREENS AND SCREEN IMAGES

§ 633. The size of screen images which will give the best results in a given case can only be determined by trial. The size should be great enough so that the people sitting on the back seats can see all the details to be shown and still not so large that those sitting near the front will be repelled by the coarseness of the image.

As a result of experiments to determine the best size of screen picture for the average seat in a room the following general rules have been worked out so:—

§ 634. **Size of the screen for lantern slides.**—The screen image must be large enough so that details are visible to the most distant spectator. For example, in teaching work and in demonstrations at scientific meetings, etc., lantern slides often contain tables of figures and printed sentences. Naturally, the farthest sitter should be able to see the figures and to read the words easily.

This could not be done by those on the back seats if the letters were much smaller than six point. Of course, if the letters on the slide are as large as eight or ten point type (fig. 216), they can be read at a glance.

In long, narrow rooms the magnification necessary to enable the people on the back seats to see the details well will make everything gigantic for those sitting near the screen.

For a well arranged auditorium, if the letters and numerals on the slide are of the size of 6 point type, such as shown in this sentence, and the screen image is from one-fourth to one-fifth as wide as the distance from the farthest seat in the room to the screen, all in the audience should be able to read the print on the lantern slide with ease.

§ 635 **Projection objectives necessary to give the proper screen image with the magic lantern.**—If the lantern can be at the extreme rear of the room, and the image of the slide is to be one-fourth or one-fifth as wide as the room is long, as stated above (§ 634), a projection objective of 30 cm. (12 in.) focus will give the desired screen image for a properly made lantern slide, no matter what the size of the room. This is because the 30 cm. objective gives an image on the screen, regardless of its distance, which will appear to the observer standing by the lantern, like the same lantern slide held 30 cm. (12 in.) in front of the observer's eyes. If the lantern slide is well made and properly proportioned all the

details should be plainly visible when the slide is 30 cm. in front of the eyes, and therefore are plainly visible in the screen image as far back as the lantern.

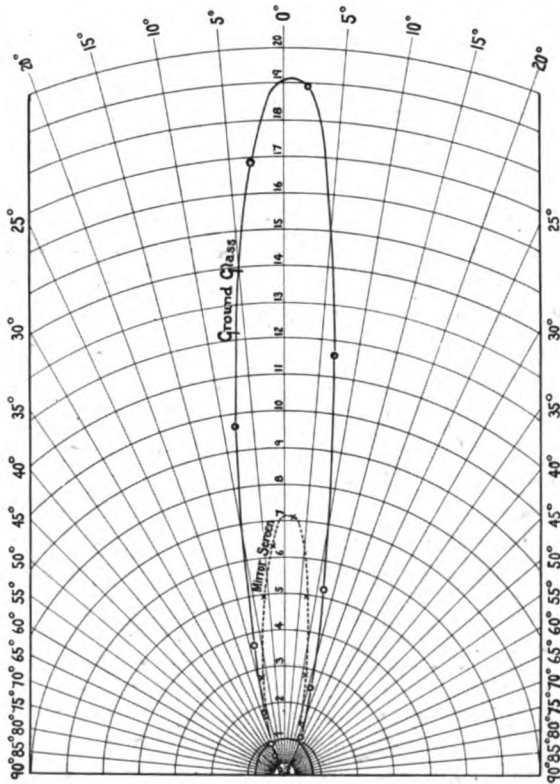

FIG. 250. DISTRIBUTION OF BRIGHTNESS OF TRANSLUCENT AND REFLECTING SCREENS WHEN SEEN FROM DIFFERENT DIRECTIONS
 Reflected Light from Magnesium Oxide and Mirror Screen.
 Light Transmitted through Ground Glass.

Note that the mirror screen when seen perpendicularly reflects 7 times as much light as does magnesium oxide, and ground-glass 19 times as much. But this great brightness of the mirror screen and the ground-glass is limited to a very narrow angle, while the white magnesium oxide reflects nearly equally throughout the entire hemisphere.
 Brightness of MgO is taken as unity and the figures on the radius indicate the number of times brighter the screen appears than this.

If the letters and numerals and other details on the slide are too small to be seen by the normal eye when held 30 cm. (12 in.) away, then they will not show clearly in the screen image with this objective at the back of the room, although they may be plainly visible to those near the screen.

As the lantern is frequently not quite at the extreme back of the room, an objective of 25 cm. (10 in.) focus is more commonly used than the one of 30 cm. (12 in.). It makes the image somewhat larger, and for many people is more satisfactory.

§ 636. **Objective to use when the lantern is not at the back of the room.**—Regardless of the position of the lantern a screen image must be large enough for all in the room to see the details as stated above (§ 633-634).

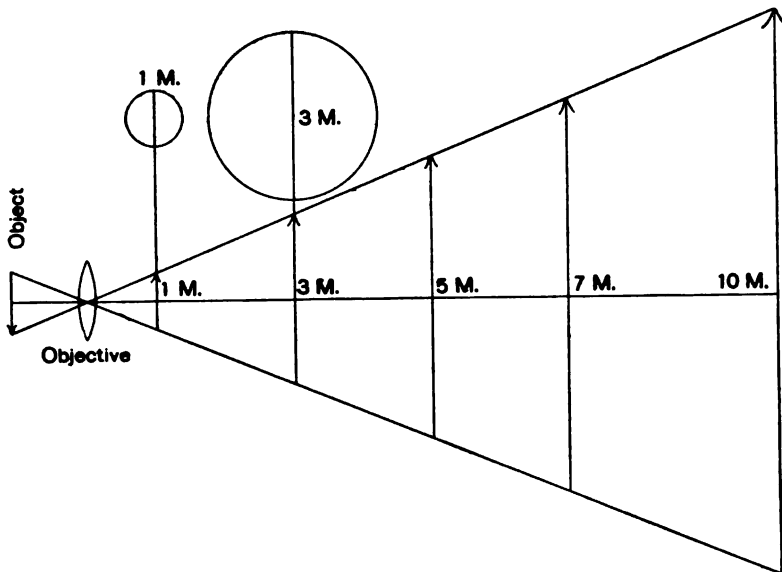

FIG. 251. SIZES OF SCREENS NECESSARY FOR DIFFERENT SCREEN DISTANCES.

This shows that the same object and objective will give a screen image of a size directly proportional to the screen distance.

If the lantern cannot be at the back of the room, but must be closer to the screen, then the projection objective must be of shorter focus than 25 to 30 cm. (10-12 in.).

To determine the proper objective to use to give the desired size of image in any case one must proceed as follows:

(1) The size of screen image is decided on by remembering that it should be between one-fourth and one-fifth the distance to the farthest seat in the room.

(2) The distance from the screen to the lantern must be measured.

(3) Following the simple optical law founded on the geometry of similar triangles that: "The size of object and image vary directly as their distance from the center of the objective," one can by simple proportion get the focus which the objective should have for a given screen image.

§ 637. Examples.—For example, suppose the distance from the screen to the farthest seat is 20 meters (66 ft.), the width of the screen should be not less than one-fourth this distance, i. e., five meters (16.5 ft.).

Now suppose that instead of the lantern being 20 meters from the screen it is only 11 meters (36 ft.) from it, what should be the focus of the projection objective to give a screen image 5 meters (16.5 ft.) wide?

The formula best adapted for this calculation is:

$$\frac{f}{o} = \frac{d}{i}$$

where f is the distance of the object from the center of the objective (focus of the objective).

o is the size of the object.

d is the distance from the objective to the screen.

i is the size of the screen image.

It is assumed in all the calculations for the magic lantern that the width of the lantern-slide opening or picture is 7.5 cm. or 3 inches.

In the above example

f is unknown.

o the size of the object is 7.5 cm. 3 in.
 d the distance of the screen image is 11 meters 36 ft.
 i the size of the screen image is 5 meters 16.5 ft.

Substituting the values in the formula we have, for metric values,

$$\frac{f}{7.5} = \frac{11}{5} \text{ or } f = \frac{7.5 \times 11}{5} = 16.5 \text{ cm., focus of the objective.}$$

For English values

$$\frac{f}{3} = \frac{36}{16.5} \text{ or } f = \frac{3 \times 36}{16.5} = 6.5 \text{ in., focus of the objective.}$$

§ 638. **Size of screen image for moving pictures.**—As the scenes depicted by the moving picture are so largely of human action, and thus resemble a theater play, one would think that the standard should be the representation of people in their natural size. The fact is, however, that in most picture theaters the people represented are of heroic or semi-heroic size, being from $1\frac{1}{2}$ to two times the natural size of ordinary people.

The large size of the moving picture on the screen has come about naturally, as the details of movement and the facial expression of

§ 636a–637a. In the formula here given it is assumed that the objective will always be at its principal focal distance from the object regardless of the screen distance. This is not strictly true, but as the screen distance is so great relatively to the distance of the objective from the object, the slight error involved in the above assumption is negligible. If the screen distance and the principal focal distance were more nearly the same, the error would be altogether too great to be neglected (see fig. 210).

It follows, naturally also, from this formula that, if any three of the elements are given, the fourth can be found. Ordinarily, it is the proper focus of the objective to use that is unknown, but any one of the elements might be desired, and it can be found if one knows three of them.

As it is the focal length of the objective that is most often required, the following may be of assistance; it simply states in words what the formula shows:

To find the focal length of the objective needed, the screen distance and the size of the screen image being known: Multiply the screen distance in meters by 7.5, and divide the product by the size of the screen image in meters and the result will give the focus of the objective in centimeters. For English measure: Multiply the screen distance in feet by 3 and divide the product by the size of the screen image in feet, and the result will give the focus of the objective in inches.

the actors could not be seen if they were only of the size of average human beings. On the theater stage the action is made more intelligible by the spoken words; but where there is only pantomime one must see the details of the action and the facial expression to make the play fully intelligible.

To enable those seated in the extreme rear seats to see the action on the screen without getting the picture too large for those on the front seats, the width of the picture should be between $\frac{1}{6}$ to $\frac{1}{4}$ of the distance of the farthest seat to the screen. The width of $\frac{1}{6}$ is on the whole the most satisfactory if the end of the room is large enough to permit a screen of this size.

§ 639. The size of the screen limited by the room.—It sometimes happens that the size of the screen which can be used is limited by the size of the wall on which it can be placed. The size of the screen may also be limited by the height of the ceiling above, and the heads of the spectators below. This is true of some lecture halls, and of many of the moving picture theaters which are remodeled store buildings. If the screen image is limited in size by any of these factors thus requiring a smaller picture than that having a width of $\frac{1}{4}$ th the distance from the screen to the farthest seat for the magic lantern or $\frac{1}{6}$ th the distance for a moving picture, it is necessary to use an objective of longer focus accordingly.

If the width is limited and one can use any height desired, the calculation is made exactly as in the previous section.

If the height is limited, then the calculation is made in the same way except that the height of the object instead of its width is taken; that is, for lantern slides the extreme opening of the mat is taken as 7 cm. ($2\frac{3}{4}$ in.), or for moving pictures 23.08 mm. long, 17.3 mm. high, $2\frac{9}{32}$ in. \times $8\frac{7}{128}$ in. (see § 570a).

For example, in a university lecture room the greatest height of the screen which could be used was 2.9 meters (9.5 ft.), and the room was 14.3 meters (47 ft.) long. The question was: What focus of objective would give this size of screen image with the lantern at the back of the room?

In this example

- f is unknown, (i. e., the focus of the objective).
- o the height of the object is 7 cm. ($2\frac{3}{4}$ in.).
- d the distance of the screen is 14.3 meters (47 ft.).
- i the size of the image is 2.9 meters (9.5 ft.).

Substituting the values in the formula we have:

For metric values:

$$\frac{f}{7} = \frac{14.3}{2.9} \text{ or } f = \frac{7 \times 14.3}{2.9} = 34.5 \text{ cm., focus of the objective.}$$

For English values:

$$\frac{f}{2.75} = \frac{47}{9.5} \text{ or } f = \frac{2.75 \times 47}{9.5} = 13.6 \text{ in., focus of the objective.}$$

An objective of 13.6 in. or 34.5 cm. would have to be specially constructed. Those on the market and easily procurable were of 30 cm. (12 in.) and 38 cm. (15 in.). The shorter focus objective gave considerably too large a screen image and could not be used, therefore the one of longer focus was taken, and a correspondingly long focus condensing lens used.

Second example. In another lecture room the lantern must be 16.75 meters from the screen and the screen could not exceed 3.35 meters in width, what should be the focus of the objective and the second element of the condenser to meet these conditions?

Applying the formula:

$$\frac{f}{7.5} = \frac{16.75}{3.35} \text{ whence } f = 37.5 \text{ cm. the focus of the objective needed.}$$

In English measure:

$$\frac{f}{3} = \frac{55}{11} \text{ whence } f = 15 \text{ in. That is, a 15 inch objective is demanded.}$$

§ 640. Size of screen and screen images for micro-projection.

—Here the law holds, that to be satisfactory, the details to be shown must be large enough so that they can be seen with ease. The microscopic specimens vary so greatly in character that no

general rule can be given for the size of screen necessary. For large halls the screen used for the magic lantern usually answers. In small rooms for special demonstrations it is advantageous to have a movable screen on a stand that can be varied in distance for different conditions. The magnification and the objective necessary for the same must be determined in each case by the lecturer before the lecture or demonstration (see § 400, Ch. IX.)

§ 641. Troubles with Rooms and Screens:

1. Poor image on the screen. This may be due to
 - (a) Insufficient light from the radiant;
 - (b) Too much light in the room;
 - (c) A poor screen—dirty or thin;
 - (d) If an approximately square room is used, then the mirror and other metallic screens will appear very dark and unsatisfactory for the spectators outside of an angle of greater than 15 to 20 degrees from the axis, and the farther outside the 15 degree position the darker will appear the screen image (fig. 247).
 - (e) The objective and second element of the condenser may be improperly proportioned, i. e., focal lengths too different (§ 89-90).
2. Oppressive in the room. Too little fresh air.
3. Room lights shining in the eyes of the spectators. Not properly placed or shaded.
4. Distorted image. The screen and the axial ray from the projection apparatus not at right angles.
5. The details of the picture not visible for the spectators on the back seats. The objective is of too long a focus and it does not magnify enough. Use a shorter focus objective.
6. The screen picture altogether too large. Too short a focus objective; use one of longer focus, and adapt the condenser to it.
7. There is a glare in the room from the ceiling or walls or both. The paint used in finishing is shiny, not dull and flat. Use more turpentine and less oil in the paint.
8. The room too dark. Use more room lights properly placed and shaded.

§ 642. Summary of Chapter XII:

- | Do | Do Not |
|--|--|
| 1. Use a room properly equipped for projection if good results are expected (§ 602). | 1. Do not expect good projection in a room not equipped for it. |
| 2. Use light-absorbing tints for tinting and decorating the projection room (§ 604). | 2. Do not use light-reflecting colors like yellow, white, light red or green for decorating the projection room; but the dark, rich, light-absorbing colors, dark red, brown, etc. |
| 3. Make all paints dull or flat, never shiny, for a projection room. | 3. Do not use paint that gives a shiny or enamel surface, for this will produce a glare by the reflections. Use flat paint. |
| 4. Light the projection room sufficiently, so that the spectators can find their seats without trouble (§ 605). | 4. Do not have the projection room darker than necessary. |
| 5. A perfectly darkened room is only necessary for special projection (§ 608). | 5. Do not attempt the most difficult projection unless the room can be made perfectly black. |
| 6. Lamps for general lighting should be shaded or so arranged that their light cannot shine directly in the eyes of the spectators or upon the image screen (§ 606). | 6. Do not use unshaded lamps for the general lighting. Light shining directly in the eyes of the spectators is very distressing. |
| 7. Have red lights near all exits (§ 607). | 7. Do not fail to have red lights by the exits. |
| 8. Take the necessary precautions to prevent light entering the room at the edges of the window shades (§ 611). | 8. Do not leave the window shades without protection at the margins. |

9. If possible place the projection apparatus at the back of the room (§ 612).

10. The axial ray of the image beam should strike the screen at right angles (§ 614).

11. Incline the screen if necessary (§ 614).

12. Light the black-board by lights behind a curved, metal shield (fig. 240).

13. If a translucent screen is used the objects must be put into the apparatus with the picture facing the objective (§ 516).

14. Use a good screen (§ 621).

15. If you use a mirror or metallic screen remember that it does not reflect equally throughout the 180 degrees (§ 629).

16. Make the screen image large enough so that the most distant spectator can see the details (§ 633, 639).

9. Do not place the projection apparatus in the middle of the room if it can be avoided.

10. Do not let the axial ray strike the screen obliquely.

11. Do not incline the screen unless necessary.

12. Do not try to use the blackboard without lighting it by hidden lights.

13. Do not forget the rules for erect images when using a translucent screen.

14. Do not use a dirty screen. Wash it or give it a fresh coat of white paint.

15. Do not use a mirror or metal faced screen in a square room; such screens are not good for the fine details necessary in micro-projection (§ 360).

16. Do not have the screen image too small nor too large.

CHAPTER XIII

ELECTRIC CURRENTS AND THEIR MEASUREMENT; ARC LAMPS, THEIR WIRING AND CONTROL; CANDLE-POWER OF ARC LAMPS FOR PROJECTION

§ 650. Apparatus and Material for Chapter XIII:

Direct and alternating current; Voltmeter, ammeter and wattmeter for direct and alternating currents; Shunt generator, motor-generator set, mercury arc rectifier; Polarity indicators; Arc lamp; Rheostat, inductor, transformer and other ballast; Carbons; Water-cell; Insulated wires, flexible cables, insulators, switches, separable plugs, caps, etc.; Fuses and circuit breakers; Wire, iron plates, etc., for home-made rheostats.

§ 651. Historical development of electric lighting.—See the Appendix.

ELECTRIC CURRENTS: KINDS AND COMPARISON

§ 652. Direct current.—The earliest electric currents studied and experimented with were produced by the voltaic cell. These currents have a constant polarity, always flowing in the same direction.

A direct electric current may be produced by a voltaic battery, or by a dynamo (§ 652a).

The first installations of electric plants were all for direct current, now they are mostly for alternating current (see below).

The principal use of direct current at present is for trolley cars, and other apparatus where variable speed motors are necessary; in electrolysis such as charging storage batteries and the decomposition of chemical compounds; for electric lighting in some of the more densely populated cities and for projection purposes.

§ 652a. Generator, Dynamo.—Generator is a comprehensive term including all means of producing electric currents whether these means be chemical or mechanical.

Dynamo, on the other hand, is a special term denoting a generator by which mechanical is transformed into electrical energy; for example, a steam engine may give motion to the dynamo and thus produce an electric current. In a word, a dynamo is a generator of electricity, but all generators of electricity are not dynamos.

§ 653. **Alternating current.**—This is characterized by flowing first in one direction and then in the opposite direction; the polarity is therefore constantly changing. (See § 676).

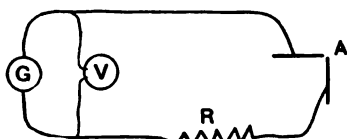

FIG. 252. CONNECTIONS OF A VOLT-METER TO MEASURE THE LINE VOLTAGE.

G Dynamo.
V Voltmeter.
A Arc Lamp.
R Rheostat.

Note that the terminals of the voltmeter are connected to the two points between which it is desired to measure the potential difference. In this case it is the main supply (across the line).

up or down in voltage by stationary transformers. This makes it possible to raise it to a very high voltage (1000 to 100,000 volts) for transmission to a distance over wires of moderate size. It is then stepped down in voltage before it is used. In this process of stepping up or down in voltage the amperage takes the reverse direction, so that the product of the volts by the amperes is a constant quantity.

The disadvantages of alternating current for the arc lamp are:

1. The arc is not as bright as with the same amperage of direct current.
2. The light is intermittent.
3. The alternating current arc is noisy.

ELECTRIC UNITS AND THEIR MEASUREMENT

§ 654. **Electric Units.**—For the purposes of this book it is necessary to refer frequently to electric units, like the *volt*, the *ampere*, the *ohm* and the *watt*; it seems proper therefore to give a brief discussion of these units.

DIRECT CURRENT UNITS

§ 655. **The Volt.**—This is the unit of electromotive force, that is the electric force or pressure necessary to produce one ampere of current in a circuit with a resistance of one ohm.

The difference of potential between the two poles of a Weston standard cadmium cell is 1.019 volts. The ordinary battery used for ringing door bells has approximately one volt pressure.

Voltage is a general term representing the pressure in volts in an electric circuit.

If the difference of pressure between the two given points is great, then the voltage is said to be high; if the difference is slight, then the voltage is low. For example, in projection one might use 55 volts for the arc lamp, or 220 volts, or 500 volts. Ordinarily neither the low voltage of 55 nor the high voltage of 500 or 220 is used, but an intermediate voltage of 110.

§ 656. **The Ampere.**—This is the unit of current. It is the current which will deposit .001118 gram of metallic silver per second from a 15% solution of silver nitrate in water. It is the current which one volt will maintain in a circuit with one ohm resistance (see below).

Amperage is the term by which is designated the amount of current in amperes flowing at any given moment. If a large amount of current is flowing the amperage is said to be high or great, if a small amount, then it is said to be low or small. For example, in projection, the amperage needed for drawing with the microscope on the house circuit (§ 493) is small (3-6 amperes), while for opaque projection (§ 289), and for moving pictures (§ 693) in large halls the amount of amperage needed is great (20 to 100 amperes).

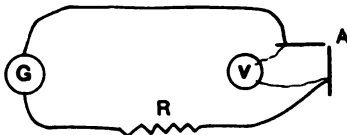

FIG. 253. CONNECTIONS OF A VOLT-METER TO MEASURE THE ARC VOLTAGE.

- G Dynamo.
- V Voltmeter.
- A Arc lamp.
- R Rheostat.

Note that the terminals of the voltmeter are connected to the two points between which it is desired to measure the potential difference. In this case it is the two carbons (across the arc).

§ 657. **The Ohm.**—This is the unit of resistance to the flow of an electric current. It is represented by the resistance, at zero centigrade, of a column of mercury 106.3 centimeters long, of uniform cross sectional area, and weighing 14.4521 grams. Such a column of mercury will have a cross sectional area of one square mm.

Ohmage is a term analogous with voltage and amperage. It is used to designate the amount of resistance in ohms of an electric circuit.

A conductor may have little resistance, as copper, etc., or it may have great resistance like German silver. Naturally then copper wire is used largely for electric circuits, and German silver wire for making resistors or rheostats (§ 724a).

§ 658. **The Watt.**—This is the unit of activity and is the rate at which work can be done by a current of one ampere under a pressure of one volt. One watt means the doing of work at the rate of 10^7 ergs per second, or one joule per second. This is approximately equal to the lifting of 1 kilogram, 10 centimeters every second.

§ 659. **Kilowatt.**—A kilowatt is 1,000 watts. This term is more common than watt. It is equal to 1.34 horse power.

§ 660. **The watts which any direct current represents** are obtained by multiplying the quantity of current flowing by the pressure—that is, the amperes by the volts. Thus, if there were an amperage of one and a voltage of one, there would be an activity of one watt. If the voltage were 10 and the amperage 100, or the voltage 100 and the amperage 10, there would be an activity of 1,000 watts, or one kilowatt.

§ 661. **Kilowatt-hour.**—This is the unit of electrical energy or work, which is in commercial use and which is used as a basis for making the charges to consumers. A kilowatt-hour is the work represented by one kilowatt when acting for one hour.

In order to find the amount of work done by an electric current it is necessary not only to know the rate at which the work is being done but also the time during which this rate is continued. Thus,

take the example of an arc lamp which uses 20 amperes direct current from a 110 volt line. The line then supplies $20 \times 110 = 2,200$ watts or 2.2 kilowatts. If this arc were used for only a few minutes, the energy supplied would be comparatively small, but if the arc were used all day, the energy supplied and hence the coal or other fuel consumed in generating this power would be comparatively large. In order to measure this energy, the power measured in kilowatts is multiplied by the time the power is used. In the above example, if the arc were run for eight hours the electrical energy used would be $2.2 \times 8 = 17.6$ kilowatt-hours.

ELECTRIC MEASUREMENTS: VOLTMETERS, AMMETERS, WATTMETERS FOR DIRECT CURRENT

§ 662. Voltmeter for direct current.—This is an instrument for measuring in volts the difference of potential between two points of an electric circuit.

The voltmeter must be adapted to the kind of current—direct or alternating—and for the pressure, low voltage or high voltage. It consists of a delicate galvanometer of exactly the same type as that for an ammeter, but it has a high resistance in series with it. This high resistance allows but a small current to flow through the galvanometer; and this small current is proportional to the difference of pressure or voltage between the binding posts of the voltmeter, and causes the needle of the voltmeter to be deflected. Numbers on the dial indicate the voltage for different amounts of the deflection.

§ 663. Connection of the voltmeter with the circuit to be measured.—One pole of the voltmeter is positive and one negative. To connect the instrument with the circuit for determining the voltage between two points, the positive binding post of the voltmeter is connected by a wire to the positive point in the circuit, and the negative binding post with the negative point in the circuit (fig. 272). This gives the full electric pressure between the two points connected with the voltmeter, although only a very small current flows through it on account of its high resistance. The

main current continues to flow in the electric circuit between the two points exactly as though the voltmeter were not in use.

The voltmeter should not be connected in series with the line as with the ammeter (§ 665). While no particular harm might be done, the high resistance of the voltmeter would allow only a small current to flow in the line and if one were using an arc lamp it would go out from the insufficient current.

If one does not know the direction of the flow in the circuit to be tested, the voltmeter can be correctly connected by trial as follows: Connect the positive binding post of the voltmeter by a wire to one of the points, and the negative binding post by a wire to the other point. Turn on the current, and if the connection is right the needle of the instrument will point to the voltage; if the connection is wrong the needle will tend to be deflected off the scale below the zero point. If it is wrong, turn off the current and reverse the position of the wires in the binding posts.

§ 664. **Ammeter.**—This is an instrument to show the amount of current flowing through a given circuit at a given instant. It consists of a galvanometer of the particular type adapted to the current used, that is, direct or alternating current. It is also adapted to the amount of current to be measured, that is small currents and large currents, say from 0 to 10, 0 to 25, 0 to 50, 0 to 100, etc.

The galvanometer part of the ammeter is a delicate instrument so that the whole current used in projection is not sent through it, but a definite fractional part goes through it and

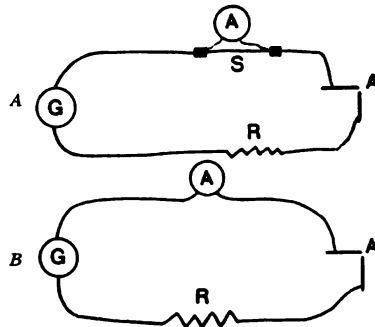

FIG. 254. CONNECTING AN AMMETER IN THE LINE TO MEASURE THE CURRENT FLOWING.

a Ammeter, *A*, with external shunt, *S*.

b Ammeter with self-contained shunt. The shunt in this type is inside of the instrument case.

Note, the ammeter is connected along one wire so that the entire current flows through the instrument and its shunt.

the main part of the current goes through a special wire, known as a shunt (fig. 254).

In some ammeters the galvanometer, and the shunt are in the same box (self-contained ammeters), in others the shunt is outside (fig. 254).

When an electric current flows through the ammeter, the galvanometer needle is deflected, the amount of the deflection measuring the amount of the current. With the ammeters used in projection, the galvanometer has been calibrated so that the needle points to the number of amperes of current flowing in a given case (fig. 145).

§ 665. Connection of the ammeter with the projection circuit.—

If one is to use an ammeter in an electric circuit, the instrument is connected with the line in series, that is along one wire. Furthermore, it is necessary to connect the positive pole of the ammeter with the positive end of the wire, and the negative end with the negative pole. In most cases when installing a projection outfit the direction of the current flow is not known, and the proper connection of the apparatus is found by trial (see § 702 for the direct current arc lamp).

To install an ammeter cut one of the wires, and insert one cut end in the positive, and the other cut end in the negative binding post of the ammeter. Then the arc lamp and the rheostat are wired as shown in fig. 270.

Now close the switch and cause the arc lamp to burn. If the ammeter is correctly connected, the needle will point to the number of amperes of current flowing. If the connection is wrong, then the needle will tend to move off the scale below the zero mark. In case the connection is wrong, open the switch and reverse the positions of the wires in the binding posts of the ammeter. When the current is turned on again the needle will be deflected until it points to the number of amperes.

By looking at fig. 273 it will be readily seen why one of the cut ends of the same wire will be positive and why one will be negative. That is, if the whole circuit is considered from the dynamo back to the dynamo, it will be seen that starting from the positive pole of

the dynamo, any point in the circuit toward or nearer this positive pole will be positive in comparison with any other point nearer the negative pole. Then if the circuit is cut at any point the end of the wire next the positive pole of the dynamo will be positive, and the end nearer the negative pole of the dynamo will be negative. Now if the cut end of the wire nearer the positive pole of the dynamo is inserted in the negative binding post of the ammeter, and the other end in the other binding post, the needle tends to be deflected in the wrong direction. If the two ends of the wire are correctly connected with the ammeter, the needle will be deflected in the right direction, and indicate the amperage.

§ 666. **Ammeter for projection.**—In projection the ammeter is usually all that is required, for the voltage on a given line is nearly constant, and can be found easily by inquiring of the central station. On the other hand, the required amount of current for different purposes varies greatly and the factors in the production of a good image are so many that an ammeter to show at a glance what amount of current is flowing is of the highest importance, for with a given amount of current the operator knows at once what kind of a light can be reasonably expected in the different cases. If the screen light is not good with the adequate amperage for the purpose then he can look to the other possible causes of failure (see § 61-96).

If one is to be able to determine for himself all the electric factors in projection work, then a voltmeter and a wattmeter should be added to his apparatus.

§ 667. **Precautions for the ammeter.**—In connecting the ammeter be sure not to connect the ammeter directly to both line wires. As the ammeter has very little resistance, putting it across the line would have practically the same effect as connecting the two points with a heavy wire, that is a short circuit would be formed and the fuses would be blown. Besides the very heavy current which would flow momentarily might be sufficient to seriously damage the delicate instrument.

§ 668. **Safe rules for the beginner to follow when connecting instruments may be stated as follows:**

For the voltmeter.—After all the connections for the circuit are complete, connect the two terminals of the voltmeter to any two parts of the line between which it is desired to measure the difference of potential.

For the ammeter.—After all the connections for the circuit are complete, and after the arc has been found to work satisfactorily, cut one of the wires and insert the self-containing ammeter in between the two cut ends just as if it were a short piece of heavy wire. If there is an outside shunt connect the ends of the supply wire to the large binding posts of the shunt and the wires of the ammeter to the smaller binding posts of the shunt.

§ 669. **The Wattmeter.**—This is an instrument for measuring electrical power or activity. There are two types of wattmeter—the portable or indicating wattmeter and the integrating or supply wattmeter. Both work on the same principle, but the method of indication is different.

The wattmeter has two sets of terminals or binding posts. One set is connected with the line in series—along one wire—like an ammeter, while the other set is connected in multiple—that is, to both lead wires—like a voltmeter. In fact this instrument is a

sort of a combination voltmeter and ammeter, as it measures the product of the volts times the amperes.

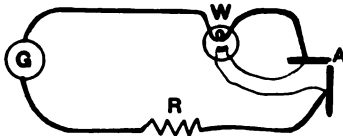

FIG. 255. WATTMETER TO MEASURE THE POWER CONSUMED AT THE ARC.

- G Dynamo.
- W Wattmeter.
- A Arc.
- R Rheostat.

The heavy line wire passes to the wattmeter and from it to the upper carbon. From the lower carbon the heavy wire passes to the rheostat and back to the dynamo. The fine wire passes from the upper carbon to the wattmeter, and from the wattmeter to the lower carbon. With this connection of the wires the power consumed at the arc is measured.

In connecting the wattmeter great care must be taken to get the sets of binding posts correctly joined with the line. That is the binding posts for the current terminals of the wattmeter must be connected in series or along one wire like the ammeter (fig. 273) while the voltage binding posts must be connected in parallel or across the line, like a voltmeter (fig. 272).

If the wattmeter were wrongly connected, the instrument could not register the watts on the one hand and on the other it might be injured.

§ 670. **Portable wattmeter.**—This has a pointer which shows directly in watts, the power consumed at a given instant.

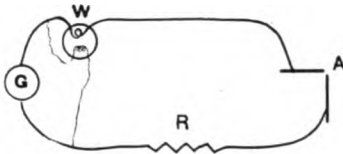

FIG. 256. WATTMETER TO MEASURE THE POWER DELIVERED BY THE DYNAMO.

G Dynamo.
W Wattmeter.
A Arc lamp.
R Rheostat.

The fine wire connects the wattmeter with the line where the power is to be measured.

toward which the pointers are directed indicate the kilowatt-hours which have been used, just as the pointers in a gas meter indicate the number of cubic feet of gas which have been used. For example, by consulting the wattmeter before and after an exhibition one can see how much work, measured in kilowatt-hours, has been consumed by the arc light.

Suppose the voltage of the line were 110, and the voltage between the carbons is 55 volts. Suppose the amperage is 20, then the watts should be (volts times amperes) $55 \times 20 = 1100$ watts at any instant, and for an hour, for example, it would be 1100 watt hours, or 1.100 kilowatt-hours.

§ 671a. With both direct and alternating current, when a rheostat is in the circuit, the amperage may be found by the aid of the stationary wattmeter, this is always present in a house supply of electricity, as is the gas meter for the gas supply, and one does not always possess an ammeter.

It is necessary to know the voltage of the line. This is usually 110 or 220. One must also know the watts, or kilowatts at any given instant. This can be found by the wattmeter as follows: Suppose the reading is 1.87 kilowatt-hours. As this number was obtained by multiplying volts \times amperes \times time, and the time is one hour, then the kilowatts of power consumed is 1.87. The

§ 671. **Stationary or house wattmeter.**—The wattmeter for the electric supply looks something like a gas meter for the gas supply. It is of the integrating type, is permanently connected with the line, and contains a wheel, the speed of whose rotation is directly proportional to the power consumed. This wheel turns pointers over the dials on which are indicated kilowatt-hours. The numbers

UNITS AND THEIR MEASUREMENT WITH ALTERNATING CURRENT

With alternating current there is, strictly speaking, no such thing as voltage and amperage as the electric potential is varying from instant to instant. Consequently a kind of average value of the electric pressure and amount of current is used instead.

§ 672. Alternating current voltage.—When alternating current is measured, the voltage indicated on the voltmeter is the mean effective voltage.

In order that this average effective value for a volt shall correspond as nearly as possible to the analogous value with direct current, the value taken is the square root of the average of the squares of the instantaneous values of the potential difference during an entire cycle. Or briefly, it is the root mean squares of the instantaneous pressure.

§ 673. Alternating current amperage.—The number of amperes indicated on an ammeter when using alternating current represents the mean effective amperage. The average effective value of the ampere is, as with the volt, the square root of the average of the squares of the instantaneous values of the current during an entire cycle.

voltage with a rheostat is the line voltage. Now as the kilowatts are the product of voltage by amperage divided by 1,000 and both the voltage and the kilowatts are known the amperage can be found by multiplying the kilowatts by 1,000 to reduce them to watts, and dividing the watts by the voltage = 110. $1870 \div 110 = 17$ amps. With alternating current, if an inductor (choke-coil) is used for regulating the current, the wattmeter can also be utilized for determining the amperage at the arc, for by experiment it is known that no matter what the line voltage is, the voltage across the arc is usually about 34 volts. The fall of potential across the inductor does not count. The wattmeter only records the power consumed by the lamp. The amperage, assuming the same number of watts as in the above example, would be found this: $1870 \div 34 = 55$ amperes. That is, with an inductor in place of a rheostat one could use several times the amount of current and use only the same number of kilowatts of power. As it is the power consumed that must be paid for, one can appreciate the saving by using an inductor or choke-coil rather than a rheostat.

The two cases just given are the only ones in which the wattmeter can be used to find the amperage. If a current-saver, transformer, rectifier, or other similar device is used in the circuit the amperage in the arc cannot be determined by the wattmeter, one must use an ammeter of the proper type for the current.

§ 674. **Watts with alternating current.**—With alternating as with direct current, the instantaneous watts are equal to the product of the instantaneous volts by the instantaneous amperes.

As the voltage and amperage with alternating current vary from instant to instant over the entire cycle, it follows that the instantaneous watts must also vary from instant to instant. To obtain the average watts over an entire cycle, the arithmetical mean of the instantaneous watts is taken. This average of the watts may be anything between zero and the product of the mean effective volts times the mean effective amperes, depending on the character of the circuit, i. e., whether the circuit contains resistance only or whether it contains both resistance and inductance.

§ 675. **Power factor.**—When alternating current is used with inductance in the circuit as described in § 736 (where an inductor or choke-coil is put in series with the arc) the power transformed into heat or work, and hence which must be supplied to the dynamo by coal or other fuel is less than the product of the mean effective volts by the mean effective amperes. This is because most of the energy required to magnetize the iron core of the inductor when the current is increasing is returned to the line when the current is decreasing. In the case mentioned the line voltage was 110; at the arc the voltage was 34, and 55 amperes were drawn. The power consumption at the arc, which is unable to return any absorbed energy to the line, is the product of the volts by the amperes, i. e., $34 \times 55 = 1,870$ watts. In this case the power factor is unity. In the case of the entire circuit, however, by multiplying the line voltage by the amperage, i. e., 110×55 we get 6050. A wattmeter would register only the 1870 watts consumed at the arc. The power factor is the value by which we must multiply the product of volts \times amperes in order to get watts. Thus, if we multiply 6050 by .31 we get 1870. The power factor is of course obtained in practice by dividing the watts by the product of volts by amperes, i. e., $P. F. = \text{Watts} \div \text{Volts} \times \text{Amperes}$; and $\text{Watts} = \text{Volts} \times \text{Amperes} \times \text{Power factor}$. Nothing comparable to this effect is possible with direct current, that is, with direct current the power factor is always unity.

§ 676. **Cycle.**—With alternating current where the current flows first in one direction and then in another with a change in polarity for each reversal, a cycle includes a change in polarity to the opposite, and back to the starting point. That is, a cycle includes flow in two directions and consequently includes two polarities; and this is repeated over and over again.

§ 677. **Frequency.**—The number of cycles per second with an alternating current is called its frequency. The frequencies in most common use are: 25 cycles, 60 cycles and 135 cycles per second. The 60 cycle frequency is most generally used for lighting circuits and the 25 cycle frequency is mostly employed for long distance transmission, and frequently for motors. The 130 or 135 cycle frequency is now uncommon.

SPECIAL DYNAMO FOR ARC LAMPS

§ 678. The characteristics of the arc are that the potential difference between the electrodes is dependent upon the arc length but not upon the current (see § 743). It is required to supply this arc with a constant current regardless of the differences in arc length. This may be done with a constant potential supply by using a rheostat in series with the arc, or it may be done by using a constant current generator. Since the early days of arc lighting, street arcs have been connected in series and are supplied by a direct current dynamo of this type, no resistance being used. These dynamos have an automatic controlling device which increases the voltage when the current falls slightly below the rated value (6.6 amperes) and which decreases the voltage should the current rise slightly above this value. For street lighting this regulation must be very close, but for projection purposes the regulation need be only approximate. There are some types of dynamos which have the proper characteristics to be connected directly to an arc lamp without intervening resistance. The characteristics of such a dynamo must be that a slight momentary increase in current caused by a lowering in the potential difference at the arc will be met by a decrease in the voltage generated, and conversely a

decrease in current will be met by an increase in the voltage generated.

§ 679. **Shunt generator.**—The connections for a shunt generator or dynamo are shown diagrammatically in fig. 257. A is the revolving armature from which the current is drawn. N and S are the poles of the field magnet and F is the field coil which keeps it strongly magnetized. The stronger the magnetization of this field magnet the higher the voltage furnished by the machine. As usually operated the field rheostat R must be continually adjusted so that the right current is supplied to the field coil F to keep the machine at the desired voltage.

§ 680. **Adaptability of a shunt generator for direct connection to an arc lamp.**—If instead of continually adjusting the rheostat R so that the dynamo will supply a constant potential, the machine is left to itself it will be found that when no current is supplied, i. e., the dynamo is running on no load, the potential difference between the terminals a and b is greatest and consequently the current flowing in the field coil F is greatest. If now current is drawn from the dynamo the potential difference between a and b will drop slightly. This will result in a decrease in the current flowing in the field coil F, a decrease in the magnetization of the field magnets and hence a decrease in the voltage generated. The result is in the direction desired, namely, that an increase in the current will be met by a decrease in the voltage.

Whether or not a shunt generator connected directly to an arc will work satisfactorily, or whether the arc will be unstable and want to either “run away” or “die out” will depend upon the details of the design of the dynamo; that is, the voltage at no load, the resistance of the shunt field coils and the resistance of the armature and also on the resistance of the wiring to the arc. Some dynamos have been designed which will work satisfactorily when connected directly to the arc without any intervening resistance. Such dynamos may be run directly by some form of engine or they may be part of a motor-generator set in which high voltage, direct current or alternating current is used to furnish the power. (See also § 682, 684).

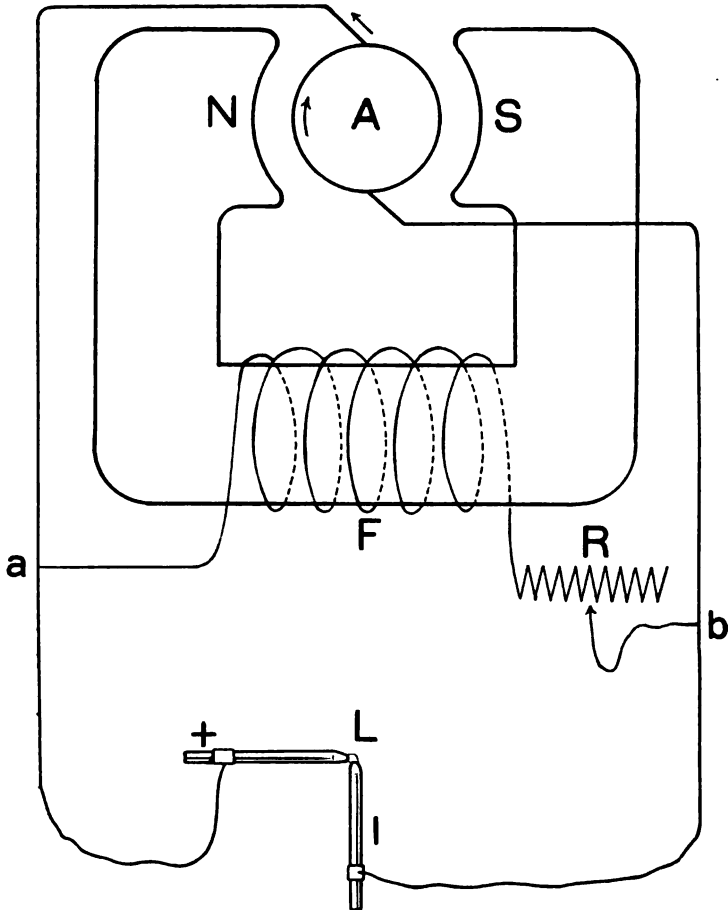

FIG. 257. SHUNT GENERATOR CONNECTED DIRECTLY TO THE ARC LAMP WITHOUT INTERVENING RESISTANCE.

N S Poles of field magnet.

A Armature rotating between the poles of the field magnet.

a and *b* Terminals of the Dynamo.

F Field coil; current through this coil magnetizes the iron of the field magnets.

R Adjustable field rheostat controlling the current flowing through the field coil.

L Arc lamp.

+ and - indicating the polarity of the wires connected to the arc.

This will maintain a uniform current in the arc regardless of its length in case the dynamo is properly designed and proportioned for the purpose.

CURRENT RECTIFIERS

§ 681. While alternating current is more cheaply generated and transmitted, especially if the distance is great, the available light given by the alternating arc is much inferior to that given by a direct current, as can be seen by consulting the table of available candle-powers for different amperages (§ 756). On this account and from the noiseless character of the direct current arc, efforts have been made to utilize alternating current to get direct current.

Up to the present time two methods of doing this for projection purposes have proven themselves successful:



FIG. 258. MOTOR-GENERATOR SET.
(Cut loaned by the General Electric Co.).

The alternating current motor is at the left, the direct current generator is at the right. The two armatures are mounted on the same shaft.

§ 682. **Motor-generator sets.**—This is an indirect way of getting direct current from alternating. It consists of an alternating current motor and a direct current dynamo attached to the same shaft. The alternating current is not converted into direct current but is used to furnish mechanical power which drives the direct current dynamo just as it could be driven by a water-wheel, a gas or other engine.

The efficiency of a motor-generator is about 60%.

If the dynamo is specially designed for the purpose, the arc lamp can be connected directly to it without using a rheostat so that there is no loss from this cause as must be the case when the rheostat is used. (See above § 680).

§ 683. **Mercury arc rectifier.**—This is a method of securing direct current from alternating. It is a utilization of the mercury arc, and gives an efficiency of about 70%. The current is slightly

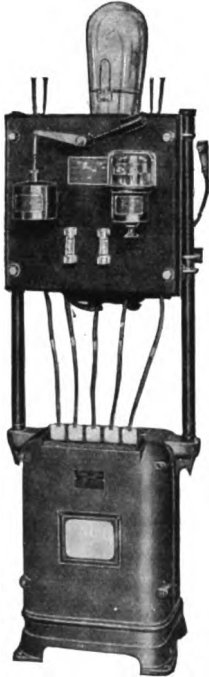

FIG. 259

FIG. 259. MERCURY ARC RECTIFIER, FRONT VIEW.

(Cut loaned by the General Electric Co.).

This size is designed for 30 amperes. It requires 14.5 amperes alternating current at 220 volts or 29 amperes at 110 volts, and delivers 30 amperes direct current at 62 volts. (See tests § 754). It consumes 2600 watts alternating current and delivers 1860 watts direct current which gives 8,600 candle-power with the projection arc.

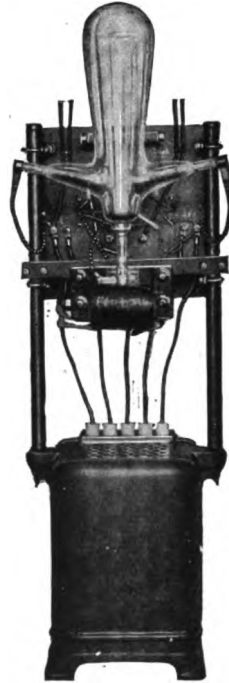

FIG. 260

FIG. 260. MERCURY ARC RECTIFIER, REAR VIEW.

(Cut loaned by the General Electric Co.).

This gives a good view of the rectifier bulb and the inductor directly below the rectifier bulb which serves to limit the current in the arc by acting upon the alternating current primary. The iron case on the floor contains a compensating reactance which serves to smooth out the fluctuations on the rectified current.

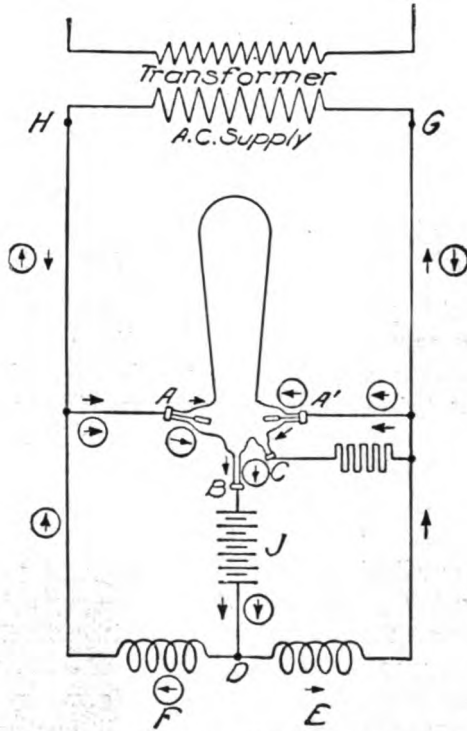

FIG. 261. MERCURY ARC RECTIFIER, DIAGRAM OF CONNECTIONS.
(Cut loaned by the General Electric Co.).

The alternating current supply comes in at the upper part of the transformer. This supplies alternating current at 220 volts (for a 110 volt arc) between the points G and H. The arrows indicate the direction of flow of the current during one-half of the cycle and the arrows enclosed in circles indicate the flow of current during the other half of the cycle. Taking the time when H is the positive pole of the transformer, the current flows down this wire and over to the point A. Here the current flows through the tube to the cathode B, through the battery J (or the arc lamp situated at J) to D. It then flows to the right through E and up to G.

When the current is reversed, current cannot follow this path because between A and B the rectifier tube acts as a valve, as the mercury arc allows current to flow towards B but never away from it, hence the current must flow from G to A' to B through J to D, through the coil F to the left and up to the point H.

The function of the coils E and F is to act as an auto-transformer, for without them current could flow directly from G to H without passing through the rectifier tube. In actual practice both coils E and F are wound on the same iron core.

The small electrode in the bottom of the tube, at *C* is used in starting the tube. In starting, the tube is first rocked making and breaking a mercury contact. A small amount of current flows through between *C* and *B* and starts the arc going, after which it will continue to burn as long as *B* is the cathode, but if the arc is extinguished even for an instant, it will go out and the tube must be tilted again before it will work.

pulsating, but the current is always in one direction and the pulsations are so slight that the crater of the positive carbon remains almost as constant as with the direct current furnished by a motor-generator set.

Both the motor-generator set and the mercury arc rectifier are necessarily expensive. For a small plant to be used much of the time for the arc lamp, and where power is needed for other purposes, like the lighting of the house, pumping water, running machinery, etc., etc., it would be cheaper to install one of the modern forms of engines. The cost of running these is relatively very little, much less than for the current supplied to the rectifier or for the motor-generator set. It is also very easy to care for the modern engine used with the generator.

By adapting the generator set for low voltages (60 volts) it is possible to connect the arc lamp directly without a rheostat, thus saving the energy wasted by heating the rheostat. A rheostat may also be used but if so it is called upon to give very slight reduction in voltage, and therefore uses up but little energy.

PROJECTION WITH 135 CYCLE AND 25 CYCLE CURRENT

§ 684. In most places where alternating current is used for lighting, the supply has a frequency of 60 cycles per second, and in this chapter it has generally been assumed that the alternating current has this frequency. There are, however, places in which the supply has a frequency of 135 cycles per second and there are others, especially small towns in the neighborhood of large hydro-electric plants, in which the supply has a frequency of 25 cycles. The authors of this book have had practically no experience with other frequencies than 60 cycles. We have reason to believe however, that with 135 cycle current the arc will give as good results as with 60 cycles and will perhaps have less tendency to show a flicker,

especially when used with moving picture projection. When 25 cycle current is used directly (is used raw) to supply the arc, the result is very bad. The screen shows a violent flicker. The general appearance is much the same as when a pan of mercury is jarred rapidly, the surface appears covered with ripples. This effect is naturally very trying to the eyes.

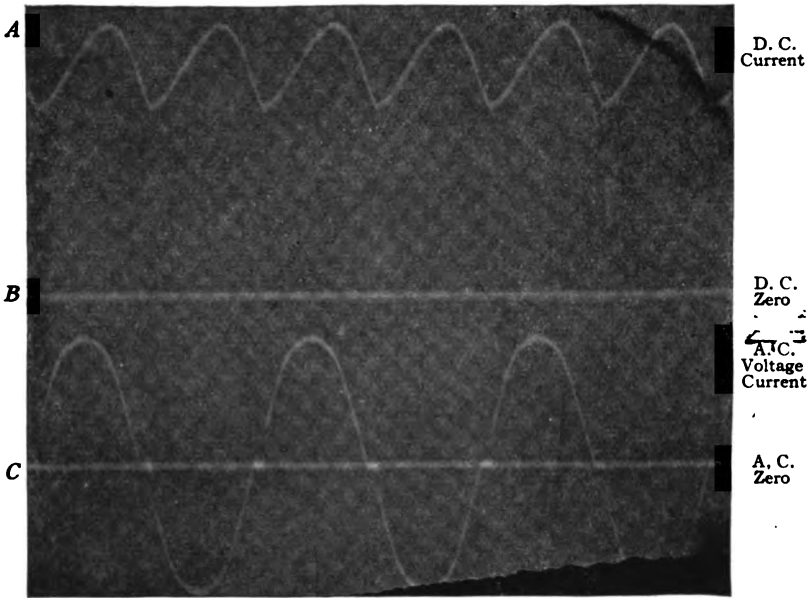

FIG. 262. OSCILLOGRAMS OF THE ALTERNATING CURRENT SUPPLY AND THE DIRECT CURRENT DELIVERED.

(Cut loaned by the General Electric Co.; made from the original photograph).

Curve A The direct current delivered.

B The direct current zero line.

C The alternating current voltage curve and its corresponding zero line.

The height of the curve A above its zero line B represents the instantaneous value of the direct current. Note that while there are slight fluctuations in the current, i. e., it is slightly pulsating, the current is always in the same direction and that these fluctuations amount to only about 30% of the average value. Note also that the maximum current value corresponds to a maximum positive value or to a maximum negative value of the alternating current voltage as shown in curve C given just below.

In order to get good projection when this current supply only is available, a motor-generator set can of course be used, that is, the 25 cycle current is used as power to drive a direct current dynamo (§ 682). The 25 cycle current can be changed to direct current by the use of a rectifier (§ 683). Such current would of course be pulsating although always in the same direction. As the authors have never seen an arc supplied from a rectifier on 25 cycle current we can make no recommendation except to examine one of these machines in actual operation. If the arc should prove sufficiently

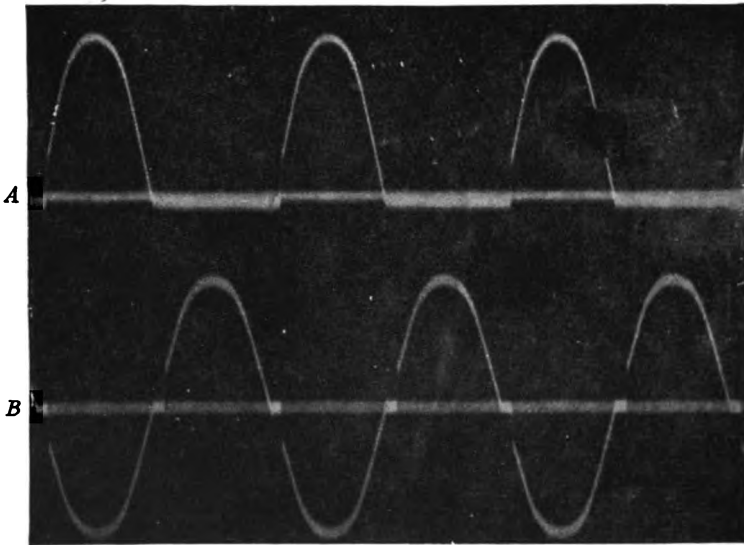

FIG. 263. OSCILLOGRAMS OF THE POTENTIAL DIFFERENCE BETWEEN THE ANODE AND CATHODE, IN RELATION TO THE IMPRESSED ELECTROMOTIVE FORCE.

(Cut loaned by the General Electric Co.; made from the original photograph).

Curve A Potential difference between anode and cathode.

Note that during half of the wave this difference is equal to the full impressed (line) voltage while during the other half wave the potential difference increases until the voltage has reached the constant value of 14 volts. When this occurs current is caused to flow through the arc and is used on the direct current side of the rectifier.

Curve B Impressed electromotive force, i. e., instantaneous value of the line voltage.

free from flicker the rectifier would doubtless answer perfectly in all other particulars. There is no doubt about the motor-generator; it will give perfect direct current for projection.

§ 685. **Need of apparatus designed for the frequency used.**—All alternating current apparatus is designed to work with one frequency only, that is a transformer, for example, if designed for use on 60 cycle current will not work satisfactorily on either 135 or 25 cycles. Hence, in ordering apparatus for alternating current it is necessary to ascertain and specify the frequency as well as the voltage and other particulars of the supply. This information can be furnished by the power company.

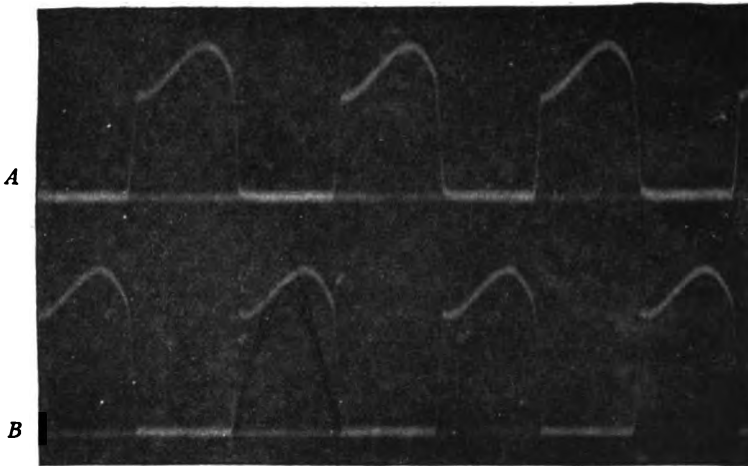

FIG. 264. OSCILLOGRAMS OF THE ANODE CURRENTS.

(Cut loaned by the General Electric Co.; made from the original photograph).

Curve A Portion of the current furnished by one anode.

Curve B Portion of the current furnished by the other anode.

Note that from a single anode, current flows in one direction only, the mercury arc acting as a valve which prevents the current from flowing in the opposite direction. When current ceases in one anode the other anode commences to furnish the current.

WIRING FOR AN ELECTRIC CIRCUIT FROM THE DYNAMO BACK TO
THE DYNAMO

§ 686. For the purposes of projection by the aid of an arc lamp, the electric current required, whether it be direct current or alternating current, is practically always furnished by a dynamo. To make the electricity available there is a conductor of some kind, usually a copper wire extending from one pole of the dynamo to the arc lamp or lamps, and from them back to the other pole of the dynamo. Such a loop of wire from pole to pole of the dynamo forms an electric circuit, regardless of the length of the wire. With direct current, any part of the wire nearer the positive pole of the dynamo is positive to any part of the wire nearer the negative pole of the dynamo, hence the wire extending out from the positive pole of the dynamo is often designated the positive wire, and the wire received into the negative pole of the dynamo is called the negative wire. It will be seen from fig. 275, 280 that the circuit is a loop of wire with the two ends connected with the two poles of the dynamo.

With alternating current, as stated above, there is no constant polarity, hence it is not correct to speak of negative and positive wires or positive and negative poles of the alternating current dynamo.

§ 687. **Amperage for different purposes.**—As the quantity of electricity needed for different purposes varies, the capacity of the generator or dynamo must vary. Also the carrying capacity of conducting wires is in general proportional to their size, hence for large currents it is necessary to have larger wires than for small currents (see the table below § 694).

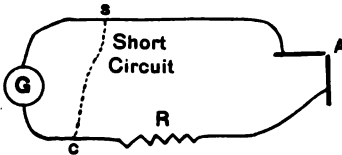

FIG. 265. SHORT CIRCUIT.

G Generator or dynamo.

s c Conductor extending across the circuit making the path back to the dynamo (*G*) shorter than the course through the arc lamp (*A*) and the rheostat (*R*).

If a wire is put across the points *s* and *c* the electricity will take that path instead of the longer path through the arc.

§ 688. **Short circuit.**—By a short circuit is meant the shortening of the distance which the

current must travel to get back to the dynamo. In figure 265 if a wire were put across the circuit at the points *s. c.* instead of the current extending entirely around the circuit, it would take the shorter course. Short circuits are undesirable for two reasons: (1) the current is not available where wanted; (2) it may be dangerous.

§ 689. **Ground.**—With many electric circuits such as with street railway circuits, one terminal of the dynamo is permanently connected with the earth. If now the wire connected to the other

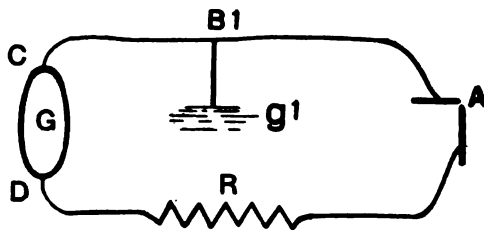

FIG. 266. AN ELECTRIC CIRCUIT WITH A SINGLE GROUND.

- C D* The two poles of the dynamo.
G Generator (dynamo).
B, A conductor extending from the electric circuit to the ground (*g¹*).
 If all the rest of the circuit is insulated this will do no harm, but see fig. 267.
g¹ The earth into which the conductor, *B*, extends.
A Arc lamp.
R Rheostat.

terminal of the dynamo should also become connected with the earth, as through a water or a gas pipe, current would wholly or in part take that path back to the dynamo.

When any part of the circuit is connected with the earth it is called a "ground."

In case the dynamo and circuit are entirely insulated from the earth, a single ground will result in no flow of current outside the wire. If, however, two points in a circuit are connected to the earth the effect will be the same as if the two points of the circuit were connected to each other, by an additional wire (fig. 266, 267).

§ 690. **Insulation of wires.**—To avoid short circuits and the consequent danger to men and animals and also the danger from

fire by the wires coming in contact with inflammable material, the wires are carefully insulated so that the current is kept in the circuit and not allowed to escape by taking short cuts or by going to the ground. Two things are necessary for this: (1) The naked wires must in no case touch each other at any point, for that would make a short circuit. (2) The naked wires must not touch anything which is a conductor.

The wires are insulated by covering them with a coating of rubber, asbestos, silk, etc., that is, some substance which will

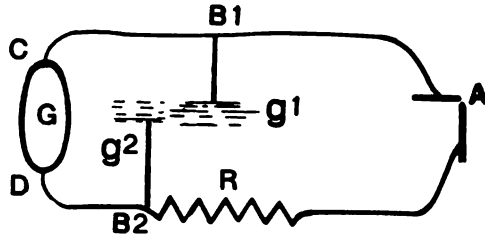

FIG. 267. AN ELECTRIC CIRCUIT WITH A DOUBLE GROUND.

C D The two poles of the dynamo.

G Generator (dynamo).

B¹ A conductor extending from the circuit near the pole *C* to the ground (*g¹*).

B² A conductor near the pole *D* extending to the ground (*g²*).

In this case the current will short-circuit, passing from the point *B²* to *g¹* and from *g¹* to *g²*, *B²* and back to the dynamo at the pole *D* instead of passing through the arc lamp (*A*) and the rheostat (*R*). The single ground is dangerous only in that there is liable to be formed a second ground from some other part of the circuit.

g¹, g² The earth into which the conductors, *B¹, B²* extend.

A Arc lamp.

R Rheostat.

not serve as a conductor. Where the wire must be uncovered, as at switches, etc., some solid substance like porcelain, slate, hard rubber, glass or some other non-conducting substance is used, for the naked wires to rest against.

REGULATIONS FOR WIRING: PRECAUTIONS

§ 691. **National Electric Code.**—To make the wiring and connections of electric apparatus good and safe in every respect, the electrical engineers, architects and fire underwriters have formu-

lated definite rules for wiring, insulation and the character and construction of fittings, the installation of apparatus and of lighting plants, etc. This national code of rules, with all authorized modifications found desirable from time to time, is published in pamphlet form by the National Board of Fire Underwriters for the guidance of those having electric wiring to do and apparatus to install. This board also publishes a list of electric apparatus and fittings which conform to this code. The two pamphlets can be secured by any one interested by sending five cents in stamps to cover postage, to the National Board of Fire Underwriters, 135 William St., New York City, N. Y.

General precautions: In wiring or changing wires and in working about the arc lamp, rheostat, etc., the current should always be turned off at a switch which will render all the wires and apparatus to be changed in any way entirely without voltage ("dead"), so that no matter what is done there is no danger of receiving a shock or of short-circuiting.

If "live wires" must be worked with, use the asbestos-patch gloves, and wrap the naked wires in asbestos paper so that it will be impossible to bring naked wires in contact. Remember also that a concrete floor, if at all moist, makes an excellent "ground" for the wires, and if a person stands on the moist floor with the wires in his hands the current is liable to pass through his body to the ground. It is safer to use a dry board or rubber mat on the concrete floor to stand on, or to wear rubbers.

§ 692. **Municipal regulations for wiring, etc.**—In addition to the regulations of the National Board of Fire Underwriters, it frequently happens that there are special regulations by the municipality concerning the number and character of the general lights in a theater, etc., and also the source of the electricity for the arc lamp and for the general lights. There may also be special regulations for the number and color of exit lights and the source of the current for supplying them. It is necessary then to know, not only the latest regulations of the National Fire Underwriters, but the regulations of the city or state where the electric plant is installed.

INSTALLATION OF AN ARC LAMP FOR PROJECTION

§ 693. In the first place it is necessary to know the maximum amperage to be used for the projection. The wiring, the fuses and the ballast (rheostat, inductor, etc.) must be adapted to this maximum current.

If the installation is adequate for the highest current that may need to be used, it will of course be adequate for any smaller current.

For drawing, and much of the ordinary magic lantern work, the current varies from 5 to 15 amperes, and if the installation were for such work alone, wiring and accessory apparatus which is safe for 15 amperes would suffice. If, on the other hand, the line were to be used for large halls also, and especially for opaque projection (Ch. VII), then the wiring and accessory apparatus would need to have a maximum capacity of 50 to 60 amperes. For moving pictures, the line should safely carry a maximum of 75 amperes, or finally if kinemacolor moving pictures are to be shown in a large hall, the wiring and accessory apparatus must be adapted for an amperage of 100 to 200.

The size of solid wires for different currents is given in the following table:

§ 694. Table of allowable carrying capacity of single copper wires of 98% conductivity.*

AMERICAN INSTITUTE OF ELECTRICAL ENGINEERS

No. Brown and Sharp Gauge	Diameter in Millimeters	Diameter in inches	Circular Mils	With Rubber Insulation Amperes	With other Insulation Amperes
No. 1	7.248	.289	83,690	107	156
No. 2	6.543	.257	66,370	90	131
No. 3	5.826	.229	52,630	76	110
No. 4	5.189	.204	41,740	65	92
No. 5	4.620	.182	33,100	54	77
No. 6	4.115	.162	26,250	46	65
No. 8	3.264	.128	16,510	33	46
No. 10	2.588	.102	10,380	24	32
No. 12	2.053	.081	6,530	17	23
No. 14	1.627	.064	4,107	12	16
No. 16	1.291	.051	2,583	8	8
No. 18	1.024	.040	1,624	3	5

*From the 1913 National Electrical Code, § 18, pp 32-33.

§ 694a. The carrying capacity of the different wires in this table is the amperage which can be safely and continuously carried by the wires without injury to the insulation or to the wire. The rubber covered wire is capable of carrying as great an amperage as the wires with more resistant insulation, but the amperage given, is that which experience has shown can be carried without undue injury to the rubber insulation, and with entire safety in continuous use.

Furthermore, it should be said that the carrying capacity given in the table is by no means the maximum capacity which the wire could carry. For example, one might send a current of 20 amperes through a No. 18 wire, but this would soon injure the insulation from the overheating. By following the Electrical Code, one is on the safe side.

§ 695. Table of allowable carrying capacity of flexible cables and cords composed of several small wires.

B & S Gauge No. of Wire	Number of wires	Rubber Insulation Amperes
No. 18	7	25
No. 18	19	50
No. 18	61	120
No. 16	7	35
No. 16	19	70
No. 16	61	170
No. 14	61	235
No. 14	91	320

ESTIMATED CARRYING CAPACITY

No. 32	40	5
No. 32	80	10
No. 30	15	3
No. 30	30	6

1913 National Electrical Code, § 94, p. 186-187.

§ 695a. This estimate is based upon the law that "The conductivity of a wire is directly proportional to its sectional area." Thus, No. 30 wire has a diameter of .01003 in. and an area in circular mils of $010.03 \times 010.03 = 100.6$. The area in circular mils of No. 18 wire is 1624. The allowable carrying capacity of No. 18 wire is three amperes when there is rubber insulation (see table above). Assuming the same proportional carrying capacity for the No. 30 wire then its capacity would be $\frac{1624}{3} = \frac{100.6}{X}$, whence $1624 X = 301.8$ and $X = .18$ amp. If one small wire can carry .18 ampere, 15 should carry $.18 \times 15 = 2.7$ amperes or in round numbers, 3 amperes. If both cords are united into one conductor there would be 30 small wires with the capacity of $.18 \times 30 = 5.4$ amps. or 6 amperes in round numbers.

For No. 32 wire in the same way: Thus, No. 32 wire has a diameter of .00795 in. The circular mils = $7.95 \times 7.95 = 63.21$ for each wire.

§ 696. Selection of material for installing the arc lamp.—After determining the maximum amount of current needed for the arc lamp, then the wire of proper size and quality and insulation to conform with the National Electrical Code should be obtained. The simplest way to do this is to go to some reliable dealer in electrical supplies and get the standard material.

Standard switches, etc., are all marked plainly so that there is no difficulty in selecting the correct sizes. In America, wire is more often designated by some standard wire gauge, e. g., that of Brown & Sharp, than by the actual diameter in millimeters or inches. In the above table the sizes in millimeters and inches corresponding with the B & S gauge numbers are given, also the area measured in circular mils.

One must not forget that everything that is used wears out, and when any piece of apparatus or the wire becomes deteriorated by use it should be replaced.

WIRING FOR THE ARC LAMP, THE RHEOSTAT OR OTHER BALANCING DEVICE, AND THE LAMP SWITCH

§ 697. Connection with the electric supply.—It is assumed that the electric supply has been properly installed by an electric company, or from a private dynamo, to within a short distance of the arc lamp. This supply will be in a proper outlet box, with fuses and switches in accordance with the National Electrical Code. In case the outlet box is on the wall close to the arc lamp, the simplest and most convenient connection between the lamp switch and the supply in the outlet box is by means of a separable attachment of the proper capacity for the maximum current. (See the table of flexible cables, § 695.) If the current is direct, then it is a convenience to have this attachment irreversible, or polarized so that

For No. 18 wire, as before, the circular mils are 1624 and the relative carrying capacity is assumed to be $\frac{1624}{3} = \frac{63.21}{X}$, whence $X = .116$ amperes. If there are 40 wires in each cord then each cord should carry $.116 \times 40 = 4.64$ amperes, or in round numbers 5 amperes. If the double cord were used for each conductor to the lamp, then in like manner twice as much could be carried, as there are 80 wires: $.116 \times 80 = 9.28$ amperes or 10 amperes in round numbers.

one cannot make a wrong connection (fig. 268A). Such an attachment would also serve for alternating current, but is unnecessary, as it makes no difference which way the attachment is connected.

The conductor from the electric supply in the outlet box to the lamp switch, if the distance is small, not over 2 to 3 meters (6 to 10 ft.), is most conveniently made of flexible cable of the proper carrying capacity (see the table of carrying capacity of flexible

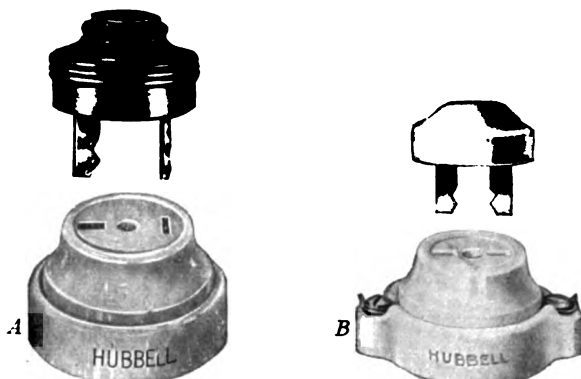

FIG. 268. SEPARABLE WALL RECEPTACLES, POLARIZED (A) AND NON-POLARIZED (B).

(Cuts loaned by H. Hubbell, Inc.).

With direct current, a polarized attachment insures the same polarity without attention on the part of the operator; with the non-polarized form there is liability of reversing the polarity unless the connections are specially marked, and care is taken in putting the separable cap in position. Either form can be used with alternating current also.

electric cables). The two wires or cables are often enclosed in a common sheath.

§ 698. In connecting the two wires to the attachment cap, the insulation is removed for a short distance (1 to 2 cm. $\frac{1}{2}$ in.), the wires scraped clean, twisted all together, and then turned to a loop to surround the set screw. Great care must be taken to avoid leaving any of the strands free; this would lessen the carrying capacity, but more important still, they might become displaced and make a short circuit (§688).

The wire is fixed firmly under the set screw, and if the current is to be large, 30 amperes and more, the wire should be soldered to its connection after the screw is firmly set down.

§ 699. **Connecting the conductors to the switch.**—This is done exactly as for the attachment cap.

In case direct current is used it is important to know which is the positive and which the negative wire. This should be determined before clamping the wire to the switch. The best method is by the

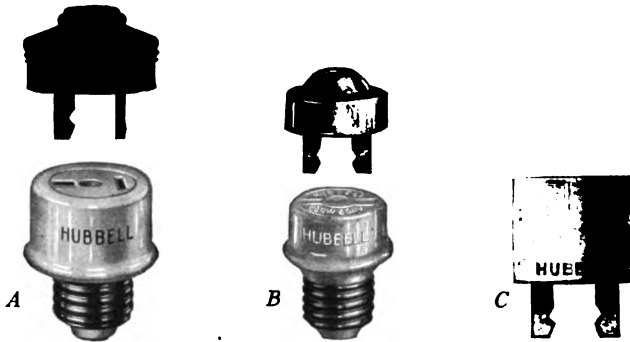

FIG. 269. SEPARABLE ATTACHMENTS, POLARIZED (*A*) AND NON-POLARIZED (*B C*).

(Cuts loaned by *H. Hubbell, Inc.*).

The attachments *A* and *B* are for the ordinary bulb socket.

A is polarized so that the same polarity of the wires is insured, for the connection cannot be reversed.

B is non-polarized and the polarity may be reversed every time the connection is made.

C is for receiving an incandescent lamp; connection is made with the supply by inserting the prongs into an attachment plug which has been screwed into a lamp socket.

use of the arc lamp (§ 702), after the arc lamp and rheostat have been properly connected.

§ 700. **Wiring the arc lamp, including the rheostat or other balancing device.**—From one pole of the switch (fig. 270), a wire of the proper size and insulation is carried directly to the negative binding post of the lamp, i. e., to the post for the lower carbon. From the other pole of the switch a suitable wire is carried to one binding post of the rheostat. From the other bind-

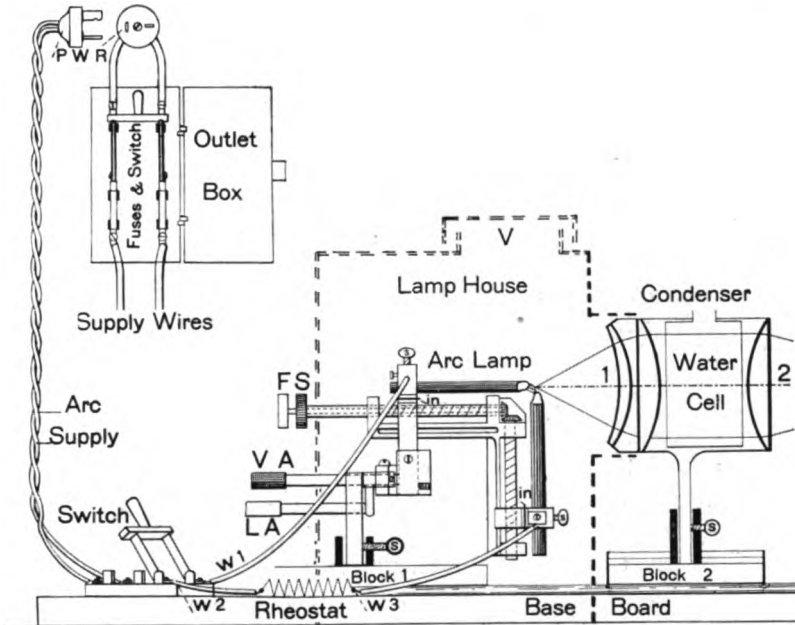

FIG. 270. WIRING OF THE ARC LAMP FOR PROJECTION.
 For full explanation, see fig. 3 and fig. 40.

ing post of the rheostat a suitable wire is carried to the positive binding post of the arc lamp, that is to the binding post for the upper carbon. This puts the rheostat, or other balancing device *in one wire*, or in series, not in parallel, or across both the wires of the circuit.

In securing the ends of the wires to the binding posts, scrape them, and twist the strands, then make a loop and put under the binding screw of the switch as described for the attachment cap. Usually for the rheostat, and the arc lamp, the wires are twisted and kept straight, then inserted into a hole, and a set screw turned down upon them.

If flexible cord or cables are used for these connections, the wires on the end, after being scraped clean should be twisted and soldered, then none of the strands will escape to lessen the carrying capacity, or possibly to make a short circuit.

DETERMINING THE POLARITY WITH DIRECT CURRENT

§ 701. **General statement and precautions.**—With direct current it is necessary, in most cases, to install the apparatus, like the ammeter, the voltmeter, the lamp, etc., in a very definite manner so that the current extends through the instrument in a given direction. That is, the positive end of the wire must be attached to the positive binding post. But when ready to install any piece of apparatus with direct current one rarely knows which is the positive and which the negative wire. It is necessary to find out by experiment.

Precautions in making polarity tests.—If possible, have a rheostat in the circuit before making the tests. One of the small rheostats for use with the small current arc lamp can be very easily introduced into the circuit (see fig. 188, 270 for wiring). If an adjustable rheostat is already in the circuit, set it for the least current.

In making the tests never allow two naked wires to come in contact for that would complete the circuit and might burn out a fuse or do something worse.

Never use a piece of metal, or a metal dish for holding the testing materials. Always use glass, porcelain or wood or some other non-conducting material. The tests are perfectly definite and safe if applied with due care.

Remember also that when repair work on the line is done, the polarity of the supply wires may be changed. This would of course change the polarity of the arc lamp and a good light could not be obtained. One must be on the lookout for every possible trouble and have the knowledge and the resourcefulness to make the necessary modifications.

DETERMINING THE POLARITY WITH AN ARC LAMP, WITH A
VOLTMETER OR AN AMMETER

§ 702. (A) If an arc lamp and rheostat are available the simplest test is to connect the arc lamp, large or small, and rheostat as directed above (§ 700). With proper carbons in place turn on

the current and strike the arc. After the lamp has burned a minute or two open the switch or pull the separable plug apart and watch the ends of the carbons. The one that remains red-hot the longer is the positive one, and the wire leading to it is the positive

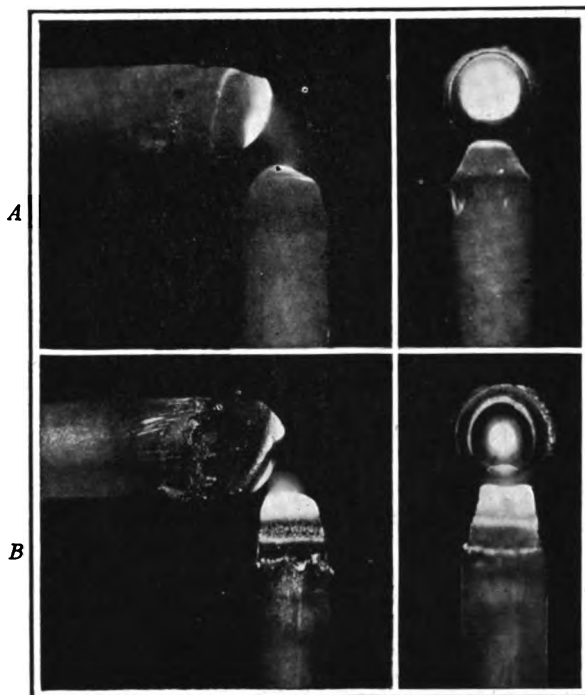

FIG. 271. SIDE AND FRONT VIEWS OF THE RIGHT-ANGLE CARBON ARC WITH CORRECT AND INCORRECT POLARITY.

A The upper figures show the correct polarity, that is, with the positive crater on the upper carbon.

B The lower figures show reversed polarity, that is, with the lower carbon positive and hence the large crater on it.

The photographs were made with a color screen in order to bring out the positive and the negative craters with the greatest clearness. The exposure for the craters was instantaneous, then there was an additional exposure of 90 seconds without a color screen, and with an illumination from a mazda lamp to bring out the carbons and give the appearance seen by the human eye (see also fig. 292-293).

wire. The method in practice is to watch the burning carbons through smoked glass or smoky mica. The positive one is markedly brighter than the negative one (fig. 271).

If the upper carbon is positive the lamp is correctly installed, if the lower carbon is positive then it is improperly installed for ordinary projection. If the positive wire goes to the lower carbon, turn off the light by opening the switch or pulling the separable plug apart. Now reverse the position of the wires in the binding posts of the lamp, and this will bring the positive wire in connection with the upper carbon, and the negative wire in connection with the lower carbon (fig. 2, 270).

If a non-polarized separable plug is used (fig. 268 B), the simplest way to reverse the polarity is to pull the cap off, turn it half way round and insert it again. When found to be in the correct position mark the socket, the plug and the cap in some way so that the connections can be made at some future time with certainty. There are polarized plugs (fig. 268A) in which the connections are so arranged that the attachment plug can be inserted only in one way, thus avoiding the change of polarity when once the wiring is correctly installed.

When the polarity is found to be correct it is advantageous for future work to mark the insulation of the positive wire near the switch with red paint. The positive side of the table switch should also be marked with a + sign or with P. using black or red paint. In like manner the insulation of the wire near where it is connected with the binding post of the arc lamp should be marked red, and a + or P. should be put alongside the binding post for the upper carbon unless it is so evident that no mistake is likely to occur.

(B) *Testing the polarity with a direct current voltmeter—* To do this connect the voltmeter with both wires (fig. 272). Turn on the current by closing the switch and if the positive wire is connected with the positive binding post the voltmeter will record the voltage in the line. If the wires are wrongly connected then the hand will try to move off the dial face below zero. If the hand does not register the voltage, open the switch, and reverse the

position of the wires in the binding posts of the voltmeter. Turn on the current and the voltmeter will register. It is well to mark the insulation of the positive wire with red, or in some other way.

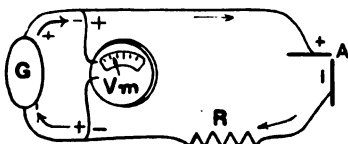

FIG. 272. VOLTMETER FOR TESTING POLARITY.

G Dynamo for direct current. The positive pole is above and the negative pole is below, as indicated by the arrows.

V_m The terminals of the voltmeter are correctly connected across the line (in multiple) or to both wires and the hand indicates the voltage on the dial. If the terminals were wrongly connected the hand would not register.

A Arc lamp.

R Rheostat.

The arrows indicate the direction of the current.

The + and — signs indicate that any point in the circuit nearer the positive pole of the dynamo is positive to any point nearer the negative pole.

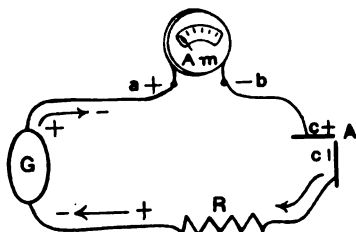

FIG. 273. AMMETER FOR TESTING POLARITY.

G Dynamo for direct current. The positive pole is above and the negative pole below.

A_m Direct current ammeter. The terminals *a* +, — *b* are connected along one wire (in series). If the positive pole of the ammeter is connected to the circuit next the positive pole of the dynamo, and the negative terminal in the wire toward the negative pole of the dynamo, as here shown, the hand will register when there is current flowing. If the connections are reversed the hand will not register when the current is flowing.

a +, — *b* The positive and the negative terminals of the ammeter.

A Arc lamp.

c + The positive carbon.

c — The negative carbon (the minus sign is put parallel with the carbon to show the direction of the current).

R Rheostat.

The + and — signs and the arrows are as with the voltmeter (fig. 272).

(C) *Testing the polarity with a direct current ammeter.*—The circuit should be connected with a rheostat and an arc lamp or one or more incandescent lamps in series (along one wire) then the switch is opened and the ammeter is inserted in one wire (in series), (fig. 273). Now turn on the current and light the lamp (§ 30). If the wires are correctly connected the ammeter will indicate the amount of current flowing; if it is wrongly connected then the hand will try to move off the dial below zero. That is, the positive wire has been inserted in the negative binding post of the ammeter, and the negative wire in the positive binding post. Open the switch, and reverse the position of the wires in the binding posts; turn on the current and the hand will register the amperage. The positive wire can then be marked red or in some other way.

CHEMICAL POLARITY INDICATORS

§ 703. **Litmus, iodized starch, salt solution and potato indicators.**—(A) *Litmus indicator.*—Take some blue litmus or other acid-alkaline testing paper, about 10 cm. (4 in.) long and place it on a pane of glass or a porcelain plate. Moisten it well. Separate the ends of the wires as indicated in the testing lamp (fig. 21). Put the two ends about 10 centimeters (4 in.) apart on the moistened litmus paper. Turn on the current. The positive wire will turn the blue litmus paper red when the current flows. Turn off the current and mark the positive conductor red, or white.

(B) *Iodized starch polarity indicator.*—Make some starch paste by mixing 15 grams ($\frac{1}{2}$ oz.) of dry starch (corn starch, laundry starch or wheat flour) with 300 cc. (10 oz.) of cold water. Add $\frac{1}{2}$ gram (7 or 8 grains) of iodide of potassium. Now heat the mixture with constant stirring until the starch is cooked. Put some of the iodized paste in a glass or porcelain dish and insert the separated wires to be tested in the paste. Turn on the current and the starch at the positive pole will be turned blue. Turn off the current and mark the positive wire in some way. (The iodized starch test is

— § 702a. If one uses a voltmeter or an ammeter of the new, soft-core type (Eclipse Volt—and Ammeters) which register both alternating and direct current, one cannot determine polarity with them, for they register whichever way they are connected with the circuit.

the one commonly employed for weak currents for it is very sensitive; it is, however, equally good for large currents).

(C) *Salt and water polarity indicator.*—Make a $\frac{1}{2}\%$ solution of common salt (NaCl) in water. Place the solution in a glass or porcelain dish about 10 cm. (4 in.) across. Insert the two separated wires to be tested in the liquid and turn on the current. When the current is on, many small bubbles will appear at the *negative* pole. In making this test remember the precautions (§ 701).

(D) *Raw potato polarity indicator.*—Cut an ordinary uncooked potato in half. Insert the wires into the potato having the wires as far apart as possible. Turn on the current. The potato around the positive pole will turn greenish. If the potato is quite

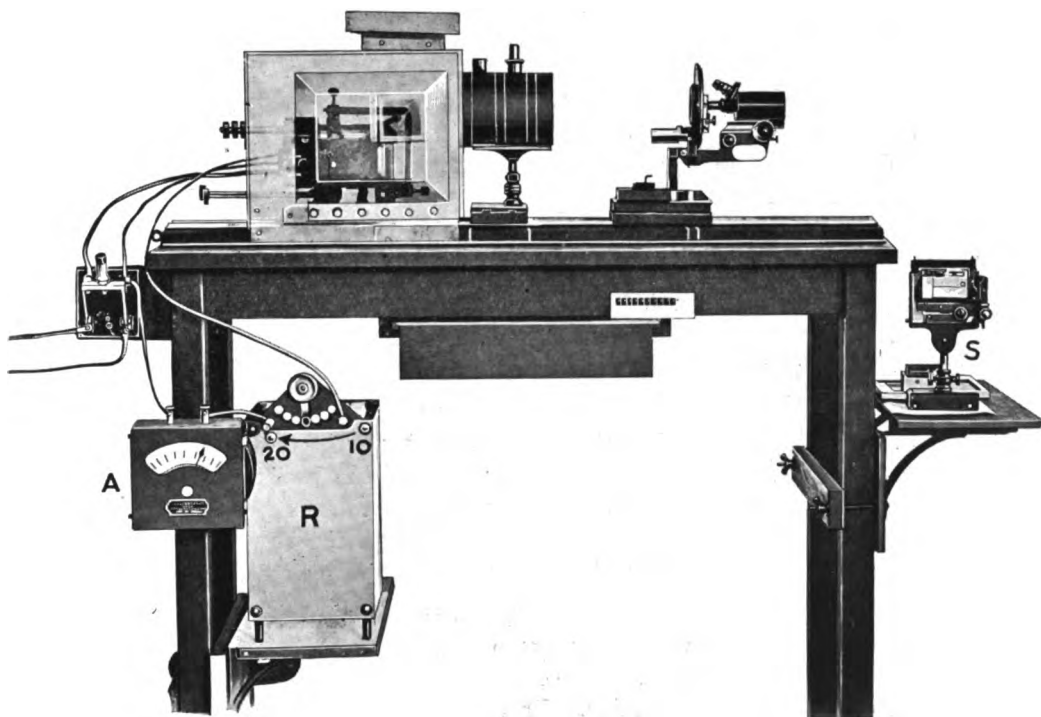

FIG. 274. THREE-WIRE ARC LAMP OF THE BAUSCH & LOMB OPTICAL COMPANY
For a full explanation see fig. 145 and § 704.

moist, many small bubbles will appear around the negative pole. But the greenish color given at the positive pole is the most certain. Turn off the current and mark the positive wire red.

With the other chemical tests (A, B, C) the indications are in no way dependent on the metal forming the wire, but with the potato test the poles entering the potato must be copper or contain copper.

§ 704. **Wiring the three-wire automatic lamp of the Bausch & Lomb Optical Company.**—This lamp is regulated wholly by electricity, there being no clock-work. In wiring the lamp one proceeds exactly as described above (§ 693-700), except that a wire is carried from the positive side of the switch to the middle binding post of the lamp directly. Another wire from the same point is carried down to the resistor or rheostat, and from the rheostat a wire to the positive or upper binding post of the lamp. From the negative pole of the switch a wire is carried directly to the lower or negative binding post of the lamp. This wiring gives the full voltage of the line for the electric mechanism governing the lamp (see fig. 145).

WIRING FOR ALTERNATING CURRENT

§ 705. This is precisely as for direct current, and one does not have any trouble about the polarity. It makes no difference which supply wire is connected with the upper carbon and which with the lower.

§ 706. **Insertion of the rheostat, inductor or other balancing device.**—It makes no difference in which of the lead wires the rheostat, etc., are inserted. Just as with direct current, however, the balancing device must be inserted along *one wire* (fig. 281), otherwise the current would not traverse the entire circuit.

§ 707. **Position of the rheostat, etc.**—The balancing effect of the rheostat is the same no matter where it is installed in the special circuit for the arc lamp. For convenience it is frequently put on or near the projection table. This is especially necessary if the rheostat is adjustable. With a fixed rheostat it is sometimes safer

to put it near the supply intake, especially if that is at a considerable distance from the lantern or other projection apparatus, then in case of a short circuit in working about the lamp or table switch, an excessive current could not flow, and there would be much less danger from fire or the burning out of fuses. (See also § 708).

§ 708. Wiring when the arc lamp is far from the supply.—When the supply is at a considerable distance from the arc lamp the flexible wire connection is sometimes used for temporary work, but is not suitable for permanent installation.

Instead of a conduit, well insulated wires are sometimes used from the general supply box to the neighborhood of the arc lamp. The wires must be secured by porcelain or other non-conducting supports every meter (3 or 4 feet) which will separate them from the wall 1 to 2 cm. ($\frac{1}{2}$ in.) and from each other 5 to 7 cm. ($2\frac{1}{2}$ in.) and hold them in place. Where the wires pass through partitions, each wire should have its own porcelain tube so that it does not come in contact with the partition. The safe rule in wiring is to treat the rubber covered wires as if they were naked. At the end it is desirable to have a metal box for the special fuse block and switch. An attachment fixture is also very convenient (fig. 270).

For the position of the rheostat. etc., see § 707.

§ 709. Wiring an arc lamp for large currents.—Arc lamps for opaque projection (Ch. VII) and for moving pictures (Ch. XI) require large amperages, and frequently the lamps become very hot, especially if the lamp-house is not large and well ventilated. For lamps requiring the large currents it is best to use flexible cables of higher capacity than is needed outside the lamp-house. The wire should also be insulated with some fire-proof material like woven asbestos.

The ordinary, rubber insulation will answer for low amperages especially when the lamp-house is well ventilated. An excellent wiring material is the flexible cord used for heating apparatus. This has rubber insulation, and also woven asbestos, and the outside is covered with woven cotton to protect the asbestos. Of course a flexible cord of the proper carrying capacity should be selected.

If it is difficult to get double cord of the right size, then each of the wires to the lamp can be composed of the double cable. This is easily done by removing the insulation at each end of the double cord and twisting both the wires together. (See the tables § 694, 695, for the carrying capacity of flexible cord and cables).

§ 710. **Wiring the arc lamp with a three-wire supply.**—Only two wires go to the arc lamp, then if one must connect the arc lamp for projection to a three-wire supply system it is necessary to remember that the middle (neutral) wire and either outer wire will give 110 volts the same as the two-wire 110 volt circuit.

If connection is made with the two outer wires then 220 volts will be used in the arc lamp. In this case a rheostat for a 220 volt circuit must be employed, or two 110 volt rheostats in series (fig. 287).

Naturally one would connect with the middle or neutral and an outside wire and employ the usual 110 volt rheostat but for the fact that such an arrangement would badly unbalance the work of the line, and might cause trouble if the electric circuit was running nearly on full load. It is therefore safer to connect with the outside wires and use the requisite amount of ballast.

SWITCHES, CIRCUIT BREAKERS AND FUSES; THEIR CHARACTER, INSTALLATION AND USE

§ 711. A switch is a device by means of which a gap (fig. 275 and 276) can be made in an electric circuit thus stopping the flow of current.

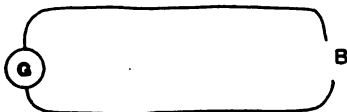

FIG. 275. CIRCUIT WITH A BREAK OR GAP.

Unless the metallic circuit, from the dynamo, *G*, back to the dynamo, is complete, no current will flow. A gap in the circuit (*B*) prevents the flow of current.

A switch should be so constructed that when it is opened it makes a gap in *all* the wires of the circuit. For example, in a two-wire circuit, the switch should make a gap in both wires, and in a three-wire circuit, a gap in all three wires. If such a switch is used the line beyond the switch is "dead," and no current can be drawn from it.

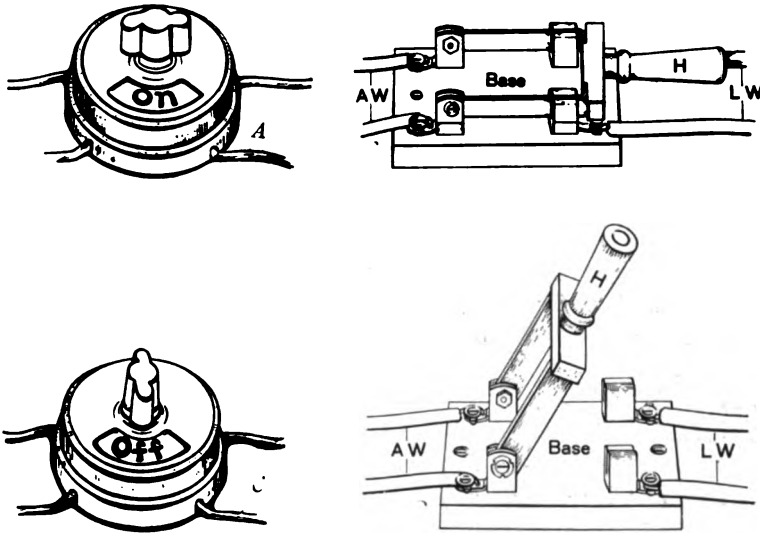

FIG. 276. SNAP AND KNIFE SWITCHES SHOWING OPEN AND CLOSED CIRCUIT.

- A Snap switch with circuit closed (current on).
- B Knife switch with circuit closed (current on).
- C Snap switch with circuit open (current off).
- D Knife switch with circuit open (current off).
- AW Wires from the switch to the arc lamp.
- Base The insulating support of the knife switch.
- H Handle of the switch blades.
- LW Supply wires for the electric current to the switch.

There are two main forms of switches: The knife switch like that shown in fig. 276 B, D, and the snap switch, which rotates (fig. 276 A, C). Any switch to be installed should conform in its construction with the National Electric Code and be plainly marked with its capacity—voltage and amperage—and the maker's name.

§ 712. **Installation of a switch.**—The non-combustible, non-conducting base should be fastened to some support, and then the wires of the line cut and scraped and connected firmly in the binding posts or under the binding screws. If the current is over 30 amperes the wires should also be soldered to the switch after the screws are well set down. A switch at the supply for the building

or special plant should be enclosed in a metal box where it can be easily got at, but not where the naked metal parts might inadvertently become short-circuited.

It is necessary also to put the switch in such a position that when it is opened it will not close of itself by gravity. If the switch is in a vertical position it must be placed with the hinge below, so that gravity will tend to open it, never to close it (fig. 277).

If the switch is horizontal, then the hinge should be tight enough so that the blades will remain in any position in which they are placed. For a double-pole, double-throw switch for two lamps see fig. 162.

A knife switch has an appreciable amount of naked metal exposed. It therefore makes a short circuit easily possible. For use with projection apparatus, especially if high amperages are to be used as with opaque projection and with moving pictures it is

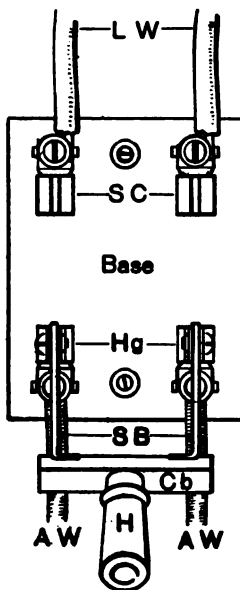

FIG. 277. OPEN KNIFE SWITCH IN A VERTICAL POSITION, WITH THE HANDLE BELOW SO THAT THERE IS NO DANGER OF THE SWITCH CLOSING BY GRAVITY.

L W Line wires from the electric supply (fig. 270) to the switch.

A W Arc lamp wires from the switch to the arc lamp. A rheostat is inserted in one of them (fig. 270).

S C Spring clamps pressing against the switch blades when the switch is closed, thus making good metallic contact.

Base The insulating base of the switch. It is held in position by two or more screws.

H g Hinges of the switch blades.

S B Switch blades. When the switch is closed these blades make a continuous circuit, and when the switch is open the circuit is broken.

C b Cross-bar of insulating material to which the switch blades and the handle are attached.

H Handle for opening and closing the switch. It is of insulating material

advantageous to enclose the switch in a metal box with a slit allowing the handle to project and move so that the switch can be opened and closed. As only the handle is exposed with this arrangement the operator is safe when manipulating the switch in the dark (fig. 278). See also § 714.

§ 713. **End of the switch to connect with the supply wires.**— Sometimes the supply wires are connected with the hinge end of the switch as in fig. 2. This has the disadvantage that the switch is then energized up to the break at the handle, when the main supply is on. As the switch is liable to get out of order and need screwing up occasionally it is better to insert the lead wires in the opposite or

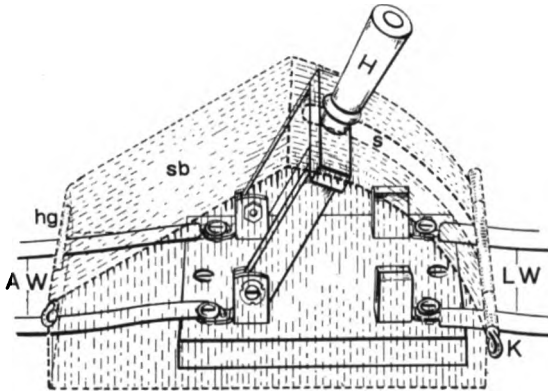

FIG. 278. ENCLOSED SWITCH IN A HORIZONTAL POSITION.

Commencing at the right:

L W Supply or line wires from the outlet box (fig. 270) to the table switch.

k Key for locking the metal cover when it is closed.

H Handle of the knife switch. It projects through the slot (*s*) in the cover. In the position shown the switch is open.

sb Switch box. This is a sheet iron box enclosing the switch so that nothing can come in contact with the naked metal of the switch. Only the switch handle projects beyond the box. The enclosing box is represented as transparent in order to show the switch and its connecting wires within. The bottom of the enclosing box is covered with asbestos board and the switch base rests on the asbestos, not on the metal of the box.

hg Hinge of the metal cover. By turning the cover over to the left the entire switch is exposed.

A W Wires from the switch to the arc lamp.

jaw end of the switch as in fig. 277, then when the switch is open the hinges and blades are "dead" and can be put in order with safety.

§ 714. **Snap Switches.**—These are sometimes used for turning on and off the current at the operating table. They are mounted on insulating material like porcelain, and are enclosed by a metal covering which is lined with insulating material. The key or button for turning on and off the current is also of insulating material. This form of a switch around the work table is convenient, and avoids any danger of accidentally short-circuiting the line. It should turn on the current and turn it off with a snap. It is also desirable that there should be a sign indicating when the current is on or off, as one cannot see directly as with the knife switch. If such a switch is used, make sure that it is of the right capacity for the maximum current and that it conforms in every way with the standard requirements. It will be plainly marked so that after it is installed one can see at any time the current and voltage for which it is designed. Snap switches are better adapted for small currents, than for large ones. Knife switches are to be used on lines with large currents.

FUSES AND CIRCUIT BREAKERS

§ 715. Fuses and circuit breakers are devices for opening or breaking the circuit whenever the current in any particular situation becomes too great. For example, if a part of the line should be short-circuited.

The devices used are of two kinds; fuses, and magnetic cut-outs or circuit breakers.

§ 716. **Circuit breakers.**—The circuit breaker is a device by which a magnetic trip releases a catch which allows a large switch to open, thus breaking the circuit.

The great advantage of a circuit breaker is that nothing is burned out or melted. It is only necessary to close the switch again and the current will be on. It acts instantly whenever the current rises above the amperage for which it is adjusted.

§ 717. **Fuses.**—A fuse is a wire of low melting point forming part of the circuit. If the current becomes too great this fuse is melted, thus making a gap in the line. The fuse is then said to burn out or to “blow.” If the current becomes much too great as in a short circuit the fuse will “blow” instantly, if however, the current is only slightly larger than the fuse is designed for—as for example, when striking the arc in an arc lamp—the fuse will not “blow” instantly, and if the overload is only for a short time it will not melt at all. If the overload continues for some time, however, the fuse will get hotter and hotter until its melting point is reached, when it will melt and open the circuit. This property of the fuse is of great advantage when using arc lamps, for the temporary overload in lighting the arc lamp is unavoidable.

§ 718. **Location and installation of fuses.**—Like the switch, the fuses should be placed in the path of all the wires of a circuit—i. e., with a two-wire system two fuses, and with a three-wire system, three fuses, etc. The wiring of a fuse block is the same as for a switch (§ 712).

There is always a switch in the supply box from the electric lighting system or from the private dynamo. In this box are also fuses to open the circuit in case of accidental short-circuiting. The fuse block, whether for cartridge fuses or for plug fuses should be selected with care to make sure that it is of the right capacity for the maximum current and conforms to the standard code. The fuses are plainly marked, so there need be no mistake.

One should not use fuses of higher capacity than the line was designed for, for fear of fire or other accident.

If the supply box is some distance from the arc lamp, many careful operators have fuses as well as a switch at the supplementary supply box in the operating room, when a conduit or fixed wires are carried from the main supply to the operating room. The fuse nearest the arc lamp is preferably of somewhat less capacity than the ones farther away, then if a fuse is blown it will be the handiest one to renew.

§ 719. **Fuses and the wattmeter.**—If but a single meter is used to measure the current for arc lights, house lights, heating appara-

tus, etc., then each group should be separately fused after the wattmeter, for then if one part of the line is cut out the rest can go on drawing current. For example, if the arc lamp were mismanaged it ought not to be possible to blow out the fuse for the house lights, and the reverse.

§ 720. **Location of fuse blocks.**—The general rule is that there must be a fuse block wherever there is a change in the size of the wire used. These fuse blocks must be in cabinets in plain sight and readily accessible. Usually also, with every fuse block there is a knife switch.

§ 721. **Capacity of fuses.**—The rated capacity of fuses should not exceed the allowable carrying capacity of the conducting wire (see tables § 694, 695), and circuit breakers should not be set more than 30% above that allowable capacity.

The allowable capacities for incandescent lamp lines are as follows:

55 volts or less	12 amperes
55-125 volts	6 amperes
125-250 volts	3 amperes

For electric lighting each special circuit or line should not be used for a current greater than will give a power of 660 watts. This would mean for example, that if one wished to use 60 watt lamps there could be only 11 of the lamps on a single line. If 40 watt lamps were used then there might be as many as 16 lamps on a line, etc.

In using flat-irons and other heating devices on an electric lamp circuit, care must be exercised not to turn on any lights on that branch of the circuit.

Likewise in using the small arc lamp for drawing with the microscope, ultra-microscopy, etc., where from four to six amperes of current are needed, one should not use incandescent lights on that line at the same time, for the current would exceed the allowable amount and probably blow a fuse.

§ 722. **Replacement of fuses.**—As fuses are liable to blow out it is well to have a supply on hand, then the burnt out ones can be

quickly replaced. To replace a fuse, open the nearest switch which will turn off the current from the line. Take out both fuses, and examine them; only one is likely to have melted. It is usually easy to tell which. Discard that one, then insert two good fuses of the proper capacity, close the switch, and the current will be available again.

If the lights on a particular line go out from the blowing of a fuse, and one is not sure which branch it is in the fuse box, the one is easily found by using the testing lamp (fig. 21) beyond the fuses. The lamp will light on all the lines with perfect fuses when put across the blades of the special line switch, or when put in contact with any naked metal part across the line. The line with a burned out fuse will not light the testing lamp, when it is applied beyond the fuse.

RESISTORS OR RHEOSTATS: INSTALLATION AND USE

§ 723. **Resistor or rheostat.**—A rheostat is a conductor having considerable resistance; it is placed in an electric circuit to regulate the amount of current. In passing through the rheostat much heat is developed by the energy consumed in overcoming the resistance. This energy consumption is a dead loss.

The conductor used is ordinarily in the form of wire or strips of metal such as German silver, iron or nickel.

§ 724. **Amount of resistance needed.**—Electricians have worked out with much accuracy the resistance of different metals and by consulting the tables furnished in books on electrical engineering one can find how great a length of a given size iron or German silver wire is necessary to afford the proper resistance for any given constant voltage, as 110 or 220. See § 724a.

§ 724a. **Ohm's Law and its application to projection apparatus.**—While the units, volt, ampere and ohm (§ 654–657) might be worth defining, still it would lead to no very practical results unless there was a definite relation between the electric quantities for which these units stand.

It has been found by experiment that there is a very definite relationship, known as Ohm's Law. (For a history of the discovery of this law by Ohm, see Dr. Shedd in the *Popular Science Monthly* for Dec., 1913).

Briefly stated Ohm's law is: "The current in a given circuit is directly proportional to the electromotive force, and inversely as the resistance:" Nichols, p. 294.

As stated by Norris it is: "The electromotive force consumed in the resistance of a conductor, is proportional to the current." P. 8.

Using the terms now employed in place of electromotive force (voltage), resistance (ohmage), and current (amperage), the law can be stated thus:

(1) *The voltage* in a conductor is equal to the amperage multiplied by the ohmage: $V = A O$.

(2) *The amperage* is equal to the voltage divided by the ohmage: $A = \frac{V}{O}$

(3) *The ohmage* is equal to the voltage divided by the amperage: $O = \frac{V}{A}$

As $V = A O$, $\frac{V}{A O} = 1$. From this form is derived the very simple diagram used practically in getting the formula for the value of any single quantity if two are known. The formula for the unknown quantity is found thus:



FIG. 279. DIAGRAM OF OHM'S LAW FOR SOLVING PROBLEMS (§ 724a).

V = Voltage.

A = Amperage.

O = Ohmage.

Cover the letter representing the unknown quantity, and the remaining letters will indicate the value of the unknown quantity.

Examples:

1. If the voltage and amperage are known, what is the ohmage?

Cover the O and there remain V/A and this is equal to O , i. e., $O = V/A$. Suppose the voltage is 110 and the amperage is 20, what is the ohmage? Applying the formula, $O = 110/20$, or 5.5 ohms.

2. If the voltage and the ohmage are known what is the amperage? Here if A is covered there is left V/O , whence the amperage equals the voltage divided by the ohmage. If the voltage is 220 and the ohmage is 5.5 as before, what is the amperage? $A = 220/5.5 = 40$ amperes. This example also illustrates the fact that if the ohmage remains constant the amperage will increase in direct proportion to the voltage. (See Dr. Nichols' definition above).

3. If the amperage and ohmage are known what is the voltage? Here the unknown quantity is represented by V . If this is covered there will be left $A O$, whence $V = A O$. If the amperage is 15, and the ohmage 8 then the voltage must be $15 \times 8 = 120$, i. e., $V = 120$ volts.

As a further example suppose one wished to make a water-cooled rheostat (fig. 283) and he had some wire which had an ohmage or resistance of 0.25 ohm per meter, how much wire would be needed with a voltage of 110 and an amperage of 15? Here voltage and amperage are known. From the formula it is seen that ohmage equals voltage divided by amperage: whence $110/15 = 7.33$ ohms, the total resistance required.

Now as 55 is the voltage required by the arc with the direct current arc lamp, the lamp itself must offer a resistance of $\frac{V}{A} = \frac{55}{15}$ for 3.66 ohms.

As the total ohmage needed is 7.33, the rheostat must possess the difference between 7.33 and 3.66 or 3.67 ohms.

If each meter of the wire to be used offers a resistance of 0.25 ohm, it will require for 3.67 ohms, $\frac{3.67}{0.25} = 14.68$ meters of the wire for the rheostat. (For the *wattage* of the current see § 660).

§ 725. **Getting rid of the heat developed.**—As much heat is developed in the rheostat, it is necessary to so arrange the coils of wire, etc., forming it, that the heat can easily escape, otherwise the wire might get so hot that it would melt. Provision for carrying away the heat then is of prime importance. For example, a large iron telegraph wire would get red hot in the air if it were used for 100 amperes, while a much smaller wire if immersed in water would carry the current easily on account of the rapid dissipation of the heat in the water.

Ordinarily the resistance wire is in coils, and these are hung on non-conductors in such a way that there is free circulation of air around and through the coils to carry off the heat.

Sometimes the wire or strips of metal serving for the resistance are imbedded in porcelain, and a considerable surface of the porcelain being exposed to the air, the heat readily escapes. This is often the method with the rheostats used for dimming the lights in theaters (theater dimmers). (See fig. 183, 186 for a theater dimmer used as a rheostat).

In fig. 198 is a small rheostat with the metal in a helical coil and wound around a porcelain core. This rheostat is for the small arc lamp to be used on the house lighting system, and restricts the current to 4–6 amperes.

§ 726. **Fixed rheostat.**—This is a rheostat in which the entire amount of resistance wire must be traversed whenever the current is on, the amperage of the current is then practically constant. For example in using the arc lamp if the rheostat is designed for 15 amperes, that current must always be used. The fixed rheostat is best adapted for any place where many use the same apparatus (fig. 280).

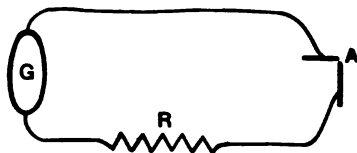

FIG. 280. CIRCUIT WITH DYNAMO (*G*) ARC LAMP (*A*), AND FIXED RHEOSTAT (*R*).

§ 727. **Adjustable rheostat.**—The adjustment consists of an arrangement by which a greater or less length of the resistance wire can be included in the circuit at will. The more resis-

tance in the circuit the less will be the amperage, and the less resistance the higher the amperage.

In some forms it is possible to have a great range of current, say from 5 to 45 amperes (fig. 281); in other forms the range may be limited, say from 15-25 amperes.

For the projection microscope and the magic lantern it is desirable to have a rheostat giving a range of amperage from 5 to 25

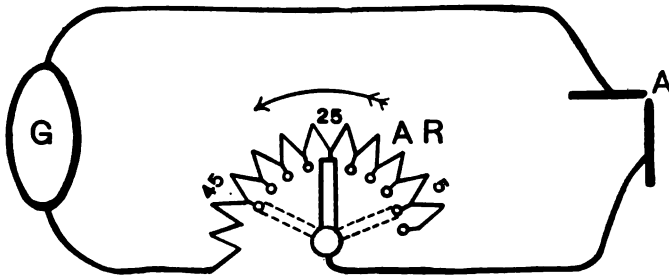

FIG. 281. THE USE OF AN ADJUSTABLE RHEOSTAT AS BALLAST FOR AN ARC LAMP

G Generator (dynamo).

A Arc lamp with right-angle carbons.

AR Adjustable rheostat.

5 If the movable contact-arm is at 5, the resistance allows but 5 amperes to flow.

25 If the contact-arm is at 25 then only half of the resistance is in the circuit and 25 amperes of current can flow.

45 If the contact-arm is opposite 45, only a small amount of resistance is in the circuit and forty-five amperes of current is allowed to flow.

The arrow indicates the direction to turn the contact-arm to increase the current.

amperes. Such a rheostat is not difficult to construct, nor is it expensive. The theater dimmer shown in fig. 183 is of this range. But an adjustable rheostat requires judgment for its proper use; for apparatus to be used by everybody it is better to have a fixed rheostat (§ 726).

§ 728. **Installing the rheostat.**—It is usually placed close to the arc lamp, i. e., inside the lamp switch, so that when the lamp switch is open the current is entirely off the arc lamp and its rheostat.

In wiring the rheostat, it is to be placed in *one wire*, (in series) as all the current must pass through it (fig. 188, 281). It makes no difference whether it is placed in the wire going to the upper carbon or coming from the lower carbon.

§ 729. **Calibration of a rheostat.**—The maker of a rheostat should mark plainly upon it its capacity if it is of the fixed form. If it is adjustable, then the range of the rheostat should be given.

Furthermore, the lower range should be plainly marked at the lowest step and the highest range at the highest step. The user of a rheostat like that in fig. 145 could not tell easily which way to turn the knob to increase or diminish the current unless the maker indicates the amperage at the two ends of the steps. In case there is no indication a person can determine it for himself if he has an ammeter.

Insert the ammeter in *one wire* of the line (fig. 273). Turn the knob of the rheostat to the middle step, insert proper carbons in the arc lamp, and turn on the current. When the lamp is burning properly note the reading on the ammeter. Turn the knob toward one side and the ammeter will indicate whether there is more or less current. One can in this way find the amount of current delivered for the different positions. It is well to mark on the rheostat face with white paint the amperages corresponding to these positions. It is also a help to have an arrow pointing from the lowest to the highest amperage (fig. 182, 281).

§ 730. **Home-made rheostats.**—While it is altogether false economy to use anything but the best in the form of a rheostat it is worth while knowing how one could be made in case of urgent need.

§ 731. **Barrel or bucket type of salt water rheostat.**—A wooden bucket or barrel is used. In the bottom is placed a large plate of iron, and one end of the supply wire is firmly fixed to this. The other end of the wire is fixed to another mass of iron. The barrel or bucket is then filled nearly full of water, and enough common salt added to make about a $\frac{1}{2}\%$ solution. The water should be well stirred to evenly distribute the salt. The upper iron and

wire are then covered by a burlaps sac so that there can not be a metallic contact between the masses of metal. This upper wire and its iron are then immersed in the barrel. If now the arc lamp is fitted with carbons, and the switch closed the arc will form as usual, the salt water and the iron plates serving as a rheostat.

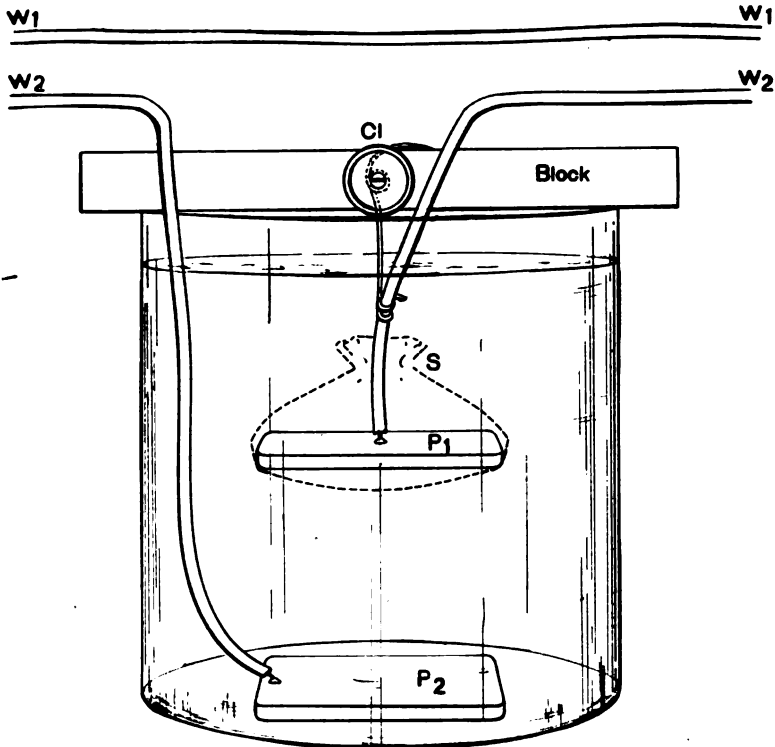

FIG. 282. SALT WATER RHEOSTAT.

W_1 , W_2 Conductors. One end of conductor W_2 is connected to an iron plate P_2 in the bottom of the dish. The other end is connected to the plate P_1 which is suspended by a string wound around the clamp. The burlaps sack S , prevents contact of P_1 and P_2 with resulting short circuit should the upper plate be let down too far. It is safer still to have both plates covered, and the container must be of wood, glass or stoneware, i.e. some non-conductor.

The jar contains a $\frac{1}{2}\%$ solution of salt. The resistance is regulated by raising or lowering the plate P_1 . If more current is required, lower the upper plate, if less current, raise P_1 so that the two plates will be farther apart.

If one wishes a greater amperage the upper wire is lowered in the barrel and if less current is desired the upper iron is lifted higher in the barrel (fig. 282). Of course there must be some means of holding the upper wire in position when it is at the right height in the barrel.

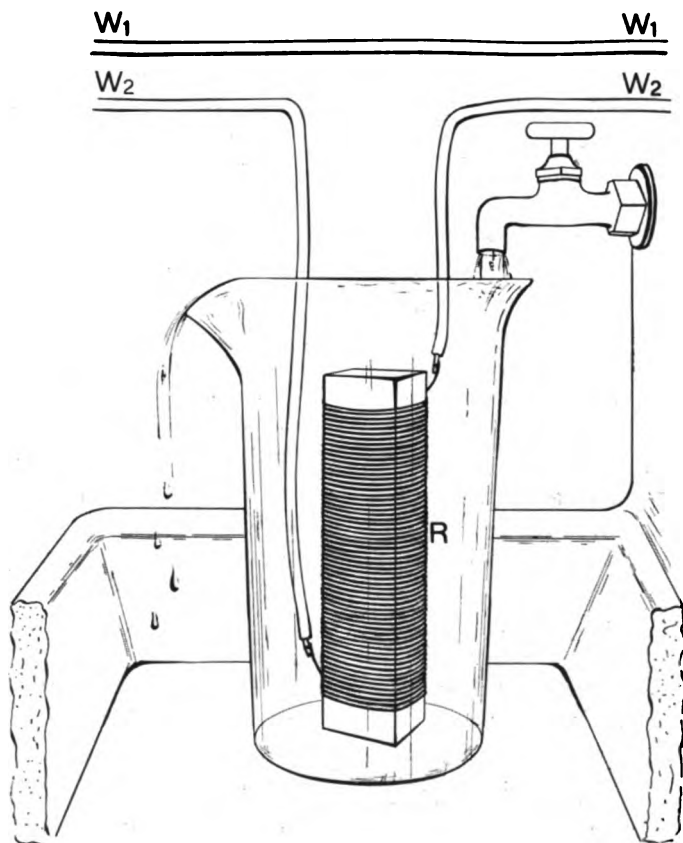

FIG. 283. WATER COOLED RHEOSTAT.

W_1, W_2 Conductors.

R Rheostat composed of the proper length of small naked wire wound around a frame of wood. The two ends of this resistance wire are soldered to the cut ends of the supply wire W_1, W_2 . The rheostat is then immersed in running water and the containing vessel of wood, glass or stoneware is placed in a sink.

In no case should one use naked wires for this rheostat, but the rubber, water-proof insulated copper wires required by the National Electric Code. The ends of the wires must be scraped and fastened to the plates of iron. This is rather a poor make-shift for a rheostat. The water soon heats up, and as it heats the resistance becomes less so that more current flows. Then to counterbalance this, fresh cold water can be added or the upper plate lifted to make the distance between the iron plates greater. Furthermore, increasing the amount of salt lessens the resistance. If there is too much salt there will be too much current, if too little one cannot get enough current without bringing the iron plates very close together, and this is not safe.

§ 732. **Home-made water cooled rheostat.**—A home-made rheostat can be constructed of small, naked wire of the proper length as shown by calculation or by the electrical tables. The wire is wound around a wooden frame in a single layer, care being taken that the different turns do not touch one another. The cut ends of one of the heavy insulated supply wires are then soldered to the two ends of the coil. The coil with the soldered junctions is then immersed in a glass or porcelain dish containing pure water, *no salt being used* (fig. 283). If the current is to be on for some time it is a great advantage to have the vessel containing the rheostat stand in a sink or in some place where water can drain away, and then to keep a stream of cold water flowing into the vessel to keep the wire cool.

This general scheme is used in making tests of the gigantic generators used in large power plants. For such tests the wire used is naked telegraph wire of the right resistance and length laid out

§ 371a. With such a bucket rheostat, 12 liters (12 quarts) of $\frac{1}{2}\%$ salt solution were used, and the distance between the iron discs could be as great as 15 cm. (6 in.). With the discs 15 cm. apart and the solution at 23° centigrade a current of 10 amperes flowed. After an hour, when the temperature had risen to 43° C., 12 amperes of current flowed. With the discs nearly in contact 20 amperes were given.

In this experiment the iron discs were 18 cm. (7 in.) in diameter. By increasing the size of the iron discs the current could be increased, and by diminishing it the current could be diminished. Iron (tin) funnels are sometimes used instead of discs. It is safer to have both discs covered with the burlaps, and the conducting wires soldered to the discs or funnels.

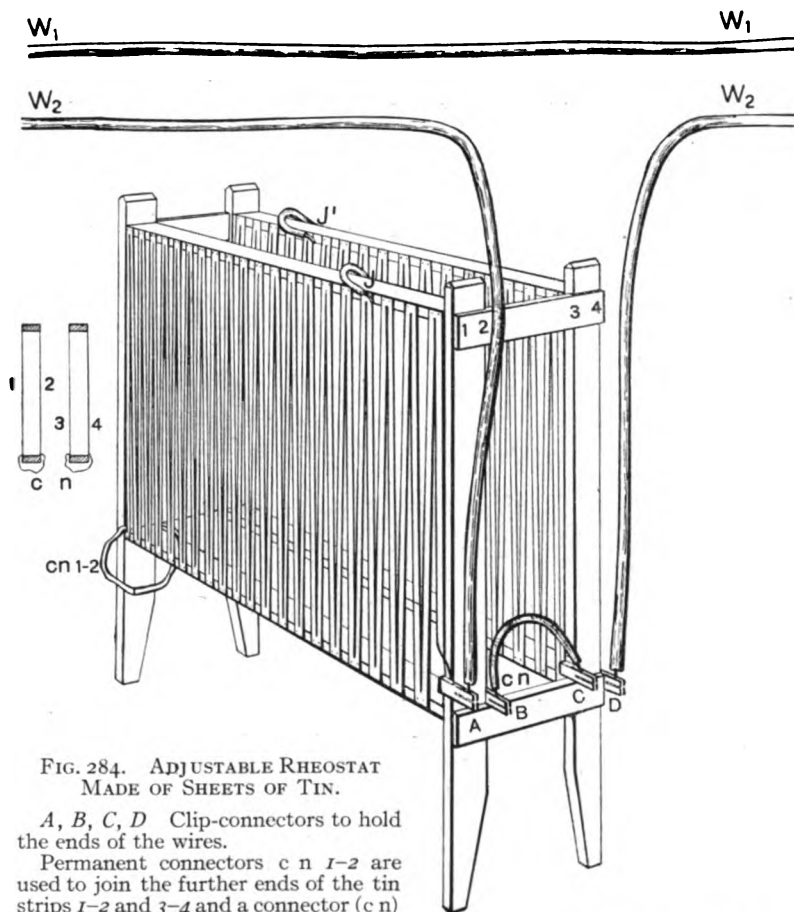

FIG. 284. ADJUSTABLE RHEOSTAT MADE OF SHEETS OF TIN.

A, B, C, D Clip-connectors to hold the ends of the wires.

Permanent connectors *c n 1-2* are used to join the further ends of the tin strips *1-2* and *3-4* and a connector (*c n*) is used between *B* and *C*.

J, J' Movable adjusters to include more or less of the resistance in the circuit and thus increase or diminish the amperage.

This rheostat is composed of four sheets of tin cut as shown in fig. 285. It is, therefore, four rheostats in series (see fig. 287). As here connected all four sheets are used. By putting supply wire *W2* from *A* to *C* or from *D* to *B* only two of the sheets would be used. Then by means of the adjusters *J* and *J'* the amount of resistance can be increased or diminished at will.

The small diagram at the left shows how the pairs of strips of each side are connected with each other at the far end.

At the near end of the frame the arched wire connects the two pairs of plates of both sides at *B* and *C*.

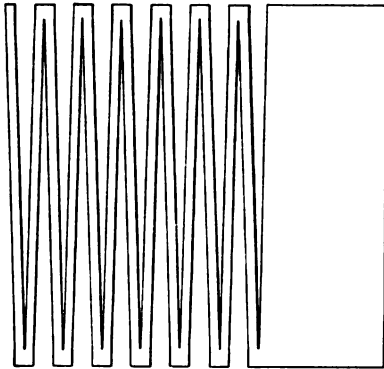

FIG. 285. TO SHOW THE TIN PLATE CUT IN INCOMPLETE STRIPS FOR THE RHEOSTAT.

Cut in this way the tin plate is like a continuous flat wire.

To make this an adjustable rheostat, a "jumper" of heavy copper wire or of sheet copper is put across from one sheet to the other as shown. By this means the current can be sent through as much or as little of the resistance as desired, thus giving a great range in the amperage. As the surface is very great in the thin sheet iron, the air currents carry off the heat developed so that this rheostat does not become unduly heated. It is a very common form around physical laboratories, but is bulky and not very well adapted to a magic lantern or a moving picture installation. Furthermore, such a rheostat does not fulfill the requirements of the National Electrical Code, as there is too much combustible material in connection with it, and the resistance is not boxed in.

§ 734. Rheostats in series.—

If one has two rheostats, less current will be allowed to flow if they are connected to the line in series, that is, so that all the current must flow through both

straight in the bottom of a river or creek. The flowing water keeps the resistance wire cool.

§ 733. Home-made rheostat of tin strips.—A good adjustable rheostat for experimental purposes can be cheaply made by cutting tinned sheet iron into strips as shown in figure 284, 285, and nailing these strips to a wooden frame. One end of the conductor is fastened to one end of the sheet, and the other to the other end of the sheet.

To make this an adjustable

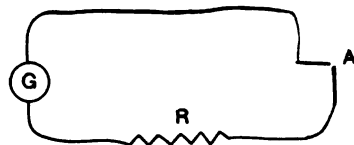

FIG. 286. AN ELECTRIC CIRCUIT AND GENERATOR.

G Generator.
A Arc Lamp.
R Rheostat.

rheostats. According to Ohm's law (§ 724a), the amount of current varies inversely as the resistance, then if two equal rheostats were used only half as much current would flow as when one rheostat is used. Also if the voltage is increased the amperage will increase in the same ratio provided the resistance remains constant. Then if one has two rheostats, each of the right capacity for an arc lamp with a 110 volt circuit, the two in series would give approximately the correct number of amperes on a 220 volt circuit. The amperage would be somewhat higher on the 220 volt circuit because when used singly on a 110 volt circuit each is somewhat reinforced by the resistance of the arc lamp. When both are used for one lamp on a 220 volt circuit there is not twice the resistance, hence the amperage will be somewhat greater than with one rhostat on a 110 volt circuit.

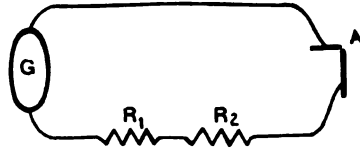

FIG. 287. RHEOSTATS IN SERIES.

G Dynamo.

A Arc lamp.

R_1, R_2 Rheostats in series, all the current must pass through both of them (compare fig. 288).

The two rheostats R_1 and R_2 are connected in series to get a smaller current than can be obtained by the use of one alone.

§ 735. **Rheostats in parallel.**—If two rheostats are inserted in parallel as shown in fig. 288, two

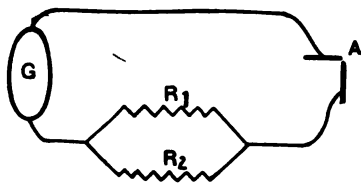

FIG. 288. TWO RHEOSTATS IN PARALLEL, GIVING TWO PATHS FOR THE CURRENT.

G Dynamo.

A Arc lamp.

R_1, R_2 Rheostats in parallel.

With two or more paths for the current, the total amperage will be the sum of the amperages going over each path (§ 735).

paths are furnished for the current. The amperage given by both will be the sum of that given by each separately, for example, if one had two fixed rheostats, each one giving five amperes of current, if they were connected with the line in parallel, 10 amperes would be allowed to flow. On the other hand if they were connected in series (fig. 287) so that all the current had to flow through both of them then only $2\frac{1}{2}$ amperes of current would be available. (See § 724 a).

§ 736. **Reactors, inductors, choke-coils, economy-coils, compensator-coils, etc.**—When alternating current is used the wasteful method of current control by means of a resistor or rheostat where so much electrical energy is transformed into heat should be avoided whenever possible.

In place of a rheostat such as is described above (§ 723+) an inductor is used. This consists of a soft-iron core around which is wound a coil of insulated wire. The alternating current passes through this coil; this alternately magnetizes and demagnetizes the soft-iron core and limits the flow of the current. But the energy is not dissipated, for the energy used in magnetizing the core is given up again when the core is demagnetized. It is true that a small amount of the energy is wasted in heating the apparatus, but the amount is so small (5% to 8%) as compared with that lost in a rheostat that it is negligible.

Variable amperage can be obtained with an inductor by having the soft-iron core movable so that a greater or less amount of it will be within the coil.

The more of the soft-iron core within the coil the greater will be the inductance and hence the less the amperage; and conversely, the less of the soft-iron core within the coil the less will be the inductance and the greater the amperage. In fig. 197 the core is only partly inserted in the coil and a medium amount of current is therefore allowed to flow.

§ 737. **Wiring the inductor and transformer.**—The inductor is

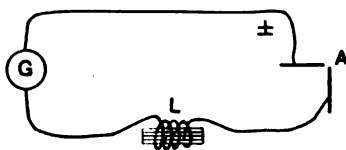

FIG. 289. INDUCTOR IN SERIES WITH AN ARC LAMP.

G Dynamo.

± Alternating current circuit.

A Arc lamp with right-angle carbons.

L Inductor to serve as ballast with alternating current.

inserted along one wire (in series) exactly as the rheostat is inserted (fig. 289). With a special arc lamp transformer the line is connected to the primary of the transformer and the arc lamp is connected to the secondary without the use of resistance (fig. 290).

§ 738. **Comparison of the amount of energy used with an inductor and with a rheostat.**—(A)

With an inductor.—Let the line voltage be 110 and the amperage 55 as shown by the ammeter; the voltage across the arc will be 34 volts. The power consumption will be volts times amperes, that is, in this case, $34 \times 55 = 1870$ watts or 1.87 kilowatts. As the inductor does not absorb an appreciable amount of energy, the 1.87 kilowatts represents the energy needed to produce the arc light.

(B) With a rheostat.—If now a rheostat is used, the wattmeter will record not only the energy required to maintain the arc light, but also the energy wasted in heating the rheostat.

For example, suppose as above that the line voltage is 110, the amperage 55, and the voltage across the arc is 34. Then as before the arc light requires $34 \times 55 = 1870$ watts or 1.87 kilowatts.

But the difference between the 34 volts at the arc and the 110 volts in the line (76 volts) is used in heating the rheostat.

The energy used in heating the rheostat is then $76 \times 55 = 4180$ watts or 4.18 kilowatts. Both this wasted energy as well as the actual energy used in the arc will be recorded on the wattmeter and the user of the arc lamp will have to pay for $1.87 + 4.18 = 6.05$ kilowatts to run his lamp instead of the 1.87 kilowatts when the inductor is used. That is it will cost more than three times as much to run the arc lamp with a rheostat as with an inductor or choke-coil.

STATIONARY TRANSFORMER FOR ALTERNATING CURRENT

§ 739. **Transformer.**—A transformer is a device for changing the voltage of an alternating electric current. This change may be an increase in the voltage—*step-up transformer*, or a decrease in the voltage—*step-down transformer*. The device consists in a soft-iron ring wound with coils of insulated wire. In the simplest

§ 738a There is no simple method of economizing with direct current comparable with the use of an inductor with alternating current. Sometimes when one must draw on a current at 220 volts pressure there is used a motor generator set. The motor is driven by the 220 volts current and the generator produces current at 60 to 70 volts pressure. At this voltage only a limited amount of resistance is necessary (§ 747), and there is some saving, but not so much as by using an inductor with alternating current.

case there are two coils (fig. 291). If an alternating current supply is connected with the primary coil an alternating current can be drawn from the secondary coil.

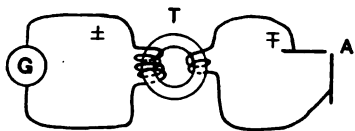

FIG. 290. USE OF A SPECIAL TRANSFORMER WITH AN ARC LAMP.

- G Dynamo.
 ± Alternating current circuit.
 T Transformer.
 A Arc lamp.

The primary of the transformer is connected to the dynamo while the secondary is connected to the arc lamp.

The transformer has sufficient "reactance" to serve as a ballast for the arc as well as to act as a step-down transformer.

The voltage and amperage which can be drawn from the secondary coil will depend upon the electric supply and upon the relative number of turns of wire in the primary and in the secondary coils. If the number of turns is the same in both, then the voltage and amperage remain practically the same as if the coils were not present. In other words the circuit is in every way *almost* as if the wire were continuous. If the transformer were perfect the voltage and amperage would be exactly the same as if it

were not present. In practice they are a little less, but a good transformer gives an efficiency of 95% to 98%.

If the secondary coil has a different number of turns from the primary coil then the voltage will vary directly as the ratio of the number of turns in the two coils, and the amperage will vary inversely as that ratio. That is, assuming that there is no loss in the transformer, the watts delivered will remain constant as the product of volts x amperes remains the same.

For example, suppose the secondary coil has $\frac{1}{4}$ th as many turns as the primary coil, then the number of volts across the secondary will be $\frac{1}{4}$ th the number across the primary and the number of amperes delivered by the secondary will be four times the number drawn by the primary. If now the primary is connected to a 220 volt line there will be a potential difference of one-fourth that number or 55 volts across the terminals of the secondary coil. Suppose the secondary coil supplies 60 amperes, as might be the case with an arc lamp, then the primary coil would draw one-fourth

of this number, or 15 amperes from the line. The watts in the two cases are theoretically exactly the same.

The watts for the primary are $220 \times 15 = 3300$.

The watts for the secondary are $55 \times 60 = 3300$.

$$(1) \frac{\text{Volts secondary}}{\text{Volts primary}} = \frac{\text{Turns secondary}}{\text{Turns primary}}$$

$$(2) \frac{\text{Amperes primary}}{\text{Amperes secondary}} = \frac{\text{Turns secondary}}{\text{Turns primary}}$$

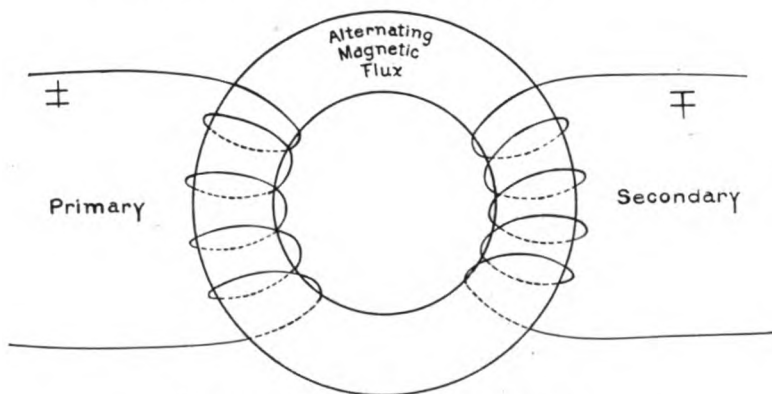

FIG. 291. DIAGRAM OF A TRANSFORMER.

Two coils of a wire, Primary and Secondary, are wound on an iron ring. An alternating current in the primary sets up an alternating magnetic flux in the iron ring, which in turn sets up an alternating electric potential in the secondary coil.

THE ELECTRIC ARC

§ 740. The construction of an electric arc is very simple. Two electrodes are taken which may be made of any conducting material. One electrode is connected directly to one of the wires of a direct current supply of over 40 volts, the other electrode is connected through a rheostat to the other wire (fig. 280). When the two electrodes are brought in contact an electric current will flow between them. If now, the electrodes are slightly separated, the current will not be immediately interrupted, but will flow through the air gap between the electrodes.

The exact nature of the resulting phenomenon will depend upon the material of which the electrodes are made, upon the voltage of the current supply and the resistance of the rheostat, and the kind of gas surrounding the electrodes.

§ 741. **Arc lamp.**—Any arrangement for holding the electrodes and feeding them together as they wear away may be called an arc lamp.

It consists of three essential elements:—(1) A clamp for holding the positive electrode; (2) A clamp for holding the negative electrode; (3) A mechanism for moving the holders and therefore the electrodes nearer together or separating them farther apart.

The electrode holders must be insulated so that the current must flow through the electrodes and not follow any short circuits (fig. 270).

For the hand-feed and the automatic types of arc lamps see Chapter I, § 9-11.

§ 742. With direct current, the arc is made up of three parts.

1. The arc stream; a highly heated, incandescent gas which conducts the current between the electrodes.
2. The positive crater; where the current leaves the positive electrode to enter the arc stream.
3. The negative crater; where the current leaves the arc stream to enter the negative electrode (fig. 292).

§ 743. **Electrical behavior of the direct current arc.**—Measurement of the voltage drop in various parts of the carbon arc reveals the fact that the potential difference between the two electrodes (§ 743a) is made up of three parts. Starting from the positive side, the potential difference between the positive electrode and the arc stream is about 32 volts. The potential difference between the arc stream and the negative electrode is about 9 volts, thus the potential difference between the electrodes with the shortest possible arc is about 41 volts (§ 743b).

As the arc is lengthened there is an additional drop in potential in the arc stream which depends mainly on the length, but partly on the cross section of the arc stream. As the arc length is changed,

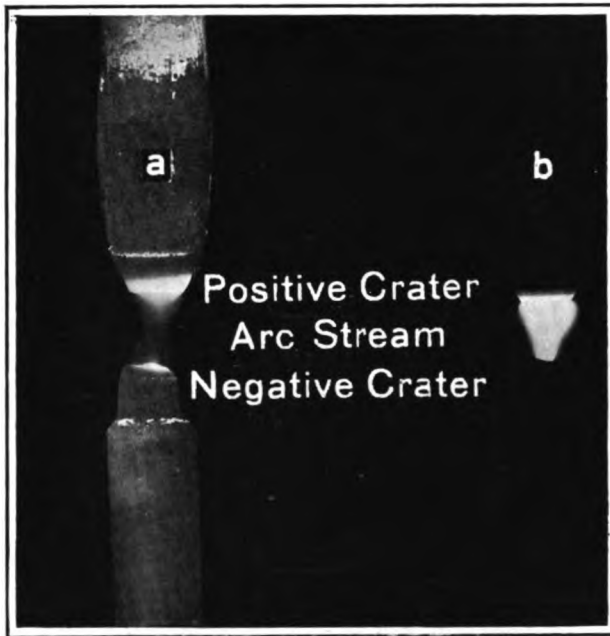

FIG. 292. THE VERTICAL CARBON ARC WITH 20 AMPERES OF DIRECT CURRENT.

a Vertical carbons with the positive carbon above and the negative carbon below. This shows that the large crater is on the positive carbon and the small crater on the negative carbon. Between the two craters extends the arc stream of hot gases.

This photograph was made with an exposure of $1/100$ second, the aperture being $F/22$. A color screen was used to cut out most of the violet, so that the arc stream would not obscure the craters. A subsequent exposure of 90 seconds was made without a color screen and with an aperture of $F/8$. The illumination during this exposure was by means of a 40 watt, mazda lamp.

b Vertical carbons with a 20 ampere direct current. No color screen. Exposure $1/100$ sec.; opening $F/22$.

This shows the size of the two craters; it also shows the conical arc stream almost as light as the craters. This is because the violet light which has relatively little effect in illumination has a great effect on the photographic plate.

This picture shows how the carbons, the craters and the arc stream appear in an instantaneous view to the photographic plate, while the one at the left (*a*) gives much more nearly the appearance to the human eye with an instantaneous view.

the change in voltage is almost entirely due to the change in the length of the arc stream.

When the arc is of medium length, as for use in projection, the potential difference between the two carbons averages about 55 volts. This would mean that there is a drop of 32 volts between the positive carbon and the upper end of the arc stream, a drop of 14 volts between the upper and lower ends of the arc stream, and 9 volts between the lower end of the arc stream and the negative carbon.

If the electrodes are made of other substances than carbon, the potential drop is differently distributed. Thus in the "Luminous"

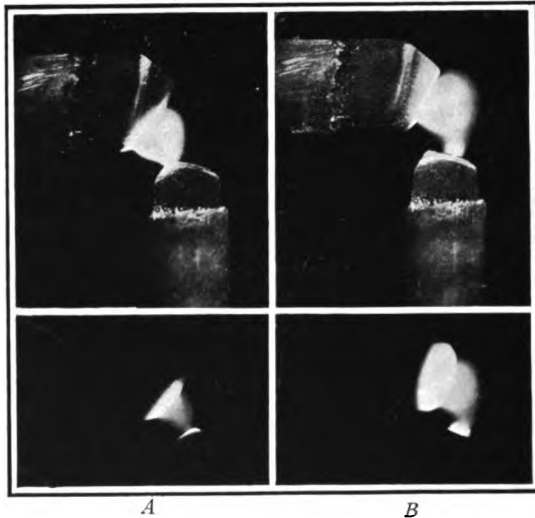

FIG. 293. SIDE VIEW OF THE RIGHT-ANGLE CARBON ARC WITH 10 and WITH 20 AMPERES OF DIRECT CURRENT

A 10 ampere arc, *B* 20 ampere arc. The size of the positive crater is markedly larger with the higher amperage.

The lower pictures were made by an instantaneous exposure.

The upper pictures were made by a double exposure, that is, an instantaneous exposure with the current on, to show the craters and the arc stream, and then an additional exposure of 90 seconds with the current off to bring out the carbons. For the second exposure a 40 watt, mazda lamp was used for illuminating the carbons.

arc which consists of a copper positive electrode and a negative electrode made of a mixture of iron and titanium oxides, the lowest arc voltage is about 30 volts. The lowest arc potential between electrodes of other substances than carbon are, magnetite 30; platinum 27; iron 26; nickel 26; copper 23; silver 15; zinc 16; cadmium 16; mercury 13.

The potential differences in the arc lamp are practically constant no matter what current is flowing, but there is a small change with change in current. This is generally such that the greater the current the less the potential difference, and may be explained as follows:

Suppose a current of 10 amperes to be flowing between the two electrodes of an arc lamp. This will be carried by a small cone shaped mass of conducting gas (fig. 293 A). If the current is increased to 20 amperes the extra heat developed is sufficient to bring more air to a high enough temperature to conduct current, and the cone of conducting gas increases in diameter (fig. 293 B).

A large cone of conducting gas will be losing heat at a relatively less rate than will a small cone, hence its temperature will be higher and its resistance will be less. As a result of the increased conductivity of the hot gases of the arc stream, the greater the current the lower will be the potential difference between the electrodes. There is also a slight lowering of the contact potential difference between the electrodes and the arc stream as well as a lessening of the potential drop in the arc stream.

THE USE OF BALLAST

§ 744. **The need of a ballast in series with the arc to control the current.**—On account of the peculiar electrical behavior of the arc lamp it is necessary to use a ballast such as rheostat, or an inductor in series with the arc, or else to use an especially designed generator.

§ 743a. While the two electrodes of an arc lamp may be of any conducting material, with projection arc lamps the electrodes are always made of carbon and are generally referred to simply as carbons.

§ 743b. These figures are approximations and vary slightly with arc length and current but are general averages for the usual arc lengths employed: 3 to 10 mm.

See Mrs. Ayrton, *The Electric Arc*.

With a metallic wire, the resistance is nearly constant, and the potential difference is greater the greater the current flowing. Any change in resistance is due to the rise of temperature when a current is flowing. The higher the temperature, the greater the resistance. An arc, on the other hand, has no definite resistance, but its resistance varies with the current flowing. This variation is such that



FIG. 294. FACE AND LATERAL VIEWS OF THE RIGHT-ANGLE CARBON ARC WITH 10 AND WITH 20 AMPERES OF DIRECT CURRENT.

A With 10 amperes, *B* with 20 amperes of direct current.

The size of the crater in the two cases is very strikingly brought out.

The middle figures had an additional exposure to bring out the carbons (see fig. 292-293), while the lateral views above and the front views below had only an instantaneous exposure.

The positive crater above and the negative crater below are clearly brought out in all the pictures (see fig. 292).

the potential difference across the arc remains nearly the same regardless of how much current is flowing.

The commercial electric supply is designed to furnish current for incandescent lamps, and is maintained at a nearly constant voltage no matter how much current is used. The arc lamp, on the other hand, is to be supplied by a constant current. If one were to attempt to connect an arc directly to the terminals of the supply

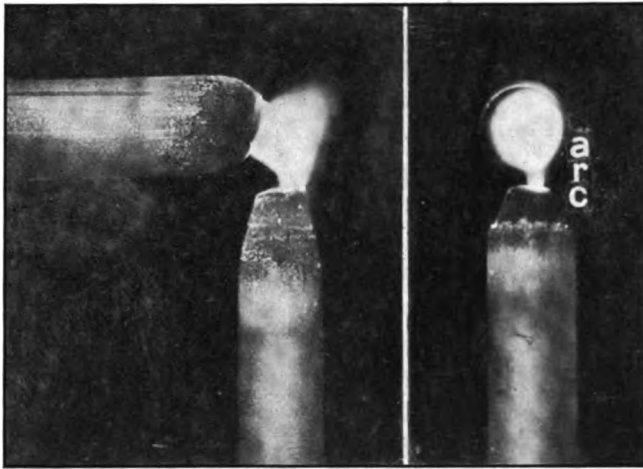

FIG. 295. LATERAL AND FACE VIEW OF THE RIGHT-ANGLE CARBON ARC WITH 20 AMPERES OF DIRECT CURRENT.

No color screen was used with the lateral view so that the arc stream would show. In the front view a color screen was used to bring out clearly the large positive crater above and the small negative crater below.

This figure is for comparison with the alternating current arc in fig. 296.

To bring out the carbons, an additional exposure was made as for fig. 292-293.

line without an intermediate rheostat, as soon as the two electrodes were brought in contact an extremely large current would flow. Theoretically, this current would be infinite, but practically the flow is limited by the very small resistance of the supply wires and the capacity of the dynamo. In a modern installation the current would be immediately interrupted by the circuit breakers and burn-

ing out of the fuses before any serious damage could result. Even after the arc is burning, if one were to remove the resistance by short-circuiting it, the current would increase to an enormous value.

§ 745. **Example with 110 volt supply, using a rheostat.**—If we assume that the arc is of such a length that the potential difference between the electrodes is 10 volts, and that this potential difference

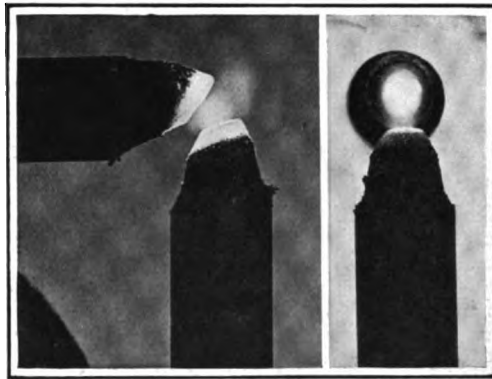

FIG. 296. LATERAL AND FACE VIEWS OF THE RIGHT-ANGLE CARBON ARC WITH 25 AMPERES OF ALTERNATING CURRENT.

By comparing this picture with fig. 295 it will be seen that in this both craters are of the same size; and that, although 25 amperes of current are flowing, the crater on the upper carbon from which the light is derived is much smaller than with the direct current. The sizes of the upper crater give a good idea of the amount of illumination furnished in the two cases.

An additional exposure was made to bring out the carbons as in fig. 292-293.

remains practically the same if the current is diminished or increased, and if the supply is 110 volts, and that this voltage is practically independent of the current used, it is evident that between one of the electrodes and one of the supply wires there must be a potential drop of 60 volts. By using a rheostat at this point the current is controlled. Thus suppose that the rheostat has a resistance of 6 ohms, then according to Ohm's law (§ 724a), as the potential difference across its terminals is 60 volts, the current will

be 10 amperes, $V/O = A$. Now suppose the arc length were changed say by bringing the electrodes in contact. In this case there would be the full line voltage, 110 volts across the rheostat and the current would be $110/6 = 18.3$ amperes. Suppose the arc length were increased until the potential at the arc was 60 volts. The potential across the rheostat would then be $110 - 60 = 50$ volts. The current would then be $50/6 = 8.2$ amperes. In this example the conditions are what is known as stable, that is, as the arc length is decreased the current is increased, but does not reach an infinite value, and as the arc length is increased the current decreases but it does not become zero.

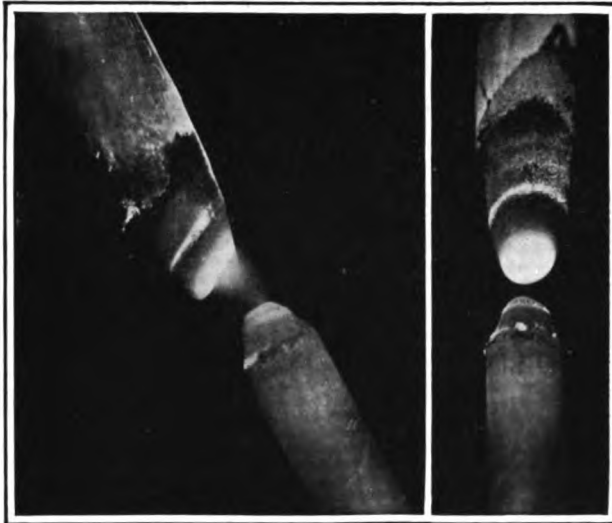

FIG. 297. LATERAL AND FACE VIEWS OF AN INCLINED CARBON ARC WITH 20 AMPERES OF DIRECT CURRENT.

This picture shows that with the inclined carbons in proper position, the positive crater on the upper carbon faces toward the condenser. It is evident also that as the carbon burns away the crater will get farther and farther above the principal axis of the projection apparatus.

An additional exposure was made to bring out the carbons as with fig. 292-293.

§ 746. **Line voltage exactly equal to arc voltage.**—It would appear that it might be desirable to use a line voltage of exactly what is required by the arc and omit the rheostat. Suppose in the above example that this were done by using a line voltage of 50 volts. Now as the arc voltage is constantly varying owing to slight irregularities in the carbons, to the wearing away of the carbons and to other causes, it is evident that for an instant the arc voltage might drop below 50 volts or it might rise above 50 volts. If the arc voltage should rise above 50 volts, the arc would immediately go out as the supply is but 50 volts, and if the arc voltage should drop slightly below this value, the current would rapidly increase. The result would be that the arc would either go out or else would act like a short circuit. In this example the conditions are unstable; that is, no definite current can be maintained.

§ 747. **Intermediate voltage.**—In practice an intermediate voltage is sometimes used, that is, dynamos to be used for projector arcs are sometimes designed for about 70 volts. Here the arc is sufficiently stable for practical purposes but requires more attention than with the higher supply voltage. Taking the above example. The arc voltage at 50 volts leaves 20 volts across the rheostat. To give 10 amperes requires $20/10 = 2$ ohms resistance. If now the electrodes are brought in contact to start the arc the current will be limited only by the resistance in the rheostat and the current will be $70/2 = 35$ amperes. If the arc gets long enough to take 60 volts, the difference to be taken up in the rheostat is but 10 volts, and the current will drop off to $10/2 = 5$ amperes. This, therefore, means that with the smaller margin between the line voltage and the arc voltage, the arc becomes less stable.

§ 748. **Ballast with alternating current.**—With alternating current, an inductor (choke-coil) is often used instead of a rheostat. This behaves as a ballast in a somewhat similar way to the rheostat but to explain the exact process of regulation would require a more exhaustive discussion of alternating currents than is justified in this book, but see § 736.

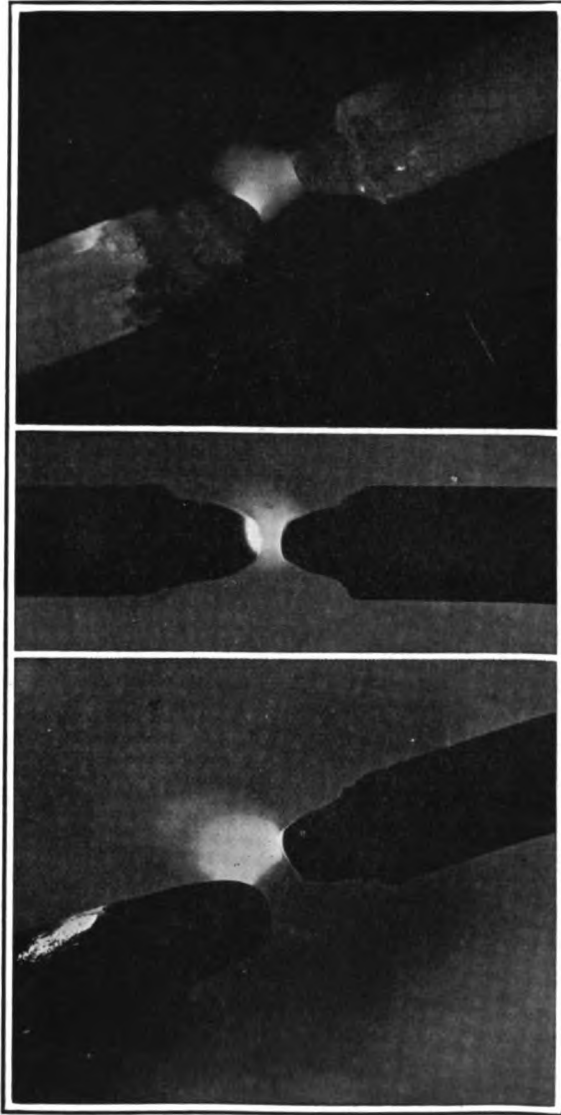

FIG. 298. FRONT AND SIDE VIEWS OF THE INCLINED CARBON ARC WITH 25 AMPERES OF ALTERNATING CURRENT.

A, C Side views. In *A* the craters are too far forward and the arc stream shows very clearly as there was no color screen used.

In *C* the craters are in proper position and the arc stream shows as it does to the eye.

B Is a front view taken with a color screen. This shows the small crater on the upper carbon. It is much smaller than the crater on the upper carbon with 20 amperes of direct current. Compare fig. 297. An additional exposure was made to bring out the carbons (see fig. 292-293).

THE LIGHT PRODUCTION OF THE ARC

§ 749. **Cause of light from the arc.**—The light production from the carbon arc is due entirely to the high temperature to which the tips of the carbons are raised, i. e., they become white hot. The practical problem in projection with the arc deals with the best method of producing this white heat and of utilizing it.

When the electric current passes between the two electrodes the heating effect in the different parts is proportional to the power consumed in them.

The current being the same in all parts, the heating effect must be in proportion to the potential drop (or voltage consumed) in the different parts.

Counting the total drop 55 volts, it is divided into:

+ crater drop	=	32 volts	=	58%
— crater drop	=	9 volts	=	17%
arc stream	=	14 volts	=	25%
Total,		55 volts		100%

We see from this that the heating effect will occur principally at the positive carbon.

Carbon being rather a poor conductor of heat, the heat generated within the small area of the crater must escape mainly by radiation.

At the negative electrode the heat production is less rapid and not so high a temperature is reached.

Between the electrodes the heat production is fairly rapid, but the hot gases of the arc stream with the carbon arc are nearly transparent and radiate energy very slowly.

Furthermore the violet lines of the spectrum in the arc stream are brighter than from the crater itself (§ 749 a).

§ 750. **Temperature of the crater.**—The temperature of the positive crater rises until such a temperature is reached that carbon

§ 749a. The great brilliancy of the violet lines in the arc stream has received two explanations: (1) That the arc stream is higher in temperature than even the crater itself; (2) That the electric current passing through the gas causes the gas to glow irrespective of its temperature. That is, it causes electroluminescence as in the vacuum tube or the aurora borealis.

is volatilized. This is the highest temperature which it is possible to obtain artificially. The temperature of the positive crater of the carbon arc has been estimated at about 3700° absolute, that is, 3427° Centigrade or 6200° Fahrenheit (§ 750a). Compare this with the temperature of the sun, about 6750° absolute, 6477° C.; the acetylene flame, 2330° absolute, 2057° C.; the gas flame, 1830° absolute, 1557° C. (§ 750b).

§ 751. **Parts of the light source.**—Considered as a light source, the direct current arc may be divided into four parts.

1. The positive crater.
2. The negative crater.
3. The hot ends of the carbons adjacent to the craters.
4. The arc stream.

The light emitted by the hot electrodes depends upon their visible radiation being approximately proportional to the 5th power of their absolute temperature. The positive crater is the hottest part of the arc and furnishes most of the light. The negative crater furnishes much less light than the positive crater, being smaller and not as hot.

The carbons are white hot for some distance away from the craters and furnish some of the light of the arc. In calculating the total light from the arc it would be necessary to consider the entire area included between the line surrounding the positive carbon which is at red heat and the corresponding line on the negative carbon.

The arc stream with the carbon arc emits but little useful light. When flame-arc carbons are used, however, the greater part of the

§ 750a. Bulletin of the Bureau of Standards, Vol. 1, p. 909 and reprint 8.

§ 750b. **Absolute temperature.**—The absolute zero is defined as the temperature at which a perfect gas would exert no pressure. This is about -273° centigrade, i. e., 273° centigrade below the melting point of ice. In calculations of high temperature and radiation, all formulæ are based on absolute temperature, that is, the temperatures where the zero is the absolute zero and where the degree is the degree centigrade.

To find the absolute temperature of a body add 273° to its temperature on the centigrade scale. Thus ice melts at 0° centigrade or 273° absolute, and water boils at 100° centigrade or 373° absolute. The temperature of the human body, 37.5° C. is 310.5° absolute. If the absolute temperature is given, subtract 273° from this value to find the centigrade reading.

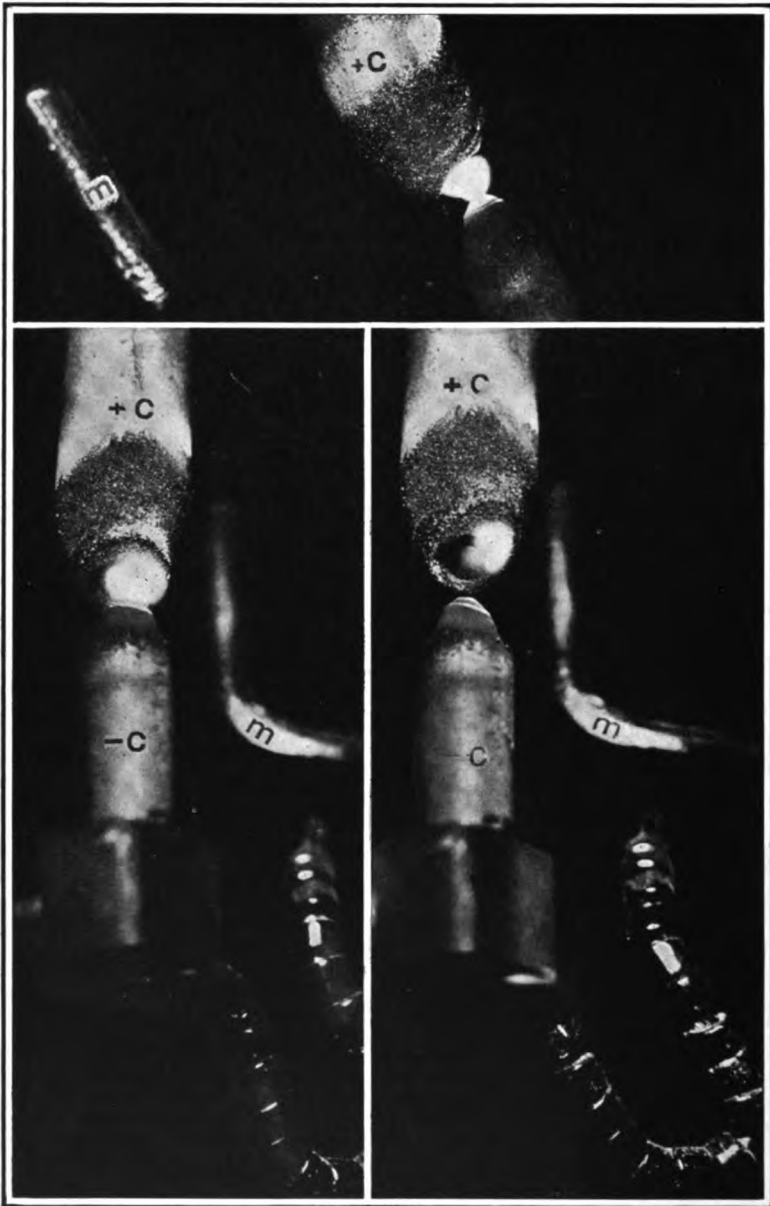

FIG. 299

FIG. 299. SIDE AND FRONT VIEWS OF THE INCLINED CARBON ARC WITH 15 AMPERES OF DIRECT CURRENT (EWON'S AUTOMATIC LAMP).

The upper carbon (+c) is soft-cored and 18 mm. in diameter; the lower carbon (—c) is solid and 12 mm. in diameter.

This is to illustrate an automatic lamp with a magnet (*m*) to control the magnetic blow; the use of a large, cored upper carbon (+c) 18 mm. in diameter; and a small solid lower or negative carbon (—c) 12 mm. in diameter.

Incidentally there is shown the wandering of the crater in the right hand lower picture. When the crater wanders in this way the source of light is outside the principal optic axis.

Photographed with an instantaneous exposure for the arcs and with an additional exposure of 90 seconds for the carbons and the blow magnet (see fig. 292-293).

light is furnished by the incandescent gases of the arc stream. Flame-arc carbons are not ordinarily used in projection.

For purposes of projection, only the light from the positive crater of the direct current arc, or usually from only one of the craters of an alternating current arc need be considered. The large objective of the magic lantern utilizes the light from both carbons with alternating current and this is important.

§ 752. **The alternating current arc.**—Most conducting materials when used as the terminals of an arc lamp will not allow a reversal or even a very short interruption of the current without going out. This property is used in the mercury arc rectifier.

When carbon electrodes are used, however, the current may be interrupted for a short interval, or the current may be reversed without putting out the arc.

When the alternating current is used, first one carbon and then the other is positive. Craters of equal intensity are formed on both carbons, but neither is as bright nor as large as is the single positive crater when direct current of the same amperage is used.

The light from a single crater is not steady but is intermittent.

The process during one cycle can be described as follows:

When the current is reversed so that, say, the upper carbon becomes positive, the crater is fairly cool. For the short time it is the positive crater, its temperature rises very rapidly. Whether or not it momentarily reaches the temperature which it would if permanently the positive crater is uncertain. The current dies out and the crater cools rapidly. When the current has reversed

its direction the crater is negative. The heating effect of the current is small and the carbon tip continues to cool until the current has again died out. This cooling still continues until the current has again reversed its direction, and increased to a considerable positive value.

The temperature of an alternating current arc crater is at no instant higher than that of a direct current arc crater with the same amperage, and, as part of the time its temperature is much lower than this, the average temperature will be lower than with a direct current crater, hence the light will be less and of a yellower color.

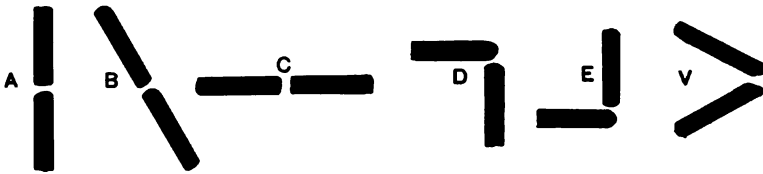

FIG. 300. SOME POSITIONS OF THE CARBON ELECTRODES USED IN PROJECTION LAMPS.

A Vertical carbons. This position gives the least light along the principal optic axis.

B Inclined carbons.

C Horizontal carbons. This arrangement is common for the search light, and for the reflectors used in projection (see fig. 95).

D The usual arrangement for the carbons when at right angles. The upper or horizontal carbon is positive with direct current. The crater on it is in the optic axis and serves as the source of light with both direct and alternating current.

E Right-angle carbons in which the horizontal, positive carbon is below. This is an unusual arrangement.

V V-arrangement of the carbons for alternating current. With this arrangement both craters supply light for the projection of lantern slides or opaque objects.

THE ARC LAMP AS AN ILLUMINANT

§ 753. The arc lamps suitable for projection purposes may have the carbons in any one of five positions.

1. With inclined carbons (fig. 297).
2. With carbons at right angles (fig. 295).
3. With converging carbons (fig. 300).
4. With vertical carbons (fig. 292).
5. With horizontal carbons along the axis (fig. 300).

Most of the light from the arc, and all of the light which is useful for projection comes from the craters of the arc; from the positive crater, if a direct current arc.

§ 753a. Table showing the proper size of cored-carbons for different amperages, and the rate of wear in millimeters per hour; also the relative rate of burning in length and in weight.

(For the small carbons to be used on the house electric lighting system see § 123, 131, 417-418.)

Direct Current, Right-Angled Carbons.

AUTOMATIC LAMP				
Amperes	Size Carbons	Burns, mm. per Hour	Relative Volume	Relative Burning Weight
10	$\frac{11}{8}$ upper	<u>37</u>	$\frac{1.8}{1}$
	8 lower	39	1	
15	$\frac{11}{8}$ "	<u>47</u>	$\frac{1.65}{1}$	$\frac{1.69}{1}$
	54	54	1	1
15	$\frac{14}{11}$ "	<u>27</u>	$\frac{1.75}{1}$	$\frac{1.67}{1}$
	11	25	1	1
20	$\frac{14}{11}$ "	<u>36</u>	$\frac{1.87}{1}$	$\frac{1.77}{1}$
	11	31	1	1
20	$\frac{14}{11}$ "	<u>36</u>	$\frac{1.53}{1}$	$\frac{1.36}{1}$
	11	38	1	1
25	$\frac{14}{11}$ "	<u>41</u>	$\frac{1.95}{1}$	$\frac{1.92}{1}$
	11	34	1	1
25	$\frac{14}{11}$ "	<u>40</u>	$\frac{1.61}{1}$	$\frac{1.31}{1}$
	11	40	1	1
HAND-FEED LAMP				
15	$\frac{11}{11}$ "	<u>53</u>	$\frac{1.65}{1}$	$\frac{1.51}{1}$
	11	32	1	1
20	$\frac{14}{14}$ "	<u>37</u>	$\frac{1.62}{1}$
	14	23	1	
40	$\frac{14}{14}$ "	<u>48</u>	$\frac{2.00}{1}$	$\frac{2.00}{1}$
	14	24	1	1
40	$\frac{15}{15}$ "	<u>44</u>	$\frac{2.2}{1}$	$\frac{2.26}{1}$
	15	20	1	1

Direct Current, Inclined Carbons.

HAND-FEED LAMP.				
Amperes	Size Carbons	Burns mm. per Hour	Relative Volume	Relative Burning Weight
15	<u>14</u> upper	<u>41</u>	<u>1.62</u>	<u>1.33</u>
	11 lower	41	1	1
20	<u>14</u> "	<u>37</u>	<u>1.84</u>	<u>1.77</u>
	11	34	1	1
25	<u>14</u> "	<u>39</u>	<u>1.9</u>	<u>1.81</u>
	11	33	1	1
40	<u>18</u> cored	<u>26</u>	<u>1.8</u>	<u>2.32</u>
	12 solid	32	1	1
15	<u>14</u> "	<u>28</u>	<u>1.48</u>	<u>1.72</u>
	14	19	1	1
40	<u>14</u> "	<u>54</u>	<u>2.4</u>	<u>2.32</u>
	14	22	1	1

Alternating Current, Hand-Feed Lamp.

RIGHT-ANGLED CARBONS.		
Amperes	Size Carbons	Burns, mm. per Hour
20	<u>11</u> upper	<u>34</u>
	11 lower	34
20	<u>14</u> "	<u>20</u>
	14 "	20
25	<u>14</u> "	<u>20</u>
	14 "	20
INCLINED CARBONS		
25	<u>14</u> upper	<u>24</u>
	14 lower	26
30	<u>15</u> "	<u>30</u>
	15 "	30
35	<u>15</u> "	<u>24</u>
	15 "	30
40	<u>16</u> "	<u>24</u>
	16 "	28

CANDLE-POWER OF ARC LAMPS

§ 754. A number of measurements of the candle-power of arc lamps have been made, partly in the Physical Laboratory at Cornell University, and partly in the Illuminating Engineering Laboratory of the General Electric Company at Schenectady. The experiments made at Cornell were for the higher currents and were made primarily to ascertain the efficiency of the mercury arc rectifier and the power consumption with different forms of ballast (§ 754a).

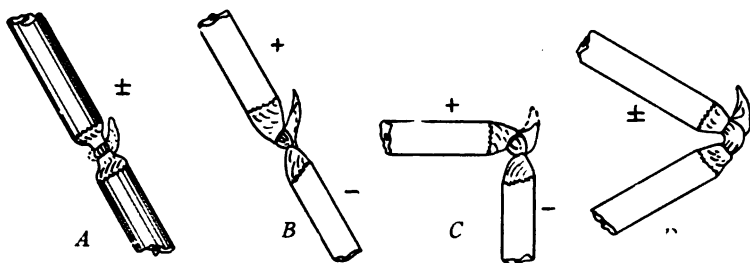

FIG. 301. CARBONS IN THE CORRECT RELATIVE POSITION FOR BOTH DIRECT AND ALTERNATING CURRENTS.

- A Inclined carbons in the correct position for alternating current.
 B Inclined carbons in the correct position for direct current.
 C Carbons at right angles in the correct position for either direct or alternating current. Direct current is indicated.
 D Carbons arranged in a V-shaped position. For this position alternating current only is employed; and the crater on each carbon contributes to the light. The V may be either in a vertical or in a horizontal plane. The vertical arrangement is the more common.

§ 755. **Variation of Candle-Power with current.**—Candle-power measurements were made in the horizontal direction, that is, along the axis of the lantern, using different currents and with both the right-angle and the inclined-carbon arrangements. Great care was taken to hold the position of the electrodes and craters as shown in fig. 301, as these positions furnish the greatest amount of light. With direct current especially, it is necessary that the crater

§ 754a. The results of the Schenectady tests were published in the *Electrical World*, Oct. 13, 1911.

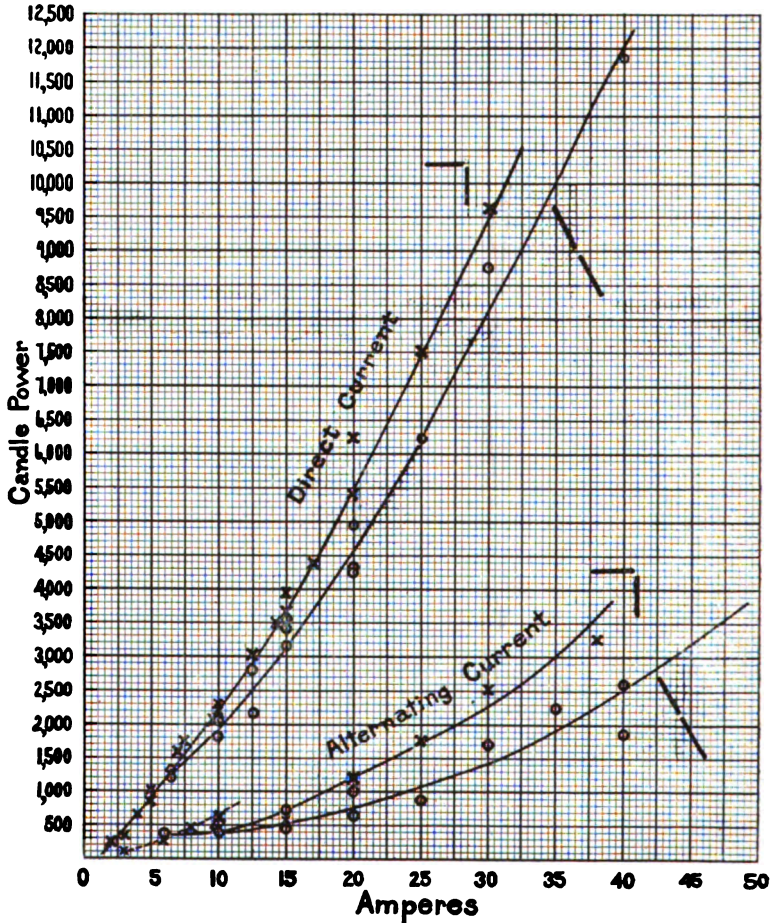

FIG. 302. VARIATION IN INTENSITY OF LIGHT FROM PROJECTION ARC LAMPS WITH DIRECT AND WITH ALTERNATING CURRENT.

x Right-angle arc.

o Inclined carbon arc.

The small dotted curve is for small currents with the right-angle arc burning 6mm. carbons.

As shown by these curves, the right-angle arc lamp gives a greater candle-power for the same current than does the inclined carbon arc lamp, with both direct and alternating current. Also that direct current gives about four times the light that the same number of amperes of alternating current gives.

face forward as is shown in figure 297 for the inclined electrodes and in figures 294-296 for the right-angle arc. The results of these measurements are shown in curve form in fig. 302. These curves show that the greater the current the greater is the amount of light given by the arc. The increase in light is, however, more rapid than the increase in current and no simple mathematical statement of the relationship is possible. The crosses indicate the individual measurements with the right-angle arrangement and the circles, measurements with the inclined carbon arc. The upper curve is for the right-angle arc with direct current. In this case the highest candle-power for the same current (amperage) is obtained. The next curve is for the inclined carbon arc with direct current. The light is not quite as much with this arrangement as with the right-angle arc.

The two lower curves are for alternating current. It will be noticed that there is a greater difference in candle-power depending on the electrode arrangement with alternating than with direct current. The short dotted part of the curve for the right-angle arrangement is for 6 mm. carbons and small currents, while the main part of the curve is for larger carbons.

A table showing the results of the individual measurements might be misleading, as large variations in the light of the arc are continually occurring and a given measurement might be made when the arc was giving its greatest or its least light. For this reason the values given in the table (§ 756) for the candle-power of the arc with different currents were taken from the curve instead of being from individual observations. These values are good averages and may be accepted as close enough to the actual candle-powers for all practical purposes in projection.

§ 756. Table of Candle-Power and Current with Arc Lights.

Size Carbons	Amperes	Direct Current Carbons		Alternating Current Carbons	
		Right-angle	Inclined	Right-angle	Inclined
6 mm.	2	200			
	3	400			
	4	650		100	
	5	900		200	
8 mm.	7.5	1,500	1,400	400	300
11 mm.	10	2,200	1,900	500	400
	12.5	2,900	2,500	600	450
	15	3,700	3,200	700	500
	17.5	4,500	3,800	950	625
13 mm.	20	5,400	4,550	1,200	750
	25	7,500	6,200	1,750	1,100
15 mm.	30	9,500	8,100	2,300	1,400
	35		10,000	3,000	1,900
	40		12,000		2,500
	45				3,200
	50				3,700
	60				4,800

§ 757. Direct current; inclined electrodes.

Amps	Volts	Watts	WATTS 110-Volt Line With Resistance	Candle-Power
15	50	750	1,650	3,490
20	50	1,000	2,200	4,900
25	51	1,270	2,750	6,220
30	53	1,590	3,300	8,750
40	51	2,040	4,400	12,350
Mean	51			

§ 758. Direct current; electrodes at right angles.

Amps	Volts	Watts	WATTS 110-Volt Line With Resistance	Candle-Power
10	56	560	1,100	2,300
15	50	750	1,650	3,680
20	52	1,020	2,200	6,230
25	62	1,550	2,750	7,500
30	58	1,740	3,300	10,150
Mean	55.6			

§ 759. Alternating current; inclined electrodes.

Amps	Volts	Watts	LINE WATTS		Candle-Power
			With Resistor	With Transformer, 96 per cent Efficiency	
20	28	560	2,200	585	620
25	27.5	687	2,750	715	894
30	26.5	795	3,300	830	1,700
40	27	1,080	4,400	1,130	1,830
50	35	1,750	5,500	1,830	4,566
60	32	1,920	6,600	2,000	4,650
Mean	29.2				

Power factor (P. F.) at arc nearly 1.00.

§ 760. Alternating current; electrodes at right angles.

10	44	430	1,100	450	590
15	42	600	1,650	625	763
20	47	920	2,200	960	1,050
25	57	1,370	2,750	1,430	1,690
30	57	1,600	3,300	1,670	2,540
Mean	49.6				

Power factor (P. F.) at arc 0.964.

§ 761. Rectifier; inclined electrodes.

DIRECT CURRENT SECONDARY			ALTERNATING CURRENT PRIMARY						
Amps	Volts	Watts	Amps	Volts	Watts	Volt-Amps	P. F.	Eff.	C. P.
15	51	765	7	175	1,100	1,225	.898	.695	3,100
20	54.5	1,090	9.5	188	1,500	1,786	.84	.727	4,720
25	54	1,350	12	194	1,900	2,330	.816	.711	6,470
30	62	1,860	14.5	220	2,600	3,190	.816	.716	8,600
40	52	2,100	19	215	3,120	4,070	.768	.672	12,150
Mean	54.7						.828	.704	

§ 762. Rectifier; Electrodes at right angles.

10	58	580	5.5	195	850	1,070	.794	.683	1,900
15	45	675	7	180	1,000	1,260	.793	.675	3,000
20	51	1,020	10	203	1,500	2,030	.739	.680	5,600
25	66	1,650	12	235	2,300	2,820	.816	.718	7,370
30	62	1,860	14	233	2,600	3,260	.798	.716	9,450
Mean	56.4						.786	.694	

§ 763. Power in kilowatts drawn from the line for different values of light. Inclined electrodes, 110-volt supply, transformer 96 per cent efficiency.

Candle-Power	KILOWATTS				
	D. C. at arc	D. C. Resist.	A. C. Trans.	A. C. Resist.	Rectifier
1,000	—	—	.6	2.7	—
1,500	—	—	.8	3.2	.7
2,000	.4	1.1	1.1	3.75	.8
2,500	.55	1.3	1.2	4.3	.9
3,000	.6	1.5	1.4	4.9	1.1
4,000	.76	1.9	1.7	5.8	1.3
5,000	1.1	2.25	2.0	6.9	1.5
6,000	1.2	2.6	—	—	1.8
7,500	1.45	3.1	—	—	2.15
10,000	1.8	3.8	—	—	2.75

§ 764. Light given for different values of kilowatt consumption.

Kilowatts	Candle-Power				
1.0	5,500	2,000	2,200	—	3,200
1.5	7,800	3,000	3,400	—	4,800
2.0	12,000	4,300	4,800	500	6,900
3.0	—	7,300	—	1,300	11,000
4.0	—	11,000	—	2,200	—
5.0	—	—	—	3,100	—

§ 765. Candle-power measurements with direct current supplied by a mercury arc rectifier.—By using a mercury arc rectifier to convert alternating current to direct current, very nearly the same light intensity is obtained as if the same amperage of direct

current were supplied by a dynamo. This is shown in figures 303-304 and in the tables which give the results of the Schenectady tests (§ 757-764).

§ 766. **Relation between the power consumption and candle-power.**—Besides the current passing through the arc, it is necessary to know the power consumption, as it is the power consumption which determines the cost of maintaining the arc.

With direct current, the right-angle arc, for example, gave 2300 candle-power and required 56 volts potential difference at the arc. This means a power consumption of 560 watts at the arc with 10 amperes. Under most circumstances, however, the current would be supplied from a 110 volt line and this would represent power

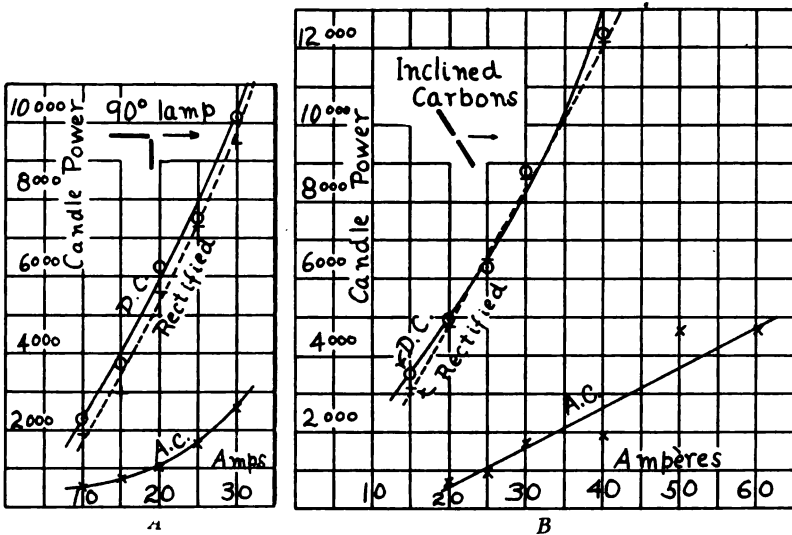

FIG. 303. RELATION BETWEEN CURRENT AND CANDLE-POWER.

A The candle-power variation with right-angle carbons, with alternating, direct and rectified current.

B The candle-power variation with inclined carbons with alternating, direct and rectified current.

These curves show that rectified and direct current give approximately equal illumination and that alternating current gives a much lower candle-power with a given amperage.

drawn from the line to the extent of $15 \times 110 = 1650$ watts. Hence, in fig. 304 there are drawn two curves for direct current, one for the power consumed at the arc, and the other for the power drawn from the line with a 110 volt supply when used with resistance.

With alternating current there are even more possibilities. There is the power consumed at the arc, the power drawn from the 110 volt line with resistance, and the power drawn from the line if a suitable transformer of high efficiency is used. In calculating the power consumption when using a transformer the actual power consumed at the arc was divided by the efficiency of the transformer. Thus with 10 amperes alternating current the right-angle arc consumed 430 watts at the arc. The transformer had 96% efficiency, hence the power drawn from the line was $430 \div .96 = 450$ watts. In addition, curves were drawn showing the power consumption when a rectifier was used.

§ 767. Results.—The results as shown in figures 302–304 are, that with the same amount of power drawn from the line, the least light is given when alternating current is used with a rheostat and the most when alternating current is used with a rectifier. With the right-angle arrangement there is more light for the same power with direct current and a rheostat, than with alternating current and a transformer, but with inclined carbons there is but very little difference in the light given for the same power supplied, whether alternating current is used with a transformer or direct current is used with a rheostat. It is to be noticed, however, that by using sufficient power it is possible to get more light by the use of direct than with alternating current.

The power drawn from the line depends on the power consumed at the arc and the efficiency of the ballast or transforming device.

§ 768. Efficiencies with different arrangement of carbons, and different forms of current.—The efficiencies of these devices are:

	With right-angle carbons	Inclined carbons
Direct Current and rheostat	= 50%	= 46%
Alternating Current and rheostat	= 45%	= 27%
Alternating Current and transformer	= 96%	= 96%
Alternating Current and rectifier	= 70%	= 70%

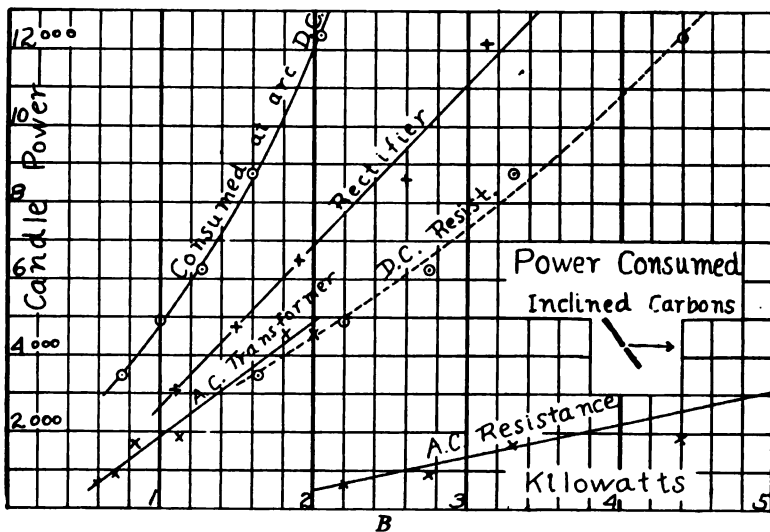
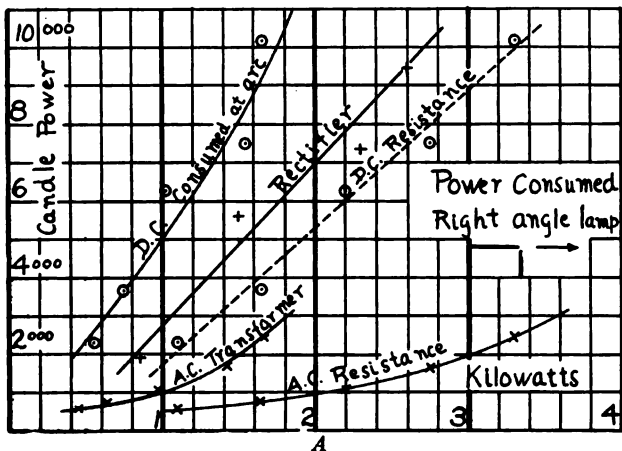

FIG. 304. RELATION BETWEEN POWER CONSUMPTION AND CANDLE-POWER.

A Lamp with right-angle carbons.

Alternating current with a rheostat gives the least light.

Alternating current with a transformer gives more light than when a rheostat is used.

Alternating current with a rectifier gives the greatest amount of light.

Direct current with a rheostat gives less light than alternating current with a rectifier.

Direct current, if only the power consumed at the arc is counted, gives the greatest illumination of all for a given power input, (left upper curve), i. e., 10,000 candle-power for less than two kilowatts of power.

B Lamp with inclined carbons.

Alternating current with a rheostat, the least light.

Direct current with rheostat, next.

Alternating current with a transformer, next.

Alternating current with a rectifier gives the greatest illumination for the power consumed.

The upper left hand curve shows that direct current gives the greatest amount of light if only the power consumed by the arc is considered and that wasted in the rheostat is not counted.

If the sets of curves for the right-angle lamp and those for the inclined-carbon lamp are compared it will be found that the right-angle lamp gives the most light for the same current in every case. The light given for the same power input is the same with rectified current for both styles of lamp. With either alternating or direct current and resistance, the right-angle lamp gives the greater light, but with alternating current and a transformer the right-angle lamp gives less light. This is due to the higher voltage of the right-angle arc when used with alternating current, the right-angle arc requiring about 50 volts while the inclined carbon arc requires but 30 volts.

In the table (§ 763) is shown the power in kilowatts drawn from the line for different intensities of the light. This table was made from the curves in fig. 304B and applies to the inclined carbon lamp, with 110 volt supply.

In the table (§ 764) is shown the candle-power for different amounts of power consumption.

§ 769. **Distribution of intensity in the different directions with the different forms of projection arc.**—Fig. 305–306 show the distribution of light around the different forms of arc lamp. The distance from the center to the curved line gives the candle-power of the lamp in the given direction. Fig. 305 shows that the right-angle arc has 3,750 c. p. in a horizontal direction, 4,000 c. p. 15° below the horizontal, and 2,900 c. p. 15° above the horizontal. These curves show the results of actual experiments. The light coming mostly from the crater, a slight change in the position of the

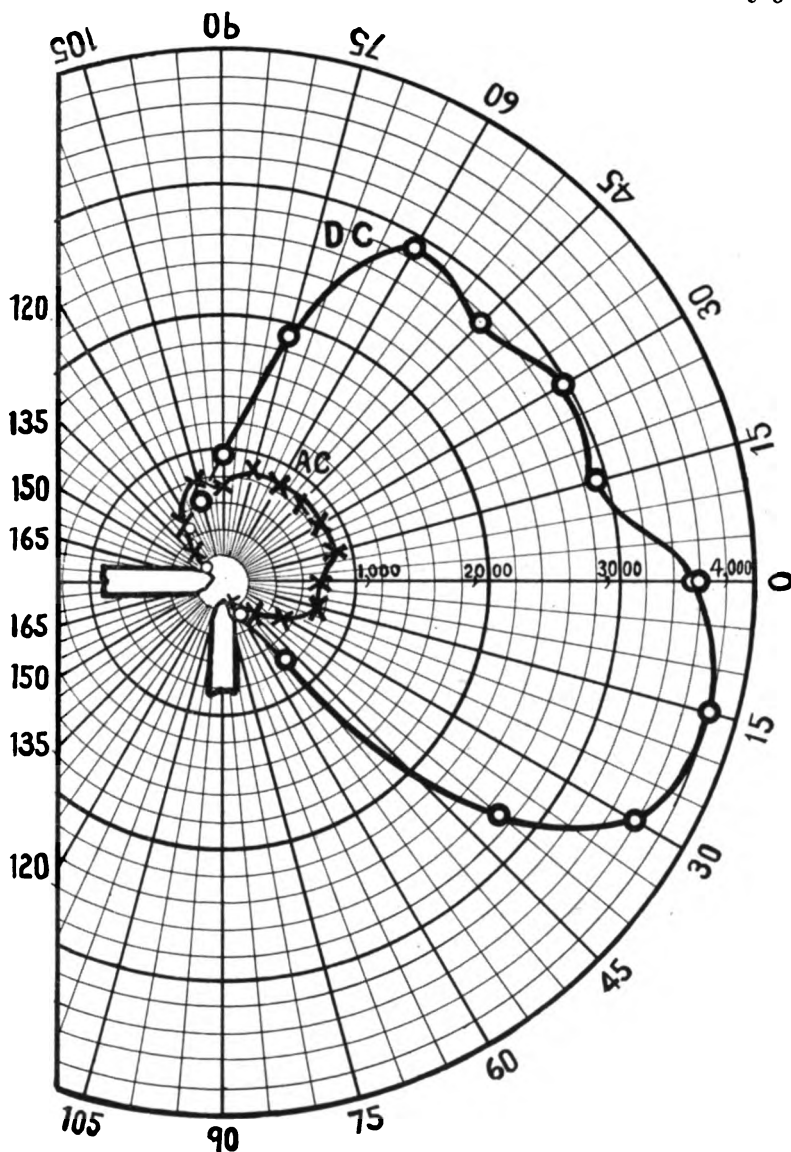

FIG. 305. DISTRIBUTION OF LIGHT INTENSITY ABOUT RIGHT-ANGLE ARCS.

o Direct current (D. C.).

x Alternating Current (A. C.).

The direction of a given point on the curve represents the direction in which the light intensity was measured. The distance of the point from the center of the figure represents the intensity in the given direction. For example, 15° above the horizontal the direct current arc has 2,900 candle-power while the alternating current arc has 850 candle-power.

The numbers around the outside represent the angle in degrees while those on the radius represent candle-power.

carbons or the angle of the craters on the carbons causes a great change in the distribution of light.

§ 770. **Right-angle electrodes.**—If the right-angle arc is used, take care to hold the crater in the best position, i. e., facing the condenser, otherwise a poor light will result. Fig. 294–295 show about the best position which can be maintained. The distribution from this arc with direct current is shown in fig. 305. The distribution of light with an alternating current right-angle arc is shown in fig. 306.

§ 771. **Converging electrodes.**—The distribution of light with converging carbons (55°) with alternating current is shown in fig. 306.

CANDLE-POWER OF ARC LAMPS

§ 773. **Intrinsic brilliancy of the crater.**—Blondel found that the intrinsic brilliancy of the positive crater of the carbon arc was nearly constant, irrespective of the current, at about 158 candle-power per square millimeter for solid carbons, and 130 candle-power per square millimeter for cored carbons. This is equivalent to 97,000 candle-power per square inch for solid, and 84,000 candle-power for cored carbons (§ 773a).

The increase in candle-power of the arc caused by an increase in current is due, not to an increase in the brightness of the crater, but to an increase in its area. This is illustrated in fig. 294, which shows a photograph of a right-angle arc with 10 amperes and with 20 amperes direct current. The increase in the size of the crater is apparent.

As has been pointed out elsewhere (Ch. IX, XIV), with small openings such as with microscopic objectives, when the crater

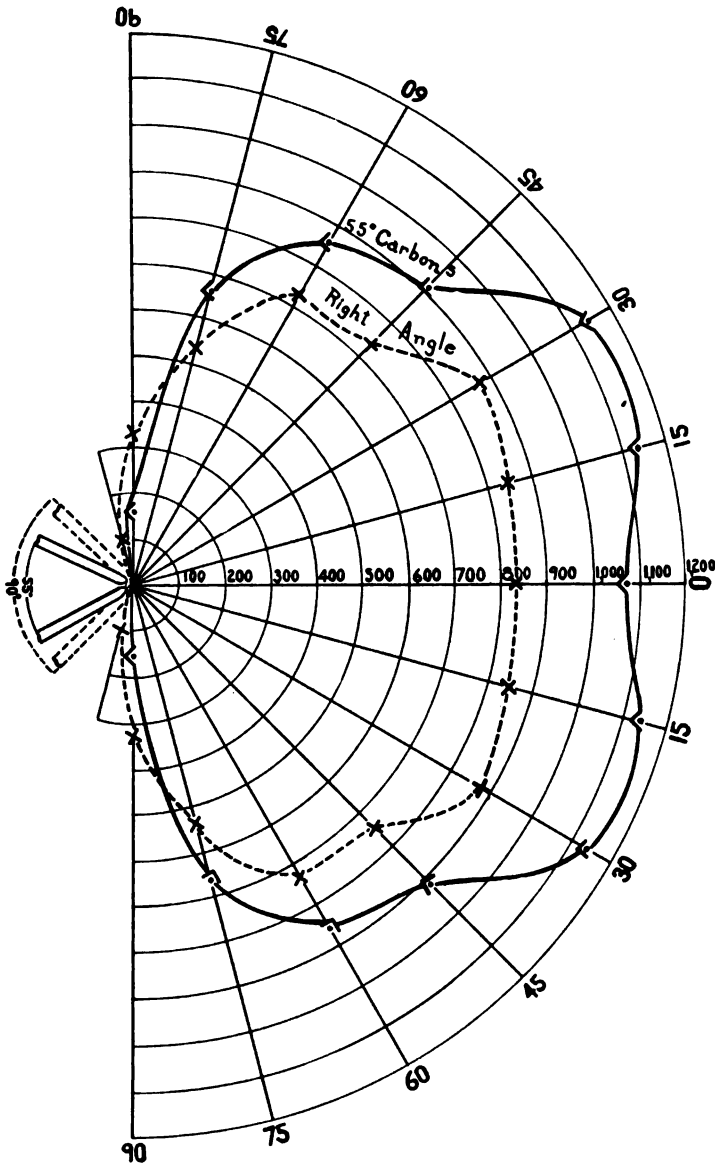

FIG. 306. DISTRIBUTION OF LIGHT INTENSITY ABOUT ALTERNATING CURRENT ARCS WITH CARBONS AT 90 AND AT 55 DEGREES.

90° Right-angle arc (dotted lines).

55° Arc with V-arranged carbons (full lines).

The numerals around the semicircle represent degrees, while those along the middle radius represent candle-power. It is to be noted that with the V-arrangement where both craters supply light that there is considerable gain over the right-angle arrangement.

image becomes too large to enter the opening (objective front), there is no advantage to be gained by increasing the current, as this merely increases the size and not the brightness of the crater and the crater image.

§ 774. **Visible and invisible radiation.**—It is a well known fact that, of the total energy supplied to an arc lamp, but a small part

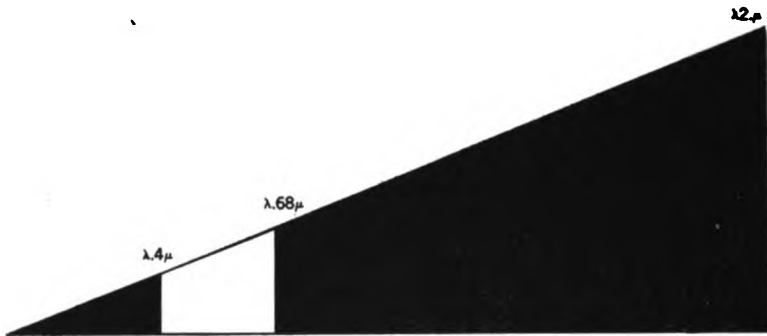

FIG. 307. NORMAL SPECTRUM ILLUSTRATING THE SEGMENT OF RADIATION WHICH IS VISIBLE.

The longest radiation represented in this diagram has a wave-length of 2μ , and is at the base of the triangle. The intermediate wave-lengths occur in regular sequence.

The segment of visible radiation occurs between wave-lengths $.68 \mu$ and $.40 \mu$. Other waves shorter than $.40 \mu$ form the ultra-violet, and those longer than $.68 \mu$ the infra-red part of the spectrum.

Under some conditions waves longer than $.68 \mu$ and shorter than $.40 \mu$ may be seen, but the radiation for useful vision falls between those wave-lengths. The height of the lines in this diagram represents the wave-lengths magnified 20,000 times at that particular point in the spectrum.

If the visible radiation is passed through a prism or a diffraction grating, the wave-lengths are arranged in regular sequence from the longest to the shortest as shown in the diagram. The longest visible waves appear red to the normal eye and the shortest violet, with the orange, yellow, green, blue, and indigo in between.

§ 773a. Blondel, Proceedings of the International Electrical Congress. Chicago, 1893.

Bulletin of the Bureau of Standards, Vol. 1, p. 122 and reprint 8.

appears in the form of radiation visible to the eye as light. A large amount of energy is radiated in the form of ether waves of such great length that they do not effect the eye and are called infra-red radiation. A small amount of energy is radiated in the form of very short invisible waves capable of exciting fluorescence and affecting a photographic plate, this is called ultra-violet (fig. 307).

RADIANT EFFICIENCY OF ARC LAMPS

§ 775, 776. In 1911 some experiments were made to determine the entire energy radiated by the arc, and the relation of this energy to the visible part of the radiation (§ 776a).

Briefly, the method consisted in getting side by side two patches of light, which are photometrically equal. One of these patches

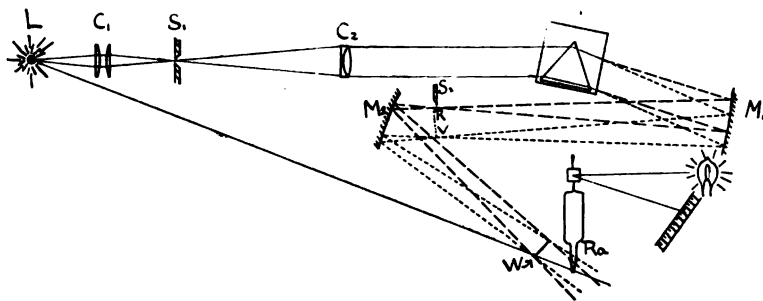

FIG. 308. ARRANGEMENT OF APPARATUS TO MEASURE L'/R .

(From the *Physical Review*).

Energy from the source L can reach the thermo-junction of the radiometer Ra by either of two paths, (a) direct, no absorption except by air, (b) through the prism train P .

Light from the source is focused by the condenser C_1 on the adjustable slit S_1 , is rendered parallel by the lens C_2 , dispersed by the prism P and focused as a spectrum $R-V$ by the mirror M_1 . The screen S_2 is placed in the red end of the spectrum so that it cuts off all of the infra-red to 68μ . The mirror M_2 reassembles the spectrum to a patch of white light at the radiometer.

The intensity of the patch of direct light is fixed by the brightness and distance of the source L , but that of the other patch W can be varied by widening or narrowing the slit S_1 , until it is of the same brightness as the direct light.

The prism consists in a 60° hollow prism of carbon bisulfide immersed in a square glass cell filled with distilled water. It gives a good dispersion with a deviation of but 20° from a straight line.

The lenses are of glass. The mirrors are plano-concave lenses, silvered on the concave side. The focal length of M_1 is 50 cm. and of M_2 is 25.

falls on the comparison screen either directly, or after passing through an 8 cm. layer of water, as the case may be. The other patch of light is robbed of all of its infra-red by the system of prisms and lenses shown in fig. 308.

The energy in these two light patches was measured by a radiomicrometer. The screen S_2 could be set to remove all of the infra-red radiation to any desired point in the spectrum. In this work, after careful experiment, it was decided to adopt the wave-length $.68\mu$ as best representing the dividing line between the visible part of the spectrum and the infra-red. The screen was accordingly set to remove all radiation of greater wave-length than this.

By this method it was possible to measure the energy represented by the total radiation of the arc, and that of the visible portions. It was also possible to insert a water-cell between the source L and the radiomicrometer and compare the light energy, with that part of the energy passing through an 8 cm. layer of water. In order to simplify the discussion, the total radiation of the arc is called R , the portion getting through the 8 cm. water-cell is called W and the luminous energy is called L . The measurements were made in such a way that the ratio of L/R or radiant efficiency was determined, or else the ratio of L/W was measured.

In addition to these values, the transmission of layers of water of different thickness was measured, that is, the ratio of W/R was determined. This ratio is called "the Water-Cell Efficiency" and was determined for a layer of water 8 cm. thick. The transmission of layers of other thicknesses is shown in § 849.

§ 777. The results of these measurements for various sources are shown in the table (§ 778). The most important values are for the positive crater of the right-angle carbon arc and for the right-angle arc with alternating current.

The positive crater shows a radiant efficiency (L/R) of roughly 10%, that is 10% of the energy radiated is visible as light, the other 90% of the energy is mostly in the infra-red. "The water-cell efficiency" (W/R) varies from 18% to 28%, averaging roughly 25%, that is, one quarter of the energy radiated gets through the

§ 776a. See H. P. Gage, *The Radiant Efficiency of Arc Lamps*, *Physical Review*, Vol. 33, p. 111, Aug., 1911.

water-cell. Of this 25%, 43% is light and the rest is infra-red. This shows the advantage of using a water-cell as there is only one quarter the heating effect with the water-cell as without it.

With the alternating current arc, the corresponding figures are approximately; Radiant efficiency (L/R) 6.4%, Water-cell efficiency (W/R) 15.6%, and of the energy getting through the water-cell (L/W) 41% is light. In this case it is seen that the water-cell removes an even greater proportion of energy and hence its beneficial effect is even greater with alternating current than with direct current. For the practical application of these values, see § 850, and fig. 342.

§ 778. Table showing the relation of light energy to the total radiation of various light sources.

(From the Physical Review, August, 1911)

Source	Amps.	C. P.	L/W Per Cent.	W/R Per Cent.	L/R Per Cent.	WATTS		AS RADIATED		AT 100% EFF.		
						R	L	W.P.C.	C.P.W.	W.P.C.	C.P.W.	Lumens per watt
Carbon arc	7.5	1550		18.5	7.9	607	48	.39	2.6	.031	32	377
	10	2300	42.9	21.7	9.3	785	73	.34	3.0	.032	31	
+ Crater ...	15	3850		27.0	11.6	1148	133	.30	3.4	.035	29	
	20	5600		28.7	12.3	1614	199	.29	3.5	.036	28	
— Crater ...		(est.)	40	8.25	3.3						30	
A. C.												
Shaded ...	15	700	40.7	17.8	7.2	457	33	.65	1.5	.047	21	
	20	1200		20.9	8.5	618	53	.51	2.0	.044	23	
Entire ...	15	700		15.6	6.3	590	37	.84	1.2	.053	19	
Arc stream...				21		6.5					21	
Flame arcs												
Entire arc												
Yellow ...	13.5	2580	57.1	26.9	15.4	430	66	.17	6.0	.026	39	290
White ...	13.5	1440	45.7	31.8	14.6	476	69	.33	3.0	.048	21	264
Arc stream												
Yellow ...	13.5		79	49.5	39							
White	13.5		54.5	50.5	27.5							
Nernst through copper sulphate		26.4			100		.665			.025	39.5	497
Hefner (Ångström)		.9			.363	11.3	.032	12.3	.08	.047	21.3	268

A. C. Alternating current.
Amps. Amperes.
C. P. Candle-Power.

L/W The ratio of the luminous energy (L) and the total energy getting through the water-cell (W) (Water-cell 8 cm. thick).

W/R The ratio of the energy getting through the water-cell (W) and the total energy (R) radiated by the light source.

L/R Ratio of light energy (L) and the total energy (R) radiated by the source.

R Total energy radiated by the source.

L The light energy radiated by the source (fig. 307).

W. P. C. Number of watts required for each candle-power with the different sources.

C. P. W. Number of candle-power given by each watt with the different sources.

In the right-hand column are given the meter candles or lumens for each watt of energy in the luminous part of the spectrum with the different sources.

CALCULATION OF THE ENERGY REQUIRED FOR THE PROJECTION OF MOVING PICTURES

§ 779. It is interesting to calculate, from the data on radiant efficiency, how much energy is required to project a moving picture. This has an important bearing on the fire risk with such projection. Suppose, for example, the picture is to be 3.7 x 5 meters in size (12 x 16.5 ft.), a suitable size for a 30 meter (90 ft.) hall. Its area will be 18.5 square meters (208 sq. ft.). A suitable average illumination of the screen would be 100 meter candles or about 10 foot candles. As the revolving shutter removes half the light, the actual momentary illumination of the screen must be 200 meter candles or 200 lumens per square meter.

Basing the calculations on this, it is seen that 18.5 x 200 or 3700 lumens will be required. When using the right-angle carbon arc with direct current the light represented by one watt when radiated in the visible part of the spectrum is 377 lumens (§ 778). In order to get 3700 lumens it requires $3700/377 = 9.8$ watts of light energy. This energy must get through the aperture plate which is 2.5 cm. x 1.75 cm. and which has an area of 4.2 square centimeters (1 in. x $\frac{3}{4}$ in., area $\frac{3}{4}$ square inch) hence the light energy per square centimeter of film area is $9.8/4.2 = 2.34$ watts per square centimeter (§ 779a). When, however, the entire radiation from the arc is used, only 10% of which is light, the energy is 10 times as great, and even when a water-cell is used where 43% of the energy is light, the energy is 2.3 times as great. These results are shown in tabular

form below, together with the corresponding values when alternating current is used.

§ 780. Radiant energy passing the aperture plate when using right-angle lamp with direct current.—

	Power passing through aperture plate	Power for each square centi- meter of film
Total radiation of arc, of which 10% is light.	98 watts	23.4 watts
Radiation passing through water-cell, of which		
43% is light	22.8 watts	5.44 watts
Visible radiation only, 377 lumens per watt.	9.8 watts	2.34 watts

§ 781. Radiant energy passing aperture plate when using right-angle lamp with alternating current.—

	Power passing through aperture plate	Power for each square centi- meter of film
Total radiation of arc, of which 6.4% is light	222 watts	53.0 watts
Radiation passing through water-cell, of which		
41% is light	34.4 watts	8.2 watts
Visible radiation only, 264 lumens per watt.	14 watts	3.2 watts

§ 782. Effect of opacity of the film.—When a nearly transparent film is used, a large proportion of this radiation passes through, but when a nearly opaque film, such as the title is shown, almost all of this energy is absorbed and converted into heat. From these tables it is not difficult to understand why, if there is no water-cell used, the film is likely to spoil or ignite if it is stopped for a few seconds while the light is falling on it. Take the example of the light furnished by the alternating current arc such as is used in a great many places. Here the film is absorbing energy at the rate of 53 watts per square centimeter, which is faster than the surrounding air can cool it. If now a water-cell is used, the energy rate is reduced to 8.2 watts. Experiment has shown that under these conditions with the water-cell, the heating effect is not great enough to ignite even a black celluloid film if for any reason it should stop moving. But it must be remembered that even if a water-cell is used the film would catch fire if held in an extremely concentrated beam. (For the time of ignition of film see § 596).

§ 779a. If the new standard size for the opening in the aperture plate (§ 570a) were used, the figures in the example would be slightly different, but the principle is shown just as well in the statement here given.

CHAPTER XIV

OPTICS OF PROJECTION

§ 790. Apparatus and Material for Chapter XIV:

See the optical apparatus in Chapters I to XI.

§ 791. **History of the optics of projection and references to literature.**—See the appendix and the works of reference in Ch. I, § 2; works on general physics, optics and astronomy.

§ 792. For the most successful use of projection apparatus it is necessary to understand some of the simplest principles of optics, and to keep in mind that in the projection of images two of the fundamental phenomena of optics are constantly present. These two phenomena are: (1) *Reflection* and (2) *Refraction*.

§ 793. **Reflection.**—By this is meant the change in direction of rays of light when they meet a surface. The change in direction of a beam of light striking a surface depends upon the character of that surface. The principle kinds of reflection are, regular reflection, irregular reflection, and semi-regular reflection.

§ 794.—**Regular reflection.**—If the surface is smooth, as in a mirror, the incident and reflected ray will be in the same plane and will make equal angles on opposite sides of the normal erected at

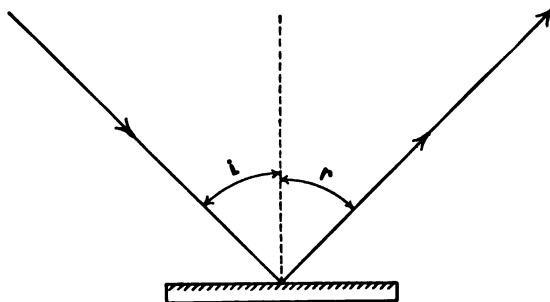

FIG. 309. REGULAR REFLECTION AT A POLISHED SURFACE.

The angle of incidence i , is equal to the angle of reflection r ; and the incident and reflected ray are in a plane perpendicular to the reflecting surface.

the point of reflection (fig. 309). Most cases of irregular and semi-regular reflection if considered from the standpoint of a small enough part of the surface are really cases of regular reflection; that is, any small particle of which the surface is made reflects the light striking it regularly, but each particle of the surface reflects the light in a different direction. Hence, taken as a whole, such a surface will not reflect the light regularly. (See Mirrors § 800).

§ 795. The use of regular or mirror reflection in projection is illustrated by the mirrors used in opaque lanterns (fig. 95-110) and by the mirrors and prisms used with drawing apparatus (fig. 180-204).

With regular or mirror reflection the observer can only see the light when he is in the path of the rays either before or after the reflection (§ 796a).

§ 796. **Irregular reflection.**—If the surface is irregular then the light striking it is reflected in various directions depending upon the position of the irregularities on the surface receiving the light. If these are very small, as in dust or smoke or as on the surface of snow, white cloth or paper, etc., then the reflected light is scattered practically equally throughout the entire hemisphere toward which the surface faces (fig. 310).

§ 797. The use of irregular reflection is illustrated by the reflected rays from the white screen upon which the image is projected by the magic lantern, projection microscope, etc. The image appears almost equally bright from any point in the room.

§ 796a. If there is dust, smoke or fog in the path of the beam of light either before or after reflection, the minute particles in the smoke or fog irregularly reflect some of the light and one can see it at any angle (fig. 320-323). Dust or scratches on the surface of the mirror enables one to see where the beam of light strikes its surface. If there is no irregular reflection then one can only see a beam of light when in its path.

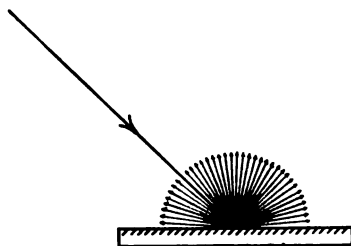

FIG. 310. IRREGULAR OR DIFFUSE REFLECTION.

A ray of light striking a rough surface is scattered equally in all directions.

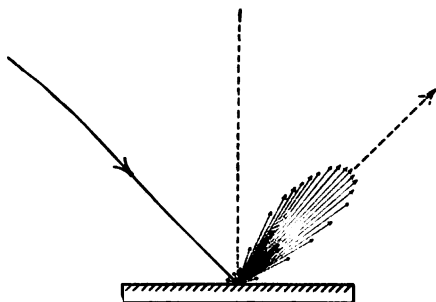

FIG. 311. SEMI-REGULAR REFLECTION.

Light striking some surfaces is scattered unequally, being reflected to a greater extent in one direction than in others. This represents the kind of reflection produced by metallic-faced screens.

The individual metal particles reflect the light regularly, but the different particles lie at different angles and reflect the light in different directions. The result is that the light is scattered in all directions, but the greater part of the light is reflected in the same general direction as it would be if the surface were perfectly polished. This is shown in fig. 247, 311, where the length or number of the rays after reflection indicates the amount of light reflected in that direction.

§ 799. The use of this semi-regular reflection in projection is in the metallic screens or mirror screens sometimes used in long, narrow auditoriums. Such screens do not appear equally bright when seen from all parts of the room but appear brightest when seen in the direction of the regular reflection from the lantern, that is, when the observer is nearly in line with the lantern, and they appear very dim when seen from the sides of the room, 15° or more from the axis of the lantern (§ 630).

§ 800. **Mirrors.**—It is possible to construct surfaces of metal or silvered glass which are sufficiently smooth to reflect nearly all of the light in accordance with the law of regular reflection (§ 794). Such a surface is called a mirror. It may be plane or curved (concave or convex).

If the mirror surface is plane, it follows from the law that the rays will have the same angular relation to one another after

§ 798. **Semi-regular reflection.**—This occurs when a surface is imperfectly polished, that is, if the surface is an irregular one but not sufficiently irregular to scatter the light equally in all directions. The most familiar example is a surface coated with silver or aluminum powder. Here

the individual metal particles reflect the light

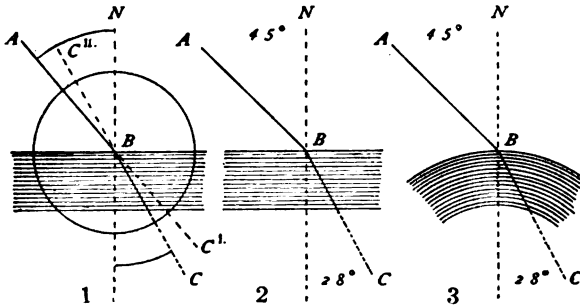

FIG. 312. REFRACTION AT PLANE AND AT CURVED SURFACES.

(From *The Microscope*)

A-C The refracted ray, changing its direction at the point of contact with the denser medium (line shading).

N-N' Normal to the refracting surface.

B Point of refraction.

A-C¹ In (1) The course the ray would have taken if the medium from *A-C¹* had been homogeneous.

C-C¹. Course the ray would have taken from the point *C* if the medium from *C¹* to *C¹* had been homogeneous.

(1) Refraction from air to water.

(2-3) Refraction from air to crown glass. As shown, if the incident ray is at 45° , the refracted ray will be at approximately 28° with the normal.

reflection as before, that is, if the rays were parallel before reflection they will be afterward; and if they were converging or diverging before they will converge or diverge after reflection.

With a curved mirror the angular relation after reflection is not the same as before. For example, with a concave mirror, parallel rays are bent towards one another and finally meet at what is called the focal point. If the mirror is convex then the rays are made to diverge on leaving the mirror.

i Incident ray in the air above the glass.
r Ray of light below the glass, after refraction.
i' Course of the ray of light if the glass were absent.

r' The refracted beam traced backward above the glass to show its apparent origin.

n n' Normals where the ray enters and leaves the glass.

This figure shows the displacement of the light by refraction through media with plane surfaces, and that the refracted light is parallel with the incident light.

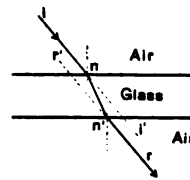

FIG. 313. REFRACTION BY GLASS WITH PARALLEL FACES.

§ 801. Refraction.—By refraction is meant the change in direction of a ray of light in passing from one transparent medium into another.

The amount of bending depends upon two conditions:

(1) The greater the angle of incidence of the light, that is, the farther from the perpendicular or normal that the light strikes the surface, the greater will be the bending on entering the second medium. And this increase is not simply with the increase of the angle of incidence, but proportionally greater, that is, in accordance with the law of sines (fig. 312).

(2) The bending also depends upon the difference of density of the two transparent media. If the difference is great, the refraction will be great, and if the difference of density is small, the refraction will be proportionally small. See also chromatic aberration (§ 810, fig. 337).

The phenomena of refraction were worked out with great accuracy by Ptolemy in the first and beginning of the second century A.D.; but the precise mathematical expression for the law of refraction was not found until about 1500 years later (Snell's and Descartes' law of sines). This law of sines includes both elements mentioned above, and is expressed thus:

$$\frac{\text{Sine of the angle made by the incident ray}}{\text{Sine of the angle made by the refracted ray}} = \text{index of refraction.}$$

§ 802. Lens.—By making one or two bounding surfaces of a transparent body curved, rays of light traversing the body are made to converge or to diverge. Any transparent body having one or both of its opposite faces curved is called a lens. The curved surfaces are usually segments of spheres, as a spherical surface can be ground and polished more accurately than can any other.

§ 803. Principal axis.—The straight line passing through the centers of the two spheres of which the surfaces of a lens are segments is called the principal axis. This axis is perpendicular to both surfaces of the lens (fig. 314).

§ 804. Optic center.—This is the point in a lens, or near it, through which light rays pass without angular deviation, that is,

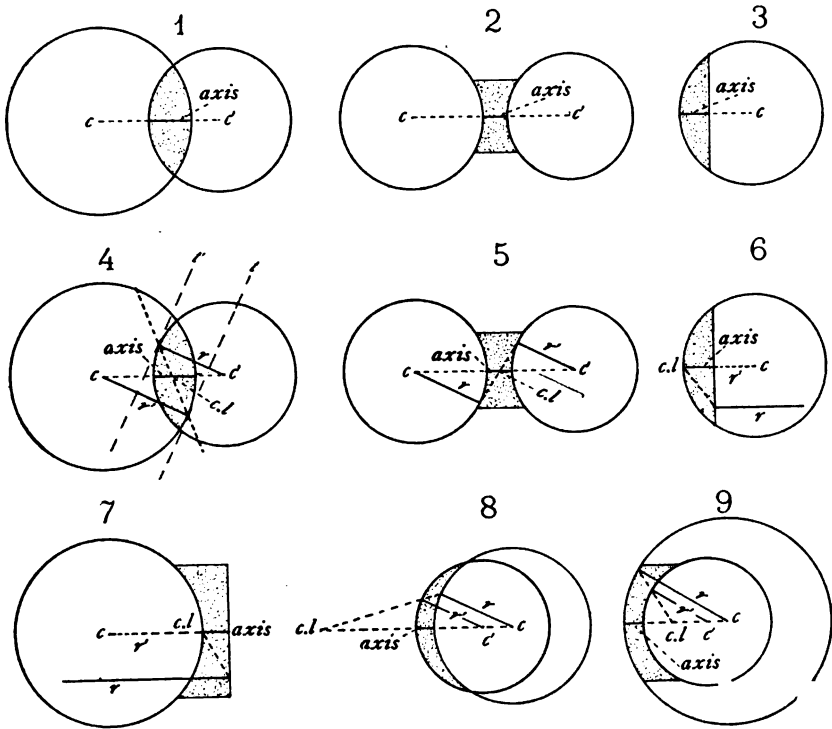

FIG. 314. THE OPTIC CENTER AND THE PRINCIPAL OPTIC AXIS OF VARIOUS FORMS OF LENSES.

(From *The Microscope*)

- $c\ c'$ Centers of curvature of the different lenses.
 As shown in all the figures each curved face of the lens is a part of a sphere of greater or less size.
 $c.l$ Optic center of the lens.
 r Radius of the sphere from which the lens is derived. (Radius of curvature).
1. Double-convex lens, the two faces having different curvatures.
 2. Double-concave lens, the two faces of different curvatures.
 3. Plano-convex lens.
 - 4, 5, 6. The same showing the optic center (cl).
 7. Plano-concave lens showing optic center (cl).
 8. Converging, meniscus lens. The optic center (cl) is outside the lens, on the convex side.
 9. Diverging meniscus lens with the optic center (cl) outside the lens, and on the concave side.

the ray before and after it passes the center of the lens extends in parallel lines. As shown by the following diagrams the optic center is found by drawing parallel radii from the two curved surfaces, or from the curved and plane surface, and joining the ends of the radii. The center of the lens is the point where the line joining the outer ends of the parallel radii cross the principal axis (fig. 314).

The reason why light rays traversing the optic center have no angular deviation is as follows: The radii are perpendicular to the surfaces of the lens; and the tangent plane perpendicular to the radius, is tangent to the sphere at the end of the radius. As the two tangents to parallel radii must themselves be parallel, it follows that a ray of light passing from one tangential point to the other is

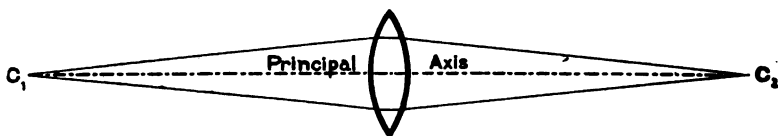

FIG. 315. CONJUGATE FOCI C_1, C_2 ON THE PRINCIPAL AXIS.

traversing a body with parallel surfaces at the point of entrance and departure, and hence it will suffer no angular deviation although the ray may be displaced, as in traversing any thick transparent body with plane faces (fig. 313). With meniscus lenses the crossing point (optic center) is on an extension of the line joining the centers of curvature (fig. 314).

§ 805. **Secondary axis.**—Every line traversing the optic center of a lens, except the principal axis, is a secondary axis. It follows therefore that every secondary axis must be more or less oblique to the principal axis (fig. 317).

§ 806. **Principal focal point.**—The principal focus or focal point of a lens or of a lens system like a condenser or a projection objective, is the point on the principal axis where rays of light parallel with the principal axis before entering the lens or combination, cross the principal axis after leaving the lens or objective. It is also sometimes called the burning point (fig. 319).

With a concave mirror it is likewise the point on the principal axis where rays parallel with the principal axis before striking the mirror are made to cross the principal axis after being reflected by the curved face of the mirror. This point is situated half way between the mirror face and the center of curvature.

§ 807. **Conjugate foci, and the mutual relation of images.**— In figures 315–318, are shown conjugate foci on a principal and on a secondary axis. In each case the object and the image might

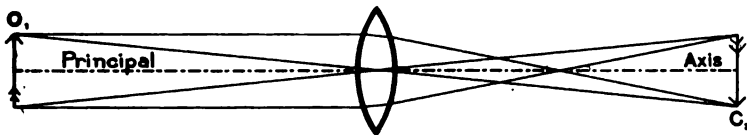

FIG. 316. METHOD OF IMAGE FORMATION ON THE PRINCIPAL AXIS.

In this case the object (C_1) and the image (C_2) are equally distant from the center of the lens, hence they are of the same length, and the distance between them is four times the principal focus of the lens.

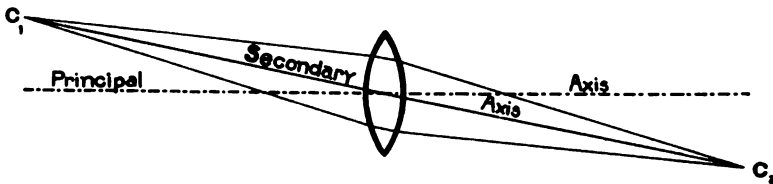

FIG. 317. CONJUGATE FOCI ON A SECONDARY AXIS.

The secondary axis passes through the optic center of the lens, and the conjugate focus C_2 is below the principal axis if the point C_1 is above it.

change places without any change in the mutual relation of the object and image. For example, if the screen picture with a magic lantern were an actual scene and the magic lantern pointed toward it as in projection, a small image exactly like the lantern slide would be formed at the level of the lantern slide. It is from this mutual relation of object and image that they are said to be conjugates.

§ 808. **How to obtain the principal focus experimentally.**— This is accomplished by holding the lens or combination, or the mirror, with the principal axis pointing directly toward the sun.

The point where the image of the sun appears indicates the principal focal point, or the burning point.

Another way to get the equivalent focal length or focus of an objective is to put it in position on an optical bench like that shown in fig. 159 and then to use a metric rule (fig. 178), or a lantern slide of such a rule as object, and a white screen or a ground-glass on the other side of the objective. The object and the screen are then moved toward and from the objective until the image is of exactly the same size as the object. The distance apart of the image and the object is four times the focal length of the objective (fig. 316).

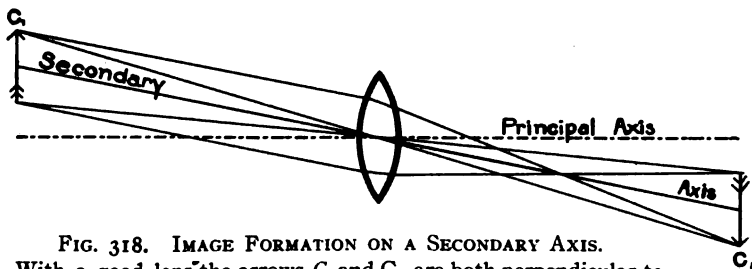

FIG. 318. IMAGE FORMATION ON A SECONDARY AXIS.

With a good lens the arrows C_1 and C_2 are both perpendicular to the principal axis.

C_1 Object.

C_2 Image. When object and image are of the same size, as here, the image is as far below the principal axis as the object is above it.

SPHERICAL AND CHROMATIC ABERRATION AND MEANS OF CORRECTING THESE DEFECTS

§ 809. **Spherical aberration.**—By this is meant the unequal bending of the light rays in different zones of a lens. As shown in fig. 320, the rays passing through the outer zones of a spherical lens are proportionally more bent than those which pass nearer

§ 808a. **Equivalent focus.**—The term equivalent focus is often employed for compound optical systems like objectives. This means simply that the objective gives the same magnification or reduction in a given case as a simple lens of that focus would give.

For example, the simple lens in fig. 209, with the object 2 cm. from the center of the lens, gives an image at 8 cm., four times as large as the object. Now any compound system of lenses which gives a magnification of four under similar conditions is said to be equivalent to this simple lens. The expression, equivalent focus is frequently designated by the initial letters of the words, *e. f.*

the axis. It results from this that the border rays cross the axis considerably nearer the lens than the central rays, hence, with parallel rays, instead of one focus, there are many foci drawn out in a line. This is shown by the bright core in the photograph of the cone of rays in fig. 322.

Except with a symmetrical, double convex lens the amount of spherical aberration depends upon which face of the lens receives the incident light, and whether the incident light is parallel, diverging or converging.

With plano-convex lenses, as shown in fig. 320-323, the spherical aberration with parallel incident light is less when the parallel light is incident on the convex face than when the lens is turned so that the light is incident upon the plane face.

For diverging rays the plane face should receive the incident light, and for converging rays the convex surface should receive the light to insure minimum spherical aberration. With all lenses, the general rule to follow is that for minimum spherical aberration, the light rays should be equally bent on entering and on leaving the lens i. e., at both refracting surfaces. Furthermore, with the same light beam, the aberration is greater for lenses of large curvature than for lenses of small curvature.

To overcome this aberration, a concave lens is combined with a convex lens, and so proportioned that the too great converging effect of the outer zone of the convex lens is just counterbalanced by the diverging effect of the concave lens in its various zones (fig. 324). A perfectly corrected, or aplanatic combination brings all the parallel rays to one focus.

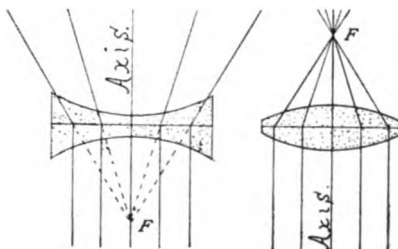
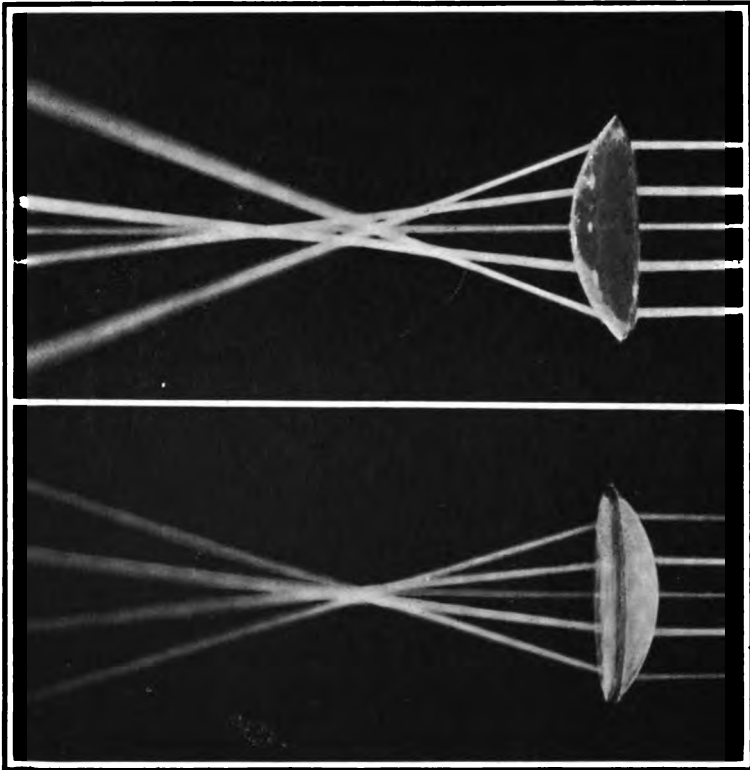

FIG. 319. THE PRINCIPAL FOCUS OF A CONVEX AND OF A CONCAVE LENS. (From *The Microscope*)

Axis, Axis. The principal optic axis of the lenses.

F The focus. In the convex lens it is where the light rays actually cross the axis. In the concave lens it is where they would cross if produced backward as indicated by the broken lines.



FIGS. 320-321. BEAMS OF PARALLEL LIGHT TRAVERSING PLANO-CONVEX LENSES TO SHOW MAXIMUM AND MINIMUM SPHERICAL ABERRATION.

Figure 320 shows the lens in the position to give the maximum aberration. That is, the border rays cross the axis much nearer the lens than the intermediate rays.

Figure 321 shows the lens in the position to give the minimum aberration. The border and the intermediate rays cross the axis more nearly in the same place.

This picture was made in a dark-room (fig. 179). The room was filled with smoke, and the light was partly scattered by the smoke, thus making the rays visible from the side (§ 796a). The first element of the triple condenser was covered in the parallel beam, with a perforated metal disc. This permitted only minute cylinders of light to escape along the diameter of the condenser.

The lens in fig. 320 appears dark as it was clean. The one in fig. 321 appears white because there was some very fine talcum dust on the face.

§ 810. **Chromatic aberration.**—By this is meant the separation of the images produced by the different wave lengths of which white light is composed. Newton thought this was a purely refractive action and therefore could not be corrected without at the same time overcoming all the refraction, hence he thought there could be no images formed by lenses or combinations of lenses without the presence of the color defect. But later it was found that some glass separated the light into colors more markedly than others of the same refraction. Now by combining two kinds of glass which act differently in this respect it was found possible

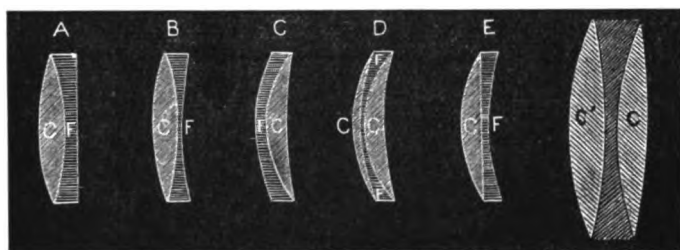

FIG. 324. ACHROMATIC LENSES.

(From Lewis Wright, *Optical Projection*).

By combining a convergent or convex crown glass lens with a divergent or concave flint glass lens it is possible to get a combination which is largely free from chromatic as well as spherical aberration. In all but *D* and the right-hand combination, but two lenses are used; in those, one flint and two crown glass lenses are used.

to bring two or three of the colors to one focus, and thus to produce practically colorless images by means of lenses (fig. 324).

Usually an objective for forming images—photographic objective, microscopic objective, projection objective—is corrected both for spherical and for chromatic aberration, so that the image is correct in every way. This is accomplished by combining concave and convex lenses of the right form and composition. Sometimes also, as with the apochromatic, microscope objectives, a natural mineral—fluorite—is introduced to make a more perfect correction than could be accomplished by artificial glass.

IMAGE FORMATION WITH THE MAGIC LANTERN

§ 811. **Ideal case.**—When using transparent lantern slides with a magic lantern and a small source of light the ideal arrangement is that shown in fig. 325.

L , is a point source of light (crater of the arc light). The condenser C , focuses this light at the point O , in the optical center of the objective. The slide-carrier S , is placed just in front of the condenser. The objective O , is at the proper distance from S , to form a real image of the slide on the screen. All of the rays of light from S pass directly through the center of the objective O , and

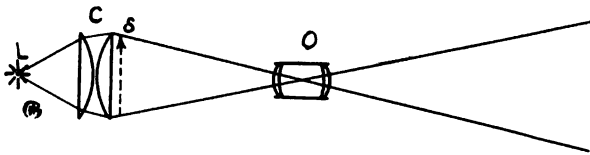

FIG. 325. LANTERN-SLIDE PROJECTION; NO SPHERICAL ABERRATION.

This shows an ideal case where there is a point source of light, and a condenser without spherical aberration. The light from the condenser crosses at the center of the objective (O) and goes on without deviation to the image screen.

- L Light source.
- C Condenser.
- S Lantern slide.
- O Projection objective.

hence undergo practically no deviation. If the source of light L , were really a point source, and the condenser C , had no spherical aberration, the shadow of the lantern slide S , in the screen without an objective would be just like the image which is projected by the objective.

§ 812. **Inversion of the image.**—In their passage from the lantern slide to the screen the rays pass from the top of the slide to the bottom of the screen, and from the bottom of the slide to the top of the screen. In like manner the rays from the two sides of the slide cross before reaching the screen (fig. 1.)

This crossing of the rays gives what is known as an inverted image.

§ 813. **Actual case.**—The actual case differs from the ideal case in that the condenser has a considerable amount of spherical aberration and that the source is not a point but is somewhat extended.

§ 814. **Spherical aberration of the condenser.**—The effect of the spherical aberration of the condenser has not been sufficiently studied up to the present, but it exerts a good deal of influence in projection especially with micro-projection and with moving pictures.

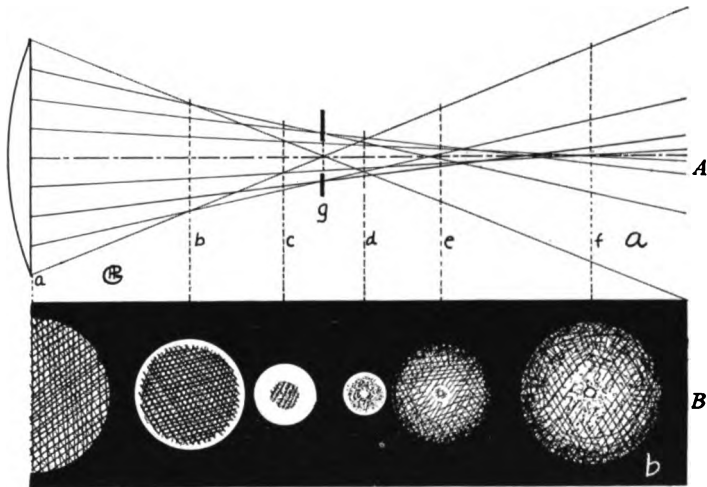

FIG. 326A. THE PATH OF THE LIGHT RAYS FROM THE DIFFERENT ZONES OF THE CONDENSER.

FIG. 326B. THE APPEARANCES ON A CARD HELD IN THE DIFFERENT PARTS OF THE CONE OF LIGHT.

a, b, c, d, e, f Lines showing where the card was held in the light cone to give the appearances in B.
g Diaphragm.

As was shown in § 809, the light from a point source will not come to a focus in a point, but the rays passing through the margin of the lens will be relatively more bent and will cross the axis sooner than those which pass through the lens near the axis (fig. 320-323, 337).

A curious phenomenon is the effect on the illumination of the screen when a diaphragm is used to cut off the margin of the cone.

If placed at *b* or *e* (fig. 326), it cuts off the margin of the cone and lets the center through but if placed at *g*, light from the center and the margin of the condenser gets through, but light from a zone part way out is removed (fig. 327).

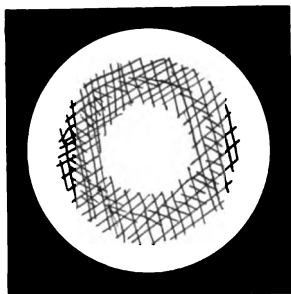

FIG. 327. APPEARANCE ON THE SCREEN WHEN ILLUMINATED BY THE CONDENSER SHOWN IN FIG. 326A IF DIAPHRAGM IS HELD IN THE POSITION *g*.

The result on the illumination of an object placed in the converging cone of light will be as shown in fig. 326B. An object placed near the condenser will be evenly illuminated. As it is moved away from the condenser face towards the crossing of the rays the outer edge first becomes more brightly illuminated than the center and then the spotted effects shown in the figure will be seen. At no position will there be an even illumination of the object when using a point source except when the object is placed next to the

condenser face, *a*. If it is necessary to eliminate the spotted effect due to spherical aberration as when exhibiting moving pictures one must use an extended source of light, so that the aberration figures from the different points of the source overlap. The arc lamp with 15 to 20 amperes direct current is sufficiently extended to give an even illumination provided a short focus condenser is used.

§ 815. **Spherical aberration of the condenser with the magic lantern.**—When using the magic lantern the spherical aberration of the condenser, unless exceedingly great, is of no special disadvantage. The rays from the different parts of the slide will not all cross at the center of the objective but will cross at different points on the axis (fig. 320, 337). If the objective is of good quality and of large enough diameter to include all of the beam of light there will result a good screen picture.

§ 816. **Effect of an extended source.**—Let *a*, fig. 330, represent a point in the slide *S*. Light which has come from all parts of the

source L , after passing through (a) will spread out over an angle and strike the objective lens O . The purpose of the objective lens O , being to collect all of the light from the point (a) on the slide and to bring it together at the point (a') on the screen. This is exactly similar to the case of image formation of a self-luminous or diffusely reflecting surface described in (Ch. VII, § 273, fig. 90) except that the light from the point (a) does not spread out in all directions, but only over the angle $x' a y'$.

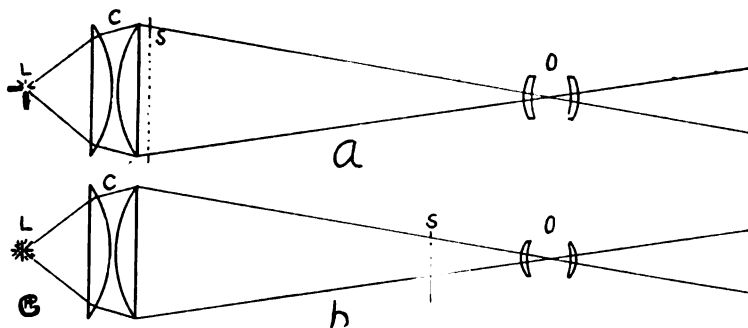

FIG. 328. INTERCHANGEABLE MAGIC LANTERN AND MOVING PICTURE PROJECTION WITH POINT SOURCE AND CONDENSER FREE FROM SPHERICAL ABERRATION.

- a* Magic lantern arrangement.
- b* Moving picture arrangement.
- L* Crater of the arc lamp as a source of light.
- c* Condenser.
- s, s* The lantern slide in (a), and the film in (b).
- o, o* Projection objectives.

§ 817. **Simplicity of the Magic Lantern.**—From the above it is seen that with the arc-light magic lantern the actual case is nearly the same as the ideal case and the manipulation of the apparatus is relatively simple.

RELATION OF THE FOCAL LENGTH OF THE CONDENSER TO THE FOCAL LENGTH OF THE PROJECTION OBJECTIVE

§ 818. **Types of condensers.**—There are in general use two main types of condenser; the two-lens type, as shown in fig. 331, and the three-lens type, as shown in fig. 332. The two-lens type

has the advantage of simplicity and cheapness while the three-lens type has the advantage that it has very little spherical aberration and at the same time it is possible to bring the lamp closer to the first surface of the condenser, thus utilizing a greater proportion of the light of the illuminant (§ 818a).

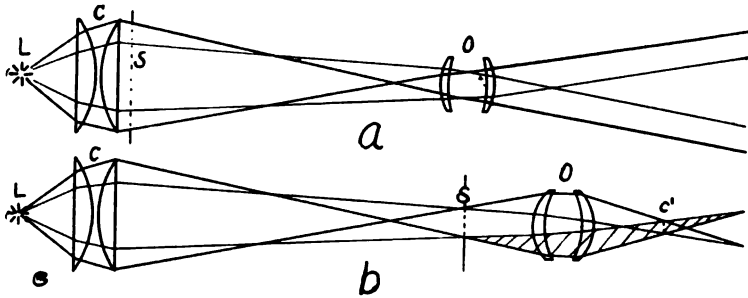

FIG. 329. ARRANGEMENT FOR INTERCHANGEABLE LANTERN-SLIDE AND MOVING PICTURE PROJECTION WHEN THE CONDENSER HAS SPHERICAL ABERRATION.

- a* Projection of lantern slide.
- b* Projection of moving picture film.
- L* Arc-lamp crater, the source of light.
- C* Condenser of two plano-convex lenses.
- S* In (*a*) the lantern slide near the condenser.
- S* In (*b*) the moving picture film.
- O* Objective for projection.
- c'* The image of the condenser face.

§ 818a. **Types of condensers.**—In the development of projection apparatus almost every form of condenser has been used from a single plano- or double-convex lens to one composed of three or more lenses. In form, the lenses have been plano-convex, double-convex, meniscus and parabolic.

For artificial light the condenser is now almost always composed of two or more lenses.

First element (fig. 332).—The first element may be composed of a single plano-convex lens or a meniscus, or it may be composed of two lenses. A meniscus and a plano-convex, or a meniscus and a double convex or finally of two meniscus lenses. The first element in all cases collects the light from the source and renders it more or less parallel.

Second element, (fig. 332).—The second element of the condenser may be a plano-convex or a double convex lens or an achromatic combination.

We have tried the different forms of condensers and have found those composed of two plano-convex lenses, or those with two plano-convex lenses and a meniscus next the light, most satisfactory (fig. 1, 2).

Finally there has been recently produced a parabolic condenser for projection with the microscope. This form eliminates almost all the spherical aberration and is promising.

§ 819. **The two-lens type of condenser.**—In choosing the objective and other optical parts of the lantern one must first consider the room in which the projection is to be done and then choose an objective of such a focal length that the picture will be of the desired size (Ch. XII, § 635). After the objective is determined upon, it is necessary to select the condenser lenses of such focal length that the best results may be obtained. There are two factors which must be balanced in this choice. First; the closer the light is to the condenser, that is the shorter is its focus, the

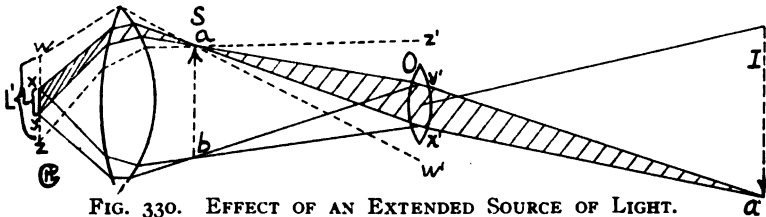

FIG. 330. EFFECT OF AN EXTENDED SOURCE OF LIGHT.

L' (w, x, y, z) Extended light source.

Single Lens Condenser near the source.

S Lantern slide.

a and b Points on the lantern slide.

O Single lens objective.

y', x' Image of the extended light source on the objective.

I, a Screen image of the lantern slide.

If the light source xy , is not too large, all of the light collected by the condenser gets through the objective.

If the light source wz , is too large, the image $w'z'$, will be larger than the objective and much light will be lost by falling outside the objective.

greater will be the amount of light which it will collect. Second; the shorter the focus of the condenser, the greater will be its spherical aberration. In order to get the minimum of spherical aberration with two plano-convex lenses such as are generally used for condensers it is necessary to turn them so that parallel or nearly parallel light strikes the curved surfaces and the diverging light from the source strikes the plane surface (fig. 321, 323). When the parallel beam strikes the curved surface of the lens, all of the rays come to a focus more nearly at the same point than when the parallel beam strikes the plane surface of the lens (fig. 320, 321). This requires that the curved surfaces of the lenses shall be turned towards each other as in fig. 329.

In order that the combination of the two lenses of the condenser shall have as little spherical aberration as possible they should be of about equal focal length. If there is a difference in focal length, the thicker lens, i. e., the one of shorter focal length, should be placed next the radiant and the thinner lens, i. e., the one of greater focal length, should be away from the radiant. The best lenses to use in a given case can only be determined by experiment but as a first trial we would suggest the following foci for condensers of 11.4 cm. ($4\frac{1}{2}$ inches) diameter for magic lantern work and moving picture projection.

§ 820. Table of condenser lenses.—

Focus of objective or Distance of Aperture Plate	FOCUS OF THE LENSES OF THE CONDENSER	
	Lens next the radiant	Lens away from the radiant
15 cm. (6 in.)	15 cm. (6 in.)	15 cm. (6 in.)
18 cm. (7 in.)	15 cm. (6 in.)	16.5 cm. ($6\frac{1}{2}$ in.)
20 cm. (8 in.)	16.5 cm. ($6\frac{1}{2}$ in.)	16.5 cm. ($6\frac{1}{2}$ in.)
25 cm. (10 in.)	16.5 cm. ($6\frac{1}{2}$ in.)	17.8 cm. (7 in.)
30 cm. (12 in.)	17.8 cm. (7 in.)	17.8 cm. (7 in.)
38 cm. (15 in.)	17.8 cm. (7 in.)	19 cm. ($7\frac{1}{2}$ in.)
45.7 cm. (18 in.)	19 cm. ($7\frac{1}{2}$ in.)	19 cm. ($7\frac{1}{2}$ in.)

With these lenses the light from the first lens will be somewhat diverging before it strikes the second lens. The best results are obtained when the two lenses are as close together as they can be put without touching.

§ 821. The three-lens type of condenser.—The three-lens type of condenser illustrated in figure 332 is designed on a different principle. Here the first combination, consisting of a meniscus lens and a plano-convex or a double-convex lens (fig. 111), is designed to render the light from a point source parallel with but a very small amount of spherical aberration. In order that the light shall be focused at the center of the objective it is then necessary that the last lens of the condenser shall bring the parallel beam to a focus where it is wanted, that is, it must have a focus approximately equal to that of the objective. For long focus objectives 38-46 cm. (15-18 in.) this of course necessitates a rather thin lens next to the lantern slide (fig. 332).

In microscopic projection (Ch. IX) and in drawing with the microscope (Ch. X) the three-lens condenser with its small spherical aberration is of great advantage. For micro-projection without a substage condenser, the final plano-convex lens of the triple condenser should have a focus of about 15–20 cm. (6–8 in.). This will answer well for objectives as high as 4 mm. equivalent focus ($\frac{1}{6}$ in.). Where a substage condenser is used, the focus of the last

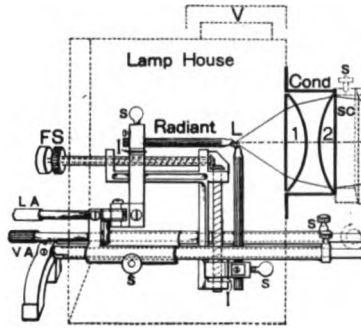

FIG. 331. TWO-LENS CONDENSER FOR PROJECTION.

The condenser (*Cond*) is shown in connection with the lamp-house and right-angle arc lamp.

The first lens of the condenser (1) is of shorter focus (i. e., thicker) than the second lens (2). The condenser is nearer the source of light (*L*) than the principal focus of the first condenser lens, hence the light beam between the condenser lenses is diverging. With this arrangement and the lenses close together a wider beam of light can be utilized for projection than as if the condenser were farther from the lamp (see fig. 343). (For a more complete explanation of this figure see fig. 379.)

plano-convex lens of the large condenser should be longer than 15 cm. One of 25–40 cm. (10–16 in.) is more satisfactory (See Ch. IX, § 402).

§ 822. **Image formation with moving pictures.**—When moving pictures are to be projected, the conditions to be met are not so simple as with the magic lantern, and one must bear in mind the actual requirements.

§ 823. **Practical requirements.**—These requirements are: (The figures for equivalent focus refer to an actual case). The moving

picture objective was 13.3 cm. e. f. ($5\frac{1}{4}$ in.) and the focal length of the magic lantern objective to go with it is indicated.

1. The dimensions of the aperture plate were 23 mm. x 17.3 mm., diagonal 28.0 mm. ($3\frac{1}{2}$ in. x $1\frac{1}{4}$ in., diagonal $1\frac{1}{8}$ in.) (For new standard aperture see § 570a).

2. The moving picture is to be thrown on the screen with an image either as wide or as high as the magic lantern picture or of the same diagonal.

Lantern slides have a maximum opening of 7.5 cm. wide, 7 cm. high, diagonal 10.2 cm. (3 in. wide, $2\frac{3}{4}$ in. high, 4 in. diagonal).

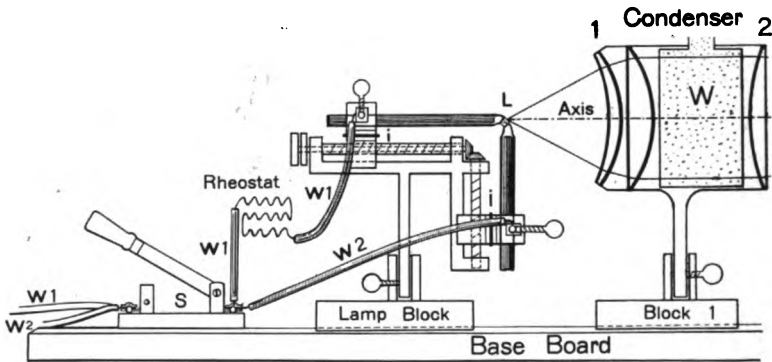

FIG. 332. THREE-LENS CONDENSER.

With a three-lens condenser the source of light is placed at the principal focus of the first element of the condenser, the meniscus and the plano-convex lens, the position of the lenses being as here shown. This gives a parallel beam of light. The second element of the condenser should then be of a focal length to cause the rays to cross at the center of the projection objective (fig. 2).

That one dimension shall be the same with both the moving picture and the magic lantern, requires that the magic lantern objective have a focus which is from 3 to 4 times as long as the moving picture objective, as is shown in the following table:

The two pictures are to be of	Lantern slide objective has an equivalent focus of
The same width	3.17 times that of M. P. objective
The same height	4.00 times that of M. P. objective
The same diagonal	3.65 times that of M. P. objective

In the above case, with a moving picture objective of 13.3 cm. focus, the focus of the magic lantern objective to use with the moving picture objective is, for the same:

Width of picture	42.1 cm.	16½ in.
Height of picture	53.1 cm.	21 in.
Diagonal of picture	48.5 cm.	19 in.

3. The same arc lamp, condenser, etc., are to be used interchangeably for either films or slides by simply pushing the apparatus sidewise. Usually the slide-carrier is mounted permanently with the condenser so that the opening is not a circle of the diameter of the condenser but a rectangle 7.5 cm. x 10 cm. (3 in. x 4 in.).

4. Even illumination of the screen.—If the light is not quite uniform it is better to have the center the brighter rather than the edge.

§ 824. **Ideal case, moving pictures.**—The ideal case of projection (shown in fig. 328 a and b) is where the light is a point source and the condenser has no spherical aberration. This is the case which is usually figured, but it is not the best in practice if an extended source is used.

When changing over to moving picture films the lamp and condenser are moved to the position b. The objective O, is still 45 cm. (18 in.) from the condenser face where the rays will cross in the diaphragm plane, and the film is placed 13.3 cm. (5¼ in.) from the objective so that it will be in focus on the screen.

§ 825. **Illumination of moving pictures, practical method.**—The method which has been found most successful in lighting moving pictures is to focus the image of the crater not on the objective but on the aperture plate. This is because a moving picture objective usually has a diameter greater than the diagonal of the film (40 mm. to 65 mm. against 28.5 mm. diagonal; 1½ in. to 2½ in. against 1⅛ in. diagonal), hence the important point is to get the light through the film; the large objective will take in all the light which can get through the film.

Figures 333-335 show the effects of different methods of lighting. In practice all three are used together, that is, the film is illuminated by the area of the condenser which is not covered by the

slide-carrier and is evenly illuminated by the combined effect of spherical aberration and an extended image of the crater.

§ 826. **Image formation with moving pictures.**—Let us trace the course of the rays from the condenser to the screen assuming

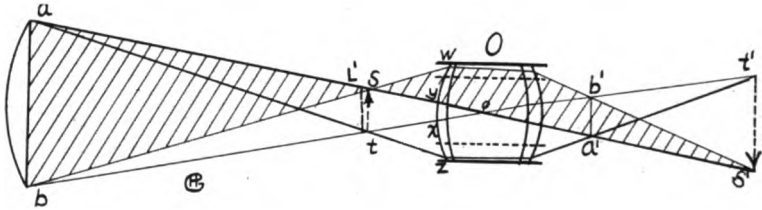

FIG. 333. IMAGE FORMATION OF A MOVING PICTURE FILM WITH AN EXTENDED SOURCE OF LIGHT.

- a, b Second element of the condenser.
- L' Image of the source of light.
- s, t Film.
- O Objective.
- w, y, x, z Points on the face of the objective.
- a', b' Image of the condenser.
- s', t' Image of the film on the screen.

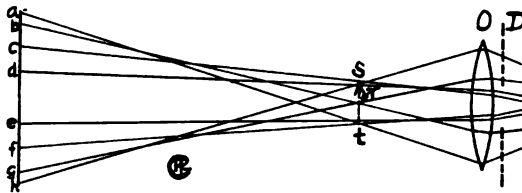

FIG. 334. IMAGE FORMATION OF THE MOVING PICTURE FILM WHEN USING A POINT SOURCE AND A CONDENSER HAVING SPHERICAL ABERRATION.

- a, b, c, d, e, f, g Points on the condenser face.
- r, s, t Film.
- D Diaphragm in front of the objective.

the crater image to cover the entire opening of the aperture plate. From every point of the condenser as a , fig. 333, light spreads out over the area $s t$. Light will reach the point s , on the film from every part of the condenser between a and b . From s , light spreads out in every direction between the limiting rays $b s w$, and $a s y$, and the objective O , collects all of this light to the point s' on the screen. Light from s , reaches s' , between the limiting rays

$s w s'$ and $s y s'$. In the same way light from t , reaches t' , between the limiting rays $t x t'$ and $t z t'$.

The objective O , will bring an image of the condenser face to a focus somewhere between it and the screen. In fig. 333 the image of the condenser face is at the point $a' b'$. With the magic lantern the condenser face and the lantern slide being so close together the image of the condenser face is nearly in focus on the screen.

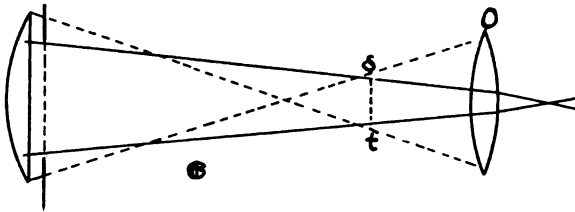

FIG. 335. THE DOTTED LINES SHOW THE MARGINAL RAYS REMOVED BY THE SLIDE-CARRIER.

s, t Film.
 O Objective.

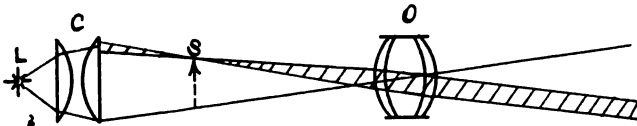

FIG. 336. SMALL CONDENSER FOR MOVING PICTURES.

This is exactly comparable to lantern projection except that the condenser and the object are smaller.

§ 827. Image formation when using a point source and a condenser with no spherical aberration.—The crater image in this case would be focused at o , and only the rays $a s y s'$, and $b t x t'$, would be used (fig. 333).

§ 828. Image formation with a point source and a condenser having spherical aberration.—The condenser must have either no spherical aberration at all or just the right amount. Fig. 334 represents a condenser having the right amount of spherical aberration. Consider the effect of each zone of the condenser in illuminating the film. The center zone from d to e , lights most of the center of the film. With this zone only, the illumination would

be dim but fairly uniform. The zones from c to d , and e to f , light a narrow ring of the film near s and t , i. e., a dim center and a bright outside ring would be produced by the zone from c to f (fig. 326, position c). The zone b to c , lights the part of the film between s and r , and f to g , lights the part between t and r , the addition of these zones is to increase the illumination of the center, making the illumination more uniform. The narrow zones a - b , and g - h , outside this, further illuminate the region in the center of the film. It is necessary to remark that with an actual point source the illumination with this arrangement can never be really uniform but the "aberration figure" will consist of a bright ring s t , a bright point r ,

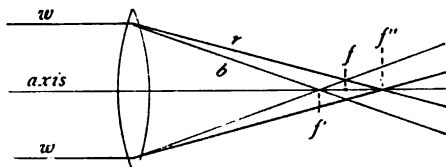

FIG. 337. CONVEX LENS SHOWING CHROMATIC ABERRATION.
(From *The Microscope*)

The ray of white light (w) is represented as dividing into the short waved, blue (b) and the long waved, red (r) light. The blue (b) ray comes to a focus nearer the lens and the red ray (r) farther from the lens than the principal focus (f). Principal focus (f) for rays very near the axis; f' and f'' , foci of blue and red light coming from near the edge of the lens. The intermediate wave lengths would have foci all the way between f' and f'' .

at the center (white ghost) and between will be a more or less evenly lighted disc. When a slightly extended source is used however, the aberration figures for the different points of the source will overlap and if the dimensions of the crater image are about one-third as great as the aberration figure an even illumination may be secured.

§ 829. **Effect of the diameter of the objective.**—If for any reason, as the insufficient diameter of the objective lenses, some of the light rays are lost after passing the film, the effect on the screen image is the same as if these rays never reached the film. Thus, if the objective O , fig. 333, has such a small diameter that it would not admit the ray b s w , the effect would be the same as if no light reached s , from the point, b , of the condenser.

By reference to fig. 334, it can be seen that if the objective has a small diameter, or if an iris diaphragm D , with a small opening is present, only light from the central zones from b to e , is permitted to pass. Increasing the diameter of the objective or diaphragm opening has practically the same effect as increasing the diameter of the condenser. As the diaphragm is opened the effect is striking, it is as if there were three layers of light upon the screen: First, the bright spot in the center of the screen increases in size until it covers the entire opening of the aperture plate, then the light has the appearance of folding over on itself and the second layer spreads over the picture starting from the edges. During this stage the illumination is uneven, there being a dark spot in the center of the field (dark ghost). The second layer of light reaches the center and goes beyond so there is a layer of light which starts at the center and spreads out towards the periphery of the field. In this stage the illumination is brighter at the center of the field than at the edges, there being a bright spot in the center (light ghost). With a larger aperture yet the third layer spreads over the entire field. For this reason one is more likely to secure an evenly illuminated field having no shadows in the center if an objective with large lenses is used than if one with small lenses is used.

§ 830. **Advantage in using a large diameter objective.**—The difficulty of lighting a picture evenly when using an objective of small diameter is often very great and requires a good deal of rather careful adjusting to eliminate a shadow in the center of the field and to get rid of the reddish brown corners at the same time. It is necessary to try various distances from the lamp-house to the aperture plate, different positions of the arc with respect to the condensers and it will perhaps be necessary to try condensers of different focal lengths. It will generally be found more satisfactory and convenient to have an objective of large diameter which will allow quite a range of adjustment either side of the very best without materially damaging the result.

§ 831. **Special condenser for moving pictures.**—If the condenser of a moving picture outfit were designed especially for that

purpose and was not intended to serve for lantern slides also, the design would be exactly similar to that for lantern-slide projection except that everything would be on a smaller scale, the condenser lenses being of smaller diameter and of shorter focal length. This would, of course, necessitate placing the lamp very close to the lenses, but they will be small and correspondingly thin and will not crack as easily as larger ones. Whether or not this would be a good design for a large size outfit using 35 to 50 amperes is not certain, but there is no doubt that good results can be obtained for projection on a small scale using three to four amperes which would not be possible on account of the difficulty of getting even illumination if the big standard size condenser were used.

§ 832. **Experiment with small size condenser.**—The method of image formation using a small size condenser is shown in fig. 336. L, is the source, an arc using 5 mm. carbons and 3 amperes of current. It is practically a point source. Condenser lenses 58 mm. ($2\frac{3}{4}$ in.) in diameter and 63 mm. ($2\frac{1}{2}$ in.) focal length placed 25 mm. (1 in.) from the source were used.

Even when using this very small source (3 mm. circle) a perfectly uniformly illuminated field was obtained, a thing which could not be done when a large condenser having the usual amount of spherical aberration was tried.

The diameter of the light cone through the objective was 2 cm. ($\frac{3}{4}$ in.). When large carbons were used and the current increased to 12 amperes the effects were to increase the brightness of the picture and to increase the diameter of the cone of light through the objective to 3 cm. ($1\frac{1}{4}$ in.). It is seen that in either case the lenses of the objective did not need to be of as large diameter as when using the ordinary large condenser.

IMAGE FORMATION WITH THE PROJECTION MICROSCOPE

§ 833. **Illumination for low powers.**—For low powers (20 to 100 mm. objectives) the principle is that the focus of the condenser should fall at the center of the projection objective and that the object should be placed in the converging cone of light in the posi-

tion to give a sharp image on the screen. To accomplish this best, the objective is so placed that the focus of the condenser is at the center of the projection objective, and then the stage of the microscope is moved back and forth until the image is sharp upon the screen. If a three-lens condenser, without a substage condenser is used, it will be found best for low powers (20–125 mm. focus) to have a condensing lens next the objective (2d element of the condenser, fig. 332) of 20 to 25 cm. (8 to 10 in.) principal focus. For the higher powers where greater numerical aperture is needed, a condenser lens of 15 cm. focus is better.

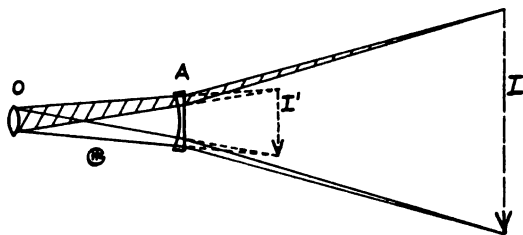

FIG. 338. IMAGE FORMATION WITH AN AMPLIFIER.

- O* The back lens of the objective.
A Amplifier (divergent lens).
I' The image which would be projected by the objective if no amplifier were in place.
I Image projected with the amplifier in place.
 Note that the rays from *A* diverge more rapidly than from *O* making the image larger than without the amplifier. (See also fig. 126).

§ 834. **Illumination for high powers.**—In all high power microscopic projection (2 to 16 mm. objectives) any source of light should be considered as an extended source whether lime light, arc light, or the sun is used.

The best method of illuminating microscopic specimens has been found to be to place the microscope so that the front lens of the objective is in the image of the crater (or the sun), (fig. 140) and then the specimen is moved up toward the objective until its image is in focus on the screen. Light will extend from every point of the object as shown in fig. 347 and strike the front lens of the objective. The action of the objective is to bring all of the light leaving a point of the object to a single point on the screen. The details of image

formation are taken up later in § 858, in connection with aperture.

§ 835. Amplifiers and oculars.—When using the projection microscope it is often desirable to magnify the screen image without changing to another objective. This may be done with an amplifier or an ocular.

§ 836. Image formation with an amplifier.—The amplifier is a negative lens or combination placed some distance beyond the objective. Without the amplifier the objective would form an image at I' (fig. 338). The effect of the amplifier (A) is to cause rays to cross at I which would otherwise cross at I' and at the same time the light from the objective O is rendered more divergent and it covers a larger area on the screen than it would without the amplifier (Fig. 126).

When using the amplifier one must focus the objective slightly farther from the specimen.

§ 837. Magnification due to the amplifier.—The magnification due to the amplifier is greater the shorter its focal length and the farther it is from the objective. The same principle is employed as with the telephoto-attachments to photographic objectives. It has been found that an amplifier of -5 diopters (20 cm. focus) 11.3 cm. from the objective will give a magnification of 1.68 times and an amplifier of -10 diopters (10 cm. focus) at the same distance will magnify 2.5 times. (See also § 356a for diopter, and for the amplifier § 392a).

§ 838. Projection ocular.—A projection ocular is required for certain apochromatic objectives which are designed to be used only with a compensation ocular, and when the microscope is used with polarized light, otherwise it is not necessary to use an ocular, although one may be used with any microscopic objective, see Ch. IX and Ch. X under demonstrations and drawing with high powers (§ 401, 405, 477).

The field lens O_1 (fig. 339) in connection with the objective forms an inverted image of the object at D . This image is in turn projected by the eye lens or combination O_2 , to the screen at I .

This image is inverted with respect to D , but erect with respect to the original object (fig. 207). A diaphragm at D , limits the size of the field and makes its boundaries sharp. Often owing to the small size of the diaphragm D , the field is not as large as desirable on the screen.

Besides limiting the size of the field there is a greater loss of light with the ocular than with the amplifier as the ocular is made of at least two separated lenses while the amplifier consists of but one lens or a cemented combination.

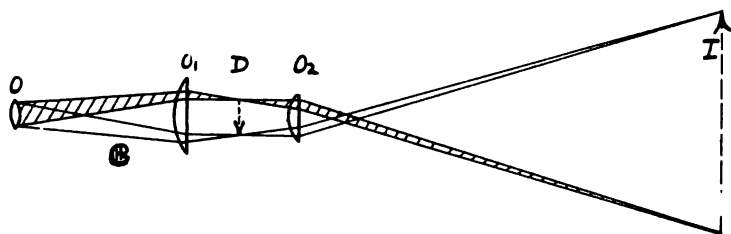

FIG. 339. IMAGE FORMATION WITH A PROJECTION OCULAR.

O Objective forming a real inverted image D , with the help of the field lens of the ocular O_1 .

O_1 Field lens of the ocular.

O_2 Eye or projection lens of the ocular. It projects a screen image I , of the real image D .

The image D , was inverted by the objective. O_2 , also inverts the image D , in projecting it, hence the final image I is erect like the object. (See also fig. 207).

APERTURE AND LIGHT LOSSES

§ 839. So far the path of the light from the source to the screen has been considered mainly from the standpoint of image formation, no account having been taken of the amount of light needed or of the losses of light and energy in the apparatus.

Light losses may occur from three causes:

1. Removal of the margin of a beam of light due to lenses of insufficient diameter.
2. Reflection of light both regular and diffused, at the surfaces of the lenses.
3. Absorption of light by the glass of the lenses, by the partial opacity of the object and by dirt.
4. Special light losses due to the nature of the experiment.

§ 840. Losses by the removal of the margin of the beam.—From the source, light spreads out in all directions. Only the light that strikes the front surface of the first lens of the condenser is available, hence the first lens should be of such a diameter and so placed that it takes in as large an angle of light from the source as possible. The use of a meniscus lens next the radiant allows a much larger angle of light to be used than does a condenser without such a lens (fig. 332, § 821).

The lenses after the first, should not remove any of the border rays of the light transmitted by the first lens, or the first lens need be of only sufficient diameter to furnish a beam of light which will just fill the opening of the other lenses.

After passing through the condenser the light is available for illuminating the object. With the magic lantern the entire diameter of the cone of light passes through the objective and reaches the screen. With moving picture projection the entire cone of light may or may not get through the objective (§ 825, 829). With the microscope, except for the lowest powers, the objective lenses are smaller than the image of the crater which is thrown on the front of the objective, and much loss of light occurs from this cause.

§ 841. Losses by reflection.—The polished surfaces of a lens reflects some light, about 4 to 5 per cent. at each surface between glass and air; 8 to 10 per cent. for each lens or plate of glass. If the surfaces of the glass are not perfectly clean or perfectly polished the light losses may amount to much more, sometimes 15% at each surface. All reflected light being lost, this effect is generally much more important than the slight absorption in the body of the glass itself. A good illustration of this reflection by glass surfaces is the brilliant reflection from windows often seen at sunset.

§ 842. Light losses by absorption.—The object (slide, film, or specimen) absorbs some of the light incident upon it. This is a necessary accompaniment of showing the object at all, but an object which does not absorb too much light is to be preferred whenever obtainable.

The glass of which lenses are made is not perfectly transparent but absorbs some light. This is especially true of the thick condenser lenses which usually look green when laid on a piece of white paper. Such green lenses will be found to absorb an appreciable amount of light. Some condenser lenses made of cheap glass will turn purple after being in use for some time.

§ 843. **Special light losses.**—The use of *polarized light* necessarily entails the loss of one-half of the light in the polarizing nicol. The analyzing nicol may transmit most of the remaining light but generally it is turned to transmit but a small portion of it (§ 884).

In *moving picture projection* the shutter covering the lens while the film is in motion removes part of the light. In this case it has been found by careful experiment that removing all of the light part of the time has exactly the same effect as removing part of the light all of the time. Some shutters remove but $\frac{1}{6}$ of the light while others remove $\frac{1}{2}$ of the light (§ 591). The latter are, however, sometimes to be preferred, the avoidance of flicker being of more importance than the slight dimming of the image.

ENERGY LOSSES

§ 844. Of the energy which is radiated by the source only a comparatively small part, from 2 to 10 per cent. is of those wave lengths which affect the eye, the major part of the energy being in the infra-red part of the spectrum (fig. 307). This infra-red radiation accompanies the light radiation and is bent by a lens in very nearly the same manner. It has been found that the difference in focus between the infra-red and the red, for glass, is no greater than the difference in focus between the red and the blue. This is due to the special dispersive qualities of glass.

§ 845. **Disadvantage of the infra-red.**—As the infra-red radiation has such great energy and consequently so great a heating effect wherever it is absorbed (fig. 307), and as at the same time it has no effect upon the eye, it is advantageous to remove it as far as possible. Energy losses, in so far as they are not accompanied by light losses, are of advantage.

§ 846. **The energy losses.**—The energy losses occur principally in three places (fig. 342):

1. In the condenser lenses.
2. In the water-cell, if there is one.
3. In the specimen.

Energy losses beyond the specimen are not considered separate from light losses.

§ 847. **Losses in the condenser.**—The glass of which the condensers are made, even if perfectly transparent to visible light, absorbs a large amount of infra-red. A piece of condenser glass 2 cm. thick was found to absorb 41% of the radiant energy from the positive crater of the right-angle arc incident upon it, while absorbing but 10% of the incident light. This has two effects.

1. The absorbed energy heats the condenser very greatly.
2. The light which gets through the condenser has a much less heating effect on the specimen than it would have otherwise.

The first effect (heating the condenser) is a distinct disadvantage to the condenser as it is one of the causes of condenser breakage. Most of the energy absorbed will be by the first lens, and in that one, more will be absorbed at the surface near the lamp than away from it; a circumstance which leads to unequal heating and puts a strain on the lens.

Different kinds of glass, equally transparent to visible light absorb different amounts of infra-red. For example, crown glass will be found to be opaque to some of the longer waves to which flint glass is perfectly transparent.

The second effect of heating the condenser is an advantage, as the specimen is relieved of a good deal of the heating effect. Lantern slides are less likely to be cracked, moving picture films are less likely to curl or catch fire, and microscopic specimens can be shown for a longer time before they are injured.

§ 848. **Energy losses in the water-cell.**—Water is very opaque to radiation of great wave length, even the thinnest films being absolutely opaque to certain wave-lengths.

The table (§ 849) and the curves (fig. 340–341) show the energy of the positive crater of the right-angle arc transmitted by layers

of water of different thickness. The lower line represents the energy transmission. About 10% of the light (and energy) is lost by non-selective reflection. If one wished to know the amount of energy transmitted to get the same light transmission, it is necessary to add 10% to the above values. The upper line represents the transmitted energy after the correction for reflection has been made. These curves show that after the first four or five centimeters of water, increased thickness does not reduce the energy very much. A 6 cm. layer of water transmits 22.5%, a 10 cm. layer transmits 20%, the difference absorbed in the last 4 cm. being but 2.5% of the incident energy.

The water-cell, by absorbing a great deal of the energy, reduces the heating effect of the light on the specimen. This energy

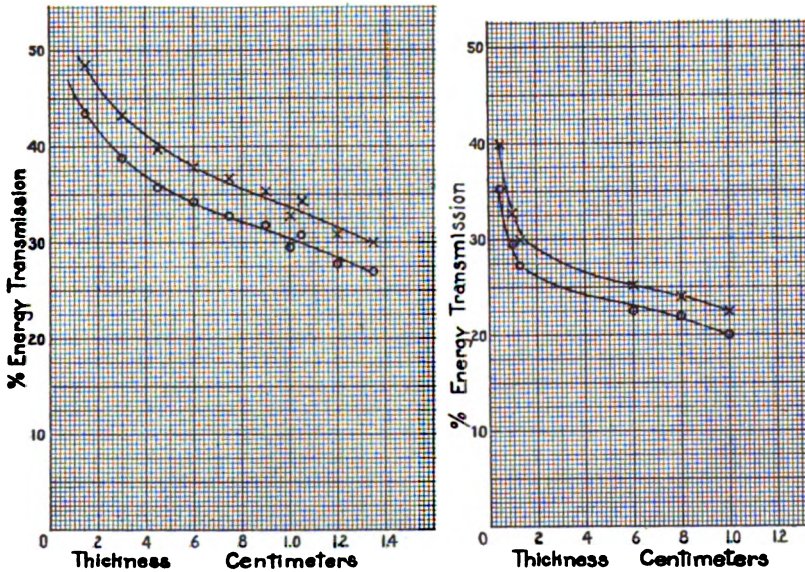

FIG. 340-341. PERCENTAGE OF ENERGY FROM THE CRATER OF THE RIGHT-ANGLE ARC TRANSMITTED BY LAYERS OF WATER OF DIFFERENT THICKNESS.

The lower curve shows the actual energy transmission in each case, and the upper curve shows the actual energy transmission corrected for reflection.

absorbed in the water-cell heats the water, but water is peculiarly adapted for this purpose for it is the best known absorbent of the infra-red, "heat rays."

Water is easily obtained and put into the cell. It has the highest specific heat of any known substance; i. e., a given quantity of water will absorb more energy when being warmed a given amount than will anything else. If the water in a water-cell becomes so hot that it gives off bubbles, a cool cell can be substituted for it. Cooling a cell by the circulation of cold water through it has not proved successful.

The temperature of the water has no appreciable effect upon the energy absorption, boiling water serving as well as ice water. The energy transmission for a water-cell was found when hot (80° C.) to be 18.4%; when cold (22° C.) 19.2%. The water was slightly turbid, being more so when hot than cold.

§ 849. **The energy transmission of layers of water of different thickness.**—The source of light is the crater of the right-angle carbon arc.

WITH 12 AMPERES DIRECT CURRENT

Thickness of the layer of water	ENERGY TRANSMITTED	
	Observed	Corrected for reflection
.15 cm.	43.5%	48.4%
.30 "	38.9%	43.2%
.45 "	35.8%	39.8%
.60 "	34.1%	37.9%
.75 "	32.9%	36.6%
.90 "	31.9%	35.4%
1.00 "	29.5%	32.8%
1.05 "	30.8%	34.2%
1.20 "	27.8%	30.8%
1.35 "	27.0%	30.0%
6.00 "	22.5%	25.2%
8.00 "	22.0%	24.0%
10.00 "	20.0%	22.5%

WITH 15 AMPERES ALTERNATING CURRENT

8.00 cm.	14.4%	15.6%
----------	-------	-------

§ 850. Table of the energy and light transmission and absorption.

ABSORBING ELEMENT	PHOTOMETRIC		ENERGY	
	Absorp.	Trans.	Absorp.	Trans.
Plane Glass	10.55%	89.45%	41.5%	58.5%
Six Centimeter Cell	10.75%	89.25%	77.1%	22.9%
Pl. glass and 6 cm. Cell	28.8%	79.2%	82.0%	18.0%
Condenser Cell, Clear	11.3%	88.7%	77.9%	22.1%
Condenser Cell, Muddy	22.6%	77.4%	78.8%	21.2%
Condenser Water-Cell, Hot and turbid			81.6%	18.4%
Same, Cold and turbid			80.8%	19.2%
Stage Water-cell, Clr.	7.9%	92.1%		
Stage Water-cell, Muddy	14.7%	85.3%		
Ten Centimeter Cell	11.1%	88.9%	79.6%	20.4%
Alum, 6 cm. Cell	15.3%	84.7%	77.2%	22.8%
Glycerin 6 cm. Cell	11.6%	88.4%	75.0%	25.0%
Mica, thin	25.3%	74.7%	27.5%	72.5%
Mica, thick	36.0%	64.0%	35.0%	65.0%
Balsam, Stage Cell	24.6%	75.4%	68.6%	31.4%
Glass Slide, green			32.3%	67.7%
Glass Slide, white			23.5%	76.5%
Green Slide with Balsam			37.0%	63.0%
White Slide with Balsam			27.4%	72.6%

§ 851. Other substances dissolved in water.—Other substances dissolved in water have not been found to improve its energy absorbing qualities. For a long time it was supposed that a saturated solution of alum was more effective than pure water but this is not so; moreover it is very difficult to prepare a saturated solution of alum which is not turbid. Tests show energy transmission of 22.8% for an alum solution as against 22.9% for clear water, while alum absorbs 15% of light as against only 10% for clear water. The alum only serves to dilute the water. Crystals of alum, $K_2 SO_4 Al_2 (SO_4)_3 24 H_2O$, absorb much energy, but it has been proved that this is entirely due to the water of crystallization.

§ 852. Energy losses in the specimen.—All the light energy absorbed by the specimen is converted into heat; hence, an opaque specimen or one which is black would become heated in the concentrated beam of light necessary for the microscope even if only the radiation in the visible spectrum were used. As the visible

radiation constitutes only about 10% of the energy radiated by the arc, this effect is insignificant in comparison to the heating due to the infra-red. Even when the water-cell is used only 43% of the energy which gets through is visible as light. A greater thickness of water would reduce this effect but little, hence it is necessary to carry the heat away from the specimen as rapidly as possible. This is done by the stage cooling cell which is in contact with the glass slide. The effect is purely one of conduction, and a thick piece of any transparent substance would answer. But water has been chosen because of its great specific heat, and the comparative cheapness of hollow glass cells.

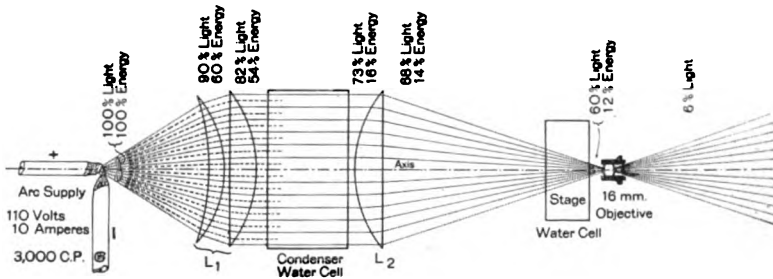

FIG. 342. ILLUSTRATION OF THE LIGHT AND ENERGY LOSSES IN THE PROJECTION MICROSCOPE.

Starting from the arc lamp the light and energy reaching the first face of the condenser are each designated by 100%. Opposite each element of the optical system is given the percentage of light and of energy transmitted by each. With the 16 mm. objective only about 6% of the original light is available for the screen picture.

§ 853. **Keeping the condenser cool.**—One of the causes of the condenser breakage is the stream of hot gases from the arc which strikes the upper part of the condenser and heats it unequally. This is specially troublesome when the lantern is tipped up at an angle. To prevent this a thin sheet of glass (watch glass) or mica may be used between the arc and the condenser. Glass is to be preferred as it is more transparent than mica and has less defects to cause shadows on the screen. The following data refer to two sheets of mica new and in good condition.

	Light absorbed	Energy absorbed
Thin piece	25.3%	27.5%
Thick piece	36.0%	35.0%

This shows a heavy loss in light, the absorption being non-selective, that is the total energy transmitted is in proportion to the light.

§ 854. **Example of light and energy losses.**—In fig. 342 is a diagrammatic representation of the light and energy losses actually found in a certain projection system. An arc light was used. The light and energy from the arc striking the first surface of the condenser were each called 100%.

After passing the first part of the condenser L_1 , there remains 82% of the light and 54% of the energy.

After passing the condenser water-cell the light was reduced to 73% while there was left only 16% of the energy.

After leaving the second part of the condenser L_2 , there was 68% of the light and 14% of the energy. Of this remaining 14% of the energy, 57% is invisible and 43% is visible as light.

When used with a magic lantern the projection objective transmits only 70% of the light reaching it. As 68% of the original light reaches the objective, the screen image must be formed by $68 \times 70 = 47.6\%$ of the original light.

With the microscope further losses occur due to the presence of the stage water-cell. The microscope objective lets through but a small amount of the light incident upon it, the loss being greater the higher the power of the objective. A 16 mm. objective, for example, transmits 10% of the incident light. In the case investigated only $10 \times 60 = 6\%$ of the light originally striking the first lens of the condenser reached the screen. If a substage condenser and an ocular are used the light for the screen image is still further reduced.

EFFECT OF APERTURE

§ 855. Increasing the aperture of a perfect lens or a combination of lenses with *undirected* light has two effects.

1. It increases the definition, that is, the image shows finer structures than does a lens of smaller aperture, i. e., it will show more lines to the millimeter or inch. See under Abbe diffraction theory § 910.

2. It lets through more light.

The effect of increasing the aperture of a lens when using *directed* light as with the magic lantern depends somewhat upon circumstances. If the directed light spreading out in the form of a cone has a greater diameter than that of the lens, the larger the lens up to the full diameter of the cone, the greater the amount of light which gets through, and the brighter will be the screen image just as with undirected light.

If however, directed light from a point in the object spreads out over a cone which has a smaller diameter than the lens, then the size of the lens is immaterial, for all the light which gets through the lens, gets through a small part of its area, and the rest of the lens is not used at all. Increasing the diameter of the lens will not increase the brightness of the screen image.

Another method of looking at the problem is to suppose the diameter of the lens fixed and that of the cone of directed light to be increased in diameter, assuming the light source to have the same intrinsic brilliancy, i. e., same brightness per square centimeter. Suppose we start with a very small source of light behind the pinhole in the screen S , fig. 343. This light will get through a small part of the lens. Now increase the area of the light source L , keeping everything else the same, the cone of light from S , will for a time all get through the lens and be collected at a point, hence the image I , of the pin hole will keep getting brighter until the cone of light just fills the aperture of the lens. When this occurs a further

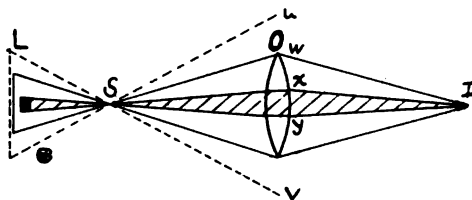

FIG. 343. SIZE OF THE LIGHT SOURCE AND BRILLIANCY OF THE SCREEN IMAGE.

Up to a certain point the larger the light source L , the greater will be the amount of light from the specimen S , which gets through the objective O , but beyond this point increase in the size of the light source produces no further increase in the intensity of the screen image as the light (u , v) passes outside the objective.

increase of the diameter of the cone of light will do no good because the light falls outside of the opening of the lens.

The conclusions from this are:

1. If there is a cone of directed light from a given point it is of no advantage to use an objective with lenses of larger diameter than this cone.

2. With a given size objective, when the object is illuminated by directed light an increase in area of the source beyond that which will fill the aperture of the objective is of no advantage.

§ 856. **Method of determining the aperture of the objective which is used.**—The simplest way is to look directly into the objective when in use; of course, using a colored glass or smoky mica to protect the eyes. Do not hold the head too close to the objective. If the whole of the back lens of the objective is filled with light the aperture is filled. If the bright light is only in the center of the back lens the bright spot is the part of the aperture which is used. It often occurs that different parts of the objective are used by the light from different parts of the object. This can be determined by looking at the objective and moving the head from side to side.

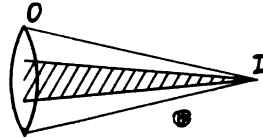

FIG. 344. THE "CLOSING ANGLE" OF LIGHT FORMING A SCREEN IMAGE.

The shaded portion shows the closing angle when an ordinary magic lantern is used with an arc lamp as a source of light; and the outside lines show the closing angle when an extended source of light, like a gas or acetylene flame, is used.

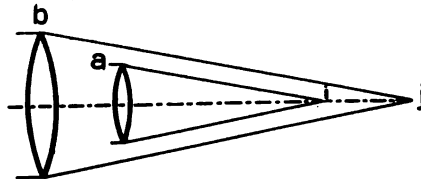

FIG. 345. THE CLOSING ANGLE OF LIGHT TO FORM AN IMAGE.

In order that the images i and j , shall be equally bright with opaque projection, the closing angle of light from the objectives must be the same. As the distance bj , is twice as great as ai , the diameter of the lens (b) must be twice as great as that of (a) and its area must be four times as great.

BRIGHTNESS OF THE SCREEN IMAGE

§ 857. The brightness of the image can be calculated in either of two ways.—

1. The relative area of the object and image and the illumination of the object.
2. The intrinsic brilliancy of the source and the closing angle of the rays forming the image.

The first case is more applicable to directed light where all of the light illuminating the object gets through the objective. For example, with a magic lantern, let the area of the slide be 50 sq. cm., 7.1 x 7.1 cm. and the area of the screen 2 x 2 meters = 40,000 sq. cm. or 800 times as much surface. Let the brightness of the slide illumination be 48,000 meter candles. The illumination of the screen will be $\frac{1}{800}$ of this or 60 meter candles.

Actually only 70% of the light from the slide will get through the objective, and the illumination will be 42 meter candles. For ordinary reading with artificial light one needs an illumination of from 30 to 50 meter candles.

The second case is most useful where the entire aperture of the lens is filled with light, as with a large light source with the microscope, and with opaque projection. Consider the same example as above except that the object is a white opaque body illuminated from the front. More data concerning the lens will be needed. Let the lens be one of 14 cm. ($5\frac{1}{2}$ in.) focus, 6.25 cm. ($2\frac{1}{2}$ in.) diameter, the size of the picture being two meters square as before; and as before the object illuminated with an intensity of 48,000 meter candles. To secure the same magnification as before requires a distance of 396 cm. (4 meters approximately) from the screen with this focus objective. Suppose the objective is looked at from the screen. Its entire opening will appear of the same brightness (except for absorption) as if there were no glass present and the illumination on the screen will be just the same as if the light reaching it were from a piece of white paper having an area of 50 sq. cm. illuminated by 48,000 meter candles. Considered as a source of light this paper disc would have a candle-power of $\frac{48,000}{10,000\pi}$

per sq. cm. (§ 857a) 50 sq. cm. gives 76 candle-power. At a distance of 4 meters from the screen this gives $\frac{76}{4^2} = 4.8$ meter candles. Counting the losses due to the lens as 30% the illumination of the screen would be 3.16 meter candles. This is about a third of the minimum illumination for projection in a perfectly dark room, and about one-tenth of what would be required for good projection.

If the intrinsic brilliancy of the source is the same and the closing angle is the same the illumination will be the same, thus, if the screen is twice as distant and the objective has twice the diameter the illumination would be the same (fig. 344-345).

In the above example no use has been made of the focal length of the objective nor the magnification of the object, these having no direct influence on the screen illumination. If a higher magnification were desired a shorter focus objective would be substituted and the object brought nearer to it. The apparent brightness of the paper seen through the objective will not change if the paper is moved closer to the objective. Therefore, if the objective has the same diameter the illumination on the screen will be just as before.

Another way of looking at the matter is this: with the shorter focus objective a certain small area of the object will be spread over a larger area on the screen, but bringing the object nearer the face of the objective, more light from the small area of the object will enter it. These two effects exactly counterbalance each other, the increased light taken in by the objective being sufficient to illuminate the larger area.

§ 857a. Formula for finding the candle-power of a surface illuminated at a given intensity.—Suppose a perfectly diffusing, perfectly white surface to be illuminated at a given intensity, say the intensity of the incident illumination is I meter candles, i. e., the incident light flux is I lumens per square meter. The light falling on one square centimeter will be $1/10,000$ lumens. This light will be scattered in all directions so that the surface appears equally bright when seen from any direction, but as the surface appears fore-shortened when seen from any other direction than the perpendicular, more light will be reflected perpendicular to the surface than in any other direction. The candle-power of one square centimeter of this surface in any given direction can be expressed as $B \cos \theta$, where the constant B , is the intrinsic brilliancy in candle-power per square centimeter of the surface considered as a source of light, and θ , is the angle between the normal to the surface and the given direction.

Consider a sphere of one meter radius having this lighted surface at its center. The light received by one square meter of the surface of this sphere will then be $B \cos \theta$ lumens. Only half of the sphere can receive light from this opaque surface and the entire light received by this hemisphere will be:

$$\int_0^{\pi/2} 2\pi B \sin \theta \cos \theta \, d\theta =$$

$$\frac{\pi B}{2} \int_0^{\pi/2} \sin 2\theta \, d2\theta =$$

$$\frac{\pi B}{2} \left[-\cos 2\theta \right]_0^{\pi/2} =$$

$$\frac{\pi B}{2} (1 - \cos 2\theta) =$$

$$\frac{\pi B}{2} (1 - \cos 180^\circ) = \pi B$$

Now if the reflecting surface is perfectly white there will be no light lost and the entire light received by the hemisphere will equal the light incident upon the reflecting surface, that is $\pi B = 1/10,000$ and $B = 1/10,000\pi$ candle-power per square centimeter. In the above example where the incident illumination is 48,000 meter candles, the surface considered as a source of light will have 48,000 candle power per square centimeter.

10,000 π

This same formula will apply to the case of opaque projection (§ 274a) where it is desired to determine the ratio of the light getting through the objective to form the screen image and the light falling on the opaque surface, assuming that this opaque surface is perfectly diffusing and perfectly white. In the case of the objective, light over a certain zone of the hemisphere is used. If the angle which the objective subtends with a point on the object taken as the center is called 2θ , then the angle between the axis and the edge of the objective is θ , and the above formula will apply, i. e., the light flux striking the objective from one square centimeter is $\pi B/2 (1 - \cos 2\theta)$. Also the total light flux reflected from the surface over the entire hemisphere is πB , hence the ratio of the light flux striking the objective to form the screen image to the light flux received by the reflecting surface is $\frac{1 - \cos 2\theta}{2}$. This takes no account of losses

due to reflection and absorption by the objective.

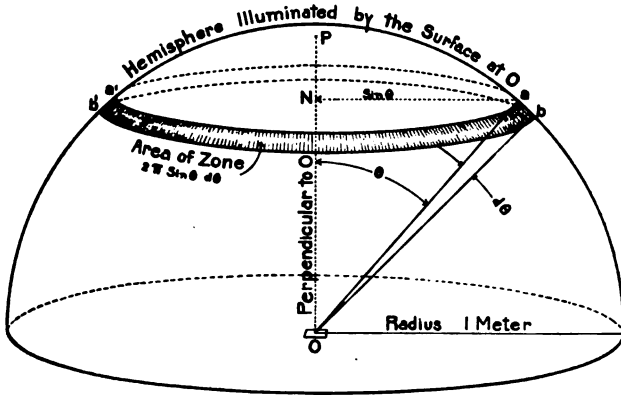

FIG. 346. CANDLE-POWER OF A SURFACE ILLUMINATED AT A GIVEN INTENSITY.

O A surface having an area of one square centimeter located at the center of a hemisphere of one meter radius. This surface is illuminated at an intensity of *I* meter candles. It receives and reflects 1/10,000 lumens. As a light source it has in the direction *OP*, *B* candle-power.

OP Perpendicular to the surface.

b'a'ab A zone on the surface of the hemisphere. This zone is located at an angular distance of θ , from the perpendicular to the surface. The angle subtended by this zone from the center is $d\theta$, and its width *ab*, is $d\theta$ meters. The radius *aN*, of the circle *aa'*, is $\sin \theta$ meters, and its circumference is $2\pi \sin \theta$. The area of the zone is then $2\pi \sin \theta d\theta$.

The intensity of illumination of this zone is $B \cos \theta$, meter candles. The light flux received by this zone is then (illumination x area) equal to

$$B \cos \theta \times 2 \pi \sin \theta d \theta = 2 \pi B \cos \theta \sin \theta d \theta.$$

IMAGE FORMATION WITH THE MICROSCOPIC OBJECTIVE WITH REFERENCE TO APERTURE

§ 858. Let *a b*, fig. 347, represent the face of the condenser which is in such a position with respect to the objective that its image *s' t'*, is in focus on the screen. With high powers the specimens will be very close to the front of the objective.

The front lens or combination of the objective *O*₁, will form an image *a' b'*, of the condenser face which may or may not coincide with the back lens *O*₂, of the objective as here shown.

Tracing the light from the condenser we see that all the light from *a*, which gets through the front lens passes through *a'*, and all light from *b*, passes through *b'*, and so on.

The light from the point s , spreads out over the angle xsy , which equals angle asb . Light from s , which has come from a , can reach the screen along the path $s x a' s'$. From b , the light follows the path $syb's'$, and from the central parts of the condenser light will go from s to s' , along the paths which lie between a' and b' .

The result is that the light which goes to make up the point s' , of the screen image has come from the entire area of the circle $a'b'$. That is, the circle $a'b'$, is the diaphragm which limits the illuminated aperture of the objective.

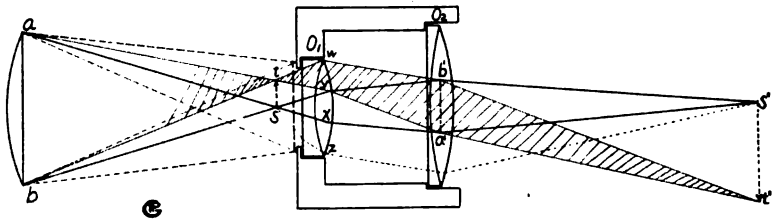

FIG. 347. IMAGE FORMATION WITH A MICROSCOPIC OBJECTIVE.

The shaded portion shows the cone of light which illuminates the point t , of the specimen and which goes to make its image t' , on the screen; all other points are similarly lighted and similarly pass on to form the screen image.

a, b The last element of the condenser (see fig. 332).

s, t Two points of the specimen to be projected.

O_1, O_2 The front and back combinations of the objective.

w, x, y, z Points on the front lens of the objective.

a', b' Image of the condenser face.

s', t' The inverted screen image of the object s, t .

When used with a magic lantern, the projection objective transmits only 70% of the light reaching it. As only 68% of the original light reaches the objective, the screen image must be formed by $(68 \times 70 = 47.6\%)$ of the original light.

With the microscope, however, only about 6% of the original light gets through the objective and goes on to form the screen image (fig. 342). If a substage condenser and an ocular are used, the light for the screen image is still further reduced.

The illuminated aperture of the objective may be increased by:

1. Using a larger diameter condenser of the same focal length.
2. Using a shorter focus condenser of the same diameter.

Either method will increase the angle asb , and the diameter of the disc $a'b'$.

The illuminated aperture might be decreased by using a large iris diaphragm to cover part of the condenser face $a b$.

In the figure the aperture illuminated $a'b'$, is less than the diameter of the rear lens. If the size of the condenser were greatly increased until its image was as large as the rear lens of the objective, the marginal ray from s , would move from $sxa's'$ to szs' . The entire aperture of the objective would be illuminated and no more light would be used by a further increase in the size of the condenser (Fig. 347).

§ 859. **Image formation of a point not on the axis.**—Light from t , will spread out over the angle $w t y$, which equals angle $a t b$, will pass through $a' b'$, and be collected to a point t' , on the screen. This light will of course fill a cone of which the limiting rays are $t w b' t'$ and $t y a' t'$ (Fig. 347).

§ 860. **Illumination of the screen image.**—Any single point on the screen as s' or t' , will be illuminated by light which has come from the bright disc $a' b'$. The illumination will therefore depend on the three factors, the brightness and area of the disc $a' b'$, and its distance from the screen (Fig. 347).

The area of the disc can, of course, be no greater than the area of the back lens of the objective, and is usually smaller. For this reason the brightest projection in a given case is obtained when the back lens of the objective appears to be entirely filled with light.

The brightness of this disc of light would, if it were not for light losses, be exactly the same as that of the original source. This follows from the fact that the brightness of an object remains the same, except for light losses, when seen through a lens or a system of lenses as when viewed directly. A lens can only change the direction, not the intensity of light, or in other words it can only change the apparent size of an object.

This being the case the screen brightness is limited not by the candle-power of a source but by its intrinsic brilliancy (candle-power per square centimeter). This assumes the image of the light to have an area great enough to cover the front lens of the objective, which is the case with most microscopic projection.

The effect of light losses by reflection and by absorption is to reduce the brilliancy of the bright disc $a' b'$. These losses are very great, and as only a small amount of light is available anyway, that is the reason we do not recommend the use of the substage condenser except in the special cases of high power demonstration, for photography and for high power drawing, where fine details are of more importance than brilliancy (see Ch. IX, X, § 401, 477).

A substage condenser will reduce the brilliancy of the disc to 70% of its former value, and our experience has been that the full aperture of all but the highest power objectives (8, 6, 4, 2 mm. equivalent focus § 808a) can be entirely filled without its use.

§ 861. Appearance when one looks into the objective.—If the eye is held at s' (a dark glass being of course held in front of the eye or better yet held just before the front of the objective at s) light will strike the pupil from all parts of the condenser image $a' b'$, the appearance being that of a bright disc of light.

The larger this disc, the greater the aperture of the objective illuminated. With low powers the entire aperture will be illuminated by the use of the large condenser alone. With high powers only the central part of the back lens will appear bright. When the bright disc spreads over the entire back lens the aperture of the objective is fully illuminated and no further increase of light is possible with a given source.

As often happens, the back lens appears illuminated not with a uniform bright disc but by a bright ring with a bright center separated by a dark ring or crescent. This is due to the spherical aberration of the condenser.

§ 862. Appearance when an amplifier or an ocular is used.—An amplifier or an ocular will spread the light from the objective over a larger area than before, of course decreasing the brightness of the screen image. This effect could be foretold by looking directly at the instrument from the screen for the bright disc of light $a' b'$ (fig. 347) will appear smaller when the ocular or amplifier is in place.

§ 863. Limit of brightness with the projection microscope.—The screen image with microscopic projection apparatus is not as

bright as could be obtained with the magic lantern. The reason is the physical impossibility of crowding more than a limited amount of light through the very small opening of a microscopic objective. The objective can be illuminated so that light comes from the entire area of the rear objective lens to form the screen image. When this occurs this objective will act like a luminous source having the same intrinsic brilliancy (except for losses) as the original source, and having the area of the rear lens. The area of this rear lens is fixed and cannot be increased. The intrinsic brilliancy of a given source is fixed. Hence, only by using a brighter source as changing from a lime light to the alternating current arc, from the alternating current arc to the direct current arc, or from the direct current arc to sunlight, or by reducing the losses due to unnecessary complication of lenses and condensers between the source and the screen, can the image brightness be increased. When using sunlight one has reached the limit of possibility for light brilliancy.

KOEHLER'S METHOD OF ILLUMINATING A SPECIMEN FOR MICROSCOPIC PROJECTION

§ 864. The simple method of lighting a specimen for microscopic projection by a condenser is, as stated above, to focus the image of the crater upon the front of the objective (fig. 140). For high powers this is practically the same as if the crater image were focused upon the specimen.

With the Köehler method a substage condenser is used. The large condenser forms an image of the crater on the diaphragm of

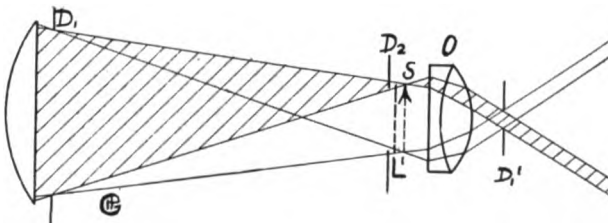

FIG. 348. ORDINARY METHOD OF ILLUMINATING MICROSCOPIC SPECIMENS.
(See § 376, 833).

the substage condenser at d_2 (fig. 170, 349). The effect of the diaphragm at d_1 , in front of the large condenser, and at d_2 , where the crater image is formed, is just opposite in the two cases. With the usual arrangement (fig. 348) the diaphragm D_1 , will limit the aperture of the objective while the diaphragm D_2 , will limit the size of the field illuminated. With the Köehler arrangement, however, (fig. 349) the diaphragm D_1 , limits the size of field illuminated, while the diaphragm D_2 , limits the aperture of the objective used.

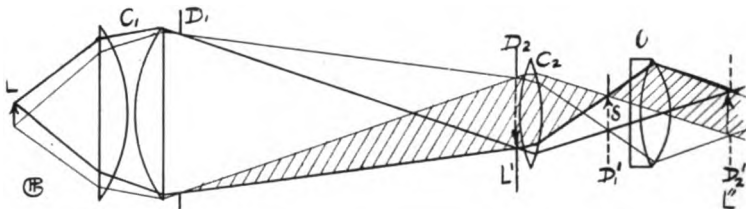

FIG. 349. KOEHLER'S METHOD OF ILLUMINATING MICROSCOPIC SPECIMENS.

- L Light source.
- C_1 Condenser.
- D_1 First diaphragm.
- D_2 Second diaphragm.
- L' Image of light source on second diaphragm.
- C_2 Substage condenser.
- S Specimen.
- D' Image of diaphragm D_1 , on the specimen.
- O Objective.
- D_2' L' Image of diaphragm D_2 and light source.

§ 865. Advantages and disadvantages of Köehler method.—

The Köehler method has the advantage that it enables an easy control of the size of the field illuminated and of the aperture of the objective used. If a larger field than necessary is illuminated, there may be undue heating of the specimen and the best results are obtained only when just the right objective aperture is used. On the other hand, the use of a substage condenser precludes the use of a cooling stage, (fig. 134), except a very thin form. It limits the size of field which may be used, and transmits only 70% of the incident light and reduces the general flexibility and ease of handling the apparatus.

CHAPTER XV

SOME USES OF PROJECTION IN PHYSICS; EXPERIMENTS ILLUSTRATING NORMAL VISION AND SIMPLE, REFRACTIVE EYE DEFECTS.

§ 875. Apparatus and Material for Chapter XV:

For polarized light, see § 879; For projection of spectra, see § 885; For photography, see § 908; For Abbe Diffraction Theory, see § 909; For eye defects, see § 916.

§ 876. Historical development of experimental projection.—

Works of reference giving methods of projecting experiments.

In every book, and in every article on projection, directions and hints are given. The following are especially full in directions, and rich in suggestions: Dolbear.—*The Art of Projecting*; Fourtier et Moltini.—*Les Projections Scientifiques*; Hassack und Rosenberg.—*Projektions-apparate*; Lehmann.—*Flussigekrystalle*; Trutat.—*Traite des Projections*; Tyndall.—*Six lectures on light*; Wright.—*Light, a course of experimental optics chiefly with the lantern*; Wright.—*Optical Projection*.

INTRODUCTION

§ 877. Many physical and chemical experiments can be exhibited to an entire class in a striking manner by the aid of projection apparatus. Sometimes transparent objects are used, and then again, as suggested by Dolbear, many experiments with opaque objects show very clearly as shadows on the screen if they are performed in the beam of the magic lantern.

Indeed, for exhibiting to a class or any large audience the varied experiments necessary in physical and chemical work, all the projection apparatus described in this book and combinations of them may be needed. By thoroughly mastering the principles of projection one can so adjust and combine the different pieces of apparatus that almost any phenomenon can be shown on the screen.

One can find many suggestions, and often detailed directions for showing various experiments in the works referred to at the beginning of this chapter.

No directions for the ordinary experiments shown by projection apparatus in every university course in physics and chemistry are given here, but we thought it wise to include a few special projection experiments that have been found by us to be especially instructive or difficult to perform by the means ordinarily used.

The experiments illustrating normal vision and the simpler refractive eye defects are included because of the importance of these defects and their prevalence with school children and students and others doing close work; and because, with projection apparatus, it is so easy to show in a striking manner what is meant by the defects, and how certainly the defects can be corrected by using the proper spectacles.

SOME SPECIAL EXPERIMENTS IN PHYSICS

§ 878. **Kind of apparatus.**—Most projection experiments in physics are only shown occasionally, hence permanent apparatus to demonstrate many physical phenomena is so costly as to be out of the question. The apparatus here described consists in lenses, objectives, prisms, clamps, arc lamps, etc., generally to be found in any laboratory where such experiments would be shown. The apparatus can either be clamped to rods or laid upon a horizontal table. The former method has the advantage that one can project in an inclined as well as in a horizontal direction; the latter method is easier to set up. When permanent apparatus is used the principle is exactly the same, permanent instead of temporary supports being used to hold the lenses.

An optical bench like that shown in fig. 158–159 is satisfactory where the apparatus is set up on a table. When it must be held at various angles some clamping arrangement is desirable.

EXPERIMENTS WITH POLARIZED LIGHT

§ 879. **Apparatus.**—

1. Right-angle arc light; Condenser; Water-cell;
2. Small Nicol prisms with openings of 1 to 2 cm. which are mounted so that they can be rotated.

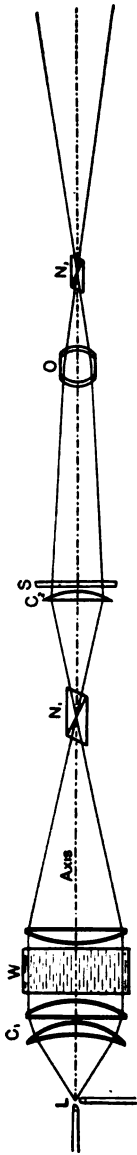

3. Pile of glass plates to polarize light. Preferably thin sheets of plate glass, but a pile of lantern-slide cover-glasses can be made to answer.

4. Plano-convex condensing lens, 5 to 10 cm. in diameter and 20 to 30 cm. focus. This lens must be free from strain.

5. Projection objective, preferably of large diameter and short focus.

6. Two sets of lenses to give converging polarized light. Two substage condensers of microscopes will answer if free from strain.

7. Objective of short focus and large diameter. A plano-convex lens will answer (see § 881).

8. *Specimens.* Pieces of mica, crystal sections, plate of glass on which crystals have formed, annealed and unannealed pieces of glass, clamp for putting the glass under strain when in the field of the lantern.

Many of the most beautiful experiments in optics require the use of polarized light. The demonstration of this phenomenon is growing more difficult owing to the increasing scarcity of the natural mineral calcite, which is used to make the Nicol prisms needed for polarizing and analyzing the light. Clear pieces of calcite are getting so rare that except for a few large Nicol prisms in private

FIG. 350. PROJECTION WITH POLARIZED LIGHT, USING SMALL NICOL PRISMS.

- L Source of light, right-angle arc.
- C₁ Ordinary magic lantern condenser.
- W Water-cell.
- N₁ Nicol prism of 1 to 2 cm. opening (polarizer).
- C₂ Condenser free from strain which renders the polarized light parallel or slightly converging.
- S Specimen.
- O Magic lantern objective.
- N₂ Nicol prism (analyzer) of 1 to 2 cm. opening.

collections and a few large crystals in museums, no prisms of large openings (5 to 8 cm.) are now to be obtained.

§ 880. **Use of small Nicol prisms.**—A method will be described for using Nicol prisms of small openings (1 to 2 cm.). This method consists in concentrating the light to small diameter in those places where it must pass through the Nicol prisms.

Let *L* fig. 350 be the source of light, preferably a small right-angle direct current arc. *W*, is a water-cell. It is imperative to use a water-cell, otherwise the polarizing Nicol will be ruined.

The polarizing Nicol *N*₁, is placed at the image of the crater. Light spreading out from the farther side of this prism is polarized. This Nicol is treated exactly as if it were an original source of polarized light. The second condenser *C*₂, which must be free

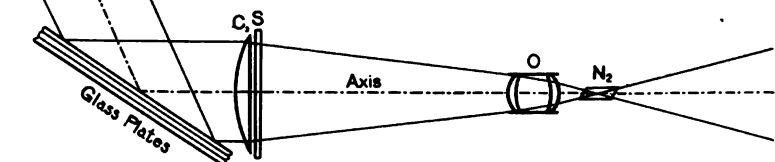

FIG. 351. LIGHT POLARIZED BY A PILE OF GLASS PLATES.

- L* The light source.
- C* Plano-convex condenser lens.
- C*₂ Condenser of long focus and free from strain.
- S* The specimen.
- O* Magic lantern objective.
- N*₂ Nicol prism with 1 to 2 cm. opening (analyzer).

from strain, renders the light parallel or slightly convergent. The specimen is at *S*. The objective *O*, is placed at such a distance from the specimen that the image of the latter will be in focus on the screen. The analyzing Nicol *N*₂, is placed at the right in front of the objective at the point where the rays cross, i. e., in the image of *N*₁, cast by the lenses *C*₂ and *O*.

When either the polarizing or analyzing Nicol *N*₁ or *N*₂, is rotated, two positions, 180° apart, will be found in which the screen is dark. If when these positions are found, a piece of mica, for example, is put in the field, it will change the plane of polarization and will give on the screen the most beautiful colors.

Another method of producing polarized light is to reflect the light from a pile of glass plates (lantern-slide cover-glasses will answer). At an angle of incidence of about 57° from the normal as shown in figure 351, the light reflected from the glass surfaces will be plane polarized. The specimen is placed at S, the objective at O, and the analyzer N_2 , at the crossing of the rays as before (fig. 351). The heating effect of the light reflected from the glass surface is so small that a water-cell is unnecessary.

§ 881. **Converging polarized light to show rings and brushes.**—

If the polarized light passing through a crystal is a converging cone, the most beautiful phenomena are shown. Fig. 352 shows the apparatus used to project rings and brushes. A parallel beam of polarized light obtained as before, strikes the lens system L_1 , designed to bring parallel light to a focus in a strongly convergent beam. L_2 , renders the light again nearly parallel. L_1 , is the usual form for this work and L_2 , is a substage condenser from a microscope, either form will give good results if free from strain. The objective O, is a lens of short focus and large diameter. It need not be a special projection objective. Three objectives were tried which gave good results. (1) A photographic objective, focus 12 cm., diameter 2 cm. (2) A magnifying glass, focus 6 cm., diameter 4 cm. (3) A plano-convex lens, focus 5 cm., diameter 6 cm. The single plano-convex lens gave the best results except that the figures were slightly distorted. The analyzing prism N_2 , must have a medium sized opening, 15 to 20 mm. free aperture, otherwise it will cut off part of the field.

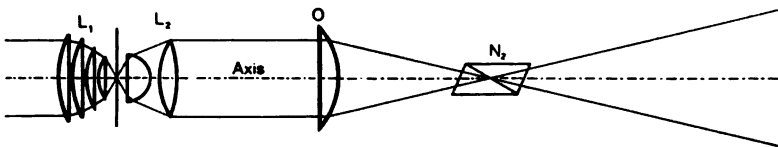

FIG. 352. CONVERGING POLARIZED LIGHT TO SHOW RINGS AND BRUSHES.

L_1 is the usual form of a lens system designed to bring parallel light to a strongly convergent beam.

L_2 is a microscope condenser, to parallelize the light from L_1 .

O objective to converge the light beam upon the Nicol prism (N_2), and to focus the rings and brushes on the screen.

N_2 Nicol prism with at least 1.5 to 2 cm. opening.

§ 882. **Detecting strain in lenses.**—Substage condensers from the microscope if free from strain are excellent for showing rings and brushes. The glass of which they are made should be perfectly homogeneous and should have no effect at all on polarized light. If the glass of which they are made is imperfectly annealed, the lenses will affect polarized light. An achromatic condenser is more likely to be free from strain than an ordinary Abbe condenser, because it is likely to be made of better glass. Strain may be tested for in each lens by holding it between crossed Nicols. A strained condenser if put in position L_2 , will show a black cross on a white ground when no crystal is used.

§ 883. **Setting up the experiment.**—The condensing lenses L_1 , and L_2 can be clamped on a ring stand. The distance between them is adjusted until the emerging light is practically parallel, the objective O , is put in place so that the image of the lens L_2 , is in focus on the screen, a Nicol prism N_2 , is put in the narrowest part of the beam of light from the objective. When the analyzer N_2 , is turned to give a dark field on the screen and a crystal section (mica, for example) is placed in the converging light between the two condensers the field becomes illuminated with bright colors and beautiful patterns.

The final adjustment of the apparatus is now made, the distance between the condensers is adjusted until the screen has the most uniform light. The objective O , is moved until the figures on the screen are as sharp as possible; the analyzer may also require a slight adjustment.

§ 884. **Brightness.**—The screen image with polarized light is never very bright, hence a very dark room is needed. A screen picture over one or two meters in diameter, (3 to 6 feet) should never be attempted.

PROJECTION OF SPECTRA

§ 885. **Apparatus.**—Magic lantern.

Stand to hold the objective in proper position if the lantern bed is not long enough.

Slit with adjustable blades.

Glass prism, hollow prism to hold carbon bisulphide, direct-vision prism.

Diffraction grating, ruled on speculum metal, or glass, or one of the replica gratings, 6,000 to 8,000 lines to the centimeter, (15,000 to 20,000 lines to the inch).

Glass cell to hold colored liquids.

Colored liquids, solutions of didymium nitrate, copper sulphate, aniline dyes, etc.

Colored glass, especially red and blue.

Arc lamp with vertical carbons.

Hollow carbons stuffed with salts as: lithium chloride, sodium chloride, potassium chloride, calcium chloride, aluminum.

Flame arc electrodes, "Yellow" and "Brilliant white."

Metallic electrodes, iron, copper, aluminum, uranium oxide in tin tube, rutile in tin tube or else luminous arc electrodes § 885a.

Screen coated with anthracene, 50 x 150 cm. to use instead of a white screen to show ultra-violet.

APPARATUS FOR THE DEMONSTRATION OF ULTRA-VIOLET LIGHT.

Quartz condensing lens and two plano-convex quartz lenses.

Source of ultra-violet light as:

Quartz mercury arc.

Arc lamp with carbons filled with various salts.

Arc lamp with carbons filled with metallic aluminum.

Arc lamp with brilliant white flame arc carbons.

Arc lamp with iron tube filled with uranium oxide.

Small card coated with anthracene to render the ultra-violet visible.

Especially since the days of Newton, the exhibition of the spectrum has been one of the most fascinating experiments in physics. It is also one of the simplest of the "special projection" experiments to perform.

§ 885a. These tubes can be made by rolling strips of tinned iron into tubes.

§ 886. **Source of light.**—In order to demonstrate an absorption spectrum of a substance it is necessary to use a source of light which has a continuous spectrum in order not to confuse the discontinuities of the light source with those caused by the absorbing medium.

§ 887. **Sunlight.**—Sunlight while not having a perfectly continuous spectrum is near enough to it for most purposes. The image of the sun should be focused on the slit as described for the crater of the arc lamp (§ 376, 833-834).

§ 888. **Carbon arc lamp.**—In the visible parts of the spectrum the carbon arc lamp will give a continuous spectrum, using preferably the positive crater of the direct current arc, although alternating current will answer.

§ 889. **The uranium arc.**—Using the vertical arc, the lower electrode made of uranium oxide is connected to the positive terminal as described in § 905. About 4 to 6 amperes should be used and a fairly continuous spectrum will be obtained. This continuous spectrum will extend well into the ultra-violet and can be observed by using an anthracene screen (§ 899).

§ 890. **The Nernst lamp.**—This can be used if necessary. Focus one filament on the slit or use a very long focus lens (one of 100 cm. focus or longer) and use the filament as a line source of light. The spectrum is continuous but not very bright.

The tungsten incandescent lamp.—One filament is focused on the screen by the objective and a slit is placed over the side of the bulb so that none of the other filaments show on the screen. This single filament acts as a line source of light.

OPTICAL SYSTEM

§ 891. The optical system for the projection of spectra is shown in fig. 353. First a condenser C, is put in front of the arc. This condenser brings an image of the arc to a focus at the slit. An objective is put at O, so as to focus an image of the slit on a distant screen at i. When a prism is used to disperse the light into a spectrum, it is placed at P and turned as shown.

If a source is used which shows a line spectrum, this spectrum will be found approximately in focus at $R V$. By focusing the objective and by rotating the prism the spectrum can be sharply focused on the screen. The sharpness of the spectrum can be increased by narrowing the slit or the brightness of the spectrum can be increased by opening the slit. If the slit is adjustable in width, judgment must be exercised to secure a spectrum which is as sharp as the occasion requires and at the same time sufficiently bright.

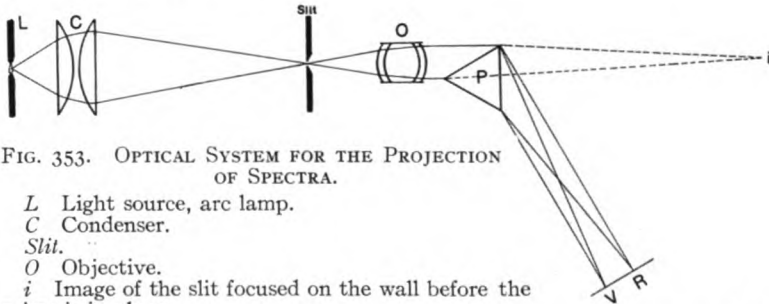

FIG. 353. OPTICAL SYSTEM FOR THE PROJECTION OF SPECTRA.

- L Light source, arc lamp.
 C Condenser.
 $Slit.$...
 O Objective.
 i Image of the slit focused on the wall before the prism is in place.
 $R V$ Spectrum focused on the wall after placing the prism in the path of the rays.

The distance from P to $R V$ must be relatively much greater than here shown, 2 meters (6 ft.) or more, in order to get a sharply defined spectrum.

Note that the red (R) is deviated less than the violet (V). Compare with a grating spectrum, fig. 360.

§ 892. **Slit.**—The slit for projection should be a fairly large one; 12 cm. square, with jaws 5 cm. long.

If one is limited by time or expense a very serviceable slit may be made by soldering a couple of pieces of tinned iron on a larger piece with a hole in it, or one of the pieces may be fastened so it can be slid closer or farther from the other. The main point to be observed is that the edges forming the slit opening must be perfectly smooth and straight so that when they are brought close together there will be no unevenness in the light which gets through.

Large slits with adjustable jaws may be obtained of dealers in projection apparatus.

§ 893. **Prism.**—A glass prism may be used, but it is much better to use a hollow prism filled with carbon bisulphide as this liquid gives a much higher dispersion than glass, thus enabling one to obtain a more extended spectrum than would be possible with a glass prism.

Caution.—In using carbon bisulphide remember that it is very volatile and its vapor is easily ignited. Hence this liquid should not be poured or left in unstoppered vessels in the neighborhood of the lighted arc. Also be sure that the hollow prism has no leaks around the stopper or elsewhere.

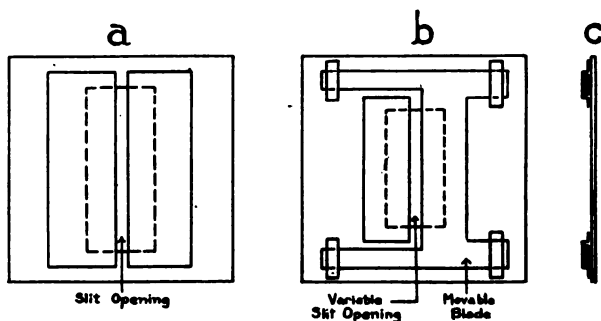

FIG. 354. HOME-MADE SLITS FOR PROJECTION.

- a* Slit with stationary blades.
- b* Slit with one movable blade.
- c* Side view of *b*.

§ 894. **Other prisms: gratings.**—The 60° prism, either solid or filled with liquid is usually the most available, but other forms are often at hand.

The compound prism due to Rutherford (fig. 356), composed of a dense flint glass prism of a large angle and two crown glass prisms cemented to it, will give a much higher dispersion than will a single prism of even very dense glass. Such a prism is used in practically the same way as a simple prism.

With a direct-vision prism (fig. 357) the axis of the spectrum is not turned to one side. Such a prism may be constructed of pieces of different kinds of glass or it may be made by filling the hollow cells of a prism with different liquids.

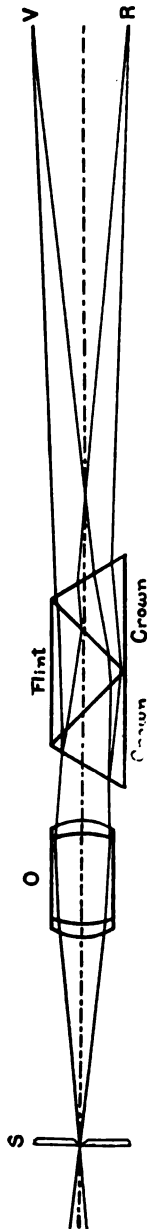

A convenient way of getting a prism which has a deviation of but about 150° while having a very good dispersion is to immerse a hollow 60° prism, filled with carbon bisulphide, in a cubical glass dish filled with water (fig. 358).



FIG. 355. HOLLOW GLASS PRISM WITH COVER AND STOPPER FOR CARBON BISULPHIDE (CS_2).

§ 895. A transmission diffraction grating, either one ruled on glass or a replica grating, held in front of the projection objective will give wide but rather faint spectra on the screen.

If a grating with rather coarse lines, 100–200 to the centimeter (250–500 lines to the inch) is used

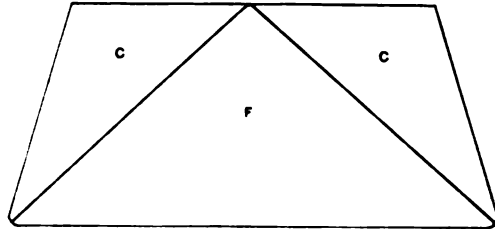

FIG. 356. RUTHERFORD PRISM.

This prism consists of a flint glass prism F , with an angle of about 90° and two crown glass prisms $C C$, cemented to it. The combination as here shown has a prism angle of about 30° and has the same deviation as a 60° flint prism, but has a much higher dispersion than could be obtained with a simple prism of even dense flint glass.

FIG. 357. USE OF A DIRECT-VISION PRISM FOR THE PROJECTION OF SPECTRA.

- S Slit.
- O Objective.
- Flint* Flint prism to cause dispersion.
- Crown, Crown* Prisms of crown glass to obviate the deviation.
- $V R$ Spectrum.

there will appear on the screen not only the central image O , of the slit but also fainter diffraction images 1, 2, 3, on both sides of the central one (fig. 357). These diffraction images are really short spectra. By using colored glasses it can be shown that with red light the images are farther apart than with green or blue light.

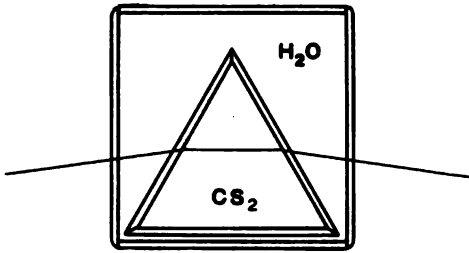

FIG. 358. LIQUID PRISM OF GOOD DISPERSION BUT SMALL DEVIATION.

It consists of a hollow prism filled with carbon bisulphide (CS_2) immersed in a glass box filled with water.

§ 896. **Grating spectra.**—If a grating with fine lines, 5,000 to 10,000 lines per centimeter (12,500 to 25,000 lines to the inch), is used the diffraction images are spread out farther and appear as extended spectra. In case the details of a spectrum are to be studied it is necessary to turn the axis of the lantern to one side as in the case where a prism is used. The

FIG. 359. USE OF A GRATING WITH COARSE LINES.

S Slit.
 O Objective.
 G Grating.
 o Primary image of slit formed without grating.
 $1\ 2\ 3, 1\ 2\ 3$ Diffraction images of the slit formed by the grating. These images are short spectra.

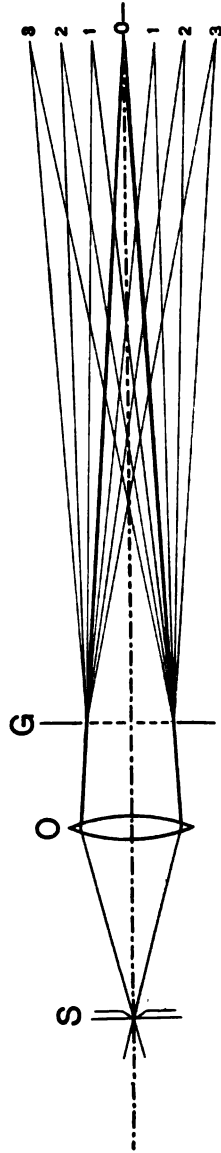

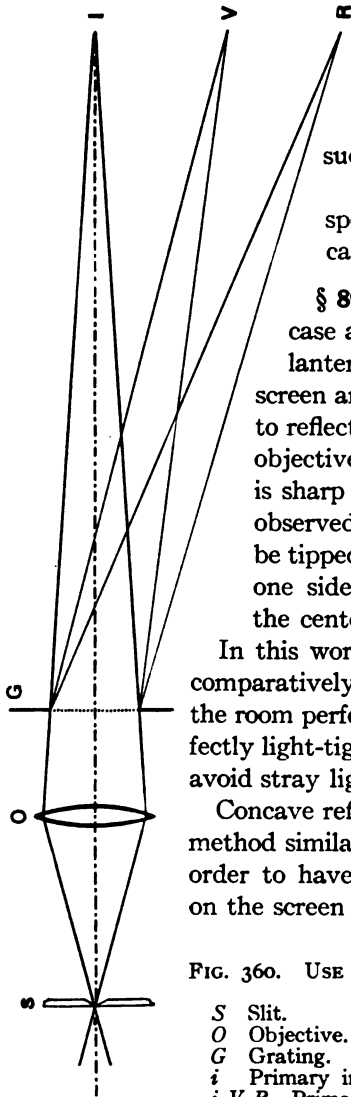

diffraction spectra are not as bright as are the spectra obtained with prisms and cannot well be used except to demonstrate that such spectra can be produced.

Sometimes if a very high order spectrum is to be shown the grating can be held obliquely as in fig. 361.

§ 897. Use of reflection gratings.—In case a reflection grating is to be used the lantern is pointed directly away from the screen and the reflecting grating held so as to reflect the light back to the screen. The objective is focused until the central image is sharp on the screen and the spectra are observed at both sides, or the grating may be tipped so as to reflect the central image to one side, when the spectra will appear in the center of the screen.

In this work it is essential in order that the comparatively faint spectra can be seen, to have the room perfectly darkened; the arc house perfectly light-tight and the lantern well enclosed to avoid stray light.

Concave reflection gratings can be used by a method similar to that for plane gratings, but in order to have the central image sharply in focus on the screen the objective must be closer to the

FIG. 360. USE OF A GRATING WITH FINE LINES FOR THE PROJECTION OF SPECTRA.

- S Slit.
- O Objective.
- G Grating.
- i Primary image of the slit.
- i VR Primary image of the slit (i), and the first diffraction image of the slit spread out into a spectrum (RV).

Note that with a grating, the red is deviated more than the violet. Compare with the prism, fig. 353.

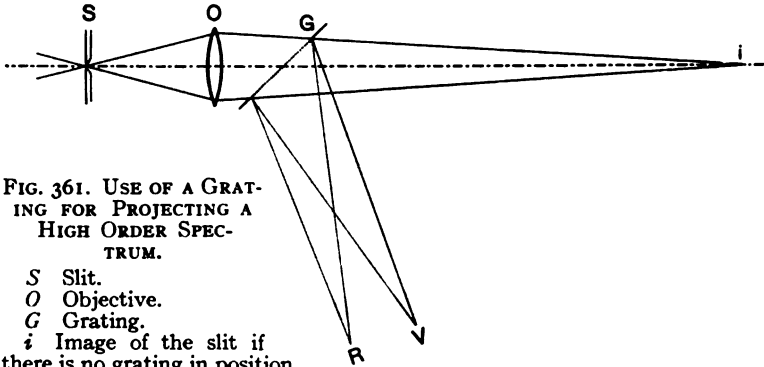

FIG. 361. USE OF A GRATING FOR PROJECTING A HIGH ORDER SPECTRUM.

S Slit.

O Objective.

G Grating.

i Image of the slit if there is no grating in position.

R V Spectrum.

The grating is tilted as shown. These high order spectra are very faint.

slit than for the plane grating, that is, the light from the objective must be diverging instead of slightly converging when it strikes the grating (fig. 363).

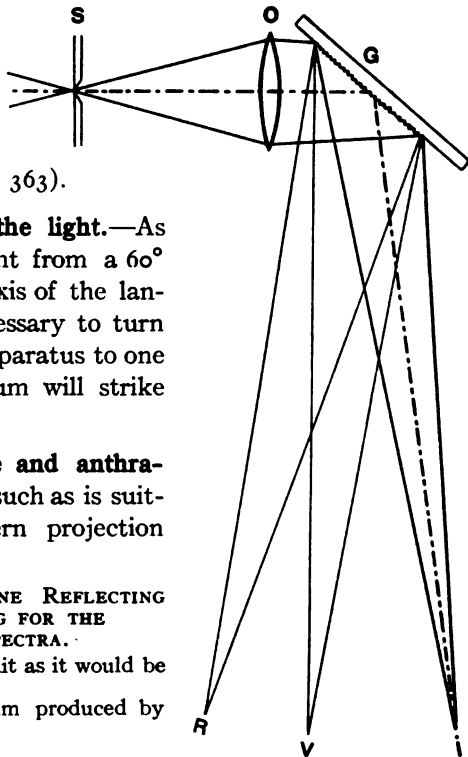

§ 898. **Direction of the light.**—As the direction of the light from a 60° prism is oblique to the axis of the lantern (fig. 353), it is necessary to turn the entire projection apparatus to one side so that the spectrum will strike the screen.

§ 899. **Screen, white and anthracene.**—A white screen such as is suitable for ordinary lantern projection

FIG. 362. USE OF A PLANE REFLECTING DIFFRACTION GRATING FOR THE PROJECTION OF SPECTRA.

i Primary image of the slit as it would be reflected by a plane mirror.

R V Diffraction spectrum produced by the reflecting grating.

will show the visible parts of the spectrum very well, that is, it will show the red, green, and blue parts.

In order to illustrate the ultra-violet parts of the spectrum, use a screen coated with anthracene. A suitable screen can be made

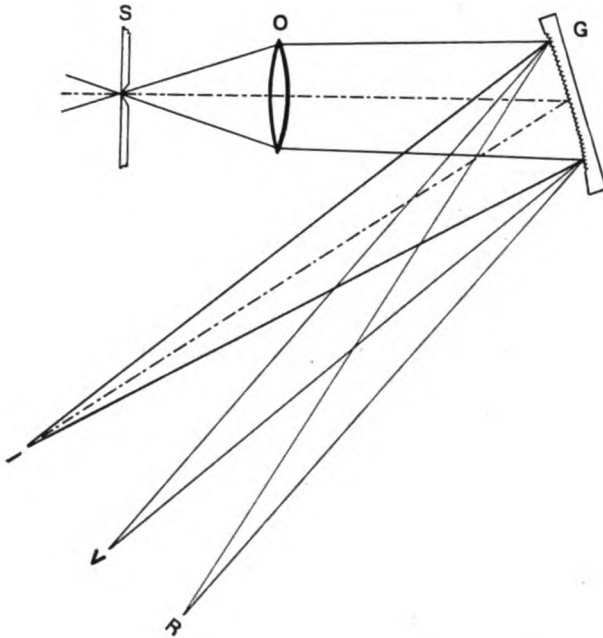

FIG. 363. USE OF A CONCAVE REFLECTING GRATING FOR THE PROJECTION OF SPECTRA.

S Slit.

O Objective.

G Concave reflecting grating.

i V R Image of the slit (*i*) and of the spectrum (*R V*).

Note that in order to get a sharp image of the slit at *i*, it is necessary to have diverging light strike the grating. The spectrum *R V* will be sharply defined under these conditions.

by taking a piece of white cardboard 50 cm. x 75 cm. and painting it with a suspension of anthracene in xylene. The anthracene used is the ordinary commercial variety of resublimed anthracene. Only enough xylene is used to make the mixture so it can be put on

the paper with a brush. This screen will show a brilliant green fluorescence wherever ultra-violet light strikes it. When the spectrum of an arc is projected upon such a screen, not only is the visible red, green, and blue to be seen, but also beyond the blue end is a vivid green fluorescence which indicates the presence of ultra-violet light.

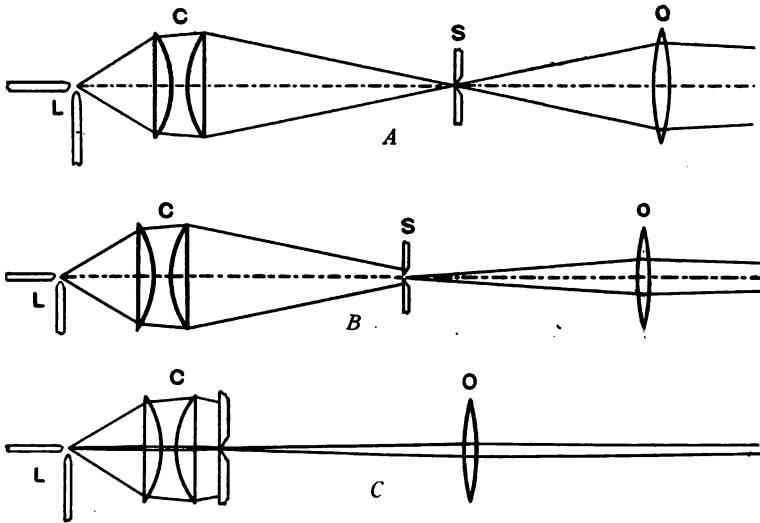

FIG. 364. ILLUMINATION OF THE SLIT FOR THE PROJECTION OF SPECTRA.

A The image of the arc focused to a small spot on the slit. The objective *O* is filled with light. The spectrum will be bright but a mere line.

B The image of the arc slightly out of focus giving a higher spectrum but not so bright.

C The slit next to the condenser in the lantern-slide position. This gives a relatively dim spectrum and illuminates a greater height of slit than is used for the spectrum.

§ 900. **Illumination of the slit.**—Excellent results may be obtained by focusing the arc on the slit by the condenser. This gives an intense illumination but the spectrum is not very high, in fact, it may be a mere line of color. To remedy this, the slit may be brought closer to the condenser than the crater image. This increases the height of the spectrum but reduces its intensity. Is

is a common practice in experiments with spectra to put the slit close to the condenser as for a lantern slide, but this lessens the brilliancy of the spectrum.

ABSORPTION SPECTRA

§ 901. The apparatus being arranged as above indicated to project a continuous spectrum, all that remains is to insert the absorbing medium between the light source and the screen, it makes little difference where. The appearance of the spectrum would be the same even if the absorbing medium were held between the eye of the observer and the screen. As a practical matter it is best to place the absorbing substance just in front of the slit. In this position any slight lack of planeness of its surfaces will not cause any interference with the optical system nor reduce the sharpness of the spectrum on the screen. The specimen may cover the entire slit, in which case the entire spectrum will show the absorption bands of the substance, or the specimen may be made to cover part of the slit, in which case, part of the spectrum will be that of the light source and part will show the absorption bands of the specimen. The advantage of having this comparison spectrum of white light is to bring out much more clearly any faint absorption of one end of the spectrum as with dilute copper sulphate or with amber glass. Liquids may best be shown by placing them in hollow glass boxes (fig. 365). Many variations of this method and many fascinating experiments will soon suggest themselves to the experimenter once the apparatus is set up.

§ 902. **Suitable substances.**—The following substances will show interesting absorption bands:

Colored glasses. Red, blue, purple, canary-yellow.

Gelatines colored with solutions of aniline dyes, for example, methyl violet, eosine (red ink), fuchsine.

Blood diluted with water.

Solutions of mineral salts, as cobalt nitrate in water, cobalt nitrate in alcohol or concentrated HCl; potassium permanganate.

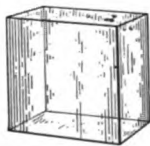

FIG. 365. GLASS BOX FOR ABSORPTION SPECTRA.

Didymium salts, such as crude didymium nitrate or the pure neodidymium, praseodidymium, erbinum, and other rare earth salts.

The following substances will show general absorption at one end of the spectrum and should be shown in comparison with the spectrum of white light:

Amber glass, green glass.

Copper sulphate, Ferric chloride, Nickel nitrate, Potassium chromate and dichromate, Chrome alum.

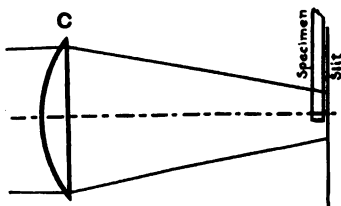

FIG. 366. COMPARISON OF SPECTRA.

C Condenser.

Specimen This covers only a part of the slit.

Slit Longitudinal view of slit.

Through the rest of the slit passes white light or light traversing another specimen. The two spectra then appear side by side.

EMISSION SPECTRA

§ 903. Besides the projection of absorption spectra, the optical system as described above will serve also for the projection of emission spectra. In this case the arc is both the specimen and the source of light.

We will suppose that it is desired to project the spectrum of a "yellow flame" carbon, this being about the easiest and most satisfactory to begin with. The apparatus is set up as shown in fig. 367. *L* is a vertical arc, the lower electrode of which is a yellow flame arc carbon or a hollow carbon filled with a sodium, potassium or other salt. The upper electrode is a carbon about 13 mm. ($\frac{1}{2}$ inch) in diameter. The carbon holder may be of the hand-feed type or an automatic lamp may be used.

§ 904. **Automatic lamp for use in projection of spectra.**—When using certain materials in the arc, the arc goes out frequently

and it is desirable to have an automatic machine to relight the arc again instantly. A very convenient device for this purpose is an enclosed arc lamp mechanism for shunt circuits. The wiring of the arc will need to be slightly modified to adapt it to the heavy currents (15 amps.) required. This is done by connecting the wires to the rheostat of the lamp at A, B, C and D (fig. 367) and by putting a german silver wire between E and F of the "series magnet" so that this magnet will not overheat and at the same time will not lift the upper carbon too suddenly.

§ 905. **Current to use.**—For the projection of arc spectra the current to use will depend upon the substance in the arc. When treated carbon electrodes are used, either alternating or direct cur-

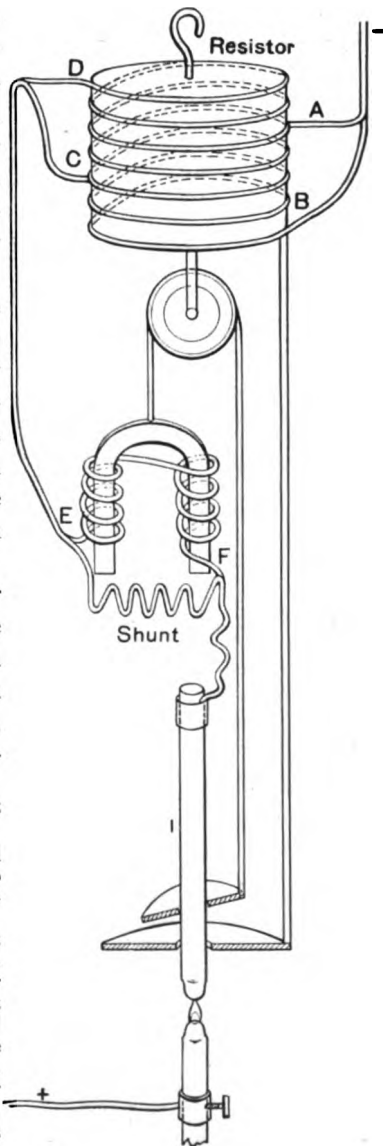

FIG. 367. AUTOMATIC ARC FOR THE PROJECTION OF ARC SPECTRA.

The mechanism is that of an enclosed shunt, direct current arc. In order to get sufficient current the wire is connected to the resistor in the two points A and B. The wire to the lifting magnet is connected at the points D and E. This gives three times the current for which the arc was designed, i. e., about 15 to 18 amperes. The lifting solenoid E F, must be shunted by a suitable resistance easily found by experiment. The clutch automatically lifts the upper carbon — whenever current is flowing. The lower carbon is stuffed with salts and connected to the positive wire.

rent may be employed, but direct current is to be preferred. About 15 amperes will give the best results. When direct current is used the lower carbon, which contains the salt to be studied, is made the positive.

With metallic electrodes or with metallic oxides contained in sheet iron tubes, direct current only, can be used. About 6 amperes give the best results in this case. The metallic electrode is made the lower, the upper electrode being carbon. Most metallic electrodes will give different results when made the positive than when made the negative terminal. The magnetite and titanium ("Luminous arc") electrodes show the lines of iron and titanium best when connected to the negative wire.

Uranium oxide contained in an iron tube will give a line spectrum when connected to the negative wire but will give a very nearly continuous spectrum when connected to the positive wire (§ 885a).

DEMONSTRATION ON A SMALL SCALE; DEMONSTRATION OF ULTRA-VIOLET LIGHT AND PHOTOGRAPHY

§ 906. **Demonstration on a small scale.**—Spectra may be projected on a small scale for the observation of a few individuals with the apparatus shown in fig. 368. This arrangement is similar in every way to that for the projection of spectra on a large screen

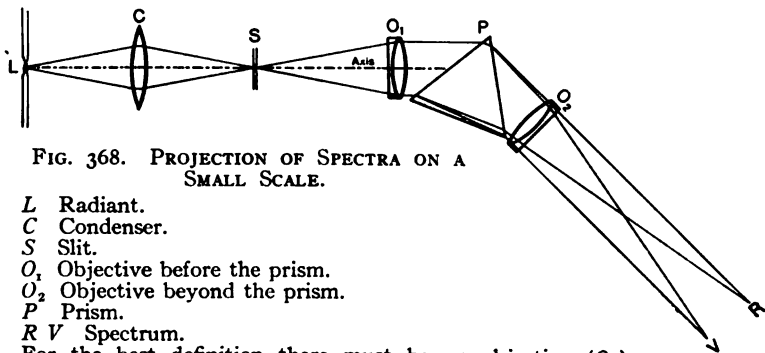

FIG. 368. PROJECTION OF SPECTRA ON A
SMALL SCALE.

- L Radiant.
- C Condenser.
- S Slit.
- O_1 Objective before the prism.
- O_2 Objective beyond the prism.
- P Prism.
- R V Spectrum.

For the best definition there must be an objective (O_2) beyond the prism to focus the spectrum (R V).

except that the additional lens O_2 , brings the parallel rays of light of each wave-length to a focus in the spectrum $R V$. The arrangement in fig. 368, with the lens O_1 , giving a converging beam, will not give good results, and the second lens O_2 , is required if any fine details in the projected spectrum are to be shown. The two lenses O_1 and O_2 , should be achromatic. The two lenses from a symmetrical photographic objective will give excellent results. Ordinary spectacle lenses can be made to answer if no others are available. The prism can be of any of the forms previously described. The spectrum is received on either a white screen or one which is coated with anthracene in order to show the ultra-violet.

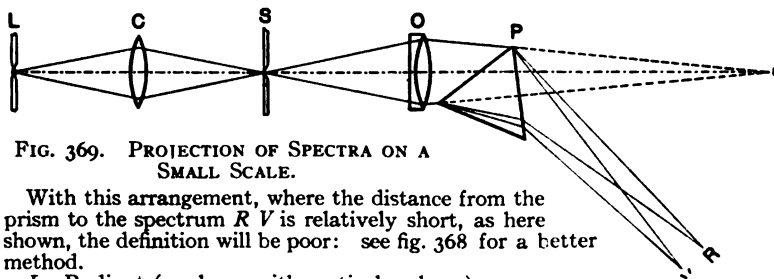

FIG. 369. PROJECTION OF SPECTRA ON A SMALL SCALE.

With this arrangement, where the distance from the prism to the spectrum $R V$ is relatively short, as here shown, the definition will be poor: see fig. 368 for a better method.

- L Radiant (arc lamp with vertical carbons).
- C Condenser.
- S Slit.
- O Objective.
- P Prism.
- I Image of the slit S when no prism is in place.
- $R V$ Spectrum projected by the prism.

§ 907. **Projection of ultra-violet.**—Ordinary glass prisms and lenses if not noticeably yellow or green will transmit radiation in the ultra violet to about $.35\mu$, which can be observed by the use of an anthracene screen (§ 899). If the *far ultra-violet* spectrum is to be demonstrated it is necessary to use a quartz system, that is, all condensers, lenses, and prisms between the source and the screen must be made of quartz, either quartz glass or quartz crystal. The apparatus is arranged as in fig. 370.

The quartz prisms are usually made of two 30° prisms, as shown in fig. 370, one of which is a right-hand crystal, the other a left-

hand crystal. The space between the two prisms is filled with glycerin.

Aside from the material of which the lenses and prisms are made there is but one thing which is different from the case with a glass system. By using quartz alone, no achromatic lenses are possible and the spectrum instead of focusing in a line at right angles to the axis of the beam, focuses along a line oblique to the axis. Thus, the far ultra-violet, UV, focuses nearer lens O_2 , than does the visible spectrum. Tilting the screen to the position indicated will enable one to get all of the spectrum in focus at once.

The anthracene screen (§ 899) will enable one to demonstrate all of the lines of arc spectra which would appear upon a photograph

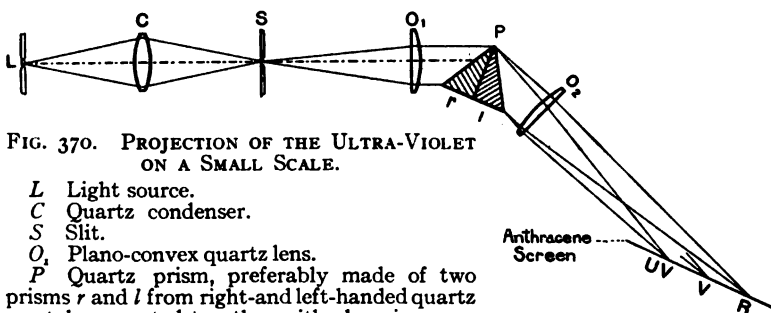

FIG. 370. PROJECTION OF THE ULTRA-VIOLET ON A SMALL SCALE.

- L* Light source.
- C* Quartz condenser.
- S* Slit.
- O₁* Plano-convex quartz lens.
- P* Quartz prism, preferably made of two prisms *r* and *l* from right- and left-handed quartz crystals cemented together with glycerin.
- O₂* Plano-convex quartz lens. Turn the convex sides of the lenses towards the prism.
- UV, VR* Focus of the spectrum.
- Anthracene screen*, fluoresces to ultra-violet. Note its oblique position.

made by the use of a quartz spectrograph, the ultra-violet lines of the aluminum arc at $.217\mu$ being easily seen. Demonstration of fluorescence of other substances to ultra-violet may be shown by substituting them for the anthracene.

The demonstration of the far ultra-violet on a large scale is hardly possible owing to the small intensity of the light emitted in this region.

USE IN PHOTOGRAPHY

§ 908. **Apparatus.**—Slit, prism, grating, symmetrical photographic objective, camera bellows, bromide paper, photographic plate.

The systems described above for the demonstration of spectra on a small scale (fig. 368, 371), may be employed for the photography of spectra. Such a system can be used, for example, to determine the wave-lengths of the radiation to which bromide paper is sensitive. If the bromide paper is held firmly against a rigid support so that the spectrum of a right angle arc may fall upon it, the

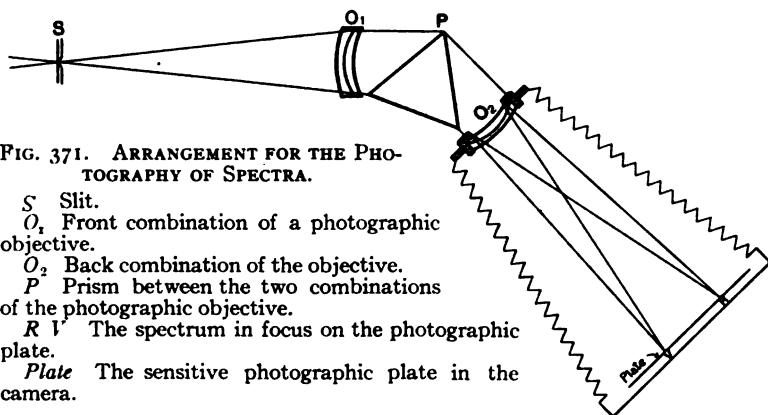

FIG. 371. ARRANGEMENT FOR THE PHOTOGRAPHY OF SPECTRA.

- S* Slit.
*O*₁ Front combination of a photographic objective.
*O*₂ Back combination of the objective.
P Prism between the two combinations of the photographic objective.
R V The spectrum in focus on the photographic plate.
Plate The sensitive photographic plate in the camera.

paper will be found to be blackened where blue and ultra-violet light struck it, but the red and green will show no action at all. If dry plates, however, are used a more complete system of shielding from the light will be required. The second lens *O*₂, may be held in a camera box as shown in figure 371. A more elaborate system for making several exposures on the same plate is not here described because, while good results may be obtained with such apparatus by sufficient labor, it is more satisfactory to use one of the regular spectrographic cameras.

DEMONSTRATION OF ABBE DIFFRACTION THEORY OF MICROSCOPIC
VISION

§ 909. **Apparatus.**—Condenser; Pinhole; Slit.

Convex lens of one meter focal length (spectacle lens of 1 diopter, § 356a).

Grating, photographic line screen (100 to 200 lines to the inch,) fine wire gauze (100 mesh), fine bolting cloth.

Telescope. The eye-piece should be of high power.

Diaphragms to remove portions of the diffraction image.

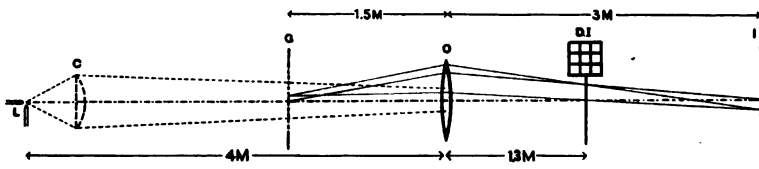

FIG. 372. LENS SYSTEM AND ARRANGEMENT FOR SHOWING THE ABBE DIFFRACTION THEORY OF IMAGE FORMATION.

L Right-angled arc lamp with small carbons (5 mm.)

C Condenser used temporarily for focusing.

G Grating with coarse lines. A halftoning, line screen or a fine wire net will answer.

O Spectacle lens of 1 diopter (1 meter focus) for projecting the image of the lamp.

DI Image of the arc lamp *L*, projected by the objective *O*.

When the grating (*G*) is in place, there is formed at this point a diffraction pattern. Various shaped diaphragms placed at this point modify the screen image of the grating at *I*.

I Screen image of the grating (*G*).

The lines and numbers above and below indicate the approximate distances between the different parts of the system which have been found to give satisfactory results.

An interesting phenomenon connected with the Abbe Diffraction Theory of image formation can be demonstrated by one of the combinations described below. The simplest is shown in fig. 372. Suppose the test object to be a diffraction grating with equidistant lines such as a fine wire gauze or a line screen such as photo-engravers use in making half tones.

§ 910. **The Abbe diffraction theory. Image formation with directed light.**—In microscopic work and with all transparency

projection, objects are not self-luminous but are illuminated by a narrow beam of directed light which, were no object present, would pass through the center of the objective. When an object, a diffraction grating for example, is illuminated with a narrow cone of light, the light is spread out into a diffraction pattern. The finer the details of the object, the larger will be the diffraction pattern. The objective will unite the light scattered from the object by diffraction just as it would light which was spread out by reflection from a white surface. Now according to the Abbe diffraction theory, the closeness with which the image will correspond to the object will depend upon the completeness with which the light from the entire diffraction pattern is collected to form the image. If the entire diffraction pattern is not united to form the image, but part of it is intercepted, the image will be that of such an object as would produce a diffraction pattern like that part of the diffraction pattern which is collected to form the image.

§ 911. **Lens system for showing diffraction images.**—The lens system shown in figure 372 will show this phenomenon. The arc lamp L, with 5 mm. carbons, three to five amperes direct current used as a point source, is set up six to eight meters from the screen at I. The condenser C is used temporarily to illuminate the objective lens O. This objective lens O, is of one meter focal length (an ordinary convex spectacle lens of 1 diopter will answer). It is placed 3M. (10 ft.) from the screen. The grating G, is placed between the source L, and the objective O, so as to be in focus on the screen at I. The condenser C is now removed. The image I, will remain as before. At DI, would be found an image of the source cast by the lens O, but it will be spread out into a diffraction pattern by the grating.

If a vertical slit is placed at DI, so as to remove all but a vertical line of images, the appearance will be of parallel horizontal lines. A diagonal slit will give the appearance of diagonal lines, no vertical or horizontal lines being seen. If a vertical rod is put in so as to remove the central row of images, the diffraction pattern will be that of a grating with fine vertical lines, twice as close together as the coarse horizontal lines, and the image at I, will have heavy

horizontal lines and fine vertical lines very close together. Diaphragms cut from black paper of various shapes, will give many curious and beautiful appearances at *I*. A small diaphragm placed so as to remove all but the central image of the pattern, or one of the lateral images, will allow light to fall on the screen but no detail can be seen.

For lecture purposes, where one requires considerably more light than for a small class demonstration, one can use a vertical slit with a condenser as the source instead of the arc lamp (fig. 373). See § 891 and § 900, figure 364. Use line gratings with the lines



FIG. 373. DEMONSTRATION OF ABBE DIFFRACTION THEORY TO A LARGE AUDIENCE, USING A SLIT.

- L* Arc lamp.
- C*₁ Condenser.
- S* Pinhole or Slit.
- C*₂ Condenser, preferably an achromatic combination.
- G* Grating.
- O* Objective. The diffraction pattern is formed at the face of the objective.
- Diaphragms are used at this point to modify the image.
- I* Image of grating.

vertical. The phenomena shown are not as interesting as when using a point source. By using slits or rods to intercept part of the diffraction pattern, the image on the screen can be made to appear as if it were of a grating having finer lines than the grating which is actually used.

If this phenomenon is projected it will probably be desired also to demonstrate it individually to a few of the observers. This may be done by the use of a telescope *t*, (fig. 374). to observe the grating. The eyepiece of the telescope should be of a high power. The condenser *C*₂ focuses the image of the pinhole just in front of the telescope objective. When the grating *g*, is in place, the diffraction images will appear on both sides of the pinhole image. If the grating is viewed by the telescope it will appear normal but if part of the diffraction pattern is stopped out by diaphragms, the grating

will appear changed as in the case of projection. The sharpness of the pattern, and the intricacy of design are however much finer than it is possible to project.

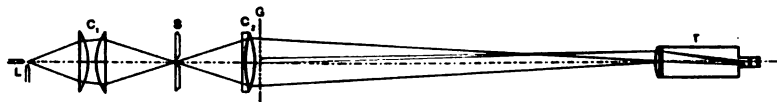

FIG. 374. DEMONSTRATION OF THE ABBE DIFFRACTION THEORY TO A SINGLE OBSERVER.

- L* Arc.
*C*₁ Condenser.
S Pinhole or Slit.
*C*₂ Condenser, preferably an achromatic combination.
G Grating.
T Telescope with high power eyepiece.

The telescope is focused on the grating and the diffraction pattern is focused just in front of the telescope objective. By placing suitably shaped diaphragms at this point, the image as seen in the eyepiece will be modified.

DARK GROUND ILLUMINATION: METHOD OF STRIAE

§ 912. Many beautiful experiments in Physics and Chemistry can be shown by what is best known as the Schlieren-methode of Toepler. This method will yield results almost as striking as those obtained by polarized light.

See Wiedemann Annalen, CXXXI, p. 33.

The use of this method enables one to demonstrate any slight lack in homogeneity of a medium which is sufficient to deviate a beam of light.

To adapt this method to projection the following apparatus can be used:

§ 913. Apparatus for the experiments with striae.—

(1) Magic lantern with the usual equipment of arc lamp, projection objective, and the first element of the large condenser.

(2) A special condensing lens or combination. This need not be of especially large diameter or short focus (5 cm. diameter, 20 cm. focus will answer), but it should be as free as possible from spherical and chromatic aberration, and must have no scratches and be kept perfectly clean.

(3) Diaphragms to shut off the direct light of the lantern. These may be simply sheets of tin.

(4) Glass cells with parallel faces.

§ 914. **Method.**—Light from the arc *L*, is rendered nearly parallel by the lantern condenser *C*₁. The diaphragm *D*₁, cuts off the lower half of this beam, the other half serving to illuminate the specimen *S*, in the glass cell. The distance between the condenser and the specimen should be from 50 to 100 cm. (2 to 4 feet). Either before or after passing through the specimen *S*, (preferably before, as in fig. 375) this light strikes the special condenser *C*₂, which brings the diaphragm *D*₁, to a focus at *D*₂. At this point is placed the diaphragm *D*₂, which is so arranged as to just cut off the remainder of the light, its edge coming to the edge of the image of the diaphragm *D*₁. The objective *O*, is focused to bring the specimen *S*, to a sharp focus on the screen before the diaphragm *D*₂, is in place. With the apparatus thus arranged the screen will be perfectly dark, all light not intercepted by the first diaphragm being stopped by the second. If, now, the liquid in the cell *S*, is not quite homogeneous but is cordy, as when glycerine and water are first mixed or when a crystal of salt is dissolving, the image of *D*₁, will not

FIG. 375. DARK GROUND ILLUMINATION; TOEPLER METHOD OF STRIAE.

- L* Arc.
- C*₁ First part of the magic lantern condenser.
- D*₁ Diaphragm.
- C*₂ Condenser of long focus. It must be as perfect a lens as can be found.
- S* Specimen, with slight inhomogeneity.
- a* An inhomogeneity in the specimen which deviates the light.
- D*₂ Diaphragm intercepting direct light from the lantern.
- O* Objective.
- a'* Image of *a*.

Note that with the objective on the axis only the upper portion of the objective is used.

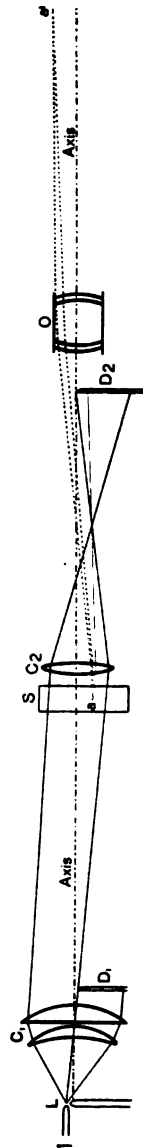

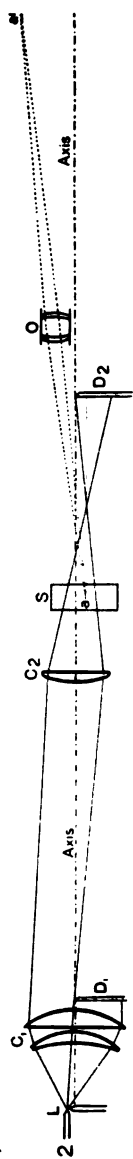

be quite sharp and some light will escape the edge of the diaphragm D_2 , and reach the screen.

The result is very striking as even a slight inhomogeneity of the medium in the glass cell will deviate light sufficiently to pass the second diaphragm and thus be seen.

Suppose a slight cord of a substance of different refractive index from its surroundings to exist at a' in fig. 376. This cord will scatter the light. A ray which would normally strike D_2 , and be intercepted, will spread out in all directions. The part of this light which strikes the objective will go to form a screen image of the cord at a' (fig. 376).

The sensitiveness of this method depends upon the sharpness of the image of the diaphragm D_1 , and the closeness of adjustment of D_2 , so as to encroach as little as possible upon it. With a very sharp image, it is possible to detect the minutest striae and inhomogeneities in the specimen.

The image sharpness may be disturbed as much by imperfections in the condensing lens C_2 , as by an inhomogeneity of the specimen, hence these imperfections, if present, will show distinctly on the screen. In fact, the method is as well designed to show the

FIG. 376. DARK GROUND ILLUMINATION; TOEPLER METHOD OF STRIAE.

- L Arc.
- C_1 First part of the magic lantern condenser.
- D_1 Diaphragm.
- C_2 Condenser of long focus. It must be as perfect a lens as can be found.
- S Specimen with slight inhomogeneity.
- a An inhomogeneity in the specimen which deviates the light.
- D_2 Diaphragm intercepting direct light from the lantern.
- O Objective.
- a' Image of a . Note that a small objective above the axis is used. The dotted lines show the course of the rays which are slightly deviated from their original path by the inhomogeneity of the specimen.

imperfections of the second condenser C_2 , as to show the specimen. The difficulty can, of course, be lessened by drawing the condenser face C_2 , out of the focus of the objective O . Dust, fingermarks, etc., will then produce a general blur, rather than a distinct image.

§ 915. **Foucault's method.**—A slight modification of the old method of Foucault for testing telescope objectives also gives good results. This method (fig. 377) dispenses with the use of the first diaphragm D_1 , the crater of the arc being the first diaphragm in this case. Instead of the ordinary condenser, is substituted a lens or set of lenses which are to form a very sharp image of the crater. Just in front or behind the objective (wherever the sharp image of the crater is formed) is a diaphragm which just covers up the crater image. Such a diaphragm may be made by fastening a round piece of black paper to a piece of plate glass. The objective brings the specimen to a focus upon the screen in the usual way. Any inhomogeneities in the specimen scatter the light so that some of it gets by the central stop at D_2 . It is this scattered light which serves to form the image on the screen at a^1 .

If the inhomogeneities of the specimen are great enough, the specimen may be projected by the method just described, (see fig. 377), except that instead of using a central stop, the lens is provided with an iris diaphragm, and the image of the arc is focused on

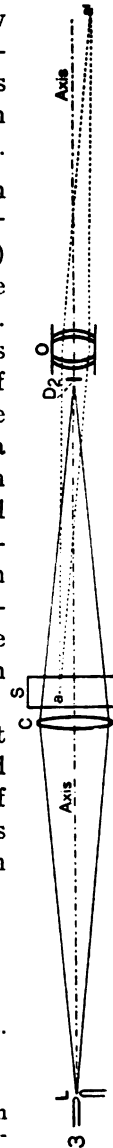

FIG. 377. DARK GROUND ILLUMINATION,
FOUCAULT'S METHOD.

- L* Arc.
- C* Condenser of long focus, as perfect as can be found.
- S* Specimen.
- a* Inhomogeneity in the specimen which deviates the light.
- O* Objective.
- D₂* Central stop to intercept the direct light from the arc.
- a¹* Image of *a*, projected on the screen.

The dotted lines show the course of the rays deviated by an inhomogeneity in the specimen which pass to one side of the central stop and reach the screen.

the center of this opening. If, now, light is slightly deviated it will not get through the small opening in the diaphragm and the inhomogeneity will appear as a dark shadow on a light background.

EXPERIMENTS ILLUSTRATING NORMAL VISION AND SIMPLE, REFRACTIVE EYE DEFECTS

§ 916. Apparatus needed for the demonstrations:

Suitable room for projection; White screen 70 to 100 centimeters (28 to 40 inches) square; Arc lamp and magic lantern condenser with lamp-house, fig. 378-379; Optical bench with a range beyond the condenser of at least 40 cm. (16 in.); fig. 159, 378-379; Lantern-slide carrier and lens support, fig. 159, 378-381; Metal holder for four trial lenses, fig. 380; Oculists' trial lenses as shown in fig. 382; Discs of tin or sheet-iron the size of trial lenses, and with holes for the pupil and a stenopæic slit, fig. 399, A, B.; Lantern slides (4) for illustrating accommodation, astigmatism and anisometropia, myopia, etc., fig. 383, 391-392, 401, (§ 916ab).

§ 916a. The cost of the special apparatus needed for the demonstrations in normal and defective vision:—

Metal lens holder for 4 trial lenses.	\$2.25
Trial lenses in trial rings (14 at 20 cts.)	2.80
Double trial lenses for unlike eyes	1.50
Lantern slides (4 at 35 cts.)	1.40

\$7.95

To this amount should be added the cost of the object and lens blocks and the vertical pieces for carrying the lens holder and the slide-carrier.

The screen of white cardboard and the lengthening rods for the optical bench are also extra, but all of these should not make a total outlay of over \$10.00 in addition to the magic lantern. As will be seen in the appendix, magic lanterns cost all the way from \$20 to \$500.

The trial lenses, lens holder and double lenses may be obtained through a local optician, or they can be got direct from a manufacturer of spectacles, etc., for example: Aloe & Co., St. Louis, Mo.; Bausch & Lomb Optical Co., Rochester, N. Y., New York City, Washington, D. C., Chicago, Ill., San Francisco, Cal.; Geneva Optical Co., Geneva, N. Y., and Chicago, Ill.; Hardy & Co., New York City, Chicago, Ill., Denver, Col., Atlanta, Ga., Dallas, Tex.; Lloyd & Co., Boston, Mass.; E. B. Meyrowitz, New York City, Minneapolis and St. Paul, Minn.; Williams Brown & Earle, and Joseph Zentmayer, Philadelphia, Pa., and many others.

§ 916b. The authors feel greatly indebted to Dr. Melvin Dresbach and to Dr. Albert C. Durand for suggestions and criticism in the preparation of the manuscript for these experiments in normal and defective vision.

DEMONSTRATIONS REPRESENTING NORMAL AND DEFECTIVE VISION

§ 917. **Source of light.**—For the most successful demonstrations of vision and its refractive defects it is necessary to have a right-angle arc lamp and a direct electric current. However, for all the experiments except the one to show unequal refraction in the two eyes, the other sources of light mentioned in this book can be used. If the large sources are used it is desirable to have a shield with an

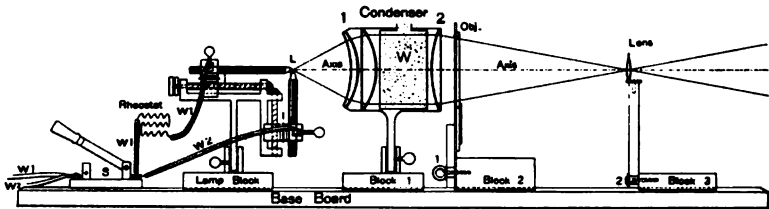

FIG. 378. PROJECTION APPARATUS WITH THREE-LENS CONDENSER AND OPTICAL BENCH FOR DEMONSTRATIONS REPRESENTING VISION.

Commencing at the left:

W¹ W¹ Supply wire to the knife-switch and from the switch through the rheostat to the upper or positive carbon of the arc lamp.

W² W² Supply wire to the knife-switch, and from the switch to the lower carbon of the arc lamp.

L The source of light (crater of the upper carbon).

Lamp Block The block for supporting the arc lamp and by which it can be moved back and forth on the optical bench.

Base Board The board on which are the tracks of the optical bench (see fig. 159).

Condenser² The triple-lens condenser. The second element of the condenser (2) should have a focus of 30 to 40 centimeters (12 to 15 inches).

W The water-cell to absorb the radiant heat.

Obj. The object (lantern slide of radial lines, etc., fig. 383-393).

Lens The trial lens serving to project the image.

Block 1 The block supporting the condenser and water-cell.

Block 2 The block serving as a support for the lantern slide, and by means of which the slide can be moved back and forth on the optical bench.

Block 3 The block supporting the lens carrier, and by means of which the lens can be moved back and forth on the optical bench.

These experiments, with the accompanying explanation, have been compiled from lectures and demonstrations given by the senior author before the Sixth District Branch of the Medical Society of the State of New York, October, 1913; The Conference of Veterinarians at the New York State Veterinary College, December, 1913; and before the Cornell University Summer School, July, 1914.

opening a little smaller than the trial lenses to put just beyond the trial lens. This cuts off any stray light falling outside the lens. If large sources only can be used, then it would be an advantage to have lenses of greater diameter than the trial lenses so that all the light could be utilized and thus give a brighter screen image. The trial lenses answer admirably for the arc light, however.

§ 918. **Centering along one axis.**—As with the magic lantern and the projection microscope, it is necessary to have all of the elements of the projection outfit on one axis (§ 51-58).

Also as the light is liable to get out of the axis, it is a great advantage to have fine adjustments on the arc lamp to bring it back in

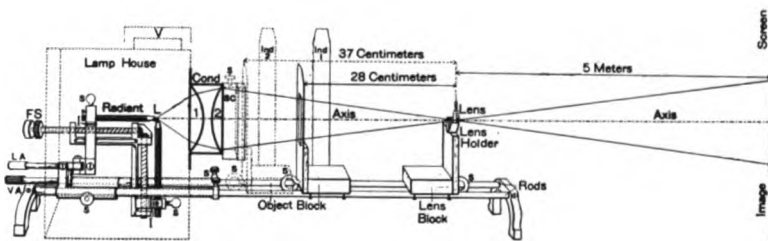

FIG. 379. PROJECTION APPARATUS WITH TWO-LENS CONDENSER FOR DEMONSTRATIONS REPRESENTING VISION.

Radiant. The arc lamp in the lamp-house. It has fine-adjustment screws (L A, V A), and feeding screws for the carbons (F S) and the source of light in the crater of the upper carbon (L).

Lamp House, V The lamp-house and its ventilator.

Rods The rods of this form of lantern. These serve as a kind of optical bench along which the different parts can be moved. They should be long enough to permit of a separation of the lens and the condenser of at least 40 cm. (16 in.).

Cond, 1 2 The two lenses of the condenser. Lens 2 should be of relatively long focus, 25 to 30 cm. (10 to 12 inches).

Object Block The block supporting the object, and by means of which the object can be moved back and forth along the rods.

Lens Block The block supporting the lens. It can be moved back and forth along the rods.

Image screen The white screen for the image. It is 5 meters (16 ft.) from the projection lens.

37 Centimeters The distance between the lens and the object for a 3 diopter lens.

28 Centimeters The distance between the object and a 4 diopter lens.

Ind 1, Ind 2 A white strip of cardboard to serve as an indicator so that the spectators can see when the object is moved toward or from the lens.

position (fig. 3). The vertical boards holding the lantern slide and the trial lens holder should have means of centering them accurately. This is provided for by the U-shaped opening at the lower end of the uprights where the set-screw is inserted to hold the uprights against the movable blocks (fig. 159, 381).

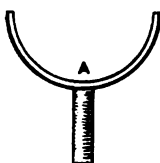
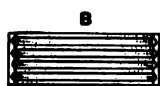

FIG. 380. METAL LENS HOLDER FOR FOUR TRIAL LENSES.
(Half Natural Size)

A Side view of the lens holder showing the stem by which it is held in place in the lens support (fig. 378).

B Face view of the lens holder showing the four grooves for containing the lenses, and in which they can be rotated.

§ 919. **Lenses, lens holder and white screen.**—For the refractive part of the eye (cornea and crystalline lens), the trial lenses used by oculists answer very well. To hold these and to permit of their rotation it is necessary to have a metal lens holder (fig. 380). A lens holder with grooves for four lenses is very desirable.

To represent the retina of the eye there is needed a white screen about one meter (3 feet) square. This screen is kept at the constant distance of 5 meters (16 ft.) from the lens in all the experiments.

§ 920. **Demonstration of normal vision.**—While men have always known that the eyes were for seeing the things in external nature, the knowledge that the eye acts like an optical instrument and produces an inverted, real image upon the retina came only when Kepler in 1604 demonstrated, in the clearest possible manner,

FIG. 381. SLIDE-CARRIER FOR THE TEST SLIDES.

This consists of:

An object block sliding on the optical bench or the rods (fig. 378-379).

A vertical board 1 cm. ($\frac{1}{4}$ in.) thick with a U-shaped opening in the lower end. A thumb-screw and washer serve to hold the board in any position against the object block.

The lantern-slide carrier consists of a thin board or a piece of cardboard with an opening of the proper size and height (object) attached to the vertical board. The try-square shaped piece (H H) is to hold the test slide (G Sl) in position. (See also fig. 159, b4).

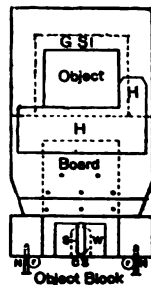

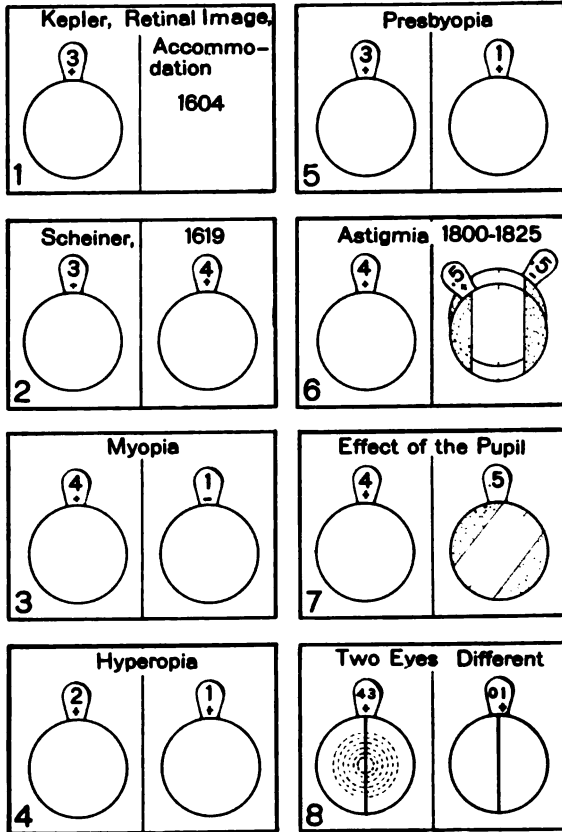

FIG. 382. OUTLINES OF THE TRIAL LENSES NEEDED FOR SIMPLE EXPERIMENTS IN NORMAL AND DEFECTIVE VISION.

(About one-third size)

- 1 A 3 diopter convex lens (+3). For *diopter* see § 356a.
- 2 A 3 and a 4 diopter convex lens (+3, +4).
- 3 A 4 diopter convex lens (+4), and a 1 diopter concave lens (-1).
- 4 A 2 diopter and a 1 diopter convex lens (+2, +1).
- 5 A 3 diopter and a 1 diopter convex lens (+3, +1).
- 6 A 4 diopter convex lens (+4), a 0.5 convex cylinder, (+0.5 cyl.) and a 0.5 concave cylinder, (-0.5 cyl.).
- 7 A 4 diopter convex lens (+4), and a 0.5 convex or concave cylinder (0.5 cyl.).

⁸ A half convex lens of 4 diopters, and a half convex lens of 3 diopters (+4, +3) in the same trial frame.

A half convex lens of 1 diopter (+1) and a half circle of plane glass (0), in the same trial frame to serve as a correcting spectacle.*

that whenever an object is seen, there must be formed an image on the retina, and that this image, following the laws of optics, must be inverted. A few years later, (1619), Scheiner showed by actual experiment with the eyes of animals that such an inverted, real image is formed on the retina; and in the year 1625, he showed that the same is true of the human eye.

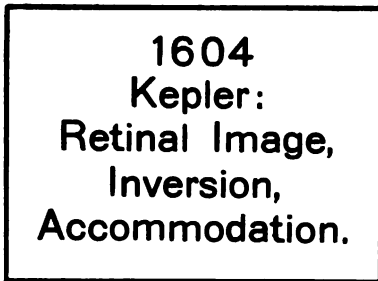

FIG. 383. LANTERN SLIDE FOR THE EXPERIMENTS IN ACCOMMODATION.

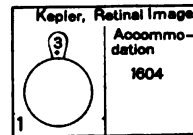

FIG. 384 TRIAL LENS FOR KEPLER'S EXPERIMENTS.

For the demonstration of normal vision with the special projector (fig. 378-379) are needed:

(1) A 3 diopter convex, trial lens (fig. 384). For the meaning of diopter, see § 356a.

(2) A lantern slide for object (fig. 383).

The screen representing the retina should be at a distance of 5 meters (16 ft.) from the lens and the lens should be 40 centimeters (15.5 in.) from the condenser and the object 36 to 37 cm. distant from the object (fig. 379).

*Of the ordinary trial lenses, this calls for three, 3 diopter convex lenses; four, 4 diopter convex lenses; one, 2 diopter convex lens; two 1 diopter convex lenses; and one, 1 diopter concave lens. In addition there are two, 0.5 diopter convex cylinders and one 0.5 diopter concave cylinder, making 14 trial lenses. These cost about 20 cents each. It would be possible to get along with 7 different lenses by using the same ones over and over, but for ease and certainty in demonstration it is better to have each step in the demonstration complete.

The authors have found it convenient to have all the lenses for each experiment in a separate box, and set edgewise, then they can be grasped quickly and surely, thus avoiding errors and loss of time.

The object should be right side up and face the condenser. If the arc lamp is lighted there will be projected on the screen a sharp image of the lantern slide. This image will be wrong side up as it is in the eye. In order to have the image erect on the screen the object must be wrong side up in the slide-carrier as in magic lantern projection (fig. 8, § 35).

For the remainder of the experiments it is desirable to have the screen image appear erect so that there may be no distraction from the special points to be shown. It is worth while remembering though, that when the image is wrong side up on the screen it will be right side up in the eyes of the observers, and when it is right side up on the screen it will be wrong side up in the eyes of the observers. Objects appear right side up to a person only when the image is wrong side up on his retina.

§ 921. Demonstration of the need of accommodation of the eye for different distances of the object.—It was pointed out by Kepler in his discussion of vision that the eye as an optical instrument could have a sharp image on the retina only in one position of the object, unless some change took place in the eye. Everyone with normal eyes knows that objects at all distances from 10 to 15 centimeters up to infinity can be seen with equal clearness. Kepler thought that the power to see objects at different distances was due to the possibility of changing the relative position of the crystalline lens and the retina by the elongation and shortening of the eye-ball.

To demonstrate Kepler's hypothesis of accommodation there are needed:

- (1) A 3 diopter, convex, trial lens (fig. 384).
- (2) A lantern slide (fig. 383).
- (3) A white cardboard screen about half a meter (15 to 20 in.) square to hold in the hands.

If now the arc lamp is lighted and the lantern slide placed 36 to 37 centimeters from the lens a sharp image will be projected upon the 5 meter screen. Now move the object to about 40 centimeters from the lens; the image will not be clear, but much blurred. To find the position of the sharp image, take the small white screen in

the hands and hold it in the path of the light from the lens. It will be found at a point between two and three meters from the lens. This shows that if the object is farther from the lens, the image will be nearer to it. Conversely, if the object is brought up toward the lens the image will move farther off. Kepler thought that following the changes in the position of the sharp image with change in the object, that for a near object the eyeball elongated to bring the retina in the most favorable position, and that when the object was far off the eyeball shortened to bring the retina up to the point where the sharp image was formed. Such a method of accommodation for objects at different distances would be effective, as everyone knows who uses a photographic camera, but as is now known it is not the method used by the eye of the higher animals and man.

§ 922. Demonstration of Scheiner's theory of accommodation.

—Scheiner admitted that the method of accommodation proposed by Kepler would be effective, but he thought that the eyeball remained unchanged in shape, and the crystalline lens changed its shape, being more convex for near objects and less convex for distant objects. He put it thus: "The crystalline lens of the eye is equal to many glass lenses."

There are needed for demonstrating Scheiner's theory:

- (1) A convex, trial lens of 3 diopters (fig. 382, 385).
- (2) A convex, trial lens of 4 diopters.
- (3) A lantern slide of fig. 383.

Put the three diopter lens in the lens holder and light the arc lamp. When the lens is 36 to 37 cm. from the lens a sharp image will be projected on the 5 meter screen. Now move the object up to 27 or 28 cm. from the lens. The image will be much blurred. Remove the 3 diopter lens and put in its place the 4 diopter lens. The screen image will be sharp again. This shows that if the crystalline can become more and less convex, depending upon the position of the object, the screen image

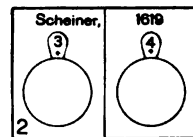

FIG. 385. TRIAL LENSES FOR SCHEINER'S ACCOMMODATION EXPERIMENT.

will be sharp without changing the position of the screen. And this is now known to be what happens in the accommodation of the eyes in the higher animals and in man. Furthermore, it has been found that for near objects there must be a muscular effort to make the crystalline more convex, while if the object is distant, the eye forms a perfect image without effort.

REFRACTIVE EYE DEFECTS

§ 923. For a person with normal eyes it is almost impossible to understand the difficulties under which one labors if the eyes are defective. The difficulties become especially trying for those who must do close work in the trades or in school work, and in exacting professional work.

From the examination of tens of thousands of school children in our own and other lands it is found that over 10% of them have eye defects of some kind. And in a careful examination of 5,000 college students 45% to 50% had ocular defects of a kind that made the use of spectacles desirable, and for many of them absolutely necessary.

It is believed that if those with normal sight had anything like a proper realization of the difficulties of those with eye defects every effort would be made to give relief.

It is hoped that these demonstrations, which are so easily made and show so strikingly the simpler refractive eye defects, will be of service in helping to give an understanding of the facts and the means for relief.

Great care has been exercised in selecting demonstrations which shall show the common defects, and those of moderate severity, not the unusually severe or rare. From the personal experience of the senior author, it is known that the appearances shown for presbyopia are not exaggerated; and friends with the other eye defects have assured us that the appearances given in the demonstrations are not uncommon.

§ 923a. For a discussion of the eye defects in school children see: Hermann Cohn, *Die Sehleistungen von 50,000 Breslauer Schulkindern*, 1899; Dr. M. Dresbach, *Examinations of the Eyes of College Students*, *The Medical Record*, Aug. 3, 1912, also in the *Educational Review*, Dec., 1913. In Dr. Dresbach's papers are many references to the work of others.

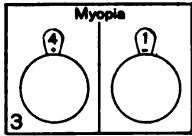

FIG. 386. TRIAL LENSES FOR MYOPIA.

§ 924. **Myopia, or short sight.**—Myopia is due to any condition in the eye by which the image of distant objects is formed in front of the retina. The retina is too far away, hence the retinal image is blurred. Persons with this eye defect are able to get clear images only when the object is quite close to the eyes.

As the effort of accommodation only aids in seeing near objects, there is no way by which short sighted persons can see distant objects clearly without the use of a telescope or of concave spectacle.

For demonstrating myopia and its remedy are needed:

- (1) A convex, trial lens of 4 diopters (fig. 386).
- (2) A concave, trial lens of 1 diopter.
- (3) A lantern slide of fig. 383.

The 4 diopter lens is to represent the refractive power of the myopic eye. It is placed in the metal lens holder, and the object is brought up to a point 27 to 28 centimeters from it. Then the image will be sharp and clear on the 5 meter screen.

Move the slide back until the distance between it and the lens is 36 to 37 centimeters. The image on the 5 meter screen will be much blurred; it is too far off. One can prove this by taking the white cardboard in the hands and finding the position of the sharp image as in § 921. Now to get a sharp image on the 5 meter screen it is necessary to reduce the curvature of the 4 diopter lens. Do this by adding the 1 diopter concave lens. This reduces the 4 to a 3 diopter convex lens, and now the image is sharp and clear on the 5 meter screen.

In the same way the short sighted person can use concave spectacles which will reduce the refractive power of the cornea and the crystalline lens, and hence the image will be formed farther away. If the right spectacles are used, the image of distant objects will be clear and sharp

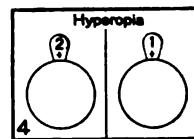

FIG. 387. TRIAL LENSES FOR HYPEROPIA.

on the retina. If the person wishes to look at near objects the eye is accommodated to make the crystalline more convex and the diverging rays from near objects are brought to a focus on the retina as with persons having normal eyes and not using spectacles.

§ 925. **Hyperopia, or long sight.**—This eye defect is due to any condition in which distant objects have their images formed behind the retina. The retina is too close to the crystalline lens, hence there is a blurred image formed on it even with parallel rays, unless there is active accommodation and the crystalline lens is made more convex. That is, with hyperopic eyes, no object can be seen without effort.

For the demonstration of hyperopia there are required:●

- (1) A convex, trial lens of 2 diopters (fig. 387).
- (2) A convex, trial lens of 1 diopter.
- (3) A lantern slide of fig. 283.

The lens of 2 diopters is to represent the refractive power of the hyperopic eye. Place the lens in the metal holder, and light the arc lamp. Move the object near to and distant from the lens, and no place within the range will be found where a clear image will be formed on the 5 meter screen. The screen is too near the lens and the sharp image is formed somewhere behind it. If the room is long enough the place where the image is sharp can be located.

Now move the object until it is 36 to 37 centimeters from the lens and add the 1 diopter convex lens. This will add its strength and the refractive power will be equal to 3 diopters, and now the image will be clear and sharp on the 5 meter screen.

With the proper convex spectacles, the long sighted person can see distant objects without effort, then when he wishes to see near objects clearly the crystalline is made more convex as with normal eyes, thus making the entire range of vision normal.

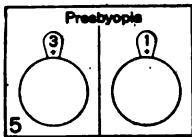

FIG. 388. TRIAL LENSES FOR PRESBYOPIA.

§ 926. **Presbyopia, or old age sight.**—This comes gradually to every one with advancing years, until finally, for most people after 60 or 65 years of age, the crystalline lens has lost its elasticity so

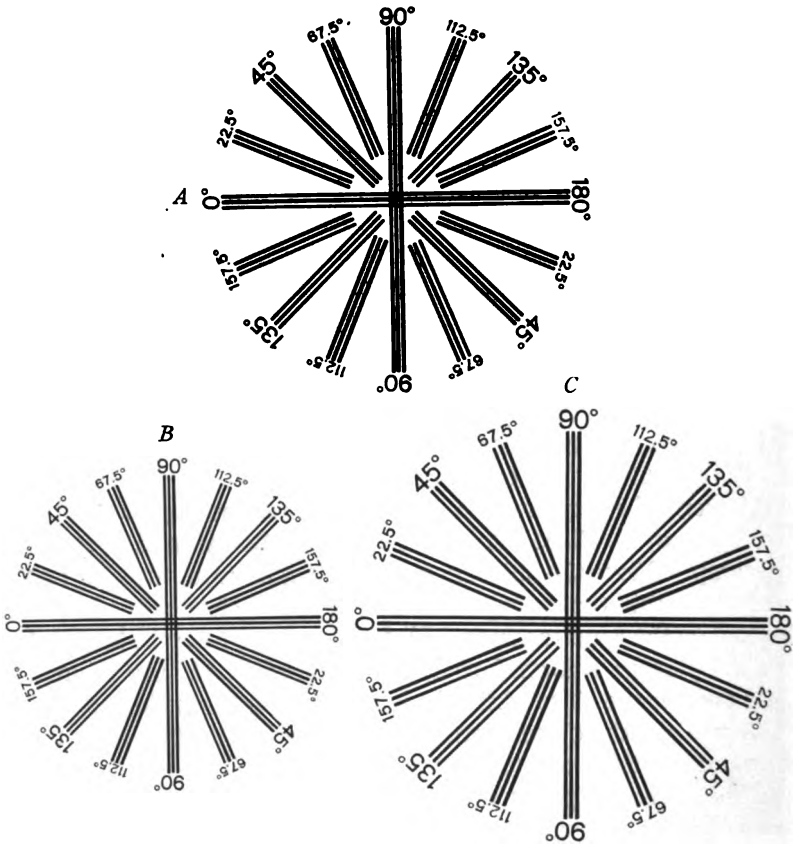

FIG. 389. THE RADIAL LINES SHOWING THE SIZE OF THE IMAGE WITHOUT SPECTACLES, AND WITH CONCAVE AND CONVEX SPECTACLES.

A shows the size of the image without spectacles.

B shows the diminished size of the image when a spectacle lens of -0.5 diopter is put with the 5.5 diopter lens. (This reduces the 5.5 to a 5 diopter lens).

C shows the increased size of the image when a spectacle lens of $+0.5$ diopter is added to the 5.5 diopter lens. (This increases the 5.5 diopter lens to 6 diopters).

The photographs were made by fixing the camera so that the objective and sensitive plate were at a constant distance, then the image was focused by moving the object farther off for B and nearer to the lens for C, just as in the projection experiments (§ 922).

that it cannot be made more convex no matter how great the effort at accommodation. If the eyes were originally normal, the images of distant objects are still clear, but the diverging rays of near objects can no longer be brought to a focus on the retina, without artificial aid.

For illustrating presbyopia there are needed:

- (1) A convex trial lens of 3 diopters (fig. 388).
- (2) A convex trial lens of 1 diopter.
- (3) A lantern slide of fig. 383.

Place the 3 diopter lens in the metal holder and the lantern slide in the slide-carrier, then move the slide up till it is 36 to 37 centimeters from the lens. Light the arc lamp and there will be a sharp image on the screen. This represents the appearance for distant objects.

Now move the object up to 27 or 28 centimeters from the lens to represent a near object. The image on the screen is much blurred, something as the ordinary print of a newspaper looks to an old man without spectacles. Put the 1 diopter lens with the 3 diopter lens making a refracting medium equal to 4 diopters, and the image on the screen will become clear and sharp, just as the print of the newspaper becomes clear and sharp to the old man when he puts on the proper spectacles.

§ 927. **Astigmatism, Astigmia, or unequal curvature of a refracting surface.**—This is a common defect in the eye, and is found very frequently in the cornea. Roughly speaking an astigmatic curve is like the bowl of a spoon or a hen's egg, the curve being greater in one direction than in the direction at right angles.

The greater curvature will, of course, bring rays of light to a focus sooner than the lesser curvature; and with such a refracting surface not all points in a circle can be focused sharply in any position. Usually objects at right angles can be sharply focused by changing the position of the objects, bringing them nearer for the greater curvature and moving them farther away for the lesser curvature. With a radial disc like fig. 389, 391, 392, if the vertical lines are sharp in one position, the horizontal lines will be sharp in

a different position of the object. The intermediate lines cannot be made perfectly sharp in any position.

With the eye when it is accommodated for vertical lines, the horizontal lines will be blurred, and when the horizontal lines are sharp and clear the vertical lines will be blurred. All the intermediate lines will be more or less blurred all the time.

To correct astigmatism it is necessary to do away with the inequality of the curvature of the refracting surface. This can be done either by increasing the lesser curvature or by reducing the greater curvature sufficiently to make the refracting surface uniform.

To demonstrate astigmatism there are needed:

- (1) A convex lens of 3 or of 4 diopters (fig. 390).
- (2) A convex cylindrical lens of 0.5 diopter.
- (3) A concave cylindrical lens of 0.5 diopter.

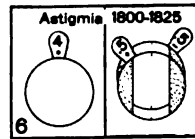

- (4) A lantern slide of the history of astigmatism (fig. 393).

FIG. 390. TRIAL LENSES FOR ASTIGMATISM.

- (5) A lantern slide of the radial lines (fig. 391).

Put the 3 or the 4 diopter lens in the lens holder, and the lantern slide of the radial lines (fig. 391) in the slide-carrier. Move the slide until the radial lines are as sharp as possible on the screen.

Put with the projecting lens the 0.5 diopter convex cylinder and turn it so that the axis of the cylinder is vertical. The horizontal lines will remain sharp, and the vertical lines will be most blurred.

The addition of the 0.5 convex cylinder produced an unsymmetrically curved refracting surface. Along the axis of the cylinder no change is made in the refractive power, hence light rays, from points in the horizontal lines, which are in planes parallel with the axis of the cylinder, are brought to a focus at the same distance as if the cylinder were absent, but rays in any plane oblique to this axis are affected by the curvature of the cylinder, and are not brought to the same focus, hence only horizontal lines appear sharp.

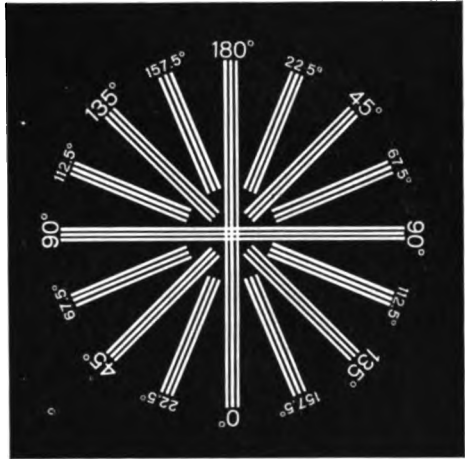
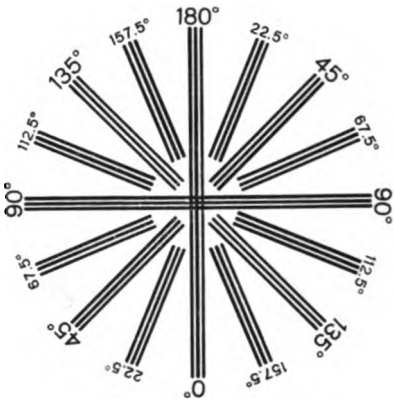

FIG. 391-392. RADIAL LINES IN BLACK AND WHITE FOR DETERMINING THE PRESENCE OF ASTIGMATISM.

A lantern slide of the radial lines is very desirable for the demonstrations on astigmatism.

The black lines on a white ground have the advantage that the lantern slide is less liable to break than the white lines on a black ground (§ 852). It will be noticed that, by contrast, the central white circle seems lighter than the white spaces between the radial lines. In like manner the central black circle seems blacker than the black spaces between the radial lines. These are optical illusions, for the white is uniform and so is the black.

Now place the concave cylinder in front of the convex cylinder and make their axes parallel (fig. 390). All the lines will become sharp again. This is because the concave and the convex cylinders with their axes parallel just balance each other and then act like a piece of plane glass. To compare the effect of astigmatism on printed matter with its effect on the radial lines, remove the cylinders and focus sharply the lantern slide of the history of astigmatism, (fig. 393). Now add the 0.5 diopter convex cylinder and make the axis vertical. The horizontal lines in the print will be sharp, but the others blurred (fig. 394-395). Now rotate the cylinder until its axis is horizontal, and the vertical lines will be sharp and clear (fig. 396-397). It is to be noted that with these Gothic letters, it is easier to read the words when the vertical lines are clear, because vertical lines preponderate.

As shown with the glass lenses it is possible to do away with astigmatism by rendering the inequality of curvature uniform, hence a person with astigmatism can be given normal vision by the use of the proper spectacles.

§ 928. **Correct position of spectacles.**—It is extremely important that glasses to correct astigmatism should be correctly adjusted to the eyes. The necessity of this can be strikingly shown by making the axes of the two cylinders in the last experiment somewhat oblique. When the axes are oblique the confusion is greater than when the correcting lens is removed entirely. Not only must the correct spectacle be used, but it must be correctly adjusted.

Furthermore, it should be known that the axis of astigmatism in the eye sometimes changes so that the spectacles which gave perfect vision at one time would not do so at a later time. In such a case new spectacles with axes arranged to meet the changed conditions in the eyes are necessary.

§ 929. **The two foci of astigmatic lenses, and the correction of astigmatism with cylinders having the same form (both convex or both concave).**—Use the same outfit as for § 927.

Focus sharply the image of the radial lines. Add the 0.5 diopter convex cylinder and make its axis vertical. The horizontal lines will be sharp. The vertical and intermediate lines will be blurred. Now move the object up towards the astigmatic combination and soon the vertical lines will become sharp and the horizontal and intermediate lines dim. In this position the focus is for the original projection lens (3 or 4 diopters) with the added curvature (0.5 diopter) of the cylinder. That is the greatest curvature is now acting to focus the image of the vertical lines. With the horizontal lines in focus, it was the least curvature which was acting.

ASTIGMATISM

Thomas Young, 1800

Philosophical Transactions of the Royal Society, 1801

Pp. 38-40, astigmatism of the crystalline lens.

P. 57, astigmatism of the cornea.

Correction by obliquity of the spectacles.

George B. Airy, 1825

Cambridge Philos. Trans. Vol. II (1827)

Correction by obliquity of the spectacles, but most perfectly by the use of cylindrical lenses.

FIG. 393. THE DISCOVERERS OF ASTIGMATISM AND THE MEANS OF CORRECTING IT.

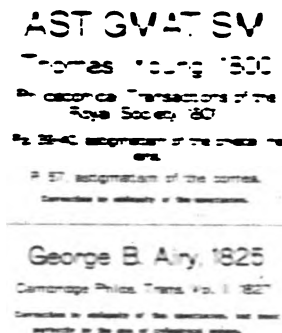
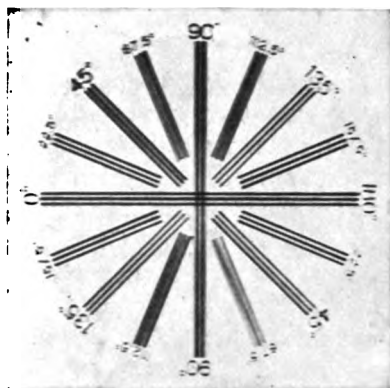

FIG. 394, 395. FIGURES SHOWING THE APPEARANCE OF THE RADIAL LINES AND OF PRINTED MATTER WHEN AN ASTIGMATIC LENS IS IN FOCUS FOR HORIZONTAL LINES.

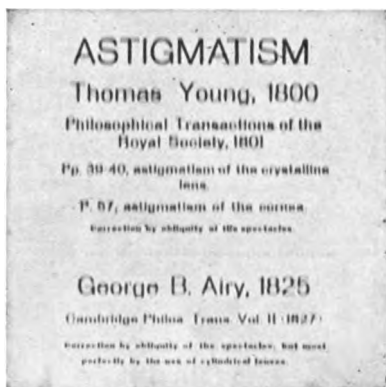
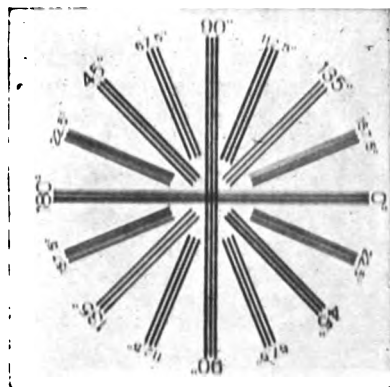

FIG. 396, 397. FIGURES SHOWING THE APPEARANCE OF THE RADIAL LINES AND PRINTED MATTER WHEN THE ASTIGMATIC LENS IS IN FOCUS FOR VERTICAL LINES.

Figures 394-397 were made by adding a $+5.5$ diopter photographic objective, and the cylinder was placed with its axis vertical in fig. 394-395, and horizontal in fig. 396 and 397; no change was made in the focus of the objective. The aperture of the objective was $F/16$ when the photograph was made.

As shown in figures 395-397, Gothic print seen through an astigmatic lens is clearer when the axis is such that the vertical lines are in focus. This is because the vertical lines are more numerous than the horizontal lines.

With the vertical lines in focus, add another convex cylinder of 0.5 diopter and arrange the axes of the two cylinders at right angles (cross the cylinders). All the lines will now be sharp, for the added convex cylinder increases the curvature where it was lacking, and thus gives the combination a symmetrical curvature. It is to be noted that when convex cylinders are crossed in this way they add to the original lens the dioptry of the cylinders. In this case 0.5 diopter, and the image is increased in size (fig. 389 C).

Two concave cylinders can be used in the same way, but with concave cylinders the entire system is reduced in dioptry the amount of the cylinders. In this case it would reduce the dioptry half a diopter and hence the image would be smaller (fig. 389 B).

§ 930. Correction of astigmatism by the obliquity of the spectacles.—It was pointed out by Young (1800), that astigmatism might be corrected by making the spectacles sufficiently oblique to neutralize the defect. This can be demonstrated very strikingly as follows:

Use the same outfit as in § 927. Make the image of the radial lines sharp on the screen and add the +0.5 diopter cylinder with the axis vertical (fig. 390). Now put a convex lens of 1 diopter in front of the cylinder and focus for the lines parallel to the axis of the cylinder (vertical in this case). Tip the convex lens up or down, i. e., across the axis of the cylinder, and when the right obliquity is reached the lines will all be sharp. This is because the tipped lens introduces the curvature lacking in the cylinder. This can be shown by removing the cylinder and the horizontal lines will be sharp showing that the vertical meridian is unchanged but the horizontal meridian has been increased in curvature.

Use the same cylinder but a concave lens of 1 diopter instead of the convex lens; focus the combination until the horizontal lines are sharp, then rotate the concave lens sidewise (i. e., parallel with the axis of the cylinder), and when at the right obliquity the radial lines will all be sharp. This is because the oblique, concave lens neutralizes the greater curvature of the +0.5 cylinder. In a word, the oblique position of the spectacle makes it act like a cylinder in

addition to its magnifying or reducing power. Acting as a cylinder it follows the law of the cylinder as given in § 929.

If one keeps in mind the effect of oblique lenses it will help to appreciate the necessity of having the spectacles properly adjusted.

§ 931. **Effect of the aperture of the pupil in vision.**—As a general statement it may be said that the larger the aperture of the pupil the more brilliant will be the image as more light is admitted. On the other hand the larger the pupil the more strongly do eye defects deteriorate the retinal image.

When the aperture of the pupil is small, only a small part of the refracting surface produces the image, and consequently any defects of curvature are minimized; but the small aperture makes the image less brilliant as only a limited amount of light goes to form it, and furthermore it requires muscular effort to contract the iris to make the pupil small. With a small pupil, objects can be seen clearly only when they are in a brilliant light, hence eye defects cannot be compensated for in a dimly lighted place by closing the pupil.

For demonstrating the effect of the pupillary aperture there are needed:

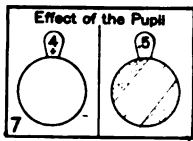

FIG. 398. TRIAL LENSES TO SHOW THE EFFECT OF THE PUPIL.

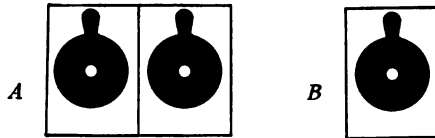

FIG. 399. DISCS WITH PUPILS OF LARGE AND SMALL APERTURE; STENOPÆIC SLIT. ($\frac{1}{4}$ size)

A Black metal discs of the size of trial lenses, one with a pupillary aperture of 2.5 mm. and the other of 7.5 mm.

B Stenopæic slit.

- (1) A 3 or 4 diopter convex projection trial lens (fig. 398).
- (2) A 0.5 diopter concave or convex cylinder.
- (3) Two black discs the size of trial lenses and with apertures, one of 2.5 mm., and one of 7.5 mm.
- (4) A lantern slide of the radial lines.
- (5) A black disc with a stenopæic slit.

Put the 3 or 4 diopter lens in place in the metal holder, and the lantern slide of the radial lines (fig. 391) in the slide-carrier. Light the lamp and focus the slide by moving it toward or from the projection lens. Now introduce the 0.5 cylinder. Only the horizontal lines will be sharp with the axis vertical or only the vertical lines if the axis is horizontal. Put in front of the projection lens the black disc with an aperture of 7.5 mm. The image will be much improved. Remove this and put in place the disc with a pupil of 2.5 mm. If now the light is well centered the entire circle of the radial lines will be fairly good. The image will be rather dim, however.

Remove the small pupil and put in place the stenopæic slit (fig. 399B). Place the slit parallel with the axis of the cylinder and the lines will all appear sharp. This is because the slit allows the light to pass only along a line, thus eliminating most of the disturbing rays from the unequal curvature. People with astigmatism can partly overcome the trouble by narrowing the pupil and partly closing the eye-lids so that objects are seen through a slit something as in the experiment (§ 931A).

§ 932. Anisometropia or unlike refraction in the two eyes.—This is not a rare defect. One eye may be normal and one astigmatic, one with myopia and the other long sighted or normal, etc. Where the two eyes are different, the efforts to get a correct image are greatly hampered, for an accommodation which would give a correct image in one eye will make the image of the other eye more confused.

When the differences in the two eyes are considerable, the image of one eye is discarded, or the poor eye is turned aside (squinted) to get it out of the way, and one gets along with monocular vision.

To make this demonstration in the most perfect manner there should be two lanterns side by side, each projecting an image at the

§ 931a. Preparation of the pupils and slit.—These are easily made by cutting out pieces of thin tin or other metal the size of the trial lenses and boring the holes and cutting the slit. Metal is recommended because the image of the crater must be focused on the pupil or slit, and paper or wood would be burned by the absorbed energy (§ 852.)

same time. If, however, direct current is available the demonstration is successful with one projector.

There are needed:

- (1) A trial frame with half the lens of 4 diopters and half of 3 diopters (fig. 400).
- (2) A trial frame with half the lens of 1 diopter and the other half of plane glass.
- (3) A lantern slide of fig. 401.

For the demonstration the arc lamp and the lens should be so related that the image of the source of light is rather large as shown

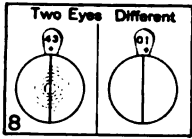

FIG. 400. DOUBLE TRIAL LENSES FOR UNLIKE REFRACTION IN THE TWO EYES.

Left Right
Eye Eye

FIG. 401. LANTERN SLIDE FOR THE DEMONSTRATION OF UNLIKE REFRACTION IN THE TWO EYES.

by the concentric circles in fig. 400. The light must be accurately centered also.

Put the lens in the metal holder and the special lantern slide in its carrier and move the slide up to a point 27 to 28 centimeters from the lens. The image of the right eye (4 diopter lens) will be sharp, and that of the left eye will be blurred. Now pull the slide back to a distance of 36-37 centimeters from the lens and the left eye image will be sharp and the right eye blurred. This is comparable to a defect of myopia in one eye and hyperopia in the other—one eye is short sighted and one long sighted. Put the slide back in position for the 4 diopter lens so that the right eye will be in focus. Now put in front of the lens the correcting lens of 1 diopter for the left half. This will make both sides of the lens 4 diopters and both images will be sharp as in normal vision (fig. 402, A.B.).

It will be seen that the blurred, left-eye image (fig. 402 A) is smaller than the sharp right-eye image. This is because the 3

dioptr lens gives a smaller image than the 4 dioptr lens (see also fig. 389 B. C.).

A	Left Eye	Right Eye
B	Left Eye	Right Eye

FIG. 402. APPEARANCE OF THE SCREEN IMAGE WITH UNLIKE REFRACTION IN THE TWO EYES AND WITH LIKE REFRACTION.

A Image of a 3 diopter left eye and a 4 diopter right eye; the 4 diopter eye is in focus.

B Image when a 1 diopter convex spectacle is added to the 3 diopter left eye, making it like the right eye.

§ 932a. In the experiment showing anisometropia each half of the double lens projects both images, but when the light is properly centered and in the correct position to give the large illumination on the lens (fig. 400), each half lens projects a much more brilliant image of its own side, hence the fainter image of the opposite side is overwhelmed and overlaid so that only one image shows on each side. If the light is not in a good position, both images show and that spoils the effect.

This demonstration with two half lenses was fully successful only when a right-angle, direct current arc lamp was used as a source of light.

By using a 1 diopter concave lens to reduce the 4 diopter half lens to a 3 diopter power, the right eye image can be made sharp when the lantern slide is in position to make the left eye image sharp, and the right eye image blurred. It is a little more satisfactory to work with the 4 diopter lens, however, and to add the 1 diopter convex lens to the 3 diopter left lens.

BRIEF HISTORICAL SUMMARY

In dealing with the historical development of projection three forms of apparatus must be considered:

I. NATURAL CAMERA OBSCURA

The formation of images in a dark place, the light from the brilliantly illuminated objects or scenes being admitted through a small opening, is a perfectly natural phenomenon and entirely independent of man's invention or control. This is represented by images of the sky with its clouds and the brilliant scenes of nature pictured on the walls of caves facing the scenes, and the images of the sun admitted through chinks between the leaves, etc.

In rooms of man's construction such images are often seen if light enters through a chance hole in the right position. General Waterhouse, from his own observation, says it is a common occurrence in the bungalows of India, and the writers have often seen the same in America.

*It was our intention when this work was undertaken to include a somewhat extended account of the discoveries and inventions relating to vision, including spectacles, general optics, and optical instruments, especially the telescope, the microscope and projection apparatus of all kinds. As the book has already exceeded its limit in size, this extended account must wait for a special work. We have thought it best, however, to add a brief summary of the more pertinent points, and a historical bibliography which will put those interested on track of the special and early sources of information.

Our appreciation is great for the aid we have received from many sources. First of all to the Library of Cornell University for its magnificent collection of works bearing on the history of science, for the purchase of rare and costly works, and for the trouble taken to borrow from other libraries, rare works for our use. Among the other libraries drawn upon we mention in the first place that of the Surgeon General's Office in Washington, D. C. Those of Columbia, Chicago, Harvard and the University of Pennsylvania also loaned us many works.

Among the individuals who gave us special aid are:

Professor George L. Burr, for securing the portrait of Scheiner, (fig. 407).

Professor E. Lavasseur of the College of France who supplied the photograph for the portrait of Marey (fig. 412).

Mr. Augustus J. Loos of Philadelphia for securing information concerning the Langenheim brothers who were the first to make photographic lantern slides by the albumen process (1850).

Mr. Edward Pennock of Philadelphia for putting us in communication with Mr. C. W. Briggs of that city. Mr. Briggs gave us much valuable information concerning his father, Dr. Daniel H. Briggs, who made the first photographic lantern slides by the collodion process (1851-1852).

Effie Alberta Read, Ph.D., M.D., for looking up references and verifying quotations in the libraries of Washington, D. C.

Theodore Stanton for aid in securing the photograph of Marey, (fig. 412).

And finally to Dr. A. C. White of the Cornell University Library for translations from the Greek and Latin works of the old writers, in which some of the earliest information on our subject is to be found.

II. ARTIFICIAL CAMERA OBSCURA

No one knows who first designedly arranged a darkened room with a white wall or screen on one side, and on the other a small opening facing some object or scene that could be brightly illuminated. All we know is that the earliest accounts of the pictures in a dark place are in connection with the explanation of some other phenomenon, and not to show that such pictures were possible. It was also recognized in the first statements, as in the works of Aristotle and of Euclid, that as light rays extend in straight lines, that those from an object must cross in passing through a small hole, and hence the images beyond the hole in the dark place must be inverted, the top being below and the right being left.

According to Wiedemann and Werner, the Arabians, Iban Al Haitem (1039 A.D.), and Levi Ben Gersen (1321-1344), gave descriptions which clearly belong to the camera obscura. However, that may be, we have the illustrated manuscripts of Leonardo da Vinci, which not only describe the phenomena of the camera obscura, but give pictures which are unmistakable. The pictures and descriptions are in connection with his explanation of vision. As Leonardo died in 1519, these manuscripts are of an earlier date, probably before 1500 A.D. (See especially folio 8 of Ms. D.)

Also in the accounts of eclipses, etc., of the astronomers Reinhold, Frisius and Moestlin, they very clearly describe and give figures of the arrangement of the dark room pictures (1540-1545); and in the quaint old volume of Cardanus (*De Subtilitate*, 1550), there is a very graphic description of the means of getting dark room pictures and of their appearance. Baptista Porta, in 1558, in his *Natural Magic*, also gives a good description. Porta is credited in the popular mind with the invention of the camera obscura, but as seen from the above, it is a natural thing, and man had got camera pictures by design before Porta was born. The *Natural Magic* of Porta was very popular in its day, and was translated from the Latin into most modern languages, hence it is intelligible that people thought him the inventor, as he gave credit to no one, and gave out that many of the things had never been known before. To credit him with the discovery of the marvelous things he describes would be like making the modern magazine writer the inventor or discoverer of the wonderful things he describes. In justice to Porta, it must be said that he states in the preface to his book that he has consulted all libraries, and has visited many skillful artisans to find out all the secrets.

It may be stated in passing, that the name "**Camera Obscura**" was not used by Porta, nor the others mentioned above. They used expressions like these: *cubiculum obscurum*, *cubiculum tenebricosum*, *conclave obscurum*, *locus obscurus*, etc. The first occurrence of the name "**Camera Obscura**" found by us is in the *Paralipomena* of Kepler, (1604), p. 209 of the original, p. 261 in the *Opera Omnia*, vol. ii. Kepler also uses the expression, "**camera clausa**," vol. ii, p. 160.

While mirrors had been used in the camera obscura for changing the position or causing the images to appear erect, so far as known at present, no one used a projection lens in the aperture of the dark room until 1568. In that year was published the work on perspective by Daniel Barbaro, and on p. 192, Ch. V, he directs that to make the image more brilliant, a convex spectacle glass be put in the aperture, and that a white paper screen be moved back and forth until the picture shows most clearly, then it can be traced. From this time onward a projection objective has always been used, except for experiments, such as with pin-hole photographic cameras, etc.

In the camera obscura considered above, the observers were in the room where the picture was formed. For a small, movable camera, something like the photographic cameras of the present, where the observer is outside the camera box, the first description found by us is the one of Robert Boyle, and dates from 1669. He called it a "A Portable Darkened Room," and says that it had already been exhibited to many friends several years before the paper was written.

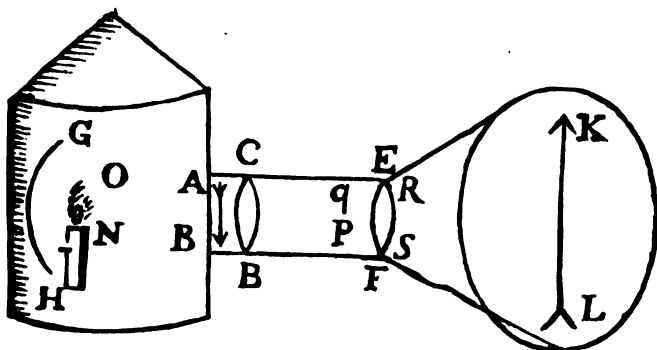

FIG. 403. WALGENSTEN'S MAGIC LANTERN (1665).

(From *Milliet de Chales, Mundus s. Cursus Mathematicus, 1674, vol. ii, p. 666*)

Here is a naked light with a reflector behind it. There is no condenser. The object is put in the proper inverted position before the objective, and the image appears erect and enlarged on the screen.

III. PROJECTION INSTRUMENTS

The third form of projection apparatus consists of a relatively small instrument in which a small object is brilliantly illuminated, and the light from it extends out through a projection lens or objective and forms a relatively large image on a white wall or screen in a dark place.

The third form is the converse or conjugate so to speak of the camera obscura where the object is large and the image small.

Projection instruments of the third class can be properly divided into three groups: 1, the Magic Lantern; 2, the Projection Microscope, and 3, the Moving Picture Machine.

1. The Magic Lantern

It is not certainly known who first produced a workable magic lantern. The first figure and description we have found is the one of a Danish mathematician (Walgensten). The figure and description occur in the mathematical treatise of Milliet de Chales (1674), where it states that "in the year 1665 there came to Lyons a learned Dane well versed in dioptrics. Among other things he exhibited a **magic lantern**. . . In the first place the greater the distance

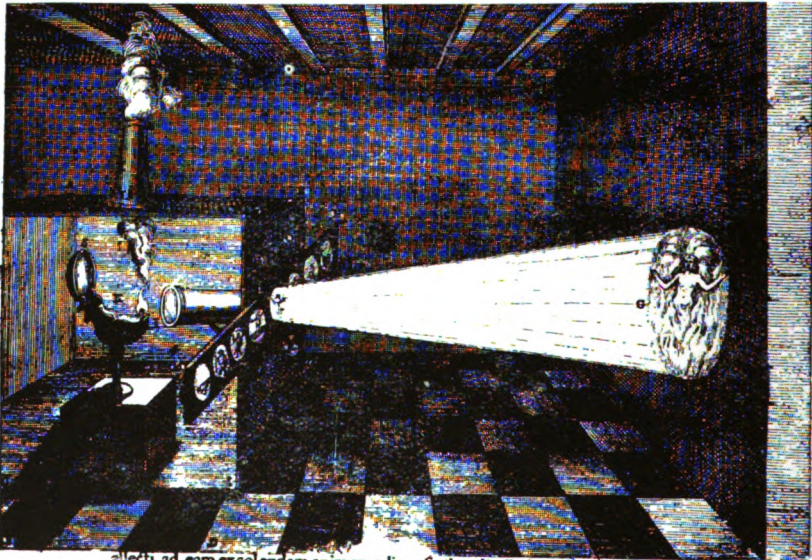

allecti ad eam excolendam animum adje- scribendis iis inventiones Lucernam fol.
teriat, Quos inter primus fuit Thomas 7671 a nobis descripam . in meliorem
Walgensteaus Danus, hand infimæ noæ formam reduxit . quàm & postea magno
Mathematicus, qui recolens meas in de- suo lucro diversis in Italia principibus ven-
didit.

FIG. 404. THE MAGIC LANTERN OF KIRCHER.

(From the *Ars Lucis et Umbrae*, 1671, p. 768)

The lamp is a naked flame with a concave reflector behind it. The lantern slide is a long strip with many pictures which can be shown one after the other.

The lantern slide appears at the wrong end of the projection objective, making it difficult to see how any image could be projected. At the bottom of the picture is a part of the text in which the better form of Walgensten's lantern is conceded.

of the wall upon which the image was exhibited the larger was the image. . . . In the third place, the little image in the lantern was inverted in order to exhibit its figure erect upon the opposite wall. If the object was removed there appeared only a circle of light" (vol. ii, p. 655; 2d ed., vol. iii, p. 680):

Figure 403 is a facsimile of the lantern of Walgensten which he exhibited at Lyons in 1665. A glance at it will show any one that it is in all essential particulars like the modern magic lantern. Indeed such lanterns are much in vogue for Christmas presents at the present time, differing only in having a kerosene lamp with a chimney instead of the naked flame as shown in the original.

Kircher himself in the second edition of his work, (*Ars Magna Lucis et Umbrae*, 1671, p. 768-769), claims that the lantern of the Dane is merely a

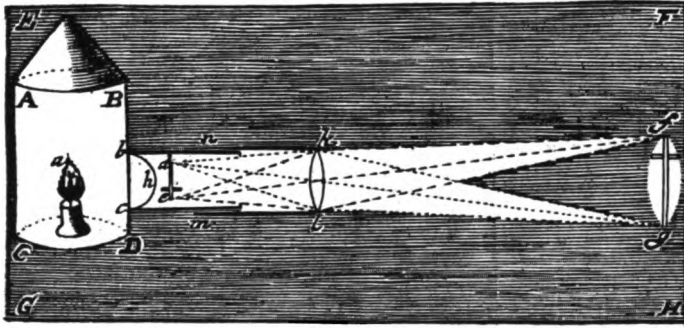

Fig. 2. Tab. 38. pag. 181

FIG. 405. MOLYNEUX'S MAGIC LANTERN WITH A CONDENSING LENS BEFORE THE OBJECT.

(From *Molyneux's Dioptrica Nova*, 1692)

This is the first picture of a magic lantern with a condensing lens that we have found.

slight modification of the one described by him, but he admits that Walgensten's instrument is in better form and has many pictures on a single slide painted in transparent colors that can be shown one after the other.

Kircher figures his magic lantern, which is here reproduced in facsimile (fig. 404). As pointed out by Neuhauss, it is difficult to see how a picture could be projected by the arrangement shown by Kircher. The text describes the lantern as here shown, so both text and figure agree. In Kircher's lantern as figured and described by himself, the object is put at the wrong end of the projection objective; or if the tube and glass shown represent a condenser, which he does not claim, then in that case there is no projection objective. In either case no image could be projected.

So far as the evidence goes then, it was not Kircher, but Walgensten who exhibited the first workable magic lantern, and the date was 1665.



FIG. 406. JOHANNES KEPLER, 1571-1630.
(From the *Library of Original Sources Vol. V*)

Astronomer. Father of Modern Dioptrics, Keplerian Telescope and Microscope. The Amplifier and the Telo-Photo Combination. Inverted Retinal Image.

2. Projection Microscope

As pointed out in the text (p. 221), the projection microscope is only a magic lantern with a relatively short focus projection objective. The screen image is therefore correspondingly larger than with the magic lantern.

The first magic lantern described (1665) was recognized as a kind of microscope by Milliet de Chales, for he says in the description: "microscopium



FIG. 407. CHRISTOPHORO SCHEINER, 1573-1650.
Astronomer and Inventor

(From the biography by Anton von Braunmuehl, 1891)

Projection Apparatus for Drawing Sun Spots. Demonstrated the Retinal Image. Said the Crystalline Lens of the Eye is Equal to Many Glass Lenses. Invented the Pantograph.

habes in hujusmodi machina," vol. ii, p. 667. A few years later (1685), Zahn in his work on all kinds of optical instruments (*Oculus Artificialis*), says on p. 255, "Lucerna magica est species microscopii." Both also point out that this kind of a microscope is preferable to the ordinary one as many can see at the same time.

If any individual should be mentioned in connection with the projection microscope, it is Kepler, for in his *Dioptrics*, 1611, he showed the advantage of adding an amplifier in projection, and also a second convex lens (ocular), to magnify the real image of the objective, and also at the same time to render it erect. See *Opera Omnia*, vol. ii, pp. 549-550, 555.

3. Moving Pictures

Moving picture projection is like micro-projection when no ocular is used. The screen distance is usually rather great and the many slightly differing pictures are changed so rapidly that the successive screen images seem to fuse together and thus give the appearance of motion.

The first step in getting moving pictures was an investigation of persistence of vision by momentary glimpses of similar moving objects. The men investigating the matter were all physicists, and the results of their observations were given in scientific papers. See in the bibliography papers by Faraday, Plateau, Horner and Stampfer. The paper on the magic disc by Plateau was dated Jan., 1833, and the paper of Horner on the *dædaleum* (zoetrope) was dated 1834, as was also the paper of Stampfer on the magic disc. Both the magic disc (fig. 408) and the zoetrope (fig. 409) give the appearance of movement with great satisfaction.

As the instruments were for one or at most for very few observers, the magic lantern was called in to give screen images so that many could see at the same time. The magic lantern was used successfully by Uchatius in 1853. He used several (as many as 12) slightly differing transparencies, each transparency having its own projection objective. The objectives were all directed toward the same point on the screen, hence the images all appeared in the same place. A lime light and condenser were attached to a crank, and moved from picture to picture in rapid succession, and the projected images gave the appearance of movement as perfectly as did the magic disc.

It was also natural that the new art of photography should be called upon to depict the various phases of a moving body for use in place of the drawings which had been previously used; this was suggested by Plateau about 1848. In 1870 Heyl realized this possibility by arranging a series of photographic transparencies of posed motion, and projecting them on the screen. The transparencies were arranged on the edge of a large disc, and by the step by step movement of the disc the successive transparencies were brought in the axis of the magic lantern. To prevent the blur while the pictures were changed, a two wing shutter was used to cut off the view. This method of projecting was very successful and required only one projection objective, consequently the number of pictures was limited only by the practicable size of the rotating disc.

Up to 1872 the pictures used were either drawings or photographic transparencies of posed movements, not photographs of movement in continuous change as at present.

From 1872 onward there have been three epoch making periods in reaching approximate perfection in moving pictures.

The first period is represented by the work of Eadweard Muybridge, who first made successful analyses of rapid movement in 1872-1881. In 1879 he arranged the successive stages of a movement on a glass disc and projected the

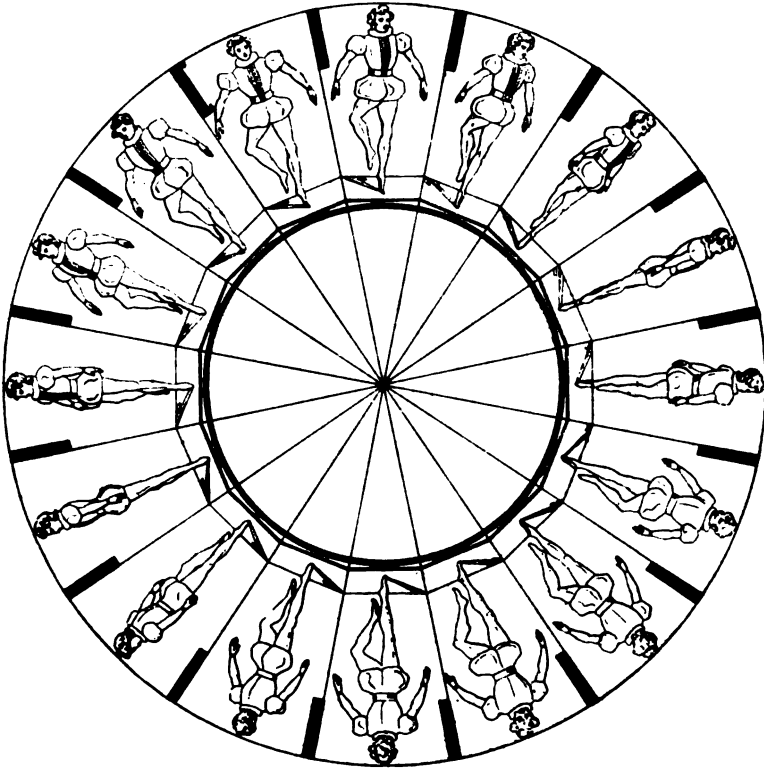

FIG. 408. PLATEAU'S MAGIC DISC (PHENAKISTOSCOPE).

(From the *Correspondance Mathematique et Physique*, Tome VII, 1832)

Notches were cut around the edge as indicated by the dark terminations of the radii. A pin is put in the center, the figures turned toward a well lighted mirror, and the disc rotated. By the momentary glimpses through the radial slits the figure seems to go through the movements of the dance. The back of the disc should be black, and the figures show better if the outlines are made heavier than in the picture.

same by means of a magic lantern, and synthesized or recombined the movement on the screen as he had previously done in the zoetrope. From 1883-1885, under the auspices of the University of Pennsylvania, over one hundred thousand (100,000) pictures of movements of men and all kinds of animals were made. These were published in several folio volumes in 1887.

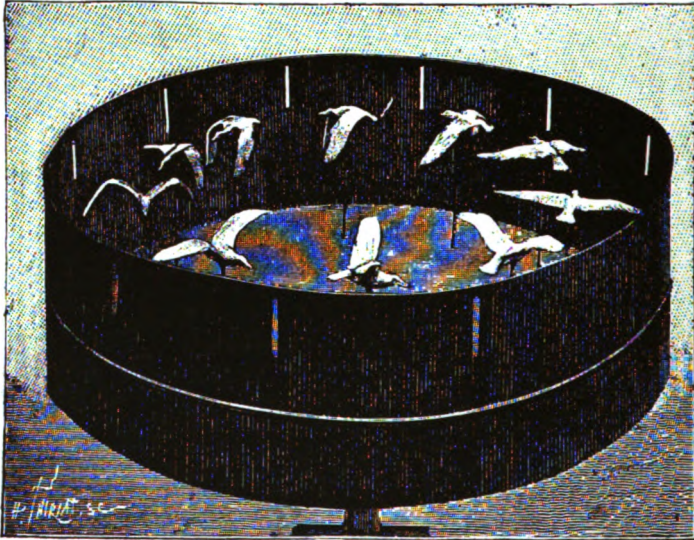

FIG. 409. THE DÆDALEUM OF HORNER (ZOETROPE).
(From *Marey, Movement, 1895*)

In this instrument figures or photographs can be arranged in a band around the inside of the cylinder, or, as in this, case models of a moving animal can be arranged in order. When the instrument is revolved the images or models seem to perform their natural movements of walking, flying, etc.

The second period is represented by the making of the gelatino-bromide process of photography practical by Maddox in 1871, and by making this process exceedingly rapid by heating or boiling the emulsion (Bennett and others in 1878 and later).

The third epoch making period was inaugurated by the Rev. Hannibal Goodwin when he worked out a practical method of making a solution and then a film of transparent, tough, flexible cellulose which was unaffected by the chemicals and liquids used in photography.

His application for a patent was filed in 1887, and the patent granted in 1898, and the validity of the patent finally confirmed by the United States

District Court of New York in 1913, and this decision confirmed by the United States Circuit Court of Appeals of New York in 1914. (See in the Bibliography).

Muybridge's first pictures were made by the wet collodion process, but his Philadelphia work was done with the new, rapid gelatino-bromide plates. He used many cameras, sometimes 24 in a row to get different phases of a motion, and sometimes the cameras were arranged in groups to get the movement simultaneously from different points of view.

In 1881 he gave demonstrations of his pictures in Europe, and projected the synthesis on the screen with the lantern, the first demonstrations being in the physiological lecture room of Marey, the French master of investigating

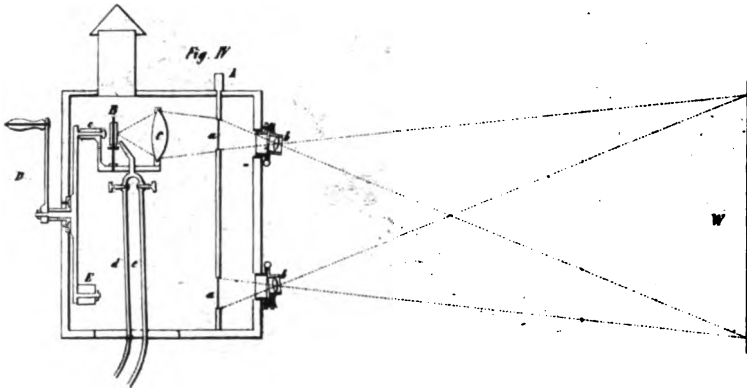

FIG. 410. THE MOVING PICTURE PROJECTOR OF UCHATIUS.

(From the *Sitz. Berichte d. k. Akad. Wiss., z. Wien. Math. Natur. Cl.*, Vol. X, 1853)

This shows some of the pictures with the individual objectives directed to the same point. The lime light and condenser and the crank for moving them from picture to picture are also shown.

animal movement by the graphic method. From that time on Marey took hold of the photographic method for the analysis and synthesis of animal motion with the greatest enthusiasm. Instead of the battery of cameras used by Muybridge, he adopted the system of the French astronomer, Janssen, using a single camera and objective, but taking many pictures on a single plate.

In 1887, he used the roller films on paper, and immediately that they were available, the celluloid films devised by Goodwin. In this way pictures could be made in a long series. Not only did Marey use the ribbon films but he devised a special camera for doing so, and a projector for showing the ribbon pictures on the screen.

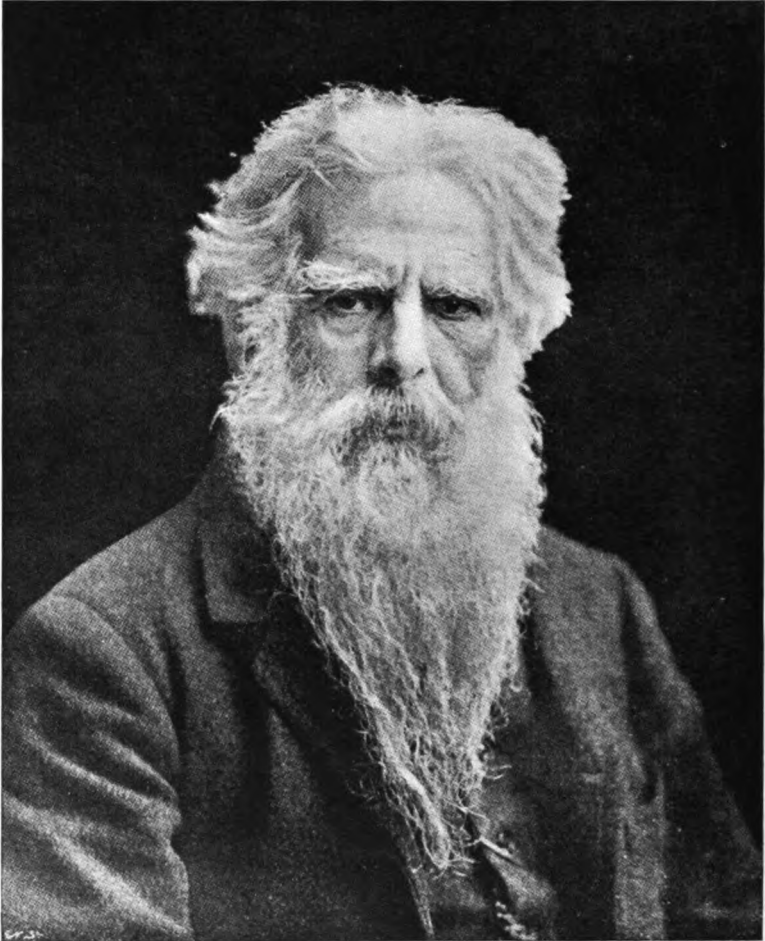

FIG. 411. EADWEARD MUYBRIDGE, 1830-1904.

(From *Animals in Motion*, 1899)

Photographic Analysis and Synthesis of Animal Motion, Commencing in 1872.

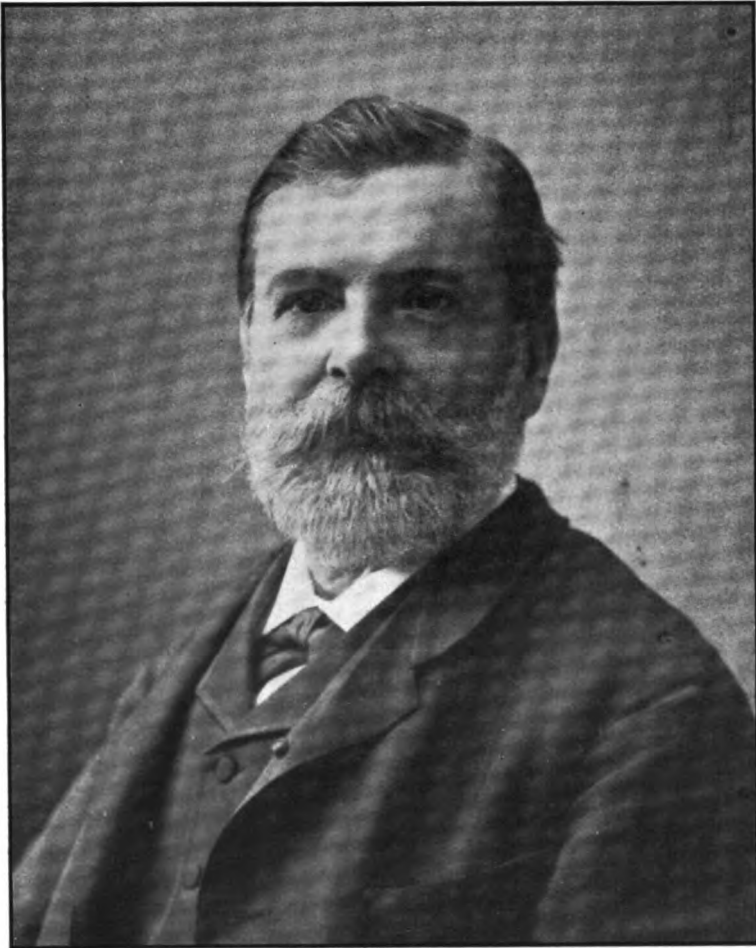

FIG. 412. JULES ETIENNE MAREY, 1830-1910.
College de France

(From a photograph furnished by Professor E. Lavoisier, College de France)
Graphic Method in Physiology; Photographic Analysis and Synthesis of
Animal Motion, 1881-1910.

In perfecting cameras to make ribbon pictures, and projectors for exhibiting ribbon transparencies of these pictures on the screen, many inventors have taken part. Among these should be mentioned Marey and his assistant, Demney, and the Lumières in France; Green and Evans, Donisthrope and Crofts in England; Jenkins and Edison in America. These were among the first to work out practical apparatus that made moving pictures possible and practical. For the present perfection of cameras, films, and projectors, and the general methods employed, the number of manufacturers and inventors is legion.

The first light used was sunlight, and that remains the most brilliant of all. Animal and vegetable oils were burned in lamps without a chimney (fig. 403-405), and very recently mineral oil (kerosene) has been used in lamps with a chimney (fig. 65-67).

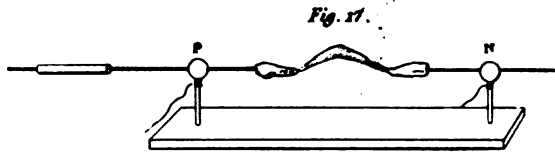

FIG. 413. DAVY'S CARBON ARC.

(From Davy's *Collected Works*, vol. iv, pl. iii, fig. 17)

See p. 110 of vol. iv for a discussion of the carbon arc. The carbons are horizontal, and the arc arches upward hence the name arc.

The lime light, the most brilliant after sunlight and the arc light, came in with the discovery by Hare in 1802 that the oxyhydrogen flame when blown against lime, etc., gave a dazzling light. This was applied to projection by Birkbeck in 1824 for the magic lantern; and in the same year by Woodward for the phantasmagoria. (Goring and Pritchard's *Micrographia*, pp. 170-171; also the *Microscopical Journal and Structural Record*, Vol. I, 1841). This light is still much used for all forms of projection. For the oxygen ether lime light, see Ives, in the Bibliography.

The electric light. This most satisfactory and powerful artificial light yet devised, was first shown by Humphrey Davy in Sept., 1800, and recorded in Nicholson's Journal of October in that year (See Cantor Lectures of Silvanus P. Thompson on the arc light, *Journal of the Royal Society of Arts*, Oct. 25, 1895, and fig. 413 for Davy's carbon arc). According to the same lecturer, W. E. Straite devised the first automatic electric lamp in 1846.

The first arc lamps were for direct current. As it was not desirable to have the carbons burn off unequally with the Jablohoff lamp where the carbons were parallel and close together, alternating currents were used (1877). (S. P.

Thompson, p. 953-954). While this works well for general lighting, it is shown in the preceding pages (553-566) that alternating current is far inferior to direct current for projection purposes.

At first the carbons were both horizontal (fig. 413), then they were made vertical, and later at various angles of inclination. In order to keep the crater of the positive carbon constantly in the optic axis, Mr. Albert T. Thompson of Boston manufactured and used, especially for projection purposes, an arc lamp in which the carbons are at right angles, the positive carbon being horizontal and hence constantly in line with the axis of the projection instrument. This was in 1894.* From that time onward the advantage of this position has become more and more appreciated, and the superiority for projection purposes is shown graphically in the curve given in Chapter XIII (fig. 302).

*The following is the statement of Mr. Albert T. Thompson concerning the 90° arrangement of the carbons in an arc lamp for the magic lantern:

BOSTON, Dec. 6, 1907.

"Replying to your valued communication of the 2d, I will state that I first manufactured the 90° arc lamps in 1894 and a careful search of all arc lamp and stereopticon catalogs published about that period, fails to show arc lamps of the 90° construction.

"I did not patent the lamp, for at that time there was no demand for them, and of course it was difficult to look into the future and realize that in a few years thousands and thousands would be sold.

"The facts to the best of my knowledge and belief were never published in any scientific journal.

Yours very truly,
A. T. THOMPSON."

SOME MANUFACTURERS AND DEALERS IN OPTICAL AND PROJECTION APPARATUS AND SUPPLIES

Within recent years there has been great improvement in projection apparatus and all the necessary accessories, and many optical manufacturing houses have taken hold of the work in earnest, so that now one can find in the open market practically everything required at reasonable prices. Furthermore, if special apparatus or combinations are desired, or if a person has notions of his own, it is not difficult to obtain the optical and electrical apparatus needed of the manufacturers, and only a small amount of special construction will be needed to adapt the apparatus to the special individual or the special purpose.

It is hoped that the special apparatus described in this volume, for example, the projection microscope and the projection outfit for showing normal and defective vision, and for some special demonstrations in physics, will give suggestions which will open the way for those who do not find the apparatus in the open market quite suitable to their needs.

As models of instruments are constantly changing and new forms are being produced, the authors advise that any one desirous of installing projection apparatus of any kind should get the catalogues of several manufacturers and select that which best suits his needs and means. It may be stated in passing, that the most expensive apparatus is not necessarily the best adapted for a given case. Often apparatus of moderate price is easier to manage and more effective. Naturally the manufacturers prefer to install an expensive outfit, but if the needs are clearly stated, and the sum available, the manufacturer will give most excellent advice as to the outfit required.

The dealers in lantern slides have a system of rental by which one can get for a moderate fee a set of slides to illustrate some special or general subject. Of course, slides of any number or grouping can also be purchased, but often a special lecture on a country or a period can be greatly helped by a good selection of lantern slides, the use of which will cost but a small sum.

For those interested in moving picture cameras, the development of exposed films, etc., the advertising pages of the *Moving Picture World* will give the names of the firms who can give the information or the help needed.

The following list of manufacturers and dealers is arranged alphabetically, and from our experience with them we know that they try to be of real service to their customers. Of course there are many others who are equally reliable; and new manufacturers and dealers are constantly coming into the field. One can get on track of them by consulting the advertising pages of standard periodicals as: *Science*, the *Scientific American*, the *Moving Picture World*, Journals in Electrical and Illuminating Engineering.

After each name in this list are given the text figure or figures taken from the publications of the given manufacturer, or the section (§) in which the apparatus or material is considered:

- American Theater Curtain and Supply Company, 105 North Main Street, St. Louis, Mo. Radium, gold fiber screens, § 629.
- The Bausch & Lomb Optical Company, Rochester, New York. Photographic objectives, microscopes, projection apparatus, spectacles and all laboratory supplies, § 916, fig. 17, 33-34, 70, 100-101, 104-107, 123, 131, 136, 169-173, 200-201, 223-224.
- R. & J. Beck, Limited, 68, Cornhill, London, England. Microscopes, photographic objectives, projection apparatus.
- John A. Brashear Company, Limited, Pittsburg, N. S., Pa. Optical, physical, astrophysical and astronomical instruments, including heliostats. Ch. VI.
- Chas. Beseler Company, 110 East 23d St., New York. Projection apparatus and lantern slides, fig. 55, § 598. Small automatic arc lamps.
- C. W. Briggs, 628 Callowhill Street, Philadelphia, Pa. Magic lantern slide manufacturer. Mr. C. W. Briggs is the son of Dr. Daniel H. Briggs who made the first photographic lantern slides by the collodion process. The beautiful lantern slides made by the son are made by the same collodion process used by the father before 1855. Ch. VIII.
- Brown & Sharpe Manufacturing Co., Providence, Rhode Island. Manufacturers of fine tools. See their wire gauge, p. 502.
- Century Manufacturing Company, 272 West Genesee St., Buffalo, N. Y. Manufacturers of "Sanitary paint" including "Artists' Scenic White" for image screens, § 625a.
- Conrad Lantern Slide and Projection Company, 4028 Jackson Boulevard, Chicago, Ill. Lantern slides for science teachers and lecturers. Ch. VIII.
- Detroit Engine Works, Detroit, Michigan. Direct current electric lighting outfits for projection and moving pictures. Kerosene engines for power § 682.
- Detroit Motor Car Supply Company, Detroit, Michigan. Sandow moving picture electric light plant, using a Sandow kerosene stationary engine, §682.
- Dolby & Company, 3613 Woodland Ave., Philadelphia, Pa. Importer and dealer in microscopes and optical apparatus, lantern slides, laboratory supplies.
- Eastman Kodak Co., Rochester, New York. Photographic outfits and supplies, including moving picture film, fig. 119, § 333a, 451.
- Edison Manufacturing Company, Orange, N. J. Moving picture machines and films, the home kinetoscope, etc., etc., fig. 63, 221, 224, 233-236.
- Education Department, Division of Visual Instruction, State of New York, Albany, N. Y. Many series of lantern slides for use throughout the state, (Ch. VIII).
- Enterprise Optical Manufacturing Co., 564-572 West Randolph St., Chicago, Ill. Moving picture machines, Calcium gas outfit etc., fig. 56.
- The Ernon Camera Shop, 18 West 27th St., New York. Moving picture camera.
- Folmer & Schwing Manufacturing Co., Manufacturers of enlarging, reducing and tilting cameras. With Eastman Kodak Co., Rochester, N. Y., fig. 119.

- Foss Gas Engine Co.**, Springfield, Ohio. Oil, gas and gasoline engines for supplying the power for a private electric lighting plant and for projection, § 683.
- Fort Wayne Electric Works of the General Electric Co.** Compensarc instead of a rheostat, § 736.
- R. Fuess**, Steglitz bei Berlin, Germany. Optical instruments, projection apparatus, heliostats, etc., fig. 79, 84.
- General Electric Company**, Schenectady, New York. Electric apparatus of all kinds, generator sets, mercury arc rectifiers, mazda concentrated filament lamps, and nitrogen lamps for the magic lantern, etc., fig. 258-264, § 754.
- General Film Company**, 200 Fifth Ave., New York. Educational films for the moving picture machine, Ch. XI.
- General Specialty Company**, St. Louis, Mo. Indirect and semi-indirect lighting fixtures, § 606.
- J. H. Gentner Co.**, Newburgh, N. Y. Mirroroide screens § 629.
- Gregory Electric Company**, 16 & Lincoln Sts., Chicago, Ill. Electric supplies, generators, motors, etc., Ch. XIII.
- Gundlach-Manhattan Optical Co.**, Rochester, New York. Photographic objectives and cameras, microscopes, projection objectives for moving pictures, etc., fig. 229.
- J. H. Halberg**, 36 East 23d St., New York. Moving picture machines and supplies of all kinds.
- Hartford Machine Screw Company**, Hartford, Conn., fig. 161.
- Harvey Hubbell, Inc.**, Bridgeport, Conn. Manufacturers of Machinery, tools, Electrical specialties, fig. 48-50, 268-269.
- P. Keller & Co.**, Successors to J. B. Colt Co., 465 Greenwich St., New York. Projection apparatus and accessories, fig. 36.
- Kleine Optical Company**, 166 North State Street, Chicago, Ill. Motion picture apparatus and supplies; theater supplies.
- Max Kohl**, Chemnitz, Germany. Projection apparatus and accessories, chemical and physical apparatus, fig. 68, 81.
- F. Koristka**, Milano, 2 Via G. Revere. Italy. Microscopes and projection apparatus, fig. 181.
- Ward Leonard Electric Company**, Bronxville, N. Y. Rheostats, circuit breakers, theater dimmers, etc., fig. 147, 183, 186-187, § 723.
- List of Electrical Fittings.** Published by the National Board of Fire Underwriters, 135 William St., N. Y., § 691. Manufacturers of standard fittings and supplies.
- Ernst Leitz**, Wetzlar, Germany, 30 East 18th St., New York. Microscopes, photographic objectives, projection apparatus, fig. 41, 96, 123, 163, 202-205.
- T. H. McAllister Company**, 49 Nassau St., New York. Projection apparatus and lantern slides, fig. 89.
- McIntosh Stereopticon Company**, 35 and 37 Randolph Sts., Chicago, Ill. Projection apparatus and lantern slides, fig. 66, 166.
- Motion Picture Camera Company**, 5 West 14th St., New York. Cameras and projectors for moving pictures.
- Motion Picture Screen Company**, Shelbyville, Indiana. Mirror screens, § 629, 6297, 630.

- National Electric Supply Company, Chicago, Ill. Rheostats, etc., fig. 138, 193, 196.
- National X-Ray Reflector Company, 236 Jackson Boulevard, Chicago, Ill. Eye-Comfort Illumination from concealed sources, fig. 237, § 606.
- New York State Education Department, Division of Visual Instruction, Albany, N. Y. Lantern slides for use throughout the state, Ch. VIII.
- Newton & Co., 3 Fleet St., London, England. Projection apparatus and lantern slides, fig. 67.
- Edward Pennock, 3609 Woodland Ave., Philadelphia, Pa. Microscopes and supplies, photographic objectives and cameras. Lantern slides, etc.
- Pennsylvania Flexible Metallic Tubing Company, Broad & Race Sts., Philadelphia, Pa. See fig. 60.
- Phantoscope Manufacturing Company, Washington, D. C. Motion picture cameras and motion picture projectors of C. F. Jenkins for the house lighting system, § 598.
- Picture Theater Equipment Company, 21 East 14th St., New York.
- Nicholas Power Company, 90 Gold Street, New York. Manufacturer of Powers Cameragraph, electrical appliances for motion picture machines. New dissolving stereopticon, "bill-splitter" current ballast, § 736, fig. 222-223, 227, 232.
- Prest-O-Lite Company, Indianapolis, Indiana. Compressed acetylene, see fig. 71.
- C. Reichert, Optische Werke, Vienna, Austria. Projection apparatus, microscopes, etc., fig. 43-44, 54.
- Ross, Limited, 3 North Side, Clapham Common, London, England. Projection apparatus, microscopes, etc.
- Franz Schmidt & Hænsch, Berlin, Germany. Projection apparatus, etc., etc., fig. 57, 69.
- Alfred L. Simpson, 131 West 132 St., New York. Simpson's solar screen for receiving the projected image of the magic lantern, moving picture machine, etc., § 629.
- Slingerland Lantern Slides. Lantern slides, plain and colored of insects, birds, trees, fruits and other nature-study subjects. Manufactured by Mrs. Mark V. Slingerland, Ithaca, N. Y.
- Spencer Lens Company, Buffalo, New York. Microscopes, photographic objectives, projection apparatus and accessories. Laboratory supplies, fig. 38, 108-111, 130, 149, 174, 198-199.
- L. S. Starrett Co., Athol, Mass. Starrett Tools, fig. 160.
- C. H. Stoelting Co., 121 North Green St., Chicago, Ill. Projection apparatus, laboratory apparatus and supplies of all kinds, fig. 16, 75, 102-103, 167.
- The Chas. A. Strelinger Co., Detroit, Michigan. The Brush electric lighting set. This consists of an engine for gas, gasoline or kerosene and a proper dynamo for direct current, § 683.
- Arthur H. Thomas Company, 1200 Walnut St., Philadelphia, Pa. Dealer and importer in microscopes and other optical apparatus and all laboratory supplies.
- A. T. Thompson & Company, 15 Tremont Place, Boston, Mass. Projection apparatus of all kinds. Inventor of the right-angle arc lamp, fig. 97, 168, 186.

Underwood & Underwood, 3 and 5 West 19th Street, New York. Magic lanterns, lantern slides showing tours of the world.

Valentine & Company, 456 Fourth Ave., New York. Valspar varnish for making glass boxes, etc., § 394a.

Voigtländer & Sohn, A. G., Optical Works, Braunschweig, Germany. Microscopes, photographic objectives and cameras, projection apparatus, fig. 124, 142.

W. Watson & Sons, 313 High Holborn, London, England. Microscopes, Projection apparatus and accessories.

Westinghouse Electric Manufacturing Company, Pittsburg, Pa. Rectifiers, transformers, balance coils, motion picture, motor-generator set, etc., etc., § 681, 723, 736, 739.

Weston Electric Instrument Company, Newark, N. J. Voltmeters and ammeters, etc., fig. 133, 145, 272-273, § 662, 664, 666, 700, 702a.

Whyte Whitman Company, 36 East 23d St., New York. Moving picture cameras.

Williams, Brown & Earl, 918 Chestnut Street, Philadelphia, Pa. Microscopes and accessories, Laboratory supplies, Projection apparatus and moving picture machines and lantern slides, fig. 32, 52, 59, 72-73, 98-99, 164-165, § 598.

Carl Zeiss Optische Werkstaette, Jena, Germany. All kinds of optical apparatus; Microscopes and projection apparatus, fig. 95, 123, 128-129, 156, 217-219.

Joseph Zentmayer, manufacturing optician, microscopes, spectacles and lenses of all descriptions etc., 226-228 South 15th St., Philadelphia, Pa.

See also the list of spectacle manufacturers, p. 651.

I. BIBLIOGRAPHY

- Arrhenius, Svante August. *Lehrbuch der kosmischen Physik.* 1026 p. 304 fig. 3 Plates. Leipzig, 1903. Price 40 marks.
- Ayrton, Mrs. Hertha. *The electric arc.* 479 p. 146 fig. "The Electrician." Printing and Pub. Co., Ltd., Salisbury Court, Fleet St., London, E. C., 1902. Price 12s, 6d.
- Ball, Sir Robert Stawell. *Elements of Astronomy, New ed.* 459 p. 136 fig. Longmans, Green & Co., London, New York, 15 East 16th St., 1886. Price \$2.00.
- Barnard, J. Edwin. *Practical Photo-micrography.* 322 p. 79 fig. 10 Plates. E. Arnold, London, 1911. Price, 15s.
- Barrows, William Edward. *Electrical illuminating engineering.* 212 p. 135 fig. McGraw Pub. Co., New York, 1908. Price \$2.00.
- Bayley, R. Child. *The Complete Photographer.* 410 p. 65 Plates. 32 fig. McClure, Phillips & Co., New York, 1907. Price \$3.00.
- Bayley, R. Child. *Modern Magic Lanterns, a Guide to the Management of the Optical Lantern for the use of entertainers, lecturers, photographers, teachers and others.* 110 + 15 p. 73 fig. L. Upcott Gill, London; Charles Scribner's Sons, 153-157, Fifth Ave., New York. Price \$.50.
- Beck, Conrad, and Andrews, Herbert. *Photographic Lenses.* 7th edition completely revised. 287 p. 163 fig. 44 plates. R. & J. Beck, Limited. 68 Cornhill, London, England. Price 1 shilling. Full discussion of modern objectives for photography and for projection.
- Cohn, Hermann (Ludwig). *Die Sehleistungen von 50,000 Breslauer Schulkindern, nebst Anleitung zu ähnlichen Untersuchungen für Aerzte und Lehrer.* Schlesische Buchdruckerei, Kunst-und Verlags Anstalt v. S. Schottlaender. Breslau, 1899. 148 p. 26 Plates. 5 fig. Price 3M, Geb. 4 M.
- Cole, Aaron Hodgman. *Manual of Biological Projection and anesthesia of Animals.* 200 p. 28 fig. Neeves Stationery Co., 543 W. 63d St., Chicago Ill., 1907. Price \$1.50.
- Cyclopedia of Motion Picture Work. 2 vols. Vol. I. Stereopticon, motion head projecting machine, talking pictures. 206 p. 119 fig., many plates. List of moving picture makers. Vol. II. Photography, motography, photo-plays, motion picture theater. 311 p. 110 fig., many plates. Published by the American School of Correspondence. Chicago, Ill., 1911.
- Dolbear, A. E. *The Art of Projecting; a manual of experimentation in physics, chemistry, and natural history with the port-lumière and magic lantern.* 158 p. 112 fig. Lee & Shepard, Boston and New York, 1877. Price \$2.00.
- Donaldson, Leonard. *The cinematograph and natural science, the achievements and possibilities of cinematography as an aid to scientific research.* 120 p. 23 fig. Ganes Ltd., 85 Shaftesbury Ave., London, 1912. Price 2s, 6d.
- Donders, Franciscus Cornelis. *On the anomalies of accommodation and refraction of the eye, with a preliminary essay on physiological dioptrics.* Translated by W. D. Moore. xviii + i + 635 p. 175 fig. New Sydenham Society, (Publications 22). London, 1864.

- Fourtier, H. *La pratique des projections.* 2 v. in 1. i, 146 p., 66 fig. ii, 142 p., 67 fig. Gauthier-Villars et Fils, 55 Quai des Grandes-Augustus, Paris, 1892-93. Price, 4 fr.
- Fourtier, H., et Molteni, A. *Les projections scientifiques; etude des appareils, accessoires et manipulations diverses pour l'enseignement scientifique par les projections.* 292 p., 113 fig. A. Molteni, 44 Rue du Chateau-d' Eau, Gauthier-Villars & Fils, 55 Quai des Grandes Augustus. Paris, 1894. Price 3 fr., 50c.
- Gould, George M. *The New Ophthalmology and its relation to General Medicine, Biology and Sociology, Congress of Arts and Science, Universal Exposition, St. Louis, 1904, Vol. VI, pp. 422-445.* Discusses among other things the relation of general health and truancy, etc., of children to defective eyes.
- Halberg, J. H. *Motion picture electricity.* 299 p., 125 fig. Published by the *Moving Picture World*, 17 Madison Ave., N. Y. Price, \$2.50.
- Harrison, Newton. *Electric-Wiring, Diagrams and Switchboards.* 272 p. 105 fig. The Norman W. Henley Pub. Co. New York, 1909. Price \$1.50
- Hassack, Karl, and Karl Rosenberg. *Die Projektionsapparate, Laternbilder und Projektionsversuche in ihren Verwendungen in Unterrichte von K. Hassack und K. Rosenberg.* 336 p. 308 fig. A Pichlers Witwe & Sohn, Wien and Leipzig, 1907. Price 6 M.
- Helmholtz, Hermann (Ludwig Ferdinand), von. *Handbuch der physiologischen Optik.* 3d ed. 564 p. 81 text fig., 6 plates, 1910. Leopold Voss, Hamburg, 1909-11. 3 v. I *Die Dioptrik des Auges*, xvi + 376 p. 146 fig. Price 14 M, geb. 16 M. II *Die Lehre von den Gesichtsempfindungen.* viii + 391 + 17 p. 80 fig. 3 Plates. Price 16 M, geb. 18 M. III *Die Lehre von den Gesichtswahrnehmungen* 564 p. 81 text fig., 6 plates, 1910. Price, 26.50 marks.
- Hepworth, Cecil M. *Animated Photography, the A B C of the Cinematograph.* Hazell, Watson & Viney, Ltd. 1, Creed Lane, Ludgate Hill, London E. C. 1900. 128 p. 31 fig. Price \$.50. *Amateur Photographer's Library*, No. 14.
- Hepworth, Thomas Cradock. *The Book of the lantern; a guide to the working of the optical or magic lantern, with directions for making and colouring lantern pictures.* 278 p. 75 fig. Wyman & Sons, Great Queen St., Lincoln's-Inn Fields, London, W. C. 1888. Price 3s, 6d.
- Hopkins, Albert A. *Magic, stage illusions and scientific diversions including trick photography.* 556 p., 400 fig. Munn & Co., Scientific American Office, New York. 1898. Price \$2.50. 12 pages of references to books on magic.
- Jenkins, C. F., and O. B. Depue. *Handbook for motion pictures and stereopticon operators.* 132 p. 20 fig. The Kenega Co., Inc. Washington, D. C., 1908. Price \$2.50.
- Index Catalogue of the Library of the Surgeon General's Office of the United States Army.* Government Printing Office, Washington, D. C. First series, vol. i-xvi, 1880-1895. Second series, vol. i-xviii + 1896-1913 +. Book and periodical literature; subjects and authors in one continuous alphabetical list. Full lists of current literature.
- Journal of the Royal Microscopical Society.* 1878 +. Published by the Society at 20 Hanover Square, London, W. England. 6 numbers per year; subscription, price 37 shillings 6 d.
- Lambert, Rev. F. C. *Lantern Slide Making.* 140 p. 27 fig. Hazell, Watson & Viney, Ltd., 52 Long Acre. London, W. C. 1907. Price, \$.50. *The Amateur Photographer's Library*, No. 22.

- Leiss, C. Die Optischen Instrumente der Firma R. Fuess, deren Beschreibung, Justierung und Anwendung. Wilhelm Engelmann, Leipzig, 1899. xiv + 387 + 1 p. 3 Plates. 233 fig. Price 11 M., geb. 12 M.
- Lummer, O., and Silvanus, Thompson. Contributions to photographic optics. 135 p., 55 fig. MacMillan & Co., New York, 1900. Price \$1.75. Discusses the different forms of photographic objectives.
- "National Electrical Code." Rules and requirements of the National Board of Fire Underwriters for Electric Wiring and Apparatus as recommended by the National Fire Protection Association, Ed. of 1913 or later. Furnished by the National Board of Fire Underwriters, 135 William St., N. Y. See § 691.
- Nichols, E. L. The Outlines of Physics. Pp. 452; 414 figures. The Macmillan Co. New York, 1897. Price \$1.40.
- Nicholas Power Company. Hints to [Moving Picture] Operators. 17 figures, 96 pages. Published by the Nicholas Power Co., 88-90 Gold St., N. Y. 1914.
- Norris, Henry H. An introduction to the study of Electrical Engineering. Ithaca, N. Y., 1912. 224 pages, 26 plates, 167 figures. Price \$1.50.
- Norton, C. Goodwin. The Lantern and How to Use It. Hazell, Watson & Viney, Ltd. 1, Creed Lane, Ludgate Hill, London, E. C., 1901. 152 p. 74 fig. Price \$.50. The Amateur Photographer's Library, No. 10.
- Nutting, Perley Gilman. Outlines of applied optics. P. Blakiston's Son & Co., 1012 Walnut St., Philadelphia, 1912. ix + 234 p. 73 fig. Price \$2.00.
- The Moving Picture World. The Chalmers Publishing Co., 17 Madison Ave. New York City. Published weekly. Subscription price \$3.00.
- Pringle, Andrew. The Optical Lantern for Instruction and Amusement. 149 p. 72 fig. Hampton & Co., 13 Cursitor St. London, E. C., 1899. Price 4s, 6d.
- Richardson, F. H. Motion Picture Handbook, a Guide for Managers and Operators of Motion Picture Theaters. 432 p. 176 fig. Moving Picture World, Pullman Building, 17 Madison Ave., New York City. Price \$2.50.
- Scientific American, 1845 + and Scientific American Supplement, 1876 + Published by Munn & Co., 361 Broadway, New York. Weekly. Subscription, \$3.00, and for the supplement, \$5.00.
- Talbot, Frederick A. Moving pictures, how they are made and worked. 340 p., 132 fig. J. B. Lippincott Co., Philadelphia, 1912. Price \$1.50.
- Tennant, John A., Ed. Lantern Slides. 51 p., 8 fig. Tennant & Ward, 122 East 25th St., New York, The Photo-Miniature, Vol. 1, No. 9, 1899. Price \$.25.
- Tennant, John A. Coloring Lantern Slides. 48 p., 11 fig. Tennant and Ward, 122 East 25th St., New York, The Photo-Miniature, Vol. 7, No. 83, 1907. Price, \$.25.
- Trutat, Eugène. *Traité général des projections.* 391 + 276 p. 185 + 137 fig. Charles Mendel, 118 et 118 Bis, Rue d'Assas, Paris, 1897. 2 v. in 1. Price 7 fr., 50c.
- Tyndall, John. Six lectures on Light delivered in America in 1872-1873. 275 p. 59 fig. Longmans Green & Co., New York, 1873.
- Wimmer, Franz Paul. Praxis der Makro- und Mikro-Projektion für die Lehrzwecke in Schule und Haus, sowie für Lichtbildvorträge, etc. 360 p. 112 fig. 26 Plates. Otto Nemnich, Leipzig, 1911. Price 5 M.

- Wistar Institute's Style Brief.** A style brief, giving the typographic arrangement and methods to be followed in the preparation of manuscripts and drawings for publication in the Journals published by the Wistar Institute. Sent free to authors by the Wistar Institute, 36th and Woodland Ave. Philadelphia, Pa.
- Wright, Lewis.** Light; a course of experimental optics, chiefly with the lantern. 367 p., 190 fig. 4 plates. The Macmillan Co., New York, 1882. Price, \$2.00.
- Wright, Lewis.** Optical projection; a treatise on the use of the lantern in exhibition and scientific demonstration. 4th edition, 450 p., 247 fig. Longmans, Green & Co., New York, 1906. Price \$2.25.
- Zeitschrift für wissenschaftliche Mikroskopie und für mikroskopische Technik.** 1884 +. Verlag von S. Hirzel, Leipzig, Germany. Published quarterly. Subscription to foreign countries, 21.60 marks.
- Zeitschrift für Instrumentenkunde, herausgegeben unter mitwirkung der physikalisch-technischen Reichsanstalt.** Verlag von Julius Springer, Berlin, 1881 +. 12 numbers per year; subscription, 24 marks.

II. HISTORICAL BIBLIOGRAPHY

- Adams, George, 1720-1773. *Micrographia illustrata; or, the microscope explained, in several new inventions; likewise a natural history of aerial, terrestrial and aquatic animals, etc., considered as microscopic objects.* lix + 325 p. 72 plates. Pub. for the author, London, 1771.
- Adams, George, 1750-1795. *Essays on the microscope, containing a description of the most improved microscopes, a history of insects, their transformations, peculiar habits, and economy with a catalogue of interesting objects.* 724 p. 31 plates. Pub. for the author, London, 1787.
- Airy, George Biddell. On a peculiar defect in the eye and a mode of correcting it. *Cambridge Philosophical Transactions*, Vol. II, (1827), pp. 267-271. This is a discussion of astigmatism and its correction by means of cylindrical spectacles. Paper read Feb. 5, 1825. See Thomas Young.
- Alhazen. *Opticæ thesaurus Alhazeni Arabis, libri septem, nunc primum editi, ejusdem liber de crepusculis et nubium ascensionibus, item Vitellionis Thuringopoloni, libri X. omnes instaurati, figuris illustrati et aucti, adjectis etiam in Alhazenum commentariis.* A Frederico Risnero. Folio, many figures. Basileae, per Episcopios. 1572.
- Bacon, Roger. *Opus Majus*, edited with introduction and analytical table by John Henry Bridges. 2 volumes and supplementary vol. Vol. I, cxxxvii + 440 p., 23 fig. Vol. II, 568 p., 187 fig. Supplement, xv + 187 p. The Clarendon Press, Oxford England, 1897-1900. For modern optics the part designated *De Scientia Perspectiva* is most important. For use of convex lenses to aid the sight of old men, see vol. ii, p. 157, and for burning flasks, p. 471.
- Bacon, Roger. *Essays contributed by various writers on the occasion of the commemoration of the seventh centenary of his birth.* Collected and edited by A. G. Little. 426 p. Clarendon Press, Oxford, England, 1914. Price, \$5.25. Biography of Bacon and essays upon his work in various fields. List of Bacon's writings.
- Baker, Henry, F.R.S. *Of Microscopes and observations made thereby.* 2 vol. New edition. 442 p., 17 pl. Vol. I *The microscope made easy.* Projection microscope. Vol. II, *Employment for the microscope.* London, 1785.
- Barbaro, Daniel. *La pratica della prospettiva di Monsignor Daniel Barbaro, eletto patriarca d' Aquileia.* Opera molto utile a pittori a scultori & ad architetti. Con privilegio. 208 p. Many figures. In Venetia, appresso Camillo, & Rutilio Borgominieri fratelli, al segno di S. Giorgio. M.D. LXVIII (1568). First known user of a lens in the camera. Cap. V, p. 192.
- Borellus, Petrus. *De vero Telescopii inventore, cum brevi omnium Conspiciliorum historia.* Ubi de eorum confectione, ac usu, seu de effectibus agitur, novaque quadam circa ea proponuntur. Accessit etiam centuria observationum microscopiarum. Authore Petro Borello, regis christianissimi consiliario, et medico ordinario. Hagae-Comitum, ex typographia Adriani Vlaco, M.D. CLV. (1655). Important for the history of optic instruments.
- Brewster, Sir David. *The Edinburgh encyclopædia.* Optics, Vol. 14, pp. 589-798, Plates 428-442. Joseph and Edward Parker, Philadelphia, 1832.

- Boyle, Honourable Robert. "Of the systematical or cosmical qualities of things." Written in 1669. To be found in the Works of Boyle in six volumes. See for the Portable darkened room. Vol. III, Ch. VI.
- Cardani, Hieronymi, Opera. Lugduni MDC LXIII (1663). The reference to pictures in a dark room occurs in: Tomus Tertius, De Subtilitate (1550 A.D.), Liber quartus, p. 426 of the left column.
- Chadwick, W. J. The magic lantern manual. 138 pp., 100 fig. Frederick Warne & Co., Bedford Street Strand, London, 1878. Price 1s.
- Davy, Sir Humphrey, Bart. Collected works; edited by John Davy. 12 Early Miscellaneous Papers. 14 Elements of Chemical Philosophy. 15 Bakerian Lectures and Misc. Papers. Smith, Elder & Co., Cornhill, London, 1839-40. 9 volumes. 10s, 6d., per Vol.. First electric carbon arc, vol. iv, pl. iii, fig. 17, p. 110.
- Descartes, (Lat. Cartesius) René, Oeuvres, Publiées par C. Adam et P. Tannery sous les auspices ministère de l'instruction publique Vol. i-xii. Dioptrique, Vol. 6, pp. 87-228, 73 fig. Leopold Cerf, 12 Rue Sainte Anne, Paris, 1902.
- Faraday, Michael. On a peculiar class of optical deceptions. Journal of the Royal Institution, Vol. I, 1831, pp. 205-223. Deals with the visual appearances in looking at two toothed wheels revolving in opposite directions.
- Foucault, (J. B.) Leon. Recueil des travaux scientifiques. 4°, 31 + 592 p. 31 text figures. Atlas, 19 double plates. Paris, 1878.
- Gemmæ Frisii, Medici et Mathematici, De Radio Astronomico et Geometrico Liber. Basilæ et Louanii, 1545 (see p. 31 of this work for an account of the method of observing eclipses in a camera obscura).
- Goodwin, Rev. Hannibal. United States patent No. 610,861 for a film support for photographic purposes, especially in connection with roller cameras. This patent was applied for May 2d, 1887, and granted Sept. 13, 1898, and is the fundamental patent covering the production of films or ribbons of cellulose for taking the place of glass and paper to serve as the backing for the sensitive coating. It is practically unaffected by the liquids and chemicals used in photography. See the opinion of Judge Hazel in the United States District Court, of New York, Aug. 14, 1913, Federal Reporter Vol. 207, pp. 351-362 in the case of Goodwin Film and Camera Co. versus Eastman Kodak Co., deciding that the patent is valid. See also the opinion of the Circuit Court of Appeals (U. S. Court), second circuit, N. Y., March 10, 1914, federal Recorder, Vol. 213, pp. 231-239 before Judges Lacombe, Coxe and Ward, Opinion by Judge Coxe. A brief history of the whole matter is given in both opinions, and the patent is held valid in both. Every one interested in the history of photography should read these opinions.
- Goring and Pritchard. Micrographia, containing practical essays on reflecting solar, oxy-hydrogen gas microscopes, micrometers, eye-pieces, etc., etc. 231 p., many figures in the text, one plate. Whittaker & Co., Ave-Maria-Lane, London, England, 1837.
- Govi, Gilberto. Galileo the inventor of the compound microscope, Journal of the Royal Microscopical Society, 1889, pp. 574-598. Discussion of the earliest discoveries and inventions in optics. The compound microscope here referred to as the invention of Galileo is the Dutch telescope used as a microscope, i. e., an instrument like the ordinary opera glass with a longer tube for the convex objective and concave ocular.

- s'Gravesande, G. J. *Physices elementa mathematica experimentis confirmata sive introductio ad philosophiam Newtonianam*. 4^o. Auctore Guilielmo Jacob s'Gravesande. 3d edition, 2 vol., 1073 p., 127 plates. Apud Johannem Arnoldum Langerak, Johannem et Hermannum Verbeek, Biblio. Leidæ. 1742. First edition, 1719.
First clock driven heliostat. Fig. 77, § 233.
- Hare, Robert Jr. Memoir on the supply and application of the oxyhydrogen blowpipe. *Philosophical Magazine*. XIV (1802), pp. 238-245; 298-306.
- Harting, P. Gebrauch des Mikroskopes und Behandlung mikroskopischer Objecte. 3 vol., 1109 p., 469 fig. Friedrich Vieweg und Sohn, Braunschweig, 1866. Price \$3.50.
- Heyl, Henry R. Contribution to the history of the art of photographing living subjects in motion, and reproducing the natural movements by the lantern. *Journal of the Franklin Institute*, CXLV (1898), p. 310-311, Vol. 145.
- Hooke, Robert. *Animadversions on the Machina Cœlestis of Hevelius*. p. 8. Published in 1674. It is in this place that Hooke states that for two points to be seen as two the visual angle must be one minute.
- Hopwood, Henry V. *Living Pictures: their History, Photoproduction and Practical Working, with A Digest of British Patents and Annotated Bibliography*. 275 + xxvii, p. 242 fig. The Optician & Photographic Trades Review, 123-125 Fleet St., London, E. C. 1899. Price, \$1.25.
- Horner, W. E. On the properties of the Dædaleum, a new instrument of optical illusions. *Philos. Mag.*, 1834, vol. iv, pp. 36-41. The Dædaleum is a hollow cylinder with slits around the edge and pictures in various phases of movement on the inside. It is revolved on the long axis of the cylinder and gives the same appearance as the magic disc of Plateau. It is now called a zoetrope.
- Ives, Fred E. The Ether-oxygen Lime Light, *Journal of the Franklin Institute*, Vol. 125, 1888. pp. 28-31. Also vol. 129, 1890, pp. 230-234. Report of a committee of the Institute on the Ether-oxygen portable lantern, (see Ch. IV, above).
- Janssen. *Présentation du revolver photographique*. *Bullt. soc franc. photog.* vol. xxii (1876, p. 100).
- Jenkins, C. F. *Picture Ribbons*. An exposition of the methods and apparatus employed in the manufacture of the picture ribbons used in projecting lanterns to give the appearance of objects in motion. 56 p., many plates and cuts unnumbered. Published by the author. Washington, D. C., 1897. Discussion of the origin and development of moving pictures.
- Kepler, Johannes. *Opera Omnia*, Vol. II, *Ad Vitellionem Paralipomena*. (De modo visionis et humorum oculi usu). 1604 pp. 226-269, 11 fig. Correct dioptrics of the eye here given, and also the explanation of the effect of convex and concave spectacles. *Dioptrica*. *Demonstratio eorum quæ visui et visibilibus propter conspicilla non ita pridem inventa accidunt*. pp. 519-567, 35 fig. 1611. The amplifier, real images, and erect images. The Keplerian microscope (modern microscope).
- Kircher, Athanasius. *Ars Magna lucis et umbræ in decem libros digesta*. 2d edition. Hermanni Scheus, Amsterdami, 1671. 1st ed. Romæ, 1646. 1st ed. 40 + 935 + 17 p., 2d ed., 30 + 810 + 9 p. About 650 fig. 34 Plates. The magic lantern is described in the second, but not in the first edition.
- Libri, Guillaume. *Histoire des mathématiques en Italie depuis la renaissance des lettres jusqu' a la fin du dix-septième siècle*. 4 vol. 8°. Chez Jules Rennard et Cie Libraires, Paris, 1838. In Vol. IV, pp. 303-314 there is discussed the invention of the camera obscura. Refers to Leonardo da Vinci. Thinks Porta reported what had been known a long time.

- Langenheim, W. Catalogue of Langenheim's colored photographic magic lantern pictures. W. Langenheim, 722 Chestnut St., Philadelphia, 1861. First edition, 1850. The Langenheims were the first to make photographic lantern slides. They used the albumen dry process, and exhibited their slides at the London World's Fair in 1851. *Art Journal of London*, April, 1851, p. 106, *Athenæum*, June, 1851, p. 631.
- Lenses, Their History, Theory and Manufacture. Bausch & Lomb Optical Co., Rochester, N. Y., 1906. 47 p., 34 fig.
- Marey, E. J. Photo-chronographie. *Comptes-Rendus Acad. de Sciences*. cvii, (1888), pp. 607, 643, 677. Description of camera with the band form of sensitive surface for photography of moving objects.
- Marey, Etienne Jules. La Chronophotographie. Nouvelle methode pour analyser le mouvements dans les sciences physiques et naturelles. *Revue generales des sciences pures et appliquees*. Vol. II, 15 Nov., 1891, pp. 689-719. The text is accompanied by many figures including the way the ribbons are actuated in the chronograph camera. There are given pictures showing the movements of men and animals including insects and some other invertebrates. Some microscopic objects with their changing shapes are also shown. Important for the history of the moving picture.
- Marey, Etienne Jules. Director of the Physiological Station. Movement. *International Scientific Series* (No. 73). 318 p., 200 fig. D. Appleton & Co., New York, 1895.
- Marey, Etienne Jules. The history of Chronophotography. Annual Report of the Smithsonian Institution for 1901. pp. 317-340; 42 fig. IX pl. See also his work. Movement, N. Y., 1895.
- Matas, Rudolph, M.D. The cinematograph as an aid to medical education and research. A lecture illustrated by moving pictures of ultramicroscopic life in the blood and tissues, and of surgical operations. Presidential address. Transactions of the Southern Surgical and Gynecological Association, 1912. 27 pages. 4 plates. A bibliography of 50 publications given, with special reference to those in medicine and surgery.
- Mayall, John, Jr. Cantor Lectures on the Microscope delivered before the Royal Society for the encouragement of arts, manufactures and commerce, Five lectures, Nov., Dec., 1885, 97 p., 103 fig., and two additional lectures in 1888, 18 pp., 26 fig. Published by the Society at John Street, Adelphi, London, W. C., England. Price, 2 shillings 6d, and 1 shilling.
- Melloni, M. Memoir on the free transmission of radiant heat through different solid and liquid bodies. *Scientific Memoirs*, Vol. I. Longman, Brown, Green and Longmans, 1837. 39 p. This paper shows the superior absorbing power of water for radiant heat. See also Ernest Nichols.
- Milliet de Chales, Claude Francois. *Cursus seu mundus mathematicus; nunc primum in lucem prodit. Ex officina Anissoniana, Lugduni, [Lyons], 1674. 3v., folio.* The second edition is dated 1690 and has four folio volumes. Fig. 403 is given on p. 666 of vol. ii in the first edition, and on p. 697 of vol. iii of the second edition.
- Molyneux, William. *Dioptrica nova, a treatise of Dioptricks, in two parts, wherein the various effects and appearances of spheric glasses, both convex and concave, single and combined in telescopes and microscopes, together with the usefulness in many concerns of human life are explained.* By William Molyneux, of Dublin, Esq. Fellow of the Royal Society. Presented to the R. S., 1690, printed 1692. Much history and translations of many Latin extracts. The first figure of a magic lantern with condenser lens, see fig. 404.

- Montucla, J. F. *Histoire des mathématiques*. New edition in 4 quarto vols. Edited by J. de la Lande. 1802. The progress of optics during the 18th century is given in vol. iii, pp. 427-605.
- Muybridge, E. *Animal locomotion*. The Muybridge work at the University of Pennsylvania, the method and the result. Printed for the University by J. B. Lippincott Company, Philadelphia, 1888. 136 pages, many text figures and diagrams.
- Muybridge, Eadweard. *Animals in Motion*. An electro-photographic investigation of consecutive phases of animal progressive movements. Commenced, 1872, completed, 1885. Folio, 264 p., many hundred figures reproduced from original photographs. Portrait of the author as frontispiece. Chapman & Hall, LD. London, 1899. In the preface is given a historical summary of the author's work in analyzing and synthesizing animal movement, and in an introduction a brief statement of the views of writers on animal locomotion from the earliest times; also diagrams and descriptions of the methods used by the author.
- Muybridge, Eadweard. Born 1830, died 1904. For biographical account see the Dictionary of National Biography, 2d Supplement, Vol. II, pp. 668-669. The Macmillan Co., New York, 1912.
- Nichols, Ernest P. A study of the transmission spectra of certain substances in the infra-red. *Physical Review*, Vol. I (1893) pp. 1-18. Alum does not improve the absorbing power of water.
- Pansier, P. *Histoire des Lunettes par le Docteur P. Pansier, d' Avignon*. 137 p., 19 fig. 6 plates. Price, 3f 50c. An excellent history of spectacles with many references to original sources and numerous figures and plates showing the various forms of spectacles at different periods. ✕
- Petri, R. J. *Das Mikroskop von seinen Anfängen bis zur jetzigen Vervollkommnung für all Freunde dieses Instruments*. 248 p., 191 fig. 2 plates. R. Schœtz, Berlin, Germany, 1896. Price, 10 marks.
- Plateau, Jean Ant. Fr. *Sur un nouveau genre d'illusions d'optiques*. Correspondance mathématique et physique de l'observatoire de Bruxelles, Publiée par A. Quetelet. Vol. VII, 1832, pp. 365-368. One plate. This paper is dated by the author, Bruxelles, le 20 janvier 1833. (See fig. 408)
- Poggendorff, J. C. *Gesichte der Physik, Vorlesungen gehalten an der Universität zu Berlin*. 937 p., 40 fig. Verlag von Johann Ambrosius Barth, Leipzig, Germany, 1879. Price 16.80 marks.
- Porta, Giovanni Baptista. *Magiæ Naturalis sive de miraculis rerum naturalium*, Naples, 1558. 2d ed., 1589. English translation of the second edition. London, 1658.
- Priestley, Joseph. *The history and present state of discoveries relating to vision, light and colours*. 812 pp., 23 pl. and a bibliography of 288 works bearing on the subjects treated. London, 1772.
- Ptolemæus, C. *L'Ottica di Claudio Tolemeo*. The optics of Ptolemy translated from the Arabic into Latin in the 12th century. Edited by Gilberto Govi. Torino, 1885. Here is stated very clearly the method of refraction from rare to dense and the reverse.
- Scheiner (Christophorus), 1575-1650 S. J. *Oculus, hoc est: fundamentum opticum, in quo ex accurata oculi anatome, abstrusarum experientiarum sedula pervestigatione, ex invisibilibus specierum visibilium tam everso quam erecto situ spectaculis, necnon solidis rationum momentis radius visualis*

- eruitur; sua visioni in oculo sedes decernitur; anguli visorii ingenium aperitur, etc. 5 p. l., 254 pp., 1 pl., sm. 4°. Aeniponti, apud D. Agricolam, 1619.
- Scheiner, Christophorus. *Rosa Ursina sive Sol, ex admirando facularum et macularum suarum phœnomena varius*. A Christophoro Scheiner, Germano sueuo e societate Jesu. Ad Paulum Jordanum II, ursinum Bracciani ducem. 784 folio pages, many plates. Apud Andream Phœum Typographum Ducalem. Bracciani, 1626-1630.
- Smith, Robert, LL.D. *A Compleat system of opticks*. pp. 458 + 171 of remarks. 63 plates in the text, 20 plates in the remarks. Cambridge, England, 1738.
- Stampfer, S. *Ueber die optischen Phœnomene welche durch die stroboskopischen Scheiben hervorgebracht werden*. Koeniglich-Kaiserliches polytech. Institut. Wien. Jahrbücher, Vol. XVIII, 1834, p. 237-. Describes a magic disc like Plateau's.
- Thompson, Silvanus P. *The arc light*. Cantor lectures delivered before the Royal Society of Arts, 1895. Jan. 14, the physics of the arc, pp. 943-960. Carbon arc by Davy, Sept., 1800. Jan. 21, the optics of the arc, pp. 961-976. Jan. 28, the mechanism of arc lamps, 980-991. It is stated, p. 981, that W. E. Staite devised an automatic lamp in 1846.
- Uchatius, Franz. *Apparat zur Darstellung beweglicher Bilder an der Wand*. Sitzungsberichte der kaiserlichen Akademie der Wissenschaften. Math-Natur. Classe., Vol. X, Wien. 1853, pp. 482-484, one plate. Describes a method of projecting moving pictures drawn on glass by means of a lime light and condenser moving from picture to picture. Each picture was fixed in position and had its own projection objective; the axis of each objective pointed to the same place and the pictures all appeared in the same position.
- Vinci, Leonardo da. *Les manuscrits de Léonard de Vinci*. Manuscrits A-M de la Bibliothèque de L'Institut, publiés en fac-similes phototypiques avec transcriptions littérales, traductions françaises, avant-propos et tables méthodique par M. Charles Ravaisson-Mollien. 6 folio volumes, Maison Quentin, 7, Rue Saint-Benoit. Paris, 1881-1890. Price, 900 francs.
- Waterhouse, J. *Notes on the early history of the camera obscura*. The Photographic Journal, including the transactions of the Royal Photographic Society of Great Britain, Vol. XXV, May 31, 1901, pp. 270-290. This is the best statement of the case found. Many extracts from original sources are given. See also the last edition of the Encyclopedia Britannica under Camera obscura, written by General Waterhouse.
- Waterhouse, J. *Notes on early tele-dioptic lens-systems, and the genesis of Telephotography*. The Photographic Journal, including the transactions of the Royal Photographic Society of Great Britain, Vol. XLII., Jan. 31, 1902, pp. 4-21, one pl. This paper gives a good account of the introduction of the combination of a convex and concave lenses for projection, i. e., the use of an amplifier.
- Wiedemann, Eilhard. *Ueber die Erfindung der Camera Obscura*. Verhandlungen der Deutschen Physikalischen Gesellschaft. 28 February, No. 4, 1910, pp. 177-182, 1 fig. Wiedemann speaks of the camera obscura of Ibn al Haitem about 1039, and of the description of this by Kamal al Din, 1300.
- Werner, Otto. *Zur Physik Leonardo da Vincis*. Inaugural—Dissertation zur Erlangung der Doktorwuerde der hohen philosophischen Facultät der Friedrich-Alexanders-Universität Erlangen, June, 1910. 179 p, 103 fig.

- Werner discusses the claims of Da Vinci, (1500), and of Levi ben Gerson, 1321-1344. Wiedemann (which see) refers back to Ibn al Haitem, about 1039.
- Young, Thomas. On the Mechanism of the Eye. Read before the R. S., Nov. 27, 1800. In the transactions of the R. S., 1801, pp. 23-88. On pp. 39-40 he describes astigmatism and shows that it can be corrected by making the spectacles oblique, p. 43. See also Airy. On pp. 57-58 is described a decisive experiment to show that the accommodation of the eye is due to a change in the crystalline lens.
- Wilde, Dr. Emil. Geschichte der Optik vom Ursprunge dieser Wissenschaft bis auf die gegenwärtige Zeit. 2 parts. I, 352 p., 3 p., II, 407, p., 4 pl. Rücker und Püchler, Berlin. Part I, 1838; Part II, 1843.
- Zahn, Joannes. Oculus artificialis teledioptricus, sive telescopium nova methodo explicatum ac comprimis-è triplici fundamento physico seu naturali, mathematica dioptrico et mechanico, seu practico stabilitum; opus curiosum theorico-practicum magna rerum varietate adornatum. 2d ed. 50 + 645 + 15 p. over 600 fig. Johannis Christophorilochneri, Norimbergæ, 1702.

INDEX

	PAGE		PAGE
Abbe diffraction theory	644-647	amperage	484
apparatus for	644	arc	542
demonstrating to an audience		arc, form of lamp	68
and to an individual	646-647	ballast with	544
grating needed for	644	carbons for	87, 552
light for	646	cycle	486
Abbe substage condenser		disadvantages with arc lamp	
	273, 280, 626		68, 475
Abbott, the Sun	139	frequency	486
Aberration, chromatic and		how produced	475
spherical	580-583	magic lantern with	68-77, 87
maximum and minimum	582, 589	micro-projection with	284
Absolute temperature	547	power factor with	485
Absorption spectra	637-638	radiant efficiency of arc	568-569
comparison spectrum with		summary for use with the	
glass box for use with	637-638	magic lantern	76
substances for	637-638	units of	484
Accommodation in vision		voltage	484
	651, 656-659	watts with	485
Kepler's theory of	657	wiring	69, 512
lantern slide for experiments	656	Ambrohn's Handbuch, Astrono-	
necessity for	657	mische Instrumente	138
produced by muscular effort	659	American, Institute of Electrical	
Scheiner's theory	658	Engineers	500
Acetylene, flame and lamp	127-130	Journal of Science	157
amount in prestolite tank	129	lantern slides	200, 201
position of lamp	128	Microscopical Society	383
summary	135	Ammeter	479, 510
Achromatic and aplanatic com-		alternating current	73
binations	581-583	connections	480-482
substage condenser	272, 626	direct current	11, 481
Adam's Essays	142	does not register	52, 510
Adapters for small carbons in		external shunt	479
large lamp	80	in projection	236, 481
Advertising Magic Lanterns	435	need in micro-projection	236
a-k on microscope slide	361, 387	precautions for use	481
Alcohol, burner	130	self-contained shunt	479
ethyl, methyl and denatured		soft-cored	510
supply	130	to measure current	479
Alcohol lamp	131	testing polarity with	509, 510
lighting	131	Amperage	476, 484
precautions, with	133	alternating current	484
putting out	133	carrying capacity of copper	
summary for use	137	wires	500
Alco-radiant	130	cords and cables	501
Alternating current	475	for different forms of projec-	
advantages	475	tion	500
		found by Ohm's law	521-522

- found by wattmeter..... 483
 varying with inductor..... 532
 Ampere 476
 Amperes and volts in transform-
 er 533
 Amplifier 229-600
 actual magnification and im-
 age 257
 image formation with..... 600
 magnification due to..... 600
 on projection microscope.... 238
 Anatomical Record..... 289, 320
 Anatomische Gesellschaft..... 363
 Angle, closing of light..... 611
 brilliance of image depend-
 ent on..... 611-613
 visual 210
 Anisometropia, unlike refraction
 in the two eyes..... 670-672
 Anthony & Co..... 210
 appearance of the screen
 image 672
 source of light for demonstrat-
 ing 670-672
 Anthracene screen for ultra-
 violet 635
 Aperture, 172, 233, 274, 278, 406, 601,
 609-611, 616
 and light losses..... 601
 effect of..... 609, 610-611
 image formation and..... 615
 of condenser, to increase.... 616
 of microscope objective. 615-616
 of projection objective, in
 opaque and transparency
 projection 172
 plate of moving picture ma-
 chine..... 406
 relation of condenser and
 objective 274
 standard for moving pictures 406
 substage condenser 278
 substage condenser to objec-
 tive 233
 with directed light 610
 Apparatus, adapted to frequency
 arrangement with sun pro-
 jection .. 286
 blackened 242
 block and its construction 291-294
 block, guide for 292
 block, size and weight..... 291
 home-made 287-296
 Apparatus for, drawing and
 photography 319
 drawing with the microscope 354
 electric currents and arc lamps 474
 lantern slide making..... 200
 lantern with alternating cur-
 rent..... 68
 lantern with direct current.. 9
 house lighting system..... 78-99
 lime light 100
 oil, gas, acetylene, alcohol... 119
 measuring radiant efficiency 567
 micro-projection 221
 moving pictures..... 390
 opaque projection..... 166
 photography 319, 643
 polarized light..... 622
 preparation of lantern slides 200
 projection microscope 221
 rooms and screens..... 439
 small current arc lamps..... 78
 sockets and stems..... 292
 spectra 627
 sunlight 138
 ultra-violet light..... 627-641
 vision experiments..... 651-672
 Achromatic objectives... 583, 600
 compensation oculars for... 600
 Arc 535
 alternating current..... 549
 carbon 537, 539
 cause of light from..... 546
 characteristics of..... 486
 construction of..... 535
 direct current..... 11, 536
 electric 535
 electrical behavior of direct
 current 536
 figure of, 507, 537-538, 540-543,
 545, 548
 inclined..... 543, 545, 548
 lamp for spectra..... 628, 639
 length and potential..... 538
 length and voltage..... 538
 parts of..... 536-537
 parts as source of light..... 547
 right-angled figures of
 507, 538, 540-542
 stream and bright violet lines 546
 vertical..... 537
 voltage..... 476, 536, 538, 544
 with 10 and 20 amperes. 249-540

- Arc lamp 12, 15, 61, 401, 536
 alternating current 68, 72, 74
 automatic 12, 61, 83, 328, 364, 512
 ballast for 539, 544
 choke coil for 88, 352, 532, 544
 direct current
 candle-power 553-565
 carbons for 87, 551
 current needed 24, 248, 328
 drawing with 328, 341
 for spectra 628, 639
 for micro-projection 236
 for vision experiments 651-672
 fine adjustments for 12, 72, 237
 going out of 48
 hand-feed 12, 62
 house circuit 80
 inductor for 88, 352, 544
 installation of 500-505
 intrinsic brilliancy of crater 564
 lighting 21, 24, 88
 "Lilliput" or baby form 81
 managing 24, 414
 material for installation 502
 opaque projection with 182
 polarity test 84, 506-511
 position of carbons in
 49, 50-51, 61, 70, 72, 550, 553
 rheostat for
 11, 70, 83, 521, 539, 544
 small 81, 82
 small automatic 83, 364
 small carbons for 341
 small with clock-work 364
 small with drawing 340
 special dynamo for 486
 starting 23
 summary for small 97
 testing polarity 506-512
 three-wire, automatic 238, 263, 512
 three-wire, supply 514
 turning off 88
 with transformer 532-534
 wiring 15, 69, 496-505, 513
 wiring when far from main
 supply 513
 wiring for large currents 513
 Arrhenius 138
 Asbestos-patch gloves 21, 74
 Astigmatism, astigmia or un-
 equal curvature 663-669
 change with age 666
 correct position of spectacles
 for 666
 correction by cylindrical lenses
 665-666
 correction by obliquity of
 spectacles 665
 correction by stenopæic slit
 669-670
 demonstration of 663-668
 discovery of by Young and
 Airy 666
 radial lines for 662-665
 Atmospheric pressure 103
 Attachment plugs 86-87, 502-504
 Auditorium for projection 395, 439
 Automatic arc lamp, 12, 61, 83, 286,
 328, 334, 336, 364, 512, 639
 Bausch and Lomb form 512
 Ewon's 548
 Leitz 364
 Nernst 92
 Reichert's 83
 Thompson's 334
 Axis of lenses 576-581
 principal, and secondary 576-579
 Ayrton, Mrs. 539
 Balancing devices 521, 532
 Ballast, alternating current
 69-70, 521, 532, 544
 direct current 11, 521, 539
 moving pictures 399
 need with arc 539, 544
 Nernst lamp 92
 position of 512-513
 small arc 83
 Ball's Astronomy 139
 Ball-pointed pen on unvarnished
 glass 187, 207, 304, 306
 Balopticon,
 diagrams 188, 189
 Edison Moving Picture at-
 tachment for 405
 large for opaque objects 192
 Nicholas Power, moving pic-
 ture attachment 404
 home 184
 Balopticon, convertible. 187, 304, 306
 Universal 191, 307
 Barbaro 675
 Barrel, rheostat 526
 Baseboard, for home-made ap-
 paratus 288-296
 fixing track to 290

- Bausch & Lomb Optical Company, cuts loaned by, 35, 60, 90, 91, 127, 184, 187-189, 191-192, 304, 306-308, 356, 358, 404-405
ref. in text, 80, 190, 286, 459, 512
- Bayley.....9, 217
- Bench, home-made optical..... 288
- Beseler, (Chas. Beseler Co.)..... 94
- Blackboard, lighting.....448-452
- Black stain for tables..... 289
- Blacked, apparatus.....7, 242-246
objectives..... 246
- Block with lead sheets..... 292
- Blocks for apparatus..... 291
- Blondel, intrinsic brilliancy determination.....564-566
- Blood corpuscles, demonstration of..... 227
- "Blow" said of a fuse..... 83
- Blow-through jet..... 105
- Botanical Gazette..... 289
- Botanische Zeitschrift..... 289
- Boyle's law and camera... 104, 129, 675
- Box to cover switch..... 517
- Break in circuit..... 514
- Briggs' lantern slides..... 673
- Brilliance, of screen image..... 610
intrinsic... 564-566, 613-615, 619
limit of, with projection microscope..... 618
reduction by substage condenser, amplifier and ocular 618
sunlight most brilliant..... 619
- British lantern slide..... 200, 203
- British photographic society... 217
- Brown & Sharp's wire gauge.... 502
- Bulletin of the Bureau of Standards.....547, 566
- Bunsen burner..... 125
- Burner, blow-through type.... 105
lime light..... 105
mixed jet..... 107
roars or hisses..... 115
- Burning out a fuse..... 519
- Burning point or focus..... 578
- Burr, Geo. L..... 673
- Bushings for small carbons in large lamp..... 80
- Camera**, adjustable back..... 212
and plate-holder..... 382
enlarging, reducing, copying 210
hinged baseboard..... 211
- landscape drawing..... 166, 167
- lantern slide making..... 209, 213
- printing by projection..... 378
- spectrographic..... 643
- tilting..... 212
- vertical..... 382
- Camera obscura, history... 673-575
- Candle-power, and current..... 559
current and size carbons
87, 248, 551-552
direct current inclined carbons 556
formula for finding..... 613
of arc lamps..... 553-565
from kilowatts..... 558
lime light, relative..... 100
petroleum lamp..... 125
power consumption..... 561-562
rectifier..... 558-559
rectifier
inclined carbons..... 557
right-angled carbons... 558
sun..... 138
variation with current... 553-556
watts, alternating current,
inclined carbons..... 557
right-angled carbons... 557
right-angled carbons... 556
- Capacity of gas cylinders 104, 128-129
- Capacity meter..... 103
- Carbon arc lamp for spectra... 628
- Carbons, adjusting..... 252
alternating and direct current with..... 340
arc with 10 and 20 amperes.. 249
arrangement of 543, 545, 548,
inclined; right-angled, 342, 507,
538, 540-542
arrangement in micro-projection..... 284
bad position..... 50
composition and movement. 72
converging, with alternating current..... 564-565
cored and solid..... 250
correct position..... 49
efficiency of different arrangements..... 560-561
electrodes..... 539
feeding with alternating current..... 74
feeding on house circuit.... 342
feeding with small arc..... 87
house system..... 341
image on screen..... 251

- inclined.....61, 70
 incorrect position..... 51
 not near enough.....47, 48
 observing with moving pictures.....403, 414-415
 polarity right and wrong.506-512
 position, 72, 284, 507, 538, 540-548,
 preparation for exhibition 250, 433
 distribution of light..... 565
 size 87, 415, 551-552.....
 size for moving pictures..... 415
 current, candle-power... 248
 house circuit..... 341
 small with alternating current 342
 small arc lamp.....79, 87
 small with direct current... 342
 solid and cored..... 250
 terminals.....12, 539
 too short..... 47
 why small on house circuit... 341
 Cardboard screen.....80, 458
 Cardanus..... 674
 Carrying capacity of electric
 cords, how calculated..... 501
 and insulation..... 500
 flexible cables..... 501
 of copper wire..... 500
 Caution for lime light..... 107
 Celluloid, films..... 431
 inflammability of..... 431
 Center of lenses.....576, 577
 of lens face, how to find...40, 41
 Centering.....23, 39
 alternating current lantern.. 73
 apparatus for vision experi-
 ments.....653, 671
 heliostat..... 150
 mazda lamp..... 91
 mechanical..... 40
 micro-projection... 246, 251, 285
 moving picture machine.410-412
 Nernst lamp..... 93
 objective..... 247
 objective hood..... 246
 objective, vertical..... 45
 optical test, condenser and
 objective..... 44
 perpendicular to axis..... 41
 radiant and condenser..... 41
 substage condenser..... 280
 troubles if incorrect..... 53
 Centimeter rule.....27, 318, 371
 Cerium iron gas lighter..... 106
 Chadburn.....173, 180, 183, 190
 Chadwick, Hepworth and Wright 173
 Chamot, Dr. E. M..... 207
 Chemical polarity indicators... 510
 Chevalier..... 322
 Choke-coils..... 88, 352, 532, 544
 Chromatic and spherical aberra-
 tion.....580, 583
 Circuit, electric..... 496
 breakers..... 518
 open and closed by switches
 514-518
 with break..... 514
 with one ground..... 497
 with two grounds..... 498
 Clock-shaft of heliostat, parallel
 with earth's axis.....147, 160
 Cloth screens..... 457
 Cohn, eye defects in school child-
 ren..... 659
 Color, used in moving pictures.. 392
 Colored moving pictures..... 392
 Coloring lantern slides..... 217
 Combined apparatus..... 356
 Combined projection, 175, 176, 180,
 182, 184, 186, 189, 193, 194, 295,
 297, 300
 avoiding contrast of images.. 177
 two complete outfits..... 297
 Comparison spectrum.....637-638
 Compensation ocular..... 232
 Concave lens for parallelizing
 light..... 337
 Condenser.....14, 587
 Abbe substage.....273, 626
 aperture of, to increase, or
 diminish.....616-617
 achromatic substage.....272, 626
 aperture of substage..... 278
 centering substage..... 280
 diaphragm opening..... 337
 distance from objective, in
 microprojection..... 247
 distance from radiant..... 41
 end to be next the radiant
 58, 62, 66
 ends reversed.....58, 62, 66
 first element of.....65, 588
 focus of second element for
 the objective.....65, 590-591
 focus too long..... 55
 focus too short..... 55
 for demonstrations in vision
 652-653

- for lantern slides 202
 for sunlight 139, 161
 lamp with special 343
 lens breaking 57
 light for different positions of
 lamp 42
 lighting with main condenser
 only 234
 lighting opaque objects with
 micro-projection with . . . 237, 273
 mounting of 58, 62
 moving picture 403
 and objective, proportions . . . 43
 opaque projection with 175
 out of center 53
 parabolic for micro-projection
 588
 protecting by sheet mica
 or glass 608
 reduction of brilliancy by . . . 618
 second element of, and the
 objective 65, 588, 590
 second element for micro-
 projection 274-278, 591
 size for drawings 331
 size for lantern slides 202
 spherical aberration of 585
 substage 232, 347
 substage, high power 271
 substage, Köhler method with
 sunlight 139, 161
 three-lens 13, 652
 two-lens 10, 653
 with spherical aberration
 without spherical aberration
 584
 types of 587
 triple 588
 two lens 588
 Conditions for good micro-projection
 309
 Connections, acetylene 129
 ammeter 480-482
 attachment cap of separable
 plug 86-87, 503-504
 electric supply 502, 513
 gas lamp 126
 lime light 106
 to the switch 504
 voltmeter 478-482
 wattmeter 482
 Connectors, metallic 106
 separable extension 87
 Converging light, parallelizing . . 273
 Cornell University 147, 673
 Crater, increase in size with current
 248, 249, 564
 temperature of 546-548
 Crystalline lens of the eye, change
 in shape for accommodation . . 658
 in hyperopia and myopia . . . 660-661
 rigid in presbyopia 661-662
 Cuff and Adams 141
 Current, alternating 475
 amount compared with direct
 73, 553-565
 at anodes, oscillogram of 495
 appearance of arc 342, 542, 545
 and candle-power 553-565
 connections of ammeter to
 measure 482
 controlled by resistance 542-544
 direct 11, 474
 direct for arc with magic lantern
 24
 for drawing 338
 for spectra 628, 640
 for experiments in vision 651-672
 for micro-projection 248
 increase in heat by increase
 of current 248
 increases size of crater 248
 insulation for large 513
 lack of 48
 lamps for small 78
 magic lantern with alternating
 68-77
 micro-projection with alternating
 284
 moving pictures with alternating
 398, 401, 566
 opaque projection 182
 oscillogram of delivered and
 supplied 493
 potential drop at arc 536-539
 precaution for heavy 186
 rectifier 489-492
 screen distance and 73
 size carbons and candle-power
 248, 551-552
 unit of, the ampere 476
 wiring for large 513
 Curtains for darkening room . . . 446
 Curves of light reflection 460-465
 Cycle with alternating current . . 486

- Dark ground illumination** . . . 647-650
 apparatus required 647
 for demonstrating inhomogenieties in liquids or transparent solids 648-650
 Foucault's method 650
 method of striæ 647
 Toepler's "Schlieren-Methode" 647-650
- Darkening room, method** 446
- Darkness, avoiding** 112
 in opaque projection 175
 of room for sunlight 143
 relative for different projection 443-446
- Dauids (Thaddeus Dauids Co.)** 207
- Davy's Carbon Arc** 686
- Daylight vision** 175
- Decentering, effects of** 53
- Decoration of projection room** 440-441
- Defective vision** 659-672
 apparatus required for . . . 651-655
 condenser for demonstrations 652-653
 demonstrations of 659-672
 lantern slides for 656-666, 671
 source of light for 670
 trial lenses for 651-655
- Delineascopes** 63, 193-196, 310, 312, 355
- Descartes sine law for refraction** 576
- Deschanel's Physics** 212
- Diaphragm, effect on cone of light** 279
 of substage condenser, effect with Koehler method, and with main condenser method of illumination 620
- Diffraction, gratings** 631, 644
 images 632
 pattern 644-645
- Diopter, definition** 229
 in spectacle lenses 655
- Direct current apparatus** 9
 arc, radiant efficiency compared with alternating 69, 474-475, 553-565
 production of 474
 summary for magic lantern . . . 64-67
 units 475-478
 use of 474
- Dirt on lenses** 55
- Distortion, how to avoid in drawing** 338
 of image 338
- Distribution of light, different forms of arc** 562
- Diverging light, to parallelize** 274
- Dolbear, Art of projecting** 122, 138, 174, 211, 621
- Double-pole switch** 12, 70, 515-517
- Drawing apparatus** 319-389
 attachment for ordinary magic lantern 327
 booth 321
 direct current arc lamp for . . . 328
 distance, varying for 335
 fastening letter to 375
 from lantern slides 326
 high power 335
 horizontal surface with magic lantern 331
 with opaque lantern 332
 house lighting system for 339
 landscapes 166
 large objects with low powers . . 333
 lettering the 374
 microscope for 344, 385
 microscope and lamp at right angles 348
 microscope in a dark room 346
 microscope without ocular or substage condenser 334
 models 357
 objectives, 16-8 mm 335
 oculars for 337
 opaque lantern 332
 outfit 350
 house system 343
 with inductor 352
 (Koristka) 323
 with microscope 343-354
 with small currents 343
 photographic camera for 332
 projection apparatus for 319
 projection apparatus, early forms 372
 projection microscope for 333
 publication of 373
 radiants other than the arc 329
 range of objects with projection microscope 333
 room and curtains 321
 room, special 320
 shelf 325
 on projection table 326

- size condenser to use 331
size and lettering 376
small 330
small arc lamp, for 340
summary 388
surface horizontal 322
surface vertical 321
table 324
 with mirror attached 323-325
 with movable shelf 325-326
tracing 374
troubles in 384
varnished slides for 205
wall diagrams 329
Dresbach, Dr. Melvin 651
 papers on eye defects 659
Durand, Dr. Albert C. 651
Dust to show light rays 247
Dynamo 474
 connected directly to arc lamp
 486-488
 special for arc lamp 486
 wattmeter to measure power
 delivered by 482
Eastman Kodak Co. 212, 215, 319
Eclipse voltmeters and ammeters 510
Ecliptic 163
Edinger 345
 apparatus, erect images with 373
 large apparatus 360-362
 outfit for small arc lamp and
 ordinary microscope 363
 vertical apparatus 360
Edison, Thomas A., figures loaned
 by and text references
 113, 400, 406, 418, 429, 435, 686
"Effects" with multiple lanterns 34
 with single lanterns 36
Efficiencies of current and carbon
 arrangement 560-562
Electric, apparatus, list of 474, 499
 arc 535-538
 circuit 496
 fan for drawing room 320
 flash light 14
 measurements 475-486
 supply, connections to 502-505
 units 475-478
Electrical behavior of arc 536, 539
 World 553
Electrodes, of carbon 539
 and potential drop at arc 536-539
 for spectra 627, 638
 stuffed with various sub-
 stances 638, 639
Electromotive force, unit of 476
Emission spectra 638-643
 arrangement of the electrodes
 for 640
 automatic arc lamp for 638-639
 current to use for 639
 different appearances with
 positive and with negative
 electrodes 640
 electrodes for 640
 yellow-flame carbons for 638
Enclosed knife switch 517
Energy losses in projection 603-609
 comparison of in water, etc. 607
 example of 609
 in the condenser 604
 in the projection objective 609
 in sheet mica 608
 in the specimen 607
 table of 607
Energy, required for projecting
 moving pictures 570-571
 with inductor and rheostat 533
Energy transmission 606
 table of absorption and trans-
 mission 607
English Mechanic 221
English Photographic Club 29
Enlargements with projection
 apparatus 378
Enterprise Mfg. Co. 101
Episcope for drawing 332
Equivalent focus 580
Erect images, in drawing 359-373
 with two projection lenses 368
Ether saturator 113
Ewon's automatic lamp 548
Exhibition, with, alcohol light 132
 alternating current lantern 73
 direct current magic lantern 19
 high powers 271
 lime light 110
 mazda lamp 92
 moving pictures 433-435
 Nernst lamp 95
 opaque lantern 179
 projection microscope 270
 room lighting, 19, 52, 66, 96-99,
 112, 120, 143, 175, 235, 303, 314,
 320, 395, 441-443, 626, 633
 with small arc lamp 90

- Exhibition with sunlight 161
 Experiments, on flicker 423-427
 with projection in physics 621-651
 with polarized light 622-626
 with vision, normal and defective 651-672
 Explosion with lime light 107
 Exposing dry plates directly to
 the projected image 381
 for printing by various lights 214
 with projection apparatus 380
 Eye, accommodation for distance
 657-658
 as a part of projection apparatus 4
 demonstration of normal vision 654
 inverted image on the retina
 655-656
 prevalence of defects 659
 refractive defects 659-672
 two eyes unlike 670
Fan, electric in drawing room 320
Faraday and moving pictures 680
Field, need of large, in micro-
 projection 254
 and objectives 254, 255
Filament, position of (mazda
 lamp) 91
Filar micrometer ocular 234
Film, burnt in concentrated light 432
 celluloid 431-432
 direction of motion 419-420
 effect of opacity on energy 571
 inspection of 427-428
 invented by Goodwin 682
 lantern slides 215
 magazine 407
 security from fire by 431-433
 mender 429
 position in machine 415
 splicing 428-429
 threading 417-418
Finimeter 103
Fire, danger from 431
 escapes 443
 -proofing curtains 321
Fire-shutter 420, 431-433
 automatic 420
Firetrap, security of 431-433
Fire Underwriters 498-505
 regulations 399
Fish, Dr. P. A. 289
Flexible metallic tubing 106
Flicker 423-427
 curve 424
 experiments on 426
 formula of 426
 position of shutter to prevent
 422-423
 table on speed 427
 theory of 426-427
Fluorite in apochromatic objec-
 tives 583
Flux of light in projection 172, 614
Focus, or burning point 578
 condenser and objective 587-592
 conjugate 579
 principal focus 578-582
 principal, how to obtain 579
Focusing 28, 30
 device on the microscope 241
 device with the magic lantern
 objective 28
 image on screen 28
 for photographing 379
 of screen image for micro-
 projection 256
Folmer & Schwing 212
"Fool-proof" 7
Formula, for absolute and centi-
 grade temperature 547
 amount of gas in a cylinder
 of acetylene, hydrogen or
 oxygen 104, 129
 black table stain 289
 determining visibility 227
 dioptry and focus of lenses 229-230
 electric quantities, Ohm's law
 483-485, 501-502, 522
 flicker with moving pictures 426
 intrinsic brilliancy of the sun
 138-139
 light flux passing an objective
 172, 613
 magnification 260-262
 making lantern slides direct
 201, 205-208
 size of screen and focus of
 projection objective 467-470
 sizing and painting screens 456
 starch paste 375
 table black 289
Foucault, method of detecting
 inhomogeneities by dark
 ground illumination 650-651

- Foucault, Recueil des Travaux Scientifiques 138
- Fourtier 9, 202
 et Moltini 621
- Frame for darkening window margins 445-447
 for retouching slides 29, 203
- French Congress of Photography 200
- French lantern slides 200
- Frequency, of alternating currents 486
 apparatus adapted to 495
- Fuess, R. 56, 138, 150, 159
- Fuse blocks, location of 520
- Fuses 399, 519
 "blowing" of 519
 burned out 47, 519-520
 capacity 520
 and circuit breakers 518-519
 location and installation 519
 on each line 519-520
 on house circuit 83, 520
 replacement of 520-521
 wattmeter 519-520
- Gas, amount in cylinders** 103-104, 129
 lamps 125
 lighter 106
 management 127
 reflector 126
 summary 136
- Gases, proportion of in lime light 108
- Gauges, pressure 102, 103, 129
- Gelatin for lantern slides 205
- General Electric Co. 553
 cuts loaned by 489-495
- Generator 474
 shunt 487
- Gentner (J. H. Gentner Co.) 459
- German lantern slides 200
- "Ghost" from reflections 245
- Glass plates for polarizing light 624
 tinted in combined projection 177
 unvarnished 207
- Glassine ink for writing on glass 207
- Gloves, asbestos-patch 21, 22, 109
- Glower of Nernst lamp 92-93
- Golgi method 240
- Goodwin, inventor of photographic film 682-683
- Goring and Pritchard 283, 454
- Gothic type for drawings 377
- Gratings for spectra 627, 632-635
- s'Gravesande 140, 146
- Ground of electric current 48, 497-498
- Ground-glass to diffuse light 380
 screen, transmission 461-462, 465
- Guide for making lantern slides 207
- Guides for apparatus blocks 292
- Guil pastils 101
- Gundlach-Manhattan Optical Co. 412
- Hand-feed arc lamp** 12, 15, 62
 lamp for alternating current 68
 lamp for small currents 286
- Hartford Screw Co. 296
- Hassock and Rosenberg 9, 621
- Heat, getting rid of, in rheostat 523
 with small currents 350
- Heating unequal on condenser 58
- Heliostat 139
 clock-driven 145
 for east window 144
 for south window 143
 for west window 145
 hand-regulated 140
 how to set clock-shaft 147
 kinds of 140
 lens and prism 157, 159
 mirror parallel to clock-shaft 154, 155
 setting up 154
 one-mirror 145, 146, 148, 150
 setting up 149
 positions of mirror 144, 156
 principle of 151
 southern hemisphere 156
 setting up 158
 two-mirror 145, 152, 153
 arranging fixed mirror 154
 arranging movable mirror 152
- Hepworth, C. M. 391
- Heyl, H. R. 680
- Hepworth, T. C. 9
- Historical Summary 673-687
- Hitchcock, Prof. Romyn 265
- Holland, translucent screens in 462
- Home kinetoscope 435
- Home-made optical bench 288-296
 projection apparatus 4, 287
 rheostats 525-530
- Home projectors 435
- Hood, on objective 245
 showing light centered and not 246
- Hooke's joint and rod 82, 329

- Hopwood, H. V. 391
 Horizontal objects 32, 268
 Horner's Zoetrope 680, 682
 House system for projection
 microscope 285
 fusing 83
 lamp for 78
 Hubbell (Hubbell Inc.)
 86-87, 503-505
 Huygenian ocular 230, 233, 280
 Hydrogen, cylinders 103
 substitute for 113
 Hyperopia or long sight 661
- Iban Al Haitem and the camera**
 obscura 674
- Illumination, dark ground** 647-650
 Foucault's method of 650-651
 Toepler's method of 650-651
- Illumination, flashes per second**
 at which flicker disappears 424
 with high powers 599-601
 with lower powers 598
 with magic lanterns 16-18, 584-587
 with moving pictures
 411-415, 593-598
 with projection microscope
 247-256, 271, 278, 284, 286, 287,
 328, 335, 346, 598-601, 617-620
- Illuminating gas for lime light** 112
 for magic lantern 125-127
- Image, brightness of** 18-19, 612-617
 carbons 251
 condenser with spherical aber-
 ration 585
 condenser without spherical
 aberration 584
 connection with aperture 615
 correct 26-27, 371, 387
 dim and brilliant in combined
 projection 177
 erect 26-27, 190, 359, 363-365-
 367, 369, 371, 373, 387
 with opaque lantern 363-365
 with translucent screen
 26, 362
 with two lenses 368-369
 formation with, the magic
 lantern 584
 effect of an extended source
 of light 586
 moving pictures 591-598
 point not on the axis 617
 projection microscope 598-601
- Image projection microscope with**
 amplifier or ocular 600-601
 a microscope objective 616
 hazy 308
 inverted 26-28, 359-371, 584
 for micro-projection 470
 for different microscope tubes 243
 for moving pictures 468
 for opaque projection 181
 for screen distances 466
 lantern slides for 464
 sharpness of 28-30, 256
 size, found by calculation 261
 found by measurement
 257-260
 stereoscopic with the magic
 lantern 37-39
 troubles with screen images
 52-57, 301, 308
- Incandescent lamp** 14
 after rheostat 17
 before rheostat 13
 testing for voltage 46
 tracing pictures 374
- Inclined carbons** 61, 70, 543-550
- Indirect room lighting** 441-443
- Inductor** 352-532
 with arc lamp 352, 532
 varying amperage with 532
 wiring 352, 532
- Infra-red radiation** 566
- Ink for unvarnished slides** 207
- Inks and pens for varnished slides**
 206-207
- Insulation with large currents**
 513-514
 for long distance wiring 513
 of wires 497-498
 regulating amperage 501
- Intensity of light, in different**
 directions 563
- Intrinsic brilliancy, of crater of**
 arc
 of the light source
 138, 564, 612-615
 of the sun 138-139
- Iodized starch polarity indicator** 510
- Iris diaphragm, effect on cone of**
 light 279, 620
- Italian lantern slides** 201
- Ives, Fred E.—Ether oxygen lime**
 light, history and new ap-
 paratus 686

- Janssen** astronomer, pictures of the transit of Venus with a photographic revolver invented by him in 1873 (see Marey, *Hist. Chronophotography*) 683
- Jablochhoff**, arc lamp with parallel carbons (see *Silvanus P. Thompson*) 686
- Jenkins, C. F.** 391, 686
- Journal of Applied Microscopy.** 289
- Journal Royal Microscopical Society** 221
- Journal Royal Society of Arts** 200, 686
- Keller (P. Keller & Co.)** 61
- Kepler** . . . 321, 361, 368, 656-657, 678
accommodation for distance 657
hypothesis of accommodation 657
inverted retinal image . . . 656-657
- Kilowatt** 477
- Kilowatt-hour** 477
- Kilowatts for candle-power** 558
- Kinemacolor moving pictures** . . . 392
- Kinetophone** 393
- Kinetoscope** 400
mechanism 418
- Kingsbury, Dr. F. B.** 324, 327
- Kircher, A.** magic lantern . . . 676-677
- Knife switch** 515, 517
- Knife switch enclosed** 517
- Knife switch vertical** 516
- Kohl, Max.** 126, 153
- Köhler method, substage condenser** 278, 305, 619-620
- Koristka's drawing apparatus** . . . 323
- Labelling lantern slides** 218
- Lambert, F. C.** 200
- Lamp arc, 12, 74, 78, 80, 182, 236, 286**
328, 339, 343, 401, 506, 536, 549,
628, 639, 652, 670
- Lamp, for general lighting** 442
for small currents 78, 286
gas 125
incandescent 14
lime light 105
on house system 78
with special condenser for house system 78, 343
- Lamp-house** 14, 72
window in 14, 72
- Landscape drawing, camera for** 166
- Langenheim** 673
- Lantern, college bench** 301
combined 176, 180, 182
multiple 34
testing 20
- Lanternists, work of early** . . . 119-120
- Lantern slides, actual size of**
opening 202
American 201
arranging 30
black ground 213
British, spotted 203
coated with gelatin for writing 205
collecting at close of exhibition 30
coloring 217
condenser to illuminate 204
confusion of size 202
correct position in carrier 26
developing 209
for showing eye defects
656, 665, 666, 671
directions for making direct 201
directions for "spotting" . . . 26, 216
duplication 19
film 215
for experiments in vision . 651-672
for showing eye defects . . . 556, 665,
666, 671
- frame for retouching, 203**
with guide lines 206, 207
hand-made 205
in individual carrier 31, 32
labeling 26, 218
making 200
mounting 216
negatives as 211
on mica or gelatin 208
opaque 56
order of 19
photographic 208
possible images of 27
possible positions of American 28
possible positions of British . . 28
printing with camera 213
printing from negative 208
rapid preparation 215
sizes 200
size of condenser required for 202
size of image 464
size of print on 208, 464
size of screen for 464
smoked glass 208

- Lantern, square 29
 "spotting" or marking
 19, 201, 216
 standard 202
 standard American 25, 200
 storing 218
 summary 220
 troubles in making 219
 typewritten 215
 unvarnished, ink and pen for 207
 varnishing 205
 Lantern slide carrier for delinea-
 scope 28, 63, 196
 carrier for experiments in
 vision 651-654
 permanent 31-32
 push-through form 23
 ways of making 203
 writing them with a pen 204-208
 Lathe bed type of projection ap-
 paratus 262, 289
 Latitude and heliostat 160
 Lasseur, Professor E 673, 685
 Law of magnification and reduc-
 tion 357, 369
 Law of reflection 140, 572-574
 Law of refraction 576
 Lecturer, suggestions to on magic
 lantern exhibition 19
 Lecture rooms 439-454
 Lecture room with gallery 448
 with raised seats 449-451
 screen at side 450-451
 translucent screen 453
 Lehmann, fluid crystals, etc. 621
 Leiss, C. 138
 Leitz, Ernst, 79, 178, 225, 299, 360,
 362, 363, 364.
 Lens, aberration, chromatic 583
 spherical 580-586
 how corrected 581
 achromatic 583
 aplanatic 581
 axis of, principal and second-
 ary 576-579
 center of curvature 577
 center, optic 576-577
 concave, convex and menis-
 cus 577
 concave to make light cone
 parallel 273, 276
 convex to make light cone
 parallel 274-276
 Lens, crystalline of the eye 657
 change of shape in accom-
 modation 658
 definition of 576
 dioptry of 229-230
 equivalent focus of 580
 focus of, principal and con-
 jugate 578-582
 focus, equivalent 580
 holder for trial lenses 651-654
 meniscus 577
 optic center of 576-577
 principal focus of 578
 principal focus, how found
 579-580
 principal and secondary axes
 576-579
 radius of curvature of 577
 secondary and principal axes
 of 576-580
 support for trial lenses 651-654
 unit of strength (diopter) 229
 Lenses, cylindrical for eye defects 664
 detecting strain in by polar-
 ized light 626
 for experiments in vision 651-672
 forms of 577
 position in the triple and in
 the double lens condenser
 10, 13, 591-592
 Oculists' trial 651
 Leonardo da Vinci 674
 Lettering, drawings 374
 fastening the letters 375
 size for drawings 376
 Letters, a-k on specimen 361, 387
 on tissue paper 375
 white on black ground 375
 Levi Ben Gersen 674
 Light from alternating current
 arc 565
 absorption by lenses and ob-
 ject 601-602, 620
 amount from sun 138
 amount with petroleum lamp 125
 for demonstrations in vision
 652, 670
 from arc, cause of 546
 from arc direct and alter-
 nating current 554
 of arc dependent on tempera-
 ture 547
 avoiding stray 380
 in center of condenser face 44

- Light, centered on objective
 face 44
 centering by objective hood 246
 closing angle for screen
 image 611
 direct on screen 52
 distribution of intensity 562-563
 distribution in semi-diffuse
 reflection 459
 distribution from white screen
 462-463
 early sources 119, 686
 energy, proportion of total
 radiation 566, 569
 flux 172, 613, 614
 flux in opaque projection 172
 from converging carbons 564-565
 from right-angled arc 564
 in exhibition room 112, 161, 441
 increasing with sunlight 161
 insufficient 51
 on screen 111
 on screen, insufficient 301
 parallelizing 273, 276, 335
 projection with feeble 120
 red near exits 443
 reflection with various screens
 249, 250
 relative amount with trans-
 parent and opaque projec-
 tion 171
 shield beyond objective 246
 shield on the window frame
 445-447
 sun most brilliant 138, 619
 sources, arc lamp, oil, gas,
 acetylene, lime and mazda
 lamps; sunlight
 11, 79, 100, 119, 125, 127, 138
 sources for spectra 627-628
 source, parts of 537, 547
 size and brilliancy of
 screen image 610
 stray, how to cut off 266
 stray, vertical microscope 268
 stray, effect on screen image
 443-444
 turning on and off 20, 88, 110, 162
 unequal on screen 308
 weak for micro-projection 287
- Light losses by, 601
 absorption by lenses and
 object 601-602, 619
 polarization 603
- reflection from lens surfaces
 601-602
 shutter in moving pictures 603
 sheet mica 608-609
 small condenser or objective
 601-602
 substage condenser 618-620
- Lighting, blackboard, 448-449
 entire opaque object 187
 indirect method 442
- Lilliput lamp 81
- Limes, for lime light 104
- Lime, arranging 109
 cracks in 115
 pitting of 109
 putting in place 108
 rotating 109
 warming 108
- Lime light 100
 burner 102
 connectors 108
 lamp for 107
 lighting 106
 management 106
 micro-projection by 287
 oxygen generator and ether
 saturator 113
 oxygen and illuminating gas
 112
 regulating flame 108
 shield 111
 snaps out 114
 starting 106, 110
 summary 117
 troubles 114
 turning out 110
- Litmus polarity indicator 510
- Long sight or hyperopia 661
- Loos, A. J. 673
- Loss of light 601-609
- Loss of energy 603-609
- Lumen 613
- McAllister** 167
- McIntosh Bat. and Opt. Co. 123
- McIntosh Stereopticon Co. 62, 301
- Maddox 682
- Magic disc 680
- Magic lantern, 9, 68, 78, 100, 119, 138,
 414, 584-587
 acetylene 127
 addition of micro-projection 309
 advertizing form 435
 American forms 59

- Magic Lantern, centering 39
 Condenser with and without
 spherical aberration 584-587
 for small drawings 330
 history 676-678
 image formation with 584
 inversion of the image 584
 light source extended and a
 point 586-589
 simplest with arc and 2-lens
 condenser 10
 standard for projection
 apparatus 9
 wiring for 15, 71, 82, 504, 512
 attachment for drawing 327
 automatic lamp, inclined car-
 bons 61
 optical bench and ordinary
 microscope 262
 drawing accessories 329, 330
 drawing surface horizontal 331
 hinged baseboard 450
 inclined carbons 70, 543-548
 light too far off 54
 light too near 54
 radiant below the axis 53
 lamp with microscope 328, 336
 large source 120
 lathe-bed form 3-lens con-
 denser, water-cell 60
 lime light 100, 101
 mantle, gas lamp 125
 mazda lamp 90, 91
 microscope 265, 365
 moving pictures 587, 591
 Nernst lamp 92, 95
 opaque objects 173
 ordinary microscope 263
 petroleum lamp 121, 122
 small arc 85, 86, 90
 small current 80
 sunlight 138, 139
 three-lens condenser 13
 two-lens condenser 10
 two-lens condenser, hand-fed
 lamp 62
 with direct current 9
 with rods and microscope 264
- Magnification, with,
 micro-projection 225, 257
 opaque projection 181
 opaque lantern 356
 wall diagrams 355
- Magnification, various objective
 and screen distances 257-261
 Magnesium oxide as standard
 screen 462
 Magic lantern with weak lights 119
 amplifiers and oculars
 258, 262, 598-601
- Magnification
 181, 228, 257-262, 357, 369
 actual 257-261
 calculated 261
 due to the amplifier 262, 600
 due to the ocular 232, 262
 how calculated 261
 how found 260, 353
 law for 357-369
 varying 351
- Management of apparatus for
 projection, 24, 73, 92, 106, 123,
 127, 414, 433
- Mantle, gas lamp 125
 inverted 126
 position 125
 upright 126
- Masks, how to employ 253
 kind and color 253
 for microscopic slides 252
- Masked sections and slides 253, 270
- Marcy's petroleum lamp 121-122
- Marey 685-686
- Mayer, Alfred M. 138, 157, 159
- Mazda lamp 90
 summary for 98
 wiring of 90
- Measurement of electric quanti-
 ties 478
- Mechanism of cameragraph 410
 for moving the film 406
 moving picture machine
 400, 402, 416
- Mercury arc rectifier 490-491
- Metallic screens 458-459
- Meter, unit of length 318
 candles 612-615
 number for reading 612
- Method of striae 647-650
- Metric rule 27, 318, 371
 system 318
- Micrometer ocular 232, 233
- Micrometer ocular, filar 234
- Micrometers by photography 353
- Micro-planar 224, 225
- Micro-projection, 221, 223, 236, 262,
 267, 284, 286-287, 296, 313, 344,
 385, 598, 615-620

- Micro-projection, addition to the
 magic lantern 307-309
 advantages 223
 alternating current 284
 apparatus 221, 319
 centering 246
 college, bench lantern 301
 condenser for 237
 conditions for good 309
 direct current arc lamp 236
 illumination for 236, 248, 271, 284,
 286-287, 305, 328, 335, 339, 598,
 616-620
 house-circuit 285
 lime light 287
 objectives 224-226
 ordinary microscope 262
 outfit for photography 382, 386
 room 235
 screen 235
 size of image 470
 size of screen 470
 size of specimens 224, 255
 summary 313
 sunlight 286
 troubles with 301
 weak lights for 287
 Microscope with amplifier 238, 600
 for drawing on horizontal
 surface 344
 drawing with inclined 345
 focusing device 241
 house circuit drawing outfit 343
 getting light through with
 concave mirror 347
 magic lantern lamp and con-
 denser 336
 objectives, objects to project
 with 269
 photo-micrography 385
 plane mirror 346
 position for drawing 345
 projection and drawing 275
 projection with ordinary 262, 263
 projection with vertical 267
 slide, masks for 252
 specimens, projection of 269
 tube 241
 size and image 243
 vertical with high powers 283
 vertical, stray light 268
 without ocular or substage
 condenser 334
 Microsummar 225
- Microtessar 225-579
 Milliet de Chales 676, 679
 Mirror 574
 at end of clock-shaft (helio-
 stat) 152, 153
 concave 573
 convex 575
 reflection 572-573
 attached to drawing table 324
 concave, as reflector 127
 concave, without substage
 condenser 349
 45 degree with vertical objec-
 tive 46, 267
 to illuminate opaque object 175
 light through microscope with
 concave 347
 with plane 346
 on drawing table 324
 parallel to clock-shaft (helio-
 stat) 154
 position at equator, for helio-
 stat 158
 position at poles for a heliostat 158
 position and time of day with
 the heliostat 144
 screen 459
 silvered on face with dim light 331
 to get erect image 190, 361
 to reflect image to drawing
 surface 322, 337
 Mirroroide 459
 Misframe 434
 Mixed jet 105, 107
 Models, drawing for 357
 Moler, Geo. S. 218, 219
 Molyneux 677
 Motion of picture film 419
 Motion Picture Screen Co. 459
 Motor-generator set 489
 Mounting, condenser 17, 62
 lantern slides 216
 low power objectives 241
 Movement of lamp at its limit .. 47
 intermittent with camera-
 graph 417
 Moving pictures,
 390, 409, 435, 468, 570, 591, 000
 apparatus for 390
 apparatus, getting in correct
 position 412
 development of the art 391, 680
 and education 394

- Moving Pictures, energy required
 for projection 570
 at home 435
 history 680-686
 illumination and optics
 409, 591, 593-598
 image formation 594-598
 in science 394-395
 size of image and screen 468
 summary and troubles 436, 438
- Moving picture and magic lantern projection 587, 591
 machine... 400-408, 410-418, 435
 inside shutter for 406-407
 installing 407
 mechanism of 415-417
 objective for 406, 412
 operating room for 396-397
 operator for 390
 optics of 409, 591
 phonograph with 393
 position in the operating room 396
 principle of 416
- Moving Picture World
 101, 207, 390-391, 397, 406
- Multiple lanterns, composition of 34
 dissolving views 35
 effects with 35
 use of 34
 wiring for 34
- Municipal regulations for wiring 499
- Muybridge 393, 681-684
- Myopia or short sight 660
- Nash, A. E.**, painting screens... 456
- National Board of Fire Underwriters 499
- National Electric Code
 499-500, 502, 515, 528
- National X-Ray Reflector Co... 442
- Negative carbon, 12-13, 222, 250, 507-508, 537-538, 547-549, 551-552, 640
- Negative photographic for lantern slide 208, 211
 making with projection apparatus 384
- Nelson 274
- Nernst lamp 92, 93, 94
 automatic 92
 for drawing 323
 for spectra 628
 summary 98
- Nernst Lamp, wiring alternating current 93
 wiring direct current 93
- Neuhauss 9, 202, 677
- Newton and chromatic aberration 583
 composition of white light... 391
 experiments with the spectrum 627
 & Co., lanterns and lantern slides 124
- Nicholas Power Co.,
 391, 402, 404, 410, 417
- Nichols, physics 521
- Nicol prism 623
 for analyzer 623-624
 polarizer 623-624
- Nicol prism spectacles 37
- Normal vision, projection experiments 652-659
 apparatus for demonstrating
 trial lenses for 651-655
 lantern slides for 656
 source of light for 652
- Norris, electrical engineering .. 522
- Norton 9
- Nose-piece for objectives... 249, 250
- Obliquity**, avoidance of 41
- Observation window in lamp-house 72
- Oculars, 230-234, 280, 337, 366, 369-372, 600
 compensation 232, 600
 designation of 231
 drawing, for 337
 eye-lens of 366, 600-601
 field lens of 366, 600
 filar micrometer 234
 image formation when used
 Huygenian 230
 magnification by... 232, 258-262
 designation 231
 for drawing 337
 filar micrometer 234
 micrometer 232, 233
 position of image and course of light 366, 601
 projection . 230, 232, 280, 366, 601

- Oculist's trial lenses, 651, 655.....
 where to be obtained..... 651
- Ohm..... 477, 521
- Ohmage..... 477
- Ohmage by Ohm's law..... 521-522
- Ohm's law..... 521
- Oil lamp..... 121
- Object, position on stage..... 257
 for projection, objectives... 268
 projection when horizontal.. 268
 size for opaque projection... 179
 visibility of..... 227
 to draw with projection
 microscope..... 333
 erect image when vertical... 190
 horizontal, image erect..... 190
 how to light..... 335
 illumination with main con-
 denser..... 234
 large, drawing with low
 powers..... 333
 for opaque projections..... 179
 position with different ob-
 jectives..... 256
- Objective..... 18, 224, 226, 281, 609
 aperture for opaque and
 transparent objects..... 172
 apparatus at rear of room... 464
 apparatus not at rear of room
 464, 468
 brilliancy of the screen image 613
 centering..... 247
 demonstrations with high
 powers..... 271
 diaphragm of..... 380
 distance from condenser 43, 247
 drawing..... 335
 focus and brightness of
 screen..... 613
 focus for room and screen.. 467
 for different sized fields.... 254
 formula for getting proper
 focus..... 467
 with hood for..... 245
 immersion..... 225, 349
 low power, mounting..... 241
 magic lantern
 18, 464, 597, 601, 609
 microscope construction... 616
 microscope and image forma-
 tion with..... 616
 moving picture..... 406
 painting black..... 246
- Objective, photographic, con-
 struction..... 225
 for photography..... 384
 for photographic printing... 379
 proportioned to condenser 43, 277
 revolving nose-piece for.... 249
 screen limited in size by.... 469
 shield for..... 30-31, 246, 293
 to use with substage condens-
 er..... 281
 various fields..... 255
 various objects..... 268-269
- Old age sight or presbyopia.... 661
- Opaque lantern for drawing... 332
 drawing on horizontal surface 332
 one source..... 173
 two sources..... 173
 with sunlight..... 174
- Opaque objects, bright images of
 lighting entire..... 187
 magnification and size of
 image..... 181
 projection, 166, 168, 183, 184, 187,
 188, 191, 192, 196
 screen and distance..... 181
 size and kind of objects.... 179
 summary..... 198
 troubles..... 195
 versus transparency. 168, 169, 170
- Operating room, for moving pic-
 tures..... 396-398, 453
 construction (M. P. World).. 397
 permanent..... 396
 temporary..... 396
- Operation of moving picture
 machine..... 420
- Operator, competent..... 390
- Optical bench..... 288-289, 294
 deceptions..... 36
 system for spectra..... 628; 641
- Optics of moving pictures... 409, 591
 of projection, general..... 572
- Orange G for staining masks... 253
- Oscillogram, anode currents... 495
 current supplied and de-
 livered..... 493
 potential and electromotive
 force..... 494
 rectifier..... 493-495
- Oxodium..... 113
- Oxone..... 113
- Oxygen, cylinder..... 101

- Oxygen-ether 114
 generator 113
 use of 113
 tank 102
 Oxy-hydrogen flame 100
 Oxylithe 113
- Paint**, amount for cloth screen . . 456
 for blackening apparatus 245
 for projection room 440
 Painted cloth screen 457, 460
 Painted wall screen 454
 Paper, holding while printing . . . 379
 Paper for masks 253
 Paper for printing with projection 379
 Paper screen 458
 Parallel light, how to obtain 273
 Parallel, rheostats in 531
 Parallelizing light 276, 335
 Patching a film 428
 Pen for slides 206, 207
 Pennock, Edward 673
 Pennsylvania Metallic Tubing Co. 108
- Petroleum, amount to use 125
 lamp 121, 123, 124
 lamp, amount of oil 125
 lamp, candle-power 125
 chimney 122
 condenser position 125
 management 123
 lamp for photo-micrography 386
 position of flame 125
 reflector 122
 smoking 133
 summary 136
- Phenakistoscope or magic disc of Plateau 680-681
- Photographic booth 321
 camera for drawing 332
 enlargements with projection 378
 lantern slides 200, 208
 objectives for prints 379
 for projection 224
 objects to project with 268
 paper with projection 379
 room 320
 Society, British 217
- Photography apparatus 319
 with projection apparatus 319, 381
 with Quartz spectrograph 642
- Photography, with spectra 643
 summary 388
 troubles 384
 Photo-micrographic camera 382
 microscope 385
 vertical camera 384
 Photo-Mineature Series 200
 Physical Review 567-569
- Physics, special projection experiments in 622
- Plaster Paris screen 454
 Plate, exposing directly 381
 Plateau and moving pictures 680
 Pointer for lecturer 271
 Polarity determination 506-511
 by arc lamp 506
 with direct current 496, 506-511
 direct current ammeter 506
 direct current voltmeter 508
 incorrect 51, 507
 indicating on wires 51, 508
 indicators, chemical 510
 Nernst lamp 95
 right and wrong in arc lamp 51, 507
 small arc 84
 test 51, 506-511
 testing by ammeter 506
 testing by voltmeter 508
- Polarized attachment plugs 87, 504
 light 622-626
 brightness of screen image 626
 condensers and objectives for 625
 dark room needed for experiments 626
 detecting strain in lenses by 626
 projection experiments with 622-626
 setting up the experiments 626
 showing rings and brushes with 625
 small Nicol prism for 624
 specimens for 623
 use of piles of glass plates 623-624
 use of small prisms 624
 wall socket 86, 503
- Popular Science Monthly 321, 521
- Porta, Baptista and the camera obscura 674
- Porte lumière 140, 144
 installation 140
 with microscope 142
 operation 143

- Porte lumière, setting up 142
 for south window 143
 for west window 145
 Porter, T. C. 424-426
 Position of Ballast 512-513
 condenser and objective 43, 251
 of filament (mazda lamp) 91
 of moving picture machine 396
 of object on stage 257
 of object with various ob-
 jectives 256
 of switch 515-518
 Post-card projector 183
 Potato polarity indicator 511
 Potential drop and arc length 536-539
 and current 536
 and electrodes 536
 Potential, oscillogram, electro-
 motive force supplied 494
 Potter, A. O. 177
 Power at arc, wattmeter connec-
 tions 482
 Power, Nicholas Company
 391, 402, 404, 410, 417
 Power consumption, candle-
 power 559, 561
 factor 485
 Precautions, alcohol lamp 133
 ammeter, wiring 481-482
 heavy currents 186, 513
 lime light 116
 in polarity tests 506
 for wiring 498, 513
 Precision Machine Co. 406
 Presbyopia, old age sight 661-662
 Pressure gauges 102, 103
 gauge, acetylene tank 128
 of one atmosphere 103
 reducing valve 102
 Prestolite tanks 127, 128, 129
 Principal axis 577-581
 focus and how obtained 578-579
 Print, size for lantern slides 208
 Printing, artificial light 214
 on paper or a dry plate,
 directly 381
 exposure for 380
 how to hold paper 379
 lantern slides 209
 lantern slides with camera 213
 paper to use 379
 Prints, enlarged from negatives . 378
 white on black 213
 Prism, 37, 46, 190, 196, 322, 337, 344,
 368, 629-632, 640-643
 erecting 368
 direct vision 627, 631
 drawing 322, 337, 344
 glass 627, 629-630
 hollow for liquids 627, 631-632
 polarizing 622-626
 quartz for ultra-violet 641
 right-angled with vertical
 objective 46
 Rutherford's 630-631
 spectacles of 37
 Prism, Nicol for polarizing or
 analyzing light 622, 624, 626
 Proceedings of the American
 Association for the Ad-
 vancement of Science 211, 321
 Proceedings of the International
 Electrical Congress 566
 of the American Microscop-
 ical Society 320
 of the Royal Society 426
 Projection apparatus, with mir-
 ror on lecture table 451-452
 outside the room 453
 for photographic enlarge-
 ments 378
 rules for construction 6
 aid to drawing 319
 apparatus, best position in
 room 446
 early use with drawing 372
 form for drawing 321
 home-made 287
 similarity of all 221
 from three standpoints 3
 universal 178, 185, 191
 of human face 170
 horizontal objects
 33, 185, 190, 268
 illumination in high power 271
 in physics 621-651
 material and apparatus for
 622, 626-627, 643, 644, 651
 of spectra 626-642
 special experiments in 622
 with polarized light 622-626
 with ultra-violet light
 627, 641-642
 microscope, 178, 221, 222, 271,
 282, 299, 300, 303, 309, 322, 598
 601
 microscope with amplifier
 238, 366, 599-600
 drawing with 333
 erect images with 367-373

- Projection apparatus, exhibition** 270
 on house circuit 234, 285
 illumination for, 237, 247, 251,
 271-282, 328, 335, 347, 598, 601
 limitations 223-224
 on market 296
 solar 142
 microscope 221, 234, 249, 271
 use 249
 defective vision demonstra-
 tions 659-672
 moving pictures
 409, 420, 433, 593
 microscopic specimens 269
 multiple lanterns 34
 normal vision 652-659
 objective 18, 224, 464
 shield for 292
 objectives, micro-projection
 224-226, 244, 263
 objective for moving pictures
 406, 412
 ocular 230-234, 280, 366, 600
 optics of 572
 position of carbons for
 49-50, 249, 342, 415, 507, 537-550
 room, form and darkness. 440-444
 specimens for 252, 268
 table 287
 with drawing shelf 325
 with vertical microscope 267
 with weak lights 120
 Projectors for home use 435
 Projectoscope combination . 185-186
 universal 302
 Proportion of gases for lime light 108
 Pseudoscopic effect 39
 "Push-through" slide carrier 23
 Pupil for eye experiments . . 651, 669
 effect of size in vision 669
 Ptolemy, phenomena of refraction 576
Quartz optical system for ultra violet 641
 spectrograph for ultra violet 642
 system for spectra of ultra violet 641
Queen & Co. 166
Radial lines for showing eye defects 662-667
Radiant or light source, 11, 68, 78, 90, 92, 100, 113, 119, 121, 125, 127, 130, 138, 553
Radiant, arrangement and centering 39-46, 56
 distance from condenser 41
 for drawing 328, 329
Radiant efficiency 567
 and mirror 189
 energy for moving pictures
 with alternating current . . 570
 direct current 571
 for opaque projection 174
 position and illumination of condenser 42
 position of in opaque projection 174
 tilted 188-196
Radiation, light energy of 566, 569
 visible and invisible 566
Ramsden's Circle or disc 230
 type ocular 234
Reactor 532
Read, E. A. 673
Rectifier for alternating current 489
Red lights near exits 443
Reducing valve for gas cylinders 102
Reflection 572
 irregular 572-573
 law of 140, 572
 losses by 175, 602
 metallic surfaced screens . . 458
 mirror 573
 regular 572
 semi-regular 573-574
 of various screens . . 460, 463, 465
 visibility of reflected beam . . 573
Reflector, acetylene lamp 127
 gas lamp 126
 in opaque projection 175
 petroleum lamp 122
Reflectoscope 180
Refraction 575-576
 at plane surfaces 575
 at curved surfaces 575
 air to glass 575
 air to water 575
 density and refraction 576
 index of 576
 law of sines 576
 Ptolemy's laws of refraction 576
 Snell and Descartes law of sines 576
Refractive eye defects 659-672
Regulations, fire underwriters, for wiring 499-505
Reichert 82, 83, 93

- Reinhold, use of camera obscura
in eclipses..... 674
- Requirements for good projection
7, 18, 222-223, 313-317, 433
for projection with weak
lights..... 120
- Resistance, to control current... 539
how to get amount needed... 521
unit of..... 477
- Retouching frame..... 29, 203
- Rewinding moving picture film.. 430
- Reynolds..... 374
- Rheostat..... 521-531
adjustable.... 263, 326, 523-524
alternating current..... 69, 532
barrel, salt water..... 525-526
calibration of..... 525
direct current..... 11, 521
energy used..... 533
fixed..... 523
heat developed in..... 523
home-made..... 526-530
installing..... 84, 339, 504, 524
in parallel..... 531
on 110 volt line..... 542
range of.... 263, 326, 523-524
salt water..... 525-526
series..... 531
tin strips..... 529-530
water cooled..... 527-528
wiring..... 504, 524
- Richardson's Motion Picture
Handbook
390-391, 397, 420, 439
- Riley, Dr..... 327, 331
- Ripolin white paint..... 264
- Roaring of alcohol lamp..... 134
- Roaring of lime light..... 115
- Rods for optical bench..... 290
- Roller screens..... 456
- Rooms, for projection..... 439
- Room, apparatus on lecture table
451-452
darkening..... 443
darkness for opaque projection
..... 175
for drawing and photography 321
for micro-projection..... 235
for moving pictures..... 395
form for projection..... 440
light in projection..... 441, 443
limiting size of screen..... 469
- Room, size with sunlight..... 162
tint and decoration..... 440
troubles with..... 471
- Salt and water polarity indicator 511
water rheostat..... 525-526
- Scale, diagrams with opaque lantern
..... 356
wall diagrams..... 355
- Scheiner..... 361, 679
demonstration of retinal
image..... 656
theory of accommodation 658
- Oculus..... 368
- Science..... 211, 327
- Scientific American..... 221
- Schmidt & Haensch..... 102, 126
- Screens..... 454-466
anthracene..... 627, 635-642
- Screen, in alcove..... 443
cloth..... 457
dark spots on..... 309
distance..... 464-471
distance, for high powers.... 282
distance, micro-projection
..... 225, 282
for opaque projection... 181, 454
for high powers..... 272, 282
hinged to meet axial ray.... 449
image, actual size..... 257
with amplifiers and oculars 258
perfection and brilliancy
18, 612-617
image, not photographically
sharp..... 256
with polarized light..... 626
size of..... 464
spectra..... 627, 635, 642
stereoscopic..... 37
with vision experiments.... 654
not light enough..... 301
with metallic surface... 458-463
micro-projection..... 235, 454
moving pictures..... 395, 454
painted cloth..... 455
painted on wall..... 454
paper..... 458
plaster of Paris..... 454
qualities of goods..... 454
reflection..... 460-465
reflection, semi-diffuse..... 459
reflection, white.. 246, 460, 462

- Screen, roller 456
 size 464
 size dependent on distance 466
 size for lantern slides 464
 size limited by room 469
 size for micro-projection 470
 size for moving pictures 395, 468
 size for petroleum lamp 125
 size for sunlight 162
 tipped to meet axial ray 449, 452
 translucent 461
 travelling 458
 troubles 471
 white washed wall 455
- Screws and nuts, thumb 296
- Search-light, use in opaque projection 187
- Sections, masked 253
- Separable, attachments 87, 503-504
 extension connector 87
 wall receptacles 86, 503
- Serial sections, masked 253
- Series, rheostats in 531
- Shadow projection with the lantern 621
- Shadows, alternating current lantern 75
 avoidance of 190
 on screen 53
- Shedd, Dr. on history of Ohm's law 521
- Shellac for sizing 456
- Shield, asbestos paper for 266
 beyond objective 246
 for drawing in dark room 351
 for drawing in light room 351
 objective 31, 111, 292
 on condenser tube 349
 to hold objective 293
- Shock, electric, if on damp floor 59
- Short sight or myopia 660
- Short circuit 47, 496
- Shunt with ammeter 479
 generator 487-488
 adaptability for arc lamp 487-488
 connected to arc lamp 488
- Shutter, automatic fire 420
- Shutters for darkening room 446
 on moving picture machine 406-408, 410, 680
 early use, by Heyl and Muybridge 680-682
 best position 422
 on moving picture machine inside 407
- Shutters, number of wings 425
 outside 408, 410
 setting or "timing" 422
 speed to prevent flicker 423-427
- Size of carbons for house system 87-88, 285, 341
 of condenser for drawings 331
 of drawing, how to obtain 329
 of screen 125, 162, 395, 464, 468-470
- Sizing, and amount for cloth screen 456
- Slide box 271
 cabinet 219
 carrier, individual 31, 32
 lantern 23
 on moving picture machine 404
 push-through form 23
 masks and masking 252-253, 387
 thickness, and position of sub-stage condenser 281, 337
 tray 270
- Slip-slides 36
- Slit for spectra 626, 629-630
 for Abbe diffraction experiments 644
 home-made slit 630
 illumination of slit 636
- Smoke to show the path of light rays 247, 582
- Snap switch 515, 518
- Snell, mathematical law of refraction 576
- Sockets for apparatus 292
- Socket, railing flange and 293
 separable attachments 87, 504
 wall 86, 503
- Sodium peroxide 113
- Sodium tungstate for fireproofing cloth 321
- Source of light for projection 11, 68, 78, 90, 92, 100, 113, 119, 121, 125, 127, 130, 138, 553
 of light in demonstrations in normal and defective vision 652, 670
- Specimen, effect of heat on 252, 607
 for high powers 283
 for high power drawing 338
 for projection 224, 252
- Spectacle makers for supplying trial lenses 651
- Spectra 626-643

- Spectra, absorption and substances for 637-638
 apparatus and material for, 626, 643
 arc lamp for 639
 chemicals to use with 627, 637, 640
 comparison spectra 638
 current to use for emission spectra 639
 electrodes and stuffed electrodes 627, 638
 emission spectra 638-640
 gratings for 627, 632-635
 illumination of the slit for 636
 optical system for 628
 optical quartz system for, 627-641
 photography of 643
 prisms for 627, 631-632, 642
 quartz optical system 627, 641
 screens, white and anthracene for 627, 635, 642
 slit for 626, 629-630
 substance to use for absorption spectra 637-638
 for emission spectra 640
 ultra-violet 641-642
 Spectrograph 642
 Spectrographic camera 643
 Specimen, stage for 239-240
 Spectacles for correcting eye defects 659-672
 prism and colored for stereoscopic screen images 37-38
 Spectrum, showing visible radiation 566
 Speed of shutter to prevent flicker 422-427
 of moving picture machine 420
 Spencer Lens Co., 28, 63, 81, 190, 193-196, 233, 241, 271, 309-312, 354, 355
 Spherical and chromatic aberration 580-583
 Splicing moving picture film 428
 Spots on screen 309
 Spotting lantern slides
 19, 26, 29, 201, 203, 216
 Stage cooling device 239, 240
 Stage, mechanical 239, 241, 242
 in micro-projection 239-240
 water-cell 239, 240, 608
 Stain for tables 289
 Stampfer's magic disc 680
 Standard, aperture 571
 Standard, material for installing arc lamp 502
 Stanley, Geo. C. 375
 Stanton, Theodore 673
 Starch polarity indicator 510
 Starrett (L. S. Starrett Co.) 295
 Stenopaenic slit 651-670
 Stereoscopic screen images 37-38
 Stimson Hall 155
 C. H. Stoelting Co., 33, 141, 185, 302
 Storing lantern slides 218
 Straite, inventor of automatic arc lamp 000
 Stray light, avoiding 380
 Striae, method of demonstrating 647-650
 Style Brief, Wistar Institute 374
 Substage condenser
 232, 271, 347, 619, 626
 achromatic 282, 626
 aperture of 278
 centering 280
 and concave mirror 348
 Köhler method with 278, 619
 objectives with 281
 plane mirror with 348
 condenser, position 337
 position depending on slide 281
 position with different objectives 282
 position with parallelizing lens 277
 reduction of brilliancy by 235, 618-620
 Summaries of the different chapters: I, 64; II, 76; III, 97; IV, 117; V, 135; VI, 164; VII, 198; VIII, 220; IX, 313; X, 388; XI, 438; XII, 472
 Summary, alternating current 76
 direct current lanterns 64
 drawing and photography 388
 heliostats and sunlight 164
 house circuit 97
 lantern-slide making 220
 lime light 117
 micro-projection 313
 moving pictures 438
 oil, acetylene, alcohol 135
 opaque projection 198
 rooms and screens 472
 sunlight 164
 weak lights 135
 Sunlight for opaque projection 174

- Sunlight, for spectra 628
troubles with 162
Support for magic lantern 80
Sun, apparent positions 163
intrinsic brilliancy 138, 613
with projection microscope .. 286
temperature 547
Sunlight, apparatus for 138
condenser for 161
for micro-projection 286
for spectra 628
Switch for opening and closing
the electric circuit 514-518
closed and open 515
double pole 12, 70
double pole double throw
knife switch 297
enclosed 517
end of knife switch next sup-
ply 516-517
for all the wires of a circuit .. 514
installation of 515
knife switch 515
lamp or table switch
12, 15, 71, 238, 263, 288
open and closed 515
position of 516-517
snap switch 515
table or lamp switch
12, 15, 71, 238
Table for drawing with attached
mirror 323-324
for projection 287
for projection with drawing
shelf 325
stain for 289
stand for moving picture
machine 401
switch for opening and clos-
ing electric circuit
12, 15, 71, 238
Talbot, F. A. 391, 439
Temperature, absolute 547
of crater, of arc lamp 546
of sun 547
Tent of cloth for drawing 350
for drawing 166
Terminals, carbon 12, 539
Tests of polarity 506-511
Theory of flicker 426
Thompson, A. T. & Co
80, 180, 191, 286, 303, 334, 687
Silvanus P. History of arc lamp 686
Thorium discs 101
Three-lens condenser ... 61, 587-592
Three-wire automatic lamp .. 238, 263
Thumb screws and nuts 296
Tin for rheostat 530
Tinted glass in combined projec-
tion 177
Tint for projection room 440
Toepler's method of striae ... 647-650
"Schlieren-Methode" 647
Tracing pictures 374
Track 290
fixing to baseboard 290
for optical bench 290
Transformer 533-535
with arc lamp 534
wiring 532
Translucent screen ... 453, 461-462
Transparency and opaque pro-
jection 168-170
Troubles in the various chapters:
I, 46-59; II, 74-75; III, 96;
IV, 114-116; V, 133-134;
VI, 162-163; VII, 195-197;
VIII, 219; IX, 301-309; X,
384-388; XI, 436-437; XII,
471
alternating current 74
direct current magic lantern 46
drawing and photography ... 384
house circuit 96
lime light 114
making lantern slides 219
micro-projection 301
moving pictures 436
opaque projections 195
rooms and screens 471
sunlight 162
weak lights, oil, gas, acety-
lene 133
Trutat 202, 621
Tube of microscope 241
Tubing, metallic 108
for optical bench 290
Tungsten lamp for spectra 628
Twilight vision 121, 175, 444
use with weak lights 121
Two-lens condenser 62, 587-591
Tyndall 621
Uchatius, moving picture projec-
tion (1853) 680, 683
Ultra-violet, anthracene screen
for 627, 635, 642

- Ultra-violet, quartz optical system for 641-642
 radiation..... 567, 641-642
 projection of..... 640-642
 United States Geological Survey 147
 Units of alternating current. 484-486
 Units of direct current..... 475-483
 Units of electricity..... 475, 484
 University of Pennsylvania and animal movement 682
 Unpacking moving picture machine..... 401
 Uranium arc for spectra..... 628
 when in the positive, and when in the negative electrode..... 640
- Valspar** varnish for water cells 205, 264
 Varnishing lantern slides..... 205
 Vertical microscope for high powers 283
 Vertical knife switch..... 516
 Vertical projection..... 33
 Violet lines in arc stream..... 546
 Visibility of objects..... 227
 Vision, daylight and twilight 121, 175, 444
 Vision, experiments with normal defective 651-659
 persistence of in moving pictures
 Visual angle..... 228
 Voigtländer und Sohn..... 226, 250
 Volt and voltage..... 476, 484
 Voltage, alternating current.... 484
 by Ohm's law..... 521
 intermediate 544
 of line and arc..... 544
 of line, voltmeter connections not present in the line..... 475
 Voltmeter, connection for arc voltage 476
 connection to circuit..... 478
 direct current..... 478
 for line voltage..... 475
 for polarity testing..... 508
 soft cored..... 510
- Walgensten**..... 3, 675-677
 Wall diagrams..... 329, 355
 Wall receptacle..... 86, 503
- Water-cell, 13, 15, 18, 57, 63, 71, 161, 194, 222-223, 237, 239-240, 264-266, 276-277, 281-282, 287, 299, 301, 309, 355, 365, 421, 432, 571, 592, 604-609
 absorption of radiant heat not affected by temperature... 606
 effect of alum, etc. in..... 607
 efficiency 568-569
 light and energy absorbed by 604-607
 in micro-projection..... 237
 the microscope stage in..... 608
 how to make..... 264
 need in moving pictures... 421, 432
 with ordinary microscope... 266
 position in micro-projection..... 239, 240
 shadow from..... 57
 stage 239-240
 sunlight 161
 sun and micro-projection... 287
 with two-lens condenser... 365, 421
 Water cooled rheostat..... 527
 Waterhouse, Gen. J. 673
 Watt, and wattmeter. 477, 482-483
 Watts, alternating current..... 485
 equal volts times amperes 477, 521
 Wattmeter..... 482-483
 amperage by..... 483
 connecting 482
 power at arc by..... 482
 power from dynamo..... 483
 White, Dr. A. C. 673
 White-washed wall screen..... 455
 Wiedemann's Annalen..... 647
 Williams, Brown & Earle 59, 91, 107, 130, 131, 182, 183, 300
 Wimmer..... 9, 202
 Winding and rewinding moving picture film..... 430
 Widow in lamp-house 72, 267, 402-403
 Window shades for darkening the room..... 445-447
 Wires for the electric circuit. 496-505
 how to connect..... 503
 insulation of..... 497-498
 wrong polarity..... 51, 506-511
 Wiring the arc lamp, 10, 13, 15, 71, 84, 263, 324, 339-340, 399, 496-535, 639

- depending on amperage..... 496
 for large currents..... 513
 for automatic lamp 512
 for moving pictures..... 399
 for multiple lanterns..... 34, 297
 for a distant supply..... 513
 inductor and transformer... 532
 mazda lamp..... 90
 municipal regulations for... 499
 Nernst lamp alternating cur-
 rent..... 93
 Nernst lamp, direct current.. 94
 on three-wire supply..... 514
 regulations for..... 498-501
 rheostat 504
 small arc lamp..... 82, 84
 Wistar Institute..... 320, 374
 Woodward, use of lime light for
 projection (1824)..... 686
 Wright, Lewis
 9, 105, 207, 243, 245, 256, 282
Zahn, early projection apparatus 679
 Zeiss, 176, 181, 187, 221, 225, 231,
 232, 250, 272, 281, 382, 385, 386
 Zeitschrift für Instr..... 221
 Zeitschrift für wissenschaftliche
 Mikroskopie 221
 Zirconium discs..... 100
 Zoetrope and magic disc... 680-682

RETURN CIRCULATION DEPARTMENT

TO → 202 Main Library

642-3403

LOAN PERIOD 1	2	3
4	5	6

LIBRARY USE

This book is due before closing time on the last date stamped below

DUE AS STAMPED BELOW

LIBRARY USE APR 28 1978

REC. CIR. APR 28 '78

SEP 28 1996
RECEIVED

SEP 06 1996

CIRCULATION DEPT.

UNIVERSITY OF CALIFORNIA, BERKELEY
FORM NO. DD6A, 8m, 4'77 BERKELEY, CA 94720

©5

(N5382s10)476-A-32

University of California
Berkeley

fuka 50
uso *ues*

YD 05061

U. C. BERKELEY LIBRARIES

C057117150

295710
Gage
Q186
G-3
UNIVERSITY OF CALIFORNIA LIBRARY

