

Repositioning Chinatown Las Vegas: Theming Authenticity and a Theory of Boring Architecture

by James Shen

B.S. (Cum Laude) Industrial Design
California State University Long Beach (2001)

SUBMITTED TO THE DEPARTMENT OF ARCHITECTURE
IN PARTIAL FULFILLMENT FOR THE DEGREE OF

MASTER OF ARCHITECTURE AT THE
MASSACHUSETTS INSTITUTE OF TECHNOLOGY

September 2007

© 2007 James Shen, All rights reserved

The author hereby grants to MIT permission to reproduce and to distribute publicly paper and electronic copies of this thesis document in whole or in part in any medium now known or hereafter created.

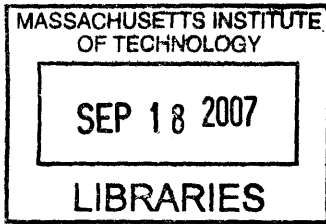

ROTCH

Author: _____ Department of Architecture
August 2, 2007

Certified by: _____ Mark Jarzombek
Professor of the History and Theory of Architecture
Thesis Co-Supervisor

Certified by: _____ Meejin Yoon Associate
Professor of Architecture
Thesis Co-Supervisor

Accepted by: _____ Julian Beinart
Professor of Architecture
Chair, Department Committee on Graduate Students

Yung Ho Chang
Professor of Architecture and
Head of the Department of Architecture
Reader

Alexander D'Hooghe
Assistant Professor of Architecture
Reader

Repositioning Chinatown Las Vegas: Theming Authenticity and a Theory of Boring Architecture

by James Shen

Submitted to the Department of Architecture on August 2, 2007,
in partial fulfillment of the requirements for the Degree of Master of Architecture.

Abstract

China's surging economy compels cities worldwide to employ an extreme form of reverse colonization. A race is in progress to build the world's largest Chinatown. St. Petersburg and Dubai's are under construction and London is talking about it.

Las Vegas belatedly joins the competition.

The city already boasts the first planned Chinatown - although it's just a strip mall. Learning from the success of its Chinatown Plaza, I propose an instant "World's largest Chinatown" in collaboration with the newly formed International Chinatown Development Corporation.

Situated in the capital of theming, Chinatown Las Vegas offers something different. The Paris Hotel Casino doesn't come with Parisians, but Chinatown Las Vegas comes with the Chinese.

How can Chinatown exploit its themed people to market its notorious otherness?

The success of current architectural practices of theming rests on its ability to mask the banal with signifiers of the exotic. The effects of this "shock and awe" approach, however, are short lived.

My project offers an alternative; I begin with the banal to not end there.

Instead of designing every aspect of the new Chinatown, I will populate the site with ready-mades; "carpet theming" by copy-paste.

Preserving all existing buildings on the site, multistory Platforms (parking structures) fill current parking lots. Chinatown Signage (Chinatown Plaza roof multiplied) blankets the site, pinned to the ground by Cores (infrastructure towers).

With:

3 components
1 square mile
1 manual (25 examples)
20,000 Chinese

an infrastructure for guerilla programming is deployed. The architect fastens the parts as the themed population begins the occupation.

Acknowledgements

I gratefully acknowledge both my official and unofficial thesis committees. A special thanks to Meejin Yoon for her patience, and for struggling with me for 4 years. Thank you to Mark Jarzombek for his unique and quirky insights, to Yung Ho Chang for introducing me to the boring and the banal, and to Alexander D'hooghe for his fresh ideas and enthusiasm.

Lucia Allais deserves my unofficial gratitude for her generosity and succinct criticisms. I kindly recognize Tunney Lee for his Chinatown expertise.

I owe many thanks to my listener and friend Tim Campos for helping me test my ideas, and thanks to Non Arkara-prasertkul for his invaluable sources. And a special thanks

to Shirley Shen for printing, binding, and submitting this thesis.

Thank you to Daniel Sinagra of the Planning Department of Clark County, Nevada for his helpful explanations, and for meeting me on such short notice. I also thank Simon Lee for hiring me and allowing me to see a Chinatown architect at work.

A familial hug to my sister Joann, my mother Susan, and my father Peter, who was my inside source to the early developments of suburban Chinatowns.

And finally I thank Jennifer Tran for her generous support and editing, and for visiting the many Chinatowns with me.

Biography

James Shen received his B.S. in Industrial Design at California State University Long Beach in 2001, and worked as a furniture designer for several years.

Contents

1.	New Chinatowns: A History of Theming Authenticity	13
2.	A Comparison of Chinatown Typologies	38
3.	Learning from Relearning from Learning from Las Vegas	46
4.	A Project for a New Chinatown Las Vegas	64
5.	End Notes	162
6.	Bibliography	166
7.	Appendix	172

Repositioning Chinatown Las Vegas: Theming Authenticity and A Theory of Boring Architecture

New Chinatowns: A History of Theming Authenticity

The *Politika Daily* has recently initiated an action to open a Chinatown in Belgrade. The action is entirely justified, having in mind that Belgrade has been known as the most open and most modern city of the Balkan peninsula for a long time. All major world capitals today have either a Chinatown or a Disneyland, or both. This is, anyway, considered one of the criteria for estimating the level of urbanization of any city.

-Mira Markovic, wife of Slobodan Milošević¹

Chinatowns are celebrated as part of the authentic fabric of many cities worldwide. Often major tourist attractions, Chinatowns are as familiar to tourists as McDonalds. The bustling activity, the variety of exotic goods and cuisines of Chinatowns convey a genuine cultural experience. In the US, a number of Chinatowns such as the ones in New York and Boston are located at the sites of their original founding. In these places, the Chinese settled and developed their enclave over an extended period of time. It is reasonable to assume that all Chinatowns that share this “authentic” history have developed through a similar “organic” process; however, this is a misconception.

In fact, Chinatowns have a long history of being planned and built from top down, with city blocks for the enclave constructed all at once. These New Chinatowns have often developed amidst the threat of relocation or restricted development due to discrimination, and have thus welcomed theming as the means for attaining acceptance. Theming is the creation of artificial environments with a specific theme. Themes are usually derived from history, or other cultures, but can also be based on fantasy. These environments usually have no relationship to or are exaggerations of their context.²

New Chinatowns employ theming in two ways:

1. Flamboyant Chinatowns are characterized by kitschy exaggeration of borrowed historic Chinese architectural elements to convey a benign otherness.
2. Closeted Chinatowns are characterized as the careful masking of otherness through the borrowing of contextual architectural elements to blend into the surrounding environment.

Some of the earliest Chinatowns are found in the US, however, for the purposes of this thesis I will concentrate on the expansion of Chinatowns on the West Coast. Accord-

ing to Margaret Crawford the practice of zoning in urban areas began in the East Coast by partitioning meatpacking industries from residential areas and in the West coast by separating Chinese laundries from residential areas. Thus, laws that were made to protect homeowners from the encroachment of retailers were also devised to isolate the Chinese. Typically, Chinatowns were confined to undesirable parts of the city near industrial ports and train stations.

Flamboyant Chinatowns

San Francisco, Los Angeles and Las Vegas

San Francisco

The first Chinatown in the US was founded in San Francisco. Like all Chinatowns of that time, it was not architecturally distinct from other parts of the city, aside from Chinese signs and occasional decorative lanterns. Early Chinese immigrants did not bring building types or styles from China.³ In San Francisco, the need for a unique architectural expression came about after the 1906 earthquake leveled Chinatown. The city had hatched plans to move Chinatown six miles away from its original site, but residents responded with an idea to build a “themed” Chinatown to be marketed as a tourist attraction. The first of



Chinese New Year parade in San Francisco Chinatown, 1885. Source: Yung, Judy. *San Francisco's Chinatown*. New Hampshire: Arcadia Publishing, 2006, 40.



Grant Avenue in San Francisco Chinatown looking south, 1944. Source: Yung, Judy. San Francisco's Chinatown. New Hampshire: Arcadia Publishing, 2006, 81.



Sing Chong Bazaar in San Francisco Chinatown, 1910. Source: Yung, Judy. San Francisco's Chinatown. New Hampshire: Arcadia Publishing, 2006, 44.

its kind in the US, San Francisco's Chinatown was "rebuilt with the explicit intent on the part of municipal authorities, landowners and Chinese merchants to exploit the exotic qualities of Chinese architectural details and ornaments."⁴ Property owners were encouraged to be flamboyant.

Instead of drawing from the traditional architecture of the Guangdong Province of Southern China where early Chinese immigrants were from, Chinese locals hired white American architects who copied the Imperial architecture from the North that more closely matched the Western image of the East. Delighted city officials discussed the building of "an oriental city...with the features outwardly characteristic of a Chinese city, with its pagodas, its temples and its lantern porticoes."⁵ The 'oriental and artistic style' was seen as a successful tool for re-imagining an urban ghetto. This strategy allowed Chinatown to survive unscathed through the widespread urban renewal schemes of Justin Herman, head of the redevelopment agency during the 50's and 60's. Herman's plans had resulted in the destruction the African American Fillmore jazz district, Manilatown, Japantown, and the Irish produce district below Telegraph Hill.⁶

San Francisco's Chinatown was more successful in thwarting dislocation than its younger twin in Los Angeles. De-

clining living conditions led to a 1933 California Supreme Court decision to tear down Chinatown and make room for the construction of the new Union Station. After several years of discussions and false starts, two separate developments, China City and New Chinatown, were finally completed in 1938. China City was created specifically for the tourist trade. The project was built with the support of Christine Sterling, the creator of the successful Mexican themed commercial street, Olvera Street, nearby. China City, promoted and supported by the movie industry, was also called the Chinese Movie Land. The site became a beneficiary of Cecil B. DeMille's film *The Good Earth*, in which materials for the set were imported from China.⁷

It was intended to depict a small Chinese village with an atmosphere of mystery. It featured quaint bazaars, shops, restaurants, lotus pools and gardens, temples and shrines on narrow winding streets and open courts. Visitors would rickshaw around the "city" and enjoy the rituals and traditional theatrical performances.⁸

Additionally, hundreds of Chinese Americans worked in Hollywood motion pictures. It is estimated that at the time, about one out of every 14 Chinese in Los Angeles had worked in Hollywood films.⁹



1940. Source: Smith, Icy. *The Lonely Queue: The Forgotten History of the Courageous Chinese American in Los Angeles*. Los Angeles: East West Discovery Press, 2000, 5.



China City theater where traditional plays were presented in English, circa 1940. Source: Smith, Icy. *The Lonely Queue: The Forgotten History of the Courageous Chinese American in Los Angeles*. Los Angeles: East West Discovery Press, 2000, 51.



Old postcard of New Chinatown, Los Angeles. Source: <http://upload.wikimedia.org/wikipedia/en/thumb/5/51/Newchinatown.jpg/325px-Newchinatown.jpg>

Enclosed by a “great wall,” China City featured small curio shops staffed by costumed merchants, hidden passage ways, such as ‘Dragon Road’ and the ‘Passage of Many Surprises,’ speeding rickshaws, hanging roasted ducks, a theater, the Chinese Junk Cafe, several other Cantonese restaurants, as well as a novel addition to the local pallet, the All-American “china burger.”¹⁰

China City’s success, however, was short-lived. The site survived only two years when it was destroyed in a 1939 fire. Rebuilt, Chinatown was again destroyed by fire in 1949. It did not reopen.



New Chinatown, 1940. Source: Smith, Icy. *The Lonely Queue: The Forgotten History of the Courageous Chinese American in Los Angeles* Los Angeles: East West Discovery Press, 2000.

New Chinatown, Los Angeles

New Chinatown, in downtown LA, was the first Chinese enclave to be owned by Chinese Americans. Civic leader Peter Soo Hoo and several local Chinese businessmen built New Chinatown’s first development, Central Plaza. One of the first pedestrian malls in the US, the project consisted of 18 stores and a bean cake factory. To ensure the safety of tourists and Chinese residents, buildings followed earthquake and fire safety standards, and used modern construction techniques. Squares fronted all sides, wide streets, updated sanitation, and controlled

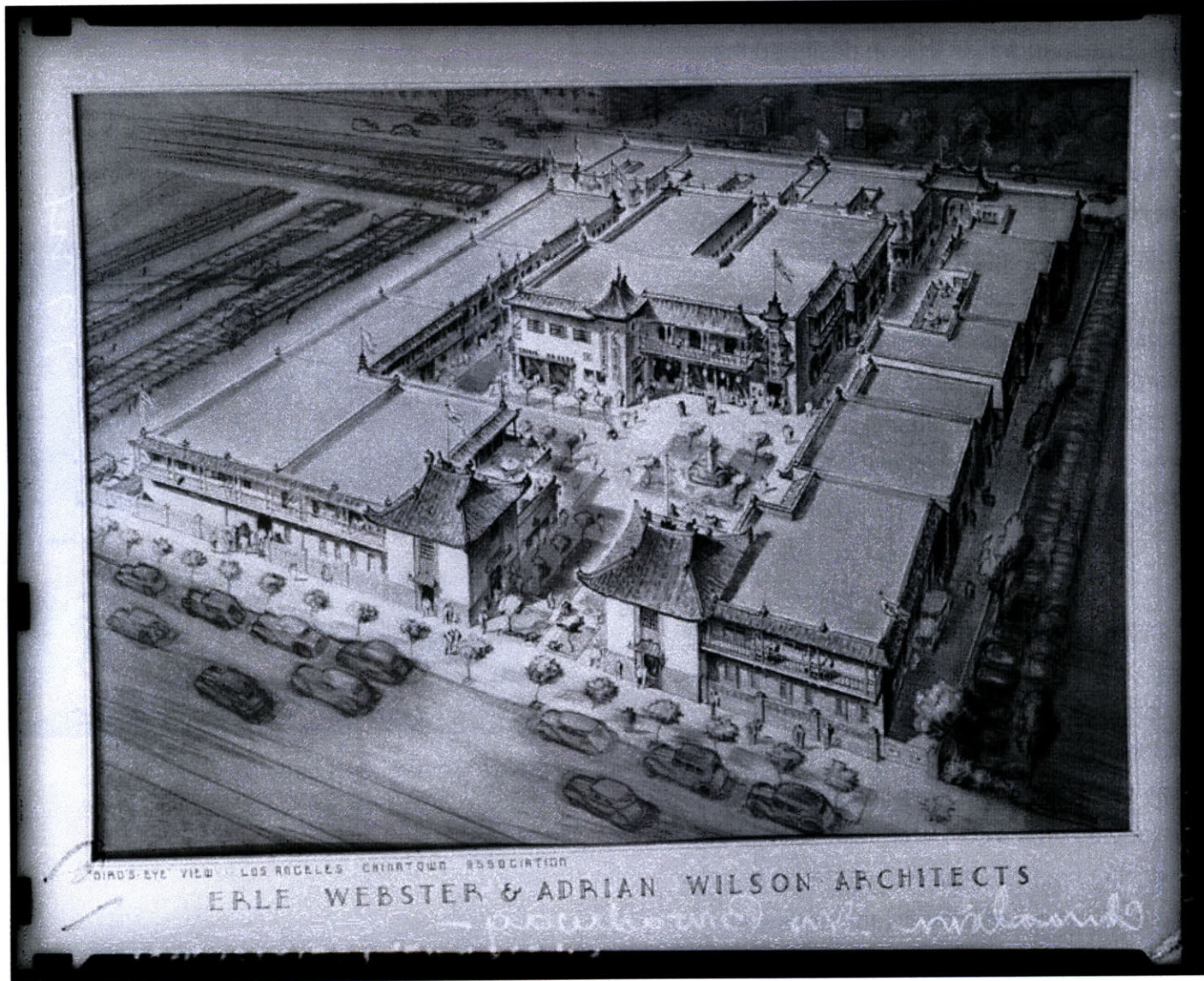

"BIRD'S EYE VIEW" LOS ANGELES CHIANTOWN ASSOCIATION

ERLE WEBSTER & ADRIAN WILSON ARCHITECTS

1000 Wilshire Blvd. Los Angeles, Calif.

Aerial view of New Chiantown Los Angeles, ca. 1938. Source: <http://content.cdlib.org/dynaxml/data/13030/7b/hb9t1nb67b/files/hb9t1nb67b-FID6.jpg>

ingress and egress made for a secure environment. Architects Erle Webster and Adrian Wilson designed the Central Plaza as a fusion of Chinese architectural elements and Modern Western buildings. Due to budget constraints buildings were kept simple. Design efforts were placed in the ornamentation of the roofs. Early examples of theme park construction, elements such as rafters, perkins and brackets were simplified and flattened as interlocking cardboard cutouts. Elaborate detailing and joinery was replaced by enlarged and exaggerated curvilinear silhouettes, colorfully rendered for maximum impact. Neon lights outlining the three dimensional profiles of the roofs were later added to take advantage of their striking character at night.

The West Gate pailou announced the plaza entrance. An ode to authenticity, the superstructure “made partially of 150 year old camphor wood”¹¹ was the oldest arch in Chinatown. Additional attractions included the East Gate or Broadway Gate by Y.C. Hong and the Seven Star Sacred Caverns (copied from a scenic spot in Guangdong Province) and wishing pool by artist Prof. Liu Hong Kay. A willow tree was planted at the pool by Paramount’s Anna May Wong, the Chinese actress born and raised in Chinatown.

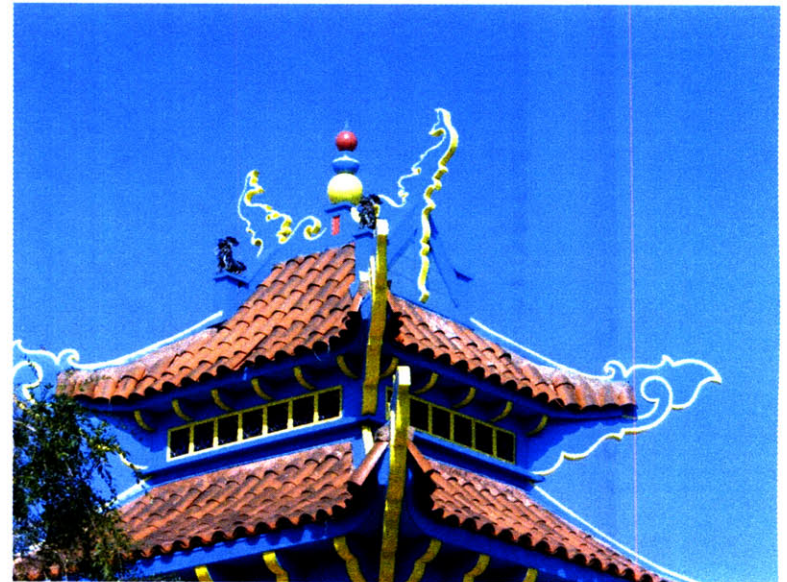

New Chinatown, Los Angeles.

New Chinatown expanded with the success of Central Plaza. Numerous shopping centers were constructed in subsequent decades in the vicinity. Among these are West Plaza (featuring upstairs apartments), Bamboo Plaza, BC Plaza, Chinatown Plaza, Dragon Plaza, Dynasty Century, Far East Plaza, Jade Pavilion, Mandarin Plaza, and Saigon Plaza.

Chinatown, Las Vegas

New Chinatowns have changed since the opening of Central Plaza, but the ethnic themed shopping mall as a model of development is more valid than ever. The Chinatown in Las Vegas, built some 60 years after Chinatown in downtown Los Angeles, also adopts theming in its design. Prior to the construction of Chinatown Las Vegas, no history of a Chinatown existed in the city, making this project unique. There exists, however, a shared history of vice (gambling, prostitution) in the development of both Las Vegas and of Chinatowns. Both Vegas and its New Chinatown were built on speculation, and were constructed from scratch.



Las Vegas Chinatown sign on I-15.

The inspiration for building his Chinatown on a vacant lot a mile from the Strip came to James Chen at the end of a weekend's gambling. He and a friend had driven from Los Angeles with the friend's mother... "She was a religious person," Mr. Chen says. "Buddhist. A vegetarian. She was quiet the whole trip – just watching. As we were leaving, she finally said, 'I guess this is what heaven is like.'¹²

Built in 1995 and located on Mountain Spring Road, a suburban area one mile from the Strip, Chinatown Plaza is the "first master planned Chinatown." James Chen refers to the fact that the project opened on a site with no Chinese people. In 1990, the whole state of Nevada had a population of only 6,618. Mr. Chen asks rhetorically in a Wall Street Journal interview "Do you want population before you build, or do you build to attract population? You don't want to be late. You want to be early. That's the game."¹³ Census data for Clark County shows a rise of the Asian population of 139.3 percent between 1990 and 1999 to a population of 64,636. The Asian population in the state of Nevada experienced a 123.7 percent increase in the same period, the largest of such increase in the nation.¹⁴

In order to court the city's approval for the New Chinatown, architect Simon Lee, a Taiwanese immigrant like Mr Chen, devised an extravagantly designed shopping mall. Adopting "authentic Tang Dynasty architecture," Lee's roofs are variations of ornamented roofs supported by

painted stucco columns. The collection of 34 shops and restaurants comprise the 85,000 square footage of retail space. The complex is organized in a U-shape around a large parking lot on an eight acre site. Set on a central axis with the mall, fountain and statue of Xuan Zang's Journey to the West, the Chinese Gate marks the entrance to Chinatown Plaza.

The first phase of Chinatown Plaza consists of a two-story structure that lines the west side of a parking lot. The structure follows a dumbbell shopping mall arrangement. The north side is anchored by a Ranch 99 Supermarket, the south by an indoor shopping area, a Sam Woo's restaurant is located in between. The second phase comprises two single story buildings that flank the parking lot on the north and south sides. A covered pedestrian walkway lines the shops.

Vegas has greatly supported the development of Chinatown. In 1999, four years after the opening of Chinatown Plaza, the city erected a sign on the I-15 to officially recognize the area as Las Vegas' Chinatown. By this time, another Asian shopping center, financed by the Chinatown Plaza contractor, opened just west of Chinatown Plaza. The following year a series of industrial warehouses on the East side of Chinatown run by Harsch Realtors, an



Chiantown Plaza, Las Vegas.

American developer based in Phoenix, underwent a major “Pan-Asian” themed renovation. Recognizing the potential in being next to Chinatown Plaza, Jordan Schnitzer, president of Harsch said “let’s do the whole thing Asian. Look this is a themed town. Our other tenants wouldn’t mind at all.”¹⁵ The remodeling essentially doubled the size of the New Chinatown. The price per square foot of land in the area has risen from \$5 to \$25 since the opening of Chinatown Plaza. Today countless projects cover a stretch of the 3.5 miles along Spring Mountain Road with representation from every major Chinese supermarket chain from Los Angeles.

In addition to economic success, Chen hoped that a commercial center would also represent Chinese culture. Combining theming and edutainment, he lined the shopping center with display panels containing snippets of Chinese history and culture. To foster a sense of community, Chen started a Chinese New Year’s festival in the parking lot. Newman writes: “He puts on a Miss Chinatown beauty pageant, holds open houses for school kids, arranges free flu shots for the elderly and offers help with their tax returns.”¹⁶ The success of Chinatown Plaza is due to the incredible amount of Asian tourists who frequent Las Vegas from cities like Los Angeles and San Diego. Chinatown Las Vegas is really the eastern most outpost of a string of

New Chinatowns that extend from Los Angeles. Busloads of tourists arrive every day in search of “real” Chinese food as they take a break from gambling. Chinatown Vegas is “usually jammed with Asians. In a desert city fixated on fantasy, Chinatown Plaza has matured into an oasis of authenticity.”¹⁷

Chinese tourists are a predictable and coveted group in Vegas. During the two weeks of Chinese New Year, there is a sharp rise in visitor spending at casinos. The first weekend, for instance, of Chinese New Years is “the second-biggest betting weekend of the year”¹⁸ at the MGM Mirage. Casinos transform their appearances to woo the Chinese:

Casinos drape enormous banners with New Year’s greetings in Chinese across their porte-cocheres and add tables for baccarat and pai gow poker, two games favored by Asian gamblers... They hold parties where managers hand invited guests red envelopes stuffed with money or special gambling chips adorned with the animal symbol of the year. At Caesar’s Palace, Celine Dion and Elton John are given a few days off so that Jacky Cheung, the Canto-pop sensation, can hold forth in the 4,100-seat Colosseum.¹⁹

Chinese restaurants along the strip cater to these high rollers of the moment, extending their hours and transforming their choices on their menus or the names of dishes “with lucky or upbeat words.”



Chinese New Year celebrations at the Bellagio Hotel Casino in Las Vegas.

The Asian developer Andrew Lai, backed with major overseas capital, has purchased land across the street from Chinatown Plaza. Lai proposes the largest project on the site, which measures 20 acres. consisting of 300 000 square feet of retail space. Named Dragon City, the development also includes a 2500-unit condominium-hotel, 300, 000 square feet of retail space, a 2500-unit condo-hotel with twin Chinese- themed housing towers. He has worked with the city to change the zoning of the area from light industry to commercial to commercial gaming. Together they have gained approval for an Asian District

Overlay consolidating various Asian themed developments including Korean, Vietnamese, and Indian projects. There seems to be no end in sight for the expansion of Las Vegas' New Chinatown.²⁰

Closeted Chinatowns

Precursor: The 'Chinese Renaissance' in China

The tradition of theming in Chinatown can be traced back to the beginning of modern Chinese Architecture. In "Learning from Chinatown: the Search for a Modern Chinese Architectural Identity, 1911-1998," Anne-Marie Broudehoux argues that the "Chinese Renaissance" or "Chinese Style" was developed by a Canadian Architect Harry Hussey and made popular by American Henry Murphy, and that "the history of Peking is the history of China in miniature." Both architects were commissioned by American institutions to make buildings that were "not foreign to China's best ideals and aspirations" and would "become part of a developing Chinese civilization."²¹ Hussey's Peking Union Medical College, commissioned by the Rockefeller Foundation in 1916, incorporated modern facilities of the building with the character of the old city. The themed architecture was to disguise the foreignness of the institutions rather than set it apart from its context.

Similarly, Murphy's Yale-in-China Campus in Changsha was to ensure that "every possible step be taken to conserve the architectural heritage of old China, blending it with the structural requirements that the modern world makes today." Inspired by the Ming Dynasty architecture of the Forbidden City, Murphy was unbothered by Beijing's 1300 km distance from Changsa, and the two cities' very different architectural styles. He applied the Chinese Style for aesthetics reasons with little concern for accuracy of copying, hoping to elevate his architecture beyond the common "crowning of modern buildings with Chinese roofs." However, Murphy's treatment of the elevation was just as superficial and contrived as the works he derided.²²

As a foreigners reinterpreting Chinese architectural styles, both Hussey and Murphy and the institutions for which they worked, paid lip service to creating an authentic Chinese style. Instead, this contrived architecture fulfilled the institutions' guise of familiarity, and served the political stance of the architects. For Broudehoux, Murphy's "concern for keeping intact what he saw as the essence of Chinese identity may thus have been driven by a fear of losing this sanctuary of 'Otherness,' essential to the constitution of Western identity, and thus to his own self-definition."²³ Adverse to the Modernist Movement that

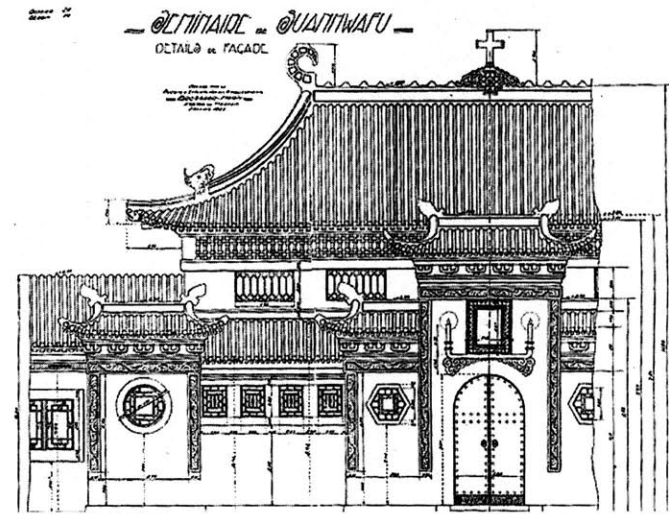

Facade details of the Seminary of Suanhwafu (location unknown), ca. 1932. Source: P. Ghesquières, *Collectanea Commissionis Synodalis*, 1941, 72.

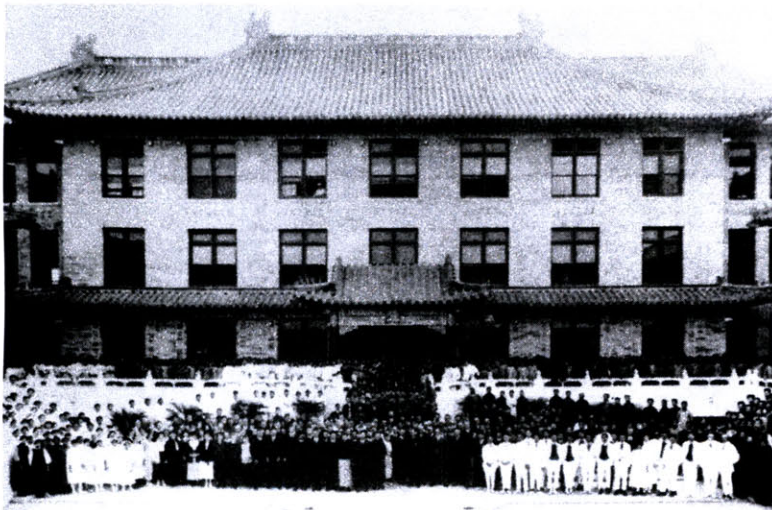

The Pekin Union Medical Colledge, Beijing, by Henry H. Hussey, 1916-1918. Source: Rowe, Peter G. and Seng Kuan. *Architectural Encounters with Essence and Form in Modern China*. Cambridge: MIT Press, 2002, 67.

was taking over Europe, many North American architects instead freely applied period-styles to their buildings. Ornamentation was independent of structural and organizational components, and switching from style to style based on the image to be communicated was standard practice. Murphy, for instance, used an American Colonial Style in the design of Yale-in-China buildings that were used predominately by Americans or ones which represented Western technological progress. Buildings which were used mostly by Chinese students, such as dormitories and libraries, were designed in the Chinese Style.²⁴

Significantly, the Chinese Style reappears throughout the last century in China, each reinvention owning its own political rhetoric. In the 20s, it became the national style for the new Republican government; in the 50's, Soviet advisor inspired the "Big Roof" style as a way to "promote a sense of national unity while expressing local identities;" and in the 80s and 90s a postmodern form of the style was forced onto architects as "it became virtually impossible to obtain a construction permit in Beijing without crowning a building with some "Chinese" decorative elements – generally a glazed tile roof." Today, the borrowing of elements from traditional Chinese architecture is found anywhere from government buildings to Starbucks. Broudehoux describes the reduction of architectural elements to "mere

icons of 'Chineseness' and the "Chinatownization of Beijing, Disney-Style." Residents of the city have themselves derided new buildings as "wearing a Western suit with a Chinese hat."²⁵

Most importantly, Broudehoux stresses the similarities between the architectural style that developed in Beijing and Chinatown architecture of the same period in the US. In both instances, buildings were cloaked to blend in with their surroundings. American architects of early Chinatowns were adept at borrowing from fashionable 'orient' styles of the time. In the following section, I will show that the theming of Chinatowns in many situations drew from sources other than China. Instead of exaggerating otherness to the point of kitsch in San Francisco, Los Angeles and Las Vegas, Chinatown architects - like Hussey and Murphy in Beijing - also used theming to conceal otherness.

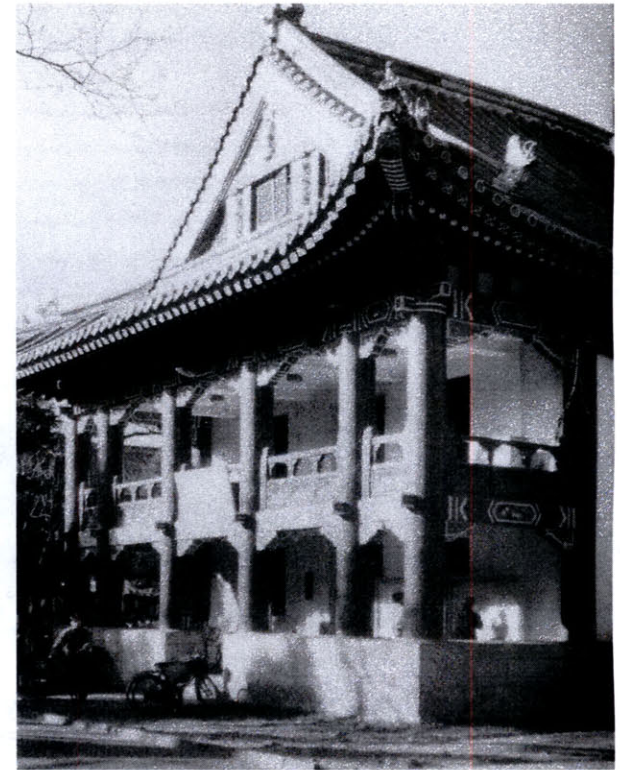

Building on the Yenching Campus, Beijing, by Henry K. Murphy, 1918-1927. 66

Closeted Chinatowns: Suburban Los Angeles

Monterey Park

This brings us to a 60-year gap in history between the opening of LA's New Chinatown and the Chinatown in Las Vegas. In the 70s, the influx of "boat people" from Vietnam mainly of Chinese descent, and Taiwanese and Hong Kong business needed to be accommodated. Unlike the residents of downtown Chinatowns, this new wave of immigrants was highly educated, politically aware and often had disposable income.²⁶ As traffic congestions and property costs in LA's Chinatown rose, and the standard of living decreased, Chinatown business owners looked elsewhere to expand. Affordable housing and prospects of suburban comforts drove the Chinese community eastward from downtown.

America's first suburban Chinatown opened in Monterey Park. The 1980 census documents the city as the first in the US with a majority Asian minority population.²⁷ Its proximity to Chinatown and the relatively low cost of housing was attractive to immigrants.

Today Monterey Park is one of many satellite Chinatowns that populate a stretch parallel to the East-West 60 and 10

Freeways. Congregating in an area called the San Gabriel Valley, these New Chinatowns include Alhambra, Arcadia, Rosemead, Rowland Heights, Hacienda Heights and San Gabriel. But cheap housing, close proximity, and the new wave of immigrants do not completely explain the phenomenon of San Gabriel Valley. The development of suburban Chinatowns should be studied via the expansion of Chinese supermarket chains, and in particular the 99 Ranch Supermarket chain.

The opening of the first Asian supermarkets by the Wu brothers, ethnic Chinese Vietnamese immigrants, instigated the growth of Little Saigon in Orange County and the New Chinatown in Monterey Park. Pioneers in developing the Asian supermarket, the Wu's, however, were not successful in expanding much further as they were family-run.

On the other hand, the success of the 99 Ranch Supermarket is due in large part to the company's adoption of an American corporate model. Also originally founded in Little Saigon, the first 99 opened in 1984 in a shopping center developed by Taiwanese businessman Roger Chen and Frank Jao, a Chinese-Vietnamese refugee, considered the father of Little Saigon. Jao is responsible for financing much of the development in what has become the largest Vietnamese community outside of Vietnam.

After many unsuccessful attempts at procuring land in the Chinatown area of Monterey Park, Roger Chen opened his supermarket in Montebello, just outside of Monterey Park. After the opening of Chen's supermarket, the Chinese restaurant Sam Woo opened in the same plaza. Although located far from other Asian businesses, these two businesses sat near the off-ramp of the 60 freeway, and were thus easily reached.

With over 12 stores on the West Coast, Sam Woo is another highly successful Chinese chain originating from Los Angeles. Several shopping centers in suburban Chinatowns are anchored by both Sam Woo's and 99 Ranch Supermarkets. Without these two fixtures, the Chinatown Plaza in Las Vegas would not be possible. This formula – a Ranch 99, a Sam Woo, and proximity to the freeway - proved successful, and has been repeated by Chen and the owners of Sam Woo at other Chinatowns and Asian commercial areas. The location of these supermarket anchored shopping centers planted the seeds for the expansion of these suburban Chinatowns.

Chinatowns are always located near transit nodes. The early Chinatowns of New York and San Francisco were located by the port, while in Los Angeles, Boston, and Chicago, the Chinatowns were founded near prominent train

stations. The highway system has allowed Chinatowns to move into the suburbs, and the Chinatown bus networks now connect Chinatowns along the East Coast and those along the West Coast.

Roger Chen's business has grown to become the largest Asian supermarket chain in North America with over 30 stores in the US and Canada. Ranch 99 supermarkets have become synonymous with New Chinatowns, as they are the main anchors that support the expansion of Chinese businesses in these new territories.



Asian Garden Mall, Little Saigon in Westminister, California.
Source: <http://www.flickr.com/photos/xanderoc/185788413/>

Significantly, these New Chinatowns do not resemble the layouts of the historic downtown Chinatowns of San Francisco and New York, but take the form of strip malls. With large parking lots, these New Chinatowns accommodate the car, and with covered outdoor areas, they are also pedestrian-friendly.²⁸

San Gabriel Square

Many of the San Gabriel Chinatowns experienced the



99 Ranch Supermarket anchored shopping center developed by Roger Chen in Malpitas, California.

same xenophobia as historic downtown Chinatowns. Due to the lack of density in the suburbs, these Chinatowns in the San Gabriel Valley would be unable to create a draw to become tourist destinations. Furthermore, marketing their 'Chineseness' to justify their existence to the community was not practical. Therefore early Chinese businesses were based on infilling, the conversion of existing structures into Chinese businesses. Like many parts of historic Chinatowns, the architecture of these businesses was not distinguishable from their American counterparts. As their ambitions grew, Chinese developers constructed entirely new developments.

In 1989, Roger Chen began construction on San Gabriel Square, a large shopping center anchored by a 99 Supermarket. At the time, the city desperately needed sales tax revenue, and welcomed Chen's development. However, residents resisted the project in fear of the ghettoisation of their neighborhood. Chen convinced the city that his Chinatown would help regenerate the area without alienating the existing community. San Gabriel Square became the largest development of its kind. An LA Times reported: "The result was a sort of instant Chinatown, unburdened by the legacy of older Chinatowns, which were often born out of involuntary segregation and evolved into tourist traps to survive." Dubbed the "Great Mall of China", San

Gabriel Square has become the center of the San Gabriel Valley, and a source of pride for the Asian community.²⁹ When Bill Clinton came to the area for campaign fundraising in 1992, his luncheon was held in San Gabriel square. “We could have had it in a downtown hotel, but we wanted to show what Asian Americans have built.” Clinton left that day with \$250,000 in donations.³⁰

The 220,000 square foot San Gabriel Plaza was also designed by Simon Lee, the architect responsible for Chinatown Plaza in Las Vegas. To gain approval for the project from the design review board, the plaza followed a Spanish Colonial style to match the surrounding suburban aesthetic, architectural ornamentation not indicative of the Chinese nature of the shopping center. In addition,



San Gabriel Square shopping center. Source: http://www.milpitasquare.com/San_Gabriel_at_dusk_large.jpg

the buildings are set on the back edge of a large triangular parking lot hidden from the street by a row of large trees.

Despite the difference in decor between the San Gabriel Plaza and the Chinatown Plaza in Las Vegas, both of Simon Lee’s projects adhere to the same spatial and programmatic organization. In fact, San Gabriel Plaza is a precursor to Chinatown Plaza. The plaza plan is L-shaped and lined with a covered pedestrian promenade. Lee’s design offers visual accessibility of all parts of the complex, creating a sense of security. The plaza was to become a place for families.

The density and verticality of the project set it apart from nearby developments. The complex is mostly two stories

high. As in Chinatown Plaza, most restaurants of the San Gabriel Plaza are located on the second floor. Upper levels of shopping plazas are more difficult to rent out, and since restaurants attract more customers, their placement forces visitors to walk upstairs. Significantly, the ground level is then freed up for other commercial use.

A three-story department store named Focus sits at the elbow of the L-shaped plan of San Gabriel Square. The plaza is the only development anchored by an Asian department store. The 99 Ranch Supermarket anchors the East Wing. San Gabriel Square has two Sam Woo restaurants, one on the ground floor of the North wing and the other atop Focus.

Simon Lee

Responsible for both Chinatown Plaza in Las Vegas and San Gabriel Square, Simon Lee is the southern California's Chinatown architect. Educated in Taiwan, and therefore well-versed in the "Chinese Style,"³¹ Lee completed his masters at UCLA, and has made a name for himself in the Chinese community by amassing an enormous portfolio of projects ranging from motels to car dealerships to whole suburban housing tracts. He has demonstrated his versatility for various architectural styles in both San Gabriel

Square and Chinatown Plaza.

Part of Lee's success derives from his reputation for swaying design review boards after just one meeting, saving clients considerable time and money. This has been important to developers who want to build projects in communities with limited minority businesses. Therefore, Lee's practice has also attracted clients of ethnicities other than the Chinese.

Whether Chinatowns are themed flamboyantly or in a closeted manner, the issue of authentic architecture is usually a peripheral matter. Authenticity is important to the extent that it allows Chinese communities and businesses to exist. Without resistance from "outsiders," Chinatowns would develop without much ornamentation, as occurred with old infill Chinatowns of San Francisco and Los Angeles. Furthermore, in New York the architecture of the historic Chinatown in Manhattan displays few examples of Chinese ornamentation.

The Age of New Chinatowns

According to Broudehoux, architecture in China is completely commodified as "city authorities now capitalize on the world idea of 'Chinese' for monetary gains."³² Not



The office of Simon Lee on the second floor of his San Gabriel Square shopping center.

surprisingly, the current Chinatown building boom is a lucrative business venture worldwide. The city of Milwaukee cites Chinatown Las Vegas to support an effort to build a Chinatown of their own. Chinatown Plaza is an example of how “newer Chinatowns have been created in a more top-down fashion...It is one reason, some say, that Nevada’s Asian population has grown.”³³ Like many other cities, Milwaukee is interested in tapping into the growing Chinese economy. The prospect for updating the city’s image is also attractive. Min Zhou, a sociology professor at the University of California Los Angeles says, “A successful Chinatown in Milwaukee could stimulate tourism and counter the stereotype of Milwaukee as homogeneous.”³⁴ To replicate the success of Chinatown Las Vegas, the backers of the Milwaukee project hope to open a 99 Ranch Supermarket on their site.

Chinatown Plaza ‘knockoffs’ are also slated for other parts of the US, like in Albany, New York, where it is pegged as a downtown revival project.³⁵ Similar Chinatown plazas exist in Rockville, Maryland (2003), Austin, Texas (2006), Plano, Texas (2007), Madison Heights, Michigan (2007), and several within the last decade around greater San Francisco and Toronto.³⁶

This trend in developing New Chinatowns also occurs outside of North America. In Glasgow, a 600,000 pound conversion of a mall into Chinatown opened in 2003. In Budapest, a 200 million Euro Chinatown opened that same year with backing from Viennese investors. In 2006, a 90 million dollar New Chinatown opened in Darwin's Central Business District in Australia.³⁷

New Chinatown projects have reached an unprecedented scale. Consisting of more than just a mall or supermarket,

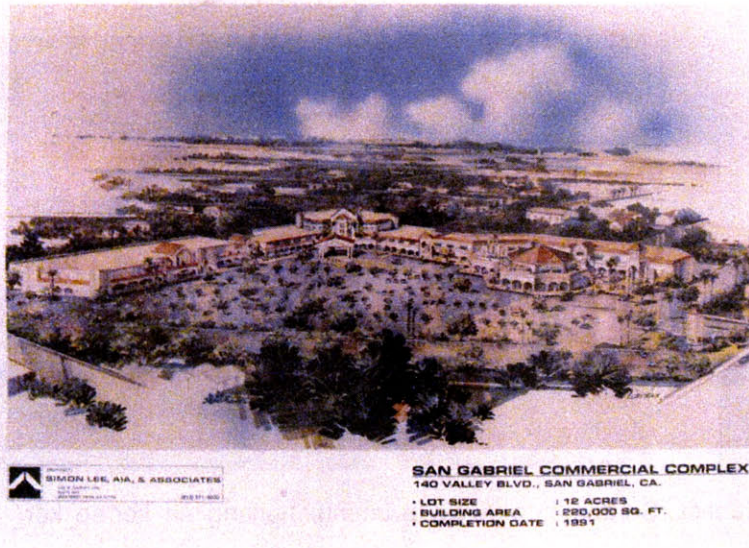

Rendering of San Gabriel Square, Los Angeles. Source: Simon Lee.

Chinatowns are built to become centers for international trade. For instance, due to the success of the Viennese-built Chinatown in Budapest, Asian investors will help transform the complex into the largest wholesale and exhibition center in Central Asia by 2010.³⁸

A larger Chinatown project is currently under construction in Dobroiesti, Romania. At the cost of 1 billion Euros, it will be completed in 2014. This 1 million square meter project will include a 16-story tower with 100,000 square meters of



Rendering of Chinatown Plaza, Las Vegas. Source: Simon Lee.

exhibition space, 600 new apartments, and a commercial area of 5,000 shops.³⁹

Dubai, however, is claiming the world's largest Chinatown as part of a 21 hectare project called International City. The 1.4 kilometer long Dragon Mart, already open, contains over 3,000 Chinese Companies and traders. A large residential area and a replica of Beijing's Forbidden City is under construction.⁴⁰

More mind-boggling is a New Chinatown under construction in St. Petersburg. The 1.5 billion dollar project is to be built on a 206 hectare site in the Krasnoselsky district. The Chinatown will be a full-fledged city.

The complex includes a 35,000 person residential neighborhood, a commercial and trade zone with hypermarkets, boutiques and restaurants, a hotel office center, and a commercial park...The area will feature exhibition halls, clubs, sports fields, a water park and outdoor stages...It



Glasgow's New Chinatown, in Cowcaddens, 2003. Source: <http://www.theglasgowstory.com/image.php?inum=TGSA05296>

Asia Center, Budapest. Source: http://www.asiacenter.hu/lang_en_ker/en_ker_s_int.php

will have 4 general education schools, 5 nursery schools, 6 libraries, a hobby center for children, an art school, 2 clinics, and even a first aid station. The Chinese call their project the Baltic City or the Baltic Pearl.⁴¹

Responding to much opposition from citizens an official in the Krasnoselsky administration is quoted as saying that the critics “do not clearly see the economic, demographic or commercial aspects of the project.”⁴²



The completed Dragon Mart mall and the Chinese residential district under construction. International City, Dubai. Source: <http://www.pbase.com/bmcmorrow/dubaiaerials&page=allJPG>



The front entrance of Dragon Mart mall. International City, Dubai. Source: <http://i.pbase.com/o6/16/724016/1/82007070.uAy5A9qf.P6236243.JPG>



Rendering of St. Petersburg Chinatown. Source: <http://petersburgcity.com/news/city/2004/12/20/baltic2/>

A Comparison of Chinatown Typologies

Example 1

Standard commercial logic says that greater storefront along major paths of circulation equals more business. Chinatown offers an alternative logic. I have found many instances in Chinatown of hallways lined with stores that end in cul-de-sacs leading deep into an interior of a building. These hallways lie not on the busy streets, but perpendicular and away from them. The lack of street frontage may be beneficial for certain Chinatown businesses, for example those selling counterfeit goods.

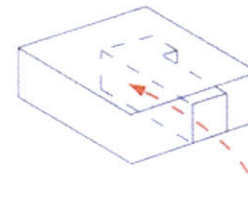

Cul-de-sac / Deep Program



Chinatown, New York



Chinatown, Las Vegas Pacific Asia Plaza
Upstairs cul-de-sac

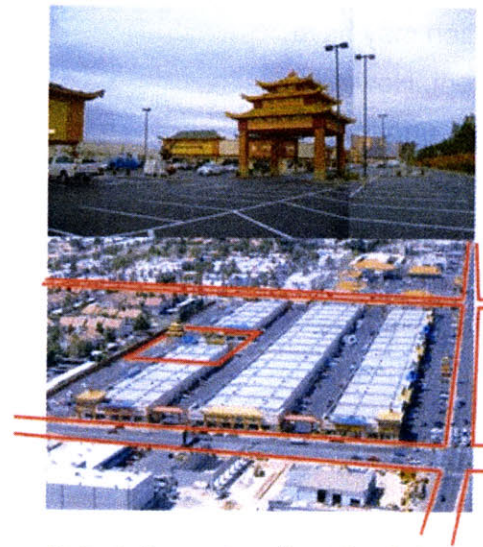

Chinatown, Las Vegas Center at Mountain Spring Road
A retail cul-de-sac located in the middle
of a parking lot with no street traffic

Example 2

Standard commercial logic says that commerce should be located on the ground floor for greater accessibility. In Chinatown it is common to find restaurants that exist on floors above street level. This condition may have transpired due to low rent. However, these restaurants have found this position beneficial. The “hidden” restaurants must then be “discovered”, especially by non-Chinese customers who cannot read the language.

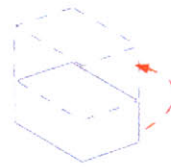

Upstairs Shops

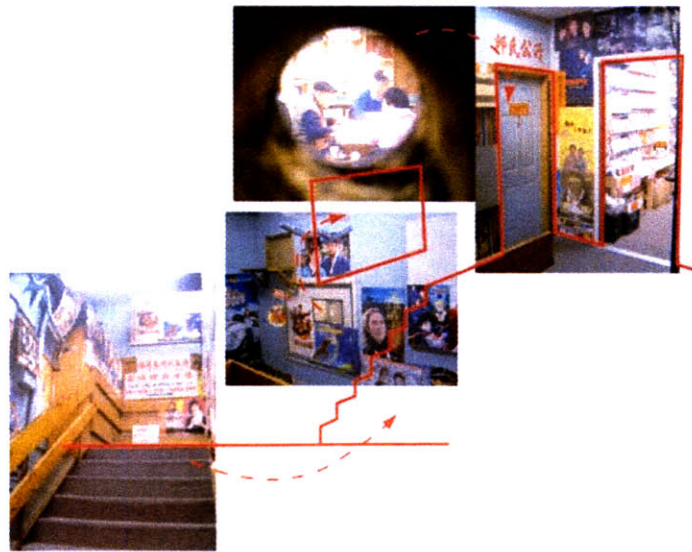

Chinatown Boston

Upstairs video store and Mijing room equipped with outlook window next to the stairway.



Chinatown, Boston

Upstairs food court with a variety of cuisines



Chinatown, Las Vegas

Pacific Asian Plaza

Example 3

Standard commercial logic says that in order to retain the well-crafted image of a retail outlet, any retail adjacent to it should contribute to that image. For example, Burberry should be placed next to a Gucci. In Chinatown, it is common to find extremely contrasting programs next to one another, but also such diverse programs located one within another. For example, in Chinatown Boston, a Vietnamese sandwich shop which sells sandwiches for \$1.50 sits within a cramped space carved out, and loosely partitioned from a jewelry store. Both businesses belong to the same owner.

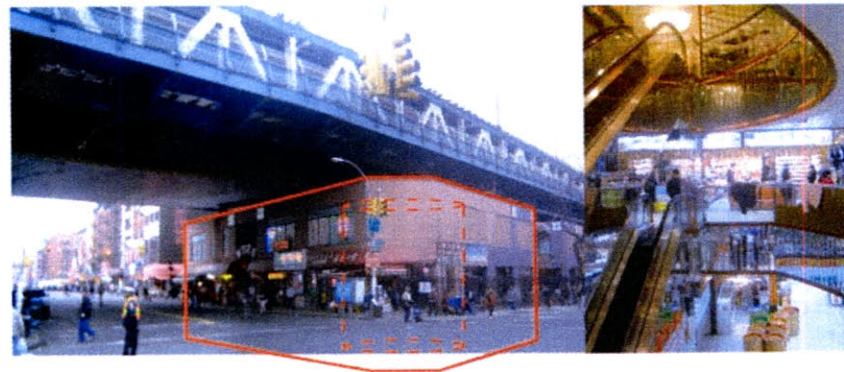
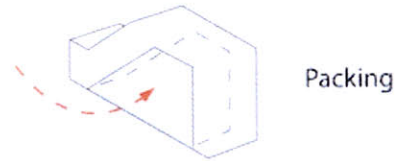

Chinatown, New York

Forsythe and 88 East Broadway

A three-story mall tucked underneath the Manhattan bridge houses a restaurant on the top floor, shops on the ground floor, and a market on an underground floor serves as an anchor for the Chinatown Bus Terminal



Chinatown, Boston

A Vietnamese sandwich shop under the same owner are packed together in a single commercial space



Little Saigon, Los Angeles

Asain Garden Mall
A Buddhist shrine is placed on a second level island with small informal stalls, directly underneath is a food courts surrounded by shops

Example 4

Standard commercial logic says that in order to maintain a bus system, a bus company must rely on built terminals as transfer stations. The Fung Wah Bus, the first Chinatown bus line, began its operations in 1995 between Boston and New York with no structures serving as bus terminals. Today the Chinatown bus network is extensive. The intersection of Forsythe St. and 88 East Broadway in Chinatown New York is lined with rows of buses, and serves as a major transportation node. The node is conveniently located near the East Broadway subway station and next to the Manhattan Bridge with a large Asian mall tucked underneath serving as its anchor.

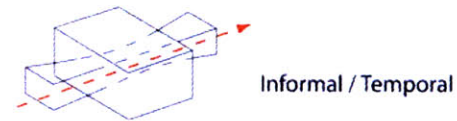

Chinatown, New York
Forsythe St. and 88 East Broadway
Chinatown Bus terminal



Chinatown, Boston Selling fresh seafood from truck



Chinatown, Las Vegas Chinatown Plaza
The parking lot of Chinatown Plaza is intentionally large in comparison to other developments in the area and can therefore accommodate tour buses.

Learning from Relearning from Learning from Las Vegas

Las Vegas sits at a contentious crossroads between Architecture and the forces of late capitalism. Although not unique to Vegas, the architect's traditional role as public servant is outlandishly twisted and intertwined with the culture of commodity in Sin City. In this suburban landscape, the American obsession with individualism and identity is amplified: the Strip is a dense array of distinct casino resorts, each with its own instantly recognizable image. In this section, I outline the development of Las Vegas architecture over the last 50 years within the framework of a project of authenticity.

Robert Venturi and Denise Scott Brown's 1972 publication of *Learning from Las Vegas* embraces image over form in architecture. Seminal in the discussion of American Post Modernism, the book documents and celebrates the city's vernacular architecture. The Venturi and the Scott Brown describe Vegas of the late 60s as a road of attention-grabbing neon signs and vast parking lots, behind which were flashing facades fronting generic buildings. Inspired by this "architecture without architects," the pair separates all of architecture into two categories:

1. Where the architectural systems of space, structure, and program are submerged and distorted by an overall symbolic form. This kind of building-becoming-sculpture we call the **duck**

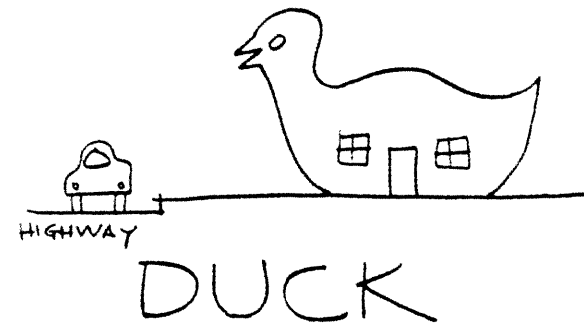

New Chinatown, 1940. Source: Smith, Icy. *The Lonely Queue: The Forgotten History of the Courageous Chinese American in Los Angeles*. Los Angeles: East West Discovery Press, 2000.

2. Where systems of space and structure are directly at the service of program, and ornament is applied independently of them. This we call the **decorated shed**.⁴³

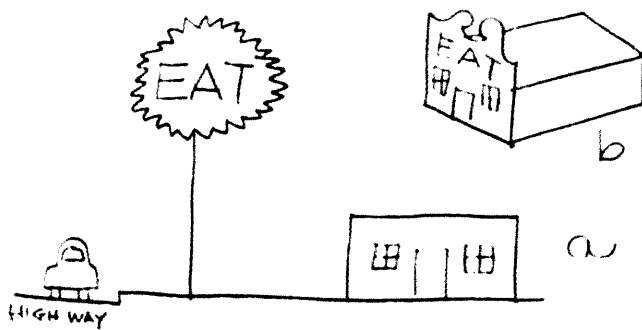

New Chinatown, 1940. Source: Smith, Icy. *The Lonely Queue: The Forgotten History of the Courageous Chinese American in Los Angeles* Los Angeles: East West Discovery Press, 2000.

Learning from Las Vegas raises two crucial concepts - easily misunderstood and neglected - that guide my design thesis: incomplete imaging in the service of flexibility, and the repositioning of modernism within the image-making machine that characterizes postmodern society.

Venturi and Scott Brown's comparison of Crawford Manor and their own Guild Hall elucidates the differences between the duck and the decorated shed. The structure and program of Crawford Manor – a duck - is excessively manipulated to produce the privileged Modernist image of technological advancement. They cite Rudolph's use of structurally integrated cantilevering balconies, non-structural but structural-looking piers, the mortar joints of reinforced concrete, and the over-articulated programmatic spaces that protrude from the plan.⁴⁴ The building is a singular ornamental object, making it impossible to discern the "signifier" from "the signified."⁴⁵ Importantly, Venturi and Scott Brown do not dislike inconsistencies or contradictions, but disapprove of their masking.

Guild Hall, on the other hand, is basic in construction and follows a floor plan typical of 1920s apartments. The sole purpose of architecture, according to the duo, is to provide shelter. The description of Guild Hall is focused on the

building's façade to emphasize its signifiers. They detail banal elements like the non-structural arch that is exposed as such, "typical" double-hung windows - slightly larger and artistically composed to create optical tension - a billboard announcing GUILD HALL, and a TV antenna ironically celebrated in gold and capping the facade. In short, the building's exterior decoration is treated as "appliqué" on a otherwise expressionless structure, creating a frontal image as the primary means of communication.

Reinhold Martin writes:

Translated into the rudiments of an aesthetic theory, in a "duck" form and function (as well as meaning) are inseparable; in a "decorated shed" their relationship is contingent, and thus a (sometimes literal) gap opens between them.⁴⁶

This "gap," I believe, lies at the core of Venturi and Scott Brown's preference for the decorated shed. In a 2000 interview with the couple, Rem Koolhaas questions this "conceptual space" in their work. Venturi responds:

...[w]e used it to acknowledge architecture as shelter, to acknowledge the validity of the generic loft, and our belief that in architecture form need not follow function but must accommodate function: most buildings should not be designed like a glove that fits every finger exactly, but like a mitten that allows 'wiggle room'-flexibility-inside.⁴⁷

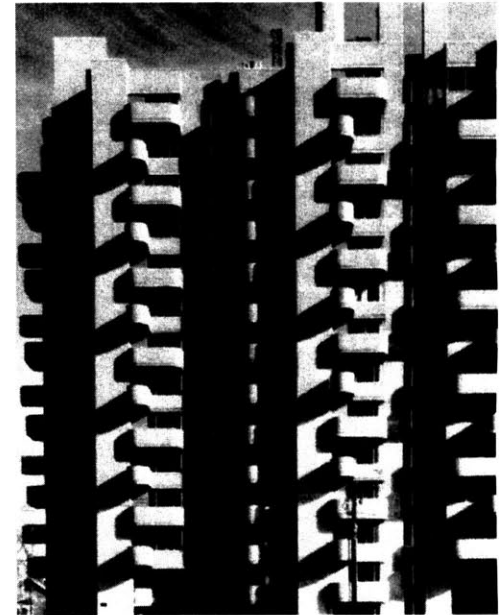

Paul Rudolph's Crawford Mansion, New Haven, 1962-1966. Source: Venturi, Robert and Denise Scott Brown. *Learning from Las Vegas: the Forgotten Symbol of Architectural Form*. Cambridge: MIT Press, 1977, 94.



Venturi and Scott Brown's Guild House, Philadelphia, 1960-1963. Source: Venturi, Robert and Denise Scott Brown. *Learning from Las Vegas: the Forgotten Symbol of Architectural Form*. Cambridge: MIT Press, 1977, 95.

The privileging of the image results in the conceptual detachment of the image from other functions of the building. Iconography is ornament hung on structure. The separation of architectural elements of image from those of function allows architects and users to reinterpret spaces free from constraints of imaging. At the same time architecture is more receptive to diverse content in imagery as it is independent from pragmatic aspects of the building. Detachment affords an interpretative space.

Therefore, while Venturi and Scott Brown are attributed with elevating the image in architecture, their diatribe against the duck resists the domination of image. By detaching structure and program from ornament, Venturi and Scott Brown prevent the possibility of constructing architecture that is completely saturated by imagery. The generic shed is then able to house program in the most appropriate manner. In a 2004 debate at MIT, Venturi criticized the interior of Frank Gehry's newly-built Stata Center for its inability to accommodate future programmatic changes. Gehry, interestingly, has become one of Venturi's most unexpected supporters, as I'll show later.

In *Learning from Las Vegas*, Venturi and Scott Brown argue that current and preceding -isms are all concerned with the production of image. The Modernist rhetoric of

utilitarianism is debunked. Modernists, they contend, were concerned with the image of utility, not the true architecturalization of utility. Venturi and Scott Brown's rejection of the closeted-nature of Modernist rhetoric positions the movement on the same field as architecture of the Vegas Strip. The movement's "'jargon of authenticity' which sought irreducible truths in space and in structure" is thrust "into the realm of ornament and signage."⁴⁸

At stake was not only the recognition of an age dominated by image but the destabilization of reality itself as not one reality but numerous possible realities constructed through the multiplicity of images. Their work alludes to the ability of architects to reproduce reality itself. Again, Martin writes:

Rather than building spaces that verified the functionalist zeitgeist at the symbolic as well as at the practical level and could thus be construed as "authentic," Venturi and Scott Brown essentially claimed to be building authentic images.⁴⁹



Downtown Las Vegas circa 1948. Source: http://gaming.unlv.edu/centennial/web/0100_0051_DownTown.jpg

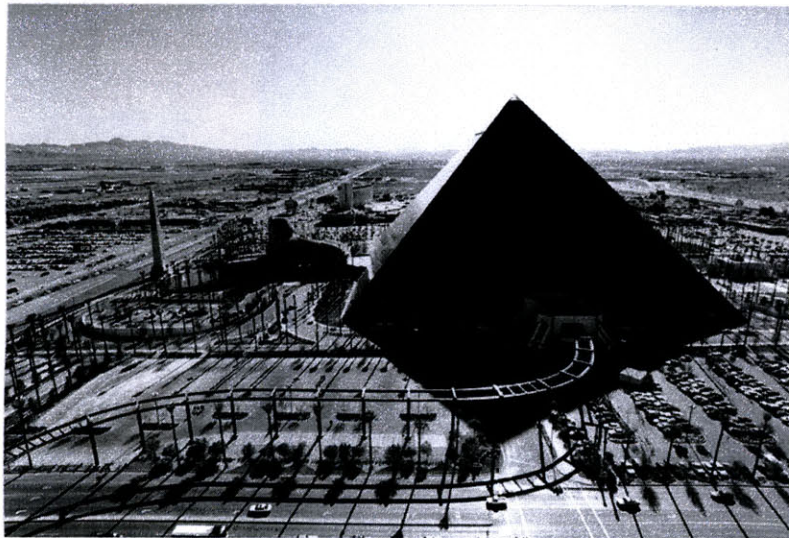

Luxor Hotel, Las Vegas. Source: http://www.flickr.com/photos/mark_b_photo/413796048/

25 Years Later

25 years after the publication of *Learning from Las Vegas* Venturi and Scott Brown revisit Sin City. In an essay titled “Las Vegas after its Classical Age” the pair describes the changes to Vegas as a “parallel evolution from signography to scenography, or from the decorated shed to the duck.”⁵⁰ They note the “MGM architectural lions head, the Luxor Hotel pyramid, the Excalibur castle, and, most vividly, the Mirage Lake cum volcano and Treasure Island Caribbean town.”⁵¹ They describe with disappointment the overshadowing of the classic neon signs by the spectacles of outdoor performances such as regular volcano eruptions and battling pirates on full-scale sinking ships.

In “Relearning from Las Vegas,” the interview mentioned previously between Koolhaas and the pair, Venturi and Scott Brown explain that Las Vegas “went from commercial strip to Disneyland...strip to mall, vulgar to dramatic.”⁵² This interview, published in *Harvard’s Guide to Shopping*, is compiled with a vast amount of documentation on the massive entertainment shopping complexes of Las Vegas. It is surprising, however, that Venturi and Scott Brown mention little of these immersive interiors. I would like to draw attention to these interiors as the spaces most indicative of changes that have taken place in Las Vegas.



Caesars Palace Sign circa 1970. Source: Venturi, Robert and Denise Scott Brown. Learning from Las Vegas: the Forgotten Symbol of Architectural Form. Cambridge: MIT Press, 1977, 110.

Interior of Forum Shops Mall in Caesars Palace Hote Casino, Las Vegas.

The phenomenon of the Casino-turned Megamall began with Caesars Palace, a casino resort that Venturi and Scott Brown first visited in 1968. Since its opening in 1966, Caesars Palace has evolved from a 14-story tower set behind a large parking lot that was marked by a monumental pediment capped sign - celebrated in *Learning from Las Vegas* - to a full fledged 30-acre Roman themed entertainment environment. Today the Palace consists of five towers with the latest 46 floors high, a Coliseum (built to house regular Celine Dion concerts), 15 acres of pools, lagoons, streams, and waterfalls, and one of the most successful shopping centers in the US, the 634,000 square feet Forum Shops. The shopping mall was constructed 1992 and finished its fourth phase expansion to 175,000 square feet in 2004. The Forum Shops simulate Roman cobble streets, house marble veneer columns, reproductions of Roman gods and goddesses, elaborately encrusted fountains and pools, robotic Caesars. An impressive vaulted ceiling looms over the country's second spiral escalator, itself dressed in ancient Roman attire. Every hour, the painted sky which spans the ceiling of the sprawling mall is lit in a way to produce an evolution of a 24-hour day.⁵³ Since the opening of the Caesars Palace mall, megamalls as themed entertainment environments have become synonymous with Las Vegas casino resorts.



1966



1975



1995



2005

Progression of Caesars Palace. Source: <http://www.vegastoday-andtomorrow.com/cpalace>.

The strip today is a haven for ducks and duck interiors, the latter being totalizing simulated environments. This evolution of Las Vegas architecture points to an additional category of architecture that Venturi and Scott Brown neglect: the duck as literally a duck. I therefore add to their definitions:

3. Where the architectural systems of space, structure, and program are submerged and distorted by an encompassing theme derived from literal referencing. This I call the decorated duck.

Venturi and Scott Brown's duck was inspired by a duck-shaped drive-through that sold long island ducks. (The Long Island Duckling was discussed in Peter Blake's *God's Own Junkyard* as popular architecture that should

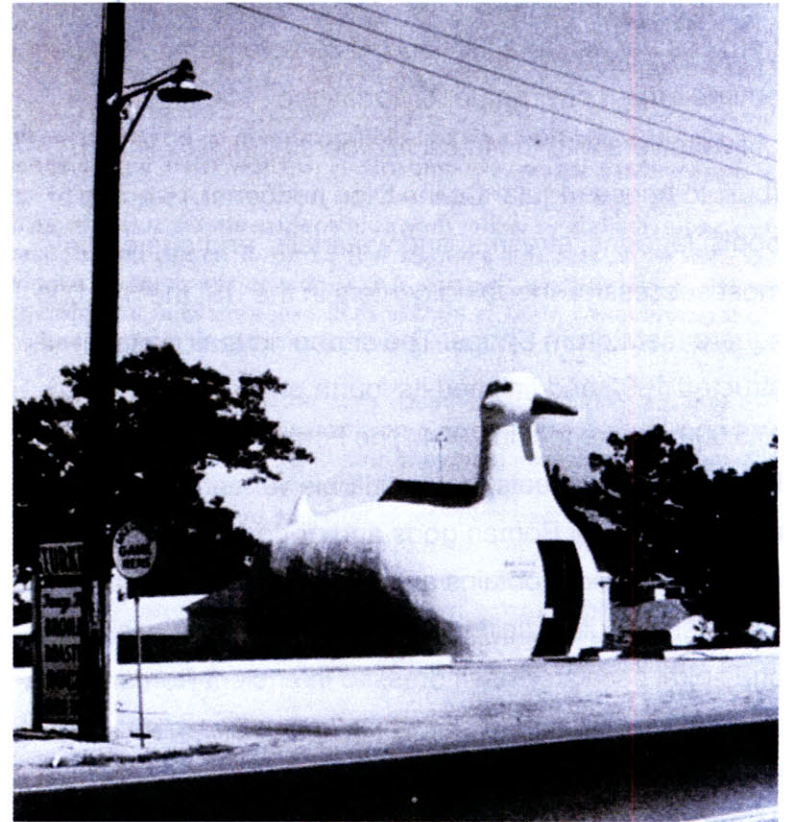

"Long Island Duckling" from Peter Blake's *God's Own Junkyard*. Source: Venturi, Robert and Denise Scott Brown. *Learning from Las Vegas: the Forgotten Symbol of Architectural Form*. Cambridge: MIT Press, 1977, 88.

be avoided.) Their use of the term duck to denote abstract sculptural architecture is unclear. Reinhold Martin writes that “they seem to defend Guild House as if it were a duck – a building in which ‘the windows look familiar; they look like, as well as are, windows.’”⁵⁴ Nevertheless, the decorated duck was neither explored in *Learning from Las Vegas* nor was it directly addressed following Venturi and Scott Brown’s return to the Strip. Instead, lamenting the shift away from the decorated shed, Venturi and Scott Brown declare that “current Las Vegas is ironically less relevant than old Las Vegas.” The city has become “an exotic theater rather than actual space,” suggesting the loss of a sort of authenticity.⁵⁵

However, the viability of the decorated duck as a carrier of imagery in a most direct and affective manner is shown by its proliferation on the Strip. While Venturi and Scott Brown recognized the lions, pyramids, and castles of the Strip, today, casino resorts like Paris, The Venetian, and New York New York sport scale replicas of the Eiffel Tower, Campanile di San Marco, the Empire State Building. Paris consists of a Versailles Hall of Mirrors lobby and art nouveau poker tables. At The Venetian, a scaled down St Mark’s Square is built with a forced perspective. A quaint Greenwich Village food court in New York New York is dotted with smoking sewer covers.

Every surface is employed as a carrier of signage, on the exterior and throughout the interior. The existence of service spaces, otherwise buried underneath layers of appliqué, is only hinted at by the thickness of the structure and Employees Only signs. With the use of constant bombardment of exotic imagery and pure emotional stimulus these ever more powerful casino resorts provide no escape from the world of the decorated duck.

The extravagance of the Strip evolved naturally from ducks to become entire simulated duck environments. With a seemingly endless budget for expressing luxury in the culture of the copy there is no end to the exuberant reproduction. Why build just a façade when you can have the whole building? Why settle for an Eiffel Tower billboard when you can have the Eiffel Tower? At Paris, a scale version of the Eiffel Tower was built instead of a full size replica only due to a conflict with flight paths. Las Vegas has become the ultimate city of simulacra. In “*Relearning from Las Vegas*”, Koolhaas exclaims to Venturi: “the development is unbelievable: the archetype of unreality – the city as mirage you described in *Learning from Las Vegas* – has, through sheer mass, become a real city.”⁵⁶

Venturi and Scott Brown, however, have never built in Las Vegas. Confronted by the dilemma of distinguishing their



The Eiffel Tower of Paris Hotel Casino in Las Vegas.

architecture from vernacular architecture designed without architects, Venturi and Scott Brown claim a distancing from popular culture with their ironic use of symbolism. Yet their “ironies were, for the less attentive, lost in the celebration of commercial excess; refined incongruities did not translate well into casino colloquial.”⁵⁷ As Venturi and Scott Brown confess, “It is sad we have seldom been able to get commercial, even though we have been interested in it and respectful of it for a long time. We are considered highfalutin, having worked at Harvard, Yale, and Princeton, and for the governments of Britain, Japan, and France. That’s an ironical sociological reason for our being excluded.”⁵⁸

On the other hand, one of today’s most infamous star architects, Daniel Libeskind, is ushering in the next phase of commercial development in Las Vegas. The \$7.4 billion City Center project is the largest privately financed development in American history, and currently the Western hemisphere. For this landmark project the developer MGM/Mirage has opted for a “designerly” approach. Rather than import themed exotic destinations, MGM/Mirage courts internationally renowned architects who sport their own brand of architecture. This project will highlight Libeskind’s 500,000 square foot “retail and entertainment district” as it will command the majority of City Center’s ¼

mile Strip frontage. Libeskind's mall will anchor four residential towers that offer over 2,800 units of luxury housing. Norman Foster, Raphael Vinoly, Kohn Peterson Fox, and Helmut Jahn are slated to design these highrises. Cesar Pelli will design the towering resort casino.⁵⁹

Libeskind's design is representative of an architecture that opposes that of Venturi and Scott Brown. His oeuvre can be traced to the other seminal postmodernist book called *Five Architects*, published in the same year as *Learning from Las Vegas*. Throughout the 70s, these two books guided the debate between the Whites, led by Peter Eisenman, and the Grays, led by Venturi and Scott Brown. As the "star" student of both John Hejduc and Peter Eisenman, two of the *Five Architects*, Libeskind's rhetoric and formal language are clearly derived from the Whites.

The Whites were motivated by the autonomy of architecture. Relying primarily on a consistent internal logic in the production of form, the resulting spatial articulation of their work reads as a narration of this process. Influenced by contemporaneous research in semiotics, the Whites desired the expression of pure form through the investigation of geometric relationships. The Grays, on the other hand, borrowed from historic iconography, constructing a narrative of popular cultural references. Libeskind's own

signature style is distinguished by variegated angles and oblique corners, producing an image of shifting landscapes. The procedural origin of this formal language of fragmentation sustains an identifiable character through its manipulated differentiation. The effect is visually tantalizing, reflecting and distorting the surrounding city in spectacle.

I call this phenomenon the designer duck. It carries all the characteristics of Venturi's duck, and one further attribute that affords it incredible marketing potential: variation. The Modernist duck ala Rudolph's Crawford Manor, and the language of its progeny, the designer duck, has developed to enable every part of the architecture to look different while being all the same. Whereas the balconies of Crawford Manor employ repetitive articulation to create enticing light and shade, Libeskind's work, as a development of the duck, employs systematic variation as sculptural form to sustain interest by conveying "true" differentiation.

It is virtually impossible to formulate a singular image of Libeskind's mall even though imaging pervades every aspect of his architecture. Here, signification is no longer relegated to a particular location within the architectural program as in the case of the decorated shed. Nor does Libeskind rely on references of existing context as is

the case with the decorated duck. The ability to remain abstract and varied while at the same time instantly recognizable renders Libeskind's formal language easily transferred to various contexts and mediums. Metaphors of glass shards, crystals and spirals are consumed as marketing fodder. Libeskind's signature style is generically appropriate to almost any program, thereby contributing to the recognizability of his brand. Branding is theming in its abstract form.

Variation successfully masks banality. The individual shops housed in Libeskind's mall are commonplace, but made more attractive through the incessantly enticing language of the architect. For Venturi and Scott Brown, the eclectic gathering of signage along Las Vegas Strip of 1972 was a source of diversity. In Libeskind's mall, discon-



Diamond shaped signage advertising Libeskind's Royal Ontario Museum in Toronto.

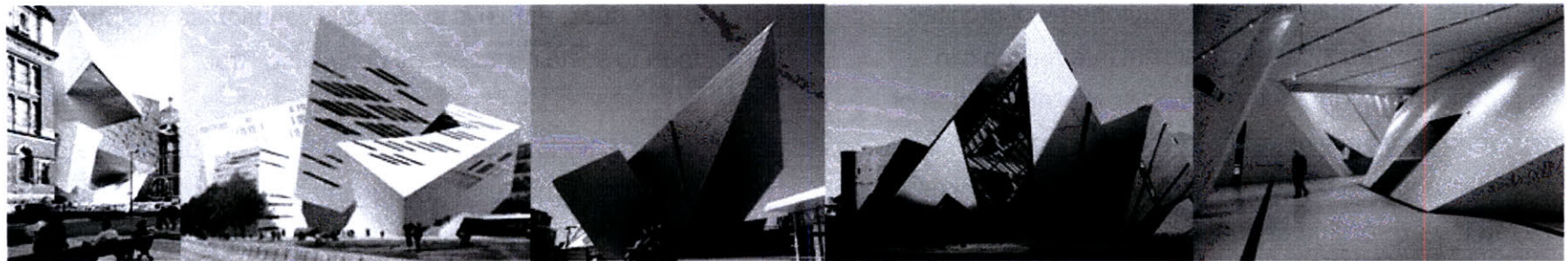

From Left to Right: Libeskind's Victoria Albert Museum 1996 proposal, Creative Media Center for the City University of Hong Kong 2002 proposal, Denver Art Museum completed in 2006, Royal Ontario Museum completed 2007, Exterior view, Interior View. Source: www.daniel-libeskind.com/

tinuity and In “Las Vegas after its Classic Age,” Venturi and Scott Brown find that Vegas is no longer relevant as it is too safe and too controlled. The proliferation of scenography is overwhelming and suffocating; Libeskind’s designer duck would most likely garner similar reactions. Venturi and Scott Brown’s position should not be misconstrued as a call for architects to be graphic designers. Within this positioning is an overarching desire for distance from the

demands of a society of consumption. But the fault of their approach is its attempt to play the same game of making unique architecture. Through ironic borrowing of architectural elements, Venturi and Scott Brown claim to make boring architecture interesting. Therefore it is truly ironic that their “aesthetic populism”⁶⁰ translates to a formalism only fully appreciated by an elite constituency.



Renderings of Libeskind designed shopping mall in City Center, Las Vegas to be completed in 2009. Source: www.CityCenter.com

I find opportunity in another Las Vegas project by perhaps the most notorious star architect, Frank Gehry. His design for the Lou Rovu Alzheimer's Institute is his first building in the city and is slated to open in 2007. A populist architect if there ever was one, Gehry's architecture guarantees every project is a tourist attraction. His architecture is identified by undulating skin, and functions in many ways as a duck. The Lou Rovu Institute is no exception. However, it is unique in that it encompasses the development of Gehry's formal language throughout his career. Underlying this evolution is the technical struggle to collapse the distance between the rectangular box and the amorphous skin that surrounds it. From one side of the Lou Rovu Institute to the other, one can clearly see a progression from boxes, to boxes covered by curvy sheets, to finally architecture as just curvy sheets. As in his other projects, the loose skin demonstrates in building scale a design process that preserves accidental rips and often arbitrary folds from the making of study models.

Venturi observes the features that sets Gehry's ducks apart from other ducks. Referring to Gehry's Pritzker Bandshell in Chicago, he alleges the building embodies "the idea of the great American loft tradition...His buildings . . . are essentially a loft with applied ornament, which are these potato chips."⁶¹ Albeit not flat in its application,

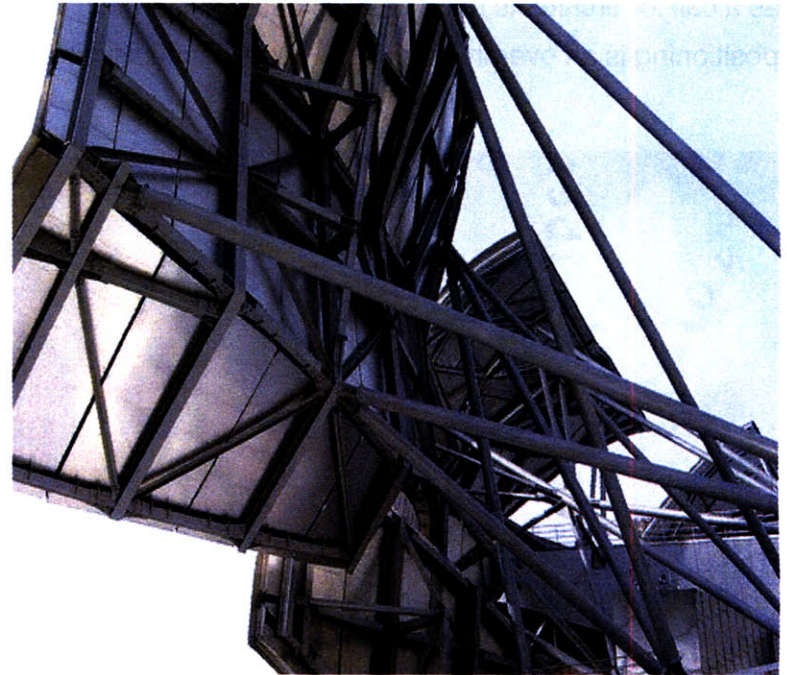

Rear view of Frank Gehry's "potato chips" of the Pritzker Bandshell in Millennium Park, Chicago.

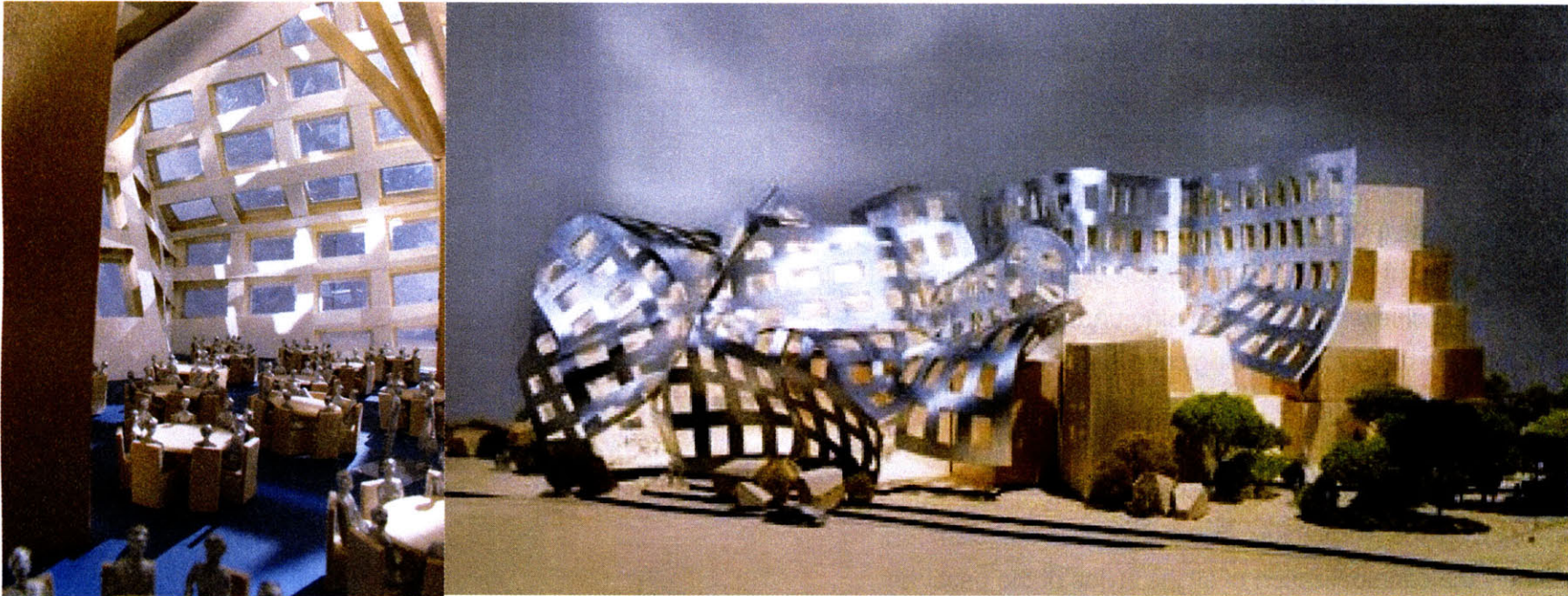

Dining Hall interior and exterior view of Frank Gehry's Lou Ruvo Alzheimer's Institute near Downtown Las Vegas; to be completed in 2008.
Source: http://www.keepmemoryalive.org/about_us.php?sub=gallery&PHPSESSID=1cfabca1372f3cce509709d897aafb99

these “potato chips” that project from the bandshell box nevertheless expose the distance between the decoration and the shed. Gehry makes no claim that the curvy skin is “real” in that it matches the form of program spaces. If anything, the superficial and seemingly arbitrary cladding of curvy skin on programmatic boxes is a joke on us. We want the curvy skin! We are enticed by articulation and variation and don’t mind that it is literally skin deep. But again, this distance may be only a matter of technology and cost. As demonstrated in the design for the Lou Rouv Institute, skin-projecting-from-boxes makes only a brief appearance. The most spectacular spaces are those under the skin without boxes. The innovation of the design is clearly the achievement of collapsing undulating skin into undulating structure. Technological achievement equals newness equals attraction.

Frederic Jameson notes, “This situation evidently determines what the architecture historians call ‘historicism’, namely the cannibalization of all the styles of the past, the play of random stylistic allusion, and in general what Henri Lefebvre has called the increasing primacy of the ‘neo.’”⁶² Desire for the newest and latest designs drive our economy of commodification.

I propose not to make boring architecture interesting, but

to make boring architecture more boring. Instead of trying to be new, copy. Criticism through counterfeit.

Gone with irony. Gone with variation.

What Las Vegas needs is boring architecture.

A Project For A New Chinatown Las Vegas

And A THEORY OF BORING ARCHITECTURE

Copy, Detach and Collect

Historically, Chinatowns have survived by marketing otherness.



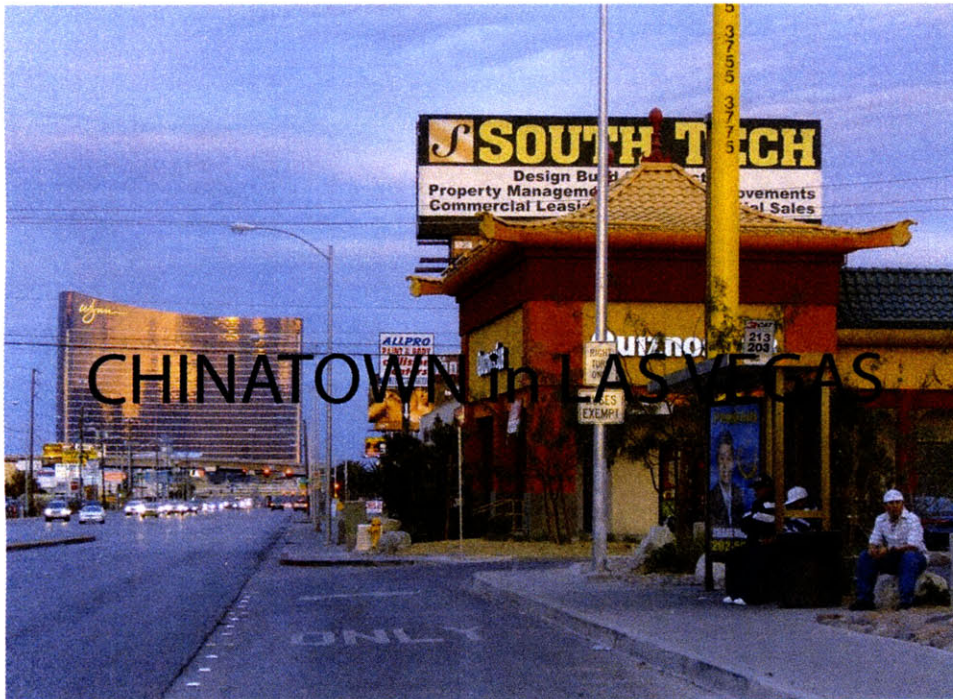

Situated in the capital of theming, Chinatown Las Vegas risks becoming just another themed development.

To set itself apart, Chinatown must take advantage of that which no other development provides: ethnicity. The Paris Hotel Casino does not come with Parisians, but Chinatown Las Vegas comes with the Chinese.

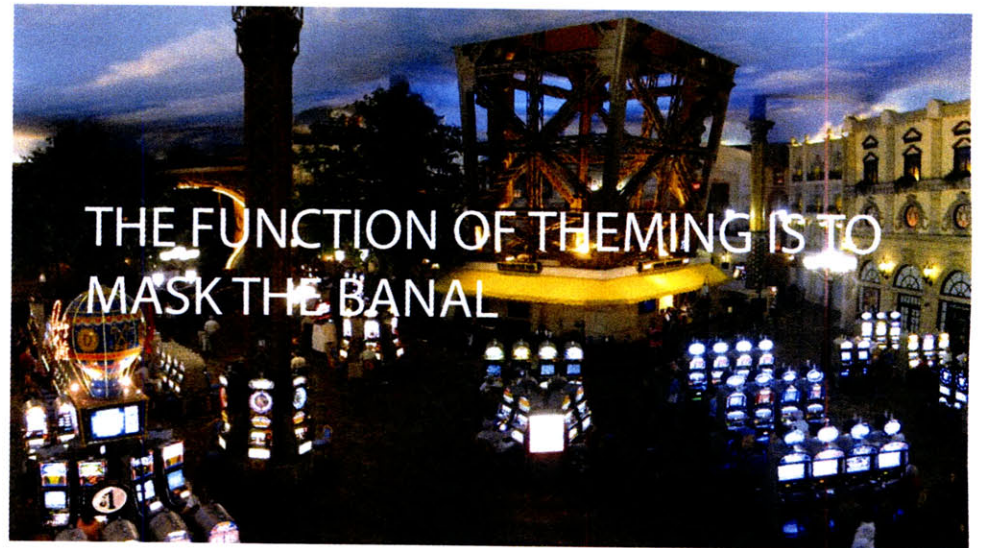

TO PUSH ARCHITECTURE INTO
THE BACKGROUND MAKE BORING
ARCHITECTURE MORE BORING

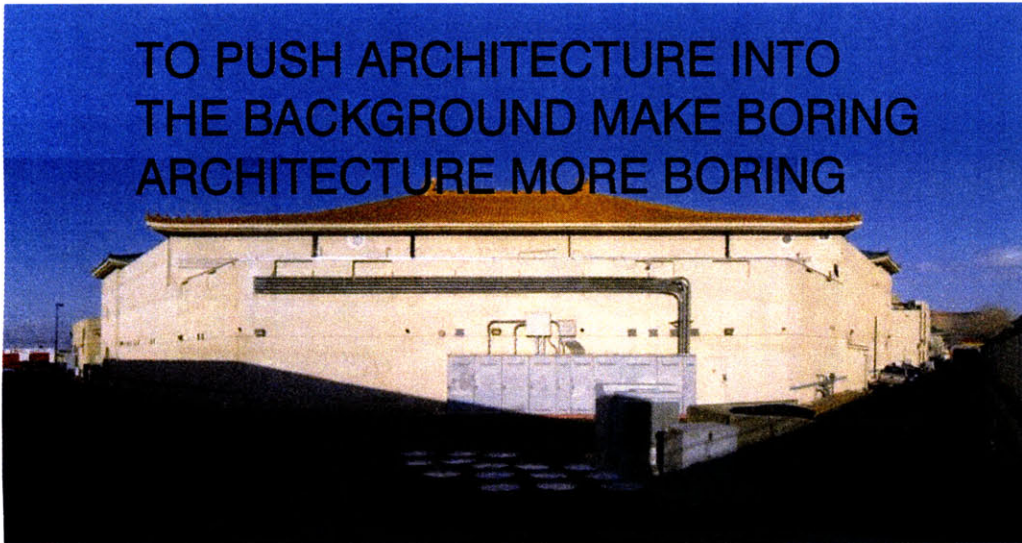

Competition amongst gaming moguls in Vegas to construct the most extravagant entertainment complexes produces certain sameness. Chinatowns have the potential for “automatic theming” where people and their activities are simultaneously spectacle and sustenance. Such a place requires a boring architecture that foregrounds the activities of Chinatown.

The following section outlines the three components of my theory of boring architecture. Working within the vein of Vegas, but also in contrast with the theatrical setting of the city, these concepts originate from Roland Barthes' description of traditional Japanese puppet theater.

A newly introduced spectator of Bunraku is immediately struck by the theater's exposed nature. A pair of elegantly crafted dolls, about half the height of a person, are each controlled by three puppeteers. Behind a miniature stage, both puppets and puppeteers are in full view to the audience. Two puppeteers dressed in black with faces covered work the lower body, left arm and hand of the puppet. Their work supports the movements of the main puppeteer, whose face is revealed but expressionless. He operates the upper body, head, right arm and hand of the puppet. Additionally, voices are projected from a speaker seated separately.



Bunraku puppets with puppeteers. Source: <http://cache.eb.com/eb/image?id=94685&rendTypeId=4>

A newly introduced spectator of Bukando is immediately struck by the theater's exposed nature. Each crafted dolls, about half the height of a person, is controlled by three puppeteers. Behind a miniature stage, both puppets and puppeteers are in full view to the audience. Two puppeteers dressed in black with faces covered work the lower body, left arm and hand of the puppet. Their work supports the movements of the main puppeteer, whose face is revealed but expressionless. He operates the upper body, head, right arm and hand of the puppet. Additionally, voices are projected from a speaker and a samisen player seated to the side of the stage.

Copy: Anti-variation or Against Illusion of Reality

As Brecht had seen, here citation rules, the sliver of writing, the fragment of code, for none of the action's promoters can account in his own person for what he is never alone to write.⁶³

The puppet in Bunraku is a miniaturized representation of the human body. In Western puppetry, on the other hand, the puppet is treated as a piece of one performer's body.⁶⁴ Distorted as caricature, puppets in Western theater are commonly performed for children. With half size 'copies' controlled by three puppeteers, Bunraku is not concerned



100 Cans by Andy Warhol, 1962 Oil on canvas, 72 x 52" (182.9 x 132.1 cm.) Collection Albright-Knox Art Gallery. Gift of Seymour H. Knox, Jr., 1963 Source: <http://www.albrightknox.org/ArtStart/art/Warhol.jpg>

with direct emotional response but rather a sustained detachment. Breaking the puppet into multiples of puppeteers denies any expression of originality. Conceived as a single controlling force, the three puppeteers are devoid of all personal expression, each detached from the emotions of the puppet they control. The multiplication of the puppeteers rejects artistic individuality, and exposes the audience to all the actions of the performers, thereby releasing viewers from illusion.

Speaking of the incessant replication of pop imagery, Andy Warhol discovered that “repetition becomes a kind of release” since “the more you look at the same exact thing, the more the meaning goes away.”⁶⁵ In architecture, copying is understood within the context of individuality. It is always employed but never acknowledged. Our culture of consumption relies on the fear that an open use of copying would devalue work. Warhol’s art, like Bunraku, demonstrates an alternative to the veneration of individual autonomy. Through copying, detachment of meaning from any subject matter can be achieved, regardless of how loaded with meaning it may be. In addition, it diverts attention from the artwork to the forces that manifest its production.

Detach: Anti-whole or Against Illusion of Totality

That distance is made explicable by Bunraku, which allows us to see how it can function...so that the copy elaborated on the stage is not destroyed but somehow broken, striated, withdrawn from that which entraps our actors.

Bunraku (this is its definition) separates action from gesture: it shows the gesture, lets the action be seen, exhibits simultaneously the art and the labor, reserving for each its own writing.⁶⁶

In Bunraku, the body of the puppet is separated, exposing the puppeteers that comprise and control it. Furthermore, there exists a tenuous distance between puppet and its voice, which is spoken by an actor placed to the side of the main stage, on a separate platform. Seated next to a Japanese lute player, the actor speaks and sings the roles of each puppet as well as narrates the performance.

Like copying, the theatrical method of detachment in Bunraku reveals the theater’s ‘work,’ while extending to the architectural treatment of the stage set. There is a multiplication and separation of the stage, a deliberate breaking up of the ground plane. One plane is occupied solely by



Disneyland parking lot with the Matterhorn amusement ride in the horizon and the Anaheim Police Department in the foreground, 1961. Source: <http://www.oac.cdlib.org/affiliates/images/cana/kt2199p9w7/hi-res/P15722.jpg>

the puppeteers, one by the puppets, and one by the narrator and his accompaniment. Yet at moments in the performance, the puppet may be turned around, its back to the audience, its body concealed by the bodies of the puppeteers who must also turn. Puppet and puppet masters trespass into the space of the other.

Thus, the open exposure of the mechanisms of simulation liberates performers and puppets from their expected physical positions. Significantly, this negation of totalizing theater allows the audience to freely view these mechanisms. The stifling environment of themed architecture, on the other hand, does not provide the opportunity for 'wiggle room' or 'running room' in the experience of a building. According to Hal Foster, who revisits Adolf Loos's theory of ornament in 'Design and Crime,' there is no life in environments that are designed in the entirety. Only in incompleteness can audiences or users become conscious of their positions in relation to the simulation.

As Barthes says: The basis of our theatrical art is indeed much less the illusion of reality than the illusion of totality.⁶⁷

Collect: Anti-individual or Against Illusion of Individuality

Language being not purified ...but one might say collected to one side of the acting, all the importunate substances of Western theater are dissolved: emotion no longer floods, no longer submerges, but becomes a reading, the stereotypes disappear without, for all that, the spectacle collapsing into originality...

As in the modern text the interweaving of codes, references, discrete assertions, anthological gestures multiplies the written line, not by virtue of some metaphysical appeal, but by the interaction of a combinatoire which opens out into the entire space of the theater...⁶⁸

The collecting of like bodies and stage sets in Bunraku has the effect of flattening visual space. Copies are gathered to become a collective whole. This flattened space organizes the various parts of the theater as a series of layers. Jameson describes this characteristic of Postmodernism as a "new kind of flatness or depthlessness, a new kind of superficiality in the most literal sense."⁶⁹ The method of collecting and the result of flattening in Bunraku, I argue, clarify the activity that is the performance.

“What draws the crowds is...the social microcosm, the miniaturized and religious reveling in real America...You park outside, queue up inside, and are totally abandoned at the exit... The contrast with the absolute solitude of the parking lot-a veritable concentration camp-is total.”⁷⁰

The concentration of simulacra set against a barren tarmac produces a similar flattening effect. What is clear in the extreme opposition is the function of each as foregrounding devices. It is in this juxtaposition that one may understand Disneyland. As Baudrillard explains, Disneyland presents itself as “imaginary” to hide that fact that it is “real.”

Collections are defined against their others. As a collection is set against another, a way out of completely designed environments is offered. Sameness clarifies difference. Within any field of view one is always afforded the opportunity to see beyond one context into another. Combination makes reality.

CONTEXT



A square footage comparison of the Las Vegas Chinatown proposal to other New Chinatown projects worldwide.



DUBAI CHINATOWN
UNDER CONSTRUCTION



ST PETERSBURG CHINATOWN
PROPOSED

Currently the two largest chinatown developemnts under construction.
The proposed Las Vegas Chinatown will be larger than both.

The New Chinatown site is one square mile, and is well situated between the Strip, the I-15 (the main highway to the Strip), and the Las Vegas ring road which borders suburbia.

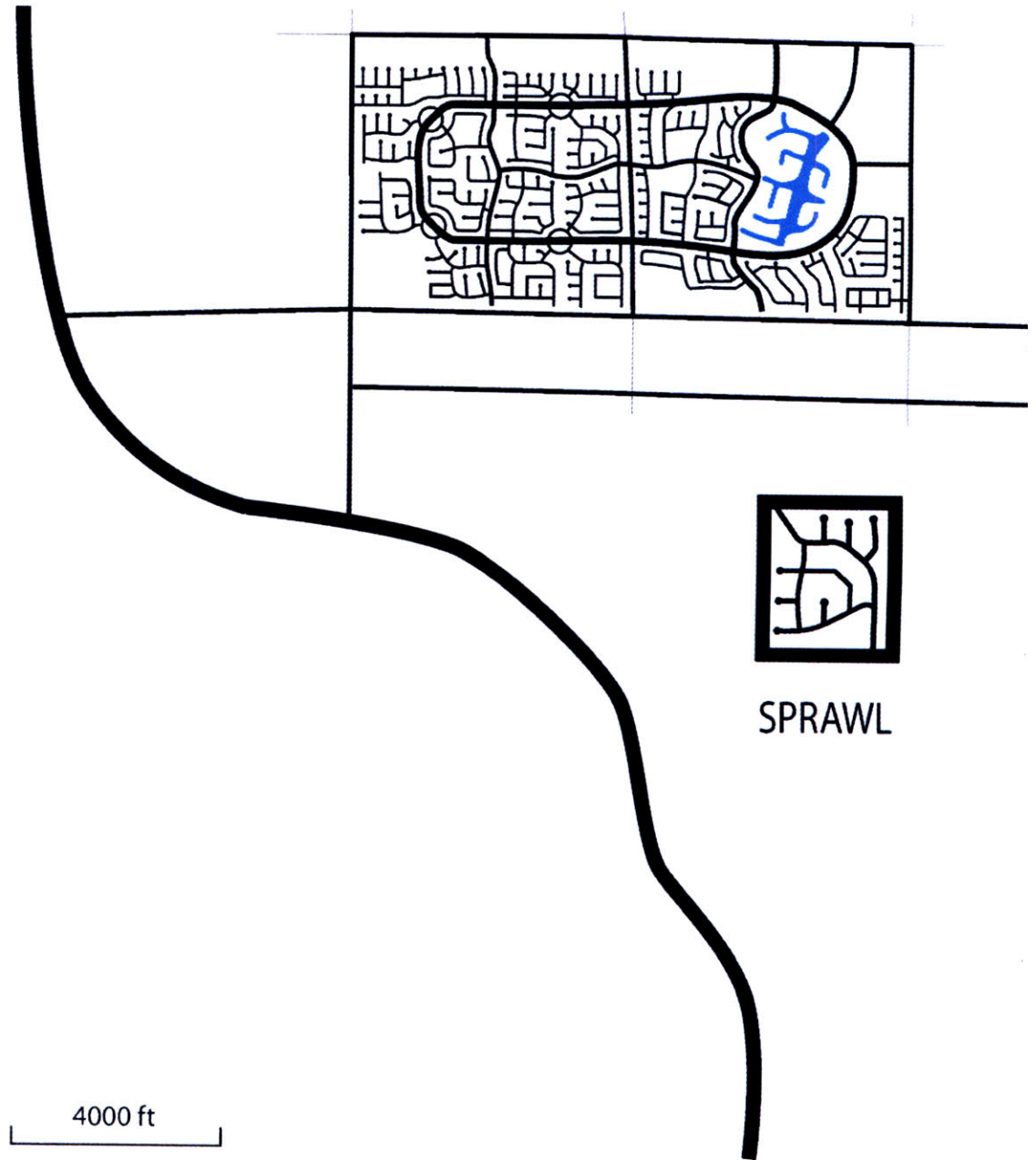

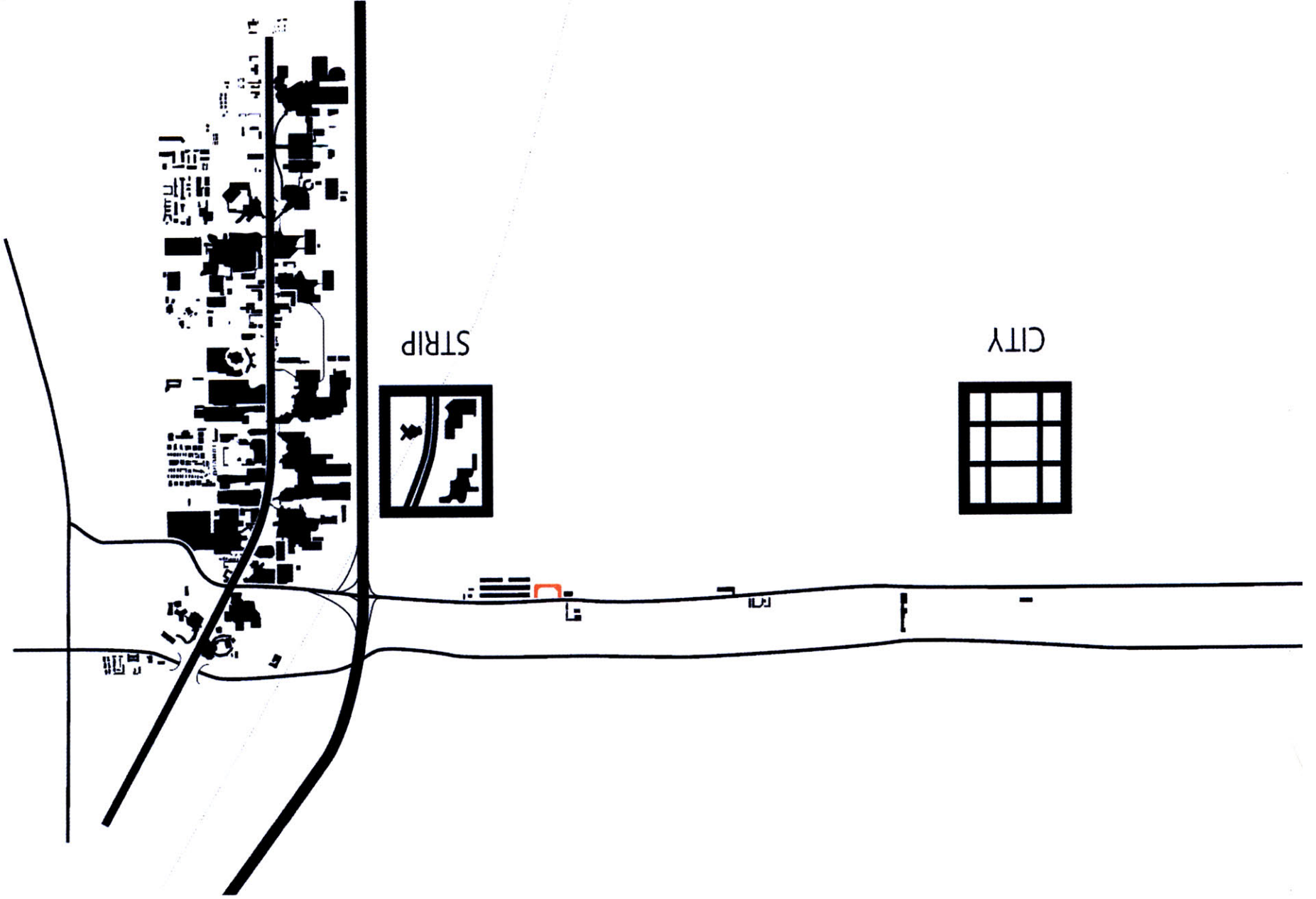

Las Vegas is well-connected to cities with major Asian populations.
Conveniently, there are direct flights between these cities and Vegas.

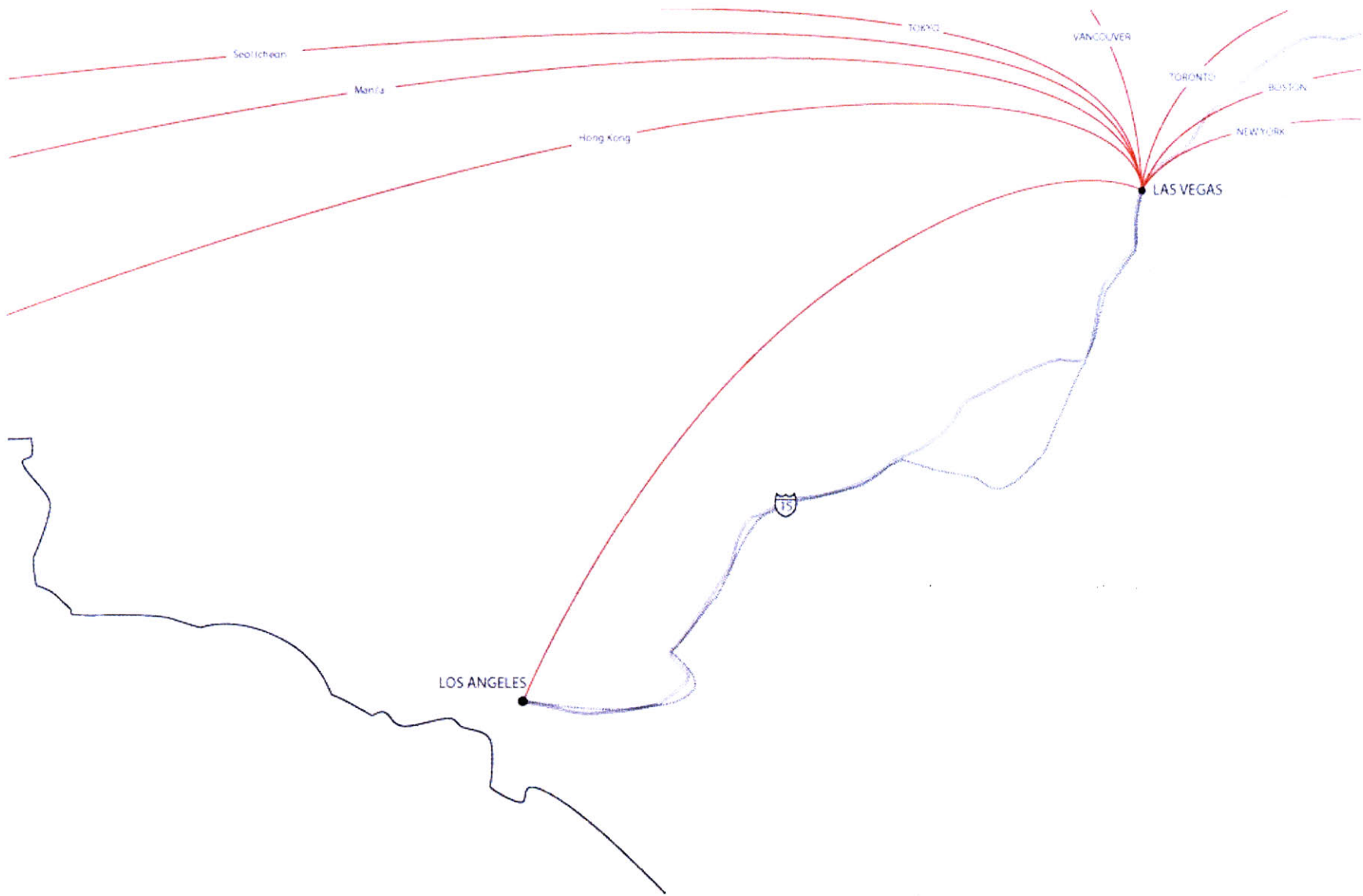



The New Chinatown is located between the suburbs and the Strip. It is connected by two main throughfares that reach the Strip. A proposed monorail expansion will come through the site. A freight rail that crosses the sight is planned to be converted into a commuter rail that connects Las Vegas to Los Angeles.



Chinatown Plaza, Las Vegas.

The Community Planning Department of Clark County, Nevada uses a series of overlays to adjust master plans to accommodate the fast rate of development in the city. The following maps are courtesy of the Community Planning Department. I have added a series of overlays to the master plan that are integral to my project.

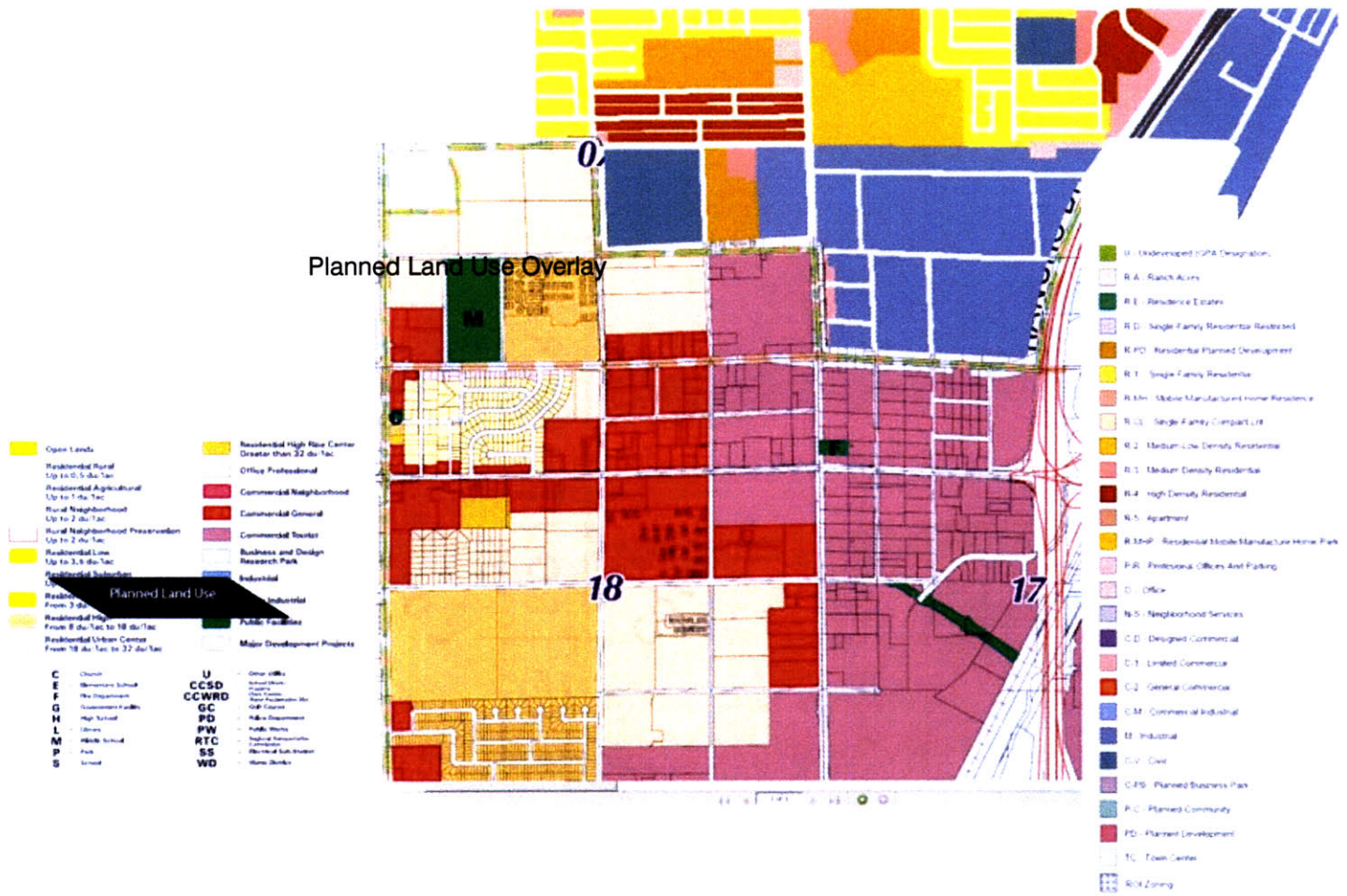

Planned Land Use Overlay

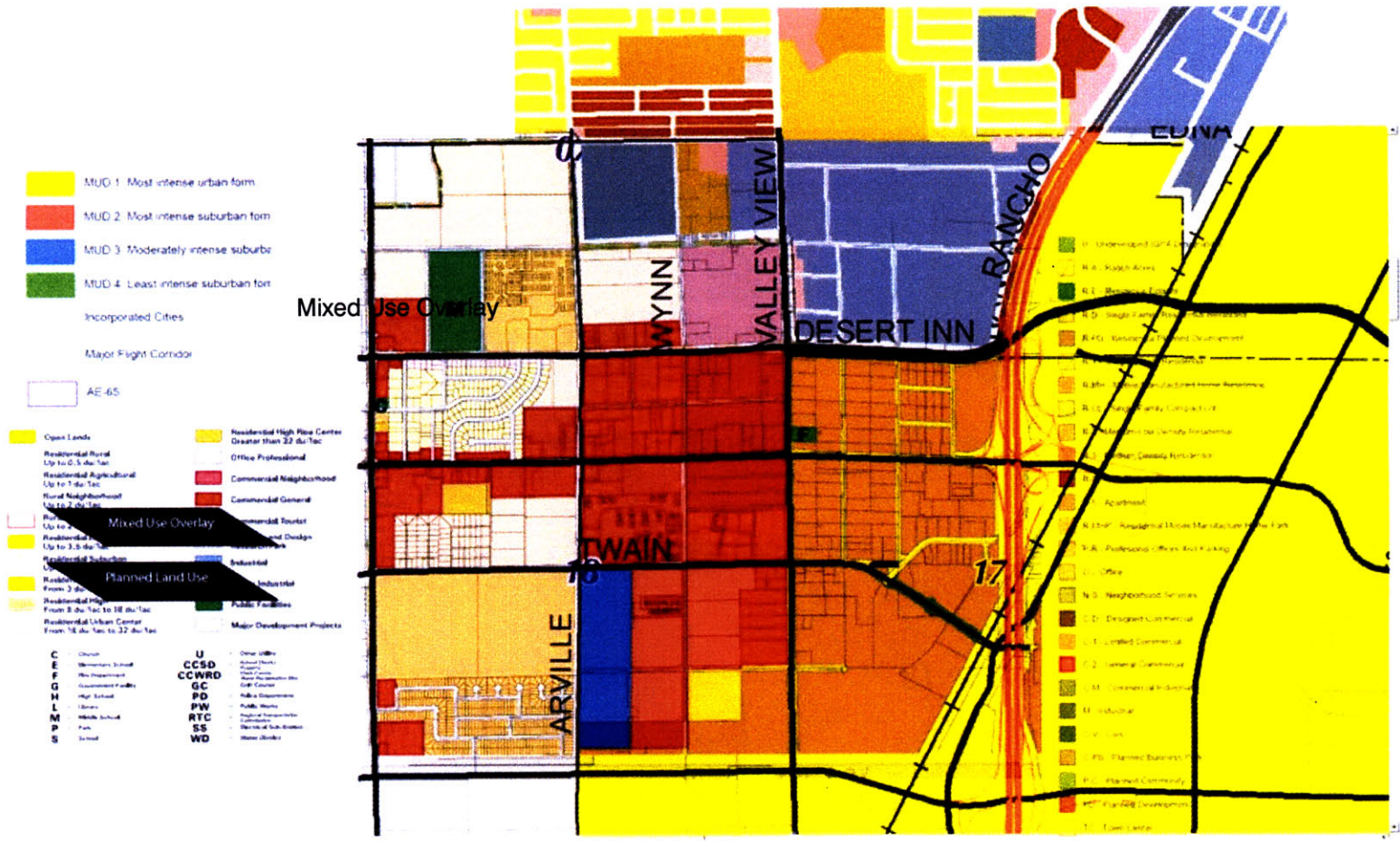

Mixed Use Overlay

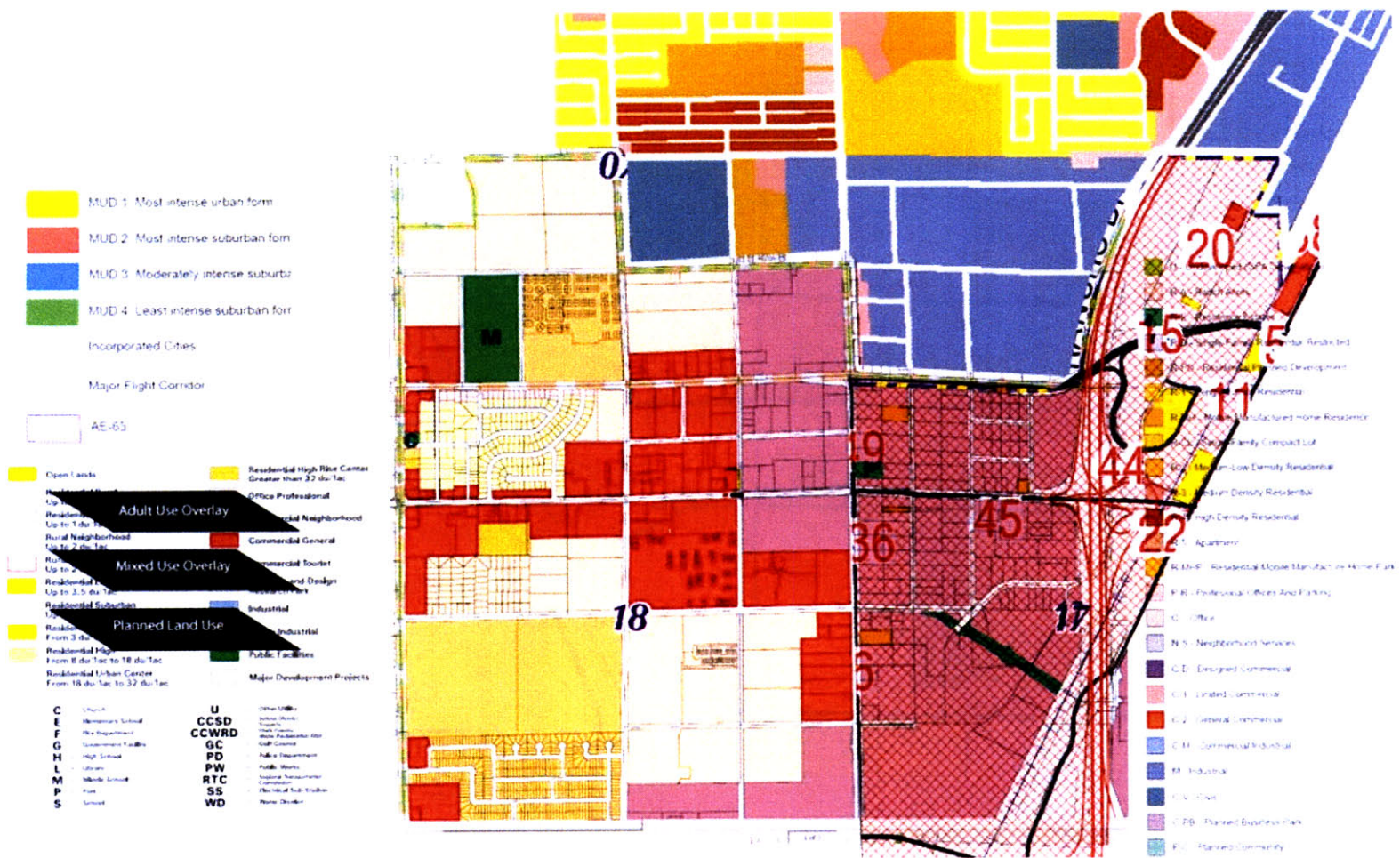

Adult Use Overlay



Asian District Overlay

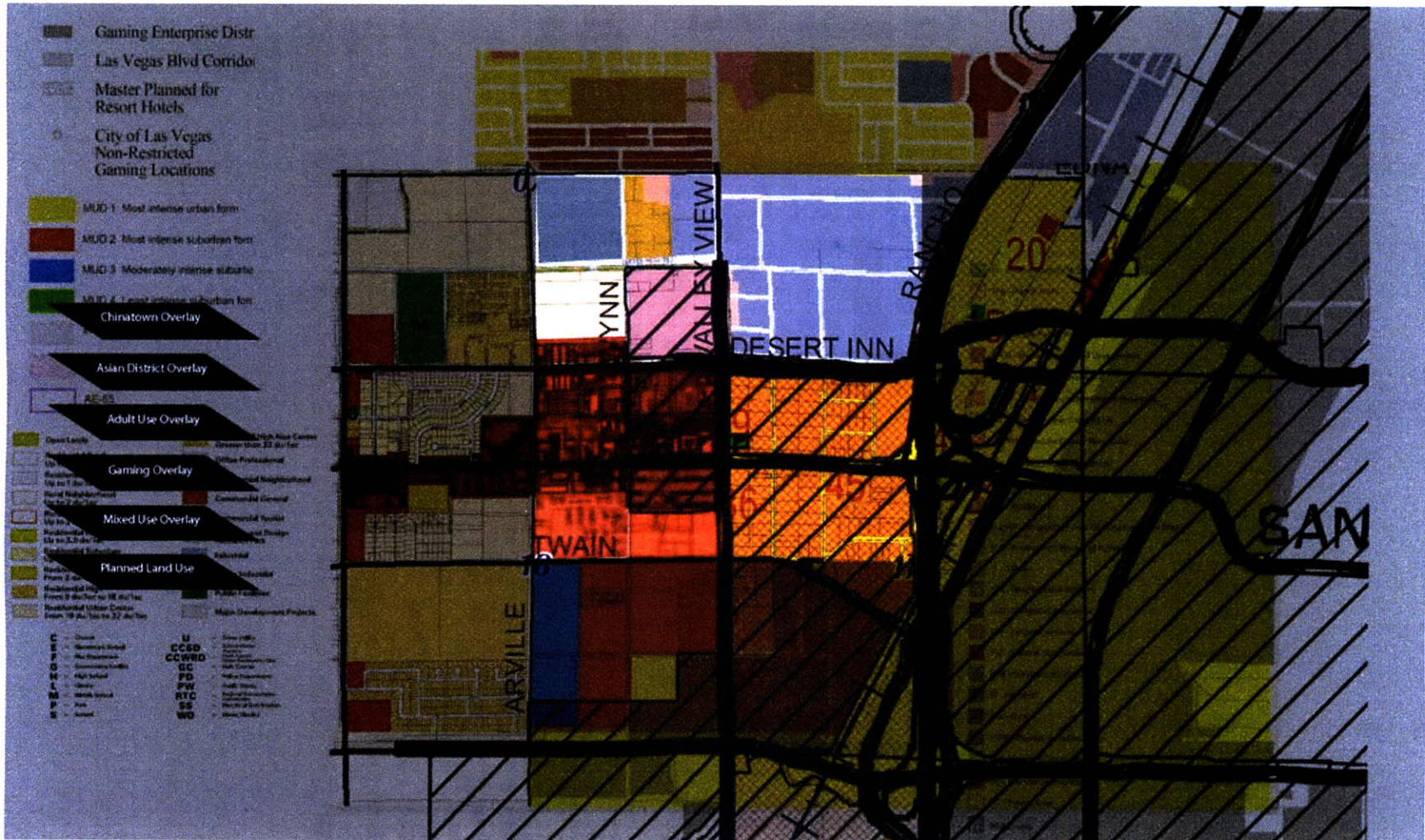

The Chinatown Overlay is my addition to the city's plans. It is the first overlay of the proposal for Chinatown in Las Vegas, and measures one square mile.

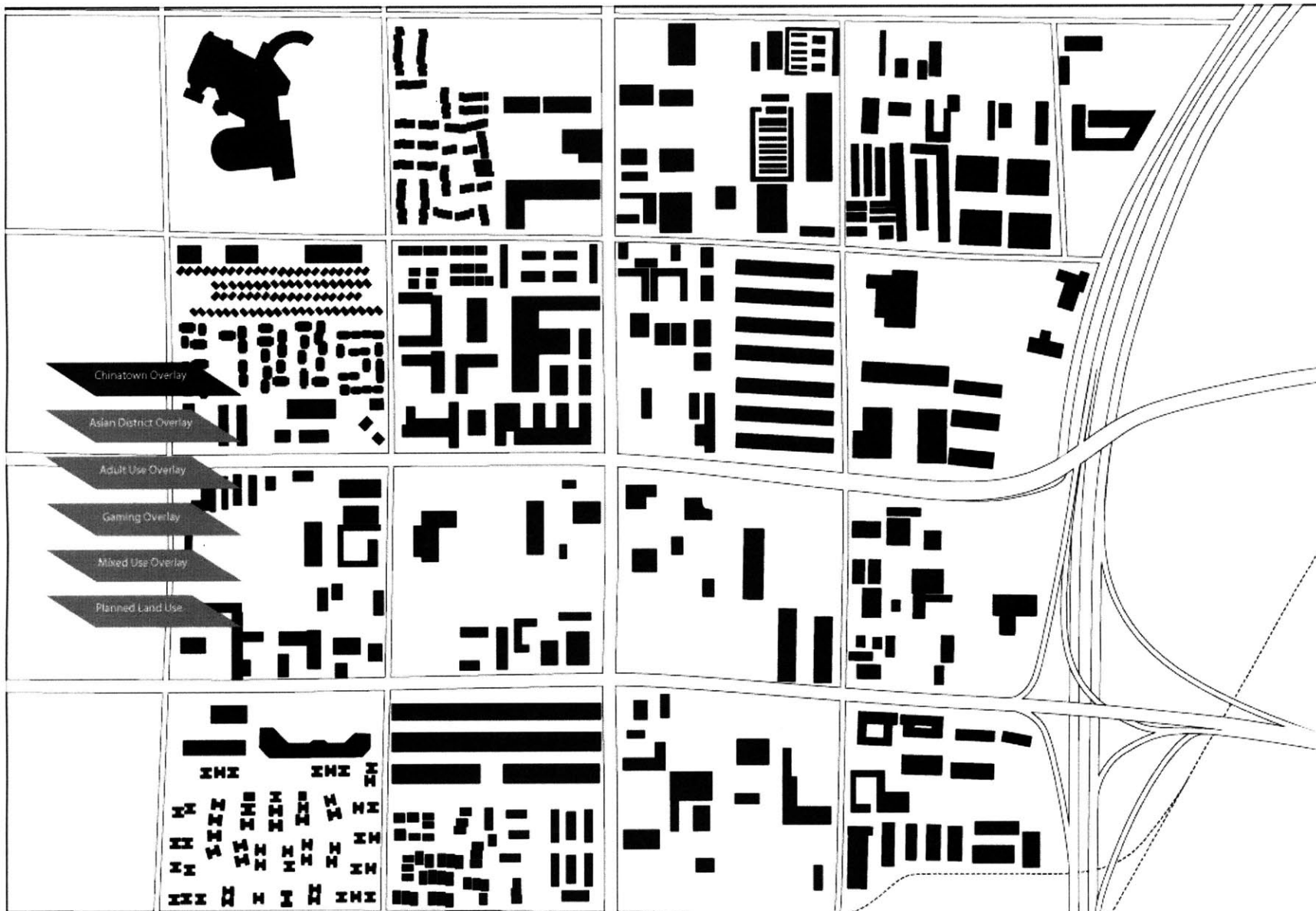

In the Chinatown Overlay, existing light industrial zone structures are preserved.

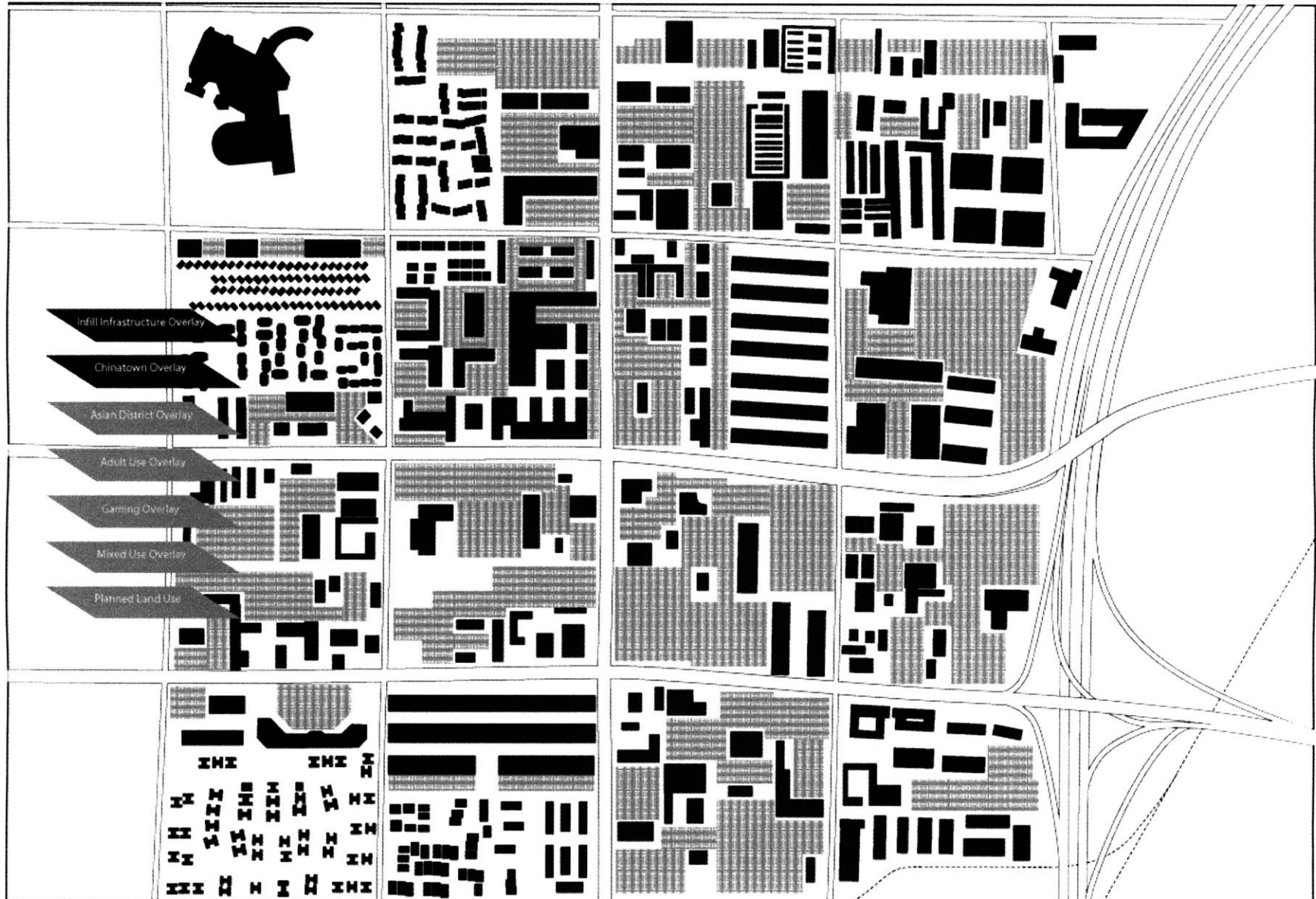

In the Infill Infrastructure Overlay, vertical platforms fill existing parking lots.

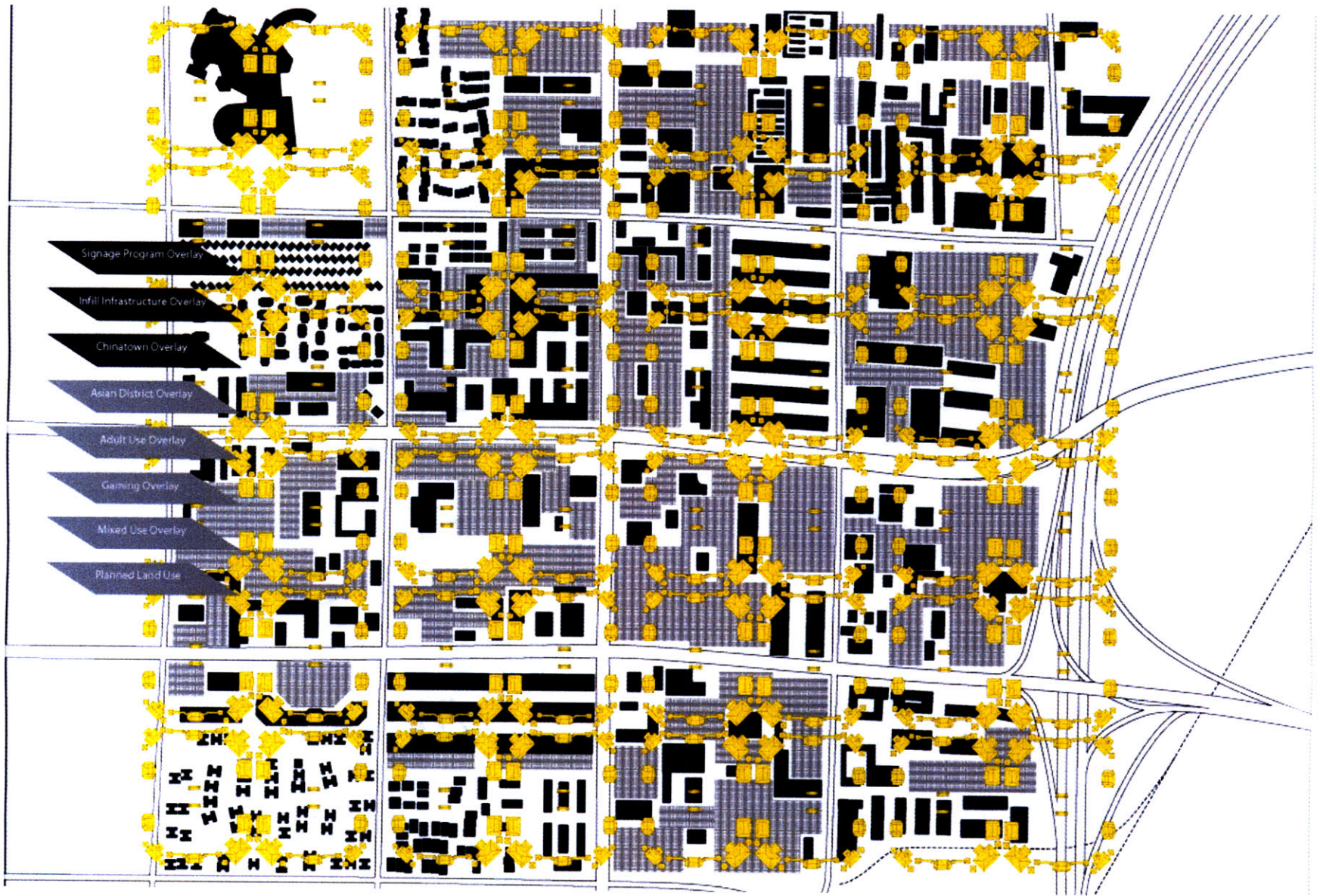

Finally, in the Signage Program Overlay, authentic Tang Dynasty roofs of Chinatown Plaza are replicated across the site to fill the one mile square.

COMPONENTS

The New Chinatown area will be populated by three types of components, serving as infrastructure for occupation.

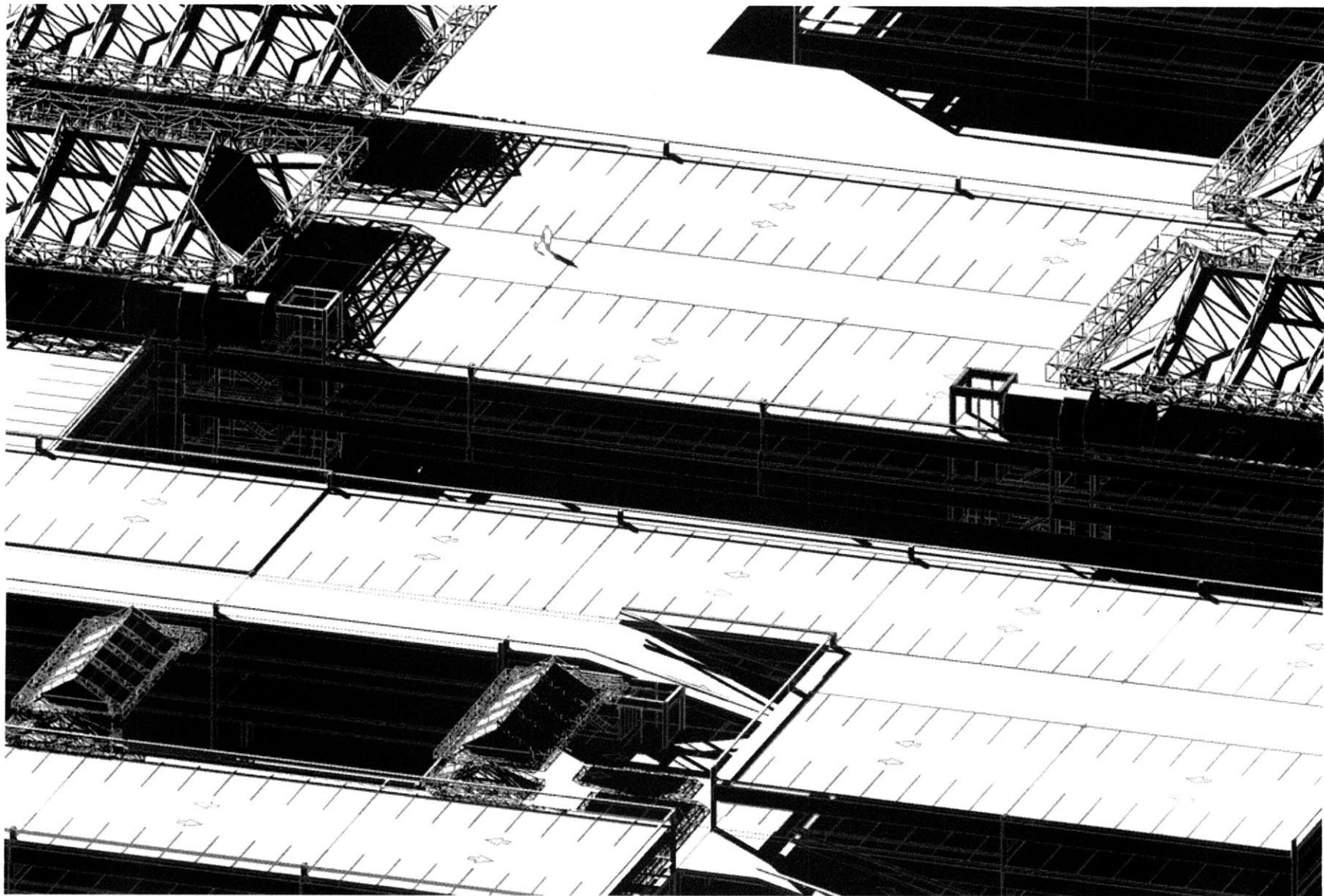

Vertical Platforms

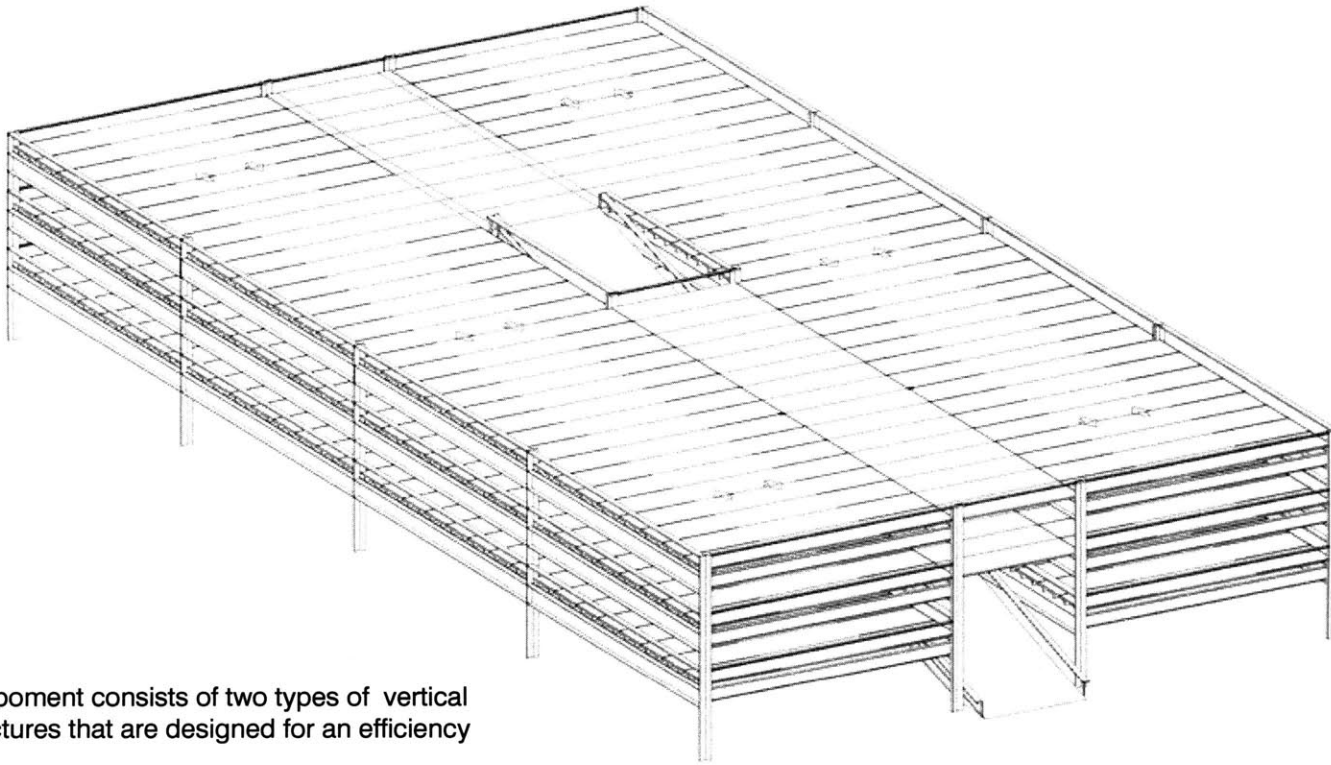

The first component consists of two types of vertical platform structures that are designed for an efficiency of speed.

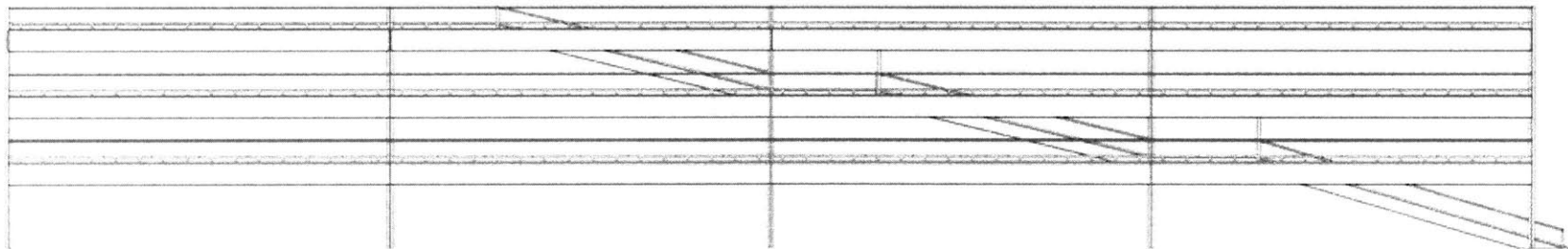

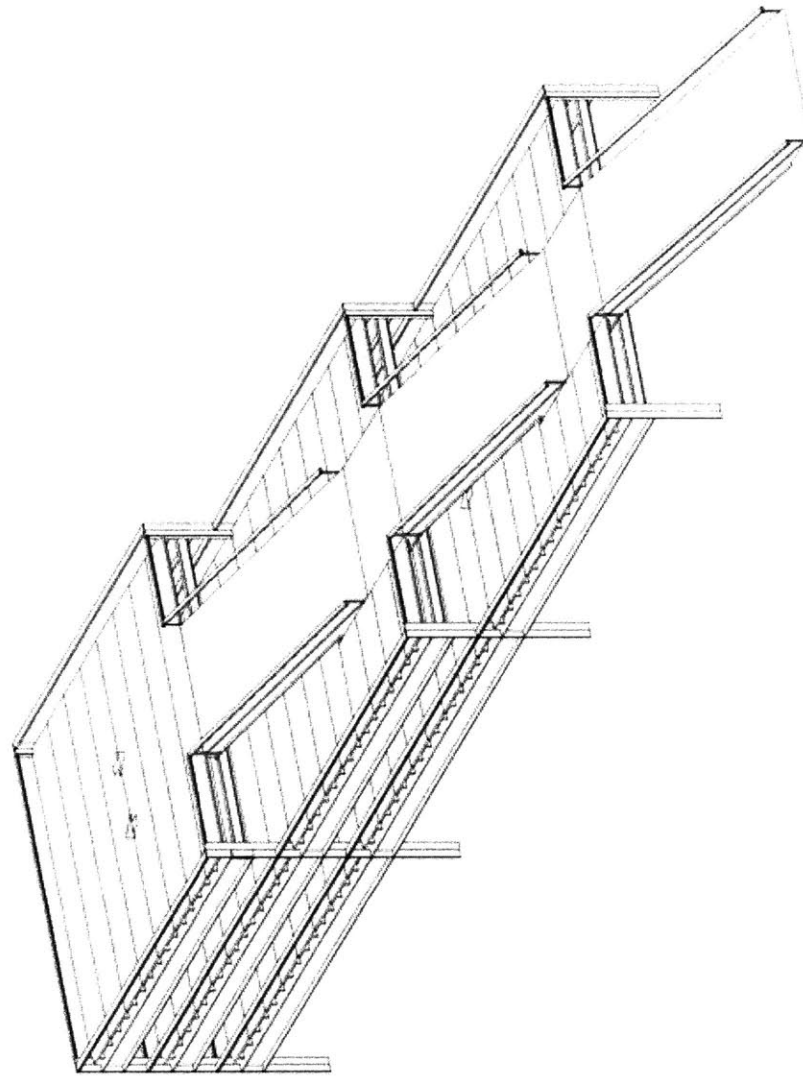

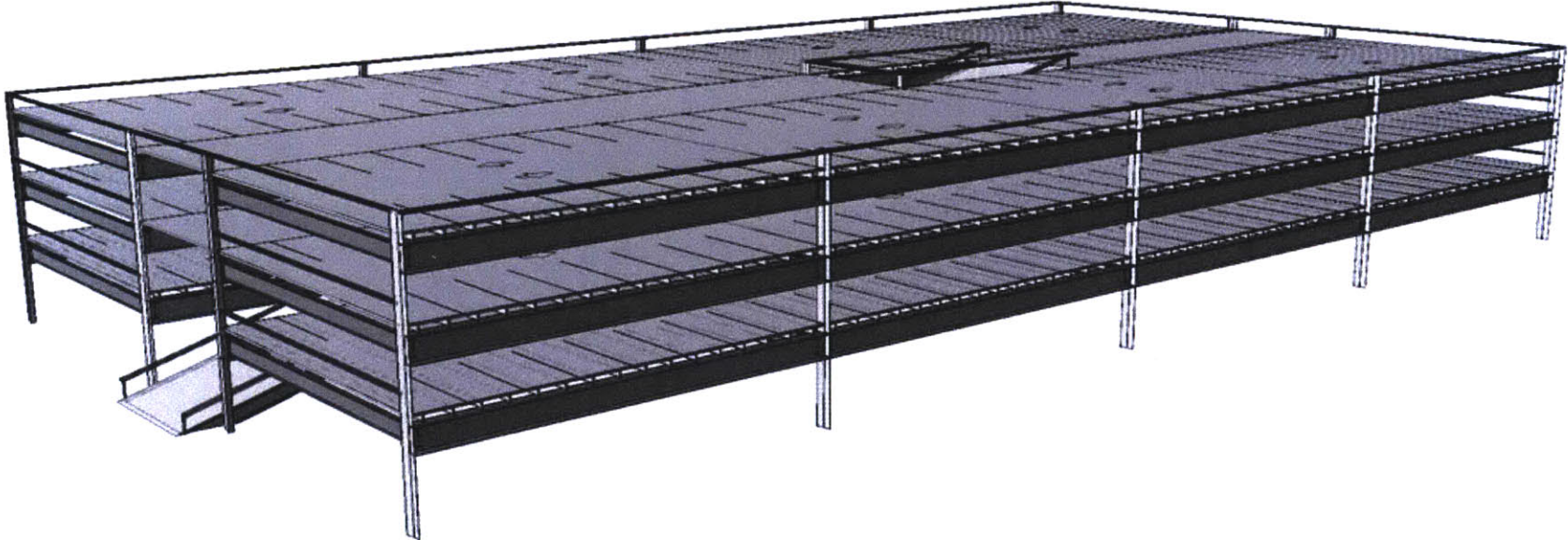

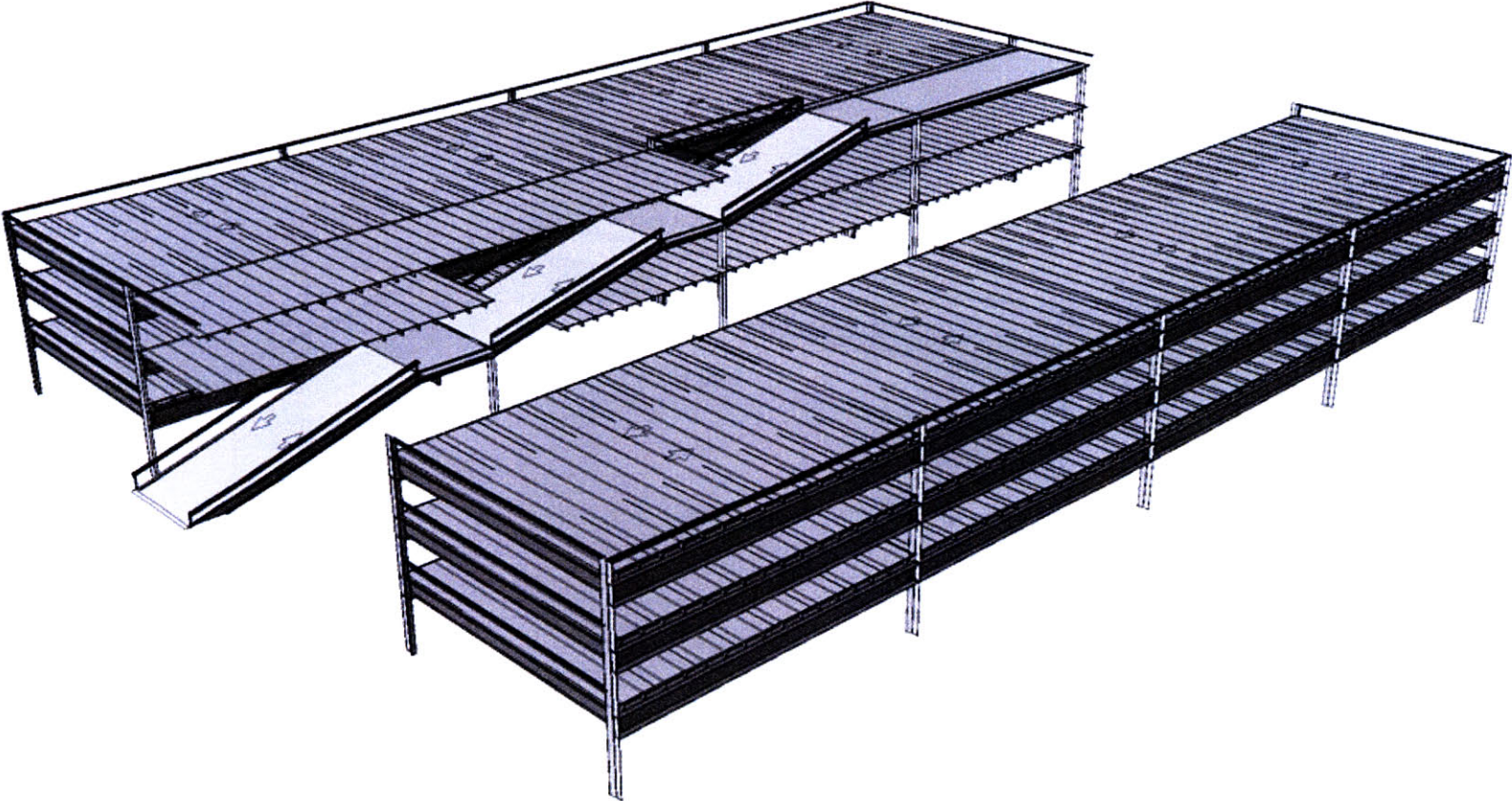

Precast Concrete Double T's stacked on top of Steel I-beams.

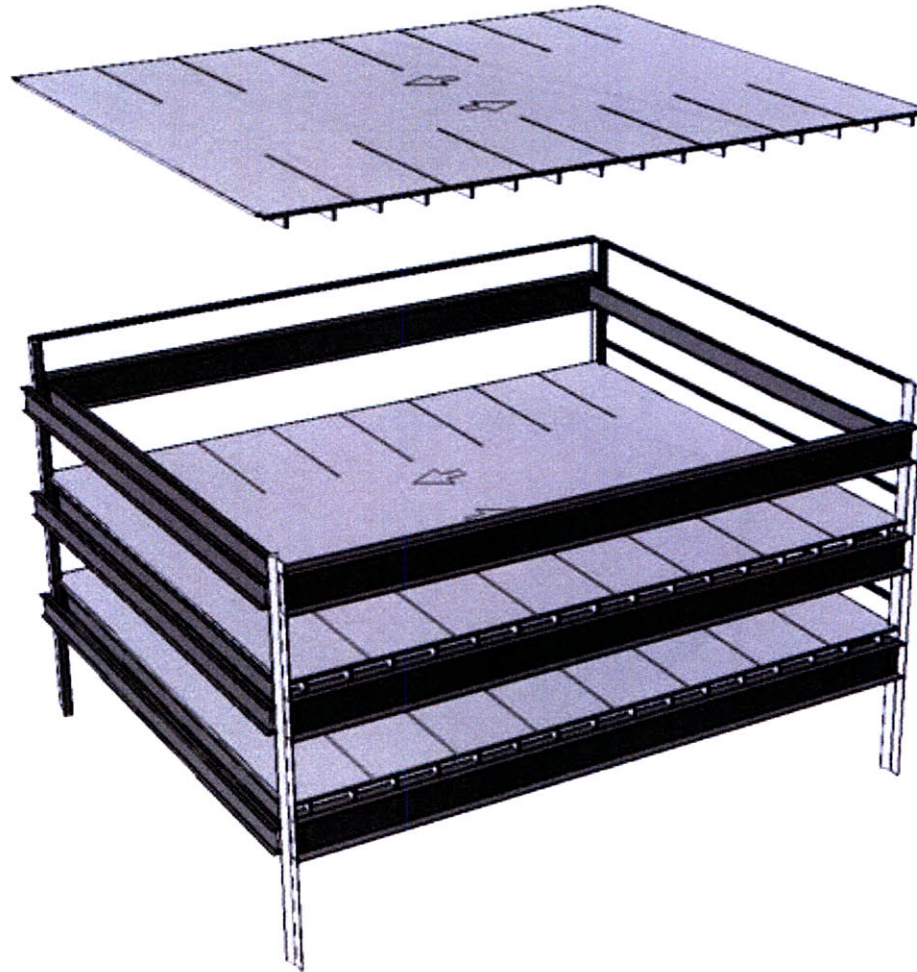

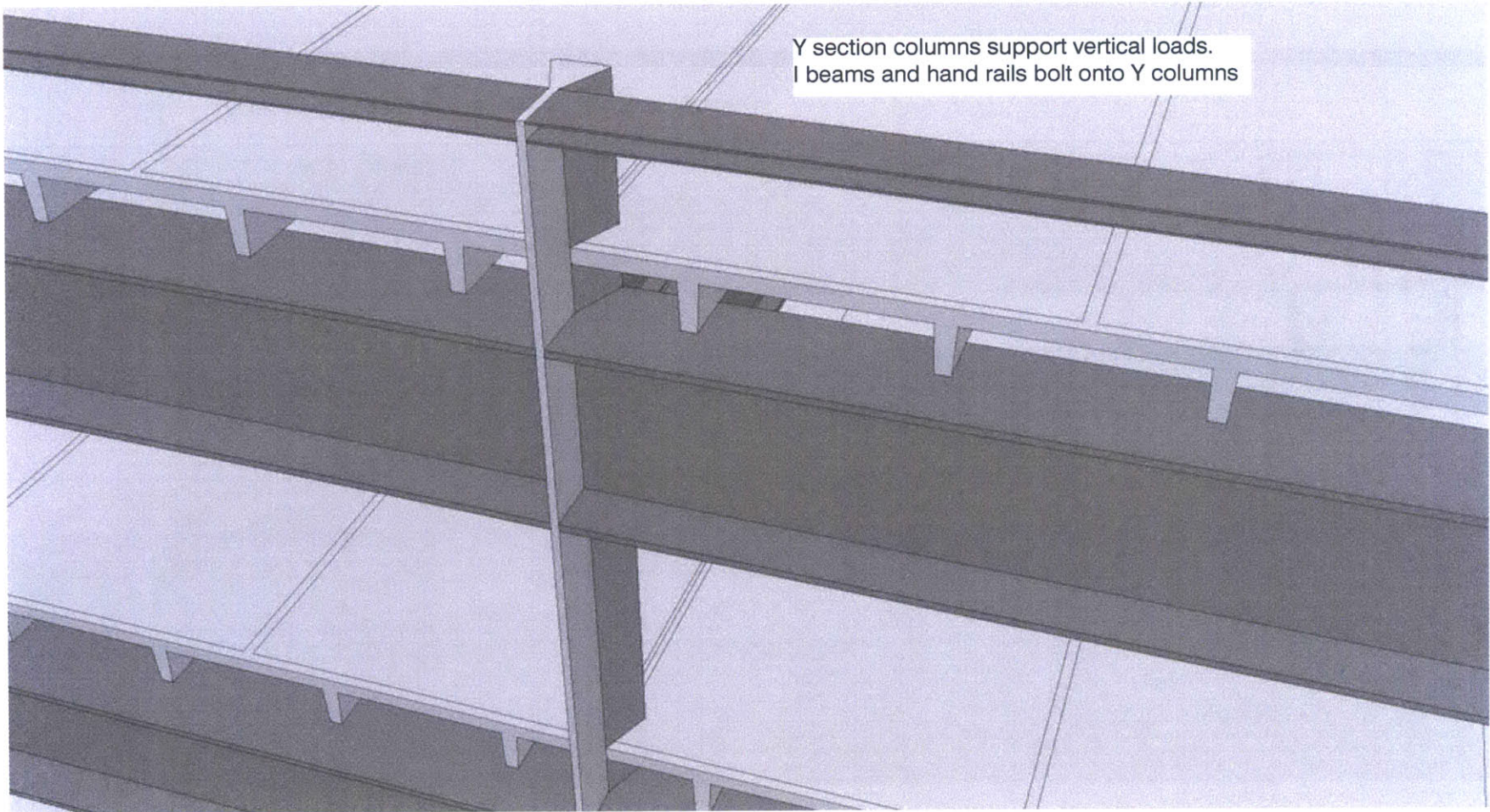

Y section columns support vertical loads.
I beams and hand rails bolt onto Y columns

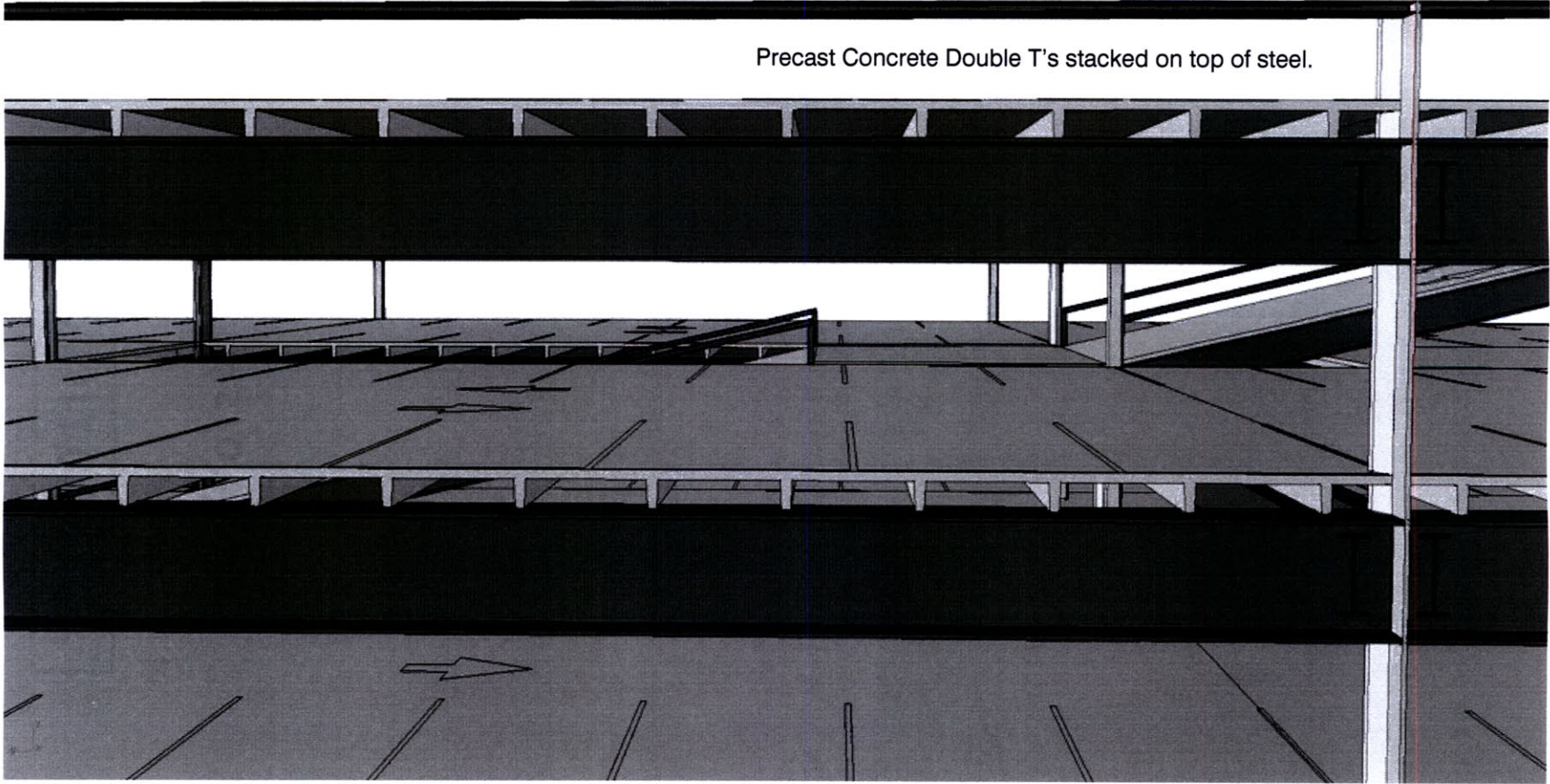

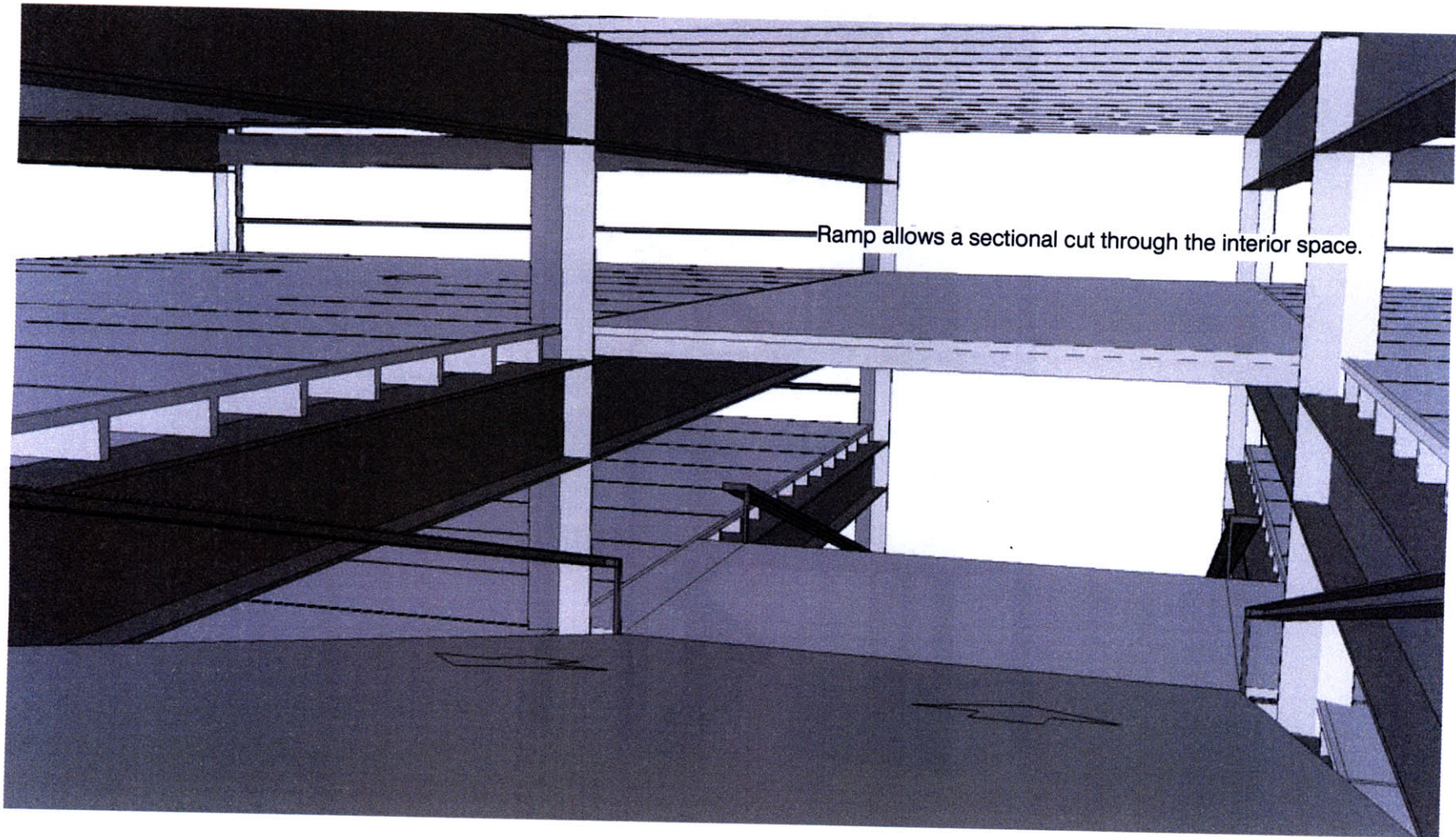

Ramp allows a sectional cut through the interior space.

Cores

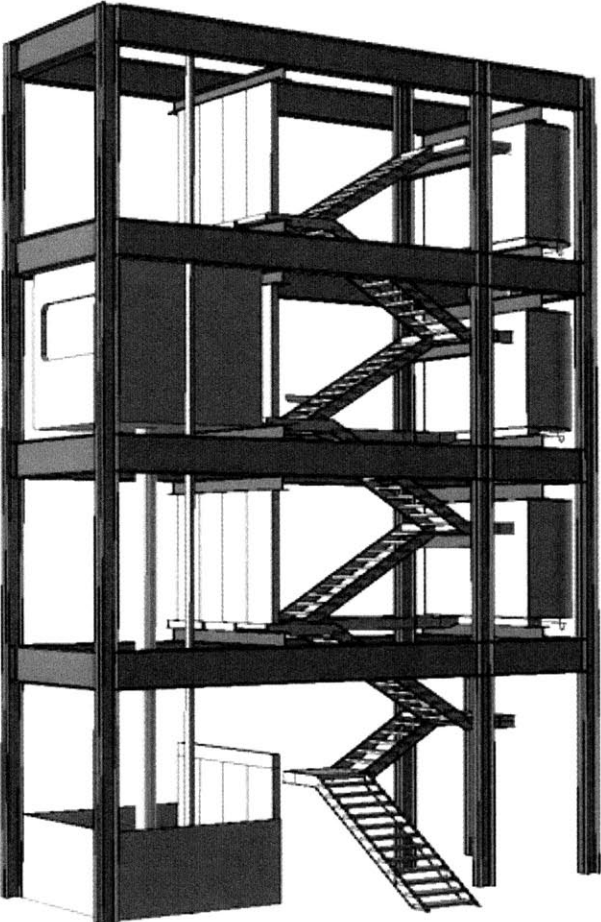

The cores supply vertical circulation with stairs and an elevator. They also contain three levels of public toilets.

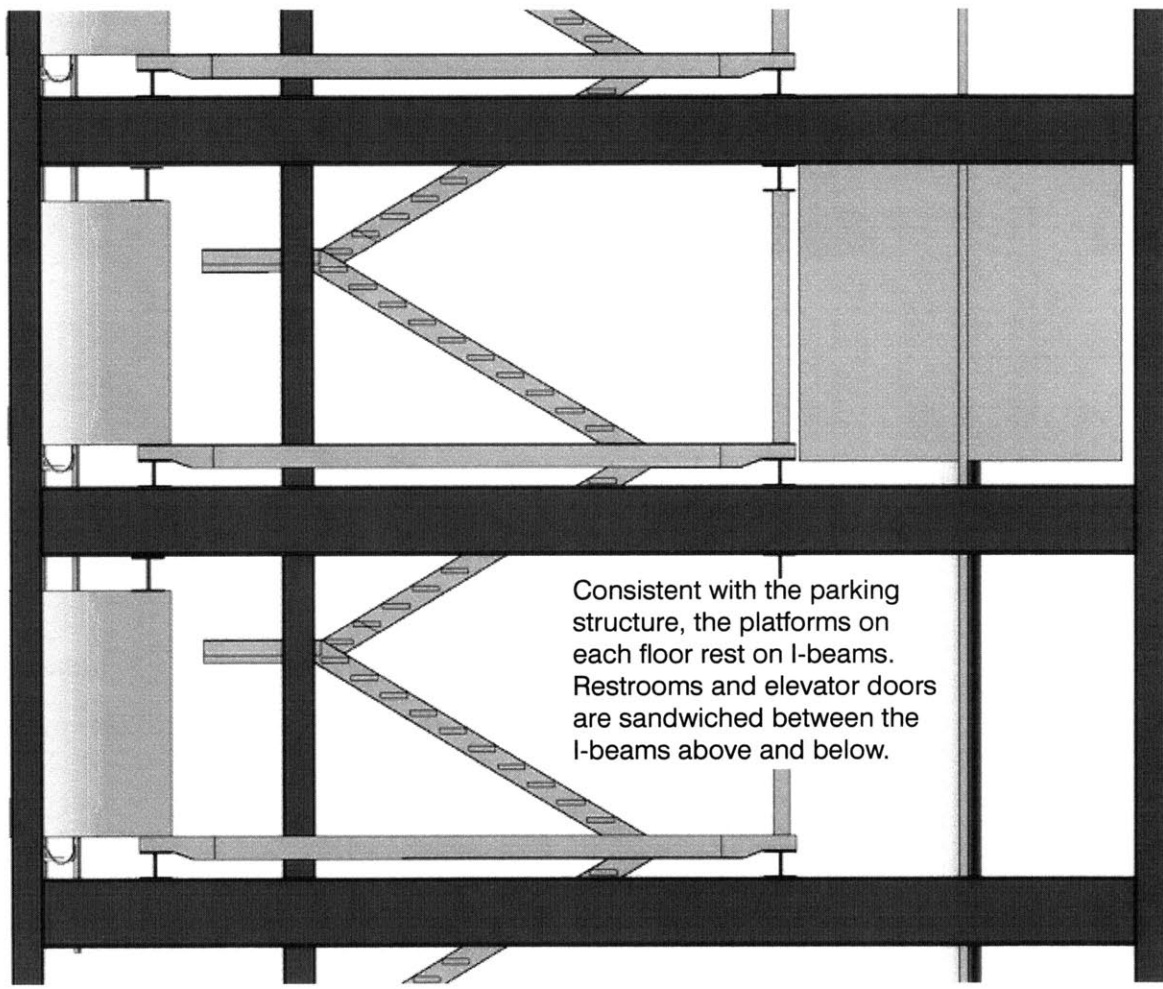

Consistent with the parking structure, the platforms on each floor rest on I-beams. Restrooms and elevator doors are sandwiched between the I-beams above and below.

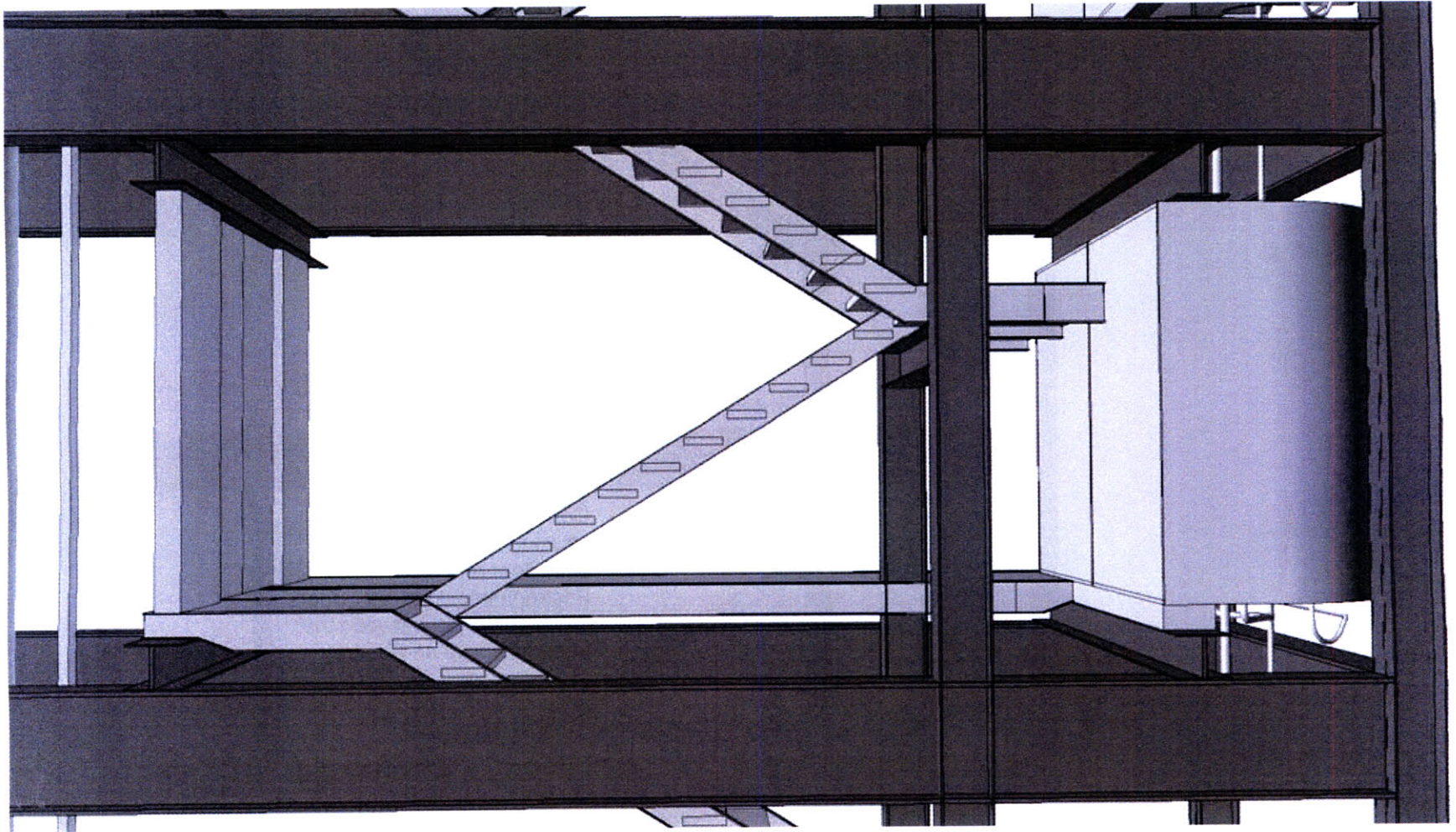

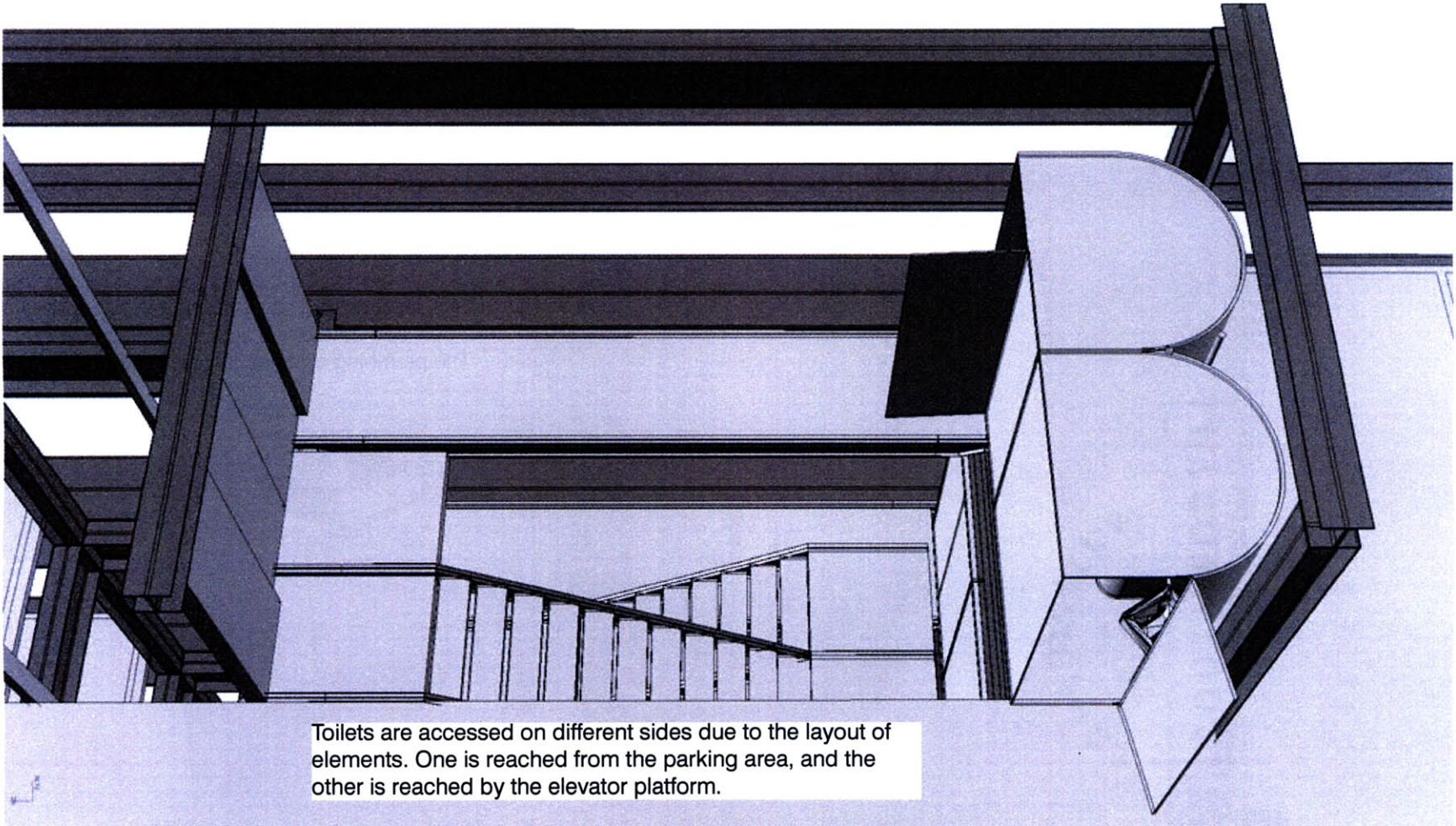

Toilets are accessed on different sides due to the layout of elements. One is reached from the parking area, and the other is reached by the elevator platform.

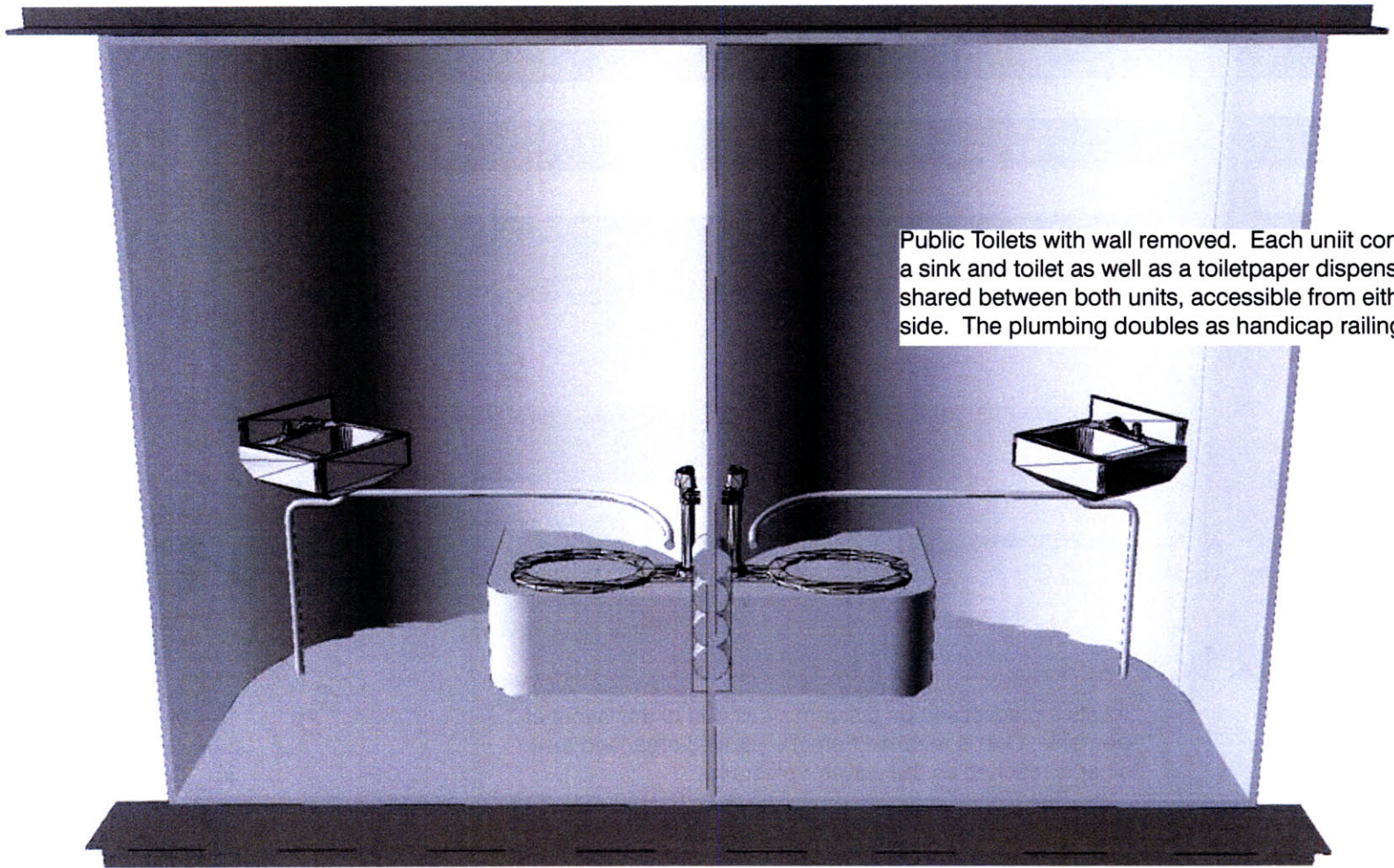

Public Toilets with wall removed. Each unit contains a sink and toilet as well as a toiletpaper dispenser shared between both units, accessible from either side. The plumbing doubles as handicap railing.

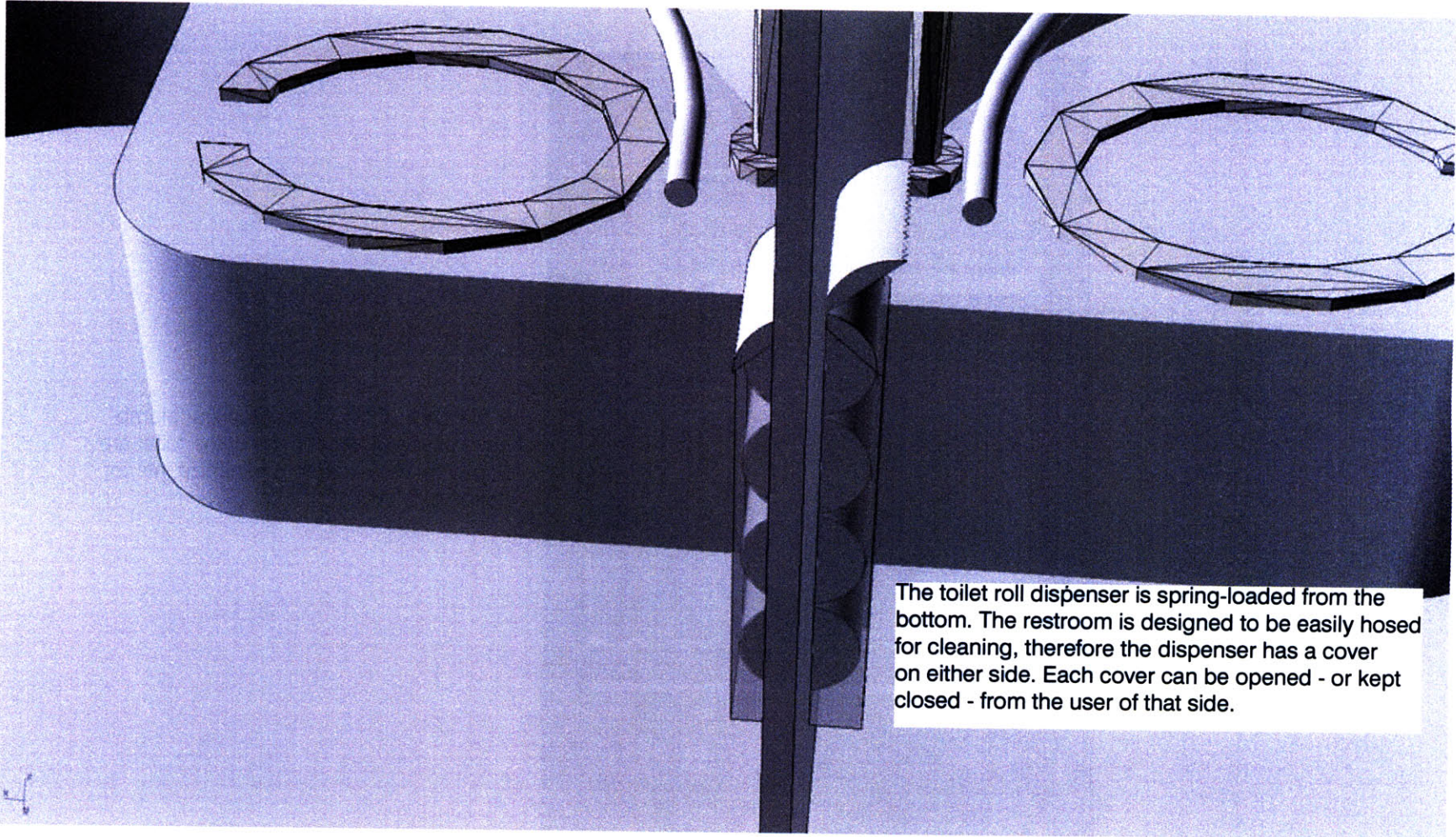

The toilet roll dispenser is spring-loaded from the bottom. The restroom is designed to be easily hosed for cleaning, therefore the dispenser has a cover on either side. Each cover can be opened - or kept closed - from the user of that side.

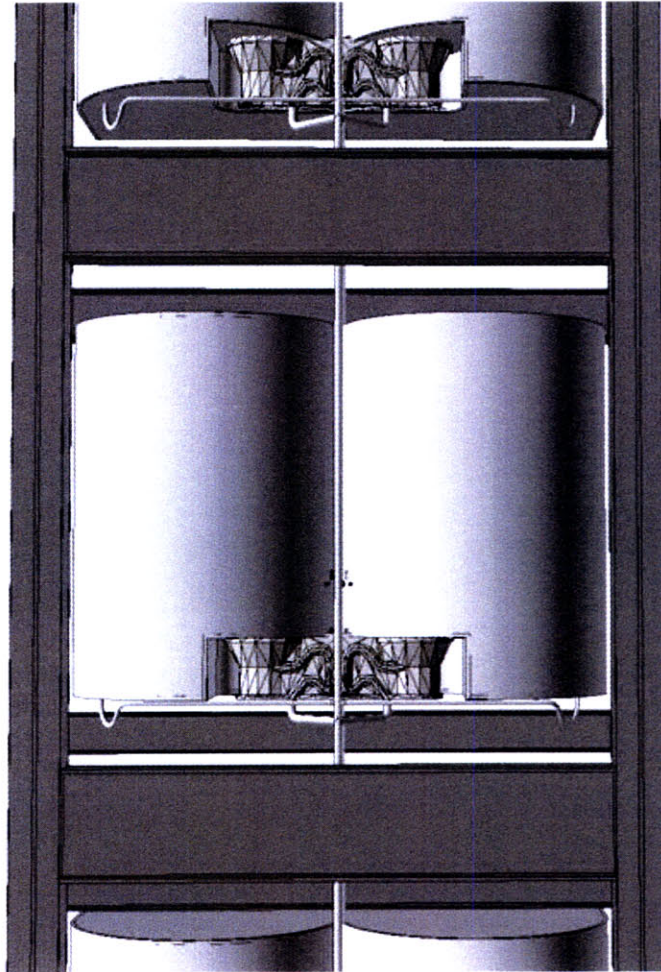

At the back of the vertical towers, plumbing is exposed. Most parts of the toilet are placed on the exterior to minimize interior cleaning.

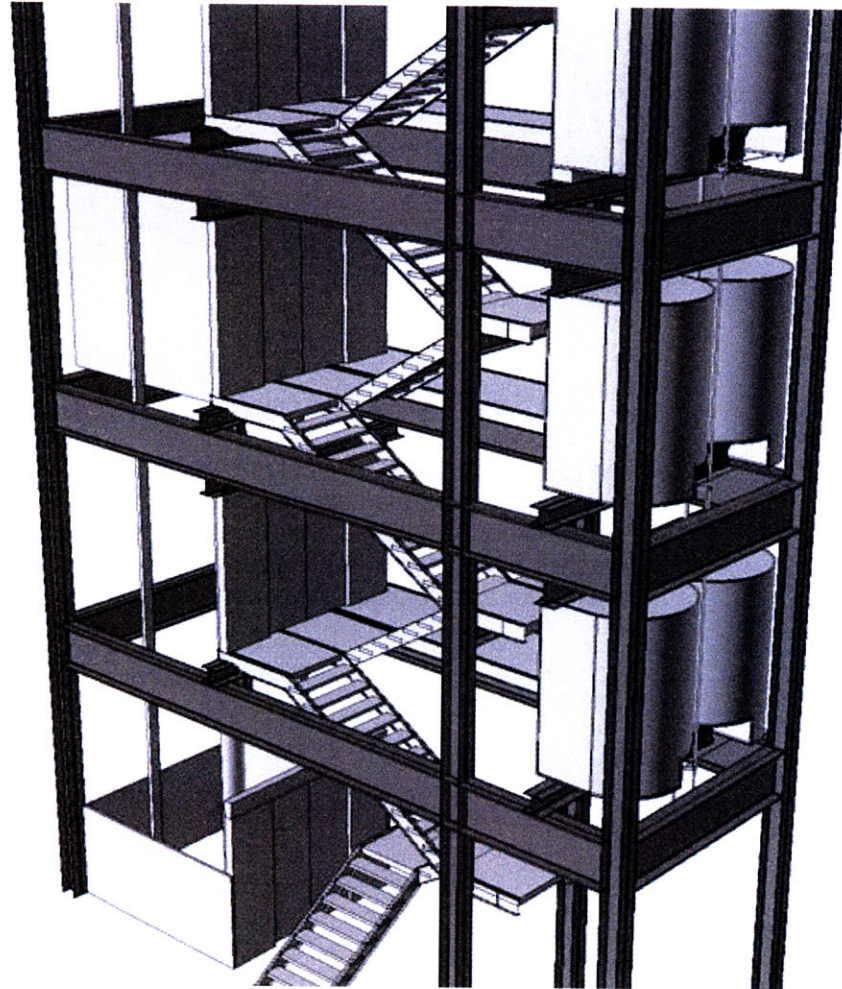

Signs

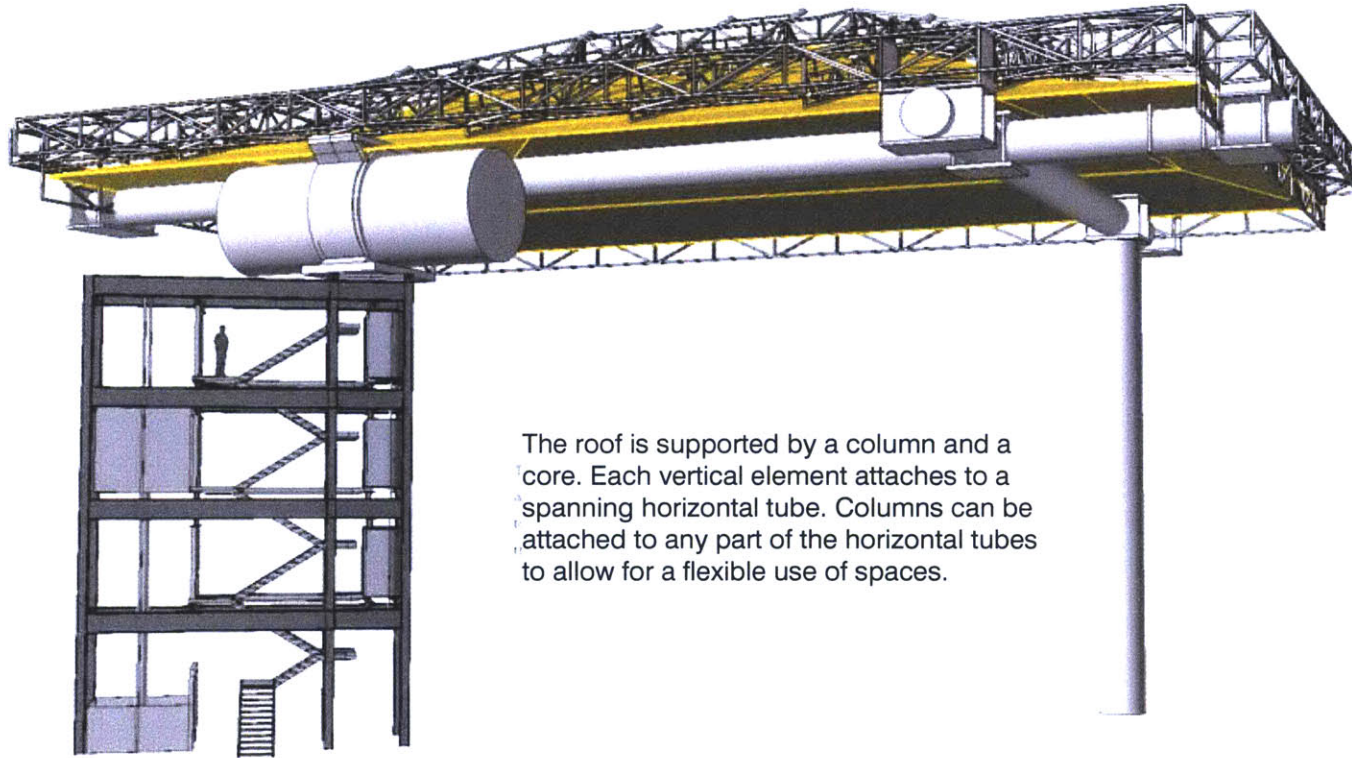

The roof is supported by a column and a core. Each vertical element attaches to a spanning horizontal tube. Columns can be attached to any part of the horizontal tubes to allow for a flexible use of spaces.

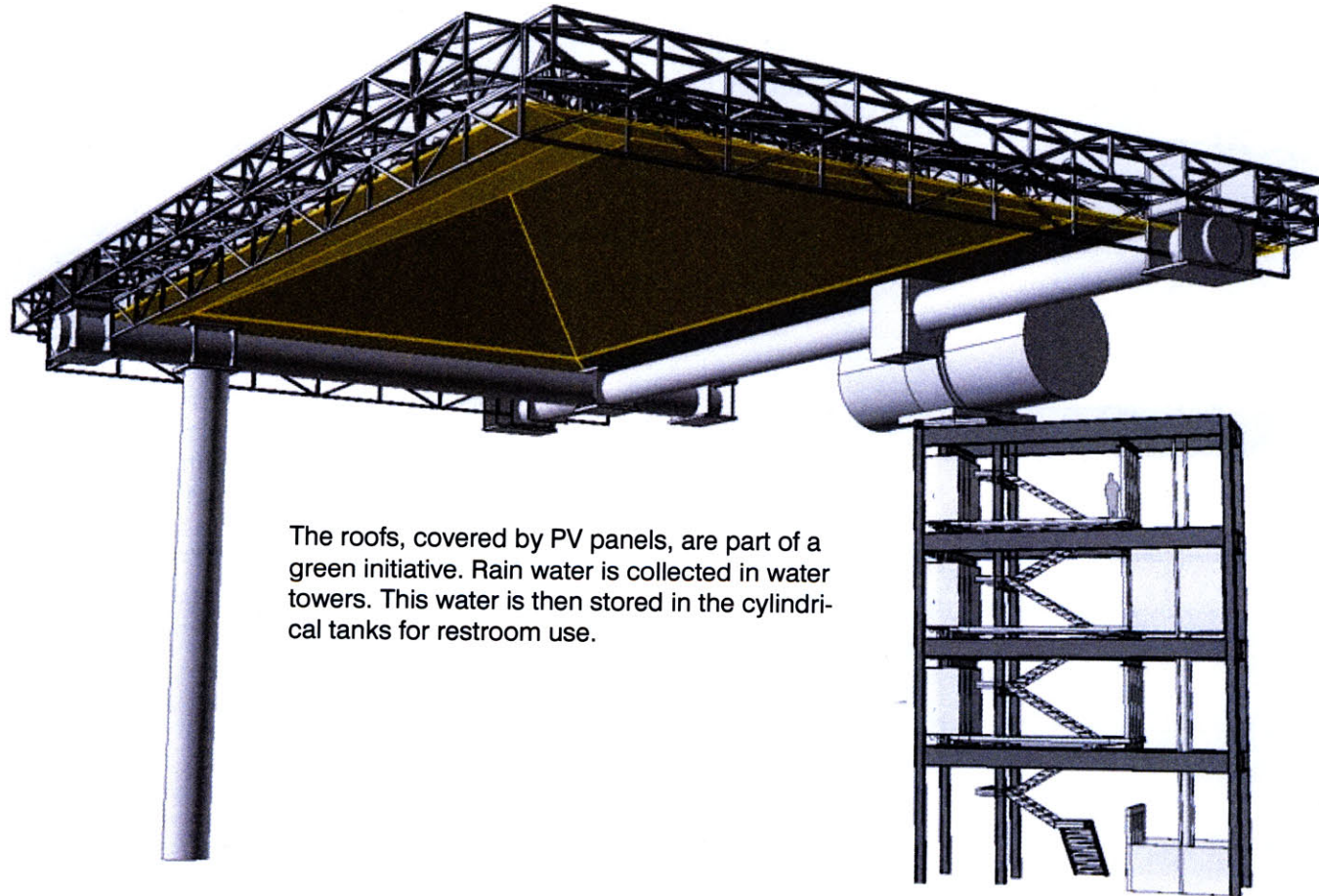

The roofs, covered by PV panels, are part of a green initiative. Rain water is collected in water towers. This water is then stored in the cylindrical tanks for restroom use.

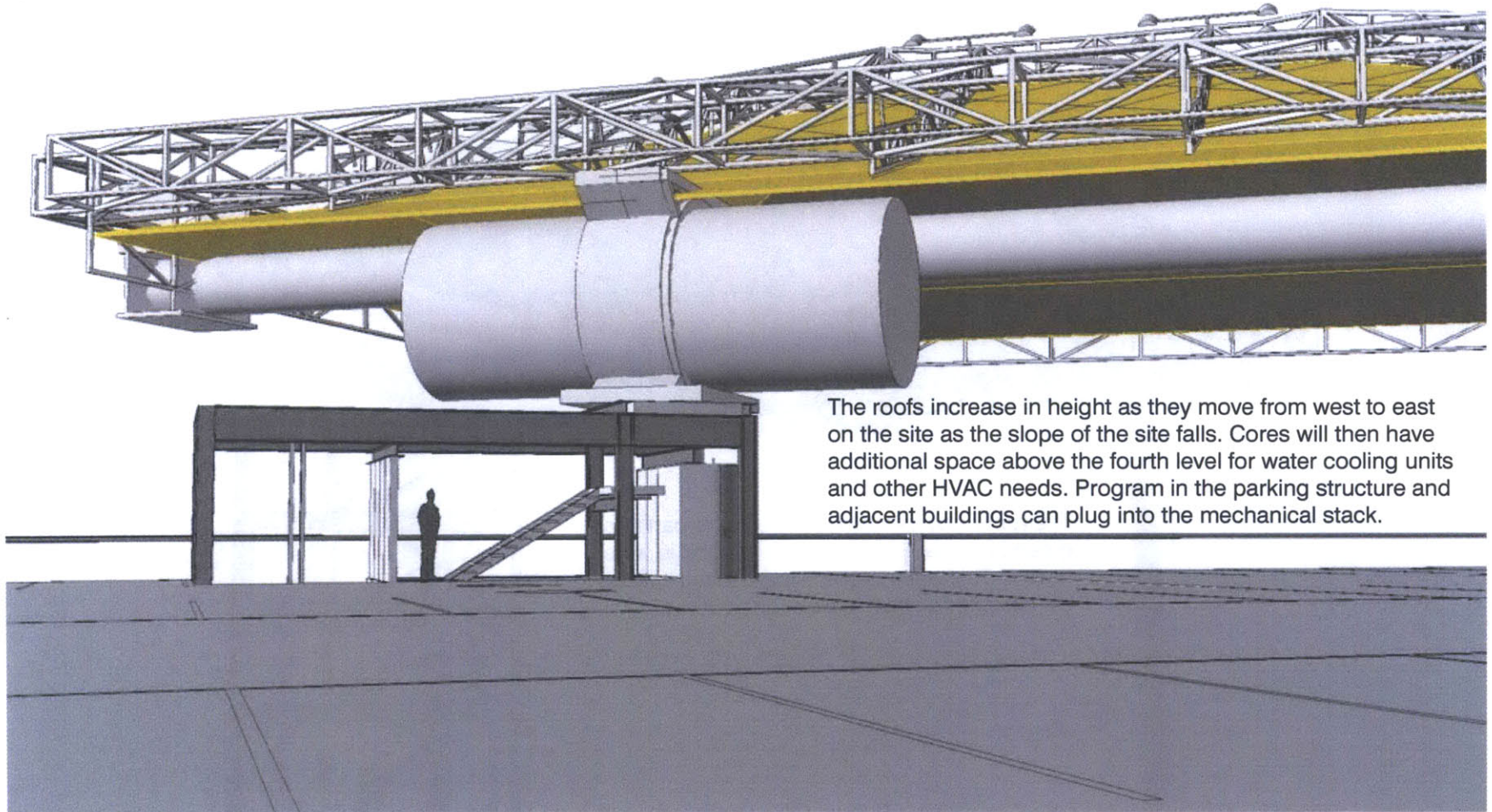

The roofs increase in height as they move from west to east on the site as the slope of the site falls. Cores will then have additional space above the fourth level for water cooling units and other HVAC needs. Program in the parking structure and adjacent buildings can plug into the mechanical stack.

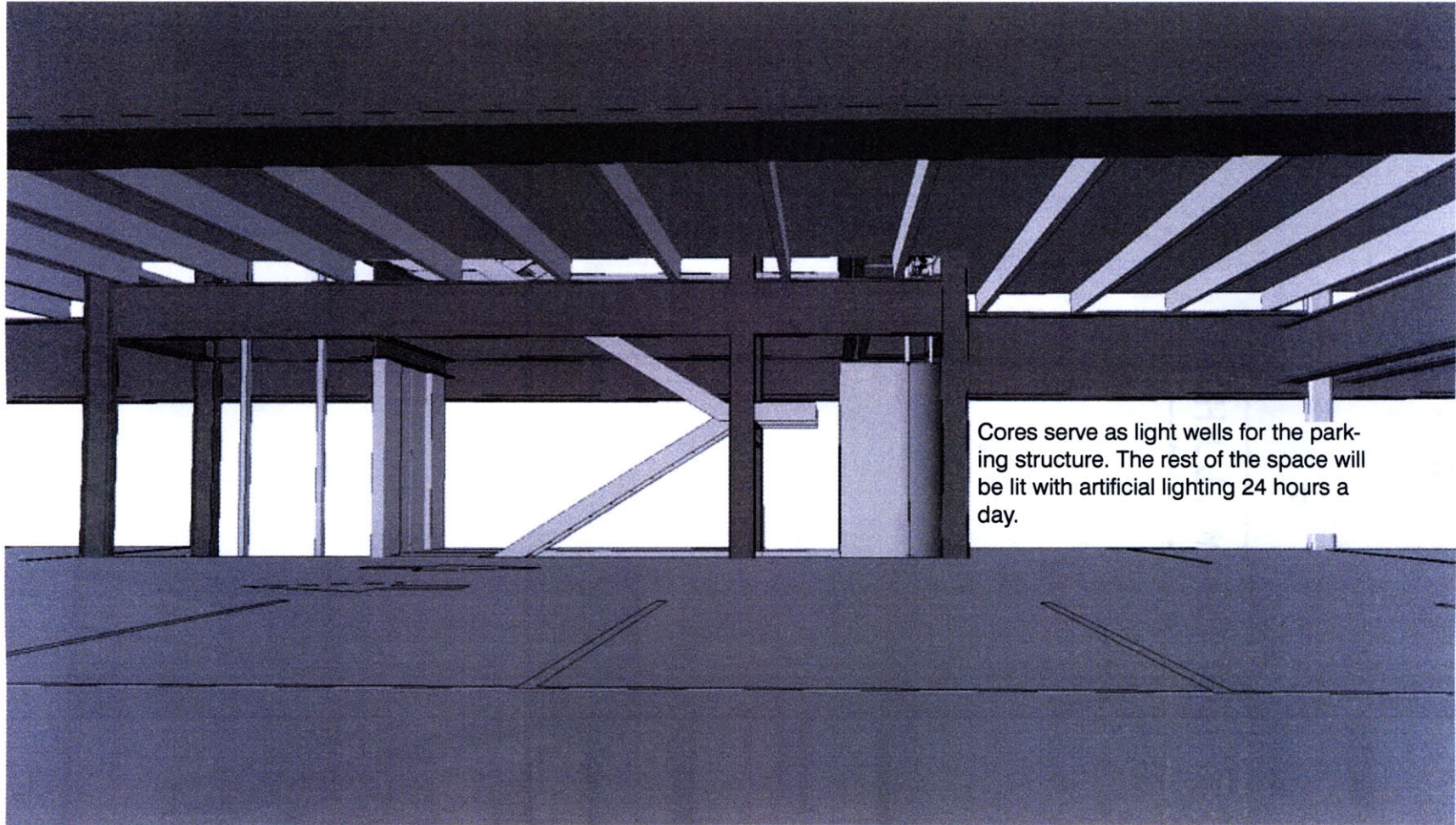

Cores serve as light wells for the parking structure. The rest of the space will be lit with artificial lighting 24 hours a day.

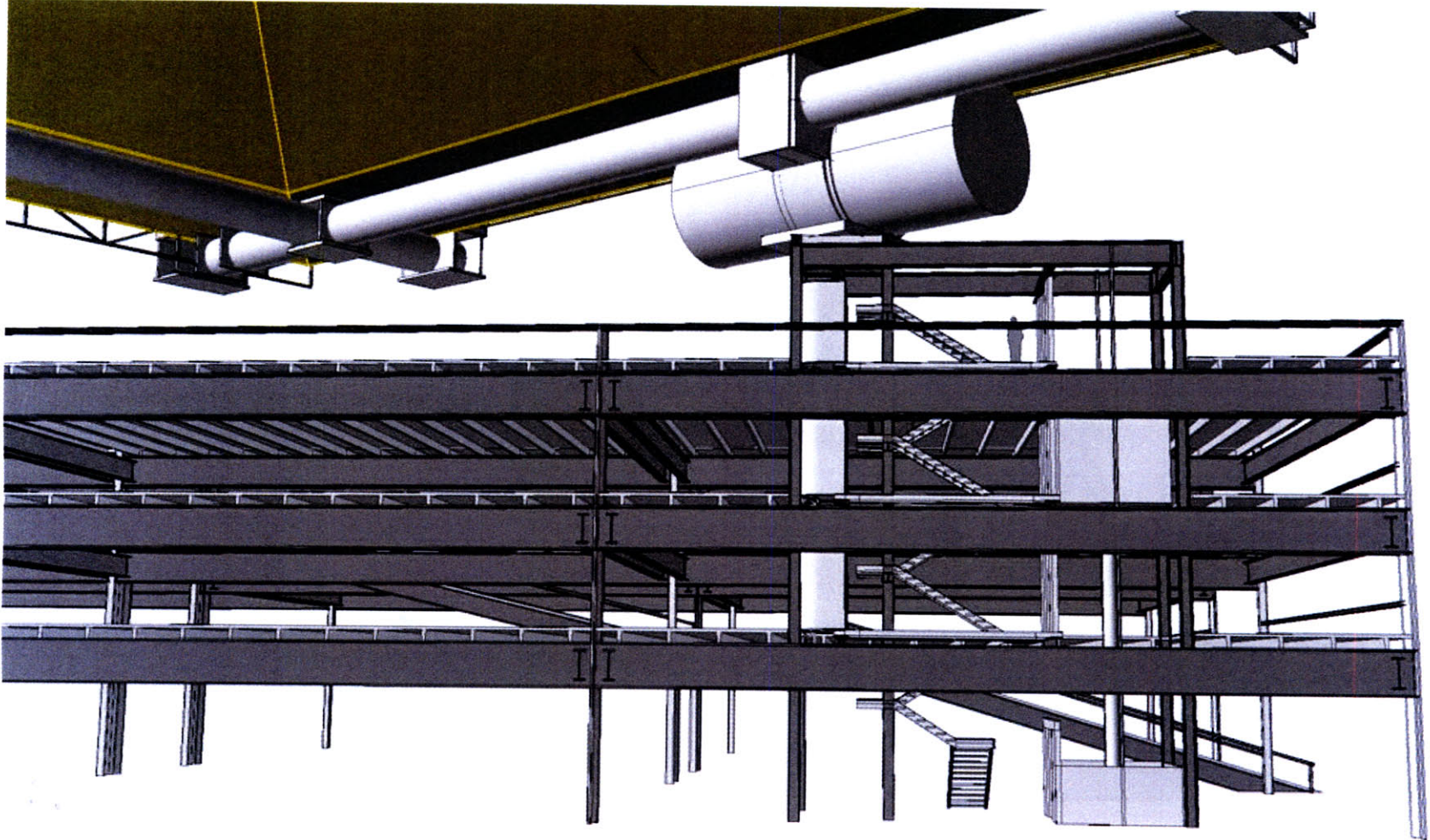

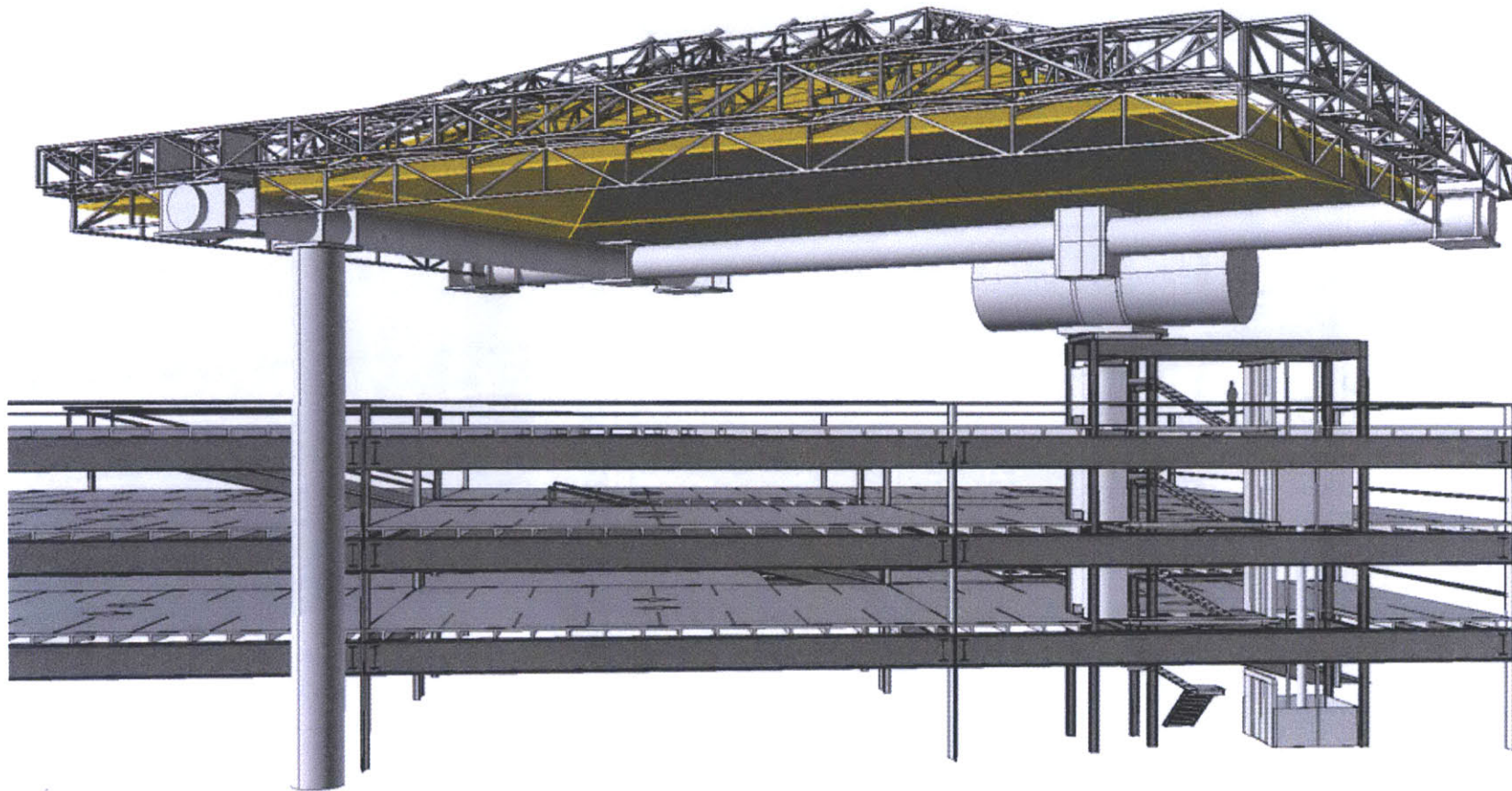

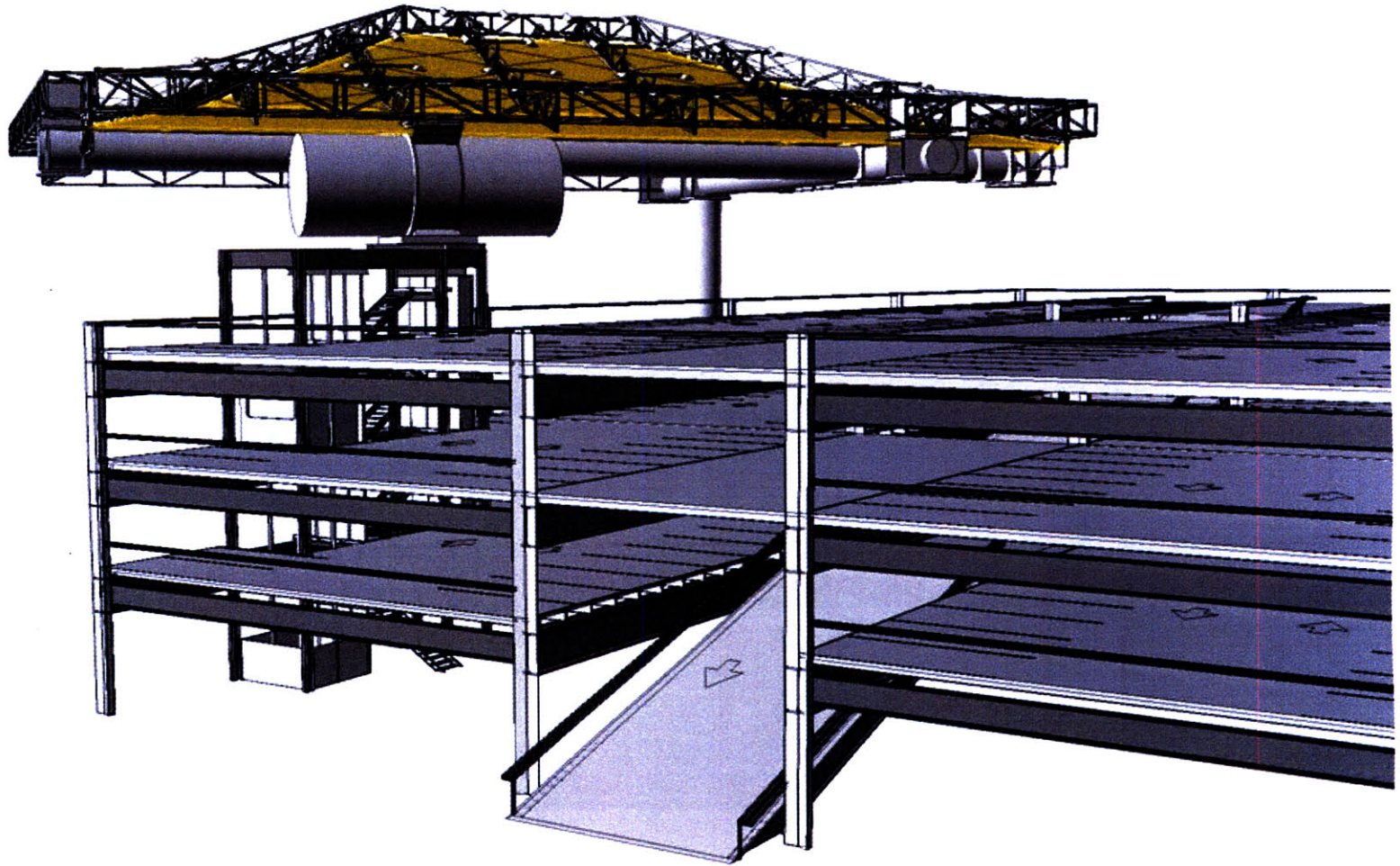

Advertising projections under Chinatown roofs/signs. These ads can be seen from the level of the pedestrian and the car.

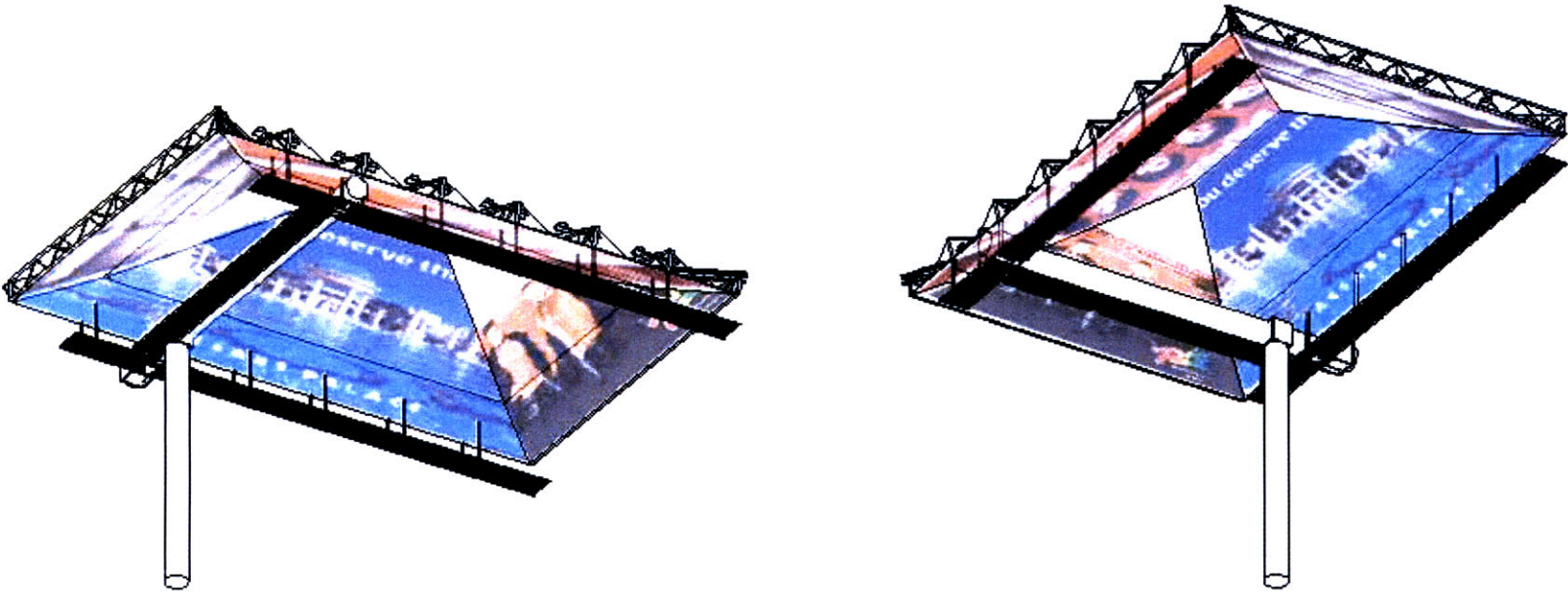

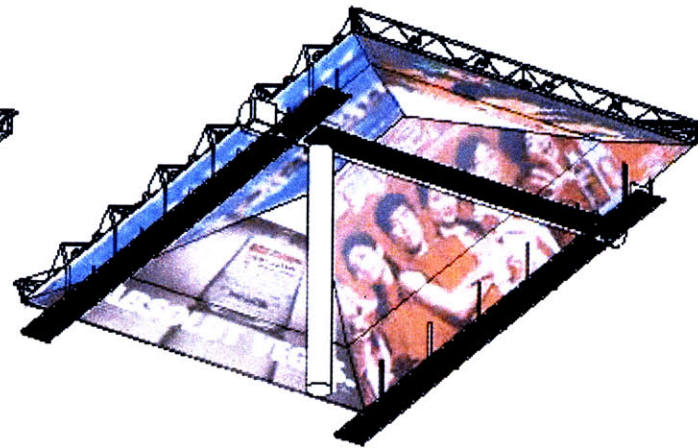
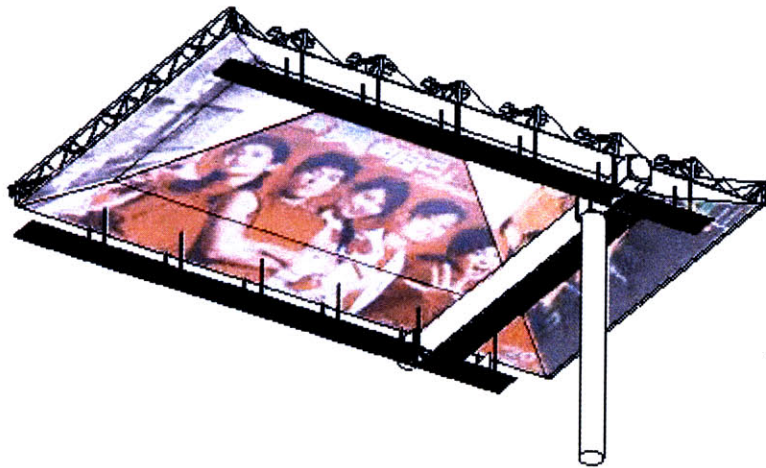

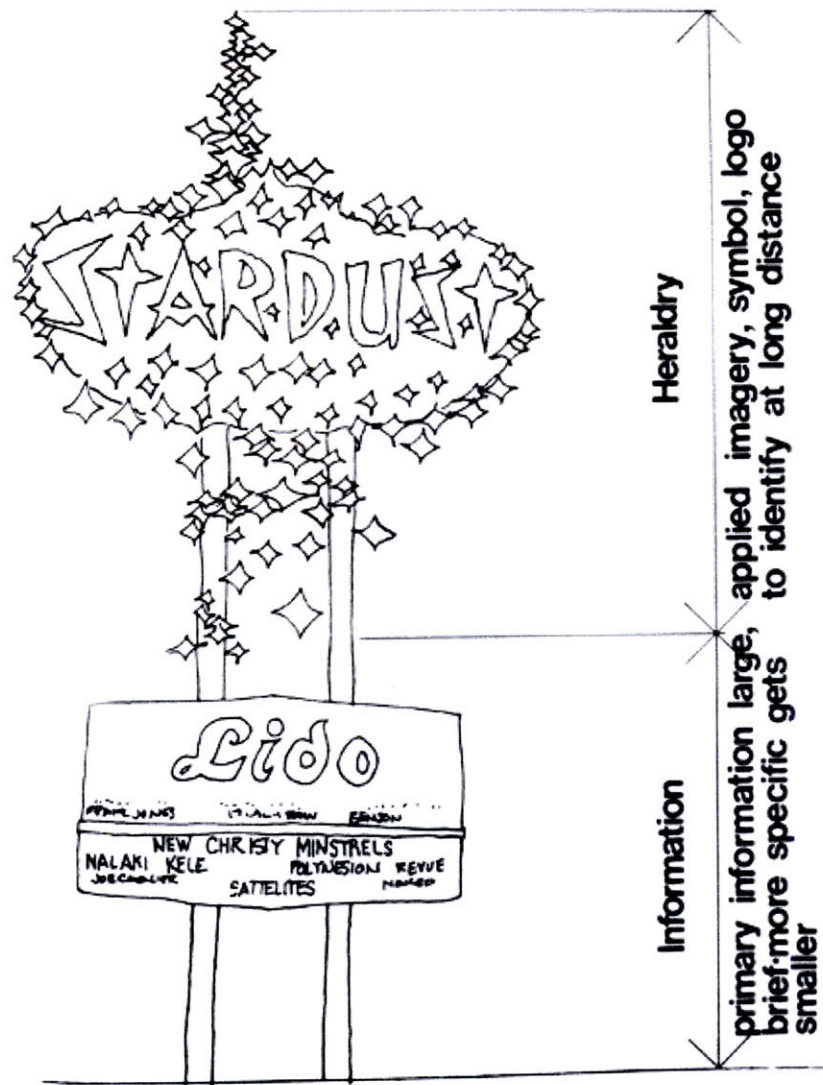

A nod to Venturi's observation that signs work on different scales and speeds.



Google Earth scale. Tops of signs act as pixels to be illuminated as an urban billboard.



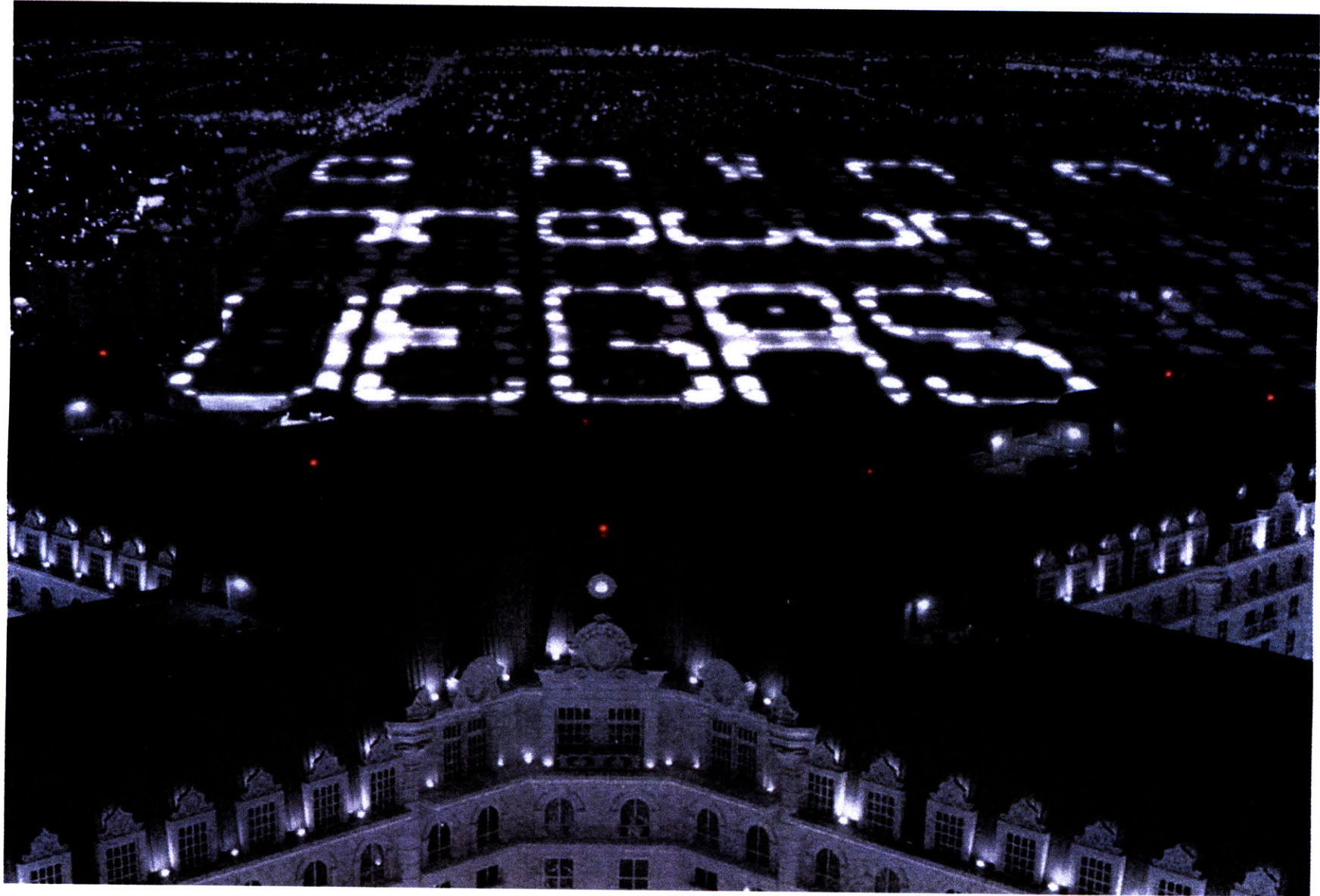

Panoramic perspective view as landscape of Chinese roofs. Roofs act as signage of the Chinatown.

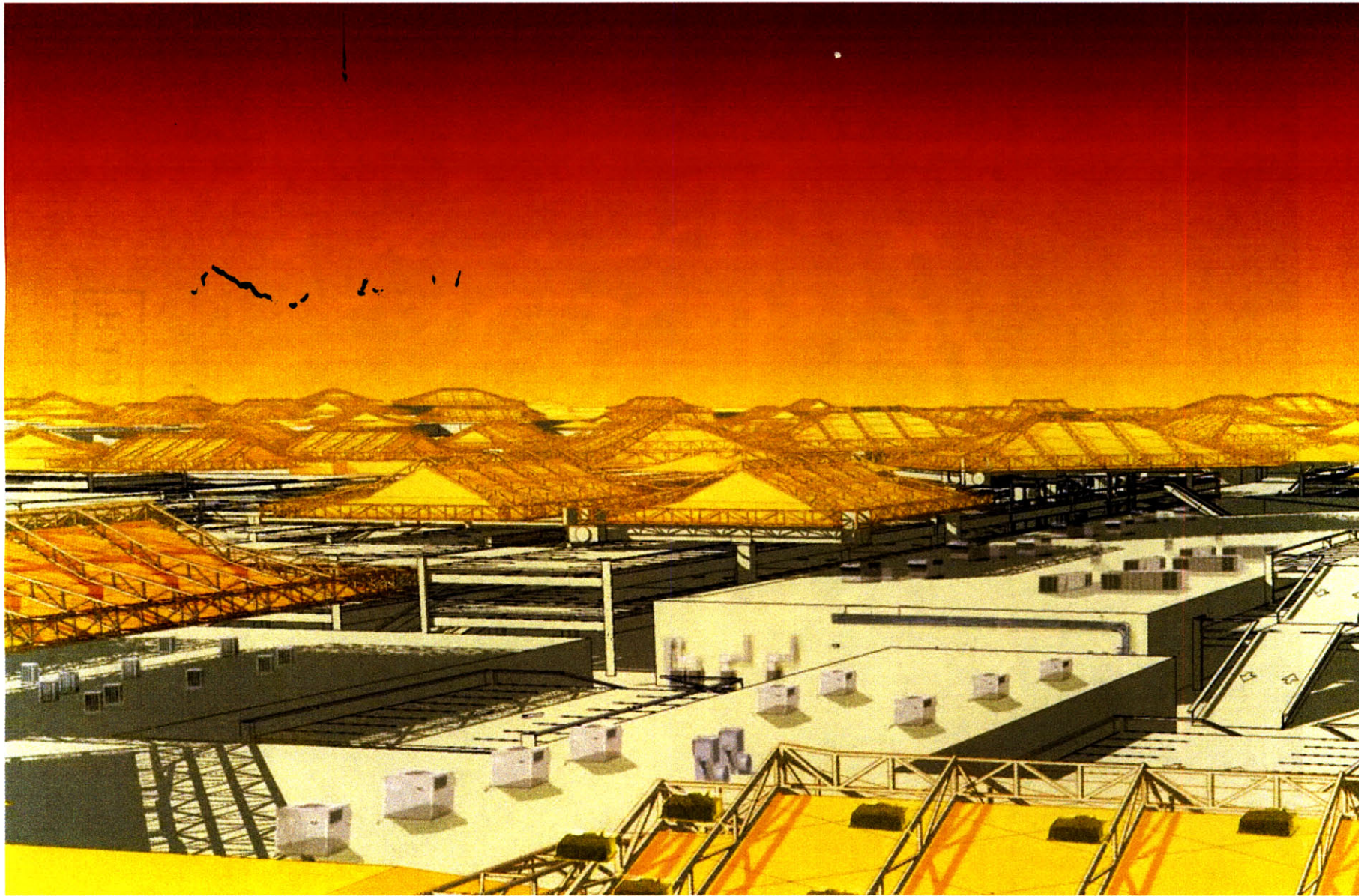

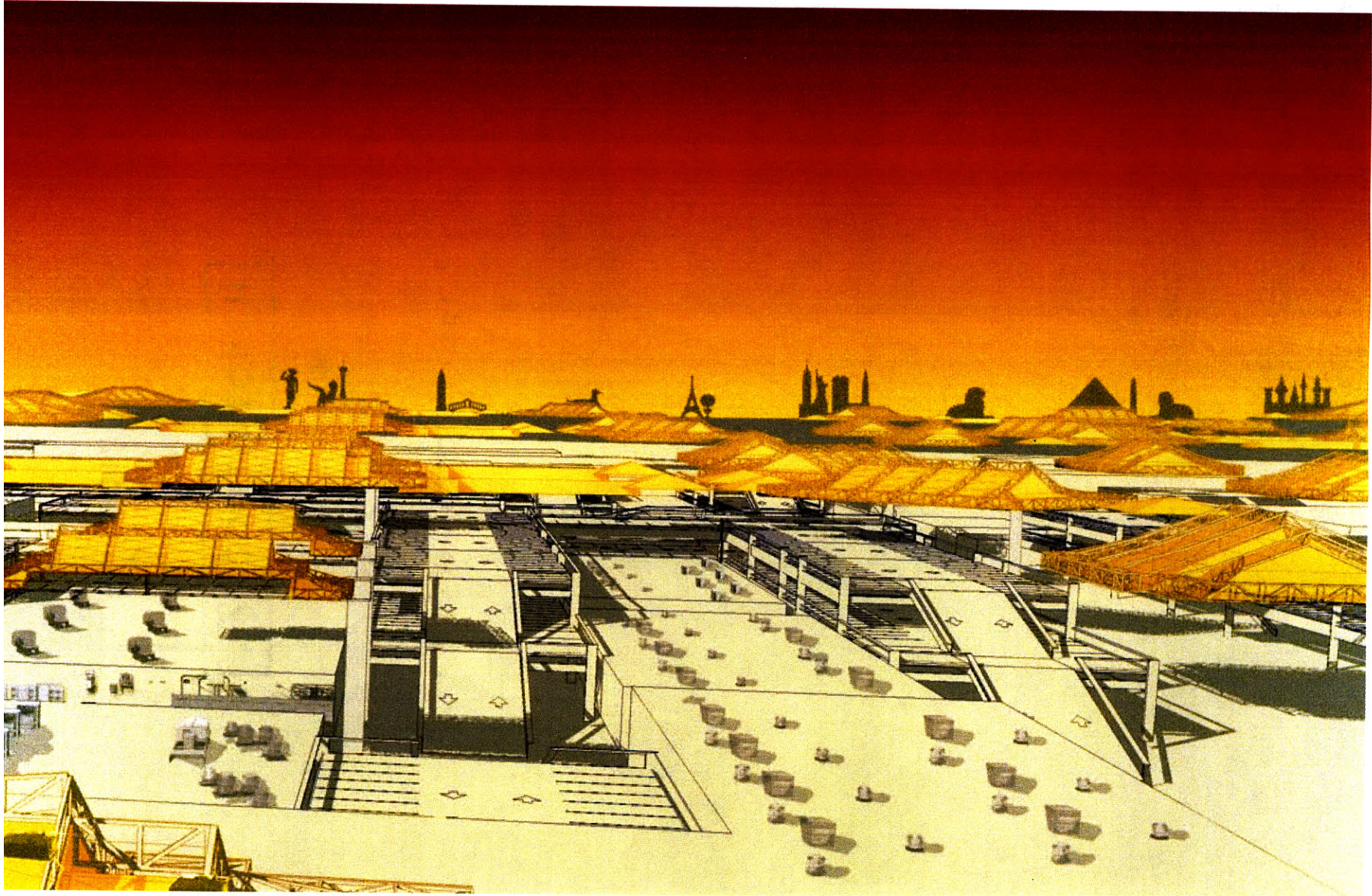

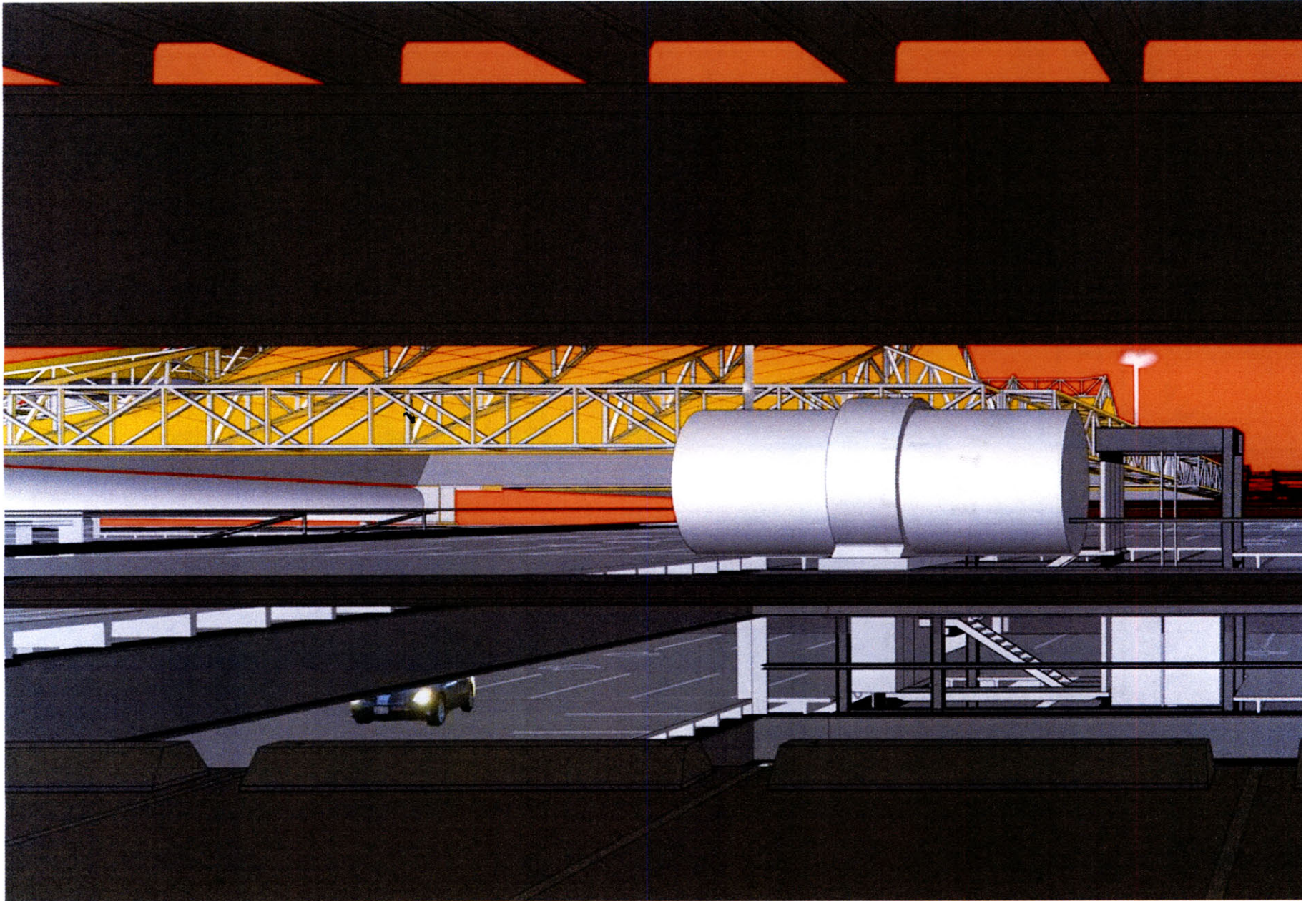

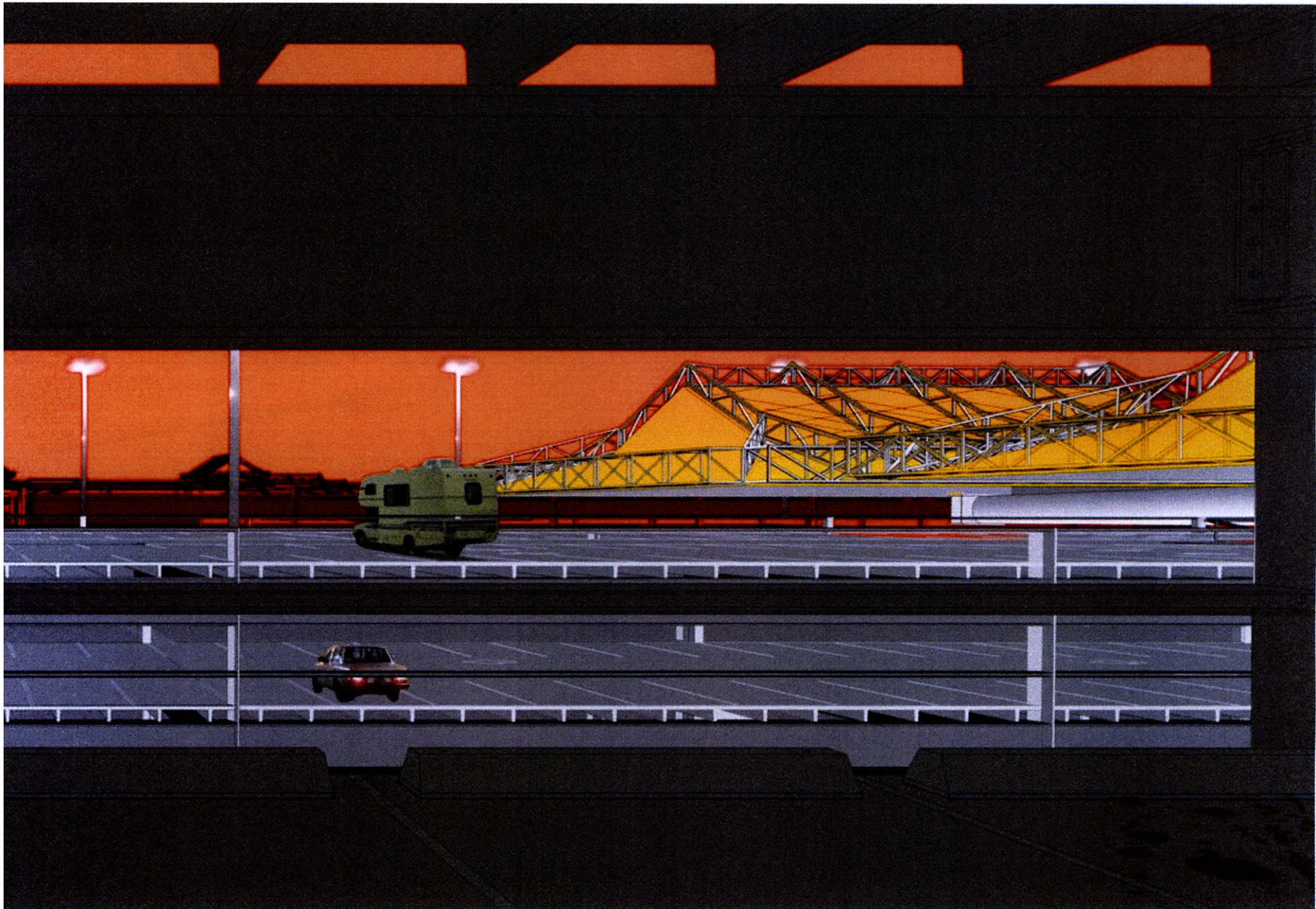

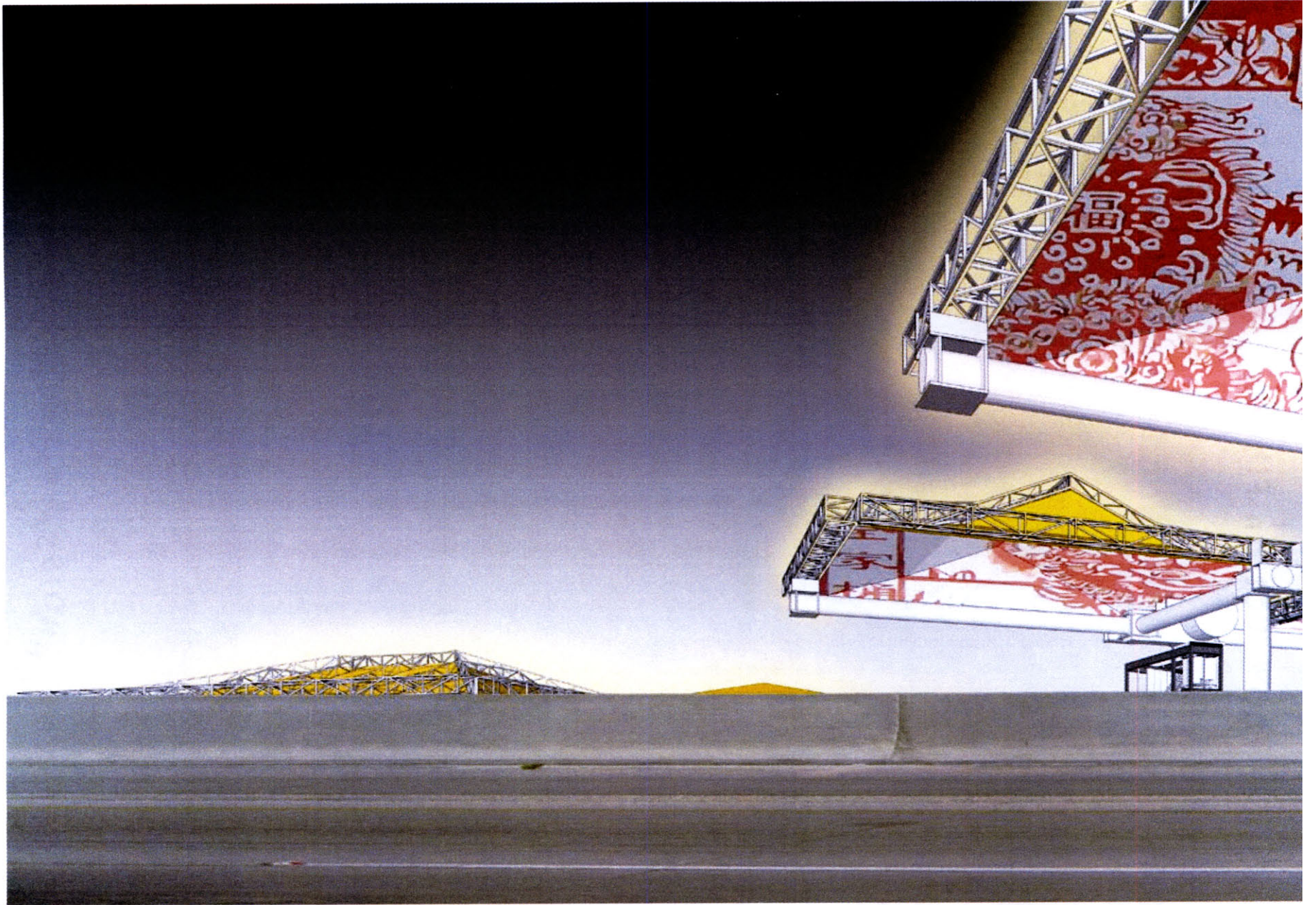



CIRCULATION

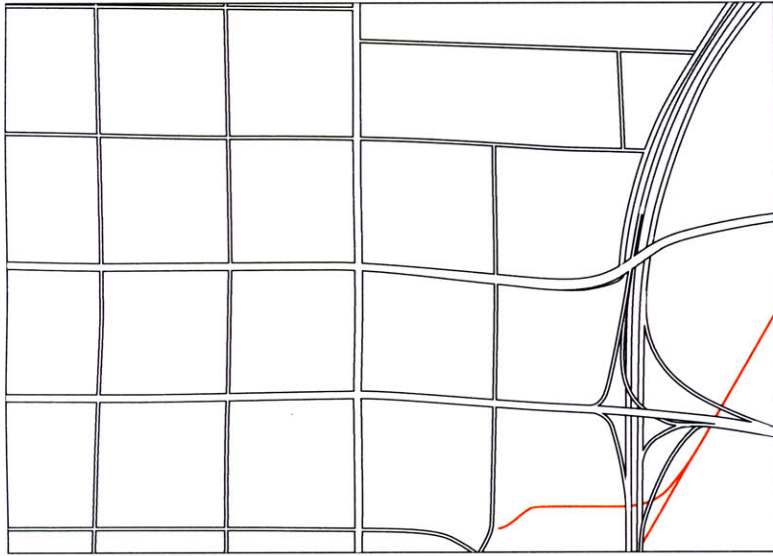

original grid

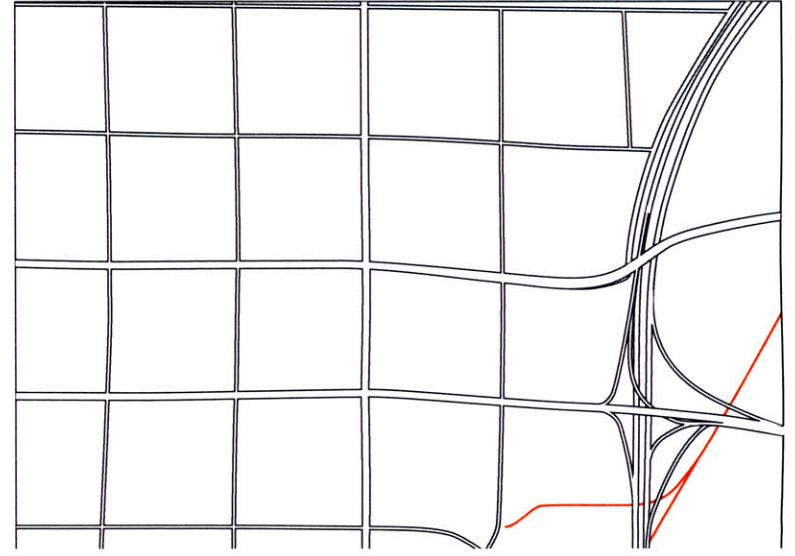

fix grid



original circulation of major roads

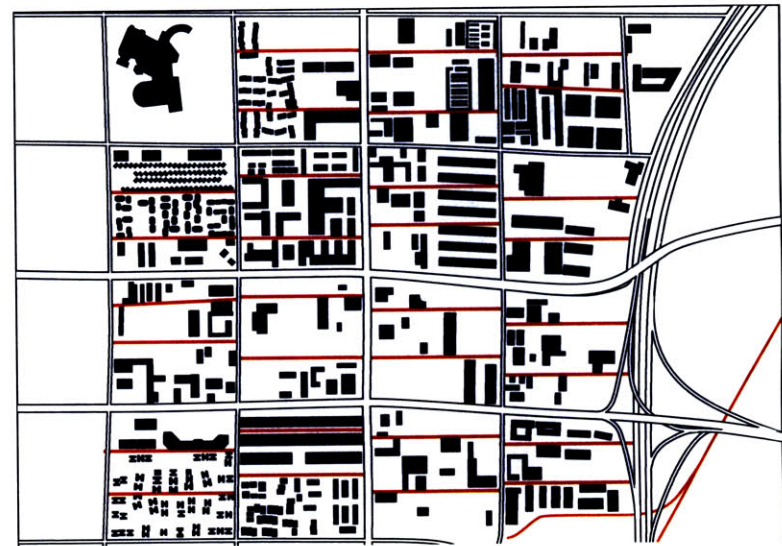

insert circulation through existing blocks and structures

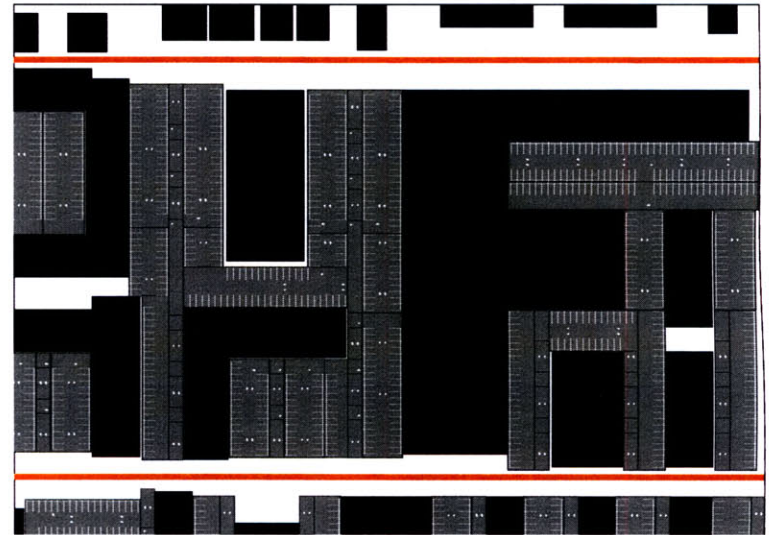
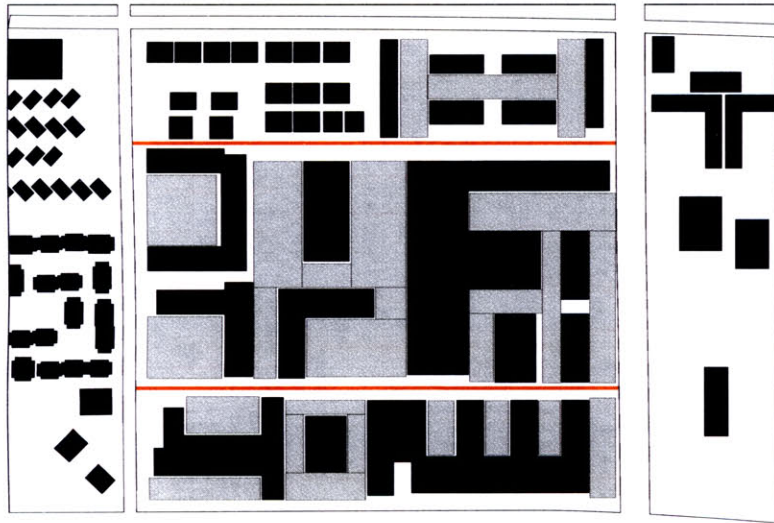

insertion of secondary roads

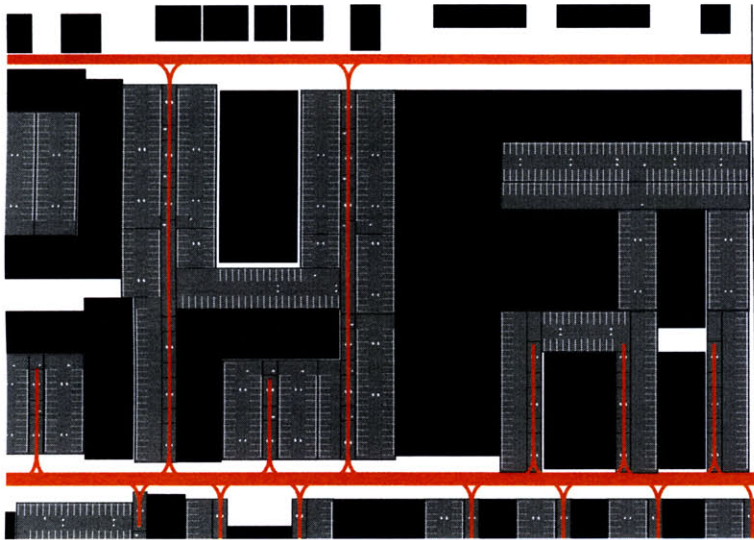

insert minor circulation paths perpendicular to secondary roads

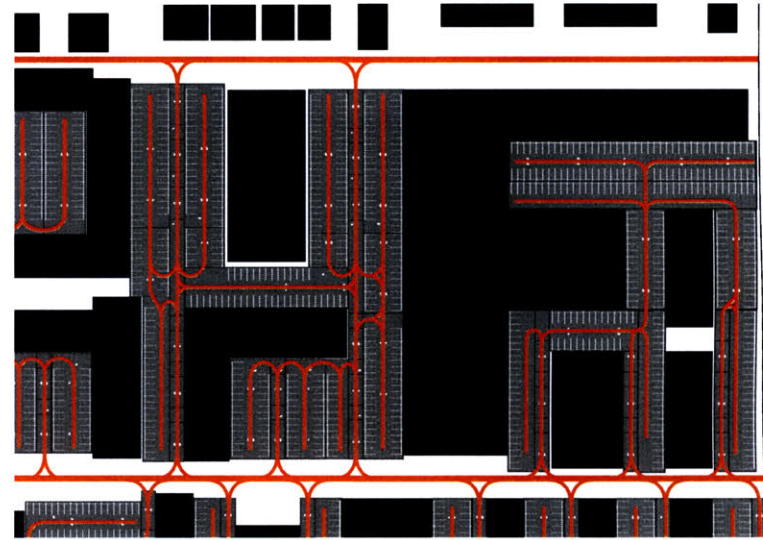

sometimes vertical platform circulation extends through to other road

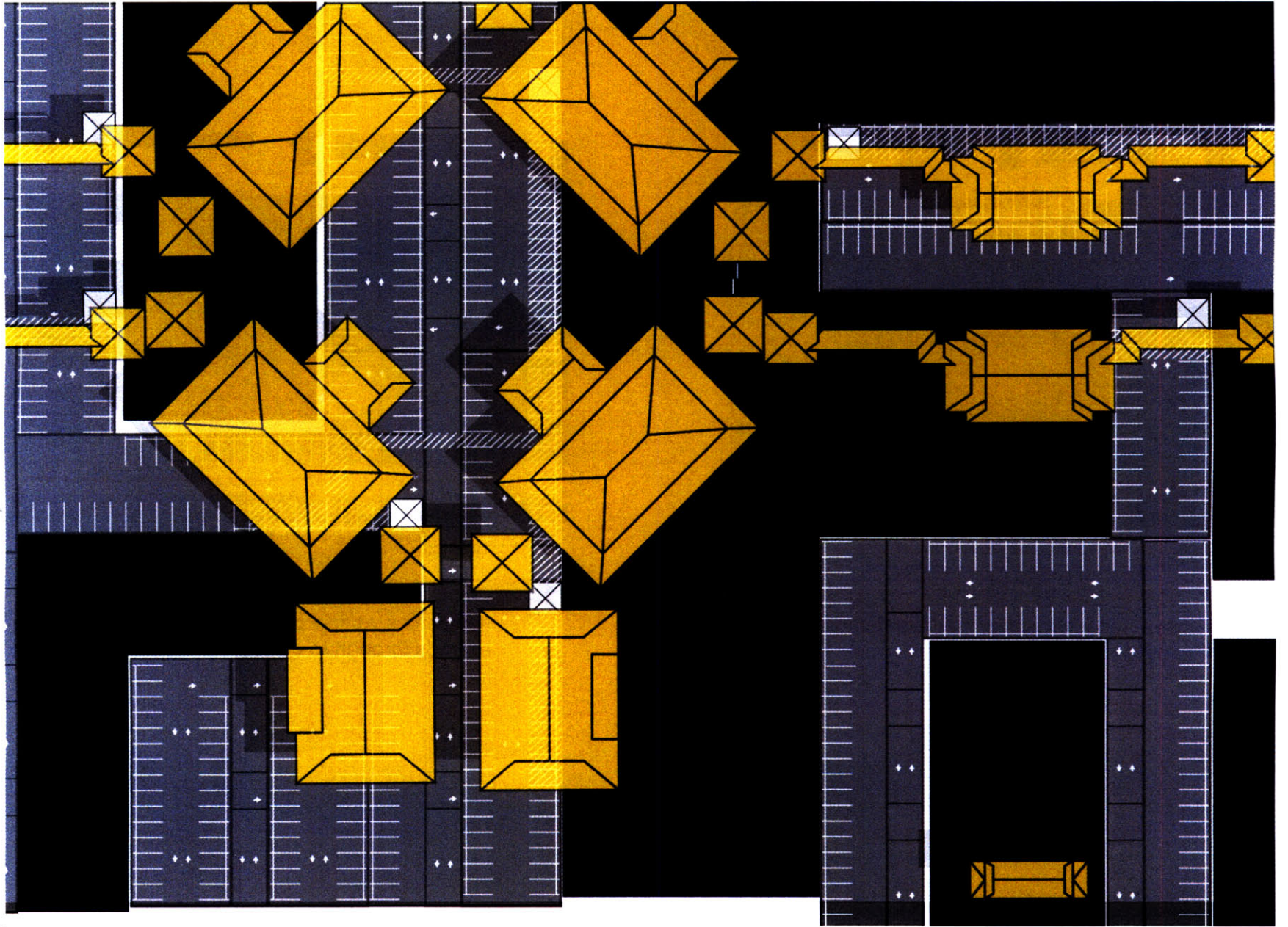

Parking paint can be manipulated to accommodate program change. Program can will be collected under the shadow of roofs. Circulation towers are located near roofs, sandwiched between the vertical platforms and the existing warehouses.

PHASING

Components occupy the site to create an instant New Chinatown. Parking Structures serve as containers for infilling as they are occupied by businesses. Existing warehouses will slowly be infilled and converted to various programmatic uses including housing. Several large anchors will be deployed at the first stage to stimulate growth.

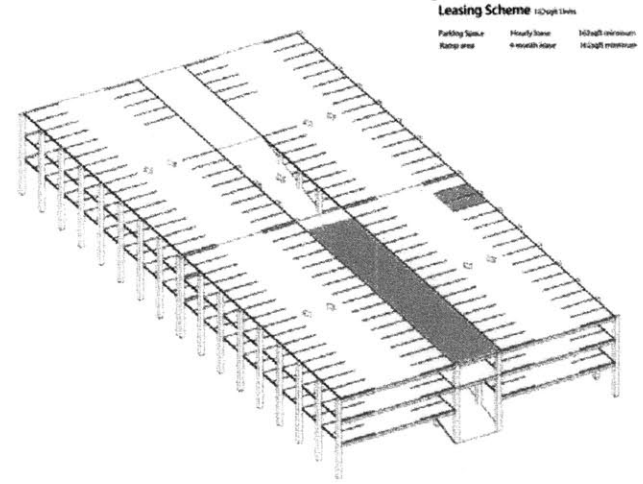
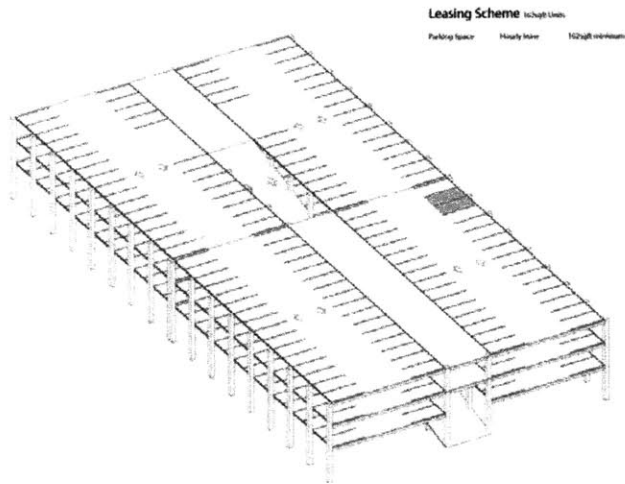

The vertical platforms serve as flexible space allowing for various forms of inhabitation. Individual Lots can be leased for as little as an hour allowing for low risk investment. These can take the form of stalls or lunch trucks. Paint can be adjusted to structure pedestrian paths and changes in lot sizes. Larger areas can be leased out without disruption of vehicular traffic as it is kept separate from the platforms.

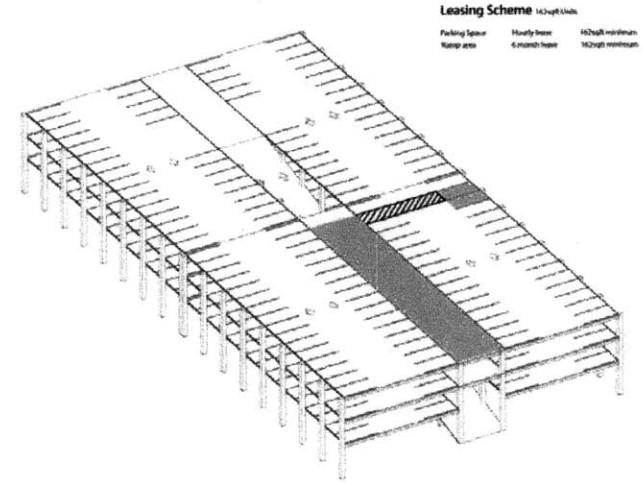
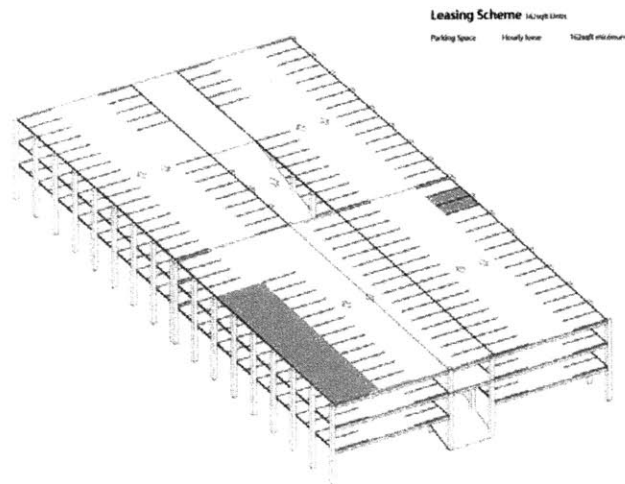

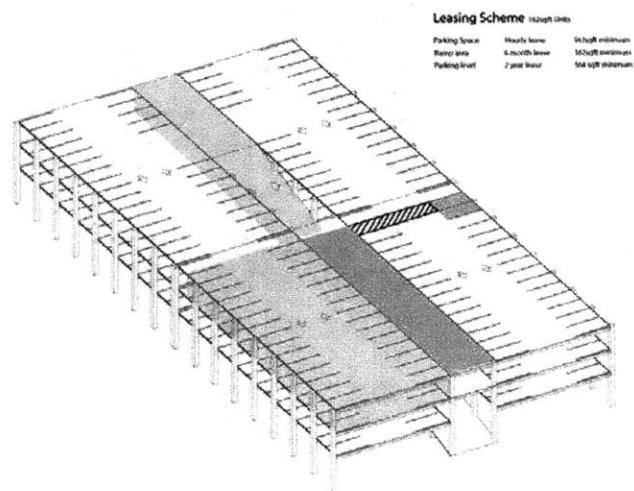
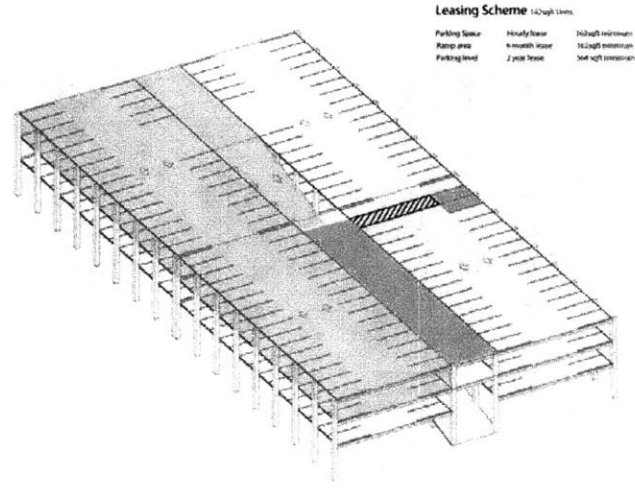
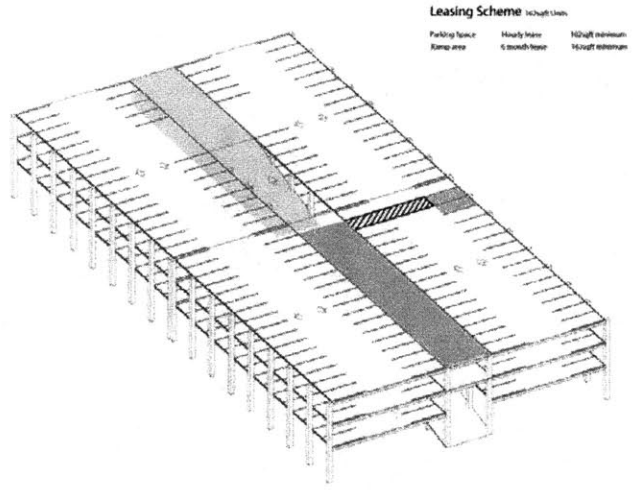

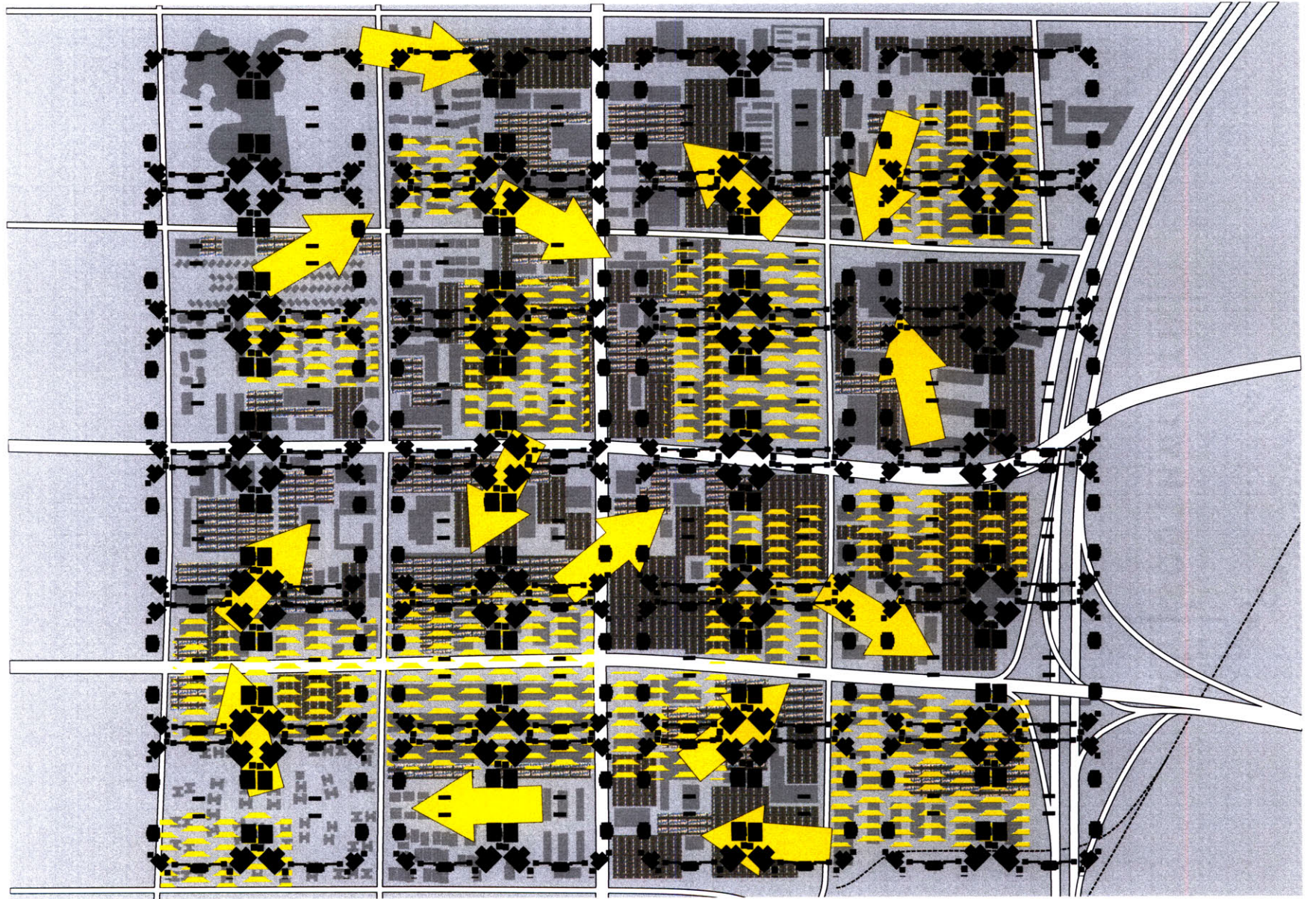

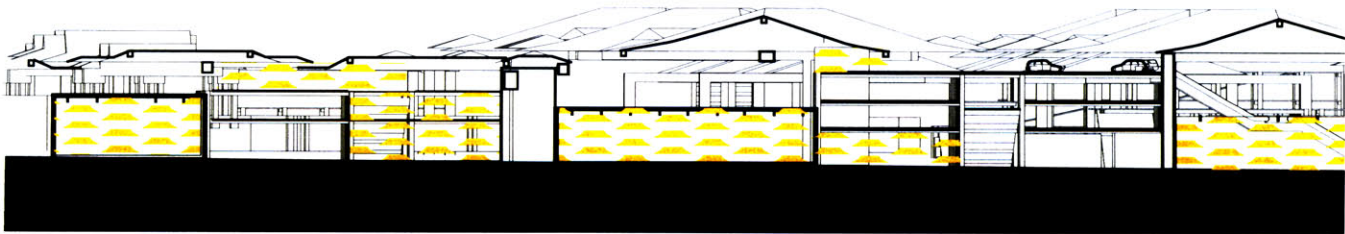
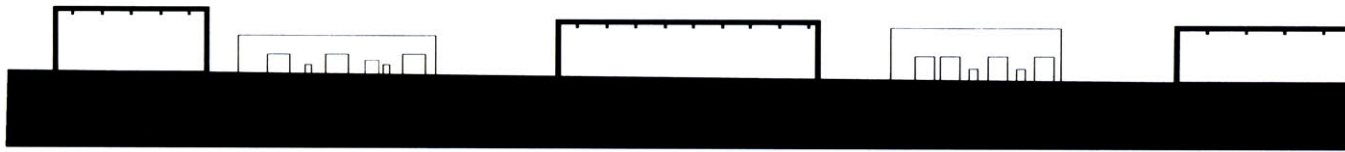

Phasing Diagrams from top to bottom:

1. Preserve existing structures.
2. Fill existing parking lots with vertical platforms (parking structures).
Businesses infill up to 50% of platform structure.
3. Warehouses will eventually be infilled as existing businesses change locations once leases run out..

PROGRAM

Major programming anchors that are deployed in the initial phase of construction include:

Fresh Killed Market

Bodies Exhibition Space and Factory (for the aesthetic display and processing of human cadavers)

Dragon City Hotel and Casino

Fake Mall (for the legal sale of counterfeit goods. the fake mall does not infringe on intellectual property because it advertises its merchandise as copies of original designer items.)

Medium-sized program includes:

Warehouse conversion housing on periphery

Supermarkets

Schools

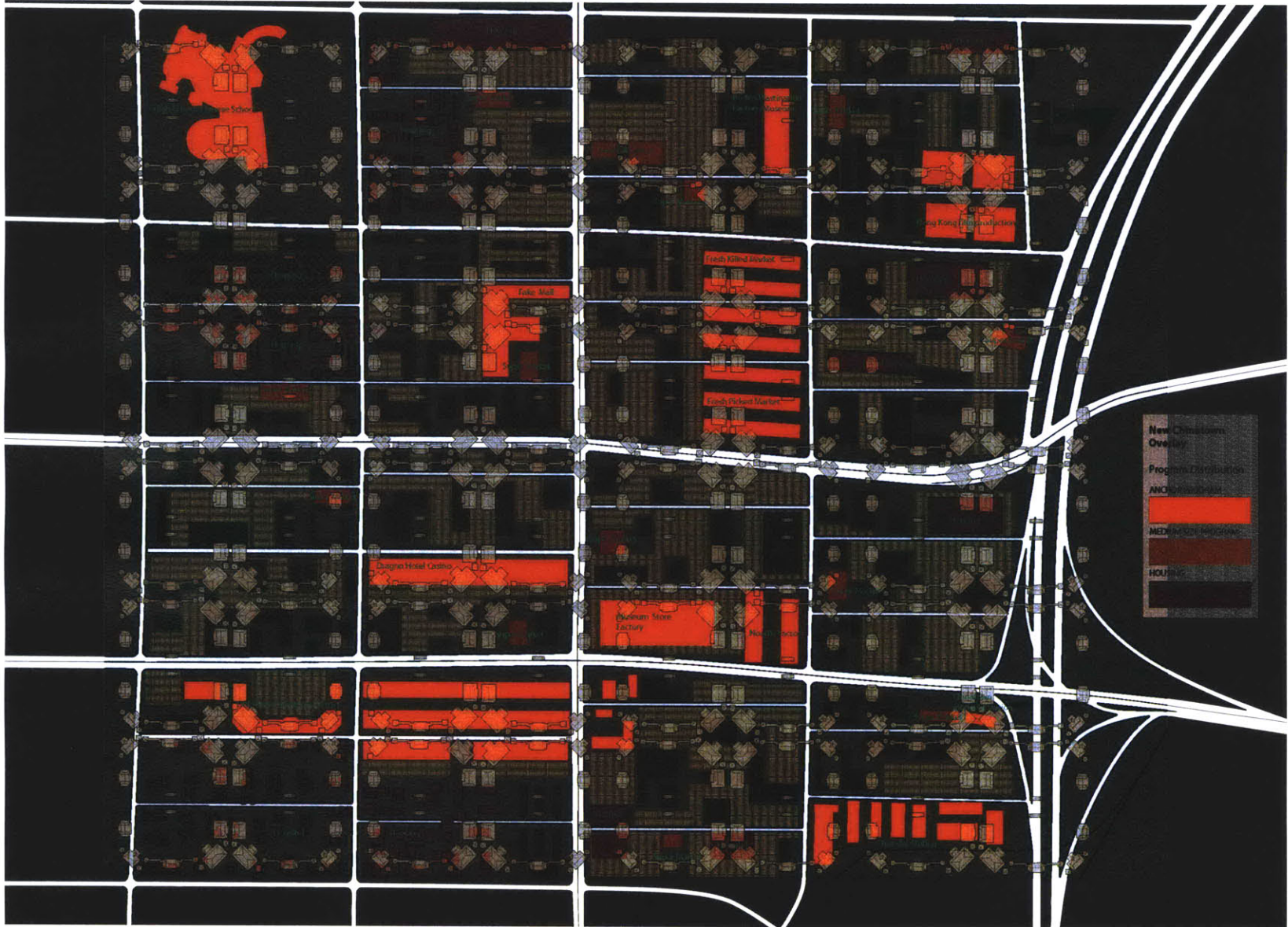

MANUAL

The Chinatown Manual is a guide for architects. It details how the spaces in Chinatown can be occupied.

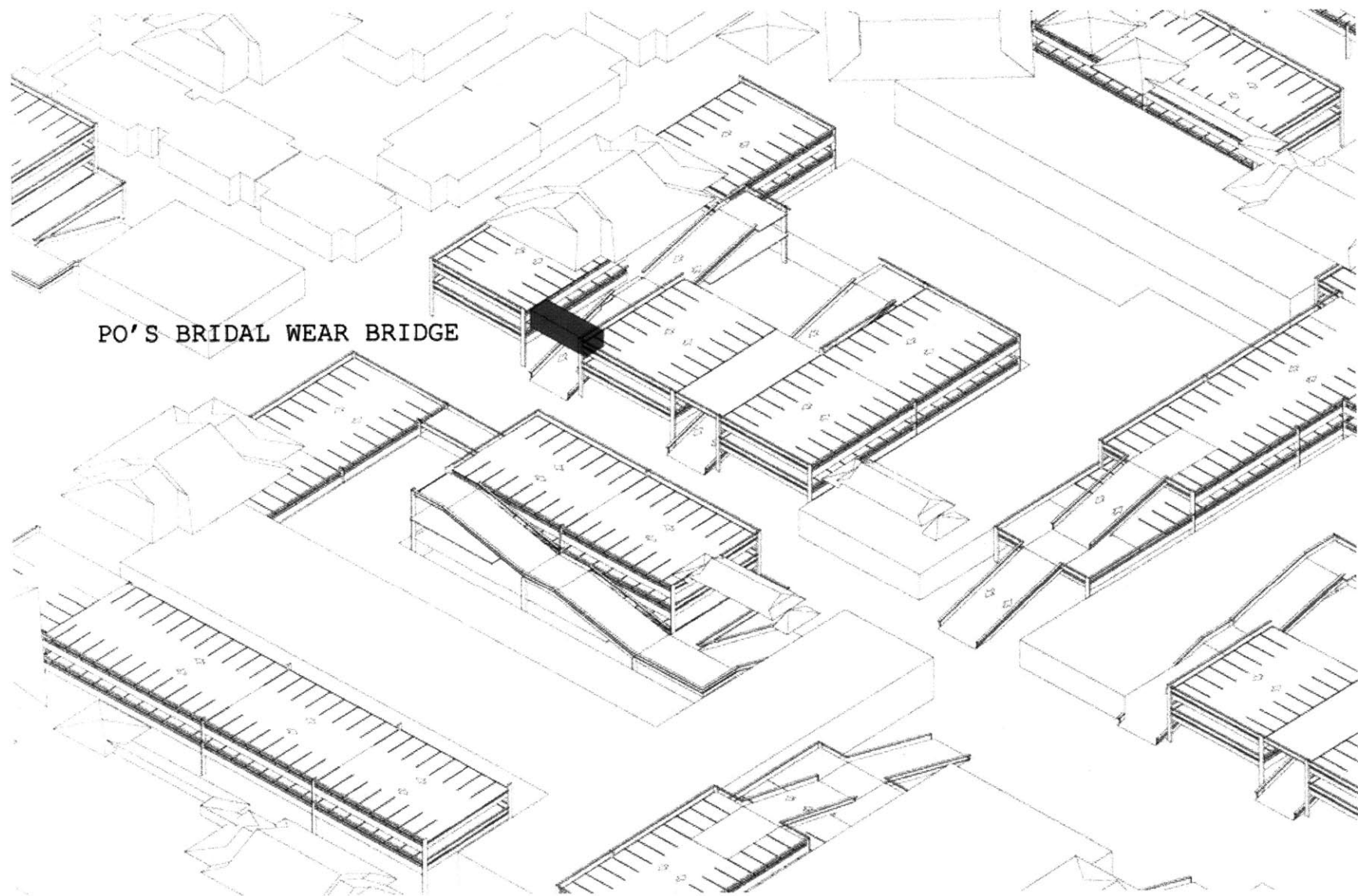

PO'S BRIDAL WEAR BRIDGE

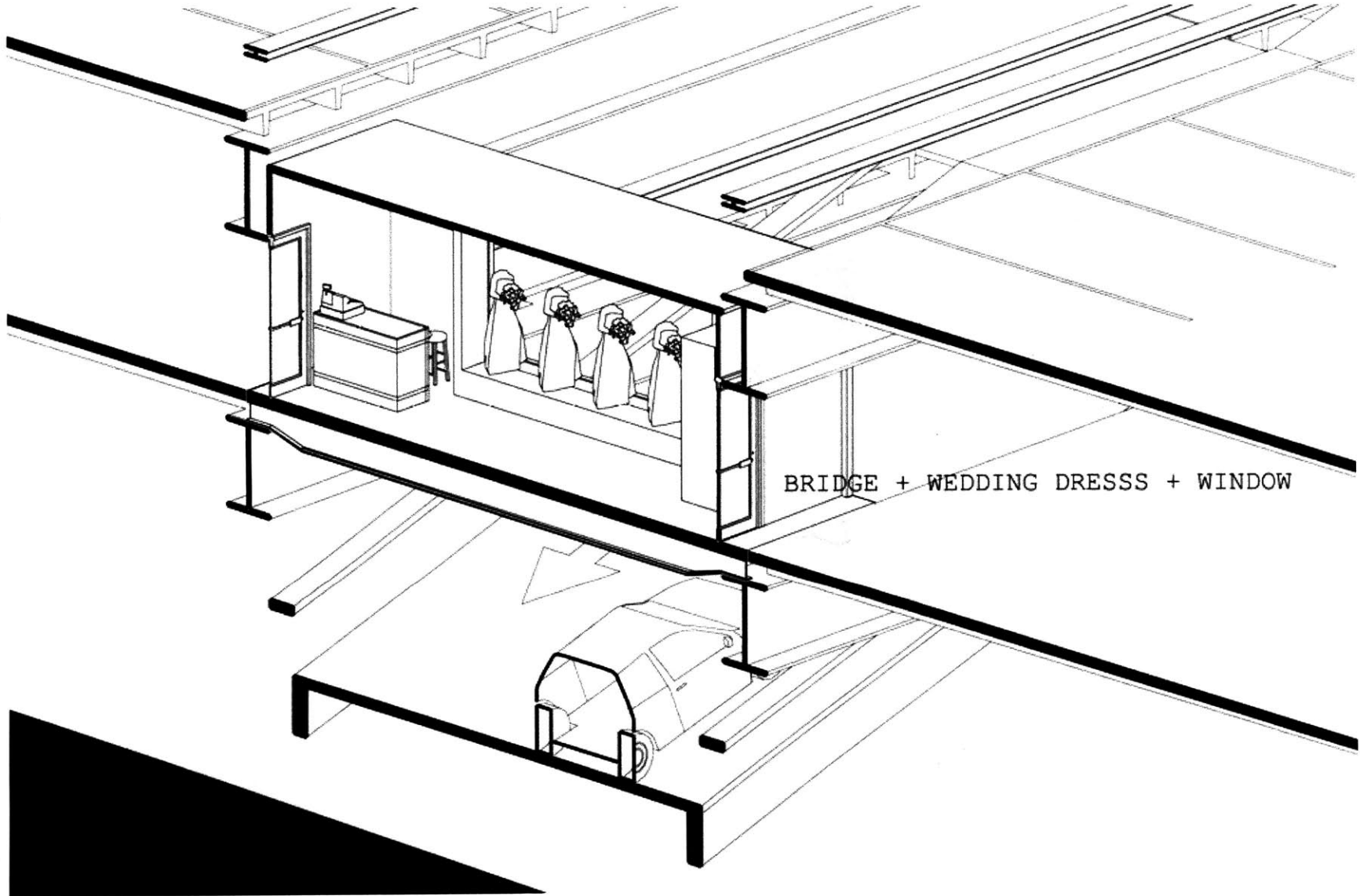

BRIDGE + WEDDING DRESSS + WINDOW

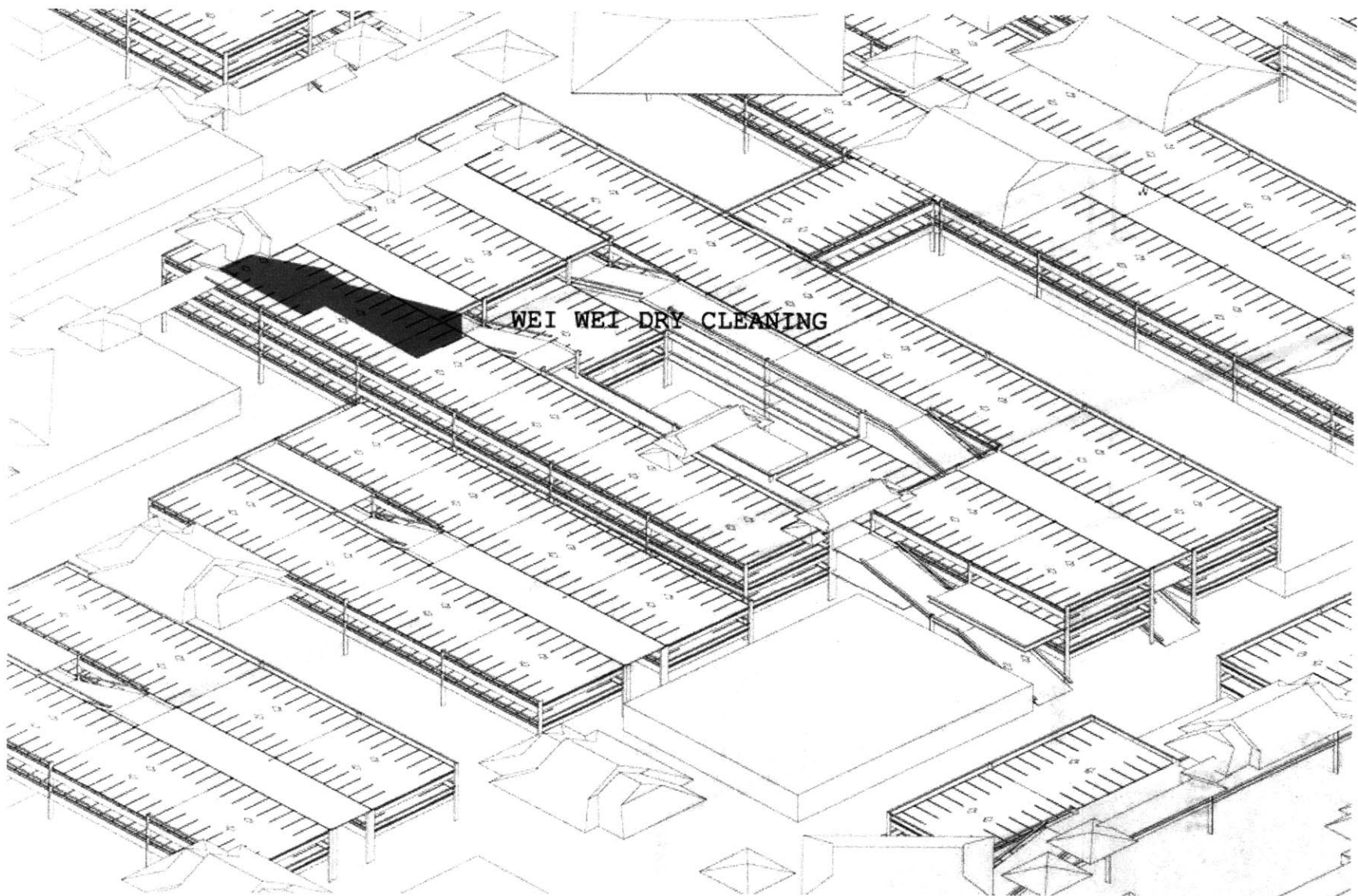

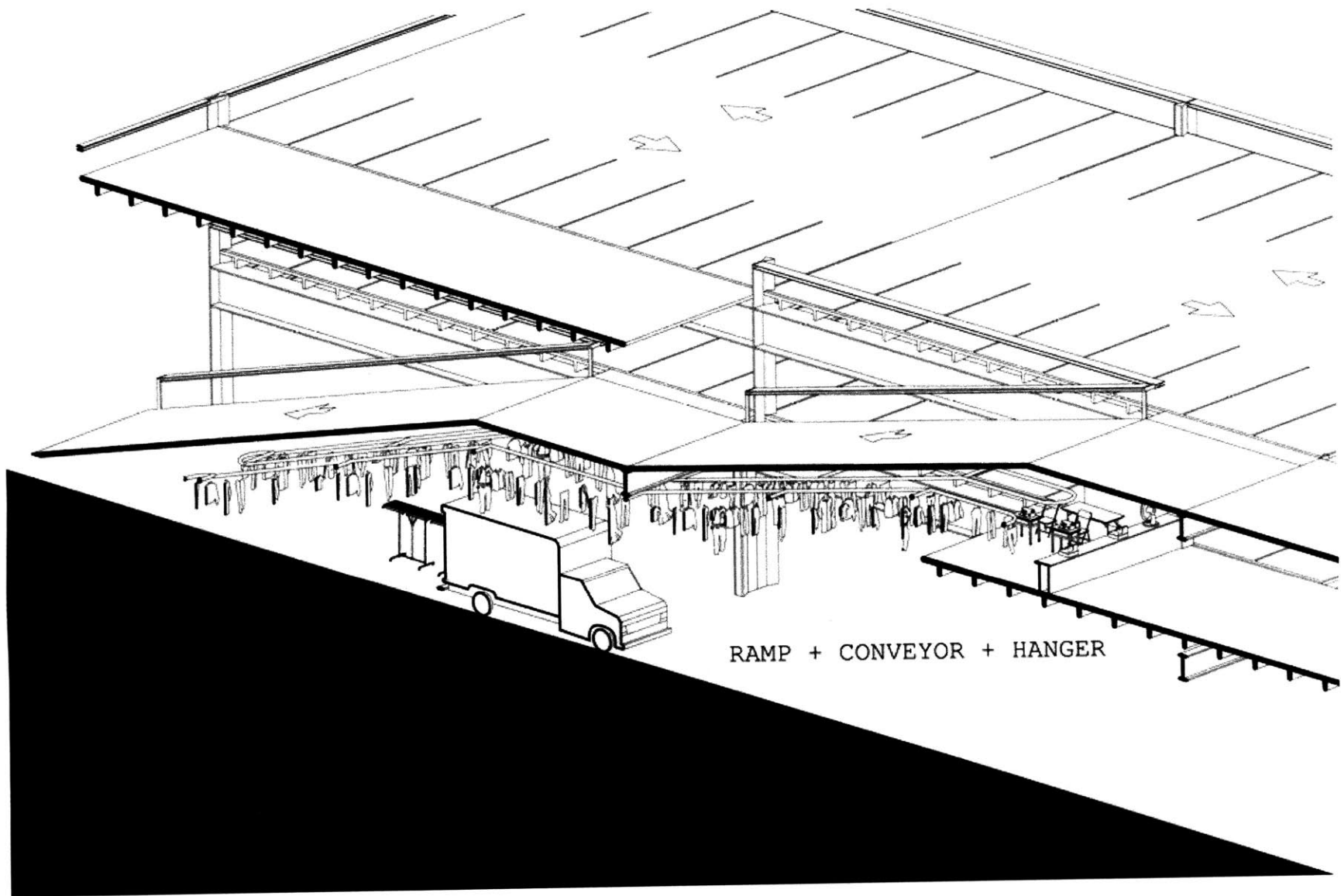

RAMP + CONVEYOR + HANGER

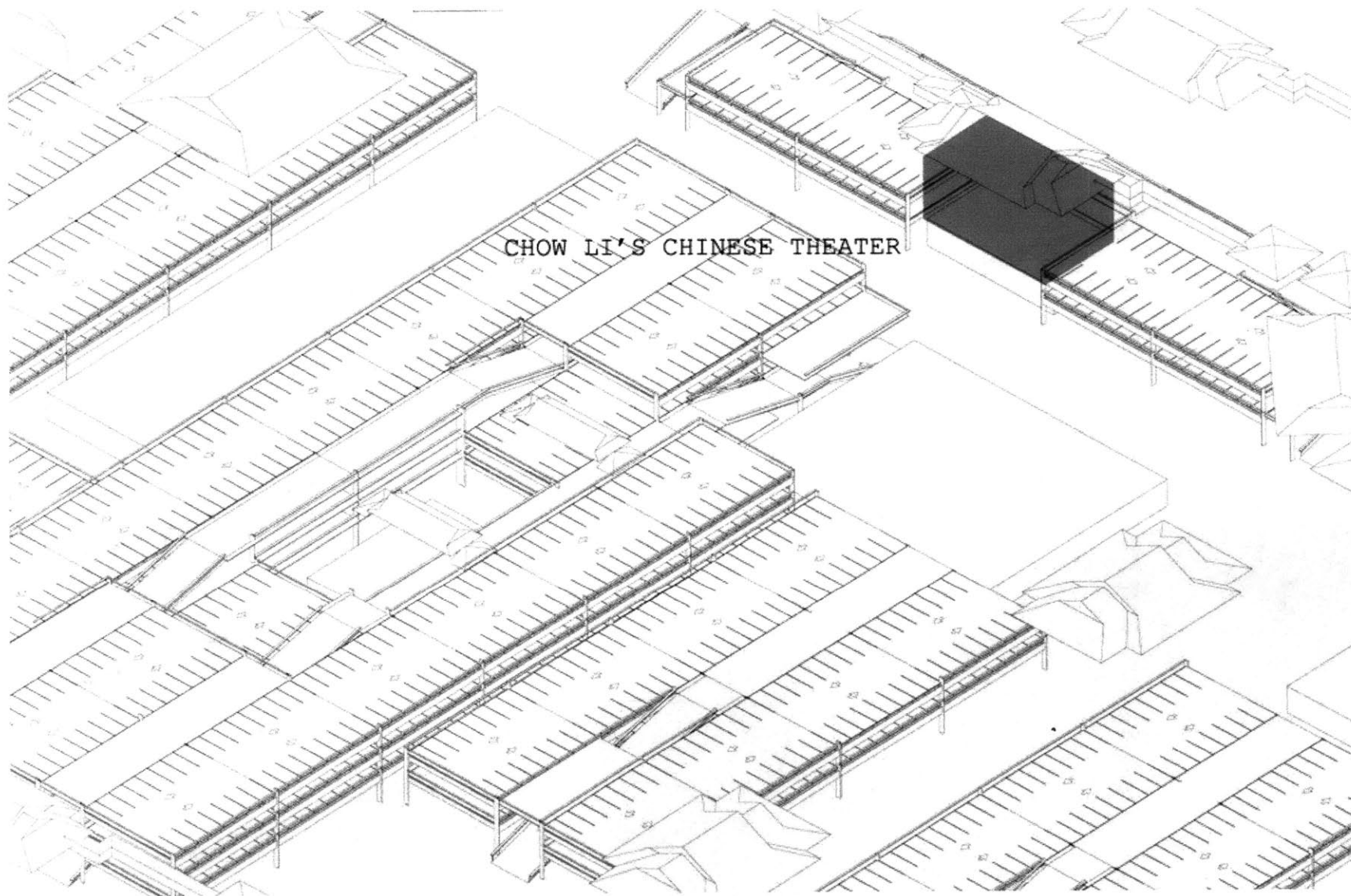

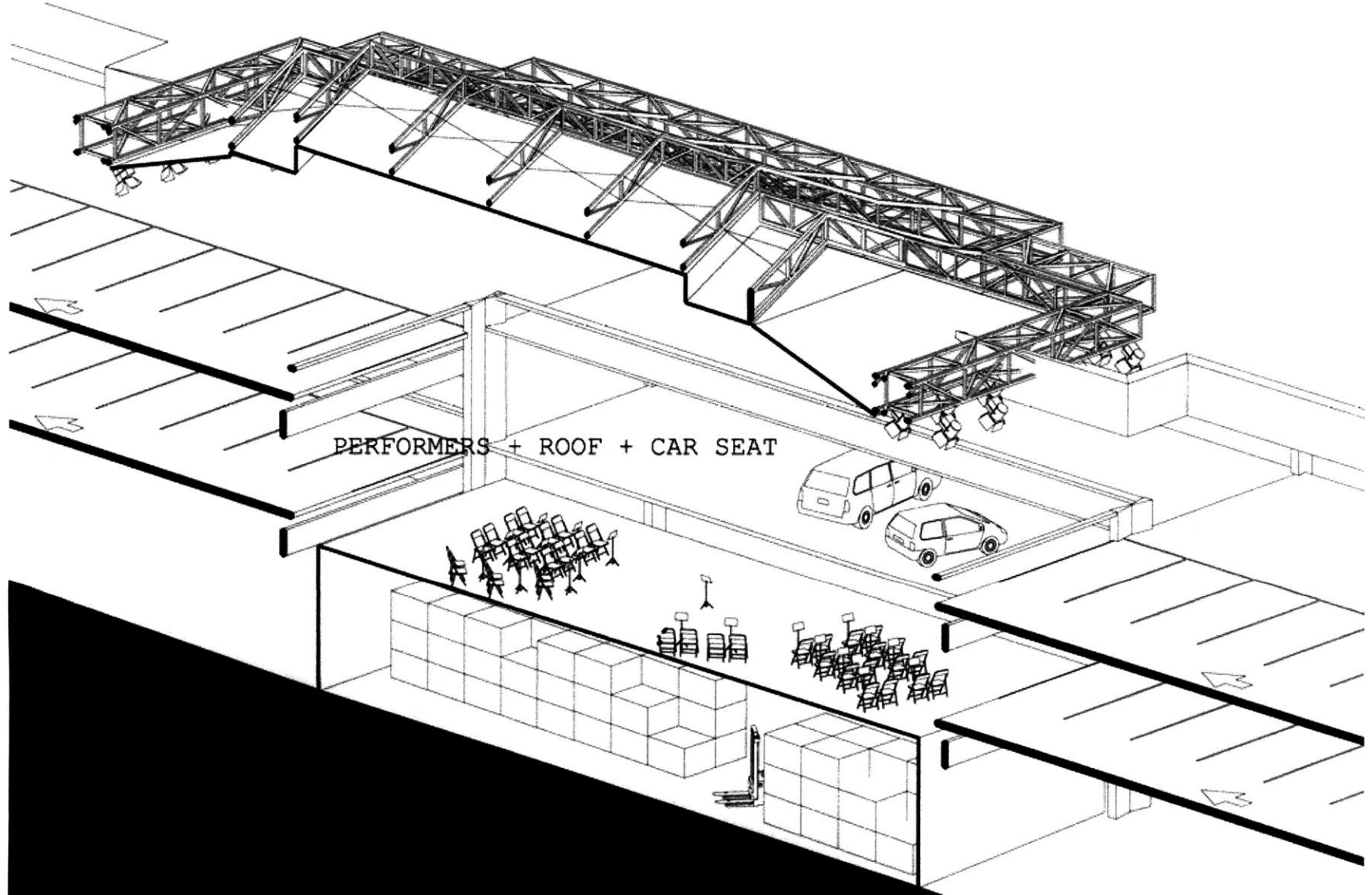

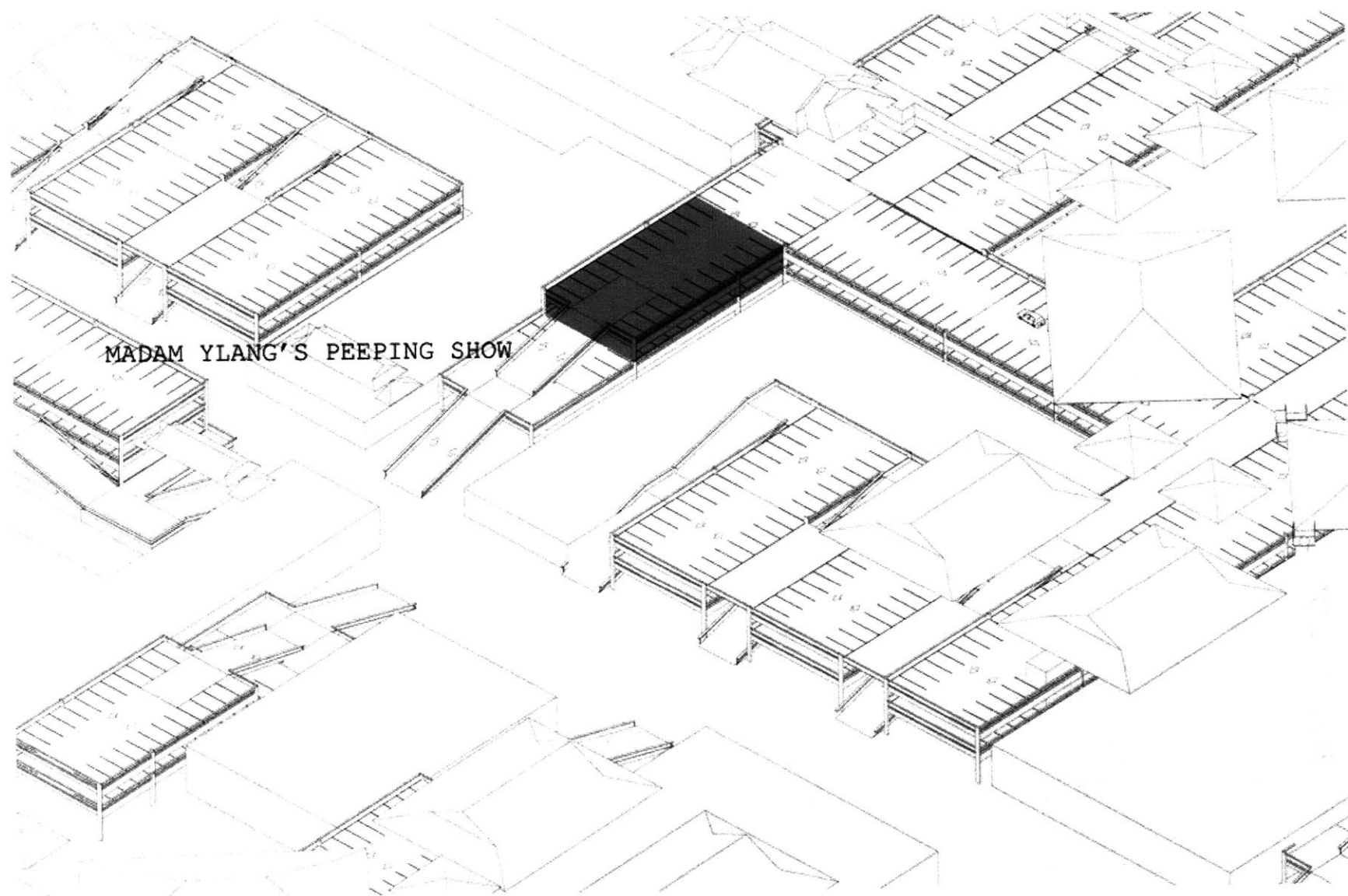

MADAM YLANG'S PEEPING SHOW

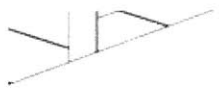

CURTAIN + GLASS BOX + FANCY CARS

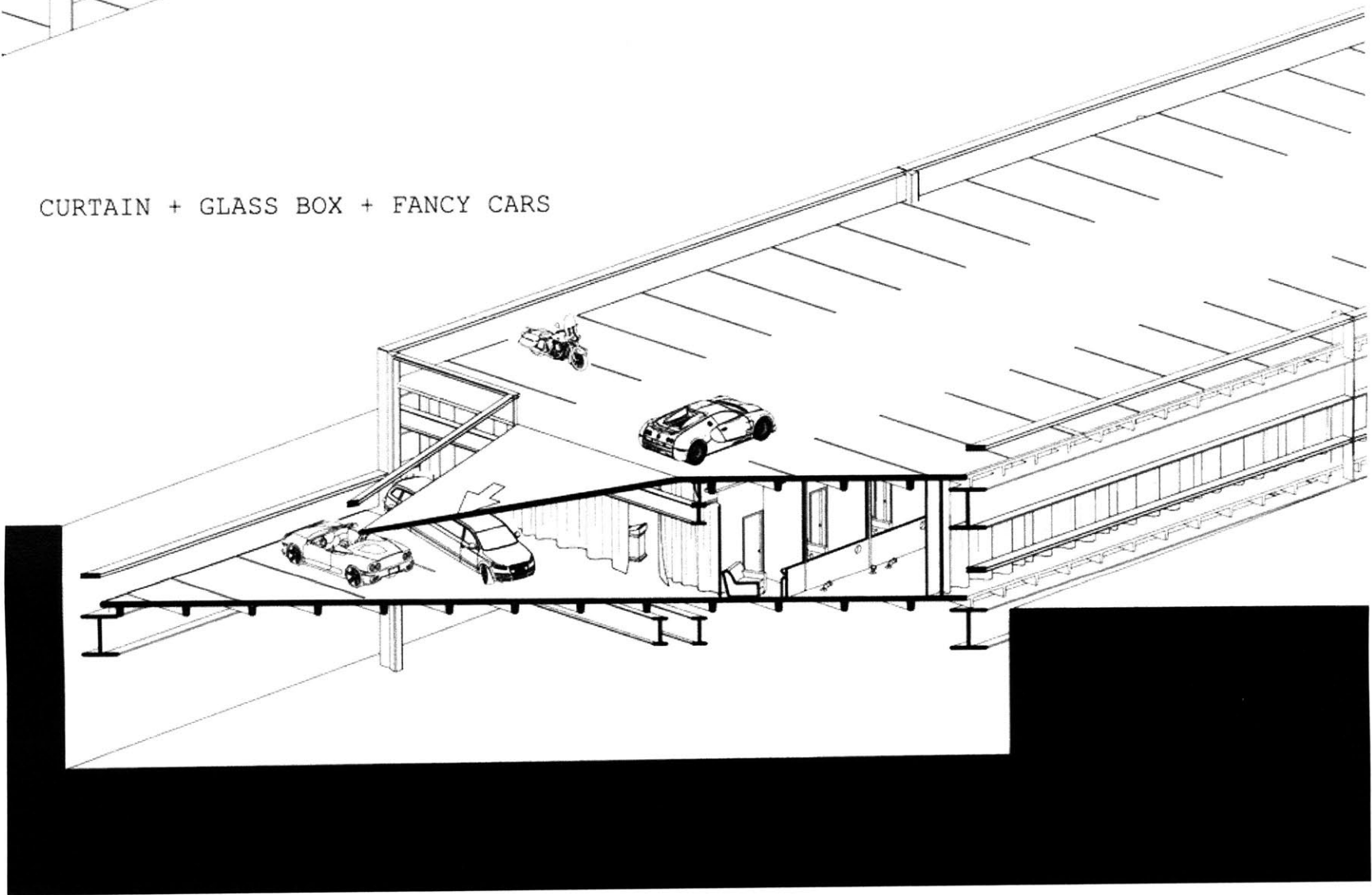

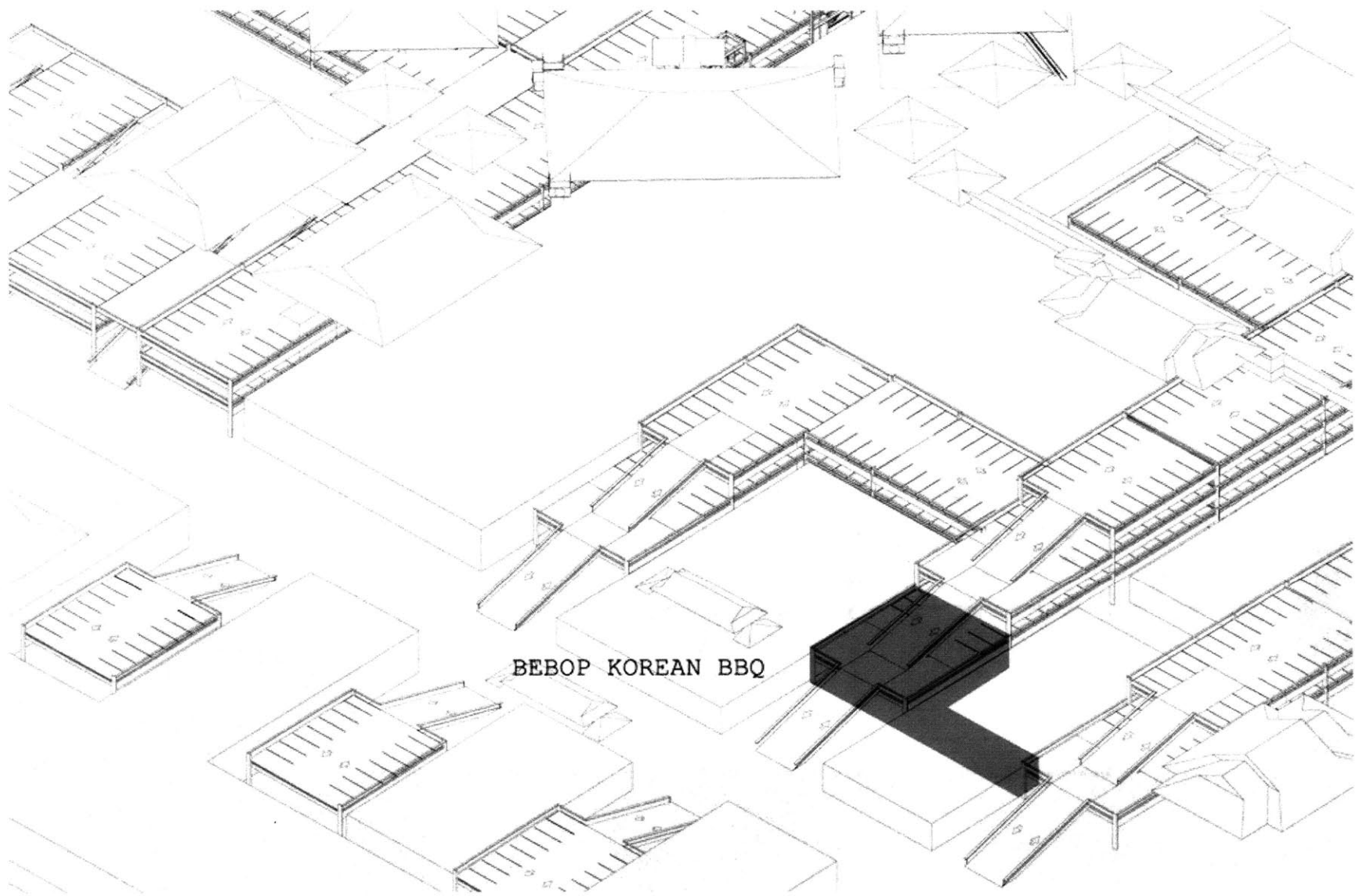

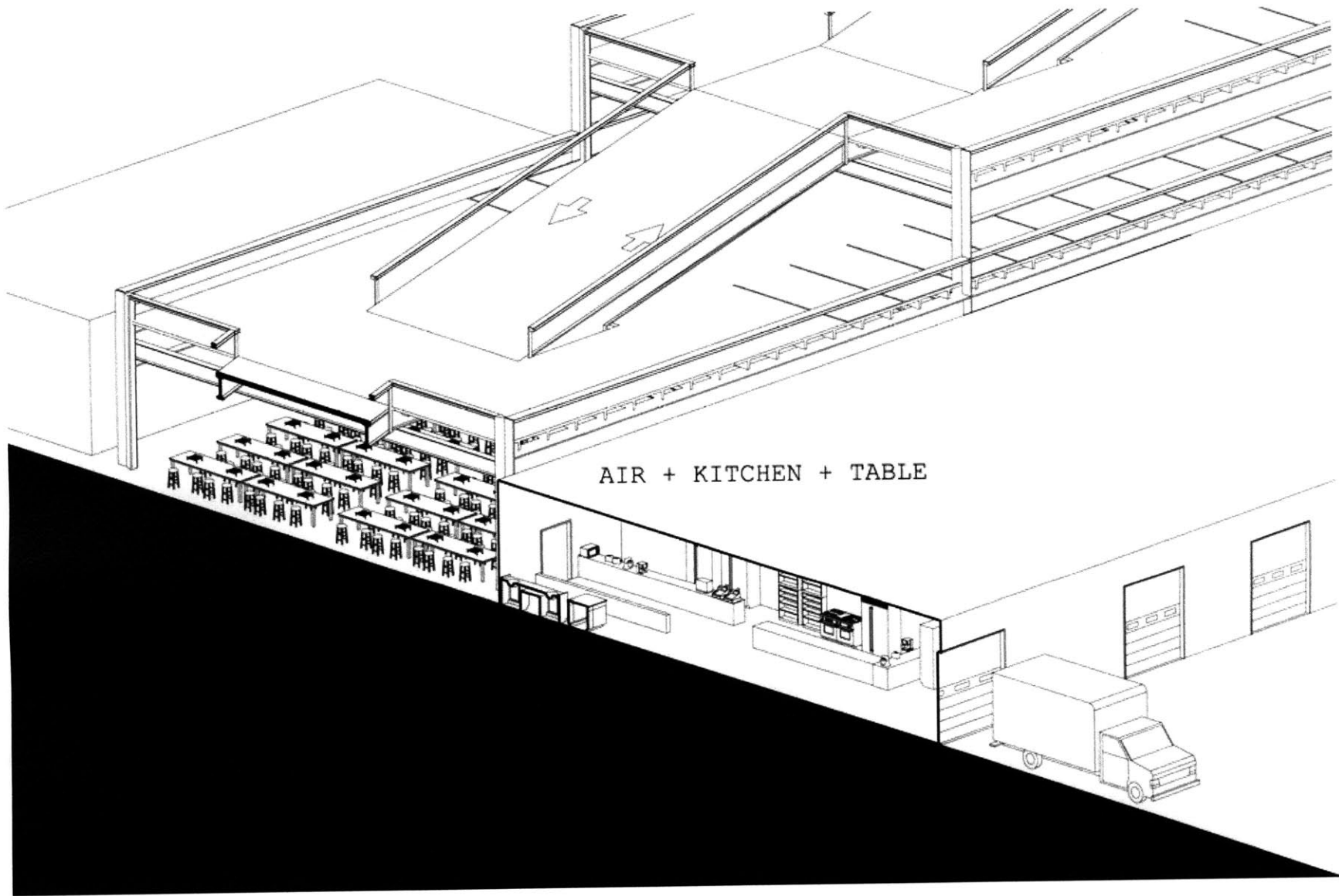

AIR + KITCHEN + TABLE

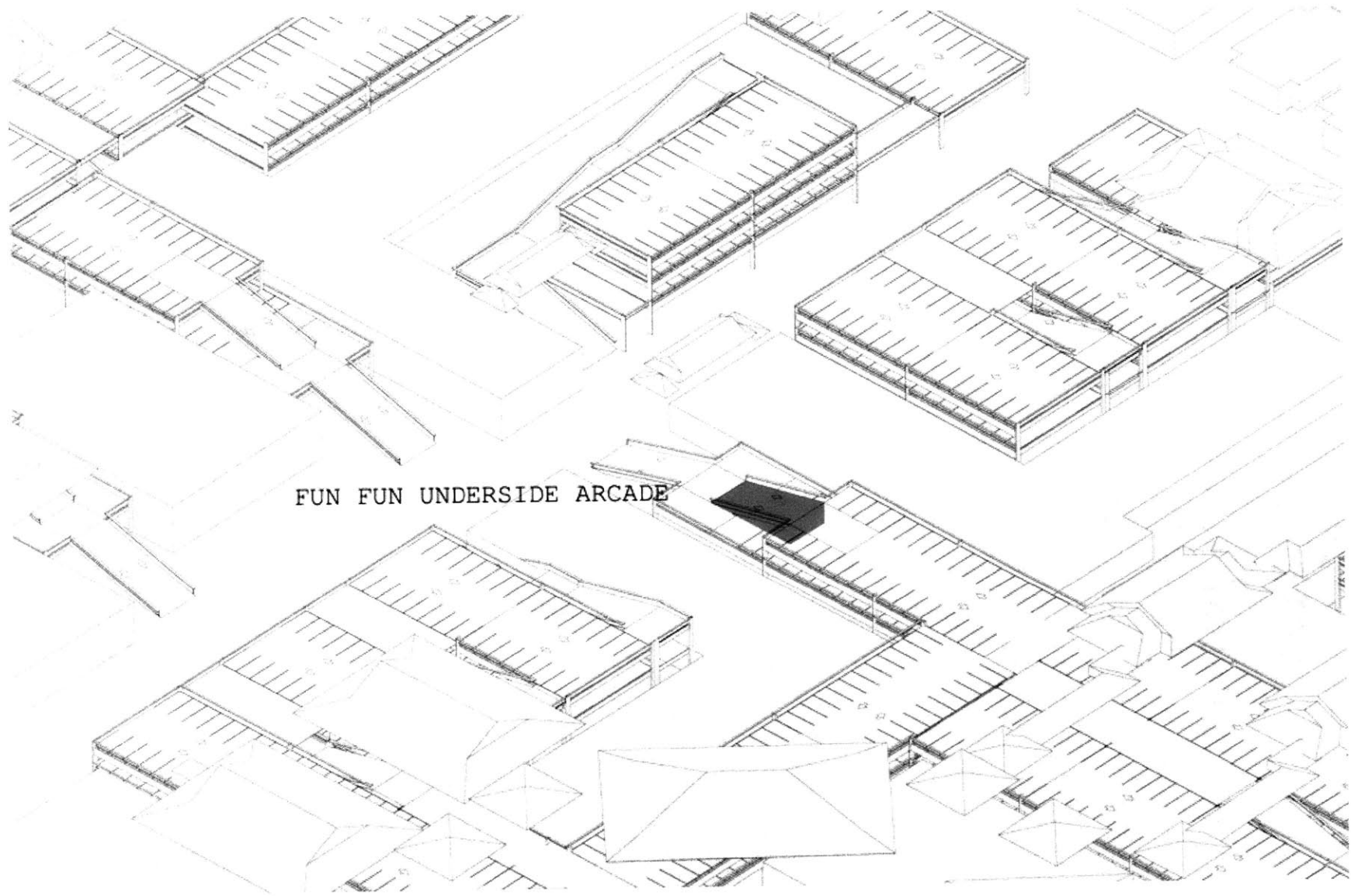

FUN FUN UNDERSIDE ARCADE

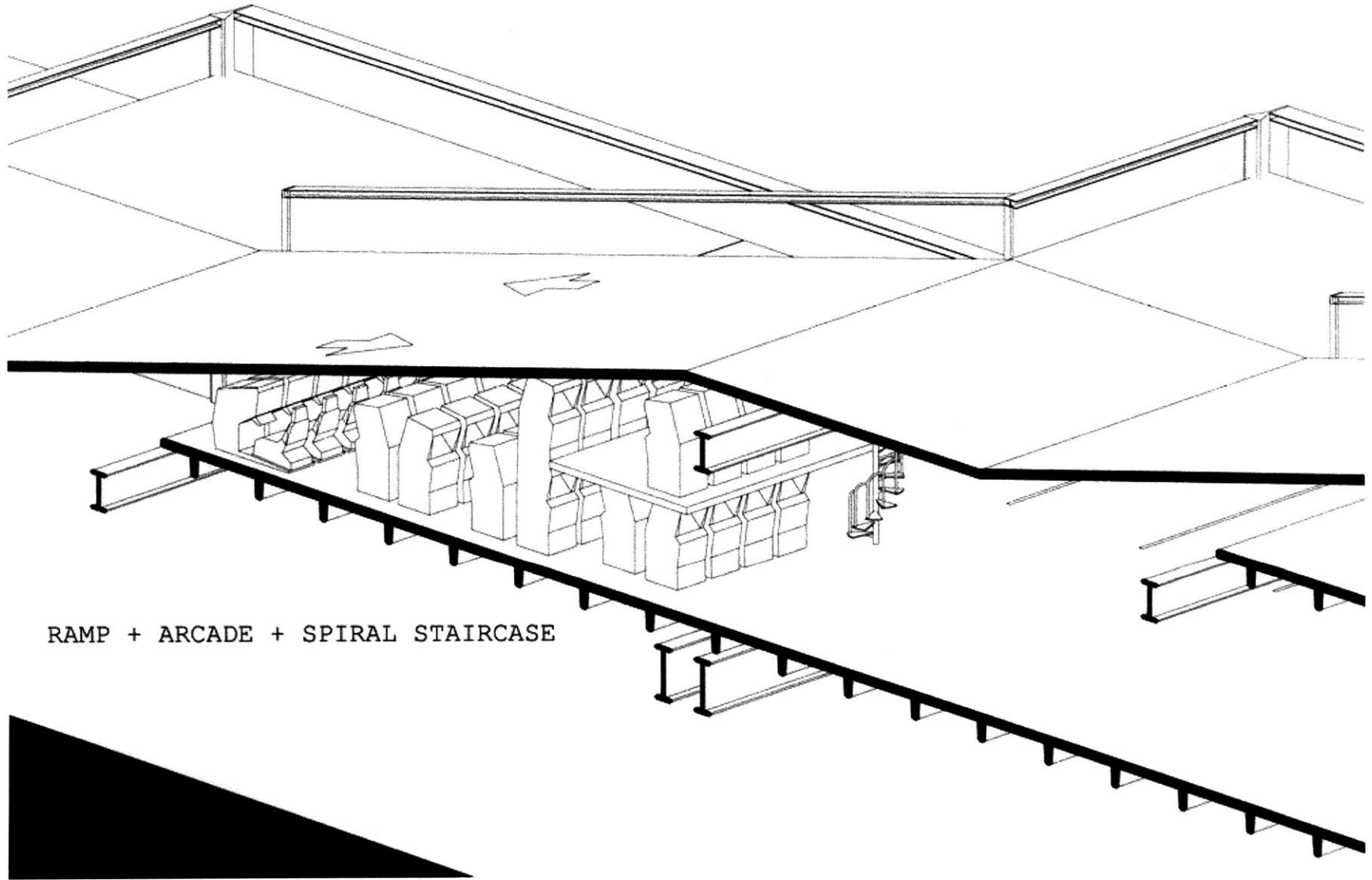

RAMP + ARCADE + SPIRAL STAIRCASE

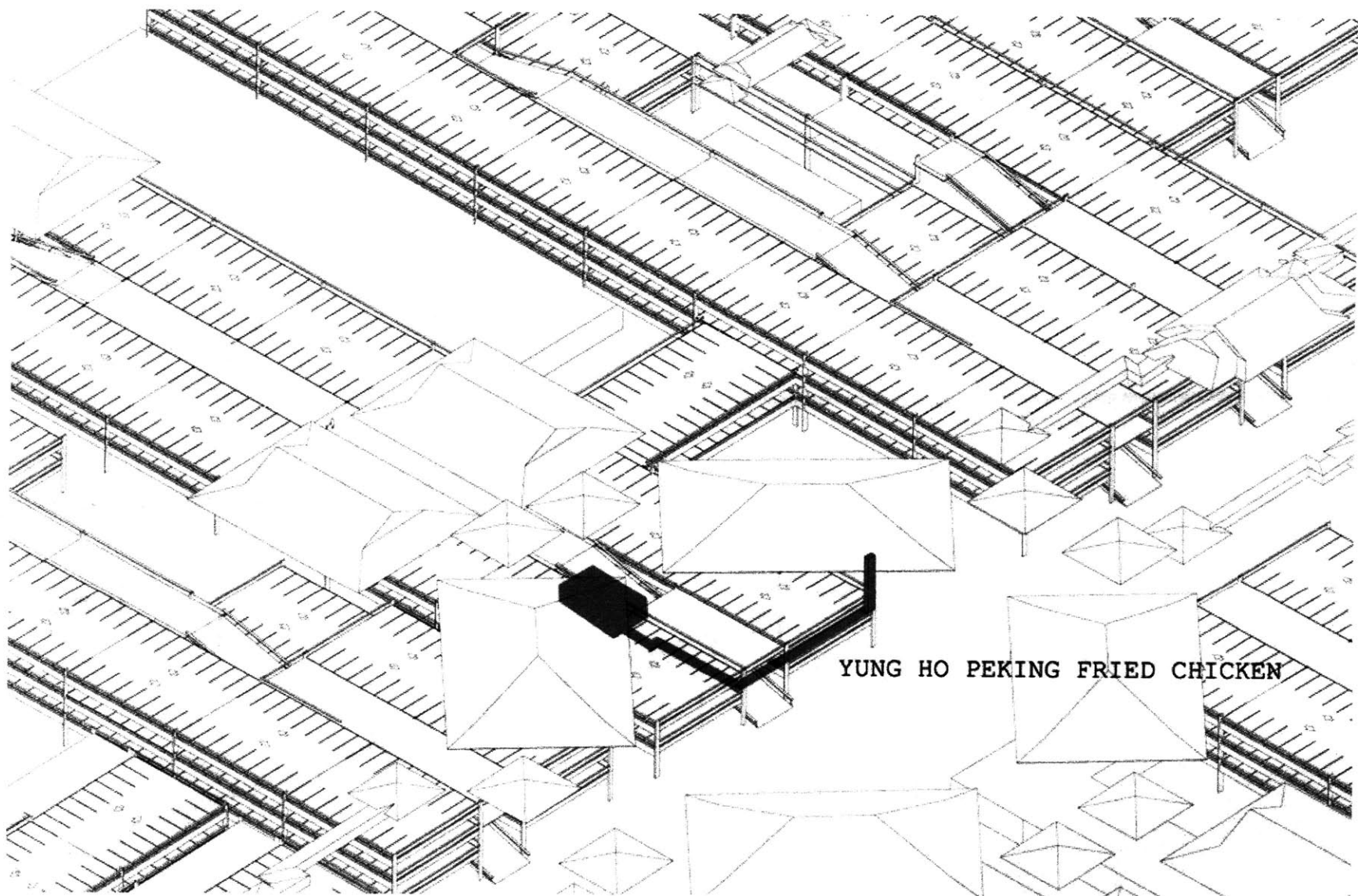

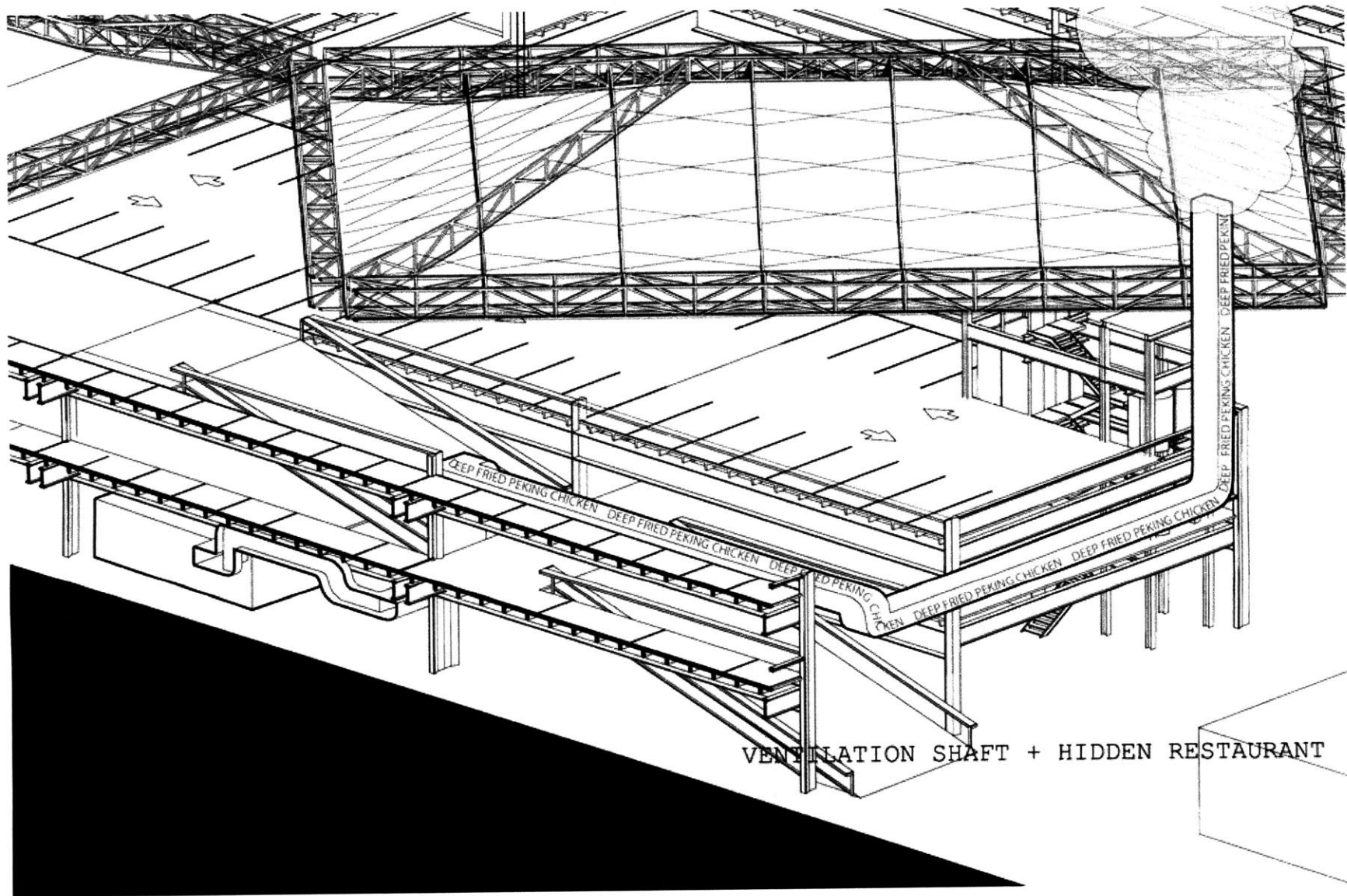

Endnotes

- ¹Vreme News Digest Agency No 307, August 23, 1997.
www.scc.rutgers.edu/serbian_digest/307/t307-2.htm
- ²<http://dictionary.reference.com/browse/theming>
- ³Anne-Marie Broudehoux, "Learning from Chinatown: The Search for a Modern Chinese Architectural Identity, 1911-1998," *Hybrid Urbanism: On the Identity Discourse and the Built Environment*. Ed. Nezar AlSayyad (Westport: Praeger, 2001), p.164.
- ⁴Ibid.
- ⁵Ibid.
- ⁶Wikipedia. Notes on Justin Hermann.
- ⁷William D.Estrada, "Los Angeles' Old Plaza and Olvera Street: Imagined and Contested Space." *Western Folklore*, Spring 1999.
http://findarticles.com/p/articles/mi_qa3732/is_199904/ai_n8847620/pg_10
- ⁸Icy Smith, *The Lonely Queue: The Forgotten History of the Courageous Chinese American in Los Angeles* (Los Angeles: East West Discovery Press, 2000). p. 26.
- ⁹Ibid.
- ¹⁰Estrada. "Los Angeles' Old Plaza."
- ¹¹Smith, *The Lonely Queue*. p. 29.
- ¹²Barry Newman, "For Asians in U.S., Mini-Chinatowns Sprout in Suburbia," *Wall Street Journal*, April 20, 2004
- ¹³Ibid.
- ¹⁴US Census.
- ¹⁵Ibid.
- ¹⁶Ibid.
- ¹⁷Ibid.
- ¹⁸Steve Friess, "Las Vegas Adapts to Reap Chinese New Year Bounty," *The New York Times*, February 21, 2007.
- ¹⁹Ibid.
- ²⁰Jennifer Robinson, "Changing Chinatown. Group Hoping to Get Zone Switch that Would Allow Gambling," *Las Vegas Review Journal*. May 14, 2005.
http://www.reviewjournal.com/lvj/_home/2005/May-14-2005/business
- ²¹Broudehoux, "Learning from Chinatown." pp. 157-159.
- ²²Ibid., p. 160.
- ²³Ibid., .
- ²⁴Ibid., p. 163.
- ²⁵Ibid., p. 173-174.
- ²⁶Timothy P. Fong. *The First Suburban Chinatown: The Remaking of Monterey Park, California*. (Philadelphia: Temple University Press), 1994. p. 67.

- ²⁷Ibid.
- ²⁸Interview with Peter Shen.
- ²⁹Peter Hong, "In San Gabriel, a Redefined China Springs from Success," *Los Angeles Times*, Sept. 20, 1997.
- ³⁰Ibid.
- ³¹Broudehoux, "Learning from Chinatown." p. 168.
- ³²Ibid., 174.
- ³³Nahal Toosi, "Chinatown in Milwaukee? Just Maybe. Backers Envision Project as Magnet for Asian Investment," *Journal Sentinel*.
<http://www.jsonline.com/story/index.aspx?id.=331496>
- ³⁴Ibid.
- ³⁵Newman, "For Asians in the US."
- ³⁶Ibid.
- ³⁷"Chinatown – Darwin," *Rondo*. February 7, 2007.
http://www.rondo.com.au/rondo/rdo_news.asp?ind=5&smii=1&articleid=0
- ³⁸"The Glasgow Story: Chinatown."
<http://www.theglasgowstroy.com/image.php?inum=TGSA05296>;
- ³⁹"Chinatown Project – EUR 1 bln Investment," *Romanian Daily*, June 20, 2006.
<http://www.romaniandaily.ro/cat42820/art9167376288/>
- ⁴⁰"International City, Dubai." 2005.
http://www.elitepropertypoint.com/d_international_city.html
- ⁴¹"New Chinatowns for Moscow and St. Petersburg," *PetersburgCity.com*. August 16, 2006.
<http://www.petersburgcity.com/news/city/2006/08/16/chinatown>
- ⁴²Ibid.
- ⁴³Robert Venturi and Denise Scott Brown, *Learning from Las Vegas: the Forgotten Symbol of Architectural Form* (Cambridge: MIT Press, 1977), p. 88
- ⁴⁴Ibid., 93.
- ⁴⁵Martin, Reinhold. "Architecture's Image Problem: Have We Ever Been Postmodern?" *Grey Room* 22 (Winter 2005), p. 8.
- ⁴⁶Ibid.
- ⁴⁷Hans Ulrich Olbrist and Rem Koolhaas. "An Interview with Denise Scott Brown and Robert Venturi," *Harvard Design School Guide to Shopping*. Ed. Chung, Chuihua Judy et al. (Köln: Taschen ; Cambridge: Harvard Design School, 2001), p. 613.
- ⁴⁸Martin, "Architecture's Image Problem," p. 10.
- ⁴⁹Ibid., p.10.
- ⁵⁰Venturi, *Learning from Las Vegas*, p. 126
- ⁵¹Ibid.
- ⁵²Ibid.

- ⁵³Wikipedia – entry on Caesars Palace.
- ⁵⁴Martin, p. 10.
- ⁵⁵Melissa Ulcran, “Still Learning from Las Vegas: Robert Venturi and Denise Scott Brown take on Sin City Architecture Three Decades Later,” *Ten by Ten Magazine*.
<http://www.tenbyten.net/vegas.html>
- ⁵⁶Olbrist and Koolhaas, p. 595
- ⁵⁷Ibid.
- ⁵⁸Ibid.
- ⁵⁹“World-Class Architects and Designers Giving Shape to Las Vegas’ Future With MGM Mirage Project CityCenter.” MGM Mirage News Release.
<http://www.prnewswire.com/cgi-bin/stories>.
- ⁶⁰Jameson, Frederic. *Postmodernism, or the Cultural Logic of Late Capitalism* (Durham: Duke University Press, 1991), p. 54.
- ⁶¹Becker, Lynn. “Bobbing for Mies – Robert Venturi at ITT.” 2005.
<http://lynnbecker.com/repeat/venturi/venturi.htm>
- ⁶²Jameson, *Postmodernism*. p.65.
- ⁶³Roland Barthes, *Empire of Signs*. Trans. Richard Howard (New York: Hill and Wang, 1982) p.55.
- ⁶⁴Ibid.
- ⁶⁵Sophie Howarth, “Pretty Fascinating Boredom,” *Tate: The Art Magazine* 24 (Spring 2001), p. 64
- ⁶⁶Barthes, p.60.
- ⁶⁷Ibid.
- ⁶⁸Ibid.
- ⁶⁹Jameson, 58.
- ⁷⁰Jean Baudrillard, *Simulations*. Trans. Paul Foss, Paul Fatton, and Philip Beitchman (New York: Semiotext(e), Inc., c1983). p. 23.

Bibliography

- Barthes, Roland. *Empire of Signs*. Trans. Richard Howard. New York: Hill and Wang, 1982.
- Baudrillard, Jean. *Simulations*. Trans. Paul Foss, Paul Fatton, and Philip Beitchman. New York: Semiotext(e), Inc., c1983.
- Benjamin, Walter. "The Work of Art in the Age of Mechanical Reproduction," in *Illuminations: Essays and Reflections*. Trans. Harry Zohn. New York, Harcourt, Brace & World, 1998.
- Brown, Patricia Leigh. "The New Chinatown? Try the Asian Mall," *The New York Times*, March 24, 2003.
- Broudehoux, Anne-Marie. "Learning from Chinatown: The Search for a Modern Chinese Architectural Identity, 1911-1998," in *Hybrid Urbanism: On the Identity Discourse and the Built Environment*. Ed. Nezar AlSayyad. Westport: Praeger, 2001.
- Chase, John. "The Garret, the Boardroom, and the Amusement Park," *Journal of Architectural Education* 47(2) November 1993. 75-87.
- Fay, Tim. "Two Centers to Debut for Asian Americans," *The Atlanta Journal and Constitution*. December 2, 1993.
- Ferretti, Fred. "An Explorer's Guide to the 'New' Chinatown," *The New York Times*, October 24, 1980.
- Frampton, Kenneth. "The Work of Architecture in the Age of Commodification," *Harvard Design Magazine* 23 Fall 2005/Winter 2006. 1-5.
- Friess, Steve. "Las Vegas Adapts to Reap Chinese New Year Bounty," *The New York Times*, February 21, 2007.
- Fong, Timothy P. *The First Suburban Chinatown: The Remaking of Monterey Park, California*. Philadelphia: Temple University Press, 1994.
- Foster, Hal. "(Post) Modern Polemics," *Perspecta* 21. 1984. 144-153.
- _____. *Design and Crime (and Other Diatribes)*. London, New York: Verso, 2002.
- Glasgow, Kathy. "Houston: A Chinatown on the Prairie." *The New York Times*. July 6, 1986.

- Green, Frank. "99 Ranch Market, A Site Where East Meets West," *The San Diego Union- Tribune*. July 9, 2003.
- Ho, Patricia Jiayi. "San Gabriel has Plans for Valley Boulevard Development," *Pasadena Star-News*. Sept, 24, 2006.
- Hong, Peter. "In San Gabriel, a Redefined China Springs from Success," *Los Angeles Times*, Sept. 20, 1997.
- Howarth, Sophie. "Pretty Fascinating Boredom," *Tate: The Art Magazine* 24 Spring 2001. 60-6.
- Kwong, Peter. *The New Chinatown*. New York: Hill and Wang, 1996.
- Isenstadt, Sandy. "Recurring Surfaces: Architecture in the Experience of Economy," *Perspecta* 32. 2001. 108-119.
- Jameson, Frederic. *Postmodernism, or the Cultural Logic of Late Capitalism*. Durham: Duke University Press, 1991.
- Learn, Scott and Angie Chuang. "Authentic Appeal," *The Oregonian*. May 1, 2003.
- Lee, Jennifer 8. "In this Chinatown, Chinese is Just a Start," *The New York Times*, July 23, 2006.
- Lin, Jan. *Reconstructing Chinatown: Ethnic Enclave, Global Change*. Minneapolis: University of Minnesota Press, 1998.
- Martin, Reinhold. "Architecture's Image Problem: Have We Ever Been Postmodern?" *Grey Room* 22 Winter 2005. 6-29.
- _____. "On Theory, Critical of What? Toward Utopian Realism" *Harvard Design Magazine* 22 Spring/Summer 2005. 104-109.
- Mattick, Paul. "The Andy Warhol of Philosophy and the Philosophy of Andy Warhol," *Critical Inquiry* 24(4) Summer 1998. 965-987.
- Murphy, Rhoads. "Boston's Chinatown," *Economic Geography* 28(3) July 1952. 244-255.
- Newman, Barry. "For Asians in US, Mini-Chinatowns Sprout in Suburbia," *The Wall Street Journal*, April 20, 2004.

- Obrist, Hans Ulrich and Rem Koolhaas. "An Interview with Denise Scott Brown and Robert Venturi," *Harvard Design School Guide to Shopping*. Ed. Chung, Chuihua Judy et al. Köln: Taschen; Cambridge: Harvard Design School, 2001. 593-617.
- Price, Seth. *Dispersion (2001-2002)*. *Ljubljana Biennial of Graphic Art 2003*. Ljubljana, Slovenia: International Centre of Graphic Arts, 2003. Rpt. New York: Greene Naftali Gallery, 2003
- Reese, Jennifer. "Two Chinatowns," *American Automobile Association* November+December 2006. 44-51.
- Rowe, Peter G. and Seng Kuan. *Architectural Encounters with Essence and Form in Modern China*. Cambridge: MIT Press, 2002.
- Schwartz, Hillel. *The Culture of the Copy: Striking Likeness, Unreasonable Facsimiles*. New York: Zone Books, 1996.
- Severson, Kim. "99 Ranch Market Stocks the World's Food on Its Shelves," *The San Francisco Chronicle*. April 24, 2002.
- Smith, Icy. *The Lonely Queue: The Forgotten History of the Courageous Chinese American in Los Angeles*. Los Angeles: East West Discovery Press, 2000.
- Venturi, Robert and Denise Scott Brown. *Learning from Las Vegas: the Forgotten Symbol of Architectural Form*. Cambridge: MIT Press, 1977.
- _____. *Iconography and the Electronics upon a Generic Architecture: A View from the Drafting Room*. Cambridge: MIT Press, 1996.
- Wong, K. Scott. "Chinatown: Conflicting Images, Contested Terrain," *Melus* 20(1), Chinese American Literature. Spring 1995. 3-15.
- Yung, Judy. *San Francisco's Chinatown*. New Hampshire: Arcadia Publishing, 2006.
- "The Asian District Overlay: What is a Design District Overlay?" Comprehensive Planning Department of Clark County, Nevada.

Web Sources

- Abelsky, Paul. "An Exaggerated Invasion: Chinese Influence in Russia's Far East is Growing, but the Dangers Are Overplayed," *Russia Profile.org*. October 12, 2006.
<http://www.russiaprofile.org/culture/2006/10/12/4528.wbp>
- Baker, Peter. "A Tense Divide in Russia's Far East," *washingtonpost.com*, July 29, 2003.
<http://www.washingtonpost.com/ac2/wp-dyn?pagename=article&node...>
- Becker, Lynn. "Bobbing for Mies – Robert Venturi at ITT." 2005.
<http://lynnbecker.com/repeat/venturi/venturi.htm>
- Brissenden, Michael. "Chinese in the Former Yugoslavia," *The World Today*. April 18, 2001.
<http://www.abc.net.au/worldtoday/stories/s279093.htm>
- Cheng, Suellen and Munson Kwok, "The Golden Years of Los Angeles Chinatown: The Beginning," Reprinted from *The Los Angeles Chinatown 50th Year Guidebook, June 1998*.
<http://oldchinatownla.com/history.html>
- Churchman, Fiona. "A New Lease on Life for Darwin's Chinatown," *ABC Darwin*. March 29, 2004.
<http://www.abc.net.au/darwin/stories/s1076429.htm>
- Eljera, Bert. "The Chinese Beverly Hills," *Asian Week*, May 24-30, 1996.
<http://www.asianweek.com/052496/LittleTapiei.html>
- Estrada, William D., "Los Angeles' old plaza and Olvera Street: Imagined and contested space." *Western Folklore*. Spring 1999.
http://findarticles.com/p/articles/mi_qa3732/is_199904/ai_n8847620/pg_10
- O'Brien, Natalie. "Chinese Hub Poised to Re-orient Itself," *The Australian*. January 6, 2000.
http://web.lexis-nexis.com.libproxy.mit.edu/universe/document?_m=46...
- Robinson, Jennifer. "Changing Chinatown. Group Hoping to Get Zone Switch that Would Allow Gambling," *Las Vegas Review Journal*. May 14, 2005.
http://www.reviewjournal.com/lvjr._home/2005/May-14-2005/business
- Rowland, Jacky. "China is Serbia's New Best Friend," *BBC News Europe*. March 22, 2000.
<http://news.bbc.co.uk/1/hi/world/europe/685566.stm>
- Shlapentokh, Dmitry, "Unhealthy Competition, Ordinary Russians Fear the Impact of China's Expansion," *Russia Profile.org*. October, 16, 2006.

<http://www.russiaprofile.org/international/2006/10/16/4548.wbp>

Toosi, Nahal. Chinatown in Milwaukee? Just Maybe. Backers Envision Project as magnet for Asian Investment," *Journal Sentinel*.
<http://www.jsonline.com/story/index.aspx?id.=331496>

Urcan, Melissa. "Still Learning from Las Vegas: Robert Venturi and Denise Scott Brown take on Sin City Architecture Three Decades Later," *Ten by Ten Magazine*.
<http://www.tenbyten.net/vegas.html>

Vreme News Digest Agency No 307, August 23, 1997.
www.scc.rutgers.edu/serbian_digest/307/t307-2.htm

"Census figures show dramatic growth in Asian, Hispanic populations," *CNN.com*. August 30, 2000.
<http://cnnstudentnews.cnn.com/2000/US/08/30/minority.population/>

"Chinatown Project – EUR 1 bln Investment," *Romanian Daily*, June 20, 2006.
<http://www.romaniandaily.ro/cat42820/art9167376288/>

"New Chinatowns for Moscow and St. Petersburg," *PetersburgCity.com*. August 16, 2006.
<http://www.petersburgcity.com/news/city/2006/08/16/chinatown>

"Chinatown – Darwin," *Rondo*. February 7, 2007.
http://www.rondo.com.au/rondo/rdo_news.asp?ind=5&smii=1&articleid=0

"World-Class Architects and Designers Giving Shape to Las Vegas' Future With MGM Mirage Project CityCenter." MGM Mirage News Release.
<http://www.prnewswire.com/cgi-bin/stories>.

"Discover Los Angeles New Chinatown."
http://www.inetours.com/Los_Angeles/Pages/Chinatown.html

"Milosevic's China Dream Flops, Chinatown-Belgrade Booms," *newKerala.com*.
<http://www.newkerala.com.news4.php?action=fullnews&id=19213>

"The Glasgow Story: Chinatown."
<http://www.theglasgowstroy.com/image.php?inum=TGSA05296>

"International City, Dubai." 2005.

http://www.elitepropertypoint.com/d_international_city.html

"Simply Dubai Property."

http://www.simplydubaiproperty.com/dev_international_city.htm

Appendix: Selected Chinatowns



Dragon Rosu Shipping Container Chinatown - Budapest, Hungary





New Infill Chinatonw - Thessaloniki, Greece





Japanese/Taiwanese town - Sao Paulo, Brazil

Chinese Mall - Sao Paulo, Brazil



Korean Mall - Sao Paulo, Brazil



Various Chinese Commercial Plazas - San Gabriel, California



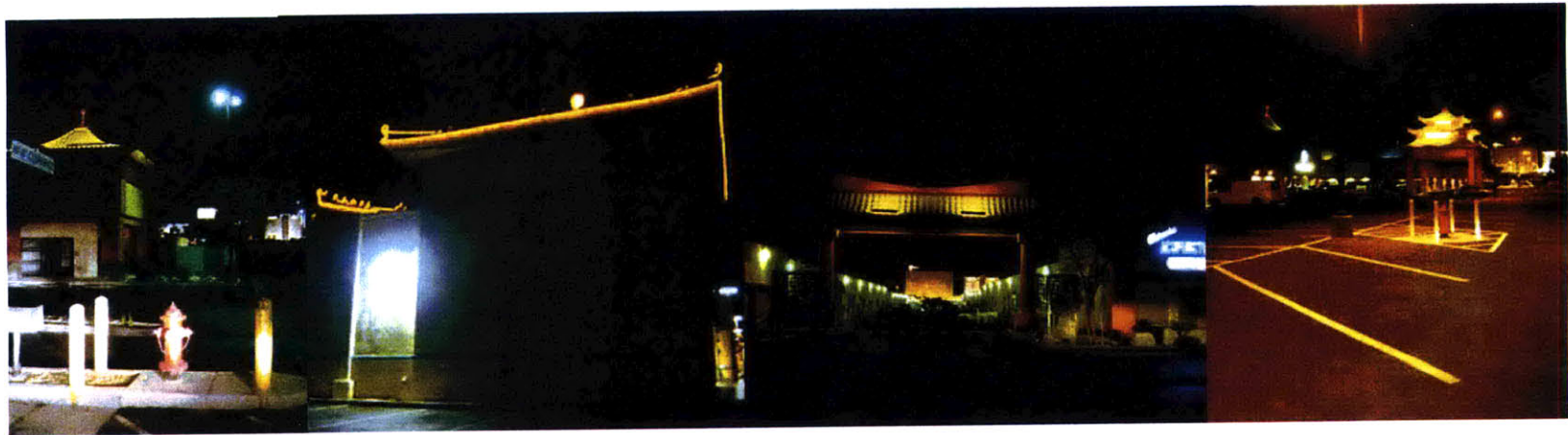

Chinatown Shopping Centers - Las Vegas, Nevada

