



Title	PHYLOGENY OF THE FAMILY SCIAENIDAE, WITH NOTES ON ITS ZOOGEOGRAPHY (TELEOSTEI, PERCIFORMES)
Author(s)	SASAKI, Kunio
Citation	MEMOIRS OF THE FACULTY OF FISHERIES HOKKAIDO UNIVERSITY, 36(1-2), 1-137
Issue Date	1989-12
Doc URL	http://hdl.handle.net/2115/21886
Type	bulletin (article)
File Information	36(1_2)_P1-137.pdf



[Instructions for use](#)

PHYLOGENY OF THE FAMILY SCIAENIDAE,
WITH NOTES ON ITS ZOOGEOGRAPHY
(TELEOSTEI, PERCIFORMES)

By

Kunio SASAKI*

*Laboratory of Marine Zoology, Faculty of Fisheries, Hokkaido
University, Hakodate, Hokkaido 041, Japan*

Contents

	Page
I. Introduction	1
II. Acknowledgments	3
III. Materials and methods	3
IV. Systematic procedures	7
V. Monophyly of the Sciaenidae	
1. Monophyly of the Sciaenidae	9
2. Systematic position of the Sciaenidae within the suborder Percoidei	19
VI. Character analysis	
1. Cranium	20
2. Infraorbitals and nasal	33
3. Suspensorium, opercular apparatus, and associated muscles	37
4. Jaws	44
5. Hyoid arch	48
6. Branchial arches and associated muscles	50
7. Pectoral girdle and associated muscles	62
8. Pelvic girdle and associated muscles	65
9. Vertebrae and associated bones	67
10. Caudal skeleton and associated muscles	73
11. Otolith	76
12. Swimbladder	81
13. Others	96
VII. Relationships within the Sciaenidae	
1. Characters	99
2. Cladistic relationships and monophyletic groups	106
VIII. Zoogeography	
1. Distribution of monophyletic groups within the Sciaenidae	119
2. Zoogeographic consideration	122
IX. Classification	126

The present work was submitted as a partial fulfillment of the requirements for Doctor's degree in Fisheries Science at Hokkaido University in 1989.

* Present address: Department of Biology, Faculty of Science, Kochi University, Akebono, Kochi 780, Japan.

X. Summary	132
XI. Literature cited	133

I. Introduction

Comprising one of the largest perciform families, with approximately 70 genera and 270 species (Chao, 1986), sciaenids commonly occur in temperate to tropical coastal waters and estuaries throughout the world. They are particularly abundant at the mouths of large continental rivers, but are generally absent or poorly represented in oceanic island groups such as Hawaii. External morphological features exhibited by the family are diverse, especially in general body form and mouth position, which have enabled sciaenids to adapt to a wide range of habitats, from benthic to pelagic. The vernacular English names of croakers and drums refer to the characteristic vocalization of the family. Related to sound production, swimbladder and otolith structure are also markedly diverse, being a most distinctive feature of the group.

To date, taxonomic and phylogenetic studies have primarily utilized swimbladder variability to establish evolutionary groupings, suggested in part by otolith morphology (Trewavas, 1962, 1977; Chu *et al.*, 1963; Mohan, 1972; Chao, 1978a, 1986). Although the great diversity of sciaenid swimbladder and otolith morphology promises much in the study of relationships, limitations are apparent when considering "primitive" states and "character polarity", according to usual cladistic methodology. Moreover, past character analyses have been *a priori*, without recourse to additional information obtained from osteological and myological studies. Although a number of works on sciaenid osteology are available (Dharmarajan, 1936; Green, 1941; Show and Yu, 1948; Kim and Kim, 1965; Topp and Cole, 1968; Taniguchi, 1969a, 1969b, 1970; Lucena, 1988), they have either been restricted to one or few species, or the findings have not been considered in the context of evolutionary relationships. Hence no overall syntheses of swimbladder, otolith, and other characters have been made to date.

In addition to the heavy reliance upon swimbladder and otolith morphology, the widespread geographic range of the family has hampered a phylogenetic analysis of the entire group. Most work has been limited to regional studies (*viz.*, eastern Atlantic by Trewavas, 1962; Chinese waters by Chu *et al.*, 1963; Indian waters by Mohan, 1972; Indo-West Pacific by Trewavas, 1977; western Atlantic by Chao, 1978a). Consequently, an overall view of sciaenid phylogeny has yet to be presented.

The primary purpose of this paper is to establish intergeneric relationships within the Sciaenidae, using morphological, osteological and myological evidence, based on the philosophical approach advocated by Hennig (1966). In addition, monophyly of the Sciaenidae and relationships within the Perciformes are considered. Distributional patterns within the family are also analysed, giving a picture of sciaenid evolution in space and time. Resulting from this work, new classification of the Sciaenidae is proposed.

II. Acknowledgments

I express my sincere thanks to Prof. Kunio Amaoka, Hokkaido University, for his guidance in the course of this study and critical reading of the manuscript. Special thanks also go to Prof. Takashi Minoda and Assoc. Prof. Kazuhiro Nakaya, Hokkaido University, for criticism of the manuscript.

I am most grateful to the following for permission to examine specimens in their institutions or for making specimens available: Mr. Masahiro Aizawa, University Museum, University of Tokyo; Dr. M. Eric Anderson, California Academy of Sciences; Dr. Eugenia B. Böhlke, Academy of Natural Sciences of Philadelphia; Dr. Marie-Louise Bauchot, Museum National d'Histoire Naturelle; Dr. Ning Labbish Chao, Fundacao Universidade do Rio Grande; Dr. Charles E. Dawson, Gulf Coast Research Laboratory & Museum; Dr. William N. Eschmeyer, California Academy of Sciences; the late Dr. Robert H. Gibbs, Jr., National Museum of Natural History, Smithsonian Institution; Dr. Karsten E. Hartel, Museum of Comparative Zoology, Harvard University; Dr. Hiroshi Hatanaka, Far Seas Fisheries Research Laboratory; Dr. Jean-Claude Hureau, Muséum National d'Histoire Naturelle; Ms. Susan L. Jewett, National Museum of Natural History, Smithsonian Institution; Ms. Patricia J. Kailola, University of Adelaide; Mr. Hirokazu Kishimoto, Institute of Oceanic Research & Development, Tokai University; Dr. Kenichiro Kyushin, Hokkaido University; Dr. Tadahiro Kitajima, Seikai Regional Fisheries Research Laboratory; Dr. Steven L. Leipertz, American Museum of Natural History; Dr. Keiichi Matsuura, National Science Museum, Tokyo; Dr. Robert R. Miller, Museum of Zoology, University of Michigan; Dr. Izumi Nakamura, Fisheries Research Station, Kyoto University; Dr. Douglas W. Nelson, Museum of Zoology, University of Michigan; Dr. John R. Paxton, Australian Museum; Dr. Theodore W. Pietsch, University of Washington; Dr. Stuart G. Poss, Gulf Coast Research Laboratory & Museum; Dr. John E. Randall, Bernice P. Bishop Museum; Dr. A.P. Kamalakara Rao, University of Madras; Dr. William F. Smith-Vaniz, Academy of Natural Sciences of Philadelphia; Mr. Arnold Y. Suzumoto, Bernice P. Bishop Museum; Dr. Nobuhiko Taniguchi, Kochi University; Dr. Yoshiaki Tominaga, University Museum, University of Tokyo; Dr. Ethelwynn Trewavas, British Museum (Natural History); Dr. Teruya Uyeno, National Science Museum, Tokyo; Mr. Alwyne Wheeler, British Museum (Natural History); Mr. Umeyoshi Yamada, Seikai Regional Fisheries Research Laboratory. Finally my special thanks go to Dr. Ning Labbish Chao, Dr. Werner W. Schwarzahans, Hamburg, and Dr. Ethelwynn Trewavas for valuable discussions about sciaenids; and to Dr. Kaoru Kido, Dr. Kazuo Sakamoto, Dr. Mamoru Yabe, and students of the Graduate School of Fisheries Science, Hokkaido University, for their kindness and willingness to discuss fish phylogeny. Dr. Graham S. Hardy, Mino City, Osaka, provided corrections to the English manuscript.

III. Materials and methods

Material examined is listed below. Abbreviations in parenthesis refer to the method of examination: D: dissection; P: partial dissection (otolith and swim-

bladder); X, radiograph. Institutional abbreviations follow Leviton *et al.* (1985).

Osteological and myological examinations were made on specimens stained in alizarin Red-S, and Wild M-8 dissecting microscope with a camera lucida utilized in the preparation of drawings. Terminology generally follows Weitzman (1962) for osteology, Winterbottom (1974) for myology, and Freihofer (1978) for nerves. The species name is omitted from the discussion when the feature described is characteristic of all examined congeneric species. Measurements (in millimeters) are of Standard Length.

Sciaenidae

New World genera and species :

- Aplodinotus grunniens*, UMMZ 164101, 4 specimens, 123 mm, (D), other specimens, 115-128 mm, (X); UMMZ 111634, 7 specimens, 67-122 mm, (X); UMMZ 184136, 18 specimens, 123 mm, (D), other specimens, 85-160 mm, (X).
- Atractoscion nobilis*, UW uncat., 168 mm, (D).
- Bairdiella chrysoura*, HUMZ 104915, 146 mm, (D); HUMZ 104919, 151 mm, (X).
- Cheilotrema saturnum*, HUMZ 110957, 161 mm, (D); HUMZ 110956, 134 mm, (X); HUMZ 110958, 216 mm, (P, X).
- Corvula macrops*, CAS (SU) 06823, 2 specimens, 128 mm, (D), 144 mm, (X).
- Ctenosciaena gracilicirrhus*, HUMZ 30878, 130 mm, (D); NSMT-P 40584, 5 specimens, 122-144 mm, (X).
- Cynoscion jamaicensis*, NSMT-P 40602, 163 mm, (D); NSMT-P 40610, 127 mm, (X).
- Cynoscion similis*, NSMT-P 40603, 2 specimens, 174 and 200 mm, (X).
- Cynoscion squamipinnis*, HUMZ 34607, 236 mm, (D).
- Cynoscion striatus*, FSFL EM-505, 350 mm, (X).
- Cynoscion virescens*, HUMZ 31056, 249 mm, (D); NSMT-P 40604, 295 mm, (X).
- Elattarchus archiduum*, CAS (SU) 06821, 6 specimens, 153 mm, (D), other specimens, 123-153 mm, (X).
- Equetus lanceolatus*, NSMT-P 40581, 134 mm, (D).
- Genyonemus lineatus*, UW 1715, 153 mm, (D); HUMZ 110924-110929, 110945-110949, 86-185 mm, (X).
- Isopisthus parvipinnis*, HUMZ 52057, 145 mm, (D); HUMZ 52063, 156 mm, (D); HUMZ 52058-52061, 99-133 mm, (X).
- Larimus breviceps*, NSMT-P 40590, 176 mm, (D); NSMT-P 40588, 40589, 40591, 40592, 174-206 mm, (X).
- Leiostomus xanthurus*, FAKU 107631, 145 mm, (D); FAKU 104727, 107632; HUMZ 109630, 67-165 mm, (P, X).
- Lonchurus lanceolatus*, GCRL 11967, 2 specimens, 163 mm, (D); 147 mm, (X).
- Macrodon ancylodon*, HUMZ 32361, 206 mm, (D).
- Menticirrhus americanus*, NSMT-P 40586, 245 mm, (D); NSMT-P 40585, 290 mm, (X).
- Micropogonias furnieri*, HUMZ 30835, 173 mm, (D); NSMT-P 40599 and 40600, 175 and 184 mm, (X).
- Nebris microps*, HUMZ 32357, 192 mm, (D); NSMT-P 40593, 194 mm, (D), NSMT-P 40596, 65 mm, (D).
- Odontoscion dentex*, HUMZ 104917, 106 mm, (D).
- Ophioscion sciera*, HUMZ 104916, 158 mm, (D).
- Pachypops* sp., HUMZ 110965, 107 mm, (D); HUMZ 110964, 96 mm, (X).
- Pachyurus schomburgkii*, USNM 123616, 6 specimens, 47 mm, (D); other specimens, 43-54 mm, (X).
- Pachyurus* sp., HUMZ 110963, 156 mm, (D).

- Paralonchurus brasiliensis*, NSMT-P 40607, 181 mm, (D).
Paralonchurus elegans, NSMT-P 40610, 192 mm, (D); NSMT-P 40613, 191 mm, (D); NSMT-P 40611 and 40612, 223 and 175 mm, (X).
Pareques acuminatus, NSMT-P 40582, 115 mm, (D).
Pareques iwamotoi, NSMT-P 40583, 170 mm, (D).
Plagioscion auratus, UMMZ 147371, 7 specimens, 158 mm, (D); other specimens, 77-92 mm, (X).
Plagioscion ternetzi, UMMZ 208124, 2 specimens, 222 mm, (D); 245 mm, (X).
Plagioscion sp., HUMZ 110962, 162 mm, (X).
Pogonias cromis, HUMZ 104921, 229 mm, (D); HUMZ 104922, 240 mm, (X).
Roncador stearnsii, HUMZ 110951, 112 mm, (D); HUMZ 110950, 110952-110955, 106-108 mm, (X).
Sciaena callaensis, USNM 36934, 297 mm, (X); USNM 120709, 188 mm, (X).
Sciaena deliciosa, FAKU 107905, 289 mm, (D).
Sciaena gilberti, CAS (SU) 22698, 4 specimens, 114 mm, (D); other specimens, 105-110 mm, (X).
Sciaena starksi, USNM 77731, 401 mm, (X).
Sciaena trewavasae, USNM 211575, 159 mm, (D).
Sciaenops ocellata, HUMZ 104920, 294 mm, (D).
Seriphus politus, UW 18980, 177 mm, (D); HUMZ 110930-110944, 32-184 mm, (P, X).
Stellifer microps, HUMZ 32211, 131 mm, (D).
Stellifer rastrifer, NSMT-P 40614, 118 mm, (D); NSMT-P 40615, 2 specimens, 118 and 122 mm, (X).
Totoaba macdonaldi, CAS 60768, 289 mm, (P, X).
Umbrina coroides, HUMZ 104918, 135 mm, (D); HUMZ 104919, 125 mm, (X).
- Eastern Atlantic genera and species:
Argyrosomus regius, HUMZ 111136, 216 mm, (P, X); FSFL unreg., 408 mm, (P, X).
Atractoscion aequidens, FSFL-R 729, 458 mm, (D).
Miracorvina angolensis, MNHN 1967-850, 226 mm, (D).
Pentheroscion mbizi, HUMZ 106567, 150 mm, (D).
Pseudotolithus (Fonticulus) elongatus, HUMZ 106565, 164 mm, (D).
Pseudotolithus (Hostia) moorii, MNHN 1967-847, 246 mm, (D).
Pseudotolithus (Pinnacorvina) epipercus, HUMZ 106566, 96 mm, (D).
Pseudotolithus (Pseudotolithus) senegalensis, HUMZ 106564, 233 mm, (D).
Pseudotolithus (Pseudotolithus) typus, FSFL-EI 593, 245 mm, (D).
Pteroscion peli, MNHN 1982-1296, 107 mm, (D).
Umbrina canariensis, FSFL-EI 982, 230 mm, (D); IORD 81-12, 148 mm, (X).
- Indo-West Pacific genera and species:
Argyrosomus japonicus, HUMZ 106580, 161 mm, (D); HUMZ 106576 and 106578, 389 and 347 mm, (X).
Argyrosomus minny, HUMZ 33176, 516 mm, (D); HUMZ 108575 and 108627, 264 and 247 mm, (X).
Aspericorvina jubata, ANSP 59956, 124 mm, (X).
Atrobucca nibe, HUMZ 110192, 215 mm, (D); HUMZ 105988-105991, 228-263 mm, (X).
Austrońbea oedogenys, AMS IB. 7193-7195, 3 specimens, 126 mm, (D); other specimens, 123 and 143 mm, (X); AMS IB. 1267, 27.4 mm, (P, X).
Bahaba taipingensis, CAS 25723, 3 specimens, 138-150 mm, (X).
Boesemania microlepis, ANSP 62510, 123 mm, (X).
Chrysochir aureus, SOSC, unreg., 3 specimens, 278-294 mm, (P, X); NSMT-P 44936, 208 mm, (X); BPBM 18619, 178 mm, (X).
Collichthys lucidus, HUMZ 110012, 115 mm, (D); HUMZ 106569, 110 mm, (X).
Collichthys niveatus, HUMZ 110013, 68 mm, (D); HUMZ 106570, 85 mm, (X).

- Daysciaena albida*, BPBM 27578, 261 mm, (X); BMNH 1889.2.1.3120, 101 mm, (X).
Dendrophysa russelli, HUMZ 101711, 93 mm, (D).
Johnius (Johnius) belangerii, HUMZ 37825, 115 mm (D); HUMZ 37859, 116 mm, (D).
Johnius (Johnius) sp., HUMZ 108600, 112 mm, (D).
Johnius (Johnieops) distinctus, HUMZ 107755, 187 mm, (D).
Kathala axillaris, HUMZ 112120, 106 mm, (D); HUMZ 112118 and 112119, 91 and 97 mm, (X); CAS 14626, 2 specimens, 64 and 94 mm, (X); BPBM 20547, 100 mm, (X).
Larimichthys crocea, HUMZ 106568, 179 mm, (D); HUMZ 108739, 285 mm, (X).
Larimichthys polyactis, HUMZ 108731, 134 mm, (D); NSMT-P 46655, 2 specimens, 160 and 173 mm, (X).
Macrospinosa cuja, ANSP 87574, 155 mm, (P, X); BMNH 1889.2.1.3092-3, 110 mm, (X).
Nibeia mitsukurii, HUMZ 90290, 159 mm, (D); HUMZ 107021, 116 mm, (D).
Otolithes ruber, FSFL-P 613, 321 mm, (D); MCZ 30808, 203 mm, (X).
Otolithoides pama, BMNH 1891.11.30: 43-45, 242 mm, (D); HUMZ 111134 and 111135, 53 and 45 mm, (P, X).
Panna microdon, USNM 288729, 14 specimens, 286 mm, (D); other specimens, 162-214 mm, (X).
Paranibeia semiluctuosa, BMNH 1898.629: 83-85; 1898.11.18.26; 1911.12.6.2-4 (mixed lot), 221 mm, (X).
Pennahia argentata, HUMZ 94940, 229 mm, (D); HUMZ 108628, 114 mm, (D).
Pennahia macrophthalmus, HUMZ 101703, 138 mm, (D); HUMZ 101704, 149 mm, (X).
Protonibeia diacanthus, HUMZ 110966, 188 mm, (D).
Pterotolithus maculatus, BMNH 1895.2.28.40, 145 mm, (X).
Sonorolux fluminis, ZUMT unreg., 2 specimens, 74 and 89 mm, (X).

Out-group taxa

- Berycidae: *Beryx splendens*, HUMZ 79840, 122 mm, (D).
 Polymixiidae: *Polymixia japonica*, HUMZ 79394, 146 mm, (D).
 Trachichthyidae: *Hoplostethus mediterraneus*, HUMZ 51824, 103 mm, (D).
 Apogonida: *Apogon carinatus*, HUMZ 79959, 99 mm, (D); *Epigonus pectinifer*, HUMZ 35576, 102 mm, (D).
 Branchiostegidae: *Branchiostegus dobiatus*, HUMZ 81530, 195 mm, (D).
 Centrarchidae: *Lepomis macrochirus*, HUMZ uncat., 88 mm, (D).
 Centropomidae: *Centropomus enciferus*, NSMT-P 29508, 217 mm, (D).
 Chelidodactylidae: *Goniistius zonatus*, HUMZ 45073, 208 mm, (D).
 Embiotocidae: *Ditrema temmincki*, HUMZ 63995, 142 mm, (D).
 Gerreidae: *Eucinostomus argenteus*, HUMZ 34577, 107 mm, (D); *Gerres oyena*, HUMZ 106117, 118 mm, (D).
 Girellidae: *Girella punctata*, HUMZ uncat., 88 mm, (D).
 Haemulidae: *Haplogenyus mucronatus*, HUMZ 10835, 124 mm, (D); *Parapristipoma trilineatum*, HUMZ 97741, 130 mm, (D); *Plectorhynchus diagraphmus*, HUMZ 101208, 175 mm, (D).
 Kuhlidae: *Kuhlia mugil*, HUMZ 48505, 89 mm, (D).
 Kyphosidae: *Kyphosus bigibbus*, HUMZ 105976, 176 mm, (D).
 Lethrinidae: *Lethrinus rubrioperculatus*, HUMZ 90170, 165 mm, (D).
 Lutjanidae: *Lutjanus vitta*, HUMZ 107050, 102 mm, (D).
 Mullidae: *Upeneus bensasi*, HUMZ 110428, 106 mm, (D).
 Nemipteridae: *Scolopsis bimaculatus*, HUMZ 90019, 162 mm, (D).
 Oplegnathidae: *Oplegnathus fasciatus*, HUMZ 51953, 105 mm, (D).
 Pempherididae: *Parapriacanthus ransonneti*, HUMZ 39873, 60 mm, (D); *Pempheris xanthoptera*, HUMZ 41426, 108 mm, (D).
 Percichthyidae: *Acropoma japonicum*, HUMZ 79966, 122 mm, (D); *Doederleinia berycoides*, HUMZ 79421, 130 mm, (D); *Lateolabrax japonicus*, HUMZ 52257, 213 mm, (D); *Malaki-*

chthys wakiyae, HUMZ 79412, 137 mm, (D); *Synagrops japonicus*, HUMZ 79597, 108 mm, (D).

Percidae: *Perca flavescens*, HUMZ uncat., 106 mm, (D).

Scorpididae: *Microcanthus strigatus*, HUMZ uncat., 125 mm, (D).

Serranidae: *Epinephelus moara*, HUMZ 110189, 146 mm, (D); *Nippon spinosus*, HUMZ 47416, 171 mm, (D); *Stereolepis gigas*, HUMZ 78521, 138 mm, (D).

Sillaginidae: *Sillago japonica*, HUMZ 55598, 165 mm, (D).

Sparidae: *Evynnis cardinalis*, HUMZ 110547, 114 mm, (D).

Teraponidae: *Terapon jurbua*, HUMZ 79350, 92 mm, (D).

IV. Systematic procedures

In order to evaluate phylogenetic relationships within the Sciaenidae as well as between sciaenids and other percoid families, the cladistic approach formulated by Hennig (1966) is adopted. Accordingly, groups derived strictly from shared derived characters (synapomorphies) are viewed as valid relationship indicators.

In assessments of perciform phylogeny by this method, difficulties are always posed by polarity determination. The fundamental difficulty is that the monophyly of this vast fish order, which includes 150 families and at least 6,900 species (Lauder and Liem, 1983) has no time been established. Patterson (1964) in fact argued for polyphyletic origins of the Perciformes. Moreover, neither evidence of monophyly, nor a well-founded scheme of interrelationships, has been proposed for the suborder Percoidei in which the Sciaenidae has been included. In most studies of percoid phylogenies, therefore, it is not possible to perform out-group comparisons between the study group and its closest relative. Nevertheless, I have accepted the monophyly of the Perciformes and its suborder Percoidei, in addition to the inclusion of the Sciaenidae in the latter, for the purpose of polarity determination.

Polarities are assessed according to the following criteria. 1) Out-group comparison. Character states most frequently found in percoids are hypothesized as being primitive for sciaenids. When the states are variable throughout the percoids, the condition possessed by the lower percoids is considered as primitive. Although the concept of "lower percoids" has itself not been well established (see Gosline, 1966; Johnson, 1984), excessive caution would hamper entirely any attempts to analyze percoid phylogeny. *Acropoma*, *Doederleinia*, *Malakichthys*, and *Synagrops* are primarily considered as the representatives of the lower percoids here, since they retain a complete set of primitive percoid conditions (see Tominaga, 1986). 2) Structural-functional complexity. Conditions structurally complex (and thus functionally more advanced) are considered to be derived. 3) Sequence of ontogenetic changes based on the rule of ontogenetic precedence (Hennig, 1966). Thus the larval and/or juvenile conditions are regarded as primitive. 4) Functional out-group (Watrous and Wheeler, 1981). Accordingly, conditions commonly found in sciaenids with a simple swimbladder (that is, the functional out-group) are hypothesized as also being primitive for sciaenids, based on the assumption that "the primitive state is likely to be associated with the state of other characters known from other evidence to be primitive (Kluge and Farris, 1969)".

Characters varying intraspecifically are not used in the proposals of phylogenies, as the primary purpose of this study is the proposal of the relationships

at the generic level (but see exceptions, below). In cases where more than one character state are present in a genus, the most primitive state is considered for analytical purposes.

Some characters are eliminated from consideration of overall phylogeny, owing to the difficulty in objective differentiation of character states. However, they may be effectively considered in smaller monophyletic units, determined by other characters. For example, the sulcus tail of the sciaenid otolith varies in its degree of curvature from nearly straight to well curved. Despite the highly divergent extremes, a number of intermediate forms prevent objective discriminate between character states. However, in a smaller unit where no intermediate forms exist, this character can be applied. Characters in this category are also used after the establishment of monophyly in the major groups.

In assessing intergeneric relationships within the Sciaenidae, most genera currently recognized are accepted as monophyletic, because material was too limited to allow varification of monophyly throughout. Some genera, however, are of doubtful monophyly. Because of variable swimbladder morphology, Chao (1986) considered that *Sciaena* is probably polyphyletic. *Argyrosomus* is similar to *Sciaena* in also having variable swimbladder morphs. *Paralanchurus elegans* is more similar to *Lonchurus* with its minute eye and very long pectoral fin, rather than to its congeners. In addition, monophyly of *Atractoscion* is also doubtful owing to its unusual distribution pattern (see Chapter VIII, Zoogeography). Consequently, the species included in these genera have been treated independently. Similarly, wherever subgenera have been recognized, each subgenus is coded separately.

Correlation of characters was also considered. In cladistic methodology, it has been widely accepted that each character has evolved independently. This view may perhaps be due to the operational rule that the every character must be equally weighted and that the most parsimonious cladogram is accordingly constructed. However, it is important to consider that each character is correlated to each other more or less, and that many characters would be effected in time once some innovative change in form and function of one occurs. In sciaenids, correlative changes are frequently observed in relation to modification of the swimbladder, as shown in the following chapters. Even if character correlation appears to be obvious (before construction of the cladogram), correlative characters are included independently. This approach leads to the heavy (indirect) weighting of certain characters which are structurally and/or functionally related to others.

The cladogram was constructed on the basis of parsimony arguments. The minimum step tree for the available data was derived using MIX (Mixed Method Parsimony) of J. Felsenstein's PHYLIP version 2.7. The tree was rooted by designating a hypothetical outgroup taxon lacking apomorphous states. All characters are weighted equally (but see above). Changes from primitive to derived and derived to primitive (reversal) were assumed as equally probable (except one character, see Character 22 of cranium). My understanding of parsimony follows "methodological parsimony" (Kluge, 1984).

V. Monophyly of the Sciaenidae

1. MONOPHYLY OF THE SCIAENIDAE

(Figs. 1-8)

At no time has monophyly of the Sciaenidae been demonstrated cladistically. The most recent diagnosis of the family (Trewavas, 1977) is based upon both primitive and derived characters. For example, three characters, viz., head covered with scales; operculum ending in two points; and posttemporal with a fimbriate edge, are widespread in percoids. This study reveals however, that the Sciaenidae is a monophyletic group defined by the following 21 synapomorphies.

Character 1: Soft dorsal fin base notably elongate, typically much longer than anal fin base. The sciaenid dorsal fin is deeply notched between the last and penultimate spines. The base of the spinous dorsal fin is short and restricted to the anterior half of the body, whereas the soft dorsal fin base is rather long, usually comprising more than 20 rays. The anal fin base is short, typically with only seven or eight soft rays. Although many percoids with a perch-like body form possess a deeply notched (or separated) dorsal fin, the spinous dorsal fin base is almost always as long as or longer than the soft dorsal fin base. Consequently, the soft dorsal and anal fins are about equally sized (e.g., Serranidae, Teraponidae, Lutjanidae, Lethrinidae). Even in the families with a relatively short spinous dorsal fin base (e.g., Sillaginidae and Apogonidae), the soft dorsal and anal fin bases are comparable in length. Accordingly, equal length soft dorsal and anal fin bases appear to represent the primitive percoid condition, although it is likely that a similar fin structure has evolved several times for functional requirements such as rapid swimming and defensive mobility. In terms of fin formation, however, sciaenids are unique in the combination of long soft dorsal and short anal fin bases.

Character 2 (Fig. 1): Third element of anal fin not transformed into a spine. Anal spines are primitively three in percoids (Johnson, 1984), whereas in sciaenids the spines number two (or in a few species, only one). Because the first anal fin pterygiophore bears two spines (Fig. 1C), as seen in fishes with three anal spines (Fig. 1A), the third element of sciaenids appears to have not transformed into a spine. Although a number of percoid groups are also characterized by less than three anal fin spines, homology among them cannot be clarified without examining pterygiophore-spine relations as pointed out by Johnson (1984). For example, the sciaenid condition is apparently nonhomologous with the two anal spines in sillaginids (Fig. 1B) and apogonids (Fraser, 1972), since their first pterygiophore bears only one spine, which indicates loss of the first spine.

Character 3 (Fig. 1): Medial elements absent in dorsal and anal fin pterygiophores. Primitively in percoids, the pterygiophores supporting the soft dorsal and anal fin rays are trisegmental (Johnson, 1980; Fig. 1D), whereas in sciaenids they are bisegmental (Fig. 1E), having resulted from the apparent fusion of the proximal and medial elements.

Character 4: Lateral line extending to end of caudal fin. Typically in percoids, the lateral line terminates in front of the caudal fin origin, whereas in sciaenids it extends to the hind margin of the caudal fin. This is one of the

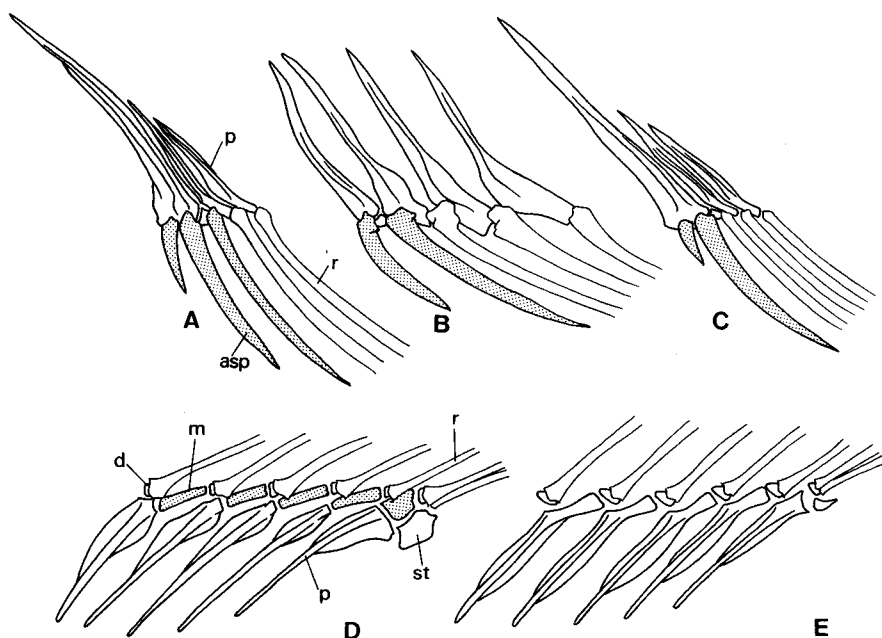

Fig. 1. Anal (A-C) and dorsal (D and E) pterygiophores. A, *Doederleinia berycoides*; B, *Sillago japonica*; C and E, *Johnius belangerii*; D, *D. berycoides*. asp, anal spine; d, distal element; m, medial element; p, proximal element; r, soft ray; s, stay.

characteristic specializations of sciaenids closely related to "sound reception" as discussed below. Evidently, extensive specialization of the organs related to sound production and reception has played a central role in the evolution of the family. As discussed by Trewavas (1977), since the lateral line functions to localize sound vibrations, its extension onto the caudal fin must increase the ability of sound detection accordingly. However, this specialization is not unique for sciaenids, having evolved several times as discussed in Character 18.

Character 5 (Fig. 2): Frontal cavernous. The sciaenid frontal is cavernous, owing to hypertrophy of the cephalic lateral line system, with a series of bridge-like bony struts covered by the scaly skin. Although nothing has been demonstrated experimentally concerning function, it seems that the wide fluid filled space on the neuromasts may act as a resonator and/or amplifier, enhancing reception of sound vibrations. In all small eyed sciaenids, such as *Panna* (Fig. 2C), the bridges on the frontal are always hypertrophic, probably to compensate for visual inability by a strengthening of hearing capability.

Frontals ornamented by such bridges are not restricted to sciaenids, being common in the lower percoids (Katayama, 1959). However, homologous attainment of the bridges in sciaenids and lower percoids is doubtful, owing to the relationships between the bridges and epaxial muscle. In sciaenids with relatively weak, wide frontal bridges (= weakly developed cephalic lateral line system), the epaxial muscle extends well onto the frontal (Fig. 2B). In sciaenids with high, crest-like bridges,

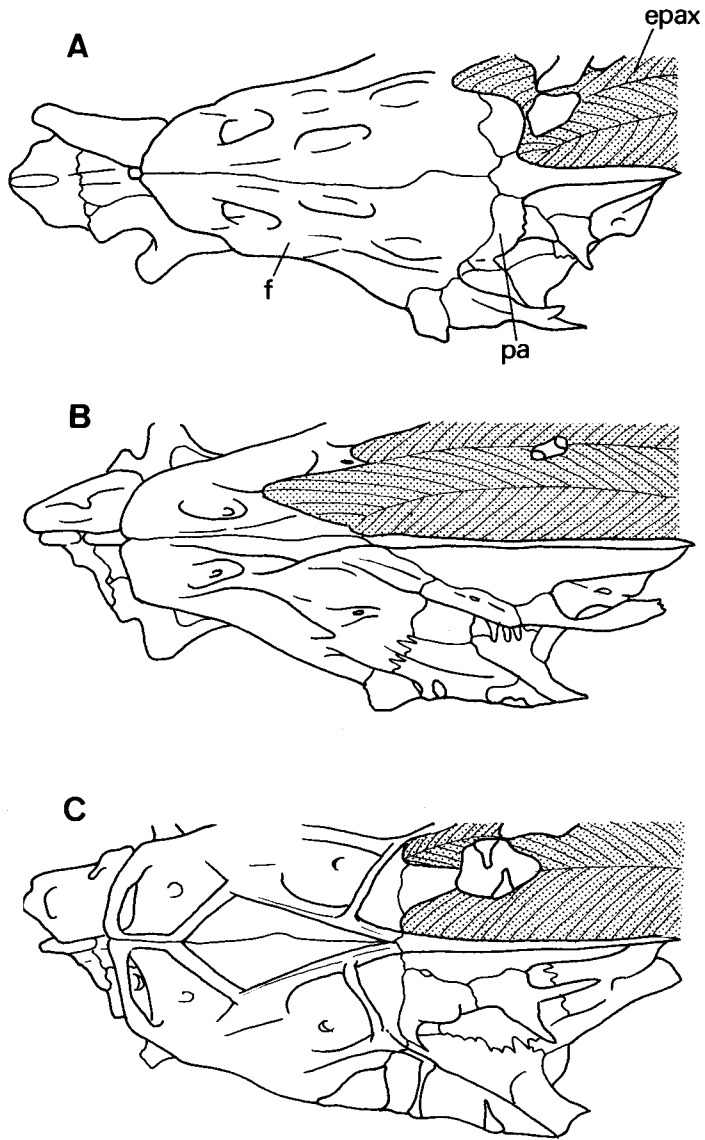

Fig. 2. Dorsal view of a lower percoid cranium (A) and sciaenid crania (B and C), showing relationship between frontal and epaxial muscle. A, *Acropoma japonicum*; B, *Leiostomus xanthurus*; C, *Panna microdon*. epax, epaxial muscle; f, frontal; pa, parietal.

the muscle terminates on the anterior border of the parietal (Fig. 2C), since the narrow bridges cannot provide sufficient surface area for muscle insertion. In lower percoids, on the other hand, the ridges vary from weak to well developed, but the muscle always terminates behind the frontal (Katayama, 1959; pers. obs.; Fig. 2A). From this, it can be postulated from both functional and structural points of view, that primitively in sciaenids, the frontal lacked crest-like bridges and was covered by the epaxial muscle (Fig. 2B). Subsequent developments of the cephalic lateral line system resulted in the exposure of the frontal, whereas in lower percoids, the frontal was not initially covered by the epaxial muscle, and development of the ridges has occurred on the muscle-free surface. Parallel development of the frontal ridges is thus strongly suggested. Accordingly I regard the cavernous frontal in sciaenids as an autapomorphy in percoids.

Character 6 (Fig. 2): Frontal covered with epaxial muscle. Because forward extension of the epaxial muscle is quite variable in percoids, the condition in lower percoids must be inferred to determine the character polarity. Since in the latter, the muscle always terminates behind the frontal, the forward extension represents an advanced condition. Although in many sciaenids the epaxial muscle terminates behind the frontal, I regard this as a further development as discussed in Character 5. This view is further supported by the the epaxial muscle usually extending forward in those sciaenids with a simple swimbladder. Thus the frontal covered by the epaxial muscle is a synapomorphy for the family, secondarily modified in some genera (see Character 5).

Character 7: Chin and snout pored. Typically in percoids, chin and snout lack pores, although minute ones are occasionally present. In sciaenids, distinct pores are always present.

Character 8 (Fig. 3): Retractor dorsalis originating laterally from first and second vertebrae. In sciaenids, the retractor dorsalis originates laterally from the first and second vertebrae, extending onto the neural spines (Fig. 3B). In most percoids examined in this study, the origin of the muscle is ventrolaterally on

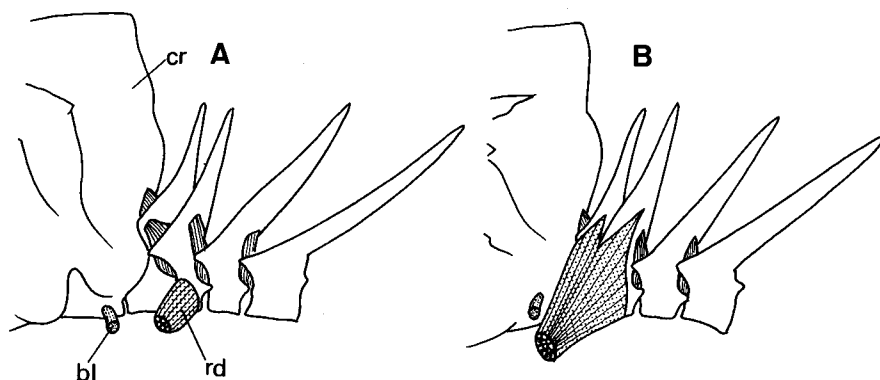

Fig. 3. Lateral view of cranium and anterior vertebrae. A, typical percoid condition (*Doederleinia berycooides*); B, sciaenid condition (*Dendrophysa russelli*). bl, Baudelot's ligament; cr, cranium; rd, retractor dorsalis.

the second (most common; Fig. 3A), second to third, or third to fourth vertebrae (where total vertebrae are numerous such as *Lateolabrax*), without extending onto the neural spines. Although the origin slightly including the first vertebra is also found in pempheridids, sparids, lethrinids, and gerreids (pers. obs.), it does not include the lateral side of the vertebra, differing from the sciaenid condition. This apomorphous muscle origin in the Sciaenidae has probably been obtained owing to the well developed swimbladder which has the thickened anterodorsal wall close to (or often partially attached to) the ventral side of the second vertebra, replacing the origin anteriorly and laterally.

Character 9 (Fig. 4): Transversus dorsalis anterior not bipartite. Primarily in perciforms, the transversus dorsalis anterior is composed of the two elements (Fig. 4A; terminology follows Anker, 1978): the musculus cranio-pharyngobranchialis 2 and the musculus transversus epibranchialis 2 (Stiassny and Jensen, 1987). The transversus dorsalis anterior in sciaenids is specialized in lacking the m. cranio-pharyngobranchialis 2 (Fig. 4B). Although Stiassny and

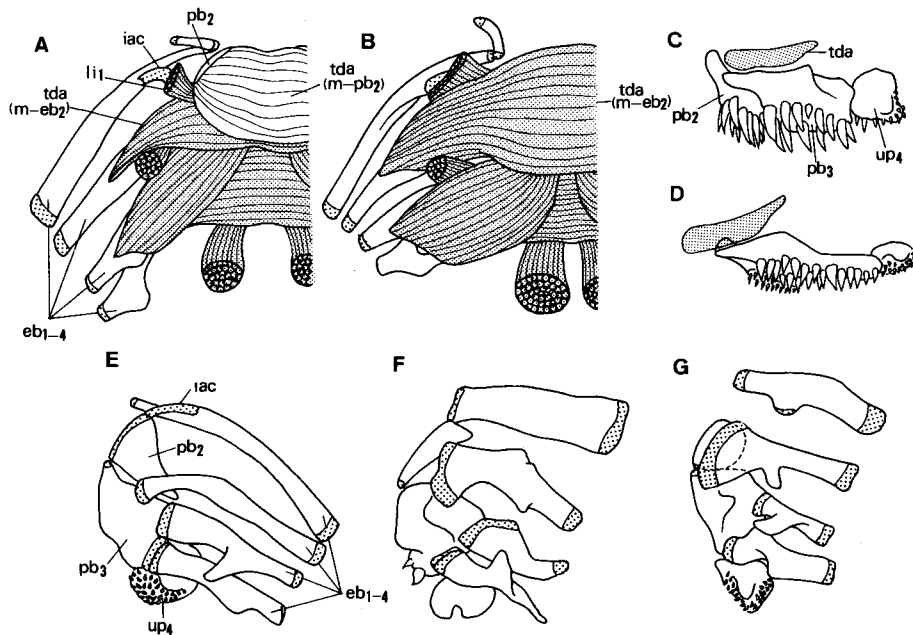

Fig. 4. Aspects of branchial arches. A and B, dorsal view of upper branchial arch; C and D, mesolateral view of upper branchial arch; E-G, dorsal view of upper branchial arch. A, typical percoid condition (*Acropoma japonicum*); B, sciaenid condition (*Panna microdon*); C, haemulid condition (*Hapalogenys mucronatus*); D, sciaenid condition (*Dendrophysa russelli*); E, sciaenid condition (*Otolithoides pama*); F, embiotocid condition (*Ditrema temmincki*); G, chelidodactylid condition (*Goniistius zonatus*). . eb, epibranchial; iac, interarcual cartilage; li, levator internus; pb, pharyngobranchial; tda (m-eb2), transversus dorsalis anterior (m. transversus epibranchialis 2); tda (m-pb2), transversus dorsalis anterior (m. cranio-pharyngobranchialis 2); up4, upper pharyngeal tooth plate 4.

Jensen stated that the embiotocids are unique among acanthomorphs in having the transversus dorsalis anterior represented only by the m. transversus epibranchialis 2, I found this condition also in the Haemulidae, Chelidodactylidae, and Gerreidae, as well as in the Sciaenidae. The question of homology therefore arises. In embiotocids the pharyngobranchial 2 is reduced in size and lacks the tooth plate, as figured by Liem (1986) and Stiassny and Jensen (1987) (see also Fig. 4F). This reduced condition may explain the muscle loss, because of the restricted potential attachment site. In sciaenids, haemulids, gerreids, and chelidodactylids however, pharyngobranchial 2 is moderately sized. Even among the latter families however, muscle-bone relationships are not uniform. In haemulids and gerreids, pharyngobranchial 2 is vertically oriented to the body axis and the m. transversus epibranchialis 2 passes behind the upper nipple-like projection of the bone (Fig. 4C), whereas in chelidodactylids, the head of epibranchial 2 is broadly expanded so as to cover most of the dorsal side of pharyngobranchial 2 (Fig. 4G). Both the m. cranio-pharyngobranchialis 2 and the interarcual cartilage are thus absent in chelidodactylids. Finally, in sciaenids, the m. cranio-pharyngobranchialis 2 is absent, in spite of the basic percoid branchial osteology (Fig. 4E). In sciaenids, pharyngobranchial 2 has little of its dorsal surface covered by the head of epibranchial 2, and the m. transversus epibranchialis 2 crosses over it (Fig. 4D). Therefore, although haemulids, gerreids, chelidodactylids, and sciaenids are identical in having the m. cranio-pharyngobranchialis 2 absent, the associated conditions cast strong doubts upon the condition being homologous. Accordingly, I regard the sciaenid condition as an autapomorphy in percoids.

Liem and Greenwood (1981) demonstrated that the m. transversus epibranchialis 2 is subdivided in the Cichlidae, and considered this condition to be one of the defining characters of the family. It is of interest to note that the subdivision is also present in preperciform *Beryx* (pers. obs.), in which there is a third transversus dorsalis anterior element arising from the posterior portion of the muscle and inserting onto epibranchial 1, after passing over the muscle bundle on epibranchial 2. This and other data suggest that the transversus dorsalis anterior modifications have repeatedly occurred independently, and thus must be evaluated with circumspection at higher taxonomic levels.

Character 10 (Fig. 5): A1 β division present. Jaw muscle configurations have been used as relationship indicators at various levels of the percoid hierarchy (e.g., Johnson, 1980; Stiassny, 1981a, b; Marino and Dooley, 1982; Godkin and Winterbottom, 1985). However, recent studies have also demonstrated that the adductor mandibulae must be evaluated with great caution, since this muscle complex has undergone independent specializations in many phyletic lineages. Hence the Paracanthopterygii as defined by Greenwood *et al.* (1966) and Rosen and Patterson (1968), to which the levator maxillae superioris (= A1 β) is important for characterization, is now no longer viewed as a valid group (Rosen, 1985). Furthermore, Marino and Dooley (1982) demonstrated that jaw muscle configurations may vary considerably, even within a single family (Branchiostegidae). The characteristic sciaenid configuration of the adductor mandibulae has been pointed out by Dietz (1914), Souché (1932), Johnson (1980), Aguilera (1982), and Gosline (1986). In sciaenids, the A1 division is completely subdivided into two sections: A1 α —a

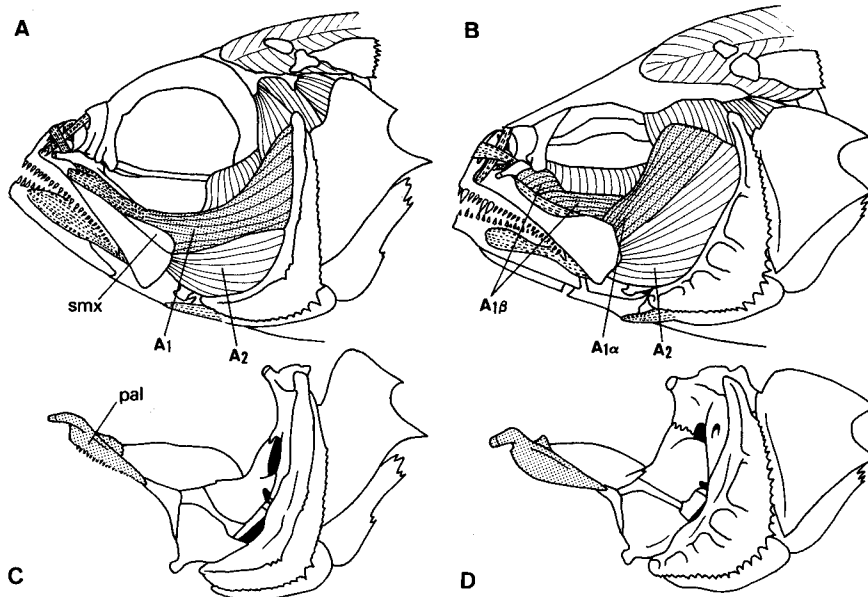

Fig. 5. Aspects of cheek muscles and suspensoria. A and C, typical percoid condition (*Doederleinia berycoides*); B and D, sciaenid condition (*Argyrosomus japonicus*). A, sections of adductor mandibulae; pal, palatine; smx, supramaxillary.

superficial element to the maxillomandibular ligament; $A1\beta$ —a profundus element to the maxillary head (Fig. 5B). It appears that the A1 division is not subdivided primitively in percoids (Fig. 5A; Winterbottom, 1974; Johnson, 1980; Stiassny, 1981b; Gosline, 1986; pers. obs.), and thus the sciaenid A1 configuration represents a specialization.

Specialized A1 division is not restricted to sciaenids, being frequently encountered in perciforms (summarized by Gosline, 1986). However, close similarity to the sciaenid condition (sufficient to suggest homology), cannot be found in other perciform families. The forward extension of the A1 division almost to the maxillary head (apparently structural prerequisite of the sciaenid condition) is present in various out-group taxa, e.g., Girellidae, Oplegnathidae, Teraponidae, Sparidae, Haemulidae (not all genera), Lutjanidae (Johnson, 1980), Mullidae (Gosline, 1985), and Serranidae (Stiassny, 1981b). However, the modifications of A1 division among these families differ from the sciaenid condition. The A1 division may comprise partial anterior separation only (Teraponidae, see Gosline, 1986) or subdivision of the A1 may originate from the infraorbitals (Lutjanidae, see Johnson, 1980). Comparing these taxa, the sciaenid configuration is unique in that the origin of the deep element ($A1\beta$) includes the anterior border of the suspensorium (mainly palatine and metapterygoid). Accordingly, the sciaenid palatine also shows a specialization (see Character 11).

Character 11 (Fig. 5): Palatine expanding ventrally. Typically in percoids, the palatine is rod-like and more or less slender (Fig. 5C), whereas in sciaenids,

a laminar, ventral expansion produces a gently rounded ventral margin (Fig. 5D). This leaf-like palatine serves as the attachment site of the anterior subdivision of $A1\beta$. Although an expanded palatine is also encountered in the Sparidae (Fig. 6B), Haemulidae, and Lethrinidae, it does not form an attachment site for $A1$ division (pers. obs.), and is thus unlikely to be homologous with the sciaenid condition in which the palatine modification is strongly associated with specializations of the cheek muscle.

Character 12 (Fig. 6): Symplectic dorsally flattened, interdigitating medially with metapterygoid. In most percoids, the symplectic is dorsally capped by a cartilage (Fig. 6A), whereas in sciaenids, it is extended as laminous projections along the inner wall of the metapterygoid (Fig. 6C). Similar specialization of the symplectic is also reported from the sparoids (Johnson, 1980), but in these such projections expand onto the outer wall of the metapterygoid (Fig. 6B), thus suggesting nonhomologous symplectic expansion. In both this character (and Character 13), the condition is lacking in some members of the Sciaenidae. The symplectic is not laminarily expanded in *Aplodinotus*, *Isopisthus*, *Cynoscion virescens*, and *Odontoscion*.

Character 13 (Fig. 6): Metapterygoid and quadrate interdigitating medially. In out-group taxa examined, the metapterygoid and quadrate is separated by a narrow strip of cartilage (Fig. 6A and B), whereas in sciaenids the two bones interdigitate medially (Fig. 6C) (except in *Dendrophysa* and *Pachyurus*). This may represent a unique specialization of sciaenids.

Character 14 (Fig. 5): Supramaxillary absent. Presence of a supramaxillary is the primitive condition in percoids (Fig. 5A). Although the loss of the element has undoubtedly occurred independently along a number of phyletic lines, its absence in sciaenids (Fig. 5B) is indicative of the relatively advanced status of the family.

Character 15: Prevomer edentulous. Presence of tooth plates on the palate and branchial cavity is a primitive percoid condition. Sciaenids are specialized in lacking prevomerine teeth, although such loss has occurred independently in other groups (Johnson, 1980). Although Cione and Torne (1987) found vomerine

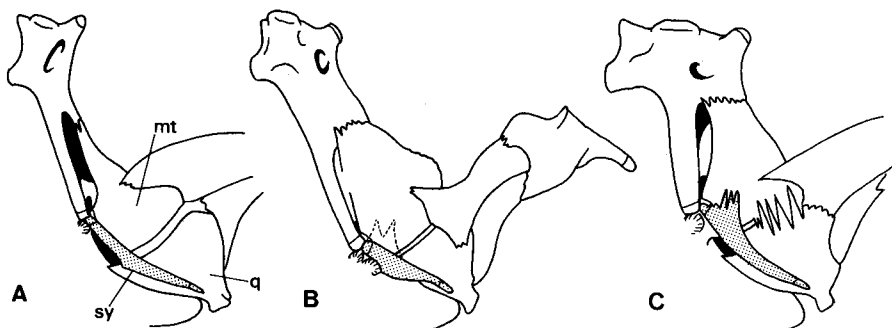

Fig. 6. Median view of suspensoria. A, typical percoid condition (*Doederleinia berycoides*); B, sparoid condition (*Erynnis cardinalis*); C, sciaenid condition (*Argyrosomus japonicus*). mt, metapterygoid; q, quadrate; sy, symplectic.

teeth in one out of 60 specimens examined of the sciaenid, *Pogonias cromis*, they considered it to be an example of atavism due to an isolated mutational event. Hence their finding does not invalidate the significance of this character.

Character 16 (Fig. 5): Palatine edentulous. A toothed palatine is the primitive condition in percoids (Fig. 5C). The toothless (apomorphic) condition of sciaenids (Fig. 5D) may be related to the ventral expansion of the palatine.

Character 17: Tooth plate absent from epibranchial 2. Primitively in percoids, the tooth plate is present on epibranchial 2, but such is absent in sciaenids. It is not certain whether this condition has arisen from fusion with pharyngobranchial 2 or by the independent disappearance of the tooth plate.

Character 18 (Fig. 7): One branchiostegal ray on epihyal. The most common number of branchiostegal rays in percoids is six or seven (Johnson, 1984: table 120). Although sciaenids have the more primitive condition (7), they exhibit a specialization in having only one ray on the epihyal (Fig. 7B). Examination of out-group taxa and literature searches reveal that the arrangement of five rays on the ceratohyal and two rays on the epihyal (i.e., 5+2; Fig. 7A) is by far the commonest condition in percoids. Even in species with six rays, two rays are usually present on the epihyal (i.e., 4+2; first ray presumably being lost). Although McAllister (1968) showed a 6+1 condition in the suborder Polynemoidei, there is no known relationships between sciaenids and this suborder.

Character 19: Drumming muscle typically present in males. Sound production is undoubtedly a basic and effective strategy in inter- and intraspecific interactions. Even within percoids, a trend towards swimbladder specializations and related muscles is apparent. Muscles thought to function as sound producers are found in the Apogonidae (not all species; pers. obs.), Centropomidae (not all species; Greenwood, 1976; pers. obs.), Serranidae (Hazlett and Winn, 1962; Gosline, 1966; pers. obs.), Teraponidae (Schneider, 1964; Vari, 1978), Pempherididae, Glaucosomatidae (Tominaga, 1986), Oplegnathidae (pers. obs.), Scorpididae (pers. obs.), Priacanthidae (not all species; Salmon and Winn, 1966; Starnes, 1988), and the Sciaenidae (numerous papers). Although Yabe (1985) considered that the drumming muscle is a primitive condition of percoids, the opposite interpretation is more likely, since it is lacking in most percoid families, including lower percoids.

Although Sciaenidae and the aforementioned percoids possess a sound-related

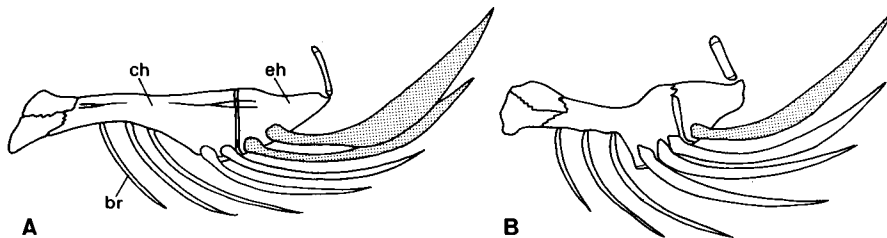

Fig. 7. Lateral view of hyoid arches. A, typical percoid condition (*Acropoma japonicum*); B, sciaenid condition (*Pseudotolithus typus*). br, branchiostegal ray; ch, ceratohyal; eh, epihyal.

muscle, the conditions are not homologous. Vari (1978) showed that the drumming muscle of teraponids is derived from the levator pectoralis, and in *Epinephelus* from the epaxial muscle. Centropomids (*Centropomus*) are very similar to *Epinephelus* (Greenwood, 1976). In pempheridids and glaucosomatids, the muscle originates from the pterotic (Tominaga, 1986; pers. obs.), which indicates strongly that the muscle has derived from modification of the dilatator operculi. In apogonids (pers. obs.) and priacanthids (Starnes, 1988), a sheet-like muscle (modified from the epaxial muscle?) interconnects the first pleural rib with the anterior portion of the swimbladder. Lastly, in oplegnathids and scorpidids (*Microcanthus*), a robust muscle bundle (derived from the obliquus superioris?) originates on the posttemporal fossa and is inserted onto the anterior end of the swimbladder, as well as to the first epipleural rib. This bone is modified having a leaf-like form (Mok and Shen, 1983) for muscle attachment and is tightly attached to the swimbladder. With regard to sciaenids, it is most unlikely that the drumming muscle has originated from the epaxial muscle, dilatator operculi, levator operculi, and obliquus superioris, but rather from the obliquus inferioris. As described by Ono and Poss (1982), the muscle develops on the lateral and ventral aspects of the obliquus inferioris, lying outside the peritoneum, and hence modification of the obliquus inferioris is inferred.

It is apparent therefore that sound producing ability in many percoids has arisen from different anatomical modifications. It follows that extension of the lateral line to the hind margin of the caudal fin is also likely to be a parallel development in sciaenids, pempheridids, and centropomids, necessitated by the increased need for sound receptivity. This inference is strengthened by the fact that such an extension does not occur in all members of the latter two families.

In sciaenids, the drumming muscle is sexually dimorphic, usually being absent or weakly developed in females (see Takemura *et al.*, 1978; Hill *et al.*, 1987). Moreover, this muscle is also absent in those sciaenids with a secondarily reduced swimbladder, such as *Menticirrhus* and *Lonchurus* (Chao, 1978a). Despite this, the development of a drumming muscle in males of most species is strongly indicative of sciaenid monophyly.

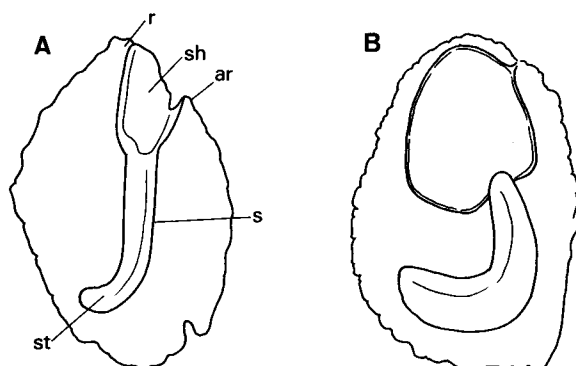

Fig. 8. Inner view of otoliths. A, haemulid (=percoid) condition (*Haploxyphys mu-cronatus*); B, sciaenid condition (*Argyrosomus japonicus*). ar, antirostrum; r, rostrum; s, sulcus; sh, sulcus head; st, sulcus tail.

Character 20 (Fig. 8): Sulcus head of otolith shallow. A series of specializations characterize sciaenid otoliths. The most distinctive feature is that the sulcus head is very shallow, whereas the sulcus tail is deeply grooved and impinges on the sulcus head (Fig. 8B). This sharply contrasts with the typical percoid condition in which the sulcus head and tail are grooved equally deeply (Fig. 8A). A second unique sciaenid character is that the sulcus head is evenly rounded anteriorly (Fig. 8B). In other percoids, the sulcus head is indented anteriorly (excisura ostii), forming the rostrum and antirostrum (Fig. 8A). Gaemers (1984) considered the presence of an excisura ostii to be a plesiomorphic characteristic. In addition to these specializations, the sciaenid otolith appears to be derived in having a large size, with a large, wide sulcus head, and strongly curved sulcus tail.

Character 21 (Fig. 8): Sulcus head evenly rounded anteriorly. See Character 20.

2. SYSTEMATIC POSITION OF THE SCIAENIDAE WITHIN THE SUBORDER PERCOIDEI

Tominaga (1986) listed the following character states as primitive for percoids: 8+7 branched caudal rays; three epurals; two postcleithra; 10+15 vertebrae; myodome closed posteriorly; 0/0/0+2 predorsals; exoccipital condyles in broad contact with each other. Tominaga noted that possessors of all of the above primitive states are restricted to the *Glaucosoma-Pempheris* lineage, the *Acropoma*-group, and several members of the Sciaenidae. In addition, the following primitive character states retained by sciaenids (but not necessarily by all members) are included: procurrent spur present (Johnson, 1975); branchiostegal rays 7 (but see Character 16); operculum ending in two points (c.f., three in Serranidae sensu Johnson, 1983); interarcual cartilage present.

On the basis of the above characters, which indicate the relative primitiveness of the family, it is suggested that the Sciaenidae has diverged early in percoid evolution, subsequently becoming highly specialized.

Of the 21 synapomorphies above, which characterize sciaenids, following 13 are autapomorphic for the family: 1, 4, 5, 8, 9, 10, 11, 12, 13, 18, 19, 20, and 21. Furthermore, of the eight remaining characters, most have probably arisen independently in a number of percoid lineages, with only Character 7 (chin and snout pored) appearing to be a reliable indicator of sister-group relationships.

Presence of chin pores is a condition shared by the Sciaenidae and Haemulidae. In fact, a close relationship between these two families has already been suggested by Trewavas (1977). Trewavas pointed out that haemulids are not only similar to sciaenids in having pores on the chin (especially *Plectorhynchus*), but also in having a small third anal fin spine, and a fimbriate edge on the posttemporal. Furthermore, both haemulids and lutjanids are similar to sciaenids in the sulcus pattern on the sagitta. In my view however, only the presence of chin pores is useful in discussing relationships, because the fimbriate edge of the posttemporal is plesiomorphic, and the second and third anal fin spines of the haemulid *Parapristipoma* are equally sized. Furthermore, it appears to me that the hypertrophy of the second anal fin spine in haemulids has resulted in the relatively short third spine compared with the second, since the third anal fin spine of haemulids is still robust and never "diminu-

tive". Concerning sulcus morphology, the sciaenid otolith is highly specialized as discussed in Character 20, whilst that of haemulids and lutjanids retain the basic perciform sulcus structure (Fig. 8A). Although the sulcus head is rather wide and the tail is relatively well curved in the latter families, this is so only a slight degree compared with other perciforms. Since the sciaenid otolith is highly specialized, sulcus morphology cannot be directly compared with that of other families.

Johnson (1980) considered the Haemulidae to be defined by the following: subocular shelf absent (but it is well developed in *Hapalogenys mucronatus*, pers. obs.); trigeminal pterygiophores absent from dorsal and anal fins (but they are present in the last pterygiophore of both the dorsal and anal fins in *Parapristipoma trilineatus*, pers. obs.); strong attachment of sixth infraorbital to skull (but rather loosely so in *Parapristipoma trilineatus*, pers. obs.); presence of enlarged lateral line pores under chin; posterior projection of posteromedial margin of metapterygoid as a rounded, vertical flange overlapping medial side of lower arm of hyomandibular (but less modified in *Parapristipoma trilineatus*, pers. obs.). It is clear that the presence of the chin pores is the only synapomorphy shared by sciaenids and haemulids.

Difficulties exist in the acceptance of a sister group relationships of sciaenids and haemulids. Haemulids, so far as examined, are advanced in their pharyngeal jaw structure in that the parasphenoid is modified posteriorly to form a tight articulation between the dorsal roof of the upper pharyngeal jaw and the floor of the cranium. In particular the posterior portion of the parasphenoid is somewhat thickened ventrally to form a pair of blunt keels, subdivided by a shallow, medial groove. The identical state is also found in *Kuhlia*, *Terapon*, *Scolopsis*, *Evynnis*, *Lepomis*, *Girella*, *Kyphosus*, *Goniistius*, *Oplegnathus*, *Microcanthus*, *Gerres*, and *Eucinostomus*. In addition, haemulids share a second synapomorphy with the latter (except for *Goniistius*) (the myodome open posteriorly) and a third synapomorphy with gerreids (the specialization of the transversus dorsalis anterior—discussed in Character 9). It follows that the Haemulidae is most likely to be the sister group of the Gerreidae, within the group characterized by modifications of the parasphenoid and the open myodome, and thus cannot be placed so close to the Sciaenidae.

In conclusion: the Sciaenidae is a group belonging to the Percoidei, representing an early offshoot in percoid evolution; neither evidence previously presented in the literature, nor characters examined in this study, has enabled the identification of a sciaenid sister group.

VI. Character analysis

1. CRANIUM (Figs. 9-20)

GENERAL DESCRIPTION

The general shape of the cranium is highly variable in its relative height, length, and width, reflecting a rich variety of body forms. The cranium comprises 17 bones, of which 11 are paired and six are unpaired, namely the prevomer,

ethmoid, lateral ethmoids, frontals, nasals, parietals, sphenotics, pterosphenoids, basisphenoid, parasphenoid, prootics, pterotics, epiotics, intercalars, supraoccipital, exoccipitals, and basioccipital.

The prevomer (unpaired) in edentulous, lying in the anteroventral portion of the cranium. Laterally expanded anteriorly, it has a short, posterior shaft lying beneath the anterior portion of the parasphenoid. The prevomer is sutured dorsally to the ethmoid and laterally to the lateral ethmoid. A narrow strip of cartilage marginally caps this bone anteromedially.

The ethmoid (unpaired) forms the anterior border of the cranium together with the prevomer. It is laterally in contact with the lateral ethmoid and is dorsally overlapped by the frontal. The upper, medial, keel-like portion tends to hang forward in those fishes with an inferior mouth.

The lateral ethmoid (paired) forms the anterior wall of the orbit, articulating dorsally with the frontal, medially with the ethmoid, ventrally with the prevomer, and posteriorly with the anterior portion of the parasphenoid. The anteromedial wall of this bone bears the olfactory tract foramen, and ventrally the facet to receive the dorsal process of infraorbital 1 (=lacrymal). More ventrally, two processes

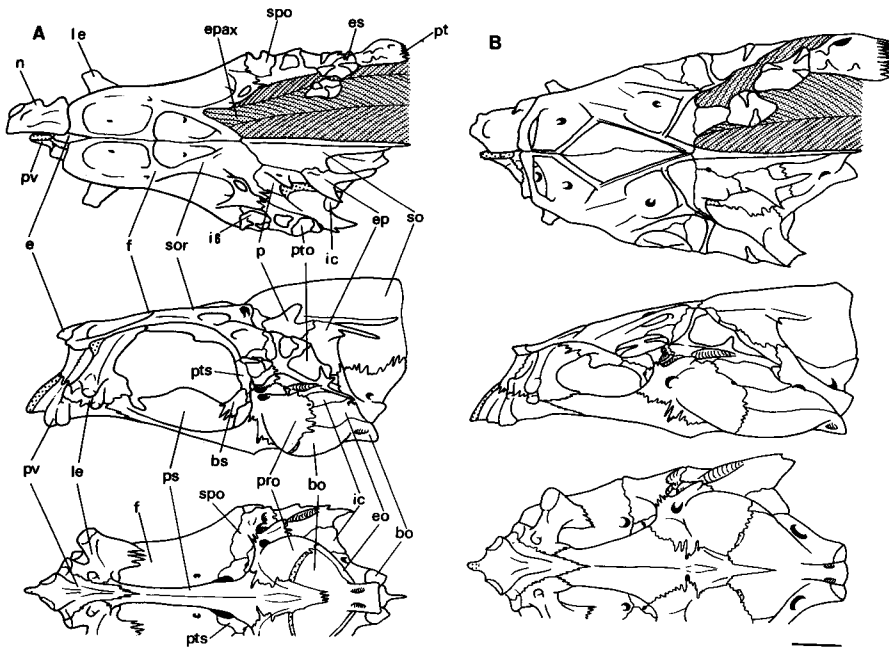

Fig. 9. Crania of two sciaenids. A, *Sciaena trevavasae*; B, *Panna microdon*. bo, basioccipital; bs, basisphenoid; e, ethmoid; ep, epiotic; epax, epaxial muscle; eo, exoccipital; es, extrascapula; f, frontal; ic, intercalar; i6, infraorbital 6; le, lateral ethmoid; n, nasal; p, parietal; pro, prootic; ps, parasphenoid; pt, posttemporal; pto, pterotic; pts, pterosphenoid; pv, prevomer; so, supraoccipital; sor, supraorbital ridge; spo, sphenotic. Top, dorsal view; middle, lateral view; bottom, ventral view. Bar=5 mm.

articulate anteriorly and posteriorly with corresponding facets on the palatine.

The frontal (paired) is the largest bone forming most of the anterior half of the dorsal skull roof. A forward extension covers ventrally the ethmoid region in those fishes with a inferior mouth, but little or not at all in fishes with a terminal or oblique mouth. The frontal is in contact with the supraoccipital, parietal, and pterotic posteriorly, with the ethmoid and lateral ethmoid anteriorly, and with the sphenotic and pterosphenoid posteroventrally. The nasal (see also p. 35 and Fig. 23) is attached to the anterior margin of the frontal. Both frontal and pterotics are highly cavernous owing to hypertrophy of the cephalic lateral line system. A series of ridges occur on the frontal (see Taniguchi, 1969a), these being variable in their degree of development. The epaxial muscle insertion point may include the supraorbital ridge or behind the entire frontal element.

The parietal (paired) lies on the dorsal skull roof just behind the frontal. It is sutured to the epiotic posteriorly, to the supraoccipital medially, and to the pterotic laterally. A thin crest (parietal crest) is usually well developed in high bodied fishes, but is either vestigial or absent altogether in low bodied fishes.

The sphenotic (paired) forms the posterodorsal corner of the orbit. It articulates with the frontal anteriorly, with the pterotic posteriorly, with the pterosphenoid anteroventrally, and with the prootic ventrally. Together with the prootic, it forms the articulation point for the anterodorsal facet of the hyomandibular. It also includes the attachment site for infraorbital 6 (dermosphenotic),

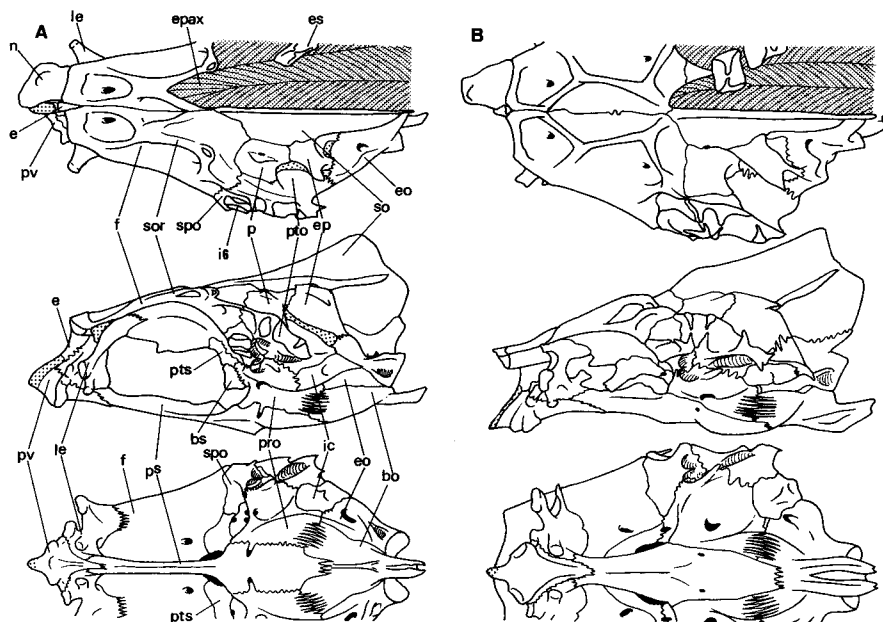

Fig. 10. Crania of two sciaenids. A, *Odontoscion dentex*; B, *Stellifer rastrifer*. Abbreviations as in Fig. 9. Top, dorsal view; middle, lateral view; bottom, ventral view. Bar=5 mm.

and connects the supraorbital and infraorbital lateral line system with a dorsolateral sensory groove on the pterotic.

The pterosphenoid (paired) lies in the posterodorsal wall of the orbit, and medially bordering the dorsal fontanelle. It typically meets the frontal anterodorsally, the prootic and basisphenoid ventrally, and the sphenotic posteriorly.

The basisphenoid (unpaired) typically bridges the posteroventral margin of the orbit. It is small and Y-shaped, typically articulating with the pterosphenoid and prootic dorsally, and the parasphenoid in the ventral midline.

The parasphenoid (unpaired) is long and shaft-like, lying between the olfactory and otic regions at the basal part of the cranium. Anteriorly, it contacts the prevomer and lateral ethmoid; posteriorly, it contacts the prootic and suturally extends into the basioccipital. The posterodorsal section of the parasphenoid forms the floor of the myodome.

The prootic (paired) forms most of the posteroventral wall of the orbit and anteroventral wall of the auditory bulla. It is attached to the pterosphenoid and basisphenoid anteriorly, the basioccipital, exoccipital, and intercalar posteriorly, the sphenotic and pterotic dorsally, and the parasphenoid ventrally. The prootic houses the trigeminofacialis chamber near its region of articulation with the sphenotic. This chamber contains three foramina for the cranial nerves: nervus oculomotoris (III), nervus trigeminus (V), and nervus facialis (VII). Typically, the three small foramina are about equal sized. The typically small carotid foramen

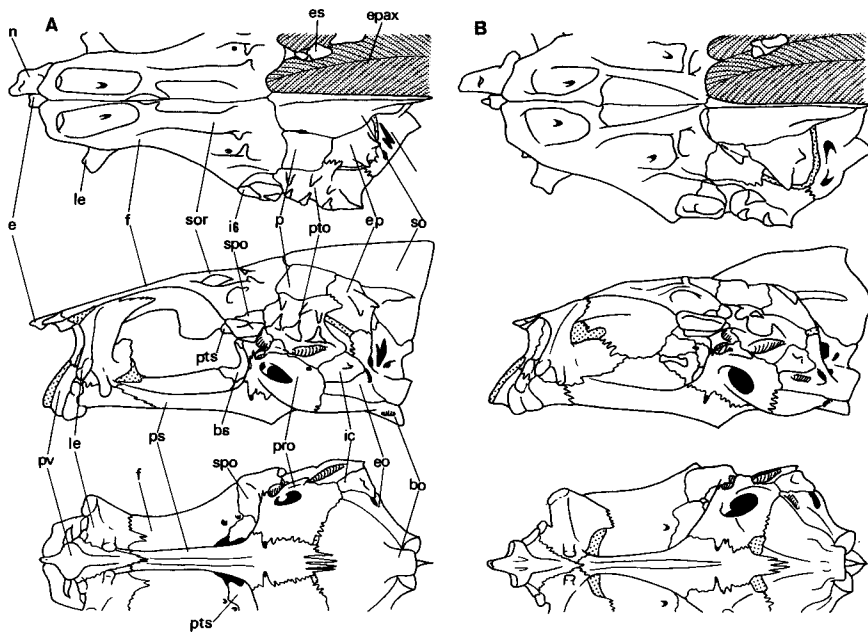

Fig. 11. Crania of two sciaenids. A, *Johnius (Johnius) belangerii*; B, *Johnius (Johnnieops) distinctus*. Abbreviations as in Fig. 9. Top, dorsal view; middle, lateral view; bottom, ventral view. Bar=5 mm.

opens on the suture separating the prootic from parasphenoid.

The pterotic (paired) forms the dorsolateral part of the cranium. It makes contact with the frontal and sphenotic anteriorly, the parietal and epiotic medially, the prootic and intercalar ventrally, and the exoccipital posteriorly. Dorsally, it forms part of the posttemporal fossa, and laterally has a groove for the cephalic lateral line system. Just ventral to this groove, an elongate depression for articulation with a facet of the hyomandibular is present, above the pterotic-prootic suture.

The epiotic (paired) forms the inner wall of the posttemporal fossa. It is sutured to the parietal anteriorly, to the supraoccipital medially, to the pterotic ventrally, and to the exoccipital posteriorly. The posterodorsal portion is bifurcate, the outer process receiving the dorsal limb of the posttemporal.

The intercalar (paired) forms a posteroventral part of the cranium. It typically meets the prootic anteriorly, the pterotic dorsally, and the exoccipital ventrolaterally. Usually, it does not extend down to the auditory bulla. Its posterior border forms a facet for articulation with the ventral limb of the posttemporal.

The supraoccipital (unpaired) is large, occupying medially the postorbital skull roof. It articulates with the frontal anteriorly, the parietal and epiotic laterally, and the exoccipital ventrally. A high median crest (supraoccipital crest) with typically smooth upper margin, is associated with a lateral ridge.

The exoccipital (paired) forms the posterior wall of the cranium. It meets the supraoccipital dorsally, the pterotic and prootic anteriorly, the intercalar and epiotic dorsolaterally, and the basioccipital ventrally, forming the side and roof of the foramen magnum. The exoccipital condyle for articulation with the first vertebra is typically in broad contact with its opposite neighbour. The ridge leading to the condyle is perforated dorsally by the the vagus (X) nerve foramen, and ventrally by the glossopharyngeal (IX) nerve foramen.

The basioccipital (unpaired) forms the posteroventral part of the cranium. It joins the exoccipital dorsally, the prootic anterolaterally, the parasphenoid anteriorly, and posteriorly forms a condyle for articulation with the first vertebral centrum. Typically, Baudelot's ligament is attached to the lateral surface of this bone.

CHARACTERS

Character 22 (Figs. 9-11, 18): Epaxial muscle terminating behind supraorbital ridge of frontal. The cavernous frontal is one of the family synapomorphies (Character 5). Within the family, development of the frontal ridges varies from rather weak to strong, being correlated functionally with the hearing capability. As a measure of the degree of development of the ridges, the relationships between the supraorbital ridges (SOR) and epaxial muscle only are considered, since the relative width and height of the frontal ridges are gradually changed. The SOR on each frontal is wide, and nearly parallel with its opposite member. Together they receive a deep extension of the epaxial muscle in *Sciaena trewavasae* (Fig. 9A), *S. deliciosa*, *S. gilberti*, *Equetus*, *Pareques*, *Ctenosciaena*, *Umbrina*, *Sciaenops*, *Odontoscion* (Fig. 10A), *Corvula*, *Elattarchus*, *Seriphus*, *Leio-stomus* (Fig. 20A), *Pogonias* (Fig. 20B), *Cheilotrema*, *Genyonemus*, and *Roncador*, whereas in other genera and species, each SOR is relatively narrow or crest-like, forming with the opposite member a more or less V-shaped angle, onto which the

epaxial muscle is not received. As discussed for Characters 5 and 6, poorly developed frontal ridges represent the primitive state in the Sciaenidae, with the epaxial muscle extending onto the frontal. Accordingly, Character 22 is considered to be apomorphous.

Character 22 is not admitted the reversal from the derived to the primitive condition, since the combined changes of the SOR and the epaxial muscle, following the loss of the functional merit, seem to be highly unlikely.

Character 23 (Fig. 10): Outer margin of lateral ethmoid concaved medially. Typically in percoids and in most sciaenids, the outer margin of the lateral ethmoid is nearly straight or at most gently curved outwards or inwards. In *Bairdiella*, *Ophioscion*, and *Stellifer* (Fig. 10B), it is medially concave. This concavity is enclosed by a thin, transparent membrane, which excludes close association of nerves or ligaments.

Character 24 (Figs. 11 and 12): Foramen for nervus facialis (VII) enlarged. Srivastava (1955) reported for the first time in sciaenids, the presence of a large, prootic foramen, in *Johnius (Johnius) coitor* and *Otolithoides pama*. He stated that the foramen was closed by a membrane, to which the anterior distal portion of the swimbladder appendages attached, forming a direct ear-swimbladder connection. Later, Taniguchi (1969a) found the enlarged foramen in *Johnius (Johnieops) distinctus* and *Johnius (Johnius) belangerii*, and Trewavas (1977) in *Johnius (Johnius) amblycephalus*. Trewavas further suggested that the large foramen was not an additional feature, but was homologous with a much smaller foramen found in other sciaenids. My observations confirm Trewavas' suggestion, because in *Johnius* the foramen for nervus facialis (VII) is enormously enlarged (Figs. 11 and 12B). Although an enlarged foramen is also present in *Otolithoides*, as found by Srivastava, it is apparently nonhomologous with that of *Johnius* (see next character).

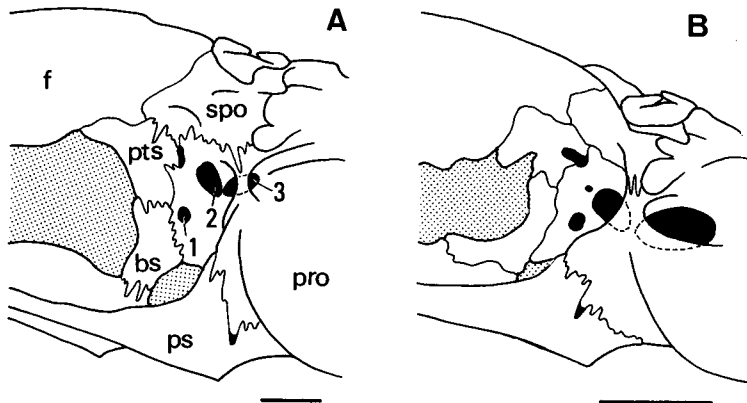

Fig. 12. Canted view from left anterolateral side of crania, showing size of foramen for nervus facialis (VII). A, *Sciaena trewavasae*; B, *Johnius (Johnius) belangerii*. 1, nervus oculomotoris (III); 2, nervus trigeminus (V); 3, nervus facialis (VII). bs, basisphenoid; f, frontal; pro, prootic; ps, parasphenoid; pts, pterosphenoid; spo, sphenotic. Bar = 3 mm.

Character 25 (Fig. 13): Carotid foramen enlarged. In *Otolithoides*, the carotid foramen is enlarged (Fig. 13A), differing from the condition in *Johnius*. Contrary to Srivastava's (1955) statement, this foramen lacks a covering membrane, since it serves as a passage for the distal portion of the swimbladder appendage to the brain case (see Fig. 72D).

Character 26 (Fig. 13): Auditory bulla notched—*Macrodon* type. In most sciaenids, the auditory bulla wall is rounded simply as in percoids, whereas in *Macrodon* the prootic, which roughly comprises anterior half of the auditory bulla, is medially squeezed, forming a distinct notch (Fig. 13B).

Character 27 (Figs. 10 and 17): Auditory bulla notched—*Stellifer* type. In *Bairdiella*, *Corvula*, *Elattarchus*, *Odontoscion* (Fig. 10), *Ophioscion*, and *Stellifer* (Figs. 10B and 17E), the lateral wall of the auditory bulla is notched approximately at its mid-height. This specialization is probably owing to the enlargement of the lapillus (anteriormost otolith), since the upper portion of the auditory bulla divided by this notch coincides with the location of the enlarged lapillus.

Character 28 (Figs. 14 and 16): Pterosphenoid in contact with lateral ethmoid. Typically in sciaenids, the parasphenoid and lateral ethmoid are widely separated from one another by the frontal (Fig. 14A) as in most percoids, whereas in *Paralonchurus brasiliensis* (Fig. 16C), *P. elegans*, *Lonchurus lanceolatus* (Fig. 14B), and *Collichthys lucidus*, the pterosphenoid expands forward, making direct contact with the lateral ethmoid. This specialization coincides with diminution of the eye and modification of the orbital region in these species, but small eyed sciaenids do not always exhibit contact of these bones (viz., *Pseudotolithus (Hostia) moorii*, *Nebris*, and *Collichthys niveatus*).

Character 29 (Figs. 11, 16, and 18): Frontal projecting downward. Typically in sciaenids, the bony interorbital septum is absent, although in some sciaenids the frontal projects ventrally forming a complete bony septum. The frontal is thus associated with the lateral ethmoid and parasphenoid in *Johnius (Johnieops)* (Fig.

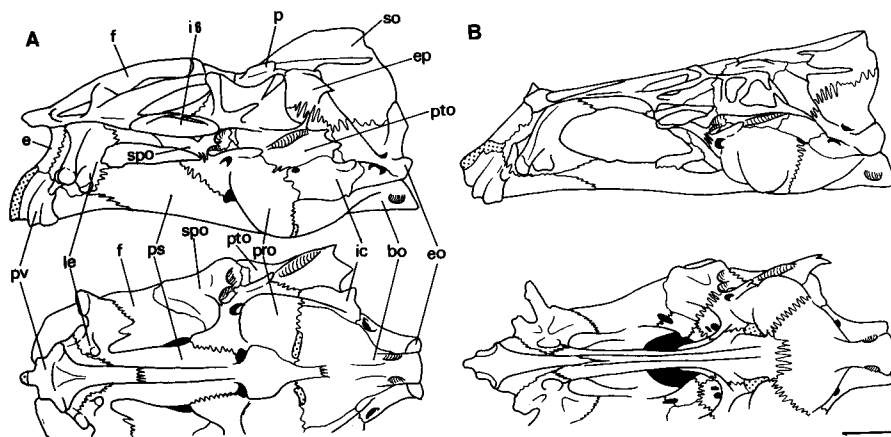

Fig. 13. Crania of two sciaenids. A, *Otolithoides pama*; B, *Macrodon ancylodon*. Abbreviations as in Fig. 9. Top, lateral view; bottom, ventral view. Bar=5 mm.

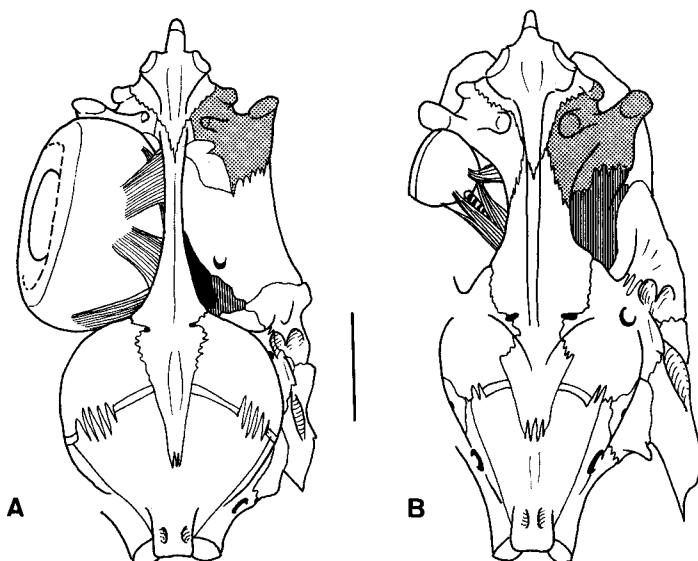

Fig. 14. Ventral view of crania of two sciaenids. A, *Pteroscion peli*; B, *Lonchurus lanceolatus*. dots, lateral ethmoid; stripes, pterosphenoid. Bar=5 mm.

11B), *Kathala* (Fig. 18), and adult *Argyrosomus japonicus* (but not in *A. mivuy*); with the lateral ethmoid in *Pseudotolithus* (*Pseudotolithus*) (Fig. 16B); and with the parasphenoid in *Pseudotolithus* (*Pinnacorvina*). Although the basicranial elements which contribute in forming the bony septum are therefore variable, the frontal persistently projects downward, forming the basis for this character. Like most sciaenids, the frontal is not projecting downward typically in percoids, and thus this projection is apomorphic. Ontogenetic sequences support this conclusion, since Taniguchi and Okada (1986) demonstrated in *Argyrosomus japonicus* that the frontal has no connection with basicranial elements in juvenile specimens, such occurring only in the course of further ontogenetic development.

Character 30 (Fig. 15): Pterosphenoid separated from basisphenoid. In most sciaenids, the pterosphenoid joins the basisphenoid ventrally as typical in percoids. However, in *Bairdiella* and *Pteroscion* (Fig. 15B), intervention by the prootic prevents direct articulation of the pterosphenoid and basisphenoid.

Character 31 (Fig. 15): Basisphenoid separated from parasphenoid ventrally. In most sciaenids (and most percoids), the basisphenoid articulates with the parasphenoid (Fig. 15A). However these elements are separated in *Plagioscion auratus* (but not in *P. ternetzi*), *Paralonchurus brasiliensis*, *Paralonchurus elegans*, *Pachyurus* sp. (not in *P. schomburgkii*), *Seriphus*, *Odontoscion* (Fig. 15C), and *Pseudotolithus* (*Pseudotolithus*) *senegalensis* (not in *P. (P.) typus*).

Character 32 (Fig. 15): Basisphenoid absent. The basisphenoid is present in most sciaenids as in percoids, whereas in *Lonchurus*, *Ophioscion*, *Panna* (Fig. 15D), *Otolithoides*, and *Stellifer*, it is absent. The loss of this element may in part be correlated with cranial modification resulting from the small eye in *Lonchurus*,

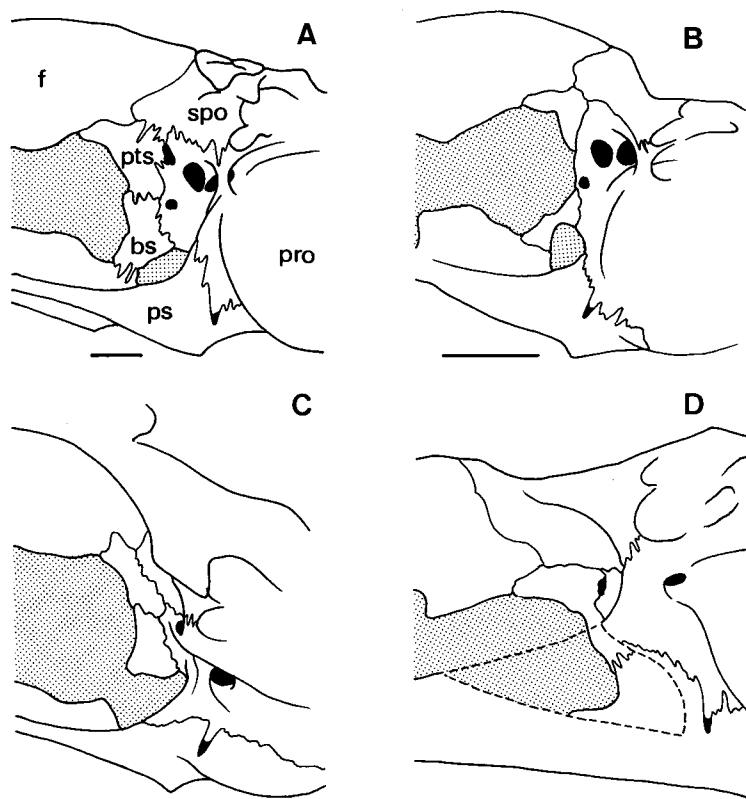

Fig. 15. Left anterolateral side of crania of four sciaenids. A, *Sciaena trewavasae*; B, *Pteroscion pelti*; C, *Odontoscion dentex*; D, *Panna microdon*. Abbreviations as in Fig. 12. Broken line indicates removed portion of parasphenoid. Bar=3 mm.

Otolithoides, and *Panna*. This is consistent with Gosline's (1968) hypothesis that degeneration of the eye is followed in time by loss of the basisphenoid. On the other hand, in *Ophioscion* and *Stellifer*, strong dorsal depression of the cranium and orbital region may be related with the loss of the element. Although one may argue that loss of the basisphenoid has been preceded by Character 31, it is not possible to test such a hypothesis. Accordingly, Characters 31 and 32 are considered separately.

Character 33 (Figs. 13, 16, and 18): Intercalar projecting downward. Typically in sciaenids as in percoids, the intercalar is not included in the auditory bulla. However, in *Otolithoides* (Fig. 13A), *Plagioscion*, *Pteroscion* (Fig. 16A), *Pseudotolithus* (*Hostia*), *Pseudotolithus* (*Pinnacorvina*), *Pseudotolithus* (*Pseudotolithus*) (Fig. 16B), *Paralonchurus elegans*, *P. brasiliensis* (Fig. 16C), *Lonchurus*, *Nibea* (Fig. 16D), *Dendrophysa*, *Austronibea*, *Pennahia argentata* (but not in *P. macrophthalmus*), and *Kathala* (Fig. 18), the intercalar projects downward, forming the lateral wall of the auditory bulla.

Character 34 (Figs. 18 and 16): Intercalar in broad contact with basioc-

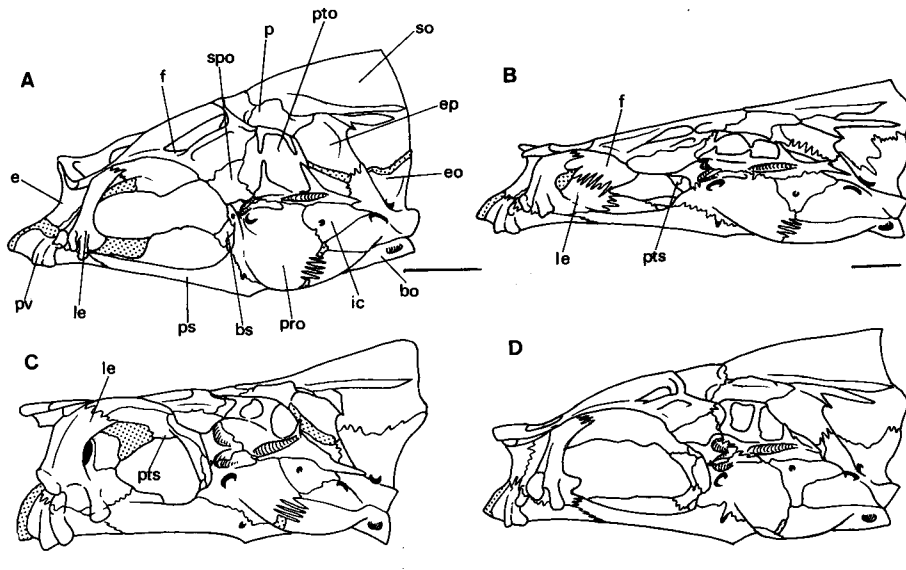

Fig. 16. Lateral view of crania of four sciaenids. A, *Pteroscion peli*; B, *Pseudotolithus (Pseudotolithus) typus*; C, *Paralanchurus brasiliensis*; D, *Nibea mitsukurii*. Abbreviations as in Fig. 9. Bar=5 mm.

capital. The intercalar is broadly in contact with the basioccipital in *Otolithoides* (Fig. 13A), *Nibea* (Fig. 16D), and *Pennahia argentata* (but not in *P. macrophthalmus*). This condition is treated as an advanced condition within Character 33.

Character 35 (Fig. 13): Intercalar in broad, ventral contact with prootic. Posteroventrally in most sciaenids as in percoids, the intercalar is in broad contact with the exoccipital. In *Macrodon* (Fig. 13B), the intercalar articulates ventrally, most broadly with the prootic and scarcely meets the exoccipital.

Character 36 (Fig. 17): Intercalar in contact with epiotic. As in typical percoids, the intercalar of most sciaenids makes contact only with the pterotic and exoccipital posteriorly (Fig. 17A), whilst in *Aplodinotus* (Fig. 17B) and *Pogonias* (Fig. 17C), the intercalar extends up the posterior wall of the cranium making contact with the epiotic. This apomorphic condition may not be independent of the well developed levator posterior muscle (see Character 68).

Character 37 (Fig. 17): Exoccipital condyles not broadly joined to each other—*Stellifer* type. Identical with the condition in lower percoids, the exoccipital condyles are broadly joined to each other in most sciaenids, whereas in *Odontoscion*, *Bairdiella*, *Corvula*, *Elattarchus*, *Ophioscion*, *Stellifer* (Fig. 17E), *Johnius (Johnius)*, and *Johnius (Johnieops)* (Fig. 17F), the condyles are only narrowly attached or completely separated.

This specialization is directly correlated with the anterolaterally expanded swimbladder which shape necessitates a laterally expanded postcranial region. Although anterolaterally expanded in all of the above genera, the structure of the swimbladder in *Johnius* is basically different (see Character 124). Accordingly, the

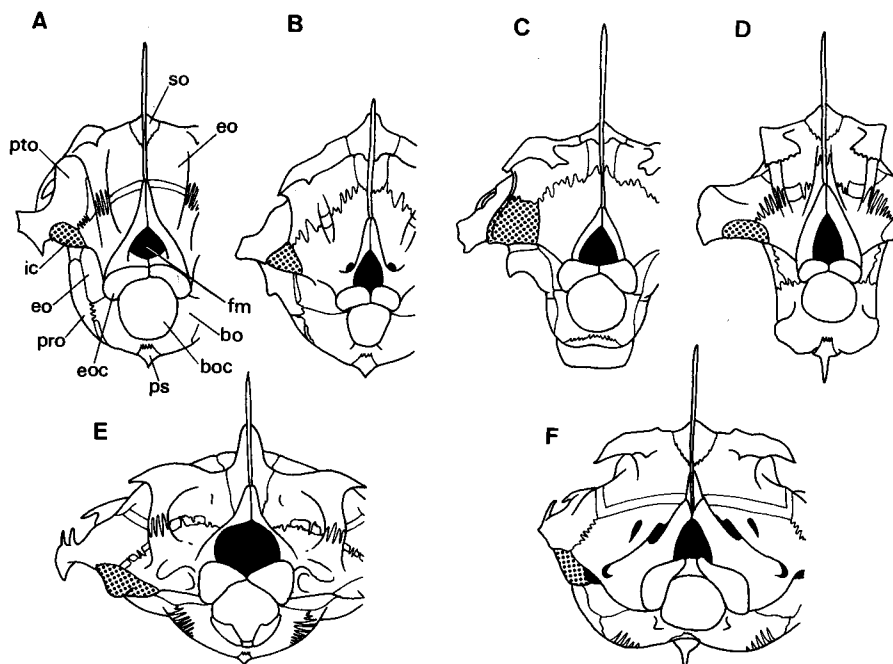

Fig. 17. Posterior view of crania of six sciaenids. A, *Micropogonias furnieri*; B, *Aplodinotus grunniens*; C, *Pogonias cromis*; D, *Leiostomus xanthurus*; E, *Stellifer rastrifer*; F, *Johnius (Johnieops) distinctus*. boc, basioccipital condyle; eoc, exoccipital condyle; fm, foramen magnum; other abbreviations as in Fig. 9.

Johnius is categorized separately from the other genera.

Character 38 (Fig. 17): Exoccipital condyles not broadly joined to each other—*Johnius* type. This includes *Johnius (Johnius)* and *Johnius (Johnieops)* (Fig. 17F). See Character 37.

Character 39 (Figs. 10, 18, and 19): Basioccipital projecting backwards—*Stellifer* type. Usually in percoids, and in most sciaenids, the basioccipital does not project backwards. However, in *Kathala* (Figs. 18 and 19A), *Corvula*, *Elattarchus*, *Odontoscion* (Fig. 10A), *Bairdiella*, *Ophioscion*, and *Stellifer* (Figs. 10B and 19B), the basal portion of the basioccipital projects backwards to support dorsally the first (*Kathala*) or first and second (other genera) vertebrae, and ventrally to suspend the swimbladder.

As in the case of Characters 37 and 38, this specialization is apparently associated with swimbladder condition. Accordingly, evaluation of swimbladder morphology enables reasonable assessment of the homologous or otherwise development of the basioccipital condition. The swimbladder is single chambered in *Kathala*, whereas in the other genera it is divided into anterior and posterior chambers (see Character 112). This may indicate that the basioccipital modification functions in order to suspend the newly derived anterior chamber in the latter genera, whereas in *Kathala*, the projection has developed simply to strengthen

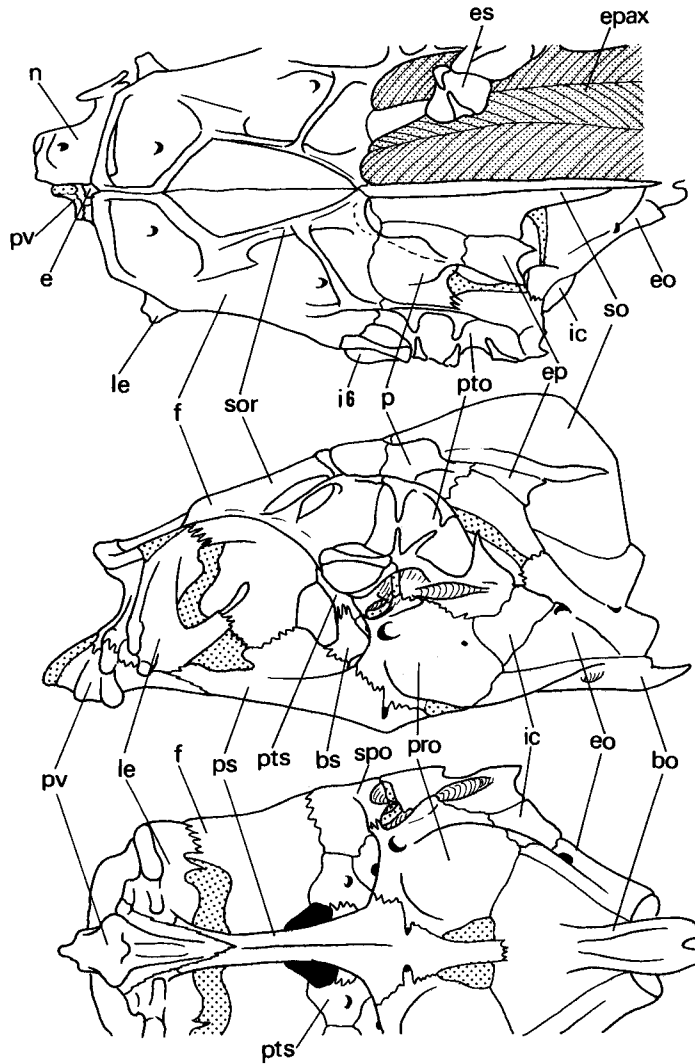

Fig. 18. Cranium of *Kathala axillaris*. Abbreviations as in Fig. 9. Top, dorsal view; middle, lateral view; bottom, ventral view. Bar=5 mm.

the bladder suspension. In addition, parallel development of the basioccipital projection is supported by the fact that the basioccipital is not modified in *Macrospinosa*. Although *Macrospinosa* cannot be included in the cladogram data base owing to a lack of material for complete dissection, there is little doubt that the genus is very closely related to *Kathala*, judging from data presently at hand (from radiograph and partial dissection). Accordingly, the basioccipital projection of *Kathala* cannot be homologous with that of the *Stellifer* type, and is assigned separate character status.

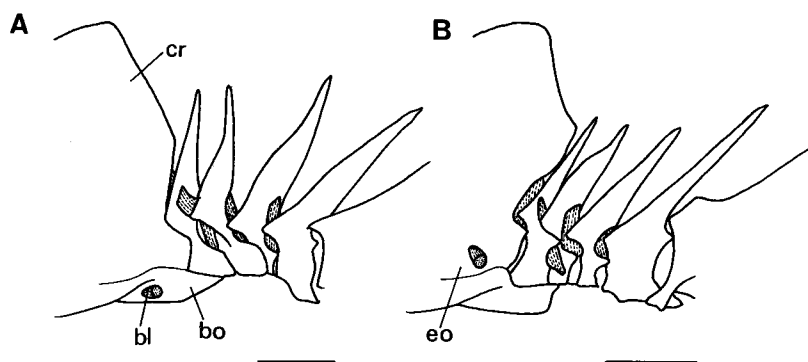

Fig. 19. Crania and anterior vertebrae of two sciaenids. A, *Kathala axillaris*; B, *Stellifer microps*. Abbreviations as in Fig. 9. Bar=3 mm.

Character 40 (Fig. 19): Basioccipital projecting backwards—*Kathala* type. This is an autapomorphy of *Kathala* (Fig. 19A). See Character 39.

Character 41 (Fig. 19): Baudelot's ligament attached to exoccipital. In most sciaenids (and percoids), Baudelot's ligament is attached to the basioccipital, but in *Corvula*, *Elattarchus*, *Odontoscion*, *Bairdiella*, *Ophioscion*, and *Stellifer* (Fig. 19B), it is attached to the exoccipital. This relocation of Baudelot's ligament may not be independent of basioccipital modification in these genera (Character 39).

Character 42 (Figs. 17 and 20): Basicranial modification—*Pogonias* type. In most sciaenids, the basicranial region has not undergone any particular modifications. However, in *Pogonias* (Figs. 17C and 20B) and *Leiostomus* (Figs. 17D and 20A), two apomorphous conditions are seen. In *Pogonias*, as noted by Stiassny and Jensen (1987), the posteroventral portion of the parasphenoid forms a flat, semicircular face encircled anteriorly by a thin, crest-like rim. This condition, as well as that of *Leiostomus* (below), is functionally associated with the highly integrated, pharyngeal jaw structure (see Characters 60–69).

Character 43 (Figs. 17 and 20): Basicranial modification—*Leiostomus* type. In *Leiostomus*, each side of the basioccipital swells outward, forming a knob-like protrusion (Figs. 17D and 20A).

Other variations.

As far as is known, a spinous supraoccipital crest occurs in the following sciaenids: *Larimichthys crocea*, *L. polyactis*, *Collicthys niveatus*, *C. lucidus*, and *Panna heterolepis*. Yamada (1973) showed in the first four species that the spines on the supraoccipital crest weaken and/or disappear with age. Trewavas (1977) stated that the spines in *Panna heterolepis* are no doubt a juvenile character. Application of this character is not possible, however, until the occurrence of the spines throughout the Sciaenidae is more thoroughly known. Presently, knowledge of sciaenid larval characters, especially those of Indo West-Pacific species, is still poor.

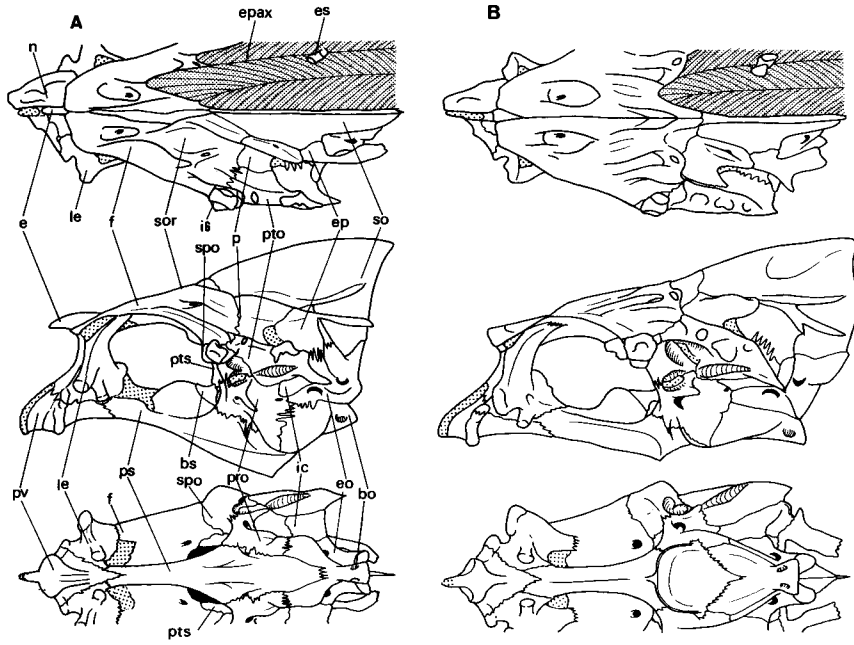

Fig. 20. Crania of two sciaenids. A, *Leostomus xanthurus*; B, *Pogonias cromis*. Abbreviations as in Fig. 9. Top, dorsal view; middle, lateral view; bottom, ventral view. Bar=5 mm.

2. INFRAORBITALS AND NASAL (Figs. 21-23)

GENERAL DESCRIPTION

The sciaenid infraorbitals always number six, although of varying size. They are associated with a series of bridges and flanges which provide protection for the infraorbital canal of the cephalic lateral line system.

Infraorbital 1 (the lachrymal) is rather deep and is the largest element of the infraorbital series. A low dorsal process on its inner margin exists for articulation with the lateral ethmoid. It overlies the maxillary along most of its length.

Infraorbital 2 is small (always less than half the length of infraorbital 1) and slightly overlaps the posterior margin of infraorbital 1. Typically, its dorsal margin is moderately broad situated between the margins of infraorbitals 1 and 3.

Infraorbital 3 is the second largest of the series. Usually obliquely set to the horizontal axis of eye, this bone bears a subocular shelf on its dorsal margin, in many sciaenids.

Infraorbitals 4 and 5 border the posterodorsal margin of the eye.

Infraorbital 6 (the dermosphenotic) is the last bone of the infraorbital series, and is tightly attached to the lateral face of the sphenotic. In this work, it is figured with the cranium.

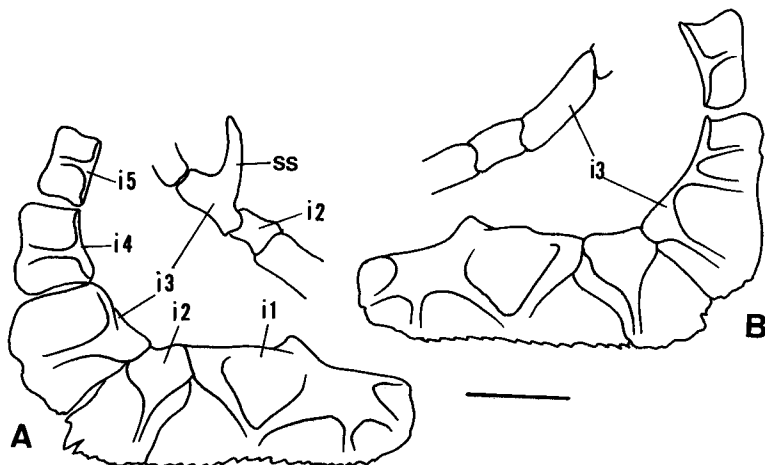

Fig. 21. Infraorbitals of *Aplodinotus grunniens*. A, right side; B, left side. i, infraorbital; ss, subocular shelf. Bar=5 mm.

The nasal is variously shaped, and is attached to the anterior rim of the frontal, from which it receives the supraorbital canal of the lateral line system. Its mesial and outer edges are turned upward.

CHARACTERS

Character 44: Eye diminutive. Although the eye size is not an osteological feature, it is included in this section, because of the direct relationship of the eye size and infraorbital structure. Because the eye is moderately large in most sciaenids, as

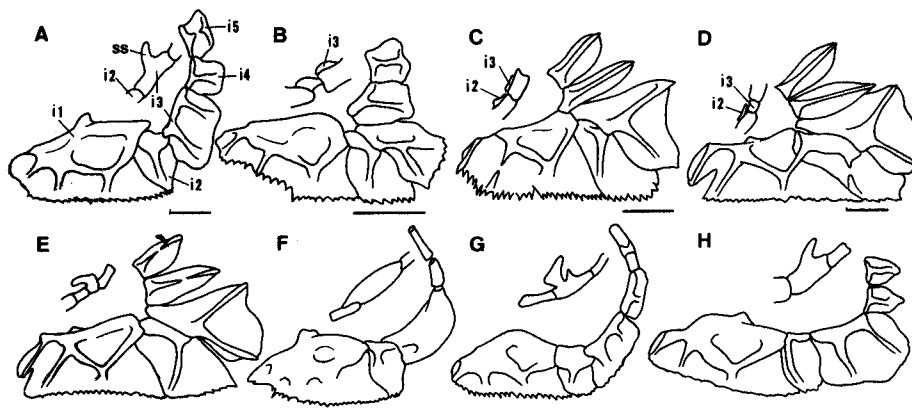

Fig. 22. Infraorbitals of eight sciaenids. A, *Micropogonias furnieri*; B, *Paralanchurus elegans*; C, *Nebris microps*; D, *Otolithoides pama*; E, *Panna microdon*; F, *Leiostomus xanthurus*; G, *Cheilotrema saturnum*; H, *Pachyurus schomburgkii*. Abbreviations as in Fig. 21. Bar=5 mm.

in percoids, the diminutive eye is considered to be apomorphous. This condition is found in *Paralochurus elegans*, *Lonchurus*, *Nebris*, *Pseudotolithus* (*Hostia*), *Otolithoides*, *Panna*, and *Collichthys*.

Character 45 (Figs. 21 and 22): Infraorbital 2 flattened dorsally. Typically in sciaenids, as in percoids, the infraorbitals are moderately thick dorsally (Figs. 21 and 22A). However, in many of the small eyed sciaenids infraorbitals 2 and even 3 have become thin laminous sheets which are almost or completely excluded from the eye margin. Infraorbital 3 is attached to the inner side of infraorbital 4 in *Paralonchurus elegans* (Fig. 22B) and *Lonchurus*; infraorbitals 2 and 3 are attached to infraorbitals 1 and 4 respectively in *Nebris* (Fig. 22C); infraorbital 2 is attached to infraorbital 1 in *Otolithoides* (Fig. 22D). Consequently this character (infraorbital 2 flattened) is scored for *Nebris* and *Otolithoides*.

Character 46 (Fig. 22): Infraorbital 3 flattened dorsally. This apomorphous condition is shared by *Paralonchurus elegans*, *Lonchurus*, and *Nebris* (see above).

Character 47 (Fig. 22): Infraorbital 3 lying almost parallel to horizontal axis of eye. Infraorbital 3 lies obliquely to the horizontal axis of the eye in most sciaenids, whereas it lies almost parallel to the horizontal axis in *Pachypops* and *Pachyurus* (Fig. 22H). Hence, these two genera are derived in this regard. In the latter genera, the eye has a rather elongate, oval shape, and this structure may be related to the unique disposition of infraorbital 3.

Character 48 (Fig. 23): Nasal acutely pointed. Typically in sciaenids, the nasal is bluntly rounded anteriorly (Fig. 23A-G), whereas it is acutely pointed in *Pachypops* (Fig. 23I) and *Pachyurus* (Fig. 23H and J).

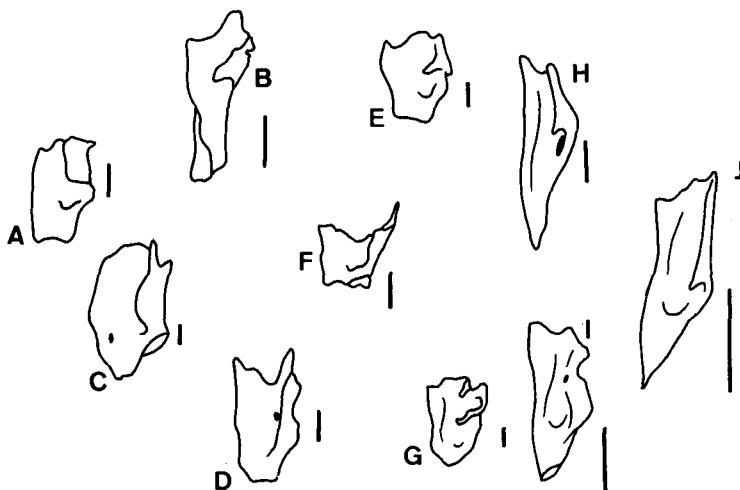

Fig. 23. Nasals of 10 sciaenids. A, *Ctenosciaena gracilicirrhus*; B, *Menticirrhus americanus*; C, *Umbrina canariensis*; D, *Pareques iwamotoi*; E, *Nibea mistakurii*; F, *Stellifer rastriifer*; G, *Pennahia argentata*; H, *Pachyurus* sp.; I, *Pachypops* sp.; J, *Pachyurus schomburgkii*. Bar=2 mm.

Other variations

Loss of the subocular shelf is frequently observed in small eyed sciaenids, although its presence or absence cannot be adopted as a character due to variations even within a single specimen (Fig. 21). Although Smith and Baily (1962) argued that loss of the shelf was correlated to the fresh water habitat, as well as to the demands of respiration and/or predaceous or piscivorous habits, this is refuted by Johnson (1980) and Datta and Bandyopadyay (1982). On the other hand, a apparent direct correlation exists between subocular shelf loss and decrease in eye size in the Sciaenidae.

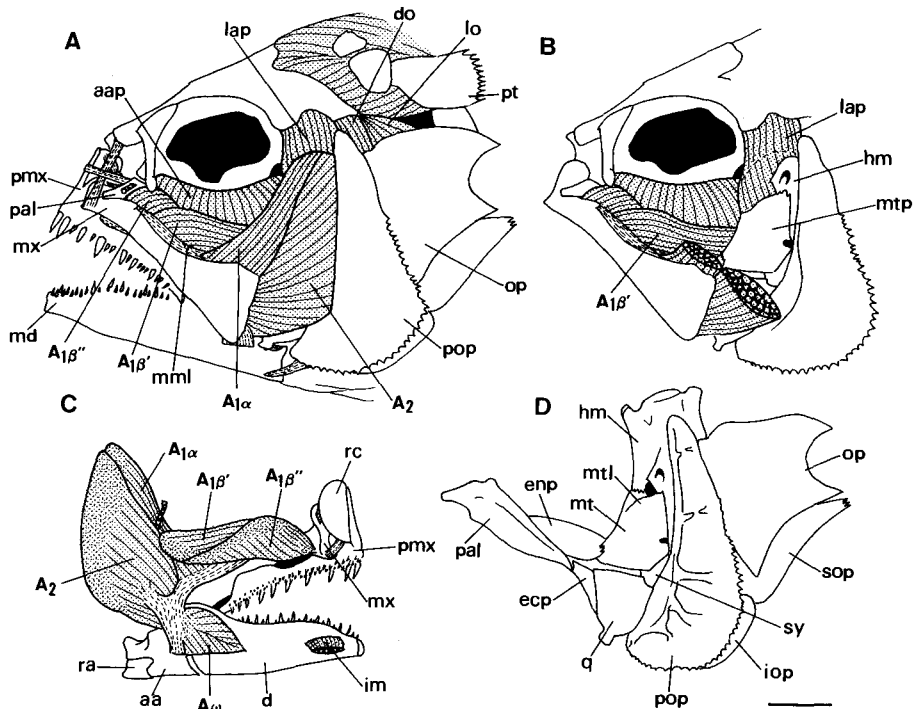

Fig. 24. Cheek muscles and suspensorium of *Pennahia argentata*. A, superficial view; B, $A_{1\alpha}$, A_2 partly removed; C, medial view of cheek muscles and jaws; D, suspensorium. aa, anguloarticular; aap, adductor arcus palatini; d, dentary; do, dilatator operculi; ecp, ectopterygoid; end, endopterygoid; hm, hyomandibular; im, intermandibularis; iop, interoperculum; lap, levator arcus palatini; lo, levator operculi; md, mandibule; mml, maxillomandibular ligament; mt, metapterygoid; mtl, metapterygoid lamina; mx, maxillary; op, operculum; pal, palatine; pm, premaxillary; pop, preoperculum; pt, posttemporal; q, quadrate; ra, retroarticular; rc, rostral cartilage; sop, suboperculum; sy, symplectic. Bar=5 mm.

3. SUSPENSORIUM, OPERCULAR APPARATUS, AND ASSOCIATED MUSCLES (Figs. 24-30)

GENERAL DESCRIPTION

A typical configuration of the sciaenid suspensorium, opercular apparatus, and associated muscles is shown in Fig. 24. The sciaenid suspensorium consists of the hyomandibular, metapterygoid, quadrate, symplectic, endopterygoid, ectopterygoid, and palatine. The general proportions vary from dorsally depressed and horizontally elongate to laterally compressed and vertically elongate.

The hyomandibular is a heavy bone with a long, ventrally directed shaft. It has three dorsal, articulating facets: the anteriormost articulating with a socket formed by the prootic and sphenotic; the medial articulating with a groove-like socket in the pterotic; and the posteriormost articulating with the anterodorsal corner of the operculum. The hyomandibular is connected to the metapterygoid anteroventrally, and is firmly attached to the preoperculum. Ventrally, it is attached to the symplectic and interhyal through the cartilaginous interspace.

The metapterygoid is rectangular or squared in form, articulating with the hyomandibular dorsoposteriorly, with the quadrate ventrally, with the endopterygoid anteriorly, and with the symplectic posteroventrally. The anterior margin of

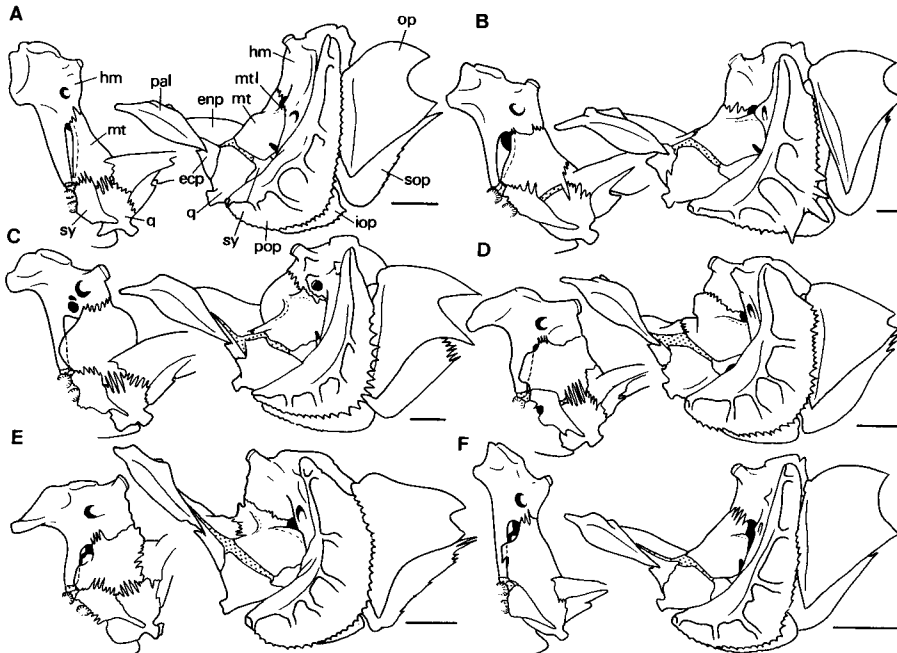

Fig. 25. Suspensoria of six sciaenids. A, *Sciaena trewavasae*; B, *Micropogonias furnieri*; C, *Menticirrhus americanus*; D, *Paralichthys elegans*; E, *Lonchurus lanceolatus*; F, *Aplodinotus grunniens*. Left, medial view; right, lateral view. Abbreviations as in Fig. 24. Bar = 5 mm.

this bone tends to extend forward (Fig. 27B-F), forming the attachment site of $A1\beta'$ (a muscle of cheek, see below). Typically, the metapterygoid interdigitates medially with the quadrate, and lacks continuous intervention of the cartilage. The metapterygoid lamina varies from absent altogether to well defined, and the interspace between the hyomandibular and metapterygoid also varies from small to large. The posteromedial margin of the metapterygoid usually fails to make contact with the medial side of the lower arm of the hyomandibular.

The quadrate is a triangular bone, with a large facet for articulation with the anguloarticular at its anteroventral corner. It is sutured to the ectopterygoid anteriorly, to the posterior edge of the endopterygoid anterodorsally, to the metapterygoid dorsally, and to the symplectic mesolaterally. The posterior margin of the quadrate, which joins the preoperculum, varies from nearly straight to distinctly convexed.

The symplectic varies in form from broad to slender; the dorsal portion is usually laminarly expanded, overlapping the lower posterior portion of the metapterygoid medially; contact of the posterior margin of the symplectic with the preoperculum varies from a very slight dorsally to broadly overlapping nearly its entire length.

The endopterygoid is a thin, laminous bone. It is sutured to the palatine

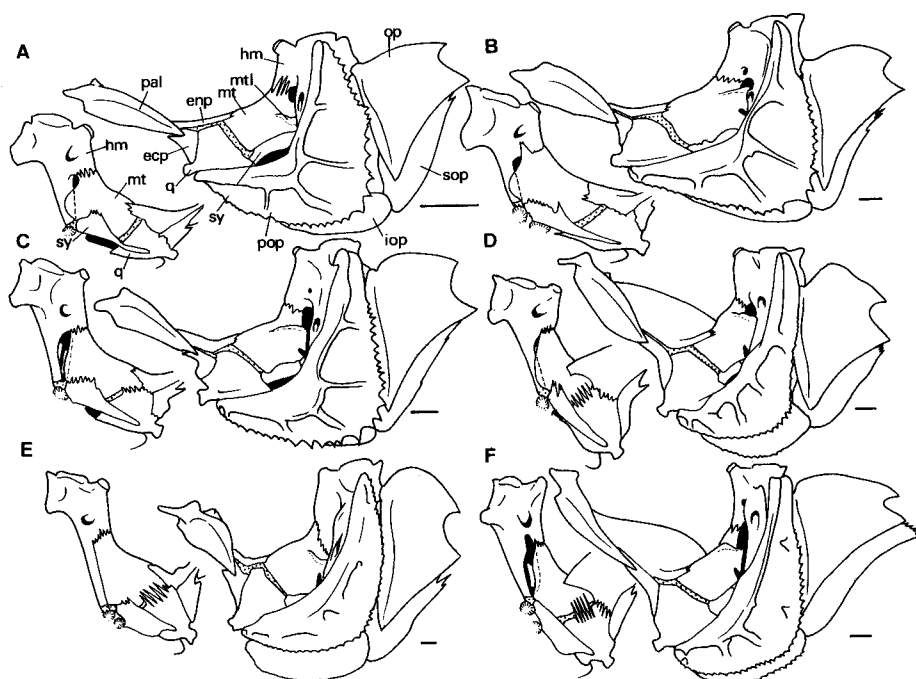

Fig. 26. Suspensoria of six sciaenids. A, *Pachyurus schomburgkii*; B, *Pachyurus* sp., C, *Pachypops* sp., D, *Pentheroscion mbizi*; E, *Leiostomus xanthurus*; F, *Odontoscion dentex*. Left, medial view; right, lateral view. Abbreviations as in Fig. 24. Bar=2 mm.

anteroventrally, to the ectopterygoid posteroventrally, to the matapterygoid dorso-posteriorly, and to the quadrate ventroposteriorly.

The ectopterygoid is a boomerang-shaped bone. It is sutured to the palatine anteriorly, to the endopterygoid dorsally, and to the quadrate posteriorly.

The palatine is edentulous and lamiously expanded to form the attachment site of $A1\beta''$ (a cheek muscle, see below). The ventral margin is typically nearly straight or slightly convex, whilst the dorsal side has two facets for articulation with the lateral ethmoid.

The muscles of the cheek associated with the suspensorium comprise A1, A2, A_w levator arcus palatine, and adductor arcus palatini.

A1 section is clearly divided into $A1\alpha$ and $A1\beta$ sections. $A1\alpha$, located dorsolaterally to A2, originates from the preoperculum and hyomandibular, and is inserted onto the posterior part of the maxillary via the maxillomandibular ligament. $A1\beta$ is medial to $A1\alpha$ and further divided into two subsections— $A1\beta'$ and $A1\beta''$ (Fig. 24). The origin of $A1\beta''$ is mainly restricted to the palatine, whereas the origin of $A1\beta'$ is primarily the matapterygoid, but may also include the hyomandibular, quadrate, endopterygoid, and ectopterygoid. Both subsections are inserted immediately behind the head of maxillary.

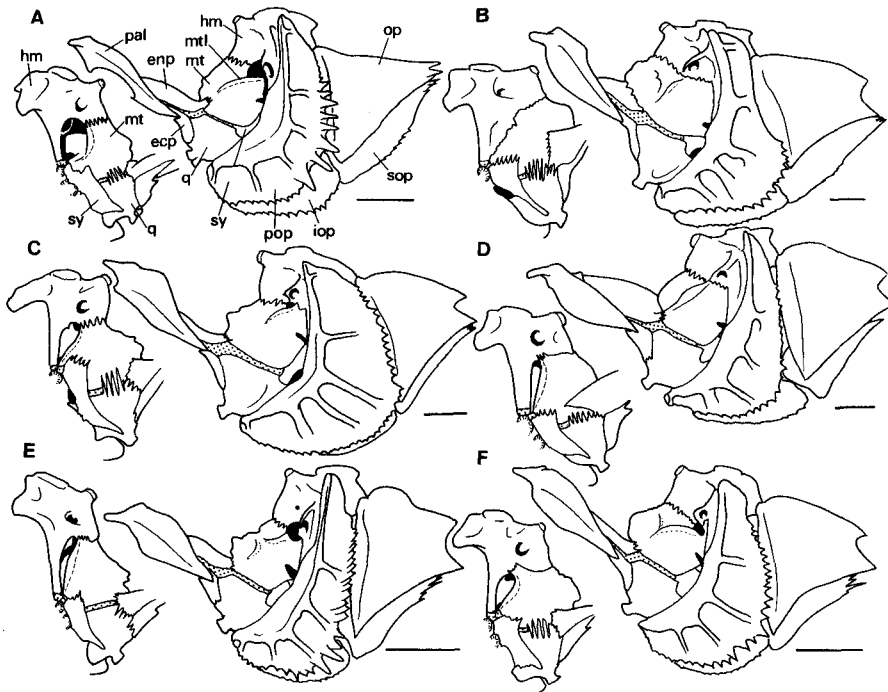

Fig. 27. Suspensoria of six sciaenids. A, *Stellifer microps*; B, *Otolithoides pama*; C, *Panna microdon*; D, *Protonibea diacanthus*; E, *Dendrophysa russelli*; F, *Austro-nibea oedogenys*. Left, medial view; right, lateral view. Abbreviations as in Fig. 24. Bar=5 mm.

The levator arcus palatini originates on the sphenotic and pterotic, and is inserted on the hyomandibular and metapterygoid. The relationships between the levator arcus palatini and $A1\beta'$ vary greatly from widely overlapping to well separated (Figs. 28 and 29).

The floor of the orbit is filled by the well developed adductor arcus palatini, usually present as a single element.

The opercular series consist of the preoperculum, operculum, suboperculum, and interoperculum.

The preoperculum is a large bone, crescentic in shape, associated with variously developed ridges which fold over the preoperculomandibular canal of the lateral line system. Its posterior margin is typically thin and weakly serrated.

The operculum is a thin triangular bone, bordered by the preoperculum anteriorly and by the suboperculum ventrally. It is produced posteriorly into two points. The dorsal border of the operculum is typically situated level with the upper margin of the hyomandibular.

The suboperculum is L-shaped, the anterior vertical arm being attached to the anteroventral margin of the operculum, and the posterior arm being slightly covered by the lower border of the operculum.

The interoperculum is thin and elliptical in form. It lies under the inner surface of the ventral part of the preoperculum. Anteriorly, it is connected with the retroarticular of the lower jaw by a strong ligament.

There are three muscles connecting the operculum with the cranium: the dilatator operculi, adductor operculi, and levator operculi. The levator operculi is usually originated on the sphenotic and/or hyomandibular, and is inserted onto the upper, medial portion of the operculum.

CHARACTERS

Character 49 (Figs. 25-27): Suspensorium strongly depressed. The sciaenid suspensorium varies considerably in length and depth, making clear-cut separation of suspensorium "types" virtually impossible. However, in *Pachyurus* (Fig. 26A and B) and *Pachypops* (Fig. 26C), the suspensorium is strongly depressed and elongate longitudinally, providing a good contrast with other sciaenid suspensoria which are at most moderately depressed. This condition considered to be apomorphous, since in the usual condition in percoids, the suspensorium is depressed from slight to moderate degree. Depression of the suspensorium in *Pachyurus* and *Pachypops* must have occurred concurrently with snout prolongation.

Character 50 (Figs. 25-27): Posteromedial margin of metapterygoid overlapping or attached to medial side of lower arm of hyomandibular. Typically in sciaenids, the posteromedial margin of the metapterygoid does not extend to the medial side of the lower arm of the hyomandibular, whereas it overlaps or is attached medially on the lower arm in *Menticirrhus* (Fig. 25C), *Paralonchurus elegans* (Fig. 25D), *Lonchurus* (Fig. 25E), *Aplodinotus* (Fig. 25F), *Pachyurus* (Fig. 26A and B), *Pentheroscion* (Fig. 26D), *Leiostomus* (Fig. 26E), and *Otolithoides* (Fig. 27B). Since this overlap or attachment has been previously reported among percoids only from haemuloids (Johnson, 1980), the character is considered a synapomorphy for the above sciaenids.

Character 51 (Fig. 27): Ventral margin of palatine medially concave. In most sciaenids, the ventral margin of the palatine is nearly straight or gently rounded, whereas in *Stellifer* it is medially concave (Fig. 27A). Expansion of the palatine is a unique condition in Sciaenidae. Consequently, the "primitive" versus "derived" state of the character cannot be determined by comparison with other percoids. However, the concavity is not present in the vast majority of sciaenids, including those with a simple swimbladder, and thus its presence represents an apomorphic condition. The functional significance of the concavity is unknown, since it is filled by a thin transparent membrane, and does not provide a pathway for muscles or nerves.

Character 52 (Fig. 28): Adductor arcus palatini divided into two elements. In most sciaenids, the adductor arcus palatini is present as a single muscle mass as is usual in percoids, whereas in *Paralonchurus elegans*, *Lonchurus* (Fig. 28A-C), and *Otolithoides* (Fig. 28D-F), the muscle is clearly divided into dorsal and ventral elements. The triangular, dorsal element arises from the anteromedial side

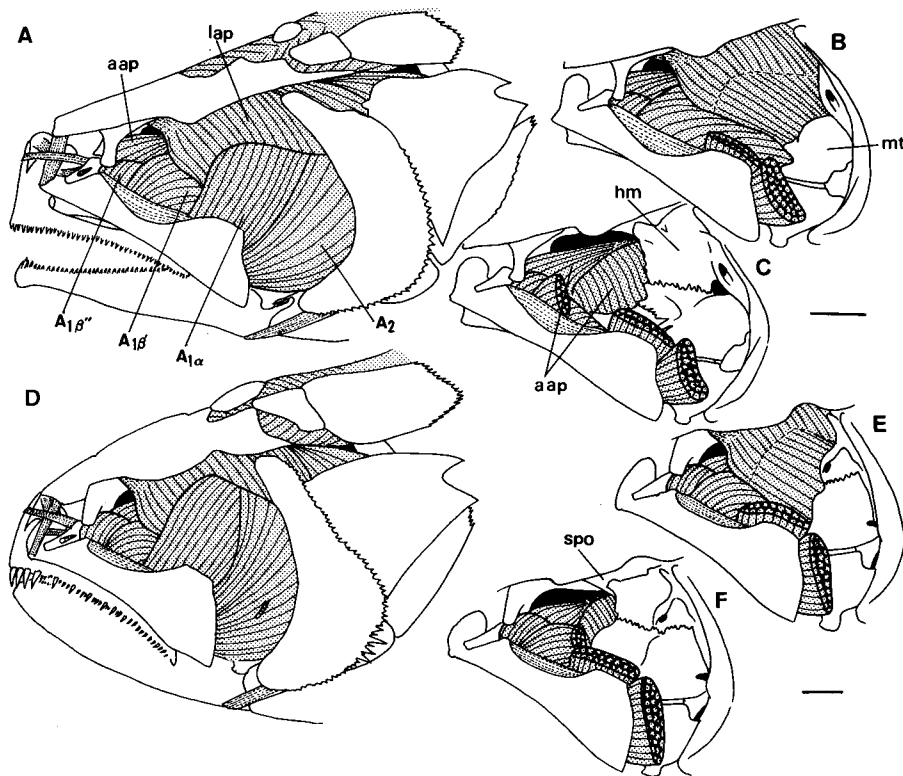

Fig. 28. Cheek muscles of two sciaenids. A-C, *Lonchurus lanceolatus*; D-F, *Otolithoides pama*. A and D, superficial view; B and E, $A1\alpha$, $A2$ partly removed; C and F, levator arcus palatini and $A1\beta'$ partly removed. spo, sphenotic; other abbreviations as in Fig. 24. Bar=5 mm.

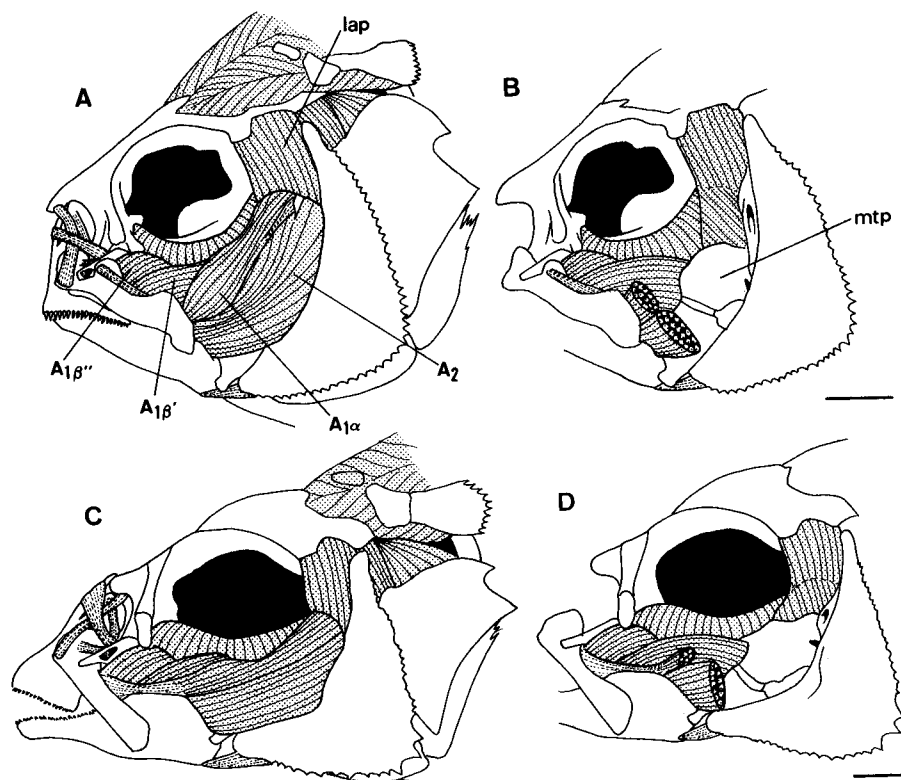

Fig. 29. Cheek muscles of two sciaenids. A and B, *Leiestomus xanthurus*; C and D, *Pachyurus* sp. A and C, superficial view; B and D, $A_{1\alpha}$, A_2 partly removed. Abbreviations as in Fig. 24. Bar=5 mm.

of the palatine and is inserted either onto the anterodorsal margin of the hyomandibular (*P. elegans* and *Lonchurus*), or onto the posterodorsal portion of the parasphenoid shaft (*Otolithoides*); the ventral element fills the floor of the orbit. This apomorphic feature has probably resulted from the overall modification of the orbital region, with the decrease in eye size.

Character 53 (Fig. 30): Levator operculi originating from posttemporal. In most sciaenids, including those with a simple swimbladder, the levator operculi originates on the cranium and hyomandibular (Fig. 30A), whereas in *Sciaena gilberti* (Fig. 30B), *Bairdiella*, *Odontoscion*, *Ophioscion* (Fig. 30C), and *Stellifer* (Fig. 30D), it originates wholly or partly on the posttemporal. Although the disposition of this muscle has not been well described in percoids, the most common, and apparently primitive state seems to be the former. Hence the muscle originating from the posttemporal represents an apomorphic character.

Other variations

Preopercular spines. The preopercular spines are sometimes distinct (e.g.,

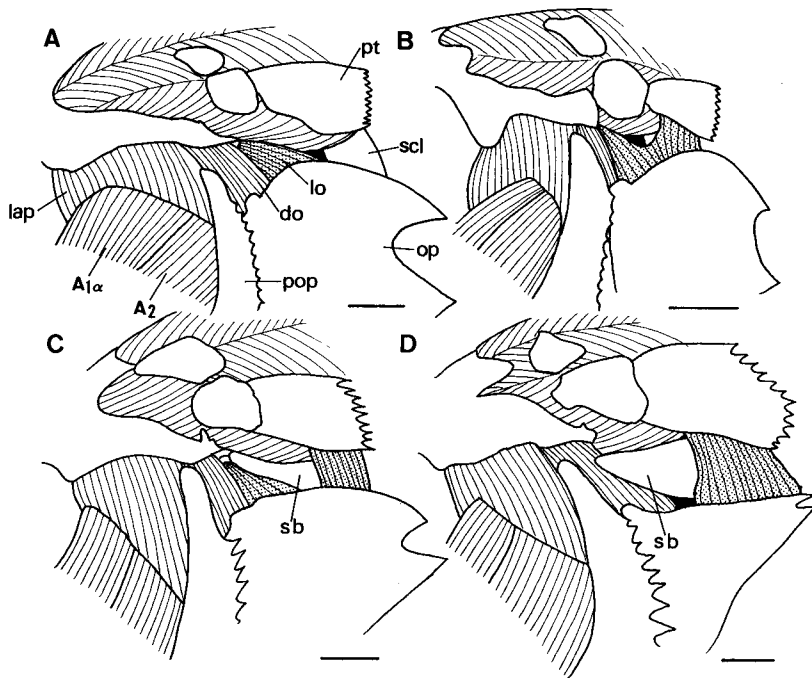

Fig. 30. Superficial postorbital muscles of four sciaenids. A, *Argyrosomus japonicus*; B, *Sciaena gilberti*; C, *Ophioscion sciera*; D, *Stellifer microps*. sb, swimbladder; other abbreviations as in Fig. 24. Bar=3 mm.

Micropogonias, Fig. 25B), but cannot be used as a character for phylogenetic analysis, because spine development in sciaenids follows a progressive rather than a stepwise pattern.

Shape of operculum. Similarly, shape of the operculum is not adopted as a character because of the progressive nature of its development. The upper half of the operculum seems to be almost lost in *Stellifer* (Figs. 27A and 30D), but a series of intermediate conditions can be traced among *Bairdiella*, *Corvula*, *Elattarchus*, *Odontoscion*, and *Ophioscion* (Fig. 30C). All these genera are characterized by having a laterally expanded anterior chamber of the swimbladder (see Character 112), progressive development of which seems to be closely correlated with reduction of the operculum. Since exposure of the swimbladder to the outer surface of the body (probably to increase hearing ability) is a notable evolutionary trend of the Sciaenidae, reduction of the operculum can be understood in this context.

Levator arcus palatini— $A1\beta'$ relationship. Although the relationship between the levator arcus palatini and $A1\beta'$ is not adopted as a character owing to the merging of developmental steps, it can be generally defined by three factors. First, the levator arcus palatini and $A1\beta'$ tend to overlap, depending upon eye size (Fig. 28). A smaller eye necessarily results in the forward expansion of the levator arcus palatini and thus the two muscles overlap. Secondly, the muscles tend to be separated in those sciaenids having a deep body (=high suspensorium) (Fig. 29A

and B). Thirdly, the two muscles tend to be separated in long-snouted sciaenids, with an elongate, depressed suspensorium (Fig. 29C and D).

4. JAWS (Figs. 31-34)

GENERAL DESCRIPTION

Sciaenid jaws consist of the following elements: the premaxillary and maxillary in the upper jaw; the dentary, anguloarticular, retroarticular, and coronomeckelian in the lower jaw. Cartilaginous elements, the rostral and Meckelian cartilages are also present. The supramaxillary is always absent.

The premaxillary includes four processes: the ascending process, articular process, alveolar process, and postmaxillary process. The rostral cartilage is attached to the posterior rim of the ascending process. The length relationships between the ascending and alveolar processes are not uniform, the former usually being longer in those sciaenids with an inferior mouth. The alveolar process is usually longer in sciaenids with a terminal to oblique mouth. Along its ventral border, the alveolar process has typically conical, regularly sized teeth.

The maxillary comprises a distinct head and shaft. Ventrally, the head has two condyles for articulation with the premaxillary articular process. Posterodor-

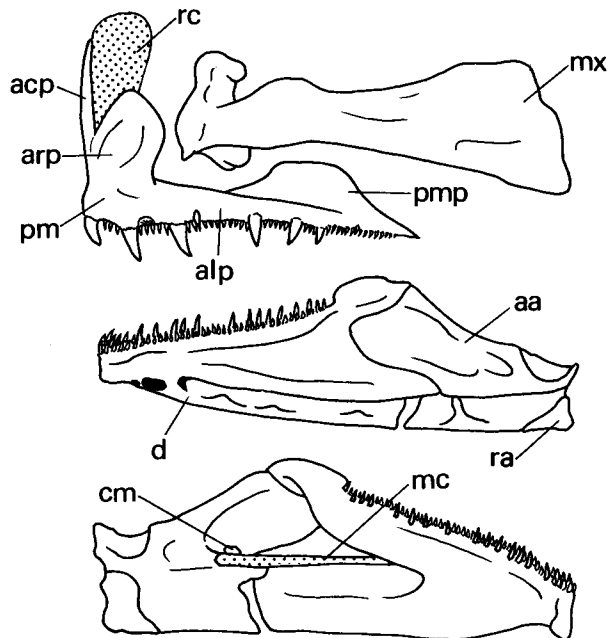

Fig. 31. Jaws of *Sciaena trevavasae*. aa, anguloarticular; acp, ascending process; alp, alveolar process; arp, articular process; cm, coronomeckelian; d, dentary; mc, Meckelian cartilage; mx, maxillary; pm, premaxillary; pmp, postmaxillary process; ra, retroarticular; rc, rostral cartilage. Bar=5 mm.

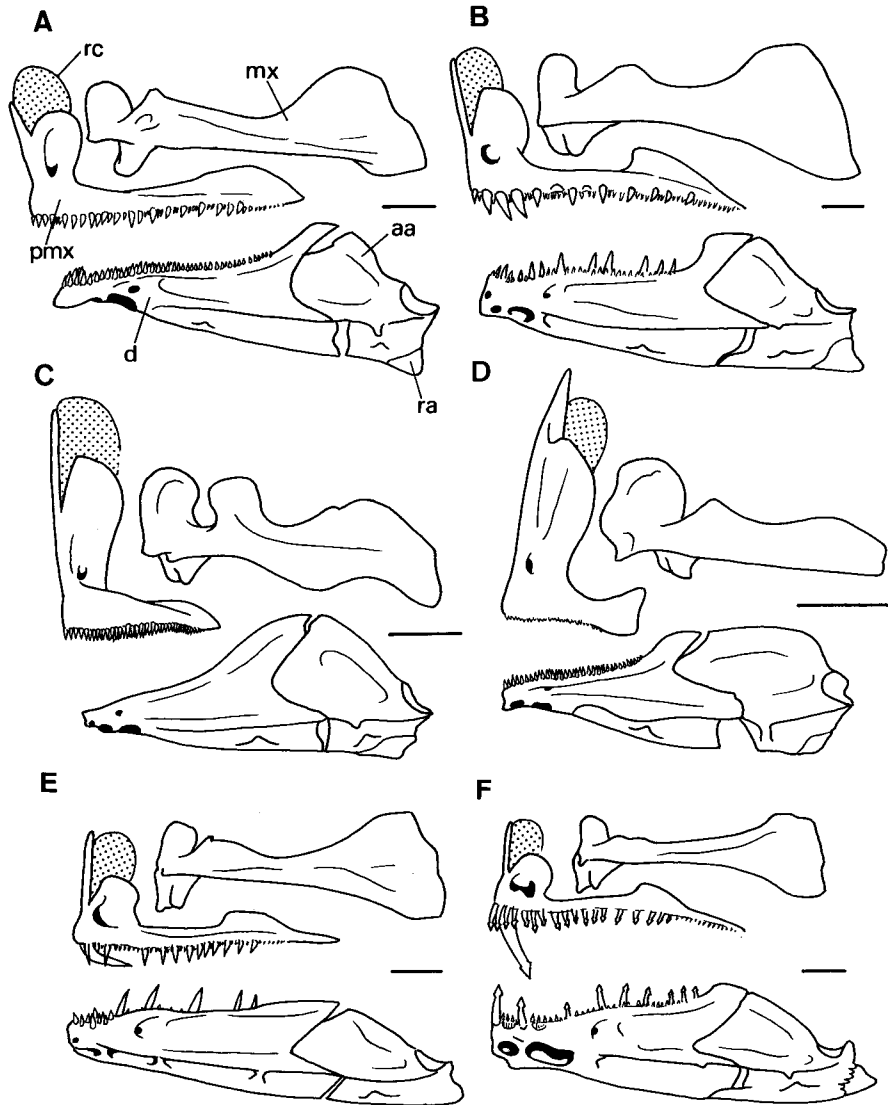

Fig. 32. Jaws of six sciaenids. A, *Lonchurus lanceolatus*; B, *Otolithoides pama*; C, *Leiostomus xanthurus*; D, *Pachypops* sp.; E, *Cynoscion jamaicensis*; F, *Macrodon ancylodon*. Abbreviations as in Fig. 31. Bar = 5 mm.

sally, it articulates with the anterior process of the palatine. Section A1 β of the adductor mandibulae is inserted medially, immediately behind the head of the maxillary which typically abuts mostly beside the ethmoid and prevomer. The shaft is flat, usually lacking a foramen.

The dentary is usually toothed, and has a groove forming the anterior portion of the preoperculo-mandibular canal of the lateral line system along the entire length

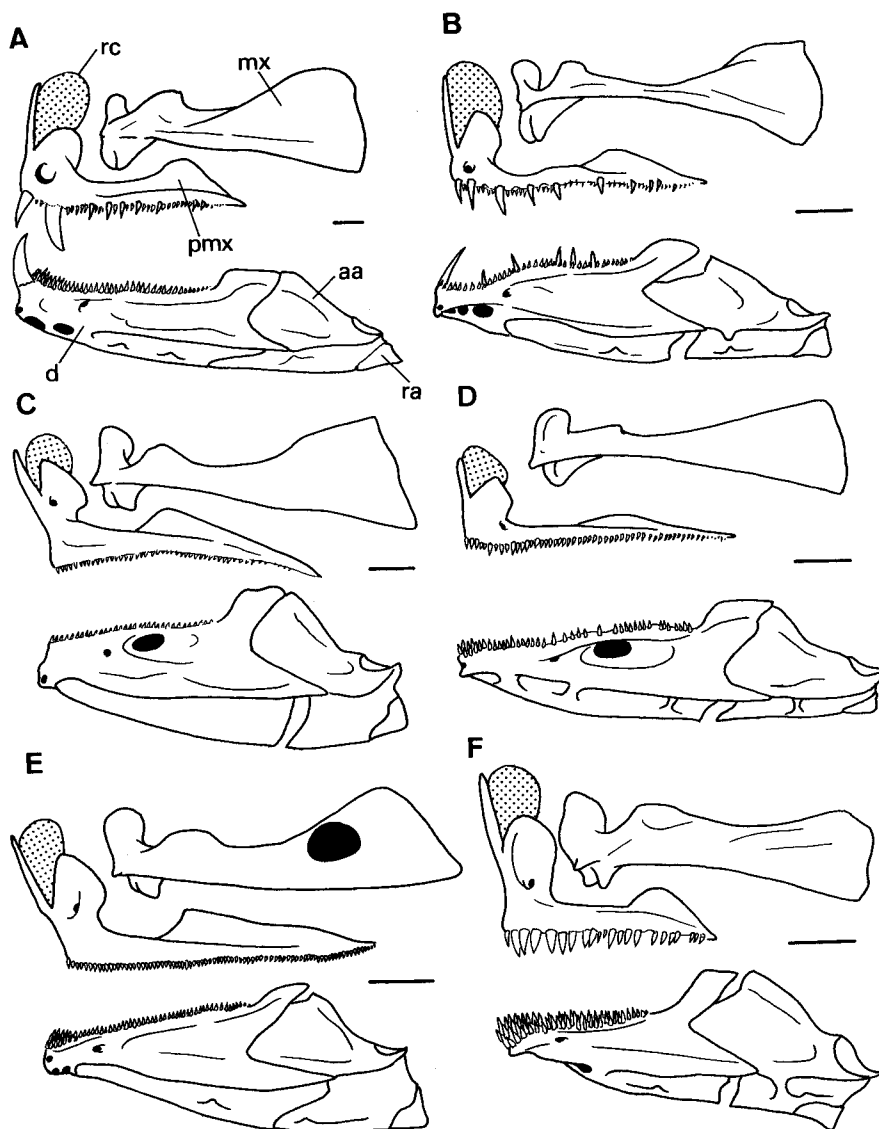

Fig. 33. Jaws of six sciaenids. A, *Otolithes ruber*; B, *Odontoscion dentex*; C, *Larimus breviceps*; D, *Seriphus politus*; E, *Collichthys lucidus*; F, *Sciaena umbra*. Abbreviations as in Fig. 31. Bar=3 mm.

of the ventral surface. Anteriorly, the groove is bridged by narrow struts or flanges, forming variably sized foramina.

The anguloarticular is anteriorly pointed, being inserted into the hollow of the dentary. It is medially attached to the dentary by Meckelian cartilage. The posterodorsal portion of the anguloarticular thickens, forming a saddle-shaped facet for articulation with the quadrate. Ventrally, it forms an open groove, which is

continuous with that of the dentary.

The retroarticular is a small bone sutured to the posteroventral portion of the anguloarticular. It provides an attachment site for the ligament connecting the lower jaw to the interoperculum.

The coronomeckelian is a tiny bone, lodged on the medial face of the anguloarticular which articulates near the posterior end of Meckelian cartilage.

CHARACTERS

Character 54 (Fig. 32): Lower jaw teeth absent in adults. Typically in sciaenids, both jaws are toothed, whereas in *Leiostomus*, teeth are absent from the lower jaw (Fig. 32C). Govani (1987) demonstrated that in this genus, teeth develop on the dentary of juveniles up to 40–50 mm SL, but are thereafter lost. This observation also indicates that the absence of the teeth is an apomorphous feature. Govani argued that the loss of teeth reflected a structural adjustment to feeding that accommodates scooping with the dentary in addition to sucking. As described and figured in Characters 70–74, the pharyngeal jaws of this genus are highly specialized. It appears therefore that the loss of teeth is fully compensated by the upgrading of the pharyngeal jaws.

Character 55 (Figs. 32 and 33): Canines present. Trewavas (1977) defined the canines as: “the few outstanding teeth, more than twice as long as any other teeth in the jaw”. In sciaenids, the canines are present in *Cynoscion* (Fig. 32E), *Macrodon* (Fig. 32F), *Isopisthus*, *Otolithes* (Fig. 33A), *Pterotolithus*, *Chrysochir*, *Elattarchus*, and *Odontoscion* (Fig. 33B). Because canines are only occasionally encountered in percoids, and then somewhat randomly, the presence of canines in

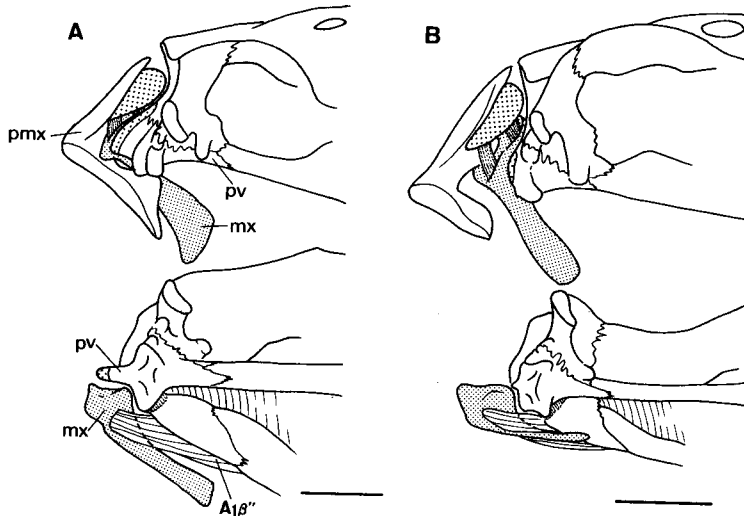

Fig. 34. Ethmo-prevomerine regions of two sciaenids. A, *Aplodinotus grunniens*; B, *Pachypops* sp. Top, lateral view; bottom, ventral view. pv, prevomer; other abbreviations as in Fig. 31. Bar=5 mm.

some sciaenids is considered to be an apomorphic feature.

Character 56 (Fig. 32): Teeth "arrowhead"-shaped. In most sciaenids as in most percoids, the teeth are conical and simply pointed at their tips, whereas in *Macrodon*, teeth on both the jaws and the pharyngobranchials have a triangulated head, similar to an arrowhead in shape (Fig. 32F).

Character 57 (Fig. 34): Head of maxillary anterior to ethmoid and prevomer. Typically in sciaenids as in percoids, the heads of the left and right maxillae are separated medially by the ethmoid and prevomer (Fig. 34A), whereas in *Pachyurus* and *Pachypops*, the maxillary heads are forward the ethmoid and prevomer (Fig. 34B). This unique development may be related to the long snout of these genera.

Character 58 (Fig. 33): Maxillary shaft foramen present. Typically in sciaenids, there is no foramen in the maxillary shaft, whereas a large foramen is present in the shaft in *Collichthys* (Fig. 33E) and *Kathala*.

Character 59 (Fig. 33): Dentary foramen present. A large foramen, usually absent in sciaenids, is present on the lateral side of the dentary in *Larimus* (Fig. 33C) and *Seriphus* (Fig. 33D).

Other variations

Mouth position and nature of dentition is highly variable in the Sciaenidae. Canines are limited to those sciaenids with large terminal or oblique mouths, possibly as an adaptation for midwater, piscivorous feeding. Conversely, a broad band of small, conical teeth has developed in those sciaenids with an inferior mouth. Further specialization is seen in the loss of lower jaw teeth in *Leiostomus*. In those sciaenids with an inferior mouth, the ascending process of the premaxillary tends to be longer than in other sciaenids. Chao and Musick (1977) demonstrated that the entire premaxillary and lower jaw moved anteroventrally in such sciaenids, whereas the upper jaw is nonprotrusible in sciaenids with a terminal to oblique mouth. In the latter the premaxillary is fixed anteriorly. This suggests that the long premaxillary ascending process structurally assists extensive mouth protrusion in some sciaenids.

5. HYOID ARCH (Figs. 35 and 36)

GENERAL DESCRIPTION

The sciaenid hyoid arch comprises the dorsal and ventral hypohyals, ceratohyal, epihyal, interhyal, branchiostegal rays, basihyal, and urohyal. The basihyal is figured and described in the section of the branchial arches (p. 50).

The dorsal hypohyal is attached ventrally to the ventral hypohyal and with posteriorly to the ceratohyal. It is attached by a ligament to the lateral surface of basibranchial 1. The ventral hypohyal caps the anteroventral surface of the ceratohyal, below the dorsal hypohyal. It is connected medially with the urohyal by a strong ligament.

The ceratohyal is the largest bone in the hyoid arch. It articulates posteriorly with the epihyal, and anteriorly with the hypohyals. A narrow strip of cartilage margins the posteroventral corner of the ceratohyal. The dentate junction between

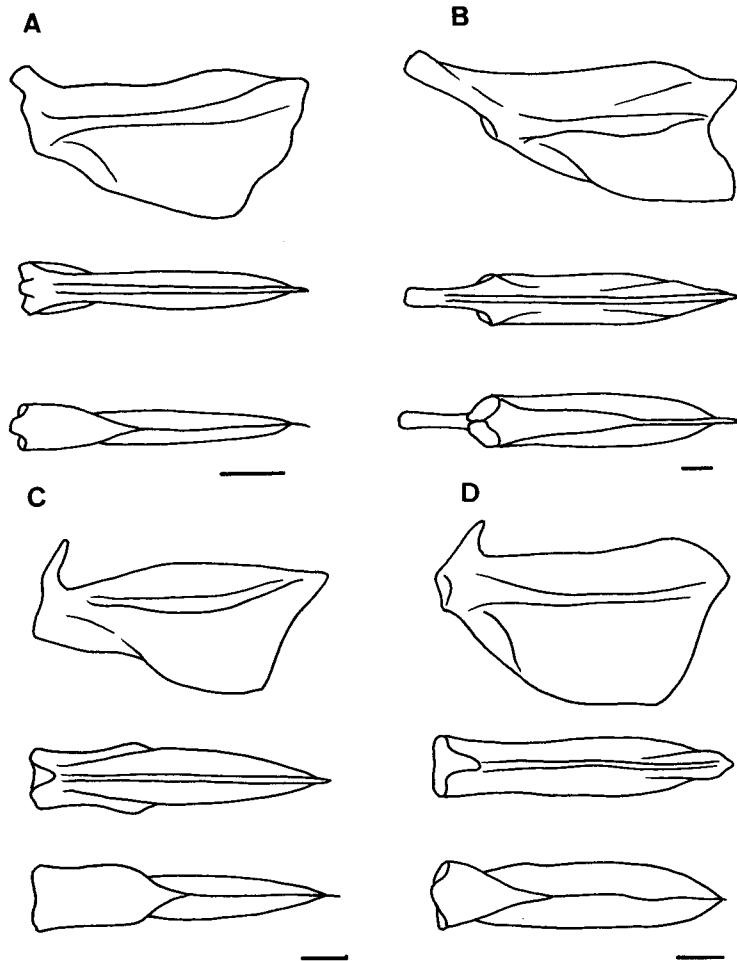

Fig. 35. Urohyals of four sciaenids. A, *Ctenosciaena gracilicirrhus*; B, *Pseudotolithus* (*Pseudotolithus*) *typus*; C, *Paralanchurus elegans*; D, *Umbrina canariensis*. dr, dorsal ramus. Top, lateral view; middle, dorsal view; bottom, ventral view. Bar=2 mm.

the ceratohyal and epihyal varies from absent altogether to well developed, with a number of intermediate forms.

The triangular epihyal is sutured anteriorly to the ceratohyal, and has postero-dorsal surface slightly notched to receive the base of the interhyal.

The interhyal is rod-like, linking the suspensorium and the lower elements of the hyoid arch. Dorsally it fits into a depression formed in the interspace between the lower shaft of the hyomandibular and the head of the symplectic. Ventrally it is attached to the posterior corner of the epihyal.

The branchiostegal rays always number seven and are attached to the cerato-

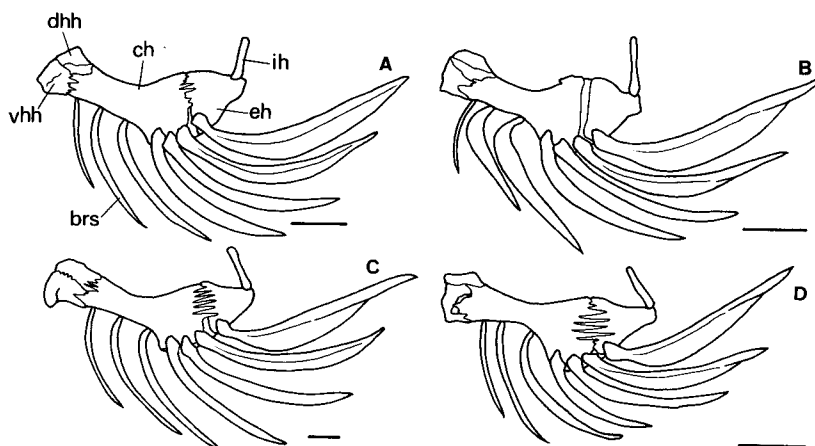

Fig. 36. Hyoid arches of four sciaenids. A, *Sciaena trewavasae*; B, *Ctenosciaena gracilicirrhus*; C, *Otolithes ruber*; D, *Isopisthus parvipinnis*. brs, branchiostegal ray; ch, ceratohyal; dhh, dorsal hypohyal; eh, epihyal; ih, interhyal; vhh, ventral hypohyal. Bar=5 mm.

hyal and epihyal. Three rays are attached laterally, and three medially, to the ventral rim of the ceratohyal. The last ray is attached to the lateral surface of the epihyal.

The urohyal is roughly plate-like, lying in the midline below the basibranchials. It is connected to the ventral side of the first basibranchial through a dorsal ramus. The strong, forward inclination of the dorsal ramus in some genera, progressively lessens posteriorly, generally tending to be inclined backwards in those sciaenids with an inferior mouth.

CHARACTERS

None.

6. BRANCHIAL ARCHES AND ASSOCIATED MUSCLES (Figs. 37-46)

GENERAL DESCRIPTION

Sciaenid branchial arches and the associated muscles are of the generalized percoid type except for the transversus dorsalis anterior and retractor dorsalis (Characters 8 and 9). The typical sciaenid arrangement of arches and muscles is shown in Figs. 37 and 38.

The basihyal (unpaired) is plate-like, roughly triangular in shape, and articulates posteriorly with basibranchial 1.

The basibranchials (unpaired) form the floor of the pharynx, and laterally make contact with the hypobranchials (except basibranchial 1). The three anterior basibranchials are well ossified, the posteriormost being cartilaginous. Basibranchial 1 is small and compressed. Basibranchial 2 is funnel-shaped, narrow anterior-

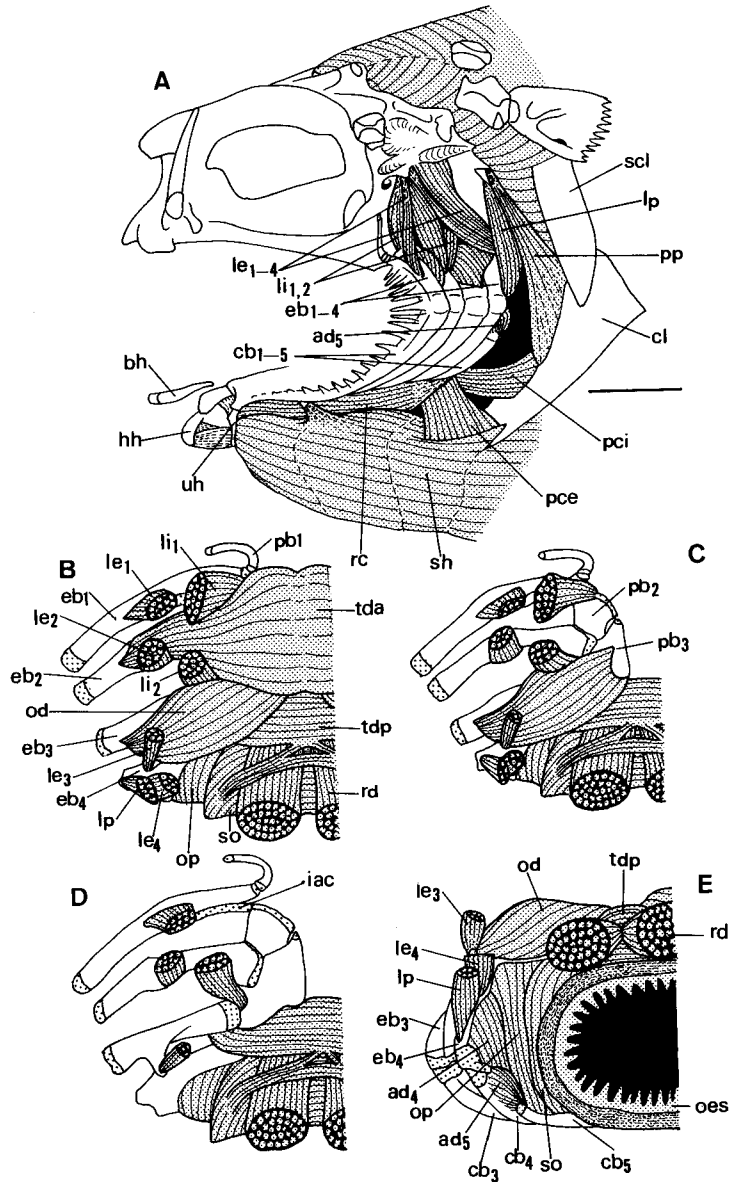

Fig. 37. Branchial region of *Ttenosciaena gracilicirrhus*. A, lateral view; B-D, dorsal view; E, posterior view. ad, adductor; bh, basihyal; cb, ceratobranchial, cl, cleithrum; eb, epibanchial; hh, hypohyal; iac, interarcual cartilage; le, levator externus; li, levator internus; lp, levator posterior; oes, oesophagus; od, obliquus dorsalis; op, obliquus posterior; pb, pharyngobranchial; pce, pharyngoclavicularis externus; pci, pharyngoclavicularis internus; pp, protractor pectoralis; rc, rectus communis; rd, retractor dorsalis; scl, supraclithrum; sh, sternohyoideus; so, sphincter oesophagi; tda, transversus dorsalis anterior; tdp, transversus dorsalis posterior; uh, urohyal. Bar=5 mm.

ly, broad posteriorly, and articulates anterolaterally with hypobranchial 1. Basibranchial 3, the largest of the series, is slender and articulates anterolaterally with hypobranchial 2, posteriorly with hypobranchial 3.

The hypobranchials (paired) are situated between the basibranchials and the ceratobranchials, and decrease in size posteriorly. Hypobranchial 3 lies in a longitudinal plane, and anteriorly, extends slightly below hypobranchial 2.

The five ceratobranchials (paired) lie between the hypobranchials and the epibranchials. The anterior four are slender and rod-like, with the fifth usually being medially expanded, forming a teeth-bearing plate.

The epibranchials (paired) form the dorsolateral wall of the pharynx, articulating with the ceratobranchials distally and the pharyngobranchials proximally. Epibranchial 1 is slender, with a flat, dorsal process along approximately three quarters of its length. This process is associated proximally with the interarcual cartilage, which extends to the anteromedial corner of pharyngobranchial 2. Epibranchial 2 is rod-like, with lateral flanges, and articulates with the medial region of pharyngobranchial 2 and the anterolateral region of pharyngobranchial 3. A tooth plate is absent from this bone. Epibranchial 3 is rod-like with a well developed, sail-like crest, which is bound to epibranchial 4. Meeting against the

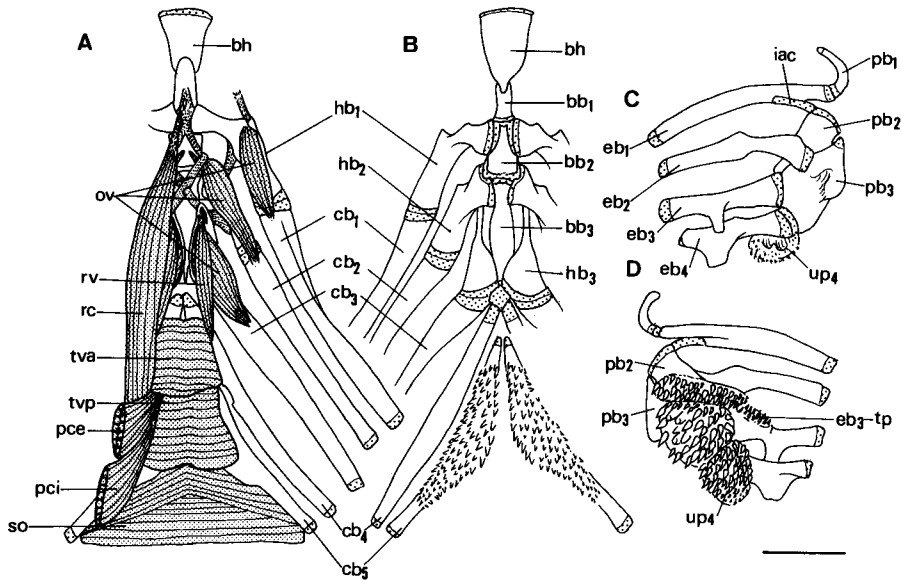

Fig. 38. Branchial arches of *Ctenoscoiaena gracilicirrhus*. A, ventral branchial muscles; B, dorsal view of ventral branchial arch; C, ventral view of dorsal branchial arch; D, dorsal view of dorsal branchial arch. bb, basibranchial; bh, basihyal; cb, ceratobranchial; eb-tb, epibranchial tooth plate; hb, hypobranchial; iac, interarcual cartilage; ov, obliquus ventralis; pb, pharyngobranchial; pce, pharyngo-clavicularis externus; pci, pharyngo-clavicularis internus; rc, rectus communis; rv, rectus ventralis; so, sphincter oesophagi; tva, transversus ventralis anterior; tvp, transversus ventralis posterior; up4, upper pharyngeal tooth plate 4. Bar=5 mm.

lateral rim of pharyngobranchial 3, it has a small tooth plate on its oral surface. Epibranchial 4 is stout, and articulates with the cartilaginous posterior corner of pharyngobranchial 3 and the anteromedial portion of upper pharyngeal tooth plate 4.

There are three pharyngobranchials (paired) and a circular pharyngeal tooth plate 4 (paired). Pharyngobranchial 1 is modified as the suspensory pharyngeal, and interconnects the prootic of the cranium and epibranchial 1. Pharyngobranchial 2 is typically flat and triangular, with a tooth plate on its oral surface. The tooth plate varies both in size and in its relationship to pharyngobranchial 3. Pharyngobranchial 3 is typically the largest in the pharyngobranchial series, with a tooth plate on its oral surface. Teeth on the plate vary from conical to molariform in shape. Pharyngeal tooth plate 4 lacks the basal skeletal element, and is usually circular in shape.

Muscles of the dorsal part of the branchial arches comprise the following: levator externus; levator internus; levator posterior; transversus dorsalis anterior; transversus dorsalis posterior; obliquus dorsalis; obliquus posterior; adductor; and retractor dorsalis.

The levator externi (paired) consist of four elements, connecting the cranium to the epibranchials. They originate just below the cranial groove for articulation of the hyomandibular. The four elements are respectively inserted epibranchial 1 (levator externus 1), epibranchial 2 (levator externus 2), epibranchial 3 (levator externus 3), and epibranchial 4 (levator externus 4). The degree of development of each of muscle elements is variable.

The levator interni (paired) consist of two elements, and share the same origin with the levator externi. Levator internus 1 is mostly inserted onto the anterior margin of pharyngobranchial 2, but may be partially inserted onto the interarcual cartilage. Levator internus 2 is inserted onto pharyngobranchial 3, just medial to the head of epibranchial 3. These two elements are separated by the transversus dorsalis anterior.

The levator posterior (paired) usually originates from the ventral side of the intercalar and exoccipital. It is inserted onto epibranchial 4, just lateral to levator externus 4. Development of the former is usually weak.

The transversus dorsalis anterior (unpaired) consists of a single element, the *m. transversus epibranchialis 2* (see Character 8), which connects epibranchial 2 of each side, by passing over dorsally (and usually completely covering) pharyngobranchials 2 and 3.

The transversus dorsalis posterior (unpaired) occupies the space between the heads of epibranchials 3 and 4, and laterally lies beneath the obliquus dorsalis.

The obliquus dorsalis (paired) is extended between pharyngobranchial 3 and epibranchials 3 and 4. Anteriorly, it lies below the transversus dorsalis anterior, and posteriorly, over the transversus dorsalis posterior.

The obliquus posterior (paired) connects the dorsal side of ceratobranchial 5 to the posteroventral margin of epibranchial 4. Typically, it is the largest muscle associated with the posterior portion of the branchial arches.

The adductores (paired) lie between the epibranchials and ceratobranchials. Usually, adductor 4 can be seen between adductor 5 and the obliquus posterior, when

viewed posteriorly. Adductor 5 is typically poorly developed.

The retractor dorsalis (paired) originates from the posterior margin of pharyngo-branchial 3 and pharyngeal tooth plate 4, and is typically inserted onto the first and second vertebrae.

The muscles of the ventral part of the branchial arches consist of the following: the sphincter oesophagi; obliquus ventralis; rectus ventralis; transversus ventralis; and rectus communis.

The sphincter oesophagi (unpaired) encircles the oesophagus. It arises ventrally from the dorsal rim of ceratobranchial 5, and dorsally from the inner, posterior margin of epibranchial 4.

The obliqui ventrales (paired) comprise three elements, interconnecting respectively hypobranchial 1-ceratobranchial 1, hypobranchial 2-ceratobranchial 2, and hypobranchial 3-ceratobranchial 3.

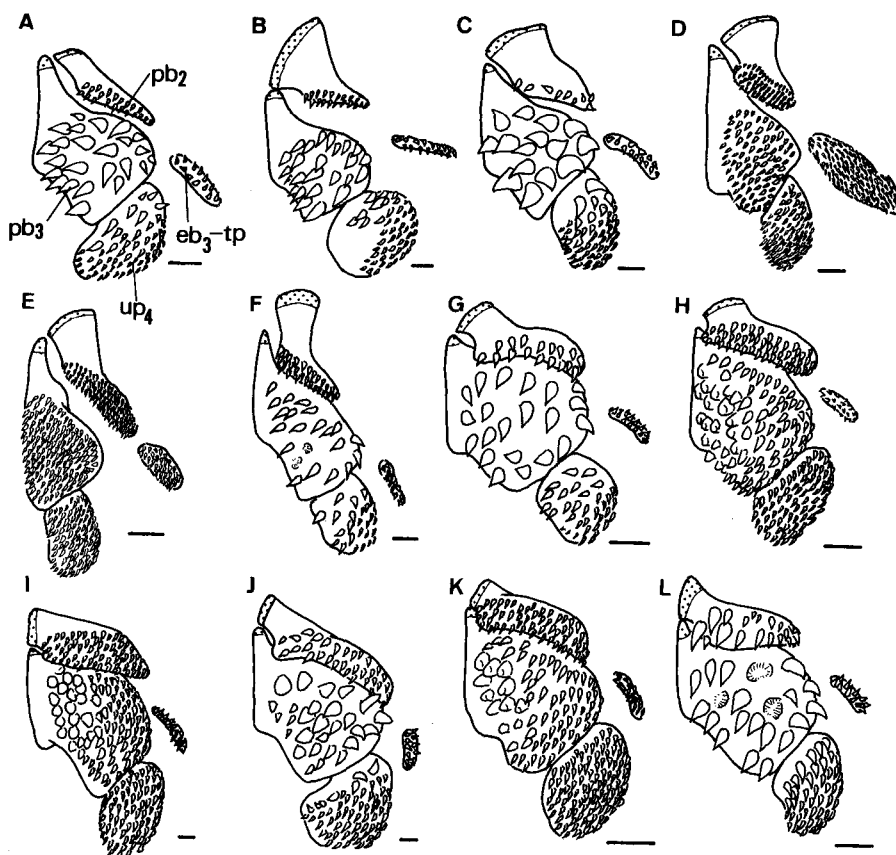

Fig. 39. Tooth plates on upper branchial arches of 12 sciaenids. A, *Protonibea diacanthus*; B, *Otolithoides pama*; C, *Menticirrhus americanus*; D, *Nebris microps*; E, *Plagioscion auratus*; F, *Seriphus politus*; G, *Pareques acuminatus*; H, *Roncador stearnsii*; I, *Sciaena deliciosa*; J, *Sciaenops ocellata*; K, *Genyonemus lineatus*; L, *Cheilotrema saturnum*. Abbreviations as in Fig. 38. Bar=1 mm.

The rectus ventralis (paired) consists of a single element, lying between the anterior tip of hypobranchial 3 and ceratobranchial 4.

The transversus ventralis (unpaired) usually consists of two elements. The transversus dorsalis anterior lies between ceratobranchials 4, and transversus dorsalis posterior lies between ceratobranchials 5.

The rectus communis (paired) originates from the dorsal side of the urohyal and is inserted onto ceratobranchial 5.

The sternohyoideus (paired) arises from the lateral side of the urohyal and inserted onto the lower region of the cleithrum. Dorsally, it develops a tendon which is inserted onto the anterior tip of hypobranchial 3.

The pharyngoclavicularis (paired) connects ceratobranchial 5 with the cleithrum. It consists of the pharyngoclavicularis externus and, medially, the pharyngoclavicularis internus.

The protoractor pectoralis (paired) connects the cranium and cleithrum. Originating from the pterotic and inserted onto the cleithrum, its development in sciaenids varies from weak to strong.

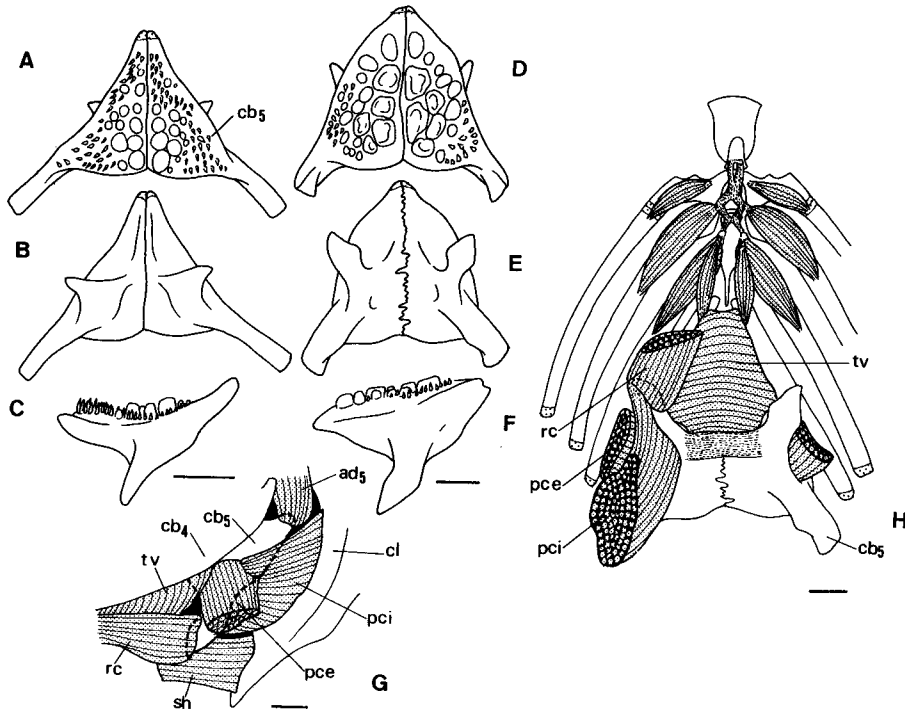

Fig. 40. Ventral branchial arches of *Aplodinotus grunniens* (A-C) and *Pogonias cromis* (D-H). A and D, dorsal view of ceratobranchial 5; B and E, ventral view of ceratobranchial 5; C and F, lateral view of ceratobranchial 5; G, lateral view of ceratobranchial 5 with related muscles; H, ventral view of ventral branchial arch. Abbreviations as in Figs. 37 and 38. Bar=3 mm.

CHARACTERS

Character 60 (Figs. 38, 39, 42, and 44): Tooth plate on pharyngobranchial 2 enlarged and anteriorly located. Primitively among percoids, the tooth plate on pharyngobranchial 2 is as large as that on epibranchial 3, and abuts obliquely onto the tooth plate on pharyngobranchial 3. Many sciaenids possess this primitive condition (Fig. 39A-C), whereas in *Bairdiella*, *Ophioscion*, *Umbrina*, *Ctenosciaena* (Fig. 38D), *Pareques* (Fig. 39G), *Equetus*, *Roncador* (Fig. 39H), *Sciaena umbra*, *S. deliciosa* (Fig. 39I), *S. gilberti*, *Sciaenops* (Fig. 39J), *Genyonemus* (Fig. 39K), *Cheilotrema* (Fig. 39L), *Aplodinotus* (Fig. 42D), *Pogonias* (Fig. 42F, but see Character 66), *Leiostomus* (Fig. 44), *Micropogonias*, *Paralonchurus brasiliensis*, and *Pachyurus*, the tooth plate on pharyngobranchial 2 is enlarged (more than twice as large as that on epibranchial 3), and anteriorly located so as to broadly rim the front margin of the pharyngobranchial 3 tooth plate. Separate treatment of the size and location of the pharyngobranchial 2 tooth plate prevents individual consideration (Fig. 39D-F), although the combination of both conditions is diagnostic. A forward location of the enlarged tooth plate on pharyngobranchial 2 aids in seizing of the prey in the narrow buccal cavity, and positioning it suitably for crushing between the upper and lower pharyngeal jaws. Further specializations derived from this condition can be recognized in *Aplodinotus*, *Pogonias*, and *Leiostomus* as discussed below.

Character 61 (Fig. 40): Interdigitating suture between ceratobranchials 5. In sciaenids such as *Aplodinotus* (Fig. 40A), *Pogonias* (Fig. 40D), *Roncador* (Fig. 41F), and *Leiostomus* (Fig. 44E), the lower pharyngeal jaw (ceratobranchials 5) exhibits pharyngognathly (Liem and Greenwood, 1981; Kaufman and Liem, 1982), in that left and right ceratobranchials 5 are united into a single unit. In the case of sciaenids, however, contact of these bones varies gradually from narrow to broad (Fig. 41), so that clear-cut character states cannot be identified. On the other hand,

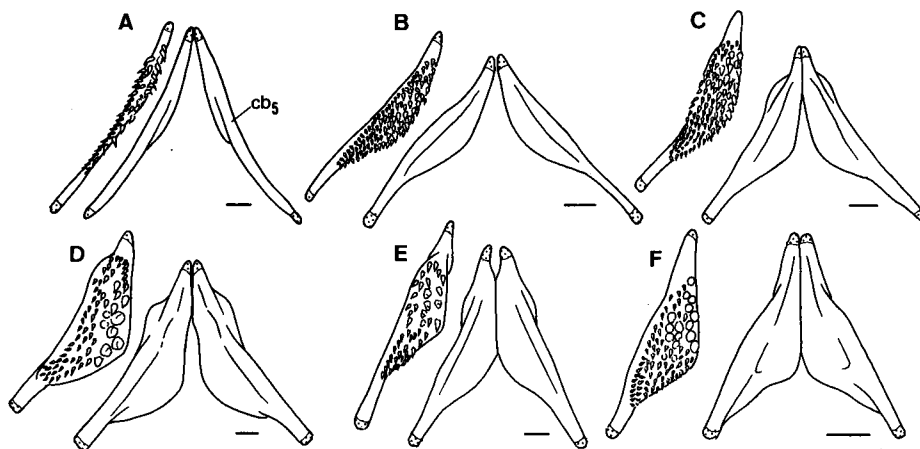

Fig. 41. Left and right ceratobranchials 5 of six sciaenids. A, *Atractoscion nobilis*; B, *Ctenosciaena gracilicirrhus*; C, *Sciaenops ocellata*; D, *Pseudotolithus (Hostia) moorii*; E, *Cheilotrema saturnum*; F, *Roncador stearnsii*. Bar=2 mm.

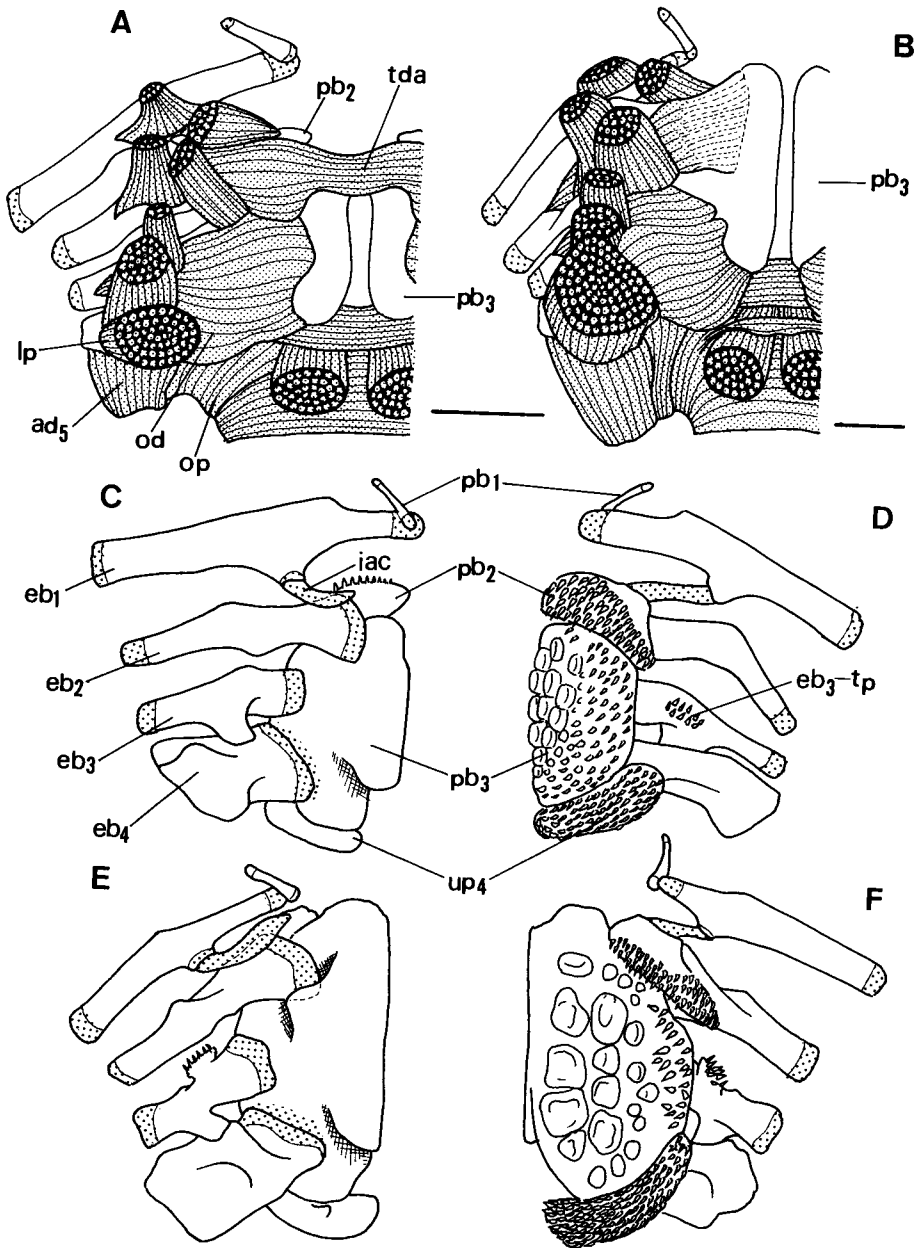

Fig. 42. Dorsal branchial arches of *Aplodinotus grunniens* (A, C, and D) and *Pogonias cromis* (B, E, and F). A and B, dorsal view with muscles; C and E, dorsal view; D and F, ventral view. Abbreviations as in Figs. 37 and 38. Bar=5 mm.

a derived character can be recognized when the nature of the suture between the ceratobranchials is considered. Whereas in most sciaenids, the suture is straight, it clearly interdigitates in *Pogonias* (Fig. 40E). This apomorphic condition, indicating a tighter unification of the 5th ceratobranchials, is typically absent in percoids.

Character 62 (Fig. 40): Ventral process present in ceratobranchial 5. In most sciaenids, the ventral side of ceratobranchial 5 has undergone no noticeable modifications, whereas both *Aplodinotus* (Fig. 40A-C) and *Pogonias* (Fig. 40D-H) possess a prominent horn-like process (figured and described by Chao, 1978a). Because this ventral process does not make contact with the cleithrum (Fig. 40G), "the pharyngocleithral joint" of Liem and Greenwood (1981) is absent. The process forms the insertion sites for the well developed rectus communis and pharyngoclavicularis internus, probably to enable elaborated forward and backward movements of the lower pharyngeal jaw.

Character 63 (Fig. 40): Transversus ventralis anterior and posterior present as a single element. In most sciaenids, the transversus ventralis anterior and posterior are present as separate divisions from one another (Fig. 38A), whereas in *Aplodinotus* and *Pogonias* (Fig. 40H), the two muscles are fused into a single element.

Character 64 (Figs. 42 and 44): Dorsal face of pharyngobranchial 3 incompletely covered by muscles. In most sciaenids, the entire dorsal face of pharyngobranchial 3 is completely covered by the transversus dorsalis anterior, transversus dorsalis posterior, and obliquus dorsalis (Fig. 37), whereas in *Aplodinotus* (Fig. 42A), *Pogonias* (Fig. 42B), and *Leiostomus* (Fig. 44A), the bone is partially exposed, owing to the obliquus dorsalis terminating on pharyngobranchial 3. The exposed portion of pharyngobranchial 3 forms a raised facet to which the cranial floor is tightly attached (for the modification of cranial floor, see Characters 42 and 43).

Character 65 (Fig. 42): Transversus dorsalis anterior not extending across dorsal surface of upper pharyngobranchials. A further specialization of Character 64, found only in *Pogonias*, the transversus dorsalis anterior lacks a medial connection, and thereby loses its "transversus" character.

Character 66 (Fig. 42): Pharyngobranchial 3 enlarged. In most sciaenids, pharyngobranchial 3 is only slightly larger than pharyngeal tooth plate 4 (Fig. 39), whereas in *Aplodinotus* (Fig. 42C and D) and *Pogonias* (Fig. 42E and F), pharyngobranchial 3 is by far the largest element in the upper pharyngeal jaw. Although pharyngobranchial 3 is also larger than pharyngeal tooth plate 4 in *Leiostomus*, the latter is not scored for this character, because the condition seems to have resulted mainly from enlargement of pharyngobranchial 2 and diminution of pharyngeal tooth plate 4.

Character 67 (Fig. 42): Tooth plate on pharyngobranchial 2 relocated obliquely to pharyngobranchial 3. A further specialization of Character 66, in which the enlargement of pharyngobranchial 3 is more prominent in *Pogonias* than in *Aplodinotus*. The position of the pharyngobranchial 2 tooth plate is modified from fully in front of to oblique to pharyngobranchial 3, probably through forward expansion of the latter, judging by the wide space between the head of epibranchial 2 and the anterior margin of pharyngobranchial 3. The oblique setting of the tooth

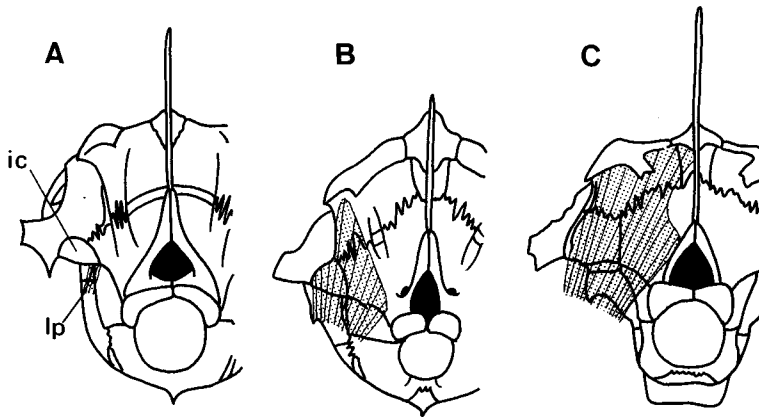

Fig. 43. Posterior view of crania with levator posterior. A, *Micropogonias furnieri*; B, *Aplodinotus grunniens*; C, *Pogonias cromis*. ic, intercalar; lp, levator posterior.

plate in *Pogonias* is regarded as a "reversal", the broad, pear-shaped pharyngobranchial 3 being characteristic for the genus and representing an extreme derivation of the upper pharyngeal jaw structure in the Sciaenidae.

Character 68 (Fig. 43): Levator posterior originating from upper half of postcranial wall. As in most percoids, the levator posterior is a weak muscle bundle, originating on the ventral side of the intercalar and/or exoccipital (Fig. 43A) in most sciaenids. However, in *Aplodinotus* (Fig. 43B) and *Pogonias* (Fig. 43C) the muscle is well developed, originating on the upper half of the postcranial wall. In *Aplodinotus*, the origin includes the epiotic, intercalar, and exoccipital, whereas in *Pogonias*, it includes the epiotic, intercalar, exoccipital, and part of the supraoccipital. It is noteworthy that in these two genera, the intercalar extends up the posterior wall of the cranium to the epiotic (see Character 35), corresponding to the derived muscle condition.

Character 69 (Fig. 42): Adductor 5 well developed. In most percoids, including most sciaenids, the largest muscle interconnecting epibranchial 4 and ceratobranchial 5 is the obliquus posterior (Fig. 37E), whereas in *Aplodinotus* (Fig. 42A) and *Pogonias* (Fig. 42B), adductor 5 is enormously developed, forming the largest muscle mass in the posterior section of the branchial arches.

Character 70 (Fig. 44): Pharyngobranchial 2 extremely large. Typically in sciaenids, pharyngobranchial 2 is much smaller than pharyngobranchial 3 (Fig. 39A-C). The condition of *Leiostomus* is unique in that pharyngobranchial 2 is much larger than pharyngobranchial 3 (Fig. 44A and D). Apparently related to this specialization, some further modifications are found in this genus: the head of epibranchial 2 is broadly expanded to support the enlarged pharyngobranchial 2 (Fig. 44C); the interarcual cartilage has lost its connection with pharyngobranchial 2; pharyngeal tooth plate 4 has become reduced in size (Fig. 44C and D); and the transversus dorsalis anterior has become a dominant muscle on the dorsal face of the upper pharyngeal jaw (Fig. 44A), providing a myological correlation for the enlarged pharyngobranchial 2. Medially the high crest of the parasphenoid serves as an

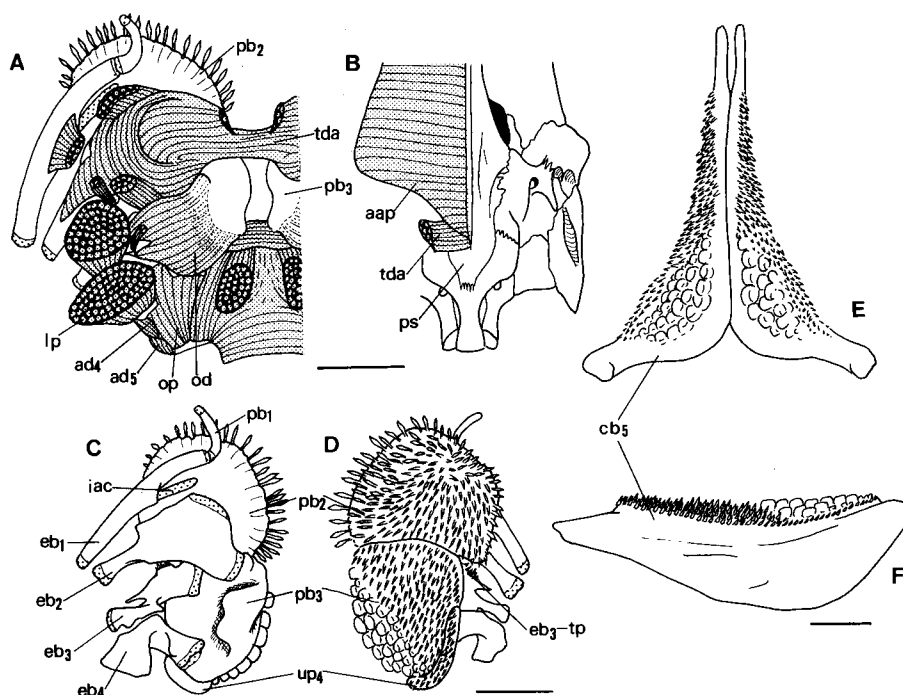

Fig. 44. Branchial arches of *Leiostomus xanthurus*. A, dorsal view of branchial arch with muscles; B, ventral view of cranium with muscles; C, dorsal view of dorsal branchial arch; D, ventral view of dorsal branchial arch; E, dorsal view of ceratobranchial 5; F, lateral view of ceratobranchial 5. aap, adductor arcus palatini; other abbreviations as in Figs. 37 and 38. Bar=3 mm.

attachment site for part of the transversus dorsalis anterior (Fig. 44B). Dense peg-like teeth on pharyngobranchial 2 suggest that the osteological/myological modification functions for conveying of the prey to the position where "crushing" is performed—that is, the space between the molariform teeth on the upper and lower pharyngeal jaws (Fig. 44D-F).

Character 71 (Fig. 44): Head of epibranchial 2 enlarged. This is an autapomorphy of *Leiostomus*. See Character 70.

Character 72 (Fig. 44): Interarcual cartilage connection with pharyngobranchial 2 lost. This is an autapomorphy of *Leiostomus*. See Character 70.

Character 73 (Fig. 44): Transversus dorsalis anterior well developed, partially inserted onto parasphenoid. This is an autapomorphy of *Leiostomus*. See Character 70.

Character 74 (Fig. 45): Retractor dorsalis originating from basicranial region and first vertebra. The origin of the retractor dorsalis from the first and second vertebrae is a synapomorphy for the Sciaenidae as discussed in Character 8 (Fig. 45A). Further modification of this muscle is found in *Bairdiella*, *Corvula* (Fig. 45B), *Elattarchus*, *Odontoscion*, *Ophioscion*, and *Stellifer*, in which the muscle

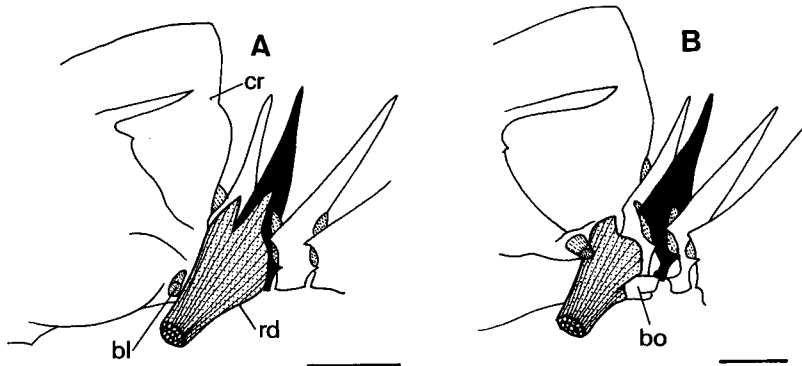

Fig. 45. Crania and anterior vertebrae of two sciaenids. A, *Dendrophysa russelli*; B, *Corvula macrops*. cr, cranium, bl, Baudelot's ligament; bo, basioccipital; rd, retractor dorsalis. Bar=3 mm.

originates from the basicranial region (including the basioccipital and part of the exoccipital) and the first vertebra. Forward extension of the swimbladder, owing to the development of the anterior chamber of the swimbladder, must have resulted in a more anterior relocation of the muscle in these genera.

Character 75 (Fig. 46): Basihyal fan-shaped. In most sciaenids, the basihyal is rod-like or roughly V-shaped (Fig. 46A-C), whereas in *Nebris* (Fig. 46D) and *Larimus* (Fig. 46E) it is laterally expanded and fan-shaped.

Character 76 (Fig. 46): Basihyal cartilaginous. In most sciaenids, a well ossified basihyal is present (Fig. 46A-E). In *Cheilotrema*, however, the basihyal is present as a small cartilaginous block, located on the ventral hypohyal (Fig. 46F).

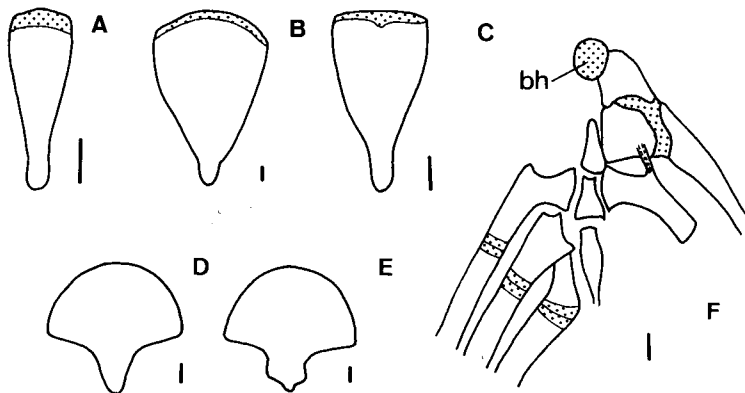

Fig. 46. Basihyals of six sciaenids. A, *Equetus lanceolatus*; B, *Pseudotolithus (Pseudotolithus) typus*; C, *Cynoscion jamaicensis*; D, *Nebris microps*; E, *Larimus breviceps*; F, *Cheilotrema saturnum*. Bar=1 mm.

Other variations

The enlarged and anteriorly located pharyngobranchial 2 tooth plate (Character 60) symbolizes the overall up-grading of the feeding apparatus within sciaenids, since a number of specializations (listed below) are frequently encountered within these genera characterized by the former feature: mouth small and terminal; pores on snout and chin well developed; chin with barbel(s); ascending process of premaxillary long, probably to allow the strong protrusion of the jaws anteroventrally (see section 4, p. 44); pharyngeal jaws consisting of blunt or molariform teeth; ceratobranchial 5 more or less broad and/or united with opposite member; levator internus I developed; levator externus IV developed; levator posterior developed; protractor pectoralis developed; pharyngobranchial 2 tightly hinging on pharyngobranchial 3; head of epibranchial 2 expanded to support enlarged pharyngobranchial 2. In summary, the mouth and pharyngeal jaws appear to have undergone integrate development, giving an advantage as benthic feeders to those sciaenids with an enlarged pharyngobranchial 2 tooth plate. The resulting protrusible jaws must be effective for "sucking" epibenthos and infauna, and the specialized pharyngeal jaws associated with well developed muscles would be advantageous for "mastication" of hard-shelled, benthic invertebrates, in addition to a wide variety of other organisms.

7. PECTORAL GIRDLE AND ASSOCIATED MUSCLES (Figs. 47-49)

GENERAL DESCRIPTION

The sciaenid pectoral girdle always includes two extrascapulae, posttemporal, supracleithrum, cleithrum, scapula, four radials, coracoid, and two postcleithra.

The extrascapula is a thin membranous bone, bearing struts which form the canal of the cephalic lateral line system. The lateral line extending from the posttemporal is conveyed into the supratemporal and supraorbital canals via the posterior extrascapula.

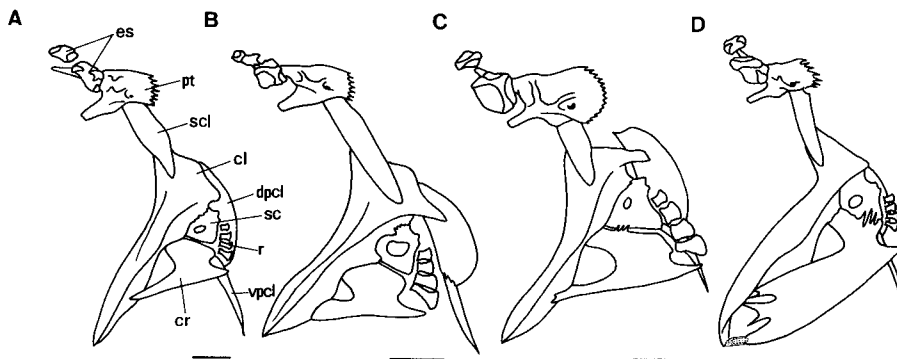

Fig. 47. Pectoral girdles of four sciaenids. A, *Sciaena trewavasae*; B, *Menticirrhus americanus*; C, *Paralichthys elegans*; D, *Macrodon ancylodon*. cl, cleithrum; cr, coracoid; dpcl, dorsal postcleithrum; es, extrascapula; pt, posttemporal; r, radial; sc, scapula; scl, supracleithrum; vpcl, ventral postcleithrum. Bar = 5 mm.

The posttemporal bears the dorsal and ventral limbs for articulation with the cranium. The anterior portion of the dorsal limb is flattened for articulation with the epiotic, whereas the ventral limb is rod-like and firmly connected with the intercalar. The posterior margin of the posttemporal is thin and fimbriate, and the lateral side is bridged by thin struts, forming a groove for the lateral line system. It is also perforated by a foramen.

The supracleithrum is leaf-like, interconnecting the posttemporal dorsally and the cleithrum ventrally. The lateral line system runs through the supracleithrum near the dorsal end.

The cleithrum is the largest of the pectoral bones, the dorsal and ventral limbs forming an obtuse angle. The dorsal limb bears a shallow depression which accepts the supracleithrum. The ventral limb bears a flange, forming a pocket which receives the lateral, pectoral fin muscles.

The scapula is roughly rectangular, sutured to the cleithrum both anteriorly and dorsally, and to the coracoid ventrally. This bone is perforated by the scapula foramen. The posterodorsal corner is distinctly concave for articulation with the dorsalmost ray of the pectoral fin.

The radials always number four, usually three and half articulating with the scapula.

The coracoid is V-shaped. Usually the ventral arm of this bone is gradually tapered and articulates directly with the cleithrum.

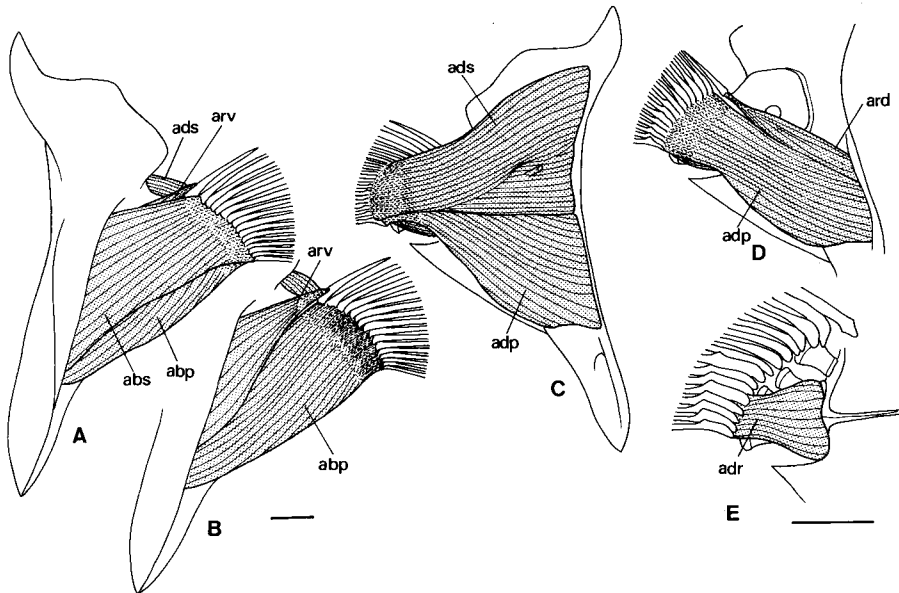

Fig. 48. Muscles of pectoral girdle of *Pteroscion peli*. A and B, lateral view; C-E, medial view. abp, abductor profundus; abs, abductor superficialis; adp, adductor profundus; adr, adductor radialis; ads, adductor superficialis; ard, arrector dorsalis; arv, arrector ventralis. Bar=2 mm.

The postcleithra always number two. The dorsal postcleithrum is crescent-shaped; the ventral postcleithrum is rod-like and slender.

The typical condition of the sciaenid pectoral girdle muscles is shown in Fig. 48. They always comprise the abductor superficialis, abductor profundus, arrector ventralis in the lateral side; adductor superficialis, adductor profundus, arrector dorsalis, and adductor radialis in the medial side. Adductor medialis is absent, and coracoradialis may be present or absent.

The abductor superficialis provides the superficial division along the lateral surface of the pectoral girdle. This muscle originates from the lateral flange of the cleithrum and is inserted onto the bases of the fin rays, except for the uppermost. The muscle may fade into the thin transparent fascia before reaching the fin ray bases in the lower two or three rays.

The abductor profundus is the medial division of the lateral muscle mass of the pectoral girdle, lying under the abductor superficialis. The former primarily originates from the coracoid (but the origin may also include the cleithrum and part of the scapula), and is inserted on the bases of all of the fin rays.

The arrector ventralis occupies the dorsomedial division of the lateral muscle mass of the pectoral girdle. This muscle originates from the lateral flange of the cleithrum and is inserted onto the anteromedial base of the uppermost ray.

The adductor superficialis is the dorsomedial division of the medial muscle mass of the pectoral girdle. It originates on the dorsomedial face of the cleithrum, and inserted onto all of the fin rays, except for the uppermost. The precise insertion is onto spurs located somewhat above the bases of the fin rays.

The adductor profundus widely occupies the medial side of the pectoral girdle. This muscle originates from the coracoid and scapula, and is inserted onto the bases of all of the fin rays, except for the uppermost. Typically this muscle does not pass through the coracoid foramen onto the lateral side of the pectoral girdle.

The arrector dorsalis is an elongate division of the medial mass of the pectoral girdle, situated just above the adductor profundus. It arises from the cleithrum and coracoid, and is inserted onto the base of the uppermost ray.

The adductor radialis is a small muscle on the medial side of the pectoral girdle. It interconnects the bases of some lower rays and the lower two or three radials.

The coracoradialis (not figured) is the muscle between the fourth radial and the posterior process of the coracoid. This muscle is either very poorly developed (comprising a few fibers only on the transparent membrane) or is absent altogether.

CHARACTERS

Character 77: Pectoral fin very long. Although pectoral fin length is not an internal character, it is considered here, because fin condition seems to be related to internal characters. Typically in sciaenids, the pectoral fin is short, not extending beyond the anal fin origin, whereas in *Lonchurus* and *Paralonchurus elegans*, it is very long, extending well beyond the anal fin origin.

Character 78 (Fig. 47): Two and half radials on scapula. In most sciaenids, three and half radials are present on the scapula (Fig. 47A), compared with two and half radials in *Menticirrhus* (Fig. 47B) and *Paralonchurus elegans* (Fig. 47C). Katayama (1959) argued that the latter state is derived for the Serranidae,

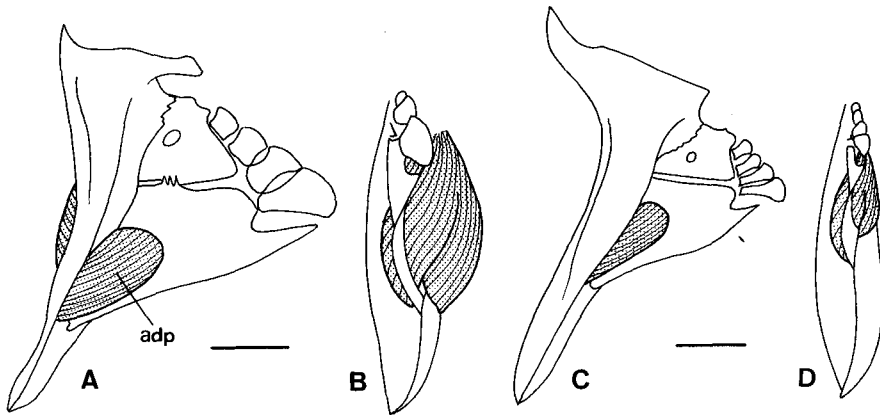

Fig. 49. Pectoral girdles of two sciaenids with adductor profundus. A and B, *Paralonchurus elegans*; C and D, *Larimichthys crocea*. Left, lateral view; right, posterior view. Bar=5 mm.

considering the condition of the Beryciformes, in which the former state is common. Similarly, Gosline (1966) applied this criterion to separate the Percichthyidae from the more advanced Serranidae. If this is so, the presence of three and half radials represents the primitive condition for percoids, including sciaenids. Alternatively, the presence of two and half radials on the scapula may be considered to represent a derived condition within the Sciaenidae.

Character 79 (Fig. 47): Ventral arm of coracoid broad. In most sciaenids, the ventral arm of the coracoid gradually tapers (Fig. 47A-C) as typically seen in percoids, whereas in *Isopisthus* the ventral arm is uniformly broad (Fig. 47D).

Character 80 (Fig. 49): Adductor profundus passing to lateral side of pectoral girdle via coracoid foramen. The adductor profundus is restricted to the medial side of the pectoral girdle in most sciaenids, whereas in *Paralonchurus elegans* (Fig. 49A), *Lonchurus*, *Larimichthys* (Fig. 49C), and *Collichthys* the muscle passing to the lateral side of the pectoral girdle via the coracoid foramen. Since this muscle appears to be restricted to the medial side of the pectoral girdle in percoids, such an extension to the lateral side is an apomorphous feature. In the *Paralonchurus* and *Lonchurus*, it appears that the unusually long pectoral fin may be functionally related to such a condition, because a well developed adductor profundus is required to aid its movement. However, the pectoral fin is moderately sized in the other two genera.

8. PELVIC GIRDLE AND ASSOCIATED MUSCLES (Fig. 50)

GENERAL DESCRIPTION

The sciaenid pelvic girdle consists of a single element, the pelvic bone (basipterygium), which is thin and triangular, bearing a fin comprising one spine and five soft

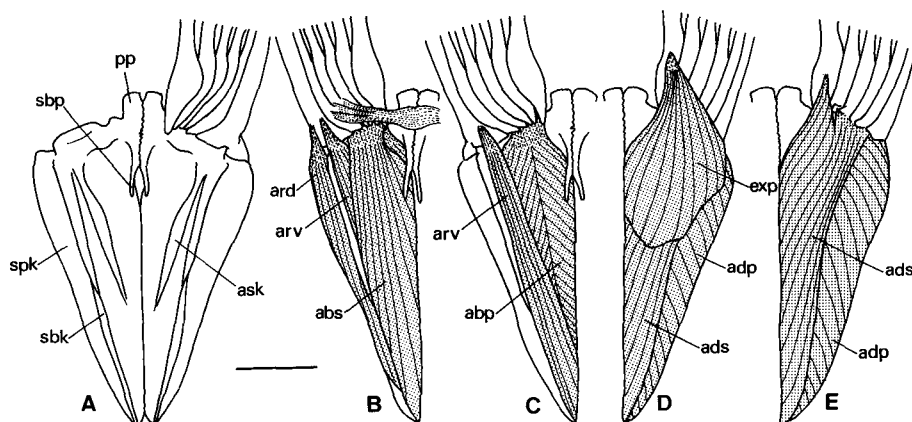

Fig. 50. Pelvic girdle of *Ophioscion sciera*. A-C, ventral view; D and E, dorsal view. abp, abductor profundus pelvici; abs, abductor superficialis pelvici; adp, adductor profundus pelvici; ads, adductor superficialis pelvici; ard, arrector dorsalis pelvici; arv, arrector ventralis pelvici; ask, accessory subpelvic keel; exp, extensor proprius; pp, postpelvic process; sbk, subpelvic keel; sbp, subpelvic process; spk, suprapelvic keel. Bar=5 mm.

rays. It is always ornamented with a series of keels and processes; the suprapelvic keel, subpelvic keel, accessory subpelvic keel, subpelvic process, and postpelvic process. A pelvic foramen (Mok and Shen, 1983) is always absent.

The muscles of the pelvic girdle always comprise the abductor superficialis pelvici, abductor profundus pelvici, arrector ventralis pelvici, adductor superficialis pelvici, adductor profundus pelvici, arrector dorsalis pelvici, and extensor proprius.

The abductor superficialis pelvici originates from the ventral side of the pelvic girdle and is inserted onto the bases of all soft rays and spine.

The abductor profundus pelvici originates from the ventral side of the pelvic girdle and is inserted onto the bases of all soft rays.

The arrector ventralis pelvici arises from the ventrolateral side of the pelvic girdle and is inserted onto the ventrolateral face of the pelvic spine.

The adductor superficialis pelvici is a division of the muscle mass lying on the dorsal side of the pelvic girdle. This muscle is sandwiched by the extensor proprius (partially) and the adductor profundus pelvici. Its insertion region includes the bases of all soft rays and spine.

The adductor profundus pelvici originates from the dorsal side of the pelvic girdle and is inserted onto the bases of all soft rays and spine.

The arrector dorsalis pelvici arises from the lateral side of the pelvic girdle and is inserted laterally onto the base of the spine.

The extensor proprius lies over the adductor superficialis pelvici and adductor profundus pelvici. Its insertion point is the innermost soft ray base.

CHARACTERS

None.

9. VERTEBRAE AND ASSOCIATED BONES

(Figs. 51-53)

GENERAL DESCRIPTION

The vertebral column comprises 24-30 vertebrae; 10-14 abdominal and 14-20 caudal. The first vertebra bears a condyle on either side for articulation with the exoccipitals. The neural spines are usually well developed except for the last two centra (see section 10, p. 73), and are variously angled to the longitudinal body axis. The first neural spine is autogenous with the centrum. Parapophyses are absent from the first three vertebrae. A transverse, bony commissure between the right and left parapophyses, is usually present in the posterior abdominal vertebrae. The ventral sides of the anterior abdominal vertebrae (particularly the third and fourth) are highly modified for suspension of the swimbladder.

More than six epipleural ribs, usually slender and tapering, are associated with the abdominal vertebrae. The relationship between epipleural and pleural ribs varies with a complete range of intermediate forms. The attachment site of the

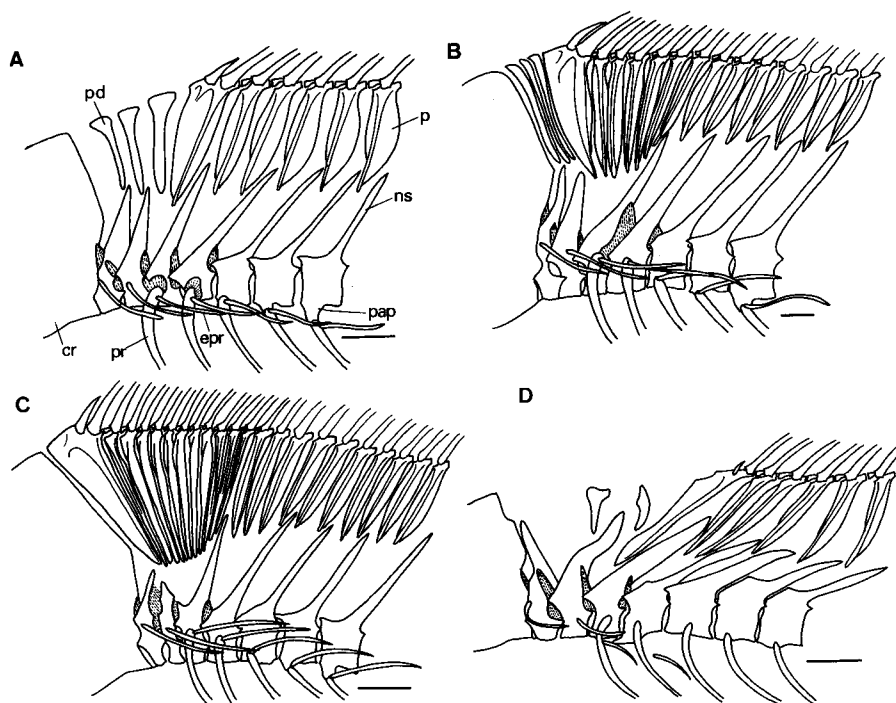

Fig. 51. Anterior abdominal vertebrae and associated bones. A, *Ctenosciaena gracilicirrus*; B, *Pareques iwamotoi*; C, *Equetus lanceolatus*; D, *Macrodon ancylodon*. cr, cranium; epr, epipleural rib; ns, neural spine; p, pterygiophore; pap, parapophysis; pd, predorsal; pr, pleural rib. Bar=5 mm.

epipleurals varies from close to well distant from the pleural head. In addition, epipleural-pleural articulation varies from direct attachment to myoseptal support only. There are seven to 12 pleural ribs, the first always being on the third vertebra. They are usually present on the abdominal vertebrae only.

The dorsal fin is typically single, comprising both spines (IX-XIV) and soft rays (19-51). A deep notch is present between the penultimate and last spines. The anal fin also comprises spines (I or II) and soft rays (6-21), with the base being typically far shorter than that of the soft dorsal fin.

The pterygiophores supporting the dorsal and anal fin rays are bisegmental, and lack free autogenous medial elements. A well ossified stay is always present. The first pterygiophore in both the dorsal and anal fins usually bears two spines.

Predorsals number 0-3, usually 3. Most commonly, the anterior predorsal is inserted in front of the first neural spine, the middle one between the first and second neural spines, the posteriormost between the second and third neural spines together with the first dorsal pterygiophore, following the 0/0/0+2/ pattern of Ahlstrom *et al.* (1976).

CHARACTERS

Character 81 (Fig. 51): Neural spines reduced in size. Typically in sciaenids, the neural spines are well developed and pointed (Fig. 51A, B and D) as in most percoids, whereas in *Equetus*, the first and second neural spines are reduced in size (Fig. 51C). This derived character is associated with a flag-like spinous dorsal fin, as discussed under Character 99.

Character 82 (Fig. 51): First and second neural spines widely separated. In percoids, including most sciaenids, a general trend is apparent in that the second and third neural spines are widely separated with increased elongation of the body. In *Cynoscion*, *Macrodon*, and *Isopisthus* (Fig. 51D) however, the first and second neural spines are very widely forked, the first being immediately behind the posterior rim of the cranium. This specialization of the neural spines appears to be related to the loss of the predorsal(s) in these genera (see Character 98).

Character 83 (Fig. 52): Fifth parapophysis enlarged. The parapophysis may be either present or absent in the fifth vertebra in sciaenids. If present, it is moderately sized, apparently functioning to serve as the attachment site for the pleural rib. The fifth parapophysis is very large and wing-like in *Ophioscion* and *Stellifer* (Fig. 52E), in which it functions not only to provide the attachment site for the pleural rib, but also to suspend the posterior chamber of the swimbladder utilizing a massive connective tissue development.

Character 84 (Fig. 52): Ventral modification of anterior abdominal vertebrae—*Lonchurus* type. The ventral surface of the anterior vertebrae are strongly modified for suspension of the swimbladder in the Sciaenidae. Show and Yu (1948) and Taniguchi (1969b) described and illustrated this character in some Chinese and Japanese sciaenids. Primitively in percoids, only a pair of processes is present on each centrum. Sciaenid specializations from this primitive condition can be categorized into seven types and treated here accordingly.

In *Lonchurus*, *Paralonchurus brasiliensis*, and *Paralonchurus elegans* (Fig. 52B), the posterior margin of the third centrum and the anterior margin of the fourth

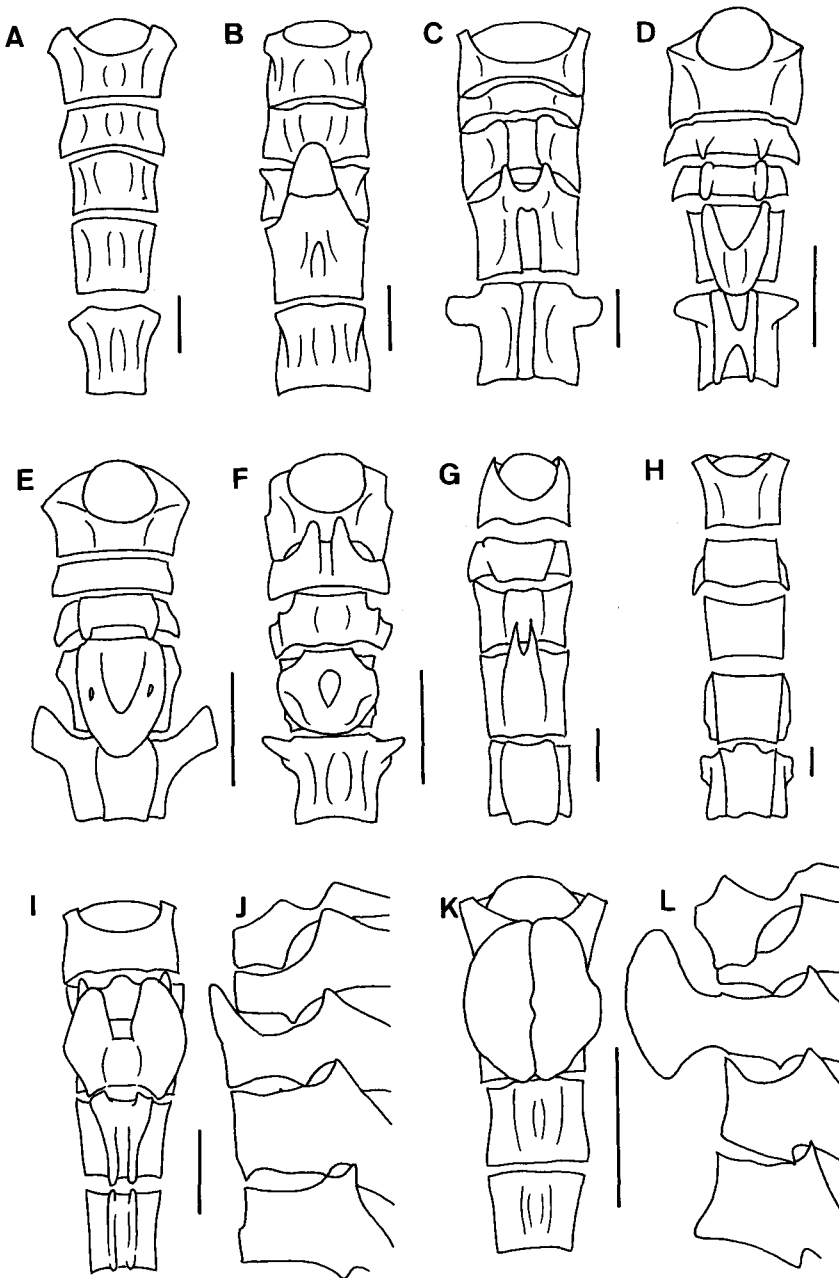

Fig. 52. Ventral and lateral (J and L) views of anterior abdominal vertebrae. A, *Sciaena trewavasae*; B, *Paralonchurus elegans*; C, *Nebris microps*; D, *Corvula macrops*; E, *Stellifer microps*; F, *Johnius (Johnius) belangerii*; G, *Macrodon ancylodon*; H, *Atractoscion aequidens*; I and J, *Larimichthys polyactis*; K and L, *Collichthys niveatus*. Bar=3 mm.

centrum are strongly produced anteroventrally as thin lamina, which combine to form a cylindrical bony tube.

Character 85 (Fig. 52): Ventral modification of anterior abdominal vertebrae—*Pseudotolithus* type. In *Nebris* (Fig. 52C), *Larimus*, *Pteroscion*, *Pseudotolithus* (*Fonticulus*), *P. (Hostia)*, *P. (Pinacovina)*, *P. (Pseudotolithus)*, and *Dendrophysa*, the haemal canal of the fourth centrum is covered by a rounded bony roof, with deeply concave anterior (all) and posterior (all, excepting *Larimus*) margins.

Character 86 (Fig. 52): Ventral modification of anterior abdominal vertebrae—*Stellifer* type. In *Bairdiella*, *Corvula* (Fig. 52D), *Elattarchus*, *Odontoscion*, *Ophioscion*, *Stellifer* (Fig. 52E), *Johnius* (*Johnius*) (Fig. 52F), *J. (Johnieops)*, and *Kathala*, the fourth vertebra is ventrally modified into a horseshoe-shaped arch.

Character 87 (Fig. 52): Ventral modification of anterior abdominal vertebrae—*Cynoscion* type. Anteriorly the fourth vertebral margin bears a pair of horn-like projections, which support the third vertebra in *Cynoscion*, *Macrodon* (Fig. 52G), and *Isopisthus*.

Character 88 (Fig. 52): Ventral modification of anterior abdominal vertebrae—*Atractoscion* type. The ventral surface of the second to fourth vertebrae are flat, and form a right angle with the lateral surface of the vertebrae in *Atractoscion aequidens* (Fig. 52H) (less modified in *A. nobilis*).

Character 89 (Fig. 52): Ventral modification of anterior abdominal vertebrae—*Larimichthys* type. *Larimichthys* (Fig. 52I and J) and *Collichthys* (Fig. 52K and L) are unique in that the third vertebra (not fourth) is modified to support the swimbladder. In both genera, the third vertebra bears a pair of oval bony plates (less developed in *Larimichthys*). See also Character 90.

Character 90 (Fig. 52): Ventral modification of anterior abdominal vertebrae—*Collichthys* type. This is a further modification of the *Larimichthys* type, found in *Collichthys* (Fig. 52K and L), in which the bony plates of each side are tightly united medially, forming a single, ventrally directed, golfclub-shaped process. The third vertebra of *Sonorolux* seems to be similarly modified, but the details could not be observed clearly from the radiographs.

Character 91 (Fig. 51): Epipleural ribs few and reduced. In most sciaenids, epipleural ribs are associated with abdominal vertebrae at least. It is not presently possible however, to determine "the widespread epipleural rib number" in percoids with certainty, due to lack of information. With regard to sciaenids, epipleural ribs most frequently number seven in genera represented in the New World, whereas they number eight to 10 in the Old World genera. I consider seven to be the primitive epipleural rib number for the family, since all sciaenids with a simple (=primitive) swimbladder possess seven epipleural ribs. However, the intraspecific variations rule against application of the epipleural rib number as a character. Consequently, a combination of the number of epipleural ribs (if less than seven) and condition (reduced and unattached to pleural ribs) is considered to be an apomorphic character. This condition is found in the following genera (epipleural rib number in parenthesis): *Nebris* (3), *Cynoscion* (4-5), *Macrodon* (4), *Isopisthus* (4-5) (Fig. 51D), and *Plagioscion* (3-6).

Character 92 (Fig. 53): Epipleural ribs inflated. In most sciaenids, the

epipleural ribs are slender and tapering, whereas in *Sciaena deliciosa* (Fig. 53F) and *S. callaensis*, the sixth and seventh especially are noticeably tear-shaped. In the former species, the first dorsal and anal pterygiophores, and the lower part of the cleithrum, are also inflated (Fig. 53E and G). Rib inflation appears to take place in fairly late stage of the ontogeny, because the seventh rib is clearly inflated in a 297 mm SL specimen of *S. callaensis*, not at all in a 188 mm SL specimen (both examined radiographically).

Character 93: Posterior dorsal fin spines not exposed. In most sciaenids, all dorsal fin spines are exposed, whereas in *Isopisthus* and *Seriphus*, the posterior spines (4-5 and 3-4 respectively) do not project through the skin, giving false impression of two dorsal fins.

Character 94: Soft dorsal and anal fins bases of equal length. Although a combination of long, soft dorsal fin and short anal fin bases is a synapomorphy for the family, a reversal has apparently occurred in *Isopisthus* and *Seriphus*. In these genera, the number of anal fin soft rays (more than 20) far exceeds the maximum number (12) for the rest of the family. Consequently, the anal fin base of the former is as long as the soft dorsal fin base. This condition is considered to be apomorphic, since it is probable that the long, anal fin base developed in step with the notable separation of dorsal fins in these genera (Character 93). Such development assists in maintaining body balance, important for *Seriphus*, which utilizes upper water column (Allen and DeMartini, 1983), unlike from other sciaenids.

Character 95 (Fig. 53): First dorsal pterygiophore bearing one spine. Typically in sciaenids, the first dorsal pterygiophore bears two spines, of which the first is by far the smaller (Fig. 53A), whereas in *Lonchururus* the pterygiophore bears

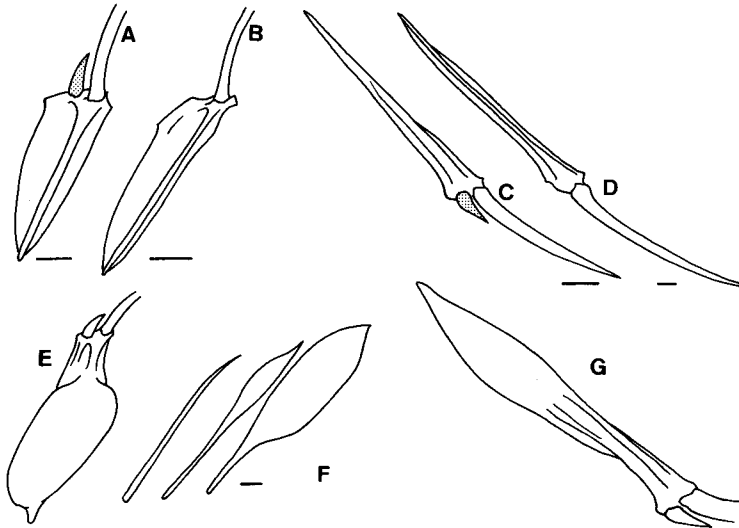

Fig. 53. First pterygiophore (dorsal: A, B, E; anal: C, D, G) and fifth to seventh epipleural ribs (F). A and C, *Johnius (Johnius) belangerii*; B, *Lonchurus lanceolatus*; D, *Menticirrhus americanus*; E-G, *Sciaena deliciosa*. Bar=2 mm.

only a single spine (Fig. 53B). Judging from the size and position of the remaining spine, the first small spine appears to have been lost.

Character 96 (Fig. 53): First anal pterygiophore bearing one spine. In most sciaenids, the first anal pterygiophore bears two spines, of which the first is by far the smaller (Fig. 53C), whereas in *Menticirrhus* the pterygiophore bears only a single spine (Fig. 53D). Judging from the size and position of the remaining spine, the first small spine appears to have been lost.

Character 97 (Fig. 51): Predorsals number less than three—*Equetus* type. The primitive number and arrangement of predorsals in percoids were intensively discussed by Johnson (1984). In sciaenids, three predorsals, with arrangement pattern 0/0/0+2/, are most common and apparently represent the primitive condition. Three conditions of predorsal loss are recognized in the family. In the first condition, the neural spines and pterygiophores of the dorsal fin have undergone no particular modifications. This condition is not included in the analyses, since the intraspecific variations are frequently observed. The second condition is represented by *Equetus* (/2+1+1+1+1+1+1+1+1+1+1), in which there are no predorsals owing to the more anterior relocation of the dorsal fin pterygiophores (Fig. 51C, see also Character 99). The third condition is considered below.

Character 98 (Fig. 51): Predorsals number less than three—*Cynoscion* type. In *Cynoscion* (/0+0/2), *Macrodon* (/0/2), and *Isopisthus* (/0/0+2) (Fig. 51D), predorsals are always absent between the cranium and the first neural spine, owing to the absence of the necessary space for their insertion (see also Character 82).

Character 99 (Fig. 51): Numerous dorsal pterygiophores in front of third neural spine. Typically in sciaenids, there is a single dorsal fin pterygiophore in front of the third neural spine (Fig. 51A), whereas numerous pterygiophores occur in *Pareques* (7; Fig. 51B) and *Equetus* (12; Fig. 51C). In these genera, the pterygiophores are closely arranged, forming a triangular, bony plate, which sustains the dorsal fin, of which the spinous portion is elongated like a flag. McPhail (1961) discussed the close relationships of the two genera, based upon the pterygiophore arrangement. *Equetus* is undoubtedly more advanced in having the higher number of the pterygiophores in front of the third neural spines. This condition may explain the loss of the predorsals, as well as the reduction of the first and second neural spines in this genus.

Other variations

Meristic variables such as the total number of vertebrae and the formation of abdominal and caudal vertebrae were not considered as characters for analysis, not only because the changes are always continuous rather than stepwise, but also because of intraspecific variability. The sciaenid vertebral number, 10+15—the primitive percoid condition (Johnson, 1984, Tominaga, 1986)—is most reasonably hypothesized as the primitive condition, judging from its commonality within the family as well as its characterizing those sciaenids with a primitive swimbladder.

10. CAUDAL SKELETON AND ASSOCIATED MUSCLES (Figs. 54-56)

GENERAL DESCRIPTION

The general configuration of the sciaenid caudal skeleton and associated muscles is shown in Fig. 54. The caudal skeleton usually consists of the following bony elements: five hypurals, one parhypural with a distinct parhypurapophysis, two uroneurals, three epurals, one urostyle, and autogenous haemal spines on preural centra 2 and 3. Two or three ventral radial cartilages are present (verified in *Nebris*, *Pennahia*, *Johnius*, and *Larimichthys*; see Fig. 56A and B).

The caudal skeleton bears both principal rays (typically one unbranched and eight branched on the upper lobe; seven branched and one unbranched on the lower lobe) and procurrent rays. A procurrent spur (Johnson, 1975) is usually well developed.

Sciaenid caudal muscles always comprise the interradiialis, hypochordal longitudinalis, flexor dorsalis, flexor dorsalis superior, flexor ventralis, flexor ventralis inferior, and flexor ventralis externus. The adductor dorsalis is always absent.

The interradiialis principally interconnects all of the principal rays, and is also present between the uppermost principal ray and the next (upper) procurrent ray.

The hypochordal longitudinalis originates mainly from the upper surface of hypural 2, but its origin partially includes the base of hypural 1, parhypurapophysis, and urostyle. It is inserted onto the bases of the dorsal principal rays, excluding the lower two or three. The first, dorsal principal ray always receives the uppermost portion of this muscle.

The flexor dorsalis typically originates on the dorsal half of preural centrum 2 and its neural spine, and extends posteriorly to the dorsal ray bases.

The flexor dorsalis superior originates near the distal end of the last two neural spines and epurals, and is inserted onto the bases of the uppermost principal ray and a few dorsal procurrent rays.

The flexor ventralis arises from preural centrum 2 and its haemal spine, parhypurapopophysis, and lower hypurals, and is inserted onto the bases of all of the ventral principal rays and a few ventral procurrent rays.

The flexor ventralis inferior lies ventral to the flexor ventralis. Its insertion is on the bases of a few ventral procurrent rays.

The flexor ventralis externus usually arises from the side of preural centrum 3, and is inserted onto the second or third ray of the ventral caudal lobe, as a thin transparent fascia.

CHARACTERS

Character 100 (Fig. 55): Lower caudal lobe with six branched rays. Typically in sciaenids, the lower lobe of the caudal fin contains seven branched rays (Fig. 55A), compared with six in *Lonchurus* (Fig. 55B). In the latter, the seventh ray in the lower lobe is unbranched.

Character 101 (Fig. 56): Flexor ventralis externus faded into flexor ventralis. In most sciaenids, the flexor ventralis extrenus is posteriorly connected by fascia to the fin ray base(s), the muscle being separated from the flexor ventralis

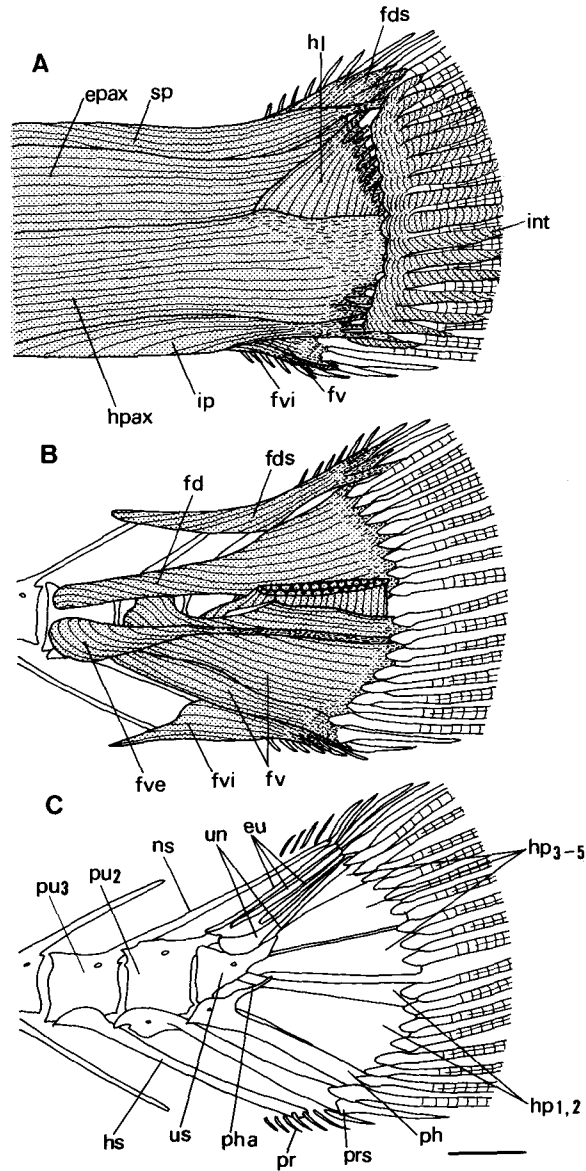

Fig. 54. Caudal skeleton and associated muscles in *Protonibea diacanthus*. A, superficial view; B, superficial muscles removed; C, skeleton. epax, epaxial; eu, epural; fd, flexor dorsalis; fds, flexor dorsalis superior; fv, flexor ventralis; fve, flexor ventralis externus; fvi, flexor ventralis inferior; hl, hypochordal longitudinalis; hp, hypural; hpax, hypaxial; hs, haemal spine; int, interradians; ip, infracarinalis posterior; ns, neural spine; ph, parhypural; pha, parhypuapophysis; pr, procurrent ray; prs, procurrent spur; pu, preural centrum; sp, supracarinalis posterior; un, uroneural; us, urostyle. Bar=5 mm.

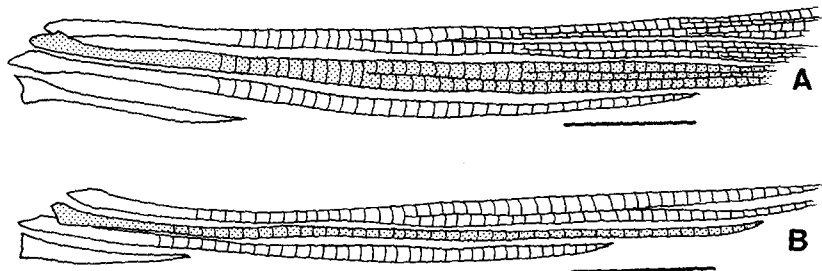

Fig. 55. Sixth lower principal ray to first procurvent ray of *Cheilotrema saturnum* (A) and *Lonchurus lanceolatus* (B). Bar=5 mm.

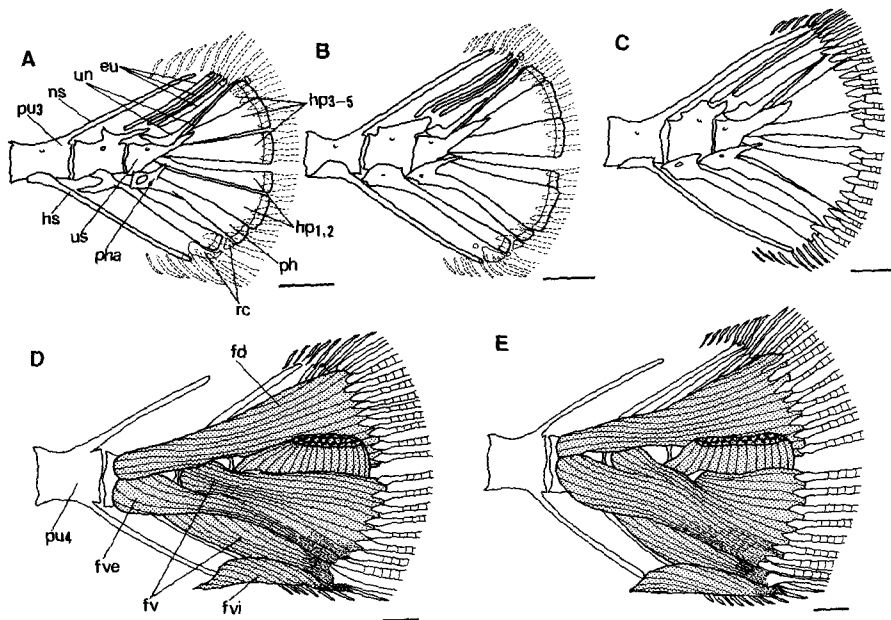

Fig. 56. Caudal skeletons and associated muscles of five sciaenids. A, *Nebris microps*; B, *Johnius (Johnius) belangerii*; C, *Pachypops* sp.; D, *Elattarchus archidium*; E, *Corvula macrops*. rc, radial cartilage; other abbreviations as in Fig. 54. Bar=2 mm.

for its entire length (Fig. 54B) as typically for percoids. However, in *Sciaena gilberti*, *Elattarchus* (Fig. 56D), *Corvula* (Fig. 56E), *Odontoscion*, *Genyonemus*, *Seriplus*, and *Collichthys*, the muscle has lost its posterior connection with the fin ray bases, instead being fused with the flexor ventralis.

Other variations

The following features are not included in analyses, because they are each subject to intraspecific variation. Johnson (1975) argued that the presence of the

procurent spur is primitive for percoids on the basis of its distribution in both preperciforms and perciforms. In light of this, the absence of the spur in *Pachypops* sp. (Fig. 56C), *Collichthys niveatus* appears to be a derived condition. However, application of the character is not possible, as noted below. Johnson listed *Collichthys lucidus* (as *fragilis*) as one of those sciaenids with a spur, but such is not present in my material. Similarly, Johnson found a spur in *Pachypops furchaeus*, but I did not find it in *Pachypops* sp. Both intrageneric and intraspecific variations are therefore apparent. Another character not considered is the fusion of hypurals 1 and 2. Despite a rich variety of caudal fin shape in sciaenids, the formation of the hypurals is remarkably uniform. Only one departure from the primitive five hypurals was found, in *Nebris microps*, which has hypurals 1 and 2 fused. This character is discarded however, since such fusion is not consistent for the species. Two epurals, compared with the usual three, are found in *Pachypops* (Fig. 56C) and *Pteroscion*, but this character is also discarded, owing to variation of epural number within *Nebris microps*.

11. OTOLITH (Figs. 57-61)

GENERAL DESCRIPTION

The sciaenid inner ear contains three otoliths: the lapillus, sagitta (very much the largest), and lagena.

Shape of the sagitta varies within the family, from thin to thick, and from circular to elongate. Usually, a distinct notch or horn-like projection(s) around the outer margin is absent. The longitudinal axis is usually straight.

The inner face of the sagitta is always convex, varying in degree from weak to strong, and transversed by a tadpole-shaped groove (sulcus). The anterior portion of the sulcus is shallow, and expanded into an oval shape (head), whereas the posterior portion is deep and narrowly elongate (tail). The head varies from rather small to moderately large, while the tail is usually well curved (J-shaped), gradually tapering distally.

CHARACTERS

Character 102 (Figs. 57 and 58): Lapillus enlarged—*Kathala* type. A series of specializations in the sciaenid otolith has been discussed under Sciaenid Monophyly (see Characters 20 and 21). Considering the peculiarities shown by the sciaenid otolith, polarity determination is based upon the principle that the condition widespread in those sciaenids with a simple swimbladder, is plesiomorphous for the family, although information from other percoids will be incorporated where possible.

In all sciaenids with a simple swimbladder, the lapillus is far smaller than the sagitta (Fig. 57A), as usual in percoids (Frost, 1927; Schmidt, 1968; Nolf, 1985), and thus the presence of a large lapillus is apomorphous.

Although a large lapillus is possessed by 10 sciaenid genera, homology among them seems to be highly doubtful, in spite of the following additional similarities, which have resulted from enlargement of the lapillus: anterior margin of the sagitta concave or nearly straight; sulcus head of the sagitta bent obliquely; posterior

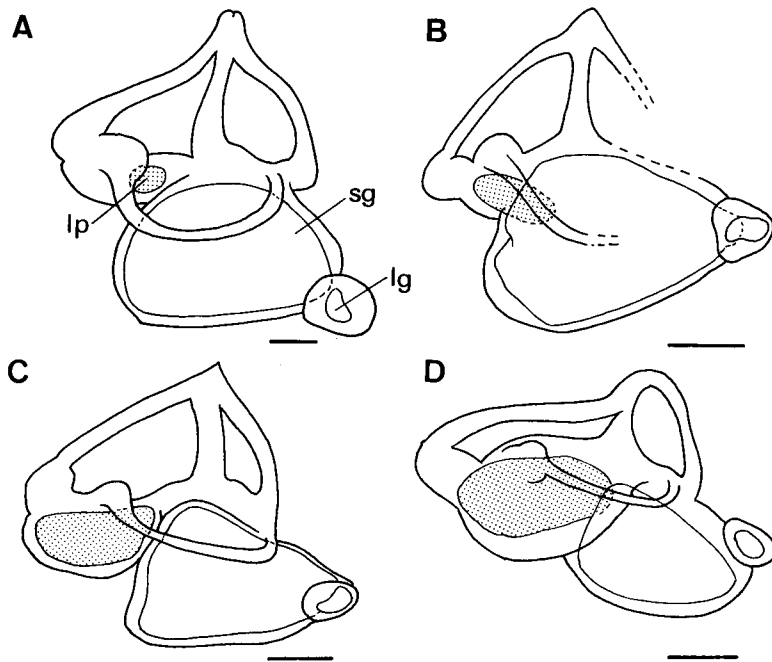

Fig. 57. Inner ears of four sciaenids. A, *Pennahia argentata*; B, *Kathala axillaris*; C, *Johnius (Johnius) belangerii*; D, *Stellifer microps*. lg, lagena; lp, lapillus; sg, sagitta. Bar=2 mm.

margin of the sagitta pointed, enabling entry to the narrow, posterior corner of the auditory bulla (possibly because the sagitta has been pushed backward by the enlargement of the lapillus); sagitta relatively small. Whilst it is true that the 10 genera can be grouped on the basis of lapillus condition, examination of a second, sound-related organ, the swimbladder, shows that the cephalic portion of the latter has been attained in three, basically different ways (see section 12, p. 81). Although the deeply cephalic appendage is not always associated with an enlarged lapillus, because both lapillus and cephalic appendages have sound-related functions, it is highly unlikely that their modification has been independent. A similar combination of elaborated swimbladder and enlarged lapillus is also found in the Ostariophysii (Greenwood *et al.*, 1966), in which the inner ear and swimbladder are linked by the Weberian apparatus. Consequently, the enlarged lapillus character is divided into three types: *Kathala* type (Figs. 57B and 58A), *Johnius* type (Figs. 57C and 58B), and *Stellifer* type (Figs. 57D and 58C). In addition, the somewhat differently modified sagitta sulcus in the three groups also supports the non-homologous nature of the enlarged lapillus.

Kathala type comprises *Kathala* and *Macrospinosa*. Although *Macrospinosa* was examined only radiographically, the enlarged lapillus was clearly recognizable. In addition, Trewavas' (1977) figure of the sagitta shows the anterior margin to be concave in this genus. Since *Macrospinosa* is identical with *Kathala*, in the

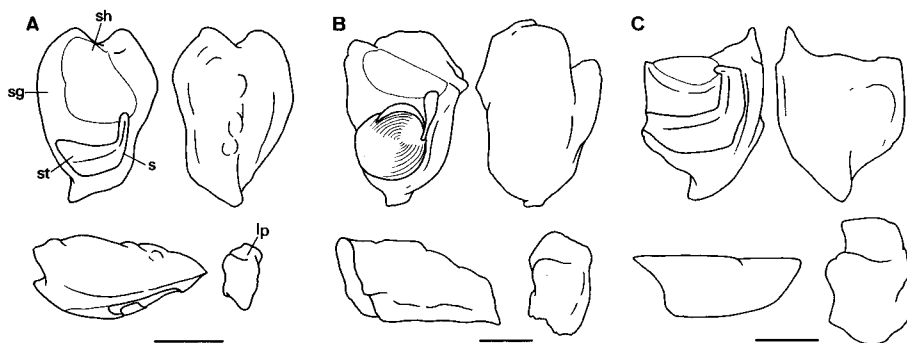

Fig. 58. Sagittae and lapilli of three sciaenids. A, *Kathala axillaris*; B, *Johnius (Johnius) belangerii*; C, *Bairdiella chrysoura*. lp, lapillus; s, sulcus; sg, sagitta; sh, sulcus head; st, sulcus tail. Top; inner surface (left), outer surface (right). Bottom; lateral view (left), lapillus (right). Bar=3 mm.

disposition of the swimbladder appendage (see Fig. 71), the former must be included in this type. Compared with the other genera, enlargement of the lapillus is weak in the *Kathala* type.

Character 103 (Figs. 57 and 58): Lapillus enlarged—*Johnius* type. See Character 102. In this type, comprising *Johnius (Johnius)* and *J. (Johnieops)*, a

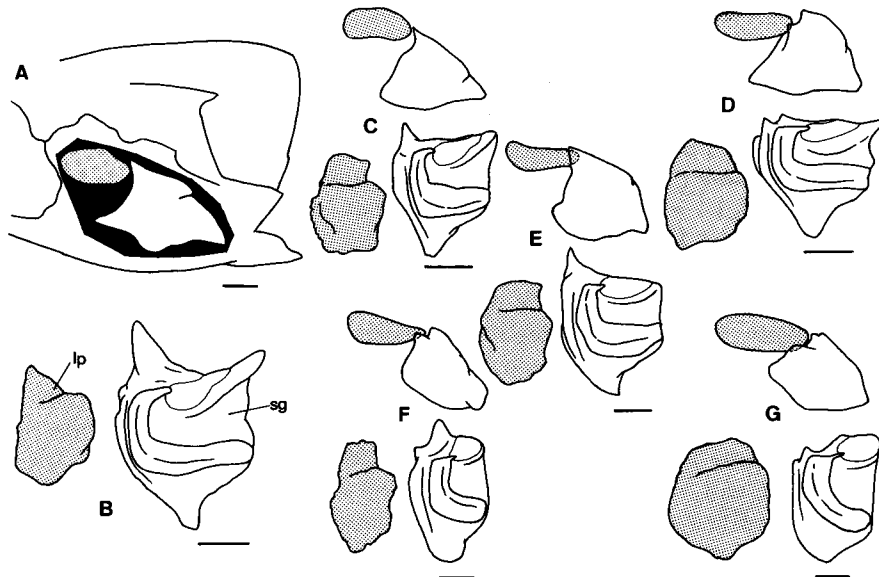

Fig. 59. Relationship between lapilli and sagittae in six sciaenids. A and B, *Elattarchus archidium*; C, *Corvula macrops*; D, *Odontoscion dentex*; E, *Bairdiella chrysoura*; F, *Ophioscion sciera*; G, *Stellifer rastrifer*. Lapilli are shaded. Abbreviations as in Fig. 58. Bar=2 mm.

large foramen has developed (Character 23), through which the enlarged lapillus can be seen. It is likely that the foramen has developed concurrent with the enlargement of the lapillus.

Character 104 (Figs. 57-59): Lapillus enlarged—*Stellifer* type. See Character 102. This type comprises *Elattarchus* (Fig. 59A and B), *Corvula* (Fig. 59C), *Odontoscion* (Fig. 59D), *Bairdiella* (Figs. 58C and 59E), *Ophioscion* (Fig. 59F), and *Stellifer* (Figs. 57D and 59G) (see Chao, 1978a).

Horn-like projections of variable size are present on the anterior margin of the sagitta. In addition, size and shape of the sulcus head are not uniform. Although such character variability and lack of distinctive developmental stages mitigate against inclusion in phylogenetic analyses, some comments can be made. There is an apparent trend in that a relatively small lapillus is accompanied by a sagitta with a prominent dorsal projection (Fig. 59A-C, E), whereas a relatively big lapillus is accompanied by a sagitta with a weak projection or even a concavity, which accepts the posterior portion of the lapillus (Fig. 59D, F, G). Hence a conclusion might be drawn that the horn-like projection on the sagitta represents a part which has not been lost, owing to the development of the lapillus. Accordingly, the presence of prominent sagittal spine may be a plesiomorphous condition within the *Stellifer* type. Similarly, the variable location and size of the sulcus head can also be

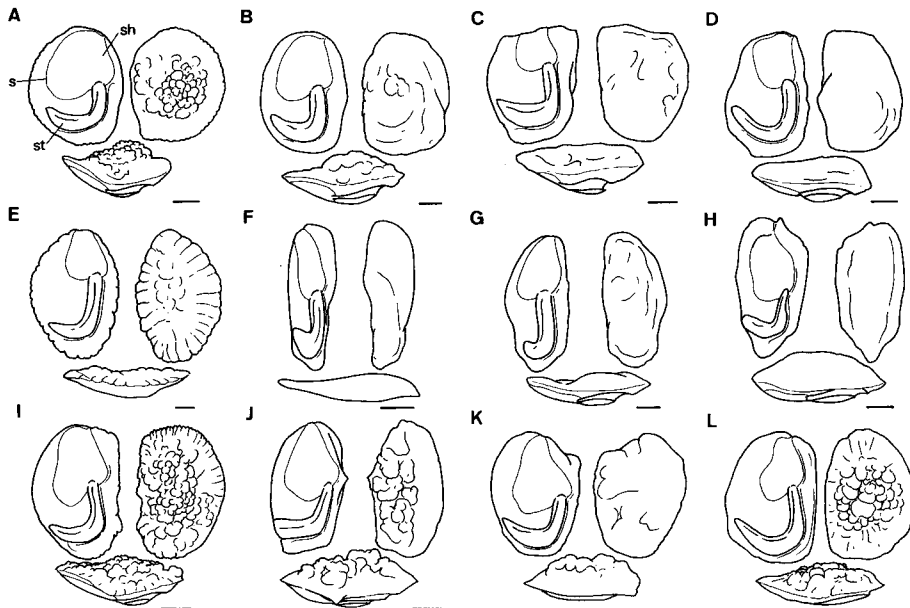

Fig. 60. Sagittae of 12 sciaenids. A, *Sciaena umbra*; B, *Umbrina canariensis*; C, *Equetus lanceolatus*; D, *Plagioscion auratus*; E, *Pachyurus schomburgkii*; F, *Lonchurus lanceolatus*; G, *Cynoscion jamaicensis*; H, *Panna microdon*; I, *Protonibea diacanthus*; J, *Austronibea oedogenys*; K, *Dendrophysa russelli*; L, *Pentheroscion mbizi*. Left, inner surface; right, outer surface; bottom, lateral view. Abbreviations as in Fig. 58. Bar = 2 mm.

explained in terms of lapillus size. In the *Stellifer* group, the sulcus head lies on the anterior surface of the sagitta. With increase in lapillus size, the sulcus head becomes rounded, smaller, and more ventrally located (compare Fig. 59A-D with E-G). These changes can be explained by the intrusion of the posterior portion of the lapillus into the anterodorsal portion of the sagitta as the lapillus enlarges, since the sulcus head becomes increasingly restricted.

Character 105 (Fig. 61): Sagitta twisted. As in percoids, the sagitta is not twisted along its longitudinal axis in most sciaenids (Figs. 60 and 61D-L), including those with a simple swimbladder, whereas it is twisted in *Pteroscion* (Fig. 61A), *Pseudotolithus* (*Fonticulus*), *P.* (*Hostia*) (Fig. 61B), *P.* (*Pinnacorvina*), and *P.* (*Pseudotolithus*) (Fig. 61C).

Character 106 (Fig. 61): Sagitta strongly twisted. This is a further stage of specialization (Character 105), and is found in all of the genera and subgenera listed in Character 105, except for *Pteroscion*.

Character 107 (Fig. 61): Sagitta notched posteriorly. In those sciaenids with a simple swimbladder, the posterior margin of the sagitta is rounded simply as in most sciaenids, whereas in *Nebris* the posterior margin is deeply notched (Fig. 61D).

Character 108 (Fig. 59): Sulcus head situated on anterior surface of

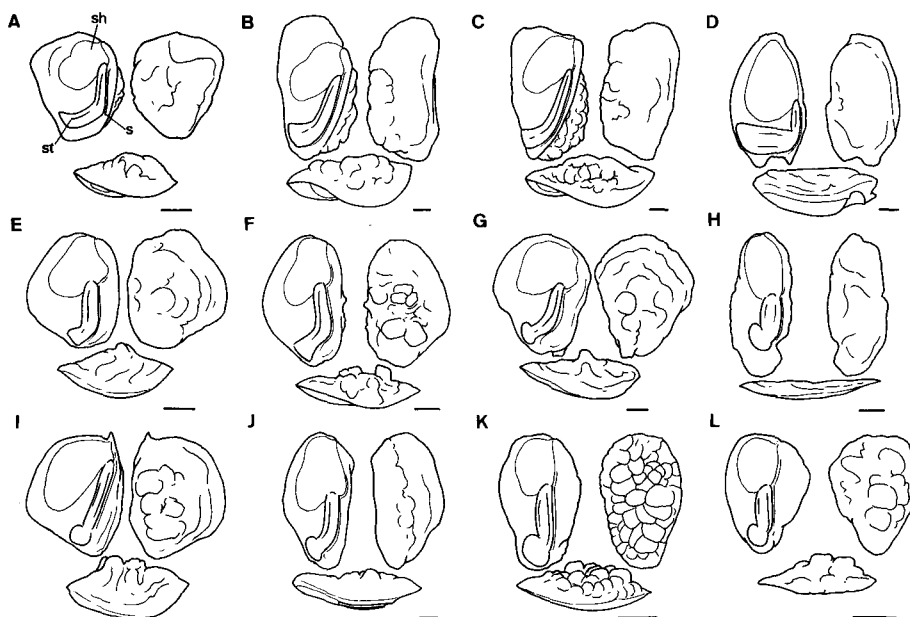

Fig. 61. Sagittae of 12 sciaenids. A, *Pteroscion peli*; B, *Pseudotolithus* (*Hostia*) *moorii*; C, *Pseudotolithus* (*Pseudotolithus*) *senegalensis*; D, *Nebris microps*; E, *Pennahia macrophthalmus*; F, *Atrobucca nibe*; G, *Micropogonias furnieri*; H, *Macrodon ancylodon*; I, *Otolithoides pama*; J, *Chrysochir aureus*; K, *Larimichthys polyactis*; L, *Collichthys lucidus*. Left, inner surface; right, outer surface; bottom, lateral view. Abbreviations as in Fig. 58. Bar=2 mm.

sagitta. In those sciaenids with a simple swimbladder, the sulcus head is located on the inner surface of the sagitta, whereas in *Elattarchus*, *Corvula*, *Odontoscion*, *Bairdiella*, *Ophioscion*, and *Stellifer*, it is located on the anterior surface of the sagitta (Fig. 59).

Character 109 (Fig. 61): Sulcus tail only slightly curved. In sciaenids, the degree of curvature in the sulcus tail is variable. Although the sulcus tail is weakly to moderately curved in most percoids, it is well curved in those sciaenids with a simple swimbladder (Fig. 60A-C). Considering the strongly apomorphic nature of the sciaenid otolith, as discussed in the monophyly of the Sciaenidae, the well curved tail can be reasonably hypothesized as primitive for sciaenids. However, although polarities of this character are thus postulated, small differences only in the degree of the curvature in some family members, restrict usefulness of the character. Accordingly, this character is applicable only within a monophyletic unit, defined by other characters, in which an objective discrimination between "well curved" and "slightly curved" is possible. Within the subfamily Otolithinae, defined by Trewavas (1977) and confirmed in this study as a monophyletic grouping, this character is effective. In the Otolithinae, the derived condition is found in *Pennahia* (Fig. 61E), *Atrobucca* (Fig. 61F), *Chrysochir* (Fig. 61J), *Otolithes*, *Larimichthys* (Fig. 61K), and *Collichthys* (Fig. 61L).

Character 110 (Fig. 61): Distal end of sulcus tail circular. In most percoids, including sciaenids with a simple swimbladder, the distal end of the sulcus tail is never expanded distally, whereas the tail is expanded into a circular shape in *Micropogonias* (Fig. 61G), *Macrodon* (Fig. 61H), *Otolithoides* (Fig. 61I), *Chrysochir* (Fig. 61J), *Otolithes*, *Larimichthys* (Fig. 61K), and *Collichthys* (Fig. 61L).

Character 111 (Fig. 58): Distal end of sulcus tail with a deep hollow cone. The condition has been observed only in *Johnius* (*Johnius*) and *J.* (*Johnieops*) (Fig. 58B).

12. SWIMBLADDER (Figs. 62-74)

GENERAL DESCRIPTION

The sciaenid swimbladder is thick walled and single chambered, usually being suspended by the third to fifth vertebrae. It typically occupies the entire length of the abdominal cavity, but does not extend posteriorly beyond the anal pterygiophores.

Various kinds of appendages, arising from the main body of the swimbladder, are classified into: bud-like, horn-like, tube-like, and arborescent. They are further distinguished by their branching pattern, number, and length. Appendage origin varies from the anterior to the posterior end of the swimbladder. Occasionally, the appendages develop along the entire lateral surface of the swimbladder. Usually, appendages do not extend forward through the septum transversum, but they extend into the head (below the cranium) through the septum in some. These appendages are named as cephalic.

A drumming muscle is typically present in males, but is usually weak or absent in females. If present, it usually originates from a thin, free-lying sheet of tendon (aponeurosis) on the dorsal side of the swimbladder.

PRIMITIVE SWIMBLADDER FOR THE SCIAENIDAE

It is considered that a simple, elongate and carrot-shaped swimbladder, which occupies the entire length of the abdominal cavity, is plesiomorphous for sciaenids. Although a range of variation is present in percoids viz., a pair of knob-shaped appendages in *Synagrops* and *Doederleinia* (Katayama, 1959; pers. obs.), two chambered in the Teraponidae (Vari, 1978; pers. obs.), constricted or vestigial in some species of *Pempheris* (Tominaga, 1968, 1986; pers. obs.), horn-like or tube-like appendages in the Sillaginidae (McKay, 1986; pers. obs.) and Gerreidae (pers. obs.), the vast majority of percoids possess a simple, carrot-shaped swimbladder. Departures from this morph are regarded as apomorphic. Moreover, the ontogenetic changes in sciaenid swimbladders are consistent with the hypothesis that a simple swimbladder is primitive for the family. Although supporting examples are few, available evidence indicates that a simple juvenile swimbladder transforms into a complex adult one in *Austronibeia*, *Pennahia*, and *Nibeia* (pers. obs.). Appendages themselves may change ontogenetically from simple to complex (Yamada, 1973; Trewavas, 1977; Chao, 1978a; pers. obs.). For polarity determination of appendage variation, structural complexity is primarily used, in the absence of feasible outgroup comparisons.

A simple swimbladder, lacking appendages, has been treated as the defining character for the tribe Sciaenini by Trewavas (1962, 1977) and Chao and Miller (1975), and the subfamily Sciaeninae by Mohan (1972) and Trewavas (1977). However, this grouping will be shown to be invalid cladistically. In the material examined, the primitive condition is found in *Sciaena deliciosa*, *S. umbra*, *S. trewavasae* (Fig. 62A), *Equetus*, *Pareques*, *Leiostomus*, *Ctenosciaena* (Fig. 62B), *Umbrina*, *Menticirrhus* (but size reduced), *Pachyurus schomburgkii* (Fig. 64G), *Aplodinotus*, *Cheilotrema*, and *Seriphus*.

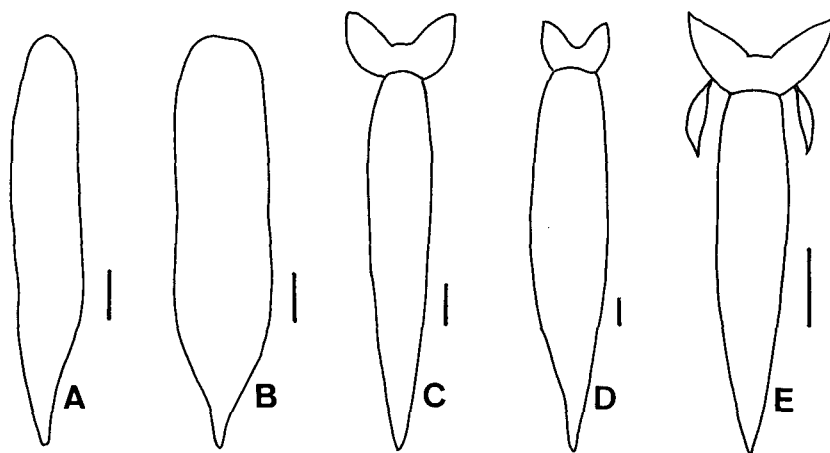

Fig. 62. Swimbladders of five sciaenids. A, *Sciaena trewavasae*; B, *Ctenosciaena gracircirrhus*; C, *Cornula macrops*; D, *Elattarchus archidnum*; E, *Stellifer rastrifer*. Bar = 5 mm.

CHARACTERS

Character 112 (Fig. 62): Swimbladder two chambered. *Stellifer* pattern of Chao (1978a). The swimbladder is divided by a constriction into the anterior and posterior chambers (Fig. 62C-E). The anterior chamber is york-shaped, and suspended by the modified basioccipital (see Character 38); the posterior chamber is elongate and tapering, and suspended by the modified fourth vertebra (see Character 85). *Corvula* (Fig. 62C), *Elattarchus* (Fig. 62D), *Odontoscion*, *Bairdiella*, *Ophioscion*, and *Stellifer* (Fig. 62E) all possess this condition, although further variations exist within these genera (see Characters 113 and 114).

Character 113 (Fig. 63): Anterior chamber of swimbladder laterally expanded to outer rim of pterotic. The anterior chamber of the swimbladder terminates laterally below the intercalar in *Corvula*, *Elattarchus*, *Odontoscion* (Fig. 63A), and *Bairdiella*, whereas it is further expanded, reaching to the outer rim of the pterotic in *Ophioscion* and *Stellifer* (Fig. 63B). The latter condition is considered apomorphic, since the expansion apparently increases hearing ability by extending the swimbladder to close to the outer surface of the body.

Character 114 (Fig. 62 and 63): A pair of appendages on anterior chamber of swimbladder. This is one of the diagnostic characters that Chao (1978a) applied in his definition of *Stellifer*, wherein a pair of appendages has developed from the posterolateral wall of the anterior chamber (Figs. 62E and 63B).

Character 115 (Fig. 64): A pair of horn-like appendages arising at anterior end of swimbladder. A single pair of appendages arising at the anterior end of the swimbladder is seemingly the most common and most easily attained

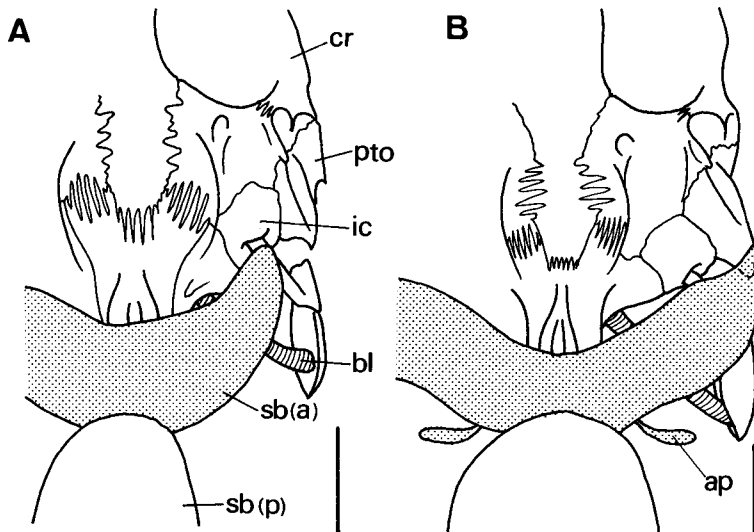

Fig. 63. Relationship between anterior chambers of swimbladders and crania of two sciaenids. A, *Odontoscion dentex*; B, *Stellifer microps*. ap, appendage; bl, Baudelot's ligament; cr, cranium; ic, intercalar; pto, pterotic; sb (a), anterior chamber of swimbladder; sb (p), posterior chamber of swimbladder. Bar=5 mm.

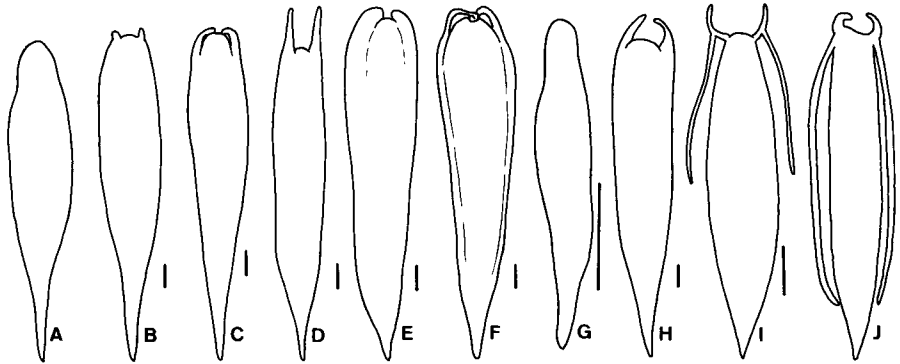

Fig. 64. Swimbladders of 10 sciaenids. A, *Larimus fasciatus* (redrawn from Chao, 1978a); B, *Larimus breviceps*; C, *Atractoscion aequidens*; D, *Cynoscion jamaicensis*; E, *Plagioscion ternetzi*; F, *Plagioscion auratus*; G, *Pachyurus schomburgkii*; H, *Pachyurus* sp.; I, *Pachypops* sp.; J, *Paralonchurus brasiliensis*. Bar=5 mm.

modification in the family. Observations on some ontogenetic sequences of swimbladders (*Pogonias*, Chao, 1978a; *Austronibeia*, *Pennahia*, and *Nibeia*, pers. obs.), suggest that many complex adult morphs have initially started from the development of a single pair of knob-like appendages at the anterior end of the swimbladder, subsequently undergoing further changes or adding additional appendages. Available data, however, are too meager to generalize, and thus the adult morphs are primarily considered here. This character includes those sciaenids possessing a single pair of anteriorly based horn-like appendages, viz., *Larimus breviceps* (Fig. 64B, but not in *L. fasciatus*, Chao, 1978a, Fig. 64A), *Atractoscion* (Fig. 64C), *Cynoscion* (Fig. 64D), *Macrodon*, *Isopisthus*, *Plagioscion ternetzi* (Fig. 64E), *Pachyurus* sp. (Fig. 64H, but simple in *P. schomburgkii*; Fig. 64G), *Pachypops* (Fig. 64I), *Paralonchurus elegans*, *P. brasiliensis* (Fig. 64J), *Lonchurus*, *Sciaenops* (Fig. 68F), *Kathala* (Fig. 71A), *Macrospinosa* (Fig. 71B), *Panna* (Fig. 71C and D), and *Boesemanina* (Fig. 71E).

The swimbladder appendage of *Plagioscion ternetzi* originates anteriorly (Fig. 64E), but is more posteriorly in *P. auratus* (Fig. 64F). The posterior origin in *P. auratus* has probably resulted from a progressive incision initiated at the inner, anterior corner of the appendage, since in *P. ternetzi*, the swimbladder is notched dorsally and ventrally along the sides, although not forming a separate tubule. Such a trend seems to be present also in *Cynoscion*, since a parallel condition is found in *C. nebulosus* (Tower, 1908, pl. 6, fig. 2). Accordingly, the posterior origin of the appendages in *P. auratus* is considered to be derived from the *Cynoscion* pattern and the most primitive condition in *Plagioscion* (Character 114) is treated as the representative of the genus.

Character 116 (Figs. 64, 65, 71): A pair of tube-like appendages arising at anterior end of swimbladder. This character is applicable to those sciaenids in which the swimbladder is associated with a pair of simple, tube-like appendages, arising at the anterior end of the swimbladder. This character is considered addi-

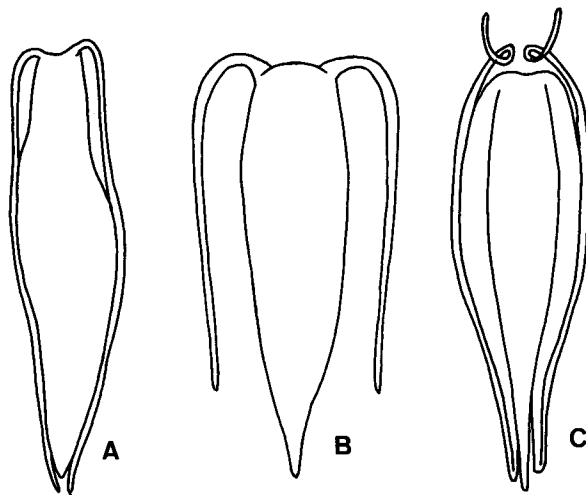

Fig. 65. Swimbladders of three sciaenids. A, *Totoaba macdonaldi*; B, *Bahaba polykladiskos* (redrawn from Chu *et al.*, 1963); C, *Nebris microps*.

tional to the presence of other modifications. For example, the swimbladder of *Paralanchurus brasiliensis* (Fig. 64J) is interpreted as a simple swimbladder + Character 115 + Character 116. The following sciaenids are scored for this character: *Pachypops* (Fig. 64I), *Paralanchurus brasiliensis* (Fig. 64J), *P. elegans*, *Lanchurus*, *Totoaba* (Fig. 65A), *Nebris* (Fig. 65C), *Panna* (Fig. 71C and D), and *Boesemania* (Fig. 71F).

According to Trewavas (1977), the Indo-West Pacific genus *Bahaba* is also characterized by a pair of tubular appendages (Fig. 65B). However, although *Bahaba* resembles the sciaenids listed above, homology of the tubules is doubtful, since those of *Bahaba* are separated from the main bladder by the drumming muscle or peritoneum (Trewavas, 1977), making a sharp contrast with former, whose tubules lie between the peritoneum and main bladder. Unfortunately, specimens of *Bahaba* were unavailable for this study, and thus only the nonhomologous attainment of the tube-like appendages can be suggested here.

Character 117 (Fig. 65): A pair of tube-like appendages, arising at anterior end of swimbladder, extending backward, and looping forward. This is the *Nebris* pattern of Chao (1978a) (Fig. 65C) and a further development of Character 116.

Character 118 (Fig. 66): A pair of tube-like appendages, divided into several tubules, arising at anterior end of swimbladder. Trewavas (1962) defined the East African sciaenid tribe Pseudotolithini on swimbladder structure in which a pair of tube-like appendages, divided into several tubules, arose from the anterior end of the swimbladder. The following sciaenids are characterized by this condition: *Pteroscion* (Fig. 66A), *Miracorvina* (Fig. 66B), *Pseudotolithus* (*Fonticulus*) (Fig. 66C), *P. (Hostia)*, *P. (Pinnacorvina)*, *P. (Pseudotolithus.)*, and *Pentheroscion* (Fig. 66D). Although their swimbladder appendages are constructed

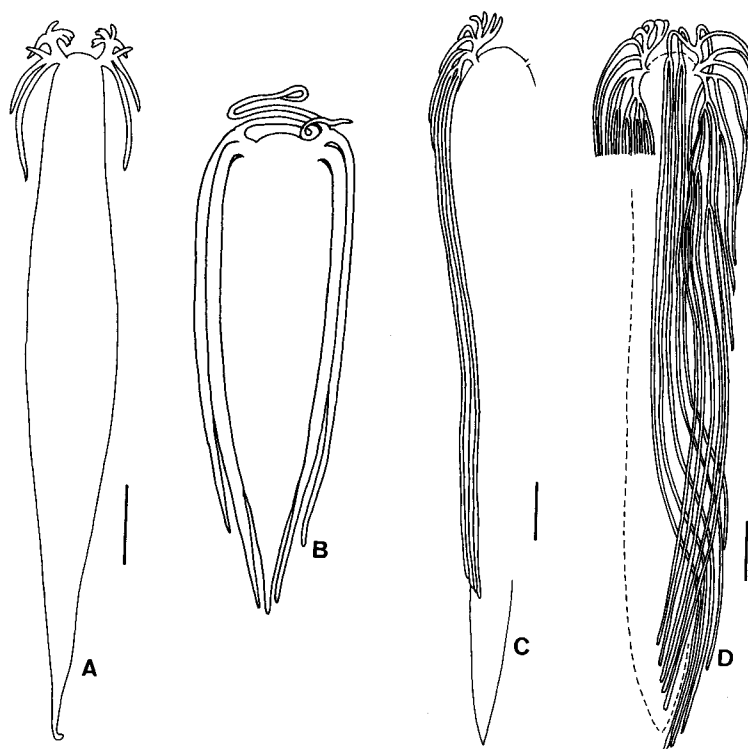

Fig. 66. Swimbladders of four sciaenids. A, *Pteroscion peli*; B, *Miracorvina angolensis* (redrawn from Chao, 1981); C, *Pseudotolithus (Fonticulus) elongatus*; D, *Pentheroscion mbizi*. Bar=5 mm.

on the same principle, they can be further divided into two groups, on the length of the appendages (Character 119).

Character 119 (Fig. 66): Tube-like appendage divided into several long tubules. This is a further development of Character 118. The appendages are short, the longest not reaching mid-length of the swimbladder in *Pteroscion* (Fig. 66A), whereas they are long, reaching more than mid-length of the bladder in the other genera (Fig. 66B-D).

Character 120 (Fig. 67): A pair of tube-like appendages arising at posterior portion of swimbladder. A pair of long, tube-like appendages arising posteriorly, extend forward along the bladder wall in *Micropogonias*, *Otolithoides*, and *Plagioscion auratus*, although in *Micropogonias* and *Plagioscion*, the condition is not homologous. Chao's (1978a) illustration of the juvenile *Micropogonias* swimbladder showed a pair of short appendages arising posteriorly. This indicates that the *Micropogonias* appendage originates posteriorly, becoming progressively longer. However, in *Plagioscion auratus* the tube-like appendages are attained by modification of anteriorly arising appendages (see Character 115). Insufficient information is available at present to clarify the situation of *Otolithoides* (see also Character 131). For the time being, *Micropogonias* and *Otolithoides* are categorized



Fig. 67. Swimbladders of two sciaenids. A, *Micropogonias furnieri*; B, *Otolithoides pama*. Bar=10 mm.

together.

Character 121 (Fig. 68): Numerous interconnected appendages arising along sides of swimbladder. A series of appendages along the sides of the swimbladder characterize *Roncador* (Fig. 68A), *Genyonemus* (Fig. 68B-D), *Pogonias* (Fig. 68E), and *Sciaena gilberti* in the New World, and the subfamily Otolithinae (sensu Trewavas, 1977) in the Old World (Figs. 69 and 70). Although similar however, close examination reveals that the nature of the appendages is considerably different in the two geographic groups. In the Otolithinae, the appendages are free from one another, whereas in the New World genera the appendages are interconnected to one another. This is especially clear in the anterior and posterior appendages

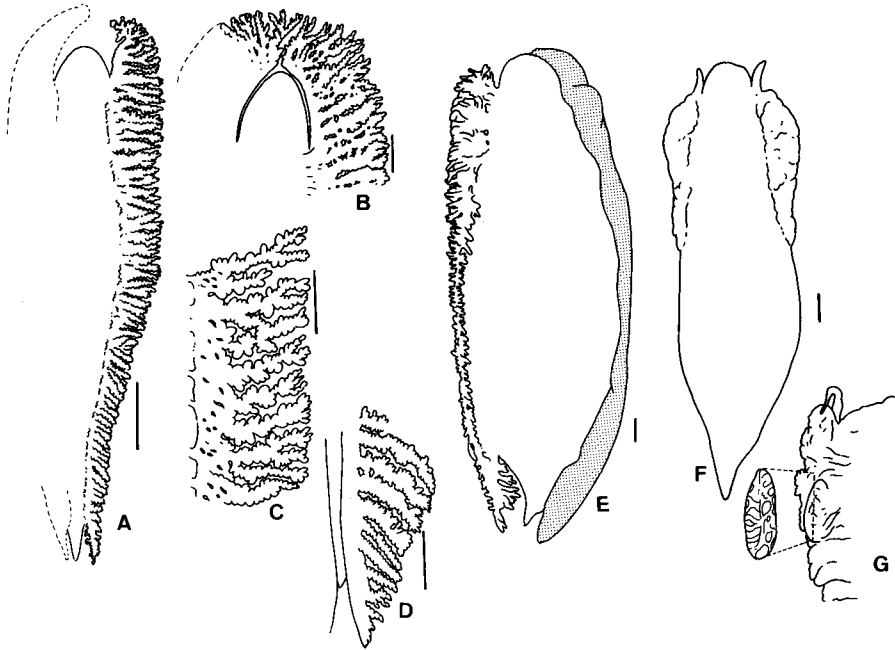

Fig. 68. Swimbladders of four sciaenids. A, *Roncador stearnsii*; B-D, *Genyonemus lineatus* (B, anterior portion; C, middle portion; D, posterior portion); E, *Pogonias cromis*; F and G, *Sciaenops ocellata* (G, cross section of appendage, redrawn from Chao, 1978a). Bar=5 mm.

(except for *S. gilberti*, see below).

Moreover, the disposition of the drumming muscle is also different (Fig. 74). In most sciaenids, including both those with a simple swimbladder and the Otolithinae, the muscle originates from a thin sheet of tendon (aponeurosis), which lies free on the dorsal surface of swimbladder (Fig. 74A), whereas in *Roncador* (Fig. 74B), *Genyonemus* (Fig. 74C), *Pogonias* (Fig. 74D), and *Sciaenops*, the muscle originates directly on the bladder wall, below (*Roncador*, *Genyonemus*, and *Pogonias*) or lateral (*Sciaenops*; see Character 122) to the appendages. In these genera, the aponeurosis is not present. If the relationship between the aponeurosis and drumming muscle is consistent, it is possible that the lateral appendages of the New World sciaenids (except for *S. gilberti*, see below) are homologous with the aponeurosis, whereas the appendages of the Old World sciaenids are derived from the modification of the bladder wall itself. Although ontogenetic studies are necessary for confirmation of an aponeurosis origin of the appendages, such is possible, since the aponeurosis is a continuous sheet of tendon, which is in accordance with the interconnected nature of appendages.

The swimbladder of *Sciaena gilberti* is characterized by 10-15 sac-like, lateral appendages (Chao, 1986), which are free from one another according to Chao's diagram. Probably owing to small specimen size, they could not be observed in this

study. As suggested by Chao, the appendages of this species are apparently autapomorphic, since numerous, sac-like appendages are known only from this species. Consequently, only the three New World genera, *Genyonemus*, *Roncador*, and *Pogonias*, are included under this character.

Character 122 (Fig. 68): Swimbladder with a pair of sac-like appendages comprising of numerous, labyrinthine chambers. The *Sciaenops* pattern of Chao (1978a), it is found only in the monotypic genus, *Sciaenops*. A pair of sac-like appendages develop dorsolaterally along the anterior half of the swimbladder, being comprised of numerous labyrinthine chambers (Fig. 68F and G). In the young specimen (294 mm SL) examined here, such labyrinthine chambers had not reached the stage described and figured by Chao (1978a) for adult material (ca. 1 m SL). This appendage may be a modification of the aponeurosis (see Character 121), but its morphology is unique to *Sciaenops*.

Character 123 (Figs. 69 and 70): Numerous arborescent appendages arising along sides of swimbladder. A number of arborescent appendages arising along the entire lateral surface of the swimbladder is the sole synapomorphy of the Indo-West Pacific subfamily Otolithinae, as defined by Trewavas (1977). This is by far the dominant swimbladder morph in that region, characterising the following sciaenids: *Argyrosomus*, *Protonibeia*, *Megalonibeia*, *Pennahia*, *Atrubucca*, *Chrysochir*, *Otolithes*, *Pterotolithus*, *Sonorolux*, *Larimichthys*, *Collichthys*, *Aus-*

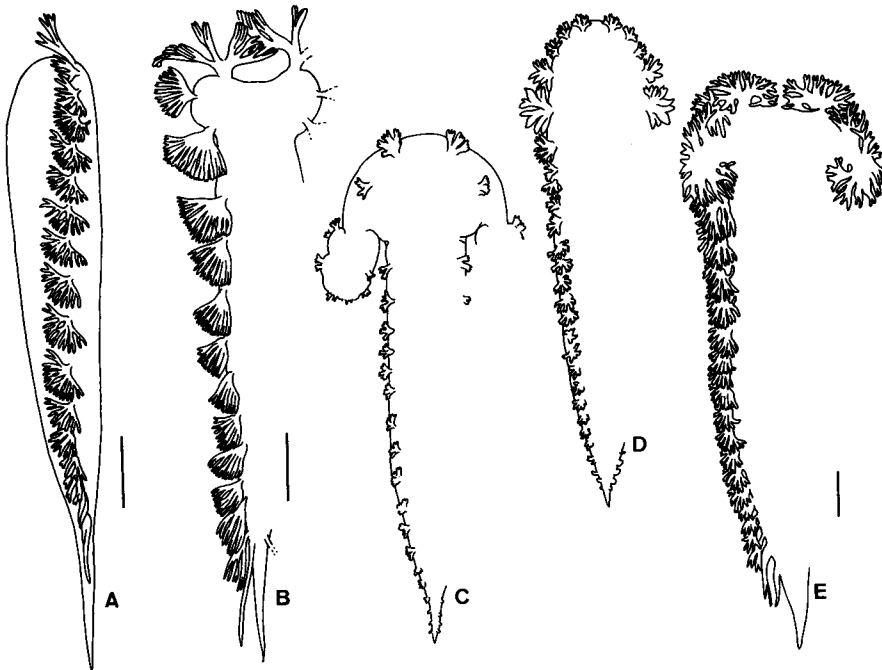

Fig. 69. Swimbladders of six sciaenids. A, *Dendrophysa russelli*; B, *Johnius* (*Johnius*) sp.; C, *Megalonibeia fusca* (redrawn from Chu et al., 1963); D, *Argyrosomus japonicus* (redrawn from Chu et al., 1963); E, *Protonibeia diacanthus*. Bar=5 mm.

tronibeae, *Dendrophysa*, *Nibeae*, *Aspericorvina*, *Daysciaena*, *Paranibeae*, *Johnnius* (*Johnnius*), and *Johnnius* (*Johnnieops*). Within them, a series of variations in the basic form are found (Characters 124-127). Although the presence or absence of cephalic appendages is one of the major differences, this character is discussed later (Characters 127-134).

Character 124 (Fig. 69): Swimbladder hammer-shaped. One of the characters on which Trewavas (1977) defined the tribe Johniini. The anterior portion of the swimbladder is swollen laterally, forming the hammer-shaped swimbladder of *Johnnius* (*Johnnius*) (Fig. 69B) and *J.* (*Johnnieops*).

Character 125 (Fig. 69): Anterior appendages enlarged. This condition characterizes *Megalonibeae* (Fig. 69C), *Argyrosomus japonicus* (Fig. 69D), and *Protonibeae* (Fig. 69E).

The swimbladder is anteriorly broad and projects posteriorly as a pair of stiff lobes in *Megalonibeae*. Chu *et al.* (1963) and Trewavas (1977) diagnosed a subfamily and a tribe respectively on the basis of this characteristic. Trewavas stated that "the expansion of the anterior end of the main bladder has occurred twice, resulting in the hammer-shaped johnine bladder and the anchor-shaped bladder of *Megalonibeae*". However, contrary to Trewavas' view, I do not consider that the *Megalonibeae* condition has resulted from the expansion of the "main" bladder. Trewavas pointed out that the similarities between *Megalonibeae* and *Argyrosomus japonicus* included a relatively small eye, double-truncated caudal fin, and relatively small swimbladder appendages. However, more noticeable is the fact that in *A. japonicus* few anterior appendages become proportionally larger than other appendages during growth, as shown by Taniguchi and Okada (1984). A similar trend is observed in *Protonibeae*, in which the stem of the larger appendage is very broad and stiff. It should be noted that the position of the broad lobe in *Megalonibeae* is identical with that of the enlarged appendages in *A. japonicus* and *P. diacanthus*. Although ontogenetic studies of the swimbladder of the *Megalonibeae* swimbladder are necessary for corroboration, I believe that the anchor-shaped swimbladder is not the result of expansion of the "main" bladder, but of excessive development of the anterior appendage(s), as foreshadowed by *A. japonicus* and *Protonibeae*. Within *Argyrosomus* species, the anterior appendages are not enlarged in *A. miiuy*, whereas they are enlarged in *A. regius* (type species of the genus), and especially so in *A. japonicus*.

Character 126 (Fig. 70): Ventral limbs of appendages prolonged, extending along abdominal cavity. Branching patterns of the appendages are extremely diverse within Character 123 (Fig. 70). Usually each appendage is restricted in position beside the bladder wall (Fig. 70A-D), whereas in *Larimichthys* (Fig. 70E) and *Collichthys* (Fig. 70F), the ventral limbs of the appendages are greatly prolonged, extending along the abdominal cavity.

Character 127 (Figs. 71 and 72): Appendage deeply cephalic—*Kathala* type. In many sciaenids, the swimbladder appendage extends into the head via the septum transversum, forming direct ear-swimbladder connection. Patterns of the cephalic appendages are described below (Characters 127-134).

In Character 127, a pair of horn-like appendages arising from the anterior end of the swimbladder, penetrates deeply into the head. *Kathala* (Figs. 71A and 72A),

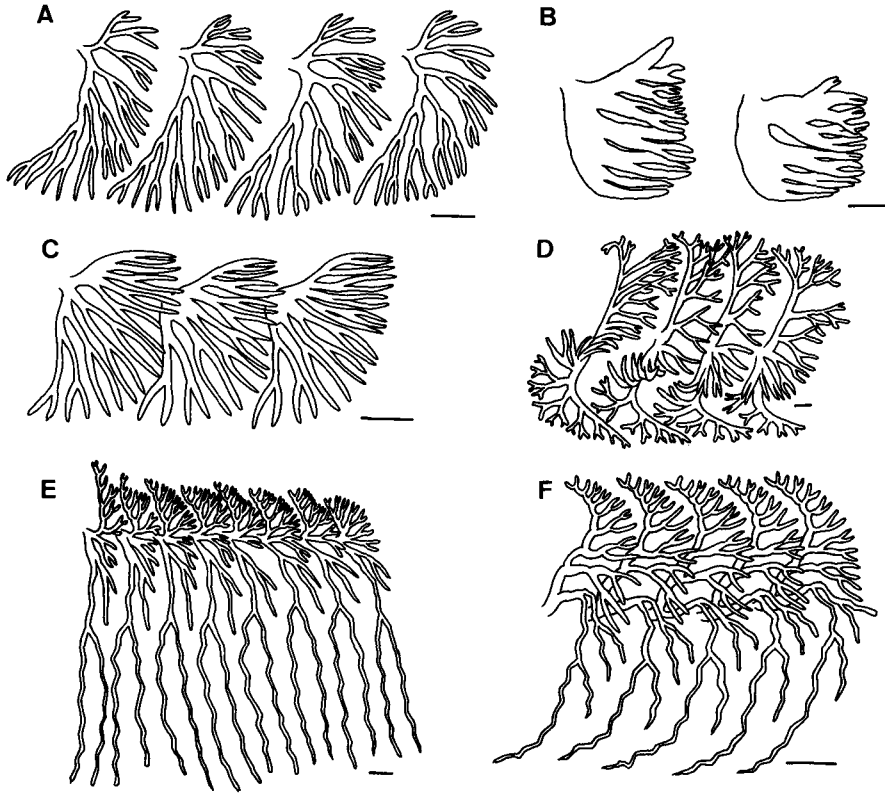

Fig. 70. Swimbladder appendages of six sciaenids. A, *Pennahia macrophthalmus*; B, *Chrysochir aureus*; C, *Austronibeia oedogenys*; D, *Atrobucca adusta*; E, *Larimichthys crocea*; F, *Collichthys lucidus*. Bar=2 mm.

Macrospinosa (Fig. 71B), *Panna* (Figs. 71C, D, 72C), and *Boesemania* (Fig. 71E and F) exhibit this feature.

Character 128 (Fig. 72): Appendage deeply cephalic—*Nibeia* type. This pattern found in certain members of the Otolithinae sensu Trewavas (1977), in which the anteriormost pair of numerous appendages enters the head (Fig. 72E and F). *Austronibeia* (Fig. 72E), *Aspericorvina*, *Daysciaena*, *Paranibeia*, *Nibeia*, *Johnius* (*Johnius*) (Fig. 73B), *J.* (*Johnieops*) (Fig. 72F), *Dendrophysa* (Fig. 73A), *Larimichthys*, *Collichthys* (Fig. 73C), and *Sonorolux* are included in this group.

Character 129 (Fig. 72): Appendage deeply cephalic—*Nebris* type. In *Nebris*, a pair of appendages arises anteriorly, initially extending backward before looping forward, and extending into the head (Figs. 65C and 72B).

Character 130 (Fig. 72): Appendage deeply cephalic—*Otolithoides* type. In *Otolithoides*, a pair of posteriorly arising appendages penetrates into the head (Figs. 67B and 72D).

Character 131 (Figs. 67, 71, 72): Cephalic appendage with several

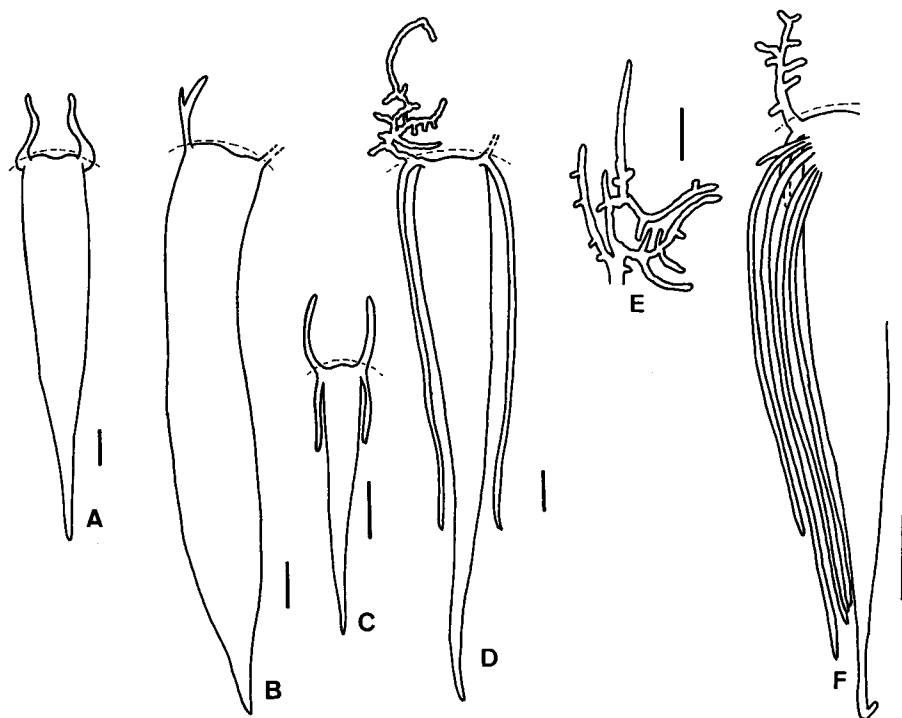

Fig. 71. Swimbladders of five sciaenids. A, *Kathala axillaris*; B, *Macrospinosa cuja*; C, *Panna heterolepis* (redrawn from Trewavas, 1977); D, *Panna microdon*; E and F, *Boesemania microlepis* (redrawn from Trewavas, 1977). Bar=5 mm.

branches. This condition is characteristic only of *Otolithoides* (Figs. 67B and 72D).

The cephalic appendages of *Otolithoides* are branched similarly to those in *Panna microdon* (Figs. 71D and 72C) and *Boesemania* (Fig. 71E and F) (see Character 127). Especially in the two former genera, each cephalic appendage encircles the auditory bulla and reaches the carotid foramen. In *Otolithoides*, the extreme tip of the appendage enters the enlarged foramen (Fig. 72D), whereas in *Panna microdon* the appendage terminates at the foramen (Fig. 72C). However, the simple cephalic appendages in *Panna heterolepis* (Fig. 71C) and the difference in the origin of the appendages argue against homologous attainment of the cephalic appendages. Trewavas (1977) noted the similarity of *Panna microdon* and *Otolithoides*, stating: "if the appendage develops as a bud at its place of the origin the difference is great, but if it develops as a tube in the connective tissue flanking the bladder and later makes a connection with the bladder, in *Otolithoides* posterior, in *Panna* anterior, the difference is less". In the absence of information to the contrary, I concur with this opinion.

Character 132 (Fig. 73): Cephalic appendage giving rise to a branch on dorsal surface of exoccipital. This is the most advanced state of Character 128.

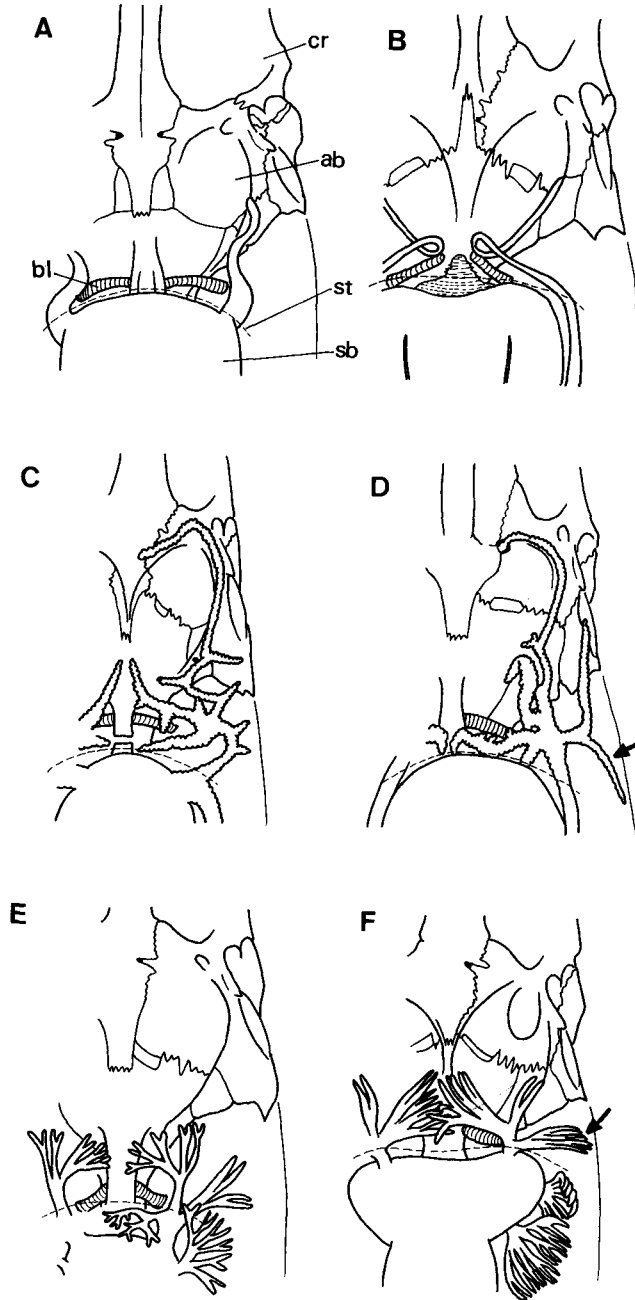

Fig. 72. Relationship between swimbladder appendages and crania of six sciaenids. A, *Kathala axillaris*; B, *Nebris microps*; C, *Panna microdon*; D, *Otolithoides pama*; E, *Austronibeia oedogenys*; F, *Johnius (Johnieops) distinctus*. ab, auditory bulla; bl, Baudelot's ligament; cr, cranium; sb, swimbladder; st, septum transversum. Arrow indicates exposed portion of appendage on shoulder girdle.

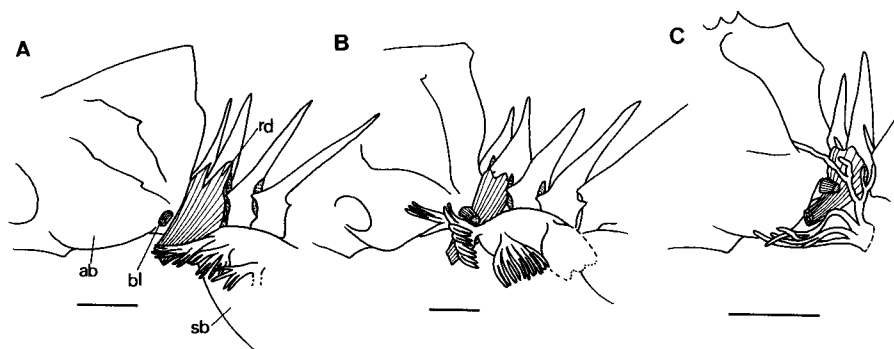

Fig. 73. Relationship between swimbladder appendages and crania. A, *Dendrophysa russelli*; B, *Johnius* (*Johnius*) sp.; C, *Collichthys lucidus*. ab, auditory bulla; bl, Baudelot's ligament; rd, retractor dorsalis; sb, swimbladder. Bar=3 mm.

In the Otolithinae (sensu Trewavas, 1977), the cephalic appendage usually spreads under the auditory bulla (Fig. 73A and B), whereas in *Collichthys* the cephalic appendage is more complex, with a branch extending onto the dorsal surface of the exoccipital (Fig. 73C).

Character 133 (Fig. 72): Cephalic appendage partly exposed on shoulder girdle—*Johnius* type. In *Johnius* (*Johnius*), *J.* (*Johnieops*) (Fig. 72F), and *Otolithoides* (Fig. 72D), part of the cephalic appendage is laterally exposed on the shoulder girdle. In *Johnius*, some lateral branches of the first arborescent appendage are spread on the shoulder girdle (Fig. 72F, arrow).

Character 134 (Fig. 72): Cephalic appendage partly exposed on shoulder girdle—*Otolithoides* type. Similar to the condition in *Johnius*, a portion of the cephalic appendage is exposed on the shoulder girdle in *Otolithoides*. However, the structure of the cephalic appendage is basically different. In *Otolithoides*, a small tubule derived from the main tubule, turns backwards and lies on the shoulder girdle (Fig. 72D, arrow).

Character 135: Swimbladder diminutive—*Menticirrhus* type. Although sciaenid swimbladders usually occupy the entire length of the abdominal cavity, in *Menticirrhus*, *Paralonchurus elegans*, and *Lonchurus*, the swimbladder is atrophic at least in adults. According to Chao (1978a), the swimbladder degenerates ontogenetically in *Menticirrhus* spp.

A small swimbladder results in a decrease in buoyancy and is closely correlated with mode of life tied to bottom. Chao and Misick (1977) demonstrated that *M. saxatilis* feeds on bottom. The triangular cross-section of the body in *Menticirrhus*, and the long pectoral fin of *Paralonchurus elegans* and *Lonchurus* similar to that of the family Dactylopteridae indicate that for these sciaenids buoyancy is not critical. A further, possible effect of the decrease in swimbladder size is inefficiency in hearing, since Sand and Enger (1973) have experimentally shown in the cod that the volume of swimbladder gas is positively related to hearing sensitivity. It is noteworthy that in those sciaenids with a degenerate swimbladder, the auditory bulla tends to be poorly inflated, housing a thin sagitta.

Although degeneration of the swimbladder is evident in *Menticirrhus*, *Paralanchurus elegans*, and *Lonchurus*, it appears to be nonhomologous. The swimbladder of *Menticirrhus* is simple, pointing to degeneration from a developed simple swimbladder, whereas in the latter two the swimbladder form is identical with the well developed swimbladder of *Paralanchurus brasiliensis*, which has a pair of both horn-like and tube-like appendages.

Character 136: Swimbladder diminutive—*Lonchurus* type. See Character 135. This condition characterizes *Paralanchurus elegans* and *Lonchurus*.

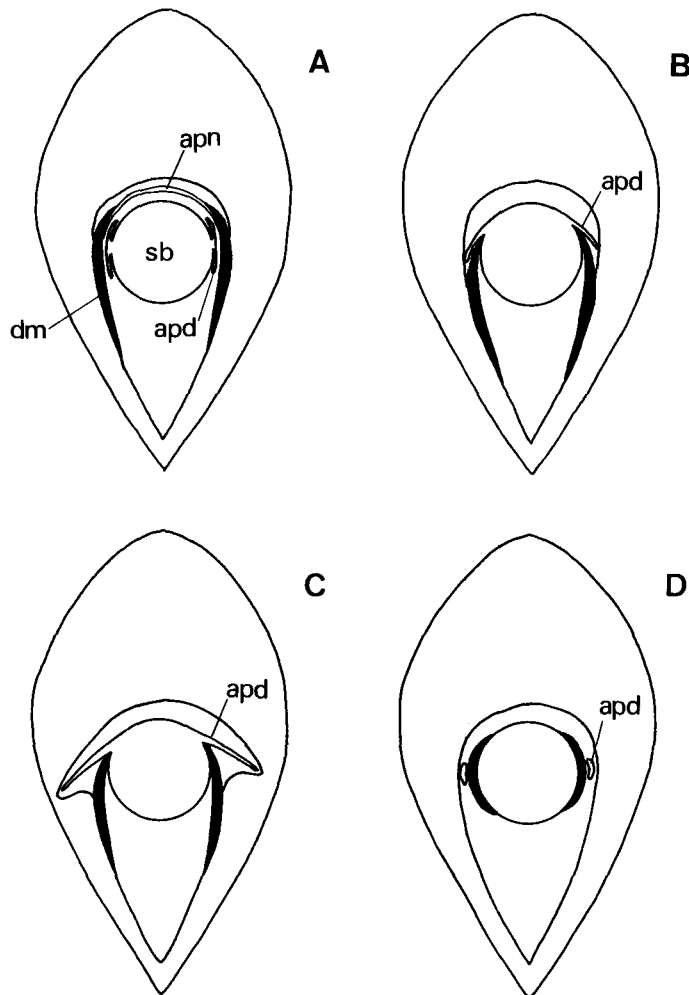

Fig. 74. Schematic illustration showing relationships between swimbladder wall, appendages, and drumming muscle. A, typical sciaenid condition; B, *Roncador stearnsii*; C, *Genyonemus lineatus*; D, *Pogonias cromis*. apd, appendage; apn, aponeurosis; dm, drumming muscle; sb, swimbladder.

Character 137 (Fig. 74): Drumming muscle originating directly on swimbladder wall. In most sciaenids, including those with a simple swimbladder, the drumming muscle originates on the aponeurosis (Fig. 74A, see also Character 121), whereas in *Roncador* (Fig. 74B), *Genyonemus* (Fig. 74C), *Sciaenops*, and *Pogonias*, the drumming muscle originates directly on the swimbladder wall. Considering the origin of the drumming muscle, from the obliquus inferioris (Character 19), and the condition in those sciaenids with a simple swimbladder, such direct insertion on the swimbladder wall is a specialization. A further specialization is found in *Pogonias* (see Character 138).

Character 138 (Fig. 74): Drumming muscle intrinsic. In *Roncador* (Fig. 74B), *Genyonemus* (Fig. 74C), and *Sciaenops*, the drumming muscle directly originates on the bladder wall, but with part of the muscle unattached, whereas in *Pogonias* (Fig. 74D), the drumming muscle is attached entirely to the wall (intrinsic) and lies internally to the lateral appendages. The latter are interconnected and separated from the bladder wall, except at each end as described and figured by Chao (1978a). In this genus, complete positioning of the obliquus inferioris from the body wall to bladder wall has been accomplished.

Character 139 (Fig. 74): Lateral wall of abdominal cavity concave—*Genyonemus* type. The lateral wall of the abdominal cavity is concave in *Genyonemus* (Fig. 74C), *Pogonias*, and *Sciaenops*, so as to accept the swimbladder appendage(s). Since such a cavity must have developed concurrently with development of the swimbladder appendages, it is possible to assess whether or not the cavity has been derived by the three genera homologously, even though the aponeurosis origin of the appendages seems to have been a common characteristic. In *Sciaenops*, the swimbladder appendages are restricted to the anterior half of the bladder, differing from those of *Genyonemus* and *Pogonias*. Although the appendages of *Genyonemus* and *Pogonias* are similar to one another, the concavity is differently formed. In *Genyonemus* the lateral wall of the abdominal cavity is sharply grooved, along almost the entire length, to accept the appendages. The concavity in *Pogonias* however is rounded and restricted to that portion of the abdominal cavity which faces the somewhat enlarged appendages located anteriorly. The *Pogonias* condition is similar to that of *Sciaenops* in this regard. It is concluded, therefore, that concavity of the lateral wall has been occasioned by the enlargement of the anterior appendage(s) in *Pogonias* and *Sciaenops*, even though the structure of the appendages differs between the genera. In *Genyonemus* the groove-like concavity has developed so as to accept the entire length of the appendages which show no sign of enlargement. Thus the abdominal wall concavity in each genus is treated as a separate autapomorphy.

Character 140: Lateral wall of abdominal cavity concave—*Pogonias* type. This is the autapomorphy of *Pogonias*. See Character 139.

Character 141: Lateral wall of abdominal cavity concave—*Sciaenops* type. This is the autapomorphy of *Sciaenops*. See Character 139.

13. OTHERS (Figs. 75-77)

Character 142 (Fig. 75): Lateral line scales modified. Typically in

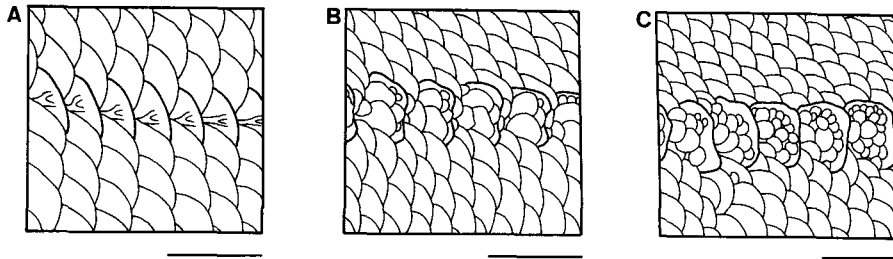

Fig. 75. Lateral line scales of three sciaenids. A, *Aplodinotus grunniens*; B, *Plagioscion auratus*; C, *Otolithoides pama*. Bar=5 mm.

sciaenids, the lateral line scales are as large as the adjacent body scales (Fig. 75A), whereas in *Plagioscion* (Fig. 75B), *Panna*, and *Otolithoides pama* (Fig. 75C, but not in *O. perarmatus*, Trewavas, 1977), the lateral line scales are enlarged and covered with small scales.

Character 143: Luminous tissue present. Specialized, luminous tissue is present on the ventral side of the head and body in *Larimichthys* and *Collichthys* (see Haneda, 1961). Similar specialization is also found in *Sonorolux* (Trewavas, 1977).

Character 144 (Fig. 76): Single, median, mental barbel present. As is usual in percoids, most sciaenids lack a mental barbel. However, a single, median, mental barbel is present in *Dendrophysa* (Fig. 76A), *Umbrina* (Fig. 76B), *Menticirrhus*, *Ctenosciaena*, and *Pachypops* (Fig. 76D).

Character 145 (Fig. 76): Median, mental barbel pored. As a specialization of Character 144, *Umbrina* (Fig. 76B) and *Menticirrhus* have a pore at the mental barbel.

Character 146 (Fig. 76): Paired, mental barbels present. In *Lonchurus*

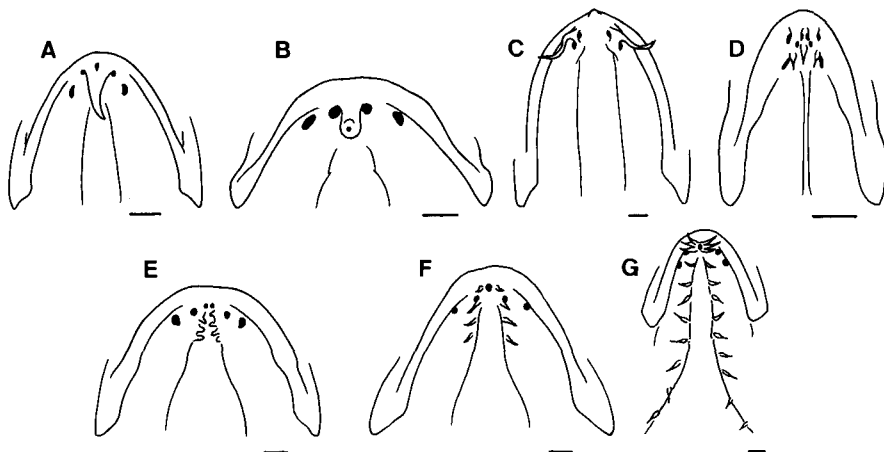

Fig. 76. Mental barbels of seven sciaenids. A, *Dendrophysa russelli*; B, *Umbrina canariensis*; C, *Lonchurus lanceolatus*; D, *Pachypops* sp.; E, *Genyonemus lineatus*; F, *Micropogonias furnieri*; G, *Paralonchurus brasiliensis*. Bar=2 mm.

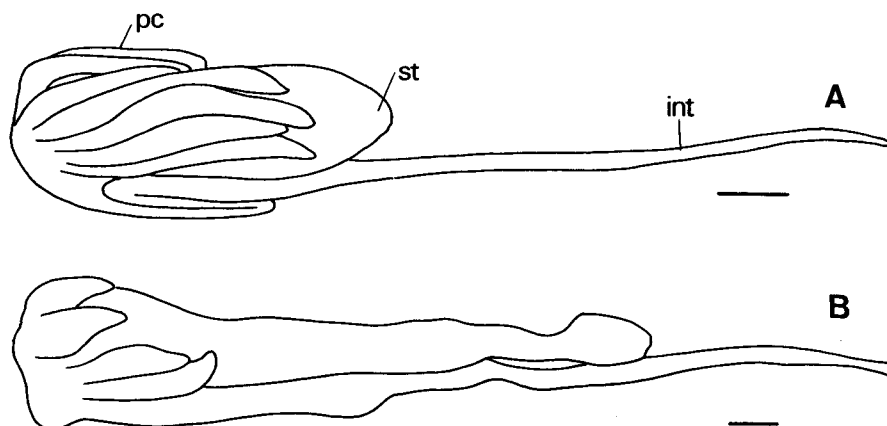

Fig. 77. Alimentary canals of two sciaenids. A, *Seriphus politus*; B, *Cynoscion virescens*. st, stomach; pc, pyloric caeca; int, intestine. Bar=5 mm.

(Fig. 76C), *Pachypops* (Fig. 76D), *Genyonemus* (Fig. 76E), *Micropogonias* (Fig. 76F), *Pogonias*, *Paralonchurus brasiliensis* (Fig. 76G), and *P. elegans*, paired mental barbels are present. However, only in *Lonchurus* and *Pachypops*, are the barbels restricted to a single pair, whereas the other genera listed above have greater mental barbel development (see next character).

Character 147 (Fig. 76): Many paired, mental barbels present. In *Genyonemus* (Fig. 76E), *Micropogonias* (Fig. 76F), *Paralonchurus brasiliensis* (Fig. 76G), *P. elegans*, and *Pogonias*, many paired, mental barbels are present. It is hypothesized here that these are derived from a single pair of barbels.

Character 148: Caudal fin truncate to lunate in adults. Although the adult caudal fin is variable in shape from acutely pointed posteriorly to lunate, a general family trend is for a change in caudal fin shape from rhomboidal to truncate or lunate according to the growth stage (Johnson, 1978). If this is so, the larval and/or juvenile form represents the primitive condition following the rule of ontogenetic precedence (Hennig, 1966). The truncate to lunate caudal fin characterizes *Odontoscion*, *Elattarchus*, *Bairdiella*, *Cheilotrema*, *Umbrina*, *Menticirrhus*, *Leio-stomus*, *Sciaena deliciosa*, *S. gilberti*, *S. umbra*, *Seriphus*, *Pogonias*, *Aplodinotus*, *Sciaenops*, *Roncador*, *Genyonemus*, *Isopisthus*, *Atractoscion nobilis*, *A. aequidens*, and *Argyrosomus japonicus*.

Character 149 (Fig. 77): Intestine straight. Chao and Musick (1977) found that *Cynoscion regalis* differed from the other five sciaenids examined by them, in having a straight intestine (Fig. 77B), compared with an S-shaped intestine in the other species (Fig. 77A). Examination has shown that a straight intestine is restricted to three genera, *Cynoscion* (Fig. 77B), *Macrodon*, and *Isopisthus*. Although the variable condition of the intestine may be correlated to feeding habits (Suyehiro, 1942), a straight intestine must be considered apomorphic, since the vast majority of sciaenids, as well as those with a simple swimbladder, are characterized by an S-shaped intestine.

VII. Relationships within the Sciaenidae

1. CHARACTERS

Character analyses in the foregoing chapter have yielded 128 derived characters within the Sciaenidae. On the basis of these, relationships within the family are inferred. These characters are listed below. Table 1 shows their distribution. Autapomorphies found in a single genus or species are not included in the table. Characters are numbered from 22, since characters 1-21 characterize the family as a whole.

Cranium

22. Epaxial muscle terminating behind supraorbital ridge of frontal
23. Outer margin of lateral ethmoid concaved medially
24. Foramen for nervus facialis (VII) enlarged
25. Carotid foramen enlarged
26. Auditory bulla notched-*Macrodon* type
27. Auditory bulla notched-*Stellifer* type
28. Pterosphenoid in contact with lateral ethmoid
29. Frontal projecting downward
30. Pterosphenoid separated from basisphenoid
31. Basisphenoid separated from parasphenoid ventrally
32. Basisphenoid absent
33. Intercalar projecting downward
34. Intercalar in broad contact with basioccipital
35. Intercalar in broad, ventral contact with prootic
36. Intercalar in contact with epiotic
37. Exoccipital condyles not broadly joined to each other-*Stellifer* type
38. Exoccipital condyles not broadly joined to each other-*Johnius* type
39. Basioccipital projecting backwards-*Stellifer* type
40. Basioccipital projecting backwards-*Kathala* type
41. Baudelot's ligament attached to exoccipital
42. Basicranial modification-*Pogonias* type
43. Basicranial modification-*Leiostomus* type

Infraorbitals and nasal

44. Eye diminutive
45. Infraorbital 2 flattened dorsally
46. Infraorbital 3 flattened dorsally
47. Infraorbital 3 lying almost parallel to horizontal axis of eye
48. Nasal acutely pointed

Suspensorium, opercular apparatus, and associated muscles

49. Suspensorium strongly depressed
50. Posteromedial margin of metapterygoid overlapping or attached to medial side of lower arm of hyomandibular
51. Ventral margin of palatine medially concave
52. Adductor arcus palatini divided into two elements
53. Levator operculi originating from posttemporal

Jaws

54. Lower jaw teeth absent in adults
55. Canines present
56. Teeth "arrowhead"-shaped
57. Head of maxillary anterior to ethmoid and prevomer
58. Maxillary shaft foramen present
59. Dentary foramen present

Branchial arches and associated muscles

60. Tooth plate on pharyngobranchial 2 enlarged and anteriorly located
61. Interdigitating suture between ceratobranchials 5
62. Ventral process present in ceratobranchial 5
63. Transversus ventralis anterior and posterior present as a single element
64. Dorsal face of pharyngobranchial 3 incompletely covered by muscles
65. Transversus dorsalis anterior not extending across dorsal surface of upper pharyngobranchials
66. Pharyngobranchial 3 enlarged
67. Tooth plate on pharyngobranchial 2 relocated obliquely to pharyngobranchial 3
68. Levator posterior originating from upper half of postcranial wall
69. Adductor 5 well developed
70. Pharyngobranchial 2 extremely large
71. Head of epibranchial 2 enlarged
72. Interarcual cartilage connection with pharyngobranchial 2 lost
73. Transversus dorsalis anterior well developed, partially inserted onto parasphenoid
74. Retractor dorsalis originating from basicranial region and first vertebra
75. Basihyal fan-shaped
76. Basihyal cartilaginous

Pectoral girdle and associated muscles

77. Pectoral fin very long
78. Two and half radials on scapula
79. Ventral arm of coracoid broad
80. Adductor profundus passing to lateral side of pectoral girdle via coracoid foramen

Vertebrae and associated bones

81. Neural spines reduced in size
82. First and second neural spines widely separated
83. Fifth parapophysis enlarged
84. Ventral modification of anterior abdominal vertebrae-*Lonchurus* type
85. Ventral modification of anterior abdominal vertebrae-*Pseudotolithus* type
86. Ventral modification of anterior abdominal vertebrae-*Stellifer* type
87. Ventral modification of anterior abdominal vertebrae-*Cynoscion* type
88. Ventral modification of anterior abdominal vertebrae-*Atractoscion* type
89. Ventral modification of anterior abdominal vertebrae-*Larimichthys* type
90. Ventral modification of anterior abdominal vertebrae-*Collichthys* type
91. Epipleural ribs few and reduced

- 92. Epipleural ribs inflated
 - 93. Posterior dorsal fin spines not exposed
 - 94. Soft dorsal and anal fins bases of equal length
 - 95. First dorsal pterygiophore bearing one spine
 - 96. First anal pterygiophore bearing one spine
 - 97. Predorsals number less than three-*Equetus* type
 - 98. Predorsals number less than three-*Cynoscion* type
 - 99. Numerous dorsal pterygiophores in front of third neural spine
- Caudal skeleton and associated muscles
- 100. Lower caudal lobe with six branched rays
 - 101. Flexor ventralis externus faded into flexor ventralis
- Otolith
- 102. Lapillus enlarged-*Kathala* type
 - 103. Lapillus enlarged-*Johnius* type
 - 104. Lapillus enlarged-*Stellifer* type
 - 105. Sagitta twisted
 - 106. Sagitta strongly twisted
 - 107. Sagitta notched posteriorly
 - 108. Sulcus head situated on anterior surface of sagitta
 - 109. Sulcus tail only slightly curved
 - 110. Distal end of sulcus tail circular
 - 111. Distal end of sulcus tail with a deep hollow cone
- Swimbladder
- 112. Swimbladder two chambered
 - 113. Anterior chamber of swimbladder laterally expanded to outer rim of pterotic
 - 114. A pair of appendages on anterior chamber of swimbladder
 - 115. A pair of horn-like appendages arising at anterior end of swimbladder
 - 116. A pair of tube-like appendages arising at anterior end of swimbladder
 - 117. A pair of tube-like appendages, arising at anterior end of swimbladder, extending backward, and looping forward
 - 118. A pair of tube-like appendages, divided into several tubules, arising at anterior end of swimbladder
 - 119. Tube-like appendage divided into several long tubules
 - 120. A pair of tube-like appendages arising at posterior portion of swimbladder
 - 121. Numerous interconnected appendages arising along sides of swimbladder
 - 122. Swimbladder with a pair of sac-like appendages comprising of numerous, labyrinthine chambers
 - 123. Numerous arborescent appendages arising along sides of swimbladder
 - 124. Swimbladder hammer-shaped
 - 125. Anterior appendages enlarged
 - 126. Ventral limbs of appendages prolonged, extending along abdominal cavity
 - 127. Appendage deeply cephalic-*Kathala* type
 - 128. Appendage deeply cephalic-*Nibea* type
 - 129. Appendage deeply cephalic-*Nebris* type
 - 130. Appendage deeply cephalic-*Otolithoides* type

Table 1. Character matrix of the Sciaenidae. 0, primitive condition; 1, derived condition; ?, condition unknown. The number of each character follows the text.

	22	23	24	27	28	29	30	31	32	33	34	36	37	38	39	41	44	45	46	47	48	49
"Sciaena" tre.	0	0	0	0	0	0	0	0	0	0	0	0	0	0	0	0	0	0	0	0	0	0
Odontoscion	0	0	0	1	0	0	0	1	0	0	0	0	1	0	1	1	0	0	0	0	0	0
Elattarchus	0	0	0	1	0	0	0	0	0	0	0	0	1	0	1	1	0	0	0	0	0	0
Corvula	0	0	0	1	0	0	0	0	0	0	0	0	1	0	1	1	0	0	0	0	0	0
Bairdiella	1	1	0	1	0	0	1	0	0	0	0	0	1	0	1	1	0	0	0	0	0	0
Ophioscion	1	1	0	1	0	0	0	1	0	0	0	1	0	1	1	1	0	0	0	0	0	0
Stellifer	1	1	0	1	0	0	0	1	0	0	0	1	0	1	1	1	0	0	0	0	0	0
Ctenosciaena	0	0	0	0	0	0	0	0	0	0	0	0	0	0	0	0	0	0	0	0	0	0
Equetus	0	0	0	0	0	0	0	0	0	0	0	0	0	0	0	0	0	0	0	0	0	0
Pareques	0	0	0	0	0	0	0	0	0	0	0	0	0	0	0	0	0	0	0	0	0	0
Cheilotrema	0	0	0	0	0	0	0	0	0	0	0	0	0	0	0	0	0	0	0	0	0	0
Umbrina	0	0	0	0	0	0	0	0	0	0	0	0	0	0	0	0	0	0	0	0	0	0
Menticirrhus	1	0	0	0	0	0	0	0	0	0	0	0	0	0	0	0	0	0	0	0	0	0
Leiostomus	0	0	0	0	0	0	0	0	0	0	0	0	0	0	0	0	0	0	0	0	0	0
"Sciaena" del.	0	0	0	0	0	0	0	0	0	0	0	0	0	0	0	0	0	0	0	0	0	0
"Sciaena" gil.	0	0	0	0	0	0	0	0	0	0	0	0	0	0	0	0	0	0	0	0	0	0
Seriphus	0	0	0	0	0	0	1	0	0	0	0	0	0	0	0	0	0	0	0	0	0	0
Sciaena umbra	1	0	0	0	0	0	0	0	0	0	0	0	0	0	0	0	0	0	0	0	0	0
Pogonias	0	0	0	0	0	0	0	0	0	0	1	0	0	0	0	0	0	0	0	0	0	0
Aplodinotus	1	0	0	0	0	0	0	0	0	0	1	0	0	0	0	0	0	0	0	0	0	0
Sciaenops	0	0	0	0	0	0	0	0	0	0	0	0	0	0	0	0	0	0	0	0	0	0
Roncador	0	0	0	0	0	0	0	0	0	0	0	0	0	0	0	0	0	0	0	0	0	0
Genyonemus	0	0	0	0	0	0	0	0	0	0	0	0	0	0	0	0	0	0	0	0	0	0
Micropogonias	1	0	0	0	0	0	0	0	0	0	0	0	0	0	0	0	0	0	0	0	0	0
"Paralanchurus" bra.	1	0	0	0	1	0	0	1	0	1	0	0	0	0	0	0	0	0	0	0	0	0
"Paralanchurus" ele.	1	0	0	0	1	0	0	1	0	1	0	0	0	0	0	0	1	0	1	0	0	0
Lonchurus	1	0	0	0	1	0	0	1	1	0	0	0	0	0	0	1	0	1	0	0	0	0
Pachypops	1	0	0	0	0	0	0	0	0	0	0	0	0	0	0	0	0	0	1	1	1	1
Pachyurus	1	0	0	0	0	0	0	0	0	0	0	0	0	0	0	0	0	0	1	1	1	1
Larimus	1	0	0	0	0	0	0	0	0	0	0	0	0	0	0	0	0	0	0	0	0	0
Nebria	1	0	0	0	0	0	0	0	0	0	0	0	0	0	0	1	1	1	0	0	0	0
Cynoscion	1	0	0	0	0	0	0	0	0	0	0	0	0	0	0	0	0	0	0	0	0	0
Macrodon	1	0	0	0	0	0	0	0	0	0	0	0	0	0	0	0	0	0	0	0	0	0
Isopisthus	1	0	0	0	0	0	0	0	0	0	0	0	0	0	0	0	0	0	0	0	0	0
Plagioscion	1	0	0	0	0	0	0	0	1	0	0	0	0	0	0	0	0	0	0	0	0	0
Atractoscion nob.	1	0	0	0	0	0	0	0	0	0	0	0	0	0	0	0	0	0	0	0	0	0
Atractoscion aeq.	1	0	0	0	0	0	0	0	0	0	0	0	0	0	0	0	0	0	0	0	0	0
Kathala	1	0	0	0	1	0	0	0	1	0	0	0	0	0	0	0	0	0	0	0	0	0
Panna	1	0	0	0	0	0	0	1	0	0	0	0	0	0	0	1	0	0	0	0	0	0
Otolithoides	1	0	0	0	0	0	0	1	1	1	0	0	0	0	0	1	1	0	0	0	0	0
Miracorvina	1	0	0	0	0	0	0	0	0	0	0	0	0	0	0	0	0	0	0	0	0	0
Pentheroscion	1	0	0	0	0	0	0	0	0	0	0	0	0	0	0	0	0	0	0	0	0	0
Pteroscion	1	0	0	0	0	1	0	0	1	0	0	0	0	0	0	0	0	0	0	0	0	0
Pseudotolithus (F.)	1	0	0	0	0	0	0	0	0	0	0	0	0	0	0	0	0	0	0	0	0	0
Pseudotolithus (H.)	1	0	0	0	0	0	0	1	0	0	0	0	0	0	0	1	0	0	0	0	0	0
Pseudotolithus (Pi.)	1	0	0	0	1	0	0	0	1	0	0	0	0	0	0	0	0	0	0	0	0	0
Pseudotolithus (Ps.)	1	0	0	0	1	0	0	0	1	0	0	0	0	0	0	0	0	0	0	0	0	0
"Argyrosomus" mi.	1	0	0	0	0	0	0	0	0	0	0	0	0	0	0	0	0	0	0	0	0	0
Argyrosomus jap.	1	0	0	0	1	0	0	0	0	0	0	0	0	0	0	0	0	0	0	0	0	0
Protonibea	1	0	0	0	0	0	0	0	0	0	0	0	0	0	0	0	0	0	0	0	0	0
Pennahia	1	0	0	0	0	0	0	0	0	0	0	0	0	0	0	0	0	0	0	0	0	0
Atrobucca	1	0	0	0	0	0	0	0	0	0	0	0	0	0	0	0	0	0	0	0	0	0
Otolithes	1	0	0	0	0	0	0	0	0	0	0	0	0	0	0	0	0	0	0	0	0	0
Larimichthys	1	0	0	0	0	0	0	0	0	0	0	0	0	0	0	0	0	0	0	0	0	0
Collichthys	1	0	0	0	0	0	0	0	0	0	0	0	0	0	0	1	0	0	0	0	0	0
Austronibea	1	0	0	0	0	0	0	0	1	0	0	0	0	0	0	0	0	0	0	0	0	0
Dendrophysa	1	0	0	0	0	0	0	1	0	0	0	0	0	0	0	0	0	0	0	0	0	0
Nibea	1	0	0	0	0	0	0	0	1	1	0	0	0	0	0	0	0	0	0	0	0	0
Johnius (Johnius)	1	0	1	0	0	0	0	0	0	0	0	0	1	0	0	0	0	0	0	0	0	0
Johnius (Johnie.)	1	0	1	0	0	1	0	0	0	0	0	0	1	0	0	0	0	0	0	0	0	0

Table 1. (Continued. From Character 50 to 84).

	50	52	53	55	57	58	59	60	62	63	64	66	68	69	74	75	77	78	80	82	83	84
"Sciaena" tre.	0	0	0	0	0	0	0	0	0	0	0	0	0	0	0	0	0	0	0	0	0	0
Odontoscion	0	0	1	1	0	0	0	0	0	0	0	0	0	0	1	0	0	0	0	0	0	0
Blattarchus	0	0	0	1	0	0	0	0	0	0	0	0	0	0	1	0	0	0	0	0	0	0
Corvula	0	0	0	0	0	0	0	0	0	0	0	0	0	0	1	0	0	0	0	0	0	0
Bairdiella	0	0	1	0	0	0	0	1	0	0	0	0	0	0	1	0	0	0	0	0	0	0
Ophioscion	0	0	1	0	0	0	0	1	0	0	0	0	0	0	1	0	0	0	0	0	0	1
Stellifer	0	0	1	0	0	0	0	0	0	0	0	0	0	0	1	0	0	0	0	0	0	1
Ctenosciaena	0	0	0	0	0	0	0	1	0	0	0	0	0	0	0	0	0	0	0	0	0	0
Equetus	0	0	0	0	0	0	0	1	0	0	0	0	0	0	0	0	0	0	0	0	0	0
Pareques	0	0	0	0	0	0	0	1	0	0	0	0	0	0	0	0	0	0	0	0	0	0
Cheilotrema	0	0	0	0	0	0	0	1	0	0	0	0	0	0	0	0	0	0	0	0	0	0
Umbrina	0	0	0	0	0	0	0	1	0	0	0	0	0	0	0	0	0	0	0	0	0	0
Menticirrhus	1	0	0	0	0	0	0	0	0	0	0	0	0	0	0	0	0	1	0	0	0	0
Leiostomus	1	0	0	0	0	0	0	1	0	0	1	0	0	0	0	0	0	0	0	0	0	0
"Sciaena" del.	0	0	0	0	0	0	0	1	0	0	0	0	0	0	0	0	0	0	0	0	0	0
"Sciaena" gil.	0	0	1	0	0	0	0	1	0	0	0	0	0	0	0	0	0	0	0	0	0	0
Seriphus	0	0	0	0	0	0	1	0	0	0	0	0	0	0	0	0	0	0	0	0	0	0
Sciaena umbra	0	0	0	0	0	0	0	1	0	0	0	0	0	0	0	0	0	0	0	0	0	0
Pogonias	0	0	0	0	0	0	0	1	1	1	1	1	1	1	0	0	0	0	0	0	0	0
Aplodinotus	1	0	0	0	0	0	0	1	1	1	1	1	1	1	0	0	0	0	0	0	0	0
Sciaenops	0	0	0	0	0	0	0	1	0	0	0	0	0	0	0	0	0	0	0	0	0	0
Roncador	0	0	0	0	0	0	0	1	0	0	0	0	0	0	0	0	0	0	0	0	0	0
Geyonemus	0	0	0	0	0	0	0	1	0	0	0	0	0	0	0	0	0	0	0	0	0	0
Micropogonias	0	0	0	0	0	0	0	1	0	0	0	0	0	0	0	0	0	0	0	0	0	0
"Paralanchurus" bra.	0	0	0	0	0	0	0	1	0	0	0	0	0	0	0	0	0	0	0	0	0	1
"Paralanchurus" ele.	1	1	0	0	0	0	0	0	0	0	0	0	0	0	0	0	1	1	1	0	0	1
Lonchurus	1	1	0	0	0	0	0	0	0	0	0	0	0	0	0	0	1	0	1	0	0	1
Pachypops	0	0	0	0	1	0	0	0	0	0	0	0	0	0	0	0	0	0	0	0	0	0
Pachyurus	1	0	0	0	1	0	0	1	0	0	0	0	0	0	0	0	0	0	0	0	0	0
Larimus	0	0	0	0	0	0	1	0	0	0	0	0	0	0	0	1	0	0	0	0	0	0
Nebris	0	0	0	0	0	0	0	0	0	0	0	0	0	0	0	1	0	0	0	0	0	0
Cynoscion	0	0	0	1	0	0	0	0	0	0	0	0	0	0	0	0	0	0	0	1	0	0
Macrodon	0	0	0	1	0	0	0	0	0	0	0	0	0	0	0	0	0	0	0	1	0	0
Isopisthus	0	0	0	1	0	0	0	0	0	0	0	0	0	0	0	0	0	0	0	1	0	0
Plagoscion	0	0	0	0	0	0	0	0	0	0	0	0	0	0	0	0	0	0	0	0	0	0
Atractoscion nob.	0	0	0	0	0	0	0	0	0	0	0	0	0	0	0	0	0	0	0	0	0	0
Atractoscion aeg.	0	0	0	0	0	0	0	0	0	0	0	0	0	0	0	0	0	0	0	0	0	0
Kathala	0	0	0	0	1	0	0	0	0	0	0	0	0	0	0	0	0	0	0	0	0	0
Panna	0	0	0	0	0	0	0	0	0	0	0	0	0	0	0	0	0	0	0	0	0	0
Otolithoides	1	1	0	0	0	0	0	0	0	0	0	0	0	0	0	0	0	0	0	0	0	0
Miracorvina	0	0	0	0	0	0	0	0	0	0	0	0	0	0	0	0	0	0	0	0	0	0
Pentheroscion	1	0	0	0	0	0	0	0	0	0	0	0	0	0	0	0	0	0	0	0	0	0
Pteroscion	0	0	0	0	0	0	0	0	0	0	0	0	0	0	0	0	0	0	0	0	0	0
Pseudotolithus (F.)	0	0	0	0	0	0	0	0	0	0	0	0	0	0	0	0	0	0	0	0	0	0
Pseudotolithus (H.)	0	0	0	0	0	0	0	0	0	0	0	0	0	0	0	0	0	0	0	0	0	0
Pseudotolithus (Pi.)	0	0	0	0	0	0	0	0	0	0	0	0	0	0	0	0	0	0	0	0	0	0
Pseudotolithus (Ps.)	0	0	0	0	0	0	0	0	0	0	0	0	0	0	0	0	0	0	0	0	0	0
"Argyrosomus" mii.	0	0	0	0	0	0	0	0	0	0	0	0	0	0	0	0	0	0	0	0	0	0
Argyrosomus jap.	0	0	0	0	0	0	0	0	0	0	0	0	0	0	0	0	0	0	0	0	0	0
Protonibea	0	0	0	0	0	0	0	0	0	0	0	0	0	0	0	0	0	0	0	0	0	0
Pennahia	0	0	0	0	0	0	0	0	0	0	0	0	0	0	0	0	0	0	0	0	0	0
Atrobucca	0	0	0	0	0	0	0	0	0	0	0	0	0	0	0	0	0	0	0	0	0	0
Otolithes	0	0	0	1	0	0	0	0	0	0	0	0	0	0	0	0	0	0	0	0	0	0
Larimichthys	0	0	0	0	0	0	0	0	0	0	0	0	0	0	0	0	0	0	1	0	0	0
Collichthys	0	0	0	0	1	0	0	0	0	0	0	0	0	0	0	0	0	0	1	0	0	0
Austronibea	0	0	0	0	0	0	0	0	0	0	0	0	0	0	0	0	0	0	0	0	0	0
Dendrophysa	0	0	0	0	0	0	0	0	0	0	0	0	0	0	0	0	0	0	0	0	0	0
Nibea	0	0	0	0	0	0	0	0	0	0	0	0	0	0	0	0	0	0	0	0	0	0
Johnius (Johnius)	0	0	0	0	0	0	0	0	0	0	0	0	0	0	0	0	0	0	0	0	0	0
Johnius (Johnie.)	0	0	0	0	0	0	0	0	0	0	0	0	0	0	0	0	0	0	0	0	0	0

Table 1. (Continued. From Character 85 to 116).

	85	86	87	89	91	93	94	98	99	01	03	04	05	06	08	09	10	11	12	13	15	16
"Sciaena" tre.	0	0	0	0	0	0	0	0	0	0	0	0	0	0	0	0	0	0	0	0	0	0
Odontoscion	0	1	0	0	0	0	0	0	0	1	0	1	0	0	1	0	0	0	1	0	0	0
Elattarchus	0	1	0	0	0	0	0	0	0	1	0	1	0	0	1	0	0	0	1	0	0	0
Corvula	0	1	0	0	0	0	0	0	0	1	0	1	0	0	1	0	0	0	1	0	0	0
Bairdiella	0	1	0	0	0	0	0	0	0	0	1	0	0	1	0	0	0	1	0	0	0	0
Ophioscion	0	1	0	0	0	0	0	0	0	0	1	0	0	1	0	0	0	1	1	0	0	0
Stellifer	0	1	0	0	0	0	0	0	0	0	1	0	0	1	0	0	0	1	1	0	0	0
Ctenosciaena	0	0	0	0	0	0	0	0	0	0	0	0	0	0	0	0	0	0	0	0	0	0
Equetus	0	0	0	0	0	0	0	1	0	0	0	0	0	0	0	0	0	0	0	0	0	0
Pareques	0	0	0	0	0	0	0	1	0	0	0	0	0	0	0	0	0	0	0	0	0	0
Cheilotrema	0	0	0	0	0	0	0	0	0	0	0	0	0	0	0	0	0	0	0	0	0	0
Umbrina	0	0	0	0	0	0	0	0	0	0	0	0	0	0	0	0	0	0	0	0	0	0
Menticirrhus	0	0	0	0	0	0	0	0	0	0	0	0	0	0	0	0	0	0	0	0	0	0
Leiostomus	0	0	0	0	0	0	0	0	0	0	0	0	0	0	0	0	0	0	0	0	0	0
"Sciaena" del.	0	0	0	0	0	0	0	0	0	0	0	0	0	0	0	0	0	0	0	0	0	0
"Sciaena" gil.	0	0	0	0	0	0	0	0	1	0	0	0	0	0	0	0	0	0	0	0	0	0
Seriphus	0	0	0	0	1	1	0	0	1	0	0	0	0	0	0	0	0	0	0	0	0	0
Sciaena umbra	0	0	0	0	0	0	0	0	0	0	0	0	0	0	0	0	0	0	0	0	0	0
Pogonias	0	0	0	0	0	0	0	0	0	0	0	0	0	0	0	0	0	0	0	0	0	0
Aplodinotus	0	0	0	0	0	0	0	0	0	0	0	0	0	0	0	0	0	0	0	0	0	0
Sciaenops	0	0	0	0	0	0	0	0	0	0	0	0	0	0	0	0	0	0	0	1	0	0
Roncador	0	0	0	0	0	0	0	0	0	0	0	0	0	0	0	0	0	0	0	0	0	0
Genyonemus	0	0	0	0	0	0	0	1	0	0	0	0	0	0	0	0	0	0	0	0	0	0
Micropogonias	0	0	0	0	0	0	0	0	0	0	0	0	0	0	0	1	0	0	0	0	0	0
"Paralanchurus" bra.	0	0	0	0	0	0	0	0	0	0	0	0	0	0	0	0	0	0	0	1	1	1
"Paralanchurus" ele.	0	0	0	0	0	0	0	0	0	0	0	0	0	0	0	0	0	0	0	0	1	1
Lonchurus	0	0	0	0	0	0	0	0	0	0	0	0	0	0	0	0	0	0	0	1	1	1
Pachypops	0	0	0	0	0	0	0	0	0	0	0	0	0	0	0	0	0	0	0	1	1	1
Pachyurus	0	0	0	0	0	0	0	0	0	0	0	0	0	0	0	0	0	0	0	0	0	0
Larimus	1	0	0	0	0	0	0	0	0	0	0	0	0	0	0	0	0	0	0	0	0	0
Nebris	1	0	0	1	0	0	0	0	0	0	0	0	0	0	0	0	0	0	0	0	0	1
Cynoscion	0	0	1	0	1	0	0	1	0	0	0	0	0	0	0	0	0	0	0	1	0	0
Macrodon	0	0	1	0	1	0	0	1	0	0	0	0	0	0	0	1	0	0	0	1	0	0
Isopisthus	0	0	1	0	1	1	1	1	0	0	0	0	0	0	0	0	0	0	0	1	0	0
Plagioscion	0	0	0	1	0	0	0	0	0	0	0	0	0	0	0	0	0	0	0	0	1	0
Atractoscion nob.	0	0	0	0	0	0	0	0	0	0	0	0	0	0	0	0	0	0	0	1	0	0
Atractoscion aeq.	0	0	0	0	0	0	0	0	0	0	0	0	0	0	0	0	0	0	0	1	0	0
Kathala	0	1	0	0	0	0	0	0	0	0	0	0	0	0	0	0	0	0	0	0	1	0
Panna	0	0	0	0	0	0	0	0	0	0	0	0	0	0	0	0	0	0	0	1	1	1
Otolithoides	0	0	0	0	0	0	0	0	0	0	0	0	0	0	0	1	0	0	0	0	0	0
Miracorvina	0	0	0	0	0	0	0	0	0	0	0	0	0	0	0	0	0	0	0	0	0	0
Pentheroscion	0	0	0	0	0	0	0	0	0	0	0	0	0	0	0	0	0	0	0	0	0	0
Pteroscion	1	0	0	0	0	0	0	0	0	0	1	0	0	0	0	0	0	0	0	0	0	0
Pseudotolithus (F.)	1	0	0	0	0	0	0	0	0	0	1	1	0	0	0	0	0	0	0	0	0	0
Pseudotolithus (H.)	1	0	0	0	0	0	0	0	0	0	1	1	0	0	0	0	0	0	0	0	0	0
Pseudotolithus (Pi.)	1	0	0	0	0	0	0	0	0	0	1	1	0	0	0	0	0	0	0	0	0	0
Pseudotolithus (Ps.)	1	0	0	0	0	0	0	0	0	0	1	1	0	0	0	0	0	0	0	0	0	0
"Argyrosomus" mii.	0	0	0	0	0	0	0	0	0	0	0	0	0	0	0	0	0	0	0	0	0	0
Argyrosomus jap.	0	0	0	0	0	0	0	0	0	0	0	0	0	0	0	0	0	0	0	0	0	0
Protomibea	0	0	0	0	0	0	0	0	0	0	0	0	0	0	0	0	0	0	0	0	0	0
Pennahia	0	0	0	0	0	0	0	0	0	0	0	0	0	0	1	0	0	0	0	0	0	0
Atrubucca	0	0	0	0	0	0	0	0	0	0	0	0	0	0	1	0	0	0	0	0	0	0
Otolithes	0	0	0	0	0	0	0	0	0	0	0	0	0	0	1	1	0	0	0	0	0	0
Larimichthys	0	0	0	1	0	0	0	0	0	0	0	0	0	0	1	1	0	0	0	0	0	0
Collichthys	0	0	0	1	0	0	0	0	1	0	0	0	0	0	1	1	0	0	0	0	0	0
Austronibea	0	0	0	0	0	0	0	0	0	0	0	0	0	0	0	0	0	0	0	0	0	0
Dendrophysa	1	0	0	0	0	0	0	0	0	0	0	0	0	0	0	0	0	0	0	0	0	0
Nibea	0	0	0	0	0	0	0	0	0	0	0	0	0	0	0	0	0	0	0	0	0	0
Johnius (Johnius)	0	1	0	0	0	0	0	0	0	1	0	0	0	0	0	0	1	0	0	0	0	0
Johnius (Johnie.)	0	1	0	0	0	0	0	0	0	1	0	0	0	0	0	0	1	0	0	0	0	0

Table 1. (Continued. From Character 118 to 149).

	18	19	20	21	23	24	25	26	27	28	33	36	37	42	43	44	45	46	47	48	49			
"Sciaena" tre.	0	0	0	0	0	0	0	0	0	0	0	0	0	0	0	0	0	0	0	0	0			
Odontoscion	0	0	0	0	0	0	0	0	0	0	0	0	0	0	0	0	0	0	0	0	1	0		
Corvula	0	0	0	0	0	0	0	0	0	0	0	0	0	0	0	0	0	0	0	0	0	1	0	
Bairdiella	0	0	0	0	0	0	0	0	0	0	0	0	0	0	0	0	0	0	0	0	0	1	0	
Ophioscion	0	0	0	0	0	0	0	0	0	0	0	0	0	0	0	0	0	0	0	0	0	0	0	
Stellifer	0	0	0	0	0	0	0	0	0	0	0	0	0	0	0	0	0	0	0	0	0	0	0	
Ctenosciaena	0	0	0	0	0	0	0	0	0	0	0	0	0	0	0	1	0	0	0	0	0	0	0	
Equetus	0	0	0	0	0	0	0	0	0	0	0	0	0	0	0	0	0	0	0	0	0	0	0	
Pareques	0	0	0	0	0	0	0	0	0	0	0	0	0	0	0	0	0	0	0	0	0	0	0	
Cheilotrema	0	0	0	0	0	0	0	0	0	0	0	0	0	0	0	0	0	0	0	0	0	1	0	
Umbrina	0	0	0	0	0	0	0	0	0	0	0	0	0	0	0	1	1	0	0	0	1	0	0	
Menticirrhus	0	0	0	0	0	0	0	0	0	0	0	0	?	0	0	1	1	0	0	1	0	0	1	0
Leiostomus	0	0	0	0	0	0	0	0	0	0	0	0	0	0	0	0	0	0	0	0	0	1	0	0
"Sciaena" del.	0	0	0	0	0	0	0	0	0	0	0	0	0	0	0	0	0	0	0	0	0	0	1	0
"Sciaena" gil.	0	0	0	0	0	0	0	0	0	0	0	0	?	0	0	0	0	0	0	0	0	1	0	0
Serphus	0	0	0	0	0	0	0	0	0	0	0	0	?	0	0	0	0	0	0	0	0	1	0	0
Sciaena umbra	0	0	0	0	0	0	0	0	0	0	0	0	0	0	0	0	0	0	0	0	0	1	0	0
Pogonias	0	0	0	1	0	0	0	0	0	0	0	0	1	0	0	0	0	0	1	1	1	0	0	0
Aplodinotus	0	0	0	0	0	0	0	0	0	0	0	0	0	0	0	0	0	0	0	0	0	0	1	0
Sciaenops	0	0	0	0	0	0	0	0	0	0	0	0	0	1	0	0	0	0	0	0	0	0	1	0
Roncador	0	0	0	1	0	0	0	0	0	0	0	0	1	0	0	0	0	0	0	0	0	1	0	0
Genyonemus	0	0	0	1	0	0	0	0	0	0	0	0	1	0	0	0	0	0	0	1	1	1	0	0
Micropogonias	0	0	1	0	0	0	0	0	0	0	0	0	0	0	0	0	0	0	0	1	1	0	0	0
"Paralonchurus" bra.	0	0	0	0	0	0	0	0	0	0	0	0	0	0	0	0	0	0	0	1	1	0	0	0
"Paralonchurus" ele.	0	0	0	0	0	0	0	0	0	0	0	1	?	0	0	0	0	0	0	1	1	0	0	0
Lonchurus	0	0	0	0	0	0	0	0	0	0	0	0	1	?	0	0	0	0	0	1	0	0	0	0
Pachypops	0	0	0	0	0	0	0	0	0	0	0	0	?	0	0	1	0	1	0	0	0	0	0	0
Pachyurus	0	0	0	0	0	0	0	0	0	0	0	0	?	0	0	0	0	0	0	0	0	0	0	0
Larimus	0	0	0	0	0	0	0	0	0	0	0	0	0	0	0	0	0	0	0	0	0	0	0	0
Nebris	0	0	0	0	0	0	0	0	0	0	0	0	0	0	0	0	0	0	0	0	0	0	0	0
Cynoscion	0	0	0	0	0	0	0	0	0	0	0	0	0	0	0	0	0	0	0	0	0	0	1	0
Macrodon	0	0	0	0	0	0	0	0	0	0	0	0	0	0	0	0	0	0	0	0	0	0	1	0
Isopisthus	0	0	0	0	0	0	0	0	0	0	0	0	0	0	0	0	0	0	0	0	0	0	1	0
Plagioscion	0	0	0	0	0	0	0	0	0	0	0	0	0	1	0	0	0	0	0	0	0	0	0	0
Atractoscion nob.	0	0	0	0	0	0	0	0	0	0	0	0	0	0	0	0	0	0	0	0	0	1	0	0
Atractoscion aeq.	0	0	0	0	0	0	0	0	0	0	0	0	0	0	0	0	0	0	0	0	0	1	0	0
Kathala	0	0	0	0	0	0	0	1	0	0	0	0	0	0	0	0	0	0	0	0	0	0	0	0
Panna	0	0	0	0	0	0	0	1	0	0	0	0	1	0	0	0	0	0	0	0	0	0	0	0
Otolithoides	0	0	1	0	0	0	0	0	0	0	0	0	0	0	0	0	0	0	0	0	0	0	0	0
Miracorvina	1	1	0	0	0	0	0	0	0	0	0	0	0	0	0	0	0	0	0	0	0	0	0	0
Pentheroscion	1	1	0	0	0	0	0	0	0	0	0	0	0	0	0	0	0	0	0	0	0	0	0	0
Pteroscion	1	0	0	0	0	0	0	0	0	0	0	0	0	0	0	0	0	0	0	0	0	0	0	0
Pseudotolithus (F.)	1	1	0	0	0	0	0	0	0	0	0	0	0	0	0	0	0	0	0	0	0	0	0	0
Pseudotolithus (H.)	1	1	0	0	0	0	0	0	0	0	0	0	0	0	0	0	0	0	0	0	0	0	0	0
Pseudotolithus (Pi.)	1	1	0	0	0	0	0	0	0	0	0	0	0	0	0	0	0	0	0	0	0	0	0	0
Pseudotolithus (Ps.)	1	1	0	0	0	0	0	0	0	0	0	0	0	0	0	0	0	0	0	0	0	0	0	0
"Argyrosomus" mü.	0	0	0	0	1	0	0	0	0	0	0	0	0	0	0	0	0	0	0	0	0	0	0	0
Argyrosomus jap.	0	0	0	0	1	0	1	0	0	0	0	0	0	0	0	0	0	0	0	0	0	1	0	0
Protonibea	0	0	0	0	1	0	1	0	0	0	0	0	0	0	0	0	0	0	0	0	0	0	0	0
Pennahia	0	0	0	0	1	0	0	0	0	0	0	0	0	0	0	0	0	0	0	0	0	0	0	0
Atrobucca	0	0	0	0	1	0	0	0	0	0	0	0	0	0	0	0	0	0	0	0	0	0	0	0
Otolithes	0	0	0	0	1	0	0	0	0	0	0	0	0	0	0	0	0	0	0	0	0	0	0	0
Larimichthys	0	0	0	0	1	0	0	1	0	1	0	0	0	0	1	0	0	0	0	0	0	0	0	0
Collichthys	0	0	0	0	1	0	0	1	0	1	0	0	0	0	1	0	0	0	0	0	0	0	0	0
Austromibea	0	0	0	0	1	0	0	0	0	1	0	0	0	0	0	0	0	0	0	0	0	0	0	0
Dendrophysa	0	0	0	0	1	0	0	0	0	1	0	0	0	0	0	1	0	0	0	0	0	0	0	0
Nibea	0	0	0	0	1	0	0	0	0	1	0	0	0	0	0	0	0	0	0	0	0	0	0	0
Johnius (Johnius)	0	0	0	0	1	1	0	0	0	1	1	0	0	0	0	0	0	0	0	0	0	0	0	0
Johnius (Johnie.)	0	0	0	0	1	1	0	0	0	1	1	0	0	0	0	0	0	0	0	0	0	0	0	0

131. Cephalic appendage with several branches
 132. Cephalic appendage giving rise to a branch on dorsal side of exoccipital
 133. Cephalic appendage partly exposed onto shoulder girdle-*Johnius* type
 134. Cephalic appendage partly exposed onto shoulder girdle-*Otolithoides* type
 135. Swimbladder diminutive-*Menticirrhus* type
 136. Swimbladder diminutive-*Lonchurus* type
 137. Drumming muscle originating directly on swimbladder wall
 138. Drumming muscle intrinsic
 139. Lateral wall of abdominal cavity concave-*Genyonemus* type
 140. Lateral wall of abdominal cavity concave-*Pogonias* type
 141. Lateral wall of abdominal cavity concave-*Sciaenops* type
- Others
142. Lateral line scales modified
 143. Luminous tissue present
 144. Single, median, mental barbel present
 145. Median, mental barbel pored
 146. Paired, mental barbels present
 147. Many paired, mental barbels present
 148. Caudal fin truncate to lunate in adults
 149. Intestine straight

2. CLADISTIC RELATIONSHIPS AND MONOPHYLETIC GROUPS

In this section, cladistic relationships and monophyletic groups are defined by synapomorphies. A single cladogram depicting the relationships between 70 genera and species in the Sciaenidae (Fig. 78) is first presented, to be subsequently divided into smaller monophyletic units, providing information on synapomorphies and autapomorphies. Taxa not available for complete dissection are also included in the analysis, if their phyletic position can be estimated with reasonable certainty, based on literature, radiographic, and/or partial dissection data. These taxa are rooted by broken lines. Numerals in parenthesis indicate character number, which may be followed by the abbreviations u, p, or r, indicating respectively: u-unique character, free from parallelism or reversal; p-character parallelism recognized in other phyletic line (s); r-character reversal recognized. Generic names in quotation marks indicate a questionable generic allocation of the species concerned (see Chapter IX, p. 126).

The family Sciaenidae can be divided into four main branches-A, B, C, and D.

Branch A (Fig. 78)

Branch A includes only "*Sciaena*" *trewavasae*. This species is strikingly primitive, in that no advanced characters are found.

Branch B (Fig. 79)

Branch B comprises *Odontoscion*, *Elattarchus*, *Corvula*, *Bairdiella*, *Ophioscion*, and *Stellifer*. Monophyly of the group is evidenced by the following suite of characters: auditory bulla notched-*Stellifer* type (27, u); exoccipital condyles not broadly joined to each other-*Stellifer* type (37, u); basioccipital projecting backwards-*Stellifer* type (39, u); Baudelot's ligament attached to exoccipital (41, u); retractor dorsalis originating from basicranial region and first vertebra (74, u);

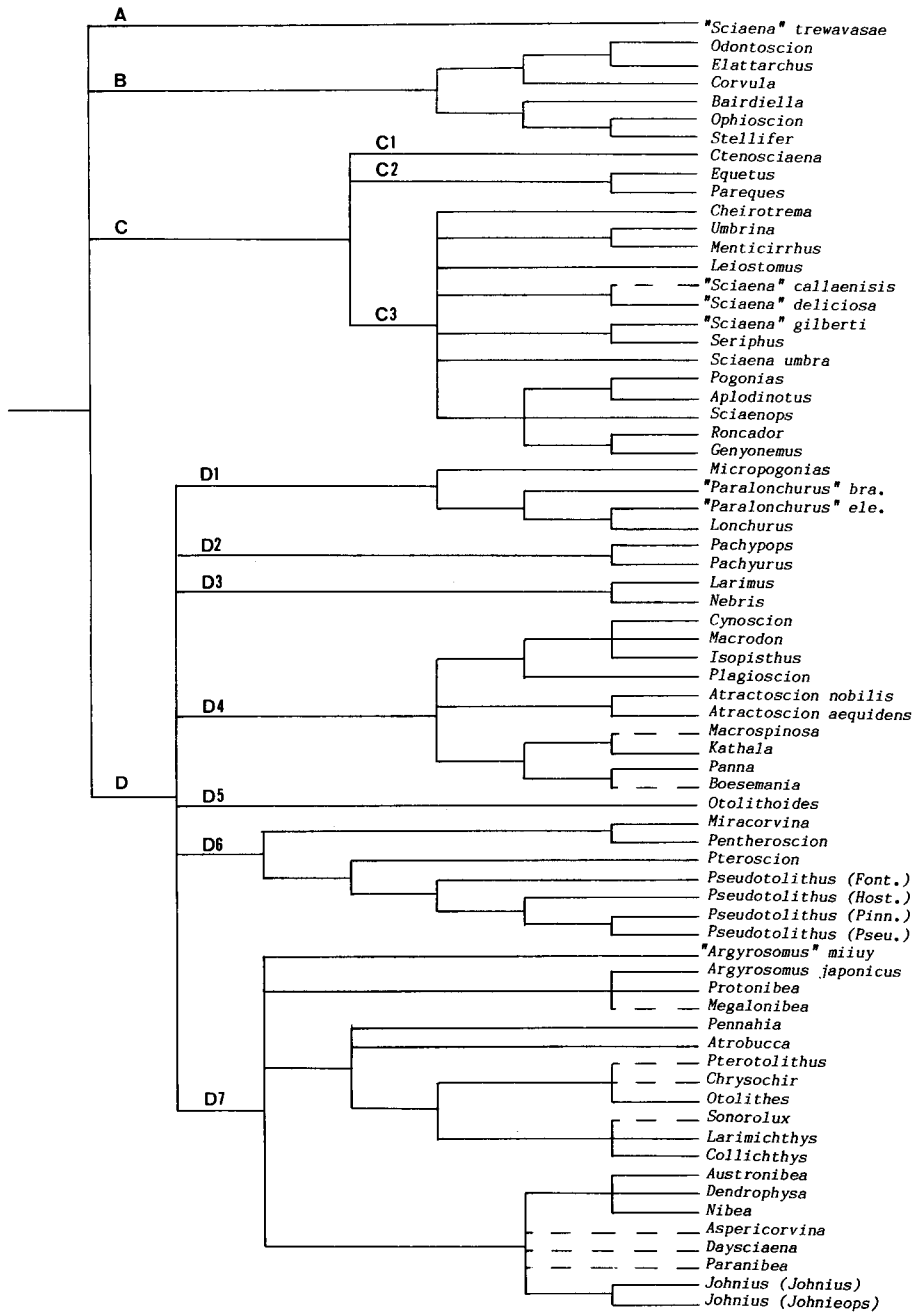

Fig. 78. Cladogram of relationships among sciaenids genera and species.

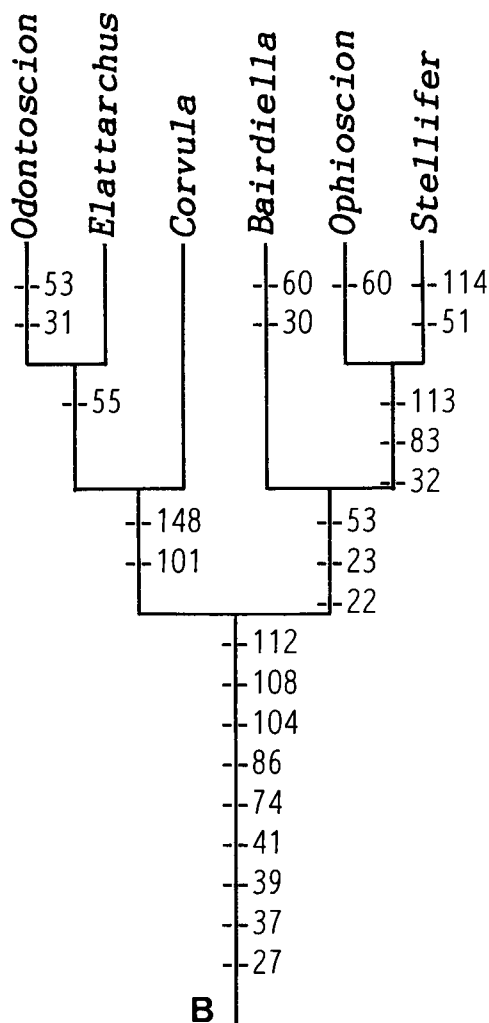

Fig. 79. Cladogram of relationships within Group B.

ventral modification of anterior abdominal vertebrae—*Stellifer* type (86, p); lapillus enlarged—*Stellifer* type (104, u); sulcus head situated on anterior surface of sagitta (108, u); swimbladder two chambered (112, u).

Branch B genera fall into two sister groups. One group—*Odontoscion*, *Elattarchus*, and *Corvula*—shares the following characters: flexor ventralis externus faded into flexor ventralis (101, p); adult caudal fin shape from truncate to lunate (148, p). In addition, *Odontoscion* and *Elattarchus* both possess canines (55, p). *Elattarchus* and *Corvula* have no autapomorphies, whereas *Odontoscion* has the basi-sphenoid separated ventrally from parasphenoid (31, p), and the levator operculi originating from the posttemporal (53, p).

The second group within Branch B, comprising *Bairdiella*, *Ophioscion*, and *Stellifer*, and is defined by the following: epaxial muscle terminating behind supraorbital ridge of frontal (22, p); outer margin of lateral ethmoid concaved medially (23, u); and levator operculi originating from posttemporal (53, p). *Ophioscion* and *Stellifer* form a monophyletic sister group to *Bairdiella*, since they share: basisphenoid absent (32, p); fifth parapophysis enlarged (83, u); anterior chamber of swimbladder laterally expanded to outer rim of pterotic (113, u). The autapomorphies of *Bairdiella* are the pterosphenoid separated from the basisphenoid (30, p), and the tooth plate on pharyngobranchial 2 enlarged and anteriorly located (60, r, p). An autapomorphy of *Ophioscion* is the tooth plate on pharyngobranchial 2 enlarged and anteriorly located (60, r, p), whereas those of *Stellifer* includes a medially concaved ventral margin of palatine (51, u), and a pair of appendages present on the anterior swimbladder chamber (114, u).

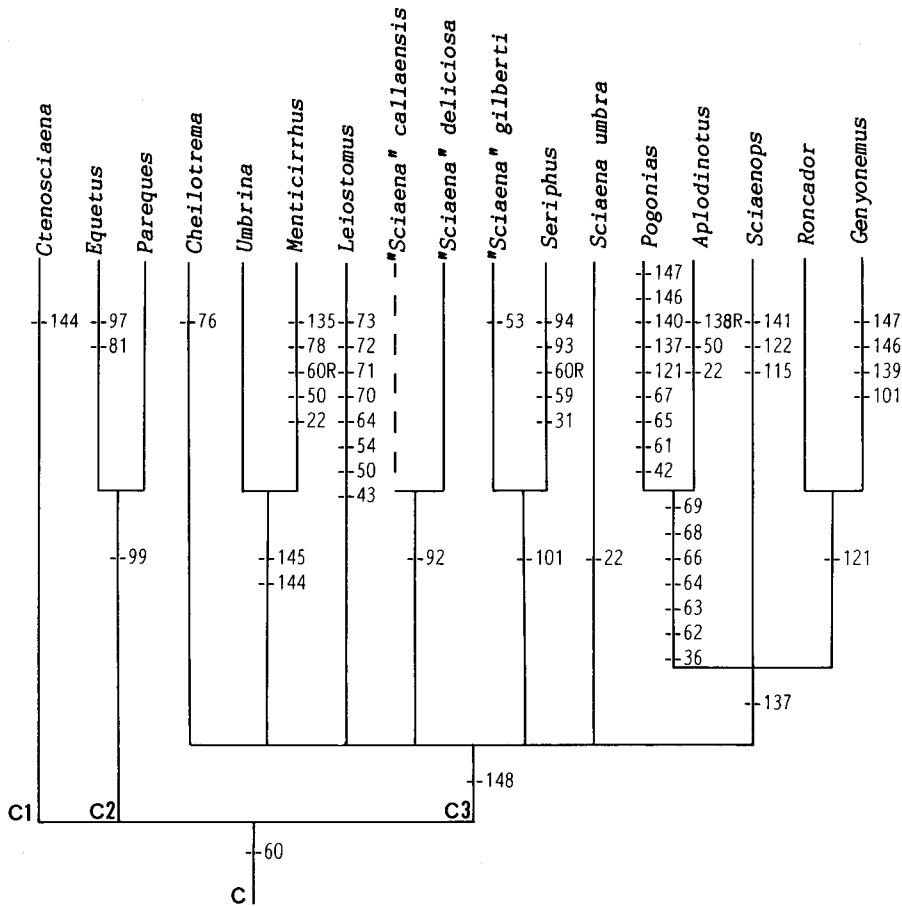

Fig. 80. Cladogram of relationships within Group C.

Branch C (Fig. 80)

Branch C, which comprises 17 genera and species, is defined by a single character, the enlarged and anteriorly located tooth plate on pharyngobranchial 2 (60, p, r). Three sub-branches, C1, C2, and C3, can be recognized.

Sub-branch C1, comprising only *Ctenosciaena*, is based upon a single autapomorphy, the presence of the single, median, mental barbel (144, p).

Sub-branch C2 includes *Equetus* and *Pareques*, and is defined by the numerous, dorsal pterygiophores in front of the third neural spine (99, u). Of the two genera, *Equatus* has two autapomorphies, smaller neural spines (81, u), and less than three predorsals-*Equetus* type (97, u).

Sub-branch C3 is the largest group within Branch C, its monophyly being based upon the caudal fin shape, being truncate to lunate in adults (148, p). It is further subdivided into seven groups. The first group includes *Cheilotrema*, which has a single autapomorphy; a cartilaginous basihyal (76, u). In the second group, the sister genera *Umbrina* and *Menticirrhus* both have a single, median, mental barbel (144, p); and median, mental barbel pored (145, u). *Umbrina* possesses no autapomorphies, whereas *Menticirrhus* possesses six as follows: epaxial muscle terminating behind supraorbital ridge of frontal (22, p); posteromedial margin of metapterygoid overlapping or attached to medial side of lower arm of hyomandibular (50, p); secondary reversal from enlarged and anteriorly located tooth plate on pharyngobranchial 2 (60, p, r); two and half radials on scapula (78, p); first anal pterygiophore bearing one spine (96, u); swimbladder diminutive-*Menticirrhus* type (135, u). The third group, which includes only *Leiostomus*, is defined by the following suite of the autapomorphous characters: basicranial modification-*Leiostomus* type (43, u); posteromedial margin of metapterygoid overlapping or attached to medial side of lower arm of hyomandibular (50, p); lower jaw teeth absent in adults (54, u); dorsal face of pharyngobranchial 3 incompletely covered by muscles (64, p); pharyngobranchial 2 extremely large (70, u); head of epibranchial 2 enlarged (71, u); interarcual cartilage connection with pharyngobranchial 2 lost (72, u); transversus dorsalis anterior well developed, partially inserted onto parasphenoid (73, u). The fourth group, comprising "*Sciaena*" *deliciosa*, and "*S.*" *callaensis*, is characterized by inflated epipleural ribs (92, u). "*S.*" *callaensis* (examined radiographically) is considered to be a sister species of "*S.*" *deliciosa*, since the seventh epipleural rib is inflated in the former. In the fifth group, "*Sciaena*" *gilberti* and *Seriphus* are included together on the basis of the flexor ventralis externus faded into flexor ventralis (101, p). "*S.*" *gilberti* possesses a single autapomorphy, the levator operculi originating from the posttemporal (53, p), although a number of sac-like appendages (see Character 121) may also be considered to be an autapomorphy of this species. The autapomorphies of *Seriphus* are: basisphenoid separated from parasphenoid ventrally (31, p); dentary foramen present (59, p); secondary reversal from enlarged and anteriorly located tooth plate on pharyngobranchial 2 (60, p, r); posterior dorsal fin spines not exposed (93, p); soft dorsal and anal fins bases of equal length (94, p). The sixth group includes only *Sciaena umbra*, characterized by a single autapomorphy; epaxial muscle terminating behind supraorbital ridge of frontal (22, p). The seventh group comprises *Pogonias*, *Aplodinotus*, *Sciaenops*, *Roncador*, and *Genyonemus*. They are

considered to be a monophyletic group, owing to their having the drumming muscle originating directly on the swimbladder wall (137, u, r). Within the group, *Pogonias* and *Aplodinotus* appear to be sister-genera, linked by a series of characters: intercalar in contact with epiotic (36, u); ventral process present in ceratobranchial 5 (62, u); transversus dorsalis anterior and posterior present as a single element (63, u); dorsal face of pharyngobranchial 3 incompletely covered by muscles (64, p); pharyngobranchial 3 enlarged (66, u); levator posterior originating from upper half of post cranial wall (68, u); adductor 5 well developed (69, u). Autapomorphies of *Pogonias* include: basicranial modification-*Pogonias* type (42, u); interdigitating suture between ceratobranchials 5 (61, u); transversus dorsalis anterior not extending across dorsal surface of upper pharyngobranchials (65, u); tooth plate on pharyngobranchial 2 relocated obliquely to pharyngobranchial 3 (67, u); numerous interconnected appendages arising along sides of swimbladder (121, p); drumming muscle intrinsic (138, u); lateral wall of abdominal cavity concave-*Pogonias* type (140, u); many paired, mental barbels present (146, p; 147, p, r). The autapomorphies found in *Aplodinotus* were: epaxial muscle terminating behind supraorbital ridge of frontal (22, p); posteromedial margin of metapterygoid overlapping or attached to medial side of lower arm of hyomandibular (50, p); secondary reversal from drumming muscle directly originating on swimbladder wall (137, r). *Sciaenops* is unique within the group having the following autapomorphies: a pair of horn-like appendages arising at anterior end of swimbladder (115, p); swimbladder with a pair of sac-like appendages comprising of numerous, labyrinthine chambers (122, u); lateral wall of abdominal cavity concave-*Sciaenops* type (141, u). Finally, in the seventh group, *Roncador* has a sister relationship with *Genyonemus*, by virtue of sharing numerous interconnected appendages arising along the sides of swimbladder (121, p). *Genyonemus* possesses several autapomorphies however, viz. flexor ventralis externus faded into flexor ventralis (101, p); lateral wall of abdominal cavity concave-*Genyonemus* type (139, u); many paired mental barbels (146, p; 147, p, r). *Roncador* on the other hand, lacks autapomorphies.

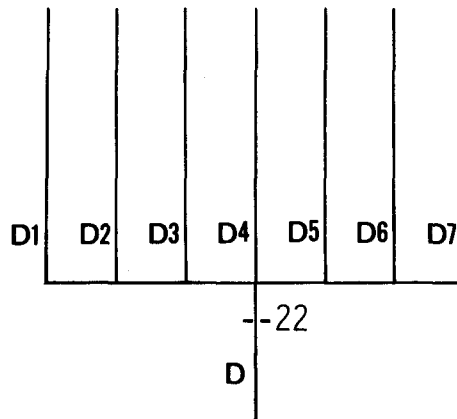

Fig. 81. Cladogram of relationships within Group D.

Branch D (Figs. 81-85)

Branch D (Fig. 81) is defined by a single synapomorphy (epaxial muscle terminating behind supraorbital ridge of frontal; 22, p), and is divided into sub-branches D1-D7.

Sub-branch D1 (Fig. 82) consists of *Micropogonias*, "*Paralonchurus*" *brasiliensis*, "*P.*" *elegans*, and *Lonchurus*, and is characterized by the following synapomorphies: enlarged and anteriorly located tooth plate on pharyngobranchial 2 (60, p, r); many paired, mental barbels present (146, p; 147, p, r). In addition, *Micropogonias* possesses two autapomorphies: distal end of sulcus tail circular (110, p); a pair of tube-like appendages arising at posterior portion of swimbladder (120, p). This genus stands apart from the remainder in sub-branch D1, which are united by having: pterosphenoid in contact with lateral ethmoid (28, p); intercalar projecting downward (33, p); a pair of horn-like appendages arising at anterior end of swimbladder (115, p); a pair of tube-like appendages arising at anterior end of swimbladder (116, p). However, "*Paralonchurus*" *elegans* and *Lonchurus* are clearly more closely related to each other, than either is to "*P.*" *brasiliensis*, being characterized by the following synapomorphies: eye diminutive (44, p); infraorbital 3 flattened dorsally (46, p); posteromedial margin of metapterygoid overlapping or attached to medial side of lower arm of hyomandibular (50, p); adductor arcus palatini divided into two elements (52, p); secondary reversal from enlarged and anteriorly located tooth plate on pharyngobranchial 2 (60, p, r); adductor profundus passing to lateral side of pectoral girdle via coracoid foramen (80, p); swimbladder diminutive-*Lonchurus* type (136, u). A reversal from Character 60 can be explained by consideration of the decrease in eye size. Since a reduction in eye size provides more space for the cheek muscles, small eyed sciaenids tend to have a large gape. The initially, small, inferior mouth, with an enlarged anteriorly located pharyngobranchial 2 (as in *P. brasiliensis*), must have become transformed into a large, terminal mouth, with a small obliquely located pharyngobranchial 2, concurrent with the decrease in eye size. It seems likely that in a large oral cavity, an enlarged and anteriorly located pharyngobranchial 2 may lose its functional merit, that is, its role in passing food backward. "*P.*" *elegans* has two autapomorphies: basisphenoid separated from parasphenoid ventrally (31, p); two and half radials on scapula (78, p), whereas *Lonchurus* has four, viz. basisphenoid absent (32, p); first dorsal pterygiophore bearing one spine (95, u); lower caudal lobe with six branched rays (100, u); secondary reversal from many paired, mental barbels present (147, p, r). "*P.*" *brasiliensis* has a single autapomorphy: basisphenoid separated from parasphenoid ventrally (31, p).

Sub-branch D2 (Fig. 82) includes *Pachyurus* and *Pachypops*, its monophyly being established by the following synapomorphies: infraorbital 3 lying almost parallel to horizontal axis of eye (47, u); nasal acutely pointed (48, u); suspensorium strongly depressed (49, u); head of maxillary anterior to ethmoid and prevomer (57, u). *Pachyurus* possesses three autapomorphies: basisphenoid separated from parasphenoid ventrally (31, p); posteromedial margin of metapterygoid overlapping or attached to medial side of lower arm of hyomandibular (50, p); enlarged and anteriorly located tooth plate on pharyngobranchial 2 (60, p). The autapomorphies of *Pachypops* are: a pair of horn-like appendages arising at anterior end of swim-

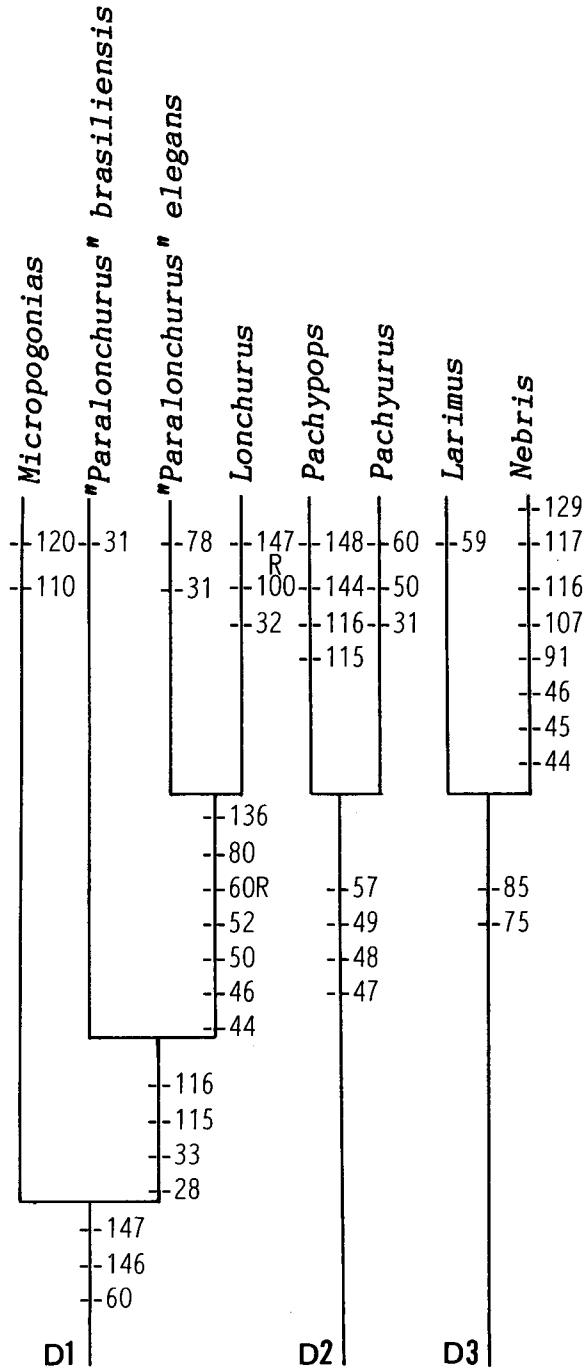

Fig. 82. Cladogram of relationships within D1, D2, and D3.

bladder (115, p); a pair of tube-like appendages arising at anterior end of swimbladder (116, p); single, median, mental barbel present (144, p); paired, mental barbels present (148, p).

Sub-branch D3 (Fig. 82) includes *Larimus* and *Nebris*. Monophyly of this group is supported by: basihyal fan-shaped (75, u); ventral modification of anterior abdominal vertebrae-*Pseudotolithus* type (85, p). *Larimus* has a single autapomorphy, that is, the dentary foramen present (59, p). Autapomorphies of *Nebris* are as follows: eye diminutive (44, p); infraorbital 2 flattened dorsally (45, p); infraorbital 3 flattened dorsally (46, p); epipleural ribs few and reduced (91, p); sagitta notched posteriorly (107, u); a pair of tube-like appendages arising at anterior end of swimbladder (116, p); a pair of tube-like appendages, arising at anterior end of swimbladder, extending backward, and looping forward (117, u); appendage deeply cephalic-*Nebris* type (129, u).

Sub-branch D4 (Fig. 83) comprising 10 genera and species, is defined by the following synapomorphy; a pair of horn-like appendages arising at anterior end of swimbladder (115, p). The sub-branch is divided into three groups. The first group comprises *Cynoscion*, *Macrodon*, *Isopisthus*, and *Plagioscion*, and is character-

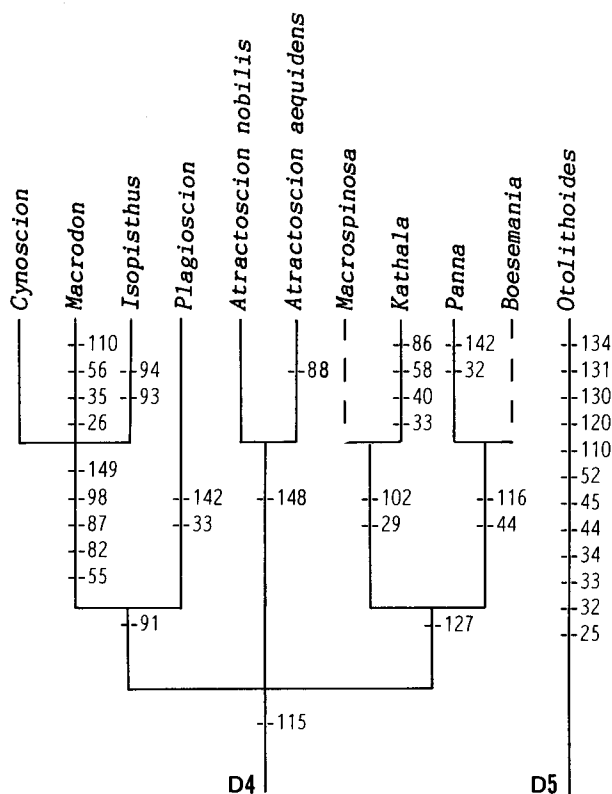

Fig. 83. Cladogram of relationships within D4 and D5.

ized by having the epipleural ribs few and reduced (91, p). The first three genera listed form a natural group, with the following characters: canines present (55, p); first and second neural spines widely separated (82, u); ventral modification of anterior abdominal vertebrae-*Cynoscion* type (87, u); predorsals number less than three-*Cynoscion* type (98, u); intestine straight (149, u). Whereas *Cynoscion* has no autapomorphies, *Macrodon* has four, viz., auditory bulla notched-*Macrodon* type (26, u); intercalar broad, ventral contact with prootic (35, u); teeth "arrowhead"-shaped (56, u); distal end of sulcus tail circular (110, p). *Isopisthus* has the following two autapomorphies: posterior dorsal fin spines not exposed (93, p); soft dorsal and anal fins bases of equal length (94, p). The group formed by these genera, contrast with *Plagioscion*, which has two autapomorphies, viz., intercalar projecting downward (33, p); and modified lateral line scales (142, p). The second of the three groups in sub-branch D4, includes *Atractoscion nobilis* and *A. aequidens*, and is characterized by the caudal fin being truncate to lunate in adults (148, p). *A. nobilis* lacks autapomorphies, while *A. aequidens* has the ventral modification of anterior abdominal vertebrae-*Atractoscion* type (88, u). The third group includes *Kathala*, *Macrospinosa*, *Panna*, and *Boesemania*, which have in common, swimbladder appendages deeply cephalic-*Kathala* type (127, u). *Kathala*'s apomorphic characters include: frontal projection downward (29, p); intercalar projecting downward (33, p); basioccipital projecting backward-*Kathala* type (40, u); maxillary shaft foramen present (58, p); ventral modification of anterior abdominal vertebrae-*Stellifer* type (86, p); lapillus enlarged-*Kathala* type (102, u). *Macrospinosa* shares with *Kathala* Characters 29 and 102, in addition to the similar disposition of swimbladder appendages. However, judging from the radiograph and partial dissection, *Macrospinosa* does not share Characters 40, 58, and 86 with *Kathala*, and is considered to be relatively primitive compared with the latter. The apomorphic characters of *Panna* are: basisphenoid absent (32, p); eye diminutive (44, p); a pair of tube-like appendages arising at anterior end of swimbladder (116, p); lateral line scales modified (142, p). *Boesemania* is considered to be a sister group of *Panna*, based on Trewavas (1977) and radiographic evidence. The swimbladder is similar to that of *Panna*, especially to *P. microdon*, in having a pair of branched cephalic appendages, in addition to the backward directed tubular appendages (116), which are common to all species of *Panna* and *Boesemania*. In *Boesemania*, many tubules are directed backwards, in contrast to a single pair of tubules in *Panna*. *Boesemania* is thus more specialized than *Panna* in this regard.

Sub-branch D5 (Fig. 83) is represented by a single genus, *Otolithoides*, which has the following autapomorphies: carotid foramen enlarged (25, u); basisphenoid absent (32, p); intercalar projecting downward (33, p); intercalar in broad, contact with basioccipital (34, p); eye diminutive (44, p); infraorbital 2 flattened dorsally (45, p); adductor arcus palatini divided into two elements (52, p); distal end of sulcus tail circular (110, p); a pair of tube-like appendages arising at posterior portion of swimbladder (120, p); appendage deeply cephalic-*Otolithoides* type (130, u); cephalic appendages with several branches (131, u); cephalic appendage partly exposed onto shoulder girdle-*Otolithoides* type (134, u).

Sub-branch D6 (Fig. 84) includes *Miracorvina*, *Pentheroscion*, *Pteroscion*, *Pseudotolithus* (*Fonticulus*), *P. (Hostia)*, *P. (Pinnacorvina)*, and *P. (Pseudotolithus)*.

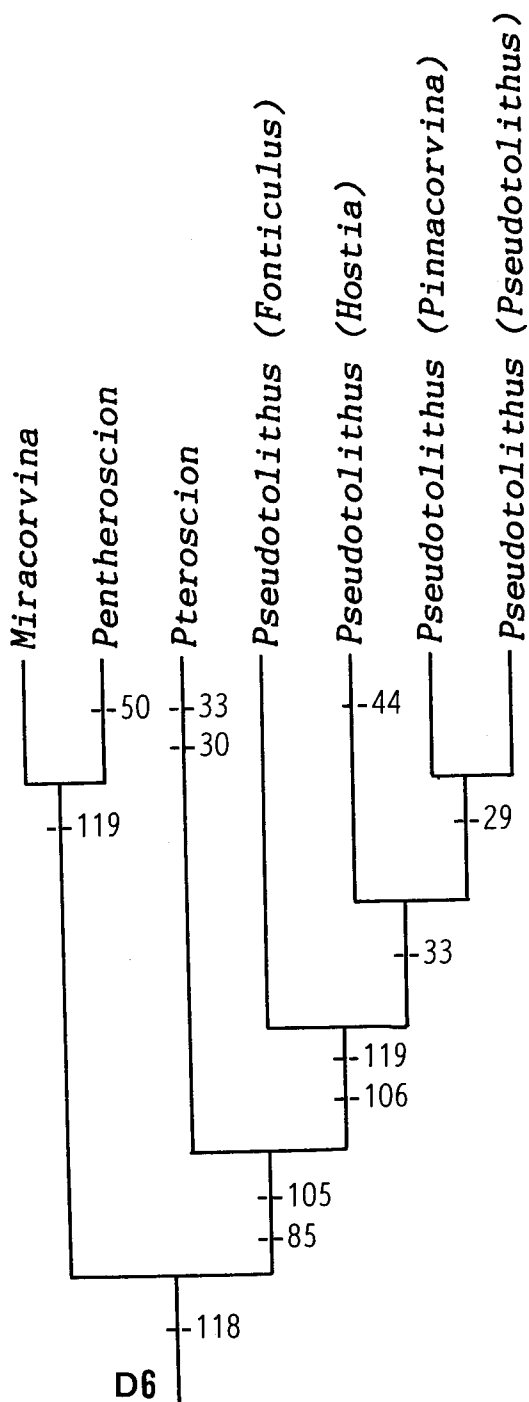

Fig. 84. Cladogram of relationships within D6.

Monophyly of this branch is supported by a pair of tube-like appendages, divided into several tubules, arising at anterior end of swimbladder (118, u). *Miracorvina* and *Pentheroscion* together form a sister group of other members of the sub-branch, and are defined by the tube-like appendage divided into several long tubules (119, p). *Miracorvina* has no autapomorphies, whereas *Pentheroscion* has one, viz., posteromedial margin of metapterygoid overlapping or attached to medial side of lower arm of hyomandibular (50, p). The remaining genera form a monophyletic group, based on the following shared characters: ventral modification of anterior abdominal vertebrae-*Pseudotolithus* type (85, p); sagitta twisted (105, u). *Pteroscion* is a sister group of *Pseudotolithus*, and has the following autapomorphies: pterosphenoid separated from basisphenoid (30, p); intercalar projecting downward (33, p). All subgenera of *Pseudotolithus* have in common a strongly twisted sagitta (106, u), and a pair of tube-like appendage, divided into several long tubules (119, p). Within these subgenera, *P. (Fonticulus)* is most primitive and has no autapomorphies. *P. (Hostia)*, *P. (Pinnacorvia)*, and *P. (Pseudotolithus)* differ from *P. (Hostia)* in having the frontal projecting downward (29, p). Both lack autapomorphies, whereas *P. (Hostia)* has a diminutive eye (44, p).

Sub-branch D7 (Fig. 85) is a large group, comprising 20 genera and species,

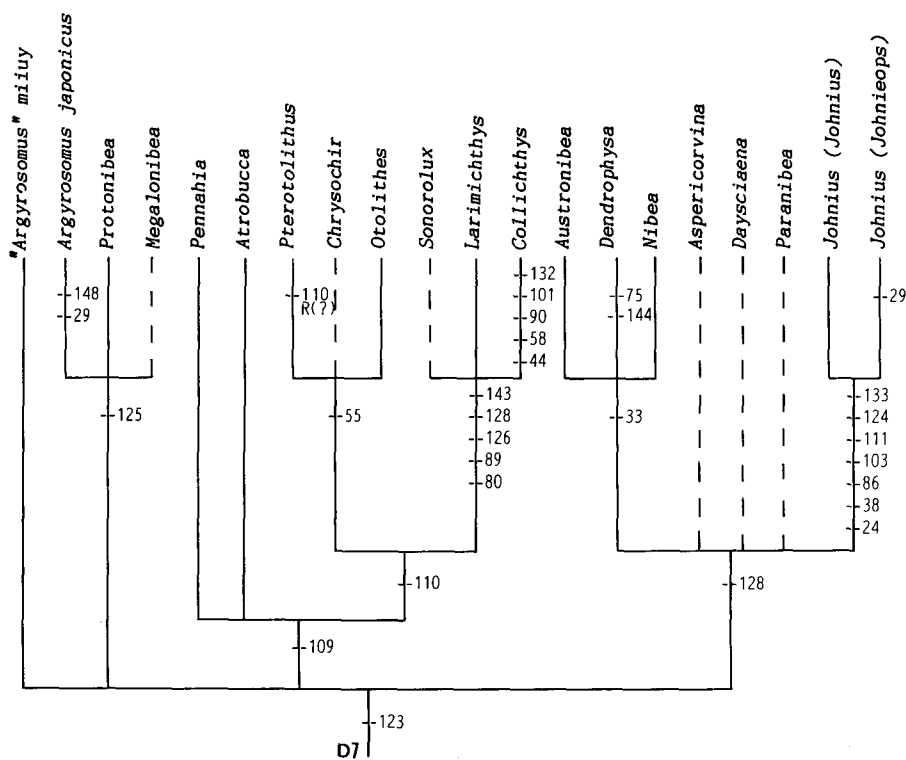

Fig. 85. Cladogram of relationships within D7.

identified by a single synapomorphy, viz., numerous arborescent appendages arising along sides of swimbladder (123, u). D7 can be further divided into four groups, the first being represented by "*Argyrosomus*" *miuuy*, which has no autapomorphies. The second group comprises *Argyrosomus japonicus*, *Protonibea*, and *Megalonibea*. They share in common enlarged anterior appendages (125, u). *Megalonibea* is included in this group based on the literature (Chu *et al.*, 1963; see Character 125). *A. japonicus* possesses two autapomorphies, the frontal projecting downward (19, p), and caudal fin being truncate to lunate in adults (148, p). The third group is represented by *Pennahia*, *Atrobuca*, *Pterotolithus*, *Chrysochir*, *Otolithes*, *Sonorolux*, *Larimichthys*, and *Collichthys*, and have in common: sulcus tail only slightly curved (109, u). *Pennahia* and *Atrobuca* have no autapomorphies. *Otolithes*, *Chrysochir*, *Sonorolux*, *Larimichthys*, and *Collichthys* form a monophyletic group, since they all have the distal end of the sulcus tail circular (110, p). *Otolithes* and *Chrysochir* have a single synapomorphy, canines present (55, p). Based on Trewavas (1977) and radiographic evidence, *Pterotolithus* is tentatively placed close to *Otolithes* and *Chrysochir*, since all genera have canines. However, the sulcus tail of *Pterotolithus* is not circular, and therefore the position of this genus is ambiguous. *Larimichthys* forms a monophyletic group together with *Collichthys*, by common possession of the following: adductor profundus passing to lateral side of pectoral girdle via coracoid foramen (80, p); ventral modification of anterior abdominal vertebrae—*Larimichthys* type (89, u); ventral rims of appendages prolonged, extending along abdominal cavity (126, u); appendage deeply cephalic—*Nibea* type (128, p); luminous tissue present (143, u). *Larimichthys* has no autapomorphies, whereas *Collichthys* has: eye diminutive (44, p); maxillary shaft foramen present (58, p); ventral modification of anterior abdominal vertebrae—*Collichthys* type (90, u); flexor ventralis externus faded into flexor ventralis (101, p); cephalic appendage giving rise to a branch on dorsal side of exoccipital (132, u). *Sonorolux* is apparently closely related to *Larimichthys* and *Collichthys*, since the former is characterized by similar vertebral, swimbladder, and otolith modifications, as well as by the presence of luminous tissue. Although vertebral number is not a generally useful character in this family, the total vertebrae usually number more than 25 in *Larimichthys* and *Collichthys*, but only 25 in *Sonorolux*—the primitive condition. Accordingly, *Sonorolux* may be primitively related to the former two genera, as suggested by Trewavas (1977). The fourth group, including *Austronibea*, *Dendrophysa*, *Nibea*, *Aspericorvina*, *Daysciaena*, *Paranibea*, *Johnius* (*Johnius*), and *Johnius* (*Johnieops*), all have a deeply cephalic swimbladder appendage—*Nibea* type (128, p). *Johnius* (*Johnius*) and *J.* (*Johnieops*) form a monophyletic group characterized by: foramen for nervus facialis (VII) enlarged (24, u); exoccipital condyles not broadly joined to each other—*Johnius* type (38, u); ventral modification of anterior abdominal vertebrae—*Stellifer* type (86, p); lapillus enlarged—*Johnius* type (103, u); distal end of sulcus tail with a deep hollow cone (111, u); swimbladder hammer-shaped (124, u); cephalic appendage partly exposed onto shoulder girdle—*Johnius* type (133, u). *Johnius* (*Johnius*) has no autapomorphies, whereas *J.* (*Johnieops*) has the frontal projecting downward (29, p). *Austronibea*, *Dendrophysa*, and *Nibea* all have the intercalar projecting downward (33, p). A single autapomorphy in *Dendrophysa* is the presence of a single, median, mental barbel (144, p), whereas *Nibea* has the

intercalar in broad contact with basioccipital (34, p). *Austronibeia* has no autapomorphies. Following Trewavas (1977), *Aspericorvina*, *Daysciaena*, and *Paranibeia* is tentatively placed close to this group, because they lack the specializations found in *Johnius*. The condition of the intercalar is unknown in the three genera.

VIII. Zoogeography

1. DISTRIBUTION OF MONOPHYLETIC GROUPS WITHIN THE SCIAENIDAE

Monophyletic groups at various hierarchical levels have been defined in the preceding chapter. Before discussing their distributions in detail, sciaenid distributions throughout the world's oceans are briefly reviewed (see Table 2, compiled from Trewavas, 1977; Chao, 1978a, 1981, 1986, and pers. comm.; pers. obs.), and major patterns are categorized, which exhibit large area endemismicity. The world's oceans are classified into four basins (for definition, see Springer, 1982): eastern Pacific, western Atlantic, eastern Atlantic, and Indo-West Pacific. New World and Old World refer to the eastern Pacific plus western Atlantic and eastern Atlantic plus Indo-West Pacific, respectively.

Wide ranging genera

Four genera may be included under this category—*Umbrina*, "*Sciaena*", *Atractoscion*, and "*Argyrosomus*". *Umbrina* is abundant in the New World (12 spp.), but is poorly represented in the Old World (3 spp.). Two of the three eastern Atlantic species occur along the east coast of Africa, as far as the east coast of India. "*Sciaena*", apparently polyphyletic, is restricted mostly to the New World, except for *S. umbra* (type species) in the eastern Atlantic. *Atractoscion* is the only sciaenid genus which is represented by populations in both the eastern Pacific and the Old World. This genus comprises two species; *A. nobilis* endemic to the eastern Pacific, and *A. aequidens*, found in the eastern Atlantic, and disjunctly along the coasts of Australia. "*Argyrosomus*", which becomes monophyletic with exclusion of *A. miiuy*, is an Old World genus, with most species occurring in the Indo-West Pacific, although two are found in the eastern Atlantic; *A. regius* is endemic to the eastern Atlantic, and *A. hololepidotus* extends from the eastern Atlantic to margins of the Indian Ocean (Natal, Mozambique, and disjunctly along the Australian coast). The distribution pattern of *A. hololepidotus* approximates that of *Atractoscion aequidens*.

Amphi-American genera

Fourteen genera distributed in the eastern Pacific and western Atlantic, but absent in other areas, are categorized as Amphi-American genera. However, no species are known to be common to both regions. In general, each genus has a greater number of species in the eastern Pacific.

Eastern Pacific genera

Seven genera (six monotypic) are endemic to the eastern Pacific.

Western Atlantic genera

Nine genera are endemic to the western Atlantic, four being restricted to freshwater of drainage systems. All of marine genera are monotypic. Of the freshwater genera, *Aplodinotus* (monotypic) is widespread in North America, whereas the other genera are restricted to South America.

Table 2. World distribution of the Sciaenidae. The number in parentheses indicates number of species shared by adjacent regions.

Genera	Number of species			
	Eastern Pacific	Western Atlantic	Eastern Atlantic	Indo-W. Pacific
Wide-ranging genera				
<i>Umbrina</i>	9	3	3	(2) 2
" <i>Sciaena</i> "	5	2	1	0
<i>Atractoscion</i>	1	0	1	(1) 1
" <i>Argyrosomus</i> "	0	0	2	(1) 7
Amphi-American genera				
<i>Pareques</i>	4	2	0	0
<i>Ctenosciaena</i>	1	1	0	0
<i>Menticirrhus</i>	6	3	0	0
<i>Larimus</i>	5	2	0	0
<i>Nebris</i>	2	1	0	0
<i>Micropogonias</i>	5	2	0	0
<i>Cynoscion</i>	11	12	0	0
<i>Macrodon</i>	1	1	0	0
<i>Isopisthus</i>	2	1	0	0
" <i>Paralanchurus</i> "	5	2	0	0
<i>Bairdiella</i>	3	4	0	0
<i>Odonoscion</i>	2	1	0	0
<i>Ophioscion</i>	8	3	0	0
<i>Stellifer</i>	13	11	0	0
Eastern Pacific genera				
<i>Cheilotrema</i>	3	0	0	0
<i>Corvula</i>	1	0	0	0
<i>Elattarchus</i>	1	0	0	0
<i>Genyonemus</i>	1	0	0	0
<i>Roncador</i>	1	0	0	0
<i>Seriphus</i>	1	0	0	0
<i>Totoaba</i>	1	0	0	0
Western Atlantic genera				
<i>Equetus</i>	0	1	0	0
<i>Leiostomus</i>	0	1	0	0
<i>Sciaenops</i>	0	1	0	0
<i>Pogonias</i>	0	1	0	0
<i>Lonchurus</i>	0	1	0	0
Western Atlantic (fresh water) genera				
<i>Aplodinotus</i>	0	1	0	0
<i>Pachypops</i>	0	4	0	0
<i>Pachyurus</i>	0	8	0	0
<i>Plagoscion</i>	0	9	0	0
Eastern Atlantic genera				
<i>Miracorvina</i>	0	0	1	0
<i>Pentheroscion</i>	0	0	1	0
<i>Pteroscion</i>	0	0	1	0
<i>Pseudotolithus</i> (<i>Fonticulus</i>)	0	0	1	0
<i>Pseudotolithus</i> (<i>Hostia</i>)	0	0	1	0
<i>Pseudotolithus</i> (<i>Pinnacorvina</i>)	0	0	1	0
<i>Pseudotolithus</i> (<i>Pseudotolithus</i>)	0	0	3	0
Indo-West Pacific genera				
<i>Bahaba</i>	0	0	0	3
<i>Macropsinosa</i>	0	0	0	1
<i>Kathala</i>	0	0	0	1
<i>Otolithoides</i>	0	0	0	3
<i>Panna</i>	0	0	0	2
<i>Boesemania</i>	0	0	0	1
<i>Pennahia</i>	0	0	0	4
<i>Atrobucca</i>	0	0	0	8
<i>Chrysochir</i>	0	0	0	1
<i>Otolithes</i>	0	0	0	2
<i>Pterotolithus</i>	0	0	0	2
<i>Protonibea</i>	0	0	0	1
<i>Austronibea</i>	0	0	0	1
<i>Aspericorvina</i>	0	0	0	1
<i>Dendrophysa</i>	0	0	0	1
<i>Daysciaena</i>	0	0	0	1
<i>Paramibea</i>	0	0	0	1
<i>Nibea</i>	0	0	0	6
<i>Megalomibea</i>	0	0	0	1
<i>Sonorolux</i>	0	0	0	1
<i>Larimichthys</i>	0	0	0	3
<i>Collichthys</i>	0	0	0	2
<i>Johnius</i>	0	0	0	20
TOTAL	92	78	18	77

Eastern Atlantic genera

Four genera, three monotypic, occur in the eastern Atlantic. *Pseudotolithus*, the largest genus of the region, currently comprises four subgenera.

Indo-West Pacific genera

Twenty three genera are endemic to the Indo-West Pacific region. *Johnius* is particularly diverse, the number of species being comparable with those of *Cynoscion* and *Stellifer* in the New World.

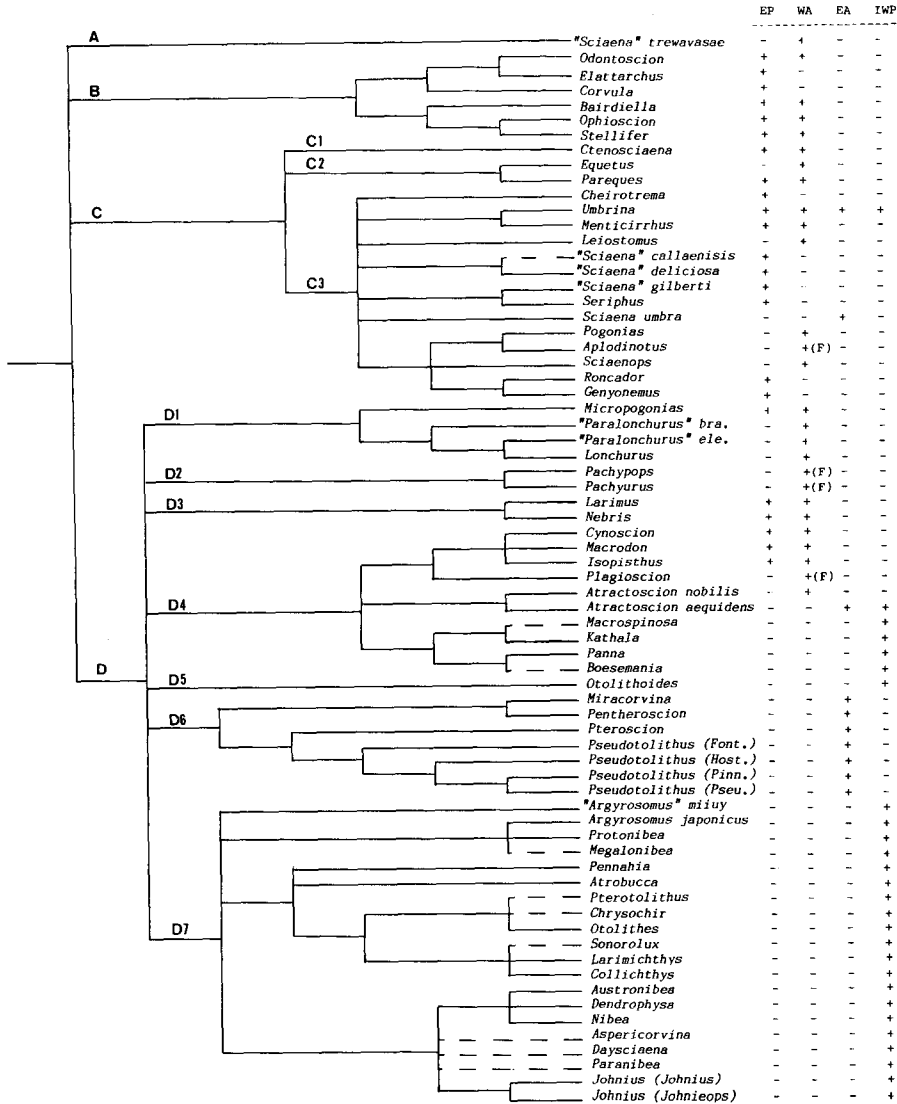

Fig. 86. Monophyletic groups and their distributions. EA, eastern Atlantic; EP, eastern Pacific; IWP, Indo-West Pacific; WA, western Atlantic. += present; -= absent. See also Table 1.

Regional endemism is clearly common in the Sciaenidae as pointed out by Chao (1986). Genera and species are most diverse in the eastern Pacific, followed by the western Atlantic and Indo-West Pacific, which are similar to one another in species richness. The eastern Atlantic is very poorly represented by sciaenids. Distribution of monophyletic groups is next considered (Fig. 86).

Branch A

This branch includes only "*Sciaena*" *trwavasae*, which occurs in the western Atlantic (southern Caribbean Sea).

Branch B

All of the genera included in this branch are restricted to the New World. *Elattarchus* and *Corvula* occur solely in the eastern Pacific, whereas the remaining four genera have an Amphi-American distribution.

Branch C

The genera and species included in this branch are distributed mostly in the New World, except for *Umbrina* (a wide ranging genus) and *Sciaena umbra* (an eastern Atlantic species). *Cheilotrema*, "*Sciaena*" *callaensis*, "*S.*" *deliciosa*, "*S.*" *gilberti*, *Seriphus*, *Roncador*, and *Genyonemus* occur solely in the eastern Pacific, whereas *Equetus*, *Leiostomus*, *Pogonias*, *Aplodinotus*, and *Sciaenops* are found in the western Atlantic or fresh water of North America (*Aplodinotus*). *Ctenosciaena*, *Pareques*, and *Menticirrhus* have an Amphi-American distribution.

Branch D

Sub-branch D1 contains New World genera and species only. *Micropogonias* and "*Paralonchurus*" show an Amphi-American distribution, whereas *Lonchurus* is restricted to the western Atlantic (but see Chapter IX, p. 126).

Sub-branch D2 comprises *Pachypops* and *Pachyurus*, both of which are distributed in Atlantic drainage systems of South America.

Sub-branch D3 includes two Amphi-American genera, *Larimus* and *Nebris*.

Sub-branch D4 includes both New and Old World genera. *Cynoscion*, *Macrodon*, *Isopisthus*, and *Plagioscion* are distributed in the New World, *Plagioscion* being restricted to Atlantic drainage systems of South America, and the remainder having an Amphi-American distribution. The unusual distribution pattern of *Atractoscion* has been noted above. Two species form the second group within sub-branch D4. The third group of this sub-branch comprises four Indo-West Pacific genera.

Sub-branch D5 is represented by *Otolithoides* distributed in the Indo-West Pacific.

Sub-branch D6 contains only eastern Atlantic genera and subgenera.

Sub-branch D7 comprises Indo-West Pacific genera and species, except for two species of "*Argyrosomus*", as noted above.

2. ZOOGEOGRAPHIC CONSIDERATION

Sciaenid zoogeography cannot be fully explained by vicariance and/or dispersalist models, owing to incomplete resolution of relationships within the family. Nevertheless, a number of zoogeographic inferences can be drawn from the distribution of monophyletic groups, and are discussed below. However, extinctions and

the fossil record are not considered in detail here.

The distribution of genera and species in most sciaenid monophyletic groups is sympatric. Branches A, B, and C, and Sub-branches D1, D2, and D3 contain only New World genera and species, except for *Umbrina* and *Sciaena umbra* in Branch C. The latter must represent New World elements which have subsequently dispersed to the Old World across the Atlantic Ocean. Pacific dispersal route of *Umbrina* is unlikely despite the genus being present in the western Indian Ocean, because it is totally absent elsewhere in the Indo-West Pacific. Dispersal across the Pacific Ocean requires the further hypothesis of extinction of *Umbrina* in the western Pacific.

Sub-branch D6 contains eastern Atlantic genera only, and therefore specialization from a ancestral form in that region is suggested.

Sub-branch D7 comprises mostly Indo-West Pacific genera and species. Although two *Argyrosomus* species are found in the eastern Atlantic, this must represent a more recent imposition, since the vast majority of this group (Sub-branch D7) are restricted to the Indo-West Pacific. *Argyrosomus* species are strong swimmers, and reach a large size (up to ca. 1 m SL), making their dispersion into other regions highly likely. Two widely disjunct populations of *A. hololepidotus* (eastern Atlantic and Australia) are further evidence of strong dispersal ability in this genus.

Sub-branch D4 contains both New and Old World sciaenids. The common ancestor of *Cynoscion*, *Macrodon*, *Isopisthus*, and *Plagioscion* is thought to have occurred in the New World, either in a marine or fresh water (South American) environment. The distribution pattern of *Atractoscion* is unusual in that the genus comprises three widely separated populations (two species): eastern Pacific (*A. nobilis*), and eastern Atlantic and Australia (*A. aequidens*). *Atractoscion* is similar to "*Argyrosomus*" in being large (over 1 m SL), and an active swimmer. The disjunct distribution of *A. aequidens* suggests a past dispersal event. The common ancestor of *Macrospinoso*, *Kathala*, *Panna*, and *Boesemania* can be hypothesized to have been distributed in the Indo-West Pacific.

The most plausible interpretation possible from the above is that the common ancestor of each of Branches A, B, C, D1, D2, D3, and D4 (part) occurred in the New World, whereas that of each of Branches D4 (part), D5, D6, and D7 occurred in the eastern Atlantic (D6) or the Indo-West Pacific (D4, part; D5 and D7).

Three hypotheses can be proposed to explain such a distribution of common ancestors. In the first, a common ancestor of the family is proposed to have a world-wide distribution, including freshwaters of the New World, and that vicariant events subsequently divided and separated the ancestral biota, giving rise to the common ancestors of each of the monophyletic groups. This follows the vicariance model of Rosen (1975). Hypothesis 2 considers the common ancestor of the family to have had a New World origin, with subsequent eastward (trans Atlantic) and/or westward (trans Pacific) dispersal of ancestors of the Old World groups. Hypothesis 3 proposes an Old World origin, with subsequent eastward (trans Pacific) and/or westward (trans Atlantic) dispersal. Of the three hypotheses, the second appears to be the most attractive for reasons explained below. In hypothesis 1, difficulties arise from the fact that sciaenids show a world-wide distribution. If the sciaenid common ancestor (one species) arose from a population isolated by some vicariant

event, the range of its predecessor cannot be determined, because the former eventually dispersed world-wide, even occupying freshwater systems. Although primary cosmopolitanism is attractive as an operational rule, such a dilemma occurs when dealing with the zoogeography of a taxon with a world wide distribution. A more attractive is for the Sciaenidae to have originated in a more or less restricted area, and successive dispersal(s) extending the range of the family, at the same time, increasing its diversity of genera and species. Such a view is in accordance with "the progression rule" of Hennig (1966). Of hypotheses 2 and 3, the second is more acceptable, according to the above rule, because the most primitive form ("*Sciaena*" *trewavasae*) occurs solely in the New World. Moreover, genera and species with both a primitive frontal-epaxila muscle relationship and swimbladder, are also restricted to the New World, except for *Umbrina* and *Sciaena umbra*. The high number of genera and species, including highly specialized forms (Branch D2), also point to the New World as the place of origin. The earliest fossil record from this region (Schwarzahns, MS) further supports this hypothesis.

If the New World is the place of origin, and the possibility of later invasions of the Old World elements is totally excluded, the sciaenids included in Branches A, B, and C, and Sub-branches D1, D2, D3, and D4 (part: *Cynoscion*, *Macrodon*, *Isopisthus*, and *Plagioscion*; *Atractoscion nobilis*) may have evolved in the place of origin without experiencing subsequent dispersals, whereas Sub-branches D4 (part: *Macrospinosa*, *Kathala*, *Panna*, and *Boesemania*), D4 (part: *Atractoscion aequidens*), D5, D6, and D7 are thought to have derived from dispersal events from the New World. Accordingly, the Old World sciaenids are considered to have resulted from a maximum of five dispersals from the New World. Furthermore, the vast majority of Old World sciaenids can be considered to have arisen from a maximum of two dispersal events (Sub-branches D5 and D6).

Regarding the direction of dispersal(s) from the New World, trans-Atlantic dispersion seems to be most likely. Dispersal from the New World across the Atlantic can be seen in Branch C, whereas trans-Pacific dispersal is not evident in any groups, except for the possible example of *Atractoscion*. Furthermore, Briggs (1974) argued on the basis of shore fish distribution analyses, that the predominant dispersal movement across the Mid-Atlantic Barrier was from west to east. Briggs also pointed out that the East Pacific Barrier operated as a one-way filter, permitting movement from west to east. Thus an origin of the Old World sciaenids following dispersion across the Atlantic is also consistent with Briggs' analyses.

Geological history has barely been included in the foregoing discussion. However, the following three points in relation with plate movements, may be made. First is that extensive sciaenid radiation occurred after South America and Africa became well separated by the Atlantic Ocean, since a greater number of genera in common could have been expected, if sciaenids had evolved extensively prior to such an event. This is supported by the oldest fossil record of a sciaenid otolith being from the Eocene Gulf (Schwarzahns, MS), at which time spreading between Africa and South America was essentially completed (Brown and Gibson, 1983). The second point, which appears to be strongly related to geological history, can be deduced from the fact that many sciaenid genera show an Amphi-American distribution. This phenomenon can be understood if 14 Amphi-American genera had

originated prior to the uplift of the Isthmus of Panama in the mid-Pliocene (Raven and Axelrod, 1974). The diversity of sciaenid species in the New World must be largely due to this vicariant event. Thirdly, the different generic composition of eastern Atlantic and Indo-West Pacific sciaenids may indicate that radiation of Sub-branch D7 in the Indo-West Pacific, and that of Sub-branch D6 in the eastern Atlantic does not predate the closure of the Tethys Seaway during the early Miocene (Hallam, 1981).

The major monophyletic groups in the New World, eastern Atlantic, and Indo-West Pacific regions are formed by sympatric genera and species, with little geographic overlap by other phyletic lines. The major barriers which have made such independent development possible are undoubtedly the Pacific and Atlantic Oceans, aided by the limited long-range dispersal ability of most sciaenids.

Although numerous factors limit dispersal ability, only reproduction and early life history factors will be discussed further. It is well known that the sciaenids utilize estuaries as spawning and/or nursery grounds (Chao and Musick, 1977). Furthermore, Kinoshita and Fujita (1988) reported the abundant occurrence of *Nibeia mistukurii* larvae in the surf zone, in particular with abundant, floating, minute dust. Kinoshita and Fujita further stated that utilization of surf zones during early life history stages, is a widespread phenomenon in the Sciaenidae. Although sciaenids are oviparous, with planktonic eggs and larvae so far as is known, the strong dependence upon estuaries during the reproduction and early life stages effectively limits transportation of eggs and larvae to offshore waters, in addition to utilization of surf zones. The absence of sciaenids in the Ryukyu Islands, Pacific Oceanic island groups, and New Zealand may be due to the lack of estuaries and/or wide separation from the major continents.

Springer (1982) pointed out as an unusual aspect of sciaenid distribution, that less than half of the species occur in the Indo-West Pacific region. Although it is not yet possible to satisfactorily explain the species' richness of the New World, establishment of many genera and species prior to the uplift of the Isthmus of the Panama must be a major reason. A second factor hinges upon the large number of New World species in Branch B (over 40 spp.). These are generally small (ca. 15 cm SL) and have a highly specialized swimbladder and related structures. These features may permit greater utilization of available niches. Similarly, the most speciose genus (*Johnius*, ca. 20 spp.) in the Indo-West Pacific is also small, and highly specialized in swimbladder and related structures. Another factor which has increased sciaenid diversity in the New World appears to be the success of *Cynoscion*. The species of this genus are active, piscivorous feeders, characterized by the strong canines. According to the distribution maps of Chao (1978b), no western Atlantic species of *Cynoscion* are common to North and South America, four species being restricted to North America, and seven to South America. This pattern suggests that *Cynoscion* has been enriched by vicariant events between two continents. Finally, the occurrence of three genera in South American river systems has no Old World counterpart, since no Old World species are known to occupy strictly freshwater habitats.

In summary: the Sciaenidae has originated in the New World, with a limited number of subsequent dispersals to the Old World across the Atlantic Ocean;

phyletic lines within the family have evolved in relative geographic independence of each other, aided by poor dispersal ability.

IX. Classification

The classification presented here is deduced from the cladogram obtained (Fig. 78). To avoid taxonomic confusions, names and concepts of past classifications are incorporated as far as possible, especially if they are valid groupings based on apomorphic features. In addition, diagnoses and some taxonomic remarks are given. Asterisks indicate new names proposed here.

Classification of the Sciaenidae

GROUP I

Subfamily	Tribe	Genus
Protosciaeninae*	Protosciaenini*	<i>Protosciaena</i> *

GROUP II

Subfamily	Tribe	Genus
Stelliferinae*	Odontoscionini*	<i>Odontoscion</i> , <i>Elattarchus</i> , <i>Corvula</i>
	Stelliferini*	<i>Bairdiella</i> , <i>Ophioscion</i> , <i>Stellifer</i>

GROUP III

Subfamily	Tribe	Genus
Sciaeninae	Ctenosciaenini*	<i>Ctenosciaena</i>
	Equetini*	<i>Equetus</i> , <i>Pareques</i>
	Sciaenini	<i>Cheilotrema</i> , <i>Umbrina</i> , <i>Menticirrhus</i> , <i>Leiostomus</i> , "Sciaena" <i>callaensis</i> , "Sciaena" <i>deliciosa</i> , "Sciaena" <i>gilberti</i> , <i>Seriphus</i> , <i>Sciaena umbra</i> , <i>Pogonias</i> , <i>Aplodinotus</i> , <i>Sciaenops</i> , <i>Roncador</i> , <i>Genyonemus</i>

GROUP IV

Subfamily	Tribe	Genus
Micropogoniinae*	Micropogoniini*	<i>Micropogonias</i>
	Lonchurini*	" <i>Paralonchurus</i> " <i>Lonchurus</i>
Pachyurinae*	Pachyurini*	<i>Pachyurus</i> , <i>Pachypops</i>

Lariminae	Larimini*	<i>Larimus</i> , <i>Nebris</i>
Cynoscioninae	Cynoscionini	<i>Cynoscion</i> , <i>Macrodon</i> , <i>Isopisthus</i> , <i>Plagioscion</i>
	Atractoscionini* Kathalini	<i>Atractoscion</i> <i>Kathala</i> , <i>Macropsinosa</i> , <i>Panna</i> , <i>Boesemania</i>
Otolithoidinae	Otolithoidini	<i>Otolithoides</i>
Pseudotolithinae*	Miracorviini*	<i>Miracorvina</i> , <i>Pentheroscion</i>
	Pseudotolithini	<i>Pteroscion</i> , <i>Pseudotolithus</i> (<i>Fonticulus</i>), <i>Pseudotolithus</i> (<i>Hostia</i>), <i>Pseudotolithus</i> (<i>Pinnacorvina</i>), <i>Pseudotolithus</i> (<i>Pseudotolithus</i>)
Otolithinae	Miichthyini*	<i>Miichthys</i>
	Argyrosomini	<i>Argyrosomus</i> , <i>Megalonibea</i> , <i>Protonibea</i>
	Pennahiini*	<i>Pennahia</i>
	Atrobuccini*	<i>Atrobucca</i>
	Otolithini	<i>Chrysochir</i> , <i>Otolithes</i> , <i>Pterotolithus</i>
	Collichthyini	<i>Sonorolux</i> , <i>Larimichthys</i> , <i>Collichthys</i>
	Nibeini	<i>Austronibea</i> , <i>Aspericorvina</i> , <i>Dendrophysa</i> , <i>Daysciaena</i> , <i>Paranibea</i> , <i>Nibea</i>
	Johniini	<i>Johnius</i> (<i>Johnius</i>), <i>Johnius</i> (<i>Johnieops</i>)
<i>Incertae sedis</i>		<i>Bahaba</i> , <i>Totoaba</i> , "Sciaena" <i>bathytatus</i> , "Sciaena" <i>starksi</i> , "Sciaena" <i>wieneri</i>

GROUP I

Diagnosis. One of four groups within Sciaenidae, which has no obvious apomorphic features. Distinguished by the combination of: epaxial muscle extending onto supraorbital ridge of frontal; tooth plate on pharyngobranchial 2 small and obliquely located to pharyngobranchial 3; swimbladder simple, lacking modifications; caudal fin rhomboidal with pointed tip.

Distribution. Western Atlantic.

Protosciaeninae New Subfamily

Diagnosis. Same as Group I.

Prortosciaenini New Tribe

Diagnosis. Same as Group I.

Protosciaena New Genus

Type species. *Sciaena trewavasae* Chao et Miller, 1975.

Diagnosis. Same as Group I.

Description of type species. See Chao and Miller (1975).

Etymology. Derived from the Greek *protos* (first) and Latin *Sciaena* (perch), in reference to the primitive nature of the type species. Gender feminine.

Remarks. *Protosciaena* is established to accommodate a single species, *P. trewavasae*, originally placed by Chao and Miller (1975) in the genus *Sciaena*. Although "*Sciaena*" (type species: *umbra*) is apparently polyphyletic, and a new generic allocation is required for each of "*S.*" *callaensis*, "*S.*" *deliciosa* and "*S.*" *gilberti*, a new name is given only for "*S.*" *trewavasae*, owing to its remote phyletic position from the type species. The generic allocations of the other "*Sciaena*" species must await a better understanding of the "*Sciaena*" species currently considered *incertae sedis*.

GROUP II

Diagnosis. One of four groups within Sciaenidae with the following: auditory bulla notched; exoccipital condyles not broadly joined to each other; Baudelot's ligament attached to exoccipital; retractor dorsalis originating from basicranial region and first vertebra; fourth vertebra ventrally modified into a horseshoe-shaped arch; lapillus enlarged; sulcus head situated on anterior surface of sagitta; swimbladder two chambered.

Distribution. New World.

Remarks. Equivalent to the *Stellifer* group of Chao (1978a).

Stelliferinae New Subfamily

Diagnosis. Same as Group II.

Odontoscionini New Tribe

Diagnosis. A tribe of the subfamily Stelliferinae with the flexor ventralis externus faded into flexor ventralis, and the caudal fin truncate to lunate in adults.

Stelliferini New Tribe

Diagnosis. A tribe of the subfamily Stelliferinae with the following: epaxial muscle terminating behind the supraorbital ridge of the frontal; outer margin of the lateral ethmoid medially concave; levator operculi originating from the post-temporal.

GROUP III

Diagnosis. One of four groups within Sciaenidae with an enlarged pharyngobranchial 2 tooth plate anteriorly located to pharyngobranchial 3 (but reversed in some).

Distribution. Essentially New World.

Sciaeninae

Diagnosis. Same as Group III.

Remarks. The subfamily Sciaeninae was established by Gill (1862b) to accommodate some North American sciaenids. Jordan and Eigenmann (1889) defined it as having a moderate number of abdominal vertebrae. A more recent concept of this subfamily was based on the simple, unmodified swimbladder (Trewavas, 1962,

1977; Mohan, 1972).

Ctenosciaenini New Tribe

Diagnosis. A tribe of the subfamily Sciaeninae with a single median, mental barbel, lacking an apical pore.

Distribution. New World.

Equetini New Tribe

Diagnosis. A tribe of the subfamily Sciaeninae with numerous dorsal pterygiophores in front of the third neural spine.

Distribution. New World.

Sciaenini

Diagnosis. A tribe of the subfamily Sciaeninae with a lunate to truncate caudal fin in adults.

Distribution. New World except for *Sciaena umbra* and *Umbrina*.

Remarks. This tribe was established by Trewaves (1962), but the definition is modified here.

GROUP IV

Diagnosis. One of four groups of Sciaenidae with the epaxial muscle terminating behind the supraorbital ridge of the frontal.

Distribution. World-wide.

Micropogoniinae New Subfamily

Diagnosis. A subfamily of Group IV with an enlarged pharyngobranchial 2 tooth plate anteriorly located to pharyngobranchial 3 (but reversed in some), and paired mental barbels (one or many pairs).

Distribution. New World.

Micropogoniini New Tribe

Diagnosis. A tribe of the subfamily Micropogoniinae with the circular distal end of sulcus tail and the swimbladder with a pair of tube-like appendages, arising posteriorly.

Remarks. Equivalent to the *Micropogonias* group of Chao (1978a).

Lonchurini New Tribe

Diagnosis. A tribe of the subfamily Micropogoniinae with the following: pterosphonoid in contact with the lateral ethmoid; intercalar projecting downward; third and fourth vertebrae ventrally form a cylindrical bony tube; swimbladder with a pair of horn-like and tube-like appendages.

Remarks. Equivalent to the *Lonchurus* group of Chao (1978a). Monophyly of the tribe is apparent. However, *Paralonchurus elegans* is clearly a sister group of *Lonchurus lanceolatus* (monotypic), rather than of *P. brasiliensis*. According to Jordan and Eigenmann (1889), the type species of *Paralonchurus (petersi)* is also characterized by a small eye and long pectoral fin, similar to *Lonchurus* and *P. elegans*. It is suggested therefore that *Paralonchurus* is a synonym of *Lonchurus*, and that a new generic name is needed for *brasiliensis*. Final clarification awaits further study.

Pachyurinae New Subfamily

Diagnosis. A subfamily of Group IV with the following: infraorbital 3 lying almost parallel to the horizontal axis of the eye; acutely pointed nasal; strongly

depressed suspensorium; head of maxillary anterior to ethmoid and prevomer.

Distribution. South American fresh water.

Pachyurini New Tribe

Diagnosis. Same as subfamily.

Lariminae

Diagnosis. A subfamily of Group IV with: fan-shaped basihyal; haemal canal of the fourth centrum covered by a rounded bony roof.

Distribution. New World.

Remarks. This subfamily was firstly proposed by Gill (1862a), for the genus *Larimus*.

Larimini New Tribe

Diagnosis. Same as subfamily.

Cynoscioninae

Diagnosis. A subfamily of Group IV with horn-like appendages arising at the anterior end of the swimbladder.

Distribution. World-wide.

Remarks. Tribe Cynoscionini (Trewavas, 1962) was later elevated to subfamily level by Trewavas (1977).

Cynoscionini

Diagnosis. A tribe of the subfamily Cynoscioninae with few and reduced epipleural ribs.

Distribution. New World.

Remarks. Equivalent to the *Cynoscion* group of Chao (1978a). Trewavas' (1977) inclusion of *Atractoscion* in this tribe is not supported.

Atractoscionini New Tribe

Diagnosis. A tribe of the subfamily Cynoscioninae with a truncate to lunate caudal fin in adults.

Distribution. World-wide except for western Atlantic.

Kathalini

Diagnosis. A tribe of the subfamily Cynoscioninae, with a pair of deep, cephalic appendages, arising at the anterior end of the swimbladder.

Distribution. Indo-West Pacific.

Remarks. Mohan (1972) erected the subfamily Kathalinae for the genus *Kathala*, but later Trewavas (1977) reduced the rank to that of tribe. Trewavas (1977) gave the rank of tribe to both *Macrospinosa* and *Kathala*, whereas she grouped together *Otolithoides*, *Panna*, and *Boesemania* under the single tribe Otolithoidini. This is not supported by the present analysis.

Otolithoidinae

Diagnosis. A subfamily of Group IV with the following: enlarged carotid foramen; basisphenoid absent; intercalar broadly in contact with the basioccipital; diminutive eye; infraorbital 2 flattened dorsally; adductor arcus palatini divided into two elements; distal end of sulcus tail circular; swimbladder with a pair of deeply cephalic, richly branched tube-like appendages arising posteriorly, and being partially exposed on the shoulder girdle.

Distribution. Indo-West Pacific.

Remarks. This subfamily was erected by Mohan (1972), but later rejected by

Trewavas (1977). Mohan included three genera (*Macrospinosa*, *Otolithoides*, and *Panna*), but it is limited here to a single tribe and genus (see also under Tribe Kathalini).

Otolithoidini

Diagnosis. Same as subfamily.

Remarks. This tribe was originally established by Mohan (1972).

Pseudotolithinae New Subfamily

Diagnosis. A subfamily of Group IV with a pair of tube-like appendages divided into several tubules, arising at anterior end of swimbladder.

Distribution. Eastern Atlantic.

Remarks. Equivalent to the Pseudotolithini of Trewavas (1962, 1977).

Miracorviini New Tribe

Diagnosis. A tribe of the subfamily Pseudotolithinae with a pair of long, tube-like appendages, divided into several tubules.

Pseudotolithini

Diagnosis. A tribe of the subfamily Pseudotolithinae with haemal canal of the fourth centrum covered by a rounded bony roof, and a twisted sagitta.

Otolithinae

Diagnosis. A subfamily of Group IV with numerous arborescent appendages along the sides of the swimbladder.

Distribution. An Old World subfamily, except for two species of *Argyrosomus*.

Remarks. Equivalent to the Otolithinae of Trewavas (1962, 1977).

Miichthyini New Tribe

Diagnosis. A tribe of the subfamily Otolithinae, distinguished by the combination of well curved sulcus tail, absence of enlarged swimbladder appendages, absence of cephalic swimbladder appendages, scaly dorsal fin.

Remarks. Although Trewavas (1977) placed *Miichthys* under the synonymy of *Argyrosomus*, the former name should be reinstated in order to reflect the phyletic position of "*Argyrosomus*" *miichthy*.

Argyrosomini

Diagnosis. A tribe of the subfamily Otolithinae with enlarged, anterior swimbladder appendages.

Remarks. This tribe was originally erected by Mohan (1972) to accommodate *Atrobucca*, *Argyrosomus*, *Dendrophysa*, *Nibea*, and *Chrysochir*. The tribe is modified here.

Pennahiini New Tribe

Diagnosis. A tribe of the subfamily Otolithinae with the sulcus tail of the sagitta only slightly curved. Distinguished from both Otolithini and Atrobuccini by the absence of both canines and well developed dorsal limbs on the swimbladder appendages respectively.

Atrobuccini New Tribe

Diagnosis. A tribe of the subfamily Otolithinae with the sulcus tail of the sagitta only slightly curved. Distinguished from Otolithini and Pennahiini by the absence of canines, and presence of well developed dorsal limbs on the swimbladder appendages respectively.

Otolithini

Diagnosis. A tribe of the subfamily Otolithinae with canines, the sulcus tail of the sagitta only slightly curved, and the distal end of sulcus tail circular (except for *Pterotolithus*).

Remarks. Apparently, the Otolithini of Mohan (1972) and Trewavas (1977) is not monophyletic group.

Collichthyini

Diagnosis. A tribe of the subfamily Otolithinae with the following: adductor profundus passing to the lateral side of the pectoral girdle via the coracoid foramen; third vertebra bears ventrally a pair of oval bony plates; ventral limbs of swimbladder appendages prolonged, extending along the abdominal cavity; swimbladder appendages deeply cephalic; sulcus tail of sagitta only slightly curved; distal end of sulcus tail circular; luminous tissue present.

Remarks. This tribe is equivalent to the Collichthyini of Trewavas (1977).

Nibeini

Diagnosis. A tribe of the subfamily Otolithinae with the intercalar projecting downward, and deeply cephalic swimbladder appendages.

Remarks. The Nibeini of Trewavas (1977) is polyphyletic, owing to the inclusion by Trewavas of the genus *Protonibeia*. Although the condition of the intercalar is unknown in *Aspericorvina*, *Daysciaena*, and *Paranibeia*, they are tentatively included in this tribe, following Trewavas (1977).

Johniini

Diagnosis. A tribe of the subfamily Otolithinae with the following: enlarged foramen for nervus facialis (VII); exoccipital condyles not broadly joined to each other; fourth vertebrae ventrally modified into a horseshoe-shaped arch; enlarged lapillus; distal end of sulcus tail with a deep hollow cone; swimbladder hammer-shaped; swimbladder appendage deeply cephalic; cephalic appendage partly exposed on shoulder girdle.

Remarks. Equivalent to the Johniinae of Chu *et al.*, (1963) and Mohan (1972), and the Johniini of Trewavas (1977).

X. Summary

(1) The objectives of this study were fivefold: to establish the monophyly of the perciform family Sciaenidae; to determine the phyletic position of the family within the suborder Percoidei; to determine intergeneric relationships within the family; to provide a zoogeographic analysis compatible with sciaenid evolution; and to present a new higher classification reflecting sciaenid phylogeny.

(2) Relationships were analyzed by cladistic methods based on morphological, osteological, and myological characters. Character polarities were determined according to one or more of the following: taxonomic outgroup comparison and functional outgroup comparison. Zoogeographic analyses followed the progression rule of Hennig (1966).

(3) Monophyly of the Sciaenidae is demonstrated by 21 synapomorphies.

(4) No close relationship of the Sciaenidae to other percoid families was detected. An earlier held view that the Sciaenidae is a sister group of the

Haemulidae is rejected, since the Gerreidae is demonstrably the sister group of the latter. The retention of a series of primitive features by the Sciaenidae indicates that the family has arisen early in percoid evolution.

(5) Relationships within the family are analyzed, based on 128 apomorphic characters. The family is divided into four groups. Group one comprises a single species, "*Sciaena*" *trewavasae*, and has no autapomorphies. Group two is defined by nine synapomorphies, resulting mainly from the development of the swimbladder anterior chamber, and includes *Odontoscion*, *Elattarchus*, *Corvula*, *Bairdiella*, *Ophioscion*, and *Stellifer*. Group three is defined by a single synapomorphy of the branchial arches, and comprises three monophyletic units: *Ctenosciaena*; *Equetus* and *Pareques*; *Cheilotrema*, *Umbrina*, *Menticirrhus*, *Leiostomus*, "*Sciaena*" *callaensis*, "*S.*" *deliciosa*, "*S.*" *gilberti*, *Seriphus*, *Sciaena umbra*, *Pogonias*, *Aplodinotus*, *Sciaenops*, *Roncador*, and *Genyonemus*. Group four exhibits a cranial synapomorphy, and comprises seven monophyletic units: *Micropogonias*, "*Paralonchurus*" *brasiliensis*, "*P.*" *elegans*, and *Lonchurus lanceolatus*; *Pachypops* and *Pachyurus*; *Larimus* and *Nebris*; *Cynoscion*, *Macrodon*, *Isopisthus*, *Plagioscion*, *Atractoscion*, *Macropsinosa*, *Kathala*, *Panna*, and *Boesemania*; *Otolithoides*; *Miracorvina*, *Pentheroscion*, *Pteroscion*, *Pseudotolithus (Fonticulus)*, *P. (Hostia)*, *P. (Pinnacorvina)*, and *P. (Pseudotolithus)*; "*Argyrosomus*" *miyu*, *A. japonicus*, *Protonibea*, *Megalonibea*, *Pennahia*, *Atrobucca*, *Pterotolithus*, *Chrysochir*, *Otolithes*, *Sonorolux*, *Larimichthys*, *Collichthys*, *Austronibea*, *Dendrophysa*, *Nibea*, *Aspericorvina*, *Daysciaena*, *Paranibea*, *Johnius (Johnius)*, and *J. (Johnieops)*.

(6) Most monophyletic groups within the Sciaenidae are formed by sympatric genera and species. Old World sciaenids are restricted mostly to the fourth to seventh monophyletic units listed above in the fourth group. Zoogeographic analyses indicate that the Sciaenidae has originated in the New World, and that a maximum of two dispersal events from the New World has given rise to most of the sciaenids in the Old World.

(7) A new higher classification of the Sciaenidae is presented, based upon the cladistic analyses. A new genus *Protosciaena* is established to accommodate the primitive species, "*Sciaena*" *trewavasae*.

XI. Literature cited

- Aguileira, S.O.A. 1982. Musculature facial em peces Sciaenidae del Atlantico oeste y rio do Amazonica. M.S. Thesis, Universidad de Oriente, Cumaná, Venezuela, 62 pp.
- Ahlstrom, E.H., J.L. Butler and B.Y. Sumida. 1976. Pelagic stromateoid fishes (Pisces, Perciformes) of the eastern Pacific: Kinds, distributions, and early life histories and observations on five of these from the Northwest Atlantic. *Bull. Mar. Sci.*, **26**, 285-402.
- Allen, L.G. and E.E. DeMartini. 1983. Temporal and spatical patterns of nearshore distribution and abundance of the pelagic fishes off Onofre-Oceanside, California. *Fish. Bull., U.S.*, **81**, 569-586.
- Anker, G.C. 1978. The morphology of the head muscles of a generalized *Haplochromis* species: *H. elegans* Trewavas, 1933 (Pisces, Cichlidae). *Neth. J. Zool.*, **28**, 234-271.
- Briggs, J.C. 1974. *Marine zoogeography*. McGraw-Hill, New York, xiv + 475 pp.
- Brown, J.H. and A.G. Gibson. 1983. *Biogeography*. The C.V. Mosby Company, St. Louis, xii + 643 pp.
- Chao, L.N. 1978a. A basis for classifying western Atlantic Sciaenidae (Teleostei: Perciformes).

- NOAA Tech. Rep., NMFS Circ., (415), i-v+1-64.
- Chao, L.N. 1978b. Sciaenidae. 94 pp. (in Vol. 4), in W. Fischer, ed. *FAO species identification sheets for fishery purposes, western Central Atlantic Ocean; fishing area 31*. Vols. 1-6; pag. var., FAO, Rome.
- Chao, L.N. 1981. Sciaenidae. 37 pp. (in Vol. 3), in W. Fischer, G. Bianchi and W.B. Scott, eds. *FAO species identification sheets for fishery purposes, eastern Central Atlantic; fishing area 37 and 47 (part)*. Vols. 1-7; pag. var., FAO, Rome.
- Chao, L.N. 1986. A synopsis on zoogeography of the Sciaenidae. Pages 570-589 in T. Uyeno, R. Arai, T. Taniuchi and K. Matsuura, eds. *Indo-Pacific fish biology: Proc. Second Int'l Conf. Indo-Pacific Fishes; July-August 1985*. Ichthyological Society of Japan, Tokyo.
- Chao, L.N. and R.V. Miller. 1975. Two new species of sciaenid fishes (Tribe: Sciaenini) from the Caribbean Sea and adjacent waters. *Bull. Mar. Sci.*, **25**, 259-271.
- Chao, L.N. and J.A. Musick. 1977. Life history, feeding habits, and functional morphology of juvenile sciaenid fishes in the York River estuary, Virginia. *Fish. Bull. U. S.*, **75**, 657-702.
- Chu, Y.T., Y.L. Lo and H.L. Wu. 1963. *A study on the classification of the sciaenoid fishes of China, with description of new genera and species*. Science and Technology Press of Shanghai, Shanghai, 100 pp., 40 pls. (In Chinese with English summary).
- Cione, A.L. and A.E. Torne. 1987. Atavistic vomerine teeth in a specimen of *Pogonias cromis* (Linnaeus, 1776) (Teleostei, Perciformes). *Copeia*, **1987**, 1057-1059.
- Datta, N.C. and S.B. Bandyopadhyay. 1982. Suborbitals and subocular shelf of certain teleostean fishes with notes on their taxonomic significance. *Matsya*, **8**, 52-58.
- Dharmarajan, M. 1936. The anatomy of *Otolithus ruber* (Bl. & Schn.). Part 1. The endoskeleton. *J. Roy. Asia. Soc. Bengal*, **2**, 1-72.
- Dietz, P.A. 1914. Beiträge zur Kenntnis der Kiefer-und Kiemenbogenmuskulature der Teleostier. I. Die Kiefer-und Kiemenbogenmuskulature der Acanthopterygier. *Mitt. Zool. Sta. Neapel*, **22**, 99-162.
- Fraser, T.H. 1972. Comparative osteology of the shallow water cardinal fishes (Perciformes: Apogonidae) with reference to the systematics and evolution of the family. *Rhodes Univ., Dep. Ichthyol., Ichthyol. Bull.* (34), 1-105, pls. 1-44.
- Freihofer, W.C. 1978. Cranial nerves of a percoid fish, *Polycentrus schomburgkii* (family Nandidae), a contribution to the morphology and classification of the order Perciformes. *Occas. Pap. Calif. Acad. Sci.*, (128), i-v+1-78.
- Frost, A. 1927. A comparative study of the otoliths of the neopterygian fishes (continued). *Ann. Mag. Nat. Hist.*, (9)20, 298-305, pl. 10.
- Gaemers, P.A.M. 1984. Taxonomic position of the Cichlidae (Pisces, Perciformes) as demonstrated by the morphology of their otoliths. *Neth. J. Zool.*, **34**, 566-595.
- Gill, T. 1862a. Catalogue of the fishes of the eastern coast of North America, from Greenland to Georgia. *Proc. Acad. Nat. Sci. Phila.*, **13**, 1-63.
- Gill, T. 1862b. Revision of the genera of North American Sciaeninae. *Proc. Acad. Nat. Sci. Phila.*, **13**, 79-89.
- Godkin, C.M. and R. Winterbottom. 1985. Phylogeny of the family Congrogadidae (Pisces; Perciformes) and its placement as a subfamily of the Pseudochromidae. *Bull. Mar. Sci.*, **36**, 633-671.
- Gosline, W.A. 1966. The limits of the fish family Serranidae, with notes on other lower percoids. *Proc. Calif. Acad. Sci., 4th Ser.*, **33**, 91-112.
- Gosline, W.A. 1968. The suborders of perciform fishes. *Proc. U.S. Natn. Mus.*, **124**, 1-78.
- Gosline, W.A. 1985. Structure, function, and ecology in the goatfishes (Family Mullideae). *Pacific Sci.*, **38**, 312-323.
- Gosline, W.A. 1986. Jaw muscle configuration in some higher teleostean fishes. *Copeia*, **1986**, 705-713.
- Govani, J.J. 1987. The ontogeny of dentition in *Leiostomus xanthurus*. *Ibid.*, **1987**, 1041-1046.
- Green, M. 1941. The cranial and appendicular osteology of *Aplodinotus grunniens* Rafinesque. *Trans. Kansas Acad. Sci.*, **44**: 400-413, pls. 1-2.
- Greenwood, P.H. 1976. A revision of the family Centropomidae (Pisces, Perciformes). *Bull. Br. Mus. Nat. Hist. (Zool.)*, **29**, 1-81.
- Greenwood, P.H., D.E. Rosen, S.H. Weitzman and G.S. Myers. 1966. Phyletic studies of teleostean

- fishes, with a provisional classification of living forms. *Bull. Am. Mus. Nat. Hist.*, **131**, 339-456, pls. 21-23.
- Hallam, A. 1981. Relative importance of plate movements, eustasy, and climate in controlling major biogeographic changes since the early Mesozoic. Pages 303-330 in G. Nelson and D.E. Rosen, eds. *Vicariance biogeography: a critique*. Columbia University Press, New York.
- Haneda, Y. 1961. A preliminary report on two new luminous fish of Bombay and Hong Kong. *Sci. Rep. Yokosuka City Mus.*, (6), 45-50.
- Hazlett, B. and H.E. Winn. 1962. Sound producing mechanisms of the nassau grouper, *Epinephelus striatus*. *Copeia*, **1962**, 447-449.
- Hennig, W. 1966. *Phylogenetic systematics*. Univ. Illinois Press, Urbana, xiii + 263 pp.
- Hill, G.L., M.L. Fine and J.A. Musick. 1987. Ontogeny of the sexually dimorphic sonic muscle in three sciaenid species. *Copeia*, **1987**, 708-713.
- Johnson, G.D. 1975. The procurrent spur: an undescribed perciform caudal character and its phylogenetic implications. *Occas. Pap. Calif. Acad. Sci.*, (121), 1-23.
- Johnson, G.D. 1978. *Development of fishes of the Mid-Atlantic Bight*. Vol. 4, U.S. Fish and Wildl. Serv., Washington, 314 pp.
- Johnson, G.D. 1980. The limits and relationships of the Lutjanidae and associated families. *Bull. Scripps Inst. Oceanogr.*, **24**, 1-114.
- Johnson, G.D. 1983. *Niphon spinosus*: a primitive epinepheline serranid, with comments on the monophyly and intrarelationships of the Serranidae. *Copeia*, **1983**, 777-787.
- Johnson, G.D. 1984. Percoidae: development and relationships. Pages 464-498 in H.G. Moser et al., eds. *Ontogeny and systematics of fishes*. A.S.I.H. Spec. Publ. 1. Lawrence.
- Jordan, D.S. and C.H. Eigenmann. 1889. A review of the Sciaenidae of America and Europe. *Rep. Comm. U.S. Comm. Fish Fish.*, **1886**, 343-451.
- Kaufman, L.S. and K.F. Liem. 1982. Fishes of the suborder Labroidei (Pisces: Perciformes): phylogeny, ecology, and evolutionary significance. *Breviora*, (472), 1-19.
- Katayama, M. 1959. Studies on the serranid fishes of Japan (1). *Bull. Fac. Educ., Yamaguchi Univ.*, **8**, 103-181.
- Kim, Y.U. and I.B. Kim. 1965. Osteological study of fishes from Korea (1). Comparative osteology of the family Sciaenidae. *Bull. Pusan Fish. Coll.*, **6**, 61-76, pls. 1-13.
- Kinoshita, I. and S. Fujita. 1988. Larvae and juveniles of bluedrum, *Nibea mitsukurii*, occurring in the surf zone of Tosa Bay, Japan. *Japan. J. Ichthyol.*, **35**, 25-30.
- Kluge, A.G. 1984. The relevance of parsimony to phylogenetic inference. Pages 24-38 in T. Duncan and T.F. Stuessy, eds. *Cladistics: perspective on the reconstruction of evolutionary history*. Columbia University Press, New York.
- Kluge, A.G. and J.S. Farris. 1969. Quantitative phyletics and the evolution of anurans. *Syst. Zool.*, **18**, 1-32.
- Lauder, G.V. and K.F. Liem. 1983. The evolution and interrelationships of the actinopterygian fishes. *Bull. Mus. Comp. Zool. Harvard Univ.*, **150**, 95-197.
- Leviton, A.E., R.H. Gibbs, Jr., E. Heal and C.E. Dawson. 1985. Standards in herpetology and ichthyology: Part I. Standard symbolic codes for institutional resource collections in herpetology and ichthyology. *Copeia*, **1985**, 802-832.
- Liem, K.F. 1986. The pharyngeal jaw apparatus of the Embiotocidae (Teleostei): a functional and evolutionary perspective. *Ibid.*, **1986**, 311-323.
- Liem, K.F. and P.H. Greenwood. 1981. A functional approach to the phylogeny of the pharyngognath teleosts. *Am. Zool.*, **21**, 83-101.
- Lucena, Z.M.S. de. 1988. Discussão dos caracteres morfológicos dos gêneros *Umbrina* Cuvier, 1816 e *Ctenosciaena* Fowler & Bean, 1923. (Pisces; Perciformes; Sciaenidae). *Comun. Mus. Cienc. PUCRS, Ser. Zool.*, **1**, 49-122.
- Marino, R.P. and J.K. Dooley. 1982. Phylogenetic relationships of the tilefish family Branchiostegidae (Perciformes) based on comparative myology. *J. Zool. Soc. Lond.*, **196**, 151-163.
- McAllister, D.E. 1968. The evolution of branchiostegals and associated opercular, gular, and hyoid bones and the classification of teleostome fishes, living and fossil. *Natn. Mus. Canada, Bull.*, (211), *Biol. Ser.*, (77), i-xiv + 1-239, pls. 1-21.
- McKay, R.J. 1985. A revision of the fishes of the family Sillaginidae. *Mem. Queensland Mus.*, **22**, 1-74.

- McPhail, J.D. 1961. A review of the tropical eastern Pacific species of *Pareques* (Sciaenidae). *Copeia*, **1961**, 27-32.
- Mohan, R.S.L. 1972. A synopsis of the Indian genera of the fishes of the family Sciaenidae. *Indian J. Fish.*, **16**, 82-98.
- Mok, H.K. and S.C. Shen. 1983. Osteology and phylogeny of squamipinnes. *Taiwan Mus. Spec. Publ.*, (1), 1-87.
- Nag, A.C. 1967. Functional morphology of the caudal region of certain clupeiform and perciform fishes with reference to the taxonomy. *J. Morph.*, **123**, 529-558.
- Nolf, D. 1985. *Otolith piscium. Handbook of paleoichthyology*, Vol. 10. Gustav Fischer Verlag, Stuttgart, 145 pp.
- Nursall, J.R. 1963. The caudal musculature of *Hoplopagrus guntheri* Gill (Perciformes: Lutjanidae). *Can. J. Zool.*, **41**, 865-880.
- Ono, R.D. and S.G. Poss. 1982. Structure and innervation of the swim bladder musculature in the weakfish, *Cynoscion regalis* (Teleostei: Sciaenidae). *Ibid.*, **60**, 1955-1967.
- Patterson, C. 1964. A review of Mesozoic acanthopterygian fishes, with special reference to those of the English Chalk. *Phil. Trans. Roy. Soc. Lond., Ser. B.* **247**, 213-482, pls. 2-5.
- Raven, P.H. and D.I. Axelrod. 1974. Angiosperm biogeography and past continental movements. *Ann. Mo. Bot. Gard.*, **61**, 539-673.
- Rosen, D.E. 1975. A vicariance model of Caribbean biogeography. *Syst. Zool.*, **24**, 431-464.
- Rosen, D.E. 1985. An essay on euteleostean classification. *Am. Mus. Novt.*, (2827), 1-57.
- Rosen, D.E. and C. Patterson, 1969. The structure and relationships of the paracanthopterygian fishes. *Bull. Am. Mus. Nat. Hist.*, **141**, 357-474, pls. 52-78.
- Salmon, M. and H.W. Winn. 1966. Sound production by priacanthid fishes. *Copeia*, **1966**, 869-872.
- Sand, O. and P.S. Enger. 1973. Evidence for an auditory function of the swimbladder in the cod. *J. Exp. Biol.*, **59**, 405-414.
- Schmidt, P. 1968. Vergleichend morphologische Studie über die Otolithen mariner Knochenfische. *Arch. FischWiss.*, **19**, (suppl.), 1-96, pls. 1-25.
- Schneider, H. 1964. Physiologische und morphologische Untersuchungen zur Bioakustik der Tigerfische (Pisces, Theraponidae). *Z. Vergleich. Physiol.*, **47**, 493-558.
- Shaw, T.H. and S.V. Yu. 1948. Preliminary notes on the vertebral column of two important sciaenid fishes, *Pseudosciaena crocea* Richardson and *Pseudosciaena manchurica* Jordan & Thompson. *Quart. J. Taiwan Mus.*, **1**, 1-13.
- Smith, C.L. and R.M. Bailey. 1962. The subocular shelf of fishes. *J. Morph.*, **110**, 10-18, pls. 1-3.
- Souché, G. 1932. Morphologie comparative des muscles élévateurs de la mandibule chez les poissons. *Mém. Soc. Sci. Phys. Nat. Bordeaux*, (7)3, 1-292.
- Springer, V.G. 1982. Pacific plate biogeography, with special reference to shorefishes. *Smithson. Contrib. Zool.*, (367), i-iv+1-182.
- Srivastava, P.N. 1955. Morphology and histology of the airbladder of certain sciaenoid fishes with the description of a new type of ear-air bladder connection. *Proc. Nat. Inst. Sci. India*, **21**, 74-78, pls. 9-10.
- Starnes, W.C. 1988. Revision, phylogeny and biogeographic comments on the circumtropical marine percoid fish family Priacanthidae. *Bull. Mar. Sci.*, **43**, 117-203.
- Stiassny, M.L.J. 1981a. Phylogenetic versus convergent relationship between piscivorous cichlid fishes from Lake Malawi and Tanganyika. *Bull. Br. Mus. Nat. Hist. (Zool.)*, **40**, 67-101.
- Stiassny, M.L.J. 1981b. The phyletic status of the family Cichlidae (Pisces, Perciformes): a comparative anatomical investigation. *Neth. J. Zool.*, **31**, 275-314.
- Stiassny, M.L.J. and J.S. Jensen. 1987. Labroid interrelationships revisited: Morphological complexity, key innovations, and the study of comparative diversity. *Bull. Mus. Comp. Zool. Harvard Univ.*, **151**, 269-319.
- Suyehiro, Y. 1942. A study on the digestive system and feeding habits of fish. *Japan. J. Zool.*, **10**, 1-303, pls. 1-15.
- Takemura, A., T. Takita and K. Mizue. 1978. Underwater calls of the Japanese marine drum fishes (Sciaenidae). *Bull. Japan. Soc. Sci. Fish.*, **44**, 121-125.
- Taniguchi, N. 1969a. Comparative osteology of the sciaenid fishes from Japan and its adjacent waters-I. Neurocranium. *Japan. J. Ichthyol.*, **16**, 55-67.
- Taniguchi, N. 1969b. Comparative osteology of the sciaenid fishes from Japan and its adjacent

- waters-II. Vertebrae. *Ibid.*, **16**, 153-156.
- Taniguchi, N. 1970. Comparative osteology of the sciaenid fishes from Japan and its adjacent waters-III. Premaxillary and dentary. *Ibid.*, **17**, 135-140.
- Taniguchi, N. and Y. Okada. 1986. Identification of young of giant sciaenid and its morphological changes with growth. *Ibid.*, **31**, 181-187.
- Tominaga, Y. 1968. Internal morphology, mutual relationships and systematic position of the fishes belonging to the family Pempheridae. *Ibid.*, **15**, 43-95.
- Tominaga, Y. 1986. The relationships of the family Glaucosomatidae and Pempherididae. Pages 595-599 in T. Uyeno, R. Arai, T. Taniuchi and K. Matsuura, eds. *Indo-Pacific fish biology: Proc. Second Int'l. Conf. Indo-Pacific Fishes; July-August, 1985*. Ichthyological Society of Japan, Tokyo.
- Topp, R.W. and C.F. Cole. 1968. An osteological study of the sciaenid genus, *Sciaenops* Gill (Teleostei, Sciaenidae). *Bull. Mar. Sci.*, **18**, 902-945.
- Tower, R.W. 1908. The production of sound in the drumfishes, the sea-robin and the toadfish. *Ann. N.Y. Acad. Sci.*, **18**, 149-180, pls. 1-8.
- Trewavas, E. 1962. A basis for classifying the sciaenid fishes of tropical West Africa. *Ann. Mag. Nat. Hist.*, (13)5, 167-176.
- Trewavas, E. 1964. The sciaenid fishes with a single mental barbel. *Copeia*, **1964**, 107-117.
- Trewavas, E. 1977. The sciaenid fishes (croakers or drums) of the Indo-West-Pacific. *Trans. Zool. Soc. Lond.*, **33**, 253-541, pls. 1-14.
- Vari, R.P. 1978. The terapon perch (Percoidae, Teraponidae). A cladistic analysis and taxonomic revision. *Bull. Am. Mus. Nat. Hist.*, **159**, 175-340.
- Watrous, L.E. and Q.D. Wheeler. 1981. The out-group comparison method of character analysis. *Syst. Zool.*, **30**, 1-11.
- Weitzman, S.H. 1962. The osteology of *Brycon meeki*, a generalized characid fish, with an osteological definition of the family. *Stanford Ichthyol. Bull.*, **8**, 3-77.
- Winterbotton, R. 1974. A descriptive synonymy of the striated muscles of the Teleostei. *Proc. Acad. Nat. Sci. Phila.*, **125**, 235-317.
- Yabe, M. 1985. Comparative osteology and myology of the superfamily Cottoidea (Pisces: Scorpaeniformes), and its phylogenetic classification. *Mem. Fac. Fish. Hokkaido Univ.*, **32**, 1-130.
- Yamada, U. 1973. Postlarvae and juveniles of little yellow croaker, *Pseudosciaena manchurica* and large yellow croaker, *Pseudosciaena crocea* in the East China Sea. *Bull. Seikai Reg. Fish. Res. Lab.*, (43), 51-71. (In Japanese with English abstract.)
- Zehren, S.J. 1979. *The comparative osteology and phylogeny of the Beryciformes (Pisces: Teleostei)*. Evolutionary Monographs, Univ. Chicago, Chicago, ii+389 pp.