Percussion Techniques

JULY 2018

DISTRIBUTION RESTRICTION: Approved for public release: distribution is unlimited.

Headquarters, Department of the Army

This publication is available at the Army Publishing Directorate site (<https://armypubs.army.mil>), and the Central Army Registry site (<https://atiam.train.army.mil/catalog/dashboard>)

Percussion Techniques

Contents

	Page
PREFACE	vii
INTRODUCTION	xi
Chapter 1 BASIC PRINCIPLES OF PERCUSSION PLAYING	1-1
History.....	1-1
Definitions.....	1-1
Total Percussionist.....	1-1
General Rules for Percussion Performance.....	1-2
Chapter 2 SNARE DRUM	2-1
Snare Drum: Physical Composition and Construction.....	2-1
Snare Drum: Acoustical Characteristics.....	2-2
Snare Drum: Striking Implements.....	2-2
Snare Drum: Grip.....	2-3
Snare Drum: Sticking Systems.....	2-3
Snare Drum: Stroke Technique.....	2-4
Chapter 3 DRUM SET	3-1
Drum Set: Physical Composition and Construction.....	3-1
Drum Set: Function and Technique.....	3-1
Drum Set: Component Parts.....	3-4
Drum Set: Performance.....	3-7
Chapter 4 KEYBOARD PERCUSSION	4-1
Keyboard Percussion: Physical Composition and Construction.....	4-1
Keyboard Percussion: Bar Stroke Basics.....	4-1
Keyboard Percussion: Rolls.....	4-3
Keyboard Percussion: Sticking and Grip.....	4-3
Keyboard Percussion: Instrument Characteristics.....	4-5
Chapter 5 BASS DRUM	5-1
Bass Drum: Physical Composition and Construction.....	5-1
Bass Drum: Acoustical Characteristics.....	5-1
Bass Drum: Notation.....	5-1
Bass Drum: Striking Area.....	5-2
Bass Drum: Striking Implements.....	5-3
Bass Drum: Grip and Stroke Technique.....	5-3
Bass Drum: Muffling.....	5-4
Bass Drum: Notes on Marching Band Performance.....	5-5

DISTRIBUTION RESTRICTION: Approved for public release; distribution is unlimited

*This publication supersedes TC 12-43 dated 25 October 2001.

Contents

	Bass Drum: Notes on Concert Band Performance	5-6
Chapter 6	CYMBALS	6-1
	Hand Cymbals.....	6-1
	Suspended Cymbals	6-3
	Cymbals: Function and Selection	6-5
Chapter 7	TIMPANI	7-1
	Timpani: Materials and Function.....	7-1
	Timpani: Setup	7-2
	Timpani: Playing Areas	7-2
	Timpani: Stroke Technique	7-3
	Timpani: Striking Implements.....	7-4
	Timpani: Muffling.....	7-5
	Timpani: Tuning	7-5
Chapter 8	TRIANGLE.....	8-1
	Triangle: Physical Composition and Construction	8-1
	Triangle: Striking Implements	8-2
	Triangle: Playing Area.....	8-2
	Triangle: Grip	8-2
	Triangle: Stroke Technique.....	8-3
	Triangle: Rolls	8-3
	Triangle: Muffling.....	8-4
	Triangle: Special Effects	8-4
Chapter 9	TAMBOURINE.....	9-1
	Tambourine: Physical Composition and Construction	9-1
	Tambourine: Striking Implements	9-1
	Tambourine: Playing Area	9-2
	Tambourine: Grip	9-2
	Tambourine: Stroke Technique.....	9-3
	Tambourine: Rolls.....	9-4
	Tambourine: Muffling	9-4
	Tambourine: Special Effects	9-4
Chapter 10	LATIN PERCUSSION INSTRUMENTS.....	10-1
	Latin Percussion: Overview	10-1
	Latin Percussion Section Makeup.....	10-1
	Latin Percussion: Congas	10-1
	Latin Percussion: Bongos	10-7
	Latin Percussion: Timbales.....	10-9
	Latin Percussion Accessories	10-11
	Latin Style Sample Scores with Drum Set Part Included.....	10-20
Chapter 11	PERCUSSION ACCESSORIES	11-1
	Percussion Accessories: Gong/Tam-Tam	11-1
	Percussion Accessories: Woodblock.....	11-2
	Percussion Accessories: Temple Blocks	11-4
	Percussion Accessories: Castanets.....	11-5
	Percussion Accessories: Finger Cymbals.....	11-7
	Percussion Accessories: Sleigh Bells	11-7
	Percussion Accessories: Ratchet	11-8
	Percussion Accessories: Slapstick	11-8
	Other Accessory Instruments.....	11-9
Chapter 12	PRACTICE AND REHEARSAL TECHNIQUES.....	12-1
	Practice Technique	12-1
	Metronome Techniques	12-1

	Rhythms.....	12-1
	Sight-Reading.....	12-2
	Performance Considerations.....	12-2
	Percussion Setup.....	12-3
	Multiple Percussion Performance.....	12-4
	Notes on Specific Music Styles and Types.....	12-4
	Personnel and Equipment Limitations or Constraints.....	12-5
	Rehearsal and Concert Organization.....	12-6
	Maintenance of Equipment.....	12-6
Appendix A	PERCUSSION AND LATIN TERMS AND DEFINITIONS.....	A-1
Appendix B	DRUM SET STYLES.....	B-1
	SOURCE NOTES.....	Source Notes-1
	GLOSSARY.....	Glossary-1
	REFERENCES.....	References-1
	INDEX.....	Index-1

Figures

Figure 2-1. Snare Drum Playing Area.....	2-2
Figure 2-2. Snare Drum Grip.....	2-3
Figure 2-3. Snare Drum Stroke Technique.....	2-4
Figure 3-1. Drum Set.....	3-1
Figure 3-2. Bass Drum Pedal Technique.....	3-5
Figure 3-3. Hi-Hat Cymbals.....	3-7
Figure 3-4. Drum Set Manuscript Conventions.....	3-7
Figure 3-5. Drum Set Style Sheets.....	3-8
Figure 4-1. Keyboard Percussion.....	4-1
Figure 4-2. Keyboard Percussion Striking Points.....	4-2
Figure 4-3. Keyboard Percussion Striking Motion.....	4-2
Figure 4-4. Keyboard Percussion Traditional Grip.....	4-3
Figure 4-5. Keyboard Percussion Burton Grip.....	4-4
Figure 4-6. Keyboard Percussion Musser Grip.....	4-4
Figure 4-7. Marimba.....	4-5
Figure 4-8. Xylophone.....	4-7
Figure 4-9. Vibraphone.....	4-8
Figure 4-10. Orchestra Bells.....	4-9
Figure 4-11. Orchestra Bells and Bell Lyre Striking Area.....	4-10
Figure 4-12. Chimes.....	4-11
Figure 4-13. Chimes Striking technique.....	4-12
Figure 5-1. Bass Drum Notation.....	5-2
Figure 5-2. Bass Drum Striking Area.....	5-2
Figure 5-3. Bass Drum Muffling.....	5-5
Figure 5-4. Bass Drum Moving Troops.....	5-5

Contents

Figure 6-1. Cymbal Notation	6-1
Figure 6-2. Cymbal Grip.....	6-2
Figure 6-3. Cymbal Crash.....	6-3
Figure 6-4. Suspended Cymbal Playing Area.....	6-4
Figure 6-5. Suspended Cymbal Roll.....	6-5
Figure 6-6. Tying the Cymbal Strap.....	6-6
Figure 7-1. Timpani.....	7-2
Figure 7-2. Timpani Playing Area	7-3
Figure 7-3. Timpani Stroke Technique	7-4
Figure 7-4. Timpani Muffling	7-5
Figure 8-1. Triangle Setup	8-1
Figure 8-2. Triangle Playing Area	8-2
Figure 8-3. Triangle Grip.....	8-3
Figure 8-4. Triangle Rolls.....	8-4
Figure 9-1. Tambourine Playing Area	9-2
Figure 9-2. Tambourine Grip.....	9-3
Figure 10-1. Conga	10-2
Figure 10-2. Conga Open Stroke.....	10-3
Figure 10-3. Conga Slap Stroke	10-4
Figure 10-4. Conga Bass Stroke	10-4
Figure 10-5. Heel Stroke.....	10-5
Figure 10-6. Fingertip Stroke	10-5
Figure 10-7. Conga Tumbao.....	10-6
Figure 10-8. Conga Samba Pattern.....	10-6
Figure 10-9. Conga Partido Alto Pattern.....	10-7
Figure 10-10. Conga Mozambique Pattern.....	10-7
Figure 10-11. Bongos	10-7
Figure 10-12. Bongo Martillo Pattern	10-9
Figure 10-13. Timbale.....	10-9
Figure 10-14. Timbale Cascara Pattern.....	10-10
Figure 10-15. Timbale Mambo Bell Pattern	10-10
Figure 10-16. Clave Grip.....	10-11
Figure 10-17. 3:2 Son Clave	10-11
Figure 10-18. 2:3 Rumba Clave.....	10-12
Figure 10-19. 3:2 Bossa Clave	10-12
Figure 10-20. Partido Alto	10-12
Figure 10-21. Cowbell.....	10-13
Figure 10-22. Son Montuno Bongo Bell Pattern	10-14
Figure 10-23. Mambo Bell Pattern	10-14
Figure 10-24. Guiro.....	10-14
Figure 10-25. Guiro Salsa Rhythm	10-15

Figure 10-26. Guiro Samba Rhythm	10-15
Figure 10-27. Cabasa.....	10-15
Figure 10-28 Agogo Bells.....	10-16
Figure 10-29. Agogo Samba Pattern 1.	10-16
Figure 10-30. Agogo Samba Pattern 2.	10-16
Figure 10-31. Agogo Partito Alto Pattern	10-16
Figure 10-32. Shaker Basic Pattern	10-17
Figure 10-33. Triangle Samba Pattern.....	10-18
Figure 10-34. Pandiero Basic Pattern	10-18
Figure 10-35. Tambourim Basic Pattern	10-19
Figure 10-36. Tambourim Pattern 2	10-19
Figure 10-37. Surdo	10-19
Figure 10-38. Surdo Marcaná Basic Pattern.....	10-20
Figure 10-39. Surdo Variation 1	10-20
Figure 10-40. Surdo Variation 2	10-20
Figure 10-41. Bossa Nova Score	10-21
Figure 10-42. Cha-Cha Score	10-22
Figure 10-43. Samba Score	10-23
Figure 10-44. Mambo Score.....	10-24
Figure 10-45. Cascara Score	10-25
Figure 10-46. Songo Score	10-26
Figure 10-47. Mozambique Score	10-27
Figure 10-48. Afro-Cuban/Nañigo Score.....	10-28
Figure 11-1. Gong/Tam-Tam.....	11-1
Figure 11-2. Woodblock	11-3
Figure 11-3. Temple Blocks	11-4
Figure 11-4. Castanets.....	11-5
Figure 11-5. Sleigh Bells	11-8
Figure 11-6. Ratchet.....	11-8
Figure 11-7. Slapstick.....	11-9
Figure 11-8. Brake Drum.....	11-10
Figure 12-1. Swing Rhythm.....	12-2
Figure B-1. Swing in 2.	B-1
Figure B-2. Swing in 4.	B-1
Figure B-3. Rock example.....	B-2
Figure B-4. Funk example.	B-2
Figure B-5. Bossa nova.	B-2
Figure B-6. Rhumba.	B-3
Figure B-7. Cha-Cha.	B-3
Figure B-8. Traditional samba.....	B-3
Figure B-9. Contemporary samba example.	B-3

Contents

Figure B-10. Mambo.	B-4
Figure B-11. Afro-Cuban/Nañigo.	B-4
Figure B-12. Songo.	B-4
Figure B-13. Cascara.	B-5
Figure B-14. Mozambique.	B-5
Figure B-15. Jazz waltz.	B-5
Figure B-16. Shuffle.	B-5
Figure B-17. Hip-Hop.	B-6
Figure B-18. Merengue.	B-6
Figure B-19. Merengue-variation.	B-6
Figure B-20. Reggae.	B-6
Figure B-21. Ska.	B-7

Tables

Table 2-1. Types of Snare Drum	2-1
Table 5-1. Bass Drum Striking Implements	5-3
Table 8-1. Triangle Types	8-1
Table 9-1. Tambourine Types	9-1
Table 10-1. Conga sizes	10-2
Table 10-2. Bongo Strokes	10-8
Table 10-3. Surdo Types	10-20

Preface

TC 1-19.30, Percussion Techniques, describes common percussion instruments used by Army bands, and provides performance techniques for each instrument. This publication is a reference guide to be used when needed.

The principle audience for TC 1-19.30 is all skill level 1-4 Soldiers holding military occupational specialty (MOS) 42R or 42S, with the additional skill identifier (ASI) of 9M, 9N, 9T, 9U, 9V, 9X, 9H, and 9K that do not double on another marching band instrument, and for trainers and musical supervisors.

Commanders, staffs, and subordinates ensure that their decisions and actions comply with applicable United States, international, and in some cases host-nation laws and regulations. Commanders at all levels ensure that their Soldiers operate in accordance with the law of war and the rules of engagement (see FM 27-10).

This publication is not the proponent publication for any Army terms.

This publication serves as the primary reference for both resident and nonresident percussion techniques instruction presented to Soldiers, noncommissioned officers, warrant officer bandmasters and commissioned officers. Trainers and first-line supervisors should ensure Soldiers holding ASI of 9M, 9N, 9T, 9U, 9V, 9X, 9H, and 9K (skill level 1-4) have access to this publication. It should be made available in the Soldiers' work area, unit learning center, and unit libraries.

As this publication is a guide, and as all possible situations and eventualities cannot be foreseen or covered by the manual, great reliance must be placed upon the application of sound judgment and common sense by all members of a music performance unit (MPU). In situations not covered by this manual and where doubt arises as to the proper action to be taken, the individual must consider their mission and apply sound judgment in making the required decision(s).

TC 1-19.30 applies to the Active Army, the Army National Guard, the Army National Guard of the United States, and the United States Army Reserve unless otherwise stated.

The proponent of TC 1-19.10 is the United States Army School of Music. The preparing agency is the Directorate of Training and Doctrine, the United States Army School of Music. Send comments and recommendations on DA Form 2028 (Recommended Changes to Publications and Blank Forms) to Commandant, U.S. Army School of Music, ATTN: ATSG-SMZ, 1420 Gator Boulevard, Virginia Beach, VA 23459-2617.

This page intentionally left blank

Acknowledgements

The copyright owners listed here have granted permission to reproduce material from their works.

The Source Notes lists other sources of quotations and photographs.

Graphic used with permission “Percussive Arts Society Standardized Drumset Notation”. Percussive Arts Society.

Graphics used with permission from *A Comparative Analysis of the Musser Grip, Stevens Grip, Cross Grip, and Burton Grip*. Berkowitz, Adam. 2011. Retrieved from <http://www.pas.org/docs/default-source/thesisdissertations/a-comparative-analysis-of-the-mechanics-of-musser-grip-stevens-grip-cross-grip-and-burton-grip-by-adam-eric-berkowitz.pdf>

This page intentionally left blank

Introduction

TC 1-19.30 is a reference guide for MOS percussionists and auxiliary percussionists (MOS 42R or 42S, with the ASI of 9M, 9N, 9T, 9U, 9V, 9X, 9H, and 9K). It replaces TC 12-43, *Percussion Techniques*.

Army percussionists are expected to be proficient in a wider variety of instruments than any other MOS in the proponent. While a civilian percussionist may specialize on one particular percussion instrument, the Army requires a percussionist to be responsible for over 50 percussion instruments. It is not possible to attain proficiency in all percussion instruments solely in the time allotted during Army institutional training (i.e. advanced individual training (AIT), advanced leader course (ALC), senior leader course (SLC)). Therefore, this publication is intended to be used as a reference when a percussionist or auxiliary percussionist is tasked to perform on an instrument they are less familiar with.

Although this publication can be used as a reference, Soldiers are highly encouraged to research for themselves the wealth of internet and/or YouTube resources such as Vic Firth or Zildjian. Also, for a list of common print materials, see the “Recommended Reading” section in the References section. For advanced percussion studies, Soldiers are encouraged to pursue private lessons with local professionals, or with School of Music percussion instructors via Skype or similar live video call mediums.

This page intentionally left blank

Chapter 1

Basic Principles of Percussion Playing

HISTORY

1-1. Percussion instruments were the first musical instruments used by man before recorded history. Archaeologists have found artifacts resembling contemporary percussion instruments in excavations of ancient civilizations. A detailed and fascinating account is James Blades' *Percussion Instruments and Their History* (see Recommended Readings in References).

1-2. The Turks first used contemporary forms of percussion instruments in 1453. Contact between Eastern Europe and the Turkish Army spread the influence of Turkish music, known as Janizary (or Janissary) music, to all Europe. Janizary bands emphasized percussion instruments, particularly the bass drum, cymbals, triangle, and tambourine. Joseph Haydn was the first important Western composer to use these percussion instruments, introducing them with his *Military Symphony No. 100*.

1-3. Nineteenth century Impressionist composers Debussy and Ravel used percussion instruments as painters used colors. Rimsky-Korsakov, Berlioz, Stravinsky, Bartok and Varese are only a few of the many composers who contributed to the development of percussion instruments in the modern orchestra.

1-4. Percussion in military bands derives from the European tradition, with the British having greatest influence. The drum was used as a signaling device from the inception of the American colonies through the Civil War, where it gave way to the bugle. Wind bands prospered during the Civil War, and the wind band was the most accessible means of presenting music to the masses for bolstering morale and esprit de corps. Modern military bands provide music for troop ceremonies, formal military occasions and patriotic gatherings. Bands also provide music for recruiting and community-relations events. Percussion is an important part of the military music structure and composition.

DEFINITIONS

Percussion Instrument. Percussion Instrument is the generic name for instruments that are sounded by shaking or striking. The two families of percussion instruments are membranophones and idiophones.

Membranophones. Membranophones are items that produce sound from a vibrating membrane, or skin, when struck.

Idiophones. Idiophones are items that produce sound from hard substances that vibrate when struck (e.g. wood, metal, glass, or stone)

TOTAL PERCUSSIONIST

1-5. A total percussionist must perform on more than 50 different instruments. When civilian percussionists may specialize on particular percussion instruments (e.g., the timpanist in an orchestra), the Army requires a percussionist to be responsible for all percussion instruments.

1-6. Many skills used on one percussion instrument can be used on others. For example, most membranophones have common playing areas. The matched grip used on set and snare drum is also used on

marimba and vibraphone. Therefore, with a few minor technique adjustments, basic techniques on many percussion instruments can easily be learned. Mastery of these techniques is a lifetime study.

1-7. Experience is the total percussionist's greatest asset. Only through listening, study, practice, performance, and trial and error can the percussionist learn the techniques necessary to perform the repertory. This publication is designed to guide your study and explain the techniques you must use to gain the necessary experience and finally, to perform musically and tastefully.

GENERAL RULES FOR PERCUSSION PERFORMANCE

1-8. Every performer must learn the techniques and gain the facility required on their instruments. They must also learn to perform various interpretations. The more the techniques are practiced, and the more the interpretations are studied, the more polished the performance will become.

1-9. Applying techniques to performance requires that the performer develop skills in the four categories of tone production: striking areas, mallet choice, stroke technique, and muffling technique.

STRIKING AREAS

1-10. Every performer must know the physical qualities of each instrument with respect to tone production. Only then can they determine the best striking areas for their purpose. The player must apply their knowledge of those qualities, use their imagination, be creative, and experiment to produce the sounds required by the music. The separate instrument sections, when applicable, will examine:

- Physical composition and construction.
- Acoustical characteristics.
- Correct tuning.
- Proper playing position.
- Standard performance directions.

MALLET CHOICE

1-11. Musical color and articulation requirements should determine mallet choice. Articulations must be analyzed to determine the attack and tone color needed for the music. Playing implements can be chosen according to these general rules:

The harder the mallet, the sharper the attack, and the shorter the tone duration.

The softer the mallet, the mellower the attack, and the longer the tone duration.

STROKE TECHNIQUES

1-12. The motions involved in striking any percussion instrument determine the intensity and duration of the vibrations. A stroke has two parts: attack and rebound.

Attack

1-13. Attack is the motion of the striking implement to the point of impact on the instrument. The length and speed of the attack determines the intensity of the sound. If the length of the attack is constant between two notes, the attack with faster implement speed to the point of impact will be louder and the vibrations will be more intense. If the speed to the point of impact is a constant, the only way to increase loudness or amplitude of the attack is to increase the distance to the point of impact. In this case, the stick or mallet height from the instrument would be greater.

Rebound

1-14. Rebound is the motion of the striking implement after impacting. The speed of the rebound determines the duration of the vibrations. The natural rebound, when the striking implement freely bounces off the playing surface, produces the longest tone. Interference with the natural rebound always shortens tonal duration. The faster the rebound, the longer the duration of the tone.

1-15. The separate instrument sections will examine stroke techniques at length. These will include information in the following areas:

- Types of strokes (single, double, multiple bounce, embellishments, special effect).
- Angles of strokes.
- Standard performance directions.
- Grips.

MUFFLING TECHNIQUES

1-16. Muffling controls tone duration. The general rule is:

ALWAYS GIVE THE NOTE ITS FULL VALUE.

1-17. The style of articulation, acoustics of the hall, resonance and pitch of the instrument, tempo, complexity of the melodic lines, and the harmonic structure of the music determine the type and degree of muffling required. Instruments which require muffling or resonance control can be muffled manually or with a muffling device, which acts to mechanically equalize duration. Accurate muffling is the true test of an accurate musical performance.

1-18. Every percussionist must become proficient in applying the four categories of tone production (striking areas, mallet choice, stroke technique, and muffling technique) for whatever percussion instrument they play. They can be used as a checklist for accurate practice and performance. They are also used by audition boards to evaluate your ability as a percussionist.

This page intentionally left blank

Chapter 2

Snare Drum

SNARE DRUM: PHYSICAL COMPOSITION AND CONSTRUCTION

2-1. Musical requirements demand several sizes of snare drum for different tone qualities. The height of the drum determines its volume and the diameter determines its pitch. Snare drum sizes range from 3½ to 14 inches in depth and 10 to 16 inches in diameter. The more common sizes are listed in Table 2-1.

Table 2-1. Types of Snare Drum

<i>Snare Drum Type</i>	<i>Size (in inches)</i>	<i>Description</i>
Concert Snare Drum	6 ½ x 14	Used for general purpose orchestral playing.
Piccolo Snare Drum	3 ½ x 13	Used for light, delicate orchestral playing or as a toy drum effect. It produces a high, crisp, and precise tone.
Dance Band/Combo Snare Drum	5 ½ x 14	Used in drum set playing. It produces a crisp, high, and responsive tone.
Marching Snare Drum	12 x 15 or 10 x 14	This produces the volume needed for marching purposes or for field drum parts in concert band literature.

2-2. The material composition of the drum's shell can affect its tone. Wood shells produce a mellow, well-rounded, and resonant tone. Metal shells produce a pointed, sharp, and resonant metallic tone.

2-3. Heads can either be made of plastic or calfskin membranes. Plastic heads are not affected by weather, are cheaper and easily available, and are easier to maintain. Heads are made in three different general weights:

- Thin for a light, delicate, ringing, and responsive tone,
- Medium for general all-purpose playing, and
- Heavy for marching or rock band purposes when a louder, stiffer, heavier tone and more durable head are required.

NOTE: The snare or bottom head is thinner than the batter or top head for more snare response.

2-4. Threaded rods that pull a metal rim down over the hoop of the head control the tension of the head. These rods screw into tension casings (lugs) attached at even intervals around the shell. Generally, drums with more lugs provide greater tuning control.

2-5. Snares are long thin strands of gut or metal attached over the bottom head with an adjustable snare strainer mechanism (see figure 2-2). Snares are activated by the vibration of the snare head, which produce a high, buzzing, rattling tone. The more strands of snares, the more snare response the drum will have.

2-6. The choice of snare type is determined by the music and player preference. The most common snare types are wire snares, gut snares, nylon snares, and combination snares.

- Wire snares are the most common and produce the most response against the snare head. They are best for indoor use.
- Gut snares produce a dry, crisp, less buzzing tone. They are recommended for use on marching snare drums for better projection of the snare tone. They are however affected by weather changes.
- Nylon snares produce a dry, crisp, well-defined tone with more response against the snare head than gut snares.
- Combination snares produce a balanced mixture of response wire, gut, and nylon.

2-7. The snare strainer is the mechanism that tensions the snares. The adjustment of the snare is very important to tone production. When snares are too loose they produce a sloppy, ringing, uncontrollable tone that lacks definition. When they are too tight they produce a choked, dry, hollow tone. When they are well adjusted they produce a clean, crisp, well-defined tone. Several types of snare strainers are manufactured. It is recommended that you get one equipped with a quick release lever to release the snares from contact with the snare head when required.

SNARE DRUM: ACOUSTICAL CHARACTERISTICS

2-8. The objective is to produce a short, crisp, tight, and penetrating tone from the combined sound of the batter head, snare head, and snare response. The basic playing areas on the snare drum are shown in figure 2-1.

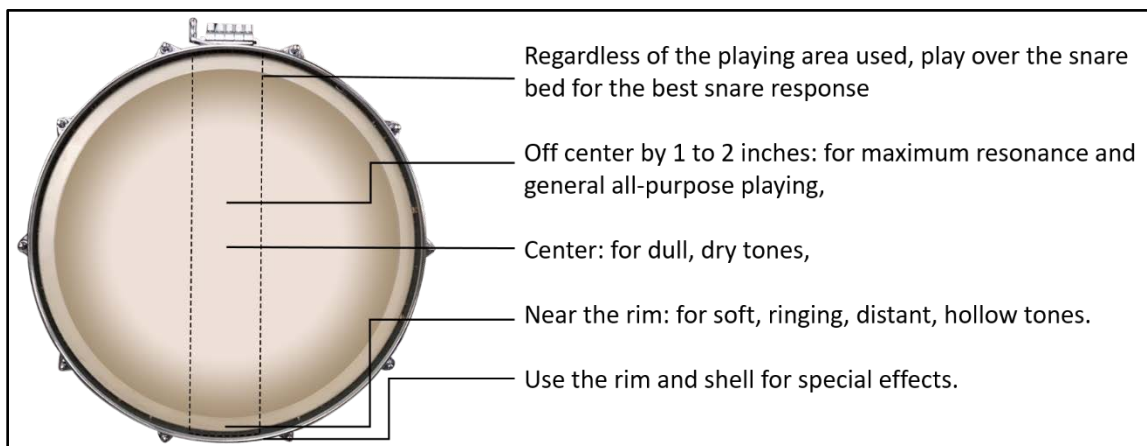

Figure 2-1. Snare Drum Playing Area

2-9. For concert band, position the drum at approximately waist level and in line with the music and the conductor. Center the snare strainer control lever in front of your body so it is within easy reach of either hand. This also aligns the snares in front of your body so that snare response is consistent throughout the range of playing areas. The tone control knob should also be within easy reach. The height of the drum stand depends on your personal preference. You must ensure you have an unobstructed view of the conductor.

SNARE DRUM: STRIKING IMPLEMENTS

2-10. Drumsticks are made from hickory, oak, rosewood, or maple. The length, diameter, and weight of the stick to be used are determined by the size of the instrument and the musical effect you desire. For example, a large stick will overpower a small drum and choke the sound. Small sticks or sticks with tapered shoulders are not heavy enough to make a large drum speak. While stick choice involves your personal preference, here are some recommendations:

- 5B: A medium stick for general purpose playing
 - A medium stick specifically for concert purposes is the Vic Firth SD1 General or similar brand/style.
- 5A: A smaller stick for softer playing.
- 3S: A large stick for marching purposes.

2-11. Sticks are available with plastic or wood tips. The plastic tips last longer, give a sharper attack, and stay more consistently in pitch. Wood tips produce a darker attack and do not hold up well under heavy cymbal playing.

2-12. When buying sticks, look and test for the following discrepancies:

- Check for warped sticks by rolling the stick across a flat surface and check for a wobble;
- Ensure the sticks have balanced weight;

- Check the stick by holding it in each hand and testing by feel.

2-13. Check the pitch of the sticks by gripping each stick the same way and tapping gently on the same hard surface. The pitch should be high and identical for both sticks. Brushes can be used on snare drums for a swish effect. Yarn mallets are used for a tom-tom effect. Other implements can be used effectively with discretion and care.

SNARE DRUM: GRIP

2-14. Individual grip variations are common. However, there are certain general rules to follow when forming the grip. The two accepted grips for snare drum are the traditional grip and the matched grip (see figure 2-2).

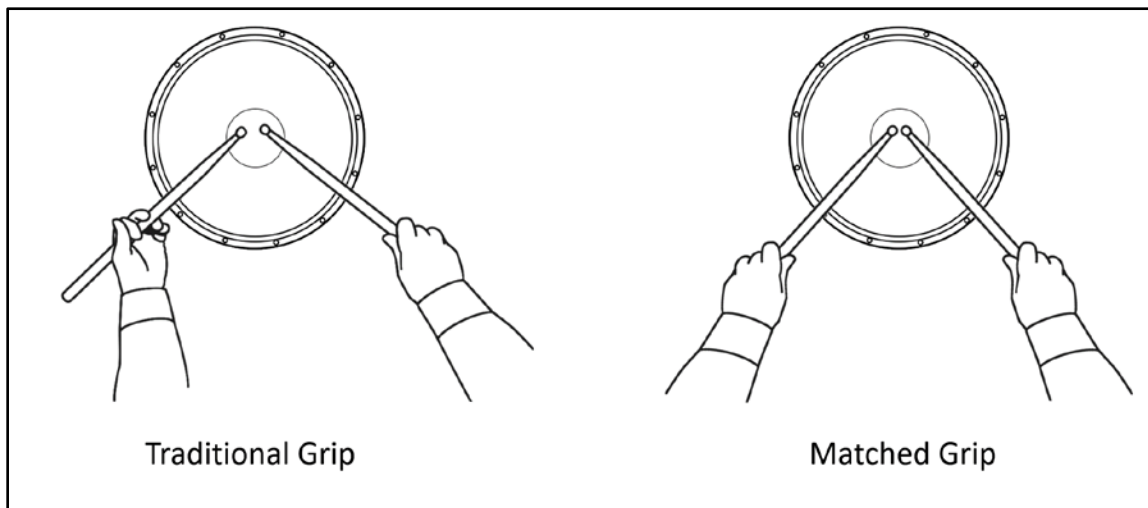

Figure 2-2. Snare Drum Grip

2-15. To form the traditional grip, turn the left palm up and place the stick in the flesh between your thumb and index finger at a point one-third of the way up the stick. Touch the tip of your thumb to the second knuckle of your index finger. By doing this, you are closing your fulcrum or pivot point. Bring your ring finger and your small finger around in a curved fashion to support the stick. Combine your wrist, thumb, and index finger as one mechanism and use your other two fingers for support.

2-16. Turn your right hand palm down and place the stick between the flat of your thumb and the second joint of your index finger. By closing your index finger around the stick, you are closing the fulcrum. Your other fingers should rest lightly along the stick as it travels through and bisects your palm. Do not clench your fingers tightly. Leave them free to allow the stick to move back and forth. The stick should feel balanced to rebound freely.

2-17. To form the matched grip, form your right hand as described in paragraph 2-16 for the traditional grip. With your left hand, form a mirror image of the right. The key to a good grip is total relaxation. At the first sign of tension, stop and relax your hands.

SNARE DRUM: STICKING SYSTEMS

2-18. There are three standard sticking systems: hand to hand, rudimental, and right hand lead.

Hand to Hand

2-19. Hand to hand system is very basic and used for teaching beginners. It is recommended because it develops the hands evenly. Both hands alternate striking notes, without regard to which beats the notes may fall. The advantage is its application to playing other percussion instruments.

Rudimental

2-20. Rudimental sticking employs the rudiments and their variations. It is useful in teaching marching snare drum where the rudiments are applied. Rudimental sticking places a coordinative demand on the player who is not usually specifically called for in concert playing. However, techniques derived from rudimental performance may be applied to concert snare or drum set applications.

Right Hand Lead

2-21. Right hand lead is applicable to snare drum and a few other percussion instruments, and may be reversed if the dominant hand is the left. This system stresses using the stronger hand on all principal pulses, beats, and accents. The other hand plays the weak beats and embellishes notes. This system should be approached only after mastering the other two systems of sticking. Right hand lead is a very consistent sticking system, providing consistent tone production. However, this system develops a strong dominant hand leaving the other hand relatively weak and underdeveloped.

SNARE DRUM: STROKE TECHNIQUE

2-22. There are three types of strokes: single, double, and multiple bounce (buzz). The general rules of stroke technique apply to the snare drum (see para. 1-12–1-15).

2-23. Perform the single stroke by starting with the stick in rest position two to four inches above the drum. Lift your wrist straight back and in one smooth motion let the stick fall to the drum. It should immediately respond by rebounding off the drum. Practice single stroke in alternation. The goal is to produce a smooth, even sound (see figure 2-3).

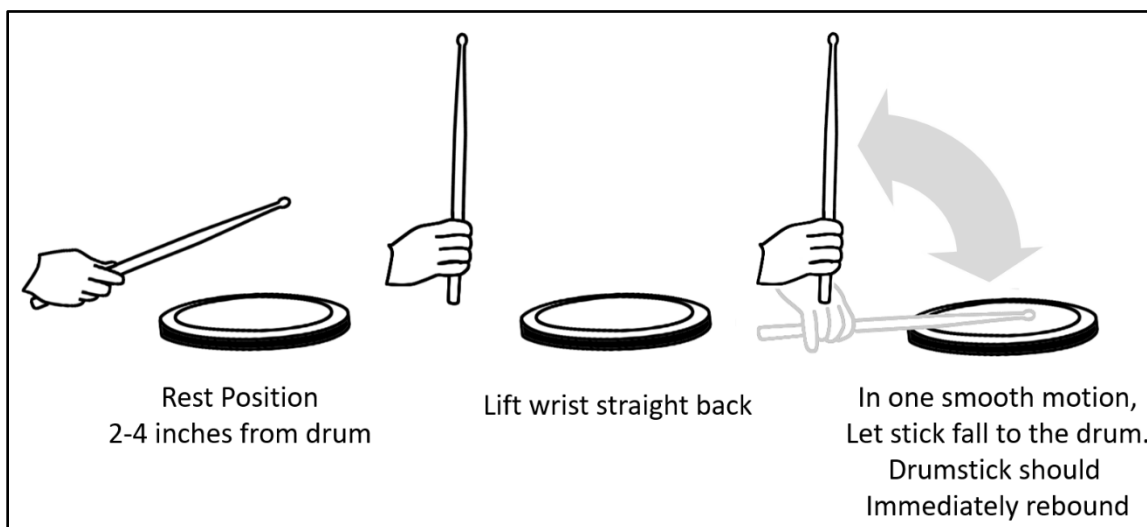

Figure 2-3. Snare Drum Stroke Technique

2-24. Perform the double stroke in basically the same way. When the stick strikes the drum and rebounds there is a second stroke, or bounce, producing the double stroke. It is important when executing the double stroke not to let the wrist control each stroke. The wrist should move once and you should hear two sounds. The stroke and the bounce should sound almost alike.

2-25. The multiple bounce (buzz) stroke is often neglected in early percussion training. The multiple bounce stroke should be a full sounding “roll” with more than two strikes per hand. To achieve this, apply a little more pressure at the fulcrum or pivot point. Varying the amount of pressure at the fulcrum and varying the hand speed determines the texture of the roll. The texture of the multiple bounce (buzz) roll can vary from a very thin, fine to a very thick, coarse sound. The roll will sound pulsed if hand speed is not increased relative to louder dynamics. The ideal concert roll is one of dense, even, overlapping buzz strokes.

2-26. Metered rolls are rolls that use a specific hand speed to determine concert roll texture or rudimental roll stroke content. Hand speed is determined by the tempo of the piece, and both hand speed and tempo determines roll content and texture. Metering of rolls in concert music allows for consistent roll textures, regardless of tempo, and gives the drummer a way to pre-negotiate sticking techniques of passages surrounding the roll.

2-27. When dealing with the snare drum, the word muffle pertains to disengaging the snares to produce the tenor drum or tom-tom effect. Sometimes the word damp or dampen is used, although the term dampen usually refers to the muting of undesirable overtones. Two methods are used to dampen (reduce undesirable overtones on) the drum. The first is the internal tone control and the second involves placing an object such as a handkerchief or timpani damper on the exterior of the head. These should be used in moderation, as the heads must vibrate to produce a good sound. For minimal dampening, your ID card works well if placed near the rim of the drum.

2-28. Whenever the drum is not in use, the snare should be disengaged to avoid the unwanted sympathetic vibration of the snares.

This page intentionally left blank

Chapter 3

Drum Set

DRUM SET: PHYSICAL COMPOSITION AND CONSTRUCTION

3-1. A drum set is a percussion configuration making it possible for one drummer to perform the same functions as three drummers, allowing a broad variety of styles. It traditionally consists of a bass drum with foot pedal, attached tom-toms (one or more) of different sizes, a floor tom-tom, free-standing snare drum, hi-hat cymbal with pedal, two cymbals, and a player's throne (see figure 3-1).



Figure 3-1. Drum Set

DRUM SET: FUNCTION AND TECHNIQUE

3-2. The following paragraphs describe the purpose of the drum set, and different techniques to use when soloing.

PURPOSE OF DRUM SET

3-3. The drum set has three functions:

- To provide a steady pulse for the band,
- To help define the style of the piece being played, and
- To assist the other players (by using kicks and fills) in the accurate performance of their parts.

3-4. An important part of the drummers' function is to play accents, or kicks, with the band. Kicks are divided into three parts: the prep, the accent, and the return

- The first is the prep. This note (or notes) that precedes the kick is usually performed on the snare drum, but may be played on any drum including the bass drum. The prep sets up the figure to be kicked and is in the style of the piece being performed.
- The second part of the kick is the notes being “kicked” or accented. The kick may be on the beat, off the beat, or several notes may be played in succession.
 - Long percussive notes being kicked will usually, but not always, be accented with the bass drum and with or without the cymbal.
 - Short percussive notes will usually be played on a “short” sound, for example, snare drum or tom-tom. The drummer must not destroy the integrity of the articulation of the line being accented.
- The third part of the kick is the return. Allowing for accented note durations, reenter the time on the next full beat after the figure to be kicked.

3-5. Fills are functionally extended preps. In most cases, a fill written in a part will terminate in a kick either by a section or the entire band. If a fill extends longer than one measure and it does not terminate in a kick, then it can be called a solo.

3-6. The following concepts must be considered when performing fills and solos:

- Individual technique,
- Rhythmic motifs,
- Dynamic contrasts, and
- Use of available instrumental timbres for tonal color.

3-7. When playing prep/kick figures or fills in certain styles, pay attention to the following concepts for each style.

Jazz

3-8. Stay in the style of the music. For basic prep/kick settings, the last note of the prep occurs on the beat before the note being kicked or anticipated. If anticipations occur sequentially, the last short percussive anticipation is the prep to the following long percussive anticipation.

3-9. For longer fills, think melodically. Use the swing rhythm articulations discussed earlier to frame the fill in the context of the feel and style of the song.

Rock and Latin

3-10. Stay in the style of the music. Do not overplay. The swing rhythm articulations will work in rock and Latin feels if you play the eighth notes straight. Beware of reversing the beat pattern of the clave, as this is culturally unacceptable. Imply the clave rhythm in your fills, if time permits.

Funk and Cut-Time Latins

3-11. In funk, the eighth-note is a short percussive note, and any note longer than an eighth-note is a long percussive note. This transposition also works with cut-time Latin grooves (e.g., mambo or samba written in cut time). The long percussive/short percussive exception in this case is that in the cut-time grooves, any notes equal to or shorter than a quarter note will be articulated short on the drum set.

SOLOS

3-12. Solos are any lengths of unaccompanied improvised material. The solo should be constructed exactly like an improvised melodic line to create rhythmic tension and release and build to a final climax. The solo should have a definite form, beginning with a concrete idea then expanded, varied, and restated to the climax. Study of musical form can be very helpful.

Trading Fours

3-13. These occur usually before the return to the melody in a combo setting. The drummer will usually trade fours or perform solos in a call/response manner over the song form. Usually works best over AABA/AABC forms, although it can work in 12- or 16-bar blues. Other length of solos can be traded in this manner (e.g., trading eights).

3-14. Use small phrases. With a two-bar period and a four-bar phrase, there are three options for solo idea construction:

- Call/response,
- Theme and variation, and
- Through-composed.

3-15. The call/response solo uses one idea for the first 2-bar period, and a completely different idea (as if you were being answered by another player) for the second period. The theme and variation is as its name implies. Use one idea for the first period, and vary it in the second. Variation can be rhythmic, melodic (re-voice the same idea), or harmonic (re-voice with double stops).

3-16. The through-composed solo is a four-bar idea played during one solo break. A good source of ideas for jazz fours is Syncopation for the Modern Drummer by Ted Reed (see Recommended Readings in References).

Form Solo

3-17. This is usually done with a big band, where the drummer, either written or improvised, will solo over one chorus of the song. This usually works well in a blues setting. A good soloist will imply the form within the solo by use of rhythmic motifs and set up the changes or the sections of the form.

Open Solo

3-18. This is the most challenging for the drummer (and sometimes for the audience as well). The drummer must maintain interest and provide, at the end of the solo, a solid foundation for the reentry of the band. Motivic development is critical to the success of this type of solo.

3-19. Do not be afraid to use dynamic contrasts. Be clear about when the band is to return or reenter. The band should have no doubts about when it is time for them to play.

Song Form

3-20. Every piece of music has a form that should be analyzed before a performance. If you know the form of the tune, you will rarely get lost, will play better because you can listen to the band rather than be buried in the music, and be able to treat the tune as a whole, rather than mechanically, measure by measure.

3-21. A phrase is a grouping of measures into a larger unit. Phrases fall in 4, 8, 12, and 16 bar groups. To play fills and solos, you must be able to hear these phrases. This greatly aids counting, reading, and playing. A common example of form is the three part ABA form: A = Statement, B = Departure or Bridge, and A= Return or Restatement.

3-22. Most popular music uses this form. The 'A' phrase is commonly repeated, producing an AABA form. The 'B' phrase, better known as the bridge, is a transition or release that departs from the 'A' phrase melodically and harmonically. The 'A' phrase returns to complete the form, usually differing in musical texture and dynamics from the original 'A' phrase. If more than half of the last 'A' phrase is materially different, then the form will be AABC.

3-23. You must know the sequence of these phrases to play effectively with the band. It is good practice to emphasize the beginning of a phrase to let the band know exactly where they are especially during improvised solos. This can tastefully be done by accenting a beat on a crash cymbal, or any playing area on the drum set that will indicate a contrast in the music.

3-24. Fills are used to connect phrases together and should be played to fit the musical texture at that point in the music. By analyzing the form, you will know how to treat each fill and contribute tastefully to the overall effectiveness of the piece.

DRUM SET: COMPONENT PARTS

3-25. Drum sets are usually comprised of a bass drum, snare drum, tom-toms, and cymbals. The component parts of each drum set will depend on the style of music being played, and individual preferences.

BASS DRUM

3-26. The tuning objective for bass drum is the lowest possible resonant tone. The exact pitch of the tone is varied according to musical style and player preference. The method of tuning is the same as the concert bass drum (page 5-1).

3-27. Muffling the bass drum has much to do with tone production and tuning. The jazz ensemble bass drum must be muffled by some means. A dull, dry, hollow, but projecting thud sound is usually the preference. Removing the front head entirely will provide an excellent tone for rock tunes. This setup also needs to be muffled. Several muffling methods may be employed. Felt strips can be mounted against the batter or front head. Also, blankets can be stuffed inside the bass drum. A sheet can be mounted against the batter or front head with a hole about 12 inches in diameter cut from the center. The bigger the hole, the less the tone is muffled. Cutting a hole in the front head about six inches in diameter produces the effect of having one head with a little added resonance.

3-28. The bass drum pedal is attached to the rim at the bottom of the batter head rim hoop. Several varieties of pedals and beaters are available. Beaters made of wood are most appropriate for loud rock playing. Beaters made of hard felt are good for general purpose playing. Beaters made from soft lamb's wool are best for soft playing.

3-29. Two techniques for using the bass drum pedal are the heel down technique and the heel up technique. See figure 3-2 for a depiction of the two techniques.

- With the heel down technique the foot never leaves the pedal. The ankle acts as a pivot while the pedal is depressed. This technique provides a natural rebound producing the most resonant tone.
- With the heel up technique only the toe is used to depress the pedal. This technique provides a slower rebound but a more forceful attack, producing a staccato and louder tone.

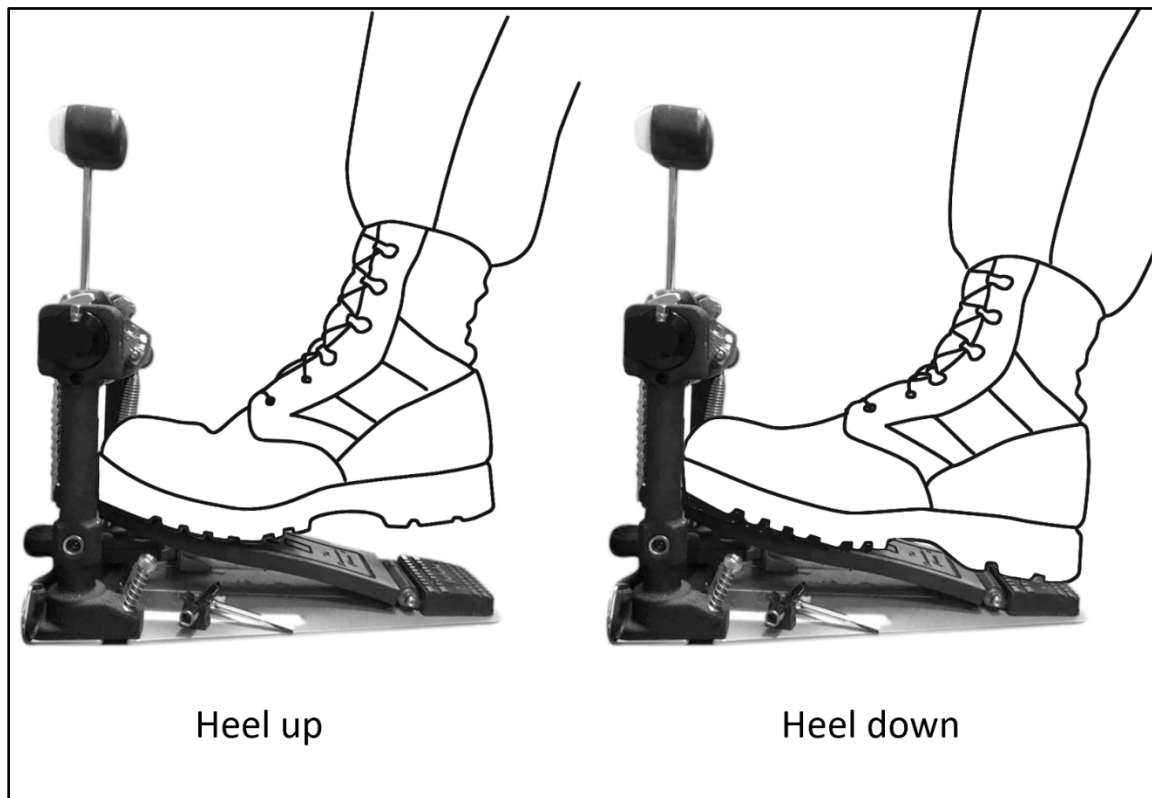

Figure 3-2. Bass Drum Pedal Technique

3-30. The bass drum should have shell-mounted spurs to prevent slippage. If slippage persists, placing a rug or mat under the drum set will usually eliminate the problem.

SNARE DRUM

3-31. Snare drum technique is identical to concert snare for tuning and muffling. Be extremely aware of sympathetic snare vibration. Release the snares when not playing, especially in soft musical textures. Snares may also be off for ballads (played with brushes) or some Latin styles where the snare sound would be out of context.

TOM-TOMS

3-32. Tom-Tom sizes range from 4 to 16 inches in diameter. It is very common to see three or more tom-toms mounted on the bass drum or floor stands.

- Melodic tom-toms are single headed tom-toms that can be tuned to definite pitches. They should be tuned from high to low between the pitches tuned on snare drum and bass drum.
- Roto-toms are capable of changing pitches with a rotary tuning mechanism. They produce more definite pitches but lack resonance because they have no shells.

3-33. Tom-Toms are indefinite pitched instruments. The objective is to tune the drum to a full, resonant, projecting tone. The method is the same as any membranophone. The pitch is relative to the size of the drum. Smaller drums should have a higher range of pitches.

3-34. The response of the head is also an important consideration. Response depends, in part, on the degree of head rebound. If it is tuned too low, the head will respond very slowly producing a flat, muddy tone. A well-tuned head has a lively resonant response.

3-35. When tuning a tom-tom with a top and bottom head, tune the top head first to the approximate pitch, then tune the bottom head to adjust and fine-tune the pitch. For maximum resonance, tune both heads to the same pitch. For a funkier sound, detune the bottom head slightly.

3-36. If muffling is required on tom-toms, several options are open to the drummer. Commercially available “O-rings” dampen the higher overtones, while emphasizing the fundamental pitch of the drum. Clamp-on tone controls attach to the rim of the drum, and are adjustable for tension and degree of dampening. Other options include cloth strips between the drumhead and the drum bearing edge, duct tape (with or without felt), or pieces of moleskin or mole foam attached to either the batter or resonant side of the drum.

Cymbals

3-37. The following paragraphs describe the three most common types of drum set cymbals: ride cymbals, crash cymbals, and hi-hat cymbals.

Ride Cymbals

3-38. The common sizes of ride cymbals are 18 to 22 inches. Striking midway between the bell and the edge produces the best ride cymbal tone.

- The flat ride is a cymbal with no bell. It produces a high-pitched “ping” sound. This cymbal is most useful in small ensembles and for recording.
- The sizzle ride cymbal has rivets that resonate to produce a sustained sound. Another way to achieve the sizzle effect is by attaching a string of small metal beads to a regular ride cymbal where the bell attaches to the cymbal stand.

Crash Cymbals

3-39. The common sizes of crash cymbals are 16 to 20 inches. When selecting a crash cymbal, you should test for response by striking it. It should respond quickly with a brilliant sound. The fast crash cymbal has a very rapid decay.

- The splash cymbal is a small cymbal only measuring 7 to 11 inches in diameter. Use it for short choke effects.
- The china type cymbal has flanged edges and produces a very dissonant sound with clashing overtones.
- The swish cymbal is a china type cymbal with rivets.

Hi-Hat Cymbals

3-40. The common sizes of hi-hat cymbals are 13 to 15 inches. Hi-Hat cymbals come in pairs with the bottom cymbal usually heavier. They are mounted on a hi-hat stand operated with your foot (see figure 3-3). They should produce a short, definite, chick sound. The pedal height should be adjustable and the stand should have an adjustable tilting screw for the bottom cymbal. The top cymbal is held in place by a clutch mechanism. Do not over tighten the clutch because it will choke the sound of the top cymbal. Tilting the bottom cymbal slightly will decrease the chances of a thin “chick” sound caused by an air pocket between the cymbals.

3-41. The hi-hat can be played using the toe with the foot never leaving the pedal; the toe and heel in a rocking motion; or the toe and leg moving up and down. Each of these techniques produces a different quality of sound from the hi-hat cymbals. Using sticks on the hi-hat while opening and closing the cymbals with the foot produces many different sounds. This technique is usually notated as open (o) and closed (+).



Figure 3-3. Hi-Hat Cymbals

DRUM SET: PERFORMANCE

3-42. The following paragraphs provide guidance on reading parts for drum set.

MANUSCRIPT/PUBLISHER CONVENTIONS

3-43. Usually the drum set parts are written somewhat within the convention of other percussion parts, with the snare on the 3rd space, bass drum on the 1st space, and other drums/cymbals keyed on the part. The parts are written using either bass clef or percussion clef. The Percussive Arts Society has published a Guide to Standardized Drum set Notation by Norman Weinberg; a book that standardizes drum set notation. The Percussive Arts Society Standardized Drumset Notation is shown in figure 3-4.

Notation Key
Percussive Arts Society Standardized Drumset Notation

crash	hi-hat	closed hi-hat	ride bell	tom 2	cross stick	kick 1	hi-hat foot	cow bell	rim shot	let ring
cymbal choke	open hi-hat	ride	tom 1	snare	floor	kick 2	foot splash	buzz roll	ghost note	

Figure 3-4. Drum Set Manuscript Conventions

READING DRUM PARTS

3-44. Two common types of drum parts are verbatim parts, and style sheets.

Verbatim Parts

3-45. Drum parts, patterns or “tutti” passages can be written to be performed different ways. Sometimes the notation is a guide to illustrate the composer/arranger’s intent, and sometimes it is to be played verbatim (as written). The OIC/NCOIC of the ensemble is the deciding authority in most cases.

Style Sheets

3-46. Most drum set parts are written as style sheets, outlining the style of the music and illustrating kicks and/or fills where appropriate (see figure 3-5). Several of the more common styles are described and illustrated in Appendix C. These examples are only samples of the many styles used.

The image displays a musical score for a drum set, titled "SWING". It consists of eight staves of music. The first staff is labeled "DRUM SET" and "C" (common time). It begins with a series of slashes representing a steady beat, followed by a "FILL" section with a half note and a quarter note. The second staff continues the slashes with some eighth notes. The third staff is labeled "SOLO FILL" and shows a series of slashes. The fourth staff shows a mix of slashes and notes. The fifth staff is labeled "SOLO FILL" and shows a series of slashes. The sixth staff is labeled "FILL" and shows a series of slashes. The seventh staff shows a mix of slashes and notes. The eighth staff is labeled "FILL" and shows a series of slashes.

Figure 3-5. Drum Set Style Sheets

Chapter 4

Keyboard Percussion

KEYBOARD PERCUSSION: PHYSICAL COMPOSITION AND CONSTRUCTION

4-1. Except for the chimes, all keyboard percussion instruments have the same vibrating characteristics. Over the resonators is the best striking area. This area provides the most resonant tone. Always use the center except when technical passages require you to play on the edge of the bar. The edge of the bar produces a resonant tone, but projection is restricted. You must decide if the distance the mallets must travel to reach the center of the bar is practical in the tempo and with your technique. Avoid striking the node of the bar at all times as this area of the bar produces a severe loss of resonance.

4-2. Resonators are hollow tubes lined up beneath the center of the bars to reinforce the intensity of the tone. The resonator tubes are closed at one end to provide an acoustic air spring that vibrates with the sound waves produced by the bar. The effective length of the tubes corresponds to the length of the sound waves of its assigned note. This is not necessarily the visible length of the resonator tube (see the front of the marimba or vibraphone as in figure 4-1).



Figure 4-1. Keyboard Percussion

KEYBOARD PERCUSSION: BAR STROKE BASICS

4-3. This section provides guidance on the striking point on keyboard percussion, and the striking motion.

STRIKING POINT ON THE BARS

4-4. There are two schools of thought on the correct point to strike the bars of mallet instruments. These relate to all instruments except chimes, which has its own specific striking point. The preferred point, and the only point you can use on orchestra bells and vibraphone, is the center or just slightly off-center of the bar. This provides the most consistent sound and the greatest vibration of the bar (see figure 4-2).

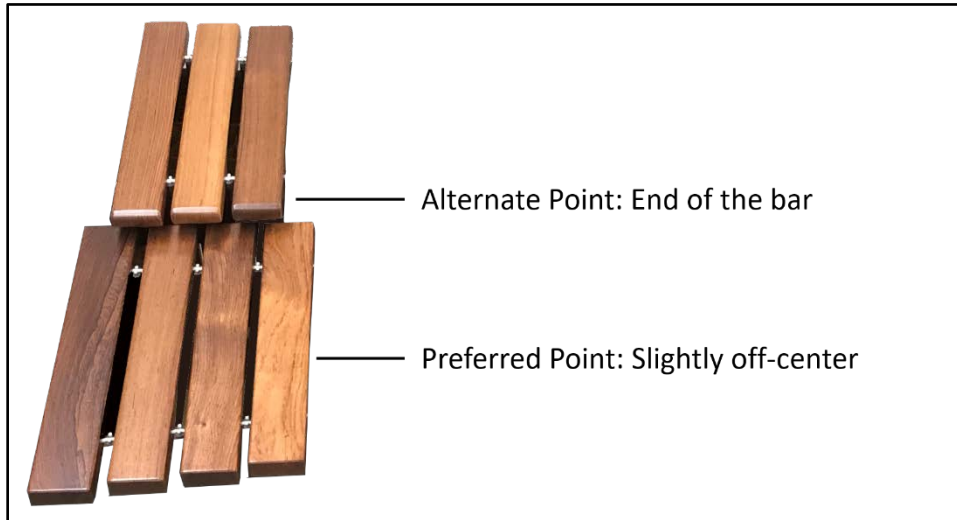

Figure 4-2. Keyboard Percussion Striking Points

4-5. The alternate striking point is at the end of the bar. This works well for marimba and xylophone when executing fast passages and using more than two mallets. While some use this striking point for all “black” keys, others will avoid using it unless absolutely necessary. Either is correct, as you will be forced to use the edge at some time in your career.

STRIKING MOTION

4-6. In keeping with the general rules of stroke technique, it follows that the most effective stroke is a direct up-down stroke. However, this is not always the case on mallet instruments. When executing fast passages, and generally in four-mallet playing, the closest distance between two bars is a short ellipse, not a straight line and most certainly not a large arc, which would give us the closest approximation to up-down stroke technique. This makes the stroke more of a glancing blow at times, yet the nature of the mallet and the bar do not really show this to be a disadvantage. When the mallet strikes a glancing blow, the excess energy (that energy not transferred to the bar) is used to propel the mallet onward in the same direction. This can be advantageous in fast passages, where the horizontal (side to side) speed of the mallets is impeded by up-down motion. Bear in mind that this only works well in fast passages, and that if there is a problem with projection or tone, the dynamic level may need to be shaded slightly upward to compensate (see figure 4-3).

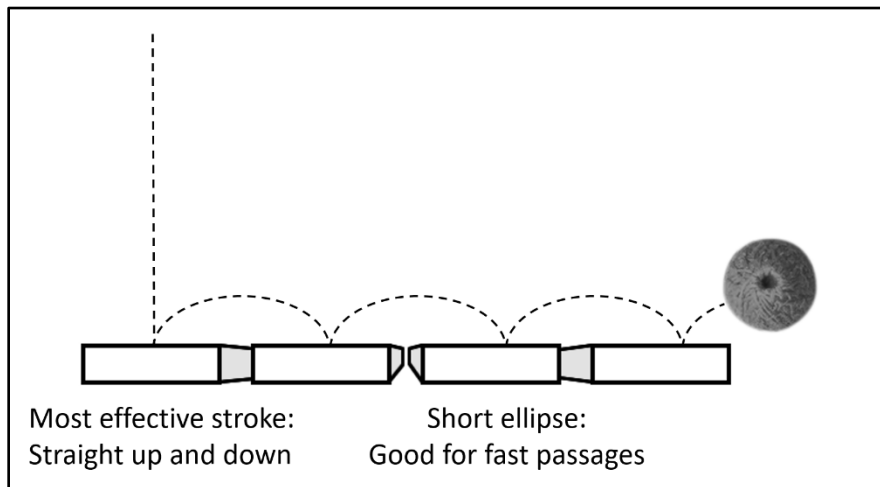

Figure 4-3. Keyboard Percussion Striking Motion

KEYBOARD PERCUSSION: ROLLS

4-7. On marimba and xylophone, rolling is the only way to play sustained notes. Rolls on marimba and xylophone are rapid single strokes that must be played evenly and smoothly. The roll is played on one note or between two notes. When using four mallets, four notes can be rolled at one time. Rolls are notated with a tremolo sign or by written 32nd notes. Rolls may be notated for vibraphone and orchestra bells for special effects.

KEYBOARD PERCUSSION: STICKING AND GRIP

4-8. Sticking is a constant problem on keyboard percussion. Traditionally, single note passages are stucked alternately hand to hand for an even sound. This is the best sticking method, but problems often arise that require double sticking or striking two or three notes with the same mallet for a more consistent flow or speed. Whenever possible, avoid double sticking great interval leaps. Use the sticking method best suited to fluid execution of the passage.

4-9. The general rules for attack and rebound apply to keyboard percussion (see para. 1-13–1-14). Mallet percussion instruments have little natural rebound, but, in most cases, the existing rebound coupled with the flex of the mallet handle will provide sufficient tone and response. As much as is practical, keep the mallet shafts parallel to the playing surface, and keep the mallets relatively close to the bars to minimize excess motion. This will also help you to sense the position of the bars more accurately.

4-10. Use the matched grip for two mallets on any keyboard percussion instrument. There are three major categories of four-mallet grips in common use: traditional, Burton, and Musser. It is recommended that you use whichever method is most comfortable for you.

4-11. Traditional: The shafts of the mallets are crossed in the palm of the hand with the outside mallet shaft under the inside. The grip operates on a spring-tension principle with fingers 3 and 4 supplying the interval closing energy, and the thumb and finger 1 supplying the interval opening energy (see figure 4-4, taken from 'A Comparative Analysis of the Musser Grip, Stevens Grip, Cross Grip, and Burton Grip' by Adam Berkowitz. See Source Notes for more information).

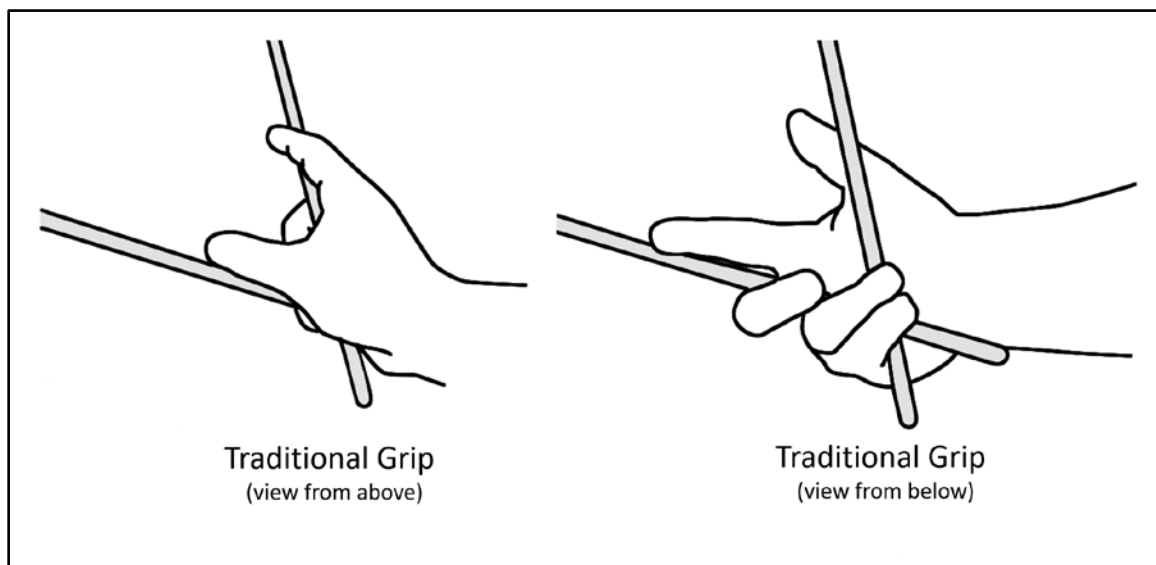

Figure 4-4. Keyboard Percussion Traditional Grip

4-12. Burton: The shafts of the mallets are crossed in the palm of the hand with the outside mallet shaft on top of the inside. The grip operates on an axle-type pivot principle with fingers 3 and 4 supplying most of the interval opening and closing energy by pushing and pulling on the shaft of the inner mallet (see figure 4-5, taken from 'A Comparative Analysis of the Musser Grip, Stevens Grip, Cross Grip, and Burton Grip' by Adam Berkowitz. See Source Notes for more information).

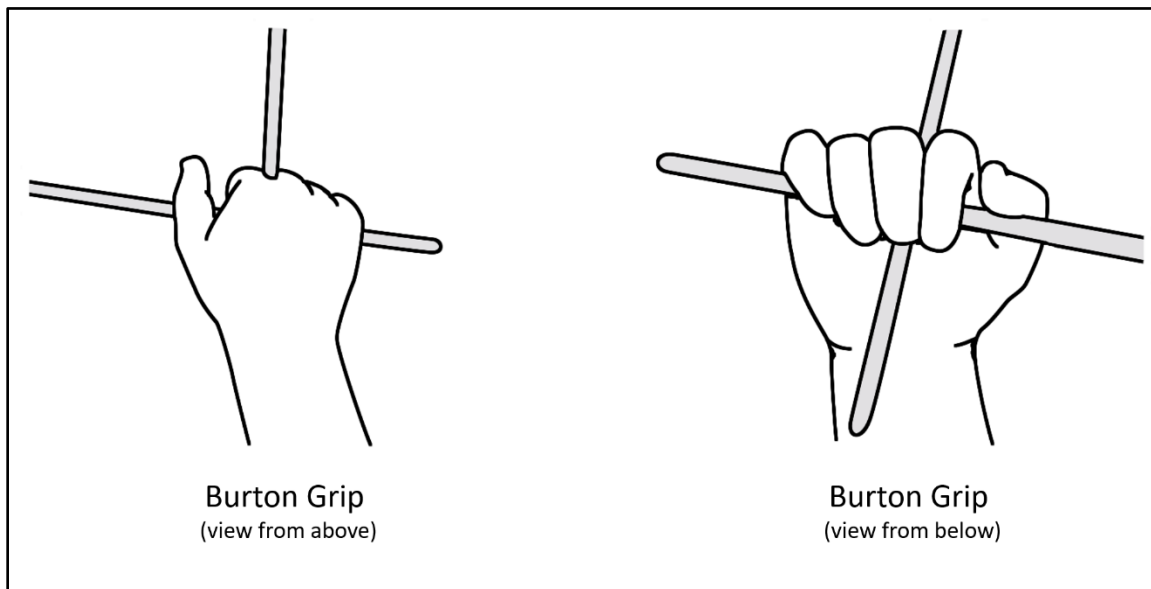

Figure 4-5. Keyboard Percussion Burton Grip

4-13. Musser: The shafts of the mallets are held in different sections of the hand with the inside mallet being controlled by the thumb and fingers 1 and 2, and the outside mallet being controlled by fingers 3 and 4. The grip operates on a horizontal pendulum principle with the interval opening and closing energy being supplied in a number of different ways (see figure 4-6, taken from 'A Comparative Analysis of the Musser Grip, Stevens Grip, Cross Grip, and Burton Grip' by Adam Berkowitz. See Source Notes for more information).

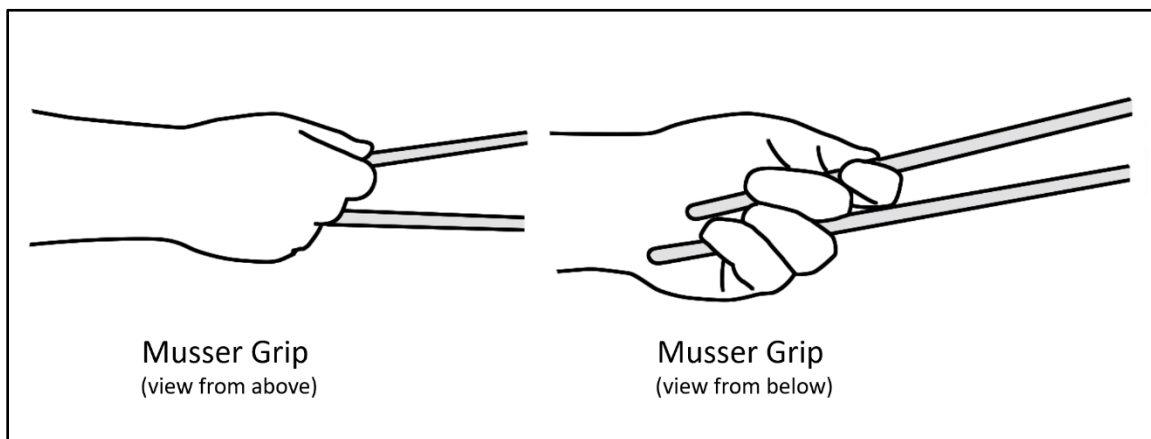

Figure 4-6. Keyboard Percussion Musser Grip

4-14. A variant on the Musser grip, also called the Stevens grip, allows for better close interval playing, better independence, and more power. It is the recommended grip for four-mallet marimba playing. For more information about this grip refer to Method of Movement for Marimba by Leigh Howard Stevens (see Recommended Reading in References).

4-15. When using four mallets, each hand opens and closes according to the notes you must play. You may require slight sideways arm movements to accommodate mallet positioning. Use the most comfortable position to play intervals. When using two mallets as in a melody line, the mallets you use will be determined by the grip you use. For traditional and Burton grip, use the inside mallet of the left hand and the outside mallet of the right hand. For the Stevens grip, use the inside mallets. Whether you are using two or four mallets, you must strive to develop independence among them.

KEYBOARD PERCUSSION: INSTRUMENT CHARACTERISTICS

4-16. This section will describe the most common keyboard percussion instruments found in Army bands, the: marimba, xylophone, vibraphone,

MARIMBA

4-17. The bars of the marimba are made from rosewood or a synthetic material called Kelon® or Acoustilon®. On professional models, the bars are graduated in size; the lower the note, the wider the bar. The sharps or flats are on the upper row of the keyboard raised above the lower keyboard to facilitate playing. Marimbas have resonators, but no damper pedal because all tones decay rapidly (see figure 4-7).



Figure 4-7. Marimba

Marimba: General Playing Notes

4-18. The marimba is the standard mallet instrument for classical solo work. Its use as a solo instrument has grown significantly in the latter part of the 20th century, as more composers wrote for the instrument. Its use in orchestras is somewhat limited, but its use in contemporary wind ensemble/band literature is increasing as more composers discover its distinct tone color. This expansion of available literature is aided by the increasing virtuosity of the world-class players such as— Leigh Howard Stevens, Gordon Stout, Keiko Abe, Robert Van Sice, and Evelyn Glennie.

4-19. Most players subscribe to a personalized variation on the Leigh Stevens techniques for four-mallet independence on marimba. These are covered extensively in his *Method of Movement for Marimba*, and percussion majors will be exposed to the basics of his techniques. When playing marimba, strive for a balanced tone throughout the instrument and think melodically. Even when playing harmony parts or accompaniments, you can approach the instrument in several ways. One approach is to think as a piano player would, implying the melody through touch and dynamic nuance. Another approach is more contrapuntal in nature, thinking of each mallet (when playing four-mallet parts) as a separate instrument, much like a wind instrument, with its own tonal characteristics (depending on the median range of that part).

Marimba: Mallet Selection

4-20. Yarn-covered mallets are most often used on marimba, but there are exceptions. For a more articulate attack sound, soft rubber mallets may be used. Cord-covered mallets (which are more suitable for vibraphone) may be used, but usually the harder versions sound harsh and brittle when used on marimba.

Yarn Mallets:

4-21. Hard yarn mallets are good for solo work because they produce very harsh, piercing attacks in the lower octave and crisp attacks in the upper octave.

4-22. Medium yarn mallets are also good for solo work and are recommended for best overall tone production.

4-23. Soft yarn mallets are excellent for background work. They produce an organ-like tone quality in the lower octaves, but the upper octaves sound almost muffled.

4-24. Extra soft yarn mallets are used only in the lower octaves for a pizzicato string bass effect or a mellow organ effect.

Soft rubber mallets:

4-25. Soft rubber mallets produce the same attack sound as medium yarn mallets, but provide a mellower tone.

4-26. Medium rubber mallets provide a xylophone effect on marimba and are good for sharp attacks, staccato passages, and solo work.

Do not use hard rubber mallets, plastic mallets, or metal mallets on marimba because they can damage the marimbas' thin bars.

4-27. There are several makes of yarn mallets that claim to sound consistent throughout the range of the instrument. These mallets have a rubber core, a layer of felt (as is used in timpani mallets), and a yarn wrapping. The felt allows the lower register to sound warm and full, while the rubber core (usually medium to hard rubber) gives body and edge to the upper register, despite the wrapping. These mallets require practice to achieve the full-range potential, and they are somewhat expensive. For players that do extensive marimba solo work, these are invaluable.

4-28. When purchasing marimba mallets, assume that you will be doing 4-mallet work. This allows for expansion if you do not currently perform with four mallets, and you can spread the wear if you only use 2 at a time. Purchase either 4-mallet sets or 2 pairs. When buying pairs, check the handles for similar thickness and flex.

4-29. The handle choices are up to you, but there are three types currently in use, birch, rattan, and fiberglass.

- Birch handles are preferred by soloists,
- Rattan handles are used commonly throughout the spectrum of players
- Fiberglass handles are less expensive.

4-30. The issues of thickness and flex occur with rattan and fiberglass handles; birch handles have almost no flex.

XYLOPHONE

4-31. The bars of the xylophone are made from rosewood, Kelon® or Acoustilon®. The upper row of the keyboard is raised above the lower keyboard to facilitate rapid stroke techniques. The bars are the same width throughout the range. Xylophones usually have resonators, but can be used without them due to the piercing tone quality of the instrument (see figure 4-8).



Figure 4-8. Xylophone

Xylophone: General Playing Notes

4-32. The xylophone is one of the oldest mallet instruments in the modern orchestra. Its characteristic high, brittle sound makes it usable as a solo voice, as an added color with other instruments such as flutes or clarinets in concert band, or to accentuate rhythmic accompaniment passages. In many cases, the xylophone is used to double woodwind lines in concert band works to add additional tone colors to the line. This makes the xylophone a technically demanding instrument.

4-33. Most of the performance problems on xylophone stem from the bar width (usually the same, not graduated like the marimba or vibraphone), the bar size (narrower than marimba or vibraphone due to the range of the instrument), and the demands of the intricate passages written for the instrument. As in the striking motion notes above, the xylophone follows the same rules with one slight variation. The “glancing blow” approach affects tone less on the xylophone, and, due to the relative speed of the passages, the average player will use more end of the bar approach on the “black” keys.

Xylophone: Mallet Selection

4-34. The basic rules of mallet choice apply to xylophone. To produce the tone characteristic of the xylophone, use hard rubber or plastic mallets. For greater depth of tone, hard rubber works better on rosewood bars. Hard plastic mallets on Kelon® will project better, but may sound thin. Yarn mallets may be used on the lower register to substitute for marimba, if no marimba is available. Softer rubber mallets produce thin, hollow, muted tones that do not project well. Do not use metal mallets, as they will damage the instrument.

4-35. In the last 15 years, more and more contemporary composers are writing 4-mallet parts for xylophone, so purchasing sets of 4 for xylophone is a good idea. If buying pairs, check for evenness of tone as well as evenness of handle thickness and flex, because this is more obvious on xylophone (especially one with Kelon® bars).

VIBRAPHONE

4-36. Vibraphone bars are made from anodized aluminum. The material produces a tone much longer in duration than wooden bars. The bars are generally graduated in width; wider for the low notes and narrower for the high notes. The keyboard is flat because of a damping mechanism that requires all the bars to be at the same level as the felt damping bar. The damping bar is attached to a pedal operated by the foot. The

damping pedal is operated in a similar manner as the damper pedal on a piano, but the pedal must be depressed before the attack for the note to sustain (see figure 4-9).



Figure 4-9. Vibraphone

4-37. The vibraphone name comes from the vibrato effect produced by rotating paddles at the top of the resonators. The paddles are turned by an electric motor that (on most professional models) has a variable speed switch to achieve the desired tremolo speed. Make sure the paddles are in the open position when not using the tremolo effect to make full use of the resonators. The tone is noticeably softer when they are closed.

Vibraphone: General Playing Notes

4-38. The vibraphone was originally used as a jazz and popular music instrument, but it has found some uses in contemporary orchestral and wind ensemble music. The popularity of players such as Milt Jackson, Red Norvo, Lionel Hampton, and most recently Gary Burton and Mike Manieri has done much to elevate the vibraphone to the status of solo instrument.

4-39. Specific performance problems on the vibraphone relate to pedaling and dampening. Pedaling on the vibraphone is much like a piano, but, with the smaller range and vibrato (when the motor is turned on), the pedal is used less than the piano.

4-40. Three methods of damping are available to you; pedal damping, hand damping, and mallet damping. The three methods can be used in combination with each other.

Vibraphone: Pedal Dampening.

4-41. Pedal damping is similar to the piano damper pedal. The notes are muffled according to their duration and phrase markings.

Vibraphone: Hand Dampening.

4-42. Hand damping is using your fingers, hands, or a combination of both.

Vibraphone: Mallet Dampening.

4-43. Mallet damping is accomplished by pressing the mallets against the bars. This method allows desired notes to ring while muffling others. This method is also effective in creating a legato or slurred effect. Muffle one bar with the mallet at the moment of attacking the next note. You must depress the pedal for this muffling method. Using mallet dampening allows the vibraphone to be more expressive with the sustained notes,

playing ties and slurs with almost wind-instrument accuracy. *Vibraphone Technique*, by David Friedman is an excellent book on the subject (see Recommended Readings in References). These techniques must be mastered by the serious vibraphone player.

Vibraphone: Mallet selection

4-44. A wide variety of mallets are available for the vibraphone.

4-45. Yarn or cord mallets are used almost exclusively on vibes. For general playing, varying degrees of hardness in yarn-covered mallets will suffice

- Soft yarn mallets provide soft effects when you desire more tone. They are used mostly for background accompaniments.
- Medium yarn mallets are good for general purpose playing.
- Hard yarn mallets are used for solo passages where less tone and more precise articulation is required.

4-46. Several sets of cord-covered mallets may be necessary for solo playing

4-47. Rubber mallets are generally used for practice purposes or for special effects. Soft to medium rubber mallets may also be used for additional attack and sharper tone.

4-48. As with marimba, if you are buying mallets specifically for vibe playing, buy sets of 4, or 2 pairs.

ORCHESTRA BELLS AND BELL LYRE

4-49. The bars are made from chrome plated, tempered steel (orchestra bells), or aluminum (marching bells or bell lyre). The keyboard layout can be raised or flat depending on the manufacturer. Bells do not need resonators because of their natural resonance. Pedals are not available because hand or finger muffling is adequate. There are hand damper mechanisms available on some orchestra bell models. The bars of the bells are mounted in a flat wooden frame and are secured by padded screws or tacks. Bell lyre bars are mounted on a light metal frame suspended vertically from the player's waist by a sling (see figure 4-10).



Figure 4-10. Orchestra Bells

Orchestra Bells and Bell Lyre: General Playing Notes

4-50. Bells, or glockenspiel, are the sopranino voice of the percussion section. They are the oldest mallet percussion instrument in the orchestra (adapted from the celeste) and are used as solo voices and to give color to sustained passages (usually with woodwinds).

4-51. Like the xylophone, the bells are somewhat difficult due to the bar spacing and size, and to the fact that playing on the end of the “black” keys produces unacceptable tone. This forces you to play in the center of the bar or, in fact, slightly off center. Due to the small size of the bars, the center becomes a secondary nodal point (see figure 4-11).

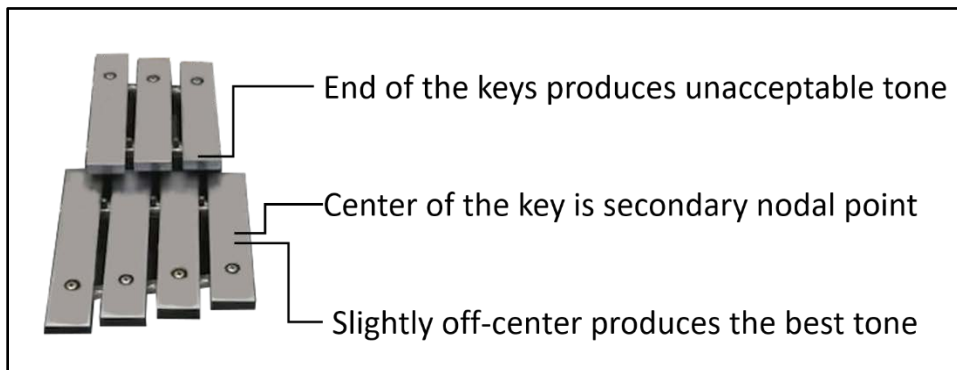

Figure 4-11. Orchestra Bells and Bell Lyre Striking Area

Orchestra Bells and Bell Lyre: Mallet Selection

4-52. Brass mallets are excellent for loud, solo passages or most parts that require metallic, penetrating, colorful bell tones. Do not use this mallet on aluminum bars, as damage to the softer metal will occur. Plastic or hard rubber mallets are excellent as general use mallets. They provide the best overall tone production with less attack sound; more tone without the metallic, piercing sound. Medium rubber mallets are the softest mallets recommended for use on bells. They produce a celesta-type sound. This sound, however, is easily buried in heavy musical textures. Handle selection is a personal choice, but rattan is preferred (the flex will assist the rebound of the mallet).

CHIMES

4-53. Chimes are large pipe-like metal tubes suspended in a vertical rack (see figure 4-12). The tubes are made of brass, generally with a striking cap at the top of the tube. They are tuned to definite pitches. The chimes with the largest diameter tubes will provide the greatest projection through large ensembles. The longer the tube, the lower the pitch. The tubes are set up in piano keyboard order. The pedal works on the same principle as the piano or vibraphone pedal (depress the pedal to sustain pitches). European chimes may have a pedal mechanism that works in reverse (the pedal is depressed to dampen the note, not sustain it).



Figure 4-12. Chimes

Chimes: General Playing Notes

4-54. Chimes are an orchestral adaptation of carillon bells, and are referred to in Europe as tubular bells. Because of the complex overtone series in a chime tube, you must really listen for balance when playing the part. Chimes tend to stand out a bit in soft passages, and get buried in loud passages. Adjust your dynamic to the band and the performance situation (e.g., if a microphone is not used, there is a bit of headroom for volume when playing outside).

Chimes: Stroke Technique

4-55. The side of the cap of each tube is the only playing area. The other parts of the tube can be used for special effects but you must be careful not to damage the tubes.

4-56. The general rules of stroke technique apply to chimes (see para. 1-12–1-15). The angle of attack is very important for proper tone production. You must strike the tube on the side of the cap, straight in, at a 90-degree angle to the tube (see figure 4-13). Striking at any other angle produces tones full of predominant unwanted overtones, especially the sixth above the fundamental. The chimes will sound far out of tune.

4-57. Striking the tube straight in with a good rebound requires the mallet handle to be parallel to the tube. Play the row of sharps and flats with the mallet held horizontally to the side while still making the stroke straight in on the playing cap (see figure 4-13).

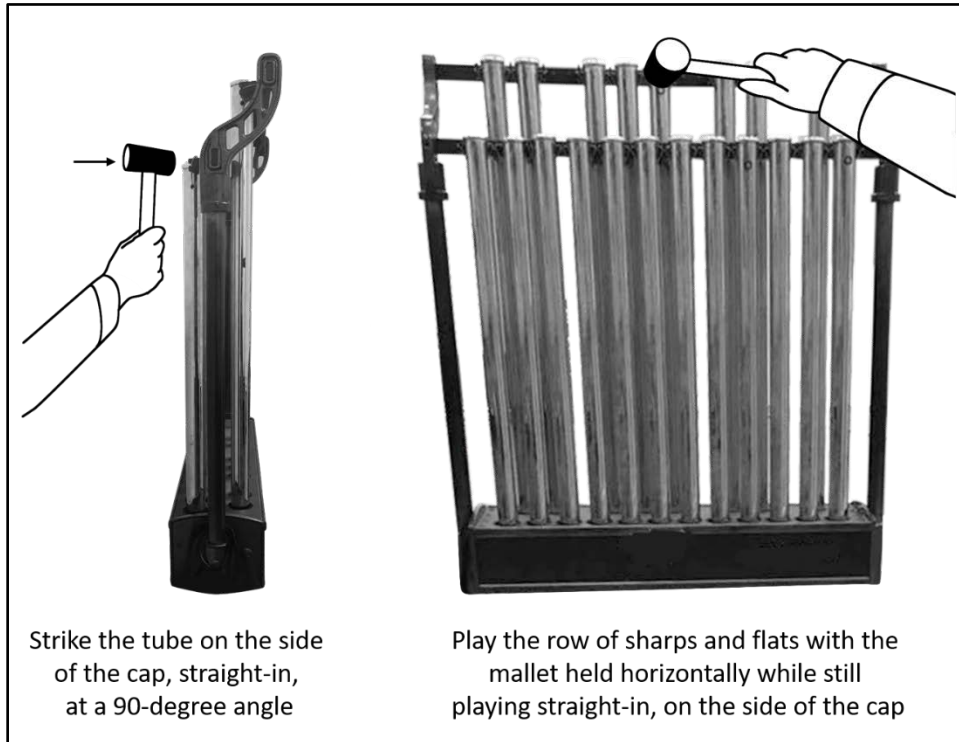

Figure 4-13. Chimes Striking technique

4-58. Chimes are muffled with a pedal or with your hands. The hands are generally used to muffle one note while another rings. The pedal must be in the off position, and the tube is muffled by grabbing its top with the non-striking hand.

Chimes: Mallet Selection

4-59. Use only rawhide hammers or other commercially available hammers specifically designed for chimes on the instrument. Anything else may damage the cap. You must have two mallets available for rapid passages. The mallets must be heavy enough to produce a proper tone from the tube. For softer attacks and more mellow tone quality, one end of the mallet should be covered with layers of soft material such as moleskin.

Chapter 5

Bass Drum

BASS DRUM: PHYSICAL COMPOSITION AND CONSTRUCTION

5-1. The bass drum is classified as a double headed membranophone. It is a large wooden or metal cylindrical shell enclosed by membranes (heads), which are tensioned by a series of lugs on each side. The bass drum must be double-tensioned so each head can be adjusted individually. Concert and marching bass drums currently in use by professional organizations are made of wood (commonly maple, birch, or beech). Multiple plies of these and other types of wood may be used for the shell material. Metal shell bass drums for concert or marching use are extremely rare and are very impractical.

BASS DRUM: ACOUSTICAL CHARACTERISTICS

5-2. The concert bass drum provides the basic rhythmic foundation for the concert band. It adds color to concert music by stressing accents, controlling dynamics, and providing rhythmic drive. Concert bass drums are available in sizes ranging from 16 x 32 inches to 18 x 40 inches. Smaller drums will not produce the resonant depth required for orchestral works and larger drums are difficult to control rhythmically.

5-3. Calfskin heads are generally preferred on the concert bass drum. Although they are more expensive, harder to find, and harder to maintain, they produce a better tone quality for concert band. Plastic heads can be used, but they produce a tone with undesirable high overtones.

5-4. The marching bass drum provides a sharp, crisp, distinct, and precise cadence. It emphasizes strong beats of the music, making it easy for the band and the troop units to march in step. The bass drummer must be able to set and hold tempos. Marching bass drums are available in sizes from 14 x 20 inches to 16 x 32 inches. These sizes allow for easier handling on the march.

5-5. Plastic heads are generally preferred on the marching bass drums. They last longer, require little maintenance, and are not affected by weather changes.

5-6. The goal of tuning the bass drum is to reach the most resonant and lowest possible indefinite pitch. The first step is to tune both the playing and non-playing heads to a low, resonant tone. Both heads must be tightened just enough to prevent a sloppy rattling sound. Make sure the tension is the same on each lug by lightly tapping the head three to four inches from each lug screw. A muffling agent (towel, T-shirt, or cloth) placed in the center will help cut down the overtones and make it easier to hear the fundamental pitch. Using a hard mallet to test these pitches will also help cut down on extraneous overtones.

5-7. Heads must be tuned to a different pitch to prevent any definite pitch from forming between them. By tuning one head lower than the other by a major or minor second, the dissonance of the overtones between the two heads should disguise any definite pitch. The resulting tone should be a low, resonant, indefinite pitched tone that will make the bass drum tone the lowest sound in the band.

BASS DRUM: NOTATION

5-8. The bass drum part is written as the lowest part on the staff, because it is the lowest sound in the band. Traditional notation is used throughout the part with no special symbols unless absolutely necessary. Whenever a special effect cannot be notated traditionally, the effect must be indicated by annotating it above the staff.

5-9. The old method of notating bass drum parts, especially in marches, used the values of the notes to indicate dynamic shading. The dynamic markings were the same, but to indicate an accent the composer would write a note of longer duration (see figure 5-1).

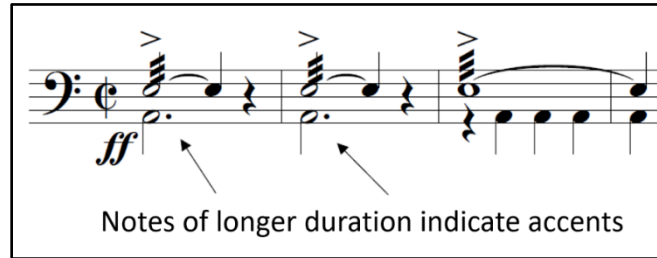

Figure 5-1. Bass Drum Notation

BASS DRUM: STRIKING AREA

5-10. Striking the bass drum in the center or at the node provides a sharp, dead attack with many low overtones sounding. This is used for staccato passages, short and crisp effects, and precise attacks needed for the marching bass drummer to keep everyone in step.

5-11. Striking the drum slightly off center or at the apex provides the most tone, little attack, and a good combination of high and low overtones. When playing on calfskin heads, avoid the spine area of the head (a slightly thicker area of the head that usually bisects the head diameter). The off-center spot, usually one or two mallet-head widths from dead center, is the best all-around playing area for concert band purposes. It is used for legato effects where long note durations are desired.

5-12. Striking the drum near the rim or at the anti-node provides a thin, soft, ringing effect with high overtones predominating. It is excellent for soft passages with long note durations. It is also the best place to perform a roll because the attacks are covered up producing a smooth roll with little effort (see figure 5-2).

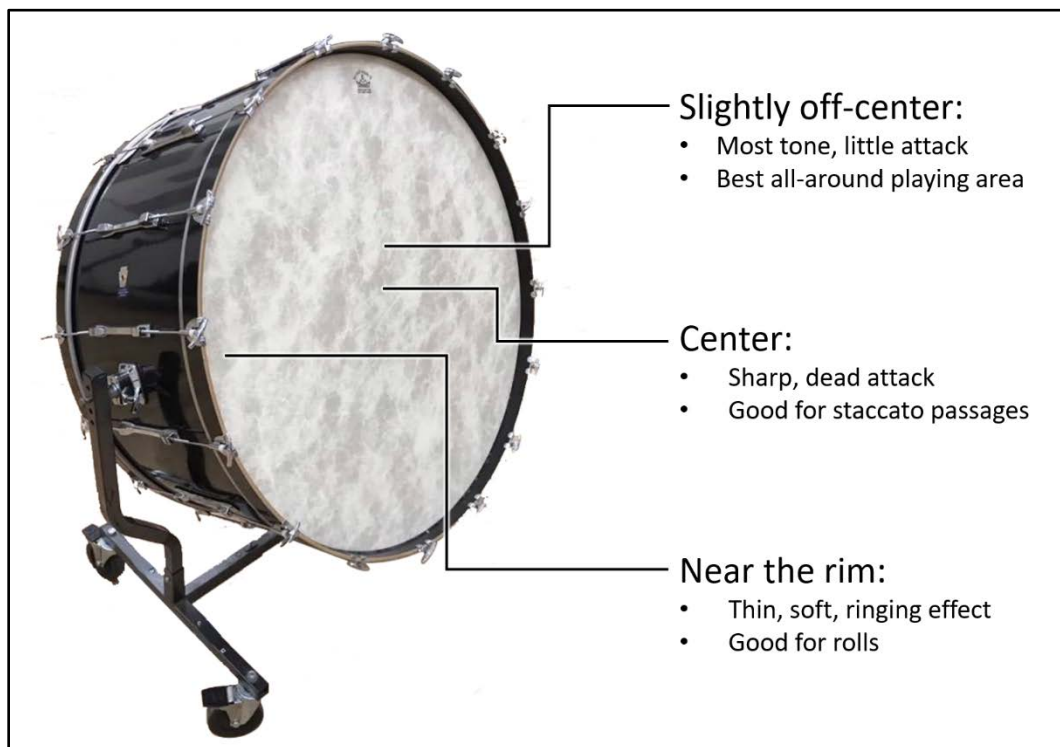

Figure 5-2. Bass Drum Striking Area

5-13. Composers looking for exotic sound effects have written parts to be played on the shell of the drum, the rim, and even the bass drum stand. Whatever area is called for, always use common sense and good musical taste when performing your part.

BASS DRUM: STRIKING IMPLEMENTS

5-14. There are a variety of striking implements available for your use, see Table 5-1.

Table 5-1. Bass Drum Striking Implements

<i>Mallet Type</i>	<i>Type of Attack</i>	<i>Uses</i>
Hard felt mallet	Hard attack	This may be used in concert band for staccato or fast rhythmic passages where little tone is required. These mallets are not good for rolling because the attacks are too harsh and noticeable.
Soft lamb's wool mallets or soft felt mallets	Soft attack	Generally used for concert band. This is an excellent mallet for slow, legato, lyrical passages.
Double-ended lamb's wool mallets	Soft attack	For playing soft and short rolls.
Wooden mallet	Hard attack	Sometimes used with traditional rope drums.

5-15. For louder or extended rolls, using two bass drum mallets specifically designed for rolls is best.

NOTE: Avoid using timpani mallets on a bass drum with calfskin heads.

Do not use wooden mallets on plastic heads; they will dent the heads.

5-16. Composers write a great variety of effects that require a wide assortment of implements or mallets. Many effects can be created with a little imagination, but your main concern must be good musical taste while preventing damage to the instrument.

BASS DRUM: GRIP AND STROKE TECHNIQUE

5-17. The only type of stroke used on the bass drum is the single stroke. Rolls on bass drum are of the single stroke variety only. They are played near the rim of the bass drum for the best sounding, smoothest tone production. As the roll moves toward the center of the drum, the attacks become more noticeable and sharper, making a good, even roll difficult to accomplish.

5-18. There are a variety of angles of strokes used on the bass drum. Direct in/out is the most useful overall stroke. The mallet travels in a straight line perpendicular to the batter head. This is the most natural and efficient stroke producing the fullest, deepest tone. Tempos and dynamics are easily controlled even at extreme speeds or high sound levels.

5-19. The matched grip is the preferred grip when playing rolls on the bass drum. When playing a roll, tilt the bass drum to make playing the roll easier. The bass drum should be equipped with a swivel stand. If the stand does not swivel, rolls should be played with the traditional grip.

5-20. Due to the size of the membranes on the bass drum, a fast roll will not allow the membrane to vibrate freely. Interference with the natural vibrations causes the lower overtones to be buried and the tonal depth of the roll to become shallow. The attacks of each stroke in the roll will sound uneven and uncontrolled because the membrane is vibrating erratically.

5-21. To roll in phase you must roll with the vibrations of the membrane. Listen for an even sound while rolling and let the mallets rebound naturally. The attacks of the stroke should blend together to produce a continuous non-pulsating roll.

BASS DRUM: MUFFLING

5-22. Muffling is another area where you, as the percussionist, must excel. The note must be given its full duration and this can prove difficult. Most muffling is done on the batter (playing) side only, using a sweeping motion similar to that used on timpani. With the non-playing hand, sweep from the edge of the drum (near the rim) to a point nearer the center of the drum to stop the sound after an attack. If the drum must be silenced completely, use the playing hand on the batter side and your non-playing hand on the resonant side to stop the sound.

5-23. Several degrees of mechanical damping are also available to you. If the part requires a drier sound, you may use your non-playing hand (resting on the batter head), external damping devices (clamp-on muffler or a small towel) or use your knee and leg to reduce the resonance of the drum. When using any external tone control (including your knee), be aware that the perceived pitch of the drum will go up, as any external tone control essentially reduces the functional diameter of the drum.

5-24. A common problem arises when playing a rapid passage with a soft mallet and there is not time to change to a harder mallet. Muffling the non-playing side while striking the notes will make the notes sound shorter and rhythmically distant.

5-25. Muffling on bass drum must be done with some discretion. If you over muffle, the drum sounds much like a large cardboard box. If you under muffle, the drum can sound like a large tin can. Calfskin heads need much less muffling on or after attacks, and only light muffling to stop sound at the end of the piece. For bass drums with plastic heads, follow the guidance in paragraph 5-26.

5-26. For the proper degree of muffling, the drum must speak the note value written, and then stopped. There are two types of muffling: decrease resonance and stop sound.

DECREASE RESONANCE

5-27. To decrease resonance (get rid of the excessive high frequencies), use your hand or a towel on the top 1/8 of the head on the batter side. This will deepen the overall sound much like an O-ring on a tom-tom, but it will not sound boxy.

5-28. If more muffling is desired, use a towel and move toward the center (but no more than halfway) to increase the effect.

STOP SOUND

5-29. To stop the sound entirely, use the non-playing hand to move from the rim toward the center of the head, keeping as much contact with the head as possible. Do not press on the head, as this may change the pitch. In a concert hall environment, the resonant side (the non-playing side) may ring for a second at the end of the piece, as this ring should blend in with the natural resonance and sustain of the hall. Muffle the nonplaying head at breaks in the music, but not too soon or too quickly, as this will change the pitch or perceived quality of the note and may draw unwanted attention to the percussion section (see figure 5-3).

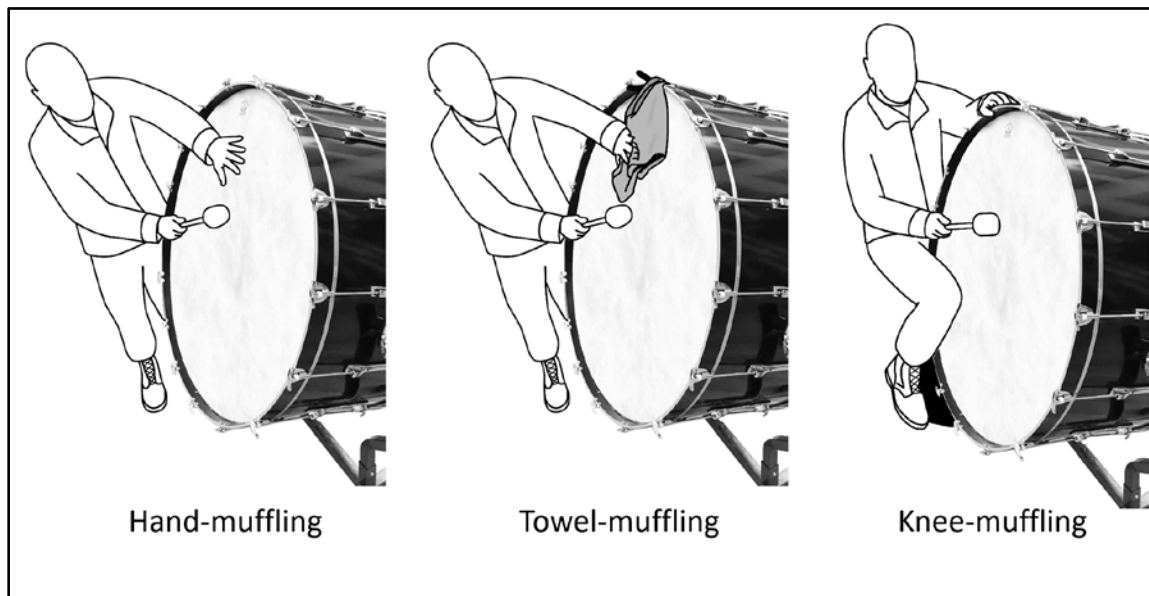

Figure 5-3. Bass Drum Muffling

BASS DRUM: NOTES ON MARCHING BAND PERFORMANCE

5-30. The following sections contain guidance for basic patterns in marches, and providing musical space in marches.

BASIC PATTERNS IN MARCHES

5-31. Bass drummers are commonly used to support the movement of troops, but they are also used in other ceremonial music and parades. The following section gives guidance in these areas.

Moving Troops

5-32. The primary function of a military band (regardless of service) is to provide troop support. Bands do this by providing music for ceremonies, parades, and other military functions. Whenever troops are moving (marching), the bass drum player provides a “heavy left” attack, and will rarely play on beat 2 (the right foot).

5-33. When the march calls for an accent on beat two, the accent is played followed by an equally heavy accent on beat one. If there are breaks or rests in the music, the bass drum continues to play as if the rest does not exist. This keeps the troops in step, because the platoon sergeants or platoon leaders are listening mainly for the bass drum to help keep them in step. The bass drummer is, in effect, “calling cadence” for the entire formation. Proper stroke technique and control will help the bass drummer provide a strong, loud, steady beat that carries through the entire formation (see figure 5-4).

Accent on beat two is followed by heavy accent on beat one

Continue to play through rests

Figure 5-4. Bass Drum Moving Troops

Other Ceremonial Music

5-34. The bass drummer may play the written parts in any music not used for troop movement. In fact, the bass drum part may play an important role in the projection of dynamics for the band. In this instance, the bass drum part should be balanced with, and support, the tuba or bass part. Accents should not be as out of context as they might be when moving troops.

Parades

5-35. Parades are usually more enjoyable for the percussion section, since they get to show off during the cadences and play more musically when the full band is playing. On a parade, the percussion section should resist the temptation to play loudly throughout. Unless one has great stamina, this is very difficult to sustain for several miles of stop and go performance. Use the marches to rest and support the band, while using the cadences to showcase the section.

PROVIDING MUSICAL SPACE IN MARCHES

5-36. The bass drum is useful in providing breathing room for the phrasing of the band. Most bass drummers will not play on every beat even if it is written that way. If they do play on every beat, the part is interpreted as supporting the sound of the tuba/low brass section, not as a timekeeper. Think of playing on every beat much as a drum set player would “feather” the bass drum for older styles of swing: the part is audible, but not present.

5-37. To clearly define the spacing of the bass drum part, one must first listen to the harmonic rhythm (frequency of chord changes) of the march and attempt to outline that rhythm with the bass drum. This gives greater freedom to play accents and prep cymbal crashes. Usually the harmonic rhythm increases closer to the cadence points or ends of phrases, so the part may need to be a bit busier there. If the march will also be used on the field to move troops, a “heavy left” interpretation will sometimes give most of the space implied in the harmony.

BASS DRUM: NOTES ON CONCERT BAND PERFORMANCE

5-38. This section contains specific information pertaining to concert band bass drum performance.

STRIKING AREAS AND TONE PRODUCTION

5-39. The desired striking areas on the concert bass drum are in part dependent on the desired tone. Most general playing will be done approximately one third of the way from the center of the drum. This gives the most resonant tone, while allowing for some degree of articulation. For staccato passages, play in the center of the head. Sometimes a harder mallet will give the impact desired. For rolls, play near the rim, but not too close. The sound thins out if the roll is played too close to the rim.

SPECIAL EFFECTS

5-40. Rattan handles are used sometimes in percussion ensembles for a thin slap sound. When called for, you may use the handles on marimba mallets. Most composers will give detailed performance direction if this is a desired effect.

5-41. Thumb rolls are sometimes used in chamber music settings for a pianississimo (*ppp*) lion’s roar effect. Use the thumb or the finger, depending on head response and the player’s thumb roll technique, to play the roll throughout the diameter of the head.

Chapter 6

Cymbals

HAND CYMBALS

6-1. The following paragraphs give guidance on the physical composition and construction, notation, grip, stroke technique, and muffling techniques for hand cymbals.

PHYSICAL COMPOSITION AND CONSTRUCTION

6-2. Hand cymbals are idiophones that are struck against each other to produce sound. Cymbals range in size from 15 to 22 inches and vary in thickness from paper-thin to extra thick. The diameter and thickness of the cymbal is chosen according to the situation you use it in and what the music calls for. To provide a greater spectrum of overtones, pick two cymbals of the same size that have a slightly different highness or lowness of tone between them.

6-3. Large and thick cymbals produce higher fundamental pitches due to the abundance of higher partials produced by the thicker metal. These cymbals will sustain longer and may be played louder without the danger of overplaying or distortion. Large thick cymbals however make rhythmic precision difficult. Smaller and thinner cymbals produce lower fundamental pitches, yet have shorter sustain, faster decay, and distort or wash out faster (thereby limiting dynamic range). Cymbal choices depend on the musical taste of the player and commander. You must experiment and choose according to the musical requirements.

6-4. Leather straps are the only devices that should be used for holding hand held cymbals. Wooden handles are the least desirable devices for holding cymbals because they can damage the cymbals. The steel rod holding the handle to the cymbal will wear an oval shape into the bell of the cymbal.

6-5. Knuckle pads protect your knuckles when you are playing hand cymbals, but they also sacrifice tonal quality. Avoid using cymbal pads on hand cymbals for concert band unless absolutely necessary. They are a must in marching band because of the constant pressure exerted on your knuckles. The best knuckle pad, the one that sacrifices the least amount of tone, is a small stiff leather pad. The large, soft lamb's wool type muffles some of the overtones.

NOTATION

6-6. Cymbal parts use traditional notation. When playing a march, cymbals read the same part as the bass drum on all parts where the dynamic level is mezzo-forte (*mf*) or above unless specifically notated otherwise. In older marches, as with bass drum, the note duration implies dynamic shading (see figure 6-1).



Figure 6-1. Cymbal Notation

GRIP

6-7. A good grip is essential to controlling hand cymbals. The leather strap is gripped between the thumb and forefinger, with the other fingers wrapped around the strap. Your forefinger must be next to the bell of the cymbal with no space between the cymbal and the finger. Point the thumb straight in, making contact with the bell. Pressure exerted by the thumb and forefinger may help you in controlling large cymbals. However, increased contact with the cymbal will dampen high overtones and distort the tone (see figure 6-2).

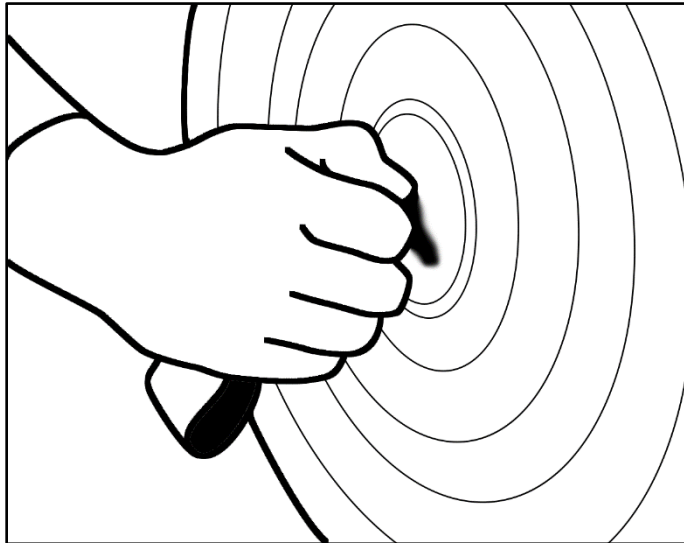

Figure 6-2. Cymbal Grip

STROKE TECHNIQUE

6-8. Control of the stroke is necessary to produce proper tone quality on hand cymbals. Sloppy technique leads to failure in producing clean, brilliant cymbal crashes. It also can lead to creating an air pocket or air lock. This happens when you bring the cymbals together flat with all the edges meeting simultaneously. This causes an undesirable momentary vacuum to form between the two cymbals, deadening the tone.

6-9. Use the following cymbal crash procedure for all hand cymbal strokes. Hold the cymbals, using the proper grip, with the top edges of both cymbals at eye level. This allows you to see the cymbal stroke while watching the conductor. Ensure your stance is solid, balancing your weight evenly to absorb any jolts from the force of the crash.

6-10. The cymbal in your non-dominant hand should be perpendicular to the floor. For control of technical passages, the cymbal can tilt slightly toward the non-dominant side. The cymbal in your dominant hand should tilt slightly toward the other cymbal. The angle depends on the intensity of the stroke. A loud tone requires a wider angle while a softer tone requires a smaller angle. If the angle is too large, the resulting sound will have two distinct attacks similar to a very open flam. If the angle is too small, the crash will sound flat.

6-11. Position one cymbal slightly lower than the other. The actual distance depends on the size of the cymbals, but a distance of one-half to one inch will usually suffice. The attack should be a direct or straight-in attack. This allows you to judge and control the speed of the attack.

6-12. The actual impact will be similar to a flam, because the constant angle of the cymbals throughout the attack causes the top edge to touch first, instantaneously followed by the bottom edge. If done properly, the flam effect will occur so quickly it will sound like one attack.

6-13. Always allow the cymbals to rebound by themselves. The top edge rebounds first, followed by the bottom edge in a clean, continuous motion. Pushing the cymbals outward will help you develop a feel for the rebound. The follow-through is very important if the cymbal crash has a let ring or L.V. (Italian: lasciare

vibrare) direction indicated. To achieve the best sound projection after the attack, face the flat bottoms of the plates toward the audience above all obstructions (see figure 6-3).

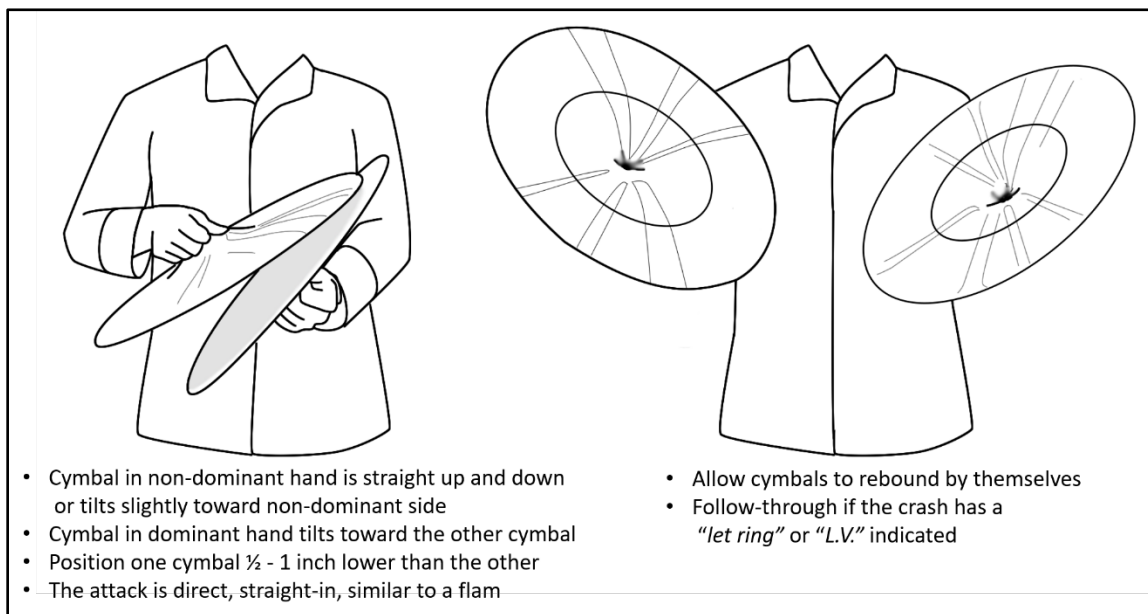

Figure 6-3. Cymbal Crash

6-14. Playing the cymbals for an extended period of time requires strength and endurance. The tutti technique provides a method of resting while playing. Using a proper grip, hold one cymbal at an angle with your elbow resting on the side of your torso. This cymbal is stationary, supported by the knuckles of the hand. It may be held at any angle, from 45 degrees to parallel, to the floor. The other cymbal does all the playing using the same stroke as described before.

6-15. When you tire, switch the role of each cymbal, but do it smoothly or at a resting place in the music. Switching from side to side will help to extend your endurance. This technique is especially useful for dynamic markings of *f* and below. It is also effective in rapid, rhythmic passages that must be played accurately and distinctly.

MUFFLING

6-16. When muffling the cymbals, always give the note its full value. When composers fail to notate parts according to the length of sounds desired, muffling is left to your discretion. Listen to the rest of the band and judge note lengths according to the piece the band is playing. When playing marches, the tutti cymbal parts (playing with the bass drum) should only be dampened at the ends of phrases or when the band attack is staccato.

6-17. Muffle the cymbals quickly and easily by drawing them into your body and squeezing them with your forearms to your side (see figure 6-4). For larger, isolated crashes, use the armpit area. For softer notes or more rapid passages, anywhere on the upper torso is acceptable as long as there is control of the sound. When muffling the cymbals, avoid contact with any items on the uniform (name tag, badges, and buttons).

SUSPENDED CYMBALS

6-18. The following paragraphs give guidance on the physical composition and construction, playing areas, striking implements, grip, and muffling techniques for suspended cymbals.

PHYSICAL COMPOSITION AND CONSTRUCTION

6-19. Suspended cymbals are primarily used in concert band and jazz ensemble/combo. All drum set cymbals, with the exception of high-hat cymbals, are technically suspended cymbals regardless of function. They have a wide spectrum of effects to heighten the overall musical expression of the band. The common suspended cymbal sizes range from 8 to 24 inches in diameter and from paper thin to extra heavy in thickness.

PLAYING AREAS

6-20. To achieve the different sounds required by various pieces of music, you must use different playing areas on the cymbal. The general rule is the closer to the edge that you strike the cymbal, lower partials predominate and rhythmic clarity is reduced.

6-21. Striking the cymbal in the bell area gives a high, pinging sound. There is a lack of resonance and the high overtones predominate. This area provides the sharpest rhythmic definition, but sounds like a bell. Striking the cymbal in the ride area provides the best combination of high and low overtones. It is the best area for rhythmic definition while still achieving a characteristic cymbal sound. Striking the edge of the cymbal provides a predominance of low overtones and the greatest resonance. It is the best area for sustained, legato notes and rolls (see figure 6-4).

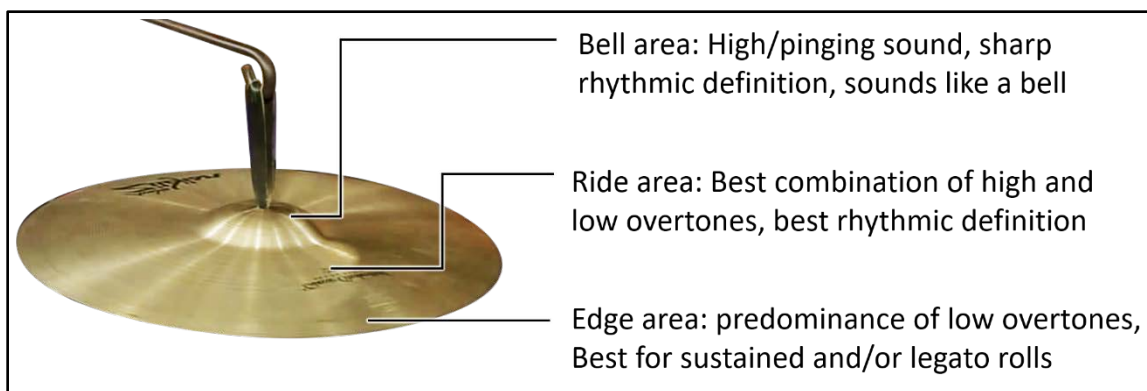

Figure 6-4. Suspended Cymbal Playing Area

STRIKING IMPLEMENTS

6-22. Soft yarn mallets provide a soft, spreading, gong-like tone quality with low overtones predominating. They are generally used for mellow effects with soft attacks and for rolls. This is the most commonly used mallet for suspended cymbal. Medium and hard yarn mallets are also used extensively on suspended cymbals. The harder mallets provide more attack, higher overtones, and less tone duration. When timpani mallets are called for, yarn mallets are usually substituted. This avoids excessive wear on the felt coverings of timpani mallets.

6-23. Rubber mallets come in three general hardness grades: hard, medium, and soft. All the rules of yarn mallets apply to rubber mallets. Do not use very hard rubber, plastic, or bell mallets on cymbals, as this will damage the tonal grooves, ruining the tone of the cymbal.

6-24. Snare drum sticks provide a faster response and a more rhythmically distinct attack than yarn mallets. They are generally used for crashes that require a sharp attack with little tone, as in fast, short staccato passages. The higher overtones predominate when using drumsticks.

6-25. With a little experimenting, many interesting and imaginative sounds can be produced on suspended cymbals. Your prime concern should be musical taste while preventing damage to the cymbal. Brushes produce a light, airy effect only heard in soft passages. For louder passages, you can use a specially made heavy, stiff wire brush. Bass violin bows produce a screeching effect when the cymbal edge is bowed like a violin. Triangle beaters, coat hangers, bass guitar strings, coins, and chains all produce a variety of scraping or sizzling effects when drawn against the grain of the rings. Be careful not to damage the tone rings.

GRIP

6-26. The matched grip is generally used on suspended cymbals. Except for special effects, the single stroke is used for playing everything including rolls. Play the roll with single strokes near the edge of the cymbal to acquire a smooth, even unarticulated sound. Position the mallets opposite each other on the diameter of the cymbal to keep the cymbal flat while playing rolls. Otherwise the cymbal will move uncontrollably, producing an uneven sound. Priming a roll is not necessary unless the cymbal is slow to respond because of its size or thickness. The same principles of rolling on the bass drum apply to rolling on suspended cymbals. Roll with the vibrations by listening for an even, smooth, continuous tone (see figure 6-5).

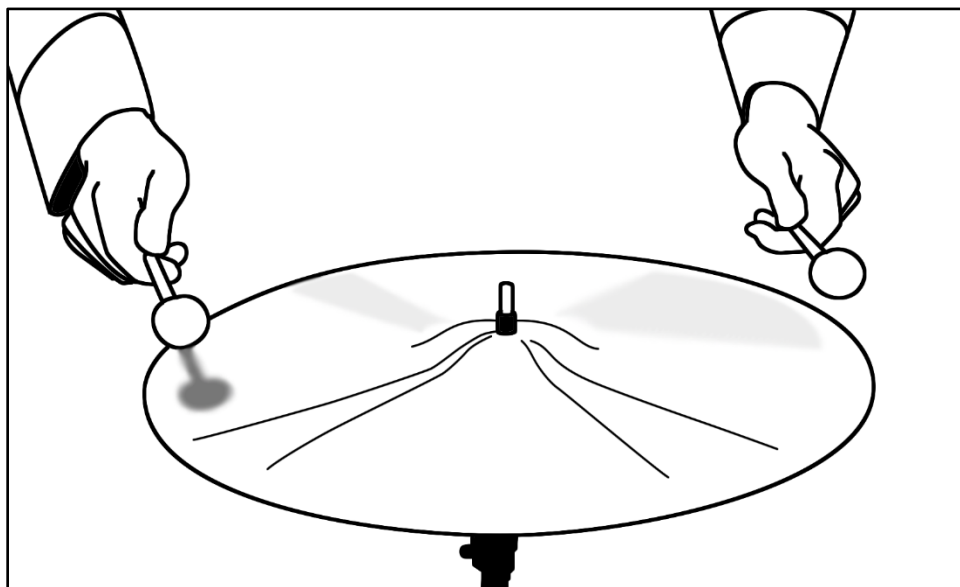

Figure 6-5. Suspended Cymbal Roll

MUFFLING

6-27. Muffling is generally achieved by playing with one hand and grabbing the cymbal with the other to stop the tone. When notes are not in quick succession, use both hands to muffle. To make a passage more articulate, you can use one hand to partially muffle the tones while the other hand is playing. If the passage is rapid with notes in quick succession, lean into the cymbal with your body. You must carefully regulate the pressure exerted by your body to ensure the proper amount of muffling.

CYMBALS: FUNCTION AND SELECTION

6-28. 6-1. The following paragraphs give guidance on the function and selection of crash cymbals and suspended cymbals, and guidance on special effects for cymbals.

CRASH CYMBALS

6-29. Crash cymbals can be used in several ways to support other scoring in a concert band or marching environment. The cymbals are powerful when used correctly, and instantly recognized when used incorrectly. When in doubt, listen to the ensemble. Attack and cut with the group you are supporting. In relation to the ensemble, a late cymbal crash is just as poor as an early one, and usually sticks out just as badly. It helps if you breathe with the group, and silently vocalize the articulation or rhythm to align the attacks.

6-30. There are three ways to play crash cymbals in a march: tutti with the bass drum (sometimes marked BD/CYM), as a separate written part, or played as a modified “heavy left” interpretation while watching the director for accent crashes.

6-31. Tutti parts work well for *mf* and louder march sections that need more driving time and not too much accent. When playing along with the bass drum, watch the director for accents as well, and come back in on the measure following the accent. Tutti playing is usually light and designed to give an edge to the sound of the bass drum.

6-32. Separately written cymbal parts are only found in marches written (or edited) during the last half of the 20th century to the present. A majority of older march music will not have cymbal parts written, except for cued solos (see “tutti parts” in previous paragraph).

6-33. The idea of the modified “heavy left” cymbal part is a variation on the tutti part that gives a bit of space to the cymbal sound and allows more reaction time for cued accents. Using this approach allows the part to sound more open, and less like just keeping time.

6-34. A common practice is to omit the cymbals when the band is playing mezzo-piano (*mp*) or softer (e.g., the trio section in a march). This is at the discretion of the director, but it works well with less experienced players or smaller bands.

6-35. A real problem with crash cymbals is replacement or maintenance of the cymbal straps. Figure 6-6 will show how to tie the knots on the cymbal straps, if your cymbal has them. Follow the illustrations in order. Remember, do not put your hands into the straps unless absolutely necessary for the march. Otherwise, grip the strap as close to the cymbal as possible, and allow the cymbal to almost hang from your hand. If you have cymbal pads, only use them on the march. In a concert situation, they cut too much of the high overtones of the cymbal, making the cymbals sound like garbage can lids.

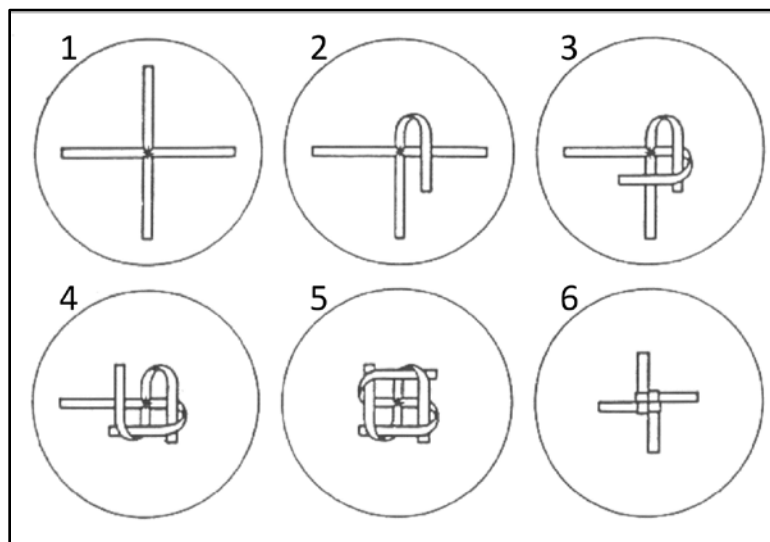

Figure 6-6. Tying the Cymbal Strap

SUSPENDED CYMBALS

6-36. The following gives guidance on choosing a suspended cymbal, and striking implements for suspended cymbals.

Choosing a Suspended Cymbal

6-37. The choice of a suspended cymbal must be done with care and consideration for the types of music that will be performed. Most medium or medium-heavy crash cymbals in the 17-20 inch range work well for most suspended cymbal duties. The real problem occurs when there are ride cymbal-type passages to consider. The obvious choice would be to use a ride cymbal, or play the part on drum set. If neither is possible (or practical, considering numbers of personnel), use a heavier than usual cymbal for suspended work.

6-38. When possible, avoid using one of a pair of crash cymbals for suspended cymbal duties unless the cymbal is properly mounted. This means that the cymbal still has its strap, and is suspended by the strap on a boom stand. The earliest uses of suspended cymbals were mounted in this way, or with a hook stand that used the strap as the attachment to the stand.

Striking Implements for Suspended Cymbal

6-39. The preferred mallet for suspended cymbal is a medium hardness yarn-covered mallet. This provides some degree of softness of attack, and gives some heft to the note. If you want a soft (pp) attack to sound beyond the front of the stage, use a slightly harder mallet than you would think normal. This gives some edge to the note, and allows you to play it closer to the edge of the cymbal.

6-40. Almost any striking implement will work on suspended cymbal when called for in the music. There are two very important exceptions, however: metal beaters and timpani mallets.

6-41. Metal beater: Use of metal on metal will stress the cymbal, may cause it to crack, and may damage the tone rings.

6-42. Timpani mallets: Use of timpani mallets will not damage the cymbal, but will damage the felt covering on the timpani mallets, and will wear them out prematurely.

SPECIAL EFFECTS

6-43. The most common special effects with cymbals are the forte-piano (*fp*) crash and the cymbal glissando. The *fp* crash is performed by crashing the cymbals normally at the level of *f* or above, and immediately muffling one cymbal. The result is a loud crash followed immediately by a softer sustain.

6-44. When performing the cymbal glissando with the crash cymbals, place the edge of one cymbal (usually the cymbal in your dominant hand) against the underside of the other cymbal. Scrape the cymbals together, moving the edge of the dominant hand cymbal toward the edge of the stationary cymbal. If you are using a suspended cymbal, use the metal handle of a retractable brush, as the metal is not heavy or hard enough to damage the lathing and tone rings on the cymbal. Place the handle tip on the cymbal near the bell, and scrape the cymbal, moving toward the edge.

6-45. A seldom-used effect today is the crash cymbal roll. Holding the crash cymbals normally, place them together as you would to crash them, but rotate the dominant hand cymbal against the stationary one. The resulting sound is loud, uneven, and raucous, but can be used in certain situations needing a loud, large, sustained roll.

This page intentionally left blank

Chapter 7

Timpani

TIMPANI: MATERIALS AND FUNCTION

7-1. Timpani are the largest tunable, definite pitch, membranophone. They have a versatile instrumental role that ranges from punctuating the tonic and dominant to functioning as a soloist. They are capable of dynamics softer or louder than any other instrument in the band. They are most effective when accentuating a dynamic climax.

7-2. Copper timpani are preferred for orchestral playing because they produce the most resonant tones. Fiberglass timpani are sometimes used in concert band. Bucket-shaped timpani are preferred for orchestral use because their acoustical characteristics create a more resonant tone. However, they are very expensive. Parabolic shaped timpani are more commonly used as they are machine made and much less expensive. Whatever bowl type is used, it should float on the rim and have no inside supports to interfere with tone production.

7-3. Timpani heads can be made from either plastic or calfskin. Plastic heads require less maintenance, are not affected by weather, last longer, and sound more consistent throughout the head than calfskin heads. Calfskin heads produce a warm, open sound, project well, and support the low brass section well. Some players prefer the tone of the calfskin heads and are willing to assume the added maintenance (tucking a collar, soaking, and extra tuning). Calfskin heads tend to be very uneven in texture, requiring you to select the head very carefully and search for the best playing areas on the head. They are significantly more expensive than plastic heads and the cost may be prohibitive for most bands. Calfskin heads should be detuned when not in use and kept damp in extremely dry conditions.

7-4. The use of plastic (Mylar) heads presents different considerations. Use slightly softer mallets when using plastic heads. This helps give the timpani a round, open, warm sound. Also, use the weight of the mallet to aid in articulation.

7-5. Timpani are available in sizes from 20 to 32 inches in diameter. The bigger the drum body, the lower the possible pitch. The pitch required determines the size of timpani to use. Normally at least two timpani, the 26-inch and 29-inch, are required. When a third timpani is added, a 23-inch drum is recommended to produce the higher tones that often occur in concert music. When a fourth timpani is added, a 32-inch timpani is recommended to produce the lower tones. If a fifth drum is required, it is usually a 20-inch timpani. Each timpani has a practical range of a perfect fifth (see figure 7-1).

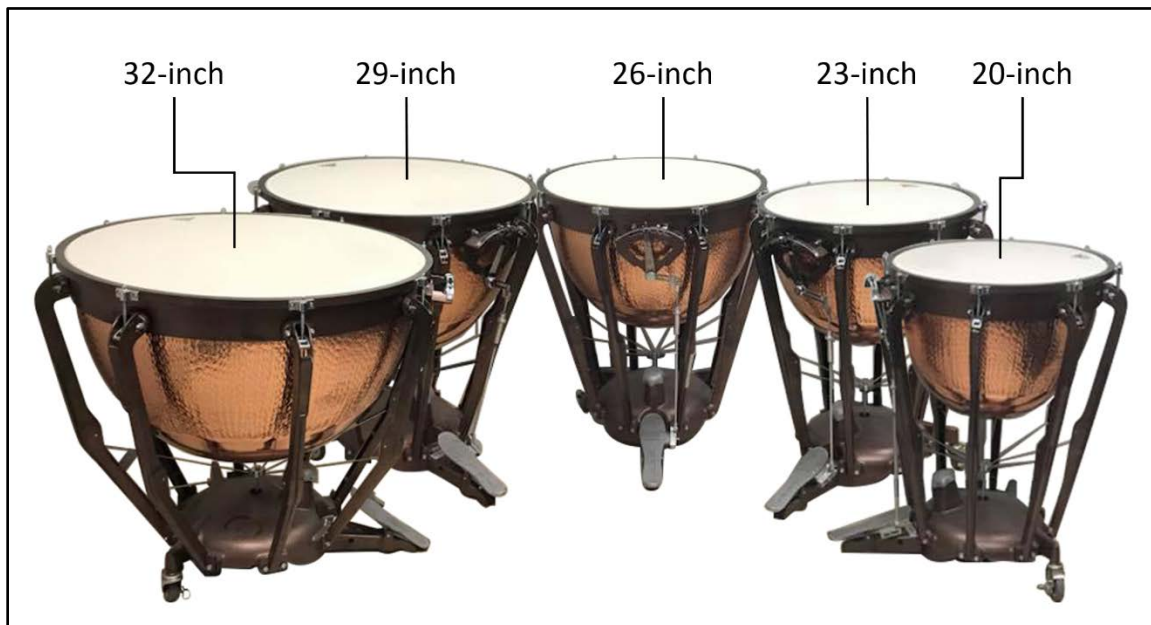

Figure 7-1. Timpani

TIMPANI: SETUP

7-6. When setting up, place the largest timpani on the left and smallest to the right. Although you may set up differently, this is most practical for easier sight-reading because the instruments are placed like a keyboard, from low to high. Arrange the timpani in a semi-circle to ensure all of the pedals are within easy reach of your feet. They should be close together, but not touching unless a muffling device is used to keep them from rattling against each other. The center of the timpani set-up must be in line with the music stand and the conductor.

7-7. Your playing position is very important. Some players prefer to stand, while others prefer to sit. This is really up to you, but here are some common areas of emphasis:

- Keep the drums you are playing in front of you. This sounds simple, but if you are playing a run over all of the drums, you will sound (and look) awkward if you cross your body to reach for the drums. Pivot at the waist while playing: you will look better, be more comfortable, and sound better, too.
- Tune quickly. Do not spend too much time bent over the drums (your ears will fatigue, and your back will also). Unless you have perfect pitch, tuning will require some work, but do not make it laborious.
- Do not “ride the pedals.” This is difficult when standing and not a good idea when sitting. If you ride the pedals (keep your feet on the pedal when not tuning), the chance of inadvertently changing the pitch (even slightly) increases. Only place your foot on the pedals when you are checking or changing a pitch.

TIMPANI: PLAYING AREAS

7-8. Generally, the playing area on the timpani is directly over the pedal of each drum, ranging from 2 to 4 inches from the rim. This is dependent on the size of the drum. The playing area on a larger drum will be further away from the rim. Playing near the rim produces a thin sound, and playing close to or in the center produces a dull sound with several overtones and minimal fundamental pitch (see figure 7-2).



Figure 7-2. Timpani Playing Area

7-9. Playing areas should be reachable by turning from the waist. Using a stool is recommended for easier tuning capability unless you are too short to reach the pedals. If you decide to sit, make sure you are close enough to reach the playing areas with your hands for muffling and to reach the pedals with your feet. If you decide to stand, use a comfortable, relaxed stance leaning slightly forward from the waist for better leverage. In either case, movement from drum to drum must be from the waist only.

7-10. The German grip is a matched grip using your wrists to produce the stroke, and is similar to the matched grip for snare drum. This grip makes it easier for beginning students to grasp the stroke production concepts. The French grip is a matched grip that uses finger control for stroke production and rolls, and should be used with caution, as the proper finger control is usually not mastered by beginning students. This grip is made by holding your hands with the thumbs up and allowing the fingers to control the stroke. The best grip to use depends on you. A complete examination of grips may require study with a qualified instructor.

TIMPANI: STROKE TECHNIQUE

7-11. The general rules for stroke technique apply to the timpani (see para. 1-12–1-15). The basic stroke has a down motion (the stroke) and an up motion (the rebound). This works easier on other drums because the rebound helps the player in setting up the proper stick height for the next stroke. On timpani however, it is more difficult since the relative lack of tension on the playing surface does not allow for maximum use of the energy generated by the stroke. This means that (especially on the larger drums) you might have to assist the rebound a bit. Some authors have implied that you “pull the sound out of the drum.” There is a fundamental concept difference here. The “rebound assist” concept implies that any stick action occurs after the stick has cleared the contact point of the head, and the “pull” concept requires you to actively produce the rebound action without any allowance for head and mallet physics. For our purposes, the rebound assist is the system we will use (see figure 7-3).

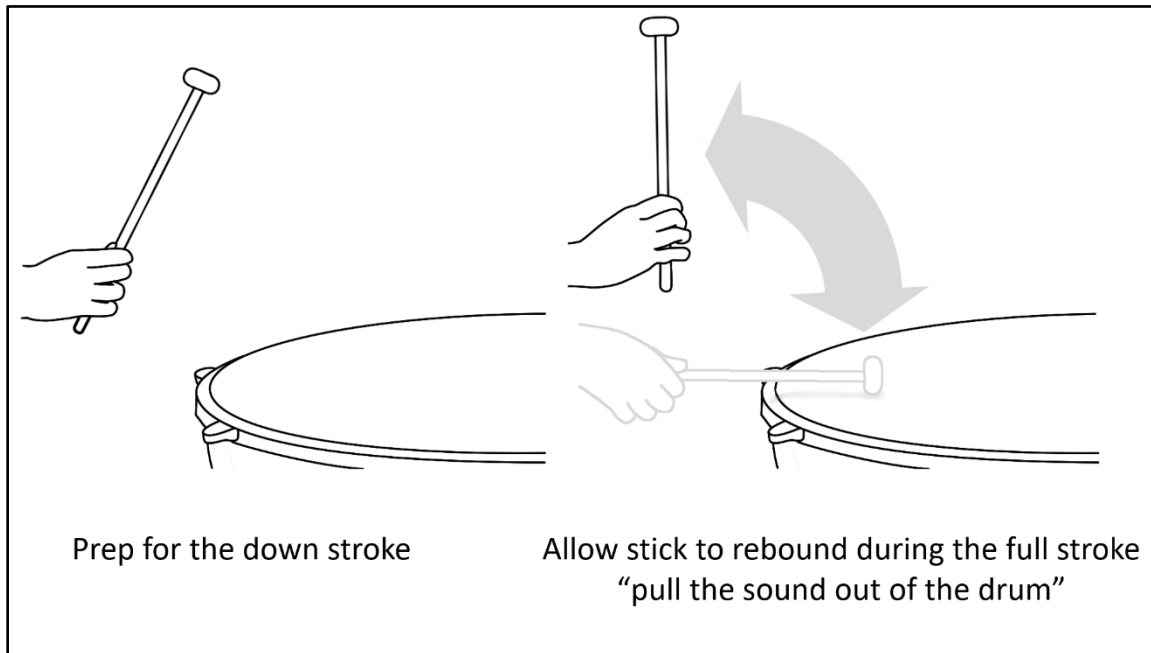

Figure 7-3. Timpani Stroke Technique

7-12. The rules described in paragraph 7-11 are especially important when applied to timpani. They will facilitate proper tone production of staccato and legato notes. Play a roll as rapidly alternated single strokes only. All rolls are single stroke. For a soft roll, use your fingers only. As the roll gets louder, add more finger pressure. Use your wrists for very loud rolls. The speed of the single stroke roll is critical to tone production of the timpani roll. The size and pitch of the head will determine the speed of the roll. The smaller the timpani and higher the pitch, the faster the roll speed. The larger the timpani and lower the pitch, the slower the roll. This actually gives you great flexibility when playing *fp* rolls or in a crescendo. For snare drummers, this means that the hand speed concepts in the buzz roll can apply to timpani. When playing soft rolls on any drum or louder rolls on larger drums, the roll speed should be a bit slower. This will help to avoid possible phase problems with the vibrations of the drum head. The roll speed increases as you either get louder or move to a smaller drum. This takes a bit of practice to get right.

7-13. Use the sticking method best suited for the musical passage and your technique. This usually requires alternating the sticks for most passages. The most obvious exception to this rule is if you are avoiding a crossover to get the notes. In this case, divide the timpani set in half (for example, the two largest drums are left hand and the two smallest are right hand), and use that hand only for the short time you need to so as not to crossover. This does not mean that you avoid crossing altogether.

TIMPANI: STRIKING IMPLEMENTS

7-14. The general rules for choice of striking implements apply to timpani (see para. 1-11). You should have at least three pairs of mallets available to you: hard mallets for staccato and rapid rhythmic passages, medium mallets for unarticulated tones or general purpose playing, and soft mallets for smooth legato and ringing tones. The articulation of the notes determines which mallets you will use.

7-15. Several types of mallets are available commercially, providing a wide range of possible effects. They range from wooden mallets that produce a very articulated staccato tone to extra soft mallets that provide a velvet-like tone with a softer attack. Special effects may require you to use other implements such as drumsticks, yarn mallets, or superball-type mallets. Use your musical discretion and common sense in providing these special effects making sure to prevent damage to the heads.

7-16. Use of soft mallets with a wood or other solid surface as the core of the mallet will provide enough weight to the playing surface to produce the desired sound, without forcing or tensing up the grip and/or the

player. As the mallet gets harder, there is more usable rebound for the mallet, providing more articulate tone without the perceived need to “pull” the sound out of the drum. When using soft mallets, there may be a situation that calls for one to assist the rebound (some would call it “pulling the sound out of the drum”). The “pull the sound” concept may be a bit overused, forcing the player to focus on the actions of the mallet after the rebound, rather than the tone being produced.

TIMPANI: MUFFLING

7-17. The basic rules for muffling also apply to timpani. The object is to give the notes their full value, but keep them from interfering with succeeding harmonic structure. When two or more timpani are playing notes in succession, the ringing tones produce a clustered harmonic effect. Muffling one timpani while striking the other will produce clean, precise, articulate tones.

7-18. The best method of muffling is to play with one hand and use the other hand to muffle the head. The muffling hand must make total contact with the fingers spread in the playing area. Be careful not to slap the head or bend the pitch by applying too much pressure on the head. A sweeping motion with the hand and fingers inward from the rim of the drum usually works best.

7-19. Fast passages require muffling and playing with the same hand. While holding the mallet between your thumb and forefinger, use the other fingers to muffle the head. Do not let the mallet strike the head while muffling. The best way to muffle is to use a sweeping or wiping motion with as much hand contact as possible. Muffling with only the fingertips will not be as effective (see figure 7-4).

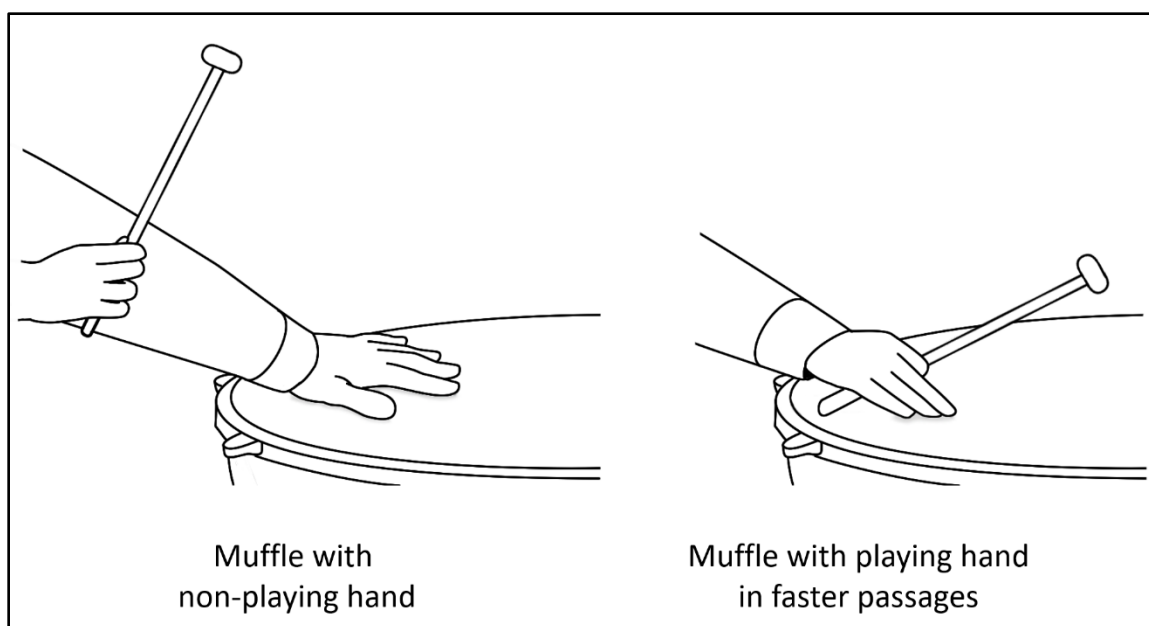

Figure 7-4. Timpani Muffling

7-20. Mechanical muffling is accomplished with circular felt pads, handkerchiefs, or similar devices. They are specified by the terms *coperto* (covered) and *scoperti* (uncovered). The devices must be easily accessible and removable. Common uses are to prevent sympathetic vibration, create muffled effects, and use as tuning aids. They are placed in different areas for different effects. Mechanical muffling can also be used to affect articulation.

TIMPANI: TUNING

7-21. Factors to consider when tuning several drums at once include the requirements of the music (e.g. how many different pitches are there?), the range of the drums (e.g. do not expect to get a high G on the 29-inch

drum!), and the proximity (e.g. how close are the pitches being changed) of the pitch changes. Ear training is essential!

7-22. If there is a part with multiple tuning changes, here is a way to approach the problem:

- Look over the part and find out how many drums are required (how many pitches occur in a single excerpt). If there are only two pitches in a given time, you may either play the piece with two drums and change pitches frequently, or use more drums to save yourself some time.
- Find the most difficult tuning changes and see if there is a note in the score that you can use as a reference. If not, relate the new note to a previous note that you played. Again, ear training is essential. You must be able to sing any interval within the space of one octave. This will help you to find odd pitches when tuning on the fly.
- Mark your part with each tuning change (mark the last note played on the drum that you need to change with “To X” (X=the new pitch). Then practice making the tuning changes. Use a fixed pitch source (mallet instrument or pitch pipe) to check your progress and accuracy.
- For major changes (more than one drum changes during measures of rest), you can pencil in the new pitch set over the rest section (e.g., F-Bb-C-D). Order pitches from lowest to highest reflecting the order of the drums.

Chapter 8

Triangle

TRIANGLE: PHYSICAL COMPOSITION AND CONSTRUCTION

8-1. Triangles are made of very hard, high-tempered, carbonized steel bent in the shape of a triangle with an opening in one corner. The triangle is suspended by a clasp held in the hand or mounted on a stand and struck with metal beaters.

8-2. The objective is to produce as many overtones as possible. The sound should be a shimmer of overtones disguising any definite pitch. The tone should not sound like an alarm bell or dinner call unless intended. Triangles, because of the variety of overtones, project tone surprisingly well. It is not unusual to have a triangle sound too soft to the player and too loud to the audience. Experiment with triangles to discover their musical personalities.

8-3. Triangle tone depends on the size, diameter, and vibrating qualities of its metallic composition. An assortment of triangle sizes and types should be available for the different musical effects required (see Table 8-1):

Table 8-1. Triangle Types

<i>Type</i>	<i>Size (in inches)</i>	<i>Description</i>
Small	4-6	For brighter tone
Medium	8	For general purpose playing
Large	10	For darker tone

8-4. Clips or clasps suspend triangles on cords. A thin cat-gut string, a viola string, or a 20-pound test fishing line will prevent muffled tones. Two cords, with one as a back-up, will avoid the catastrophe of a broken support string.

8-5. Clips can be homemade from a clothespin by drilling two small holes for the cords. If it is necessary to use a stand, the gripping end of each clip should be wrapped in moleskin to avoid noise from the stand (see figure 8-1).



Figure 8-1. Triangle Setup

8-6. Special stands can be made from parts of old cymbal stands to hold as many as three triangles. Its adjustable height makes this type of stand ideal for triangle playing. It also leaves both hands free to play.

TRIANGLE: STRIKING IMPLEMENTS

8-7. Triangle beaters are usually made of the same material as the triangle, and are produced in several sizes. Several companies market triangle beater sets, where several pairs of beaters of varying diameters and weights are packaged together.

8-8. Smaller beater diameters produce brighter, lighter tone with less volume. Larger beater diameters produce darker, heavier tone with more volume. At least three pairs of different size beaters must be available to produce the required effects.

- Use a small beater to produce high overtones and a more delicate, softer tone.
- Use a medium beater to produce a good mixture of high and low overtones for general playing.
- Use a large beater to produce the lower overtones for loud, harsh effects.

8-9. In addition, there are several implements you may use for special effects:

- A spike or large nail will make the low overtones predominant and sound loud tones as in a dinner or alarm bell.
- Knitting needles of various sizes are ideal beaters for a wide variety of delicate effects.
- Wooden coat hanger rods produce the most delicate, soft tones.
- Snare drum sticks produce hollow, wooden attack sounds.

TRIANGLE: PLAYING AREA

8-10. Because each triangle has its own musical personality, every player must experiment with the triangle to locate its different playing areas. A triangle has more than 10 playing areas, each one sounding differently.

8-11. The best general striking area is on the base of the triangle, opposite the open corner, with the beater in a generally straight up and down position. This area produces the best pitch cluster of overtones for general purpose playing (see figure 8-2).

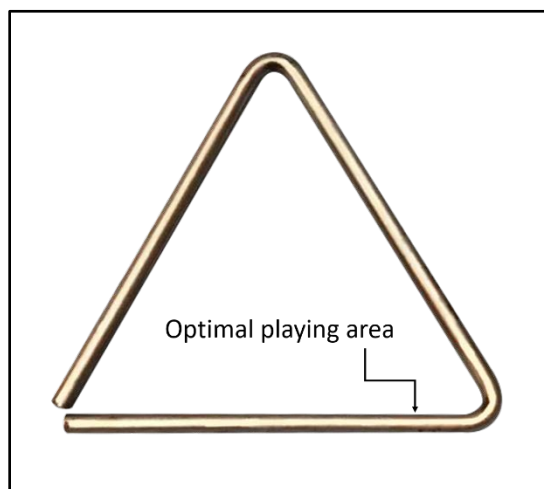

Figure 8-2. Triangle Playing Area

TRIANGLE: GRIP

8-12. Rest the clasp across the thumb and middle finger of the non-dominant hand (assuming you will be using your dominant hand for striking the triangle). Place your index finger over the top of the clasp to stabilize the clasp. Your third and fourth fingers are curled and in position to dampen the triangle when

necessary. Face the open end of the triangle toward the elbow of the arm holding the clasp. Hold the triangle high enough to see the playing surface, the music, and the conductor. This also allows the audience to visually confirm the sound they will hear, and makes the part more effective.

8-13. Grip the beater between the thumb and index finger, approximately 1 inch from the end of the beater. Place the middle finger below the index finger, near the end of the beater. The middle finger provides the main momentum for the stroke. Hold the arms stationary. They are not involved in the stroke. This method allows the player to watch the conductor and music without missing the triangle when making the stroke. It also allows the player to use finger control for stroke technique (see figure 8-3).

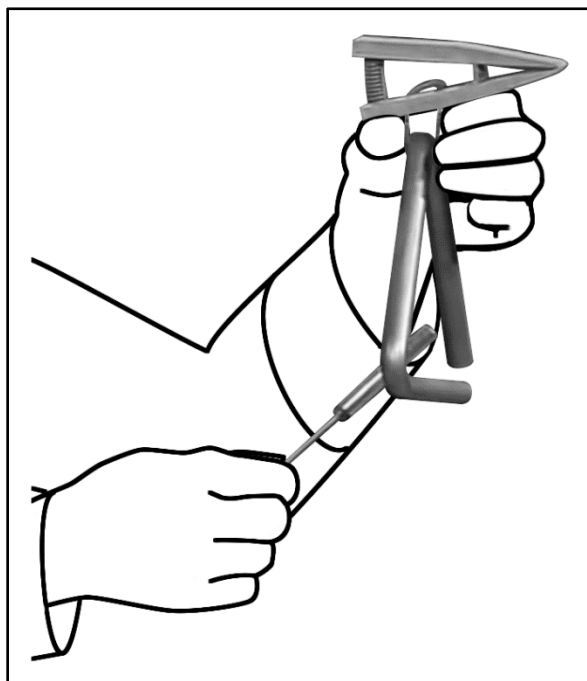

Figure 8-3. Triangle Grip

TRIANGLE: STROKE TECHNIQUE

8-14. When striking with the beater, use the tip for pianissimo effects. As the dynamic increases, use more of the beater on the triangle until you are about 1/4 inch inside the triangle. Using too much beater will make the triangle sound muffled.

8-15. The principal stroke technique rules apply to triangle (see para. 1-12–1-15). Dynamic range and rhythmic complexity will determine the method of stroke. Normal strokes will produce almost no rebound, so adjust attacks and stroke motion accordingly.

TRIANGLE: ROLLS

8-16. Rolls can be executed either while holding the triangle, or while it is mounted (see figure 8-4).

ROLL WHILE HOLDING THE TRIANGLE

8-17. Holding the triangle normally, bounce the beater between the sides near the base, opposite the open end. For the best tone while rolling, use the proper finger action while holding the wrist steady. The closer to the corner the roll is played, the softer the roll will sound. To crescendo, move the beater further from the corner, as required by the length of the crescendo.

ROLL WITH THE TRIANGLE MOUNTED

8-18. Mount the triangle on a stand using one clip and play a single-stroke roll using two beaters. Two clips are better on loud passages to keep the triangle from moving. Two clips will muffle some tone but in loud passages the loss is unnoticed. Perform fast rhythmic passages in the same manner.

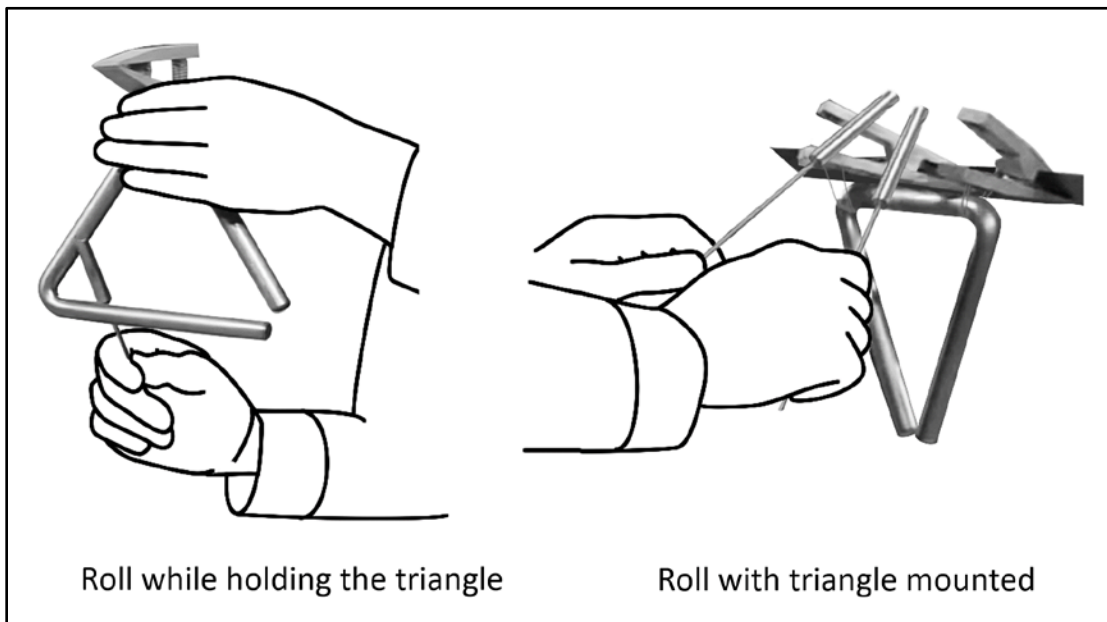

Figure 8-4. Triangle Rolls

TRIANGLE: MUFFLING

8-19. Triangle is the exception to the general rule for muffling because of its characteristic high overtone ring. When muffled quickly, the result is a choked, clank tone with a high overtone after ring. The general rule on triangle is:

Never muffle a triangle unless you have to, but if necessary, do it slowly and carefully.

8-20. Muffle only in obvious parts, such as the end of the piece, on fermatas, or on cut-offs. Muffle triangles with the heel of the hand and the fingers. Muffle with your fingers when the triangle is mounted.

TRIANGLE: SPECIAL EFFECTS

8-21. For a vibrato effect, after striking the triangle, shake the triangle up and down. Another way is to wave the hand, fingers cupped, over the base of the triangle.

8-22. To create a *fp* effect, strike two triangles at the same time, and muffle one of them after the attack.

Chapter 9

Tambourine

TAMBOURINE: PHYSICAL COMPOSITION AND CONSTRUCTION

9-1. The tambourine is a membranophone because of the batter head and an idiophone due to the jingles. Tambourines consist of a shell or frame with mounted jingles and batter head tacked on the frame or held by adjustable lugs.

9-2. Tambourines range in size from 6 to 15 inches in diameter. To accommodate most musical requirements, the percussionist should have at least three tambourines described in Table 9-1.

Table 9-1. Tambourine Types

<i>Size (in inches)</i>	<i>Description</i>	<i>Uses</i>
10	Double row of jingles	For general purpose and loud playing
8	Single row of jingles	For softer, delicate, and less jingle sounds
10	Double row of jingles, headless	For rock and Latin effects

9-3. Shells are usually made of wood for tambourines with heads, and metal or plastic for tambourines without heads.

9-4. Jingles are mounted in slot openings of the shell with steel pins. When choosing a tambourine, a player must decide what type and how many jingles are required for the music. Generally, the more jingle sound required, the more jingles the tambourine should have mounted on it. Tambourines are available with one or two rows of jingles and a variety of jingle arrangements.

9-5. The two types of jingles are Mexican (German) jingles and Spanish jingles:

- Mexican jingles, also known as German silver jingles, are cupped, smooth, and generally nickel plated disks. They are used for the liveliest jingle sound and greatest tone projection.
- Spanish jingles are corrugated or fluted disks that are heavier and duller sounding. Use this type where softer, more delicate, crisper tones are required.

9-6. Heads on higher quality tambourines are made of goatskin or calfskin, while plastic (Mylar) is used on more inexpensive products. Natural skins are preferred for concert band use, while plastic heads or headless tambourines are preferred for popular music due to the increased projection and higher tone.

9-7. Calfskin heads are usually attached to the shell of the tambourine by tacking the head onto the shell. This decreases the weight of the instrument and makes the instrument easier to control. Weather changes affect calfskin heads, creating a problem for heads that are tacked on. To tighten the head, especially in damp weather, put the head near a heat source such as a light bulb. Never use matches or other heat sources that will dirty the head or cause probable damage. To help make the head less sensitive to weather, varnish the head, on both sides, with two or three coats of marine spar varnish.

9-8. Plastic heads are attached to the shell by means of separate adjustable lugs. These add weight to the instrument, and make the instrument more cumbersome to play. A material advantage to plastic heads is their immunity to weather changes.

TAMBOURINE: STRIKING IMPLEMENTS

9-9. The hands are generally used to play tambourine. Mallets or sticks are used to imitate an Indian drum, an effect that requires more batter head tone than jingle sound.

TAMBOURINE: PLAYING AREA

9-10. The playing area must be chosen according to the dynamics and the amount of combined head and jingle tone required (see figure 9-1).

9-11. Strike the tambourine near or on the center for *mf* and louder passages; this produces the greatest volume of head sound.

9-12. Strike near or on the rim for *mp* and softer passages; this produces less head sound and more jingle sound.

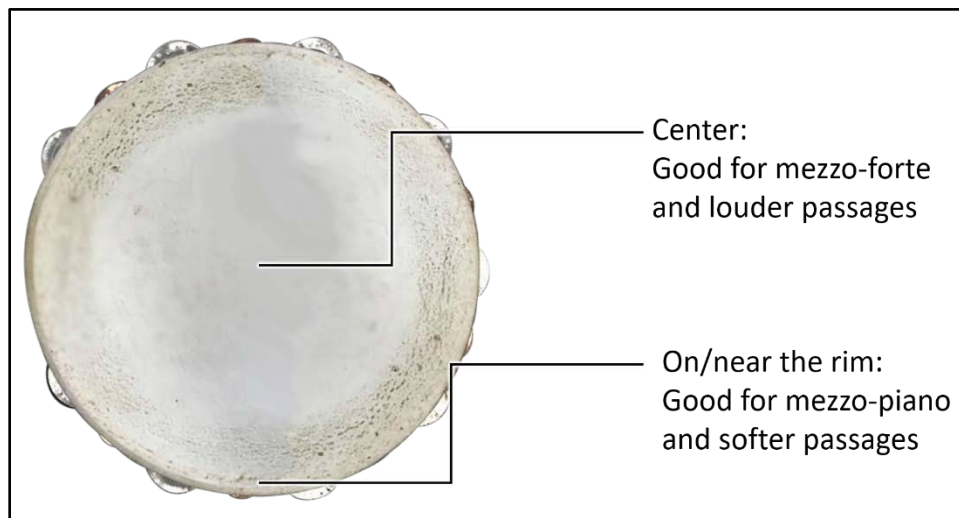

Figure 9-1. Tambourine Playing Area

TAMBOURINE: GRIP

9-13. Hold the tambourine in your non-dominant hand. To avoid extraneous noise, do not switch the instrument from hand to hand.

9-14. Most tambourines have a finger hole to be used by the middle finger for support. To utilize this, place the middle finger partway through the hole from inside the tambourine, then curl the rest of the hand around the rim until the thumb is firmly placed on the batter head. The thumb must have a good grip on the shell of the instrument, to support loud strokes and rolls.

9-15. The holding angle of the tambourine determines the activity of the jingles. Straight up and down produces the most jingle activity. This position allows free vibration of the jingles. Parallel to the floor produces medium jingle activity, allowing a constricted vibration of the jingles. 45-degree tilt is the angle of least jingle activity. This position stops the jingles from vibrating (see figure 9-2).

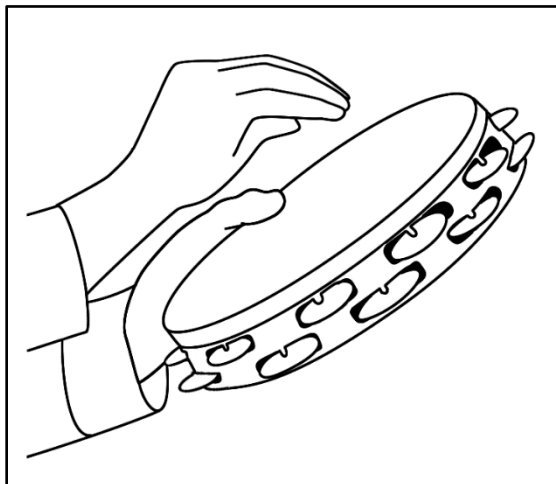

Figure 9-2. Tambourine Grip

TAMBOURINE: STROKE TECHNIQUE

9-16. The principal stroke technique rules apply to tambourine (see para. 1-12–1-15). Dynamics and rhythmic difficulty determine the method of playing the tambourine. There are four types of strokes used on the tambourine.

LOUD SINGLE STROKES

9-17. These are struck in the center with flat part of the fist, between the first and second knuckles. Do not strike with the knuckles; this produces a thin, weak ringing tone.

SOFT SINGLE STROKES

9-18. These are struck near the rim with the fingers cupped and the fingertips even for good attack control. For very soft delicate effects, strike on the rim with one finger. To increase the dynamic level, add more fingers. To add head sound to the overall timbre, strike the batter head closer to the center. Listen carefully to the band and use the technique best suited for the required blend.

LOUD MULTIPLE STROKES

9-19. These are used to play loud rapid rhythms, and require special techniques:

Stand-mount Method

9-20. Using the thumbhole, attach the tambourine to a cymbal stand. Use extra cymbal felts if necessary to keep the tambourine from moving or rotating excessively. Use both hands to perform the passage in the manner described for loud single strokes. If desired, use mallets or sticks. When using mallets or sticks care must be taken not to pull or break the head.

Knee-fist Method

9-21. Strike the tambourine alternately with the fist and on your knee. Raise one knee by placing your foot on a chair or case. Hold the tambourine as in the loud single stroke technique (head toward the knee) and strike the inside of the batter head with the fist. Then strike the outside of the batter head with the knee.

9-22. For a consistent sound, use the “right hand lead” system for striking. The first strokes are naturally louder and easier to control than the knee strokes. Therefore, on strong pulses, accented notes and primary rhythms use the fist to make the stroke whenever possible.

SOFT MULTIPLE STROKES

9-23. These are used to play soft rapid rhythms and require special techniques.

9-24. Lay the tambourine on a trap table cushioned with a towel or padding. Play near the rim with the fingertips of both hands. For a lot of head sound, lay the batter head up. Place it upside down for no head sound. If desired, use mallets or sticks.

9-25. If a trap table is not available, prop your leg on a chair and use your thigh to support the tambourine. The forearms or palms control the head sound while the fingertips are striking the rim or near the rim. For no head sound, lay the batter head against the thigh.

TAMBOURINE: ROLLS

9-26. Two types of tambourine rolls are shake rolls and thumb rolls.

SHAKE ROLLS

9-27. The shake roll is best for loud rolls *mp* and higher. Hold the tambourine vertically and twist the wrist rapidly in an even, controlled manner.

THUMB ROLLS

9-28. The thumb roll produces soft rolls of five or six seconds in length, or short burst effects. Friction between the rim of the tambourine head and the thumb creates the roll. The fleshy part of the thumb exerts a light rubbing motion around the rim of the head, causing the jingles to vibrate. You can create friction for the roll by using bee's wax, bass violin rosin, or a rubber thumb cover. Some players prefer to place a strip of sandpaper, glued with rubber cement, around the rim for a foolproof method of producing the roll.

9-29. To produce an extended thumb roll, use the figure eight (8) motion near the rim. This technique requires a lot of practice and is seldom required.

ATTACK AND RELEASE OF ROLLS

9-30. The general rule is to examine the score to see whether the band should accent the note at the beginning or end of the roll. Strike the tambourine to start or release the roll. This gives clear articulation to the roll duration. When releasing the roll, always stop the jingles from sounding by tilting the tambourine at a 45-degree angle. The player must decide how to articulate the attacks and releases.

TAMBOURINE: MUFFLING

9-31. Muffling is rarely necessary. To stop the jingles from sounding, turn the tambourine to a 45-degree angle.

NOTE: Dropping or handling a tambourine carelessly can ruin a concert. Be sure the trap table is padded to keep noise to a minimum.

TAMBOURINE: SPECIAL EFFECTS

9-32. Some common special effects for tambourine are rock band tambourine, flam effects, drum set tambourine, and tambourine on timpani.

ROCK BAND TAMBOURINE

9-33. Rock Band tambourine technique is designed to reinforce the drummer's cymbal pattern, help keep the time steady, provide accents, and reinforce the basic pulse on beats two and four. The player must judge what will fit with the music. Any of the previously described techniques can be used as required.

9-34. The most commonly scored effect is steady sixteenth notes with accents on two and four. Shake the tambourine back and forth with a relatively stiff wrist motion for the sixteenth notes, while striking the rim with the palm of the hand on the accented beats.

FLAM EFFECTS

9-35. Begin the sound with a downward motion of the tambourine to cause the jingles to sound with a grace note, and then strike the principal note immediately.

DRUM SET TAMBOURINE

9-36. A headless tambourine designed to be mounted on a hi-hat pedal. The tambourine sounds when the pedal is depressed.

TAMBOURINE ON TIMPANI

9-37. Place a tambourine upside-down on the head of timpani. When the timpani is struck, it will add a jingle effect.

This page intentionally left blank

Chapter 10

Latin Percussion Instruments

LATIN PERCUSSION: OVERVIEW

10-1. Latin percussion instruments evolved from the intermingling of several musical cultures. The native cultures of South America and the West Indies interacted with that of Spanish and Portuguese colonists and African slaves. The blend led to the development of modern Latin percussion.

10-2. In Latin America the prominent role of Latin percussion instruments touches almost every phase and detail of everyday life. For example, in Brazil numerous neighborhood bands rehearse all year for the band competition at Carnival time. The winning band achieves more national prominence than the winning team at our baseball World Series. Workers on their lunch hour often use sticks, cans, bottles, or other improvised instruments to produce rhythms that seem amazingly complex and intricate to us.

10-3. Latin music is essentially rhythmic, with melody and harmony playing a secondary role. Quickly improvised and simply constructed Latin percussion instruments used for accompanying dancers account for the rhythmic nature of Latin music. The rhythmic dominance results from the complex and intricate layers of rhythms provided by as many as ten percussionists.

10-4. Latin percussion instruments provide a basic rhythmic foundation or ostinato effect. This is a constant, recurring, and unchanging rhythmic pattern. Solos can be performed on any of these instruments, especially bongos, but usually only fills or flourishes are added to the color of the musical texture.

LATIN PERCUSSION SECTION MAKEUP

10-5. The basic salsa percussion section consists of congas, bongos, and timbales. Other auxiliary instruments may be added and are usually played by the vocalists or the horn players.

10-6. The conga player will play what is usually referred to as tumbao, which is a repeated pattern that creates the groove (For patterns, see Figures 10-6 through 10-9 on pages 10-4 and 10-5). There may be variations during the choruses or the montuno section.

10-7. The bongo player will play a pattern (usually varied and soloed around) called the martillo. When the song enters the montuno section, they will change to the large cowbell and play the montuno pattern.

10-8. The timbale player will start on the shell of the drums playing paila or cascara. When the song enters the montuno section, they will play a different pattern on the closed end of the mambo bell.

10-9. Unlike Western music, where the divided beat is strictly even, Afro-Cuban music “floats” the divided beat and is somewhat flexible in interpretation. This “float” is different with different players; some will play the divided beat almost straight, while others will make the divided beat feel almost dragging or swinging. However, there is a difference in the Latin interpretation and the American jazz feel. The Latin interpretation is more straight (but not quite), while the jazz feel is more $2/3-1/3$ at moderate tempos.

10-10. Latin American music has influenced the music of North America tremendously. The rhythm of rock, jazz, and popular music has all been influenced by Latin music.

LATIN PERCUSSION: CONGAS

10-11. The following paragraphs give guidance on the physical composition and construction, sizes, playing position, tuning, playing techniques, rolls, special effects, and common rhythms for the conga.

PHYSICAL COMPOSITION AND CONSTRUCTION

10-12. Conga drums are single-headed, barrel-shaped drums that function as the base of a Latin American band. They are the largest and oldest of Latin American instruments, probably descended from Africa. Choosing shells is the player's preference, but more professional players use wooden shell drums (see figure 10-1). Wooden shells produce a more mellow and resonant tone. Fiberglass shells produce a sharper, more projecting tone.



Figure 10-1. Conga

10-13. Heads were originally made from very thick (1/16 inch thick) muleskin or goatskin. Due to their rarity, calfskin is now used. Calfskin heads produce the most authentic sound. Plastic heads are used only because they are so much cheaper than calfskin. Unfortunately, a plastic head cannot yet come close to producing the characteristic tones required for an authentic conga sound, although several manufacturers are still working to fix this problem.

NOTE: Only heads that can be tuned with adjustable lugs should be used. A tacked head is too affected by weather to be reliable.

SIZES

10-14. Congas are 9 ½ to 12 ½ inches in diameter and average 30 inches in height. Conga drums are available in three main sizes: Conga, Quinto, and Tumbadora (see Table 10-1).

Table 10-1. Conga sizes

<i>Order of preference</i>	<i>Type</i>	<i>Size</i>	<i>Description</i>
1	Conga	11–11 ½ inches	Medium size drum, on which most of the patterns are based
2	Tumbadora	12–12 ½ inches	Largest drum, used as a bass voice
3	Quinto	9 ½–10 ½ inches	The smallest in diameter, sometimes used as a solo instrument

10-15. A conga player may use one to three or more drums depending on the tone variety desired. For economy, the conga should be purchased first, then the tumbadora, and then the quinto. The conga and tumbadora should be sufficient for most required effects.

PLAYING POSITION

10-16. The congas are most commonly set up with the quinto on the left, conga in the middle, and tumba on the right. This setup accommodates right-handed players, and should be reversed for left-handed players.

For greater ease of motion and stroke, the drums on the left and right should be placed in front of the feet. Of course, final setup decisions are left to the player. The conga is held between the player's legs or mounted on a stand. The drum bottom must never rest flat on the floor.

NOTE: When playing on a carpeted area, place a reflecting soundboard under the congas for tone projection. When amplifying the instrument, center the microphones 6 to 12 inches above each drum.

TUNING

10-17. Congas are usually tuned in intervals of thirds, with the middle conga sounding (approximately) middle C (plus or minus 1 whole step). However, some players prefer to tune in intervals of fourths or fifths. The method of tuning or tensioning the drum is the same for all membranophones. To ensure even tension for the calfskin heads, tension each lug sequentially and detune the drums after each use.

PLAYING TECHNIQUES

10-18. A beginning player must remember that an experienced conga player has calloused hands because of much painful practice. The calloused hands provide endurance as well as imparting a tone quality different from that of uncalloused hands. This is in no way intended to discourage the beginner from attempting to practice or perform on congas within the limits of their endurance.

10-19. To produce the characteristic tones on conga drums requires mastery of several different types of hand strokes. General rules for stroke technique apply (see para 1-12–1-15).

Open Stroke

10-20. This produces deep, low, penetrating, resonant, and unmuffled tones. All of the fingers, except the thumb, strike the head making the stroke from the wrist. Striking the drum halfway between center and edge (the joints where the fingers join the hand are approximately at the shell/collar area of the drum) produces the most resonant open tone (see figure 10-2).

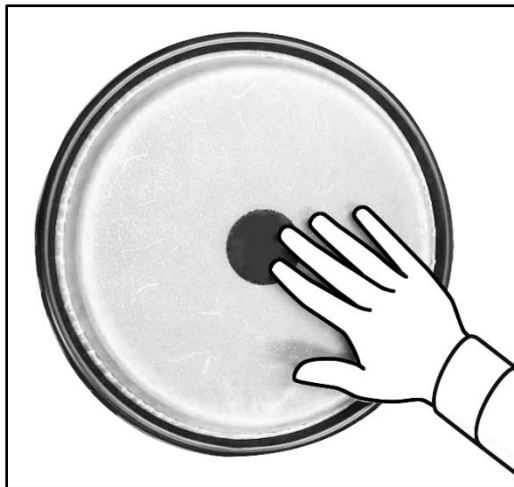

Figure 10-2. Conga Open Stroke

Slap Stroke

10-21. This produces an accented, high, tight, penetrating, sharp tone. Make the stroke with a combined wrist and forearm motion. The heel of the hand rests on the counterhoop at the same time the fingers strike the head. The fingers must be relaxed to be slapped against the head and produce the desired high tone. The

quality of the tone is determined by the contact of the fingertips, or the first knuckle of the fingers, on the head. As the heel of the hand strikes near the counterhoop, the fingers follow through making a grabbing motion, which allows the fingertips to make the stroke (see figure 10-3).

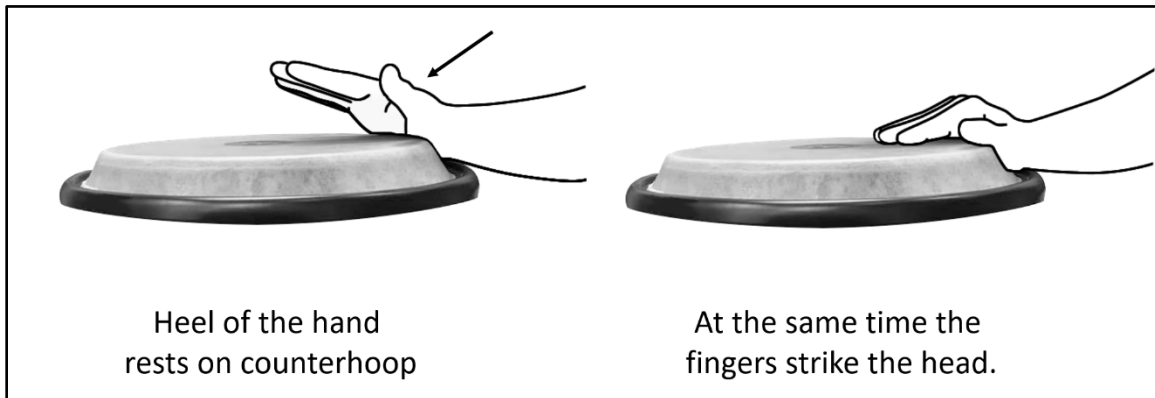

Figure 10-3. Conga Slap Stroke

10-22. For a higher pitch slap, muffle the head slightly with the other hand. This technique is useful for salsa patterns, as it places the other hand in the proper position for heel and tip strokes that may follow the slap.

Bass Stroke

10-23. This produces a low tone with some projection. Make the stroke by letting the entire hand fall onto the head while tilting or lifting the conga with your knees (see figure 10-4).

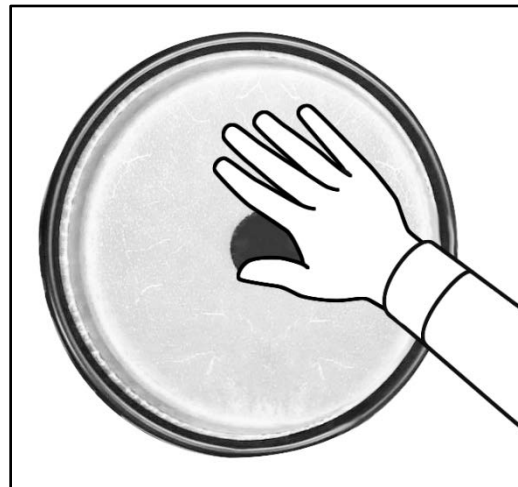

Figure 10-4. Conga Bass Stroke

Heel Stroke

10-24. This produces a low tone similar to the bass stroke, but without the projection. Make the stroke by striking the head halfway between the center and the rim with the heel of the hand (see figure 10-5).



Figure 10-5. Heel Stroke

Fingertip Stroke

10-25. This stroke provides a light, subtle muffled tone when done correctly, and is sometimes referred to as a dead stroke. While the heel of the hand is resting on the drum (after a heel stroke), strike the head with the fingertips of the same hand. The fingertips of the opposite hand will also create the same effect when the drum is muffled (see figure 10-6).

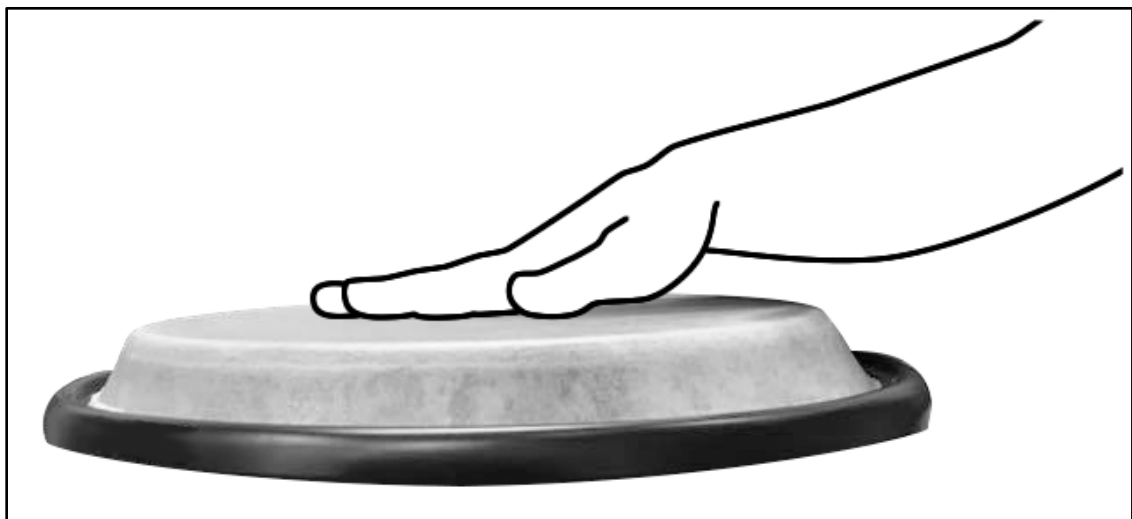

Figure 10-6. Fingertip Stroke

Double Stroke (Heel-Tip)

10-26. This stroke combines the heel and fingertip stroke in a 'double-stroke roll' fashion. Make the stroke by alternating heel and fingertip strokes with each hand.

ROLLS

10-27. With the exception of the heel-tip stroke combination, all rolls are single stroke. Short roll combinations can be executed, but they are “double stroke” in the strictest sense of the term (not stroke/rebound, but two distinct strokes with one hand).

SPECIAL EFFECTS

10-28. Two special effects that can be used with the conga are the changing pitch effect, and the howling drum effect.

Changing Pitch Effect

10-29. Strike the head with one hand while using the elbow or rigid fingertips of the other hand to apply pressure to the head.

Howling Drum Effect

10-30. This will occur if you produce friction between the head and a fingertip, similar to a tambourine thumb roll. Usually, wetting the fingertips lightly with saliva will be enough to create this friction. The fingertip is rubbed straight across the diameter of the drum.

COMMON RHYTHMS

10-31. Figures 10-7 through 10-10 show some common rhythms for the congas. For additional patterns, see the Style Scores later in this chapter (see pages 10-41–10-48).

Tumbao (3-2 son clave)

Figure 10-7. Conga Tumbao.

Swing Tumbao

10-32. For Swing, use the second measure of Figure 10-7 in a 1-measure pattern. Swing the eighth notes.

Samba

Figure 10-8. Conga Samba Pattern

Partito Alto.

H T S O O O S S S O O O S

H= Heel Stroke O= Open Stroke S= Slap Stroke T= Thumb Stroke

Figure 10-9. Conga Partito Alto Pattern

Mozambique

O S H O O O S S O O

H= Heel Stroke O= Open Stroke S= Slap Stroke

Figure 10-10. Conga Mozambique Pattern

LATIN PERCUSSION: BONGOS

10-33. The following paragraphs give guidance on the physical composition and construction, playing position, tuning, playing areas, striking implements, playing techniques, and common rhythms for the bongos.

PHYSICAL COMPOSITION AND CONSTRUCTION

10-34. Bongos are a set of six- and eight-inch, single-headed wood shell drums attached together (see figure 10-11). Originally the heads were goatskin, but calfskin and plastic heads are now in use.



Figure 10-11. Bongos

10-35. Usually a solo instrument in Latin American bands, bongos are used to play fills and flourishes, play in and around the melody, and improvise at will. They also provide ostinato rhythmic patterns.

PLAYING POSITION

10-36. The bongo player usually sits holding the drums between their knees. Bongos can also be mounted on a stand. Position the small bongo on the non-dominant side (left for right-handed players) and the large bongo on the dominant side. Reverse the bongos if playing with mallets to make reading easier.

TUNING

10-37. Originally the heads were attached with tacks, but tunable heads with adjustable lugs are now commonly used. Tune bongos to very high pitches at intervals of fourths or fifths, depending on player preference.

PLAYING AREAS

- 10-38. On center provides a dull, sharp, and resonant tone.
- 10-39. Off center provides the most resonant, ringing, and open tone.
- 10-40. Near the rim provides a thin, hollow tone.
- 10-41. On the rim provides a pop or slap tone quality.

STRIKING IMPLEMENTS

- 10-42. Traditionally bongos are played with finger or hand strokes. Such strokes require calloused fingers to produce proper tone qualities.
- 10-43. For most percussionists whose hands are not developed, using thin timbale sticks or rattan mallet handles best produces good tone quality. The ends are wrapped with tape or moleskin.

PLAYING TECHNIQUES

- 10-44. To play bongos with the fingers, use combinations of the strokes listed in Table 10-2.

Table 10-2. Bongo Strokes

<i>Stroke Type</i>	<i>Fingers used</i>	<i>Stroke Description</i>	<i>Effect</i>
Single Finger Stroke	Forefinger or thumb	The attack, rebound, and playing area chosen determine tone quality	Produces a high, open tone
Sweep or Dead Stroke	Fingers	Sweep the fingers across the head as the head is struck	Produces an elongated dead tone
Double Finger Stroke	Forefinger and middle finger	Same as single finger stroke	Produces high, more solid and open, full tones
Slap or Pop Stroke	Two or three fingers	Fingers placed over the rim	Produces forceful, piercing tones

- 10-45. Use conga strokes on bongos as required by the music. To play bongos with a stick requires stroke techniques that follow the general rules (see para. 1-12–1-15).

COMMON RHYTHM

- 10-46. Figure 10-12 shows a common bongo pattern. When performing, alternate the hands (dominant hand first)

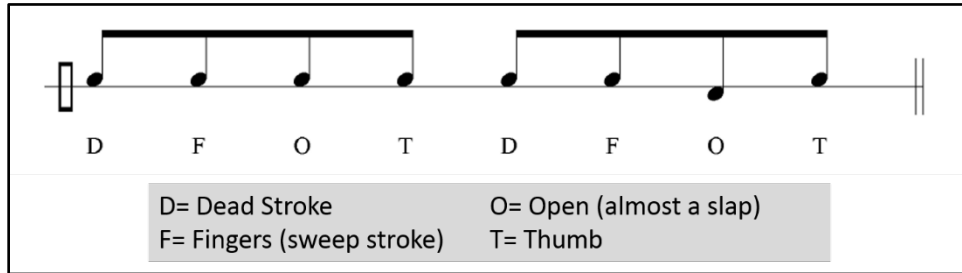

Figure 10-12. Bongo Martillo Pattern

LATIN PERCUSSION: TIMBALES

10-47. The following paragraphs give guidance on the physical composition and construction, sizes, playing position, tuning, striking implements, playing area, stroke technique, and common rhythms for the timbales.

PHYSICAL COMPOSITION AND CONSTRUCTION

10-48. Timbales are pairs of single-headed, metal drums mounted on a stand (see figure 10-13). Originally the heads were goatskin, but calfskin or plastic is now used. Timbales function similarly to the drum set in a Latin American band.



Figure 10-13. Timbale

SIZES

10-49. Diameters range from 10 to 14 inches for the smaller drum (macho) and 11 to 15 inches for the larger drum (hembra). Size choice is left to the player, but the more common combination is 14 and 15 inches.

PLAYING POSITION

10-50. Timbales are mounted on a stand with the hembra to the left and the macho to the right. Cowbells are mounted on the drum or stand with the larger (mambo) bell to the right and the smaller (cha-cha) bell to the left. This position can be reversed for left-handed players.

TUNING

10-51. Originally heads were tacked on (when wooden shells were in use), but tuning mechanisms are common on all timbales today. Tune timbales to their mid-range, an interval of a fourth or a fifth apart, depending on the player's preference.

STRIKING IMPLEMENTS

10-52. Timbale sticks are wooden dowels about 12 to 14 inches long in varying diameters from 5/16 to 1/2 inch. The 3/8-inch diameter is a good general-purpose stick. Hands also play different strokes similar to the conga drum technique. Hands are used in light musical textures.

PLAYING AREA

10-53. The playing areas are the same as any membranophone. Playing on the center of the head produces a dull, thuddy, somewhat resonant tone, often used to imitate the open tone of the conga. Playing off center produces the most resonant tone. Playing near the rim produces a hollow, thin, and ringing tone. Playing on the shell produces a metallic clicking tone, commonly known as cáscara.

10-54. Rim shots produce high pitched, accented, and pointed tones. Use rim shots to imitate open tones on bongos. Strike the rim hoop and near the rim at the same time. The closer to the center the stick makes contact, the louder and more resonant the rim shot.

STROKE TECHNIQUE

10-55. The general rules of stroke technique apply to timbales (see para. 1-12–1-15). Muffled strokes (dead strokes) are used extensively to add contrasting tones to the accented strokes. The left hand is used to perform open and dead strokes on the hembra (larger drum).

COMMON RHYTHMS

10-56. Figure 10-14 shows a cascara pattern with LH playing muffled and open tones on hembra (x=muffled; o=open).

Figure 10-14. Timbale Cascara Pattern.

10-57. Figure 10-15 shows a mambo bell pattern (played on top or closed end of bell, add the LH pattern from figure 10-11 with stick in very loud passages).

Figure 10-15. Timbale Mambo Bell Pattern

LATIN PERCUSSION ACCESSORIES

10-58. The following sections discuss the most common Latin percussion accessories encountered in Army bands: claves, maracas, cowbell, guiro/reco-reco, afuche/cabasa, agogo bells, vibraslap, shaker, triangle, pandeiro, tambourim, and surdo.

CLAVES

10-59. Claves are lathed dowels of hard wood such as ebony, redwood, or, preferably, rosewood. They are six to ten inches long and about one inch in diameter. The tone is produced by striking the claves against each other, creating a resonant penetrating click. In Brazilian claves, one clave is a hollow wood tube struck by a solid wood clave.

10-60. Grip the lower-pitched clave lightly in the dominant hand. Rest the other clave on the fingernails of the non-dominant hand. The curled fingers provide a resonating chamber necessary for full tone production. Avoid as much hand contact as possible to allow the claves to vibrate freely (see figure 10-16).

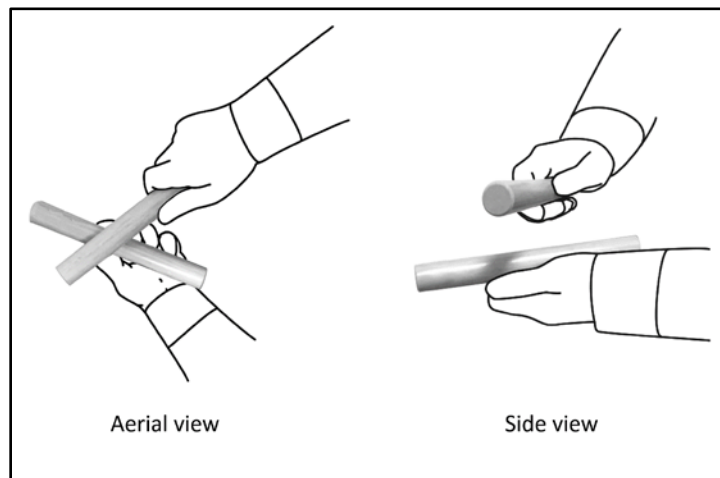

Figure 10-16. Clave Grip

10-61. Hold the higher-pitched clave stationary in the non-dominant hand and strike its center with the lower-pitched clave. Experiment to find the best sounding playing area. The highest tone is needed to project the tone through heavy musical textures.

10-62. The word clave comes from the Spanish for key or code. The click of the clave rhythm is the foundation for all Latin rhythms. Any musician lost in the network of intricate rhythms can find the beat by listening to the ostinato of the clave.

10-63. Son clave developed around 1900 in the Cuban province of Oriente. The roots of salsa music lie in the son clave. This rhythm can be played forward (3-2) or reverse (2-3), and this direction seldom changes during a song (Figure 10-17).

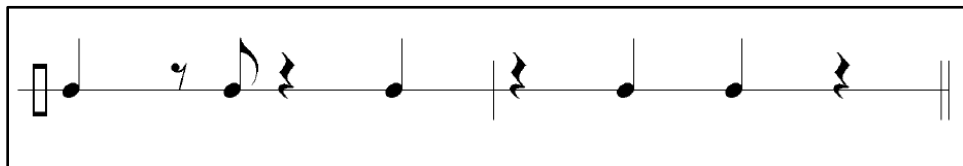

Figure 10-17. 3:2 Son Clave

10-64. Rumba clave is a variation of son clave used for more pop-oriented songs. As in the son, it can be played forward or reverse, and the offset in the 3 side implies a shifting of the 3 side of the clave to the 2 side. Most pop styles (e.g. songo, mozambique, guaguanco) will use reverse rumba clave (Figure 10-18).

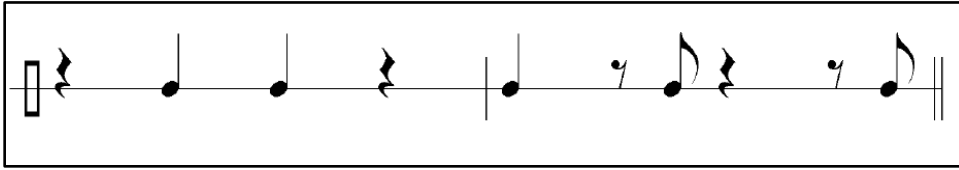

Figure 10-18. 2:3 Rumba Clave

10-65. Bossa clave is the clave pattern used for the bossa nova, the variation of the samba developed during the “cool jazz” period of the 1950s (Figure 10-19).

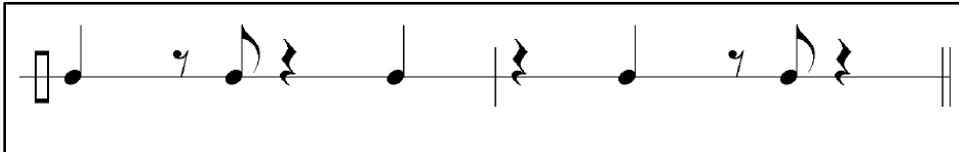

Figure 10-19. 3:2 Bossa Clave

10-66. A clave-like pattern used in samba music is the partido alto, and the pattern in figure 10-20 is played or implied on several instruments (caxixi, tambourim, pandeiro, agogo bells).



Figure 10-20. Partido Alto

MARACAS

10-67. Maracas are made from wood or plastic, in the shape of a hollow round ball with a handle. Originally, maracas were dried gourds, a native squash-like vegetable, used as rhythm instruments. The maracas contain seed or shot that strike against the inner walls of the shell. The density and size of the shell determine the attack, intensity, and pitch of the tone.

10-68. When choosing maracas, listen for the sound projection and match the appropriate characteristics of the shell and shot to the effect required by the music. The beads striking the shell of the maracas produce a crisp and pulsating chick sound. To be matched, one maraca should sound slightly higher than the other.

10-69. Use a matched grip on maracas. Pick up maracas carefully to avoid accidental noises. Hold the maracas with the low tone in the left hand, and the higher one in the right.

10-70. The objective is to make the seeds or shot strike the walls of the maracas in a clean crisp manner. Two accepted methods are the vertical position and the horizontal position.

- Vertical position for *mf* and louder. With the handles parallel to the body and at eye level, shake them with a combined wrist and arm, back and forth, snapping motion. Make the shot alternate between the front and back walls of the shell. Making all of the shot strike the walls at once requires practice. Do not let the shot roll around the shell wildly.
- Horizontal position for *mp* and softer. Hold the handles parallel to the floor. Place your forefinger on the shell for more control. Move the wrists and fingers in short, delicate snaps, and make the shot hit only the bottom wall of the shell.

10-71. Rolling Effect. Perform rolls by holding the handles above the shell and, using short circular wrist motions, cause the beads to swirl around the shell. For loud rolls, shake the maracas rapidly back and forth in the vertical position.

10-72. Maracas sustain a steady eighth note pattern to provide a Latin flavor (see figure 10-24 on page 10-15).

COWBELL

10-73. The cowbell, as its name implies, is a bell hung around a cow's neck. When used as percussion instruments, the clappers are removed. German cowbells, or almglocken, are pitched versions used in some European folk music. The bell is held in the hand, mounted singularly, or in pairs, or attached together like the Brazilian agogo bells. In Latin music, cowbells serve the same purpose as cymbals in North American music (see figure 10-21).



Figure 10-21. Cowbell

10-74. Cowbells range in size from six to nine inches. Agogo bells are smaller versions of cowbells attached together with a curved rod. They are manufactured to sound approximate intervals of thirds. Larger cowbells will produce lower tones. A nine-inch bell is best for hand playing. Six and nine inch cowbells (cha-cha and mambo bells) can be mounted on timbales.

10-75. Two playing areas are available. Playing near the open end provides the fullest and most ringing tone. Playing near the top or the closed end provides a high, pinched, muffled tone.

10-76. The butt end of a drumstick, a clave (use only if nothing else is available to avoid damage to the clave), a timbale stick, or a “cowbell beater” (essentially a clave made of hickory or maple) may be used to strike the cowbell.

10-77. Balance the cowbell in the open palm of the hand with its open end facing away from the body. Hold the cowbell between eye and chest level to project the sound. Position the fingers along the side of the cowbell so they can grasp the cowbell when a muffled tone is needed.

10-78. For the open sounds (near the open end of the bell), strike either over the open end with the stick parallel to the bell surface or, for a slightly deeper sound, strike the opening at a 45 degree angle from the bell surface.

10-79. For the higher-pitched sounds (near the closed end), strike the bell with the stick either parallel to the playing surface or with the tip of the stick approximately 1 inch from the top of the bell.

10-80. The metallic construction of some cowbells causes them to produce an overwhelming ring. For most Latin music this ring is part of the characteristic timbre of the instrument. If the ring is not wanted (e.g., Rock effects), use heavy adhesive tape (duct tape) on the inside of the bell to dampen the tone.

10-81. When using hand-held techniques for the cowbell, the fingers can muffle the cowbell to provide a variety of tonal colors. The open and muffled tones result in a characteristic rhythmic drive effect.

10-82. Figure 10-22 shows a bongo bell pattern (higher notes are on top of bell; this is over 3-2 son clave).

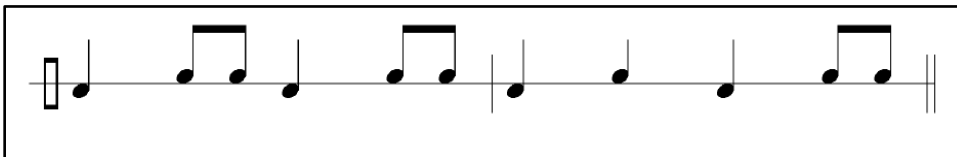

Figure 10-22. Son Montuno Bongo Bell Pattern

10-83. Figure 10-23 shows a mambo bell rhythm (used by timbale players), also over 3-2 son clave.

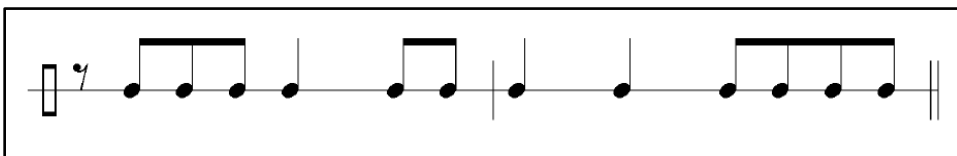

Figure 10-23. Mambo Bell Pattern

GUIRO/RECO-RECO

10-84. Originally, the scraper (guiro) was made from a gourd or cowhorn. Those made from a length of bamboo or wood are called a reco-reco. The guiro is a long hollow tube or gourd with notched strips cut into the surface. The guiro used in the merengue is made of metal and scraped with a metal pick or fork (see both types in figure 10-24).

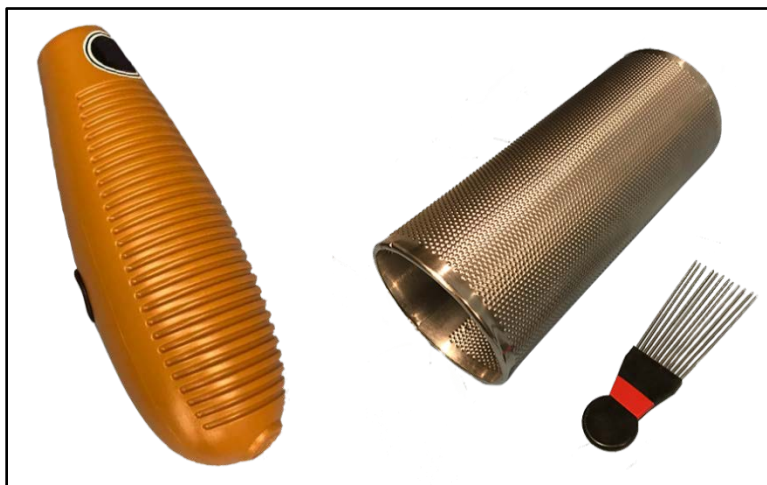

Figure 10-24. Guiro

10-85. The diameter and density of the implement used to scrape the instrument determines the pitch and intensity of the tone. Thinner scrapers produce higher timbre. Common implements are stiff wire rods, thin wooden sticks, coins, triangle beaters, keys, and combs. The most common are thin wooden sticks, tapered toward the playing end.

10-86. Grip the guiro in a manner that will allow it to vibrate freely. The different types of guiros may have different types of grips. The most common type has two finger holes for the thumb and middle finger. Hold the guiro between eye and chest level for the best tone projection.

10-87. Play the guiro with a series of back and forth scrapes. The faster the scrape, the higher the pitch and the shorter the duration of the note. As more pressure is exerted on the guiro, the sound will get louder.

10-88. The pressure and speed of the scrape may also vary during the stroke of the scrape for an accent effect. The lengths of the scrape will depend on the duration of the notes.

10-89. Figure 10-25 and 26 show two common guiro rhythms.

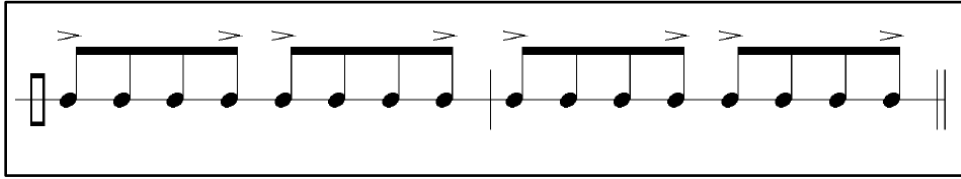

Figure 10-25. Guiro Salsa Rhythm

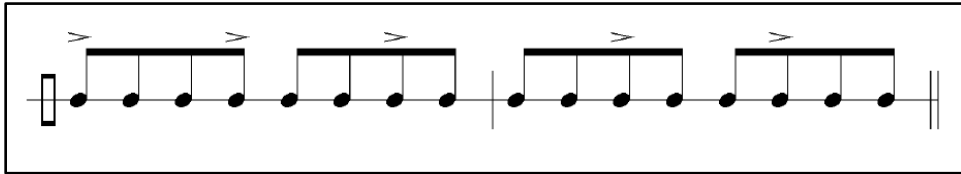

Figure 10-26. Guiro Samba Rhythm

AFUCHE/CABASA

10-90. Originally a large, round, corrugated gourd covered with a loosely netted string of beads, the modern cabasa is a hollow, corrugated aluminum cylinder covered with strings of metal beads. A wooden handle is attached to the bottom (see figure 10-27). The sound produced is much like the scraping of the guiro. The cabasa can also be used as a substitute for sandpaper blocks.



Figure 10-27. Cabasa

10-91. Hold the handle in one hand and place the beaded surface against the palm of the other hand. Produce a scraping sound by rotating the handle. Use the fingertips to slap the beads or slap the beads of the cabasa against the palm of the hand for a crisp chick sound.

10-92. To achieve a soft maracas effect, shake the cabasa back and forth.

AGOGO BELLS

10-93. Agogo bells are pairs of bells connected with a metal rod (see figure 10-28). They are usually held in one hand and played with a stick with the other hand. Agogo bells are used to play ostinato patterns in Brazilian samba music.



Figure 10-28 Agogo Bells

10-94. A common technique is to squeeze the bells together to produce a chick sound. This sound may be used to fill in the eighth notes not notated in figures 10-29 through 10-31.

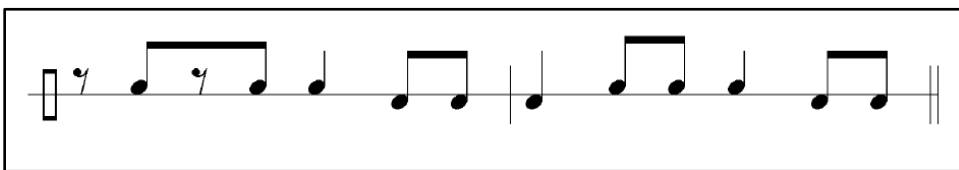

Figure 10-29. Agogo Samba Pattern 1.



Figure 10-30. Agogo Samba Pattern 2.

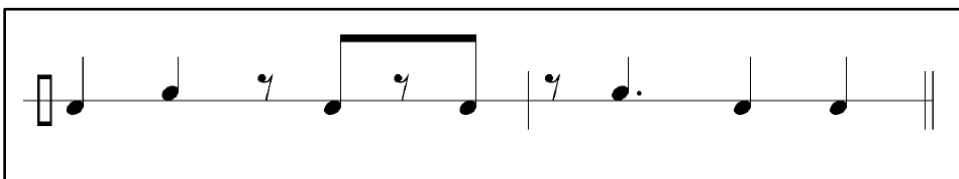

Figure 10-31. Agogo Partito Alto Pattern

VIBRASLAP

10-95. Originally, the vibraslap was the skeletal jawbone of a donkey, horse, or cow with the teeth loosely held in their sockets with wire rivets. The modern version is a hardwood-sounding box with metal rivets loosely mounted inside. A wooden striking ball on the end of a curved metal rod is attached to the box. The tone produced is a long resonant buzz.

10-96. Grip the handle in one hand with the striking ball above the wooden box. Hold the instrument vertically between eye and chest level. Strike the ball with the other hand. Observe all rules for stroke technique (see para. 1-12–1-15). Depending on your preference, strike the ball with an open palm or clenched fist.

10-97. The vibraslap is used sparingly in Latin music, usually on strong beats of every other measure or every fourth measure.

SHAKER

10-98. The shaker was originally made from a long cylindrical gourd filled with seeds or beads. The modern version is similar but made from wood. Metal ones are called tubos. The shaker is filled with shot. The tubo is used for loud effects because of the metal’s greater sound projection. The wood shaker is used for mellower, softer effects.

10-99. There are two ways to hold a shaker, based on the size of the shaker: holding the shaker diagonally, or in the center.

- Hold the shaker diagonally in front of you, at chest level, and support each end by the tips of the fingers. This method provides the best sound projection, but may be impractical in a multiple percussion setting.
- Hold the shaker in the center. This grip is good for extended playing. When one hand gets tired, simply switch hands. This method muffles some of the vibrations, and does not project as well.

10-100. The objective is to make the seeds or shot strike the walls of the shaker in a clean and crisp manner. The sound is produced when the wrist and arms snap the tube in a back and forth motion. The faster the snap, the cleaner the sound.

10-101. As with maracas, shakers sustain a steady eighth note pattern. Changing the back and forth pattern to out and up, then out and down, produces the pattern in figure 10-32 (the arm moves in an inverted L motion):

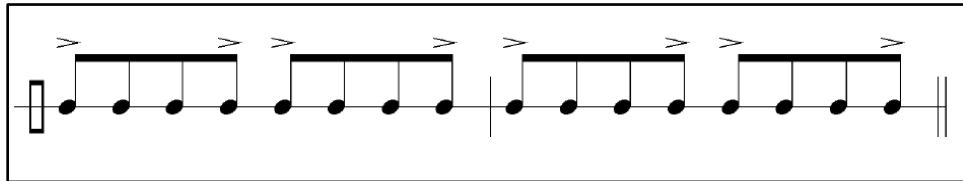

Figure 10-32. Shaker Basic Pattern

10-102. To achieve this sound with one hand, firmly grip the shaker in the center with palms up. Hold the tube horizontally and try to place an even number of beads or shot on each side of the tube. Rotate the wrist quickly from front to back in a controlled eighth note pattern.

10-103. For a softer effect, use the two-handed playing technique. Tilt the tube and shift all of the shot to one end. Shake only the end the shot is in.

10-104. A roll is performed by swirling the shot in a circular motion with one hand.

TRIANGLE

10-105. For Latin rhythms, the triangle is either: held in the hand and played with a triangle beater (using the grip hand to produce open or muffled tones), or held on a triangle clip (again, using the grip hand to muffle when necessary).

10-106. Figure 10-33 shows a common triangle samba pattern.

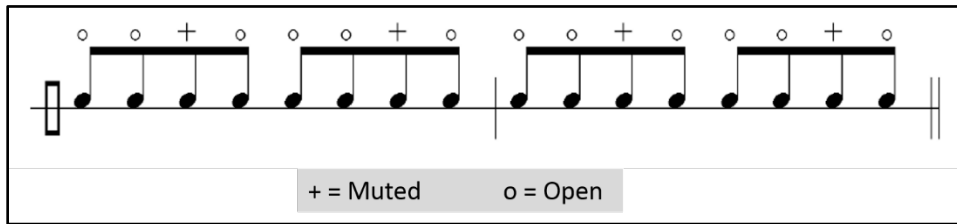

Figure 10-33. Triangle Samba Pattern.

PANDEIRO

10-107. The pandeiro is the Brazilian version of the tambourine. They are usually made of wood with concave jingles facing each other for a drier sound. Heads may be plastic or calf, and the heads are tunable. Most common sizes are 10-inch and 12-inch diameter.

10-108. Hold the pandeiro in the non-dominant hand. Grip the instrument so that the fingers of the grip hand may be used to muffle the head if necessary.

10-109. The thumb and fingers are used independently to produce different sounds on the pandeiro. The basic patterns use an alternating thumb/finger motion in the dominant hand.

10-110. Here is a key for the notated rhythm in figure 10-26:

- 1: thumb stroke near edge of the head (similar to a rim shot)
- 2: finger stroke in upper center of the head
- 3: thumb stroke or heel of hand in lower center of the head
- 4: finger stroke, same as number 2 (if accented, it is a slap stroke)

10-111. The fingers of the hand holding the instrument mute (x) or open (o) from inside the instrument (see figure 10-34).

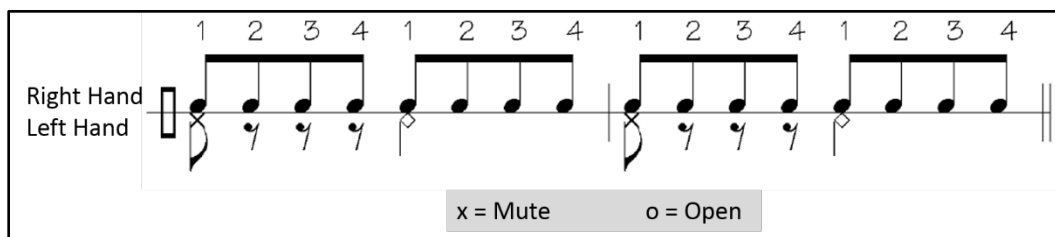

Figure 10-34. Pandeiro Basic Pattern

TAMBOURIM

10-112. The tambourim is a frame drum (similar to a tambourine, but without jingles) with a tunable head. The head is most often plastic. Sizes range from 5 to 8 inches in diameter.

10-113. A small stick (similar to a small timbale stick) called the baguette de tambourim is used to strike the head.

10-114. Hold the tambourim with the non-dominant hand with a grip similar to that of the tambourine. Grip the instrument so that your middle finger may touch the head from the underside.

10-115. The general rules of stroke technique apply (see para. 1-12–1-15). The grip hand is used to muffle the head to produce closed tones. The fingers may also play a filler rhythm on the underside of the head. There are several stroke types for tambourim:

- Tip of stick in center of head. This is used for open and closed tones.
- Rim shots. These are used for accents and to provide a high-pitched pop sound.

- Rim shots with shoulder of stick. This is used to produce a louder accented note.

10-116. Figures 10-35 and 10-36 show two common tambourim patterns.

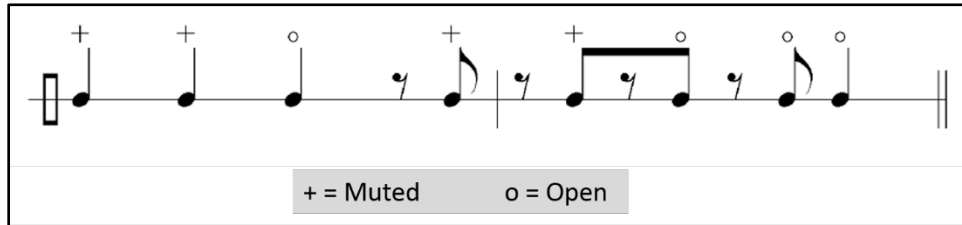

Figure 10-35. Tambourim Basic Pattern

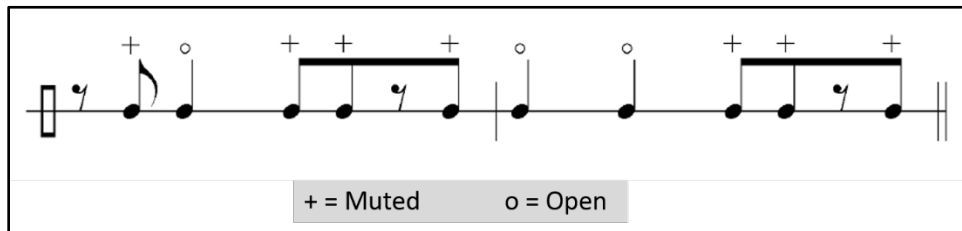

Figure 10-36. Tambourim Pattern 2

SURDO

10-117. The surdo is a wood or metal barrel-shaped drum with heads on both sides (see figure 10-37). Most commercial surdos available in North America are made with metal shells. The heads can be either calfskin or plastic. Surdos are most commonly used in Brazilian samba music, where the surdo defines the basis of the samba groove.



Figure 10-37. Surdo

10-118. A mallet, similar to a small bass drum mallet, is used in the right hand, while the left hand is used without sticks or other implements.

10-119. There are three types of surdos: surdo marcaná, surdo reposta, and sorto-cortador (see Table 10-3).

Table 10-3. Surdo Types

Type	Size	Uses
Surdo Marcaná	Largest: approximately 20 inches by 22 inches	Used to perform the lowest pitches
Surdo Resposta	Middle: approximately 15 inches by 16 inches	Used to play the lighter downbeats
Surto-Cortador	Smallest: approximately 12 inches by 13 inches	Used for the syncopated parts

10-120. There are four basic strokes used on the surdo:

- Left hand strikes the surdo. Use this for open tones or to mute the head.
- Right hand strikes the surdo with the mallet (open tone).
- Right hand strikes the surdo with the left hand muting the head (closed tone).
- Right hand strikes the rim (open or closed).

10-121. In figures 10-38 through 10-40, the top line is for the right hand. The bottom line is for the left hand. When the left hand aligns with the right hand, the left hand is used to muffle the tone (closed tone). If the left hand falls between the notes of the right hand, the left hand is used for filler tones. These rhythms form the basis for jazz samba rhythms on drum set.

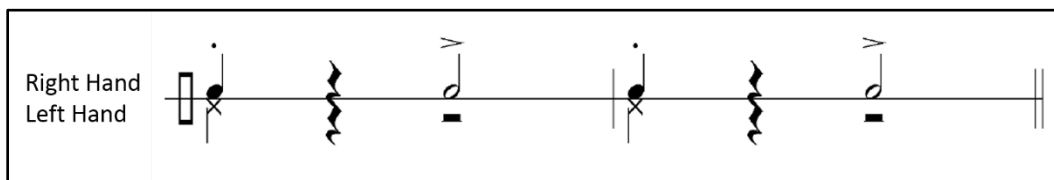

Figure 10-38. Surdo Marcaná Basic Pattern

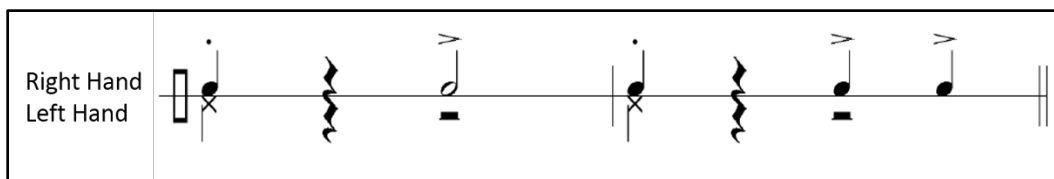

Figure 10-39. Surdo Variation 1

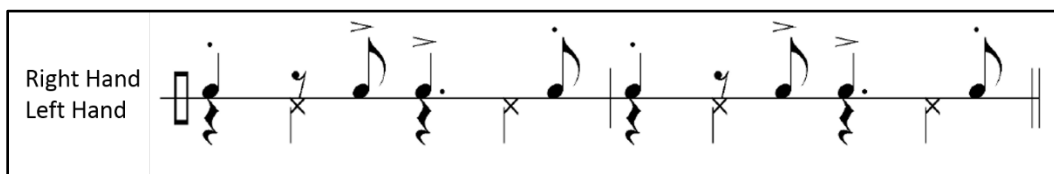

Figure 10-40. Surdo Variation 2

LATIN STYLE SAMPLE SCORES WITH DRUM SET PART INCLUDED

10-122. Figures 10-41 through 10-48 show various Latin style scores with drum set parts included.

The image displays a musical score for a Bossa Nova piece, organized into five staves. The top staff is for the Piano, showing a complex harmonic structure with chords and melodic lines in both treble and bass clefs. The second staff is for the Bass, featuring a simple, rhythmic line. The third staff is for the Clave, showing a characteristic Bossa Nova rhythm pattern. The fourth staff is for Accessory Instruments, specifically Cabasa or Shaker, with a steady, rhythmic accompaniment. The fifth staff is for the Drum Set, showing a complex rhythmic pattern with various drum sounds indicated by 'x' marks.

Figure 10-41. Bossa Nova Score

The musical score is arranged in seven staves, each representing a different instrument. The key signature is one flat (B-flat) and the time signature is common time (C). The score is as follows:

- PIANO:** Features a complex harmonic accompaniment with chords and moving lines in both the treble and bass clefs.
- BASS:** Provides a steady, rhythmic bass line with eighth and quarter notes.
- CLAVE:** Shows the characteristic 3-2-3 rhythmic pattern of the cha-cha.
- ACCESSORY INSTRUMENTS:** Includes a **GUIRO** with a steady, rhythmic pattern of eighth notes.
- CONGAS:** Features a complex, syncopated rhythmic pattern.
- TIMBALES:** Labeled **CHA-CHA BELL**, it features a rhythmic pattern with 'x' marks indicating specific strokes.
- DRUM SET:** Features a complex, syncopated rhythmic pattern.

Below the drum set staff, a legend defines the notation used for the conga and timbale parts:

H= Heel Stroke O= Open Stroke S= Slap Stroke T= Thumb Stroke

Figure 10-42. Cha-Cha Score

The image displays a musical score for a Samba piece, organized into seven staves. The top two staves are for Piano, with a treble clef on the upper staff and a bass clef on the lower staff. The third staff is for Bass, using a bass clef. The fourth staff is for Clave, showing a rhythmic pattern of eighth notes in the first measure followed by rests. The fifth staff is for Shaker, indicated by a bracket and the word 'SHAKER' above it, showing a continuous eighth-note pattern. The sixth staff is for Triangle, indicated by a bracket and the word 'TRIANGLE' above it, showing a continuous eighth-note pattern. The seventh staff is for Drum Set, indicated by a bracket and the words 'AGOGO BELLS' above it, showing a complex rhythmic pattern. The score is divided into four measures, with the first measure containing the primary rhythmic and melodic material, and the subsequent measures showing variations and rests.

Figure 10-43. Samba Score

The musical score is arranged in seven staves from top to bottom:

- PIANO:** Treble and bass clefs. The right hand plays a melodic line with eighth and sixteenth notes, while the left hand provides harmonic support with chords and single notes.
- BASS:** Bass clef. A simple bass line consisting of quarter and eighth notes.
- CLAVE:** Treble clef. A rhythmic pattern of eighth notes with accents, characteristic of a mambo clave.
- CONGAS:** Treble clef. A rhythmic pattern of eighth notes. Below the staff, the strokes are labeled: H T S T H T O O H T S O O T O O.
- BONGOS:** Treble clef. A rhythmic pattern of eighth notes, including a section labeled "BONGO COWBELL".
- TIMBALES:** Treble clef. A rhythmic pattern of eighth notes with accents, often used for the mambo's characteristic "mambo" sound.
- DRUM SET:** Treble clef. A complex rhythmic pattern involving the snare, hi-hat, and tom-toms, with a section labeled "MAMBO BELL".

Legend: H= Heel Stroke O= Open Stroke S= Slap Stroke T= Thumb Stroke

Figure 10-44. Mambo Score

The musical score for Cascara includes the following parts and patterns:

- PIANO:** Melodic accompaniment in treble and bass clefs.
- BASS:** Bass line in bass clef.
- CLAVE:** Rhythmic pattern in 2/4 time.
- CONGAS:** Rhythmic pattern with stroke notation: H T S T H T O O H T S O O T O O.
- BONGOS:** Rhythmic pattern with stroke notation: D F O T D F O T D F O T D F O T. Labeled as **MARTILLO PATTERN**.
- TIMBALES:** Rhythmic pattern with 'x' marks for specific strokes.
- DRUM SET:** Rhythmic pattern with 'x' marks for specific strokes.

Legend:
H= Heel Stroke O= Open Stroke S= Slap Stroke T= Thumb Stroke
D= Dead Stroke F= Fingers (sweep stroke)

Figure 10-45. Cascara Score

The musical score is arranged in a multi-staff format. The top two staves are for the Piano, with a treble clef on the upper staff and a bass clef on the lower staff. The third staff is for the Bass, with a bass clef. The fourth staff is for the Clave, showing a simple rhythmic pattern. The fifth staff is for Accessory Instruments, with a treble clef and a 'CABAJA' marking above the first measure. The sixth staff is for the Congas, with a treble clef and a rhythmic pattern of notes and rests, with the letters 'H T S T O O O O H O S O O O O H T S T O O O O H O S O O O O' written below the notes. The seventh staff is for the Timbales, with a treble clef and a rhythmic pattern. The eighth staff is for the Drum Set, with a treble clef and a rhythmic pattern. At the bottom of the score, there is a legend: H= Heel Stroke, O= Open Stroke, S= Slap Stroke, T= Thumb Stroke.

Figure 10-46. Songo Score

The musical score is arranged in seven staves. The top two staves are for the Piano, with a brace on the left. The third staff is Bass. The fourth staff is Clave, with rhythmic notation. The fifth staff is Congas, with rhythmic notation and letters 'O' and 'S' below it. The sixth staff is Bongos, with rhythmic notation. The seventh staff is Drum Set, with rhythmic notation. A legend at the bottom indicates 'O= Open Stroke' and 'S= Slap Stroke'.

PIANO

BASS

CLAVE

CONGAS

BONGOS

TIMBALES

DRUM SET

O= Open Stroke S= Slap Stroke

Figure 10-47. Mozambique Score

The musical score is arranged in a system with the following parts from top to bottom:

- PIANO:** Treble and bass staves with chords and arpeggios.
- BASS:** Bass staff with a melodic line.
- CLAVE:** Staff with a rhythmic pattern of eighth notes.
- ACCESSORY INSTRUMENTS:** Staff with a **COINBELL** part.
- CONGAS:** Staff with a rhythmic pattern and the lyrics **O T S T O O H T S T O O O T S T O O H T S T O O** written below the notes.
- BONGOS:** Staff with a rhythmic pattern.
- TIMBALES:** Staff with a rhythmic pattern and a **MAMBO BELL** part.
- DRUM SET:** Staff with a complex rhythmic pattern.

Legend: H= Heel Stroke O= Open Stroke S= Slap Stroke T= Thumb Stroke

Figure 10-48. Afro-Cuban/Nañigo Score

Chapter 11

Percussion Accessories

PERCUSSION ACCESSORIES: GONG/TAM-TAM

11-1. Originally, tam-tams were Chinese instruments of indefinite pitch, and gongs were tuned instruments. In 1790, the rarity of gongs in Europe forced orchestras to substitute the tam-tam. Ever since, Western music has used the terms “gong” and “tam-tam” interchangeably. Tuned gongs are still available, but are used rarely in most symphony orchestras.

FUNCTION

11-2. The gong produces a spreading tone of unrelated overtones. It is used for loud, thunderous, climactic passages and to provide solemn Oriental effects. Gong sizes range from 12 to 40 inches. Larger instruments have lower fundamental pitch and slower response (see figure 11-1).



Figure 11-1. Gong/Tam-Tam

11-3. Composers write for the gong with traditional notation. However, duration is normally not indicated so you must make muffling decisions. In most cases, the muffling rule exception that applies to triangle also applies to gong. Refer to the score, listen to the band, confer with the conductor, and use your best judgment to resolve duration questions.

STRIKING IMPLEMENTS

11-4. Because of the instrument’s size, you must use large and heavy mallets to produce maximum tone. The standard gong mallet has a long metal handle with a felt or lamb’s wool covered steel ball on one end. This mallet is used for 80 percent of all gong parts. Use two of these mallets for very loud rolls. The small gong mallet is similar to the standard gong mallet except that it is smaller and lighter. Use two matched mallets for regular rolls.

11-5. You may create a number of special effects with various striking implements. Bass drum beaters produce light, thin, shallow tones. Drumsticks, triangle beaters, and brushes produce soft effects when you use them on the rim of the gong. You can produce a high, whining effect by drawing a bass bow across the edge of the gong. Produce a haunted house effect by rubbing a rubber mallet across the gong. You can produce a low suspended cymbal roll effect or a high, light, delicate, small gong effect with yarn mallets.

TECHNIQUE

11-6. To choose a playing area, you must know which overtones are predominant, what response is needed for the attack, and the required duration of the tone. The center produces a dull, dead attack on impact. A widely spreading tone follows with the lower overtones predominating. This is the slowest response area, and is used when more attack and punch are required

11-7. Striking the gong off-center produces the best combination of high and low overtones, the greatest tonal duration, and the widest dynamic range. The distance off-center is relative to the size of the gong. This playing spot is used when more wash and less initial attack are required.

11-8. Striking the gong at the edge produces the highest overtones. The tone is shallow and of relatively short duration. Response is slightly slower than when striking the gong off-center.

11-9. The characteristic sound of the gong is an immediate decrescendo followed by a quick crescendo. If a faster attack is required, the gong must be primed.

11-10. Priming the gong means striking the gong softly anywhere on its surface to start it vibrating for a faster response at the actual attack. In deciding whether to prime the gong, you should consider the musical function of the gong part and the interaction of the gong part with other instruments (e.g., is the gong sound and attack part of the entrance of the other instruments or is it functionally triggered by the other instrument entrance?).

11-11. The strokes you use on the gong should always be straight-in single strokes. The general rules for stroke technique apply to the gong (see para. 1-12–1-15). You can achieve a roll with one mallet, but it is better to use two. Strokes similar to those you use on suspended cymbal provide better control. Roll in phase to produce an even, smooth, and non-pulsating roll.

MUFFLING

11-12. The gong's slow tone decay usually will force you to muffle it. To muffle the gong completely, put pressure on the back of the gong with widespread fingers and palm. At the same time, apply pressure to the front of the gong with the side of your leg. The more pressure you apply, the quicker the tone is muffled. Be careful of buttons or other uniform items that may cause unwanted noise.

11-13. You can control the overtones by using your hand or the mallet and exerting light pressure against different playing areas. Muffling the center lightly will stop the low overtones while leaving the high overtones ringing. Muffling the edge lightly stops the upper overtones while allowing the low overtones to ring.

11-14. Grabbing the edge of the gong with your hand or rubbing the mallet head across the gong can effect a decrescendo. The decrescendo rate depends on how much pressure you exert. Sympathetic vibrations must be eliminated. A low, droning tone will be noticeably audible when the band stops playing. To eliminate this, cover the gong with a towel or its own cover.

PERCUSSION ACCESSORIES: WOODBLOCK

11-15. Twentieth century composers introduced the woodblock to Western music. Originally used for religious rites and celebrations in Oriental cultures, the woodblock imparts an Oriental flavor to 20th century music.

PHYSICAL COMPOSITION AND CONSTRUCTION

11-16. The woodblock is an idiophone usually made from a rectangular block of wood. Some are made of plastic. Most types have slots $\frac{1}{4}$ inch wide on the two long sides that act as resonating chambers. The tone produced is a penetrating, non-pitched, non-sustaining “tick” or “tock” sound. The playing surfaces are convex as opposed to the flat playing surface of the Latin percussion woodblocks. The block size, placement of the slotting, and density of the wood determine the resonance and pitch of the tone.

11-17. Woodblocks are 6 to 8 inches in length, $2\frac{1}{2}$ to 3 inches wide, and $1\frac{1}{2}$ to $2\frac{1}{2}$ inches deep. There should be at least two sizes available to produce the required effects: large for low tones, and small for high tones (see figure 11-2).



Figure 11-2. Woodblock

STRIKING IMPLEMENTS

11-18. The principal rules for implement choice apply to woodblock (see para. 1-11).

11-19. Using the tip or head of a drumstick produces a high, percussive, hollow, and penetrating effect. This is a good tap dancing effect. The shoulder or butt of the stick produces a lower, more resonant, and very penetrating sound. This is a good horse hoof effect.

11-20. Hard rubber mallets produce the fullest and most resonant sound of all of the implements. Be careful not to strike abusively; these mallets will dent and possibly crack the woodblock.

11-21. Medium rubber mallets produce suitable soft effects where sharp percussive attacks are not needed.

11-22. Hard yarn mallets produce a less percussive attack with a full tone for delicate effects.

11-23. Softer mallets than described will not project the tone. Do not use bell mallets or any other implement that will damage the instrument.

PLAYING AREA

11-24. Playing in the center produces a resonant tone. Playing on the edge over the tone slot will produce a lower and less resonant tone. Do not strike this area abusively hard; it will crack easily. The edge opposite the tone slots and the sides of the woodblock are nodal areas and sound dead. Except for Latin percussion blocks, striking the woodblock on its underside will produce a different tone. This is caused by the slight difference in the size of the resonating cavity formed by the tone slot.

GRIP AND STROKE TECHNIQUE

11-25. The principal rules of stroke technique apply to woodblock (see para. 1-12–1-15). Grip the woodblock on its end over the suspending holes. Hold it at eye level for easy rhythmic passages where only one mallet is needed. Never hold it in your palm; this will muffle it.

11-26. For passages requiring two mallets, place the woodblock on a towel or, preferably, on a woodblock holder mounted on the trap table or stand.

PERCUSSION ACCESSORIES: TEMPLE BLOCKS

11-27. Originating in China, where they are still used for religious rituals, temple blocks were introduced to Western music by 20th century composers. Composers use temple blocks like woodblocks, to add an Oriental flavor to their music. Along with producing an Oriental atmosphere, temple blocks are also used for horse hoof effects, as a woodblock substitute, and for special musical effects such as clock sounds and primitive rhythms.

PHYSICAL COMPOSITION AND CONSTRUCTION

11-28. Temple blocks are idiophones that usually come in sets of five. The tone produced is much like that of a woodblock but mellower and less penetrating. They are carved from wood in graduated sizes to produce high to low tones. They tend to emit a definite pitch, but will blend harmonically because of their short sound decay. Choose a set of temple blocks that produces evenly spaced tones. They need not be tuned to a pentatonic scale or particular pitches, although most commercial temple block sets approximate a pentatonic scale tuning.

11-29. Two types of commercially available stands can be used to mount temple blocks. The choice is up to the player (see Figure 11-3):

11-30. Straight blocks are set up to produce tones from high to low in a straight line. The main advantage is that sight-reading is easier.

11-31. Double-tiered blocks are set up in two tiers with the two highest notes on top, and the three lowest notes on the bottom. This makes sight-reading difficult, but makes certain sticking situations easier.

11-32. Another version of the double-tiered setup has the three highest notes on top and the two lowest notes on the bottom. Some manufacturers use this arrangement exclusively (see figure 11-3).



Figure 11-3. Temple Blocks

STRIKING IMPLEMENTS

11-33. The general rules of implement choice apply (see para. 1-11).

11-34. Using the bead of a drumstick produces a light “tick” sound and the butt of the stick produces a fuller, more resonant “tock” sound.

11-35. Medium hard rubber mallets produce the best all-purpose tone. Softer mallets can be used to produce mellow tones; however, such tones are easily obscured because they cannot penetrate normal musical texture.

NOTE: Drumsticks will dent, crack, and chip the instrument if used abusively. Metal implements, hard rubber, or plastic mallets will damage the soft wood. They should never be used.

PLAYING AREA

11-36. The top center of the front edge produces the best tone. On synthetic blocks, playing nearer the edge of the block will project more evenly throughout the range.

STROKE TECHNIQUE

11-37. The general rules for stroke technique apply to temple blocks (see para. 1-12–1-15). When rolls are required, single stroke rolls are used exclusively.

PERCUSSION ACCESSORIES: CASTANETS

11-38. The following paragraphs discuss the physical composition and construction, types striking implements, and stroke techniques for castanets.

PHYSICAL COMPOSITION AND CONSTRUCTION

11-39. Castanets are idiophones consisting of wooden, spoon shaped clappers that are struck against each other or a sounding board to produce a clicking sound. The wood can be any hard wood, such as— rosewood (the most common), ebony, mahogany, redwood, or snake wood. There are plastic types available but they produce inferior tones.

TYPES

11-40. There are three types of castanets: finger castanets. Machine-mounted castanets, and handle-type castanets. The most commonly used by Army bands are machine-mounted and handle type (see figure 11-4):



Figure 11-4. Castanets

Finger Castanets

11-41. Finger castanets are commonly used by Spanish dancers but are impractical orchestral instruments because there are easier ways to produce similar effects. Playing finger castanets is an art in itself, requiring more practice time than a total percussionist can afford.

Machine-Mounted Castanets

11-42. Machine mounted castanets are spring-mounted on a wooden base that acts as a sounding board. They are played with the fingertips or mallets and are the most practical type to use in a concert band. They are effective on soft passages but cannot cut through thick musical textures.

Handle Type Castanets

11-43. Handle type castanets have one or two pairs of castanets mounted on each side of a handle that serves as a sounding board. They are fixed to the board by a cord or gut string that must be tensioned properly. The

cord must permit the castanets to strike the board freely with control. Handle-type castanets are most commonly used for loud, full passages.

11-44. A variation on the handle-type consists of a pair of castanets mounted on the handle of a modified cake server or putty knife that has enough blade left to attach the castanets. Because there is no sounding board, the castanets produce an authentic Spanish sound. They are played by slapping them into the palm of the hand. A pair in each hand can be struck on a raised knee for fast passages and roll effects.

STRIKING IMPLEMENTS

11-45. Handle castanets are generally played with the hands or fingers. The mounted ones can also be played with soft yarn mallets for a higher volume, but the attack sound is clumsy and sloppy.

STROKE TECHNIQUE

11-46. The rules of stroke technique apply to all castanets (see para. 1-12–1-15) but are essential to the machine-mounted type. Although the shaker type requires a more involved technique, the principal rules apply.

Finger and Machine Mounted Castanets

11-47. Spanish dancers use three rudiments for finger castanets that can be applied to the machine mounted type:

- The Golpe. Single strokes played with two fingers, usually the middle and ring finger of either hand.
- The Double Golpe. Single strokes or golpes played with both hands in unison.
- The Carretilla. Multiple strokes using four fingers of the right hand in a rapid, rolling, clawing motion starting with the small finger. The carretilla is always followed by a golpe in the left hand. The resulting effect is a quick, single stroked, five stroke roll.

NOTE: Machine-mounted castanets must be adjusted for proper response. The springs or cords must be tensioned properly to permit good attacks and rebounds.

Handle Castanets

11-48. Musical dynamics and rhythmic difficulty determine the technique used.

11-49. Forte (*f*) passages can be played in three ways:

- Hold the handles and snap the wrist sharply for each note. This produces a sloppy flam effect characteristic of castanets. For loud passages a shaker castanet can be used in both hands. For very loud passages, use a double shaker type in both hands.
- For a crisper effect hold the castanet in one hand and strike it against the palm of the other hand.
- For loud fast passages use two sets of castanets, one in each hand, alternately striking them against a raised knee.

11-50. Piano (*p*) to mezzo-forte (*mf*) passages can be played in three ways:

- Hold the handle near its end in one hand. Strike the handle, below the castanets, with the fingertips of the other hand. Allow for the delay between the stroke and the sound response.
- Place the handle in the belt or waistband and strike the castanets with the fingertips of both hands. This produces the clearest and most precise sound for soft, fast rhythms.
- Use the first and last techniques as described for the *f* passages, but place a forefinger on the top castanet, allowing only the bottom castanet to strike the sounding board.

11-51. Fortissimo Effect. For very loud parts, substitute slapsticks for castanets. Hold the slapsticks in each hand as you would normally. Use the forefingers to control how far the slapsticks open.

PERCUSSION ACCESSORIES: FINGER CYMBALS

11-52. Since ancient times, Middle Eastern dancers have performed to the rhythms of finger cymbals. Modern composers use finger cymbals to add a Middle Eastern/East Asian flavor to their compositions.

PHYSICAL COMPOSITION AND CONSTRUCTION

11-53. Finger cymbals are idiophones, two or three inches in diameter, made from bronze or brass alloy. In certain Asian cultures they are used as religious instruments, and are important in prayer rituals. They are fitted on the fingers with an adjustable elastic strap or preferably gripped like hand cymbals. They can also be suspended from a triangle clamp and struck. Finger cymbals produce a high shimmering sound with many high overtones sounding. Some overtones are more predominant but not enough to produce a definite pitch. When struck together, finger cymbals ‘sound’ a half-step apart. Finger cymbals blend well with any instrument, regardless of key.

STRIKING IMPLEMENTS

11-54. Finger cymbals are struck against each other or struck with a triangle beater, brass mallet, or plastic mallet. Use the implement best suited for the required attack needed to blend with the musical texture.

PLAYING AREA

11-55. While finger cymbals have the same playing areas as a suspended cymbal, its edge is used most often.

GRIP

11-56. For general concert playing, grip finger cymbals by their elastic straps, between the thumb and forefinger.

STROKE TECHNIQUE

11-57. In concert band, the desired sound is generally achieved by striking the edge of one finger cymbal against the other. Hold finger cymbals at eye level to have visual contact with the playing area, the conductor, and the music, and to project the sound over the band. Be sure to apply basic stroke techniques (see para. 1-12–1-15).

11-58. When playing singly with a mallet, the cymbal should face bottom-up. It should be struck on its edge.

MUFFLING

11-59. Muffle the cymbals with the fingers not involved in gripping.

SPECIAL EFFECTS

11-60. Forte-piano (*fp*) effects can be achieved by muffling one of the finger cymbals after the initial attack and rebound. Because one finger cymbal usually sounds higher than the other, choose the muffled cymbal carefully.

11-61. A vibrato effect will be achieved after striking, by an up-down, wrist motion with the finger cupped to project the sound.

PERCUSSION ACCESSORIES: SLEIGH BELLS

11-62. Jingle bells are attached to a leather strap or wooden handle (as shown in figure 11-5). They can be purchased in complete pitched sets.



Figure 11-5. Sleigh Bells

11-63. Two methods are used for playing sleigh bells:

- The first is to hold them vertically with the handle up, and strike the handle with the fist or open palm. For softer or less precise attacks, grip the handle with some of the hand above the end of the handle and strike the holding fist with either the other fist or palm.
- The second approach is to play the bells in the same manner as a shaker. Use the two-handed shaker technique if the shaking approach is more appropriate to the music. Shaking the bells will produce less articulate rhythms.

11-64. The most difficult technique to acquire is picking them up or laying them down noiselessly. This takes much practice, and no easy method has been devised to do this, so be very careful and take your time.

PERCUSSION ACCESSORIES: RATCHET

11-65. A flat piece of thin wood set against a geared wheel, causing an obnoxious, machinegun-like grinding sound (see Figure 11-6).



Figure 11-6. Ratchet

11-66. The ratchet is played by cranking for the duration of the event, and rolls are played in the same manner as snare drum rolls (in terms of duration). Extra care is necessary for exact starts and stops to ensure correct duration and articulation.

PERCUSSION ACCESSORIES: SLAPSTICK

11-67. A slapstick is a pair of boards held together by a hinge. Larger ones have handles on each board; smaller ones have a spring hinge to help the striking board return to its position (see Figure 11-7). If no commercial slapstick is available (or does not meet your needs), construct one from hardwood boards about two feet long and four to five inches wide. Attach them with a hinge at one end and mount rigid handles about one-third of the way up the length from the hinges.

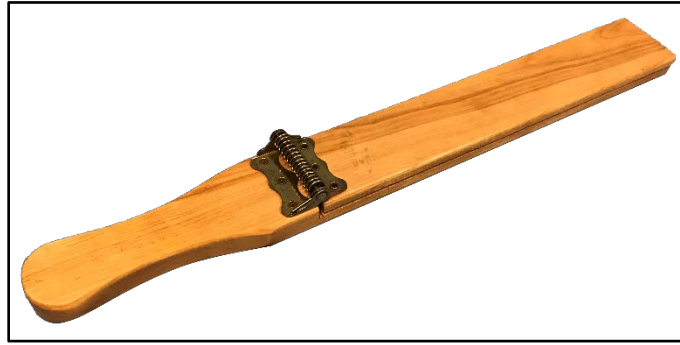

Figure 11-7. Slapstick

11-68. The slapstick is normally played by a slapping wrist motion, causing a loud crack. It is used as a whip effect or a substitute for any loud contact noise. Regardless of the type of slapstick used, do not place the fingers between the striking surfaces at any time during performance.

OTHER ACCESSORY INSTRUMENTS

11-69. The following paragraphs describe some other common accessory instruments: anvil, siren, sandpaper blocks, bell plate, whistle, thunder sheet, horse's hooves, auto horn, wind machine, brake drum, and flexitone.

ANVIL

11-70. Can be a real anvil or a special bar. Strike with a metal beater or hammer.

SIREN

11-71. Sirens are available in a whistle type (large or small) or an automobile type (electric). Hand-crank sirens are available as rental instruments.

SANDPAPER BLOCKS

11-72. As the name implies, sandpaper blocks are just blocks of wood with sandpaper tacked onto them. Use coarse for loud effects and fine for soft effects. The blocks produce the vaudeville soft shoe effect. A cabasa is an acceptable and more durable substitute.

BELL PLATE

11-73. A steel plate suspended with gut or heavy wire and played with a hard beater (a rawhide mallet is best). It can be used as a substitute for instruments such as the— anvil, church bell, fire bell, or train bell.

WHISTLE

11-74. Bird whistles are the most common; they include rooster, hen, nightingale, bob-white, quail, and duck whistles. Also available are slide whistle and police whistle.

THUNDER SHEET

11-75. A large thin, galvanized metal sheet that is shaken for a thunder storm effect. It is most effective when amplified.

HORSE'S HOOVES

11-76. Coconut shells on a slate or brick surface. Temple blocks will also produce the desired effect.

AUTO HORN

11-77. An old squeeze type 'honk' or 'ooga' horn. These are also referred to as klaxon horns.

WIND MACHINE

11-78. A canvas or notched wooden cylinder causing the desired sound when the wheel is turned. Pitch and intensity increase as the cylinder turns faster.

BRAKE DRUM

11-79. Use an actual brake cylinder from an old automobile (see figure 11-8). When struck with a hard mallet (brass mallet, plastic mallet, or small ball-peen hammer), it gives a clear, bell-like tone. Sometimes it is tuned to a specific pitch by grinding. Brake drums are often used in sets of five or more. They can be suspended for best resonance or laid out on a padded table. Use different mallets for different effects. When an anvil is not available, this is sometimes an acceptable substitute.



Figure 11-8. Brake Drum

FLEXITONE

11-80. A small resonant, flexible metal strip with an attached striking ball. Used for glissando effect and microtonal sliding effects.

Chapter 12

Practice and Rehearsal Techniques

PRACTICE TECHNIQUE

12-1. Proper practice techniques will help you to develop skills not yet mastered, as well as maintain skills that have been developed. Before you can prepare a piece of music for performance, you must have mastered all the techniques that you may encounter in the music. A practice session need not be unnecessarily long if it is approached in a logical sequence. Forty-five minutes of practice at a high level of concentration and a goal in mind is more effective than two or three hours of unstructured practice.

12-2. Practice sessions must be as structured as an ensemble rehearsal. When you practice, where you practice, how long, and what you practice are all factors that must be considered when developing your practice session. Each exercise should lay the groundwork for the next set of exercises. Practice sessions should consist of a balance of material including scales, technical etudes, melodic studies, sight-reading, and solos. Proper practice habits must be developed.

METRONOME TECHNIQUES

12-3. Time is one of the major responsibilities of a percussionist. To develop a strong sense of time, you must work with a metronome or other device as much as possible. Start at a slow tempo and gradually work up to faster tempos. To determine the appropriate tempo to work scales, use the tempo in which you can perform your most difficult scale to gauge how fast you should practice. When you reach a point on the metronome that articulation, tone, and technique are not performed properly, decrease the tempo and gradually work your way back up.

12-4. Once you have begun to establish your ability to keep consistent time with the metronome beating on all four beats, vary the beat pattern by slowing down the metronome to half its tempo and practice playing on beats one and three or two and four.

12-5. As you continue to strengthen your sense of time, practice using the metronome beating only on one beat per measure. Have it sound on beat one. Then vary your practice using it to sound on beat two, and continue this pattern until you are comfortable playing with the metronome on any beat.

RHYTHMS

12-6. Rhythmic styles are varied and more open to interpretation than other aspects of music. However, the ability to subdivide correctly remains constant and is an important component in playing various styles in an authentic manner.

12-7. When playing swing, you must understand how the eighth note is subdivided in order to create the proper feel. The swing eighth is generally played as the first two notes of a triplet tied together, followed by the third note. This creates a long eighth followed by a short eighth. Subdividing the triplet properly allows you to create a swing feel by emphasizing beat two and four (see figure 12-1).

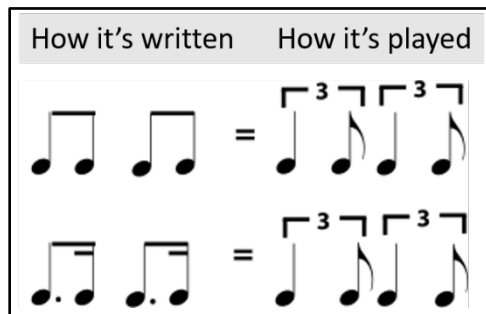

Figure 12-1. Swing Rhythm

12-8. Some of the more common Latin rhythms are the bossa nova, samba, cha-cha, and rhumba. These make up the basic foundation for other rhythms like the mambo, mozambique, cascara, songo, guaguanco and Afro-Cuban 6/8 or 12/8. Many of these rhythms can be used over rock or funk grooves to create a large repertoire of rhythms.

12-9. Rock and blues rhythms consist mostly of straight and shuffle patterns, but there are many variations of these two styles. Through the years the concept of rock rhythms has evolved. To become familiar with the rock styles throughout the years, it is important to listen to recordings from different eras. This will show you how the concept has changed. The rhythms may be similar, but how they are used may vary greatly.

SIGHT-READING

12-10. Sight-reading is an integral part of musicianship. It develops concentration and strengthens the ability to recognize and play rhythms. One sign of an accomplished musician is their ability to sight-read. Sight-reading should be a part of the practice schedule and developed and improved just like any other technical skill.

12-11. When you first encounter a new piece of music, take time to study it. Look for tempo indications, including variations and changes in tempo, time signatures, changes in meter that will change the basic pulse, unusual rhythms, and familiar scale patterns. In addition, think about overall tonality, pitch centers, key signatures, modulations, difficult intervals, arpeggios, scale passages, and accidentals. Pay particular attention to style, the general spirit of the music, articulations, dynamics, and phrasing.

12-12. Before playing the music on your instrument, think it through in your head. Work out specific rhythm problems and difficult scales. Get a feel for the style of the piece and become familiar with the road map.

12-13. A key to improving your sight-reading is improving your basic level of technique. When performing on keyboard percussion instruments, a strong mental picture of the keyboard must be imprinted in your mind. Through serious practice of scale and arpeggio patterns, you can achieve this.

PERFORMANCE CONSIDERATIONS

12-14. Before you begin to perform, there are several factors that you need to keep in mind: playing position, playing posture, and preparation.

PLAYING POSITION

12-15. Allow yourself enough time to assume a good playing position with respect to the instrument(s) you are playing. If playing timpani and you are seated, ensure that the seat height is sufficient to reach the drums and the music stand. If playing drum set, ensure that the drummer's throne and the set are adjusted for your particular physical makeup.

PLAYING POSTURE

12-16. Maintaining a good playing posture means keeping your body generally erect, the instruments positioned between you and the conductor, and your head and eyes directed toward the conductor. Make sure that the music is either between you and the conductor, or, in the case of the drum set, the music position does not restrict your eye contact with the conductor.

PREPARATION

12-17. Review your music before the performance for any key, meter, and tempo changes. Check for special performance markings and pre-marked cues given by the conductor. Ensure your music is in the proper order and that any possible page turn conflicts are identified and resolved.

12-18. To the audience, the visual aspect of a performance is as important as the musical aspect. Remember that the first impression is a lasting impression. The first thing the audience sees is you, the performer. If you look professional, the audience will take that image home with them. The following is a list of factors that influence the appearance of an ensemble: military appearance and bearing; and stage presence.

Military Appearance and Bearing

12-19. Maintaining outstanding military appearance and bearing is not only noticeable to those around you, but also to those in the audience. This is a major part of the lasting impression. As a military musician, you are in constant view of the public and need to strictly adhere to regulations pertaining to appearance and grooming at all times.

Stage Presence

12-20. The way you present yourself on the performance stage is an overall reflection of your competence and confidence. Keep all unnecessary movements to a minimum. If you look lost or disappointed due to a player error, the audience will assume that you are. Good posture is important, not only to your performance, but to your appearance as well. If you look sloppy, odds are you will sound sloppy.

12-21. Be alert and attentive throughout the performance. Remember that the performance begins when the band walks on stage and ends only when the band leaves the stage. Keep your place in the music at all times. Watch the conductor for any cues or gestures that might be directed towards you as well as any changes in tempo or meter. React appropriately if you are recognized by the conductor to stand or bow as a soloist or as a member of the ensemble.

PERCUSSION SETUP

12-22. Setting up is another important part of any performance. In most cases, each section will set up for a performance in the same manner as they rehearse. Section set up is usually left up to the discretion of the conductor, but can be modified by the section leader to meet section requirements. Set up includes having the proper number of chairs and stands, required music for the performance, and any accessories needed for the performance. Percussion setup involves four critical areas: the requirements of the music, available personnel, available equipment, and available space.

REQUIREMENTS OF THE MUSIC

12-23. Check the music to see what instruments are needed, how many personnel are required for the performance, and how many parts, if any, must be substituted or omitted due to lack of equipment or personnel.

AVAILABLE PERSONNEL

12-24. For example, if the part requires four distinct snare drum players, and only two exist in the band, there may be a problem performing this piece, unless you can cross-train the rhythm section players to perform the part. Also, if the piece requires seven players and currently only three are assigned, either there

must be aggressive doubling of parts, or some parts must be omitted. Unless the parts are being used to train personnel, it is better to assign parts according to the strengths of players in the section.

AVAILABLE EQUIPMENT

12-25. Again, if the part requires three xylophone players, and the band is only authorized one xylophone, this may require substitution of equipment or electronic doubling. If the instrument is not currently owned, but is available, check with the supply sergeant or first sergeant about obtaining the instrument well before the commitment. This must be balanced against authorizations of certain types of equipment, and if the extra instrument is not authorized, try a loaner from a local band or rental if the part is that important.

AVAILABLE SPACE

12-26. Whenever possible (and much of the time this is difficult), set up the percussion section exactly as it will be done at the performance site. This will help anticipate any logistic problems with the parts that can be attributed to lack of, or inappropriate, space considerations.

MULTIPLE PERCUSSION PERFORMANCE

12-27. Percussion parts may require one person to play several instruments simultaneously, or several written parts seemingly “at once” during the performance. This is referred to as multiple percussion performance. Several factors are involved in successfully performing multiple parts: ease of reading, ease of transition, and logic of setup.

EASE OF READING

12-28. The parts must be readable. If two or more parts must be combined onto one page for ease of performance, it is sometimes better to rewrite the part than cue other instruments. Ensure that this rewrite is legible. Music printing software is available and sometimes much more efficient, as parts can then be saved and reused.

EASE OF TRANSITION

12-29. The instruments must be accessible and arranged in a logical fashion. If the parts call for multiple-pitched toms, arrange them low to high, similar to a piano keyboard. If the part calls for multiple timbre instruments, also arrange them low to high. If pitch class accessibility is not most important, place the most often played instrument centered on the music stand. Arrange all other instruments in such a way as to be within comfortable arms reach.

LOGIC OF SETUP

12-30. In addition to the instruments, have all mallets, sticks, and other striking implements within easy reach, particularly if you are playing such different instruments as bass drum, snare drum, suspended cymbal, and triangle all on the same part!

NOTES ON SPECIFIC MUSIC STYLES AND TYPES

12-31. This section gives specific guidance for two common styles for Army bands: marches and concert band music.

MARCHES

12-32. Percussion parts for traditional marches usually consist of snare drum, bass drum and cymbals. Drum corps style marches can include quads, mallet percussion, and auxiliary percussion, as well. Some things to watch for in marching parts:

12-33. When there is so separate cymbal part, use the duration of the bass drum attacks to cue cymbal crashes. Otherwise, cymbals are tutti with bass drum (see page 6-1 for more information).

12-34. Extra parts, such as regimental snare drum parts, are designed to be played with descant trumpet parts (if they exist). Usually the combined snare/bass part works fine, but look for separate bass drum/cymbal part.

12-35. Other parts not in “battery” (for example, triangle/bells/timpani parts for Stars and Stripes Forever) can be ignored in a marching setting (unless you are marching with a bell player). Keep the parts available for when you use the piece in a concert setting.

CONCERT BAND MUSIC

12-36. There are two main areas of concern with concert band percussion parts. The first is that the part may not be divided at all, and all of the instruments needed for the entire section (sometimes including timpani) are on one part. If the part is not divided on the page there is the additional challenge of figuring out just how many players you need to cover the parts, and then you will have to check the parts to ensure that no one is overlapping their part with another part that they are assigned.

12-37. The second concern (that sometimes occurs due to poor editing or less than knowledgeable composers) is that the parts may be divided, but the publisher’s organization is impractical due to personnel, space, or equipment constraints.

12-38. When reviewing a piece, look at the composer’s organization first. Sometimes it is the most logical arrangement of equipment and players. Next, look at your own band and the available players. If you use the composer’s version, do you have the bodies to cover all of the parts? Last, look at the equipment needed. Do you have all of it? If not, can you get it?

PERSONNEL AND EQUIPMENT LIMITATIONS OR CONSTRAINTS

12-39. Army percussionists sometimes have to cope with personnel or equipment constraints. The following paragraphs describe the best way to handle these issues.

PERSONNEL ISSUES

12-40. To properly perform most contemporary concert-band/wind-ensemble literature, rhythm section personnel must augment the MOS percussionists. For the smaller sections, the MOS percussionists must cover snare drum, timpani, and drum set or auxiliary percussion parts. Non-MOS percussionists must cover all other parts. Usually (but not always), there is at least one experienced MOS percussionist that can act as a subject matter expert to assist the non-MOS percussionists.

12-41. When using non-MOS percussionists in a marching band setting, it is advisable to have a predetermined list of standard marches. This practice aides the non-MOS percussionists’ ability to prepare, and reduces overall training time.

EQUIPMENT ISSUES

12-42. Equipment authorization and policies differ greatly between bands, and your best source of information is the supply NCO in your band. Most only have one each of the mallet instruments, and some do not have the more exotic instruments (e.g., crotales or celeste). See CTA 50-909, Table 78, for specific large instrument authorizations. In these situations, available budget and proper planning will determine whether you purchase the instrument, rent the instrument, or arrange a loan from a school or another band.

PRIORITY ASSIGNMENT OF PARTS

12-43. If there are a limited number of players available for rehearsals or performances, here is a workable priority of parts to cover:

- 1. Snare drum/bass drum/cymbals (if only two players, play SD/BD parts on drum set).
- 2. Timpani.
- 3. Auxiliary percussion (as much as can be covered).

- 4. Mallet percussion (this may move up if solo passages need to be covered. In that case, omit the auxiliary parts).
- 5. “Junk track” toys and optional percussion parts.

REHEARSAL AND CONCERT ORGANIZATION

12-44. The section leader should assign parts as soon as the concert order is set. This allows for more direct choreography of movement between parts and helps the flow of the concert from the point of view of the percussion section.

12-45. In rehearsals, do not cover for missing players unless the missing part is higher on the priority list. Shift to cover the most important parts (e.g., solos), and stay as much as possible on the part assigned. For percussion majors, this might seem boring, but it will ensure a cleaner and more polished performance. For some percussion minors, the consistency of time on a specific part may be the only way to ensure a clean performance.

12-46. In the concert, if you have rehearsed as you perform, the performance should be smooth. If things go wrong in performance, remember that the only one who knows is you until you show the audience your mistake (i.e. facial expression, body gestures, or mouthing expletives). Practice your stage presence as you do your part. If you adhere to these guidelines then your performances should go without a hitch.

MAINTENANCE OF EQUIPMENT

12-47. All issued equipment and accessories must be kept serviceable at all times. It is an individual responsibility to ensure the serviceability of equipment. Mission effectiveness will suffer when serviceability and maintenance are neglected. Refer to Task Number 514-441-1059, Perform Maintenance on Assigned Instrument, Percussion (see References). It is understood that proper playing implements (e.g., sticks and mallets) will be present at all rehearsals and performances.

Appendix A

Percussion and Latin Terms and Definitions

Agogó

A percussion instrument of West African origin, the agogó is essentially a two-note clapperless double-bell, joined by a curved piece of metal and struck by a stick. Used in the African-derived religions of Brazil, it is one of several new percussion instruments introduced to the United States by Brazilian musicians during the 1970s.

Aguinaldo

Though they are sung around Christmas, Puerto Rican aguinaldos cover a wide range of social and topical as well as religious subjects. They are sung solo or by a choir and are based on the ten-line décima, which traveled from Renaissance Italy to Spain, and thence to virtually all of Latin-America.

Alignment

In drum set performance, the performance error that occurs when one or more parts do not line up rhythmically with the other parts, making the pattern feel awkward. In isolation, the parts are being played correctly. In a correctly aligned pattern, all limbs playing the correct part in the correct place in the measure; a misaligned part is one where the part is being played metronomically correct (even if you isolate the part) but the part does not line up with the other voices in the drum set. See also phasing.

Baiáo

One of many rhythms of the African-influenced Northeast of Brazil, the baiáo became popular in Rio de Janeiro around 1950 as a reaction against the increasingly international popular music of the time. Its most famous exponent, Luis Gonzaga, made the accordion-led regional group extremely popular. A few American jazzmen experimented with the baiáo in the early 1950s, but it was too unsuccessful to be called a bridge between the samba and the bossa nova.

Bajo Sexto

A form of 12-string guitar used as an accompanying instrument by Chicano singers.

Balance

In drum set performance, the lack of predominance of any one voice unless dictated by musical requirements.

Barrio

El The district. The districts or neighborhoods of Latin American towns are called barrios, so when Latin immigrants settled in large numbers in New York's East Harlem, it became The District. The nickname has stuck even though many major American cities now have barrios.

Batá Drums

Double-headed drums shaped like an hour-glass with one cone larger than the other. Sacred to Yoruba religion in Nigeria, they are also necessary to Cuban and American lucumí worship. A number of salsa musicians have recently begun using batá drums in secular music.

Berimbau

A Brazilian musical bow of Congo-Angolan origin. An open goured resonator is held against the chest, and the instrument's string is tapped with a stick.

Bolero

The Cuban bolero, originally a mid-paced form for string trios, became very popular internationally, usually in a slower and more sentimental form. The modern bolero is a lush romantic popular-song form, largely distinct from salsa, and very few singers are equally good at both.

Bomba

Originally a Puerto Rican three-drum dance form of marked west-central African ancestry, the bomba is especially associated with the Puerto Rican Village of Loiza Aldea. In its old form it is still played there at the festival of Santiago, and New York Puerto Rican folk revival companies also perform it from time to time. Even in the dance band form introduced by Rafael Cortijo in the late 1950s, the bomba's melodies, as well as rhythmic pulse, are strongly African.

Bongó

Small double-drum played resting on the calves of a seated musician, called a bongosero. Its heads are tuned a fourth apart. Widely used in Cuban music of many sorts, especially the quartets and sextets playing sones, and an integral part of the salsa percussion section. In salsa, as in earlier string-based groups, the bongó tends to be played more ad lib than other drums and provides a complex counterpoint to a number's main rhythmic pulse. The basic toque for the bongó, called the martillo, can be rendered onomatopoeically as "Dicka-docka-dicka-ducka."

Bossa Nova

A Brazilian fusion of cool jazz elements with various Brazilian rhythms, including the baião but particularly the samba. Often wrongly considered Afro-Brazilian, it is a sophisticated and recent form developed by hip musicians and avant-garde poets. Most were white, though Bola Sete a leading bossa nova guitarist, is an exception.

Broken Time

In swing, time that deviates from the basic pattern yet maintains tempo and groove. For example, bebop patterns that do not use any ostinato for timekeeping.

Bugalú

The Latin bugalú was a somewhat simplified and more sharply accented mambo with English lyrics, singing that combined Cuban and black inflections, and R&B influenced solos. For a few years the bugalú, and a lesser known Puerto Rican rhythm, the jala jala, were staples of the "Latin soul" movement.

Buzz Roll

A snare drum roll so closed that individual sounds blend into a continuous tone.

Cencerro

Large hand-held cowbell played with a stick, producing two notes according to where it is struck. In Cuban music and salsa, usually played by the bongó player when the band goes into the "ride" or mambo, after the main vocal sections.

Chachachá

The chachachá is said by some to have derived from the second section of the danzón, and by others to be a slower mambo. It was sometimes called a double mambo in New York, because its basic dance step was the mambo with a double step between the fourth to first beats. The chachachá developed around 1953 in the hands of Cuban Charangas, most notably the Orquesta Aragón.

Charanga

A Cuban dance orchestra consisting of flute backed by fiddles, piano, bass, and timbales. Charangas tended to play different dances from the Afro-Cuban conjuntos, the most characteristic being the danzón. Charangas ranged from large society units to small street-bands. Modern charangas use bongó and conga in the rhythm section and have taken on many more Afro-Cuban elements than their predecessors.

Cierre

Essentially a break, the cierre ranges from a two-note bongó phrase to a complicated pattern for a full band more like a bridge-passage. Good cierres are fundamental to salsa structure, but they are so varied and used in so many ways that closer definition would be misleading.

Clave

An offbeat 3/2 or 2/3 rhythmic pattern over two bars. The basis of all Cuban music, into which every element of arrangement and improvisation should fit. Clave is an African-derived pattern with equivalents in other Afro-Latin music. The common 3/2 Cuban clave varies in accentuation according to the rhythm being played. Clave seems to be part of the inspiration for the two-bar bass patterns in modern black music. 2/3 reverse clave is less common, though the guaguancó uses it.

Claves

Two strikers of resonant wood used less frequently in salsa than in earlier Cuban music. The claves player usually plays the basic clave pattern (see page 10-9), which is normally implied rather than stated by modern bands. Many variants of claves exist throughout Latin America.

Collar

That portion of a drum or timpani head which extends from the hoop to the edge of the shell.

Conga Drum

A major instrument in the salsa rhythm section, the conga is literally the Congolese drum, and it began life in the Afro-Cuban cults. Arsenio Rodriguez is said to have introduced it to the conjuntos on a regular basis, and Machito's Afro-Cubans were the first to use it on New York bandstands. There are several types of conga, including the small quinto, a solo improvising the instrument; the mid-sized conga; and the large tumbadora. Played by an expert, the conga is capable of a great variety of sounds and tones, not only from the different ways of striking or rubbing the head, but through raising the instrument from the ground when it is played held between the knees. A conga-player is called a conguero or congacero.

Conga Rhythm

The Cuban conga was originally a carnival dance/march from Santiago de Cuba, with a heavy fourth beat, but the rhythm is common to carnival music in many parts of the New World. The conga rhythm is more easily simplified than most Cuban rhythms and was a natural for nightclub floor shows. It never became permanent in mainstream Latin music, though Eddie Palmiere introduced a modified version called the mozambique in the late 1960s.

Conjunto

Cuban conjunto sprang from the carnival marching bands and combined voices, trumpets, piano, bass, conga, and bongó. Arsenio Rodriguez ran a seminal Cuban conjunto that used the smokey tone of the tres (see page A-9) to balance the brass, and over the years conjuntos began adding a trombone or even in New York substituting trombones for trumpets. The chicano conjunto consisted of an accordion lead, guitar and/or bajos sexto (see page A-1), often bass, and sometimes spoons, with an additional bongo or other Cuban-derived percussion during the 1960s. Used strictly for instrumental dance music until the 1930s, during the 1940s it became the standard backing for corridos, rancheras, and other vocal forms. The Puerto Rican conjunto, the basic group of jibaro country music, consisted of cuarto, guitar, and güayo scraper, though trumpet and/or clarinet were added at various times, and accordion-led conjuntos playing danzas and waltzes for dancing were not uncommon.

Contradanza

17th and 18th century dance of French origin from which many Latin American ballroom dances derive via mainland Spain, including the danzón and the danza.

Coperto

Covered.

Coro

The chorus. In salsa, the two or three-voice refrains of two or four bars sung during montunos. The lead singer improvises against the refrains. Coros are used in various ways in arrangements; as reprises or, by an alteration of the refrain, to establish a change of mood.

Corrido

This Mexican and Chicano ballad form developed during the 19th century and reached its peak during the first half of the 20th. Pure folk ballads in their simplicity, detail, and deadpan performing style, the corridos were the history books, news reports, and editorials of the illiterate. They chronicled the whole the Mexican Civil war, almost all notable crimes, strikes, and other political events, and many other subjects.

Cuatro

A small ten-stringed guitar, one of the many guitar variants to be found in Spain and Latin America. The cuatro is a major instrument in Puerto Rican jibaro country music.

Cuica

A small Brazilian friction drum with a tube fastened to the inside of the drumhead, which is rubbed to produce a squeaky sound. Based on the same principle that children use with a wetted finger and a window pane, but infinitely more varied. The cuica became a familiar sound in 1970s disco music, jazz, and salsa.

Damp, Dampen

Stop vibration suddenly by contact with fingers or hands.

Danzón

A Cuban ballroom dance derived from the contradanza in the late 1870s. It was regularly played by flute-and-fiddle charangas until the early 1950s. The danzón bears the mark of Europe and its first section was usually a promenade, but its charm is notmerely nostalgic. Its melodies echo from time to time in modern salsa.

Descarga

The word means discharge and is a Latin musician's slang term for a jam session. Descargas occupy a position midway between salsa and Latin-jazz, since they tend to preserve the Cuban structures yet contain far more jazz soloing than does salsa.

Feel

Knack, facility, or skill often deriving from an innate ability. In drum set performance, feel refers to the overall effect of the pattern on the listener (music as a transcendent art form).

f

Forte. Loud

fp

Forte-piano. Loud then soft

Groove

To execute with maximum control and effect. In drum set performance, the organization of ideas and notes. Metronomically correct patterns that groove have dynamic shadings that effect the overall context of the pattern. A pattern is said to groove when there is correct alignment and an absence of phasing. See also alignment and phasing.

Guaguancó

The mid-paced guaguancó has African roots and was originally a drum form related to the rumba. Though often played 4/4, it has strong 6/8 feel. The basic rhythm is traditionally carried by three congas and usually includes a good deal of solo drumming. The theme of a modern guaguancó is a somewhat loose melody line. It is one of the few 2-3 reverse clave forms.

Guajeo

A riff in the charanga style, especially for violin. Functionally, guajeos tie the melodic and rhythmic elements of a number together, acting as a sort of trampoline for the flute and other solos. They are melodic patterns firmly based on the basic clave and tumbao.

Guajira

The slow guajira came from the Spanish-Cuban music of the guajiros. Much of its feeling comes from Hispanic melodies and guajeos that were originally, and often still are, played on the tres. The guajira is similar to the slow son montuno but is more delicate and less driving. Its lyrics frequently use rural nostalgia.

Guajiro Music

The Spanish-derived idiom of the Cuban farmers. The main instruments are the tres, guitar, and percussion, and the main form includes the décima, a ten-line verse from the 17th-century Spain.

Guaracha

The original Cuban guaracha was a topical song form for chorus and solo voice, with improvisation in the solo. It was presented in 3/4 and 6/8 or 2/4 time signature. The guaracha developed a second section, employed for much improvisation, as in the son montuno. It appeared to have almost died out in Cuba by the 1930s, yet it is now one of the forms commonly used by salsa groups; a fast rhythm with a basic chicka-chicka pulse. Its last section is the probable source of the instrumental mambo. The guaracha is said to have originated in 18th-century maisons d'assignation and its lyrics are still often racy and satirical.

Güayo

See Güiro.

Güiro

A scraper. The Cuban and Puerto Rican güiro, often called güayo in Puerto Rico, is made from a notched gourd and played with a stick. Poor players produce a steady ratchet-like sound. Skilled ones provide endless, crisp counterrhythms against the rest of the percussion section. The güiro, like maracas, is usually played by a singer. In the Dominican Republic, the güiro, also called the güira there, is made of metal and played with a kind of metal fork. The metal instrument's harsh sound adds a zest to country merengue playing, but it is rarely used in salsa.

Habanera

Cuban dance of Spanish origin, the first major Latin influence on American music around the time of the Spanish-American War. Provided the rhythmic basis of the modern tango, which makes its influence in 20th century American music difficult to trace.

Inspiración

Inspiration, an improvised phrase by a lead vocalist or instrument.

Jíbaro Music

The jibaros are the mountain farmers of Puerto Rico, and their music is the most strongly Hispanic part of the island's folk tradition. Mostly string-based, jibaro music uses many Spanish-derived forms, including the ten-line décima verses-which a good singer must be able to improvise. A notable instrument is the small cuatro guitar. Many fine jibaro musicians, including singers Ramito and Chuitin, and cuatro player Yomo Toro, live in New York. Though various Puerto Rican salsa singers had used occasional jibaro inflections, Willie Colon brought the style into salsa by hiring Toro for a Christmas album in 1972.

Latin Jazz

A hybrid of jazz and Latin music. The term could cover anything from a Cuban number with a couple of Louis Armstrong phrases, to a straight jazz number with a conga, but is best confined to crosses with a more or less full Latin rhythmic section. It may also combine several Latin and jazz elements, and an instrumental frontline.

Latin Rhythms

The basic meter of salsa is 4/4, organized by the two-bar clave pattern. The individual forms are not simply “rhythms” that can be tapped with a pencil, but combinations of rhythmic pulse, melodic phrases, speed, song forms, and so on.

Latin Rock

A hybrid of rock and Latin elements. Most commonly rock-oriented guitar and keyboard solos are played over salsa-derived rhythms, but often rock and salsa rhythmic elements are blended; bands may use sections with a salsa coro, and build rock solos out of Latin guajeo.

Latin Soul

Hybrid style from the late-1960s, combining salsa and rhythm and blues elements. Latin soul, which was based on early rhythm-and blues and the bugalú, grew up among East Harlem and Bronx teenagers, who used both Spanish and English lyrics over a music that was somewhat more Latin than black.

Lucumí

Cuba’s most widespread African-derived religion. Its theology is based on the faith of the Nigerian and Dahomeyan Yoruba people, and Yoruba is the liturgical language of Cuban lucumí. In Latin-American terms, luccimí is one of many African-derived faiths, and is widespread in Puerto Rico (and the Latin United States) under the general name of santería. Lucumí gave important elements to modern salsa, including much of its rhythmic basis, several songs, and a great deal of African melodic flavor. Many modern salsa musicians, especially in New York, are adherents of lucumí, or santería, and the sacred batá drums are coming back into use in secular music.

Mambo

An Afro-Cuban form that came out of the Conolese religious cult. The big band mambo of the 1940s and 1950s developed characteristic contrasting brass and sax riffs, which many musicians regard as stemming from the last section of the guaracha.

Mambo Section

A section of contrasting riffs for salsa frontline instruments, setting trumpets against saxes or trombones, for example, sometimes under an instrumental solo. The section was said to derive from the guaracha, and got its name during the late 1940s and early 1950s.

Maracas

A tuned pair of rattles made from gourds filled with pebbles or seeds, one of a wide range of America-derived rattles. A skilled maraca-player (e.g. Machito) plays a subtle role in the polyrhythmic counterpoint.

Mariachi

Mexican strolling groups of (usually) semiprofessional musicians. Originally string orchestras, but since the 1940s they have become trumpet-led ensembles. Their name stems from a corruption of the French marriage, since they were frequently hired for weddings.

Marimba

A form of xylophone with wooden slats over resonators. The name is African, but the mariamba is widespread in western Columbia, parts of Mexico, and in particular Guatemala. Marimba groups were very popular in the United States during the 1920s.

Marimbula

A bass descendant of the African finger-piano, the marimbula consists of a wooden box with prongs of metal fastened to it, and tuned to play a series of bass notes. The marimbula was common in Cuba and the Dominican Republic, as well as in several non-Latin Caribbean islands.

Maxixe

An old Brazilian dance derived from an earlier local ballroom dance heavily influenced by the early 20th century tango, It was briefly popular in the United States around World War I, but never caught on to any permanent extent.

Merengue

Though dances by this name are found in many countries, the merengue is originally from the Dominican Republic, where it dates back at least to the early 19th century. The modern merengue has a notably brisk and snappy 2/4 rhythm, with a flavor very different from the somewhat more flowing Cuban and jaunty Puerto Rican dances. The country form, for accordion, tambora drum, metal scraper, and voice, is heard everywhere in the Dominican Republic. The big band version of Dominican bands like Johnny Ventura's and Felix del Rosario's is often heard at New York concerts.

mf

Mezzo-forte. Moderately loud.

mp

Mezzo-piano. Moderately soft.

Montuno Section

A vehicle for improvisation in Cuban and salsa numbers, based on a two or three-chord pattern repeated ad-lib under the instrumental or vocal improvisations. The piano often maintains a repeated vamp of guajeos, a process known as montuneando.

Orquesta Típica

A Typical Orchestra. From Cuba, a now extinct type of group, combining a flute and two clarinets, with timbales prominent in the rhythm. In Mexico, a group organized by "trained" musicians to present cleaned-up versions of folk and popular music.

Pachanga

The pachanga was a rage among New York Latin teenagers around 1961, as played by the then hugely popular charangas. There is some dispute as to its origins. It seems to be Cuban, but it never reached the popularity there that it enjoyed in the eastern United States. It had a fast, syncopated ta-tum ta-tum pulse. The pachanga died out because the dance involved proved to be too energetic for most.

Phasing

In drum set performance, the performance error that occurs when one voice or part is being performed incorrectly, thereby making the pattern feel awkward. In isolation, the part is being performed incorrectly (usually an incorrect interpretation of the rhythm or style). An "out of phase" part is one where the specific limb is not being played correctly, so it seems misaligned, but if you isolate the part in question, there is a variance in note values that renders it incorrectly performed. See also alignment.

p

Piano. Soft

ppp

Pianississimo. Very very soft.

Playing Spot

Point on the head, bar, tube, or surface where the beater should strike for maximum resonance.

Plena

An Afro-Puerto Rican urban topical song form said to have been developed in Ponce during World War I. The plena has four or six-line verses, with a refrain. Lyrical content is social comment, satire, or humor. Instrumentation has ranged from percussion through accordion or guitar-led groups to various dance band formats. Its most famous composer and exponent was Manuel Jiménez, known as Canario. It has been a minor influence on salsa through the work of Rafael Cortijo in the late 1950s and Willie Colon in the 1970s.

Ranchera

The ranchera, developed in the nationalist theater of the post-1910 revolution period in Mexico, became very much the equivalent of United States commercial country music. Professional singers developed an extremely emotional style, one of whose characteristics is a held note at the end of a line, culminating in a "dying fall" that could drop a third or more. Rancheras became an important part of

Chicano music from the 1950s onward as moved from a folk-popular form to a greater professionalism.

Rumba

Most of what Americans call rumbas were forms of the son which swept Cuba in the 1920s. The Cuban rumba was a secular drum form with many variants, including the guaguancó and the Columbia, though modern musicians tend to regard all these as separate. Its descendent variations can be heard in New York parks any summer weekend, played by groups called rumbas or rumbones. By analogy, a percussion passage in a salsa number, or a percussion-only jam session, is sometimes called a rumba or rumbón.

Salsa

A contemporary word for hot, up-tempo, creative Latin music, it means gravy or sauce. Originally it was used as a descriptive like 'swinging' or 'funky'. The origins of the current usage are obscure, but it began to circulate in the late 1960s.

Samba

An African-Brazilian dance with several variations in different parts of Brazil. The best-known are the urban sambas, said to derive from the maxixe and the highly persuasive sambas of the carnival "schools" of Rio. The characteristic shuffling 2/4 rhythm, fused with jazz, was part of the bossa nova.

Scoperti

Uncovered.

Secco

Short (Italian). Used to denote a note that should be immediately dampened.

Septeto or Sexteto

The Cuban septetos and sextetos of the 1930s played mostly sones and boleros. They were trumpet-led string groups, usually with tres, guitar, maracas, bass and bongó. Famous groups included the Septeto Nacional and the Sexteto Habanero. The music they played fell somewhere between the guajiro string groups and the brassier conjuntos. Septeto trumpet style is singularly lyrical, moving between 19th-century brass-band cornet and jazz in its inspiration. The Septeto style as a whole is subtle, crisp, and charming.

Shekere

An African-derived rattle made of a large gourd with bead held by a string net on the outside. It is one version of a rattle common in Africa and African-Latin America and works on the opposite principle from maracas.

Son

The son is perhaps the oldest and certainly the classic Afro-Cuban form, an almost perfect balance of African and Hispanic elements. Originating in Oriente province, it surfaced in Havana around World War I and became a popular urban music played by string-and-percussion quartets and septetos. Almost all the numbers Americans called rumbas were, in fact sones. El Manicero (The Peanut Vendor) was a form of son derived from the street cries of Havana and called a pregon. The rhythm of the son is strongly syncopated, with a basic "chicka-CHUNG" pulse.

Son Montuno

A reverse clave (2-3) form, usually mid-paced or slow, with a pronounced "CHUNGchicka" feel. The son montuno developed as a separate form from the general son tradition. It was, like the guaracha, one of the first forms to include a second, improvised section, the montuno. Though it is not fast, the Afro-Cuban son montuno has an intense, almost relentless quality.

Sonero

In the strict sense, a man who sings or plays the Afro-Cuban son, but now the improvising lead singer in the salsa style. A good sonero improvises rhythmically, melodically, and verbally against the refrain of the coro. The word guarachero is a synonym, though less used.

Tambora

A double-headed drum, basic to the Dominican merengue. It is played with a single stick, while the other head is damped by hand to give tonal variety.

Tango

Probably the world's best known dance after the waltz, the modern tango developed in Argentina at the beginning of the 20th century. It took its rhythm from the Cuban habanera and the Argentinian milonga, and its name probably from the Spanish tango andalúz.

Timbales

A percussion set-up consisting of two small metal drums on a stand, with two tuned cowbells, often a cymbal and other additions. The timbales descended from a small military dance and concert bands. They were originally confined to the charangas and orquestas típicas, to which they imparted a distinctive, jaunty, march-like rhythm, but during the 1940s they came into wider use. The timbales are played with sticks, with the player striking heads, rims, and the sides of metal drums. This, plus cymbal and cowbells, makes for a varied instrument. A standard timbales beat, the abanico, is a rimshot-roll-rimshot combination.

Tipico

An imprecise but extremely important concept in modern salsa. Literally it means typical or characteristic, but it is more generally used to identify the downhome, rural, popular styles of the Latin countries. Thus, the Cuban tipico music that became so important in New York in the 1960s and 1970s was basically conjunto and charanga music. But the septetos are also tipico, since their style is simple and popular rather than bourgeois.

Toque

A beat, but essentially a standard rhythmic phrase for percussion. Many toques derive from African religious drumming, in which particular rhythmic patterns were used to summon individual gods. A Latin percussionist is judged not by their energy level, but by their knowledge and use of standard toques and variations in their improvisations and support of the band.

Tres

A nine-string Cuban guitar. It is a mainstay of guajiro music and of the Afro-Cuban septetos. The tres was established as an important part of the Cuban conjunto by Arsenio Rodriguez, himself a fine player. The instrument came into New York salsa during the Cuban típico revival of the late 1960s and early 1970s.

Tumbao

A repeated rhythmic pattern for bass or conga drum. Based on the fundamental clave, the bassist's tumbaos provide the scaffolding for the constant rhythmic counterpoint of the percussionists.

This page intentionally left blank

Appendix B

Drum Set Styles

BASIC STYLES

B-1. Every working drummer should have a command of these basic styles.

SWING IN 2

B-2. Notice in the Swing in 2 (figure B-1), there is “space” for the half note bass line. This is implied when you play the written part, measure 2, on the ride cymbal. This breaks up the “swing” time pattern and allows for the unobtrusive entrance of the bass player. Even though the eighth notes are written straight in this example, swing the eighth notes. The degree of swing will depend on the tempo.

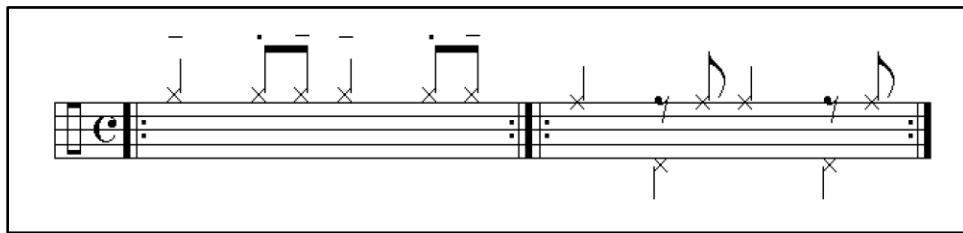

Figure B-1. Swing in 2.

SWING IN 4

B-3. The basic Swing in 4 (figure B-2) has no bass drum written, because in all but the oldest swing forms, the bass drum was not a dominant voice. It was used historically to support and enhance the sound of the upright bass, but this is no longer necessary. With the advent of bop drumming influencing modern swing styles, the bass drum is an independent voice used only when needed for kicks and fills. As in the Sing in 2, swing the eighth notes.

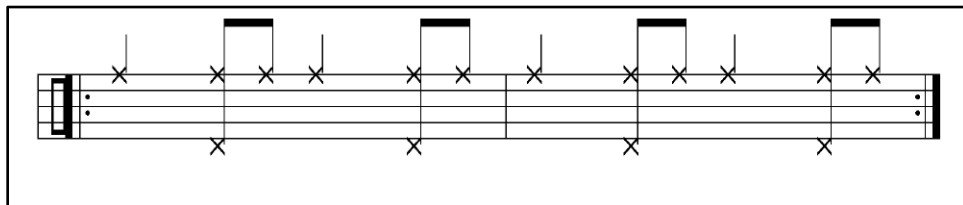

Figure B-2. Swing in 4.

ROCK

B-4. This is about as basic a rock beat as you can get (figure B-3). Rock feels in general are eighth-note based.

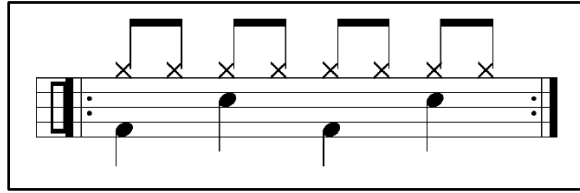

Figure B-3. Rock example.

FUNK

B-5. Again, this is about as basic a funk beat as you can get (figure B-4). The main difference between rock and funk is the prevalence of the sixteenth-note patterns. It is not necessary to play a constant stream of sixteenth notes in order for it to be funk, but the underlying rhythmic pulse should be the subdivided beat. This can be implied with the drums and more obvious in the horn or rhythm section lines.

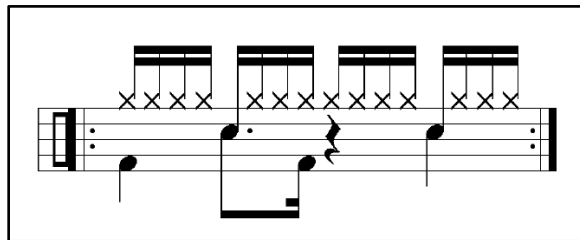

Figure B-4. Funk example.

LATINS (ALSO SEE CHAPTER 10)

B-6. The following paragraphs describe some common Latin drum set rhythms: Bossa Nova, Rhumba, Cha-Cha, Samba, and Mambo.

Bossa Nova

B-7. This style is authentic for songs like “The Girl from Ipanema” (see figure B-5). The bossa clave in this example can be reversed without losing authenticity. For audition purposes, establish the written part and this clave direction for one song section before varying.

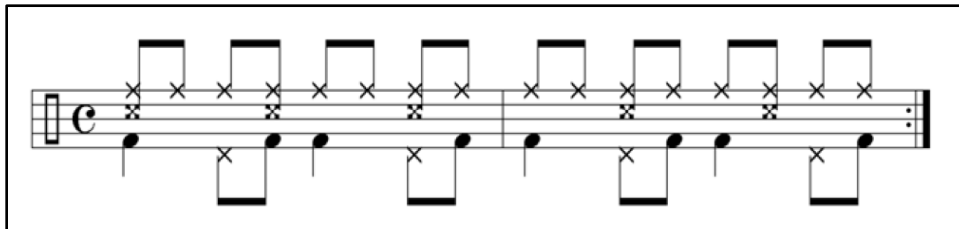

Figure B-5. Bossa nova.

Rhumba

B-8. The Rhumba, and its close relative, the bolero, is a relatively slow dance rhythm (figure B-6). The hands should be approached as if playing hand drums. For audition purposes, establish this pattern (at least one song section) before varying.



Figure B-6. Rhumba.

Cha-Cha

B-9. The Cha-Cha is a slow dance rhythm (see figure B-7). The left hand part mirrors the conga player. For audition purposes, establish this pattern (at least one song section) before varying.

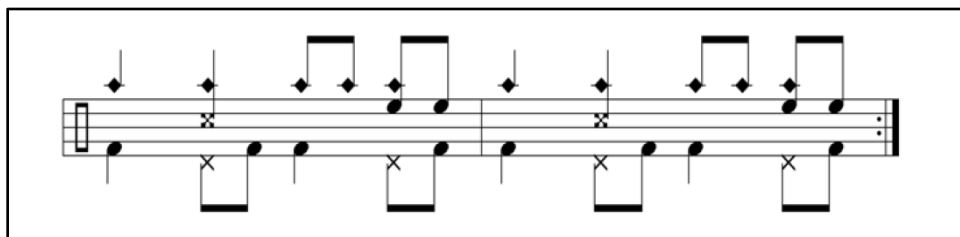

Figure B-7. Cha-Cha.

Samba

B-10. This is the “old school” samba. It is the basis from which we derive all other forms of samba, and is based on a variation of the surdo pattern (see figure B-8).

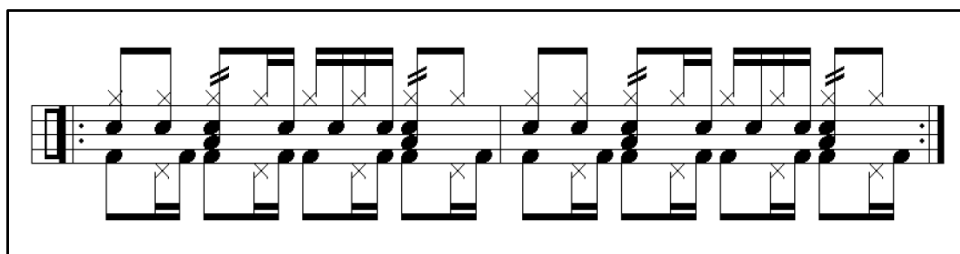

Figure B-8. Traditional samba.

B-11. Figure B-9 shows one of many possibilities for a contemporary samba that might be used in a jazz band or combo format.

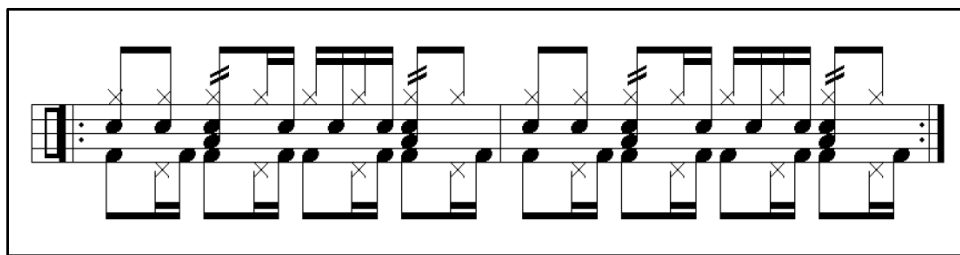

Figure B-9. Contemporary samba example.

Mambo

B-12. The mambo beat (figure B-10) is the basis for all of the duple-meter based advanced Latin beats. Correct interpretation of this rhythm will imply the 2-3 clave rhythm. For audition purposes, establish this pattern (at least one song section) before varying.

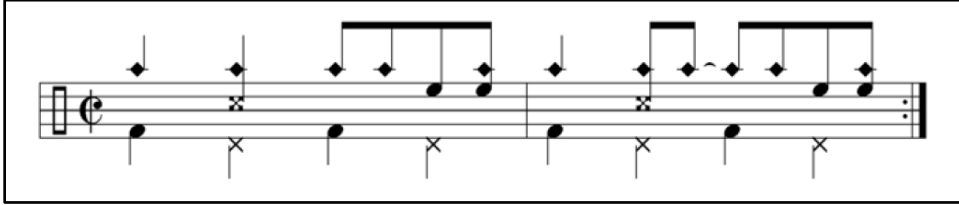

Figure B-10. Mambo.

ADVANCED STYLES

B-13. Some advanced styles that may be encountered by Army percussionists are: afro-Cuban, songo, cascara, and mozambique.

AFRO-CUBAN 6/8

B-14. Shown here in its 12/8 relative, this is Latin compound time with a 3:2 clave (see figure B-11).

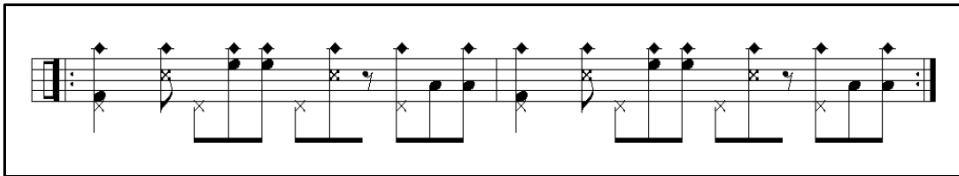

Figure B-11. Afro-Cuban/Nañigo.

SONGO

B-15. Songo (figure B-12) was developed in the 1970s as a way to introduce the drum set into what was originally “virgin” territory, that of the Latin percussion triumvirate (bongos, timbales, and congas). This example is the most basic form of the style. Hi-hat may be played on 1 and 3. The cross-stick may be either snare or cross-stick rim shot. The bass drum on beat 4 can be omitted or de-emphasized.

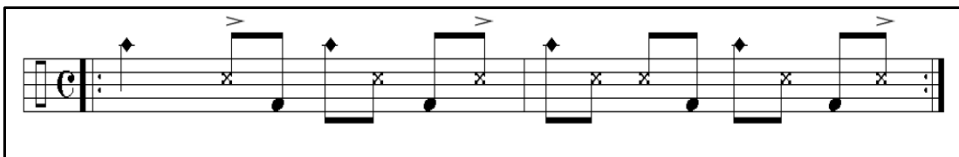

Figure B-12. Songo.

CASCARA

B-16. Spanish for “shell”, Cascara is referring to the rhythm played on the side of the timbales. This is played during verses and softer sections of salsa tunes (e.g., during piano solos). The palito pattern [see RH pattern in figure B-13 and mambo bell pattern (page 10-8, figure 10-12)] can be played on the shell of the floor tom.



Figure B-13. Cascara.

MOZAMBIQUE

B-17. Adapted from the conga rhythm, mozambique was popularized in the United States by Eddie Palmieri (see figure B-14). The name has no association with the African nation of Mozambique.

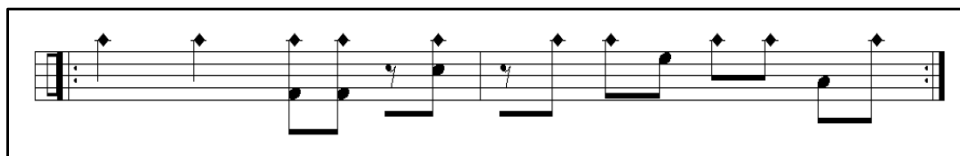

Figure B-14. Mozambique.

OTHER STYLES

B-18. Some other common styles are: jazz waltz, shuffles, hip-hop, merengue, reggae, and ska.

JAZZ WALTZ

B-19. Most jazz waltzes are fast (counted in one), but you can slow this down a bit and still be credible (figure B-15). The bass drum should be feathered or implied. Swing the eighth notes.

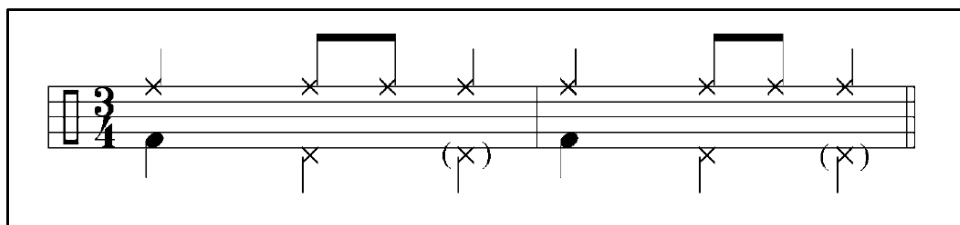

Figure B-15. Jazz waltz.

SHUFFLES

B-20. Derived from older blues feels, the shuffle has risen in popularity due in part to contemporary blues players (figure B-16). This is also the basis for country swing and rockabilly feels. The dotted rhythm written here can be more dotted or played more in a swing feel.

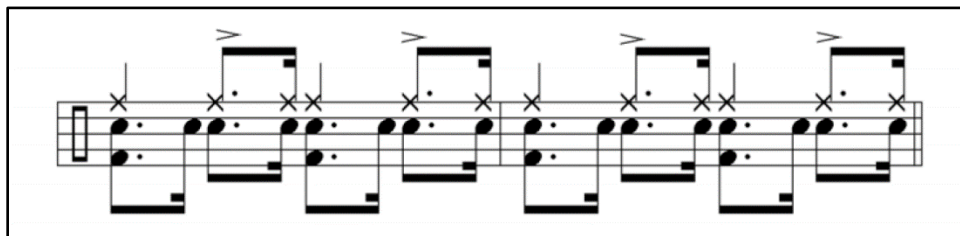

Figure B-16. Shuffle.

HIP-HOP

B-21. Figure B-17 is a good basic feel for the hip-hop or rap tune.

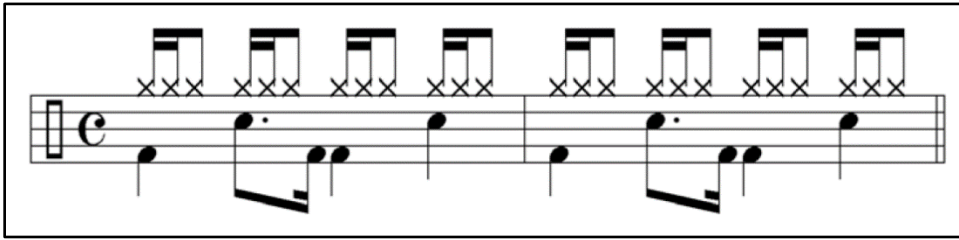

Figure B-17. Hip-Hop.

MERENGUE

B-22. Play figure B-18 with the snares off. The second example is a slightly funkier variation (figure B-19).



Figure B-18. Merengue.

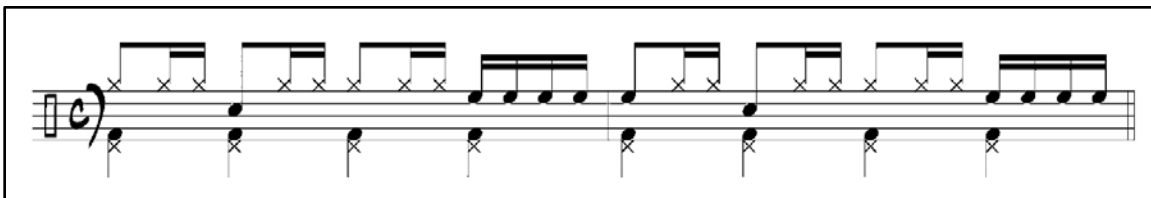

Figure B-19. Merengue-variation.

REGGAE

B-23. Figure B-20 shows a common reggae groove, be sure to swing the sixteenth notes.

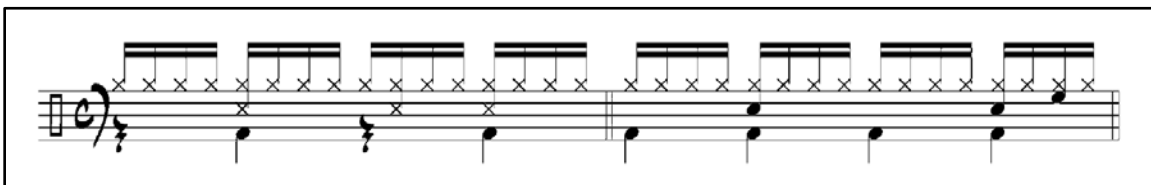

Figure B-20. Reggae.

SKA

B-24. Figure B-21 is a bit faster than the normal reggae beat, and has a different feel. Sixteenth notes can swing on this groove as well.

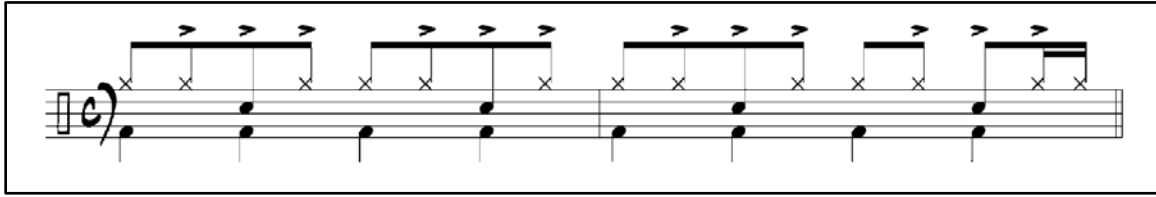

Figure B-21. Ska.

This page intentionally left blank

Source Notes

This division lists sources by page number. Where material appears in a paragraph or figure, it lists the page number followed by the paragraph or figure number.

- 1-1 ***Percussion Instrument***. Percussion Instrument is...” Apel, Willi. *Harvard Dictionary of Music* (2nd Edition). Harvard University Press. Cambridge, MA. 1969 p. 653.
- 3-7. (Figure 3-4) Percussive Arts Society. Percussive Arts Society Standardized Drumset Notation.
- 4-3 through 4-4 (figures 4-4, 4-5, and 4-6). Berkowitz, Adam. *A Comparative Analysis of the Musser Grip, Stevens Grip, Cross Grip, and Burton Grip*. 2011. Retrieved from <http://www.pas.org/docs/default-source/thesisdissertations/a-comparative-analysis-of-the-mechanics-of-musser-grip-stevens-grip-cross-grip-and-burton-grip-by-adam-eric-berkowitz.pdf>

This page intentionally left blank

Glossary

The glossary lists acronyms and terms with Army or Joint definitions.

SECTION I – ACRONYMS AND ABBREVIATIONS

AIT	advanced individual training
ALC	advanced leader course
APD	Army Publishing Directorate
ASI	additional skill identifier
CTA	common table of allowance
DA	Department of the Army
FM	field manual
MOS	military occupational specialty
MPU	music performance unit
NCO	noncommissioned officer
NCOIC	noncommissioned officer in charge
OIC	officer in charge
SLC	senior leader course
U.S.	United States

SECTION II – TERMS

This section contains no entries

This page intentionally left blank

References

All URLs accessed 24 Oct 2017.

REQUIRED PUBLICATIONS

These documents must be available to the intended users of this publication.

Most joint publications are available online: http://www.dtic.mil/doctrine/new_pubs/jointpub.htm.

Most Army doctrinal publications are available online: <https://armypubs.army.mil/>.

DOD Dictionary of Military and Associated Terms. June 2018.

http://www.dtic.mil/doctrine/new_pubs/dictionary.pdf.

RELATED PUBLICATIONS

These documents contain relevant supplemental information.

JOINT PUBLICATIONS

This section contains no entries.

ARMY PUBLICATIONS

Most Army doctrinal publications are available online: <https://armypubs.army.mil/>.

CTA 50-909, *Field and Garrison Furnishings and Equipment*. 20 November 2008. Retrieved from <https://fmsweb.army.mil/unprotected/splash/>.

FM 27-10, *The Law of Land Warfare*. 18 July 1956.

Individual Task 514-441-1059, *Perform Maintenance on Assigned Instrument*. 30 April 2012.

Retrieved from <https://rdl.train.army.mil/>

PRESCRIBED FORMS

This section contains no entries.

REFERENCED FORMS

Unless otherwise indicated, DA Forms are available on the Army Publishing Directorate (APD) web site: <https://armypubs.army.mil/>.

DA Form 2028. *Recommended Changes to Publications and Blank Forms*.

RECOMMENDED READINGS

Bartholomew, Wilbur. *Acoustics of Music*. New York: prentice Hall. 1942. p. 129-139.

Blades, James. *Percussion Instruments and Their History*. Praeger, New York. 1970.

Breithaupt, Robert. *Complete Percussionist: A Guidebook for the Music Educator* (2nd ed.). Oskaloosa, Iowa. CL Barnhouse Company. 2005

Cirone, Anthony. *Portraits in Rhythm, 50 Studies for Snare Drum*. Belwin-Mills Publishing Corp. 1966.

Cook, Gary. *Teaching Percussion* (3rd ed.). Schirmer. 2006

Da Fonseca, Duduka & Weiner, Bob. *Brazilian Rhythms for Drumset*. Alfred Publishing Co. 1991.

Friedman, David. *Vibraphone Technique*. Berklee Press Publications. 1973.

References

- Goldenberg, Morris. Modern School for Snare Drum. Alfred Publishing Co. 1955.
Modern School for Xylophone Marimba Vibraphone. Alfred Publishing Co. 1950.
- Malabe, Frank & Weiner, Bob. Afro-Cuban Rhythms for Drum set. Alfred Publishing Co. 1990.
- Pratt, John S. '14 Modern Contest Solos' for Snare Drum. Alfred Publishing Co. 1959.
- Reed, Ted. Progressive Steps to Syncopation for the Modern Drummer. Alfred Publishing Co. 1996
- Riley, John. The Art of Bop Drumming. Manhattan Music, Inc. Miami, FL. 1994.
- Stevens, Leigh Howard. Method of Movement for Marimba. New York: Marimba Productions. 1979.
- Weinberg, Norman. Guide to Standardized Drumset Notation. Hal Leonard Corporation. 2002.

Index

All entries are by paragraph number.

A
afuche. *See* cabasa,
agogo bells, 10-93–10-94
anvil, 11-70
auto horn, 11-77

B
bass drum, 5-1–5-7
 , concert, 5-38–5-41
 , grip, 5-19
 , marching, 5-32–5-37
 , muffling, 5-22–5-29
 , notation, 5-8–5-9
 , striking area, 5-10–5-13
 , striking implements, 5-14–
 5-16
 , stroke technique, 5-17–5-18,
 5-20–5-21
bell lyre. *See* orchestra bells,
bell plate, 11-73
bongos, 10-33–10-35
 , common rhythms, 10-46,
 10-122
 , playing area, 10-38–10-41
 , playing position, 10-36
 , playing techniques, 10-44–
 10-45
 , striking implements, 10-42–
 10-43
 , tuning, 10-37
brake drum, 11-79

C
cabasa, 10-90–10-92
castanets, 11-38–11-44
 , striking implements, 11-45
 , stroke technique, 11-46–
 11-51
chimes, 4-53–4-54
 , mallet selection, 4-60
 , stroke technique, 4-55–4-59
claves, 10-59–10-66
concert band, 12-36–12-38
congas, 10-11–10-15
 , bass stroke, 10-23
congas (continued),

 , common rhythms, 10-31–
 10-32, 10-122
 , double stroke (heel-tip),
 10-26
 , fingertip stroke, 10-25
 , heel stroke, 10-24
 , open stroke, 10-20
 , playing position, 10-16
 , playing techniques, 10-18–
 10-19
 , rolls, 10-27
 , slap stroke, 10-21–10-22
 , special effects, 10-28–10-30
 , tuning, 10-17
cowbell, 10-73–10-83
cymbals, crash, 6-29–6-35
 See 'drumset' for drumset
 crash cymbals,
 , special effects, 6-43–6-45
cymbals, hand, 6-1–6-5
 , grip, 6-7
 , muffling, 6-16–6-17
 , notation, 6-6
 , stroke technique, 6-8–6-15
cymbals, hi-hat. *See* drumset,
cymbals, ride. *See* drumset,
cymbals, suspended, 6-18–6-19,
6-36–6-38
 , grip, 6-26
 , muffling, 6-27
 , playing area, 6-20–6-21
 , striking implements, 6-22–
 6-25, 6-39–6-42

D
drum set, 3-1
 , bass drum, 3-26–3-30
 , cymbals, crash, 3-39
 , cymbals, hi-hat, 3-40–3-41
 , cymbals, ride, 3-38
 , funk and cut time Latins,
 3-11, B-5, B-12
 , jazz, 3-8–3-9, B-2–B-3, B-19–
 B-20
 , manuscript conventions, 3-43
 , parts, 3-45–3-46
drum set (continued)
 , purpose, 3-3–3-7

 , rock and Latin, 3-10, B-4,
 B-6–B-11
 , snare drum, 3-31
 , solos, 3-12, 3-17–3-19
 , song form, 3-20–3-24
 , tom-toms, 3-32–3-36
 , trading fours, 3-13–3-16
drumset styles, B-1
 , Afro-Cuban/nañigo, B-14
 , bossa nova, B-7
 , cascara, B-16
 , cha-cha, B-9
 , funk, B-5
 , hip-hop, B-21
 , jazz waltz, B-19
 , mambo, B-12
 , merengue, B-22
 , mozambique, B-17
 , reggae, B-23
 , rumba, B-8
 , rock, B-4
 , samba, B-10–B-11
 , shuffles, B-20
 , ska, B-24
 , songo, B-15
 , swing in 2, B-2
 , swing in 4, B-3

E

equipment issues, 12-42

F

finger cymbals, 11-52–11-53
 , grip, 11-56
 , muffling, 11-59
 , playing area, 11-55
 , special effects, 11-60–11-61
 , striking implements, 11-54
 , stroke technique, 11-57–
 11-58
flexitone, 11-80

G

general rules for percussion, 1-8–
1-9
 , mallet choice, 1-11
general rules for percussion
(continued)
 , muffling techniques, 1-16–
 1-18

Entries are by paragraph number

, striking areas, 1-10
 , stroke technique, 1-12-1-15
 gong, 11-1-11-3
 , muffling, 11-12-11-14
 , striking implements, 11-4-11-5
 , technique, 11-6-11-11
 guiro, 10-84-10-89

H

hi-hat cymbals. *See* drumset,
 horse's hooves, 11-76

K

keyboard percussion, 4-1-4-2
 , grip, Burton, 4-12
 , grip, general rules, 4-8-4-10, 4-15
 , grip, Musser, 4-13
 , grip, Stevens, 4-14
 , grip, traditional, 4-11
 , rolls, 4-7
 , striking area, 4-4-4-5
 , striking motion, 4-6

L

Latin percussion, 10-1-10-10
 , scores, 10-122

M

maintenance, 12-47
 mallet percussion. *See* keyboard percussion,
 maracas, 10-67-10-72
 marches, 12-32-12-35
 marimba, 4-17-4-19
 , mallet selection, 4-20-4-30
 metronome techniques, 12-3-12-5

O

orchestra bells, 4-49-4-51
 , mallet selection, 4-52

P

pandeiro, 10-107-10-111
 performance considerations, 12-14-12-30
 personnel, 12-40-12-41, 12-43

practice technique, 12-1-12-2
See also rehearsal,

R

ratchet, 11-65-10-66
 reco-reco. *See* guiro,
 rehearsal, 12-44-12-46
See also practice technique,
 rhythms, 12-6-12-9
See also styles,
 ride cymbals. *See* drumset,

S

sandpaper blocks, 11-72
 shaker, 10-98-10-104
 sight reading, 12-10-12-13
 siren, 11-71
 slapstick, 11-67-11-68
 sleigh bells, 11-62-11-64
 snare drum, 2-1-2-4
 , drumset snare, 3-31
 , grip, 2-14-2-17
 , playing area, 2-8
 , snare types, 2-5-2-7
 , sticking systems, 2-18-2-21
 , striking implements, 2-10-2-13
 , stroke technique, 2-22-2-28

surdo, 10-117-10-121

suspended cymbals. *See*
 cymbals, suspended,

T

tambourim, 10-112-10-116
 tambourine, 9-1-9-8
 , grip, 9-13-9-15
 , muffling, 9-31
 , playing area, 9-10-9-12
 , rolls, 9-26-9-30
 , special effects, 9-32-9-37
 , striking implements, 9-9
 , stroke technique, 9-16-9-25

tam-tam. *See* gong,

temple blocks, 11-27-11-32
 , playing area, 11-36

, striking implements, 11-33-11-35
 , stroke technique, 11-37

thunder sheet, 11-75

timbales, 10-47-10-49
 , common rhythms, 10-56-10-57, 10-122
 , playing area, 10-53-10-54
 , playing position, 10-50
 , striking implements, 10-52
 , stroke technique, 10-55
 , tuning, 10-51

timpani, 7-1-7-7

, muffling, 7-17-1-20
 , playing area, 7-8-7-10
 , striking implements, 7-14-7-16
 , stroke technique, 7-11-7-13
 , tuning, 7-21-7-22

triangle, 8-1-8-6

, grip, 8-12-8-13
 , Latin, 10-105-10-106
 , muffling, 8-19-8-20
 , playing area, 8-10-8-11
 , rolls, 8-16-8-18
 , special effects, 8-21-8-22
 , stroke technique, 8-14-8-15
 , striking implements, 8-7-8-9

V

vibraphone, 4-36-4-40
 , dampening, 4-41-4-43
 , mallet selection, 4-44-4-48
 vibraslap, 10-95-10-96

W

whistle, 11-74

wind machine, 11-78

woodblock, 11-15-11-17
 , grip and stroke technique, 11-25-11-26
 , playing area, 11-24
 , striking implements, 11-18-11-23

X

xylophone, 4-31-4-33
 , mallet selection, 4-34-4-35

TC 1-19.30
25 July 2018

By Order of the Secretary of the Army:

MARK A. MILLEY
General, United States Army
Chief of Staff

Official:

A handwritten signature in black ink, appearing to read 'Mark F. Averill', written in a cursive style.

MARK F. AVERILL
Acting Administrative Assistant
to the Secretary of the Army
1820001

DISTRIBUTION:

Distributed in electronic media only(EMO).

