

1 Observations of the chemical and thermal response of
2 ‘ring rain’ on Saturn’s ionosphere

3 James O’Donoghue^a, Luke Moore^b, Jack Connerney^{c,a}, Henrik Melin^d, Tom
4 Stallard^d, Steve Miller^e, Kevin H. Baines^f

5 ^a*Planetary Magnetospheres Laboratory, NASA Goddard Space Flight Center, Greenbelt,*
6 *Maryland, USA*

7 ^b*Center for Space Physics, Boston University, Massachusetts, USA*

8 ^c*Space Research Corporation, Annapolis, Maryland, USA*

9 ^d*Department of Physics and Astronomy, University of Leicester, Leicester, UK*

10 ^e*Atmospheric Physics Laboratory, Department of Physics and Astronomy, University*
11 *College London, London, WC1E 6BT, UK*

12 ^f*NASA Jet Propulsion Laboratory, M/S 183-601, 4800 Oak Grove Drive, Pasadena, CA*
13 *91109, USA*

14 **Abstract**

In this study we performed a new analysis of ground-based observations that were taken on 17 April 2011 using the 10-metre Keck telescope on Mauna Kea, Hawaii. Emissions from H_3^+ , a major ion in Saturn’s ionosphere, were previously analyzed from these observations, indicating that peaks in emission at specific latitudes were consistent with an influx of charged water products from the rings known as ‘ring rain’. Subsequent modeling showed that these peaks in emission are best explained by an increase in H_3^+ density, rather than in column-averaged H_3^+ temperatures, as a local reduction in electron density (due to charge exchange with water) lengthens the lifetime of H_3^+ . However, what has been missing until now is a direct derivation of the H_3^+ parameters temperature, density and radiative cooling rates, which are required to confirm and expand on existing models and theory. Here we present measurements of these H_3^+ parameters for the first time in the non-auroral regions of Saturn, using two H_3^+ lines, Q(1,0⁻) and R(2,2). We confirm that H_3^+ density is enhanced near the expected ‘ring rain’ planetocentric latitudes near 45°N and 39°S. A low H_3^+ density near 31°S, an expected prodigious source of water, may indicate that the rings are ‘overflowing’ material into the planet such that H_3^+ destruction by charge-exchange with incoming neutrals outweighs its lengthened lifetime due to the aforementioned reduction

in electron density. Derived H_3^+ temperatures were low while the density was high at 39°S , potentially indicating that the ionosphere is most affected by ring rain in the deep ionosphere. Saturn’s moon Enceladus, a known water source, is connected with a dense region of H_3^+ centered on 62°S , perhaps indicating that charged water from Enceladus is draining into Saturn’s southern mid-latitudes. We estimated the water product influx using previous modeling results, finding that $432 - 2870 \text{ kg s}^{-1}$ of water delivered to Saturn’s mid-latitudes is sufficient to explain the observed H_3^+ densities. When considering this mechanism alone, Saturn will lose its rings in 292_{-124}^{+818} million years.

15 *Keywords:* Saturn, ionosphere, rings, magnetosphere, ring rain

16 **1. Introduction**

17 In the Saturn system, submicrometre charged icy grains are able to stream
18 from the rings into the planetary atmosphere via the magnetic field. This
19 process, termed “ring rain”, erodes and sculpts the ring system through
20 the interplay between electromagnetic, gravitational and centrifugal forces
21 (Northrop and Hill, 1982; Connerney, 2013). Saturn’s atmosphere adopts
22 this discarded ring matter, causing dramatic changes in ionospheric chem-
23 istry and the removal of haze (O’Donoghue et al., 2013; Connerney, 1986).
24 Saturn’s ring system is comprised of clusters of ice ranging in size from be-
25 low 0.01 cm and up to 10 m distributed in an approximately inverse cubic
26 power-law manner, such that the majority of ring system is composed of small
27 fragments (Zebker et al., 1985; Cuzzi et al., 2009). The chemical composition
28 of the rings is considered to be almost pure water ice, but they are thought to
29 be contaminated by tholins - a mixture of simple hydrocarbons (e.g. CH_4 and
30 C_2H_6), nitrogen and other components, giving the rings their characteristic
31 tan color (Nicholson et al., 2008; Cuzzi et al., 2018). Submicrometre-sized ice
32 particles or icy grains are able to acquire charge via photoionization or ex-
33 posure to a micrometeorite impact’s dense plasma cloud (Connerney, 2013).
34 On becoming charged, these grains have an array of velocities with respect to
35 the planetary magnetic field which permeates the rings: this is either faster
36 (super-rotating), slower (sub-corotating) or the same velocity as the moving
37 magnetic field lines, which rotate at the solid-body planetary rotation rate.

38

39 Three major forces act on the charged grains in Saturn’s rings **along a**

40 given magnetic field line: gravity pulling the grains towards the planet, and
41 the centrifugal and magnetic mirror forces which act to pull the grains back
42 into the ring plane. At $1.62 R_S$ (where $1 R_S$ is Saturn's equatorial radius
43 60,268 km) within the ring plane, charged grains that are stationary with
44 respect to the magnetic field experience only gravitational and centrifugal
45 forces, which are in balance at this location (the grain is stable) (Northrop
46 and Hill, 1982). At radial distances slightly less than $1.62 R_S$, however, grav-
47 ity begins to dominate, accelerating charged grains towards the planet (the
48 grain is unstable) (Northrop and Hill, 1983). However, charged grains mov-
49 ing at Keplerian velocity super-rotate with respect to the magnetic field and
50 therefore orbit magnetic field lines due to the Lorentz force. These grains,
51 unlike those at $1.62 R_S$, are subjected to a magnetic mirror force which re-
52 pels them back towards the ring plane when they approach the planet; this
53 breed of grain therefore has a radius of force balance that is closer to Saturn,
54 which is calculated to be $1.525 R_S$ (Northrop and Hill, 1983; Northrop and
55 Connerney, 1987; Connerney, 2013). The sharp density gradient between the
56 B and C rings is near $1.525 R_S$, and may even be the result of 'ring rain' elec-
57 tromagnetically eroding the rings at this location (Northrop and Connerney,
58 1987).

59
60 Saturn's magnetic dip equator lies above the ring plane offset towards
61 Saturn's north pole, so that near to the ring plane the magnetic field has a
62 component pointing towards the southern hemisphere. As a result, at radial
63 distances $<1.525 R_S$, recently produced ionized grains that are relatively
64 motionless compared to the rings will be drawn southwards; gravitational
65 forces acting parallel to magnetic field lines are in control here. Note that
66 the grains also have a perpendicular (to the ring plane) velocity distribution
67 of their own which pushes them either northwards or southwards; assuming
68 this is a Maxwellian-like distribution, the grains will still preferentially be
69 drawn southwards, with only the highest velocity grains potentially able to
70 escape northwards. Charged grains produced between $1.525 R_S$ and $1.62 R_S$
71 also fall preferentially to the south, but the grains are able to oscillate about
72 the ring plane here due to the weaker gravitational force pulling the grains
73 planetward along field lines (Connerney, 1986). Pathways for an influx of
74 ring material into the equatorial ionosphere have also been modeled. For
75 example, collisional drag may explain the influx of neutral grains (Mitchell
76 et al., 2018), whereas positively charged dust grains are also expected to be
77 deposited near Saturn's equator (Liu and Ip, 2014; Hsu et al., 2018). Such in-

78 fluxes, which have now been observed by Cassini (Mitchell et al., 2018; Perry
79 et al., 2018; Hsu et al., 2018; Waite et al., 2018), would help to explain the
80 observed depletion in ionospheric electron density there (Kliore et al., 2014).
81 Estimating the mass loss of the rings is of great importance for determining
82 the age, lifetime and evolution of the rings, which are presently understood
83 to have existed for between 4.4 million and 4.5 billion years (see Northrop
84 and Connerney, 1987; Connerney, 2013, and references therein).

85

86 The Pioneer 11 spacecraft was the first human made object to fly by Sat-
87 urn in 1979 (Kliore et al., 1980). Saturn’s ionosphere was predicted to have an
88 electron density of around 10^5 cm^{-3} , based on photoionization of atmospheric
89 neutrals (mostly H and H_2) by extreme ultraviolet (EUV) radiation from the
90 Sun (McElroy, 1973; Waite et al., 1979). However, when Kliore et al. (1980)
91 analyzed the attenuation of the Pioneer 11 radio signal, which had traveled
92 through Saturn’s ionosphere, the electron density peak was found to be $\sim 10^4$
93 cm^{-3} , an order of magnitude lower than predicted. Later, the Voyager 1 and
94 2 spacecraft, in 1980 and 1981 respectively, showed peak electron densities
95 between $\sim 6 \times 10^3 \text{ cm}^{-3}$ and $\sim 2.3 \times 10^4 \text{ cm}^{-3}$ (Atreya et al., 1984). The lowest
96 electron densities were found at 36° north, while the highest densities were
97 found at 73° north: this was counter-intuitive since the electron production
98 mechanism is solar EUV ionization, which is maximized at mid-to-low lati-
99 tude, depending on season. These model-observation discrepancies could be
100 resolved however, with the introduction of a planet-wide exogenous water in-
101 flux of $\sim 4 \times 10^7 \text{ molecules cm}^{-2} \text{ s}^{-1}$, which leads to a net reduction in electron
102 density (Connerney and Waite, 1984; Moses and Bass, 2000). In addition, a
103 localized water influx of $\sim 2 \times 10^9 \text{ molecules cm}^{-2} \text{ s}^{-1}$ was predicted to fall into
104 Saturn from the inner edge of the B ring (at $\sim 1.525 R_S$) (Connerney and
105 Waite, 1984). The Cassini spacecraft later revealed latitudinal variations of
106 peak electron densities using 59 radio occultations, with values ranging from
107 $\sim 1 \times 10^3 \text{ cm}^{-3}$ to $\sim 3 \times 10^4 \text{ cm}^{-3}$ which correspond to the low-mid latitudes and
108 auroral regions, respectively (Kliore et al., 2014).

109

110 Observations consistent with a ring-derived water influx that flows along
111 magnetic field lines were first found using Voyager 2 green filter images of
112 Saturn by Connerney (1986), which showed dark bands (indicating less re-
113 flection of sunlight) at 44° , 46° , 52° and 64° planetocentric latitude north.
114 These bands map along magnetic field lines to $1.525 R_S$, $1.62 R_S$, $1.95 R_S$
115 and $3.95 R_S$, respectively, in the ring plane. The first two listed radial dis-

116 tances correspond to the theoretical water sources between the B and C rings
 117 discussed earlier, while $1.95 R_S$ corresponds to the Cassini division, and 3.95
 118 R_S is the orbit of Enceladus - a known source of water to the Saturnian mag-
 119 netosphere (Dougherty et al., 2006; Hansen et al., 2011). The reduction in
 120 reflected light leading to these dark bands is thought to indicate the loss of
 121 stratospheric haze: Connerney (1986) proposed that haze particles could act
 122 as condensation nuclei to the downward diffusing water, thus making haze
 123 particles heavy enough to sink. Saturn’s hydrocarbon (e.g. C_2H_2) abundance
 124 was calculated at four latitudes using Hubble Space Telescope (HST) obser-
 125 vations, with a minimum value found at 41° south while increasing towards
 126 the polar regions (Prangé et al., 2006). As photochemical models show that
 127 the presence of water in the stratosphere depletes hydrocarbons (Moses and
 128 Bass, 2000), the results were described by Prangé et al. (2006) to be con-
 129 sistent with an influx of water flowing from the rings to the atmosphere via
 130 magnetic field lines.

131

132 H_3^+ , one of the most abundant ions in Saturn’s ionosphere, is produced
 133 in the following reaction chain:



134 Where e^* is a fast electron and EUV is an extreme ultraviolet photon
 135 from the Sun. As soon as H_2^+ is created by reactions (1) - (3), reaction (4)
 136 takes place almost instantaneously (Miller et al., 2010; Stallard et al., 2015).
 137 In the auroral/polar region, H_3^+ peaks in density at an altitude of ~ 1155
 138 km above the 1-bar pressure surface (Stallard et al., 2012), and production
 139 occurs in the range 900 to 4000 km (Tao et al., 2011).

140

141 In 2011, the 10 meter Keck II telescope on Mauna Kea, Hawaii, was used
 142 to observe the pole-to-pole H_3^+ ion emissions from Saturn (O’Donoghue et al.,
 143 2013). Broad peaks in H_3^+ intensity were discovered at planetocentric lati-
 144 tudes 43° and 38° north and south, respectively. As a result of the geometry
 145 of Saturn’s magnetic field, which can be thought of as being approximated
 146 by a dipole that is slightly offset north of the planet’s center, both latitudes
 147 share a common field line; this field line intersects the ring plane at ~ 1.525

148 R_S (Connerney, 1986). Magnetic conjugacy was directly observed, so the
149 intensity peaks that were found are related to the magnetosphere. Following
150 this observation, Moore et al. (2015) demonstrated through modeling that
151 the increase in H_3^+ emissions was better explained via an increase in H_3^+ den-
152 sity, rather than a (column-averaged) H_3^+ temperature increase. It was found
153 that any water product inflow under 1×10^7 molecules $\text{cm}^{-2} \text{s}^{-1}$ will rapidly
154 recombine with electrons, mitigating the loss of H_3^+ by the same process,
155 such that H_3^+ densities ought to be larger where water falls. However, Moore
156 et al. (2015) also found that for large water influxes (greater than $\sim 2 \times 10^8$
157 molecules $\text{cm}^{-2} \text{s}^{-1}$) the loss rate of H_3^+ by charge-exchange with water be-
158 gins to overtake the enhancement in H_3^+ by the reduction in electron density.
159

160 More recently, the signature of ring rain in H_3^+ emissions were re-detected
161 in Keck II telescope observations taken in 2013; the brightness of these emis-
162 sions was a factor of ~ 4 lower than in 2011, likely owing to an estimated 90 K
163 decrease in ionospheric temperature from 2011 to 2013 (O’Donoghue et al.,
164 2017). Surprisingly however, the contrast between bright and dim features
165 in H_3^+ emissions were larger in 2013, indicating an increased influx of ring
166 material. Indeed, because the opening angle of the rings was larger in 2013,
167 more of the ring’s surface area is exposed to solar EUV ionization, so the pro-
168 duction of charged icy grains ought to be larger (O’Donoghue et al., 2017).
169 In 2017 the Cassini spacecraft flew between the planet and rings, allowing for
170 the first time the ability to probe the ring-planet interface region in situ. On-
171 board Cassini, the impact mass spectrometer Cosmic Dust Analyzer (CDA;
172 Srama et al. (2004)), detected the presence of grains tens of nanometers in
173 size at high concentration near the ring plane and at mid-latitudes in the
174 northern and southern hemispheres: a spectacular confirmation of the ring
175 rain process (Hsu et al., 2018). In the present paper we continue to expand
176 our understanding of ring-atmosphere coupling by assessing the thermal and
177 chemical influence ring rain has on Saturn’s ionosphere for the first time,
178 through a new analysis of Keck II data taken in 2011 (O’Donoghue et al.,
179 2013).

180 2. Observations and data reduction

181 Ground-based observations of Saturn were obtained on 17 April 2011, be-
182 tween 10:33:42 and 12:46:28 Universal Time (UT), using the 10-metre Keck
183 telescope on Mauna Kea, Hawaii. The dataset obtained in this observation

184 is available in the linked Research data. Saturn’s northern hemisphere was
185 tilted towards the Earth (and the Sun) with a sub-Earth latitude of 8.2° -
186 Saturn was in northern spring. The collected light was passed to the high-
187 resolution Near-InfraRed SPECTrometer, NIRSPEC (McLean et al., 1998),
188 which was used in cross-dispersed mode with a resolution of $R = \lambda/\Delta\lambda$
189 $\sim 25,000$, providing a spectral resolution of $\Delta\lambda \approx 1.59 \times 10^{-4} \mu\text{m}$ at 3.975
190 μm . The wavelengths covered were near 3.5 and $4.0 \mu\text{m}$, as they include the
191 Q- and R-Branch ro-vibrational transition lines of the H_3^+ ion. NIRSPEC’s
192 slit dimensions were configured to be $0.432''$ wide by $24''$ long, with a pixel on
193 the CCD corresponding to $0.144''$ squared on the sky. The spectrometer slit
194 was aligned along Saturn’s noon meridian in a north-south direction, along
195 the axis of the planet’s rotation as shown in Figure 1. Note that Saturn’s
196 magnetic field is co-aligned with the planetary axis of rotation to 0.0095°
197 (Dougherty et al., 2018). While the planet rotated, spectral images were
198 acquired of Saturn between $103 - 176^\circ$ Saturn System III Central Meridian
199 Longitude (CML). Each set of spectra acquired consists of twelve 5-s inte-
200 grations, creating exposures 60 s long, consisting of Saturn (A) and sky (B)
201 frames with the telescope slewing between the relevant positions of each in
202 the sky in an ABBA pattern: in total, 46 A and 46 B frames were captured.

203 Standard astronomical data reduction techniques were applied to the
204 data, such as sky subtraction, accounting for non-uniformity in the response
205 of NIRSPEC’s detector and flux calibration (using the star HR 6035). These
206 processes ensure that unwanted emissions from Earth’s atmosphere (mainly
207 from water), telescope and instruments are removed, and that photon counts
208 at the detector are converted to units of physical flux - see e.g. O’Donoghue
209 et al. (2016) for more details. After data reduction, each spectral image
210 is aligned before being co-added to produce a single image representing the
211 entire dataset, selected wavelengths of which are shown in Figure 2. Using ge-
212 ometric information obtained from planetary ephemeris (NASA’s Horizons
213 web interface at <https://ssd.jpl.nasa.gov/horizons.cgi>), planetocentric lati-
214 tudes were assigned to the data. Telluric seeing, which during this period
215 was $\sim 0.4''$, adds uncertainty in determining the location of the planet’s limbs
216 since the data are spatially smeared by ± 2 pixels, equating to ~ 2 of latitude
217 near 45° north. A cosine correction of the planetary emission angle was ap-
218 plied to remove the line-of-sight effects of viewing geometry.

219
220 One of the challenges of this work is measuring H_3^+ transition line emis-
221 sions at mid-to-low latitudes, which are up to an order of magnitude weaker

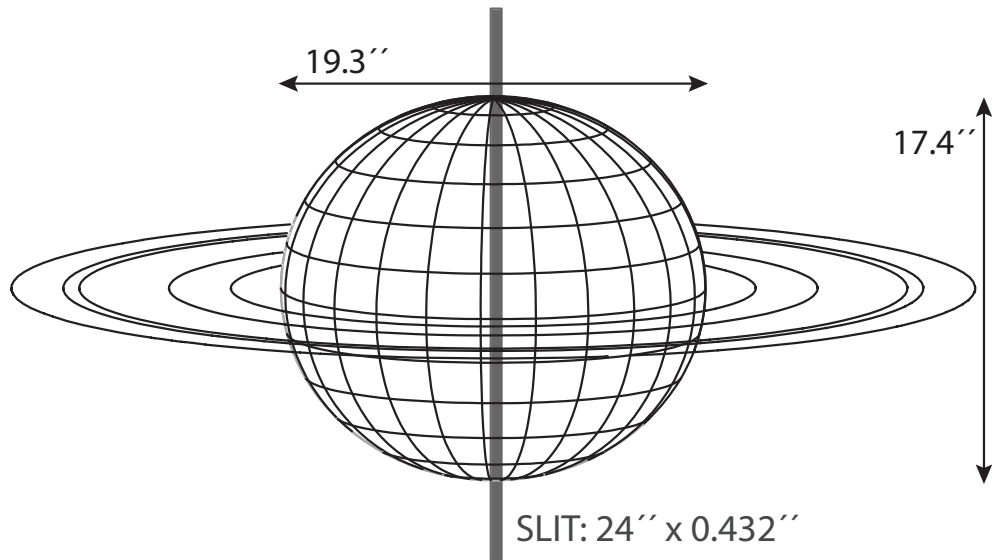

Figure 1: Saturn in conditions of northern spring, 17 April 2011. Gridlines on the planetary body are spaced in 15-degree intervals of longitude and latitude. The arrowed lines show the angular extent of Saturn and the dimensions of the NIRSPEC spectral slit in seconds of arc. This image was generated using the Planetary Data System (PDS) online tools at <https://pds-rings.seti.org/tools/>.

222 than auroral/polar emissions at Saturn. H_3^+ emissions are therefore more
 223 sensitive to residual signals left over from the data reduction process, e.g.
 224 sky emission subtraction leaves residuals of about 1% of the peak auroral
 225 intensity, which is about 1-10% of the peak intensity at mid-to-low latitudes.
 226 This is mitigated against by selecting larger spatial areas (longitude and lat-
 227 itude) in order to increase the signal to noise. The next challenge is in how
 228 to deal with unwanted emissions emanating from Saturn itself, which has
 229 at least over 100 different species of neutrals and ions present (Moses and
 230 Bass, 2000); the emissions wavelengths from many of the lower-abundance
 231 members of these species are not fully understood, and so may register as
 232 localized noise at specific wavelengths and latitudes. The two H_3^+ lines in
 233 this study, however, were chosen in Kronian-atmospheric windows produced
 234 by methane's absorption of sunlight, avoiding noisy regions at most lati-
 235 tude seen on the left of panel b) in Figure 2. Previous studies have been
 236 successful in deriving H_3^+ temperatures and densities from two H_3^+ spectral
 237 lines (O'Donoghue et al., 2016; Johnson et al., 2018). Figure 3 shows the
 238 co-addition of data from Figure 2 between 30° to 39° planetocentric latitude

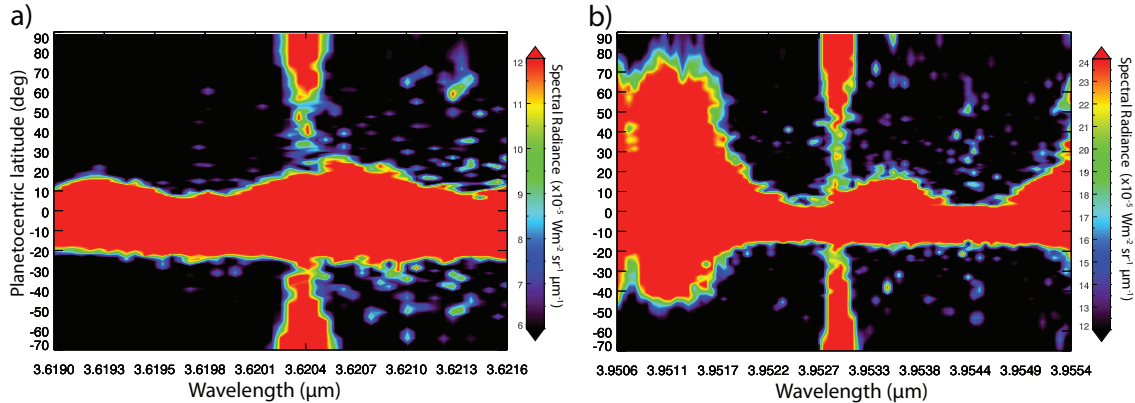

Figure 2: Fully reduced co-added spectrum composed of 46 spectral images of Saturn, in wavelength and planetocentric latitude. These two panels are centered on two (vertical) ro-vibrational transition lines of H_3^+ . In a) is the R-branch H_3^+ transition line designated R(2,2⁻), while b) shows the fundamental H_3^+ line, Q(1,0⁻). Both lines are observable because methane absorbs most of the incident solar radiation in these wavelength ranges. The horizontal emissions near the equator are the continuum reflection of sunlight from the rings. Note that the spectral radiance is ‘thresholded’ between the numbers shown in the color bars.

239 south. Fitting to H_3^+ lines (described in the Data Analysis section) requires
 240 that the minimum background spectral radiance is found and subtracted, so
 241 that the H_3^+ line begins from a background of zero. Pixel-to-pixel extremes,
 242 such as hot pixels that survived the data reduction process, were accounted
 243 for by smoothing the data by $0.0025 \mu\text{m}$ (4 pixels) prior to establishing the
 244 minima of each bin. Figure 3 displays a background subtraction as shifted
 245 data (black asterisks), with the pre-shifted data in grey.

246

247 To remove unwanted, blended emissions from the H_3^+ lines (shown in red
 248 in Figure 3 and labeled as noise), a non-linear least squares curve fitting rou-
 249 tine called MPFIT was employed (Markwardt, 2009). In this work, MPFIT
 250 is programmed to look for multiple Gaussians within the data; the first Gaus-
 251 sian distribution is fixed in wavelength to an H_3^+ line and allowed to vary in
 252 height and width, while additional Gaussians are used to characterize nearby
 253 noise and are free to vary in wavelength, height and width. Typically each
 254 H_3^+ line is either not blended or is blended with one other line, as is the case
 255 in Figure 3). Once a solution is found, the Gaussian noise distributions are
 256 subtracted from the data, leading to the gold colored H_3^+ -only line in Figure

257 3.

258 Standard deviations in the Q- and R- branch data were calculated from
259 the wavelength ranges 3.954 - 3.955 μm and 3.618 - 3.62 μm , respectively,
260 and included the planetocentric latitude range 40° to 90°N. These areas were
261 chosen to represent the standard deviation, rather than the area immedi-
262 ately around the H_3^+ lines, in order to accurately represent the dispersion
263 of data in the array: the standard deviation is thus less affected by small
264 spatial/spectral scale features, such as residuals leftover from sky subtraction
265 and uncharacterized emissions from Saturn's many species. When estimating
266 the minimum background of the smoothed array for the purposes of shifting
267 the array down, an additional uncertainty is introduced: this is included by
268 calculating the standard deviation of the smoothed array in the latitude and
269 wavelength ranges above. A final uncertainty is introduced after using MP-
270 FIT - the model-data difference known as residuals. These residuals, along
271 with the standard deviations above, are propagated through to achieve the
272 final standard deviations shown in Figure 3. Note that the Q-branch data
273 are a factor ~ 3 brighter than the R-branch, so three standard deviations are
274 shown in this figure instead of one for aesthetic purposes.

275

276 3. Data analysis

277 H_3^+ emits a spectrum of at least 3 million ro-vibrational transition lines,
278 and each line varies in intensity at a particular rate that depends on the
279 ion's temperature (Neale et al., 1996). With a model of this temperature
280 dependence we can therefore obtain the column-averaged H_3^+ temperature,
281 $T_{\text{H}_3^+}$ (Kelvin), through observations of the ratio between two or more H_3^+
282 emission lines. The model fitting routine used herein uses the spectroscopic
283 line list from Neale et al. (1996), the latest H_3^+ partition function constants
284 from Miller et al. (2010), and varies a sum of Gaussian distributions that
285 represent H_3^+ (called the spectral function) until the line-ratios match the
286 least squares fit to the observed data (for more detail see Melin et al., 2013,
287 and references therein). To find the total number of emitting ions per unit
288 area - the H_3^+ column density - we divide the observed emissions by those
289 that a single H_3^+ ion emits at the temperature calculated above. This pro-
290 duces a column-integrated density, $N_{\text{H}_3^+}$ (cm^{-2}). The radiative cooling rate
291 (or, radiance) of H_3^+ is given by $L_{\text{H}_3^+}$ ($\text{Wm}^{-2} \text{sr}^{-1}$): it is the radiative power
292 imparted by H_3^+ at all wavelengths from a surface area to a given steradian

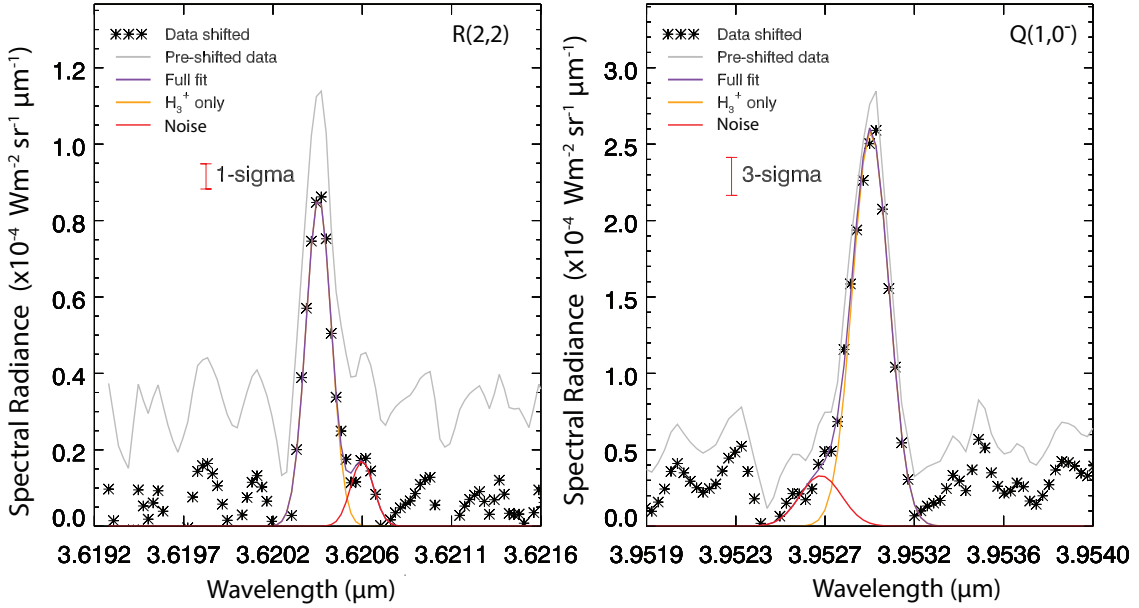

Figure 3: Spectral radiance of Saturn co-added from 103 - 176° CML and 37 - 47°S planetocentric latitude, extracted from the data presented in Figure 2. A full description of the features of this figure is given in the main text.

293 of solid angle. Calculation of $L_{\text{H}_3^+}$ is achieved by multiplying $N_{\text{H}_3^+}$ by the
 294 sum of all emissions of a single H_3^+ ion for the calculated $T_{\text{H}_3^+}$. The radiative
 295 cooling rate was introduced by Lam et al. (1997) as ‘total emission’ in a
 296 study of Jupiter’s ionospheric H_3^+ . $L_{\text{H}_3^+}$ is a useful parameter as it reveals the
 297 amount of energy lost by the ionosphere via radiative cooling to space by H_3^+ .
 298

299 Prior to fitting to data using the above H_3^+ model, the H_3^+ -only emissions
 300 and a single standard deviation from Figure 3 are extracted. In Figure 4,
 301 modified H_3^+ -only line emissions from Figure 3 are shown, with each new
 302 data curve representing an original H_3^+ -only curve, but with the addition
 303 and subtraction of one standard deviation from each respective panel. The
 304 H_3^+ -fitting model is then run as follows: first, the lower data curve from
 305 panel a) is fitted alongside the higher data curve in panel b) and second, the
 306 higher data curve from panel a) is fitted with the lower data curve of panel
 307 b). Performing the fits this way ensures that the full range of possible line
 308 ratios between these two H_3^+ lines are included in the results, based on the
 309 relative standard deviations from each panel. Having a range of possible fits

310 leads to a range of H_3^+ parameter outputs ($T_{H_3^+}$, $N_{H_3^+}$, $L_{H_3^+}$): the upper and
 311 lower values for each parameter, along with the uncertainties from the model
 312 fitting itself, represent the overall uncertainties in the results to follow. Note
 313 that the data in Figure 4 rests on random noise that was generated within
 314 the bounds of one standard deviation, and that this used to illustrate the
 315 uncertainty in background of the array.

316

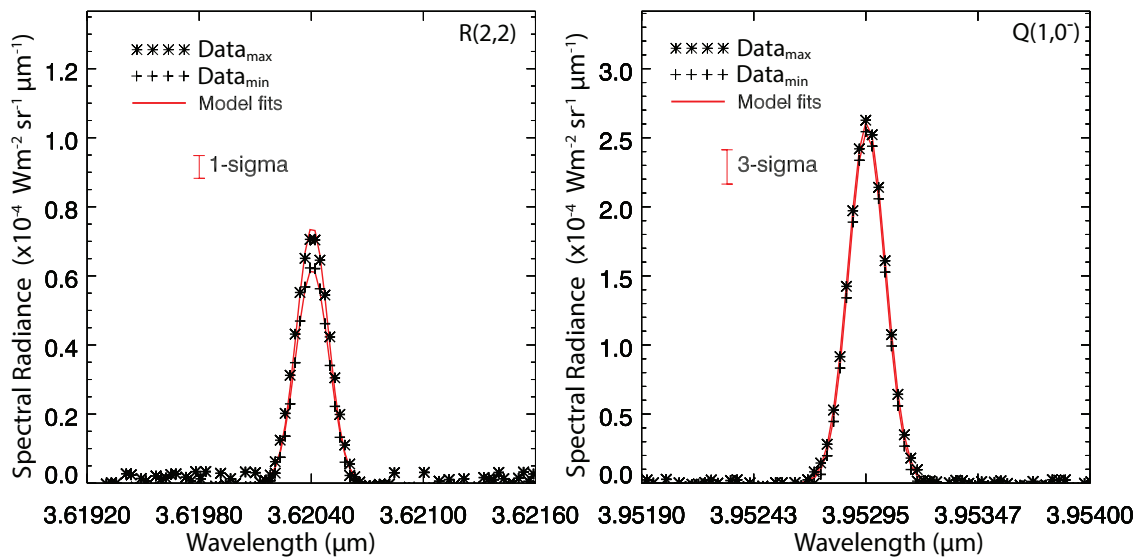

Figure 4: As Figure 3, but only including a modified version of H_3^+ -only emissions and model fits to the data, as described in the main text.

317 In order to map planetary latitudes to radial distance in the ring plane,
 318 the path of magnetic field lines are traced from the ionosphere to the ring
 319 plane using a model of Saturn's magnetosphere. For this, we use the Voy-
 320 ager 2 "Z3" magnetic mapping model of Connerney et al. (1982) with the
 321 coefficients: $g_1 = 21,248$ nT, $g_2 = 1,613$, $g_3 = 2683$ (Dougherty et al., 2005).
 322 Here we used spherical harmonic coefficients based on Voyager 2 spacecraft
 323 derived data. This model includes a full order-3 internal field, ring current
 324 and accounts for the oblateness of the planet, and uses a Saturn equato-
 325 rial radius of 60,268 km. An ionospheric height of 1200 km was chosen for
 326 this mapping, which is approximately the observed H_3^+ density peak altitude
 327 (Stallard et al., 2012), and is consistent with modeled H_3^+ altitudes at mid-
 328 latitude (Kim et al., 2014).

330 4. Results and discussion

331 Owing to this dataset having the highest signal strength of H_3^+ recorded
 332 at mid latitudes on Saturn, we are able to see and use two spectral lines to
 333 calculate column-averaged H_3^+ temperatures, densities and radiative cooling
 334 rates, allowing us to finally measure how ring rain affects upper-atmospheric
 335 chemistry and energy balance. In Table 1 we present the results obtained by
 336 fitting to Saturn’s local-noon H_3^+ emissions, integrated between 103 - 176°
 337 CML. A total of eleven fits were obtained from pole to pole, with an ab-
 338 sence of fits near the equator being due to a combination of low H_3^+ signal to
 339 noise and interference from the continuum reflection of sunlight by the rings.
 340 These results are the first non-auroral (<70°N/S latitude) H_3^+ parameters to
 341 ever be derived at Saturn, and so offer new insights into the thermal and
 342 chemical modification of the ionosphere and co-located thermosphere by the
 343 impinging ring rain phenomenon and other phenomena. The following re-
 344 sults map mostly to features in the equatorial plane such as the A, B and C
 345 subdivisions of the main rings, Saturn’s satellite’s Mimas and Enceladus, the
 346 E-ring and the aurorae. In addition, a B/C ring boundary was also studied
 347 due the expectation that it is a source of charged icy grains.

348

349 Figure 5 shows $N_{\text{H}_3^+}$ and normalized inverse (stratospheric) haze opacity,
 350 τ^{-1} taken from Connerney (1986), as a function latitude and radially mapped
 351 distance. Connerney (1986) proposed that haze particles could act as con-
 352 densation nuclei to the downward diffusing water, thus making haze particles
 353 heavy enough to sink. Here we show the inverse haze opacity, which repre-
 354 sents the degree to which the haze layer has become thinned (by ring rain): a
 355 value of 0 means the haze layer is dense, while a value of 1 means the haze is
 356 less dense. Densities of H_3^+ are high near Saturn’s auroral regions, but reach
 357 their highest point near the expected location of a ‘ring rain’ influx emanating
 358 from the B- and C-rings. In the north, the results suggest that the inner-edge
 359 of the B-ring is the largest source of icy grains. While the uncertainties are
 360 large in the northern hemisphere, limiting our ability to draw definitive con-
 361 clusions about the influence of rain there, 39°S was found to have a high $N_{\text{H}_3^+}$,
 362 with uncertainties mostly clear of those at adjacent latitudes. These peaks
 363 in $N_{\text{H}_3^+}$ most likely indicate that an influx of ring material (such as water) is
 364 falling at these latitudes and removes electrons, which in turn increases the

Table 1: Saturn’s fitted H_3^+ parameters as a function of planetocentric latitude (Lat PC) and corresponding magnetic field mapping out to the equatorial plane (Eq. Radius). Note that this mapping was evaluated at 1200 km altitude above Saturn’s 1-bar pressure surface. Parameter uncertainties shown are one standard deviation. The listed features are the approximate locations covered by each latitudinal swath.

Region	Lat PC	Eq. Radius (R_s)	Feature	$N(\text{H}_3^+)$ 10^{11} cm^{-2}	$T(\text{H}_3^+)$ Kelvin	$L(\text{H}_3^+)$ $10^{-6} \text{ Wm}^{-2} \text{ sr}^{-1}$
1	80 - 69°N	30.7 - 5.7	Aurora	4.9 ± 3.8	443 ± 65	4.3 ± 0.8
2	69 - 60°N	5.7 - 2.97	Enceladus/E-ring	1.0 ± 0.6	515 ± 58	4.1 ± 0.6
3	60 - 53°N	2.97 - 2.09	A-ring to Mimas	5.3 ± 4.5	424 ± 69	2.6 ± 0.5
4	51 - 43°N	1.93 - 1.51	B-ring	11.6 ± 9.2	377 ± 47	2.4 ± 0.3
5	47 - 43°N	1.69 - 1.51	B/C Boundary	6.1 ± 5.4	433 ± 84	2.8 ± 0.6
6	26 - 37°S	1.25 - 1.52	C-ring	1.1 ± 0.8	544 ± 96	4.6 ± 1.2
7	35 - 44°S	1.46 - 1.81	B/C Boundary	24 ± 16.5	348 ± 31	2.9 ± 0.2
8	37 - 47°S	1.52 - 1.99	B-ring	7.2 ± 4.5	396 ± 36	3.3 ± 0.3
9	47 - 57°S	2.0 - 2.9	A-ring to Mimas	3.5 ± 1.3	455 ± 27	6.5 ± 0.4
10	57 - 67°S	2.9 - 5.8	Enceladus/E-ring	5.2 ± 1.2	479 ± 17	15.5 ± 0.7
11	68 - 75°S	6.4 - 18.0	Aurora	2.7 ± 0.7	519 ± 23	14.4 ± 0.8

365 H_3^+ density by mitigating the H_3^+ -electron recombination rate (Moore et al.,
366 2015). The highest density was observed in the southern hemisphere from
367 region 7, which is expected since the magnetic field permeating the rings is
368 inclined towards the south (Connerney, 1986). The low H_3^+ density of region
369 6 appears to be the result of an exceptionally high rain influx: we define
370 this area as an ‘overflow’ region, and it coincides with the thinnest region of
371 stratospheric haze. Indeed, Connerney (1986) predicted an influx near 38° S
372 of 2×10^9 molecules $\text{cm}^{-2} \text{ s}^{-1}$ which is in agreement with Moore et al. (2015),
373 who show that influxes greater than 4×10^8 molecules $\text{cm}^{-2} \text{ s}^{-1}$ are enough to
374 locally reduce $N_{\text{H}_3^+}$ through charge-exchange between H_3^+ and water, which
375 begins to overwhelm the enhancement in H_3^+ given by the reduction in elec-
376 tron density.

377

378 The northern regions 4 and 5 have an average column-integrated H_3^+ den-
379 sity of $8.85 \pm 5.3 \times 10^{11} \text{ cm}^{-2}$, which is consistent with a water product influx
380 of between 7×10^6 and $7 \times 10^7 \text{ cm}^{-2} \text{ s}^{-1}$, according to Figure 4 of Moore et al.
381 (2015). This implies that regions 4 and 5 deliver $27 \pm 22 \text{ kg s}^{-1}$ of water
382 products to the ionosphere, if the flow is deposited at all longitudes. For re-
383 gions 7 and 8, the average H_3^+ density of $15.6 \pm 8.5 \times 10^{11} \text{ cm}^{-2}$ implies a water

384 product influx of $14 \pm 7 \text{ kg s}^{-1}$. To explain the H_3^+ density range of region 6,
 385 a water product flow rate of either near $4 \times 10^5 \text{ molecules cm}^{-2} \text{ s}^{-1}$ or 2×10^9
 386 $\text{molecules cm}^{-2} \text{ s}^{-1}$ is required (Moore et al., 2015). Since the latter value is
 387 what is predicted by Connerney and Waite (1984), we favor the higher rate
 388 here and thus eliminate the problem of degeneracy for this region. An influx
 389 $6 \times 10^8 - 4 \times 10^9 \text{ molecules cm}^{-2} \text{ s}^{-1}$ can explain the density range found in re-
 390 gion 6 (Moore et al., 2015), which corresponds to $420 - 2800 \text{ kg s}^{-1}$ of water
 391 products entering the planet. In total, we estimate an influx of water prod-
 392 ucts from Saturn’s rings to the planet, at the latitudes measured here, of 432
 393 $- 2870 \text{ kg s}^{-1}$. At this mass loss rate, and using a total mass of Saturn’s rings
 394 of $1.52 \times 10^{19} \text{ kg}$ (Voosen, 2017), the ring system has 292_{-124}^{+818} million years
 395 before it is completely consumed by the planet. This estimate of ring lifetime
 396 has a number of assumptions: 1) that the ring system is able to disperse over
 397 time (e.g. by micrometeoroid bombardment), allowing the C-ring to act as
 398 a continually replenished source region; 2) we measured Saturn during the
 399 conditions of northern Spring, so the values above do not yet account for how
 400 Saturn’s ring rain influx may change with season; 3) equatorial losses were
 401 not accounted for here (Perry et al., 2018; Waite et al., 2018), so the mass
 402 loss rate and ring lifetime estimates above are upper limits based strictly on
 403 a mid-latitude influx of water products alone.

404
 405 Moore et al. (2015) estimated $N_{\text{H}_3^+}$ from the observations of $\text{H}_3^+ \text{ Q}(1,0^-)$
 406 line emission taken by O’Donoghue et al. (2013), i.e. the same observations
 407 reported here (e.g. see Figure 2), by assuming a range of $T_{\text{H}_3^+}$ of $\sim 430 - 500$
 408 K in both hemispheres. H_3^+ densities near 39°S were modeled to be $1.8 - 3.2$
 409 $\times 10^{11} \text{ cm}^{-2}$, while those at 45°N were found to be range $1.6 - 3 \times 10^{11} \text{ cm}^{-2}$
 410 (Moore et al., 2015). By comparison, average densities of $11.6 \pm 9.2 \times 10^{11}$
 411 cm^{-2} and $24 \pm 16.5 \times 10^{11} \text{ cm}^{-2}$ were found near 45°N and 39°S , respectively,
 412 were derived from our observations. The northern values are (within uncer-
 413 tainties) in loose agreement with modeling, but the observed southern values
 414 exceed the expected density. To explore why this is the case, we examine
 415 the fitted values of $T_{\text{H}_3^+}$ in Figure 6, which show temperatures of 377 ± 47
 416 K at 45°N and 348 ± 31 K at 39°S . Since the observed intensity of a given
 417 H_3^+ line depends linearly upon the ion’s density and exponentially on the
 418 ion’s temperature (Melin et al., 2014), a model of H_3^+ emission that uses an
 419 overestimate of temperature will necessarily underestimate the ion’s density
 420 (and vice versa). The modeled H_3^+ densities will be larger at most latitudes

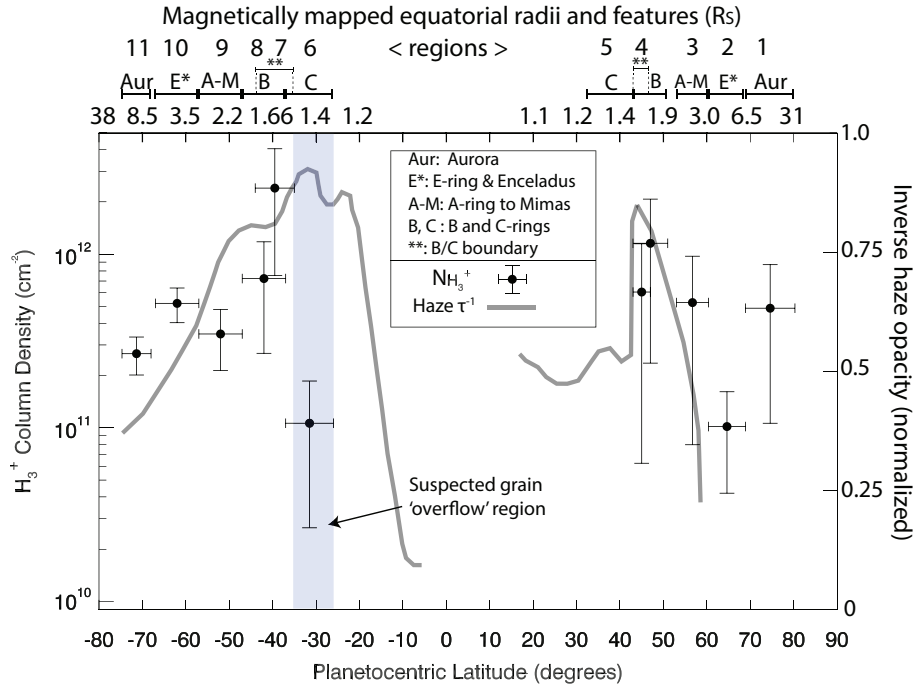

Figure 5: Saturn’s fitted H_3^+ column densities, $N_{\text{H}_3^+}$ and normalized inverse haze opacity, τ^{-1} , as a function of planetocentric latitude and corresponding magnetic field mapping out to the equatorial plane, R_s . Latitudinal/radial ranges of each measurement are given by the horizontal lines on each value, while the density uncertainties (one standard deviation) are given by vertical lines. A blue-shaded region indicates the ‘overflow’ region where the largest influx of ring rain is expected (2×10^9 molecules $\text{cm}^{-2} \text{s}^{-1}$). The listed features are the approximate locations covered by each latitudinal swath.

421 in the model of Moore et al. (2015), provided that the observed temperatures
 422 of 348 - 377 K are used instead of the previous 430 - 500 K (Luke Moore,
 423 personal communication).

424

425 We will now consider how the altitudinal distribution of the ring rain
 426 influx may give rise to an anti-correlation between $T_{\text{H}_3^+}$ and $N_{\text{H}_3^+}$ (the Spear-
 427 man’s rank coefficient between these parameters is $r = -0.93$). At 39°S, for
 428 example, ring rain enters the upper atmosphere from space, and while diffus-
 429 ing down to lower altitudes the grains will sublime (vaporize) according to
 430 the speed and size of the grains (Moses and Poppe, 2017; Hamil et al., 2018).
 431 The grain sizes and velocities derived from the Cassini CDA instrument data

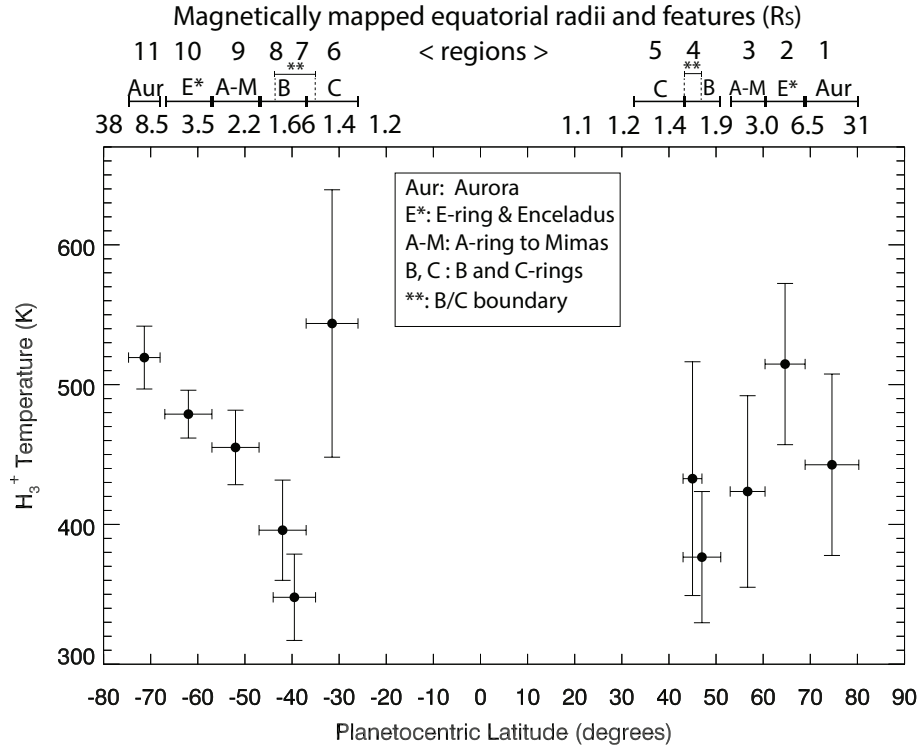

Figure 6: Saturn’s fitted H_3^+ column averaged temperatures, $T_{H_3^+}$, as a function of planetocentric latitude and corresponding magnetic field mapping out to the equatorial plane, R_s . Latitudinal/radial ranges of each measurement are given by the horizontal lines on each value, while the temperature uncertainties (one standard deviation) are given by vertical lines. The listed features are the approximate locations covered by each latitudinal swath.

432 were generally found to be ~ 10 s of nm in radius and have velocities of up to
 433 several km s^{-1} (Hsu et al., 2018). According to the grain precipitation model
 434 of Hamil et al. (2018), the nearest matching grain velocity/size for grains that
 435 undergo significant sublimation are either $15 \text{ km s}^{-1} / 100 \text{ nm}$ (which disintegrate by
 436 1085 km altitude) or $25 \text{ km s}^{-1} / 10 \text{ nm}$ (1408 km final altitude).
 437 When a photochemical model examined the release of a parcel of water in
 438 Saturn’s atmosphere at 1750 km , it was found that the heaviest losses to
 439 electron densities occur by altitudes of 1000 km (Moore and Mendillo, 2007).
 440 We will assume (therefore) that chemical reactions between water products
 441 and the atmosphere are most fervent near 1000 km , following sublimation
 442 within the $1000 - 1500 \text{ km}$ range (Moses and Poppe, 2017). With the addi-

443 tion of water products to lower altitudes, local electron densities would be
 444 reduced and consequently H_3^+ ions would then have longer lifetimes, while
 445 the column-integrated emissions become more representative of the deeper,
 446 colder parts of the ionosphere (Moore et al., 2009; Tao et al., 2011). The
 447 high reported temperature in the south mapping to the C-ring may then be
 448 due to lower-atmospheric H_3^+ being depleted by the aforementioned ‘overflow’
 449 at lower latitudes, leaving primarily hotter/high-altitude upper-atmospheric
 450 H_3^+ to be detected. A corresponding anti-correlation between $N_{\text{H}_3^+}$ and $T_{\text{H}_3^+}$
 451 is also be present at 45°N , although the uncertainties in the region are too
 452 large to draw any definitive conclusions.

453

454 The mid-latitude temperatures reported here are mostly a few 10s Kelvin
 455 lower in temperature than those reported for the exosphere by Koskinen et al.
 456 (2015), an offset which was predicted by Moore et al. (2015). However, at
 457 latitudes pertaining to ring rain the temperatures are far lower, likely due
 458 to the anti-correlation effect described in the previous paragraph. The auroral/polar
 459 observations reported here were also analyzed by O’Donoghue
 460 et al. (2014), who compared and contrasted Saturn’s main auroral emis-
 461 sions in each hemisphere by summing the data between $68 - 80^\circ$ north and
 462 south planetocentric latitude. Absence of Kronian-atmospheric windows (by
 463 methane absorption of sunlight) at the low latitudes led to only two H_3^+ lines
 464 being usable in the present work, whereas five H_3^+ lines were able to be used
 465 in the auroral regions of the previous study, leading to lower uncertainties.
 466 The northern H_3^+ temperature and density was found to be 527 ± 18 K and
 467 $1.6 \times 10^{11} \pm 0.3 \text{ cm}^{-2}$, while the southern parameters were 583 ± 13 K and
 468 $1.2 \times 10^{11} \pm 0.2 \text{ cm}^{-2}$, respectively O’Donoghue et al. (2014). We mostly overlap
 469 these northern auroral latitudes and partially overlap the southern latitudes
 470 in this work (see Table 1), and see the same general results within uncertain-
 471 ties: that the southern aurorae of Saturn have hotter, less dense H_3^+ than the
 472 northern aurorae. The northern auroral temperatures (region 1) are colder
 473 at 443 ± 65 K, but this may be due to O’Donoghue et al. (2014) including 1
 474 degree latitude more of region 2 than we do in the present paper.

475

476 The radiative cooling rate of H_3^+ , $L_{\text{H}_3^+}$, is shown in Figure 7 as a function
 477 of latitude. By far the largest output of radiation to space from H_3^+ leaves
 478 from the southern auroral regions, a result that was also found at Saturn
 479 using Keck data in both 2011 and 2013 (O’Donoghue et al., 2014, 2016).

480 The pole-to-pole radiative cooling rate falls off towards the mid latitudes but
481 lingers particularly high near 62°S . $L_{\text{H}_3^+}$ appears to be driven by relatively
482 high $N_{\text{H}_3^+}$ as opposed to $T_{\text{H}_3^+}$ in this region. Region 10, around 62°S , is of spe-
483 cial interest because a ‘second auroral oval’ of H_3^+ was found at this location
484 by Stallard et al. (2008), followed by detection of the northern Enceladus
485 footprint in the UV (Pryor et al., 2011). This region maps to the icy moon
486 Enceladus which orbits at $3.95 R_s$ (Tokar et al., 2008). Enceladus is a geo-
487 logically active body, outgassing neutral water products into a broad torus
488 which encircles Saturn, some of which becomes charged by photoionization
489 and charge-exchange (Johnson et al., 2006). A field-aligned current system
490 between Saturn and the Enceladus torus is thought to arise from this that
491 heats Saturn’s ionosphere, owing to ionospheric drag induced by accelerating
492 the charged part of the torus into co-rotation with the planet (Ray et al.,
493 2012). If charged water ions from the torus are able to flow into the iono-
494 sphere, they could have also caused the subtle rise in H_3^+ density seen here
495 in a similar manner to ring rain. It is possible that both heating and ionized
496 water precipitation occur simultaneously, but our results hint that charged
497 water from Enceladus may be preferentially draining into Saturn’s southern
498 mid-latitudes. It is unclear why latitudes in the northern hemisphere associ-
499 ated with Enceladus do not also show a large H_3^+ density.

500

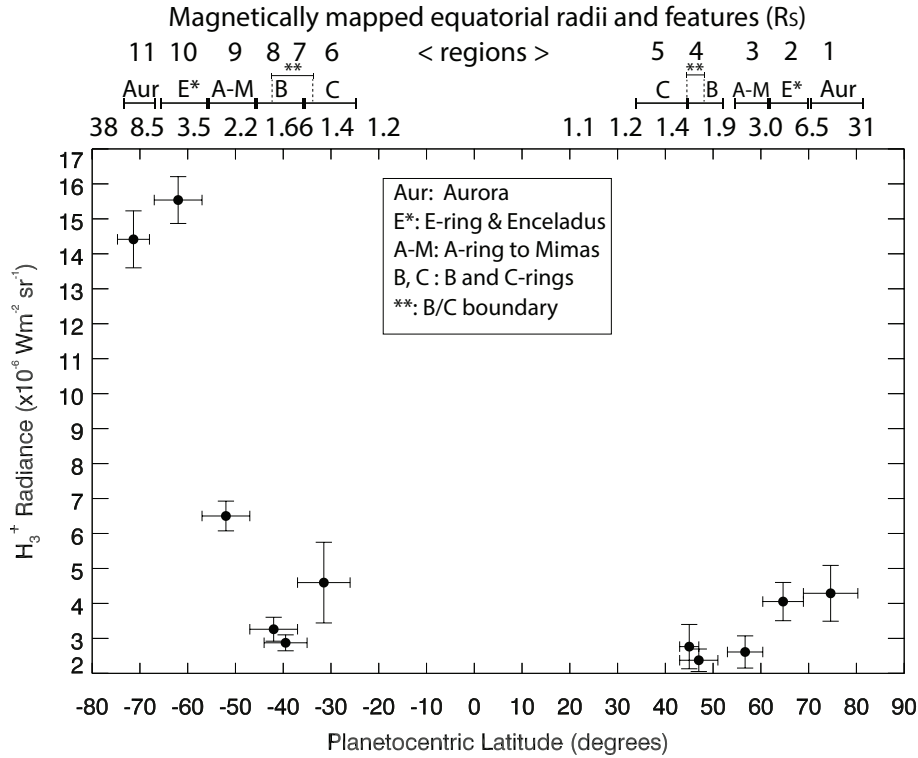

Figure 7: Saturn’s fitted H_3^+ radiances (radiative cooling rates), $L_{H_3^+}$, as a function of planetocentric latitude and corresponding magnetic field mapping out to the equatorial plane, R_s . Latitudinal/radial ranges of each measurement are given by the horizontal lines on each value, while the radiance uncertainties (one standard deviation) are given by vertical lines. The listed features are the approximate locations covered by each latitudinal swath.

501 5. Conclusions

502 Ground-based observations of Saturn were obtained on 17 April 2011
 503 using the 10-metre Keck telescope on Mauna Kea, Hawaii. H_3^+ emissions
 504 were previously analyzed from these observations, showing peaks in emission
 505 at specific latitudes that correspond well with an expected influx of charged
 506 water products (O’Donoghue et al., 2013). Subsequent modeling showed
 507 that the larger emissions are most likely driven by an increase in H_3^+ density
 508 (rather than temperature) relative to adjacent latitudes, and that this is
 509 facilitated by the removal of electrons which allow the H_3^+ lifetime to be
 510 extended where the influx occurs (Moore et al., 2015). In this study we

511 performed a new analysis of the April 2011 data, successfully deriving the
512 H_3^+ parameters temperature, density and radiative cooling rates for the first
513 time at the non-auroral regions of Saturn. Until now, we have not had direct
514 evidence that H_3^+ densities are driving the peaks in H_3^+ emission. Our findings
515 are summarized below:

- 516 1. We find that H_3^+ density is enhanced near 45°N and 39°S planetocen-
517 tric latitudes. An influx of ring material (probably water) causes the
518 enhancements seen through the chemical pathway described by Moore
519 et al. (2015).
- 520 2. The high H_3^+ density at 39°S is due to the northward-offset magnetic
521 field in the vicinity of the ring plane, which leads to charged grains
522 being immediately drawn southwards due to gravitational forces in that
523 region (Connerney, 1986). Southern hemisphere mapping to the C-ring
524 shows low H_3^+ density, likely due to the expected very large water influx
525 that begins to decrease H_3^+ densities when charge-exchange between
526 with water and H_3^+ begins to dominate (Moore et al., 2015). We define
527 this area as an ‘overflow region’.
- 528 3. We estimated the water product influx needed to explain the H_3^+ den-
529 sities by using previous modeling results (Moore et al., 2015). The rates
530 obtained were in agreement with the modeling work decades earlier by
531 Connerney and Waite (1984). The total water influx from the rings to
532 Saturn’s mid-latitude ionosphere inferred from the H_3^+ measurements
533 herein is $432 - 2870 \text{ kg s}^{-1}$, values that would deplete the rings in
534 292_{-124}^{+818} million years.
- 535 4. An anti-correlation between H_3^+ temperature and density was observed.
536 H_3^+ temperatures were low while the density was high at 39°S , likely
537 indicating that the ionosphere is most affected by ring rain in the deep
538 ionosphere near 1200 km (Moore and Mendillo, 2007; Hamil et al.,
539 2018), as deeper precipitation necessarily weights the H_3^+ density and
540 emissions to colder parts of the ionosphere (Moore et al., 2009; Tao
541 et al., 2011). In the region 6 (32°S) ‘overflow region’, this weighting
542 is reversed and high-altitude, warm H_3^+ emission dominate, as low-
543 altitude H_3^+ is expected to be completely depleted.
- 544 5. Saturn’s icy moon Enceladus appears to affect the mid-latitudes, with
545 62°S exhibiting relatively high H_3^+ density compared to adjacent lati-
546 tudes. The results may indicate that charged water from Enceladus is
547 draining into Saturn’s southern mid-latitudes, though no corresponding

548 northern density peak was found.

549 **Acknowledgements** James O’Donoghue’s research was supported by an
550 appointment to the National Aeronautics and Space Administration (NASA)
551 Postdoctoral Program at the NASA Goddard Space Flight Center, adminis-
552 tered by Universities Space Research Association under contract with NASA.
553 This material is based upon work supported by NASA under Grants NNX14AG72G
554 and NNX17AF14G issued through the SSO Planetary Astronomy Program.
555 The data presented herein were obtained at the W.M. Keck Observatory,
556 which is Operated as a scientific partnership among the California Institute of
557 Technology, the University of California, and NASA, and the data in the form
558 of fits files are available from the Keck archive at <https://www2.keck.hawaii.edu/koa/public/koa.php>
559 We are grateful to the staff at the Keck Observatory. The authors wish to
560 recognize the significant cultural role and reverence that the summit of Mau-
561 nakea has within the indigenous Hawaiian community: we are fortunate to
562 have the opportunity to conduct observations from this mountain.

563 Atreya, S. K., Donahue, T. M., Nagy, A. F., Waite, Jr., J. H., McConnell,
564 J. C., 1984. Theory, measurements, and models of the upper atmosphere
565 and ionosphere of Saturn. University of Arizona Press, pp. 239–277.

566 Connerney, J., Apr. 2013. Solar system: Saturn’s ring rain. *Nature* 496, 178–
567 179.

568 Connerney, J. E. P., Aug. 1986. Magnetic connection for Saturn’s rings and
569 atmosphere. *Geophys. Res. Lett.* 13, 773–776.

570 Connerney, J. E. P., Ness, N. F., Acuna, M. H., Jul. 1982. Zonal harmonic
571 model of Saturn’s magnetic field from Voyager 1 and 2 observations. *Nature*
572 298, 44–46.

573 Connerney, J. E. P., Waite, J. H., Nov. 1984. New model of Saturn’s iono-
574 sphere with an influx of water from the rings. *Nature* 312, 136–138.

575 Cuzzi, J., Clark, R., Filacchione, G., French, R., Johnson, R., Marouf,
576 E., Spilker, L., 2009. Ring Particle Composition and Size Distribution.
577 Springer, Dordrecht, p. 459.

578 Cuzzi, J. N., French, R. G., Hendrix, A. R., Olson, D. M., Roush, T., Vahi-
579 dinia, S., Jul. 2018. HST-STIS spectra and the redness of Saturn’s rings.
580 *Icarus* 309, 363–388.

- 581 Dougherty, M. K., Achilleos, N., Andre, N., Arridge, C. S., Balogh, A.,
582 Bertucci, C., Burton, M. E., Cowley, S. W. H., Erdos, G., Giampieri, G.,
583 Glassmeier, K.-H., Khurana, K. K., Leisner, J., Neubauer, F. M., Russell,
584 C. T., Smith, E. J., Southwood, D. J., Tsurutani, B. T., Feb. 2005. Cassini
585 Magnetometer Observations During Saturn Orbit Insertion. *Science* 307,
586 1266–1270.
- 587 Dougherty, M. K., Cao, H., Khurana, K. K., Hunt, G. J., Provan, G., Kellock,
588 S., Burton, M. E., Burk, T. A., Bunce, E. J., Cowley, S. W. H., Kivelson,
589 M. G., Russell, C. T., Southwood, D. J., 2018. Saturn’s magnetic field
590 revealed by the cassini grand finale. *Science* 362 (6410).
591 URL <http://science.sciencemag.org/content/362/6410/eaat5434>
- 592 Dougherty, M. K., Khurana, K. K., Neubauer, F. M., Russell, C. T., Saur,
593 J., Leisner, J. S., Burton, M. E., Mar. 2006. Identification of a Dynamic
594 Atmosphere at Enceladus with the Cassini Magnetometer. *Science* 311,
595 1406–1409.
- 596 Hamil, O., Cravens, T. E., Reedy, N. L., Sakai, S., Feb. 2018. Fate of Ice
597 Grains in Saturn’s Ionosphere. *J. Geophys. Res. (Space Physics)* 123, 1429–
598 1440.
- 599 Hansen, C. J., Shemansky, D. E., Esposito, L. W., Stewart, A. I. F., Lewis,
600 B. R., Colwell, J. E., Hendrix, A. R., West, R. A., Waite, Jr., J. H.,
601 Teolis, B., Magee, B. A., Jun. 2011. The composition and structure of the
602 Enceladus plume. *Geophys. Res. Lett.* 38, L11202.
- 603 Hsu, H.-W., Schmidt, J., Kempf, S., Postberg, F., Moragas-Klostermeyer,
604 G., Seiß, M., Hoffmann, H., Burton, M., Ye, S., Kurth, W. S., Horányi,
605 M., Khawaja, N., Spahn, F., Schirdewahn, D., O’Donoghue, J., Moore, L.,
606 Cuzzi, J., Jones, G. H., Srama, R., 2018. In situ collection of dust grains
607 falling from saturn’s rings into its atmosphere. *Science* 362 (6410).
608 URL <http://science.sciencemag.org/content/362/6410/eaat3185>
- 609 Johnson, R. E., Melin, H., Stallard, T. S., Tao, C., Nichols, J. D., Chowd-
610 hury, M. N., Jul. 2018. Mapping H_3^+ Temperatures in Jupiter’s Northern
611 Auroral Ionosphere Using VLT-CRIFRES. *J. Geophys. Res. (Space Physics)*
612 123, 5990–6008.

- 613 Johnson, R. E., Smith, H. T., Tucker, O. J., Liu, M., Burger, M. H., Sittler,
614 E. C., Tokar, R. L., Jun. 2006. The Enceladus and OH Tori at Saturn.
615 *Astrophys. J.* 644, L137–L139.
- 616 Kim, Y. H., Fox, J. L., Black, J. H., Moses, J. I., Jan. 2014. Hydrocarbon
617 ions in the lower ionosphere of Saturn. *J. Geophys. Res. (Space Physics)*
618 119, 384–395.
- 619 Kliore, A. J., Nagy, A., Asmar, S., Anabtawi, A., Barbinis, E., Fleischman,
620 D., Kahan, D., Klose, J., Aug. 2014. The ionosphere of Saturn as observed
621 by the Cassini Radio Science System. *Geophys. Res. Lett.* 41, 5778–5782.
- 622 Kliore, A. J., Patel, I. R., Lindal, G. F., Sweetnam, D. N., Hotz, H. B., Waite,
623 J. H., McDonough, T., Nov. 1980. Structure of the ionosphere and atmo-
624 sphere of Saturn from Pioneer 11 Saturn radio occultation. *J. Geophys.*
625 *Res.* 85, 5857–5870.
- 626 Koskinen, T. T., Sandel, B. R., Yelle, R. V., Strobel, D. F., Müller-Wodarg,
627 I. C. F., Erwin, J. T., Nov. 2015. Saturn’s variable thermosphere from
628 Cassini/UVIS occultations. *Icarus* 260, 174–189.
- 629 Lam, H. A., Achilleos, N., Miller, S., Tennyson, J., Trafton, L. M., Geballe,
630 T. R., Ballester, G. E., Jun. 1997. A Baseline Spectroscopic Study of the
631 Infrared Auroras of Jupiter. *Icarus* 127, 379–393.
- 632 Liu, C.-M., Ip, W.-H., May 2014. A New Pathway of Saturnian Ring-
633 Ionosphere Coupling via Charged Nanograins. *Astrophys. J.* 786, 34.
- 634 Markwardt, C. B., Sep. 2009. Non-linear Least-squares Fitting in IDL with
635 MPFIT. In: Bohlender, D. A., Durand, D., Dowler, P. (Eds.), *Astronomi-
636 cal Data Analysis Software and Systems XVIII*. Vol. 411 of *Astronomical
637 Society of the Pacific Conference Series*. p. 251.
- 638 McElroy, M. B., Mar. 1973. The Ionospheres of the Major Planets (Article
639 published in the *Space Science Reviews* special issue on ‘Outer Solar Sys-
640 tem Exploration - An Overview’, ed. by J. E. Long and D. G. Rea.). *Space
641 Sci. Rev.* 14, 460–473.
- 642 McLean, I. S., Becklin, E. E., Bendiksen, O., Brims, G., Canfield, J., Figer,
643 D. F., Graham, J. R., Hare, J., Lacayanga, F., Larkin, J. E., Larson, S. B.,
644 Levenson, N., Magnone, N., Teplitz, H., Wong, W., Aug. 1998. Design

- 645 and development of NIRSPEC: a near-infrared echelle spectrograph for
646 the Keck II telescope. In: Fowler, A. M. (Ed.), Society of Photo-Optical
647 Instrumentation Engineers (SPIE) Conference Series. Vol. 3354 of Society
648 of Photo-Optical Instrumentation Engineers (SPIE) Conference Series. pp.
649 566–578.
- 650 Melin, H., Stallard, T. S., Miller, S., Geballe, T. R., Trafton, L. M.,
651 O’Donoghue, J., 2013. Post-equinoctial observations of the ionosphere of
652 uranus. *Icarus* 223 (2), 741 – 748.
- 653 Melin, H., Stallard, T. S., O’Donoghue, J., Badman, S. V., Miller, S., Blake,
654 J. S. D., Feb. 2014. On the anticorrelation between H_3^+ temperature and
655 density in giant planet ionospheres. *Mon. Not. R. Astron. Soc.* 438, 1611–
656 1617.
- 657 Miller, S., Stallard, T., Melin, H., Tennyson, J., 2010. H_3^+ cooling in planetary
658 atmospheres. *Faraday Discussions* 147, 283–291.
- 659 Mitchell, D. G., Perry, M. E., Hamilton, D. C., Westlake, J. H., Kollmann,
660 P., Smith, H. T., Carbary, J. F., Waite, J. H., Perryman, R., Hsu, H.-W.,
661 Wahlund, J.-E., Morooka, M. W., Hadid, L. Z., Persoon, A. M., Kurth,
662 W. S., 2018. Dust grains fall from saturn’s d-ring into its equatorial upper
663 atmosphere. *Science* 362 (6410).
664 URL <http://science.sciencemag.org/content/362/6410/eaat2236>
- 665 Moore, L., Galand, M., Mueller-Wodarg, I., Mendillo, M., Dec. 2009. Re-
666 sponse of Saturn’s ionosphere to solar radiation: Testing parameterizations
667 for thermal electron heating and secondary ionization processes. *Planetary
668 and Space Science* 57, 1699–1705.
- 669 Moore, L., Mendillo, M., Jun. 2007. Are plasma depletions in Saturn’s iono-
670 sphere a signature of time-dependent water input? *Geophys. Res. Lett.*
671 34, 12202.
- 672 Moore, L., O’Donoghue, J., Müller-Wodarg, I., Galand, M., Mendillo, M.,
673 Jan. 2015. Saturn ring rain: Model estimates of water influx into Saturn’s
674 atmosphere. *Icarus* 245, 355–366.
- 675 Moses, J. I., Bass, S. F., Mar. 2000. The effects of external material on
676 the chemistry and structure of Saturn’s ionosphere. *J. Geophys. Res.* 105,
677 7013–7052.

- 678 Moses, J. I., Poppe, A. R., Nov. 2017. Dust ablation on the giant planets:
679 Consequences for stratospheric photochemistry. *Icarus* 297, 33–58.
- 680 Neale, L., Miller, S., Tennyson, J., Jun. 1996. Spectroscopic Properties of the
681 H_3^+ Molecule: A New Calculated Line List. *Astrophys. J.* 464, 516–520.
- 682 Nicholson, P. D., Hedman, M. M., Clark, R. N., Showalter, M. R., Cruik-
683 shank, D. P., Cuzzi, J. N., Filacchione, G., Capaccioni, F., Cerroni, P.,
684 Hansen, G. B., Sicardy, B., Drossart, P., Brown, R. H., Buratti, B. J.,
685 Baines, K. H., Coradini, A., Jan. 2008. A close look at Saturn’s rings with
686 Cassini VIMS. *Icarus* 193, 182–212.
- 687 Northrop, T. G., Connerney, J. E. P., Apr. 1987. A micrometeorite erosion
688 model and the age of Saturn’s rings. *Icarus* 70, 124–137.
- 689 Northrop, T. G., Hill, J. R., Aug. 1982. Stability of negatively charged dust
690 grains in Saturn’s ring plane. *J. Geophys. Res.* 87, 6045–6051.
- 691 Northrop, T. G., Hill, J. R., Aug. 1983. The inner edge of Saturn’s B ring.
692 *J. Geophys. Res.* 88, 6102–6108.
- 693 O’Donoghue, J., Melin, H., Stallard, T. S., Provan, G., Moore, L., Badman,
694 S. V., Cowley, S. W. H., Baines, K. H., Miller, S., Blake, J. S. D., Jan.
695 2016. Ground-based observations of Saturn’s auroral ionosphere over three
696 days: Trends in H_3^+ temperature, density and emission with Saturn local
697 time and planetary period oscillation. *Icarus* 263, 44–55.
- 698 O’Donoghue, J., Moore, L., Connerney, J. E. P., Melin, H., Stallard, T. S.,
699 Miller, S., Baines, K. H., Dec. 2017. Redetection of the Ionospheric H_3^+
700 Signature of Saturn’s “Ring Rain”. *Geophys. Res. Lett.* 44, 11.
- 701 O’Donoghue, J., Stallard, T. S., Melin, H., Cowley, S. W. H., Badman, S. V.,
702 Moore, L., Miller, S., Tao, C., Baines, K. H., Blake, J. S. D., Feb. 2014.
703 Conjugate observations of Saturn’s northern and southern H_3^+ aurorae.
704 *Icarus* 229, 214–220.
- 705 O’Donoghue, J., Stallard, T. S., Melin, H., Jones, G. H., Cowley, S. W. H.,
706 Miller, S., Baines, K. H., Blake, J. S. D., Apr. 2013. The domination of
707 Saturn’s low-latitude ionosphere by ring ‘rain’. *Nature* 496, 193–195.

- 708 Perry, M., Waite Jr, J., Mitchell, D., Miller, K., Cravens, T., Perryman, R.,
709 Moore, L., Yelle, R., Hsu, H.-W., Hedman, M., et al., 2018. Material flux
710 from the rings of saturn into its atmosphere. *Geophys. Res. Lett.*
- 711 Prangé, R., Fouchet, T., Courtin, R., Connerney, J. E. P., McConnell, J. C.,
712 Feb. 2006. Latitudinal variation of Saturn photochemistry deduced from
713 spatially-resolved ultraviolet spectra. *Icarus* 180, 379–392.
- 714 Pryor, W. R., Rymer, A. M., Mitchell, D. G., Hill, T. W., Young, D. T.,
715 Saur, J., Jones, G. H., Jacobsen, S., Cowley, S. W. H., Mauk, B. H.,
716 Coates, A. J., Gustin, J., Grodent, D., Gérard, J.-C., Lamy, L., Nichols,
717 J. D., Krimigis, S. M., Esposito, L. W., Dougherty, M. K., Jouchoux,
718 A. J., Stewart, A. I. F., McClintock, W. E., Holsclaw, G. M., Ajello, J. M.,
719 Colwell, J. E., Hendrix, A. R., Crary, F. J., Clarke, J. T., Zhou, X., Apr.
720 2011. The auroral footprint of Enceladus on Saturn. *Nature* 472, 331–333.
- 721 Ray, L. C., Galand, M., Moore, L. E., Fleshman, B. L., Jul. 2012. Charac-
722 terizing the limitations to the coupling between Saturn’s ionosphere and
723 middle magnetosphere. *J. Geophys. Res. (Space Physics)* 117, A07210.
- 724 Srama, R., Ahrens, T. J., Altobelli, N., Auer, S., Bradley, J. G., Burton,
725 M., Dikarev, V. V., Economou, T., Fechtig, H., Görlich, M., Grande, M.,
726 Graps, A., Grün, E., Havnes, O., Helfert, S., Horanyi, M., Igenbergs, E.,
727 Jessberger, E. K., Johnson, T. V., Kempf, S., Krivov, A. V., Krüger,
728 H., Mocker-Ahlreep, A., Moragas-Klostermeyer, G., Lamy, P., Landgraf,
729 M., Linkert, D., Linkert, G., Lura, F., McDonnell, J. A. M., Möhlmann,
730 D., Morfill, G. E., Müller, M., Roy, M., Schäfer, G., Schlotzhauer, G.,
731 Schwehm, G. H., Spahn, F., Stübiger, M., Svestka, J., Tschernjawski, V.,
732 Tuzzolino, A. J., Wäsch, R., Zook, H. A., Sep. 2004. The Cassini Cosmic
733 Dust Analyzer. *Space Sci. Rev.* 114, 465–518.
- 734 Stallard, T., Miller, S., Melin, H., Lystrup, M., Cowley, S. W. H., Bunce,
735 E. J., Achilleos, N., Dougherty, M., Jun. 2008. Jovian-like aurorae on
736 Saturn. *Nature* 453, 1083–1085.
- 737 Stallard, T. S., Melin, H., Miller, S., Badman, S. V., Baines, K. H., Brown,
738 R. H., Blake, J. S. D., O’Donoghue, J., Johnson, R. E., Bools, B., Pilk-
739 ington, N. M., East, O. T. L., Fletcher, M., Aug. 2015. Cassini VIMS
740 observations of H_3^+ emission on the nightside of Jupiter. *J. Geophys. Res.*
741 (Space Physics) 120, 6948–6973.

- 742 Stallard, T. S., Melin, H., Miller, S., O' Donoghue, J., Cowley, S. W. H.,
743 Badman, S., Adriani, A., Brown, R. H., Baines, K. H., Oct. 2012. Tem-
744 perature changes and energy inputs in giant planet atmospheres: what we
745 are learning from H_3^+ . *Phil. Trans. Roy. Soc.* 370, 5213–5224.
- 746 Tao, C., Badman, S. V., Fujimoto, M., Jun. 2011. UV and IR auroral emission
747 model for the outer planets: Jupiter and Saturn comparison. *Icarus* 213,
748 581–592.
- 749 Tokar, R. L., Wilson, R. J., Johnson, R. E., Henderson, M. G., Thomsen,
750 M. F., Cowee, M. M., Sittler, E. C., Young, D. T., Crary, F. J., McAn-
751 dreds, H. J., Smith, H. T., Jul. 2008. Cassini detection of water-group
752 pick-up ions in the Enceladus torus. *Geophys. Res. Lett.* 35, 14202.
- 753 Voosen, P., Dec. 2017. Saturn's rings are solar system newcomers. *Science*
754 358, 1513–1514.
- 755 Waite, J. H., Atreya, S. K., Nagy, A. F., Sep. 1979. The ionosphere of Saturn
756 - Predictions for Pioneer 11. *Geophys. Res. Lett.* 6, 723–726.
- 757 Waite, J. H., Perryman, R. S., Perry, M. E., Miller, K. E., Bell, J., Cravens,
758 T. E., Glein, C. R., Grimes, J., Hedman, M., Cuzzi, J., Brockwell, T.,
759 Teolis, B., Moore, L., Mitchell, D. G., Persoon, A., Kurth, W. S., Wahlund,
760 J.-E., Morooka, M., Hadid, L. Z., Chocron, S., Walker, J., Nagy, A., Yelle,
761 R., Ledvina, S., Johnson, R., Tseng, W., Tucker, O. J., Ip, W.-H., 2018.
762 Chemical interactions between saturn's atmosphere and its rings. *Science*
763 362 (6410).
764 URL <http://science.sciencemag.org/content/362/6410/eaat2382>
- 765 Zebker, H. A., Marouf, E. A., Tyler, G. L., Dec. 1985. Saturn's rings - Particle
766 size distributions for thin layer model. *Icarus* 64, 531–548.