



# **Depth of Field and Bokeh**

by

H. H. Nasse

## Preface

### ***"Nine rounded diaphragm blades guarantee images with exceptional bokeh"***

Wherever there are reports about a new camera lens, this sentence is often found. What characteristic of the image is actually meant by it? And what does the diaphragm have to do with it?

We would like to address these questions today. But because "bokeh" is closely related to "depth of field," I would like to first begin with those topics on the following pages. It is true that a great deal has already been written about them elsewhere, and many may think that the topics have already been exhausted. Nevertheless I am sure that you will not be bored. I will use a rather unusual method to show how to use a little geometry to very clearly understand the most important issues of 'depth of field'.

Don't worry, though, we will not be dealing with formulas at all apart from a few exceptions. Instead, we will try to understand the connections and learn a few practical rules of thumb. You will find useful figures worth knowing in a few graphics and tables.

Then it only takes another small step to understand what is behind the rather secretive sounding term "bokeh". Both parts of today's article actually deal with the same phenomenon but just look at it from different viewpoints. While the geometric theory of depth of field works with an idealized simplification of the lens, the real characteristics of lenses including their aberrations must be taken into account in order to properly understand bokeh. The diaphragm is not enough, and that is all that needs to be said here.

There are also plenty of pictures for illustrating this topic for those who do not want to get deeply involved in the theory of their camera, so we really wish everyone a lot of fun with the reading.

## "Schärfentiefe" or "Tiefenschärfe" for depth of field?

When searching the net, there is a seemingly endless amount of entries about our topic and much of what is there for reading is of course incorrect or incomplete. It is therefore not surprising that photography forums like to spend so much time discussing it.

There was a particular increase in the interest to understand depth of field when the first digital SLR cameras were put on the market in the smaller APS-C format, which were compatible with "old" lenses for the 24x36 mm format. But the question was whether the engraved scale on the lens still applies or not.

In the German forums we even find some heavy debate about the proper term for the depth of field - should it be "Schärfentiefe" or "Tiefenschärfe", saying "depth of sharpness" or "sharpness of the depth"?

We shouldn't split hairs over it, particularly when we see that this depth itself is not a very precise feature anyway. Both terms have been in common use for a while now. And both refer to the same characteristic of photographic imaging - namely that a clear two-dimensional photographic image can be made of objects in a three-dimensional space under certain conditions, even though the camera can only be focused on one specific distance.



*Equipment details of a camera from 1934: a "Tiefenschärfe" table instead of a "Schärfentiefe" one! Language is not always so strict, so we have to allow both terms to be used. This debate about terms is of course useless for those who read the translated English version!*

The fact that we can capture a considerable portion of the three-dimensional space in front of and behind the optimally focused distance on the film or chip is because we can obviously tolerate or not even notice a certain amount of blurriness.

It is really a blessing that this is the case, because there is hardly any camera so precise that it can be 100% sure to bring the optimum performance of the lens onto the film or sensor. That is because limited film flatness in analogue times, focusing errors, and other mechanical tolerances make it more difficult.

But as long as the errors are not too great, we usually do not notice them.

**Depth of field is based on the acceptable blurriness and is therefore essentially based on arbitrary specifications.** But it is not the case that the sharpness of the image is actually constant at a certain depth of space and then stops being so in front of and behind it. The sharpness is always continuously changing with the distance of the object.

## When is the depth of field not dependent upon the focal length?

### What is behind the scale on the lens?

When someone says that the depth of field is not at all dependent on the focal length, of course we would like to contradict that. After all, practical experience has shown us that wide-angle lenses make images with a large depth and telephoto lenses have a rather selective sharpness. Despite this, the person making the original claim may be right, but must clarify which type of depth is meant. Those speaking English have it better because they use two clearly different terms: **depth of field** and **depth of focus**.

The former stands for what we generally consider to be "Schärfentiefe" in German, namely the depth in the object space. But there is also a depth in the image space inside the camera. This image-side depth, called depth of focus in English, is not actually dependent on the focal length but rather on the f-number, which is easy to understand:

Every picture element is generated by a large number of beams of light that shine through the aperture and combine in the picture element. In doing so, they form a **light cone** whose area is the image of the aperture seen from the sensor. This picture of the aperture is called the **exit pupil**. You can easily see it when you look into a lens from behind while you point it to a light surface:



The **f-number** is the ratio of the distance from the image plane to the exit pupil and the diameter of the exit pupil. The **angular aperture of the light cone** therefore only depends on the f-number.

A large aperture (meaning a low f-number) means a truncated light cone, and a small aperture (meaning a higher f-number) means a pointed light cone.

$$f - number = \frac{DistEP}{DiameterEP}$$

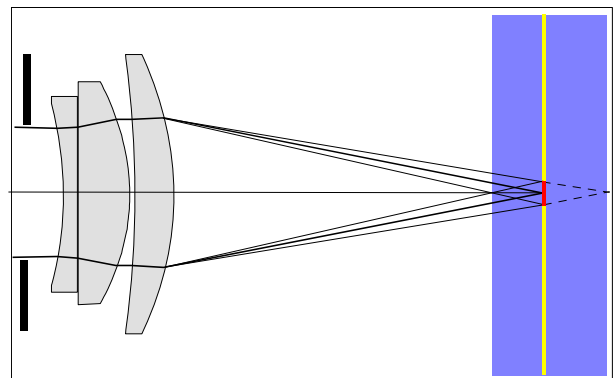

If the sensor surface (**yellow line**) intersects with the light cone at a certain distance from the point of the cone, the resulting intersection is the **circle of confusion** marked red in above drawing.

The **total image-side depth of focus** (the blue section of the image space in the diagram above) is twice the product of the diameter of the circle of confusion ( $z$ ) and the f-number ( $k$ ):

$$depth \cdot of \cdot focus \approx 2 \cdot z \cdot k$$

This simple equation can be seen in the engraved depth of field scales:

The rotary angle on the focusing ring is proportional to the image-side focus adjustment and the depth-of-field markings on the lens barrel are therefore proportional to the f-number.

(Strictly speaking, the image-side depth of focus behind the image plane is just slightly larger, but this can be ignored.)



*Examples of depth-of-field scales on lenses: engraved on the left, and a complex solution on the right where the two red indicators are moved by a gear system when the aperture is set. In both cases, the distances from the index in the middle to the depth-of-field markings are proportional to the f-number. The intervals between the individual scale markings are of course also dependent upon the specification of the acceptable circle of confusion and the thread pitch of the focusing ring. That is why such scales are no longer useful on many modern AF lenses if they have extremely steep focusing. The depth-of-field scales are symmetrical on the left and right.*

You may sometimes come across those who hold the viewpoint that a longer focal length has a larger image-side depth of focus. That is not true, however, because the image-side depth of focus is only dependent on the f-number. This misconception comes from confusing the **image-side depth of focus** with the **depth of the three-dimensional image**.

Short focal lengths only have a very short focus movement because they display everything from the near foreground to the distant background in a very short image space - their image is flat. Long focal lengths require a significantly larger focus movement because the image of the same object space is much deeper.

If cameras are poorly calibrated, the sensor may be completely next to the flat image for very short focal lengths and then the entire motif will appear to be slightly blurry. With a long focal length, on the other hand, despite poor calibration it will still be perfectly clear somewhere, even if it is not where it is supposed to be. This experience also leads to the misconception that short focal lengths have a short image-side depth of focus.

It is true, however, that the depth of field **in the object space** is also (almost) independent of the focal length if we compare the respective imaging of the object at the **same imaging scale**. For photographs with different focal lengths and the same image format, of course, this means that the photographs are taken from correspondingly different distances.

The fact that the depth of field is only dependent on the imaging scale regardless of the focal length no longer applies with very large distances. Even at closer taking distance, two photographs of an object will not be identical if they are taken with two different focal lengths, even if the depth of focus is practically identical. Besides the perspectives, the maximum blurriness of the distant background differs. It is lower for shorter focal lengths than for longer ones.

In the following pages we will move on from the image space inside of the camera where the circles of confusion actually arise and take a look at the space in front of the lens in order to understand why that is the case.

## Depth of field and the entrance pupil

On the last two pages we have taken a look at the light cone on the image side and learned that circles of confusion arise when these light cones are truncated by the sensor surface. The beams of light travelling from an object point into the lens do not have an intersection on the sensor surface in that case, but rather somewhere in the space in front of it or behind it. In either case, their energy is distributed across an expanded spot on the sensor surface that we may no longer perceive as a sharp picture element.

The acceptable deviations of the best focus point from the sensor surface in the camera may be interesting for the camera manufacturer, but when we are taking photographs we are more concerned with the space in front of the lens. All distance scales on lenses refer to the object side. That is why we have to convert the **image-side depth of focus into the object-side depth of field**. And at that point we usually face the trouble with the formulas, which we try to avoid today.

The light cones that cause the circles of confusion do not originate in the lens but rather come from the corresponding object points. This means that there are also light cones on the object side in front of the lens. Their base area is the **entrance pupil**. That is the **image of the aperture** that we see when we look at a bright surface through **the front** of a lens from a certain distance:



The **entrance pupil** can also be located far in the back of the lens, so we should not be fooled by its name. In the case of the long **Tele-Tessar** lenses for the Hasselblad, the entrance pupil is in the film magazine.

A virtual plane in front of the lens within the focus distance is intersected by the light cones travelling nearer from points further away; it is intersected by the rear extensions of light cones from closer object points.

The intersections with this object-side plane are the images of the circles of confusion in the sensor plane - we call them "**object-side circles of confusion**" for simplicity. Even if they are not physically present, we can still say that because **every beam path can also be inverted**. Making use of something that is not even physically present is the trick to simplifying the concept.

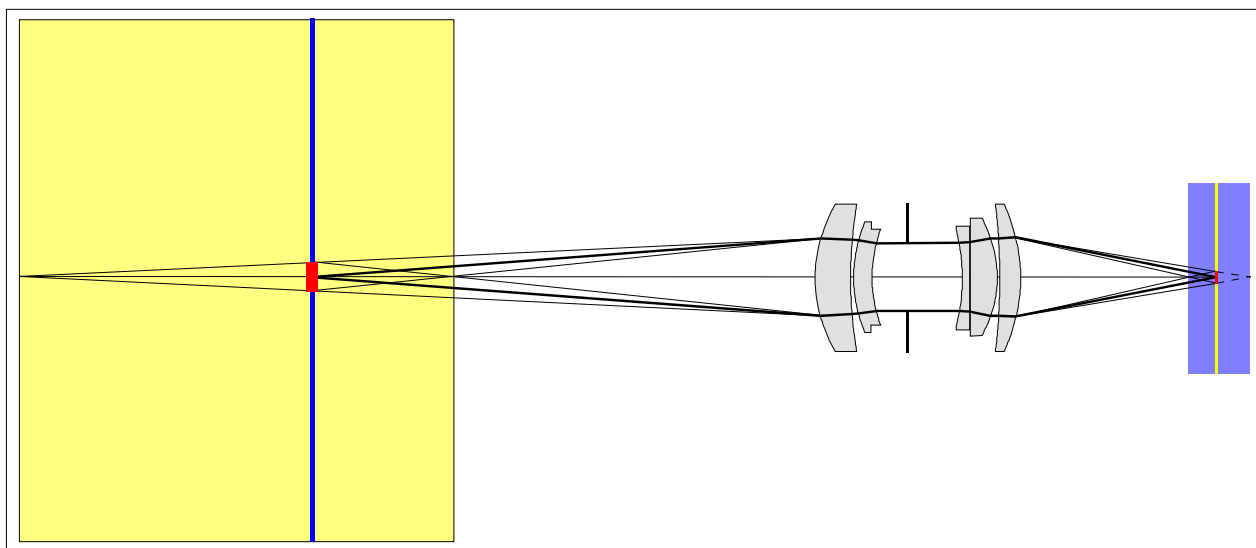

In the diagram on the previous page, the blue image space is on the right, behind the lens. It is the image of the object space marked yellow on the left in front of the lens. The furthest points on the left are also displayed in the image space on the left, closer to the lens. The blue line in the object space is the image of the sensor surface marked yellow on the right in the image space – it is the focal plane. The circles of confusion that appear on the sensor surface are marked red. They have a corresponding mark in the object-side focal plane.

If an image is made with an imaging scale of 1:100 in 35 mm format 24x36 mm allowing for the usual 0.03 mm circles of confusion, then the images of the circles of confusion in the focal plane in the object space can be as large as 3 mm maximum. The field of the focal plane displayed on the sensor is 2.4 x 3.6 m. The ratio of the diameter of the circle of confusion and the field size is identical on both sides.

We will consider later how small this ratio between the diameter of the circle of confusion and the image size should be. At any rate, it is the parameter of the acceptable blurriness. And in the object space this ratio depends on three things:

1. How big is the object field?
2. Where is the point of the light cone?
3. How big is the base area of the light cone?

Conditions 2 and 3 determine how narrow an object-side light cone is. And condition 1 then determines the relative size of the intersection of the cone with the focal plane.

The base area of the light cone is the **entrance pupil**, and its **diameter** is the quotient of the focal length and the f-number. Lenses with a long focal length and wide-aperture lenses (small f-numbers) have large entrance pupils, and lenses with a short focal length and small-aperture lenses have small entrance pupils.

$$Diameter_{EP} = \frac{FocalLength}{f - number}$$

With a little geometry, we can now easily see how the depth of field depends on the **taking distance, the focal length and the aperture**:

### 1. Distance

If we double the focusing distance, the size of the object field in the focal plane also doubles - not its area, but rather the width, height and diagonal lengths. At the same time a light cone from a point behind the focal plane will be twice as narrow, because the base area remains the same and we infer the length of the cone. As a result, the ratio of the field diagonal and circle of confusion becomes four times as large as before or, in other words: the **depth of field grows with the square of the focusing distance**.

### 2. Focal length

The focal length behaves similarly: if we halve it, for example, the size of the object field in the focal plane also doubles. At the same time, half the focal length means half the diameter of the entrance pupil, which then makes the light cone twice as narrow from a point behind the focal plane. As a result, the ratio of the field diagonal and circle of confusion becomes four times as large as before or, in other words: the **depth of field with equal focusing distance is inversely proportional to the square of the focal length**.

### 3. Aperture

If we stop down the aperture of the lens, we reduce the area of the entrance pupil. Its diameter decreases by a factor of 0.71 with each single f-stop, by a factor of 0.5 after two stops. This also narrows the light cone. If the size of the object field remains the same, the **depth of field increases linearly with the f-number**. Stopping down the aperture two stops, for example from a 5.6 aperture to an 11 aperture, usually doubles the depth of field.

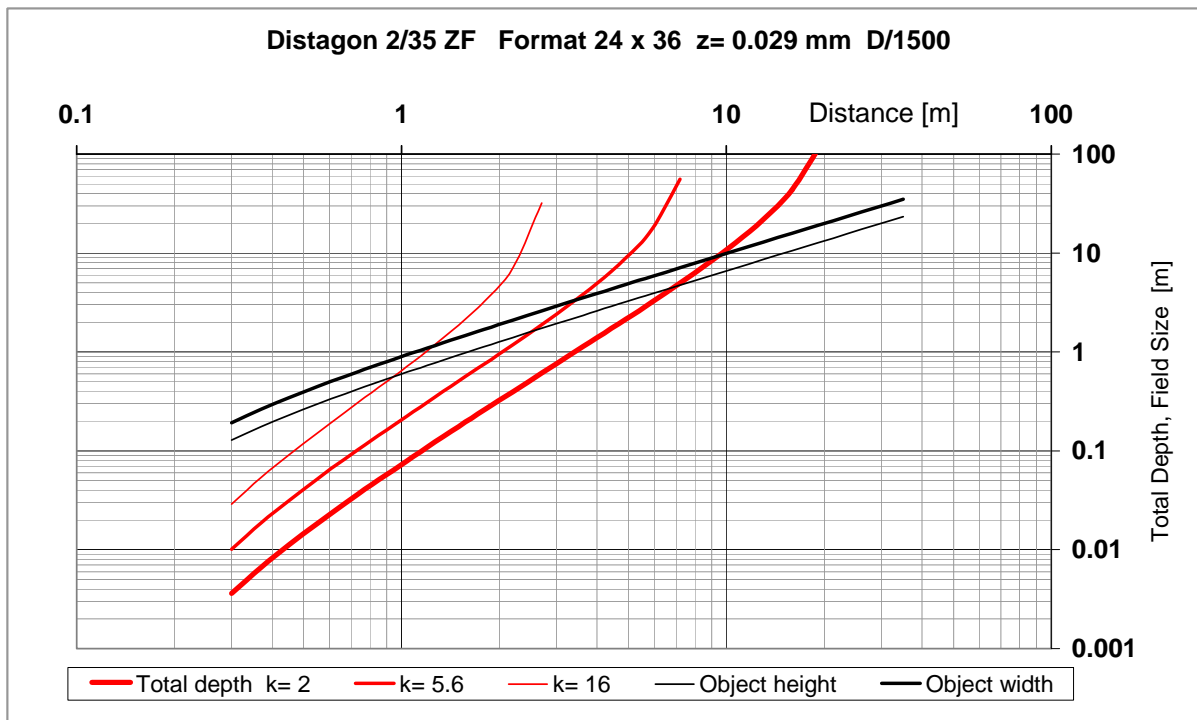
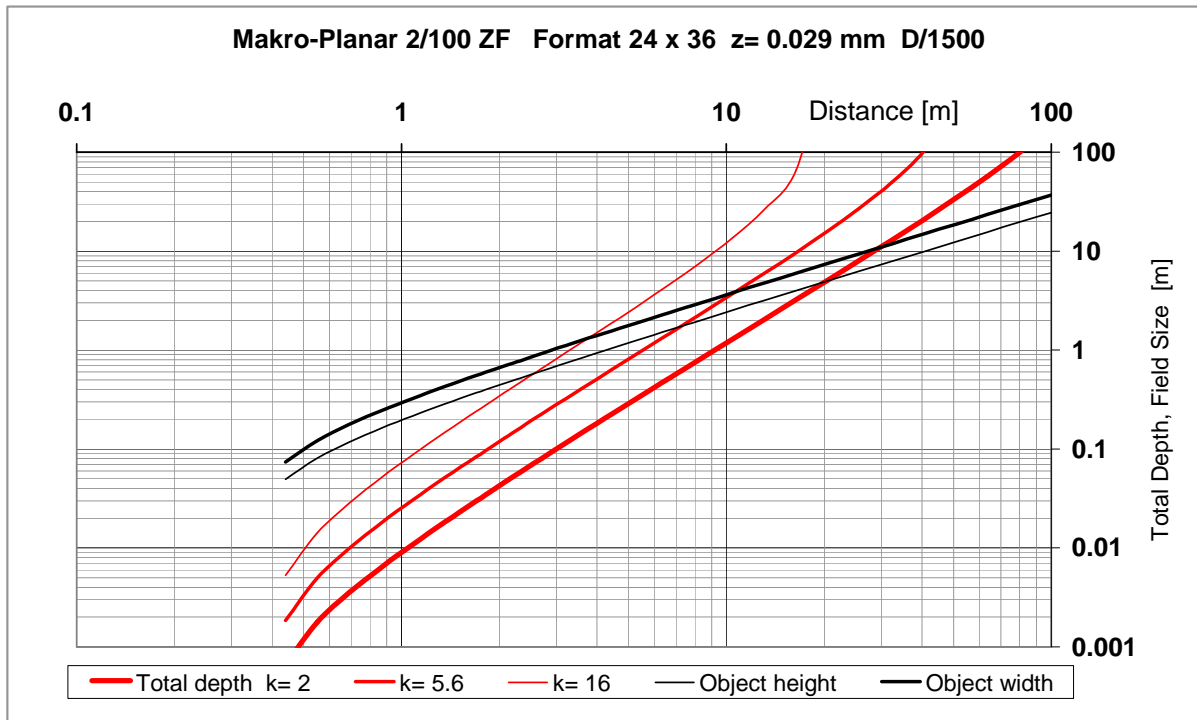

Graphical representation of the relationships described on the previous page. The meter scale on each axis is divided logarithmically so that distance always changes by the same factor for each equally long increment. These types of scales are useful for displaying wide ranges of size variations in one image and give us very simple curves. They are only a bit warped on the edges if we come close to the lens or the infinity focus. The focus distance runs along the horizontal axis and the total depth of field runs along the vertical axis.

Logarithmic scales have ten intervals of varying length for the same steps of numbers, step size is 1 between 1 and 10, 10 between 10 and 100, 100 between 100 and 1000, 0.01 between 0.01 and 0.1 ... and so on.

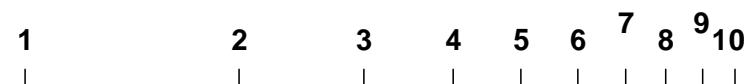



Now we can also just as easily explain what happens during a change in the film format:

#### 4. Smaller film format with the same lens

If we remove a lens from an old analogue camera and attach it to a digital camera of the same system that has a somewhat smaller APS-C sensor, then there is a "crop factor". We do not talk about an extension of the focal length, it doesn't exist in this case. After all, the lens does not know how much of its image circle we are capturing with our sensor.

The size of the object field is reduced by the crop factor while the object-side light cones remain the same, as long as we use the same lens and do not change the aperture setting.

That is why the points of the light cones may not be located so far from the focal plane if we want to maintain the same ratio of diagonal to circle of confusion. **Reducing the size of the film format therefore reduces the depth of field by the crop factor.**

#### 5. Different film formats with the same object field

If we select the suitable focal length to ensure that we always display the same field with different film formats, then things go just the other way round: **reducing the size of the sensor format increases the depth of field, and enlarging the sensor format reduces the depth of field**, as long as we always use the same aperture setting. That is because a smaller sensor format displays the same object field with an accordingly shorter focal length. If the same f-number is used, then the entrance pupil is reduced by the crop factor and the light cones are narrower.

For the same reason, medium format photographs show a significantly smaller depth of field with the usual apertures, even though the absolute diameter of the image-side circles of confusion is larger, usually 0.05 mm as opposed to 0.03 mm in 35 mm format. If the medium format lens is adapted to a 35 mm camera, then of course we have to calculate with the 0.03 mm of the smaller format.

The acceptable diameter of the circle of confusion is therefore not a characteristic of the lens but rather the sensor format. A feature of the lenses is only the smallest possible circle of confusion, and this arises from the correction of the lens aberrations.

At first glance we therefore observe a paradoxical characteristic whereby large formats have a **smaller object-side** depth of field and simultaneously a **larger image-side** depth of focus with the same apertures and object fields. This is also reflected in the mechanical tolerances of cameras: Large-format cameras can be built with carpenter precision, and the camera module in a mobile phone requires  $\mu\text{m}$  (micrometer) precision. Those are the extremes, but in SLR photography we can already see the difference between APS-C and full-frame format with regard to the requirements for focusing accuracy.

It appears to be a confusing paradox at first glance, but of course it has a very simple explanation. We just photographed object fields of the same size with different sizes of image formats. If the acceptable blurriness is supposed to be the same with these different cameras, it means that the ratio of the object field diagonal and the "object-side circle of confusion" should be the same. The object-side light cones travelling from a point behind the focal plane, for example, should therefore be the same for all compared cameras. If the images have different format sizes, however, the imaging scale is different. Under these conditions, the image-side circles of confusion must therefore increase along with the scale factor.

The object-side light cones can only be the same if all entrance pupils are of the same size, however. But because object fields of the same size mean longer focal lengths for larger image formats, the f-numbers must be different.

## The big format comparison

We now know that the depth is only dependent on the size of the entrance pupil if we have the same distance and the same angular field. The pupil diameter is the quotient of the focal length and the f-number.

If the focal length then changes by a factor determined by the image format, we only have to multiply the f-number by the same factor. Then the quotient, that is to say the entrance pupil, has the same value again and we have the same depth of field relationships.

There are therefore **equivalent f-numbers** for all formats, corresponding to the linear format size.

An aperture of 2.8 in 2/3" format therefore approximately corresponds to an aperture of 8-11 in 35 mm format and an aperture of 22 in a 6x7 medium format. With the APS format we have to open the aperture one stop in order to have the same depth of field relationships as in the 35 mm format, as long as we have the same angular field.

The widely spread practice of describing the angular field of lenses by calculating the equivalent 35 mm focal length is therefore inconsistent if it does not convert the aperture as well. But on the other hand there would be a conflict: a converted f-number would be incorrect as an exposure parameter.

The table shows us that the small formats have fewer or in some case nearly no variation possibilities of the depth of field and hence the look of images.

Diagonal [mm]	6.6	8	11	21.6	26	40	70	90	150
Format	3.96x5.28	4.8x6.4	6.6x8.8	13x17.3	15.6x20.8	24x32	42x56	54x72	90x120
k/D	1/2.5"	1/1.8"	2/3"	4/3"	APS	35mm	4.5x6	6x7	9x12
0.025						1	1.7	2.4	4
0.035						1.4	2.4	3.4	5.6
0.05					1.4	2	3.4	4.8	8
0.07				1.4	2	2.8	4.8	6.7	11
0.10			1.2	2	2.8	4	6.7	9.5	16
0.14		1.2	1.7	2.8	4	5.6	9.5	13	22
0.20	1.4	1.7	2.4	4	5.6	8	13	19	32
0.28	2	2.4	3.4	5.6	8	11	19	27	45
0.40	2.8	3.4	4.8	8	11	16	27	38	64
0.55	4	4.8	6.7	11	16	22	38	54	90
0.80	5.6	6.7	9.5	16	22	32	54	76	128

*Each line of this table contains the **equivalent f-numbers** that have the same depth of field figures with the same angular fields. Formats are each cropped to the 3:4 aspect ratio, aperture values are rounded to half-stops, and the left-hand column in blue shows the f-number as a fraction of the format diagonals. The lower lines represent the maximum reasonable f-numbers with respect to image degradation by diffraction..*

## Depth of field with the same imaging scale

The imaging scales are different in each column in the format comparison on the previous page because we are looking at different cameras. In our photographic practice it is more common that we have one single camera and different lenses for it. For that reason, we are sometimes faced with the question of which focal length to use. The decisive criteria are the room conditions, intended perspective, and background.

Are there also differences with regard to the depth of field if we want to display a motif in the same size? Would the 2/50 or 2/100 macro lens be better, for instance?

**The depth of field (almost) does not depend on the focal length at all but rather on the imaging scale**, and we can understand that as follows:

A focal length that is twice as long creates an image of the same size from an approximately doubled distance, and with the same f-number its entrance pupil diameter is twice as large. Because of the increased focusing distance the object side cone of light is nevertheless the same. As a result, the “object side circles of confusion” are also the same.

**However:** the infinitely distant background is displayed with a different amount of blurriness because the entrance pupils are different.

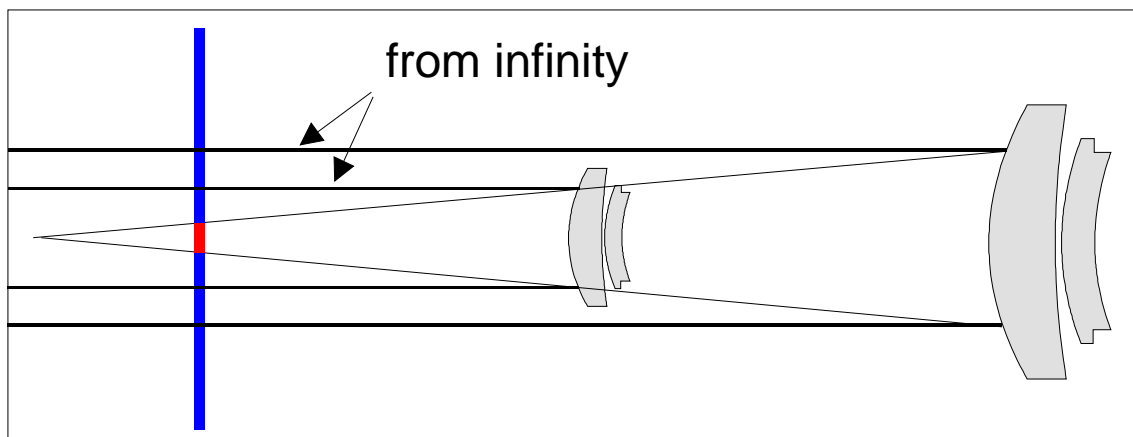

*The geometric explanation for the rule that the depth of field is not dependent on the focal length for a given size of the object field: with the same f-number, the size of the entrance pupils is proportional to the focal length and focusing distance. The light cones, and therefore also the circles of confusion, are always the same.*

*But the bundles of light entering from the infinite distance into the entrance pupils intersect the object plain in different areas. That is why the blurriness in the image is not the same for very distant objects. This tells us that the nice and simple rule explained on this page does not accurately apply to all photographic cases. We will come back to the deviations later.*

## The hyperfocal distance

If we think of conditions where the depth of field stretches from the focus distance into **infinity**, then it becomes clear that we may have been a bit too naive when talking about doubling or halving the depth of field. Infinite distances can neither be doubled nor divided in two.

But the same rules apply in the format comparison for the **hyperfocal distance**, the shortest focus distance where the depth of field reaches infinity. We can easily understand this with the help of our object-side light cones again:

A light cone coming from infinity and entering the lens is a bundle of parallel beams and its angular aperture is  $0^\circ$ . Its diameter is the same as the diameter of the entrance pupil. The hyperfocal distance is therefore the distance **where the acceptable "object-side circle of confusion diameter" is as large as the entrance pupil**.

And once again the rule applies that the smaller sensor format has the smaller entrance pupil if it has the same angular field and the same aperture. The acceptable object-side circle of confusion is therefore already in smaller object fields, meaning it is reached at a shorter distance.

Looking at the cones of light we can easily see that the **front end of the depth of field** is located at half of the hyperfocal distance. That is because the beam cone, whose rear extension is as large as the entrance pupil in the hyperfocal object plane, has its point right in the middle between the entrance pupil and the object plane.

At this point we should make an exception and use a few formulas, because they are the most important ones of the whole topic and are also so simple that we can calculate them in our head:

$$EP = \frac{f'}{k}$$

The diameter of the entrance pupil is the focal length divided by the f-number k

$$Z_{\text{hyperfocal}} = EP = M \cdot z'$$

The object-side circle of confusion Z at hyperfocal distance is as large as the entrance pupil, and the image-side circle of confusion  $z'$  results from it through the magnification M

$$M \approx \frac{\text{Dist}}{f'}$$

The magnification is approximately the ratio of the distance and the focal length; from that follows:

$$\text{Dist}_{\text{hyperfocal}} \approx \frac{(f')^2}{z' \cdot k}$$

EP = diameter of the entrance pupil,  $f'$  = focal length,  $k$  = f-number, M = magnification, Z = object-side circle of confusion,  $z'$  = image-side circle of confusion, Dist = distance

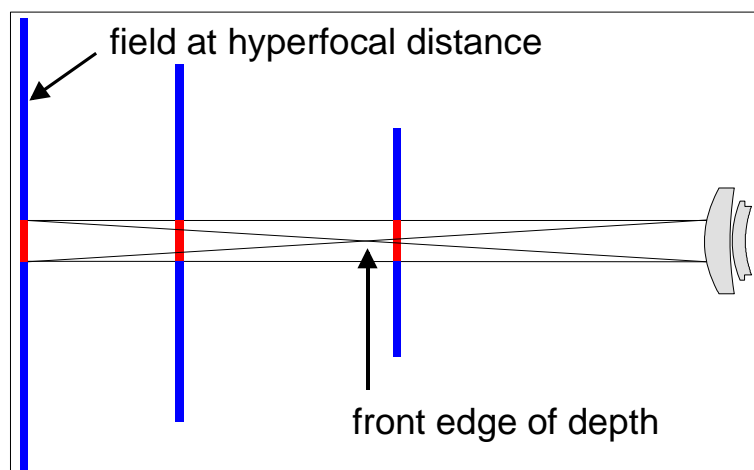

It is especially easy to do calculations with these sizes if we relate everything to the diagonal of the sensor format ( $D$ ); then the formula of the hyperfocal distance looks more complicated at first but finally results in very easy numbers that can actually be used to calculate the hyperfocal distance in our heads:

$$Dist_{\text{hyperfocal}} \approx \frac{D}{z'} \cdot \frac{D}{k} \cdot \left(\frac{f'}{D}\right)^2$$

A 35 mm format lens with the focal length  $f' = 85$  mm and  $f$ -number  $k=2$ , a sensor diagonal of 43 mm, and a requested circle of confusion diameter of  $D/1500$  results in:

$$Dist_{\text{hyperfocal}} \approx 1.500 \cdot 21.5 \cdot (2)^2 = 129m$$

(The factor of 1.5 must actually be doubled for the highest sharpness requirements!)

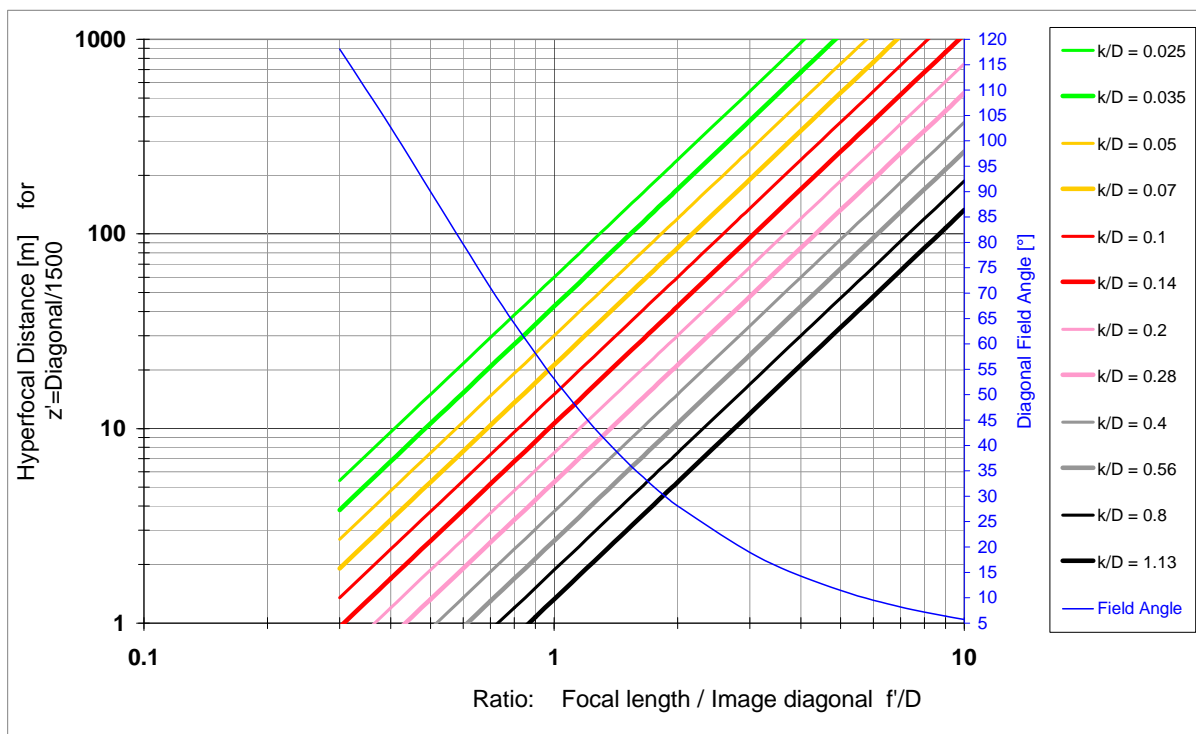

Those who want to avoid the calculations can also use this chart that universally applies to all formats because the aperture and focal length are not absolute but rather related to the diagonal of the sensor format. The short telephoto lens in the example above has a focal length twice as long as the sensor diagonal; the  $f$ -number 2 is about  $1/20$  ( $=0.05$ ) of the diagonal: so we can find the hyperfocal distance by starting from 2 on the horizontal scale and moving upward until we reach the thin yellow line for  $k/D=0.05$ .

The hyperfocal distance is often underestimated; in order to check whether the infinity alignment of a lens and a camera is correct, one has to look for very distant objects in case of longer focal lengths.

The **hyperfocal distance** is a type of **key variable** for calculating the depth of field - if we know it, then we can calculate the depth of field for any distance from that alone. That is because it is the product of three ratios (see previous page) so it includes everything that we need for our conception of "object-side circles of confusion":

- The ratio of the focal length and the sensor diagonal determines how fast the object field becomes larger with increasing distance from the camera.
- The ratio of the focal length and the f-number determines the diameter of the entrance pupil, and therefore how narrow the light cones are from points outside the focal plane.
- The ratio of the sensor diagonal and diameter of the circle of confusion determines the acceptable blurriness.

The following chart provides a very simple overview of the magnitudes of depths of field for normal taking conditions. Each coloured line represents a certain constant depth of field beginning at 1cm in the upper left-hand corner and ending at 100 meters at the black line. The axes of the chart are only distances measured in meters, with the focusing distance on the horizontal axis and the hyperfocal distance on the vertical axis. F-numbers, format sizes, and focal lengths are not listed because they are already included in the hyperfocal distance. This chart is therefore universal for all camera formats.



## Rules of thumb

The hyperfocal distance can be used to give a few rules of thumb for the depth of field:

**"If the focus distance is 1/10 of the hyperfocal distance, then the depth of field is 1/5th of the focus distance."**

**"If the focus distance is 0.4 times the hyperfocal distance, then the total depth of field is of the same amount as the focus distance."**

**"If the focus distance is one third of the hyperfocal distance, then the depth of field behind the focal plane is twice as large as the depth forward in front of the focal plane."**

A part of the last rule ("1/3 in front, 2/3 behind") is often found in photography textbooks. But it is not generally true. It only applies to a certain focusing distance for each aperture. The distribution is more symmetrical at shorter distances and gradually becomes less symmetrical at longer distances, which is very obvious when we approach the hyperfocal distance.

There is a relationship between the distance from the camera to the near and far limits of the depth of field and the focus distance that applies to all apertures and distances:

$$Dist = \frac{2 \cdot Near \cdot Far}{Near + Far}$$

To put that into words, the focus distance is the product of the near limit and the far limit divided by the average of the near limit and far limit. (Also called 'harmonic mean', for example: near limit 3 m, far limit 6 m, focus distance 4 m, 18 divided by 4.5). From that we can calculate that the distribution of the front:back relationship is only 1:2 if the distance to the far limit is twice as far as to the near limit. In other words, the total depth of field is as large as the distance between the camera and the near limit.

For those who enjoy the beauty of mathematical relationships, it should be noted that this is the precisely the case for the distance where the size of the "object-side circle of confusion" is 1/3 of the entrance pupil, therefore 1/3 of the respective hyperfocal distance.

For a 50 mm lens with 35 mm film format having a circle of confusion of 0.03 mm and aperture of 8, the focus distance to fulfil above condition is 3.5 meters, a standard picture taking situation. That is why this rule continues to haunt through the literature. But it does not generally apply in any way. The distribution in the close range and macro range in particular is very symmetrical. Reversing the lens does not change anything about this either, but rather only influences the correction condition.

If we use relatively long focal lengths with a very large hyperfocal distance, then we must assume a symmetrical distribution of the depth of field in front of and behind the focal plane.

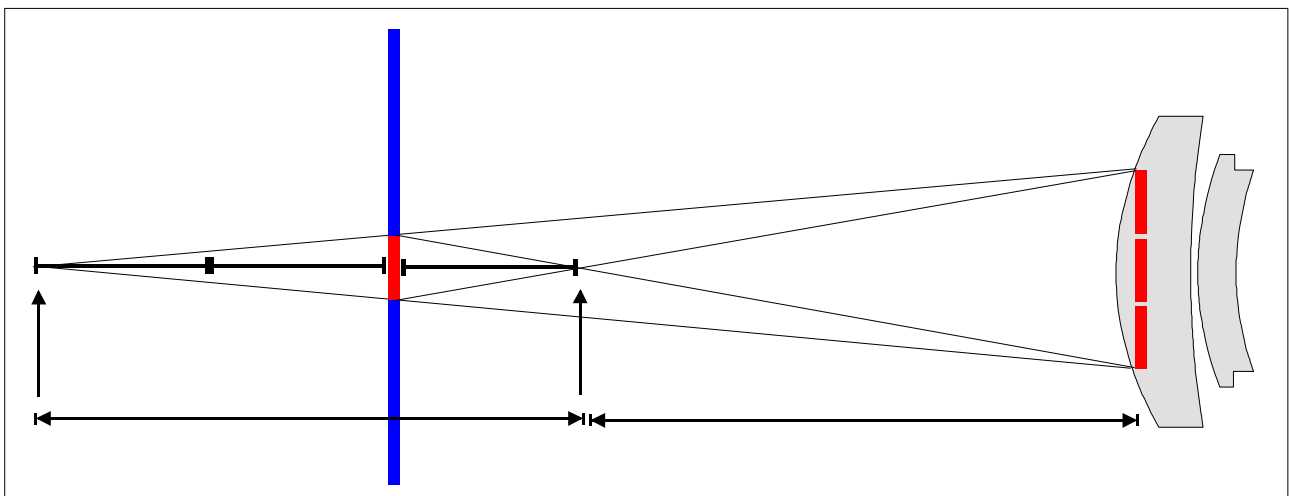

## Close-up

With the usual maximum close-up lens setting (scale 1:8 to 1:10), and even more with macro lenses or close-up accessories like extension rings or bellows, depth of field becomes very small. The scales engraved on the lens mount then only provide little help. For many modern lenses with their steep distance scales they are not much more than a useless decoration.

Many explanations of the topic of depth of field skip over macro photography because the usual formulas and tables for long distances do not apply in those cases. At close range, the lens no longer actually has the f-number that is engraved on the ring; we have to calculate using the effective aperture - some cameras display it, others do not. The amount that this effective aperture value deviates from the nominal value depends not only on the scale but also on the construction of the lens.

Telephoto lenses show a heavier loss of the effective f-number at close range than symmetrically constructed lenses do. Modern macro lenses have lens groups that move relative to each other in order to keep the correction stable at all distances. As a result, their focal length also changes with the focusing. So there are plenty of complications.

An extensive and detailed explanation of the optical rules in macro photography including the field of magnified imaging would therefore be too much to cover within the framework of today's topic.

I would like to at least provide our readers with the most important figures for our two 2/50 and 2/100 macro lenses for 35 mm format, first as a graphical overview and then as a table at the end of the chapter:

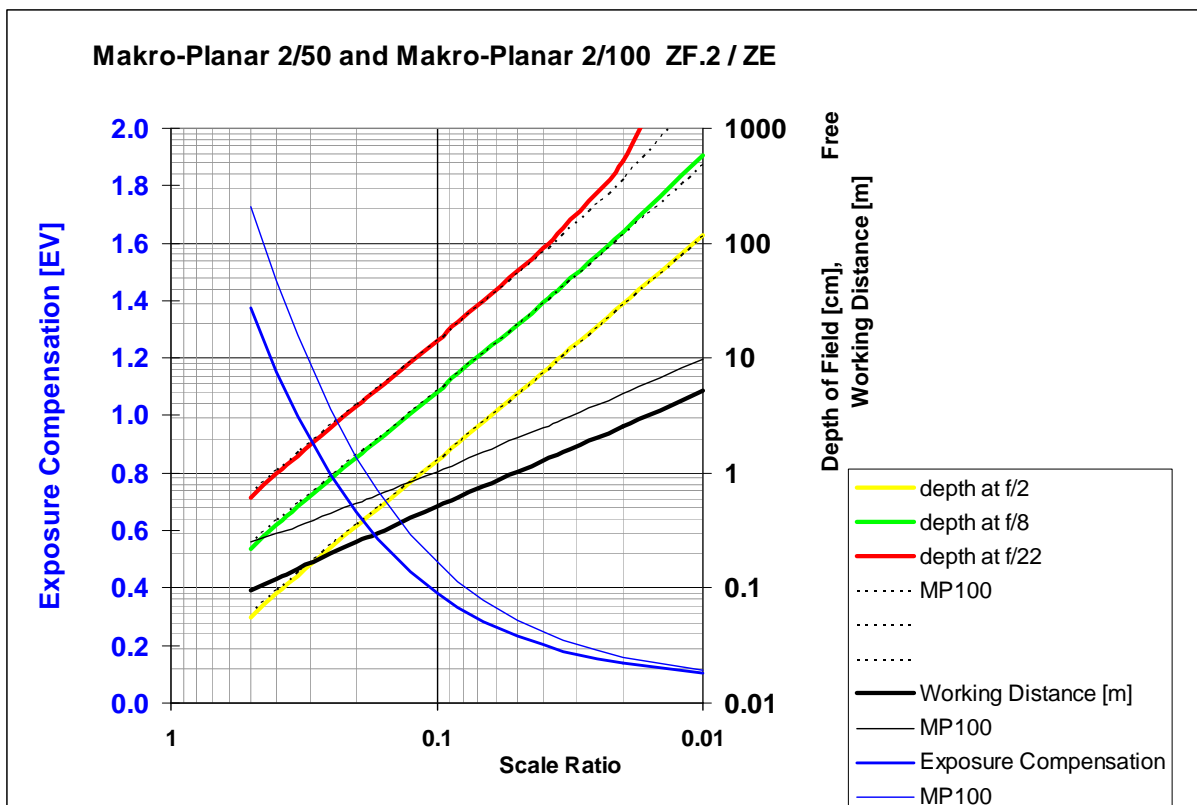

*Depth of field, free working distance (without lens hood), and required compensation of exposure of the two macro planar 2/50 and 2/100 lenses, calculated for 35 mm format and circle of confusion diameter diagonal/1500.*



The graph on the previous page is similar to the one on page 8, although here the depth of field is not displayed over the focusing distance but rather the imaging scale or magnification of two lenses at the same time. The fact that the same imaging scale is achieved from different distances can be seen with the two black lines. The yellow, green, and red lines show the depth of field for full aperture, f/8 and f/22 for the 2/50. The values for the same apertures of the 2/100 are drawn as dotted black lines. These lines are congruent almost everywhere - another nice proof that the depth of field is mostly only dependent on the imaging scale. There are only deviations at the ends: on the right side at magnification 0.01 and at f/22, the rear limit of the depth of field comes close to the "infinity" value for the 2/50.

On the left side at imaging scale 1:2, the 2/100 has a bit more depth of field with the same nominal value of the f-number, the dotted lines are just a bit higher than the coloured ones.

Is that a benefit of the optical construction of the 2/100 in comparison to the 2/50? No, because the slightly larger depth of field is a result of the 2/100's loss of speed, which is 1/3 of an aperture stop higher, as we can see with the blue curves. At image scale 1:2 its maximum aperture is no longer f/2 but rather f/3.6, and with the 2/50 the maximum aperture is only reduced to f/3.2. This difference between our two macro lenses is an indication that depth of field does not come free and we have to pay for it with exposure time. In fact, a very fundamental general physical law is behind it: **the law of conservation of energy**.

That is because the angular aperture of the object-side light cone also determines how much optical radiant energy enters into the lens. And only this energy can be distributed onto the image surface. If we compare two images of the same sensor size, then the one that needs a longer exposure time with the same sensitivity has the larger depth of field because it has collected less energy on the image-side with a narrower light cone (we must of course rule out absorption by filters etc. - we are only dealing with geometric efficiency). The specific optical construction of a lens is therefore in the end meaningless for the depth of field.

Telephoto lens constructions lose more light at close range; that is because their entrance pupil is located relatively far back, so the object-side light cone becomes a bit narrower if the distances to the object are similar to the dimensions of the lens. But all we have to do is simply use a wider aperture to have the same depth of field as with a symmetrical lens.

**Different sensor formats with the same sensitivity have the same object-side depth of field if their exposure times have the same ratio as their sensor areas.** That is because the same depth of field means that the same amount of energy is collected from the object for both pictures; if this energy is distributed across a sensor area twice as large, the light intensity is divided in half and an exposure time twice as long is required.

When practically all formats worked with the same emulsions in analogue photography, this meant that small formats were always advantageous if a large depth of field had to be achieved at fast shutter speeds. If the signal-to-noise ratio of the sensor increases with the format size, which is to some amount the case with digital cameras, then we can compensate for the increased need for light of the larger format for the same depth of field by increasing the sensitivity.

If we put aside the requirements of offhand photography and photograph static objects using a tripod so that the exposure time can be any length, then there is no difference at all between different film formats with regard to the maximum achievable depth of field.

Because light travels in waves, the diffraction determines how far we can close the aperture without losing picture quality in the end. It ensures that a picture element creates an Airy disk whose diameter in micrometers is about the same as the f-number. The relative size of the Airy disk with regard to the format therefore allows for smaller apertures with a larger format. **All formats have the same depth of field at the diffraction limit.**

## Makro-Planar 2/50

Scale	EC [EV]	WD [m]	Total Depth-of-Field [cm]								UF
			k=2	2.8	4	5.6	8	11	16	22	
1: 100	0.1	5.15	118	167	245	361	581	1026	4592	2427	15.4
1: 50	0.1	2.57	29.5	41.4	59.6	84	124	179	294	521	15.3
1: 40	0.2	2.06	19.0	26.6	38.2	54	78	111	174	275	15.2
1: 30	0.2	1.54	10.8	15.1	21.6	30.4	44	61	93	137	15.0
1: 25	0.2	1.28	7.5	10.5	15.1	21.2	30.4	42	63	91	14.9
1: 20	0.2	1.02	4.9	6.8	9.7	13.7	19.6	27.1	40	57	14.8
1: 15	0.3	0.77	2.8	3.9	5.6	7.8	11.2	15.4	22.7	31.7	14.5
1: 12	0.3	0.61	1.8	2.5	3.6	5.1	7.3	10.0	14.6	20.3	14.3
1: 10	0.4	0.51	1.3	1.8	2.5	3.6	5.1	7.0	10.3	14.2	14.0
1: 8	0.5	0.41	0.83	1.17	1.67	2.33	3.33	4.59	6.70	9.25	13.7
1: 6	0.6	0.30	0.48	0.72	0.97	1.35	1.93	2.66	3.87	5.34	13.1
1: 5	0.7	0.25	0.34	0.48	0.68	0.96	1.37	1.88	2.74	3.78	12.7
1: 4	0.8	0.20	0.22	0.31	0.45	0.63	0.90	1.23	1.79	2.47	12.2
1: 3	1.0	0.15	0.13	0.18	0.26	0.36	0.51	0.71	1.03	1.42	11.3
1: 2.5	1.2	0.12	0.09	0.12	0.18	0.25	0.36	0.49	0.71	0.98	10.7
1: 2	1.4	0.10	0.06	0.08	0.11	0.15	0.22	0.30	0.44	0.61	9.9

## Makro-Planar 2/100

Scale	EC [EV]	WD [m]	Total Depth-of-Field [cm]								UF
			k=2	2.8	4	5.6	8	11	16	22	
1: 100	0.1	9.81	117	164	236	335	493	715	1198	2209	15.4
1: 50	0.2	4.93	29.6	41.5	59.3	83	120	167	251	364	15.1
1: 40	0.2	3.96	19.1	26.7	38.2	54	77	107	158	225	15.0
1: 30	0.2	2.98	10.9	15.2	21.8	30.5	44	60	89	124	14.8
1: 25	0.2	2.50	7.6	10.7	15.3	21.4	30.6	42	62	86	14.7
1: 20	0.3	2.01	4.9	6.9	9.9	13.9	19.8	27.3	40	55	14.5
1: 15	0.4	1.52	2.8	4.0	5.7	8.0	11.4	15.7	22.9	31.6	14.1
1: 12	0.4	1.23	1.9	2.6	3.7	5.2	7.5	10.3	15.0	20.6	13.8
1: 10	0.5	1.03	1.3	1.9	2.6	3.7	5.3	7.3	10.6	14.6	13.5
1: 8	0.6	0.84	0.87	1.22	1.74	2.44	3.48	4.79	6.98	9.61	13.1
1: 6	0.7	0.64	0.51	0.72	1.02	1.43	2.05	2.81	4.09	5.63	12.4
1: 5	0.9	0.54	0.37	0.51	0.73	1.02	1.46	2.01	2.93	4.03	11.9
1: 4	1.0	0.45	0.24	0.34	0.49	0.68	0.97	1.33	1.94	2.67	11.2
1: 3	1.3	0.35	0.14	0.20	0.28	0.40	0.57	0.78	1.14	1.56	10.3
1: 2.5	1.5	0.30	0.10	0.14	0.20	0.28	0.40	0.55	0.80	1.10	9.6
1: 2	1.7	0.25	0.06	0.09	0.12	0.17	0.25	0.34	0.50	0.69	8.8

Depth-of-field tables for the **Makro-Planar 2/50** and **2/100** lenses. The *f*-numbers are the engraved numbers. EC is the required exposure compensation in aperture stops [EV], WD is the free working distance measured from the focal plane to the filter thread of the lens.

UF is the **useful f-stop**, where an MTF-figure of 10% for 90 linepairs/mm is achieved due to limitations by diffraction. This means that even with 24MP full frame cameras there is only a very small loss of sharpness that can still be balanced out with digital edge enhancement. Combinations of scale and *f*-number that no longer meet this requirement are listed in gray in the table. The depth of field is calculated for the standard 0.03 mm circle of confusion in 35 mm format. The best performance with the useful *f*-stop is not achieved in the total depth, of course.

## The diameter of the circle of confusion

All of the curves and tables shown so far have been calculated assuming a circle of confusion diameter that fits 1,500 times into the diagonal of the image. But we must explain why this size is so often chosen and why we should sometimes choose another one. Depth of field is the result of an arbitrary specification, or rather it depends on the viewing conditions. Whether we tolerate a small or large amount of blurriness has no influence on the fundamental characteristics of the depth of field.

The human eye will not perceive any loss of sharpness in an image if the power of the eye is the only thing determining which smallest details can be recognized. On the other hand the eye will perceive an image as blurry if the eye is capable of seeing significantly more than is shown. **The resolution that the eye can recognize must be the benchmark.**

If we test the ability of the eye to recognize resolution with periodic black & white patterns, then we see that normally performing test subjects have a limit of approximately 8 line pairs per mm that they can recognize if the test pattern is within a distance of 250 mm from the eye. At longer distances, of course the eye is less capable of recognizing as much; at two meters away it is barely possible to distinguish a pattern with one pair of lines per mm from a simple gray surface of the same shape. This experiment can be done easily using the lines on a ruler.

If we want to describe the performance of the eye independently of its distance from the object, then we use the angular resolution. It thereby matches the numbers above, that the eye can distinguish the smallest details from one another if they appear at a **visual angle of one arc minute**. This is the **physiological critical angle** of the human eye.

If we look at a 12x18 cm picture, for example a 5x magnification from the completely used 35 mm format viewed from a 25 cm distance, then we see 1/3000 of the diagonal of this picture at a visual angle of one arc minute.

That means that our eye would not even notice if the picture had a higher sharpness. This circle of confusion is therefore the strictest sensible requirement for the given viewing conditions.

We could of course magnify the negative or sensor image even more, for instance 20 times to the poster size of 48x72 cm. In digital photography that can be done with just a few mouse clicks. Then we can already view 1/3000 of the picture diagonal at a visual angle of four arc minutes if we are still viewing the image from 25 cm away; the eye can then see much smaller details.

However, the entire image width then appears to us at an angle of 110°; we cannot overlook that entirely and still see the smallest details everywhere in the image at the same time. If we look at it in this way then our eyes must wander about in the image, and they see details but not the entire image.

If we look at the poster from 1 meter away, however, then we are looking at the image width at an angle of 40° - such as with a 12x18 cm image from 25 cm away - which we can comfortably view in its entirety.

Whenever we observe images in this way, then 1/3000 of the picture diagonal is the strictest sensible requirement for the circle of confusion diameter. A circle of confusion twice as large, 1/1500 of the diagonal, viewed at a visual angle of 2 arc minutes, still provides a satisfying sharpness even then; this requirement corresponds approximately to the often used 0.03 mm circle of confusion for the 35 mm format.

But we must not forget that our expectations for the image sharpness can no longer be met with this usual circle of confusion if we make cropped enlargements or view the details in large prints. After a 20x magnification we see the 0.03 mm criterion of the 35 mm format from a distance of 25 cm at a visual angle of over 8 arc minutes – it appears to be blurred.

In the 50s, the depth of field for 35 mm lenses was often calculated with a circle of confusion of 0.05 mm, meaning 1/865 of the picture diagonal. This can be viewed at 2 arc minutes if we look at a 10x15 cm postcard image from a distance of 35 cm. In those days of amateur photography, that corresponded to the somewhat more discerning viewing habits when it was still most common to paste contact prints from roll-film cameras into photo albums.

The depth of field is therefore a rather fuzzy dimension that depends heavily on the viewing conditions. Strictly speaking we can even find reasons for to use different circle of confusion sizes for different focal lengths of a camera:

If we view images "from the right perspective", meaning closer to the same angle at which they were really viewed by the camera when they were taken, then we must view the wide-angle images from a closer distance than images from normal or telephoto lenses. As a result, we must calculate the depth of field in wide-angle images using smaller circles of confusion. The depth of field was calculated more discerningly for the DISTAGON 4/40 from the old C series for the HASSELBLAD than for all other lenses in the series. Because even without viewing them from the right perspective, the details that interest us in wide-angle images are usually smaller and therefore place stricter requirements on the sharpness of the image.

## How precise are tables and depth of field calculators?

Usually most tables pretend to have a precision that is neither available nor sensible in reality. That is partly because the values calculated in the tables are based on the arbitrary specification of a limit value (acceptable circle of confusion diameter).

In reality, however, the sharpness is continuously changing in the depth and its subjective perception is also somewhat based on the image content in addition to the viewing conditions. There is therefore no clear limit!

The **from-to** tables with millimetre precision at meter distances, on the other hand, easily give the impression that there are two precisely positioned flat limit surfaces in front of the camera between which everything is displayed at constant sharpness. But there are a few things wrong with this notion.

Most tables and calculation programs found on the internet are based on the geometric model of the light cones and circles of confusion that we have also been using for illustration. Yet despite how nice it is, it is only an idealization of the real optical processes in a lens. That is because this model does not recognize aberrations, colours, or diffraction. In the geometric model, the circle of confusion is a disc with even brightness.

In reality, however, the distribution of brightness in the focused and lightly unfocused point image is uneven. We will deal with that in more detail below. All types of aberrations from real lenses cause a series of deviations from the geometric model:

- In ideal lenses, the image-side depth of focus grows nearer and farther away at the same rate when the aperture is made narrower. In real lenses, however, there can be a displacement to one side called the focus shift. When it is very large, the near limit of the depth of field range might remain unchanged when the aperture is narrowed.
- Away from the optical axis, this shift often has opposite direction compared to the centre of the image, the depth of field space is then curved.
- If lenses suffer from vignetting by parts of the lens barrel, then the depth of field at the edge of the frame is larger than in the centre because the size of the pupil decreases due to the vignetting.
- Depending on the lens aberration, the type of blurriness can be different in front of and behind the focal plane.
- The location of the depth of field range also depends somewhat on the colour of the light.

The usual tables and calculators therefore provide some useful clues for practice, but they should not be taken too seriously.

## Depth of field and modulation transfer MTF

The meaning of depth of field can also be understood if one measures how the contrast of the image in terms of the modulation transfer MTF (see CLN30 and CLN31) changes with deviation from the best focus. Curves that are almost bell shaped are found in this measuring process; these curves show very well that the sharpness of the picture is in no way constant within the depth of field but is continuously changing. The curves also show that not so much remains of the best performance of a lens at the edges of the usual depth of field range.

As a rule of thumb we can say that when defocusing the image by the length of  $k / R$  ( $k = f$ -number,  $R =$  spatial frequency in line pairs per millimetre), the MTF value falls from the maximum to about 20-30 %.

Such measurements of MTF related to focus also indicate the limitations of the simple geometric model as an explanation of depth of field. We find many examples where the image-side depth of focus is not symmetrical to the best focus for various reasons but is extended more to the front or to the rear side.

We can also find examples where, at the same f-number, the depth of field varies in size, not because we are looking at different spatial frequencies because of different formats, but because the curves of the same spatial frequency have different widths.

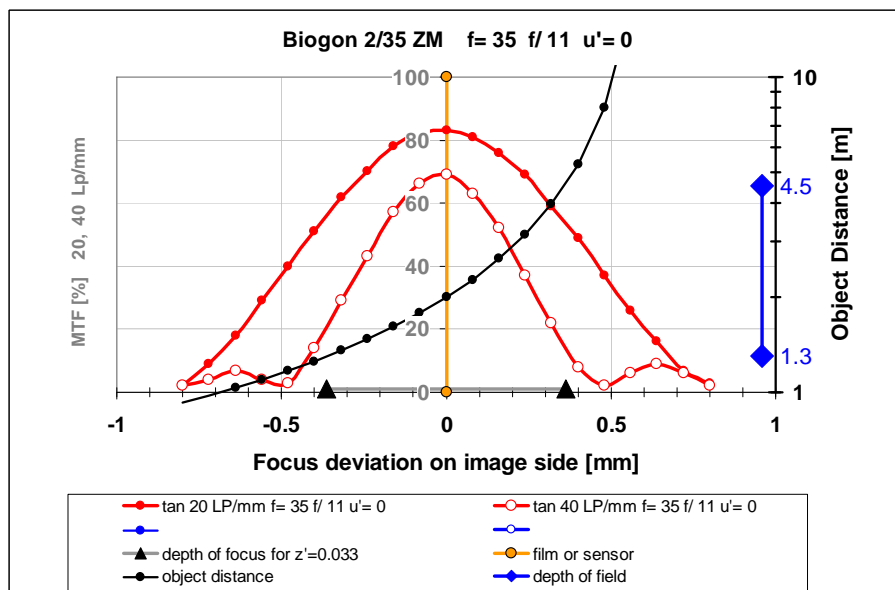

The red curves in the above chart show the MTF values for the spatial frequencies 20 and 40 line pairs per millimetre and also how they change in longitudinal direction with focus deviation if the lens is set to f/11.

The position of each measuring point in the image space is indicated by the focus deviation on the horizontal axis; negative values are closer to the lens. At zero we have no deviation and hence the best contrast; the film or sensor should be there - represented by a yellow line.

The black triangles on the image side focus scale indicate the depth of field according to the geometric model of the circle of confusion - in the above example 11 x 0.033 mm in both directions.

The black curve shows the relationship between the distances in the object space and the associated positions in the image space when focussing on a distance of 2 metres. The object distances can be read on the scale on the right-hand edge of the chart. Thus the image-side depth of focus between the black triangle marks goes with the object-side depth of field between the blue marks; these can also be seen in the picture below showing the depth of field scale on the lens barrel.

If you read off the MTF values at the limits of the depth of field area near the triangular marks, you will still find 10 to 20% at 40 Lp/mm. If one then takes account of the additional losses by the sensor, the resolution there should be a maximum of 40 Lp/mm, or if in a five-fold enlargement, 8 Lp/mm. The eye can do no more when examining something from a distance of 25 cm; the image is still perceived as being sharp. However, in the case of greater enlargements it is obviously necessary to further restrict the permissible deviation from the ideal focus.

If the diaphragm is opened further, the curves become narrower (please note the different scale). The following curves were measured on the same lens of the **Biogon 2/35 ZM**, again in the middle of the image at aperture 4. The black curve for the relationship between the image and the lens distance applies for focusing a distance of 4 metres:

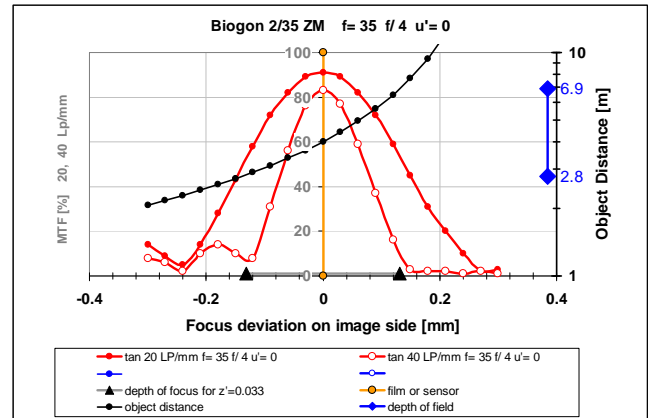

Compared with the geometric depth of focus marks the curves have become a shade narrower. At the same time the maximum MTF values at the best focus are somewhat higher. It is due to the incipient influence of **diffraction** that at f/11 the maximum contrasts are reduced and that the curves are wider than expected from the ratio of the f-numbers 11 and 4.

If one measures a lens with a longer focal length and similar performance at the same f-number, curves of almost the identical width are obtained as can be seen in the example of the **Sonnar 2/85 ZM**. This is therefore proof that the image-side depth of field does not depend on the focal length but only on the f-number. However, the black curve, which shows the relationship between the object distance and the image space position, now looks quite different. It is now much flatter because the image of the same deep object has greater depth than with a shorter focal length. Therefore a smaller object-side depth of field now goes with the same image side depth of focus.

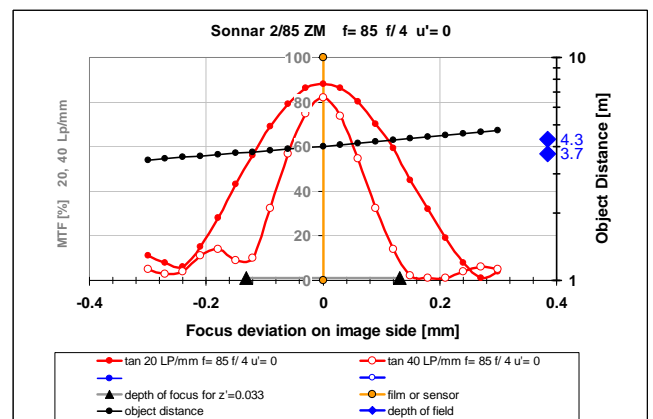

The MTF curves of the previous page are very similar to each other. This is not always the case; at the edges of the depth range which is calculated according to the geometrical theory MTF figures might be quite different. This tells us that this theory is a simplification of reality:

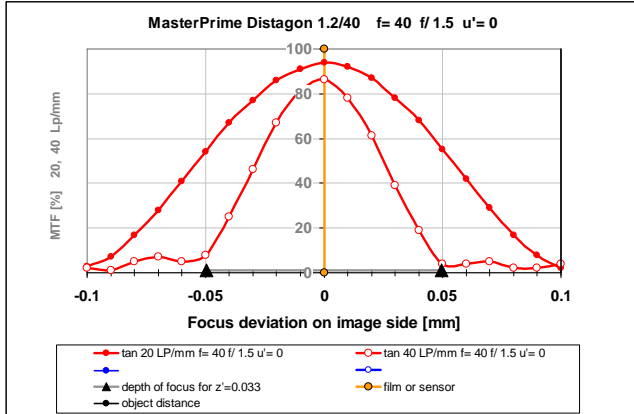

High performance lens Zeiss MasterPrime for a 35mm ARRIFLEX film camera at aperture 1.5. At such apertures and high performance level one can see how high the demands placed on the precision of the camera are; 1/100 mm changes the MTF at 40 Lp/mm by 20%!

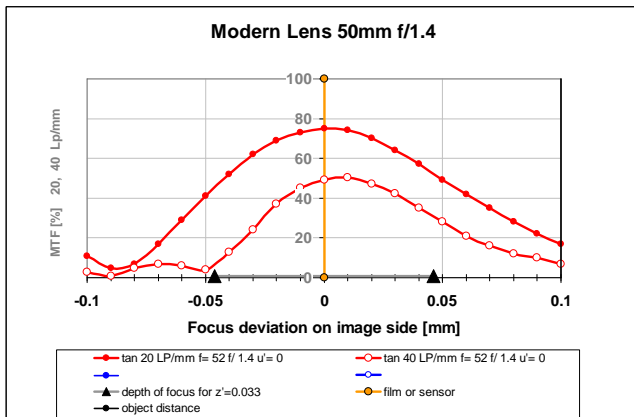

Modern 1.4/50 first class 35 mm lens fully open

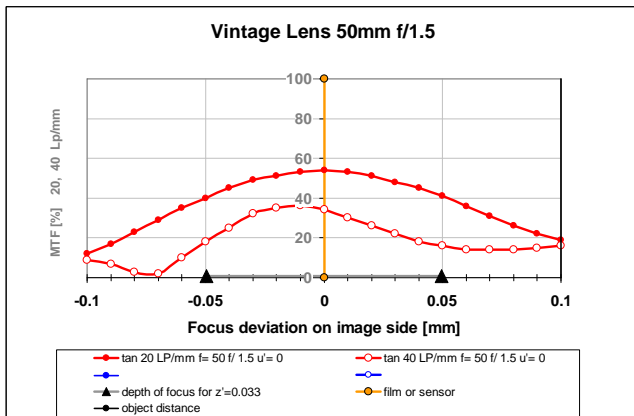

A vintage fast lens which has larger aberrations when fully open at f/1.5; it has a much flatter and wider curve and therefore a slightly increased depth of field; and within the depth of field a smaller difference between the best values and those that can still be tolerated.

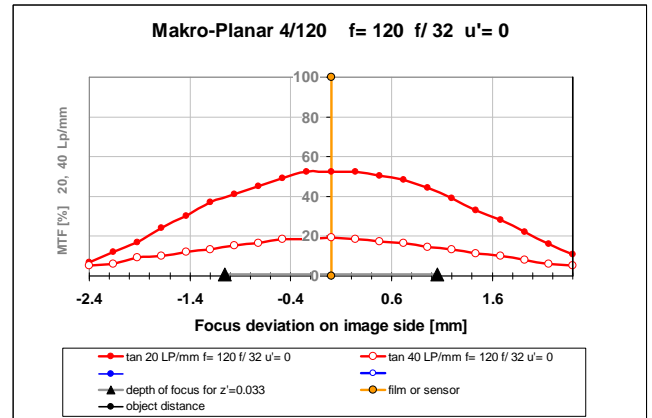

A macro lens very sharply stopped down to f/32; the MTF is reduced by diffraction and more spreading in depth.

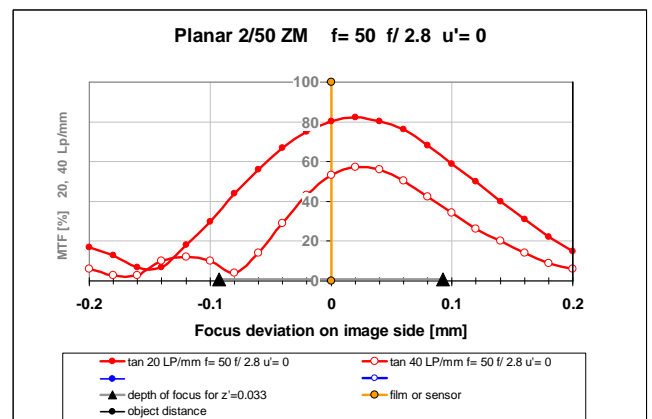

A fast 50mm lens measured at f/2.8. The focus reference (yellow line) is defined by the best MTF at f/2 and 20 Lp/mm. It shows a very slight displacement due to a focus shift and slightly skewed curves. The position of the depth of field does not agree with the geometric theory of the circle of confusion.

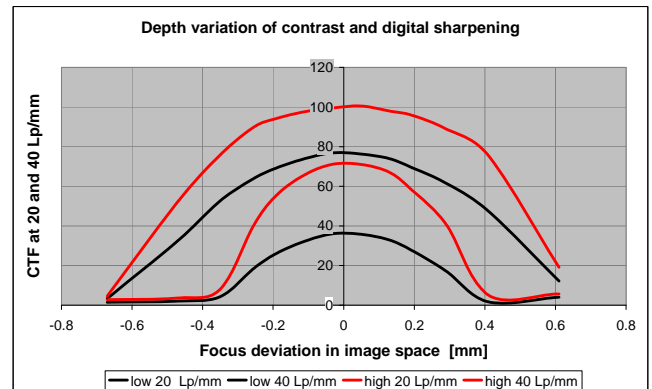

When one measures how contrast transfer in the digital image, (including the lens and the processing of pixel data) varies with the focus, the curves look different: they appear more rounded and flat. This is no surprise since the low-pass filter is also a kind of image degradation, similar to the aberrations or the diffraction in the previous cases. These data are from a good lens at f/11, so you may compare with page 21. High sharpening increases the depth just a little bit, but it may as well cause a more harsh transition.

## Resolution

Which resolution can be least achieved within the depth of field range? If this is expressed in terms of MTF measurement the question is translated into: "At what spatial frequency does the contrast transfer (MTF) drop below a certain threshold (e.g. 10 %)?"

Typical values which answer this question can be seen in the following chart which shows how contrast transfer gradually decreases with increasing spatial frequency, in other words with of the structures getting finer and finer. In order to make the figures independent of the format size, the spatial frequency is not given in absolute terms in line pairs per mm but in line pairs per image height. The blue curve shows the relationship with the very familiar 35mm format: the corresponding absolute spatial frequencies can be seen from the blue scale on the right-hand side.

The data apply for a lens which is limited by diffraction at aperture  $k = 0.2 \times$  image diagonal. In the 35 mm format this is about  $f/8$ ; in the  $2/3$ " format the corresponding aperture is  $f/2$  – at this high speed diffraction limited performance is only achieved by very elaborate and expensive lenses such as the Zeiss **DigiPrime**.

The black curve applies to the best focusing; the other curves indicate the contrast transfer at the edge of the depth of field area at a circle of confusion diameter  $z'$ . As the f-number the circle diameter is related to the format size, so that the chart is valid for different sensor formats.

One can also see from these curves that resolutions greater than 2000 line pairs per image height cannot play a major role in many fields of practical photography because they can only be achieved with extremely tight focus tolerances and with very flat objects.

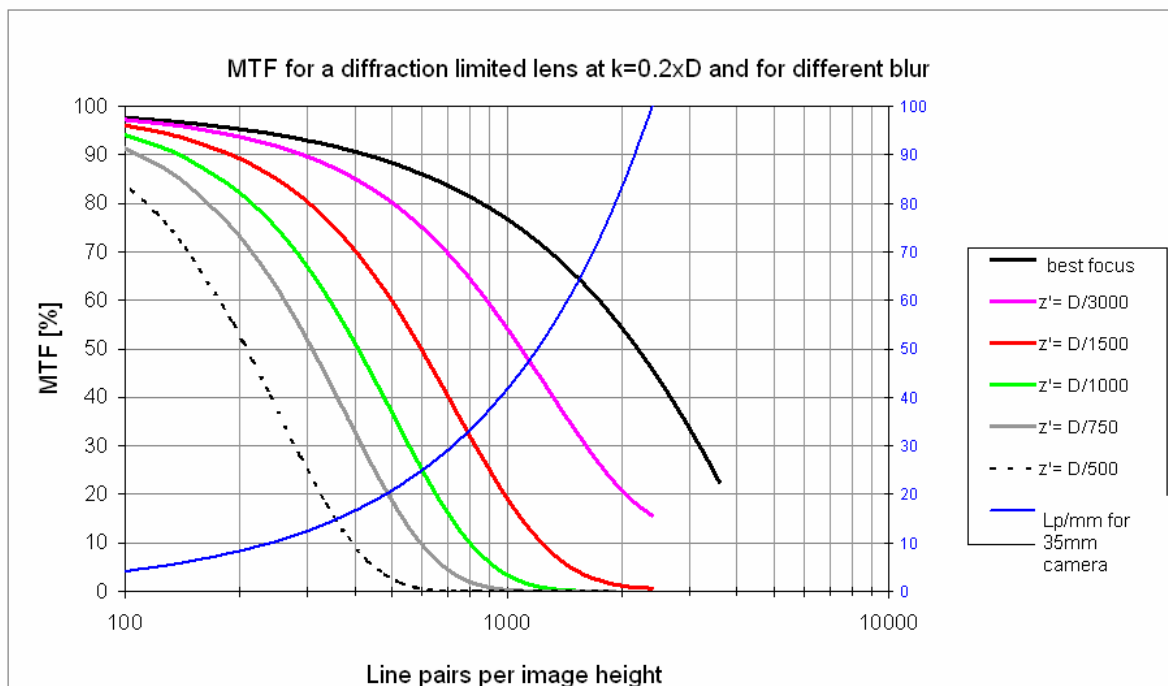

Resolving power of the lens at different permitted degrees of blurriness described by the diameter of the circle of confusion as a fraction of the image diagonals. A lens which is restricted by diffraction at aperture 8 achieves a resolution of about 4000 line pairs per image height in 35mm format. At a circle of confusion of  $z'=D/1500$ , in other words at the popular value of 0.03mm, the resolution drops to about 1200 line pairs per image height.



## Bokeh – properties of blurriness

Large depths of field can be desirable; in macro-photography it would be great to have more of it than is possible. However, it is as well often undesirable, as a good image is usually characterised by the absence of superfluous and distracting items.

A composition parameter which can help us to achieve this objective is the adjustment of the blurring in front of and behind the main subject by a suitable combination of **aperture, focal length and taking distance**. A blurred background frees the main subject from distracting unimportant details and increases the three-dimensional illusion of the picture. Blurred parts of the picture can also be decorative and play a very important part in the composition of the picture.

We therefore want to deal with blurring in the following pages. This image attribute is indeed more of an aesthetic and therefore subjective nature and cannot be described as simply with figures as it is the case with a well focused, sharp image. Thus its subtleties in lens tests play no important part sometimes. This is quite different in Japan: as well as figures for contrast, resolution etc., every test always includes examples of images with blurred flowers, leaves and other items which often act as the background to photographs. It is therefore perfectly right that the Japanese word “**bokeh**” is used around the world as a collective term for all attributes of blurring.

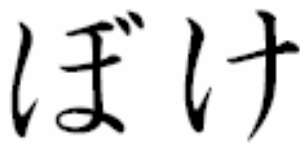

*The root of the Japanese word **boke** or **bokeh**\* actual means nothing good; its meaning is similar to “confused” or “dizzy” and is used to name mental states in exactly the same way. In photography the term “confused” relates naturally to light beams which no longer come together at a single point in an orderly manner.*

\* I like to thank my colleague Hiromi Mori for the Japanese Hiragana characters and for her explanations of the meanings.

In spite of the subjective nature of the matter we nevertheless want to attempt to remain faithful to the style and character of our technical articles by describing bokeh with some numbers. Of course, this cannot be done on very simple scales, for example, “a grade 5.5 bokeh”, because blurring always depends on a large number of parameters. But figures can help us to improve our understanding of connections.

All the parameters listed here influence the phenomena outside the focal plane:

- Picture format
- Focal length
- f-number
- The camera-to-subject distance
- Distance to the background or the foreground
- Shapes and patterns of the subject
- Aperture iris shape
- Aberrations of the lens
- Speed of the lens
- Foreground/background brightness
- Colour

It is therefore not surprising that one often hears different and sometimes contradictory judgements about the bokeh of many lenses. Undue generalisations are all too often drawn from single observations.

Many effects are attributed to the lens even though they are mainly caused by the subject in front of the camera. Differences between lenses are often very marginal but are then grossly exaggerated.

In principle one should not turn the ranking in the significance of the elements in a picture on its head and raise small technical artefacts to the rank of the most important part. In many pictures the main subject is the deciding moment – and all bokeh then literally retreats into the background.

But in the beauty of calmly composed pictures it can already mean the step towards perfection. And here everyone can have their own yard-sticks.

## The quantity of blurriness

The most important and clearest attribute of blurring is simply the amount of it. When considering the depth of field we have been concerned with permissible blurring; this blurring is allowed if it is quite unnoticeable in the conditions in which the picture is viewed. We have learnt that limits are fluid in this process.

But outside these limits where one clearly sees the blurring, we can describe the extent of the blurring in exactly the same way as within the limits of the depth of field: by the diameter of the circle of confusion.

This means that we now will deal with very large circles of confusion, and to understand the meaning of these numbers we should connect them to our experience about a well-known photographic situation:

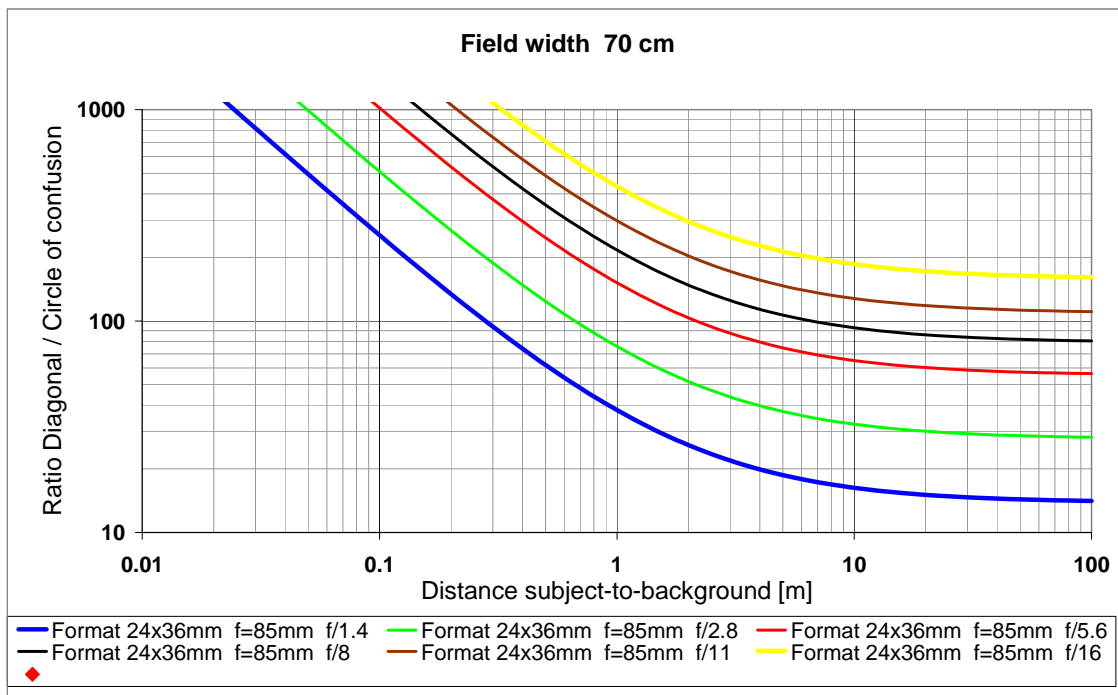

The chart describes a typical photographic situation e.g. in portrait photography: the object field is 70cm wide and photographed in 35 mm format with an 85mm lens. The focus distance to the main subject set on the lens is therefore 1.8 metres.

The distance of the background from the main subject is indicated on the horizontal axis; the vertical axis shows the size of the circle of confusion with reference to the image diagonal. Therefore in this chart the region of the depth of field with which we have been concerned in the first part is up at the top on the left, just outside the scale; at this point the circles of confusion are diagonal/1500 or less; we are there still close to the focus; as we move to the right we move away up to a distance of 100 metres in the background.

Each curve in the chart represents one of the aperture values specified in the legend and all curves have the same character. Initially they fall uniformly (in this process the circles of confusion gradually become larger) and then reach a kind of saturation beyond a background distance of about 10 m. Thus, the blurring does not become any greater at larger distances. This limit depends, of course, on the aperture and when we compare the figures with our experience or just try it with our camera, we learn that we need circles of confusion larger than 1/100 of the diagonal in order to separate the main subject from the background.

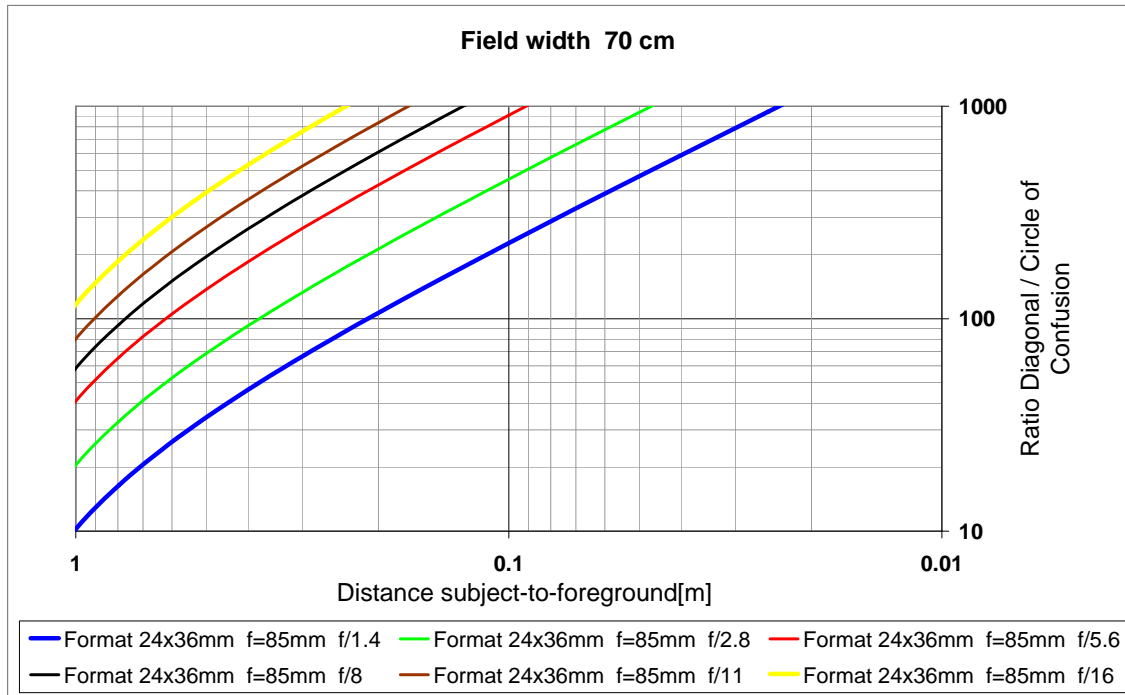

*This is how the corresponding curves for the foreground appear if we imagine once again that the camera is situated on the left. At a distance of 1m from the foreground and 1.8m focus distance the horizontal scale therefore commences 0.8m in front of the camera or, to put it more precisely, before the sensor plane. There is no saturation to a limit in the close foreground; instead the curves become increasingly steep; the blurriness becomes increasingly greater. It is thanks to this property that it is possible to make filigree obstructions in the foreground, e.g. the wire mesh of a cage at the zoo, disappear from view with lenses that are wide open.*

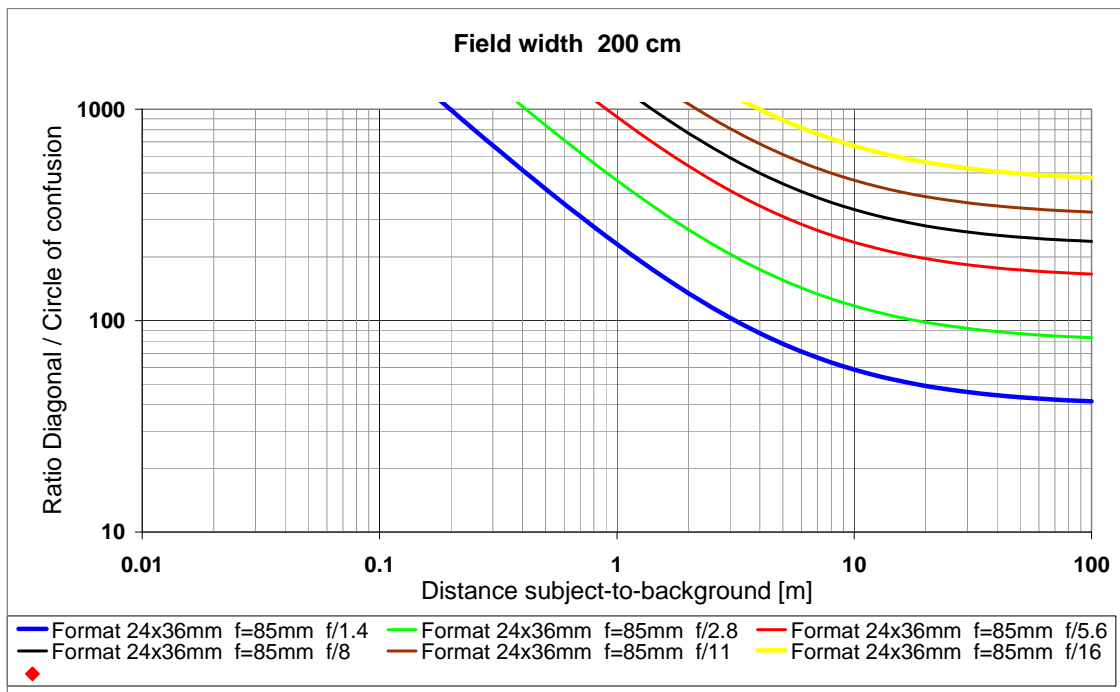

*If the taking distance increases (in this case 4.8m is reached at an object field width of 2m), the highest achievable blurriness decreases. In order to reach the same degree of background blurriness as at closer distance, one has to use wider apertures or take care that the distance to the background is larger.*

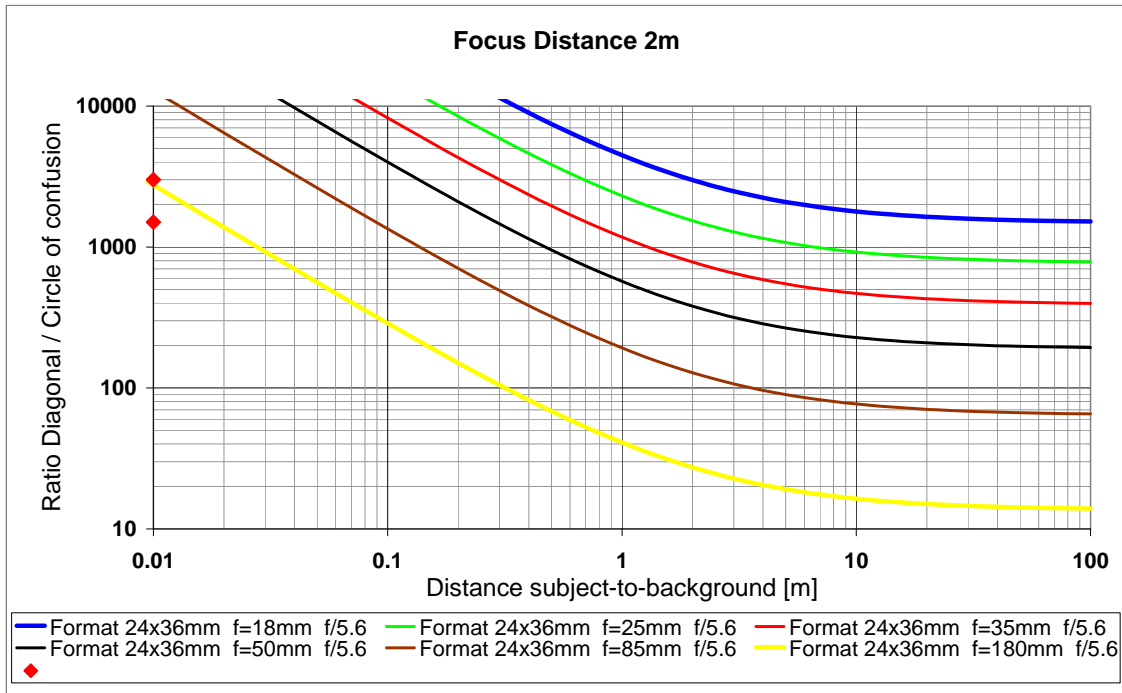

We are here comparing six different focal lengths in 35 mm format; each case is at the same aperture 5.6 and with the same distance of the camera from the subject. The reproduction scales for the pictures are therefore different. The two red diamonds on the vertical axis mark the circle of confusion diameters “diagonal/1500” and “diagonal/3000” which have been assumed for the calculation of the depth of field. The blue curve indicates that at a focal length of 18mm at least the weaker of the two depth conditions is still maintained irrespective of the distance behind the subject – the depth of field stretches into infinity. In the case of the other wide angle focal lengths, the sharpness is no longer perfect in the distant background but neither has it fully disappeared.

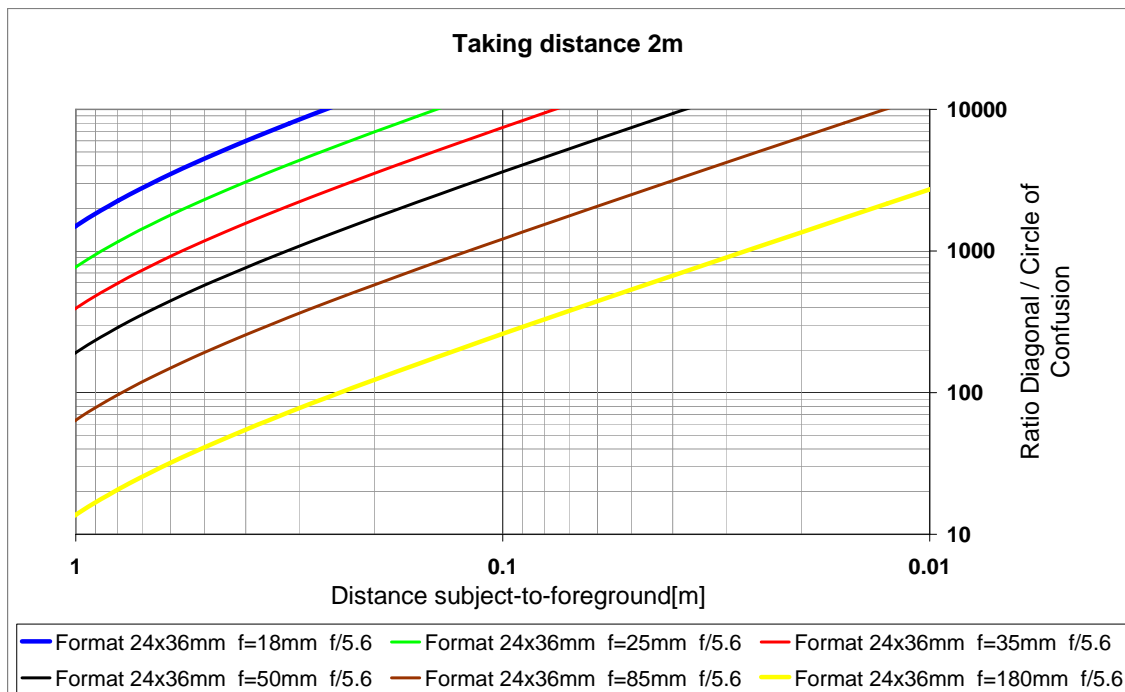

The same lenses are featured here with respect to the foreground. If we compare the distance from the main subject at which certain blurriness is reached in the upper and lower charts e.g. the value 1000, we then see that the spread before and after the focus is symmetrical with the longer focal lengths, but is increasingly asymmetrical in the case of shorter focal lengths. The red curves for 35mm approximate very closely to the “1/3 in front – 2/3 behind” rule.

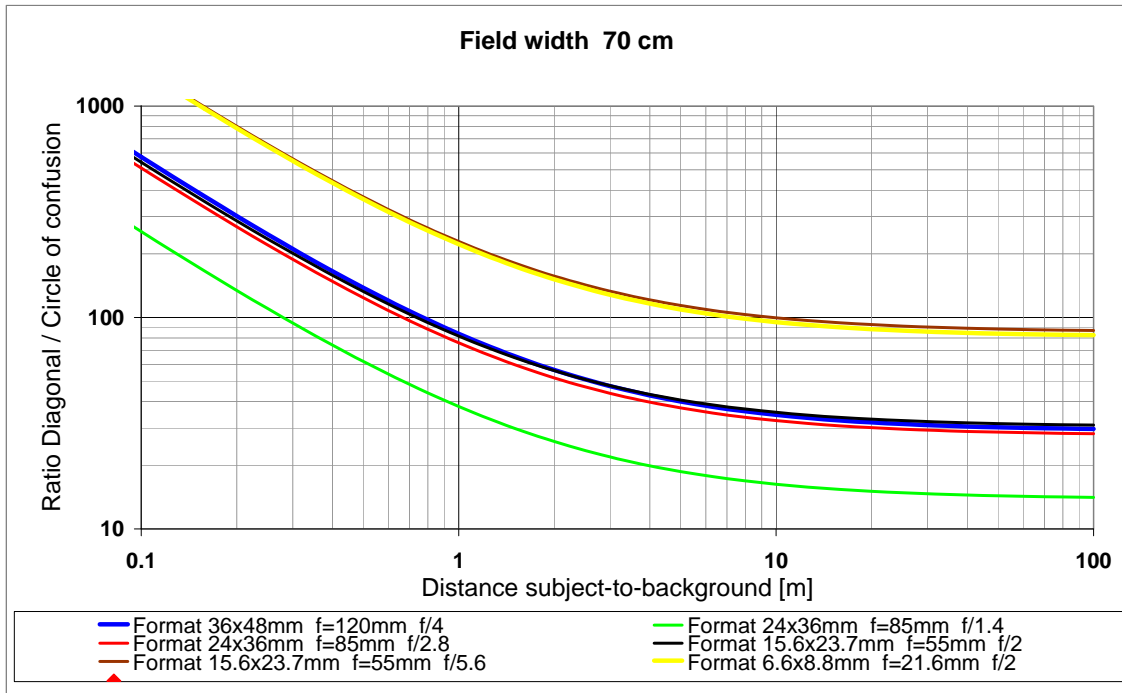

We have now returned to the first subject example but are now taking the photographs from the same distance in different formats, in other words with different focal lengths but in each case with the same angular field. If equivalent aperture numbers are chosen (see the table on page 10), the attributes of the depth representation of different formats are identical and the curves are then congruent. However, in the case of the very small format (2/3") it is necessary to work with very wide apertures and maintain sufficient distance from the background in order to achieve a good level of blurriness.

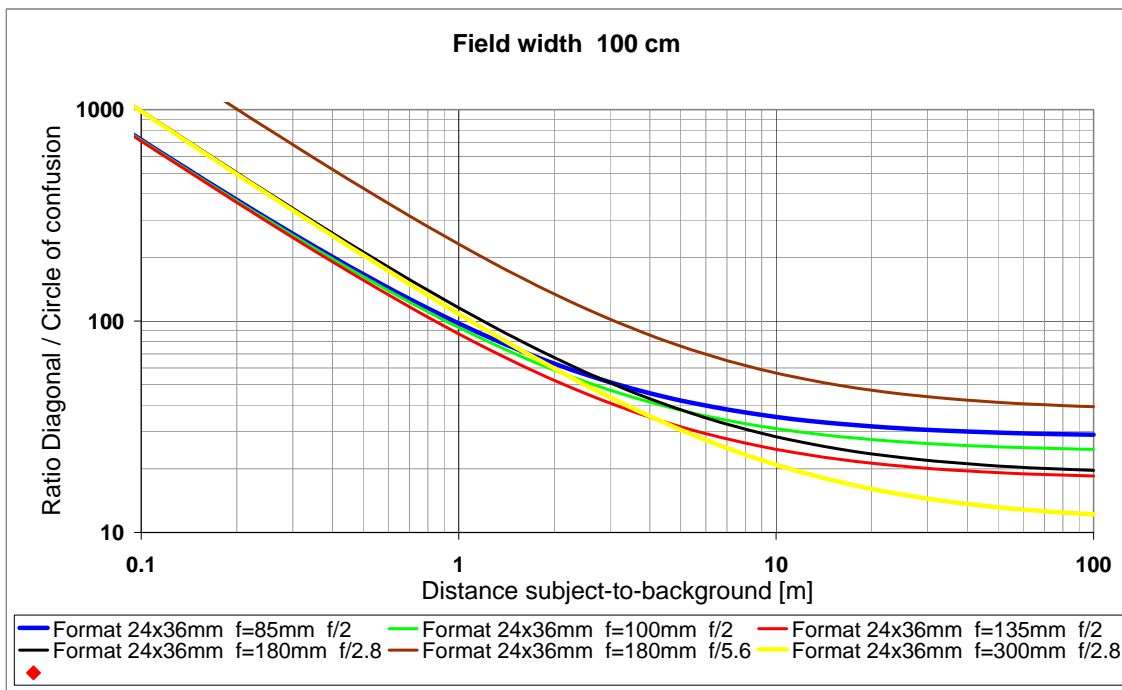

We are now comparing six different focal lengths and aperture values on 35 mm format. We are therefore photographing from distances of between 2.5 and 8.5m. The first three curves (blue, green and red) are all for aperture f/2; these curves all initially leave the zone of focus congruently and therefore confirm that depth of field depends only on scale and the aperture figure. But at greater distances behind the focal plane the longer focal distance creates increasing blurriness. We also see the same if we compare 300mm and 180mm (black and yellow).

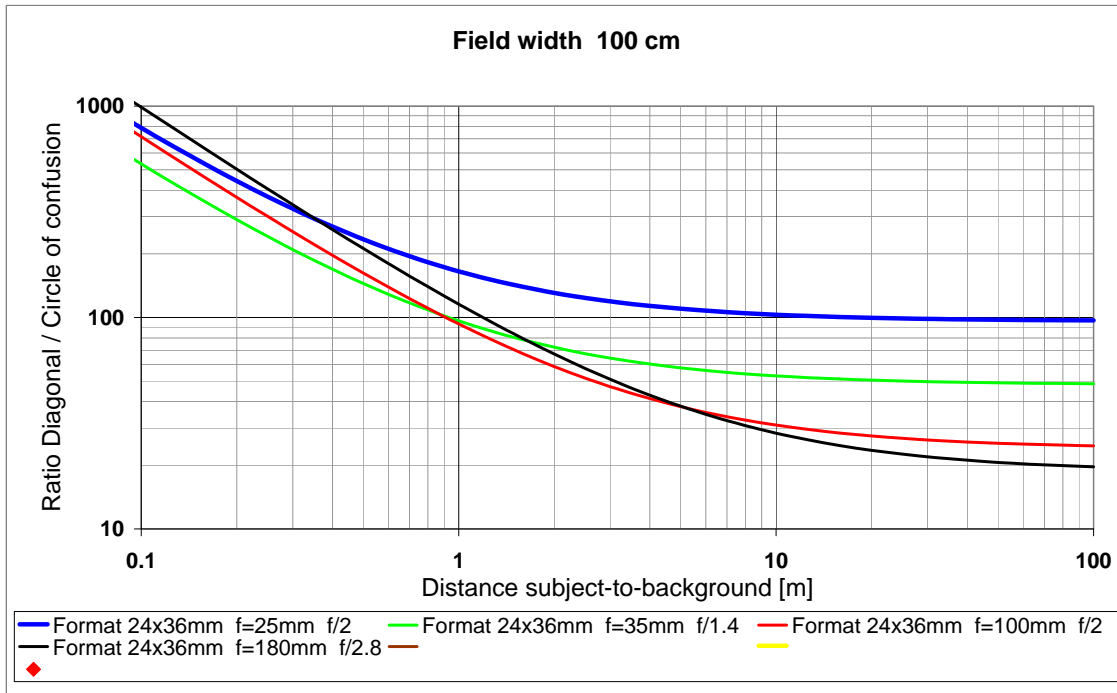

Another comparison in 35 mm format with a larger range of focal lengths but each with the same reproduction scale of the main subject: while the influence of aperture clearly dominates at very small levels of blurriness on the left and determines the order of the curves, in the far distant background the influence of focal length predominates. If the subject is to be truly separated from the background, one ideally needs both – a longer focal length and a high speed lens.

All these curves of the large circles of confusion can be easily understood if you look back once again to page 11 and examine the sketch you see there. In your imagination or on a piece of paper let the point of the light cone move behind the blue focal plane and see how the cross section of the cone changes with the focal plane. The cross section of the cone is the image of the circle of confusion which forms on the sensor.

The decisive parameter for the quantity of the blurriness is therefore the **physical size of the entrance pupil**. If by “bokeh” you mean principally the ability to be able to represent the background as very blurred, soft and lacking detail, it is necessary to have an entrance pupil which is sufficiently large. A large photo format, a high aperture lens and longer focal lengths have the best potential in this direction.

There are lenses where the angle of the light cone entering the lens from the subject is so important that this information is written on the lens barrel:



The number 0.75 on this microscope lens for a 20x magnification is the sine of half the light acceptance angle of 48.5° and tells us that the lens has a resolution limited by diffraction at about 2300 Lp/mm with a minute depth of field of 0.001mm.

As a comparator: a photographic lens with an imaging scale of 1:10 and a nominal f-number of 8 has a light acceptance angle of 0.6°; the resolving power limited by diffraction is then 16 Lp/mm measured in the subject and the depth in which this resolution is achieved is 20mm.

## Aperture iris images

It often happens that many circles of confusion of similar brightness overlay each other and intermingle in a picture in such a way that the individual circle can no longer be recognised. This causes the flat, smooth character of a very blurred background. But sometimes one point of the subject is much brighter than its surrounding area - for instance, light sources are reflected in glossy surfaces or drops of water. In such a case the associated circle of confusion is always accentuated beyond its surroundings in the picture such that it is possible to see its geometric shape. In this case we can see that we are not always dealing with circles because the entrance pupil is an image of the mechanical iris blades.

The aperture of the lens determines the basic area of the light cones which do not appear exactly as the cones in our school books. We therefore see the number and shape of the iris blades if the sensor plane intersects with the cone at a position where its cross-section area is still very large.

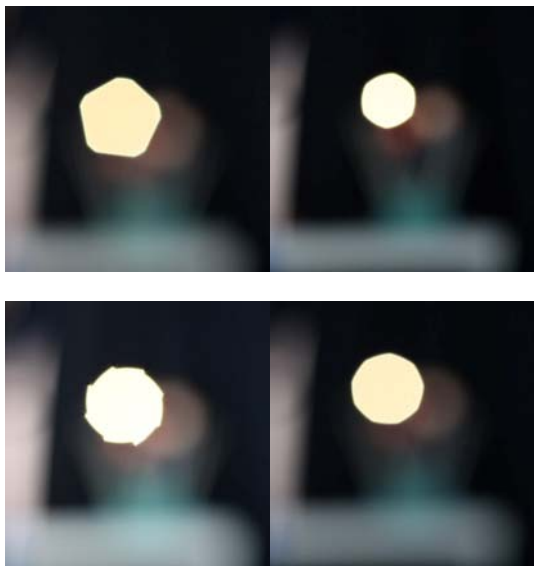

*Four examples of iris structures with 5, 6, 8 and 9 blades which are made visible by a very out of focus bright light source which is depicted. The lens at the top on the left is only stopped down a half stop from the full aperture, which is why it is possible to see short curves of the circular full aperture between the five straight edges of the iris.*

Such iris images can be very decorative items in a picture. If they are strikingly bright they attract the view of the observer. A 'beautiful' geometry of the iris is therefore desirable. But an iris image reminiscent of a saw blade as in the example below on the left is often perceived as disruptive.

With a sufficiently large number of iris blades and a suitable curvature it is possible to come close to the ideal of a circular aperture. Regular pentagons or hexagons which were frequently seen in earlier days are now felt to be too 'technical'. But at the end of the day it is naturally a matter of taste.

At the **edge of the photo** iris images are also altered by **vignetting** if the light cones going to the edge of the photo at wide apertures are intersected by front or rear parts of the lens barrel or by the limited diameter of rear and front elements:

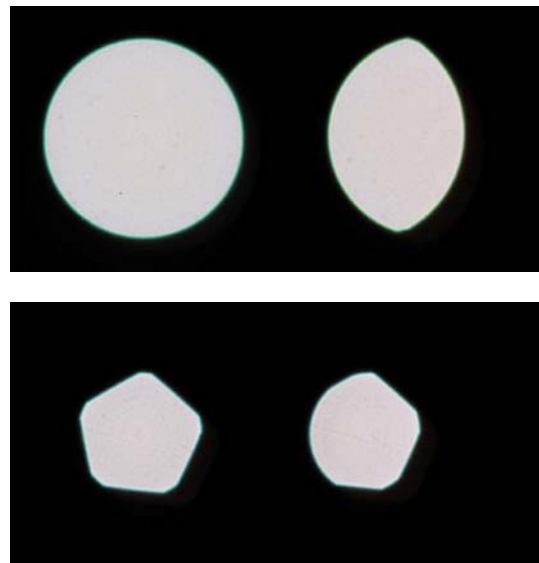

*How vignetting becomes visible in iris images: a circle in the middle of the picture becomes a two-sided figure composed of segments of circles at the edge; a pentagon turns into a strange composite shape. Thus it is only possible to see regular iris forms in the overall surface of the photo if the lens is stopped down so far that artificial vignetting is no longer present.*

However, alongside the design-based properties of the lens, quite natural, unavoidable effects give reason that images of highlight areas not only display perfect circles. To be specific, if many highlight areas are located in close proximity to each other – a reflective water surface would be an example – the bright areas created by each individual highlight area overlap and the points of brightness cumulate in these areas of overlap:

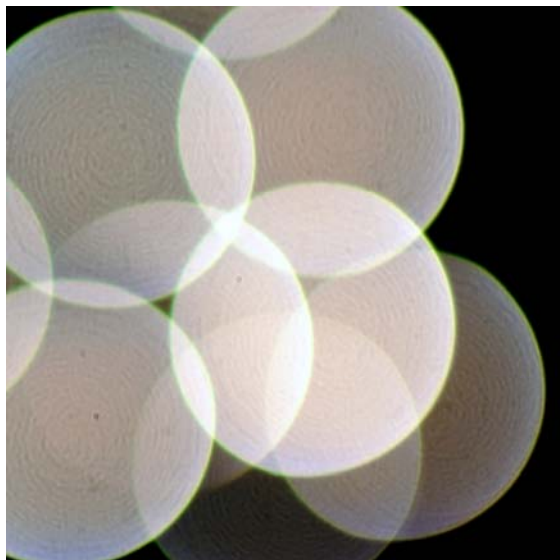

*If the iris images of out of focus highlight areas overlap, these bright areas cumulate and create new geometrical shapes in this way.*

If you look at this picture very closely, you can see another interesting effect – all the defocused spot images contain a circular structure. It is possible to recognise from this that the lens has an **aspherical surface** as these surfaces are often not as smooth as a conventionally polished lens. Particularly in the case of lenses which are manufactured by pressing hot liquid glass it is possible to recognise the traces of the turning process with which the mould was manufactured.

It is possible to combine rotational and pivotal movements when polishing spherical surfaces because the curvature of the surface is the same everywhere; in this case no traces are left. In the case of aspherical surfaces the curvature is variable and therefore demands other processing techniques. Residual unevenness of these surfaces becomes visible if a very small light source is reproduced very much out of focus.

It is often possible to observe similar effects in photos taken using flash photography with digital compact cameras if there are specks of dust floating in the air close to the camera and these specks are illuminated by the flash. They are very brightly illuminated due to their close proximity to the flash but at the same time are reproduced very much out of focus. Their inner structure and transparency therefore create in many observers the perception of transparent spheres floating in the room. If you search the Internet for '**orbs**' you will find dozens of articles in which this phenomenon is interpreted as mysterious ghosts. But in reality the reason is a diffraction pattern of the light waves travelling through the lens surfaces.



*'Light orbs' from a compact camera with integrated flash.*

Such disruption to light waves is particularly significant if "soft filters" are used on the lens. In the case of the Zeiss 'Softar' filter the effect is caused by small lens-shaped bumps distributed across the surface of the filter. These, too, are visible in the iris images:

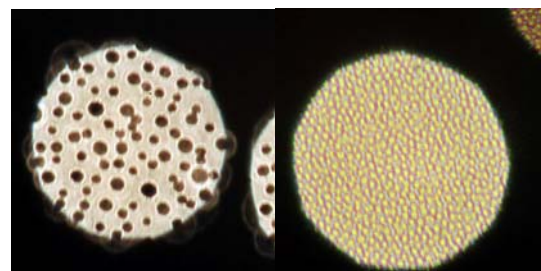

*Iris images with the Zeiss "Softar" and Minolta "Portrayer" soft filters*



Sometimes the phenomenon of the individual iris images is equated with “bokeh”; under this heading one finds collections of pictures in which iris images are mixed with photos of soap bubbles. But this is not what is meant by “bokeh”. In the iris image the lens is reading the cards to a certain extent but what significance has all this for the reproduction of image areas in which there are no highlight areas?

In the following examples of photos we will see that one should not over-estimate the significance of the shape of the iris:



*Test subject: two flowers which are not wilting under a spot-light, slivers of wood and metal knitting needles as a model for blades of grass and, in the background, a small, bright, circular light source as an iris indicator.*



*Test subject photographed slightly out of focus with the lens with 5 iris blades (see page 31)*

The f-numbers chosen for these pictures were exactly the same as for the iris images on page 31. However here it is possible to see the geometrical shape of the iris only indirectly in the alternating wide and narrow beams of light which radiate out from the light source. These are caused by the diffraction of the light at the edges of the iris blades.

The geometrical shape of the bright disc of the image of the light source does not betray the exact shape of the iris. This is because in the slight out of focus which has been set here, the circular illuminated surface of the light source is still relatively large in comparison to the tiny pentagonal image of each individual point on the illuminated surface. Therefore the image appears to be fairly round. But this changes if the out of focus is increased

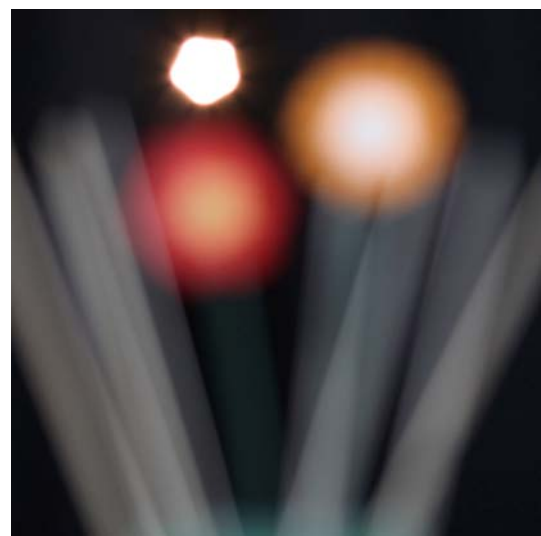

*Test subject photographed very much out of focus. Above, the focus is closer to the foreground; below, the camera is set to “infinity”.*

Thus whether we see the shape of a bright object or the shape of the iris depends on a size ratio. An object which is practically dot-shaped always shows us the shape of the iris if it is out of focus. Conversely the outline shape of a rather larger object always dominates if the image is only slightly out of focus. In between there is a transition zone in which both shapes are mixed.

It is apparent in the pentagonal diaphragm images of the last two photos that they are reversed to each other. The reason is because in the upper photo the sensor plane is behind the focus and in the lower image it is in front. Behind their point of intersection with the focus all the light beams exchange their position in the light cone.

Except in the picture of the highlight areas we do not find the shape of the iris in any other element of the image. **Lines and long edges** particularly generate an **image of many highlight areas** blurred in one direction – the shape of the iris is unimportant in this.

Only in the slightly out of focus iris image at the bottom of the previous page can we see a couple of gentle highlight areas at the edge of the flowers showing the pentagonal shape of the blades. They disappear as the image goes further out of focus because the amount of light in the point is then distributed across such a large area that it is no longer noticed.



*Lens with 8 iris blades*



*Lens with 9 iris blades*

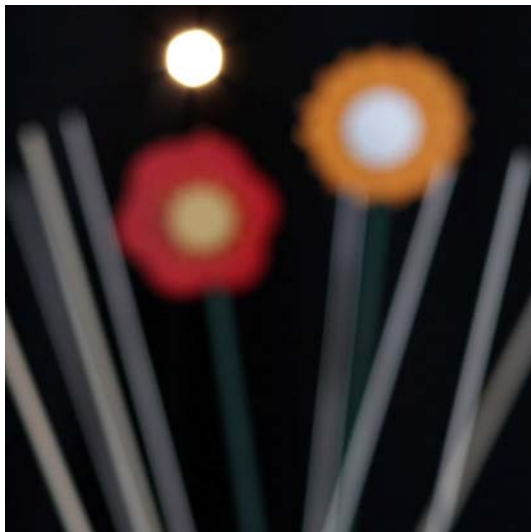

*Lens with 6 iris blades*

In summary we can say that the shape of the iris can become visible in the picture either obviously as a decorative feature or as a disturbing artefact and that it can betray interesting facts about the lens to us. However, the iris can remain totally invisible in many pictures. Yes, and if we use a lens with the aperture fully open, it can of course play no role at all.

Nevertheless or perhaps in just such a case there can be major differences in the bokeh.

## The Nature of Blurriness

We have come to understand the basic characteristics of depth of field with the aid of a little geometry: we have taken a look at **light cones** that are intersected in different places by the sensor of the camera (see pages 4 and 6). The intersections are the circles of confusion, and so far we have always assumed that they appear as homogenous light disks.

If that were true, then the circles of confusion would only depend on the purely geometrical factors of the lens that can be entered into a depth of field calculator, for instance. All lenses would then have to be the same when using the same f-number and same focus deviation.

We know, however, that lenses are not at all alike at their best focus, especially not with a wide aperture. Differences in contrast and sharpness naturally occur in such cases. But why should these differences disappear completely if we compare them at a deviation from the best focus? The measurements of the contrast transfer depending on the depth in the image have already shown us how different lenses can be, not only at best focus but also at the calculated limit of the geometric depth of field (see page 23). Let us find out why that is the case.

The geometric theory of depth of field is an idealized model that does not take aberrations into account; it simply assumes that all light cones intersect at one point:

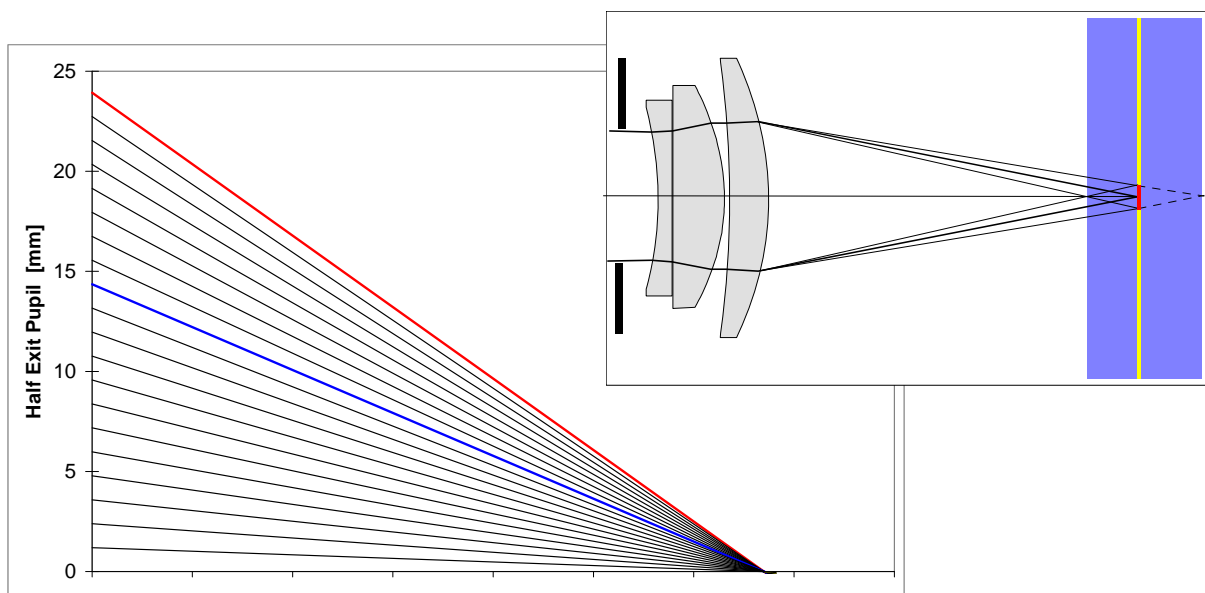

*This graphic is simply a somewhat more abstract version of the sketch on page 4. Because the lens is symmetrical, we are just looking at one half of the light cone to save space. We have drawn 20 rays of light that are travelling from one half of the exit pupil and all intersect at one point. The dimensions of the exit pupil are typical for a 1.4/50 mm lens.*

*We have highlighted two rays of light in particular: the marginal ray is marked red: the ray marked blue that is more on the inside is travelling from a point of the pupil plane that is 14 mm away from the optical axis. If the aperture is narrowed from 1.4 to 2.4, the blue ray will become a marginal ray and the rays on the outside will be blocked by the iris blades.*

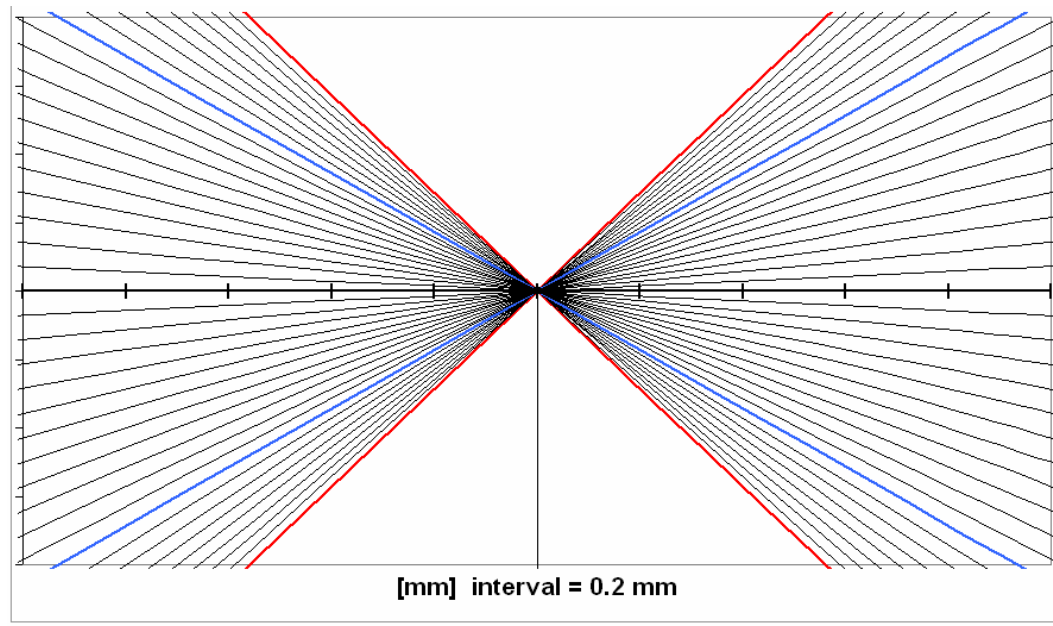

If we magnify the surroundings of the intersection, we see the ideal conditions: all rays converge on the focal point in orderly lines travelling alongside each other, intersect there at a single common point, and then leave the focal point in just as orderly of a way on the backside. That is how we have always imagined it in all of our depth of field calculations - but it is too perfect to be true.

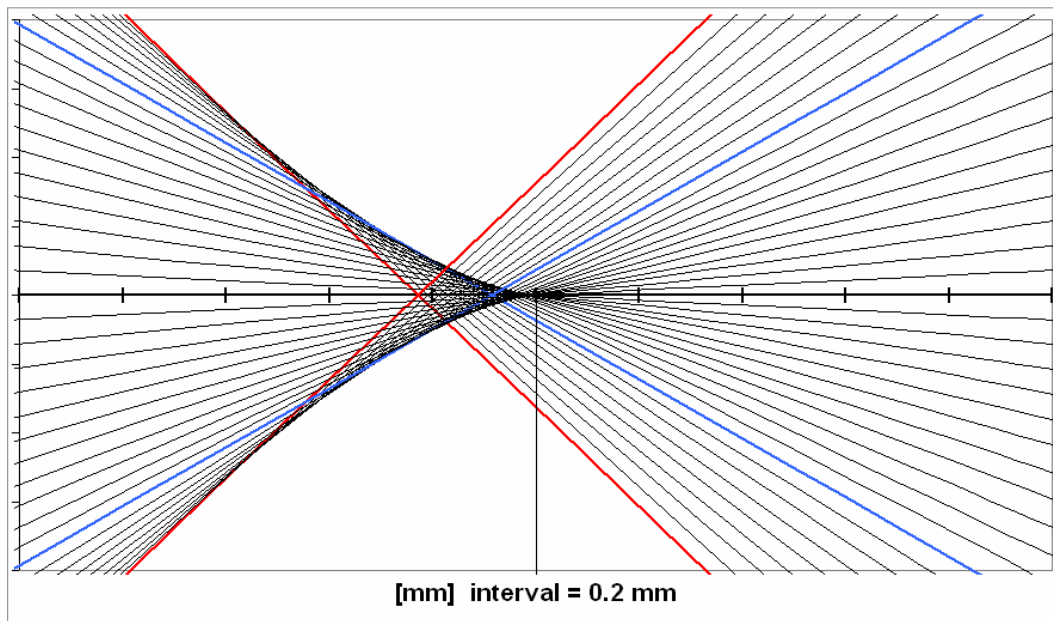

A real lens can also look like this. The rays from different heights of the pupil no longer have the same point of intersection, but rather each zone of the pupil has its own point of intersection. They are all on the optical axis, but are at different distances from the lens. The focus of the marginal rays is not as far away; the rays travelling with a flat slope that are close to the optical axis intersect at the black point further away.

This image defect is called "**spherical aberration**." Because the point of intersection of the marginal rays of light is closer to the lens for simple collective lenses and this natural defect is similar to above example, the type described above is called "**spherically under-corrected**." The greatest constriction of the double cone is in front of the black dot, and that is where the best focus is at full aperture. If the aperture is narrowed, the focus moves to the black dot - the lens has a positive focus shift.

There is a particularly interesting point further to the left in the graphic above, about 0.4 mm in front of the focal point of the paraxial rays: there, the marginal rays seem to overtake those travelling more on the inside. The light cone is no longer ideally arranged, and we could say that the rays of light are "confused."

**This is the original meaning of the Japanese word "bokeh."**

There are so many rays that overlap in this zone of intersection that a ring with increased brightness results. This means that the circle of confusion is not a disk with homogenous brightness.



In practical photos, that can look like this:



*Foreground blurriness with Sonnar 1.5/50 ZM, a spherically under-corrected lens.*

There are no rays that intersect or overlap behind the focal point. Quite the opposite; the density of the rays on the outside is somewhat less than in the ideal geometric light cone. The circle of confusion is therefore larger behind the focal point than in geometric theory, and the brightness decreases moving outward from the inside, while the circle is smaller in front of the focal point and is clearly bordered by a bright ring around the outside.



On the outside, the circle of confusion has a thin green border because on the outside we see the rays of light whose focal point is closest to the lens. Since green light has the closest focal point in the normal chromatic aberration it dominates the cover surface of the light cone behind the focus.



*Background blurriness with Sonnar 1.5/50 ZM*

The nature of the background blurriness of a spherically under-corrected lens is appealing to the human eye. The background is calming and the contours of the object are retained longer even in the blur. Further below you will find examples illustrating this.

There are disadvantages to this imaging property, however:

- The more appealing the blurriness is in the background, the less appealing it is in the foreground. There it often seems harsh and disturbing. It generates swirls of small highlights and transforms lines into double lines.
- If we want to generate a noticeably beautiful bokeh in the background, then we must make the under-correction so noticeable that the focus shift is also very large and makes focusing difficult.
- In addition, the contrast rendition of the lens is overall poor by necessity. Because the outside rays form a halo surrounding the spot where the inner rays form a small image point, the contrast is reduced.

We must make use of this characteristic moderately with lenses intended for general use and have to limit the spherical **under-correction**. In any case, we should avoid spherical **over-correction**. This is not to say that the lens is now better than good - overcorrection just means that the spherical aberrations now have a different signature. The marginal rays then intersect far behind the focal point of the paraxial rays. The bokeh characteristics are then simply reversed. The foreground characteristics with under-correction are found in the background in case of overcorrection. And because background is almost always more important, it would be the less desired balancing of the lens.

But even spherical aberration which remains completely within the range of the mild under-correction, yet shows clear signs of the measures that are intended to limit the growth of the spherical aberration. It can already cause a slight increase in the outward brightness. That is why lenses with larger apertures are usually not completely free of it. They should not be compared to lenses with a more modest maximum aperture where the spherical correction is much simpler either.

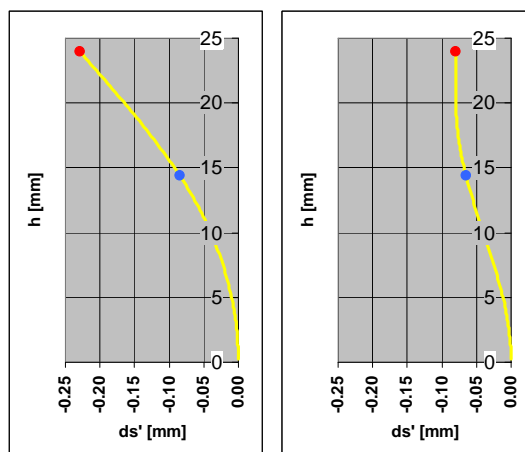

Common diagram of the longitudinal spherical aberration in optics: the vertical axis shows the starting point of a ray in the pupil plane, expressed by the distance from the optical axis, and the horizontal axis shows the deviation from the focus position. The directions correspond to the graphics on the previous pages. The diagram on the left shows a strongly under-corrected lens.

But even with the well-corrected lens on the right, the brightness profile of the circles of confusion already shows a "thin ring" emphasizing the edge:

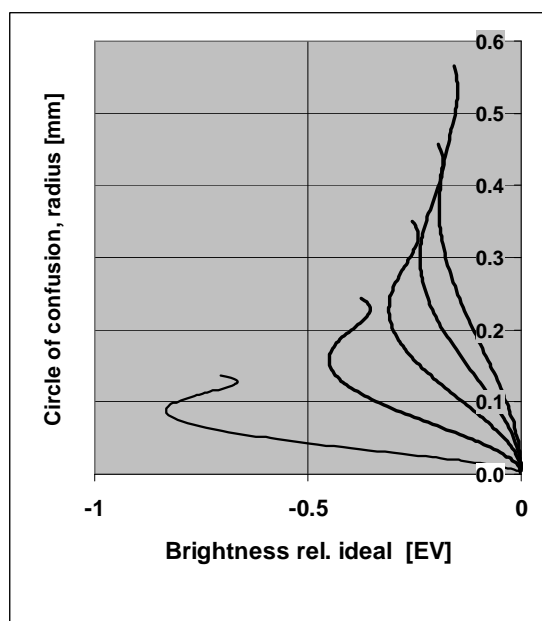

Brightness variation for circles of confusion of various sizes in the background with a lens showing mild spherical under-correction. The more it is defocused, the smaller are the deviations from the ideal disc with homogenous brightness throughout.

Somewhat stronger counteractive measures towards spherical overcorrection strongly increase the brightness around the circumference of the circles of confusion:

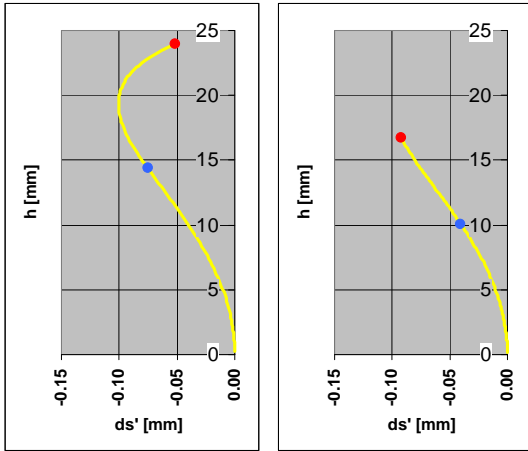

But if the lens is stopped down one stop (charts on the bottom and above on the right-hand side), the reversal point of the longitudinal spherical aberration is excluded and the brightness profiles look pleasant again.

In this example we can also see that the brightness profiles become flatter when the image is blurred more.

In reality the brightness gradient at the edge of the blur circle is not as high as shown in above charts. They had been calculated for a single wavelength, but in reality different colours have different circles, which makes things a bit more smooth. Real lenses have as well a longitudinal chromatic aberration; the focus of the rays depends on the wavelength. And these deviations are of similar amounts as the spherical ones:

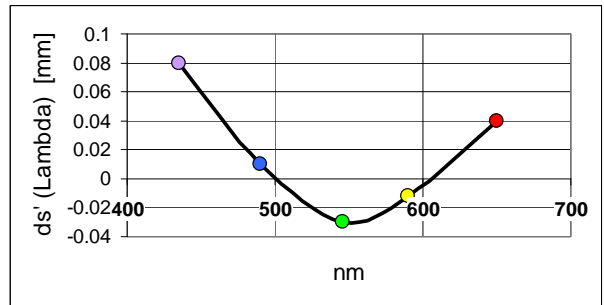
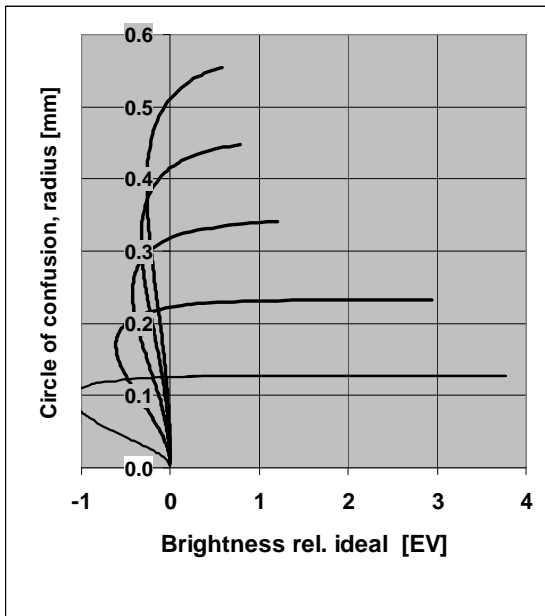

Thus the focus deviations of the colours are different and the according circles of confusion have slightly different size:

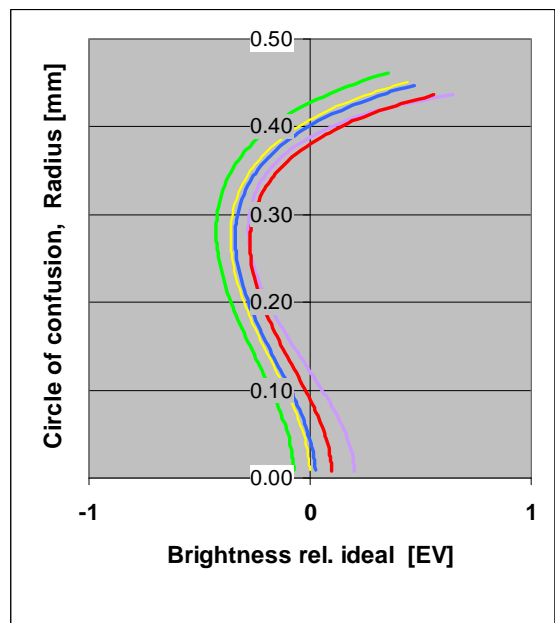
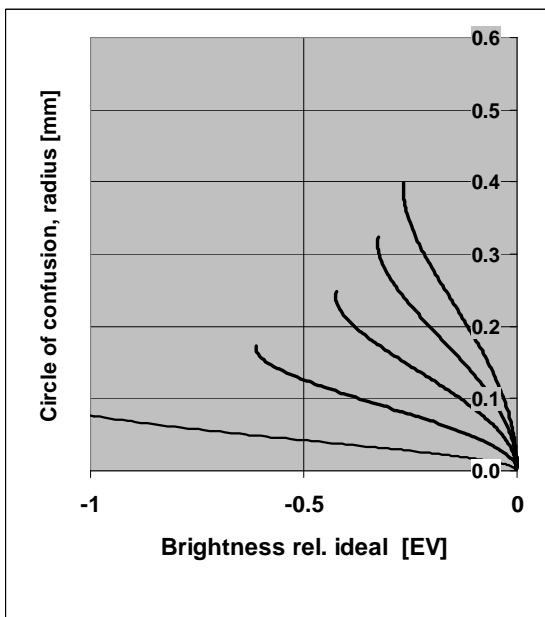

This combined effect of different aberrations causes that in the background of the image the inner area of the blur circles is dominated by the colours which have the longer focal distance. These are usually the colours from the ends of the visible spectrum which mix to a purple shade. The edge of the blur circle is dominated by the colours from the middle of the spectrum. This explains the green fringes which we see in the blurred image of a white spot.

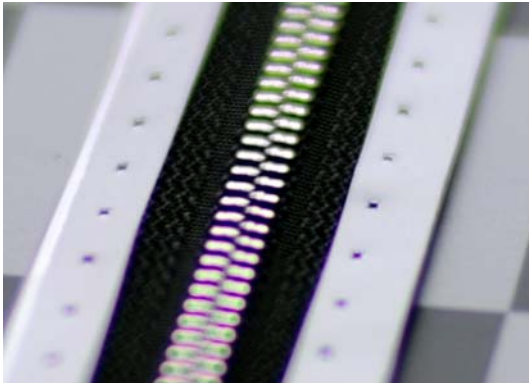

*Two examples of colour-bokeh near the focus. Above all glossy details are in the background, below they go through the focus. There you can observe the reversal of the colour effects in front of and behind the focus. That one sees only the green fringes but not the purple core is due to the too high brightness of the highlights.*

*As with the brightness profiles of blur circles the handwriting of the lens with respect to colour-bokeh disappears more and more, when it is strongly out-of-focus, or when it is stopped down.*

This leads to the following rules about bokeh:

- *Some caution is advised when making judgments about the bokeh depending on the lens correction, because bokeh is extremely variable.*
- *The correction balancing has an especially strong influence on the blurriness of the rendition at small deviations from the focal point. If there is a lot of blurriness, it usually becomes more and more negligible.*
- *The aperture has a strong influence; even closing the aperture a small amount can cause very visible changes to the nature of the blurriness. Slower prime lenses generally have smaller spherical aberration by nature. So it is no wonder that their bokeh is praised for its appeal.*
- *The spherical aberration of a lens also changes depending on the imaging scale. Bokeh characteristics therefore depend on the focusing distance as well.*



After working through many difficult diagrams, we will now relax and use a few example pictures to illustrate the influence of spherical aberration, which should also invite you to have a look to the image files available for download:

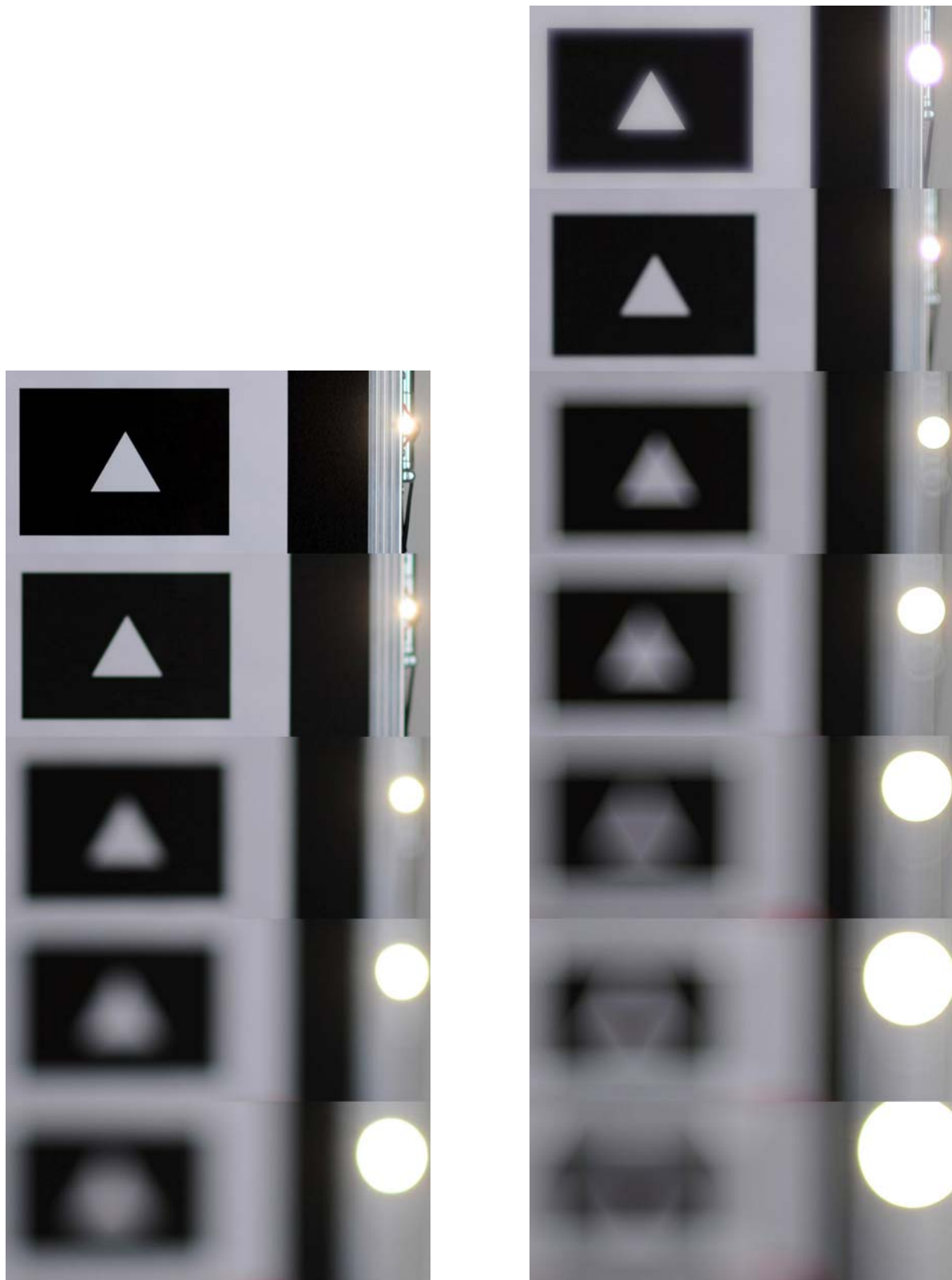

*On the left is a focus series of images showing blurriness in the background using a lens with normal spherical correction while the right side is using an overcorrected lens. Its characteristics: a veil is present at the best edge sharpness (top picture), many artefacts can be seen in the blurry picture.*

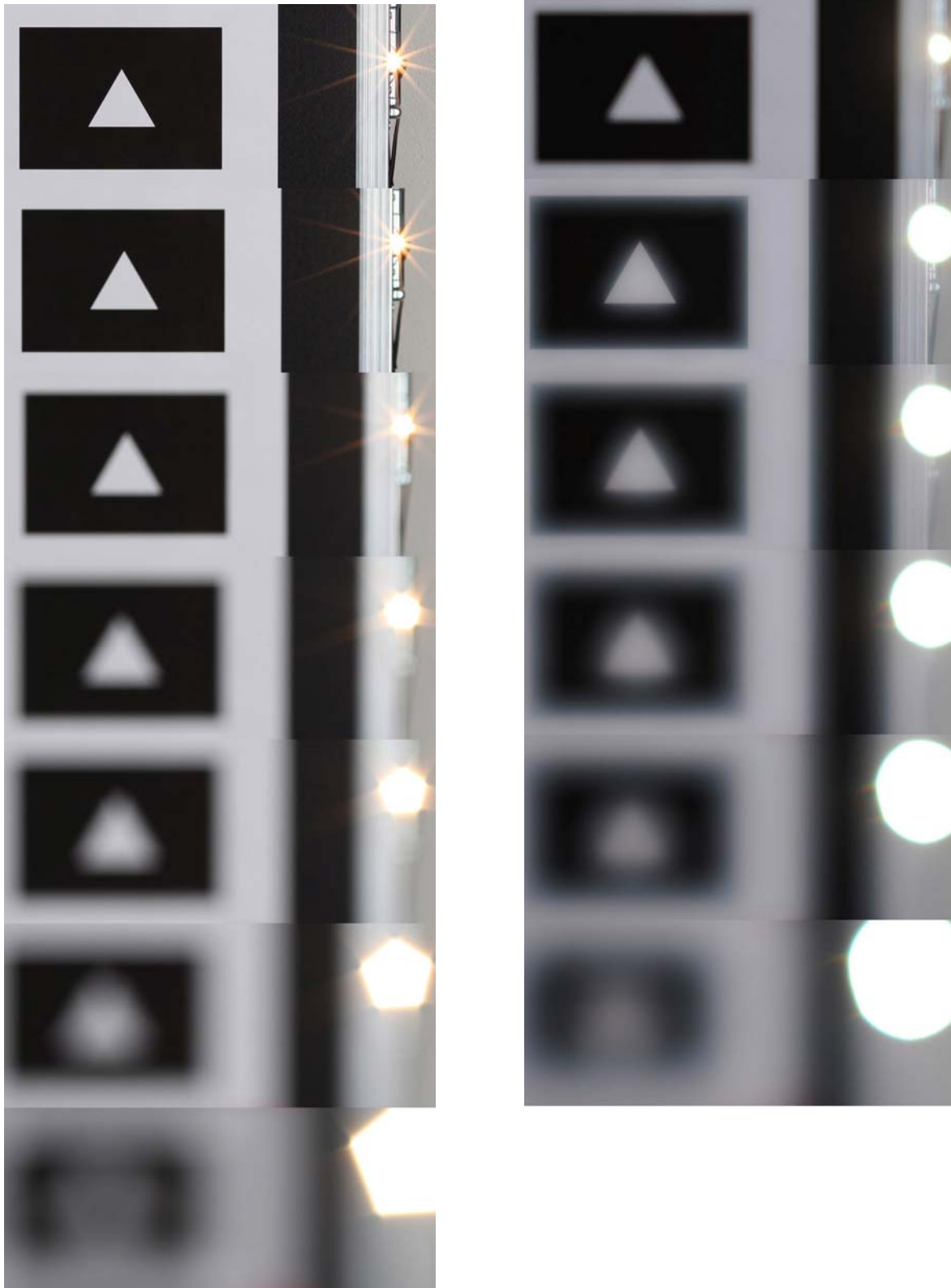

*On the left is a focus series of images showing blurriness in the background using a lens with normal spherical correction and five iris blades, while the right side is using an under-corrected lens. Its characteristics: a veil is present at the best edge sharpness (second picture from the top), the contour of the triangle remains for a long time. Because of the veil of the spherical aberration, the very bright highlight appears much larger.*



*A 700x820 pixel crop from a 24MP-image, above with strong spherical aberration, below with good correction. The hatching in the hair is at about 40 Lp/mm on the sensor. Scale ratio was 1:10. These images are available as download files.*

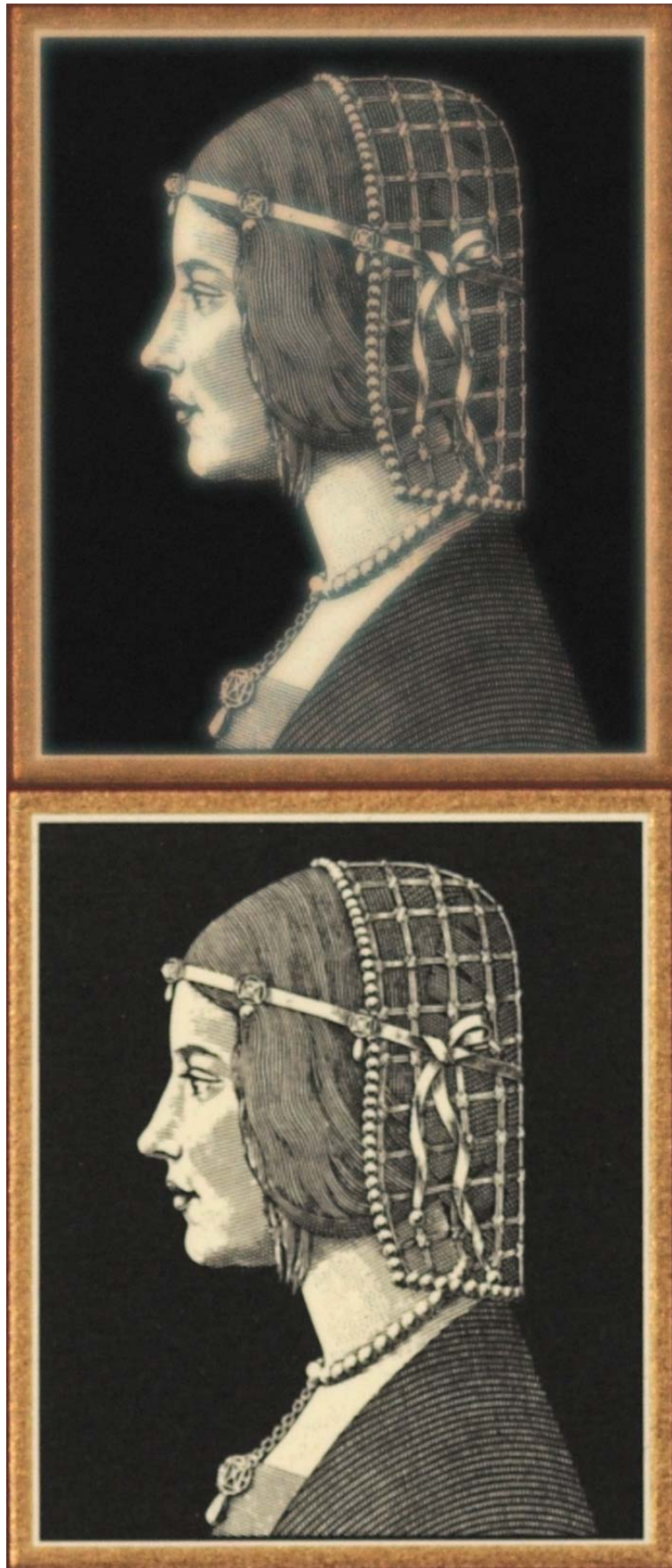

*The same lenses as the previous page, now defocused by 1.5x depth of field, the subject is in the background. With a lens that is poorly corrected, the change in sharpness and contrast is significantly less - but with compromises at maximum picture quality.*

## Image files for download

### Image 1 to 7

These images show the Zeiss factory in Oberkochen with a different amount of blur, achieved by combining different focus settings and f-numbers. The lens was a Planar 1.4/50 on an APS-C camera. In some images a red arrow marks a prominent highlight where the sun was reflected in the screen window of a car. Two blue arrows mark the width of a bright structure.

- Image 1 Best focus shot
- Image 2 Circle of confusion is about 1/1000 of the image diagonal
- Image 3 Circle of confusion is about 1/200 of the image diagonal
  
- Image 4 Circle of confusion is about 1/90 of the image diagonal;  
The exposure with f/1.4 shows the bright green fringe at the edge of the blur circle due to spherical and chromatic aberration
  
- Image 5 Circle of confusion is again 1/90 of the image diagonal;  
The exposure was now with f/11. The bright fringe at the edge of the blur circle of the highlight has nothing to do with aberrations of the lens, it is caused by diffraction.
  
- Image 6 Circle of confusion is about 1/45 of the image diagonal
- Image 7 Circle of confusion is about 1/10 of the image diagonal

### Image 8 to 11

Dead leaves are shown with different blur. We would certainly prefer the very sharp or the very soft version as an image background. The other two don't appear calm, somehow noisy. But they had been taken with f/2.8 and f/11, where unfavourable features of the bokeh are of very low importance. This tells us, that unpleasant backgrounds have sometimes nothing to do with the lens.

### Image 12

Two images with different background bokeh show a zoom lens at long focal length on the left and a prime lens Makro-Planar 2/100 on the right. Both shots taken at f/5.6

### Image 13

This is an arrangement of small crops from 24MP images of a full frame camera. The original detail is 5cm high and was imaged at scale 1:10. Thus the hatched structure in the hair of the lady is in the image at around 40 Lp/mm. Each horizontal line of nine images is a focus sequence: on the left side the camera is most close to the subject, to the right the subject moves through the focus into the background. The distance step between neighbouring images is 4mm, hence 0.04 mm on the image side.

The images of the top row have been taken with the Makro-Planar 2/100 at f/2.8. Calculating with a permitted circle of confusion of 1/500 of the field results in a depth of field of 1.9cm. Two images on the left and the right of the centre image should be within this range. If you look carefully you can see that only the two nearest neighbours fulfil the most demanding sharpness expectations, the two outer ones show some loss already.

In the second row a lens was used which was assembled in such a way that it had considerable spherical aberration. It shows much less sharpness and brilliant contrast, but at the same time it shows less variation over the depth. Highly corrected lenses have a more sudden transition from sharpness to blur.

The tree lower rows compare three lenses at f/1.4, where the nature of the blur behind and in front of the focus is very different. Especially in the background the resolution of some detail can be maintained over a larger range than compared to images taken at smaller aperture f/2.8. This demonstrates the limits of all simple calculations about depth of field.

[Image 14 to 17](#) some illustrations of the text as jpg-file.