

*Volume Three*

EUROPE: ARGUMENT TO V-E DAY

JANUARY 1944 TO MAY 1945

# THE ARMY AIR FORCES

## In World War II

PREPARED UNDER THE EDITORSHIP OF

WESLEY FRANK CRAVEN

*Princeton University*

JAMES LEA CATE

*University of Chicago*



New Imprint by the  
Office of Air Force History  
Washington, D.C., 1983

THE UNIVERSITY OF CHICAGO PRESS, CHICAGO 37

Cambridge University Press, London, N.W. 1, England  
W. J. Gage & Co., Limited, Toronto 2B, Canada

*Copyright 1951 by The University of Chicago. All rights reserved. Copyright 1951 under the International Copyright Union. Published 1951. Composed and printed by THE UNIVERSITY OF CHICAGO PRESS, Chicago, Illinois, U.S.A.*

Copyright registration renewed 1979

This work, first published by the University of Chicago Press, is reprinted in its entirety by the Office of Air Force History. With the exception of editing, the work is the product of the United States government.

**Library of Congress Cataloging in Publication Data**  
Main entry under title:

The Army Air Forces in World War II.

Vol. 1 originally prepared by the Office of Air Force History; v. 2, by the Air Historical Group; and v. 3-7, by the USAF Historical Division.

Reprint. Originally published: Chicago: University of Chicago Press, 1948-1958.

Includes bibliographical references and indexes.

Contents: v. 1. Plans and early operations, January 1939 to August 1942—v. 2. Europe, torch to point-blank, August 1942 to December 1943—[etc.]—v. 7. Services around the world.

1. World War, 1939-1945—Aerial operations, American. 2. United States. Army Air Forces—History—World War, 1939-1945. I. Craven, Wesley Frank, 1905— . II. Cate, James Lea, 1899— . III. United States. Air Force. Office of Air Force History. IV. United States. Air Force. Air Historical Group. V. United States. USAF Historical Division. D790.A89 1983 940.54'4973 83-17288 ISBN O-912799-03-X (v. 1)

## FOREWORD

to the New  
Imprint

**I**N March 1942, President Franklin D. Roosevelt wrote to the Director of the Bureau of the Budget ordering each war agency to prepare “an accurate and objective account” of that agency’s war experience. Soon after, the Army Air Forces began hiring professional historians so that its history could, in the words of Brigadier General Laurence Kuter, “be recorded while it is hot and that personnel be selected and an agency set up for a clear historian’s job without axe to grind or defense to prepare.” An Historical Division was established in Headquarters Army Air Forces under Air Intelligence, in September 1942, and the modern Air Force historical program began.

With the end of the war, Headquarters approved a plan for writing and publishing a seven-volume history. In December 1945, Lieutenant General Ira C. Eaker, Deputy Commander of Army Air Forces, asked the Chancellor of the University of Chicago to “assume the responsibility for the publication” of the history, stressing that it must “meet the highest academic standards.” Lieutenant Colonel Wesley Frank Craven of New York University and Major James Lea Cate of the University of Chicago, both of whom had been assigned to the historical program, were selected to be editors of the volumes. Between 1948 and 1958 seven were published. With publication of the last, the editors wrote that the Air Force had “fulfilled in letter and spirit” the promise of access to documents and complete freedom of historical interpretation. Like all history, *The Army Air Forces in World War II* reflects the era when it was conceived, researched, and written. The strategic bombing campaigns received the primary emphasis, not only because of a widely-shared belief in bombardment’s con-

tribution to victory, but also because of its importance in establishing the United States Air Force as a military service independent of the Army. The huge investment of men and machines and the effectiveness of the combined Anglo-American bomber offensive against Germany had not been subjected to the critical scrutiny they have since received. Nor, given the personalities involved and the immediacy of the events, did the authors question some of the command arrangements. In the tactical area, to give another example, the authors did not doubt the effect of aerial interdiction on both the German withdrawal from Sicily and the allied landings at Anzio.

Editors Craven and Cate insisted that the volumes present the war through the eyes of the major commanders, and be based on information available to them as important decisions were made. At the time, secrecy still shrouded the Allied code-breaking effort. While the link between decoded message traffic and combat action occasionally emerges from these pages, the authors lacked the knowledge to portray adequately the intelligence aspects of many operations, such as the interdiction in 1943 of Axis supply lines to Tunisia and the systematic bombardment, beginning in 1944, of the German oil industry.

All historical works a generation old suffer such limitations. New information and altered perspective inevitably change the emphasis of an historical account. Some accounts in these volumes have been superseded by subsequent research and other portions will be superseded in the future. However, these books met the highest of contemporary professional standards of quality and comprehensiveness. They contain information and experience that are of great value to the Air Force today and to the public. Together they are the only comprehensive discussion of Army Air Forces activity in the largest air war this nation has ever waged. Until we summon the resources to take a fresh, comprehensive look at the Army Air Forces' experience in World War II, these seven volumes will continue to serve us as well for the next quarter century as they have for the last.

*RICHARD H. KOHN*  
*Chief, Office of Air Force History*

## FOREWORD

\* \* \* \* \*

**I**N PLANNING a seven-volume history of *The Army Air Forces in World War II* the editors hoped to achieve a reasonable degree of unity in a complex narrative which seemed to divide itself into three related but sometimes disparate themes: air operations against the European Axis; air operations against the Japanese; and those services in the United States and in the several theaters which made combat operations possible. To those hardy souls who get through the seven stout volumes—and the editors hope they are legion—this unity may be discernible; but for readers whose endurance is less rugged or whose interests are less catholic the volumes have been so arranged that the three themes may be found treated with some degree of completeness in, respectively, Volumes I, II, and III; Volumes I, IV, and V; and Volumes I, VI, and VII. This information has been purveyed in an earlier volume, not without an eye to its possible effect on sales; it is repeated here to fix the present volume into the context of the whole series. For with Volume III the story of the AAF's war against Hitler's Germany and his satellite nations—and hence one subsection of the series—is completed.

Volume I dealt mainly with plans and preparations; Volume II described the AAF's war against Hitler which began in mid-1942 in the skies over Libya and France. In the Mediterranean, where U.S. air forces were part of an effective Anglo-American team, the war went well and in a number of combined operations the Allies conquered North Africa, Sicily, and southern Italy and by the end of 1943 were confronting the enemy, strongly entrenched, along the Sangro and Garigliano rivers and were planning an amphibious operation designed to open the road to Rome. In northwestern Europe, however, the AAF had scored no such obvious victories. Its only sustained operations, strategic bombardment by the Eighth Air Force as a part of the Anglo-American Combined Bomber Offensive, had not as yet proved

decisive nor had the Allies achieved that superiority over the Luftwaffe which was prerequisite to both the strategic and the tactical air mission. As 1943 wore out, the AAF was anxiously awaiting the spell of clear weather which would allow a concentrated series of strikes against the sources of German air power and thus, in respect to both the ETO and MTO, Volume II ended on a note of expectancy.

The present volume begins with the winter bombardment campaign of 1943-44 and ends with the German surrender in May 1945: it tells of air's contribution to the slow drive up the Italian peninsula; it describes the activities of the strategic bombers as they beat down the Luftwaffe and, turning to other targets, ruined the German war economy; it tells how tactical forces prepared for and supported the landings in Normandy and then spearheaded the Allied sweep across France and, after a check and a serious counterattack, across Germany. The volume contains then the climax of air operations, and the denouement too—for before the armistice the strategic bombers had run out of targets and the Eighth Air Force had begun its redeployment to the Pacific, while tactical forces had little to do beyond policing duties. The measure of the air victory and of the vast power which made it possible may be seen in a typical American gesture at war's end—a great sight-seeing excursion in which the Eighth flew 30,000 of its ground personnel over Europe to view the damage wrought by the planes they had serviced.

The chapter headings and subtitles provide a working outline of the present volume. Roughly, these may be grouped around four main topics: (1) the air war in Italy; (2) the strategic bombing campaign; (3) tactical operations in support of the land armies from the Cotentin to the Elbe; and (4) supporting operations of various sorts.

The war in Italy brought more than its share of disappointments to the Allies. For a year after the TORCH landings the Mediterranean had been *the* active theater for the Allied forces as they pushed, with only temporary checks, from Oran and Casablanca and from Egypt to a line well above Naples. But as this volume opens they had bogged down, thwarted in their effort to break through to Rome by rugged terrain, rugged weather, and a rugged German defense. With the OVERLORD invasion of France imminent, the Mediterranean no longer had first priority for resources; it became, and was to remain, a secondary theater.

Nevertheless, in early 1944 the Allies in Italy enjoyed a marked

superiority over the Germans in air power and this would increase in time. The newly established Mediterranean Allied Air Forces, which Eaker had come down from England to command, was a complex organization in which the Twelfth and Fifteenth Air Forces were the principal U.S. components. The Twelfth was to carry a heavy responsibility for tactical operations and the Fifteenth, though engaging occasionally in like activities, was to find its primary role in assisting the Eighth and RAF's Bomber Command in the Combined Bomber Offensive.

Both forces participated in the first large-scale endeavor to break the stalemate, the landing at Anzio. They cut communications lines into the battle area, softened defenses, and provided—in spite of the distance of their fighter bases from Anzio—an effective cover for the landings. The lodgment was made but Operation SHINGLE, successful as an amphibious assault, failed in its purpose of forcing the Germans to withdraw from their Gustav Line, and the Anzio beachhead became a liability whose defense put a heavy drain on air and ground resources. Winter weather severely handicapped the air war; its only useful function was to ease a difficult command decision in February—whether to send the Fifteenth Air Force on the long-awaited attacks on German aircraft factories or to use it tactically to help protect the endangered beachhead at Anzio.

Two spectacular air operations after Anzio have attracted a degree of attention wholly incommensurate with their military importance. On 15 February U.S. bombers destroyed the Benedictine abbey at Monte Cassino, hallowed throughout Christendom as the wellspring of western monasticism. Eaker was opposed to the strike, though he thought the monastery was being used by German troops, an assumption which is still being debated. The reluctance of AAF leaders to bomb cultural or historical monuments is sufficiently documented in this history—witness the extreme care exercised in hitting military targets at Rome; the tragedy in the case of Monte Cassino is made more bitter by its futility as a military act.

The same was true at the town of Cassino which was literally razed by U.S. bombers on 15 March in an effort to crack the Gustav Line. Here Eaker was flatly against a tactic which he thought more likely to impede, by craters and rubble, than to help the advance of armor; when ground forces moved in too slowly to take advantage of the momentary shock the heavy pounding gave German defenders, the

operation failed as he had predicted. Criticisms of air power that came afterward were not always fair, since the attack was clearly a misuse of a weapon; unfortunately the lesson was not wholly absorbed and similar errors were to be repeated later.

With the coming of spring, air operations increased in intensity as MAAF inaugurated STRANGLE, an appropriately labeled operation designed to choke off the enemy's communications so that his Gustav Line might be forced when he had consumed reserve supplies at the front. After much debate over rival suggestions—whether to concentrate on bridges or on marshalling yards—the issue was settled by a latitudinarian compromise which listed for simultaneous attack *all* features of the railroad system: bridges, yards, tunnels, tracks, rolling stock, and shops, and coastal shipping as well. Launched officially on 19 March, STRANGLE enjoyed an early success which grew more marked as bombers and fighter-bombers increased the accuracy of their strikes. Severely hampered in their use of railroads, the Germans came to depend more heavily upon M/T but as trucks were diverted to the long north-south haul the number available for lateral distribution shrank. Thus when a heavy ground offensive (DIADEM, jumped off 12 May) forced the Germans to expend more supplies at the front the carefully hoarded reserves were quickly depleted and the Allies cracked the line, linking up with the Anzio beachhead which at last began to pay dividends. Tactical air forces rendered close support in the assault but it was their sustained interdiction program that turned the trick. By 4 June the Allies had reached Rome and thereafter the German retreat became a rout which seemed to presage an early German collapse in Italy. In the air especially the Allies enjoyed an overwhelming superiority; the Germans came to depend more upon heavily reinforced AA forces than upon fighter defense, until MAAF claims of enemy planes destroyed were often less than Allied losses. An even stronger defense for the enemy was the weather which worsened at the end of June; by August the Germans had dug in again along the Gothic Line. An Allied attempt to sever all communications in the Po Valley (MALLORY MAJOR) achieved a considerable success but it was impossible to choke off supplies in the broad Lombard plain as it had been in the narrow peninsula and the enemy held tenaciously to his new line.

The Allied cause in Italy was weakened by the diversion of air and ground forces for the invasion of southern France (DRAGOON).



## FOREWORD

This assault, long a matter of contention among the Americans, the British, and the Russians, was postponed until August but moved thereafter rapidly enough. It offered little that was novel to combined forces who had gone over half-a-dozen beaches in the MTO and in size it was dwarfed by the recent OVERLORD landings. There had been the familiar pattern of preparation: strikes at communications by which enemy reinforcements might move in; attacks on German air installations (only light blows were required here); and bombing of coastal defenses. Planes based in Italy and Corsica participated in these pre-invasion activities and in providing cover for the landings. Several successful airborne operations gave clear indication of how much had been learned since the tragic attempts in Sicily. XII TAC stayed with the Seventh Army, helped chase the Germans up the Rhone Valley and beyond until by early September they pulled up just short of Belfort.

In Italy, as in northwestern Europe, Allied hopes of an early victory continued strong well into September as the Fifth Army crossed the Arno and broke through segments of the Gothic Line and the Eighth Army took Rimini. MAAF's tasks were to sever escape routes, particularly at the Po, and to help ground forces thrust the enemy back on those closed exits. But the armies, weakened by transfers and tired by long battles, could not breach the stubborn German defense and in October it was no longer a question of cutting the enemy's lines of retreat; the interdiction program continued but priorities now favored more northerly lines in an effort to cut off supplies coming from north of the Alps via the Brenner and other northeast passes while fighter-bombers attempted to destroy supply dumps in the forward area.

Allied operations had been handicapped by much wet weather which slowed the ground advance and which held back the bombers often enough to allow the Germans to repair bridges and rail lines. Allied air forces, weakened by diversions in favor of DRAGOON, suffered further losses as additional bomber and fighter-bomber units were sent to France and to the Pacific. Indeed, throughout autumn and winter there was much sentiment in favor of moving all AAF forces in Italy up into France, and the Fifth Army as well. Though this drastic step was never taken, the very threat, coupled with the piecemeal cannibalization of Twelfth Air Force, brought to the several MTO headquarters an air of uncertainty which lasted until the eve of victory. Internal changes in the command structure—the estab-

ishment of XXII TAC on 19 October and the wholesale reshuffling of commanders when Eaker went back to the States in March 1945—seem to have had less effect on operations than transfers of combat and service units.

At any rate, the Italian campaign became to Allied soldiers “the forgotten war.” Air preparations for a winter attack on the German lines proved abortive when a counterattack launched by Kesselring on 26 December induced MTO Headquarters to cancel the planned drive. Thereafter the Allies went on the defensive and for three months there was little ground activity. This threw upon air the main burden of the theater directive to maintain constant pressure upon the enemy, and the 280 combat squadrons of MAAF became “by far the most potent Allied weapon in the Mediterranean.” Except for a brief period in November when Fascist Italian air units trained in Germany gave a futile challenge, MAAF was untroubled by enemy air opposition; the general practice of sending out medium bombers without escort was a taunting symbol of the impotence of the GAF.

The long-anticipated withdrawal of German divisions toward the Reich began on 23 January and thereafter MATAF (supported occasionally by SAF) intensified efforts to interdict the routes toward the Alpine passes. Other communications were cut and when the final Allied offensive jumped off in April, XXII TAC and DAF greatly aided the breakthrough by a tremendous effort against German positions. So thoroughly had communications been disrupted, especially at the Po, that there was no chance of an orderly retreat to a new line and the total surrender came on 2 May, just a year after the beginning of the punch through the Gustav Line.

The Fifteenth had meanwhile been engaged in strategic operations (which will be described presently) and, with the Balkan Air Force, in supporting the Russian advance which drove the Axis powers from Rumania, Bulgaria, Greece, Yugoslavia, and part of Hungary. Bombing airdromes, supply centers, and rail targets, MAAF forces encountered the usual difficulties in cooperating with an ally who would not allow any real system of liaison to be established or any rationally determined bomb line.

The subtitle of the present volume suggests that it begins with January 1944. Actually the narrative reviews briefly the strategic air operations of the last two months of 1943. The Eighth Air Force had begun its attack against the German war machine on 17 August 1942.

Dedicated to the principle of high-altitude daylight precision bombardment the Eighth had with difficulty resisted outside pressure to change its tactics, and diversion of forces to North Africa and of effort to unprofitable attacks on U-boat pens had interfered with its primary mission. The Casablanca Directive of 21 January 1943 had insured the continuation of strategic bombardment in the Combined Bomber Offensive and with growing forces the Eighth had increased the weight and effectiveness of its attacks during spring and summer 1943.

In spite of the fine defensive qualities shown by B-17's and B-24's flying in large formations, the GAF had on occasion taken heavy toll of the U.S. bombers and as German fighter strength in the west increased it had become apparent that an all-out attack on Nazi air power would be a necessary preliminary to any successful strategic bombardment campaign and to the great invasion of Europe planned for the spring of 1944. During the autumn of 1943 weather prevented any such attack and, as the opening chapter shows, the Eighth turned instead to an experiment with radar bombing. Hopes based on initial success were not borne out by later missions; here as in most cases involving use of intricate instruments the majority of crews never succeeded in getting maximum results from their equipment. The only justification was the assumption that blind bombing was better than no bombing and it is hard to avoid the conclusion that the "numbers racket"—pressure from Washington to get more planes over Europe—was responsible for some wasted effort. A more fruitful experiment of the period was concerned with the development of long-range fighter escorts. The failure to produce such a plane had been one of the AAF's most serious mistakes and now under pressure of necessity engineers in the ETO and the United States combined to improve and enlarge auxiliary tanks which gave seven-league boots to conventional fighters—the P-38, P-47, and especially the P-51. To Goering's discomfiture these fighters eventually went to Berlin and beyond and mixed it with German interceptors on better than even terms, but it was months before there were enough of them to provide adequate protection.

By the beginning of 1944 the Eighth Air Force in England and the Fifteenth in Italy were approaching planned strength. An inter-theater headquarters, Gen. Carl Spaatz's U.S. Strategic Air Forces in Europe, enhanced the flexibility inherent in the widely based heavy bombers with their threat of coordinated blows. In November 1943 Eighth Air

Force had drafted a plan (ARGUMENT) for a series of closely spaced attacks against about a dozen factories producing fighter components or fighters—Me-109's and -110's, Ju-88's and -188's, and FW-190's. The program would need a succession of half-a-dozen clear days and at last, on 19 February, such a period was predicted. USSTAF laid on the first missions next day and in less than a week had dispatched more than 3,300 sorties from the Eighth, 500 from the Fifteenth. Bombing varied from excellent to fair but the over-all results were certainly great and perhaps decisive. It is difficult even now to judge exactly "how big was the Big Week." German fighter production was to increase rather than decrease during 1944 but the significant point is that production did not keep up with the planned schedule and for that failure the Big Week and subsequent bomber attacks were largely responsible.

In last analysis the pragmatic test is perhaps the best: never after February was the Luftwaffe to be the menace it had been; though it would inflict heavy losses at times Goering's force had lost control of the skies over Europe. In this victory over the GAF other factors besides the bombing of aircraft plants must be considered: attacks on airfields and losses inflicted in battle. Here tactical air forces and the heavies' "little brothers," the fighter escorts, played their part, as did the RAF. The Big Week cost USSTAF 226 heavy bombers and 28 fighters destroyed but the Luftwaffe suffered even more heavily and was to continue to suffer whenever challenging a well-escorted bomber formation.

ARGUMENT was considered by the AAF as a prerequisite for the systematic destruction of carefully determined segments of the Nazi war economy, but the heavies were not allowed to turn immediately to that program. The main weight of their efforts during the early spring was expended on nonstrategic objectives in attacks against V-weapon installations and in strikes preparatory to the invasion. It had long been agreed that the strategic arm should be used in support of the landings until the beachhead was secured and thereafter as needed by the armies, and with this there was no argument in USSTAF. But there was long debate over the best possible use of the heavies, Spaatz favoring an all-out attack on the oil industry but losing to those who preferred an extensive campaign against communications. The subordination of strategic forces to the invasion involved no command difficulties, however, when in March Eisenhower as su-

## FOREWORD

preme commander took over USSTAF along with RAF Bomber Command and Allied Expeditionary Air Forces. Spaatz and many of his senior officers had served under Eisenhower in the Mediterranean and the formal chain of command was strengthened by the great mutual understanding and respect that existed between SHAEF and USSTAF.

Tactical demands on the heavies continued after D-day, with a lasting responsibility for attacks on airdromes and for carpet bombing for the ground forces; but late in June USSTAF was able to devote more attention to strategic targets. The oil campaign had begun earlier, in a small way: in April for the Fifteenth, in May for the Eighth. Now to Spaatz's satisfaction this target system assumed first priority as the Eighth joined the RAF in assaults on synthetic plants in Germany. The Fifteenth continued to return to Ploesti and to installations in Hungary, Austria, and eastern Germany with such pertinacity that when the Russians overran Rumania the Ploesti refineries were idle and ruined.

The success of the oil campaign could be gauged immediately by shortages of fuel which were discernible in German operations and as well by the desperate efforts made to minimize the effectiveness of the attacks. Passive defenses were used extensively, and AA guns were clustered around oil centers so heavily that for the Eighth Air Force flak became a more dangerous weapon than the fighter, and bomber formations were opened up to reduce losses from ground fire. Fighters still offered rugged resistance on occasion and the Fifteenth especially suffered from their interceptions so that it was necessary to renew attacks on factories producing conventional aircraft as well as jet planes, not yet in combat but a threat greatly feared by Allied airmen. The forces sent out during the summer were huge and the tempo of operations fast. The telling pace created problems of morale among overworked aircrews; there were charges that some crews deliberately sought refuge in neutral countries—Switzerland and Sweden—but careful investigation showed these charges groundless.

The summer of 1944 witnessed an experiment in cooperation with the Russians that was more enlightening than fruitful, an effort to utilize airdromes in Soviet-held territory as alternate bases for heavies from England or Italy. The concept of shuttle bombing, well liked by the AAF, was in this case particularly attractive to Arnold and other air commanders who hoped thus to lay under heavy attack industrial

plants in eastern Germany, to foster closer relations with the Soviets, and to impress them with the importance of strategic bombardment so that they might furnish bases in Siberia for B-29 attacks against Japan. Stalin gave full verbal consent to the project but subordinate officials moved slowly and it taxed American patience to prepare three airfields for heavy bomber use. A number of missions were staged from these fields, some with fair success but none of great significance. Certainly none was as brilliant an operation as the German night attack on the airdrome at Poltava which caught the B-17's on the ground, destroying forty-three and damaging twenty-six. Russian interest, never very warm, cooled perceptibly. The Soviet command limited unreasonably (or so the AAF thought) the choice of targets and the venture fizzled out in an argument over whether heavies from the Russia bases should be allowed to supply the forces of Gen. Bór-Komorowski, beleaguered in Warsaw. Altogether the experiment was of little importance tactically and early estimates that it had fostered better relations between the two allies were overly optimistic. Americans did learn something of the Russian's genius for obstruction and one may wonder if the code name for the project, FRANTIC, was chosen with some foreknowledge of the frayed nerves which would be characteristic of men imbued with Arnold's hurry-up pace when faced with the Russian slowdown. Other relations between the AAF and the Soviets, particularly in regard to U.S. efforts to get agreement on a bomb line, were equally frustrating.

In September control of the strategic forces reverted to the CCS, not without opposition from Eisenhower and most of the air leaders, who had suffered little in the way of interference from SHAEF. Insofar as USSTAF was concerned, the change in command structure made little practical difference; the U.S. heavies continued to render support to the ground forces on occasion but were able to devote an increasing share of their missions to strategic targets. By the end of September hopes of an immediate invasion of the Reich and of an early collapse of the Nazi government had faded; the Allied armies had outrun their supply lines and as they regrouped and set up a more stable logistical system it was the strategic air forces alone which carried the war to the German homeland. With unprecedented power available various plans were discussed for concentrated attacks on German population areas that might crush the will to resist. Usually Arnold, Spaatz, and other top commanders in the AAF opposed these plans as

contrary to their doctrines of precision bombing; the record is clear enough on their often-reiterated objection to terror or morale bombing. Their concern with public opinion in America and in Germany and with what "history" would say contrasts strikingly with the non-chalance with which area bombing was introduced in Japan, and it is interesting to speculate as to whether the practice in the Pacific war was responsible for the change in policy for Germany during the months just before V-E Day.

The directive under which USSTAF opened its autumn campaign put oil in first priority. Heavy fighting during summer had depleted German fuel reserves and the damage to refineries had brought production to a low ebb by September; but Germany was making the most of its great recuperative powers and throughout the autumn (especially in November) the Eighth and Fifteenth and RAF's Bomber Command continued to hammer steadily and heavily at refineries with an over-all success which was not fully appreciated at the time. In second category came ordnance, armored vehicles, and motor transport in an effort to blast those factories which would equip the new people's army. This target system was scratched as unprofitable after a brief trial; post-war investigations suggest that further attention to the munition plants might have paid big dividends. As the armies prepared for a late autumn offensive the heavies, along with the tactical air commands, were thrown against the German railroad system, not without some misgivings on the part of USSTAF, where it was feared that the system was too complex and flexible to be destroyed. Efforts at the time could not cut off shipments of military goods but they did minimize civilian traffic and this was the beginning of the internal collapse of the Nazi economy.

USSTAF during the autumn returned to attack aircraft factories and, more often than was customary with heavies, airfields. Some of this effort was against jet plants and fields, but conventional single-engine fighters had again become a threat as the Germans concentrated on production of Me-109's and FW-190's and shifted more of their units from the eastern front to the Reich. They had plenty of fighters (and Allied estimates were surprisingly accurate) but had lost many of their skilled pilots. There was not enough fuel for an adequate training program or for intercepting each bomber formation but occasionally the Luftwaffe would put up a nasty fight.

When the counterattack in the Ardennes came in December strate-

gic forces were thrown into the battle. The ability of the Nazis to mount so formidable an attack brought on a great deal of soul-searching among air leaders and with them, as with ground commanders, there was a swing from the overconfidence of early fall to an unwarranted pessimism. Actually, the Ardennes offensive had drained the Nazi machine dry and misgivings about the success of the strategic bomber programs against oil, transportation, and armaments were not justified by conditions in the Reich. A new directive for the bomber campaign issued on 12 January listed oil, railroads, tank factories, counter-air strikes, support of ground forces, and yards producing new-type submarines in that order of priority. Technically support of ground forces might take precedence over other objectives and during January accounted for three-fourths of USSTAF missions, but much of that effort was expended against rail communications. In the west rail objectives were more limited in area and more concentrated than in previous efforts to knock out the whole German network. In the southeast the Fifteenth aided the advance of Russian armies by striking transportation centers in Yugoslavia, Hungary, and Austria while continuing its homework for the Allies in Italy. As in the oil campaign, this air force, overshadowed in publicity by the older and larger Eighth, conducted its missions with skill and persistence.

England-based bombers also aided the Russian armies by a series of great strikes against German cities where rail yards were gorged with trains carrying troops to the front and evacuating refugees from the east. Berlin, Leipzig, Dresden, and other cities were hit by mighty formations in attacks which, especially in the case of Dresden, drew the sort of criticism which the AAF had long feared. By this time, however, USSTAF even experimented briefly with the idea of sending out radar-controlled war-weary B-17's filled with explosives. With 80 per cent of the very heavy bomb tonnage in February dropped by radar, precision bombing was no longer the shibboleth it had once been and the accidental bombing of Schaffhausen in Switzerland was a symbol of the fury of the air war in the desperate effort to knock out Germany. The CLARION operation of 22 February, in preparation for a great ground offensive, was a moderately successful variation of the sort of wide-ranging attack, advocated during the previous autumn, which would bring the war home to towns and villages previously undisturbed.

In March, with the ground armies making progress on all fronts,



the heavies were able to return to strategic targets though they participated in the successful attempt to isolate the Ruhr which began on 21 March. Strategic targets became less numerous as one industrial organization after another was scratched from the list. On 16 April, with few profitable targets left, the bomber offensive was officially declared finished though several missions were dispatched thereafter. For it there was no dramatic finish marked by a surrender or an armistice but of its success the gutted shell of German industry was a grim reminder.

Meanwhile the advance of the Allied armies from the English Channel to the Elbe had been made possible by the operations of the tactical air forces, operations of such magnitude and variety that in their context one reads with some perplexity post-war charges that the AAF was dominated wholly by its concept of strategic bombardment. Planning for the OVERLORD invasion had been begun by a combined Anglo-American team early in 1943 and had continued at an accelerating pace in 1944. The detailed plan with its annexes is a complex document of extraordinary interest—and in passing one may hope that in time security regulations will permit the publication in full of this or some similar plan for the edification of the public; the science of war is to be seen in its most impressive form in such an attempt to predict and organize requisite forces.

The command arrangement provided, as has been shown above, that both strategic and tactical forces should come under Eisenhower's control in advance of the invasion. Tactical forces, British and American alike, were united under AEF with Air Marshal Leigh-Mallory in command. This headquarters was an unfortunate exception to the rule of harmonious command relations in combined Anglo-American organizations. A reviewer of an earlier volume objected mildly to the tendency of our authors to go into detail in discussing command relations and the personalities which made for their success or failure. Here one may suggest, without belaboring the point, that the personality of Leigh-Mallory and the reaction of American airmen to his control of their combat units were factors of more than passing interest.

It had been planned originally that AAF tactical units would operate as part of an expanded Eighth Air Force, but the final decision was to establish a separate tactical force. Its numerical designation, its commander (Brereton), and the nucleus of its staff were taken from

the old Ninth Air Force of the desert war. A few medium bomber groups were drawn from VIII Air Support Command but almost all of its combat units came fresh from the States during the months immediately preceding OVERLORD, a fact which determined in large measure the nature of its extensive training program and of its early operations. The Ninth's internal structure, highly complex, was arranged along functional lines with an emphasis on flexibility and mobility. Its numerous combat units were to be grouped into the tactical air commands (IX, XIX, XXIX TAC's), each of which was to be attached to an army on the continent, but with the understanding that units would be shifted from one to the other as needed.

Pre-invasion operations consisted of attacks on coastal defenses, against airdromes, against communications, and against V-weapon sites. So thorough were these preparations and so skilful was the planning that D-day, for all its tremendous air effort, went off with relative smoothness. An airborne operation of unprecedented magnitude preceded the touchdown of seaborne troops and, with losses that were heavy enough but well under expectations, contributed notably to the success of the landings. Fighters assigned to cover the amphibious assault found little to do, for the Luftwaffe made no serious effort to attack the war's greatest invasion fleet. This lethargy on the part of the GAF was in itself proof of the success of attacks on aircraft factories, airdromes, and on planes in flight and it justified the great resources thrown into the air war. The one air operation on D-day that proved unsuccessful was the bombardment of defense positions on OMAHA beach by Eighth Air Force heavies, an attack laid on at the insistence of ground commanders and against the better judgment of AAF leaders.

In the struggle to consolidate the beachhead and secure the whole of the Cotentin, Ninth Air Force furnished close support first with planes flying out of England, then by the roulement method from hastily prepared strips near the front, and finally from bases set up in Normandy as unit after unit moved across the Channel. At the instigation of the ground commanders, the AAF put on a big show calculated to facilitate the capture of the key port of Cherbourg. The hastily conceived operation was not a model of planning or of air-ground cooperation and though it eased somewhat the capture of Cherbourg the attack, like most of the saturation bombings of strongly defended enemy positions, was only moderately successful. Air's most impor-

tant contribution was the isolation of the battlefield and here, following accepted doctrines, the AAF was spectacularly successful. Mediums and fighter-bombers cut every rail bridge over the Seine between Paris and Rouen and, when deception was no longer paramount, they scored heavily on crossings over the Loire; marshalling yards and rail lines in a wide area were smashed. The difficulty of moving up German reinforcements and the decisive effect the delays had on the battle for Normandy were attested by practically every enemy general interviewed after the war.

To aid in the breakout from the Cotentin the air forces put on COBRA, a stupendous carpet-bombing attack. Again the gains scored, though not negligible, hardly justified the effort expended and the day was saddened by heavy casualties among friendly troops through errors in bombing. Far more significant in the long run was the development of a most intimate type of air-ground cooperation in the airplane-tank team. Involving a generous exchange of liaison officers between the two arms and efficient VHF communication between fighter-bombers and tanks, the system gave to armor a new mobility which was in large part responsible for Patton's breakout and rapid career across France.

Meanwhile the interdiction program continued, but with a new set of targets chosen with a view toward a more open type of warfare. While Allied armies pushed ahead steadily, bombers continued to slug at harbor defenses, rarely with unequivocal success. Heavily built fortresses, some of ancient vintage, absorbed all that the heavies and fighter-bombers could throw at them and the grim tenacity of the garrisons paid off abundantly by depriving the Allies of harbors badly needed to nourish the battle for France. The success of the German holding action here (like that of the Japanese in some of their cave-pitted Pacific islands) was in flat contradiction to much stuff that has been written decrying the "Maginot complex"; heavy fortifications may win no war but ruggedly defended they were of great strategic value against the most formidable air and artillery weapons.

By mid-September France had been liberated, most of Belgium and Luxembourg, and part of Holland. Momentary hopes for a rapid push into the Reich began to fade as the armies ground to a halt for lack of supplies. The stormy weather of June that had curtailed the use of artificial harbors, the failure to seize or to seize intact the regular ports, damage done to the French transportation system, and the very rapidity of the advance once the Allies had shaken their columns out of

## THE ARMY AIR FORCES IN WORLD WAR II

Normandy—these factors played hob with logistical phasing and it was necessary to pause until an adequate supply system could be built up. Air had helped defer that pause by hauling fuel and other supplies to columns racing across France. Heavy bombers as well as transports had turned to this emergency trucking business for which small provision had been made. More might have been done had there been preliminary planning and had it not been necessary to hold troop carrier units on stand-by alert against expected calls for airborne operations; but since it is useful to know the limitations as well as the potentialities of air power, it should be pointed out here that with available equipment ground operations on the scale of the Battle of France could not have been supported by air transport alone.

While ground and air forces were regrouping at the threshold of Germany, the long debate over future strategy was decided against the advocates of a single drive into the Reich and in favor of the two-pronged attack, north of the Ardennes and in the southeast, but with pressure along the whole front and with the heaviest support going to Montgomery's 21 Army Group at the extreme left of the Allied lines. That decision had been determined in advance by terrain, proximity to England's airfields, the need to get Antwerp or Rotterdam as a port of entry, and the desire to overrun V-weapon sites within range of England. As an opening round in the battle to break into the north German plain the Allies began Operation MARKET-GARDEN on 17 September. The immediate objective was the territory between Arnhem and the Zuider Zee, possession of which would allow the British Second Army to cross the Ijssel and flank the Siegfried Line. The airborne phase was the largest yet executed, with the whole of Brereton's First Allied Airborne Army being dropped or landed in the Eindhoven-Arnhem-Nijmegen area during a period of three days. Although the long-drawn-out landing operation was executed by day, losses were slight; fighters from Eighth Air Force and ADGB completely throttled the Luftwaffe and heavy attacks on AA positions by RAF Bomber Command helped keep down losses from flak. Weather, originally favorable, delayed air landings subsequent to D-day and the resupply of troops and although the airborne units seized a number of key water crossings—their most important objectives—the ground troops were slow in effecting a junction with them. German defense proved more stubborn than had been expected and the Allies had to

## FOREWORD

withdraw from some of their positions, while holding a few important bridgeheads.

With this failure to get across the Rhine in September the Allied armies lost all chance of ending the war before the Germans could rally from the disastrous effects of the summer campaigns. Though some hope of an early victory persisted, it required several weeks to clear the water approaches to Antwerp; and progress on other fronts served chiefly to bring American armies into position for an all-out Allied offensive scheduled for December.

That month saw instead Hitler's last desperate bid in the Ardennes. The Fuehrer's plan and his aims, as fully as they can be reconstructed, are well enough known to most readers of military history. Familiar too is the general attitude of overconfidence among the Allies that made it possible for von Rundstedt to score one of the war's most important surprises. In retrospect it is difficult to understand why the Allies were so completely fooled. There was available much incidental intelligence, some from ground reconnaissance, more from air. Bad weather between 17 November and 16 December helped cloak the extensive preparations of the Nazis but the frequent sorties of tac/rece groups and visual sightings by fighter-bombers on armed reconnaissance brought in countless bits of detailed information on troop movements, build-up of supplies, and, an especially grim portent, of concentrations of ambulances and hospital trains. Air passed this raw material of intelligence along and its interpretation (save in the case of information on the GAF) was the ultimate responsibility of G-2. Air intelligence was not blameless, however. Here, as in the Kiska fiasco of August 1943,\* the AAF was at fault in not stressing more incisively the significance of the data provided by its planes and the failure suggests that there was a shadowy "twilight zone" between air and ground headquarters which proved disastrous. Even after the breakthrough it was difficult to pin down responsibilities. Arnold, ever sensitive to criticism of the AAF, attempted to get a critique from Spaatz but the latter's reply was noncommittal, perhaps in loyalty to Eisenhower since the major fault could not be blamed on USSTAF.

During the initial breakthrough and the fluid battle which followed, weather was a staunch ally of the Germans. Only the stubborn resistance of ground units blunted the enemy's drive and held him to

\* See Vol. IV, 391-92.

gains which though substantial were less than anticipated; the time thus gained allowed Eisenhower to rearrange his commands and to develop a strategy for containing, then pushing back, the German armies. The GAF, momentarily resurgent, came to the support of its own troops in greater strength than it had shown in months. In the Allied counter-air strikes which followed the versatile fighter-bomber again proved its worth and night fighters worked overtime. Here, as was so often true in the Pacific, the AAF showed a quantitative weakness in the latter category, perhaps to be accounted for by dominant offensive doctrines and a preference for daylight operations. Within a few days the GAF had shot its bolt and as von Rundstedt's armies approached the Meuse the weather turned. Five wonderfully clear days (23-27 December) followed during which Allied planes of every type hammered incessantly at enemy airdromes and at communications at the front and the rear. Before the clouds shut in again this interdiction program had already hurt the mobility of the German columns. Air had also rendered close support over difficult terrain, had flown numerous armed reces, and had dropped supplies to the beleaguered forces at Bastogne. By the end of the year the Germans had given up the idea of reaching the Meuse; the surprise attack delivered by the Luftwaffe against Allied airdromes on New Year's Day was a futile gesture by a defeated air force.

During January, as the Allies slowly pinched off the Ardennes salient, weather was generally bad with a dozen days in which not even fighter-bombers could get up. On flyable days, however, Allied air put tremendous forces over the battle and the eastern approaches thereto with notable effect. With the enemy in full retreat planes took over a function not unlike that of cavalry in earlier wars, harrying the withdrawing columns by hitting bridges, road junctions, road blocks, and fortified positions, and beating up traffic congestions. Von Rundstedt's opinion accorded to air a highly significant share in his defeat.

By mid-January, with the Bulge no longer a menace, SHAEF was planning its own offensive with Devers and Bradley erasing German holdings west of the Rhine and Montgomery making the big push across the north German plain. Air operations in each sector followed the by now familiar pattern of interdiction and close support, but on a scale never equaled in war before. Beginning with the lucky seizure of the bridge at Remagen on 7 March, the Allies crossed the Rhine

## FOREWORD

in a number of places with aid of a huge lift of the First Allied Airborne Army near Wesel (VARSITY) that showed great improvement over the September jump at Arnhem.

Thereafter the drive across Germany went at a fast clip which at times outran the short-ranged tactical planes whose bases could not be moved up in time to permit fighter-bombers to spearhead the attack. The Luftwaffe too suffered for want of bases as the ground armies swept over their ruined fields, and though there was an occasional flurry of activity by German fighters their efforts were feeble enough. As the armies moved into assigned positions to await junction with the Russians the tactical forces turned for a while against munitions factories that might arm a new people's army and to the task of isolating the so-called National Redoubt in Bavaria. But the real tactical job had been done, and with distinction, when the armies reached the Elbe.

Four scattered chapters in the volume deal with miscellaneous activities which for want of a better designation have been called "supporting operations." One deals with logistical support of the Ninth Air Force before and after D-day. Machinery for support of U.S. strategic air forces had been in operation in England since 1942 and in Italy had been developed for the Fifteenth in the winter of 1943-44. Because those air forces continued to fly from semipermanent installations their stepped-up operations of 1944-45 required little more than an extension and improvement of existing facilities. For the Ninth, however, a new type of warfare opened with the OVERLORD invasion, a war of movement with shifts more rapid, if of less distance, than those in the Pacific; if terrain and transportation were more favorable for the constant shift from airfield to airfield than in the Pacific, the formidable size of the Ninth Air Force created special problems. It has become the fashion of late years for the civilian historian to pay tribute to the importance of logistics, perhaps at times, in healthy reaction against the blood-and-trumpet writers of an earlier day, to the neglect of the combat operations for which supply systems are created. The editors, not wholly unpartisan readers, have felt that this chapter has achieved a nice balance with the combat narrative in describing the move to the continent and the successive advances from OMAHA and UTAH beaches to the borders of the Reich and on to the Elbe. The story includes the work of the aviation engineers who built the airfields and other installations, and the arrangements for supply and maintenance of the huge tactical forces. These activities, if

less than perfect in every detail, showed boldness in design, skill in execution, and something of the American genius for large-scale organization.

On a smaller scale and along lines less familiar to the AAF were operations in support of underground resistance forces on the continent. These activities were shrouded in an aura of mystery which heightens their drama but which tended to minimize during the war recognition due those crews who flew the difficult and hazardous missions. In these operations the AAF acted only as a common carrier, delivering parcels and passengers at the behest of Special Force Headquarters, a coordinating agency of which the U.S. members were drawn from OSS.

The earliest task of this sort (and a continuing one) was the dropping of propaganda leaflets. Originally performed by tactical units as an additional duty, the job of "nickeling" was taken over by special squadrons on a separate basis, with equipment and tactics peculiarly adapted to their mission and with an argot of their own that enriched the English language with a number of apt expressions. Even after the establishment of these squadrons tactical units were levied upon for large operations, as in the case of the 3d Bombardment Division which spent much of the summer of 1944 in special operations. These included dropping or landing supplies for resistance forces, infiltrating agents, and evacuating agents, Partisans, casualties, American airmen, and occasionally noncombatants.

As France was liberated the foci of "carpetbagger" activities in western Europe shifted north, to the Low Countries, Denmark, Norway, Poland, and even Germany. In Italy the Partisans were less well organized than in France and operations in the peninsula were not on a large scale until autumn of 1944, though a fantastic murder case recently made public has indicated something of the importance of the supplies dropped in the battle for northern Italy. In the Balkans operations were fairly heavy and relatively very significant in encouraging resistance movements in Greece, Albania, and Yugoslavia. Aid to Tito's forces was particularly important; it included as well as the usual operations three mass evacuations. That of June 1944, done at Tito's request, rescued him and his staff from an almost certain threat of capture by the Germans. The story, in light of present conditions, is not without its sardonic humor: the Americans did most of the heavy work while the Russians carried Tito and his top brass. But that was 1944, not 1951.



Nazi boasts of a secret weapon were common enough to become a standard joke among the Allies. During 1944 the Germans did produce such weapons, which with better luck might have saved them from defeat. Allied airmen were justified in their apprehensions about jet fighters, which but for Hitler's bad judgment might well have won for the Germans control of the skies over Europe. In another case the Fuehrer's intuition helped the cause of the Allies, when he delayed development of the guided missiles known usually as the V-1 and V-2. The former was a pilotless jet aircraft with an explosive warhead, cheap to produce and within its limits an efficient and effective weapon. The latter, a supersonic rocket of frightening potentialities, was more difficult to perfect, and the Germans lost valuable time through rivalries within the Nazi hierarchy.

British intelligence became acquainted, though imperfectly, with the V-weapon threat in the spring of 1943 and by autumn was thoroughly alarmed; because of a lack of complete exchange of information with the Americans—a most unusual and regrettable exception to the usual rule—the Allies were slow in developing a policy for defensive measures. The only immediate countermeasure seemed to consist of bombardment of V-weapon installations, particularly those diagnosed as launching sites. Various tactics were attempted with bombers of every type, but with results which did not seem decisive. American airmen objected to the diversion of heavy bombers from the strategic campaign for CROSSBOW strikes with as much fervor and as little success as they had in the case of the diversion to U-boat pens in 1942-43. In extensive experiments at Eglin Field the AAF perfected a technique of low-altitude attacks by fighter-bombers which seemed more economical and more effective than that involving use of B-17's and B-24's but this innovation was resisted by the British, particularly by Leigh-Mallory, and was never given a fair trial. And so the heavies and mediums bore the brunt of the bombing of V-weapon sites; by sheer weight these attacks delayed the German program by some several months, enough probably to explain the postponement of the V-weapon attack until after the OVERLORD invasion.

By D-day many responsible leaders had come to the conclusion that the whole threat was a hoax but on the night of 12/13 June the first V-1 hit in England and the rate of attack was soon adjudged dangerous. Even then the Anglo-American organization for defense was too loose for efficient action. Under general control of the Air Ministry, this staff held resolutely to an emphasis on bombing launching sites—

as opposed to bombing component factories, assembly lines, supply dumps, and transportation lines. CROSSBOW missions continued to infringe upon other operations, rarely upon tactical but frequently upon strategic. By the end of August the V-1 threat had abated but it was the capture of launching sites by ground forces rather than bombing which put an end to the peril.

The final phase was that of the V-2, which in the early autumn was launched against targets in England and on the continent, especially the strategic port of Antwerp. In defense of Great Britain against this danger the AAF took little part and again it was the advance of the armies which wiped out the V-weapon menace. Air power had failed to eradicate these unconventional air weapons but here again it was the airmen who first understood the limitations of their arm; and Spaatz may have been right in believing that given a free hand the AAF could have made a better showing.

In the final chapter, "Mission Accomplished," an attempt is made to evaluate the contributions of the Army Air Forces toward the victory in Europe. This was not an easy chapter to write. Records of our own air forces and of the GAF provide ample data for the operational story and, thanks to the indefatigable efforts of the United States Strategic Bombing Survey, there is a wealth of materials on the German industry under bombardment. The mute evidence of physical destruction is impersonal enough but much of the written record and all of the recorded interviews are colored by a personal or organizational bias. For a series of events as complex as was the war against Germany the historian, no matter how well informed and how dispassionate, will find it difficult to establish universally acceptable causal explanations and it is hardly likely that the interpretation contained herein will satisfy every reader. To the editors, at any rate, the judgments offered seem fair and sober, calling attention as they do to the mistakes of the AAF as well as to its very substantial accomplishments. Overenthusiastic claims advanced during the war are corrected but the author points out too the errors of those who, by citing out of context isolated statements from the USSBS, have used those authoritative critiques to belittle the cause of air power. Briefly, the thesis put forth in this volume is that air power did not win the war but that the Allies could not have gained the victory at all without the air ascendancy gained by the AAF and RAF and that the final victory was won more rapidly and at less cost because Anglo-American air

power was superior to the German in production, in strategy, in combat, and in related services. In the face of that general superiority individual errors in concept and failures in execution lose their importance save as they inform those who plan for other wars.

Practical considerations of publication made it convenient to bring out Volume IV of this series in advance of Volume III. This inversion of order has subjected the editors to some mild chaffing about absent-minded professors but since the fourth volume brought the story of the AAF's war against Japan down to July 1944 it makes possible some useful if preliminary comparisons between that struggle and the air war in Europe. From 1941 most top strategists in Washington believed that Germany was the most dangerous enemy and Europe the most important theater and that hence the preponderant effort should be made in that area until Hitler was defeated. This thesis was sharply challenged by commanders in the Pacific and by some in Washington but was upheld, save as naval forces were concerned, until V-E Day. The long debate during World War II is given fresh interest by current discussions of national policy in which, under different circumstances, a similar problem has emerged: how best to divide our not unlimited resources to confront aggression in Europe and in the Far East. Perhaps the differences outweigh the similarities in the situation as of 1941 and 1951 but no thinking American can afford to neglect such evidence as recent history affords.

Throughout World War II, AAF Headquarters strategists were staunchly in favor of the beat-Hitler-first thesis. Their appraisal of potential enemies and their strategy for the air war were incorporated in AWPD/1, a plan drawn up in September 1941. This remarkable document, classified as secret but published in a competent abstract by the Washington *Times-Herald*, the Chicago *Tribune*, and other papers on 4 December 1941, can be found in the *Congressional Record*, Vol. 87, Pt. 14, A5448-51. Read in connection with the present volume and especially with the appraisal contained in Chapter 22, AWPD/1 takes on a new significance. The strength and resourcefulness of Germany's armed forces, the skill of her scientists and technicians, and the resilience of her industry and transportation system—all these appear graphically in the story of the air war and to the editors seem to justify the most important decision of the war.

One matter of appraisal has involved much labor for the authors and some embarrassment for the editors—that is, the question of just

how heavy were the losses inflicted upon German fighters by U.S. planes, particularly heavy bombers. A more significant question is whether the GAF's offensive and defensive power was broken by Allied air forces and here an affirmative answer can be documented from the early spring of 1944 on. The defeat of the Luftwaffe was the work of the AAF and RAF and in terms of final results it matters little whether, to paraphrase a favorite saying of Arnold's, the German planes were destroyed in the factories, on the ground, or in the skies. But current assessment of enemy losses was a most important factor in operational planning during the war and for the historian the effort to evaluate those assessments constitutes a most interesting problem in source criticism.

The Eighth Air Force realized quite early that the claims by bomber crewmen of German fighters destroyed were too high. Efforts were made to tighten up on methods of reporting and evaluating claims and early records were repeatedly scaled down—for whatever may have been their attitude in regard to headlines for the public, operational officers in the desperate struggle wanted facts, not bloated claims. In spite of, or perhaps because of, these corrections authors in this series have treated official scores with reservation unless substantiated by other evidence.

When Volume II was going to press a new file of German records turned up which seemed to show AAF claims preposterously exaggerated, and with consent of the authors involved the editors called attention to this evidence and to results obtained when it was applied in a few test cases chosen at random. Unfortunately some reviewers emphasized this feature of the volume without noticing the tentative nature of conclusions based on new but fragmentary evidence. The editors were pleased that press notices critical of the AAF, though they came during the B-36 controversy when unfavorable publicity might have been mischievous, brought no recrimination from the U.S. Air Forces. Subsequent research in other enemy records in England and in Germany has modified sharply the impression created by a hasty use of the one file available in 1949. No firm answer can be given to the question of fighter losses on the basis of German files so far discovered—and in passing it is interesting to note that the official records of the "methodical" Germans are in respect to air force matters much less precise than our own and in some cases are quite obviously padded. But the historian who has done more research on

## FOREWORD

the problem than any other has calculated that the AAF shot down perhaps half as many GAF fighters as were claimed, a not unreasonable margin of error if one considers the conditions under which the original observations were made. And so, with new evidence available the editors have again accepted a new interpretation and, they hope, a more lasting one.

The tasks in Volume III have been spread more widely than in Volumes II and IV. Ten authors, whose current professional connections are indicated in the Table of Contents, have contributed to this volume; of these, three, Arthur B. Ferguson, Alfred Goldberg, and Albert F. Simpson, are already known to readers of the series and it is necessary only to introduce the newcomers. Joseph W. Angell served during the war as historical officer of the AAF Proving Ground Command and after the end of hostilities undertook at AAF Headquarters a special study of V-weapon operations. John E. Fagg, after service with the Far East Air Forces, turned his attention to strategic operations in Europe as a member of the staff of the AAF Historical Division. Robert T. Finney joined that staff after a lengthy tour of duty with the AAF in MTO. Robert H. George became historical officer of the Ninth Air Force shortly after its establishment in ETO in the fall of 1943. During the war Martin R. R. Goldman served on combat duty with a B-24 unit of the Eighth Air Force. David G. Rempel represented the AAF Historical Division at Air Staff, SHAEF. After service with the ground forces in MTO, Harris Warren was assigned to study special air operations in the AAF Historical Division.

Col. Wilfred J. Paul, Director of the U.S. Air Force Historical Division, and Dr. Albert F. Simpson, Air Force Historian, again have given editors and authors alike every assistance at their command. It is no mere formality to say that without the intelligent understanding with which this assistance has been rendered the completion of the volume would have been impossible. Of Colonel Paul's capable staff Mrs. Wilhelmine Burch, Sgt. James B. Donnelly, and Messrs. Ernest S. Gohn and Robert F. Gleckner are due special acknowledgment for the many blunders they have saved the editors through their careful review of both manuscript and proof. For whatever they may have overlooked the editors are happy to take full responsibility. The generous spirit which has characterized other members of the Historical Division has laid the editors under an obligation for so many and such

## THE ARMY AIR FORCES IN WORLD WAR II

varied services that it is possible only to list those to whom the indebtedness is heaviest: Col. Garth C. Cobb, Col. Byron K. Enyart, Lt. Col. Arthur J. Larsen, Lt. Col. Eldon W. Downs, Lt. Col. Ernest B. Stevenson, Maj. Thad S. Strange, Capt. George H. Satterfield, Capt. George H. Saylor, S/Sgt. John A. Hennessey, S/Sgt. Marjorie Z. Nicodemus, T/Sgt. John C. Rayburn, Jr., Sgt. Jerry L. Hawes, Sgt. Malcolm J. Gentgen, Mrs. Juliette A. Hennessey, Miss Marguerite K. Kennedy, Dr. Edith C. Rodgers, Mr. Frank Myers, Mrs. Lucille Sexton, Mrs. Lola Lowe, Miss Sara Venable, Miss Ruth McKinnon, and Mr. David Schoen.

Once more Mr. John C. Nerney of the Air Historical Branch of the British Air Ministry has responded to appeals for help in a spirit which faithfully reflects the close partnership in which the RAF and the AAF fought the war. With equal generosity and helpfulness Mr. L. A. Jackets and other members of the same organization have lent to us their special knowledge of pertinent records.

No less friendly has been the response to requests for aid by numerous AAF officers who during the war bore a heavy responsibility for the operations here recorded. Their names appear repeatedly in the footnotes, and it is hoped that these citations may serve as sufficient acknowledgment by authors and editors of a heavy debt. If any one of them should be singled out for special mention, it is Lt. Gen. Ira C. Eaker, now retired, whose consistent support of historical officers under his command was supplemented by a decision at the close of the war to turn over to the Historical Division his own personal files. The editors like to think, not without reason, that his action represents the willingness of air officers to stand on the record.

WESLEY FRANK CRAVEN  
JAMES LEA CATE

CHICAGO, ILLINOIS  
12 October 1951

# CONTENTS

\* \* \* \* \*

## I. FROM POINTBLANK TO OVERLORD

ARTHUR B. FERGUSON, *Duke University*

JOHN E. FAGG, *New York University*

JOSEPH W. ANGELL, *Pomona College*

ALFRED GOLDBERG, *USAF Historical Division*

1. WINTER BOMBING . . . . .	3
ARTHUR B. FERGUSON	
2. BIG WEEK . . . . .	30
ARTHUR B. FERGUSON	
3. PLAN FOR OVERLORD . . . . .	67
JOHN E. FAGG	
4. CROSSBOW . . . . .	84
JOSEPH W. ANGELL	
5. THE NINTH AIR FORCE . . . . .	107
ALFRED GOLDBERG	
6. PRE-INVASION OPERATIONS . . . . .	138
JOHN E. FAGG	

## II. INVASION OF WESTERN EUROPE

ROBERT H. GEORGE, *Brown University*

JOHN E. FAGG, *New York University*

7. NORMANDY . . . . .	185
ROBERT H. GEORGE	
8. THE BATTLE OF FRANCE . . . . .	228
ROBERT H. GEORGE	

THE ARMY AIR FORCES IN WORLD WAR II

9. THE STRATEGIC BOMBER STRIKES AHEAD . . . . . 278  
JOHN E. FAGG

III. ITALY

ALBERT F. SIMPSON, *USAF Historical Division*  
ROBERT T. FINNEY, *USAF Historical Division*

10. ANZIO . . . . . 325  
ALBERT F. SIMPSON

11. ROME . . . . . 371  
ALBERT F. SIMPSON

12. INVASION OF SOUTHERN FRANCE . . . . . 408  
ALBERT F. SIMPSON

13. BATTLE OF NORTHERN ITALY . . . . . 439  
ROBERT T. FINNEY  
ALBERT F. SIMPSON

IV. SUPPORTING OPERATIONS

HARRIS WARREN, *University of Mississippi*  
JOSEPH W. ANGELL, *Pomona College*  
ALFRED GOLDBERG, *USAF Historical Division*

14. AIR SUPPORT FOR THE UNDERGROUND . . . . . 493  
HARRIS WARREN

15. CROSSBOW—SECOND PHASE . . . . . 525  
JOSEPH W. ANGELL

16. LOGISTICAL MOBILITY . . . . . 547  
ALFRED GOLDBERG

V. THE GERMAN FRONTIER

DAVID G. REMPEL, *San Mateo Junior College*  
JOHN E. FAGG, *New York University*



CONTENTS

17. CHECK AT THE RHINE . . . . . 595  
    DAVID G. REMPEL

18. AUTUMN ASSAULT ON GERMANY . . . . . 636  
    JOHN E. FAGG

19. BATTLE OF THE BULGE . . . . . 672  
    DAVID G. REMPEL

VI. GERMANY

    JOHN E. FAGG, *New York University*  
    DAVID G. REMPEL, *San Mateo Junior College*  
    MARTIN R. R. GOLDMAN, *USAF Historical Division*

20. THE CLIMAX OF STRATEGIC OPERATIONS . . . . . 715  
    JOHN E. FAGG

21. FROM THE RHINE TO THE ELBE . . . . . 756  
    DAVID G. REMPEL  
    MARTIN R. R. GOLDMAN

22. MISSION ACCOMPLISHED . . . . . 783  
    JOHN E. FAGG

NOTES . . . . . 811

GLOSSARY . . . . . 913

INDEX . . . . . 917



# LIST OF MAPS AND CHARTS

\* \* \* \* \*

MAIN OBJECTIVES OF "BIG WEEK" OPERATIONS . . . . .	34
THE CROSSBOW NETWORK, JANUARY 1944 . . . . .	94
ORGANIZATION OF THE NINTH AIR FORCE, 6 JUNE 1944 . . . . .	111
TACTICAL DISPOSITION NINTH AIR FORCE, 6 JUNE 1944 . . . . .	120
AIRBORNE OPERATION NEPTUNE, 5-6 JUNE 1944 . . . . .	187
D-DAY AIR DISPOSITIONS AND PRINCIPAL TARGETS ASSIGNED IN THE ASSAULT AREA . . . . .	191
THE BATTLE AREA, JUNE-SEPTEMBER 1944 . . . . .	229
INTERDICTION, MAY-AUGUST 1944 . . . . .	259
PRINCIPAL OIL TARGETS BOMBED BY THE STRATEGIC AIR FORCES TWELFTH AIR FORCE, 29 JANUARY 1944 . . . . .	282
ALLIED STRATEGY IN ITALY, JANUARY 1944 . . . . .	334
THE ANZIO LANDING AND THE INITIAL EXPANSION OF THE BEACH- HEAD . . . . .	347
CENTRAL ITALY PRINCIPAL RAIL LINES AND ROADS . . . . .	375
FIFTEENTH AIR FORCE, 15 JUNE 1944 . . . . .	398
PRINCIPAL RAIL LINES, SOUTHERN FRANCE . . . . .	422
TWELFTH AIR FORCE, 31 AUGUST 1944 . . . . .	444
PRINCIPAL RAIL LINES, NORTHERN ITALY . . . . .	457
MAAF, 1 NOVEMBER 1944 . . . . .	465
BALKAN AREA SERVED BY AAF SPECIAL OPERATIONS . . . . .	508
STATUS OF U.S. AIRFIELDS IN WESTERN EUROPE, 8 MAY 1945 . . . . .	564
HEADQUARTERS IX AIR FORCE SERVICE COMMAND . . . . .	576

THE ARMY AIR FORCES IN WORLD WAR II

NAVIGATION DIAGRAM FOR OPERATION MARKET . . . . .	603
OPERATIONS IN HOLLAND, 17 SEPTEMBER-3 DECEMBER 1944 . . . . .	605
OPERATION MADISON . . . . .	625
SIXTH ARMY GROUP OPERATIONS, 5 NOVEMBER-16 DECEMBER 1944 . . . . .	630
RAILWAYS IN GERMANY BOMBED BY ALLIED AIR FORCES . . . . .	651
GERMAN PREPARATION FOR THE ARDENNES COUNTEROFFENSIVE . . . . .	674
BATTLE OF THE BULGE . . . . .	684
INTERDICTION OPERATIONS, 23 DECEMBER 1944 TO 31 JANUARY 1945 . . . . .	691

# LIST OF ILLUSTRATIONS

\* \* \* \* \*

	FACING
OVER BERLIN: RADAR BOMBING THROUGH 7/10 CLOUD . . . . .	40
LITTLE BROTHERS: P-38, P-51, P-47 . . . . .	40
BIG WEEK: REGENSBURG-PRÜFENING . . . . .	40
BIG WEEK: REGENSBURG-OBERTRAUBLING . . . . .	40
V-1 . . . . .	104
LAUNCHING V-2 . . . . .	104
V-WEAPON SITE IN NORMANDY . . . . .	104
BEFORE D-DAY: LOW-LEVEL RECONNAISSANCE OF BEACH DE- FENSES . . . . .	104
NORMANDY BEACHHEAD UNDER P-38 COVER . . . . .	104
ISOLATING THE BATTLEFIELD . . . . .	200
Normandy Rail Cuts	
Loire Bridge at Saumur	
NINTH AIR FORCE COMMUNICATIONS . . . . .	200
Headquarters Installations	
Tank to Fighter-Bomber	
STRAFING MOTOR TRANSPORT IN FRANCE . . . . .	200
VON RUNDSTEDT'S HEADQUARTERS AFTER A VISIT BY XIX TAC	200

THE ARMY AIR FORCES IN WORLD WAR II

	FACING
CAMERA GUNS RECORD VICTORIES . . . . .	232
Attack on Me-109	
Strafing FW-190	
DIRECT HIT ON AMMUNITION TRUCK . . . . .	232
BERLIN FLAK DESTROYS B-17 . . . . .	232
B-17 BELLY WOUND NOT FATAL . . . . .	232
FIFTEENTH AIR FORCE WRECKS PLOESTI REFINERIES . . . . .	296
Stella Romana	
Concordia Vega	
EIGHTH AIR FORCE ATTACKS OIL REFINERIES . . . . .	296
Merseburg-Leuna	
Harburg	
FRANTIC: B-17's EN ROUTE TO RUSSIA . . . . .	296
FIFTEENTH AIR FORCE RUINS AIRDROME AT NEUBURG, AUSTRIA	296
MONTE CASSINO: THE ABBEY IN RUINS . . . . .	328
CASSINO: THE TOWN UNDER ATTACK . . . . .	328
ALL ROADS LEAD TO ROME . . . . .	328
BRIEFING PILOTS OF 332D FIGHTER GROUP IN ITALY . . . . .	328
AIR DROP FOR DRAGOON . . . . .	424
Run-in	
Bail-out	
BROKEN BRIDGES IN ITALY . . . . .	424
Bressanone	
Piazzola	
Ponte di Piave	
Nervesa	

LIST OF ILLUSTRATIONS

	FACING
MAQUIS RECEIVING SUPPLIES IN CARPETBAGGER MISSION . . . . .	424
DIRECT HIT ON HIGHWAY BRIDGE IN ITALY . . . . .	456
CATHEDRAL AND BRIDGE: ROUEN . . . . .	456
CATHEDRAL AND BRIDGE: COLOGNE . . . . .	456
B-25 HITS BRIDGE AT BRIXLEGG . . . . .	456
HAULING GAS FOR PATTON'S TANKS . . . . .	584
EMERGENCY AIRSTRIP IN THE NORMANDY HEDGEROWS . . . . .	584
AIRFIELD CONSTRUCTION . . . . .	584
Square-Mesh Track	
Pierced-Steel Plank	
AIRFIELD CONSTRUCTION: HESSIAN MAT . . . . .	584
BATTLE OF THE BULGE: NINTH AIR FORCE HITS ST.-VITH . . . . .	680
BATTLE OF THE BULGE: BOMBED-OUT PANZER . . . . .	680
MARSHALLING YARDS . . . . .	680
Linz	
Dasburg	
Salzburg	
NAZIS WATCH AS EIGHTH AIR FORCE BOMBS FACTORY AT KASSEL . . . . .	680
VARSITY LINE-UP, 24 MARCH 1945 . . . . .	744
EIGHTH AIR FORCE BOMBS DRESDEN . . . . .	744
BERLIN FACTORIES HIT BY EIGHTH AIR FORCE . . . . .	744
DEATH OF THE LUFTWAFFE . . . . .	744
Strafing Attack by 353d Fighter Group, 16 April 1945	
Bad Abbling Airdrome, May 1945	

United States Air Force  
Historical Advisory Committee  
(As of May 1, 1983)

Lt. Gen. Charles G. Cleveland,  
USAF  
*Commander, Air University, ATC*

Mr. DeWitt S. Copp  
The National Volunteer Agency

Dr. Warren W. Hassler, Jr.  
Pennsylvania State University

Dr. Edward L. Homze  
University of Nebraska

Dr. Alfred F. Hurley  
Brig. Gen., USAF, Retired  
North Texas State University

Maj. Gen. Robert E. Kelley, USAF  
*Superintendent, USAF Academy*

Dr. Joan Kennedy Kinnaird  
Trinity College

Mr. David E. Place,  
*The General Counsel, USAF*

Gen. Bryce Poe II,  
USAF, Retired

Dr. David A. Shannon (*Chairman*)  
University of Virginia



SECTION I

\* \* \* \* \*

*FROM POINTBLANK TO OVERLORD*



## CHAPTER 1

\* \* \* \* \*

### WINTER BOMBING

BY THE opening weeks of 1944 all phases of the American war effort had come to be dominated by plans for an invasion of northwestern Europe. Since the beginning of hostilities the War Department had held steadfastly to the belief that such an invasion would prove decisive in the defeat of Germany, but this strategic concept did not govern to an equal degree the minds of Prime Minister Churchill, President Roosevelt, and influential U.S. Navy and British officers. Consequently, a firm decision to mount the cross-Channel operation had not been reached until the latter half of 1943.

The Combined Chiefs of Staff at Casablanca, in January 1943, had elected to follow up an anticipated victory in North Africa with the invasion of Sicily, and they further indicated their inclination to postpone a direct assault on western Europe by scheduling a preliminary bombing offensive against Germany that would not reach its climax until early in the following year.\* In consonance with the assumptions which gave shape to the Casablanca decisions, the CCS in April 1943 assigned to Lt. Gen. Sir Frederick E. Morgan, as chief of staff to the supreme Allied commander (COSSAC), the task of preparing an outline plan for a trans-Channel operation to be staged early in 1944.† The British and American chiefs committed themselves to that date at their Washington conference in May 1943, and three months later at Quebec they approved Morgan's plan for OVERLORD, as the operation had been coded, on the understanding that it would be launched during the spring of 1944.<sup>1</sup> Even so, the U.S. chiefs experienced some uneasiness regarding Britain's attitude toward OVERLORD in the interval

\* See Vol. II, 300-306.

† *Ibid.*, 632-34.

between the Quebec meeting and the reassembling of the Combined Chiefs at Cairo in November 1943.<sup>2</sup>

At that time the Prime Minister undertook to remove any fear that the British "had weakened, cooled, or were trying to get out of OVERLORD," but he insisted that the operation should not become a tyrant dictating all strategy nor a pivot so firm that every opportunity in the Mediterranean would have to be ruled out.<sup>3</sup> The British chiefs of staff, while showing some reluctance to fix a specific date for the invasion, were inclined to favor projects in the eastern Mediterranean which might impose a delay in western Europe.<sup>4</sup> Thus plans for OVERLORD still lacked the firmness the Americans would have preferred as the conferees moved to Iran for consultation with Marshal Stalin and the Russian staff. At Tehran the Russians pressed vigorously for a final commitment to OVERLORD and suggested that Mediterranean forces be thrown into direct support of that operation by invasion of southern France.<sup>5</sup> This last suggestion was already under consideration by Allied planners,\* and in the end it was agreed that Anglo-American forces would invade France from two sides (in addition to OVERLORD there would be an invasion of southern France, coded ANVIL) and that the Russians would simultaneously undertake a large-scale offensive on the eastern front.<sup>6</sup> OVERLORD, with a target date for May 1944, had become a firm commitment.

At Cairo, following the Tehran conference, the identity of the supreme commander for OVERLORD also had been determined. For months the question had been a subject of speculation, with inner military circles and the public alike expecting Gen. George C. Marshall to receive the post. In fact, Churchill had come forward at Quebec with an offer to accept Marshall as soon as it became clear that President Roosevelt would insist upon naming an American.<sup>7</sup> There was no haste to make the appointment, however, for the status of the supreme command itself was in doubt for some months and General Marshall's colleagues were reluctant to see him leave Washington. At Tehran, Marshal Stalin demanded that the invasion leader be named within a week at most,<sup>8</sup> and after much reflection President Roosevelt seems to have reached the conclusion that Marshall was truly indispensable as Chief of Staff.<sup>9</sup> Thus the choice fell on General Eisenhower, to the surprise of the appointee, who heard the news from the President at

\* See below, p. 409.

Tunis.<sup>10</sup> After a visit to the United States, Eisenhower reached London in mid-January 1944 to assume command of what soon became known as the Supreme Headquarters, Allied Expeditionary Forces and more commonly simply as SHAEF.

Already, significant progress had been made toward developing the air organization upon which the supreme commander would depend during the invasion. At Quebec in the preceding August, Air Chief Marshal Sir Trafford Leigh-Mallory, former head of RAF Fighter Command and chief air planner with COSSAC, had been designated air commander in chief of the Allied Expeditionary Air Force (AEAF). Leigh-Mallory activated his headquarters on 25 November 1943 and established it a short time later at Stanmore, Middlesex, a pleasant suburb of London and formerly seat of RAF Fighter Command. His deputy, Maj. Gen. William O. Butler, headed the American contingent of the new headquarters. Under AEAF came the RAF Second Tactical Air Force and, after 15 December, the rapidly growing U.S. Ninth Air Force, commanded by Maj. Gen. Lewis H. Brereton.\*

The question of the extent of Leigh-Mallory's responsibility had proved from the first to be a troublesome one. Was he merely to coordinate the operations of the Ninth Air Force and of British tactical units? Or was AEAF to become a highly centralized command exercising wide operational and administrative powers over its component parts? With this second view the new air commander in chief was in full accord. More than that, he implied an ambition as well to control the heavy bomber forces when he contended that both strategic and tactical air forces should come under one air commander, but he weakened such prospect as he had of gaining that control by his often-expressed opinion that it would not be necessary to achieve complete air supremacy before launching the invasion.<sup>11</sup> All AAF thinking rested upon the assumption that the full resources of the Eighth Air Force must be concentrated on the successful completion of the Combined Bomber Offensive against Germany's war potential and particularly against the German Air Force as an indispensable preliminary to the invasion. Consequently, American air officers both in Washington and in England undertook to delimit the powers of the AEAF. General Butler tried in vain to secure capable AAF officers of sufficiently high rank to make of AEAF a genuine Anglo-American organization.

\* See Vol. II, 735-40. On the Ninth Air Force, see *ibid.*, 496, 641-43.

## THE ARMY AIR FORCES IN WORLD WAR II

Leigh-Mallory's command early received and never quite lost its reputation of being a British-dominated organization, a factor which diminished its effectiveness and later caused it to be by-passed in many important matters.

Partly to offset AEAFF, the United States Strategic Air Forces in Europe (USSTAF) had been established as of 1 January 1944 with administrative control over both the Eighth and Ninth Air Forces.\* While thus serving to preserve administrative controls on a national basis, USSTAF also provided the means for coordinating the heavy bomber operations of the Eighth Air Force in the United Kingdom with those of the recently established Fifteenth Air Force in the Mediterranean. The American leaders had hoped for more than this—for an inclusive organizational structure incorporating under one commander all operations from the Atlantic and the Mediterranean against the Axis and combining in one air command all British and American strategic bomber forces.<sup>12</sup> The British chiefs, however, were unwilling to subordinate RAF's Bomber Command to such a unified control, which threatened also to interfere with contemplated projects in the Mediterranean. Indeed, it proved impossible to gain consent even for the proposal that some arrangement should be made for the more effective coordination of the operations of Bomber Command and the Eighth Air Force, for the British resisted any attempt to disturb the virtually independent position of Bomber Command.† Sir Charles Portal, chief of air staff, RAF, would continue to serve, as he had before, as the coordinating agent of the Combined Chiefs of Staff for strategic bomber operations against Germany, but the strategic air forces remained outside the OVERLORD command chain with a relationship undefined until well into the spring of 1944.

It was natural that Eisenhower should have brought with him to his new command many of the officers closely associated with his achievements in Africa and the Mediterranean, including Air Chief Marshal Sir Arthur W. Tedder who was named deputy supreme commander, Lt. Gen. Carl Spaatz who assumed command of USSTAF, and Maj. Gen. James H. Doolittle who replaced Lt. Gen. Ira C. Eaker as commander of the Eighth Air Force. Eaker, meanwhile, had been re-assigned as head of the newly established Mediterranean Allied Air

\* See Vol. II, 740-44, 751-56.

† *Ibid.*, 722-28.

Forces.\* General Eisenhower had expected Spaatz to manage heavy bomber operations for OVERLORD, and he was a little surprised that Tedder, who he had hoped would serve as his "chief air man," was in a vague position as officer without portfolio in air matters while "a man named Mallory" was titular air commander in chief.<sup>13</sup> But with veterans from an old team to help, it might be anticipated that all problems of command could be solved. Meanwhile, the approaching climax of the Combined Bomber Offensive held the focus of attention.

The CBO had been inaugurated in the spring of 1943 in accordance with a directive issued by the Combined Chiefs of Staff to accomplish "the progressive destruction and dislocation of the German military, industrial and economic system, and the undermining of the morale of the German people to a point where their capacity for armed resistance is fatally weakened."<sup>14</sup> Detailed plans had envisaged an offensive, developed in four phases of three months each, that would reach its climax by 1 April 1944. These plans did not attempt to look beyond the invasion of Europe, for it was as a preliminary to OVERLORD that the CBO found its place in Allied strategy.<sup>†</sup>

In theory at least, the bomber offensive embraced the combined efforts of the Eighth Air Force (supplemented after 1 November 1943 by those of the Fifteenth Air Force)<sup>‡</sup> and of the RAF Bomber Command. The American bombers would attack key installations according to the AAF's own doctrine of daylight precision bombardment, while planes of the RAF struck by night in accordance with its policy of bombing industrial areas and centers of population. AAF and RAF forces had the same general objective, which was destruction of the German ability to make war, but the target systems specified in the CBO plan had been elaborated by an American committee and were suited primarily to the operating methods of the American force. It was assumed that the "area" bombing of the RAF would be complementary to the daylight campaign, but, owing mainly to differences in tactics and operating potentialities, the two forces in fact seldom achieved more than a general coordination of effort. The CBO was thus a combined offensive but not a closely integrated one, and it is possible to treat the American daylight bombing campaign as a story separate from, though naturally closely related to, that of the RAF.

\* See Vol. II, 744-51.

† *Ibid.*, 348-76.

‡ On the origins of the Fifteenth Air Force, see *ibid.*, 563-74, 723-27.

*The Challenge of the GAF*

On 27 December 1943, General Arnold addressed to the commanding generals of the Eighth and Fifteenth Air Forces the following New Year's message:

- a. Aircraft factories in this country are turning out large quantities of airplanes, engines and accessories.
- b. Our training establishments are operating twenty-four hours per day, seven days per week training crews.
- c. We are now furnishing fully all the aircraft and crews to take care of your attrition.
- d. It is a conceded fact that OVERLORD and ANVIL will not be possible unless the German Air Force is destroyed.
- e. Therefore, my personal message to you—this is a *MUST*—is to, “*Destroy the Enemy Air Force wherever you find them, in the air, on the ground and in the factories.*”<sup>15</sup>

Thus, in brief compass if not in perfect literary form, did the commanding general of the Army Air Forces lend emphasis to the most urgent problem confronting the U.S. heavy bomber forces at the beginning of 1944.

The German Air Force, and particularly its fighter strength, had been designated in the original CBO directive as “an *Intermediate* objective second to none in priority.”\* “Intermediate” was here used in the AAF sense of an objective to be accomplished before the critical target systems could be reached; actually the growing resistance to Eighth Air Force missions in the fall of 1943 had made it clear that the destruction of the Luftwaffe before the Normandy D-day was the AAF's most *immediate* task. Indeed, the CBO in its last phase became so completely a counter-air offensive that the code name POINTBLANK came commonly, though erroneously, to mean the attack on the GAF rather than the combined offensive in its broader outline.†

The Eighth Air Force, freed of an earlier necessity to devote much of its limited strength to generally unprofitable attacks on submarine facilities and possessed of a steadily growing strength that would reach a total of twenty-five heavy bombardment groups by the end of 1943,‡ had attacked during the summer and early fall in increasing force such high-priority targets as the ball-bearing plants at Schweinfurt and air-

\* See Vol. II, 366-67.

† *Ibid.*, 712-30.

‡ On the build-up of AAF forces in the United Kingdom, see *ibid.*, 635-64.



craft factories at Regensburg, Marienburg, and Bremen. Many of these targets lay deep in enemy territory, and repeatedly the bombing had been both accurate and destructive. As yet, it is true, the attack had had little immediate effect on German front-line strength, for the Germans, confident of a quick victory, had not completely mobilized their industrial organization<sup>16</sup> and still possessed in 1943 unused production capacity which served as a cushion protecting them from the full effect of the combined AAF and RAF attack. But that attack had been pressed to a point greatly reducing the remaining cushion, and the German economy, in some of its more critical aspects, would be seriously affected by additional destruction.

The difficulty, from the point of view of the AAF, lay in the fact that the German Air Force and its supporting industry had been able to absorb increasing punishment without decline in combat strength. Indeed, as the loss of 60 out of 228 bombers attacking Schweinfurt on 14 October emphasized,\* the GAF gave every evidence of increasing rather than declining strength. Not until after the cessation of hostilities was the full record of enemy activity available, a record which revealed that the stimulus provided by the Allied air attack had stirred the Germans to an effort that would bring the peak in their wartime aircraft production as late as the summer of 1944.<sup>17</sup> This in itself represented a not inconsiderable victory for the bombers, for they had forced the enemy to concentrate an increasing proportion of his war effort on the construction of airplanes now used for purely defensive purposes. But even had this fact been fully understood in the fall of 1943, it could have provided only limited comfort for the bomber crews who undertook to fight their way through a stiffening resistance in the air and from the ground.

Efforts already under way to provide long-range fighter escort for the bombers promised an answer to the problem, but for a while it seemed a question whether the supply of long-range escort could be obtained in time to keep pace with the accelerating air war. Although as early as August the radius of action of the P-47 had been extended to 340 miles, the problem of escort for deep penetrations into Germany was faced squarely only after lack of escort had seriously hampered the execution of POINTBLANK.† Hopes were pinned initially on the P-38, when on 15 October 1943 the 55th Fighter Group joined

\* See Vol. II, 699-704.

† *Ibid.*, 334-37, 654-55, 679-81.

the seven P-47 groups already operating with VIII Fighter Command. With the addition of two 75-gallon wing tanks the Lightning could perform escort to a maximum of 520 miles from bases.<sup>18</sup> On the Wilhelmshaven mission of 3 November the superior endurance now possessed by this group proved especially valuable during the farthest leg of the journey and made the escort virtually continuous throughout the bomber route. In the process the P-38's, already favored among fighters in the Mediterranean and the Pacific, saw their first real combat in the ETO and enjoyed their first victory, claiming three of the enemy without losing a single one of their number. They could probably have destroyed more but remained, according to the strict orders then governing their tactics, in close support of the bombers, warding off attacks and refusing to be drawn off in independent combat.<sup>19</sup>

Again during a pathfinder mission to Bremen on 13 November the P-38's demonstrated their ability to go the distance (the longest to date for fighter escort), tangle on more than equal terms with the enemy, and provide invaluable support for the bombers over the target area. The enemy fought tenaciously, employing all of his considerable stock of tricks to draw off the escort and reach the bombers. He seemed especially anxious to maneuver his twin-engine rocket-firing planes (mostly Ju-88's) into a position from which they could deliver an attack unmolested by escort fighters. Rocket fire had by this time become the most deadly of the tactics used by the Germans against the bomber formations, and it was consequently a matter of the keenest concern to both sides to see how effective the new longer-range fighter escort would be in foiling these attacks as well as the more routine passes attempted by the single-engine Me-109's and FW-190's.<sup>20</sup>

Left alone after the P-47's had reached the limit of their endurance the relatively small force of forty-seven P-38's found themselves outnumbered, possibly as much as five to one. As a result they were badly mauled. Although only two of their number were known to have been shot down, five others failed to return. In addition, sixteen of those that came back were battle damaged. One pilot demonstrated the durability of the P-38 by bringing his plane back from Bremen on one engine. Technicians who examined the craft discovered more than one hundred bullet holes and five 20-mm. shell holes. The twin tails and the vertical stabilizer were badly damaged, but the pilot was unhurt. Despite the losses and damage suffered, and despite the fact that the number of enemy aircraft shot down was not impressive, the P-38's

were responsible again for holding bomber losses in the target area to a supportable level; and it could reasonably be hoped that a larger force could do the job still more effectively and with relatively less cost to the escort itself.<sup>21</sup>

The P-38 was clearly a most effective fighter, and the Germans honored it with an increasing share of attention.<sup>22</sup> But it was also the easiest of the Allied fighters for the enemy to identify and therefore attack. It was becoming evident that the P-51 could be developed into a more maneuverable fighter and, even more important, into one of longer range. During the fall and winter months, therefore, many observers tended to look increasingly to the Mustang (hitherto considered primarily an attack fighter) as the answer to the problem of the "long reach."

In September 1943 General Arnold urged the RAF to put as many of its Mustang-equipped squadrons as possible at the disposal of the Eighth Air Force for long-range escort. Air Chief Marshal Portal agreed to devote four such units to the daylight bombing project in January of 1944. On October 30 General Arnold decided to stop any allocation of long-range P-51's or P-38's from going to tactical reconnaissance units or to any theater other than the United Kingdom for the remainder of 1943—this despite urgent requirements for those types in other quarters.<sup>23</sup> For the rest of the year the P-51 remained linked in American air plans with the P-38 as essential to the long-range escort problem.<sup>24</sup> By the end of the year Maj. Gen. William E. Kepner, of VIII Fighter Command, referred to the P-51's as "distinctly the best fighter that we can get over here," adding that, in view of "pending developments in Germany," they are "going to be the only satisfactory answer."<sup>25</sup> Meanwhile, however, all P-51 units destined for the ETO were being assigned to the Ninth Air Force, which was being groomed for the tactical support of OVERLORD. This situation, which General Kepner deplored, had for practical purposes been remedied by an agreement made late in October establishing the support and protection of the heavy bombers engaged in POINTBLANK as the primary tactical role of all U.S. fighter units in the United Kingdom until further notice.<sup>26</sup> Accordingly, the one P-51 group (the 354th) operating in the theater prior to 1944 flew almost exclusively in support of the daylight bombing campaign and under VIII Fighter Command control, although assigned to IX Fighter Command.

The P-51's of the 354th Group for the first time flew escort in a stra-

tegic mission on 5 December when two wings of heavy bombers struck targets in the Paris area. Two squadrons of P-51's escorted the B-17's from the French coast to Poix, southwest of Amiens, where P-47's relieved the P-51's for the remainder of the mission.<sup>27</sup> On 13 December P-51's helped take a large force of bombers to Kiel. It was an all-out effort, involving no less than 710 bombers—the largest force dispatched to that date. Three of the twelve combat wings sent out by VIII Bomber Command attacked Bremen under escort provided chiefly by P-47 groups. The larger force, comprising the remaining nine wings, attacked Kiel with support in the target area from the two long-range units of P-38's and P-51's. This was the first time the P-51's had flown to what was then the limit of their escort range. Enemy reaction proved exceptionally weak, however, and the Mustangs saw only light action, claiming one Me-110 probably destroyed and losing one of their number, cause unknown.<sup>28</sup> On 20 December in the course of another of the bombing trips to Bremen the P-51's and P-38's were engaged more briskly. The P-47's provided support for the bombers to and from the target, leaving to the longer-range units the task of protecting the bombers over the target area. This time the enemy reacted with considerable intensity, trying as usual to place his rocket-firing twin-engine fighters in position to attack under the protection of the single-engine planes. This the forty-four P-51's and thirty-five P-38's were able effectively to prevent. The former accounted for three enemy aircraft destroyed and one probably destroyed at a cost of three of their own pilots and planes.<sup>29</sup> Again on a large pathfinder mission to Ludwigshafen on 30 December both the P-51's and the P-38's performed creditably at what was then considered extreme fighter range.<sup>30</sup> By January 1944 the value of the P-51 as a long-range escort plane had become so apparent that the principles on which allocations had been made in the theater between the Eighth and Ninth Air Forces were completely revised. On 24 January British and American commanders came to an agreement which placed most of the P-51 units in the Eighth Air Force.<sup>31</sup> Eventually, the Eighth would be equipped almost exclusively with P-51's, the P-47's and the P-38's being transferred to the Ninth Air Force.<sup>32</sup>

To the amazement of many seasoned observers (not the least of whom was Hermann Goering), the American fighters flew with the bombers to Berlin and even beyond by March 1944. But this triumph came only at the end of a winter during which much uncertainty had

continued to hang over the CBO. It had been recognized in November 1943 that the growing power of the GAF demanded an all-out attack on the German aircraft industry by the Eighth and Fifteenth Air Forces.<sup>33</sup> The plan for such a coordinated attack, drafted at that time and coded ARGUMENT,<sup>34</sup> was based on a realistic appreciation of the high cost that would have to be paid in the absence of effective escort. To speak in the unavoidably impersonal calculus of strategic bombardment, it was assumed that only a high profit could justify the anticipated cost, and so the plan called for approximately a full week of clear weather over most of central Europe with good enough weather in the base areas of southern Italy and eastern England to permit the bombers to take off and land. That stretch of favorable weather did not come until well into February, when the Eighth and Fifteenth Air Forces launched the series of coordinated attacks later christened the "Big Week."<sup>\*</sup>

### *Radar Bombing*

Meanwhile the Eighth Air Force had plunged into an intensive experiment in radar bombing in an effort to reduce as far as possible the limitations imposed by the fall and winter weather. Although it was hoped that radar equipment could in time be made reasonably accurate, it was not considered a substitute for visual bombing but rather a supplement which would allow the daylight bombing force to maintain the pressure of strategic bombardment on German morale and on the German economy as a whole. Admittedly a campaign of radar bombing would involve some compromise with the doctrine of "precision" bombing and with the POINTBLANK priorities, strictly interpreted.<sup>35</sup> In its early stages at any rate, radar missions would be restricted to targets which would show up clearly on the radar screen—for the most part city areas located on coast lines or on estuaries, since the distinction between water and land was easy to recognize and this greatly facilitated target identification. Moreover, although any large industrial area could be located without too much difficulty, it was not possible to identify specific factories unless they happened to be unusually isolated and unusually extensive.<sup>36</sup> But it seemed better to bomb low-priority targets frequently, even with less than precision accuracy, than not to bomb at all. Accordingly, from mid-October 1943 to mid-

\* See below, pp. 31 ff.

February 1944 the story of daylight strategic bombing from the United Kingdom is essentially the story of an experiment in radar bombing.

The decision to use radar was, of course, no sudden development in the fall of 1943.\* In the previous winter, during the early months of its operations in the ETO, the Eighth Air Force had discovered that the weather was one of the chief obstacles to be overcome. Tricky enough throughout the year, weather over England and western Europe presented peculiar difficulties in the fall and winter months, when severe storms could be expected between London and Berlin on the average of every three days and when cloud cover over Germany was persistent and thick.<sup>37</sup> General Spaatz and General Eaker accordingly laid plans late in 1942 to develop a pathfinder unit, radar-equipped and trained for the task of leading bomber formations to their target during conditions of poor visibility. Plans prior to the summer of 1943 were based largely on the experience of the RAF, and such radar installations as were attempted were made with British equipment. Best suited to the requirements of the Eighth's long-range missions was H<sub>2</sub>S, a device in which a beam of transmitted energy scanned the ground below the plane, the reflected signals presenting a map-like picture on the indicator screen, characterized by dark areas for water, light areas for ground, and bright areas for broad reflecting surfaces of towns and cities.<sup>38</sup> Use had been made of this equipment by planes of the 482d Bombardment Group (H) as early as 27 September 1943, but the British were hard pressed to meet their own needs, and in October the Americans were still experiencing difficulty in using H<sub>2</sub>S at high altitudes.<sup>39</sup>

Meanwhile, in the United States, the Radiation Laboratory at M.I.T. had undertaken to develop an improved version of the H<sub>2</sub>S type. Using a new and shorter microwave length than had ever been used before, scientists there built a radar set which would give a sharper and more faithful picture of the ground. The new device, called H<sub>2</sub>X, was being put into production in the summer of 1943, but time was too precious to squander waiting for the arrival of factory models; so the Radiation Laboratory agreed to build twenty sets, enough to equip a dozen B-17's and provide the necessary spares. These twelve planes, manned by crews already partially trained in handling H<sub>2</sub>X, arrived in England early in October to join the 482d Group. With them came scientists of the Radiation Laboratory, who set up a branch of that

\* See Vol. II, 689-94.

organization in the United Kingdom for the purpose of coordinating the work of the laboratory with that of the Eighth Air Force. The H2X crews spent the remainder of October in further training and would have preferred to do still more in the way of simulated bombing missions over the English countryside. The bad bombing weather was already at hand, however, and they were ordered to complete their training over Germany itself, each crew with a combat wing of sixty bombers behind it.<sup>40</sup>

The first of these "practice" missions took place on 3 November when eleven pathfinder planes (nine of the new H2X planes were supported by two carrying H2S)<sup>41</sup> led a force of 539 bombers in an attack on the port area of Wilhelmshaven. Earlier in the year Wilhelmshaven had been a high-priority objective for the American bombers because of the submarine building being done there. It had been the scene of the first Eighth Air Force mission over German soil,\* and it had been attacked on several other occasions prior to the middle of 1943. But by that time submarine installations had lost much of their importance as an objective for strategic bombing, although they retained a high place in the as yet unrevised CBO directive. Destruction of the ship-building activities at Wilhelmshaven doubtless would increase the total strain on German industry, but it would certainly not contribute to the pressing, short-term results being sought before D-day. Like many other target selections in the fall and winter of 1943, the decision to strike Wilhelmshaven reflected the needs of the radar-bombing experiment rather than those of the POINTBLANK campaign. That city, situated on the coast line near the estuary of the Weser River, could be easily identified on the radar screen which registered with peculiar clarity the contrast between water and land. By routing the attacking force over the North Sea it was possible to reach the port with a minimum of hazardous time spent flying over heavily defended enemy territory. Moreover, it was now possible to provide fighter protection throughout the entire route. All of the above considerations made Wilhelmshaven an ideal objective for a force led by inexperienced pathfinder crews. A heavy attack promised, withal, an impressive degree of general, area destruction.

It was a significant mission. In the first place it was the largest yet sent out by the Eighth Air Force. The 1st and 3d Bombardment Divisions (commanded respectively by Brig. Gens. Robert B. Williams

\* See Vol. II, 323-24.

and Curtis E. LeMay) each dispatched a task force of over two hundred B-17's, and the 2d Bombardment Division, under the command of Brig. Gen. James P. Hodges, sent out a task force of 117 B-24's. Despite conditions of poor visibility the large force of 566 bombers assembled without difficulty; and of this number, only 27 failed to reach the objective and bomb.<sup>42</sup> Of greater significance was the fact that the attackers, entirely dependent on radar, dropped a record bomb load of more than 1,400 tons through a solid layer of cloud with enough accuracy to hit and damage the aiming point. The eleven available pathfinders had been distributed among the seven combat wings into which the B-17's of the 1st and 3d Divisions had been divided. That left the B-24's of the 2d Division without pathfinders but with instructions to release their bombs on parachute marker flares dropped by the preceding formations, a procedure which left considerable room for error, since the interval between combat wings gave time for the flares to drift and since the bombardiers sometimes found it hard to distinguish them from antiaircraft bursts. Compared to that of a well-executed visual mission, the bomb pattern for the day's operations was widely spread, but there was enough of a concentration of hits within the port area to damage many of the ship-building installations.<sup>43</sup>

Stated in terms of strategic results, the record becomes less impressive. A British Ministry of Home Security report, dated 21 January 1944, estimated that, although the bombing of 3 November had caused "moderate" damage to workshops in the port area, those shops had not been used to their capacity and it was therefore unlikely that the damage caused more than a week's delay in the output of submarines. No damage to the hulls being built at the time of the attack had been discerned.<sup>44</sup> But in the context of the radar-bombing experiment these facts were of less importance than that the yard was hit at all through 10/10 cloud and by inexperienced pathfinder crews.

Also encouraging to the Eighth Air Force was the relatively slight loss suffered. Only 7 of the 539 attacking bombers were lost and, of these, probably only 3 were shot down by enemy aircraft. The German fighters, faced with the problem of rising to the attack through the overcast, did not react in as large numbers as on some earlier occasions. But the principal reason for the defensive success of the mission lay in the superior fighter support afforded by eight groups from VIII Fighter Command. To the effectiveness of this support the statements made after the mission by crew members whose experience had in-



cluded the tough air fighting of early October gave eloquent and unanimous testimony: "This was my 25th mission, and for me it turned out to be the milk-run of all milk-runs." "Not a fighter could be seen up there today except our own." "We'll have a milk bottle instead of a bomb pasted on our ship for this mission. Enemy fighters came up, took a look at us, and went home."<sup>45</sup>

This first H2X mission encouraged the believers in radar bombing and converted the doubtful, perhaps too readily, for the results gained that day were to a large extent beginner's luck, as in time became apparent. The Wilhelmshaven mission gave an unfounded hope of potential accuracy; and it may therefore have contributed to an unfortunate tendency to treat H2X as a rival of visual bombing rather than a supplement to it. It may also have helped to make the Eighth too easily satisfied with the greatly accelerated rate of operations it was able to achieve during the remainder of the winter through the use of the new equipment. However limited may have been the strategic results achieved, this acceleration did serve to meet the insistent demand from Headquarters, AAF that the Eighth go all out.\*

Certainly the rate of operations in November was remarkable. At no date during the month would the weather forecast have warranted a visual attack against objectives in Germany, yet German targets were attacked nine times. On two other occasions visual attacks were made on objectives in Norway.<sup>46</sup> During December, with the weather map equally discouraging for visual bombing, the Eighth dropped more bombs than ever before in any one month (13,142 tons)<sup>47</sup> and for the first time exceeded the tonnage dropped by RAF Bomber Command.<sup>48</sup> Occasionally, of course, it was possible to bomb visually by making use of chance breaks in the undercast; but on the few occasions when such a shift was accomplished, the weather forecast would not have warranted dispatching a force of bombers on a purely visual mission.<sup>49</sup>

Most of the radar-bombing missions conducted during the remainder of 1943 were led by H2X planes, often supported by the few equipped with H2S. Occasionally ground radar of the Oboe type† was used when targets in the near-by Ruhr area were selected for attack. On 5 November, for example, a heavy force of bombers was dispatched to Gelsenkirchen and Münster, both within operating radius of the

\* See Vol. II, 715-21.

† Oboe, unlike H2S, depended on beams transmitted by ground stations and thus could be used only for short-range missions into Germany. See *ibid.*, 690-91.

Oboe equipment, and the force was accordingly led by Oboe pathfinder aircraft. Two days later Oboe again was used. Although theoretically more accurate within its range than the self-contained H<sub>2</sub>X, Oboe presented so many technical difficulties that the Eighth Air Force commanders became reluctant to use it.<sup>50</sup> On 10 December, General Eaker urgently recommended an intensive program of H<sub>2</sub>X production, one which would give that equipment priority over all other radar aids destined for the Eighth. Tests conducted during the previous six weeks had, he claimed, proved conclusively that H<sub>2</sub>X was the most promising equipment for winter campaign. As a planning objective he suggested six H<sub>2</sub>X-equipped planes per heavy bombardment group.<sup>51</sup>

The H<sub>2</sub>X equipment was, however, discouragingly slow in coming. Manufacture on a production basis took time; and there were other competing claims on the product.<sup>52</sup> The situation had not improved in mid-January 1944. General Spaatz wrote to General Arnold as follows: "The most critical need of the Strategic Air Forces is for more Pathfinder aircraft. A few H<sub>2</sub>X planes now will profit our cause more than several hundred in six months."<sup>53</sup> Not until February of that year did production models of H<sub>2</sub>X begin to reach the United Kingdom.<sup>54</sup> Meanwhile the same dozen B-17's, equipped with the same hand-made H<sub>2</sub>X models and manned by the same overworked crews, continued to lead increasingly heavy forces to German industrial cities.

The size of the missions mounted by the Eighth Air Force during the latter part of 1943, together with their unprecedented frequency, was certainly their most outstanding characteristic. Operating strength of the Eighth increased from 20 $\frac{3}{4}$  heavy bomber groups in October to 25 $\frac{3}{4}$  groups at the end of December; and the ability of the groups to maintain a high rate of operations increased even more rapidly. The record set on 3 November of 566 bombers dispatched was broken on 26 November when VIII Bomber Command sent out 633. On 13 December a total of 710 bombers took off on a combat mission. On Christmas Eve the record was again raised, this time to 722, of which 670 were able to complete the mission.<sup>55</sup>

This spectacular acceleration in the daylight bombing offensive, made possible by radar bombing, tended to shift attention from strategic results. At a time of year when precision visual attacks were almost out of the question, it could reasonably be assumed that damage inflicted on areas important to the enemy war effort was helpful, regardless of the value, measured in terms of POINTBLANK, the dam-

aged property might possess. There had, indeed, been a tendency on the part of American air planners in the theater during early fall to look upon the forthcoming radar-bombing campaign as a highly desirable, if temporary, shift from pinpoint bombing of specific factories to the British technique of area devastation in districts of industrial concentration. Like the work done by RAF Bomber Command, such a project would supplement the precision objectives of the POINT-BLANK plan. Not only would property, and much of it of immediate value to the war machine, be destroyed but the constant clearance and reconstruction would have to be done by manpower taken directly or indirectly from the war effort. Aside from its effect on civilian morale, such bombing would constitute a direct attack on manpower, which was naturally (though exaggeratedly) considered a critical factor in the German war economy.<sup>56</sup>

It is in this light that the late 1943 campaign must be estimated. Few of the high-priority POINTBLANK targets were selected for attack. By far the greatest weight of bombs fell on the ship-building and port areas of Bremen, Wilhelmshaven, and Kiel. These objectives, chosen frankly for their suitability as targets for a force still inexperienced in the techniques of radar bombing,<sup>57</sup> suffered severely. Bremen in particular was attacked six times between 13 November and 20 December, the last three attacks within an eight-day period and involving a total of almost 1,200 heavy bombers.<sup>58</sup> It was impossible to determine the exact results of these attacks at the time. Bombing through overcast obviously precluded strike photos in most instances, and destruction revealed by subsequent photo reconnaissance was hard to distinguish from that accomplished by the many previous raids made by both British and American bombing forces against the same areas. It is not much easier now that enemy records are available. Little more can be said with assurance than that, as area bombing went, these missions seem to have been effective.<sup>59</sup>

Probably the most successful mission of the period was that of 13 December against Kiel. Conditions were perfect for radar bombing—clouds not too high to cause trouble, yet thick enough to provide an absolutely opaque carpet beneath the attacking forces and one through which the enemy fighters could make their way only with some difficulty.<sup>60</sup> A total of 478 bombers, 12 of them pathfinders, attacked. The bombing was heavy and, for blind bombing, well concentrated. Damage was inflicted on town and dock areas. The principal submarine-

building yard, Deutsche Werke, suffered several hits both by high-explosive and incendiary bombs. The latter appear to have done the most damage to hard-to-replace machine tools, most of which had been well protected by concrete walls against blast damage from any of the high-explosive bombs ordinarily used. The contemporary estimate of a production loss of one month (the equivalent of one 500-ton submarine) appears to have been optimistic. Much additional damage of unassessable value was, of course, inflicted on various other plants and installations in the dock area.<sup>61</sup>

Generally speaking, however, the bomb patterns made by pathfinder-led forces in November and December were too scattered to effect more than accidental damage to any particular industrial plant or installation of importance. The aiming point became a highly theoretical term. On only two missions did bombs fall in the assigned target area. Photo interpretation indicated that only 6 of the total of 151 combat boxes depending on radar (data from 15 October to 15 December) dropped their bombs within one mile of the aiming point; 17 dropped within two miles; 30 dropped within five miles. These figures are of course only approximate, because they do not include the large number of bombs which fell in water nor do they do justice to the incendiaries, the pattern of which is more difficult than that of high explosives to trace. At Bremen, the city most heavily attacked, no high explosives fell within two miles of the aiming point, and only five combat boxes succeeded in placing their cargo within five miles. Especially discouraging were the results at Ludwigshafen on 30 December when the I. G. Farbenindustrie plant suffered little damage. Though an inland target, it should have been easily identifiable on the radar screen because of its position on the Rhine, and the radar operators had by that time the benefit of two to three months' experience.<sup>62</sup>

By the end of the year it was becoming clear that radar aids had not worked, and were not likely to work, miracles of accuracy. They had allowed the daylight bombers to resort during prolonged bad weather to a type of area bombing which presumably kept pressure on the enemy at a time when he might have been recuperating. That, despite the optimism raised by the beginner's luck at Wilhelmshaven on 3 November, was all most air planners originally had expected it to do, at least for some time. By the end of the year any increase in accuracy, it was evident, would depend on the acquisition of more and better equipment manned by more and still better-trained men than had hitherto been available.<sup>63</sup>

As, with the coming of January, General Spaatz assumed the primary responsibility for the Combined Bomber Offensive, the factor of time lent additional urgency to plans for coordinated and sustained attacks against the vital centers of the German aircraft industry. But the weather continued to be a faithful Nazi collaborator, and there was nothing to do but wait and, meanwhile, maintain a constant pressure on the German war economy by radar bombing. From 4 January to 15 February the heavy bombers of the Eighth Air Force flew combat missions on twenty-one days. Only six of these twenty-one missions were accomplished entirely by visual bombing methods; and of these six only two were against industrial targets in Germany. Nine of the missions flown during this six-week period were in support of the CROSSBOW operations against German long-range weapons in the Pas-de-Calais,\* but they were undertaken for the most part only when more meaty objectives in the Reich were out of reach; and with one exception they were not carried out with anything like full combat strength.<sup>64</sup>

The year's operations began on 4 January with a heavy radar-bombing mission against the port installations and ship-building plants at Kiel, with Münster as a secondary target. Some 644 heavies were dispatched, of which 555 completed their bombing. The following day the Eighth again hit Kiel, along with several other objectives scattered over a thousand-mile front. The 215 bombers that reached the target at Kiel were able to drop their bombs on visual sighting and inflict severe damage to three of the buildings of Germania Werft.<sup>65</sup>

Two days later the bombers flew to Ludwigshafen under the guidance of pathfinder aircraft. Visual attack on high-priority targets in the aircraft industries was impossible owing to cloudy weather and Ludwigshafen was considered an easily recognized bombing target. The huge chemical works of the I. G. Farbenindustrie was always an important objective—even more important than the air planners then realized. It was felt that a follow-up attack on Ludwigshafen would be in order, after the mission of 30 December.<sup>66</sup> Like the earlier missions, that of 7 January was not without effect. The Oppau works had halted production after 30 December, and had only resumed ammonia production on 5 January. After the January attack no methanol or isobutyl oil was produced for the remainder of the month. Just as production of these items was being resumed it was again halted by another Eighth Air Force radar-bombing attack on 11 February which stopped iso-

\* See below, Chap. 4.

butyl oil production for two weeks and methanol production for five weeks. These attacks constituted part of a series of early efforts beginning on 23 September 1943, by both British and American forces, which substantially reduced average daily production of important chemicals.<sup>87</sup> Taken together they came close to justifying radar bombing as a method of striking a selected industry. Yet the results were still small in proportion to the total weight of attack. For example, out of a total of 279.5 tons of high explosives dropped over Ludwigshafen on 7 January, 127 bombs, totaling 36 tons, hit the I. G. Farben plant.<sup>88</sup>

On 11 January the weather over central Germany cleared for a very brief period, but long enough to allow the Eighth to dispatch a heavy force to the high-priority targets in the German aircraft industry. A force of 663 B-17's and B-24's was dispatched to bomb the A.G.O. Flugzeugwerke A.G. at Oschersleben, principal center of FW-190 production remaining after the destruction of the Marienburg plant in October 1943; the Junkers Flugzeug u. Motorenwerke at Halberstadt, believed to be making wings for the deadly rocket-firing Ju-88's; and three separate plants in the Brunswick area operated by Muhlenbau u. Industrie A.G. These three plants were jointly engaged in manufacture of aircraft parts and assembly of the not less deadly Me-110's. In case the weather should close in and prevent visual bombing it was planned to bomb the city of Brunswick and surrounding industrial area by radar.<sup>89</sup>

Since any such deep penetration toward vitally important targets was likely to provoke aggressive defensive action, especially when the path led in a more or less straight line to within some ninety miles of Berlin, the bombers badly needed fighter escort. Eleven groups of P-47's and two groups of P-38's were allocated in such a way that each of the three bomber formations would be covered from the Dutch coast to within 50 to 70 miles of the target and on the return trip from about 100 miles from the target to the Dutch coast. Six squadrons of RAF Spitfires were detailed to furnish withdrawal escort during the last stage of the route over enemy territory. Only the first of the three formations was to have support in the target area, to be supplied by the one available group of P-51's which alone was capable of staying any appreciable time at such distance from base.

As actually flown, this mission gave proof, if proof were needed, of the extremely complicated factors involved in such an operation; and it helps to explain why more frequent attacks were not made

against aircraft industry targets during the winter months. Although forecasters had reason to believe the target areas would allow visual sighting, weather in the base areas made take-off and assembly difficult. Moreover, the weather along the route so deteriorated that the second and third formations (composed respectively of the B-17's of the 3d Bombardment Division and the B-24's of the 2d Bombardment Division) were recalled. No signal was sent to the B-17's of the 1st Bombardment Division, because, by the time the decision was made to recall, they were scheduled to be within fifty miles of Brunswick. The leading combat wing of the second formation was also far enough into enemy territory when the signal was received for its commander to decide to go on to the primary target. The remaining three combat wings of that formation, together with the entire third formation, bombed a number of targets of opportunity in western Germany on their way home. As things finally worked out, only 139 bombers attacked Oschersleben, only 52 bombed Halberstadt, and only 47 bombed one of the Brunswick targets, the M.I.A.G. plant at Waggum, some five miles from the city. In all, 238 of the 663 dispatched bombed their primary targets. It proved also a delicate task to place the fighter escort where it was needed at just the right moment. The P-51 group which was to provide target support rendezvoused ahead of schedule and was able to do little more than take the bombers to the target. This left a considerable stretch of time before the withdrawal support came in sight, and during that interval the German fighters did some of their most destructive work.

Possibly fearing that Berlin was the bombers' destination the Luftwaffe reacted in force, and demonstrated that it had lost none of its ability to make a deep bomber penetration by daylight a costly enterprise. Its fighters gave the Eighth Air Force the stiffest battle it had had since that October day of 1943 when the Germans so seriously mauled a similar force attacking Regensburg and Schweinfurt. Indeed it appeared that they had in some respects improved their tactics. Never before had they been able to stay with the bomber formations for such extended periods. By using belly tanks the Germans were able to remain out of escort range, following the bomber formation until the escort was forced to return to base or until only a few escorting planes were left. Then, dropping their tanks, the enemy planes pressed home large and coordinated attacks on the relatively unprotected AAF formations. In instances where the bomber formation was as tight as was

required for mass protection against single-engine fighters, the German twin-engine fighters made use of the opportunity to lob rockets into it from a point beyond normal gun range, often with deadly effect. If on the other hand the formation became spread out enough to make rocket attack relatively harmless, its elements fell prey to mass attack by single-engine fighters.<sup>70</sup>

The first formation, three combat wings of which attacked Oschersleben while two attacked Halberstadt, bore the brunt of the fighting. The single P-51 group (the 354th) split its force of forty-nine planes into two sections in order to protect the bombers at both targets and was therefore able to provide only limited protection even though its pilots fought brilliantly, claiming fifteen enemy planes destroyed with no combat losses to themselves.<sup>71</sup> As for the Germans, they seemed to both bomber crews and escort pilots to comprise the entire Luftwaffe. The force of 174 bombers from the lead formation that flew to Oschersleben lost 34 of their number, the great majority to enemy aircraft. Total losses that day ran to 60 bombers.<sup>72</sup>

But the fighter factories had been reached and seen and bombed; and that fact was enough to raise the spirits of the strategic bombing experts who were beginning to despair of getting to them before too late.<sup>73</sup> Moreover, considering the size of the attacking forces, the results were encouraging. It does not, after all, require a very large force to do important damage to factory installations if its bombing is sufficiently accurate. One of the formations bombing Oschersleben was able to place 51 per cent of its bombs within 1,000 feet of the aiming point. Two of the groups bombing the Waggum plant near Brunswick got respectively 73 and 74 per cent of their bombs within that radius. Reconnaissance reported very extensive damage at both plants. At Oschersleben several buildings were hit directly and others sustained damage by either bomb bursts or fire. At Waggum almost every major installation received a direct hit.<sup>74</sup>

After 11 January the weather over Germany again closed in, making even radar bombing impracticable, and for more than two weeks this situation lasted. Either cloud conditions over Germany were such as to make formation flying at high altitudes impossible or else weather in the base areas made the launching of a mission to any objective whatever a dangerous operation. It was, however, possible for the Eighth to send three missions during that period against CROSSBOW installations on the French coast, and finally on 29 January it sent an un-



precedented force to Frankfurt am Main, "the Chicago of Germany," where over 800 aircraft bombed the industrial area of the city by radar. The day following, another heavy force flew to Brunswick, again bombing through clouds. On 3 and 4 February maximum efforts were made in pathfinder attacks against Wilhelmshaven, Emden, and Frankfurt.<sup>75</sup>

The scale of these radar-bombing missions and their frequency was impressive. It was particularly encouraging to General Arnold, who had for months been eager to step up both the rate and scale of bombing.<sup>76</sup> But the missions still constituted essentially an attack against industrial areas. However damaging they may have been to the total enemy economy, they were no substitute for the long-awaited campaign against the specific factories in the German aircraft industry. Between 5 February and 19 February the Eighth ran three relatively light pathfinder missions to Frankfurt and Brunswick, a couple of raids on airfields and bases in France, and several CROSSBOW missions. More frequent pathfinder operations into Germany were prevented in part by the weather, but also by a shortage of pathfinder aircraft. The Eighth was still employing essentially the same number of radar-equipped planes and radar-trained crews as in the late weeks of 1943. Reinforcement was in sight, but for the time being the Eighth was having to cut its operations to fit the number of pathfinder planes and crews available.<sup>77</sup>

Meanwhile the Fifteenth Air Force was having even greater difficulty than the Eighth in accomplishing its share of the POINT-BLANK offensive. On 2 November 1943, the day-old air force had made a dramatic debut by bombing the Messerschmitt airframe plants at Wiener Neustadt.\* Indeed, it was the most devastating of the many attacks made by the American bombing forces against this very important aircraft manufacturing center. Production figures, which for the month of October showed a total output of 218 aircraft, fell to 80 for November and to 30 planes for December.<sup>78</sup> Ironically, however, the Fifteenth Air Force, which owed its origins in no small part to the hope that operations from Mediterranean bases would be free of the more serious handicaps of the fall and winter weather, found its high-priority strategic targets in southern Germany and Austria almost constantly shielded by cloud. Weather in the base area, which that fall was bad enough, was more than matched by the weather in the target

\* See Vol. II, 582-83.

area, and such were the shortages of equipment and trained personnel that a serious radar-bombing program for the Fifteenth could not be developed until the spring of 1944.<sup>79</sup> After the Wiener Neustadt mission of 2 November 1943, the energies of the new air force were almost exclusively absorbed for the remainder of the year by the forward move from African bases to Foggia and by attacks on targets of primary concern to the Italian ground campaign.

The demands of that campaign in January became even heavier. Preparatory air attacks for the Anzio landing began on 2 January, and the landing itself took place on the 22d.\* On thirty-five of the days between 1 January and 21 February the Fifteenth sent out missions ranging in size from 50 to 325 bombers, but only four of these missions could be said to have struck targets related to the strategic bombing program. Except for a few relatively light attacks on industrial targets, including the ball-bearing plant at Villa Perosa and aircraft production and installations at Maribor and Klagenfurt, most of the effort was expended in support directly or indirectly of the Anzio beachhead.<sup>80</sup> Some of this effort, by the bombing of airfields and air service installations in Italy and even southern Germany, contributed to the ultimate defeat of the Luftwaffe, which was the immediate objective of POINTBLANK, but such attrition could not be considered a substitute for an all-out attack on the sources of GAF strength.

### *The February Directive*

As the weeks of January and early February passed without a favorable break in the weather over central Europe, AAF commanders experienced a growing impatience, for time was running out. But they awaited the final test with confidence. Indeed, General Spaatz still privately regarded POINTBLANK not merely as a prerequisite to OVERLORD but as a perfectly feasible alternative to it, and regretted the decision of the Combined Chiefs to risk a huge invasion when there existed a possibility of eventually bombing Germany out of the war.<sup>81</sup> RAF Bomber Command for some time had been operating at effective strength, and both the Eighth and the Fifteenth Air Forces were rapidly, if somewhat belatedly, reaching the strength envisioned by the CBO planners.<sup>†82</sup> Equally significant for AAF forces was the fact that

\* See below, pp. 336 ff.

† As of 19 February the Eighth Air Force had 19½ groups of operational B-17's, 8½ groups of B-24's, 8 groups of P-47's, 2 of P-38's, and 2 of P-51's. The Fifteenth had 8 groups of B-24's, 4 of B-17's, 3 of P-38's, and 1 of P-47's.

most of the experimentation in the tactics and techniques of daylight strategic bombing already had been accomplished, though there would be a continuing need for experimental effort in adapting the lessons of experience to the constantly changing circumstances of the air war.

The early weeks of 1944 brought also agreement between the Allied staffs as to CBO objectives and procedures that had been under debate since the preceding fall. At that time AAF leaders, prompted by a sense of the short time remaining before OVERLORD and by the growing challenge of the GAF, had sought revision of the basic CBO Plan to bring it more closely into accord with the realities of the current situation and had argued for the need of a new directive that would effect a closer coordination of the RAF and AAF bombing efforts.\* The debate, extending through most of the winter, reveals a sharper difference between the British and the Americans over procedures than over the question of general objectives.

The British agreed that for the time being the CBO must be directed chiefly toward destruction of the Luftwaffe, but they maintained that adequate machinery already existed for revising the list of target priorities as the strategic or tactical situations might require. Similarly, machinery for coordinating day and night attacks existed in the Air Ministry. Detailed coordination, it was claimed, could rarely be achieved because of the variability of weather conditions and the lengthy preparations needed before large bomber forces could be launched on an operation. Target priority lists were kept under constant review, and the targets assigned to U.S. and British forces were those "most suitable to their tactical ability and geographical location."<sup>83</sup> Despite these protestations that both Allied forces were being used as fully as weather and the tactical situation would allow against the proper targets, American planners continued to express skepticism. In a CCS meeting of 21 January 1944, for example, General Marshall countered the British argument with evidence that only 20 per cent of the Allied bomb tonnage had been expended on the vitally important German fighter targets.<sup>84</sup>

The debate ended on 13 February 1944 in the issuance of a new directive,<sup>85</sup> which defined the CBO objective as follows:

The progressive destruction and dislocation of the German military, industrial and economic systems, the disruption of vital elements of lines of communication and the material reduction of German air combat strength, by the successful prosecution of the combined bomber offensive from all convenient bases.

\* See Vol. II, 721-28.

## THE ARMY AIR FORCES IN WORLD WAR II

German single- and twin-fighter airframe and component production was bracketed with the Axis-controlled ball-bearing production in first priority. Second priority went to installations supporting the German fighter force. Other targets, listed in the order of their priority, were (1) CROSSBOW targets, which were to be attacked by all means available over and above those required for operations of top priority against the GAF; (2) Berlin and other industrial areas, to be attacked by RAF Bomber Command and USSTAF (the latter using blind-bombing devices when necessary) whenever weather or tactical conditions proved suitable for such activities but not for operations against the primary objective; and (3) targets in southeast Europe—cities, transportation, and other suitable objectives in the Balkans and in satellite countries—to be attacked by the Mediterranean Allied Air Forces whenever weather or tactical conditions prevented operations against POINTBLANK objectives or in support of land operations in Italy. “Mutually supporting attacks” by the strategic air forces of both nations “pursued with relentless determination against the same target areas or systems, so far as tactical conditions allow” was the stated concept that should guide the combined operations. Over-all control of CBO operations remained in the hands of the chief of air staff, RAF, as agent for the CCS; and USSTAF would continue to coordinate the operations of the Eighth and Fifteenth Air Forces. The commander of the AEF was ordered to devote as much of his tactical air force strength as could be spared from necessary preparations for OVERLORD to the execution of this directive.

One would hardly be justified in regarding the new directive as an unqualified victory for the American point of view. There was reason now to believe that a larger share of the RAF's night bombing effort would be devoted to the small industrial centers intimately connected with the aircraft and ball-bearing industries, even at the risk of greater loss to enemy fighters and at the expense of the RAF's program of bombing the large city areas.<sup>86</sup> Little if any real change had been made in the machinery of coordination, however, and while the RAF had conceded a heavier claim against its resources for attacks on the GAF, the AAF would know some concern over the fact that CROSSBOW operations had been given so high a priority. During January and February thirteen out of twenty-nine missions undertaken by the Eighth Air Force were flown in support of CROSSBOW, and thereafter the proportion would increase.<sup>87</sup>

Claims for support of the land campaign in Italy also continued to be a subject of concern to AAF leaders. At the establishment of USSTAF in January it had been stipulated that, though POINT-BLANK retained first priority for all heavy bomber operations, the theater commanders at their own discretion could use the heavies within their respective theaters to meet a strategic or tactical emergency, provided they kept the commanding general of USSTAF informed as to their action.<sup>88</sup> Up to the close of February this problem of "diversion" had been handled in Italy by personal arrangements between Eaker and Gen. Sir Henry M. Wilson,<sup>89</sup> with the result that the Fifteenth Air Force devoted much of its effort to assistance of the ground campaign and yet was available for use by USSTAF in coordinated attacks on the GAF when a favorable stretch of weather finally came during the third week in February.\* But on 27 February the Combined Chiefs directed that until further notice the campaign in Italy† must have priority over all operations and first call on all Allied resources in the Mediterranean—land, sea, and air.<sup>90</sup> Arnold and Spaatz were alarmed lest this result in a permanent diversion of heavy bomber strength in support of what they felt had become a deadlocked campaign until they received assurance that Wilson would use his new prerogative only for the duration of the current emergency.<sup>91</sup>

\* See below, pp. 358–60.

† Developments there are discussed below, pp. 346–61.

## CHAPTER 2

\* \* \* \* \*

### *BIG WEEK*

**A**T LONG last, on 19 February 1944, the weather over the German fighter factories began to open up, and during the six succeeding days the concerted bombing attack which had been projected since November 1943 became a reality. The plan, drafted originally and repeatedly modified by the Combined Operational Planning Committee (COPC) under the code name ARGUMENT,<sup>1</sup> pointed toward a series of coordinated precision attacks by the Eighth and Fifteenth Air Forces against the highest-priority objectives, most of which by February 1944 were situated in central and southern Germany. The RAF agreed to make its night area attacks coincide with the daylight missions both in time and in place.

The projected operation was to be directed principally against the airframe and final assembly phase of single- and twin-engine production. It had been consistently assumed by those responsible for selecting targets for the CBO that bombing of airframe manufacture would be reflected more rapidly in enemy front-line fighter strength than an attack on the aeroengine manufacture. The policy based on this assumption, however, was coupled with one giving a high immediate priority to the antifriction-bearing industry which lay, one might say, at the opposite end of the production line but which was believed to be highly concentrated in so small a number of targets as to make the system highly vulnerable.\* As finally worked out, the ARGUMENT plan looked to a combination of attacks against final assembly, antifriction bearings, and component parts manufacture. Thus, for example, bombing of the Erla assembly plant at Leipzig-Möckau, engaged in assembling Me-109's, was to be supplemented by bombing the Heiterblick component factory at Leipzig which supplied major parts

\* See Vol. II, 356-57.

for assembly at the airfield. Ju-88 twin-engine fighter production at Bernburg was made to share the bombing attack with the fuselage factory at Oschersleben and the wing factory at Halberstadt, on both of which it depended. Likewise, the Messerschmitt assembly plant at Regensburg-Obertraubling was to be bombed simultaneously with the component factory at Regensburg-Prüfening. This technique was, of course, unnecessary at the Messerschmitt factories at Gotha and Augsburg where both final assembly and major component manufacture were carried out in the same factory area.<sup>2</sup>

The primary responsibility for mounting the attack belonged to USSTAF. It had not been anticipated that this headquarters would ordinarily direct daily operations involving either or both of the two AAF heavy bombardment forces, the Eighth and Fifteenth. Its general task was a supervisory and policy-making one, but in the case of coordinated operations undertaken by the two forces the day's activity was to fall under the immediate direction of USSTAF's deputy for operations, Maj. Gen. Frederick L. Anderson.<sup>3</sup> ARGUMENT had been scheduled repeatedly—every time, in fact, that early weather reports seemed to offer any hope; but each time deteriorating weather had forced cancellation.<sup>4</sup> By February the destruction of the German fighter production had become a matter of such urgency that General Spaatz and General Anderson were willing to take more than ordinary risks in order to complete the task, including the risk of exceptional losses that might result from missions staged under conditions of adverse base weather. General Spaatz on 8 February had directed that ARGUMENT must be completed by 1 March 1944.<sup>5</sup>

### *ARGUMENT*

On 19 February the USSTAF weather section, the central agency through which all forecasting was coordinated for the American bomber and fighter forces in the United Kingdom, became aware of two extensive pressure areas, one centered in the Baltic and one just west of Ireland, which were developing in a way that made good weather over central Europe and the home bases seem probable. If the pressure area over the Baltic moved southeast across Europe as was anticipated, the resulting winds would break out the cloud and leave clear skies or, at worst, scattered clouds. Neither the Eighth Air Force nor Ninth Air Force weather observers shared the confidence of USSTAF on this prospect. As a result, neither General Doolittle of

the Eighth nor General Brereton, whose Ninth Air Force medium bombers would be heavily involved as diversionary forces, was enthusiastic about Anderson's proposal to attempt as difficult and dangerous an operation as ARGUMENT the following day.<sup>6</sup>

Nevertheless, General Anderson continued to explore the possibilities and conferred by cable with Eaker to determine whether Maj. Gen. Nathan F. Twining of the Fifteenth Air Force was prepared to cooperate. The request caught Eaker at an embarrassing time. He had been assured by those in command of the ground campaign at Anzio that the following day would be a critical one on the beachhead. Both Lt. Gen. Mark W. Clark of the Fifth Army and Maj. Gen. John K. Cannon of the Twelfth Air Force hoped for full assistance from the heavy bombers of the Fifteenth. Weather reports received in Italy indicated, furthermore, that the proposed south German targets would offer little chance for visual bombing; and since the Fifteenth had as yet no H<sub>2</sub>X equipment, a diversionary attack on area targets as suggested by USSTAF would be impossible. Eaker also feared that if the Fifteenth were withdrawn for POINTBLANK operations at this critical stage of the Italian campaign General Wilson might feel compelled to declare an emergency and employ the heavy bombers by direct command. Eaker wished to avoid such a declaration, lest the control exercised by his own headquarters over the operations of the Fifteenth be robbed of all flexibility. Accordingly he requested that the Fifteenth not be committed by USSTAF on the 20th.<sup>7</sup> Spaatz, to whom the impending air battle promised results so decisive that any diversion of support from the land campaign in Italy would be justified, took the question to Air Chief Marshal Portal, who answered that the Prime Minister wished all available forces to be used in support of the beachhead.<sup>8</sup> Participation by the Fifteenth on the 20th was accordingly left to Eaker's discretion.<sup>9</sup>

The mission remained on the books, at least for the Eighth, and preparations went ahead on the assumption that it would be flown the next morning. During a night that brought little sleep for the responsible commanders, doubts continued to be expressed concerning the weather prospect. Could the fighter escorts get up through the clouds considered likely over the bases? Might not the icing that would result seriously reduce their efficiency? General Kepner, in command of the Eighth Air Force fighters, believed it would cut the efficiency of the P-38's by half but did not foresee too much difficulty for the P-47's



and P-51's. General Spaatz felt the mission should be flown if necessary without full fighter support. But what of the bombers themselves? Could they negotiate assembly through 4,000 to 5,000 feet of cloud with the likelihood of even more trouble from icing than the fast-moving fighters would encounter? It was suggested that de-icing fluid could be used and cockpit windows opened after the cloud area was passed, and so the debate continued, but early in the morning of the 20th the wires carried down from headquarters the final decision—"Let 'em go."<sup>10</sup>

The force assembled for the mission was the largest in the history of the American strategic forces. Sixteen combat wings of heavy bombers, numbering over 1,000 planes, were dispatched, of which total 941 were credited with sorties. All available AAF fighter escort was provided, 17 groups in all—13 P-47, 2 P-38, and 2 P-51—drawn from both VIII Fighter Command and the Ninth Air Force. In addition to these American escort groups, the RAF provided 16 fighter squadrons, consisting of Spitfires and Mustangs.<sup>11</sup>

Twelve specific targets had been selected, representing major assembly and component plants for Me-109's, Me-110's, Ju-88's, Ju-188's, and FW-190's. Most of the objectives lay in the Brunswick-Leipzig area; but three lay in the north, two in the Posen area of Poland and one at Tutow. Six combat wings of bombers were sent to the latter targets by a route which led over the North Sea and across the southern part of Denmark. The remaining ten combat wings were to bomb the targets in central Germany. Since these wings would certainly encounter the stiffest resistance from the Luftwaffe (the northern route lay largely beyond the lanes usually defended by the Germans), they were given all the available escort. Several of the American fighter groups were to refuel and make second sorties. The main bombing force was to enter the enemy radar screen in time to prevent large numbers of fighters from concentrating on the unescorted northern force. In order to facilitate fighter support, the combat wings of the main force were to fly at close intervals over the same route until it became necessary to diverge toward their respective targets. Both parts of the day's mission could easily be interpreted, and probably were by many German observers, as a threat to the national capital.<sup>12</sup>

Thanks to these precautions, to the generally excellent support of friendly fighters, and doubtless also to the fact that the RAF had bombed the city of Leipzig heavily the night before and had worn out

## THE ARMY AIR FORCES IN WORLD WAR II

much of the night fighter force, the bombers of the Eighth suffered relatively little from enemy attack. This was good news to those who remembered earlier attempts at penetrations deep into enemy territory—the Schweinfurt mission of 14 October or the most recent of such operations on 11 January when of 651 bombers making sorties 60 failed to return. On 20 February, against many of the same targets, only 21 were lost out of a force of almost 1,000.<sup>13</sup>

The bombing, wherever it was accomplished visually (at Leipzig, Bernburg, and Brunswick and at several targets of opportunity), was good. Severe damage was, for example, done to four plants of A.T.G. Maschinenbau GmbH, in the Leipzig area. A.T.G. was one of the licensees of Junkers and was engaged in airframe manufacture and as-



sembly, especially of the twin-engine Ju-88. Destruction was especially heavy in terms of structural damage. Machine tools, although not damaged quite so severely as Allied intelligence believed at the time, were badly mauled. The mission of 20 February caused a loss of slightly more than one month's output for the entire concern.<sup>14</sup> The Erla Maschinenwerke GmbH also suffered heavily, especially its main plant at Heiterblick and the assembly plant at Möckau being used for the manufacture of Me-109's, a type of which the Erla complex as a whole produced 32 per cent. An estimated forty completed aircraft and an undetermined amount of component parts were destroyed at these two plants. The bombs also killed some 450 workers in slit trenches and in inadequate air-raid shelters provided at Heiterblick. As at A.T.G., damage to buildings was proportionally greater than to machine tools, a surprising number of which remained undamaged or repairable. It was this raid, however, that decided the plant authorities to begin a serious policy of dispersal, with all its attendant loss of production and dependence on vulnerable lines of rail communication.<sup>15</sup>

This mission of 20 February was the beginning of the dramatic series of strategic operations that has come to be called the Big Week. On the night of 19/20 February it all seemed a hazardous gamble on the doubtful long-range weather forecast. That the first mission was attempted can be attributed to the stubborn refusal of General Anderson to allow an opportunity, even a dubious one, to slip past him. To the intense relief of USSTAF headquarters the gamble paid off. Not only had an apparently good job of bombing been achieved but the cost must have seemed gratifyingly small to men who had been talking in terms of a possible loss of 200 bombers and crews. So, when the weather prospect for the 21st indicated continuing favorable conditions over Germany, an operation was enthusiastically undertaken. The feeling was spreading within USSTAF headquarters, and from there to the operational headquarters, that this was the big chance.

As on the previous day it was the RAF that dealt the initial blow. On the night of 20/21 February, Air Chief Marshal Sir Arthur Harris' Bomber Command struck at Stuttgart, a city important to the aircraft industry, with over 600 planes. USSTAF planned to bomb the two M.I.A.G. factories at Brunswick, both of which were producing component parts for the twin-engine, rocket-firing Me-110, and also to attack half-a-dozen important airfields and storage parks in western Germany.<sup>16</sup> It was hoped that the medium bombers of the Ninth Air

Force and the heavies of the Fifteenth could cooperate. But the former, as on the 20th, found weather over assigned airfield targets in the Low Countries unfavorable, and the Fifteenth found it impossible because of bad weather even to fly missions in support of the ground action.<sup>17</sup> On the part of the Eighth it was another all-out effort, planned and launched on a scale not far short of the previous mission. But the strategic results were not so encouraging. True, the large air park at Diepholz was severely and accurately bombed, as were several of the other airfields attacked, but the principal targets at Brunswick were found covered by cloud. The bombardiers switched from visual to pathfinder tactics and succeeded in dropping a heavy tonnage of bombs on the city, but without damaging the aircraft factories directly.<sup>18</sup>

Weather reports for the next day continued to indicate good prospects for visual bombing over many important targets, and special attention was invited to evidence that the high-pressure area responsible for the clear weather was moving south in such a way as to open up the two top-priority objectives—Regensburg and Schweinfurt. A promise of good weather farther north also encouraged the planners to debate seriously an attack on the next highest on the priority list, the Erkner ball-bearing factory near Berlin. A mission to Erkner undertaken simultaneously with attacks on the southern targets, however, would spread the forces too much and make them too vulnerable to enemy attack. Excellent results had been achieved on the two previous missions by sending the bombers and their fighter escort into enemy territory as a team, only splitting the force when the target areas were neared. Even after Erkner had been ruled out, the remaining targets presented a dangerous spread, and so the news that the Fifteenth would be able to send a force against Regensburg was especially welcome. It was decided that on the 22d the Eighth should attack aircraft factories at Schweinfurt, Gotha, Bernburg, Oschersleben, Aschersleben, and Halberstadt, leaving Regensburg to be bombed from Italy by the Fifteenth. In addition, a small diversionary force, equipped with radar-jamming devices, was to fly to Denmark and bomb the Aalborg airfield. This force, it was hoped, would hold a number of enemy fighters in the north and would make it hard for the enemy to detect the main force of bombers until after it had formed over England.<sup>19</sup>

A number of things went wrong with these plans. The B-17's of

the 3d Bombardment Division, which constituted the Schweinfurt force, found it impossible to assemble because of the unfavorable weather over their bases. Several collisions occurred in the air, and General LeMay finally ordered this part of the mission abandoned. His decision, though apparently justified under the circumstances, left the Fifteenth to face stronger defenses than would have been met had the bombers of the Eighth been able to get as far south as Schweinfurt. The B-24's of the 2d Bombardment Division on their way to Gotha also ran into trouble. Badly strung out as they crossed the Channel, they found it impossible to organize on the way inland and the decision was made to recall. These defections left only the five combat wings of the 1st Division which had been scheduled to attack Oschersleben, Halberstadt, Bernburg, and Aschersleben. Oschersleben, most important of these objectives, was obscured by cloud and was passed over in favor of targets of opportunity. Many planes of the Halberstadt force found the same difficulty and adopted the same alternative. As a result, only 99 bombers out of a force of 466 dispatched by the Eighth that morning succeeded in bombing their primary targets, and only 255 planes bombed any target at all. Fortunately, the Fifteenth had better luck and was able to get off a force of 183 bombers against Regensburg, where 118 planes bombed the Messerschmitt factory at Obertraubling.<sup>20</sup>

Bombing results at the major targets were very uneven, owing principally to the degree of visibility allowed the bombardiers. The thirty-four bombers that attacked the Aschersleben Motor Works (manufacturing Ju-88's and other products for the Junkers complex) are credited with causing a 50 per cent production loss for two months. The Bernburg attack, aimed also at Ju-88 production, was one of several effective missions which eventually damaged the assembly buildings to the extent of 70 to 80 per cent. Bombing was poor at Halberstadt. The Fifteenth at Regensburg gave a good start to a second campaign against that segment of the Messerschmitt system, a campaign which was carried on still more effectively three days later by both air forces.<sup>21</sup>

The German fighters made the bombers of both the Eighth and the Fifteenth pay more heavily on the 22d than on the two preceding missions. On those two occasions the bombers, with excellent fighter support and other factors in their favor, had a relatively easy time of it, but on this day the Germans successfully tried a new tactic against

the Eighth Air Force. Instead of concentrating their efforts in the target area, where fighter escort was now usually provided, or even on the later stages of the flight toward the target, they attacked early in the penetration at a time when fighter cover was either thin or entirely lacking. In the course of the running battle that ensued the Eighth lost 41 bombers out of a force of 430 credited with making sorties. Part of the trouble arose from a widely spread-out bomber force; when many of the units turned away to seek targets of opportunity, the invading force lost what compactness it had maintained on the penetration flight and this made it hard for the two groups of long-range P-51's acting as target area support to afford complete cover. The escort in general had a field day, claiming sixty of the enemy destroyed at a cost of eleven of their number.<sup>22</sup> The Fifteenth, also running into stiff enemy opposition, lost fourteen of its bombers, chiefly to twin-engine fighters.<sup>23</sup>

Prospects for a visual attack by the Eighth on the 23d looked so poor that no mission was planned. General Doolittle welcomed the break in operations. For three successive days his bomber crews had been working under high pressure and they were tired. The long-range fighter escort units were even more exhausted, but presumably the German Air Force was tired too, and had weather promised an even chance for visual bombing, a mission would doubtless have been flown.<sup>24</sup> The Fifteenth was able to send a small force of 102 bombers to Steyr, in Austria, where they destroyed 20 per cent of the plant area at the Steyr Walzlagerwerke, then turning out between 10 and 15 per cent of the German ball-bearing production.<sup>25</sup>

The weather over central Germany opened up again in time for another full-scale coordinated mission on the 24th. This time it was decided to strike hard at Schweinfurt's antifriction-bearing plants, most important of their sort in the Axis countries. In addition to the five combat wings of B-17's dispatched to Schweinfurt, three combat wings of B-24's were sent to Gotha to bomb the important Gothaer Waggonfabrik A.G., largest producer of twin-engine Me-110's, and a third force, amounting to five combat wings, was to bomb aircraft component factories and assembly plants in northeastern Germany and Poland at Tutow, Kreising, and Posen, all producing FW-190's. Since it was not at all certain that these northern targets would be open to visual bombing, and since the position of the last two in occupied territory made them unsuitable for the relatively inaccurate radar

bombing, the third force was directed as an alternative to bomb the city of Rostock. The Fifteenth Air Force agreed to fly in force against the Steyr-Daimler-Puch aircraft component plant at Steyr.<sup>26</sup>

Care had to be taken to prevent heavy enemy fighter reaction to the northern force dispatched by the Eighth, since the extreme length of its flight prevented the use of even the long-range fighter escort then available. It was hoped that by carefully timing the flight of the main force the enemy controller could be prevented from committing too many units to the task of intercepting the Tutow-Kreising-Posen force. The actions of the Fifteenth against Steyr and of the main force of the Eighth were calculated to be mutually helpful in splitting the German defenses.

These precautions apparently worked well for the northern force, although the overcast weather encountered no doubt helped to discourage enemy fighters. The Schweinfurt-Gotha forces and that of the Fifteenth, however, ran into plenty of trouble. The 87 B-17's of the Fifteenth that flew to Steyr (27 others became separated and attacked the Fiume oil refinery) experienced almost all the German interceptor tricks that had been worked out against the Eighth during the previous year—coordinated attacks by four to six single-engine fighters, rockets fired at long range from twin-engine aircraft, and aerial bombs. The attacks were especially heavy against the rear formation, all 10 bombers of which were shot down. The Steyr force lost a total of 17 bombers in this air battle, despite excellent withdrawal support provided by 146 P-47's and P-38's. A similar story was told by the B-24 crews that flew to Gotha. Despite almost continuous fighter cover, the B-24 formations suffered persistent and concentrated attack, especially in the target area, and lost 33 planes out of the 239 dispatched that morning. The Schweinfurt force fared somewhat better, losing only 11 planes. The supporting fighters lost 10 and claimed the destruction of 37 of the enemy. Bomber claims (108 German fighters destroyed) reflected the intensity of the battle.<sup>27</sup>

It is hard to estimate the exact amount of damage done to the Schweinfurt ball-bearing industry by the 574.3 tons of high explosives and incendiaries dropped by the 238 B-17's on 24 February because that night the RAF, guided by the fires left burning from the American attack, dropped a much greater weight of bombs on the entire industrial area of Schweinfurt. The combined attack was thus the heaviest yet directed against that city, but it was not the most damaging to

the antifriction-bearing industry. The attack of 14 October retained that honor throughout the war. It was not that the bombing of 24 February was inaccurate, for three of the four bearing plants sustained major damage in the daylight raid with direct hits on machine shops, storage buildings, and power stations. It was simply that Schweinfurt, considered as a POINTBLANK objective, was not the target it had been in the fall of 1943. Since the October raid, Vereinigte Kugellager Fabriken A.G. had been busily engaged in dispersing its activities. By February 1944 it had moved 549 machines to the new locations, leaving only 73 per cent of its total stock of machines in the Schweinfurt plants. Thus Schweinfurt was only about 60 per cent as valuable a target in February 1944 as it had been in October 1943. Nevertheless the bearing plants suffered heavy damage in the raids of 24-25 February, especially in the departments processing rings; and the ball department, already half-dispersed, lost another 10 per cent of its machines. Many of the most important processes remained, however, unaffected.<sup>28</sup>

Bombing at Gotha was especially accurate, and probably more important strategically than at Schweinfurt. Over 400 bombs, both high explosive and incendiary, fell in the target area, 93 of which hit buildings; this does not count the large number of fragmentation bombs (180 tons out of a total of 424) dropped also. Almost every building in the very compact factory area was damaged. The eastern half of the plant, where the aircraft manufacture was centered, was generally destroyed, although machine tools, the vital part of the production system, received surprisingly slight damage, considering the amount of damage to buildings. Most of the loss of machine tools resulted from fires. Even falling debris and steel girders did less damage than factory executives had expected. In fact the loss of production following the raid resulted less from actual damage to the machine tools than from their inaccessibility. Much time and labor had to be expended clearing heavy girders from the machines caught under them. Some loss of production also resulted from the policy of dispersal begun on official order after 24 February. In all, the U.S. Strategic Bombing Survey estimated that as a result of this mission the Gothaer Waggonfabrik A.G. lost about six to seven weeks' production or the equivalent of 140 planes. Recuperation was rapid, however. In a little over two months the concern was operating again at full capacity. But it must be remembered that, in order to bring about full



P-51, P-47



OVER BERLIN: RADAR BOMBING THROUGH 7/10 CLOUD

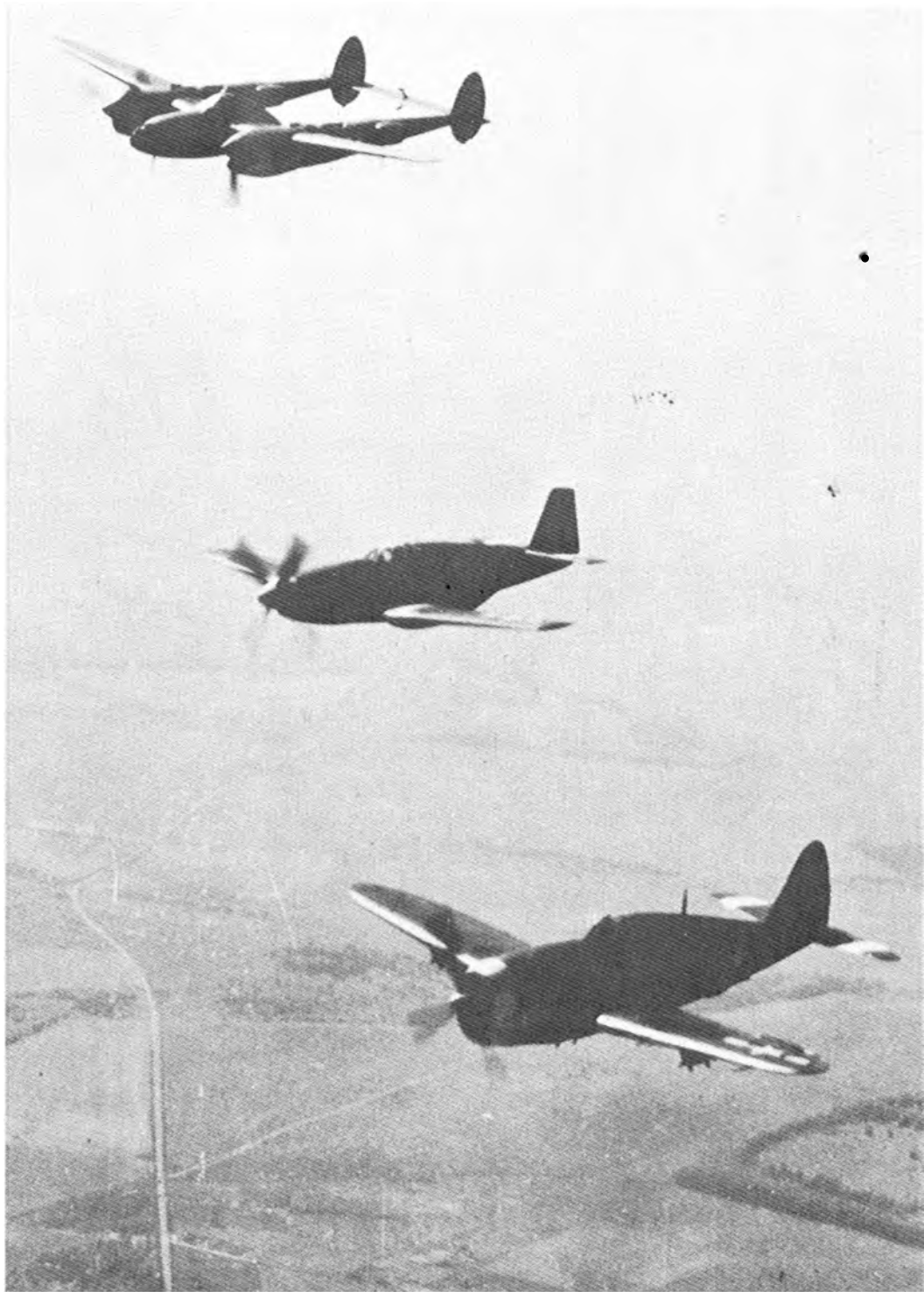

LITTLE BROTHERS: P-38, P-51, P-47

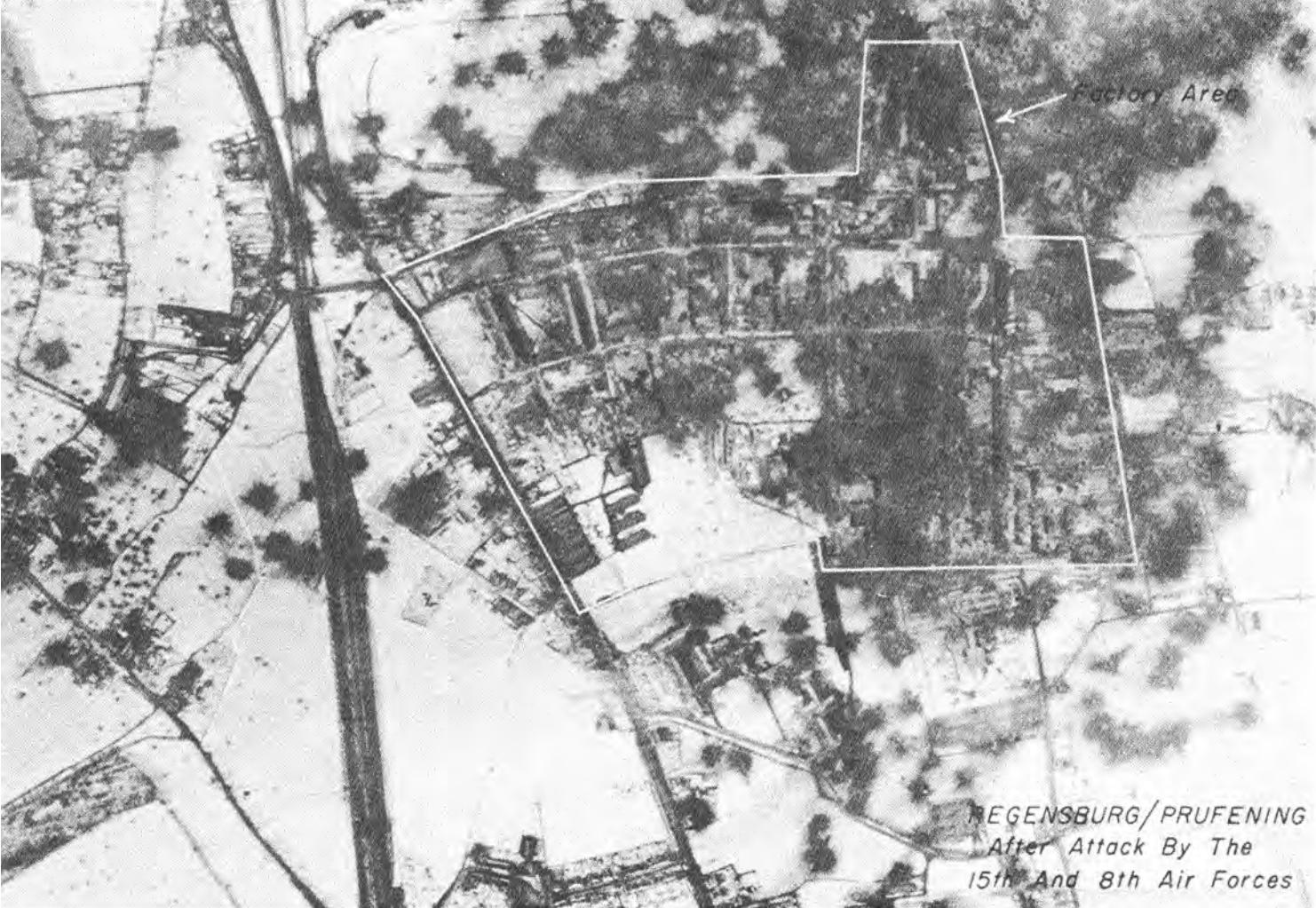

*Factory Area*

*REGENSBURG/PRÜFENING  
After Attack By The  
15th And 8th Air Forces*

**BIG WEEK: REGENSBURG-PRÜFENING**

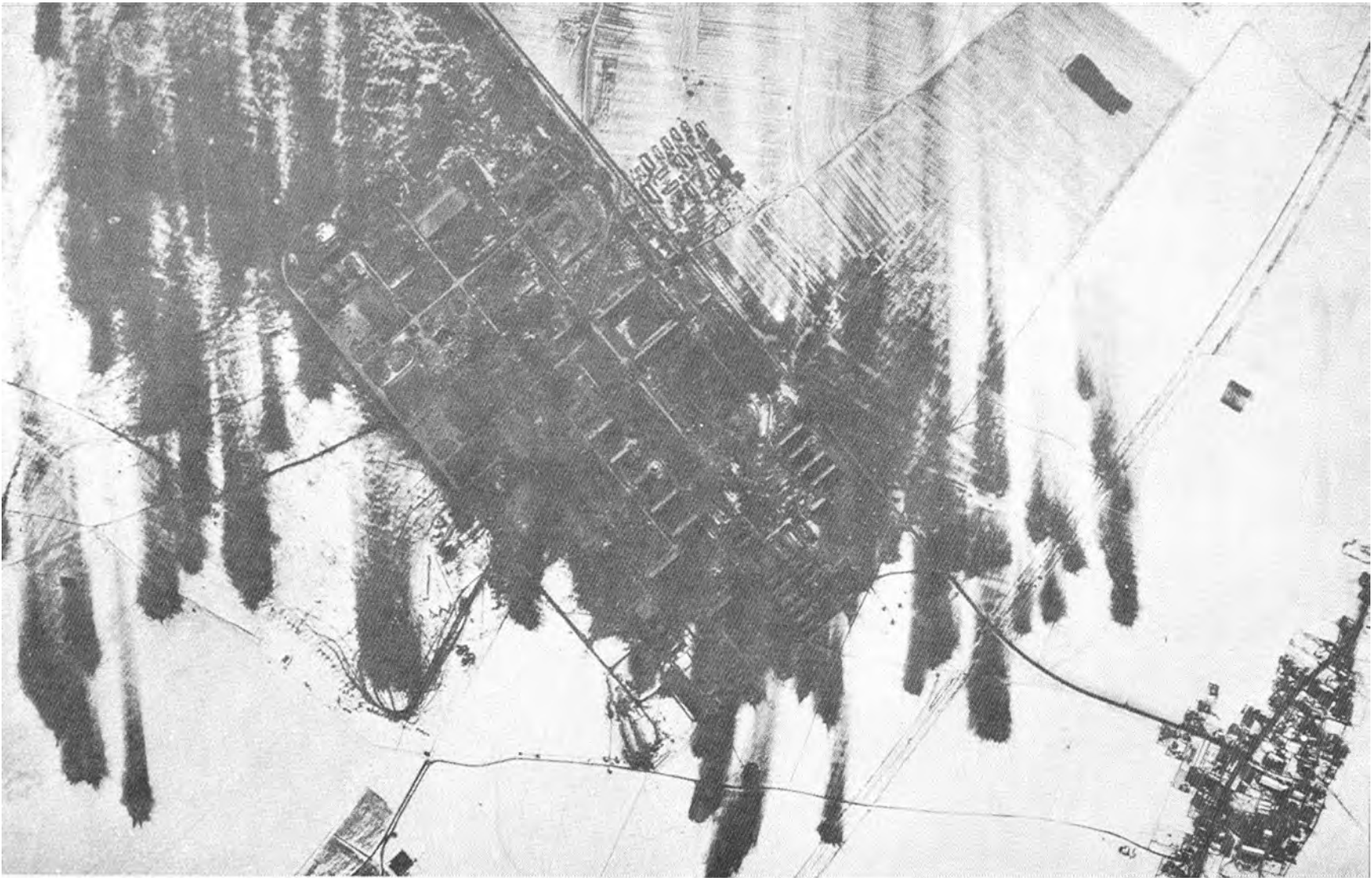

**BIG WEEK: REGENSBURG-OBERTRAUBLING**

production at new dispersed plants, a heavy drain was placed on other factories in the Messerschmitt ring.<sup>29</sup>

As if to add a final touch of celebration to a week of unwonted liberality, the weather on 25 February permitted the daylight bombing forces to choose almost any targets they wished in German territory. The decision was made in USSTAF headquarters to launch another full-scale coordinated attack by both strategic air forces against the remaining high-priority objectives in southern Germany. The Fifteenth was directed to attack the Messerschmitt component plant at Regensburg-Prüfening. The Eighth was given both Messerschmitt factories at Regensburg, the Messerschmitt parent plant at Augsburg, the antifriction-bearing plant of V.K.F. at Stuttgart, and the factory of Bachmann—Von Blumenthal at Fürth, manufacturing components and assembling Me-110's.<sup>30</sup>

The mission promised to be a dangerous and taxing day's work for both forces, involving as it did for each an extremely deep penetration. USSTAF planners hoped that this closely coordinated attack, the first to be attempted on the same day by the Eighth and Fifteenth against the same objective, would split and confuse the German fighter forces. It was also hoped that the Germans would be showing the strain of five days of constant action. An additional advantage lay in the fact that the targets were fairly well concentrated, making it possible for the Eighth to move its huge force along a single line of penetration under a single comprehensive plan of fighter cover. The Fifteenth was not in such a favorable position. It lacked escort of sufficiently long range to provide protection during the most distant phase of the penetration. It suffered also from the handicap of a relatively small force. Only bombers equipped for long-range flying could be sent as far as Regensburg, and, although the Fifteenth dispatched that day almost 400 bombers, only 176 were airborne on the main mission. The remainder hit yards and port installations at Fiume, the harbor at Zara, warehouses and sheds at Pola, rail lines at Zell-am-See, and the airfield at Graz-Thalerhof.<sup>31</sup>

As it happened, the German fighters concentrated relatively larger forces on the Fifteenth than on the Eighth, with the result that the Foggia-based bombers lost 33 of their number on the Regensburg mission, or nearly one-fifth of the attacking force. The fighting was intense, and the bomber crews claimed large numbers of the enemy shot down.<sup>32</sup> The Eighth, on the other hand, lost only 31 of its total

force of 738 credited with sorties.<sup>33</sup> It was another proof of the fact, long since conceded by American strategic bombing experts, that a daylight bomber force without full fighter cover could not hope to get through an aggressive enemy without excessive losses, especially when, as in this instance, the enemy chose to concentrate on the weaker and more poorly protected force.

All forces were able to bomb their primary targets on the 25th and to do so with generally good accuracy. Results were especially important at Regensburg and Augsburg, although a great deal of destruction was done also to plant and finished aircraft at Fürth. Regensburg was the heart of the Me-109 production and it was considered worth any reasonable risk, including a slight reduction in bombing altitude, to do an effective job on the two plants there. In the raids by the Fifteenth on 22 February and 25 February on the Obertraubling factory and by the Eighth against both factories on the 25th, scarcely a building escaped damage, many being utterly destroyed. The effect on aircraft production was great. Plant records indicate that production fell from 435 planes per month in January 1944 to 135 per month in March 1944, the decline resulting entirely from bomb destruction. The Regensburg system did not again reach scheduled production levels for four months.<sup>34</sup> The main Messerschmitt plant at Augsburg underwent similarly drastic treatment. Blast and fire from over 500 tons of bombs destroyed approximately thirty buildings. Production capacity was reduced by about 35 per cent. Almost one-third of all machine tools were damaged, and 70 per cent of stored material destroyed. The plant was, however, back in full production in little over one month.<sup>35</sup>

Allied intelligence, working on the basis of extremely accurate reports of damage to factory buildings, quite understandably expected more loss of production than actually occurred. The error arose partly because these reports contained no detailed information regarding dispersal of plant functions. Since the summer of 1943, when the first heavy raid was made by the AAF against the Regensburg factories (17 August), the Messerschmitt company had been energetically engaged in dispersing the activity of all major plants in a closely integrated system of small factories, many of them cleverly concealed in forest areas adjoining the original manufacturing centers. The effect of bombing attacks was thus greatly reduced. The 17 August 1943 raid, for example, had prevented the Regensburg complex from returning to scheduled production for five months. Although much

heavier and more devastating, the attack of 25 February retarded manufacture for only four months.<sup>36</sup> Another source of miscalculation lay in the fact that here, as elsewhere, the machine tools, which were the least replaceable part of the production process and of vital importance, suffered astonishingly slight damage considering the general devastation. Underestimating the recuperability of such plants, USSTAF failed in many instances to schedule return raids which, undertaken fairly soon after the completion of an apparently very effective one, might have finished work only partly accomplished.<sup>37</sup>

After these attacks of 25 February the weather turned bad (indeed, it would be generally so for another month) and ended the Big Week.

### *How Big Was the Big Week?*

The question naturally arises, how big was the Big Week? To those who participated in it and who directed its operations it looked very big indeed. Perhaps it looked even larger to the public relations men and the press writers who were responsible for giving it the tag that has clung to it ever since. If under the unromantic eye of the historian it loses some of its legendary proportions, it remains nevertheless a truly big and important campaign.

Here are some of the facts, many of them gathered since the end of the war and reconciled where possible with German records. Over 3,300 bombers from the Eighth Air Force and more than 500 from the Fifteenth attacked the main POINTBLANK targets. These forces dropped a total of almost 10,000 tons of bombs—a scale of attack roughly equal to that of the Eighth Air Force during its entire first year of operations. Losses, though heavy, were less than had generally been anticipated. USSTAF planners were prepared to accept losses of as many as 200 heavy bombers on a single day's operation. The Eighth actually lost some 137 heavy bombers in the entire six days' campaign, the Fifteenth 89—an over-all average of about 6 per cent. Fighter sorties in support of the heavy bomber missions amounted to approximately 2,548 for the Eighth Air Force, 712 for the Ninth, and 413 for the Fifteenth. Total fighter losses were 28. A rough estimate of crewmen lost, including those killed in action, missing, and seriously wounded, would be 2,600.<sup>38</sup> In addition to the weight of attack delivered by the American forces, mainly in connection with visual bombing of specific industrial targets, the RAF made five heavy raids against cities containing priority POINTBLANK targets: Leipzig,

Stuttgart, Schweinfurt, Steyr, and Augsburg. Some 2,351 of its aircraft dropped 9,198 (U.S.) tons of bombs for a loss of 157 heavy bombers,<sup>39</sup> about 6.6 per cent. This figure, slightly higher than that of American losses, is most interesting in the light of earlier estimates of the relative costs of day and night bombing.

The scale of these coordinated operations was thus big enough in all reason. It is more difficult to estimate their effect on the enemy with equal exactness because it cannot be done entirely on a quantitative basis. Certain general conclusions seem warranted, however. The U.S. Strategic Bombing Survey, after ransacking German sources, estimated that the 4,000-odd tons of bombs dropped on targets in the aircraft industrial system alone damaged or destroyed 75 per cent of the buildings in plants that at the time accounted for 90 per cent of the total German production of aircraft. The immediate reaction in the industry was one of consternation, we are told. The German authorities, whose plans had hitherto rested on unduly optimistic foundations, now apparently for the first time showed signs of desperation. As a result of the bombing, the aircraft industry received in late February a formal order to disperse its plants. That order, of course, merely intensified a policy begun locally and unsystematically after that industry first came under daylight bombing attacks in the second half of 1943. Also the bombings helped to precipitate a crisis in the over-all organization of aircraft production which culminated in the shifting of responsibility from Goering's Air Ministry to a special agency operating within the Albert Speer Ministry of Armaments and Munitions. In short, the February bombings had the effect of galvanizing the aircraft industry into feverish action.<sup>40</sup>

Thanks in part to that activity, directed as it was with considerable resourcefulness, the effects of the February bombings were substantially mitigated. Damage, moreover, proved on more careful investigation to have been proportionately less severe in the vital category of machine tools than to buildings; in fact a very high percentage of the former was salvaged. Dispersal was especially successful in the airframe and final-assembly branch of the industry (the one singled out for priority attack) since it was possible to carry on most of the necessary operations in roughly constructed frame shelters, many of them well concealed in wooded areas. As a result of these several factors, aircraft production recuperated very rapidly. Interestingly enough, the



February bombings, heavy and accurate as they were, caused less total delay in aircraft production than did the relatively lighter and more isolated attacks conducted by the Eighth Air Force in August and October 1943. The latter are credited with causing a three-month delay in production—the former with only about two months' loss.<sup>41</sup>

Failure to take into account the phenomenal recuperability of the aircraft industry, especially in its airframe branch, led Allied intelligence agencies to overestimate the effects of the February bombing campaign. Reasonably accurate during 1943, Allied estimates of German fighter production became after February 1944 grossly optimistic. The average monthly production of German single-engine fighters during the last half of 1943 was 851, as against Allied estimates of 645. For the first half of 1944, on the other hand, actual production reached a monthly average of 1,581, whereas Allied intelligence estimated only 655.<sup>42</sup>

Allied estimates were even further off in dealing with the antifriction-bearing industry. In this instance the original estimates, on the basis of which that industry had been selected for top-priority bombing, had been too optimistic. Ball bearings were vital enough to the aircraft industry. But they were too well cushioned in the production process: basic stocks were too large, the pipelines in the aircraft industry too well filled, and the possibility of economy too great for even the most successful bombing of the bearing plants to affect final aircraft production appreciably. Furthermore, owing to the vigorous policy of dispersal which has been mentioned before, the Schweinfurt plant had nowhere near the importance it had possessed in 1943.<sup>43</sup>

Unquestionably the Big Week derived much of its importance from these errors in intelligence. Yet it must be remembered that the February bombings did deny many hundreds of aircraft to the enemy at a time when they were badly needed and could probably have been brought into effective use against the Allied invasion of Europe. The fact that the Germans suffered only a temporary setback in their overall program of aircraft production is less important than that they lost a significant number of planes at a critical point in the air war and that, at the same critical juncture, they were forced to reorganize and disperse the entire industry. According to the U.S. Strategic Bombing Survey, the February campaign would have paid off even if its only effect had been to force the enemy into an intensive program of dis-

## THE ARMY AIR FORCES IN WORLD WAR II

persal. For that program not only accounted indirectly for much wasted effort and production loss; it also left the industry vulnerable to any serious disruption in transportation. The dispersal policy did, in fact, defeat itself when Allied bombers subsequently turned to an intensive strategic attack on transportation.<sup>44</sup>

Moreover, the effect of the Big Week on German air power was not restricted to bomb damage. Indeed, there is reason to believe that the large and fiercely fought air battles of those six February days had more effect in establishing the air superiority on which Allied plans so largely depended than did the bombing of industrial plants. Total USSTAF claims of enemy aircraft destroyed amounted to well above 600, with more than a third of these victories credited to the fighter escort and roughly another third to the bombers of the Fifteenth Air Force, which enjoyed no long-range escort.<sup>45</sup> It is impossible at this time to get from enemy sources an exact check on these figures, and it may be impossible for all time to do that, but available German records do indicate, if allowance is made for inevitable duplications, that USSTAF claims were not far off.

GAF records by agreement with the United States at the close of the war went to Great Britain, where the unavoidably tedious analysis of the full record by the Historical Branch of the Air Ministry is as yet incomplete. However, certain figures, though still unreconciled, provide informative clues as to the critical character of the air battles of early 1944. The historical section of the German high command, in compiling cumulative combat losses for the West (including the Reich) from the time of the invasion of Russia in June 1941, showed a total of 2,581 fighter planes lost up to January 1944 and the loss of an additional 307 during that month. Losses in February jumped to 456, of which number only 65 were night fighters, the type directed chiefly against the missions of the RAF. The initial cumulative entry for March, moreover, shows by comparison with the closing entry for February a discrepancy of 77 additional losses in the category of single-engine fighters, and thus the total for February may well have been 533 planes. The total for the month of March rises to 567, of which 94 were night fighters.\* A bound record (26FX-36a of the high command), which is stamped with a security mark indicating it was compiled for the information of the high command alone, charts total

\* QM Collection of the OKL 6th Abteilung.

aircraft losses, beginning with January 1944, at intervals of approximately ten days as follows:

10 Jan. 1944	..... 355	29 Feb. 1944	..... 545
20 Jan. 1944	..... 335	10 Mar. 1944	..... 514
31 Jan. 1944	..... 661	20 Mar. 1944	..... 552
10 Feb. 1944	..... 508	31 Mar. 1944	..... 777?
20 Feb. 1944	..... 388		

The same source indicates that 433 flying personnel were killed in February 1944, that 341 were reported missing, and that 277 had been wounded. Preliminary Air Ministry studies based on German records (AHB 6, No. 132 and AHB 6, No. 133) show the following very tentative monthly totals for all theaters:

	<i>Aircraft Destroyed</i>	<i>Losses from All Causes</i>
January 1944	..... 1,050	1,311
February 1944	..... 1,501	2,121
March 1944	..... 1,591	2,115

Losses on the Russian front are listed, respectively, as 168, 466, and 431. It will be difficult to reconcile all of these figures, and it is not always possible to determine the exact basis on which the original statistics were compiled, but they do agree in their testimony to an upturn, possibly even a sharp upturn, in attrition as of February 1944 and to results even more disastrous for the following month.

Strong confirmation for such a conclusion is found in the abrupt change which occurred in GAF strategy after February. Although still capable of the stoutest kind of local resistance on occasion, the enemy now refused to commit himself to a policy of full-scale opposition to the daylight bombing campaign. He would send up only token resistance to some missions and then concentrate as large a force as in earlier months against a particular operation. At other times the GAF would try no more than to gain a local superiority by sending overwhelming numbers against one unit, especially a unit that had in some way become separated from its fellows or was left without adequate escort.<sup>46</sup> In short, the policy was one of conservation of strength and it conceded to the Allies the vital point of air superiority.

Responding to long-awaited opportunities, Allied commanders pressed hard their every advantage, and for the first time in many months looked beyond the "intermediate" objective of defeating the GAF to schedule systematic attacks on other inviting targets.<sup>47</sup> No longer were bombing missions scheduled and routes of flight selected

with an eye to avoiding enemy defenses. Instead, in March it became deliberate policy to use every device that might force the GAF into combat.<sup>48</sup> Fighter escort, which hitherto had been held down to close support of the bombers, now was increasingly cut loose from strictly defensive assignments with orders to seek out and destroy the foe.<sup>49</sup> And as the role of escort became thus primarily an offensive one, the extension of fighter range made it possible to send great fleets of escorted bombers all the way to Berlin.

### *Berlin*

During the last days of February and the first days of March, the Eighth Air Force because of the weather had to confine its activities to a few short-range missions against CROSSBOW installations on the French coast and to a couple of pathfinder expeditions, one to Brunswick and one to Frankfurt. But on 4 March 1944 the Eighth for the first time bombed Berlin.

Hitler's capital had been listed in the directive of 13 February\* as a peculiarly suitable target for operations by both the British and the American strategic bombing forces (the latter employing radar technique as needed) "whenever weather or tactical conditions are suitable for such operations and unsuitable for operations against the primary objectives." The purpose of attacks on Berlin was not merely to destroy the important industries located in the area, such as the ball-bearing plants at Erkner, nor even to shake enemy morale, although it was obvious that the Germans could hardly avoid some discouragement at the thought of both RAF and AAF attacks against their capital. It was hoped that the German fighters would react quickly to any threat to Berlin and would in the ensuing air battles suffer heavy losses. This hope had initially embraced overcast and night attacks against other important industrial areas as well, but the attacks on Brunswick and Frankfurt brought out something less than full-scale opposition. Bad ground weather undoubtedly helped to keep the German fighters down but could not entirely explain the weakness of the opposition encountered after 25 February. It having been assumed that the operations of the Big Week had greatly reduced the importance of the top-priority aircraft and antifriction-bearing factories, it became correspondingly more important to force a higher rate of attrition on the GAF in being. And if there was any target for which the GAF would fight, surely that target was Berlin.

\* See above, pp. 27-28.

Consequently, as soon as it was apparent that the intensive campaign against the aircraft and bearing industries could be suspended for the time being, USSTAF headquarters planned to turn the Eighth Air Force as rapidly and with as heavy force as possible against Berlin. It hoped to launch a visual attack against the V.K.F. antifriction-bearing plant at Erkner and the Robert Bosch A.G. in the Klein Machnow suburb of Berlin, makers of specialized electrical equipment for aircraft and military vehicles. Should neither of these plants be open for visual bombing the Friedrichstrasse section of Berlin was to become the objective for pathfinder-led forces, since its large and important railway facilities offered an especially suitable PFF target.<sup>50</sup>

The decision to undertake an intensive bombardment of Berlin implied a new confidence on the part of the American air command in the ability of the long-range fighter escort to take the heavy bombers to distant and well-defended targets. And, in fact, the Berlin campaign of March 1944 marked an important milestone in the development of the long-range fighter. Since its first use in the theater as escort on combat missions in December 1943, the P-51 had rapidly demonstrated its unique suitability for this purpose. Operations during January, in which the limited number of P-51's then available were able to give target support to the bombers on all their important missions, further confirmed the feeling that this plane was the answer to the long-range escort problem.<sup>51</sup> Since January, the range of the P-51 had been extended. Without external tanks that aircraft could escort to a point approximately 475 miles from base, a distance roughly equal to the maximum escort range of the P-47 equipped with two 108-gallon auxiliary wing tanks. In March it was demonstrated that the P-51 with two 75-gallon wing tanks could escort to a point about 650 miles from base, with two 108-gallon tanks it could reach the then unheard of escort range of 850 miles.<sup>52</sup> Long-range escort, which of recent months had been recognized by all as the bottleneck of the daylight strategic bombing campaign, was now a reality. More of the P-51's were needed, especially in the Fifteenth Air Force, which had to go through bitter enemy opposition during February without them; but they were operating by March in sufficient numbers to protect some of the Eighth's largest daylight bomber formations even over the most distant targets.\*

\* At the end of March 1944 there were operating in the Eighth Air Force, and in addition to the Ninth's 354th Group, three groups—the 4th, 355th, and 357th—with 140 P-51 planes completely operational.

On 3 March the bombing force had been briefed for Berlin targets and directed to use either visual or overcast techniques as the situation warranted. But the bombers ran into steadily deteriorating weather as they flew over the North Sea. Over Jutland Peninsula cloud tops extended to 28,000 feet and, together with dense and persistent contrails, made formation flying almost impossible. Most of the combat wings therefore abandoned the mission. A few units bombed Wilhelmshaven and various other targets of opportunity.<sup>53</sup>

The effort made on 4 March again proved none too successful. One of the fourteen combat wings of bombers managed to get through or around the clouds and bomb the Klein Machnow suburb of Berlin, but the rest of the force once more either had to turn back or bomb targets of opportunity in the Ruhr. The single combat wing that flew on to Berlin was escorted effectively in the target area by one P-51 group and some units of another. As it neared the target area it was attacked aggressively by thirty to thirty-five single-engine German fighters, which constituted the only serious opposition encountered by the bombers throughout the mission. One P-51 group which failed to make contact with the bombers sighted a force of nearly seventy enemy aircraft in the Berlin area, but the latter refused to close with the American fighters. Losses suffered that day by both bombers and escort resulted probably more from the bad operating conditions than from enemy action. The combat wing (in this case only twenty-nine planes) that bombed Berlin began what looked like a promising visual attack on the Bosch plant through a break in the clouds, but it was forced to continue the run by radar, and no serious damage appears to have been done to that establishment.<sup>54</sup>

The mission of 4 March is significant chiefly because it was the first time American forces had bombed Berlin, but that fact, in its moral effect, was important. Nor was that effect confined to the enemy. The London *Evening Standard*, in a leading editorial headed "Allies over Berlin," spoke hopefully of the increased scope of integrated Anglo-American bombing and saw in this first trip of the Americans to a target long held in high regard by the RAF "a sign of the unshakeable comradeship" of the American and British peoples. German propagandists, who had spread wild rumors of political cleavage, had been given "a resounding answer to all such rattle."<sup>55</sup>

Two days later the American bombers returned to Berlin. This time visual conditions appeared likely and the bombing forces were again

given the Erkner bearing plant, the Bosch electrical equipment plant, and, in addition, the Daimler-Benz Motoren GmbH at Genshagen, twenty miles south of Berlin, producer of the engines used in the latest type FW-190's and Me-410's. In case of overcast, all formations were accompanied, as usual, by pathfinders. In all, 660 aircraft attacked, dropping a total of 1,626.2 tons of bombs, both high explosive and incendiary. Overcast conditions and the attempt to make use of uncertain visual opportunities tended to split up the bomber forces and confuse the aimings with the result that bombs were scattered here and there, mostly within the greater Berlin area but few near any of the high-priority industrial targets.<sup>56</sup>

In sharp contrast to their experience on the 4th, the bombers ran into exceedingly bitter and effective opposition. Despite almost continuous escort by successive relays drawn from fifteen Eighth Air Force fighter groups and four groups from the Ninth Air Force, the bombers sustained intensive attacks by a larger force of enemy fighters than had been encountered since the Big Week. Many of them were twin-engine aircraft, about half of which were night fighters. The appearance of the latter for the first time in several weeks was explained by the fact that the RAF had not been active over central Germany for several nights. The bomber force lost sixty-nine aircraft, most of them to enemy fighter action, although the number lost to anti-aircraft fire was larger than usual. Eleven of the escorting fighters were also shot down. Bomber crews claimed ninety-seven enemy destroyed; the escort fighter pilots claimed eighty-two.<sup>57</sup> It is impossible with available enemy records to support claims so high as these, but it is clear that both sides lost heavily in a fierce and important air battle.<sup>58</sup>

Clearly also, the GAF could still offer serious resistance. Yet it was just such air fights that the American commanders hoped to provoke, confident as they were in the ability of their airmen to impose a ruinous wastage upon the enemy. If their confidence rested in part on claims still chronically inflated, despite every effort to distil the truth from them, it nevertheless reflected what was coming to be one of the most important facts in the air war: the actual air superiority of the Allies. Berlin, the city the Germans appeared willing to defend at high cost, retained its high priority for daylight attack by heavy bombers escorted by increasing numbers of long-range P-51's.

On 8 March, two days after this heavy air battle, the Eighth Air

Force had its first chance to bomb targets in the Berlin area totally without the aid of radar equipment. Again the main objective for visual attack was the Erkner bearing factory. This time the bombing was heavy and reasonably accurate. A total of 462 aircraft dropped 300.4 tons of high explosives and 762.8 tons of incendiaries over the target area. Some 68 bombers were forced because of difficult maneuvering at the target to bomb elsewhere. The bearing plant at Erkner sustained heavy damage as a result of seventy-five direct hits by high-explosive bombs on buildings and an unascertainable, but doubtless equally large, number by incendiaries. The plant was out of operation entirely for a considerable period of time.<sup>59</sup>

Although there was nothing about the weather on the 8th to inhibit the German fighter defenses, and, despite the fact that the bomber force had as on both previous Berlin missions flown the shortest and most direct course across Germany, fighter opposition was much weaker than on the 6th. It was especially weak in the twin-engine aircraft which had taken such a large part in that earlier action. Undoubtedly the losses sustained by the Luftwaffe on the 6th and the strain imposed by the repeated bombing of central German targets on the already overburdened enemy pilots held many units on the ground. But it must also be remembered that the bombers on the 8th enjoyed the most complete long-range escort yet assembled. Four groups of P-51's, numbering 174 aircraft, supported the bombers on the last leg of the penetration flight, throughout the target area, and for a considerable distance on the withdrawal. A record total of 1,015 American fighters took off for escort duty that day, of which 891 received credit for sorties. The bomber force lost, in all, 37 planes out of 590 credited with sorties. The escort lost 17, but claimed 87 of the enemy. Strong forces of Ninth Air Force B-26's escorted by RAF Spitfires bombed airfields in Holland, their attacks timed in such a way as to embarrass the fighter units stationed in the west just at the time they would be preparing to intercept the bombers both on penetration and withdrawal. It is doubtful, however, whether these diversionary missions did much to weaken the enemy line of defense which was becoming established well to the east, in the Dümmer See area of Germany.<sup>60</sup>

The Berlin mission of 8 March, coming as it did close on the heels of two other attacks on the capital, forced the German propagandists to use all their resourcefulness. The sight of compact and orderly forma-



tions of American heavy bombers flying in clear sky over the city could not but have made a deep impression on the Berliners. We have Goering's word that the appearance of American long-range fighters over Berlin was even more disturbing to the military. That, he told interrogators on one occasion, was something he had never thought possible. But it was the tight formations of heavy bombers that had first of all to be explained. On 13 March the Berlin papers, responding to what was evidently a general decision in the propaganda ministry, finally broke silence. The *Berliner Boersen-Zeitung* declared: "If the inhabitants of the capital were surprised that, despite the heavy defenses and heavy losses, isolated enemy formations reached the capital in formation, it must be remembered that this need not be interpreted as a sign of strength at all." From the *Voelkischer Beobachter* came the additional answer: "If occasionally they fly in a clear sky without at the moment being pursued by the dreaded German fighters, only the layman is fooled, and then only for a few minutes. . . . In their case the closed drill formation is not a sign of strength."<sup>81</sup>

Eighth Air Force bombers made only one more trip to Berlin and its environs during the remainder of March. The consistently bad weather which had blanketed central Europe since the third week in February made even pathfinder missions to the capital impracticable until 22 March, when the Eighth once more set out for the Berlin area. This time they intended if possible to bomb the Heinkel aircraft plants at Oranienburg and the Bayerische Motorenwerke at Basdorf, maker of engines for FW-190's. But the chances of a visual bombing run were not too good, and all formations prepared as an alternative to bomb the Friedrichstrasse section of Berlin itself by pathfinder. Some units tried to bomb visually, but the greater weight of attack was made by overcast methods. The enemy fighters reacted only on a very limited scale, despite weather conditions reasonably good for purposes of interception, and it is doubtful whether the fighters were responsible for more than 1 or 2 of the 12 bombers lost out of a force of 669 flying sorties. The rest went down as a result of accident or antiaircraft fire. Such fighters as did attempt to intercept carefully avoided the American escort, which was unable to register a single claim against the enemy in the air.<sup>82</sup>

If the weather discouraged further attacks on Berlin, it proved equally discouraging to any other high-priority enterprise during the last three weeks of March. For the most part, the Eighth was forced

to fall back on fairly large pathfinder missions to the old familiar industrial centers: Frankfurt, Brunswick, Wilhelmshaven, and Münster. Brunswick, with its important aircraft industries, sustained three such attacks, and Frankfurt, two. Occasionally, when conditions were unfavorable for activity over Germany, the Eighth would dispatch limited forces to assist in the bombing of CROSSBOW targets on the French coast. Twice it was decided that pressure on the GAF under such circumstances could best be maintained by sizable precision attacks against a number of airfields in France. During few of these missions, to either France or Germany, did the bombing force encounter serious enemy fighter opposition. When, as in the case of the missions on the 16th and 18th to the aircraft factories in southern Germany, the Luftwaffe chose to make a fight of it, the reaction was limited to certain phases of the penetration flight and to the target area.<sup>63</sup> It was on 18 March that the Eighth Air Force made its only visual attack on the aircraft factories since the Big Week, in one of the two predominantly visual attacks against German targets during the entire month of March.

For all these limitations, it had been a month of the utmost activity for the Eighth Air Force, which operated on twenty-three days during the month, and on thirteen of those occasions may be said to have operated at maximum strength. But the month's activities fell far short of the intensive and selective February attacks on the high-priority POINTBLANK objectives. The missions that were run kept the German war machine under constant pressure, but it was not the kind of pressure the American strategic bombing experts hoped to be able to apply. It was not concentrated at those points which Allied intelligence, on grounds not always too sound, believed vital to the enemy war effort.<sup>64</sup>

As for the Fifteenth Air Force, it was unable to contribute significantly during March to the furtherance of POINTBLANK, unless its frequent attacks on Italian airfields might be considered an indirect contribution to the general battle of attrition being fought with the GAF. After its very effective participation in the Big Week, the Fifteenth returned almost exclusively to the bombing of marshalling yards, bridges, and airdromes in Italy. The rate and scale of its operations increased, owing largely to the availability of three new heavy bomber groups—the 459th, 460th, and 463d, all of which became operational during March—but it was seldom able to get across the

Alps and failed to attack the high-priority targets in southern Germany. Partly to blame was the land campaign which continued to be critical, but the weather in Italy itself was not good for flying during March—missions were canceled on eighteen days—and the principal handicap to strategic operations over Germany was the solid bank of cloud that hung a great deal of the time over the mountains between the Fifteenth and its German objectives and which the heavy bomber formations repeatedly found impossible to fly over, under, or through. Although a radar-bombing program was being worked out in Italy, no H<sub>2</sub>X missions were as yet possible. The Fifteenth was also in bad need of long-range escort, as had been demonstrated by the high rate of loss sustained in the February missions to Regensburg and Steyr. But the force was prepared to accept these losses if an opportunity for a visual attack against a priority POINTBLANK target presented itself.<sup>65</sup>

The contribution made by the Fifteenth to the defeat of the GAF during the early months of 1944 was not confined, however, to the few missions flown to CBO targets in Germany. Partly in connection with the Italian ground campaign and partly in an effort to press the counter-air campaign, the Fifteenth had for example on 30 January dealt a serious blow to the enemy air arm in Italy by a mission against airfields and repair depots in the Po Valley. So skilfully was the work of the escort fighters coordinated with that of the bombing forces that large numbers of the enemy were destroyed either in the air or on the ground. After this date, and to a large extent as a result of such quasi-tactical operations as the one just mentioned, air opposition to strategic day operations within Italy virtually ceased.<sup>66</sup>

The March operations, particularly those of the Eighth Air Force, marked in many respects a turning point in the air war. It became fully apparent during this month that the GAF had lost the advantage it had maintained so successfully from the fall of 1943 to late February. When escorting fighters were present the Germans showed a marked disinclination to tangle either with the bombers or with the escort. When, as happened on one or two occasions, notably on 18 March, an error in timing left the bombers for a while without fighter protection, the Germans made clever and devastating use of the opportunity.<sup>67</sup> The Luftwaffe could still hit, and hit hard; but it was no longer capable of that sustained counterattack which had at one time so nearly frustrated the entire CBO. From this point on, the rate of

loss to enemy aircraft suffered by the Eighth Air Force tended sharply to decrease.

Antiaircraft fire, on the other hand, tended to become more dangerous. Always a major threat, it had nevertheless accounted more for reparable battle damage than for bombers shot down. Since January, however, the German ground defenses had been steadily reinforced, so that by March the daylight bombing forces were facing a greatly increased volume of flak, much of which was directed with improved accuracy. According to Field Marshal Wilhelm Keitel, Hitler himself after the fall of 1943 became convinced that flak was the only possible defense against air attack. The improvement in antiaircraft was obviously meant to compensate for the decreasing effectiveness of the GAF,<sup>68</sup> and by the late spring of 1944 flak had come to be responsible for more of the losses sustained by AAF bomber forces than were the German fighters.<sup>69</sup>

This fact made both the Eighth and the Fifteenth pay close attention to their defense against flak. It was often impossible to avoid flak areas, especially when the distance to targets deep in Germany required a more or less direct course. Nor was it possible to do more than had already been done in the way of high-altitude flying and evasive tactics. It was, however, possible to reduce the size of formations, especially now that the need for concentrating maximum fire against attacking fighters had decreased. By so doing, a smaller target could be presented. This tactic was being worked on in the late spring of 1944. It was also possible to increase the use of radio countermeasures. Beginning in October 1943, the countermeasure known as Carpet had been employed, and in December 1943 Window was used for the first time. The object of both devices was to jam the enemy's radar so that he could not make use of automatic gun-laying equipment. During the period covered by this chapter, however, the Eighth Air Force, which was doing most of the experimental work in the use of these countermeasures, had not enough equipment, nor was it able to make enough use of it to be very effective. Flak continued throughout the summer of 1944 to be the major defensive concern of the daylight bombers.<sup>70</sup>

### *Final Estimate*

On 1 April 1944 the Combined Bomber Offensive reached its legal end and the U.S. Strategic Air Forces passed from the control of the RAF chief of air staff, acting as agent for the CCS, to that of the

supreme Allied commander, although the transfer was not formally effected until 14 April.<sup>71</sup> In a very real sense, of course, the month of April 1944 marks the beginning of a decisive phase of the CBO, for only then did the Allied bombing forces undertake those paralyzing attacks against the sources of Germany's oil supply and against her transportation system which, according to most German authorities, eventually came as near as was necessary to that "fatal" weakening of the German war economy envisioned by the CCS at Casablanca in January 1943. But the Combined Bomber Offensive had found its official place in the pre-invasion strategy in the form of a four-phase plan for operations extending from April 1943 to 1 April 1944,\* and the termination of that period of time demands at this point some attempt to estimate the over-all accomplishment.

The CBO Plan had provided for systematic attack against a wide variety of key war industries, but it had also embodied the principle that first the enemy's main lines of strategic defense would have to be breached. In other words, it had been considered necessary that the enemy's submarine fleet and his air force be defeated before his vital industries could be bombed, and these two objectives accordingly had been placed at the top of the priority list of Eighth Air Force targets. It was in this sense that the one had been made an "intermediate objective second to none in priority," and the other had received top place in the listing of primary objectives. Much time and effort had gone into a campaign against the submarine pens and yards until, with the summer of 1943, the enemy submarine fleet had suffered defeat at the hands of agencies other than the Eighth Air Force. This left the German Air Force in undisputed possession of first priority, and from June 1943 to April 1944 the counter-air offensive continued to represent the major effort of the American bombers. Indeed, the crucial question as to the effectiveness of the Combined Bomber Offensive will be answered if it can be determined how successful the U.S. strategic bombing forces were in their campaign to defeat the Luftwaffe.

Other aspects of the CBO effort by the American daylight bombers prior to 1 April 1944 can be dealt with summarily. The antisubmarine offensive was a misdirection of effort, and one for which AAF leaders were not primarily responsible. Occasional shrewd blows at basic industries such as the bombing of the synthetic rubber works at Hülse in June 1943 and of the light-metal industry at Heröya, Norway, in

\* For discussion and evaluation of that plan, see Vol. II, 348-76.

July of that year, though very damaging, were too isolated to be decisive in the long run. The rest of what one might term this miscellaneous effort had the principal virtue of making the Germans reach down deeper into their considerable reserves of productive capacity, materiel, and manpower. But it also helped rouse them belatedly to the threat involved in the bomber offensive.

Less easily dismissed are the series of concentrated and heavy radar-bombing missions against such important industrial centers as Frankfurt, Ludwigshafen, and Bremen. Essentially area bombing attacks, they fall under the same criticism to which the entire policy of area devastation, as distinct from the selective or the so-called precision type of attack, has been subjected.<sup>72</sup> Any destruction of life or property doubtless makes things more difficult for an enemy; and the area bombing policy unquestionably helped to cut through a thick cushion of excess energy and productive capacity that protected the German economy. These operations also served to force a continuing diversion of the enemy's resources to purely defensive effort and thus helped to cut down his offensive potential. But the results are hard to measure and there are other difficulties including those which bear on the moral issue—an issue that would be raised repeatedly by the AAF itself in objection to later proposals for diversion of its effort from selective to area bombardment.\*

What, then, of the visual and more or less accurate attacks launched by the American strategic forces prior to 1 April 1944 against German air power? On 6 June 1944, General Eisenhower was able to say to the invasion forces under his command, "If you see fighting aircraft over you, they will be ours."<sup>73</sup> As a matter of fact, Lt. Gen. Werner Junck, commander of German fighter defenses in the invasion area, later admitted that on D-day he had on hand only 160 aircraft, of which but 80 were in operational order, and that during the ensuing month he was furnished for his critical area reinforcements amounting only to 600 planes.<sup>74</sup> In other words, SHAEF was able to count on air superiority during the entire invasion operation. Because it was just that situation that the strategic bombing forces had been laboring since June 1943 to achieve, the answer to the question stated at the beginning of this paragraph would seem to be clear.

And so it is. The GAF had suffered decisive defeat. That defeat was brought about by attrition of the German fighter forces in the air and

\* See below, pp. 284, 638-40, 726-28, 733.

on the ground, by the consequent deterioration in quality of the German fighter pilots, and by attacks on German aircraft production which caused delay in the expansion of the German fighter force. Allied air superiority thus gained was maintained throughout the European war by the combined efforts of the RAF and USAAF through continued attrition, through destruction of the sources of aircraft fuel, and through disruption of the GAF system of supply, repair, and dispersed manufacturing facilities by attacks on the entire transportation network.<sup>75</sup> Just before the invasion of Normandy the growing power of AEF had helped to clinch the initial victory,\* but that the issue already had been settled by the strategic forces is clearly written in the inability of the GAF to defend even the Fatherland after February. In an analysis of the causes of Germany's defeat in the air, Air Marshal Sir Norman H. Bottomley in August 1947 concluded that "in the building up of a situation of air superiority which was an absolute prerequisite of the projected land assault of Europe, the greatest contribution made by any force was that made by the Strategic Air Forces, and particularly by those of the United States."<sup>76</sup>

Clear as these general conclusions are, the story of the defeat of the GAF remains a very complex one. While it is not the purpose of this history to tell it in detail or retrace the ground thoroughly surveyed by various agencies, especially the U.S. Strategic Bombing Survey, some of the problems, paradoxes, and enigmas involved in it bear re-sketching—if for no other reason, in the interests of a clearer understanding of what strategic air power can and cannot do.

Most baffling of all at first glance is the fact that the German aircraft industry continued to expand throughout 1943 and most of 1944 despite the severe and accurate pounding given it by daylight bombing forces. To be sure, it suffered two serious setbacks. The raids of the summer and fall of 1943 are estimated to have caused as much as three months' loss of production; those of February 1944, a total of two months. To the Allied strategists, accurately informed about damage to plant buildings if not to the inner workings of the factories,<sup>77</sup> it seemed at the time that the GAF must certainly be on the decline from sheer inability to replace its losses.<sup>78</sup> After the 1943 raids, however, the German fighters not only maintained their front-line strength but added to it, becoming by 1944 a more serious threat than ever to Allied operations of all sorts. After the February 1944 attacks, their ability

\* For the operations of the Ninth Air Force, see below, pp. 121-26 and Chap. 6.

to oppose daylight bombing missions tended rapidly to deteriorate, and this fitted Allied expectations, but there was to be a surprise after the termination of hostilities. Investigation of German production records revealed the astonishing fact that, despite the staggering blows delivered by the Allies in February, aircraft acceptance figures for single-engine aircraft rose rapidly until September 1944.<sup>79</sup> A chart showing both this increase and the rising weight of bombs dropped on the industry up to April 1944 would picture this paradox graphically—and quite misleadingly.

The increased production of fighter aircraft in 1944 was in reality part of a huge program of expansion begun in 1943. As a result of Germany's early and easy victories and of a curiously shortsighted and optimistic forecast of military needs, Hitler and his staff had allowed the air arm to take a relatively low priority in the arms programs governing production early in the war, a decision supported by refusal to believe the accurate reports of rapidly accelerating British and American aircraft production. Allied intelligence on the contrary tended before 1943 very naturally to believe that the Germans were producing far more planes than was actually the case. Only in September 1942 did the German high command approve a program of substantially increased aircraft production, and as Germany began to feel the rising air strength of the Allies, a greatly enlarged production program was worked out in April 1943. In answer to the rising tempo of the CBO, the Germans greatly enlarged that program in August 1943 and again in October of that year. By February 1944, the time of the heaviest attacks against the industry, these planned programs were on the point of producing maximum results. Pipelines were full. Some dispersal of plants had been successfully carried out. The industry was humming after a winter during which the weather had granted it relative immunity from heavy attack.<sup>80</sup>

The February bombings, damaging as they were, served also to redouble efforts to promote aircraft production and thus to stimulate the industry. The Speer ministry, the new authority in charge of that industry and one fully alive to the urgency of the situation, ordered dispersal on a grand scale, made use of the still considerable reserves of unused plant capacity and equipment (the industry had at least 100 per cent excess in this respect before the inauguration of the CBO), diverted labor and materials in short supply from less critical activities, and even employed the tactics of political terrorism in order to increase



production. What the total production for 1944 would have been but for the bombing must remain a matter of conjecture. But it is with this huge program of expansion in mind that the effectiveness of the bombing attacks must be estimated.<sup>81</sup>

It must also be borne in mind that the production figures are not reflected in any proportional increase in the enemy battle order, which is the crucial datum. According to figures compiled by the U.S. Strategic Bombing Survey from German sources, a total of 25,860 single-engine fighters were accepted from production in 1944. Of this total a large percentage seems to have represented aircraft repaired after battle damage. Such, at any rate, is strongly suggested by a document (*Auswertung der Einsatzbereitsch der fliegenden Verb. vom 1 August 1943 bis November 1944*) now in the custody of the British Air Ministry and picked up at Berchtesgaden at the end of hostilities with the high classification common to files of the enemy high command. Its figures are compared with the USSBS totals in the following table:

USSBS Single-engine Acceptances	Fighters of the Jagd Type		
	Newly Built (neubau)	Repaired	
Jan. ....	1,315	1,162	237
Feb. ....	1,016	794	320
Mar. ....	1,377	934	373
Apr. ....	1,696	1,016	456
May ....	1,907	1,380	384
June ....	2,177	1,704	596
July ....	2,627	1,875	671
Aug. ....	2,779	1,798	676
Sept. ....	3,031	....	....
Oct. ....	2,735	....	....
Nov. ....	2,776	....	....
Dec. ....	2,424	....	....

It is readily apparent that the totals for the two right-hand columns compare very closely with those given at the left. The Germans wrote off an aircraft as lost when it was damaged by 60 per cent and classified the plane as damaged when injuries were estimated at 10 to 60 per cent. USSBS studies indicate that losses of single-engine fighters in front-line units came for the year to about 8,500 and that an additional 8,000 planes were damaged in excess of 10 per cent. According to the same source, the German order of battle in that category increased from 1,500 to no more than 2,200 during the year.<sup>82</sup> Certainly the Luftwaffe as a fighting force seldom gave Allied analysts reason to doubt the accuracy of estimates of German production during 1944

which turned out to be much smaller than the official German figures.\*

One answer to this problem lies in the supply and quality of German pilots. No matter how many aircraft were produced they were of no possible use unless men were available to fly them. This appears to have been the weakest point in the entire German air situation. The bottleneck within this bottleneck was the training program. It has been discovered that, again as a result of too optimistic an estimate of requirements, the German high command found itself in need of a substantially increased flow of pilot replacements in 1943. Pressure was consequently put on the fighter training schools to speed up their program. But the training of pilots requires aviation fuel; and Germany did not have enough leeway in this respect to allow the schools to be prodigal in their gasoline consumption. In fact, it became difficult for the schools to obtain enough for a minimum program. They could, therefore, follow two alternative courses: either fall short of the required replacements or cut hours of training so that fuel allocations would be sufficient to produce the required number of pilots. They chose the latter policy, with the result that pilots entered combat increasingly ill-trained. Faced with thoroughly trained American and British pilots, these replacements fought at a disadvantage, which helps explain the increasing rate of attrition imposed on the GAF. The consequent rise in the demand for replacements simply completed the vicious cycle.<sup>83</sup>

It was, however, only in the spring of 1944, in March to be specific, that the deterioration in quality of the German pilots first became really apparent. Before that date the GAF had always been able to maintain a sufficient number of experienced pilots in their main line of defense to give the Allied attackers stiff battles, not to say a few resounding defeats. But the course of events was working progressively

\* *Auswertung der Einsatzbereitsch der fliegenden Verb.*, cited above, offers interesting evidence as to allotments to combat units during the summer months of high production. Luftflotte Reich, which was almost wholly concerned with defending Germany against Allied heavy bombers, received in June 520 Me-109's and 237 FW-190's, in July 387 Me-109's and 137 FW-190's, in August 272 Me-109's and 167 FW-190's. Luftflotte 3, which faced the Allied forces in France and Belgium, received in June 485 Me-109's and 267 FW-190's, in July 283 Me-109's and 229 FW-190's, and in August 177 Me-109's and 211 FW-190's. The same source indicates, however, that Luftflotte 3 had available and in a state of readiness in June 287 single-engine fighters and 89 night fighters. In July the figures were 244 and 404, respectively. For August 324 single-engine fighters are listed and for September 296, but no figures are given for either of these months as to the number of night fighters. This source shows strength for Luftflotte Reich as follows:

June	287 SE fighters,	103 TE fighters,	and	322 night fighters
July	311	" 257	"	102 "
Aug.	273	" ...	"	418 "
Sept.	420	" ...	"	665 "

against the Germans and for the Allies. The attack on oil resources began in the late spring and summer of 1944. The German high command was then shown the full extent of its mistakes, for its pilots, whose training had been skimped in an effort to save oil, were unable to make use of the huge production of aircraft to stop the destruction of the remaining oil supply.<sup>84</sup>

This pilot problem again calls attention to the importance of the air fighting during the spring of 1944. It was as a result of the air battles, especially those of the Big Week, that the GAF was for the first time forced to admit defeat. Except for the last quarter of 1943, the German fighter force had been suffering a steadily increasing number of losses since the beginning of the CBO. The vast majority of those losses, and almost the entire increase, occurred on the western front and in defense of Germany's industrial heart.<sup>85</sup> By March the ability of the GAF to defend the Reich and engage in combat on anything like equal terms with Allied bombers and fighter forces had passed its marginal point and was steadily deteriorating whereas the capabilities of the Allies were improving. If the German losses sustained during this critical period were less than claimed by the American fighter pilots and bomber crews (Goering said they were usually only about one-third as large as the claims),<sup>86</sup> the fact remains that the GAF was losing an increasing number of planes and pilots. The GAF was swamped by a force superior both in numbers and in quality. If it was not destroyed—and it continued in fact to be capable of occasional bursts of extreme energy—it nevertheless suffered in February and March 1944 a significant defeat.

The principal credit for this defeat in the air has rightly been given to the American long-range fighter escort, but it is also true of course that the long-range fighter force could not by itself have carried the battle to the enemy. It was in a frantic effort to defend the industries of the Reich from the heavy bomber that the GAF had been given high, if belated, priority in production and reorganized into an almost exclusively defensive force. The German pilots whenever possible avoided combat with the escort fighters. The Allied victory in the air in early 1944, important as it was, must be considered in the last analysis a by-product of the strategic bombing offensive.

It is difficult, however, to escape the conclusion that the air battles did more to defeat the Luftwaffe than did the destruction of the aircraft factories. Recognition of this fact must not, of course, lead the unwary to overlook the effects of that destruction. It has been pointed

out above that the February bombings deprived the GAF of a substantial number of fighter planes at a time when they were badly needed and that in forcing the German aircraft industry to expedite dispersal of its factories they caused considerable indirect loss of production and, what is even more important, left the industry extremely vulnerable to any dislocation of transport facilities. When that dislocation finally came about as a result of the concentrated attack on transportation, it contributed more than anything else to the complete breakdown of the aircraft industry. The 1943 attacks, especially considering the weight of effort applied, were even more effective, because the industry had not at that time begun serious dispersal and was consequently more vulnerable to precision attack. Finally it must be remembered that the German fighter forces lost the decisive air battles of early 1944 in an effort to protect those industries from bombing. Theirs was a desperate effort prompted by what the German high command certainly considered a desperate peril.

Hindsight nevertheless searches for the answer to certain troublesome questions. Was a campaign against the fighter factories and ball-bearing plants the most effective use of strategic air power during the pre-invasion phases of the CBO? If, despite the bombings, the aircraft industry in fact expanded beyond the point where its products could be put effectively into battle—if, in other words, the bottleneck existed not in production but in trained pilots—how much good was done by merely delaying that production program? Since oil proved in the long run to be the Achilles heel of the Nazi war machine, and since the entire chemical complex surrounding the production of synthetic oil has been found to have constituted probably the most vulnerable objective in the enemy economy, might oil not have been attacked profitably at an earlier date—possibly in place of the all-out campaign against the aircraft industry, certainly in place of that against the ball-bearing industry? Would the GAF have reacted just as vigorously to an attack on oil and chemicals as it did in defense of those latter industries? The answers to these questions as to all “what would have happened if” questions will always be open to some debate; nor is it the function of this chapter to answer them. The opinion has, however, been expressed in an earlier section of this history\* that, had Allied intelligence understood how closely integrated were the oil, synthetic rubber, and the chemical industries, how vulnerable a target system that complex presented, and how far-reaching would have been the effects of substantial

\* See Vol. II, 362-63.

damage to it, the weight of the CBO might have been turned in that direction at an earlier date, possibly with decisive effect. The results ultimately achieved by the attack on oil might have appeared much sooner. There is little doubt, moreover, but that the GAF would have reacted as fully to such a campaign as to the attack on the aircraft industry, and would have suffered as decisive a defeat in the air as it actually sustained in defense of that industry.

Even within the top-priority aircraft industry there is reason to doubt the wisdom of placing airframes above aeroengines as the preferred objective. In this instance, however, it must be borne in mind that the choice of airframes was dictated in part at least by the necessity of producing quick results. By 1944, especially, the short time remaining before OVERLORD forced the Allied air planners to think in terms of denying the enemy planes coming off the assembly line in the immediate future rather than to plan a campaign against the earlier stages of aircraft manufacture which might cut off the flow of planes six months later. If the criticism of this choice is valid, and it is the testimony of most German authorities that it is,<sup>87</sup> it applies particularly to the 1943 phases of the bomber offensive rather than to the final pre-invasion phase and to the operations of the Big Week.

Faulty intelligence also accounts in part for a serious failure in conducting the daylight offensive. Generally speaking, follow-up attacks were not made soon enough after initial successful bombings. German industrial authorities testified that they feared more than anything a series of heavy attacks timed in such a way as to subject a plant to renewed damage before salvage reconstruction or dispersal could be successfully accomplished.<sup>88</sup> This is particularly true of the attacks made in 1943 against the aircraft and antifriction bearing industries. There is in these instances, of course, another factor to consider: the Eighth Air Force either had not the strength or was not able to find favorable weather opportunities to follow up some of its initial successes. But it remains a matter of real doubt whether indecisive strategic bombing attacks against vitally important industries, no matter how successful they may be as single missions, are strategically wise. They merely tip the attacker's hand and prompt just the sort of countermeasures which, in fact, eventually secured the German aircraft industry from the worst direct effects of bombing.

This conclusion raises another problem of importance in evaluating the pre-invasion phases of the daylight bombing offensive. Through most of 1943 the Eighth Air Force did not have enough strength, either

in bombers or (more serious) in long-range escort to do the job assigned to it. Its efforts were often for that reason scattered and indecisive. Nor did the Fifteenth Air Force prior to April 1944 provide the reinforcement its creators had had in mind. That was not entirely the fault of the air planners. The ground campaign in Italy sapped much of its strength. But operations from Mediterranean bases failed to provide the hoped-for release from weather restrictions. Weather over the Alps and over the priority south German targets turned out during the winter months to be quite as bad for visual bombing missions as that encountered by the Eighth Air Force. Moreover, coordinated attacks by the two forces, that simultaneous pounding of the enemy from two directions about which so much was said in the planning discussions, proved, except in a very general sense, an illusion. The Big Week witnessed the first of such coordinated missions actually carried out, although on several earlier dates they had been planned. No further coordinated operations were attempted before April. After that date plans for closely coordinated operations lost much of their urgency. The GAF no longer constituted a problem of overwhelming importance, and the two daylight bombing forces could plan their operations relatively free from the tactical need of splitting the enemy air defenses. That the creation of a strategic force to operate from Italy paid large dividends is conclusively demonstrated by the brilliant campaign begun in April against the Ploesti oil refineries. But the fact remains that the Fifteenth Air Force was not able to contribute as significantly to the pre-invasion phase of the CBO as had been expected.<sup>89</sup>

So much for the shortcomings of the American strategic bombing effort in this pre-invasion phase of the CBO. Because they require careful analysis, sometimes of factors that have only recently come to light, they take more pages and thought than the successes. They may also prevent some observers from seeing the larger and relatively simpler fact that the daylight bombing offensive did succeed. True, it failed to achieve all the objectives set forth in the original CBO Plan; the task of defeating the Luftwaffe became finally an all-absorbing one. Possibly, too, it might have achieved even this "intermediate" objective more efficiently. But in conclusion let the reader bear well in mind that by 1 April 1944 the GAF was a defeated force, and that in bringing about its defeat the bomber crews and fighter pilots of the Eighth and Fifteenth Air Forces played a large, indeed a decisive, part.

## CHAPTER 3

\* \* \* \* \*

### *PLAN FOR OVERLORD*

AS THE Combined Bomber Offensive approached the terminal point set in the original plan, the question of how next the heavy bombers should be employed—a subject already under vigorous debate—took on a new urgency. Paralleling the discussion of objectives and targets was an equally pressing problem of command and, as would be expected, the two questions were intimately joined one to the other. Time, if nothing else, argued that the issues must soon be settled, for there remained only two months, more or less, between the termination of the CBO and the invasion of France. The overshadowing importance of that impending invasion naturally held first place in the minds of all leaders and governed the conclusions they reached.

#### *Plans for the Invasion*

Planning for OVERLORD itself had assumed a more urgent aspect after the unavoidable interruptions occasioned by the shuttle of new commanders between the Mediterranean and the United Kingdom at the turn of the year. General Eisenhower's headquarters was located on the southern outskirts of London at Bushy Park, Teddington, where USSTAF also had its headquarters.\* To each of the various subordinate headquarters Eisenhower assigned the responsibility for working out detailed plans pertinent to its own organization, but tendencies toward departmentalization of the work were overcome by a remarkable spirit of informal cooperation which received every encourage-

\* Because of a mischance more comical than serious, the U.S. authorities entrusted with construction of headquarters for SHAEF confused Bushy Park and Bushey Heath. The latter, which had been chosen for the site, was close to Leigh-Mallory's headquarters while Bushy Park was miles away. (See Sir Frederick E. Morgan, *Overture to Overlord* [New York, 1950], pp. 256–57.)

ment from the supreme commander.<sup>1</sup> Ground force plans were devised for the most part at Gen. Bernard L. Montgomery's headquarters in St. Paul's School, London, where air and naval officers were usually on hand to represent their commands. AEAFF's pre-invasion study was performed at Leigh-Mallory's headquarters in Stanmore and in Norfolk House in London where a staff remained until May 1944, when all air planning machinery was finally transferred to Stanmore.<sup>2</sup> Officers of the Ninth Air Force participated in AEAFF planning, drew up programs peculiar to their organizations, and kept in touch with logistical and ground force agencies. An AEAFF group eventually known as the Combined Operational Planning Committee studied air support for the invasion while so-called planning syndicates specialized on such subjects as beach appreciation, weather, security, intercommunication, build-up, and many others.<sup>3</sup>

While the strategic air forces maintained liaison officers with other commands, it was not until General Spaatz complained on 15 April 1944 about the exclusion of USSTAF from OVERLORD planning that relations became close.<sup>4</sup> That situation and the inconvenient geographical separation of the planning agencies were probably the major weaknesses of the pre-invasion establishment.<sup>5</sup> Also, ground force commanders sometimes found it awkward to deal with the several parallel air organizations.<sup>6</sup> Nevertheless, the various headquarters and their staffs performed their exacting labors on schedule and always in the utmost secrecy. The extraordinarily high degree of cooperation that prevailed among the two nations and the several services was a matter of sober pride and of great credit to all concerned.

The COSSAC study OVERLORD\* remained the fundamental document for invasion planning. That plan had outlined an initial assault by three divisions on the Caen-Bayeux sector of the Normandy coast to take place about 1 May 1944. Then would come the seizure of Cherbourg and the Brittany ports and, after sufficient build-up of forces, the capture of Paris and the Seine ports. After that the Combined Chiefs of Staff would have to set new objectives, for OVERLORD was not of itself an operation designed to win the war. The mission of the air forces was to overcome the disadvantages inherent in an overwater attack on a well-protected coast. So essential was this function that air considerations fairly dictated the choice of the invasion site to some point between Flushing, in the Netherlands, and

\* See above, p. 3.



Cherbourg. In this area the Pas-de-Calais sector clearly offered the maximum opportunities to exploit Allied air capabilities, particularly where the short-range Spitfires were concerned. But the Pas-de-Calais was the best defended region precisely because it was the most vulnerable. Also, Allied ground forces would find it difficult to expand from the beaches there to ports as distant as Antwerp and Le Havre. Second best from the air point of view, but far more promising for the ground forces, were the beaches near Caen. This was the least defended area within Allied reach, the soil was suitable for quick airfield development, and it was near the excellent port of Cherbourg.<sup>7</sup> All in all, the majority of invasion planners from early 1942 on had regarded the Cotentin beaches as the most inviting point for the assault, notwithstanding their considerable distance from English bases. And there was no reason afterward to regret this choice.

A favorable air situation above the invasion routes and the landing beaches was one of the essentials laid down for OVERLORD in COSSAC's plan. This required, first of all, a degree of success by the POINTBLANK campaign in reducing drastically German aircraft production and in compelling the enemy to concentrate his surviving fighters in the Reich instead of deploying them to meet the invading forces. Attrition of the German Air Force might be expected from the almost daily missions into enemy territory which would exact their price from Me-109's and FW-110's that attacked the bomber fleets. But it would not be enough to choke off aircraft production and shoot down fighters, for by prudent hoarding the Germans still might possess 1,600 airplanes in May 1944 to contest the invasion.<sup>8</sup> Thus, all airfields within a 150-mile radius of Caen should be so disrupted that the Germans would be forced to operate from bases as far back from the invasion beaches as the English airfields from which the Allies would fly. In addition, the enemy's control and air warning systems would have to be dislocated by jamming and by the bombing of key installations.<sup>9</sup> Aside from such specific considerations, COSSAC's planners were fully aware that the disintegration of Germany's cities and industries as a result of the air offensive would be a major if indirect contribution to OVERLORD.<sup>10</sup>

Given a favorable air situation, the invasion of Normandy would become possible, which it would not be if the enemy enjoyed air supremacy. COSSAC sketched out many important tasks for Allied air power shortly before and during the Channel crossing. Air recon-

naissance would have to be thorough. When D-day came, troop carriers would transport two-thirds of one airborne division to seize Caen and near-by river crossings in the initial assault.<sup>11</sup> Bombers would conduct a short but very heavy attack on beach defenses just before the landing craft touched France.<sup>12</sup> A vast umbrella of Allied fighters would protect the crammed LST's and the crowded beaches from enemy air forces. During the remainder of D-day bombers would operate against hostile communications and airfields and would delay and harass land reinforcements.<sup>13</sup> Allied signal units would get on the far shore as quickly as possible,<sup>14</sup> and air engineers would begin the construction of landing strips so that fighter-bombers could furnish direct support to the ground forces.<sup>15</sup> In all, the COSSAC plan of 1943 envisaged most of the air tasks for OVERLORD and provided a pattern for more detailed planning. Important changes were made in the light of new conditions and altered concepts, but the excellence of this basic invasion plan was widely appreciated.<sup>16</sup>

After the principal officers who were to lead the invasion took up their duties in England they insisted upon several significant revisions of the COSSAC plan. Since his first reading of the outline, General Eisenhower had thought that the three-division assault was insufficient and that the initial landing was in too much of a column and on too narrow a front.<sup>17</sup> Other top leaders also held this view, and at the first formal meeting of the supreme commander and his commanders in chief on 21 January 1944 it was agreed to take steps to strengthen the assault.<sup>18</sup> Accordingly, Eisenhower secured permission from the Combined Chiefs of Staff to employ five divisions in the initial landing. This meant that the front would have to be extended to the Ouistreham beaches in the east and the Varreville beaches on the Cotentin Peninsula in the west. Leigh-Mallory readily accepted the change, even though he thought it would become necessary for the air forces to provide two canopies of fighters instead of the single one contemplated in the original plan.<sup>19</sup>

But differences of opinion arose when the ground commanders demanded that airborne forces drop behind the Varreville (UTAH) coast line prior to the seaborne assault in order to block German reinforcements and counterattacks and to facilitate American advances in the direction of Cherbourg. Leigh-Mallory predicted that casualties in such an attempt would be prohibitive, later estimating that perhaps three-fourths of the paratroops would be lost.<sup>20</sup> Churchill, Eisenhower,

Bradley, Montgomery, and Brereton were not convinced by the air commander in chief and vigorous efforts were undertaken to procure more air transports to strengthen the airborne operation. It was several months before final plans for the massive drop could be devised, and Leigh-Mallory's opposition to the Varreville assault did not abate. On another airborne issue the air commander in chief had his way. This was in abandoning the COSSAC proposal to drop British paratroops into Caen; instead, bridges on the Caen Canal and the Orne River, but not the town itself, would be seized by this force.<sup>21</sup> Meanwhile, Headquarters AAF submitted to Eisenhower over General Marshall's signature a proposal to employ several divisions in a gigantic drop not far from Paris just before and on D-day to divert the Germans from the beachhead and to function strategically as a type of mass vertical envelopment.\*<sup>22</sup> But General Eisenhower, along with Montgomery and Bradley, regarded the plan as too ambitious and felt that such a force might be immobile if it landed deep in France before the coast line was secured.<sup>23</sup> With some regret the AAF discarded the project.

The five-division assault scheme underscored that war-long problem of the western allies: the shortage of landing craft. One method of obtaining more LST's was to postpone D-day from 1 to 31 May, thus allowing more time for them to arrive from British and American shipyards. That this delay would mean risking less favorable weather conditions for OVERLORD was a disadvantage General Eisenhower felt it necessary to accept.<sup>24</sup> And, of course, there was the danger that the Russians might be disconcerted. Another way to help fill up the deficit in landing craft was to withdraw LST's from the projected operation ANVIL, the invasion of southern France supposed to be launched about the same time as OVERLORD. The British strongly urged the cancellation of ANVIL all along,<sup>25</sup> but the Americans were willing only to postpone the southern invasion about sixty days. The delay of OVERLORD and ANVIL (subsequently DRAGOON) was a help to the air forces, which had more time for training and rehearsals, strategic bombing, and pre-invasion operations.

The re-evaluation of invasion problems in the light of the wider front and the later target date appeared in the Initial Joint Plan, NEPTUNE, of 1 February 1944. The code name NEPTUNE, inci-

\* General Morgan has indicated that the inspiration for this proposal traced in no small part to General Kenney's success with the airdrop at Nadzab in September 1943. (See this series, Vol. IV, 184-86; Morgan, *Overture to Overlord*, pp. 203-5.)

dentally, almost supplanted OVERLORD in theater usage; it denoted a more restricted phase of the operation, the Channel crossing and seizure of the beachhead, and also it applied to the Normandy area itself. Prepared by air, ground, and naval staffs, the Initial Joint Plan rounded out many details which had been omitted or vaguely treated in the COSSAC study, such as planning procedures, command organization, training exercises, beach studies, build-up and mounting of forces, and various other subjects. The definitions of air tasks were in general conformity with those set forth in the COSSAC document except that they were more precise.

In several instances, however, the Initial Joint Plan embodied altered conceptions of air force employment, reflecting the ideas of Air Chief Marshal Leigh-Mallory. One paragraph, which was promptly deleted, gave him control of strategic air operations in the weeks before the landing.<sup>26</sup> Furthermore, the bombing offensive against the Reich was implicitly subordinated to preliminary air activities in support of the invasion<sup>27</sup> because Leigh-Mallory was convinced that air supremacy would be won at the time of the landing and not by continuance of the CBO-type of operations. Then, the prominent place assigned in the Initial Joint Plan to air attacks on Hitler's secret-weapon installations<sup>28</sup> was not in accord with most AAF estimates of the danger itself and the probable effectiveness of such neutralization.\* Finally, the plan called upon the air forces to impose a general paralysis on the German railway system from the Atlantic coast to the Rhine.<sup>29</sup> Very extensive disruption would be necessary, for the network was thick and complex and the Germans had at their disposal abundant reserves in labor and rolling stock.

### *The Transportation Issue*

The proposal to reduce drastically the rail capacity of western Europe brought about a protracted controversy on the proper use of air power in support of OVERLORD. Only after an exhaustive examination of other possibilities was this program, the so-called transportation plan, accepted by General Eisenhower and finally implemented. The project involved diverting a large proportion of Eighth Air Force and RAF Bomber Command effort from strategic targets in Germany to pre-invasion objectives in France and Belgium. Perhaps it delayed the opening of the oil campaign which ultimately proved

\* See below, pp. 97-104.

so decisive that men wondered why it had not been begun sooner. For a time the transportation plan threatened to jeopardize the attainment of air supremacy before D-day. Also, it complicated the unsettled questions of control of the strategic air forces and required a painful decision with regard to civilian casualties in the occupied countries. Long after D-day, there remained the sobering question as to whether the results of the plan were commensurate with the cost in air effort and the ruin inflicted on French and Belgian cities.

There was no question about the need to cripple the railway system in France to the point where the Germans could not build up their forces by land as fast as the Allies could pour theirs in by sea. But the method for accomplishing this aim previously had been expected, in the COSSAC plan and in other pre-invasion proposals, to be interdiction: line-cutting, strafing, bridge-breaking, and the destruction of a few rail focal points—all part of the accepted pattern of isolating a battlefield.<sup>30</sup> Now, however, Leigh-Mallory was proposing a long-term program of attrition to wear down and ruin the enemy's railway capacity by attacks on rail centers in French and Belgian towns, attacks which would destroy rail yards, sidings, stations, sheds, repair shops, roundhouses, turntables, signal systems, switches, locomotives, and rolling stock. Through this plan he expected to produce a railway chaos in western Europe, and by concentrating on the repair organization the Allies could render the Germans helpless to recover from this destruction.<sup>31</sup> The authors of the transportation plan may have been several civilian specialists in the Air Ministry, notably Solly Zuckerman and E. D. Brant, who had been meditating about such a program for some time.<sup>32</sup> Or possibly it was Air Chief Marshal Tedder, Eisenhower's deputy commander, who had supervised a less ambitious campaign of this nature in the Mediterranean theater.<sup>33</sup> At any rate, Leigh-Mallory and Tedder were convinced by January 1944 that the transportation plan was vital to OVERLORD.

The plan took more definite shape in the meetings of the AEF bombing committee, where Leigh-Mallory, Brant, and Zuckerman discovered more and more advantages in it notwithstanding the frigidly unreceptive attitude of the British generals from SHAEF and the Eighth Air Force representative.<sup>34</sup> Zuckerman likened the railway network to a nervous system, damage to any part of which would affect the whole. He believed the attrition campaign would require ninety days and that it should bear most heavily on the routine rail servicing

centers in France and Belgium.<sup>35</sup> The advocates estimated at first that 33, then 40, later 79, and finally 101 railway centers would have to be bombed. A veritable railway desert would be the result! Even if all traffic were not brought to a standstill, what was left could be canalized so that it could be strafed by fighters or stranded by line cuts. Thus the Germans would be unable to bring reinforcements into Normandy; nor could they supply their troops that would be isolated there. Leigh-Mallory insisted that this method of paralyzing German transportation was far preferable to the conventional interdiction program, for the latter gambled too much on good weather shortly before D-day and might reveal to the enemy the proposed invasion site.<sup>36</sup>

An AEAF study on the employment of bomber forces in OVERLORD, produced on 12 February 1944, brought out more points in favor of the transportation plan.<sup>37</sup> Its statistics seemed to show that two-thirds of the railway capacity of western Europe was devoted to German military traffic. Any significant damage, therefore, would be calamitous to the enemy. Furthermore, the rail centers were accessible targets, most of them being in range of fighter escort and ground radar facilities. Nor were they large and resistant. Few of them covered as much as a 500-acre area, and an average of four 500-pound bombs per acre might suffice to turn a rail center into a heap of ruined trackage and equipment and burned-out facilities. That the transportation plan was within Allied capabilities seemed entirely likely. Between February 1944 and D-day bombers could drop some 108,000 tons of bombs, and transportation targets would probably require only 45,000 tons. Thus air effort would be available for a last-minute interdiction program, should it prove necessary, and for other target systems. But the only difficulty with respect to these calculations was the evident fact that the tactical air forces could not by themselves carry out the transportation program. Clearly, most of the tonnage would have to be delivered by USSTAF and RAF Bomber Command heavies, which would mean shifting them from strategic attacks on German industry to pre-invasion operations at a much earlier date than had been contemplated in any of the invasion plans.

General Spaatz and Air Chief Marshal Harris of RAF Bomber Command thus came into the picture. On 15 February 1944 the two commanders explored the implications of the transportation plan with Leigh-Mallory. Spaatz at once declared that the whole program was at cross purposes with his directives.<sup>38</sup> He felt sure that it would divert

the heavy bombers from vital POINTBLANK targets for a campaign of dubious value. Most important of all, he believed the transportation plan would endanger the winning of air supremacy before the landing,<sup>39</sup> for the offensive against German aircraft production was just then at its climax. Air Marshal Harris sided with Spaatz, for he thought that the best support Bomber Command could give to OVERLORD was to intensify its attacks on German cities. And he criticized the transportation plan in sharp terms, saying that it was based on a fallacy, the false assumption that interdiction would not be effective.<sup>40</sup> But Leigh-Mallory, who had once before aroused misgivings in Spaatz's mind with his opinion on the need for air supremacy in advance of OVERLORD,\* stood by his proposal. He made it clear that he intended for the strategic air forces to begin the rail center bombings under his own direction by 1 March 1944.<sup>41</sup>

Apprehensive that the destruction of German aircraft industries might be interrupted, Spaatz informed General Arnold, who replied that the transportation plan might have tragic consequences if it were implemented too early.<sup>42</sup> The USSTAF commander also warned General Eisenhower that a premature shift of heavy bomber effort from strategic targets in Germany to rail centers in France and Belgium might result in a battle for air supremacy over the beachhead on D-day.<sup>43</sup> The supreme commander was no less anxious than his air officers about assuring control of the skies before the landing, and he delayed his decision for more than a month. Meanwhile, the strategic air forces went ahead with their campaign against German aircraft production and won a momentous victory which, if not quite as overwhelming as it seemed at the time, nonetheless guaranteed Allied air supremacy for the rest of the war.

An imposing list of personalities and agencies opposed the transportation plan in February 1944, among them Churchill, Sir Alan Brooke, Portal, Doolittle, Fred Anderson, the Joint Intelligence Committee, the Ministry of Economic Warfare, and others. Their arguments were usually along the lines of demonstrating the superior effectiveness of interdiction to attrition in attacking a railway system and of pointing out the attractions of other target systems. Nor did the opponents of the plan overlook the point that a shattered railway system in France might subsequently hamper the advance of the liberating armies across that country. SHAEF circulated an analysis by a French agent

\* See above, pp. 5, 72.

who contended that the program would injure French civilian traffic far more than German military movements.<sup>44</sup> A committee composed mainly of British railway experts employed by the U.S. embassy in London came out emphatically in favor of a short-term interdiction program on the ground that only one-fifth of the French railway system was devoted to German military traffic<sup>45</sup> (as opposed to the AEA estimate of two-thirds and the postwar conclusion of one-third).<sup>46</sup> To wreak any serious interference upon German rail communications, the committee believed, some 500 rail centers would have to be demolished, and not the smaller number suggested by Leigh-Mallory and Tedder. At least half of those targets were large, well constructed, and generally difficult to damage. Other opponents raised the point that a rail center was the worst possible place to break a line, for repairs could be effected within two days at the most.<sup>47</sup> How much more effective and easy it would be to forego the attrition program altogether and seal off the Normandy area by interdiction, most of the arguments concluded, and to devote surplus bombing effort to worth-while campaigns. At one point the opponents of the transportation plan were so confident of winning out they considered how they could extricate Air Chief Marshal Tedder from his commitment to it without embarrassing him.<sup>48</sup>

Spatz's counterproposal for bomber support of OVERLORD came in the form of a "Plan for the Completion of the Combined Bomber Offensive," which he submitted to General Eisenhower on 5 March 1944. This study repudiated the transportation plan with exhaustive documentation,<sup>49</sup> showing how it involved an impossibly large undertaking and would not produce significant military effects in time to benefit the invasion. But the heart of the USSTAF plan considered positive means for injuring Germany. Now that the enemy's air force was broken, the strategic air forces could attack two other vital target systems that lay within reach for the first time, oil and rubber.<sup>50</sup> Maintaining that his calculations were conservative, Spatz held that the air forces could bring about a 50 per cent reduction in German gasoline supplies within six months.<sup>51</sup> From England heavy bombers could operate against synthetic petroleum plants in western and central Germany, and the Fifteenth Air Force could attack from its Italian bases the important crude oil refineries in Rumania and elsewhere in southern and central Europe. The effects of such bombings on German industry and troop mobility on all fronts would be so drastic that the enemy



high command might consider whether or not to oppose OVERLORD, or even to continue the war. Devoting first-priority effort to this oil campaign, the heavy bombers could police the German Air Force as second priority, attack rubber and tire industries as third, and, as a last resort, bomb rail centers in the Reich whenever bad weather shielded the primary objectives. Spaatz's program called for fifteen days of visual effort by the Eighth and ten days by the Fifteenth Air Force. After fulfilling it, the heavy bombers could turn their efforts to direct tactical support of the invasion under a plan which SHAEF, the Air Ministry, and USSTAF might devise.<sup>52</sup>

Full of promise as this bold proposal was, the transportation plan was winning adherents. Leigh-Mallory made much of the danger of waiting until shortly before D-day to interdict communications into Normandy; to take chances with the weather in carrying out a short-term program seemed to him an unjustifiable risk.<sup>53</sup> And the ground forces, of course, had to be assured of protection against German reinforcement of the invasion area. Somehow Air Chief Marshal Harris was won over to the transportation plan,<sup>54</sup> and he altogether opposed the USSTAF project to bomb oil production, which he at first took to be another of the panaceas so frequently pressed on the air forces.<sup>55</sup> General Brereton of the Ninth Air Force was in favor of the rail center program,<sup>56</sup> and RAF Chief of Air Staff Portal began to lean to the plan. Probably the most effective champion was the deputy supreme commander, Air Chief Marshal Tedder, who opposed Spaatz's oil program on the grounds that there was not enough time before D-day to damage production seriously and that the tactical air forces of AEF and RAF Bomber Command could not take effective part in such a campaign. On the other hand, he believed that all air forces could work together successfully in dislocating the railway system of western Europe to the point that German military traffic could scarcely move.<sup>57</sup>

USSTAF adduced further arguments in favor of an oil campaign and a brief interdiction program. It contended that the Germans needed only from fifty to eighty trains per day to move their reserves into the invasion area—a mere fraction of their capacity which would remain available no matter how many rail centers were destroyed. Spaatz stressed the success of interdiction in previous campaigns, and he predicted that the Germans would not even defend their rail centers, thus not allowing the Allies to deplete GAF fighter strength. As for Tedder's point that USSTAF, AEF, and RAF Bomber Command

could all operate in fulfilling the transportation plan, Spaatz rejoined that three wrongs did not make a right. Nor was he unmindful of the expected high casualties among friendly civilians who lived near the rail centers in occupied countries and the disadvantages of making the French railways difficult to use when the time came for the Allies to advance toward the Reich. Finally, he regarded it as most important to open the oil campaign promptly, since only fourteen plants were turning out 80 per cent of Germany's synthetic petroleum, most of which was used for gasoline. Those plants required no more bombing effort than a corresponding number of rail centers. Yet the loss of fourteen synthetic oil plants might be catastrophic to the Germans, who could easily spare fourteen rail centers.<sup>58</sup> Spaatz pressed his case with vigor and sent to the MTO for General Eaker, who strongly advised Eisenhower not to adopt the transportation plan.<sup>59</sup>

A decision had to be made. The differences of opinion arose from varying interpretations of experiences in Sicily and Italy and were derived from the same intelligence data on the European railway system. The divisions were not along national lines, nor of the RAF and the AAF, but, in Mr. Churchill's phrase, "criss-cross between them."<sup>60</sup> Several British agencies favored oil and interdiction, while others supported the transportation plan. Among the AAF generals in England considerable variance of opinion prevailed, and while Headquarters AAF tended to follow Spaatz's views, it declined to commit itself on the ground that this was a matter for General Eisenhower to decide.<sup>61</sup>

At a conference at WIDEWING on Saturday, 25 March 1944, all views on the issue were aired. Tedder supported Leigh-Mallory's proposal. Harris and Portal raised a few doubts but gave it qualified approval. General Eisenhower said he thought there was no real alternative; the transportation plan was the only one which offered a reasonable chance for the air forces to make an important contribution to the land battle during the first vital weeks of OVERLORD. General Spaatz made his final plea: the GAF would fight to defend oil installations but not the rail centers; an oil campaign would have decisive effects within six months, but the transportation plan could not be decisive within any measurable length of time.<sup>62</sup>

On the following day Eisenhower officially made his decision—in favor of the transportation plan. As he wrote General Marshall a few weeks later, he was convinced "there is no other way in which this tremendous air force can help us, during the preparatory period, to get

ashore and stay there."<sup>63</sup> In choosing this plan, however, the supreme commander left the way open for an early beginning of an oil campaign and the inclusion of an interdiction program near D-day. And, as will be seen, he settled the command organization for the rail center bombings in a way that pleased Spaatz, who agreed that, in view of all the factors involved, Eisenhower's decision was justified.<sup>64</sup>

A formidable obstacle remained before the transportation plan could go into effect. The British War Cabinet, and especially the Prime Minister, were appalled by the number of French and Belgian casualties likely to result when the rail centers were bombed. Some estimates ran to 160,000, and it was feared that disagreeable political and diplomatic reactions might ensue, that there would arise among the French a serious revulsion against Britain and America over what might seem to them a ruthless use of air power.<sup>65</sup> General Eisenhower gradually overcame the hesitations of the British cabinet and even of French officials by insisting resolutely on the sober military necessity of making a successful landing and driving the enemy out of France as quickly as possible.<sup>66</sup> On 7 May 1944, after a few bombings had been carried out, Churchill wrote the President that he was by no means convinced of the wisdom of the transportation plan.<sup>67</sup> But General Arnold and the War Department were resolved that Eisenhower should be left with freedom of action in the matter.<sup>68</sup> The transportation plan was to be regarded as one of the prices of liberation which, even with 10,000 casualties,<sup>69</sup> proved much less terrible than had been anticipated.

### *Command of the Heavies*

The question of fitting the strategic air forces into the invasion command lay in the background of nearly all air considerations that came up from time to time. Neither the American nor the British staff had changed its opinion since the discussions of November 1943.\* The U.S. Joint Chiefs were still determined to give General Eisenhower command of all air forces for the critical period of OVERLORD. The British still wished RAF Bomber Command to retain its semiautonomous position without falling under Eisenhower's control. Shortly after he arrived in England, General Eisenhower received a letter from General Arnold reminding him of the AAF's desire to do everything possible to bring the air forces under the supreme command.<sup>70</sup> In thanking Arnold for his support Eisenhower said he was "perfectly willing

\* See Vol. II, 737-38.

to avoid terms and language that might startle anyone," but he wanted full power to determine missions and priorities for all forces without having to negotiate in the heat of battle.<sup>71</sup> General Spaatz was entirely in favor of placing USSTAF at the disposal of the supreme commander; in fact, he had advocated such an arrangement when he first heard about OVERLORD.<sup>72</sup> And at lunch one day in January 1944 he and Tedder privately agreed that whatever organization was decided upon, they would conduct air operations in the way that had proved so successful in the Mediterranean campaigns—under Eisenhower's direction.<sup>73</sup>

During the early weeks of 1944 Prime Minister Churchill and the Air Ministry continued to resist American pressure to bring RAF Bomber Command into the invasion structure on the same terms as USSTAF. Bomber Command should assist OVERLORD at the critical period, of course, but otherwise it might operate as the British desired.<sup>74</sup> Another element in the situation was the attitude of Leigh-Mallory, who, as air commander in chief for OVERLORD, intended to play a considerable part in directing strategic air force operations; the imposing headquarters which he was assembling at Stanmore aroused concern at USSTAF that he might succeed.<sup>75</sup> Leigh-Mallory's ideas concerning air supremacy before the invasion and the bombing of rail centers evoked the reverse of enthusiasm in Spaatz, who strongly opposed endowing that officer with any significant degree of control over the Eighth Air Force.<sup>76</sup> Even the British were not anxious to confide their bombers to the air commander in chief.<sup>77</sup> The final settlement of the transportation issue on 26 March 1944 took into consideration Spaatz's wishes regarding the command structure for that program. Eisenhower stipulated carefully that Tedder and not Leigh-Mallory would direct the transportation campaign and that USSTAF and RAF Bomber Command would be parallel to AEF in its execution.<sup>78</sup>

That proved to be the pattern for adjusting the air command question: the equal stature of AEF, USSTAF, and Bomber Command within the supreme commander's organization. It was reached when Prime Minister Churchill yielded to Eisenhower's views after the latter threatened, as General Marshall reportedly had once said he would do under the circumstances,<sup>79</sup> to "go home" unless he commanded the air forces during the invasion.<sup>80</sup> With Churchill's opposition surmounted, Eisenhower, Portal, and Spaatz worked out an agreement

which placed the strategic air forces under the supreme commander with the understanding that Tedder would supervise OVERLORD air operations for SHAEF, that the security of the British Isles (against the robot-bomb and rocket threat)\* might take precedence over all air priorities, and that the command organization would be reviewed after the Allied armies were established on the continent.<sup>81</sup> These arrangements were acceptable to Headquarters AAF, although General Arnold took the precaution of adding a proviso which gave the Combined Chiefs of Staff power to review and approve the final plan for strategic air force participation in OVERLORD before it went into effect.<sup>82</sup> Lastly, a question of terminology arose. The British wanted to charge Eisenhower with "responsibility for supervising" air operations, while the supreme commander himself insisted upon the phrase "command of" so there could be no doubt of his right to control such operations.<sup>83</sup> The final wording of the directive, devised in Washington before Eisenhower's recommendation arrived, gave the supreme commander "direction of" air operations out of England.<sup>84</sup> Eisenhower began to exercise his new power on an informal basis by the last of March 1944,<sup>85</sup> and at midnight on 13/14 April 1944 he officially assumed control.<sup>86</sup>

Thus Eisenhower commanded or directed AEF (Ninth Air Force, Second Tactical Air Force, Air Defence of Great Britain and several assorted RAF groups), RAF Bomber Command, USSTAF (Eighth and Fifteenth Air Forces, with only the Eighth really under Eisenhower's direction), U.S. 1st Army Group, 21 Army Group, and Allied Naval Forces—altogether a most formidable aggregation of forces. Tedder coordinated the operations of the three air commands and supervised their strategical operations in support of OVERLORD. Actually, it seemed to some American officers, he enjoyed the enviable position of possessing authority without responsibility.<sup>87</sup> Leigh-Mallory was officially the air commander in chief for OVERLORD and chief of AEF; he was also allowed to supervise heavy bomber operations that were purely tactical. He was not to assume rigid control of the strategic air forces until 1 June 1944, and then only for a short time.

The command settlement was a successful compromise of various conflicting interests and points of view. Yet it imposed several awkward relationships on USSTAF. For example, while Spaatz and Tedder were close, only one American officer sat on Tedder's nine-man coun-

\* See below, Chap. 4.

cil for air matters. Thus USSTAF and Eighth and Ninth Air Force headquarters were sometimes overlooked in secondary matters.<sup>88</sup> The primacy in priority given the robot-bomb and rocket threat sometimes proved irksome to USSTAF. And there remained the disturbing AEF situation. The largest component of that organization, Ninth Air Force, was under Leigh-Mallory for operations and Spaatz for administration. A belated effort to reduce friction within AEF was made in May 1944 by assigning Maj. Gen. Hoyt S. Vandenberg as deputy commander. The Fifteenth Air Force in Italy was one of the twin pillars of USSTAF and therefore was responsible to Spaatz for strategic operations, but the MTO commander, General Wilson, had the power to put the Fifteenth on tactical tasks in the land battle if he declared an emergency; however, he used this prerogative with admirable restraint.<sup>89</sup> Finally, the Combined Chiefs of Staff granted authority under British pressure and over Spaatz's objections to permit the MTO commander to order heavy bomber attacks on political objectives whenever he thought such blows might do some good.<sup>90</sup> This meant in fact the bombing of the capitals of those nations in south-eastern Europe, Mr. Churchill's "Balkan jackals,"<sup>91</sup> which at that stage of the war always seemed to be tottering but would not fall.

Opinion in Headquarters AAF tended to be critical of the air organization for the invasion, although it was pleased that USSTAF and RAF Bomber Command had been brought under Eisenhower's direction.<sup>92</sup> General Arnold occasionally toyed with the idea of elevating Spaatz to a command which would embrace all U.S. air forces in Europe, thus giving him a position practically parallel to Eisenhower's except for the critical period of the invasion.<sup>93</sup> Early in 1944, Spaatz discouraged the proposal since Eisenhower asked him not to press it in view of the delicate negotiations then in progress with regard to Bomber Command.<sup>94</sup> Toward the end of April, however, after he had seen air units nominally under his control ordered on diverse missions by a half-dozen different headquarters, Spaatz informed Arnold that the full potential power of the American air forces was not being realized. Thus he privately recommended the "progressive integration of all U.S. air forces operating against Germany," to be effected after the invasion.<sup>95</sup>

This combination of the American air forces, a project often considered, was not to be achieved before the European war ended. There was no serious possibility of "marrying" the RAF and the AAF, for each possessed very large forces and was devoted to different operating

## PLAN FOR OVERLORD

methods. Also, American officers disliked serving under British command, an attitude which was undoubtedly reciprocated. But Spaatz thought it was imperative to free the air forces from all commanders whose primary interest lay in other directions than the air war.<sup>96</sup> Long before<sup>97</sup> and long after D-day<sup>98</sup> he contended that a properly conducted strategic air war would eliminate the need for the invasion by land forces, or at least reduce it to a mere occupational operation. Such an air offensive was not to take place, however; it had very early been determined to subordinate air power to the more conventional types of warfare, thus making the victory in the last analysis a land victory won with the support of the air forces. Both Spaatz and Arnold were reconciled to this situation and did their best to make things easier for Eisenhower at the time of his historic responsibility. Hence the AAF agreed to suggest no changes in the command structure until after the invasion forces were securely established in France and then, as it turned out, it was not disposed to revise the system at all.

The organizational machinery for the invasion was not really as unwieldy as it appeared, as Spaatz pointed out after V-E Day,<sup>99</sup> nor as tangled as it looked on charts. Actually, it functioned exceedingly well, not so much because of its structure as because of the good sense and proper spirit of top British and American commanders as well as the intense conviction all down the line that the invasion had to succeed. "It will, I think, be considerable time before anybody will be able," General Morgan has observed, "to set down in the form of an organizational diagram the channels through which General Eisenhower's orders reached his aircraft."<sup>100</sup> But reach them they did, and to good effect.

## CHAPTER 4

\* \* \* \* \*

### *CROSSBOW*

LATE in 1942 British intelligence received with disquieting frequency reports of German long-range “secret weapons” designed to bombard England from continental areas. Shortly before dawn on 13 June 1944, seven days after the Allied invasion of Normandy, a German pilotless aircraft designated the V-1 flamed across the dark sky from the Pas-de-Calais and exploded on a railroad bridge in the center of London.<sup>1</sup> A new era in warfare had begun.

After the V-1, which was essentially an aerial torpedo with wings, came the V-2, a twelve-ton rocket missile that reached a speed of nearly 4,000 miles per hour and, in contrast to the V-1, descended on its target without even so much as a warning noise. The first V-2 fired in combat exploded violently in a suburb of Paris on 8 September 1944; the second struck London a few hours later.<sup>2</sup> By the time of Germany’s collapse in the spring of 1945 more than 30,000 V weapons (approximately 16,000 V-1’s and 14,000 V-2’s) had been fired against England or against continental targets in areas held by the advancing land armies of the Allied forces.<sup>3</sup>

In May 1943, Flight Officer Constance Babington-Smith, a WAAF member of the Allied central photographic interpretation unit in London, had interpreted a small, curving black shadow on a photograph of Peenemünde, in the Baltic, as an elevated ramp and the tiny T-shaped blot above the ramp as an airplane without a cockpit. The V-1 had been seen and recognized by Allied eyes for the first time.<sup>4</sup> Almost simultaneously, at Watten on the Channel coast of France, Allied intelligence observed with profound curiosity the construction of a large and unorthodox military installation of inexplicable purpose. As throughout the summer other such installations were identified, their purpose became clear enough to cause an increasing weight of British and Ameri-



can air power to be thrown into the effort, often blind, to prevent the Germans from employing a new, mysterious, and nightmarish weapon.<sup>5</sup> To this effort was given in December 1943 the code word CROSSBOW,\* which thereafter was used to designate Anglo-American operations against all phases of the German long-range weapons program—operations against German research, experimentation, manufacture, construction of launching sites, and the transportation and firing of finished missiles, and also operations against missiles in flight, once they had been fired.<sup>6</sup> Allied CROSSBOW operations, begun informally in the late spring of 1943 and officially in December of that year, did not end until the last V weapon was fired by the Germans a few days before their surrender in May 1945.

### *The German V Weapons†*

Three new “secret weapons” of the first magnitude were introduced in World War II: radar, long-range missiles, and the atomic bomb. Of these weapons, the long-range missile was the only one first developed and exploited in combat by the Germans.

Military strategists had long dreamed of an “ideal” missile—one that could reach beyond the range of conventional artillery and that would prove less costly to manufacture and less complex to operate than the bomber aircraft.<sup>7</sup> Ironically, a clause in the Versailles Treaty which forbade the Germans to develop conventional military aircraft<sup>8</sup> impelled certain farsighted German militarists to consider the creation of long-range missiles powered by jet or rocket propulsion. The Allies, unhampered by any such restriction, seem to have given little thought after 1918 to the potentialities of long-range missiles. They had, it is true, experimented during the last years of the first world war with the idea of the remote control of conventional aircraft by mechanical and electrical devices, but after the Armistice only a few airmen retained an active interest in this type of long-range weapon.<sup>9</sup> A failure of imagination in some military quarters, together with insufficient funds, rendered the peacetime development of long-range missiles impossible, on any significant scale, in England or America.<sup>10</sup>

Even the German army appears to have waited until early in 1930

\* This choice of words has been attributed to Churchill as one suggesting “an obsolete, clumsy and inaccurate weapon.”

† The “V” designation originally meant *Versuchsmuster* (experimental type); interpretation of the “V” as representing *Vergeltungswaffe* (vengeance weapons) was a later addition by German propaganda agencies.

before taking a serious interest in the long-range missile as a military weapon.<sup>11</sup> Although intensive rocket research by German scientists and technicians had been under way since 1920, it was only after watching the experiments for a decade that the ordnance department of the German army absorbed a handful of ardent enthusiasts who initially had been more interested in rocket postal service between Berlin and New York and in trips to the moon than in developing new weapons of warfare.<sup>12</sup> In 1931 Capt. Walter Dornberger (later Major General) was placed in charge of a military rocket development program, and by 1932 an "A" series\* of military rockets was well under way.<sup>13</sup> Shortly after coming to power in 1933, Hitler visited the army's experimental rocket station at Kummersdorf, on the outskirts of Berlin,<sup>14</sup> but he was unimpressed and for nearly ten years remained skeptical of the importance of long-range rockets. Influential members of the German general staff, however, were deeply interested in the possibilities of long-range weapons. In 1934 Field Marshal Werner von Fritsch, commander in chief of the Reichswehr, was so impressed by a successful demonstration of a V-2 prototype that he gave Dornberger's experimental organization enthusiastic and effective support.<sup>15</sup> Von Fritsch's successor, Field Marshal Walter von Brauchitsch, gave even firmer support to the German rocket program.<sup>16</sup>

Military specifications for the V-2 were established in February 1936,<sup>17</sup> and from that time forward the German ordnance division was committed to rapid development and production of the V-2. Construction of the Peenemünde experimental station, which was undertaken jointly by the ordnance division and the Luftwaffe, began in 1937.<sup>18</sup> By 1939 more than one-third of Germany's entire aerodynamic and technological research was devoted to the hope of creating missiles capable, in the extreme, of bombarding New York City.<sup>19</sup> During the later years of the war integrated research and production activity on long-range weapons was in progress from the Danish border to Switzerland and from the coast of France to the Russian front.<sup>20</sup>

The first full-sized V-2 was launched in June 1942; the fourth, fired on 3 October 1942, achieved a fall on target at a range of 190 kilometers. In the previous April, General Dornberger—certain of the technical success of the new weapon—had laid before Hitler material and

\* In the German series designation for long-range military rockets, of which the V-2 was the fourth type, "A" stood for *Aggregat*, a noncommittal cover name meaning "unit" or "series."

operational requirements for firing 5,000 V-2's a year from the French coast. Hitler, with perhaps characteristic fanaticism, inquired if it would be possible to launch 5,000 V-2's simultaneously in a single mass attack against England. Dornberger informed Hitler that such an operation was impossible. He promised, however, to inaugurate a spectacular bombardment of London in the summer of 1943. Accepting General Dornberger's plan, Hitler issued orders for V-2 production and for the creation of a rocket-firing organization. Production of the V-2 commenced at Peenemünde. Plans were established for its manufacture in other parts of Germany and for construction of a chain of rocket-firing sites on the French coast.<sup>21</sup>

The Luftwaffe, its prestige still suffering from the Battle of Britain, found itself unwilling that Germany should be saved entirely by efforts of the army. An already overloaded experimental and production organization was called upon by Goering to produce a "retaliation weapon" to outshine, if possible, the massive, complex, and costly V-2 developed by army ordnance.<sup>22</sup> The flying bomb was conceived with much haste and uncommon efficiency; it was in full production less than two years after the initial experimentation began.<sup>23</sup> For its particular purposes in the war the V-1 proved to be a more efficient and successful weapon than the V-2, although it was a less spectacular mechanism.\*

Both weapons competed for Hitler's favor and their production interfered, in varying degrees, with the production of other essential materiel and weapons. The German war machine, already overburdened with factional conflict and lacking adequate centralization, suffered from the ensuing struggle between proponents of the two new weapons and in the subsequent vacillations of Hitler. Early in March 1943, Reichsminister Albert Speer, who belatedly had been placed in charge of all German war production, brought General Dornberger the news that Hitler had dreamed the V-2 would never land on England; his interest in the project was, accordingly, gone and its priority canceled.<sup>24</sup> Later in the month Speer, who was very high in Hitler's favor and could afford to act independently, sent the chairman of a newly created long-range-weapon development commission to Peenemünde to determine what could be salvaged from the V-2 program. Speer's emissary returned from Peenemünde bursting with enthusiasm for the project. Because he had some confidence in the V weapons and

\* See below, p. 543.

because he could afford the risk, Speer very carefully redirected the mind of Hitler to a revival of the V-2 program, with the result that Dornberger and Prof. Werhner von Braun, the technician chiefly responsible for creating the V-2, were ordered in May to report in person to Hitler. Assisted by motion pictures of V-2 take-offs and of target demolitions at ranges of 175 miles, Dornberger and von Braun succeeded in persuading Hitler to restore the V-2 production program, but only after the irreparable loss of at least two months' delay in consequence of the Fuehrer's dream.<sup>25</sup>

To General Dornberger, Hitler is reported later to have declared:

If only I had had faith in you earlier! In all my life I have owed apologies to two people only, General Field Marshal von Brauchitsch who repeatedly drew my attention to the importance of the A-4 [V-2] for the future, and yourself. If we had had the A-4 earlier and in sufficient quantities, it would have had decisive importance in this War. I didn't believe in it. . . .<sup>26</sup>

He had ordered the V-2 program restored on a basis of the highest priority. Plans for construction of the huge launching sites in France were tripled in scale and given great urgency. Under a plan drafted by Dornberger in April 1942 and expanded in May 1943, operations against London were to begin with a firing rate of 108 rockets per day, and this rate would be stepped up as production increased. The new target date for commencing operations against London was set for 15 January 1944, the date also fixed by the Luftwaffe for the initiation of flying bomb attacks.<sup>27</sup> The combined firing rates of V-1 and V-2 missiles, together with other long-range weapons in preparation but never used,\* would enable the Germans to throw some 94,000 tons of high explosives against England in a single month. Within a year after the beginning of operations, according to German estimates, it would be possible to bombard England at an approximate annual rate of one million tons of explosive,<sup>28</sup> which was roughly the tonnage dropped on a much larger geographical area by the Anglo-American bomber offensive in its most successful year.<sup>29</sup>

These high hopes received support from Willy Messerschmitt, who informed Hitler that German industry could, through an all-out effort, produce as many as 100,000 V-2's per month.<sup>30</sup> But even after May 1943 Hitler failed to resolve the conflicts arising from rivalries within the V-weapon program itself, to the detriment of plans both

\* Principally of a long-range artillery type for which elaborate firing installations were prepared on the French coast.

for the V-1 and the V-2.<sup>31</sup> Responsible German quarters continued to place varying interpretations on the utility of the weapon, with the high command showing a tendency to discount its importance.<sup>32</sup>

Though not ready on schedule the V weapon would be ready by summer of 1944, and well in advance of that date Allied circles knew genuine concern lest the Germans achieve one or all of the objectives set forth by proponents of the new weapon: postponement or disruption of the Allied invasion of the continent, cessation of the bomber offensive against Germany, a truce in consequence of a stalemate.<sup>33</sup>

### *The Need for a CROSSBOW Policy*

As early as November 1939 the British government had received reliable and relatively full information on German long-range-weapon activity, and as intelligence reports through the winter of 1942-43 brought increasing evidence of that activity, it became clear that German intentions, however fantastic they appeared to be, demanded evaluation. In April 1943, accordingly, Duncan Sandys of the British War Cabinet undertook a full study which resulted in the advice that a threat from German "secret weapons" should be taken seriously.<sup>34</sup> The RAF promptly inaugurated an aerial reconnaissance of continental areas that became with time the most comprehensive such operation undertaken during the entire war.\*

Particular attention was given to activity observed early in May at Peenemünde, a secluded spot on the Isle of Usedom in the Baltic Sea. It was on a photograph of Peenemünde that Flight Officer Babington-Smith first identified the V-1.† Full-scale reconnaissance of installations there continued, and it was decided early in July to send against Penne-münde a massive heavy bomber mission.<sup>35</sup> With Air Chief Marshal Sir Arthur Harris of RAF Bomber Command in personal charge of preparations, plans were made with the utmost care, and late in the evening of 17 August 1943, a day already made memorable by the Regensburg-Schweinfurt mission of the Eighth Air Force, 597 RAF bombers began the long run to the Baltic coast. The attack at Peenemünde began shortly after midnight. There is wide and perhaps irreconcilable variance in estimates of the success of this attack. Only this much can be

\* Between 1 May 1943 and 31 March 1944 nearly 40 per cent of Allied reconnaissance sorties dispatched from the United Kingdom were devoted to CROSSBOW. Ultimately, over 1,250,000 aerial photographs were taken and more than 4,000,000 prints prepared.

† See above, p. 84.

stated positively: 571 of the 597 aircraft dropped nearly 2,000 tons of high explosives and incendiaries in the general area of the Peenemünde installation;<sup>36</sup> more than 700 persons at the station, including one of the most valuable German rocket experts, were killed;<sup>37</sup> and some damage was done to experimental buildings, though none of the critical installations, such as test stands and the wind tunnels, seems to have been hit.<sup>38</sup> These were substantial, if not decisive, achievements. There were, however, two important consequences of the attack. The Germans had received full warning that massive efforts would be made to prevent or disrupt the use of their new weapons, and they proceeded to disperse V-weapon activity from Peenemünde, though there is good evidence that plans to transfer important production activities had been made before the attack.<sup>39</sup>

Ten days later, on 27 August, the Eighth Air Force sent out its first CROSSBOW mission—an attack by 187 B-17's on the German construction at Watten.<sup>40</sup> British intelligence estimated that the damage inflicted would require as much as three months to repair, but continued reconnaissance of the French coast revealed new constructions of a similar type, all in the Pas-de-Calais. In addition to the immense buildings at Watten, later described by General Brereton as "more extensive than any concrete constructions we have in the United States, with the possible exception of Boulder Dam,"<sup>41</sup> the British discovered large constructions under way at Lottinghem and Wizernes. In September, other constructions of the same magnitude were observed at Mimoyecques and Siracourt, and within a short time thereafter similar activity was revealed at Martinvast and Sottevast, on the Cherbourg peninsula.<sup>42</sup> Within five months' time (the Watten site had been discovered in May 1943), seven "Large Sites," as they came subsequently to be described, had been identified from which, it was believed, the Germans were preparing to fire rocket missiles against London and other British targets.\*

\* The large sites, which were mainly underground, embraced related but sometimes separate structures thousands of feet long, often with steel and concrete walls 25 to 30 feet in thickness. The connecting tunnels and underground chambers of the more massive of the large sites could have sheltered, it has been estimated, at least 200,000 people in a single site. It has been established that the Germans intended to quarter that many operating personnel in the seven large sites. Throughout the CROSSBOW operations the Allies generally assumed that these large sites were primarily associated with large rockets (V-2's). After inspection of the seven captured sites by an Allied mission in February 1945, it was concluded that Siracourt and Lottinghem (Pas-de-Calais) and Sottevast and Martinvast had been intended as storage, assembly, and firing sites for the V-1; that only Wizernes had been conceived

Throughout the fall and early winter of 1943 intermittent and light attacks by the Allies were dispatched to harass building activities at three large sites. The site at Watten was bombed on 30 August and 7 September in small raids by medium and heavy bombers of the Eighth Air Force. Mimoyecques was twice bombed in early November by the Second Tactical Air Force. The large site under construction at Martinvast received 450 tons from the same air force between 25 November and 2 December.<sup>43</sup>

Discovery of a second type of German construction on the French coast was made by aerial reconnaissance on 24 October 1943.<sup>44</sup> In response to reports from agents in the Pas-de-Calais a close photographic cover of the area around Yvrench-Bois-Carré revealed a series of concrete structures, the largest of which were two curiously shaped buildings, each nearly 300 feet in length, resembling gigantic skis laid on edge. The installation at Yvrench-Bois-Carré was designated as the "Prototype Ski Site." By the middle of November, twenty-one ski sites\* had been identified.<sup>45</sup>

As Allied reconnaissance of the French coast continued with unremitting effort a significant relationship among the ski sites became apparent: the alignment of all the ski sites in the Pas-de-Calais indicated an orientation directly on London. It was impossible for British intelligence to escape the conclusion that the closely integrated and rapidly growing network of installations was to be used for some type of concentrated long-range attack against the world's most populous city—and the heart of the staging area for the forthcoming invasion of the continent.<sup>46</sup> A few military and civilian analysts regarded the whole series of ski sites, together with the seven large sites, as a gigantic

as a site for assembling and firing V-2's; that the Mimoyecques site had been designed to house batteries of long-range guns of unorthodox design; and that Watten had been designed as an underground factory for chemicals used in firing both types of V weapons. Though Dornberger and von Braun agree in substance with the foregoing estimate, they do not give so precise a statement as to the original purpose of the seven large sites. The 1945 mission, it may be noted, had this to say after exhaustive analysis of the Watten site: "No real clue has ever been found." (See BAM [AHB], File 77 [reports].)

\* One hundred and fifty ski sites were projected and surveyed by the Germans. Of this number, 96 sites were brought to some stage of completion; 74 were more than 50 per cent completed; 22 were totally completed. Each ski site contained half-a-dozen steel and concrete structures, some with walls 8 to 10 feet thick; the two ski buildings at each site, constructed of concrete and steel, were nearly 300 feet long. The ski sites were, as Allied intelligence had quickly decided, intended as firing sites for V-1's.

hoax by the Germans, a deliberate fraud of the first magnitude to frighten or divert the attention and effort of the Allies from their attempt to invade the coast of France. General Spaatz, for example, was not convinced even in February 1944 that these installations did not represent an inspired German feint.<sup>47</sup> A larger number of scientists and technicians, however, were of the opinion the large sites were being prepared to launch huge rockets weighing as much as 100 tons and that the smaller ski sites were to send vast numbers of the Peenemünde pilotless aircraft, estimated to weigh as much as 20 tons, against the civilians of London and against troop and supply concentrations.<sup>48</sup> Rumor added other interpretations. The Germans, it was reported, were preparing to bombard London with huge containers bearing gruesome and fatal "Red Death"; the Germans were preparing to shoot enormous tanks of poison gas to destroy every living creature in the British Isles; the Germans, even, were preparing a gigantic refrigerating apparatus along the French coast for the instantaneous creation of massive icebergs in the Channel or for dropping clouds of ice over England to stop the Allied bombers in mid-air.<sup>49</sup>

Thus, late in November 1943, a year after the British had first received serious intimations of the existence of German long-range weapons, after more than six months' repeated observation of widespread activity unexplainable by any conventional military conceptions, and as new rumors of frightfulness daily reached England in the mounting flood of underground reports, there existed for the Allies three central facts: (1) the Germans were up to something on grand-scale proportions, whether fraud or threat; (2) there was no positive knowledge of what the Germans were up to, though some contemporary estimates later proved to be remarkably accurate; and (3) there was no concerted Allied policy for preventing the accomplishment of Germany's mysterious objectives.

It was, perhaps, impossible for the Allies to devise an entirely satisfactory policy in the light of the bewildering and uncertain intelligence concerning the threat and in view of existing commitments to POINTBLANK and OVERLORD. The Allies developed, therefore, a *series* of policies, all of which had the purpose of destroying or neutralizing the new threat to the safety of Britain and to the execution of OVERLORD. Measures commensurate with the scale of the German effort were first considered in Great Britain late in November 1943. Although at the first of the month the existence of only one



ski site and of seven large sites had been verified, the twenty-one ski sites identified by 12 November had been increased to thirty-eight by the 24th.<sup>50</sup> As the opinions of British intelligence on the capabilities of heavy rockets and pilotless aircraft were laid before the War Cabinet on 29 November, orders were issued for intensified reconnaissance and increased bombing of the chain of ski sites and for the creation of a central military agency to interpret intelligence and to devise and execute countermeasures.<sup>51</sup>

Bombing efforts against the array of existing ski sites could not, however, await the establishment of such a central agency. On the first of December, Air Chief Marshal Leigh-Mallory of the AEF and Air Marshal Bottomley, deputy chief of staff for air operations, sought the advice and support of General Eaker in his capacity as commanding general of the United States Army Air Forces in the United Kingdom. Eaker promptly indicated "complete agreement" with the British proposal that tactical air forces being assembled for use in OVERLORD should begin immediate attacks against ski sites more than 50 per cent completed, and he instructed General Brereton to alert the Ninth Air Force for the initiation of the proposed operations. On 3 December the British War Cabinet approved an AEF and Air Ministry plan for sustained attacks against ski sites. Several hours later, General Brereton received a directive to commence Ninth Air Force CROSSBOW operations with the highest priority.<sup>52</sup>

The intensified aerial reconnaissance, ordered by the War Cabinet on 29 November, was begun on 4 December. The whole of a belt extending southeastward 150 miles in width from London and Portsmouth was covered at a scale of 1:18,000. At the end of the first week's operations sixty-four ski sites had been identified, an increase of twenty-six sites over the number reported on 24 November. As the sustained reconnaissance continued, every foot of land in a sweep of territory reaching from Ostend through Bethune, Doullens, Neufchâtel, and St. Saens to Le Havre, as well as the entire northern half of the Cherbourg peninsula, was photographed from the air. The huge task of photography and analysis was largely completed by the third week in December and revealed, in addition to the seven large sites, a chain of ski sites, ten to twenty miles in width, extending more than three hundred miles along the French coast. Sites in the Pas-de-Calais were all oriented on London, those in the Cherbourg peninsula on Bristol.<sup>53</sup> The sum total of identified ski sites had risen from sixty-four to sixty-

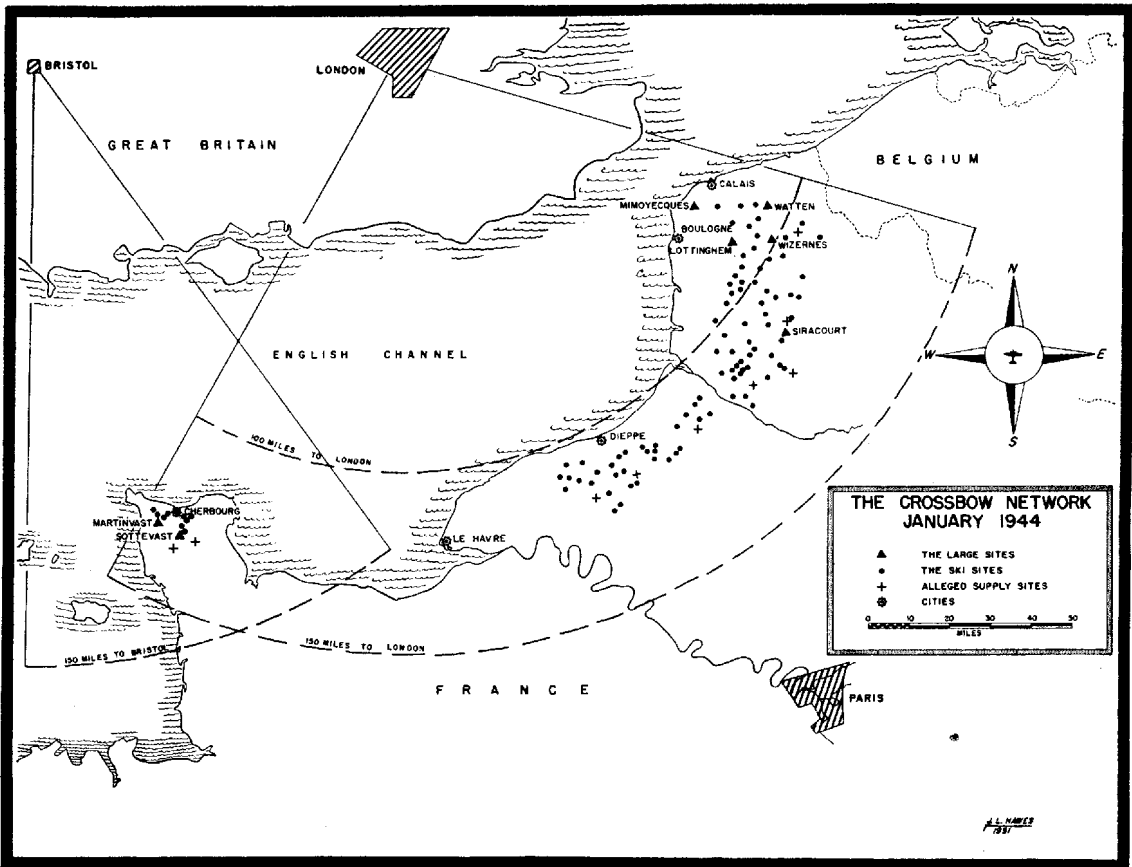

nine and then to seventy-five.<sup>54</sup> The Ninth Air Force, beginning its CROSSBOW operations on 5 December,<sup>55</sup> had joined RAF Second Tactical Air Force in an attempt to carry out the directive which placed these targets in the highest priority for Allied tactical air forces. But for a time the effort was both limited, partly because of the weather, and generally ineffective.

Meanwhile, the newly established CROSSBOW agency in the Air Ministry<sup>56</sup> set up a complex system of site directories and target priorities. Operational analysts in the Air Ministry and in the several air forces attempted to estimate the number and weight of attacks required to achieve significant damage to ski sites.<sup>57</sup> CROSSBOW operations were at first planned in accordance with these estimates but, since the figures provided by operational analysts were unreliable from the beginning, bombing efforts very quickly came to depend upon empirical rather than theoretical bases.<sup>58</sup>

On 15 December the British chiefs of staff, considering the ineffectiveness of early efforts by the tactical air forces, agreed that an all-out attack by the Eighth Air Force heavies would be the most effective measure available. They accordingly requested the Eighth Air Force, which during this period found opportunities to strike primary CBO targets rigidly restricted by winter weather,\* to give "over-riding priority" to such an attack as soon as the weather permitted.<sup>59</sup> The weather continued to be unfavorable, and it was not until the day before Christmas that the Eighth Air Force launched its first major mission against the chain of ski sites. Mission No. 164, the largest Eighth Air Force operation to date, employed more than 1,300 aircraft. Escorted by P-38's, P-47's, and P-51's, 670 of 722 heavy bombers dropped 1,700 tons of bombs on twenty-three ski sites.<sup>60</sup> The crews had been told only that they were attacking "special military installations," but the outside world was for the first time explicitly informed of the existence of the new German threat. The *New York Times* announced in bold headlines that U.S. and British flyers had hit the "Rocket Gun Coast" and in an editorial commented: "The Germans have now created a diversion. They have at least won a breathing spell for themselves and temporarily . . . diverted part of the Anglo-American air power. . . . The threat alone has succeeded in lightening the weight of attack upon Germany."<sup>61</sup>

Not until December 1943 had the British conveyed to their Ameri-

\* See discussion above in Chap. 1.

can allies the full measure of their alarm concerning the threat of new German weapons. Though somewhat nettled by this delay, American authorities in Washington shared the uneasiness existing in England, and on 20 December the Joint Chiefs of Staff began a survey of the "Implications of Recent Intelligence Regarding Alleged German Secret Weapons."<sup>62</sup> Two days later General Marshall requested Lt. Gen. Jacob L. Devers, commanding general of ETOUSA, to report immediately on CROSSBOW countermeasures in force and under consideration. The following day, 23 December, Devers briefed Marshall on information available to ETOUSA and indicated that a courier was leaving England that night to bring sketches of a ski site to Washington.<sup>63</sup> At the suggestion of General Marshall, Secretary of War Stimson, on 29 December, appointed a War Department committee "to interpret all existing information on German secret weapons for long-range attack against England and to assist in determining what countermeasures may be taken."<sup>64</sup> Under the chairmanship of Maj. Gen. Stephen G. Henry, director of the War Department New Developments Division, the committee was directed to seek "close co-ordination between the War Department, Navy, Army Air Forces, Army Ground Forces, Army Service Forces, and the United Kingdom" in the search for a solution to the CROSSBOW problem.<sup>65</sup>

The American CROSSBOW committee, strongly impressed by the hesitancy of British leaders to reveal the true nature of the danger, found in their delay cause for fear that the problem was possibly even more "acute" than had been indicated. It seemed to members of the committee "rather late in the picture" for the United States to be receiving detailed information, and at their first meeting early in January they were impressed by the report that American air commanders in Britain had learned "only three weeks ago" what they were bombing.<sup>66</sup> As a result General Marshall wrote in rather strong tones to Field Marshal Sir John Dill, chief of the British Joint Staff Mission to America and the senior British member of the Combined Chiefs of Staff, that "this matter is of utmost importance to our minds and the United States is ready to assist the British with all of its military and civilian resources to combat this threat" but "the preliminary work of the Committee indicates that we cannot lend fullest support to this project, particularly in the field of countermeasures, unless we have full information on the British progress in meeting this problem."<sup>67</sup>

Already the British chiefs of staff had taken up with COSSAC in mid-December the question of whether the new menace called for

some radical revision of plans for OVERLORD.<sup>68</sup> General Morgan's estimate of the threat to OVERLORD was presented to the British chiefs of staff on 20 December.<sup>69</sup> Any appreciable revision of the existing invasion plans was considered impracticable, but COSSAC warned that the threat must be considered as capable of "prejudicing" an assault mounted from the southern coast of England. The initial American estimates, to say the least, were gloomy. In its first report, the War Department's special committee admitted that it saw "no real solution to the problem."<sup>70</sup> An earlier estimate of the situation by AAF Headquarters had suggested the extreme possibilities of biological warfare, gas warfare, and the use of revolutionary explosives of "unusually violent character," and that the Germans might achieve a stalemate or a cessation of the Combined Bomber Offensive in consequence of the devastation brought to England. If the Germans withheld their attacks until D-day, they could cause "maximum confusion" at a most critical time and might be successful in entirely disrupting the invasion operation.<sup>71</sup>

These estimates suggested the need for a concentrated Allied endeavor to prevent the Germans from using their new weapons or, at the least, to reduce the scale of operations achieved. The Allies were also required to consider the most somber implications of the threat, the use of gas or biological warfare and the possibility that the Germans were in a position to use atomic energy, in which field they were known to be well advanced; accordingly the Joint Chiefs of Staff took the precaution of directing the supreme Allied commander to prepare to take countermeasures if the Germans introduced either gas or biological warfare in launching their V-weapon attack against England.<sup>72</sup> Among the varied proposals for countering the threat was one suggesting that the Allies might launch a gas attack against the ski sites, but this was dismissed,<sup>73</sup> as was a proposal to undertake a ground reconnaissance in force of the French coast.<sup>74</sup> Though there appeared to be not much reason for satisfaction with the early air CROSSBOW operations,<sup>75</sup> circumstances argued that the Allies must depend chiefly on a continued air effort, and opinion in the United States came quickly to a focus on the problem of improving the bombing techniques employed against ski sites.<sup>76</sup>

### *The Eglin Field Tests*

General Arnold was particularly interested in the development of effective minimum-altitude attacks by actual field test. He felt there

had been too much guesswork and pure speculation in estimating the effect of CROSSBOW bombing countermeasures. He was determined, in so far as possible, to place at least one phase of the CROSSBOW problem on a pragmatic basis.<sup>77</sup> On 12 January 1944 General Marshall approved the suggestion of the War Department committee that the Army Air Forces be given, as a project of the highest priority, "the technical and tactical inquiry into the means, methods, and effectiveness of air attacks against CROSSBOW targets in France."<sup>78</sup> It seems to have been assumed that the study would be undertaken primarily in the theater, close at hand to actual operations, but instead it was shortly decided to assign the major responsibility to the AAF Proving Ground Command at Eglin Field, Florida.

Conventional directives would not do in so urgent a situation. On the morning of 25 January, General Arnold telephoned Brig. Gen. Grandison Gardner, in command at Eglin Field. At first, General Arnold spoke in evasive terms: "Must be careful what I say, but maybe you'll recognize what I mean when I say that about 150 of them located north coast of France . . . shaped like skis." He then indicated the purpose of his call: "I want some buildings reproduced. I want to make simulated attacks with a new weapon. I want the job done in *days* not *weeks*. It will take a hell of a lot of concrete . . . give it *first priority* and complete it in days—weeks are too long."<sup>79</sup>

General Gardner immediately mobilized the full resources of the 800,000-acre proving ground and its thousands of personnel. With utmost secrecy the Army Air Forces duplicated in the remote pine barrens of the Florida Panhandle the construction so closely observed on the Channel coast of France. The task assigned to the Proving Ground Command was absorbing and exacting: the reproduction and destruction, by various means, of a series of German ski sites.

Building materials were scarce, and neither time nor security would permit conventional negotiations for construction priorities. Proving Ground Command purchasing agents roved the country for hundreds of miles around. Construction materials were rushed by air, train, and truck into the secret ranges of Eglin Field. Working in twelve-hour shifts, thousands of civilian and military laborers assembled concrete, steel, lumber, brick, and building blocks into a series of key target buildings and entire ski sites. The Army Ground Forces sent camouflage units and a full anti-aircraft battalion to prepare the Eglin Field CROSSBOW sites for effective tests of German defenses.<sup>80</sup>

Hardly had the concrete set when every appropriate type and variety of weapon available to the AAF was thrown against replicas of the German installations. As additional target buildings and sites were completed, the success of each type of munition, the effectiveness and vulnerability of attacking aircraft, and the efficiency of every possible tactical operation were scrupulously checked and analyzed by teams of military and civilian experts. General Gardner telephoned General Arnold concerning the progress of each day's attacks. Periodic reports, indicating from the first the superiority of minimum-altitude attacks, were relayed from Washington to the theater.<sup>81</sup> On 19 February General Arnold and Air Marshals Bottomley and Inglis were present at Eglin Field to observe various methods of attacks against CROSSBOW targets. When General Gardner was convinced the Proving Ground had thoroughly tested the validity of every available weapon and method of attack, he submitted, on 1 March 1944, a final report outlining the findings.<sup>82</sup> The rigorous and exhaustive tests at Eglin Field verified beyond question the opinion of the War Department's CROSSBOW committee, of General Arnold,<sup>83</sup> and of American air commanders in England: minimum-altitude attacks by fighters, if properly delivered, were the most effective and economical aerial countermeasure against ski sites; medium- and high-altitude bombing attacks, which threatened a serious diversion from POINTBLANK operations, were the least effective and most wasteful bombing countermeasures.

The Proving Ground Command, Army Air Forces Board, and AAF Headquarters joined in a strong recommendation that the findings of the Eglin tests "be made available without delay to the Air commanders charged with the destruction of CROSSBOW targets,"<sup>84</sup> and within a week after the report had been submitted, a special mission of American officers, headed by General Gardner, had arrived in the theater.<sup>85</sup> General Gardner, or other members of the mission, visited SHAEF, ETOUSA, and every major air headquarters in England and discussed the Eglin Field test findings with General Eisenhower and with leading British and American air commanders.

### *The Continuing Debate*

The Proving Ground report was enthusiastically received by American air officers and appeared to elicit interest among British authorities,<sup>86</sup> a reception which seemed to promise that the Proving Ground

technique for destruction of German ski sites would be immediately and widely employed in the growing offensive against CROSSBOW installations. But the results were quite different from those at first anticipated. The efforts of the American CROSSBOW mission, in fact, precipitated a controversy over bombing methods which is difficult to understand and which was never resolved.

Spaatz, Vandenberg, and Brereton strongly supported the introduction of the Eglin Field minimum-altitude technique into wide-scale operations.<sup>87</sup> The British, however, continued to favor employment of heavy bombers as the major instrument for the CROSSBOW offensive, principally on the ground that fighter attacks had, in some instances, been costly and ineffective in the early months of CROSSBOW operations. Leigh-Mallory, the principal British air commander concerned with CROSSBOW operations, was inflexibly opposed to a reduction of bomber operations in favor of fighter attacks. On 4 March he had written to Spaatz: "I think it is clear now that the best weapon for the rocket sites is the high altitude bomber."<sup>88</sup> His preference for heavy bombers was ostensibly based upon his belief that fighters were especially vulnerable to German defenses around CROSSBOW sites. The Germans had, it was true, steadily increased their flak defenses in the Pas-de-Calais and Cherbourg areas. There was evidence, however, from both British and American sources that fighter attacks currently employed in the theater were superior to bomber operations both in accuracy and in economy.<sup>89</sup>

There was some British skepticism concerning the validity of the Eglin Field ski-site constructions. Apparently the British regarded the Eglin Field structures to be more substantial than their German prototypes. They were therefore inclined to disregard the experimental evidence that 1,000- and 2,000-pound delayed-action bombs delivered by low-flying fighter aircraft were superior to the 250- and 500-pound bombs normally employed against ski sites. In conveying to General Arnold their distrust of the Eglin Field test data, the British fell back, in several instances, upon some rather curious logic. They failed to observe, for example, that if the Eglin Field sites were actually more substantial than German sites, the target accuracy and economy of the Eglin Field method would be all the more effective.<sup>90</sup> As the diversion from other commitments grew in magnitude, Spaatz, Vandenberg, and Brereton frequently conveyed to General Arnold their rising concern about the CROSSBOW diversion.<sup>91</sup> Leigh-Mallory, perhaps the



most obdurate opponent of minimum-altitude bombing of CROSSBOW sites by American forces, drew support from a revision of the CCS directive of 13 February 1944, in which CROSSBOW was listed as the second principal task of the heavy bombers.\* Leigh-Mallory wrote to Arnold late in March 1944: "I feel certain we must continue to rely on the Heavies."<sup>92</sup>

Before receiving this letter, General Arnold had written a strong letter to Air Marshal Sir William L. Welsh, of the British Joint Staff Mission, requesting him to inform the Air Ministry of Arnold's opinion that the time had come for "unusual measures in securing a proper evaluation" of the CROSSBOW situation. "I wonder," General Arnold inquired, "if Leigh-Mallory, Bottomley, and Inglis now feel that every effort has been directed to evaluate this problem once and for all."<sup>93</sup> Arnold did not, of course, underestimate the seriousness of the V-weapon threat. He urged, simply, as he had in earlier months and would continue to do, the avoidance of an unnecessary diversion in CROSSBOW operations and the application of the most effective and economical measures to the destruction of the German installations. His appeal to the Air Ministry did not, apparently, meet with success, for the CROSSBOW diversion continued to grow in magnitude.† When Leigh-Mallory's communication reached Washington, Arnold replied: "I must state quite frankly my disappointment that attacks by fighters have not been more effective." He repeated his earlier warning: the continued and unnecessary diversion of heavy bombers "at the expense of the Combined Bomber Offensive is in my opinion unsound."<sup>94</sup>

From the American point of view the evidence seemed to support an earlier report that the CROSSBOW program was bogging down in "an enormous amount of theoretical analysis, confusing technical intelligence and opportunity to test various theories."<sup>95</sup> General Spaatz wrote frequently to Arnold of the increasing dissatisfaction in the theater. There was no cohesive controlling organization, Spaatz declared, and in consequence air efforts were being restricted or diverted because of "control by commanders who have only limited objectives."<sup>96</sup> A paper from USSTAF reported the glossing-over of the

\* See above, p. 28.

† Arnold's letter to Welsh was dispatched 30 March 1944. During that month 2,800 sorties and 4,150 tons of bombs were expended in Anglo-American CROSSBOW operations. In April the effort was increased to 4,150 sorties and 7,500 tons of bombs. (Coffin Report, App. J, pp. 184, 186.)

realities of the CROSSBOW situation and noted the lack of provision "for the best use of available forces in the best way."<sup>97</sup>

The conflict over policy increased as D-day approached. While the British held firmly to their refusal to adopt the Eglin Field technique of minimum-altitude bombing, and heavy bombers were diverted in increasing numbers from POINTBLANK operations, there was a resurgence of acute alarm in England over the German V-weapon threat. In February, ground sources had reported the appearance of a new type of pilotless aircraft launching site.<sup>98</sup> The "Modified Sites" were very simple installations, often concealed in farm structures or in small manufacturing plants. They could be quickly constructed, easily camouflaged, were difficult to detect, and, once discovered, were very poor targets because of their small size.

For the third time, orders were issued for an aerial reconnaissance of the entire French coast.<sup>99</sup> Many of the modified sites were so expertly camouflaged they escaped detection altogether, but by 12 June, when firings began, 66 modified sites had been identified.<sup>100</sup> The Germans, meanwhile, continued to employ large labor forces in the repair of bombed large and ski sites, whether in an attempt to prepare for their eventual use or simply as a means of diverting Allied bombing effort from the CBO, the Allies did not know.\* The discovery of modified sites and continued construction at the other sites required the Allied commanders to consider the CROSSBOW situation once more. On 18 April Sir Hastings Ismay, Secretary of the War Cabinet, informed General Eisenhower of the War Cabinet's view that more intensive bombing efforts should be made against the large sites and ski sites. "The Chiefs of Staff," Ismay stated to Eisenhower, "consider that this is one of those matters affecting the security of the British Isles which is envisaged in . . . the directive issued to you by the Combined Chiefs of Staff on 27th March 1944."<sup>101</sup> General Eisenhower was requested to direct that CROSSBOW operations be accelerated and be given "priority over all other air operations except POINTBLANK until such time as the threat is overcome."<sup>102</sup>

The supreme Allied commander acceded to the wishes of the War Cabinet. In fact, he went beyond the terms of the request. Following

\* General Dornberger, in an interview with the author, reported Hitler as saying "if the bombs were dropped on these sites, they wouldn't drop on Germany" and that for this reason the construction should be continued. Von Braun gives a somewhat different explanation: "Todt went ahead for a long time just to show . . . [his organization's] capacity to build in the face of heavy bombing."

Eisenhower's instructions, Tedder informed Spaatz on 19 April of the decision that "for the time being" attacks on CROSSBOW targets were to be given priority over all other air operations.<sup>103</sup> This action caused acute concern at AAF Headquarters in Washington. For weeks General Arnold had consistently supported minimum-altitude attacks against CROSSBOW targets without effecting a change in theater policy, and early in May, at his instruction, his headquarters reviewed the air operations conducted against V-weapons in the second half of April. CROSSBOW operations, AAF Headquarters concluded, had grown out of proportion to the importance of the target or had become so uneconomical "as to be wasteful, and should be curtailed."<sup>104</sup> Complaints from General Spaatz corroborated this view. He had informed Washington of pre-OVERLORD demands upon him so exacting that he seriously doubted his ability to meet them.<sup>105</sup> The CROSSBOW diversion, in the opinion of AAF Headquarters, had reached such proportions that "it may well make the difference between success and failure in accomplishing our pre-OVERLORD objectives."<sup>106</sup>

To support its conclusions concerning the CROSSBOW situation, the AAF prepared for dispatch to the theater a strong cable which indicated the magnitude of the diversion, noted the failure of American forces to employ minimum-altitude attacks against CROSSBOW targets, and suggested re-examination of the Eglin Field report. The Office of the Chief of Staff, while in agreement with the essential purpose of the proposed cable, objected to the implied "attempt to run General Eisenhower's operations" and insisted upon revision of the message. After several days of negotiations between AAF Headquarters and the War Department General Staff, a cable from which "a number of teeth were drawn" and its original meaning "entirely changed" was agreed upon and dispatched to General Eisenhower.<sup>107</sup>

Little or no change in operational policy followed this last effort of General Arnold to remedy the CROSSBOW situation,\* even though certain tests in the theater tended to confirm the Eglin Field tests. On 6 May General Spaatz informed Arnold of a trial minimum-alti-

\* In May the Allied forces dispatched 4,600 sorties and dropped 4,600 tons of bombs against CROSSBOW targets. Of these totals, VIII Bomber Command contributed 800 sorties and 2,600 tons; AEAFF 3,800 sorties and 2,000 tons. RAF Bomber Command was inactive against CROSSBOW targets during this period. The Eighth operated chiefly against large sites; AEAFF against ski sites. (Coffin Report, App. J; CROSSBOW Countermeasures Progress Report, Nos. 38 and 39.)

tude attack carried out by the 365th Fighter Group. After intensive training and briefing by Eglin Field officers, four fighter pilots attacked four ski sites with P-47's carrying two 1,000-pound delayed-fuze SAP bombs. Though very heavy machine-gun fire was encountered at each site, three of the four attacking P-47's achieved Category A damage (sufficient to neutralize a ski site for several months), with no loss of aircraft.<sup>108</sup> The Eglin Field report had established the P-38 as twice as effective as the P-47 in low-altitude ski-site attacks and had recommended, for maximum damage, the use of 2,000-pound bombs. But the first fighter pilots to use the Eglin Field technique in the theater had, with a less effective aircraft for this purpose, inflicted Category A damage at an expenditure of one ton of explosive per site. This was in contrast to the expenditure of 1,947 tons per site by heavy bombers for similar damage in the last two weeks of April.<sup>109</sup> Further evidence of the superiority of minimum-altitude attack was provided by General Doolittle at the end of May. In reviewing Eighth Air Force operations against CROSSBOW targets, he wrote to General Arnold that "Mosquitoes are the most effective type of aircraft." The British fighter, General Doolittle stated, had achieved the highest degree of damage with less tonnage, fewer attacking sorties, and fewer losses than any other type of aircraft.<sup>110</sup> As this report suggests, the British had made some concessions to AAF demands, but the weight of the effort was still carried by the medium and heavy bombers.

By the spring of 1944 a more or less fixed pattern of CROSSBOW bombing operations emerged. Massive raids by heavy bombers of the Eighth Air Force—principally B-17's—were supplemented by almost continual attacks (weather permitting) flown by medium bombers of the Ninth and the RAF, by smaller-scale attacks at frequent intervals by heavy bombers from the Eighth, and by fighter and fighter-bomber attacks. The Eighth's heavy bombers usually attacked in boxes of six at heights varying from 12,000 to 20,000 feet.<sup>111</sup> In the offensive's earlier months the Eighth relied entirely on visual sighting, but in the late winter and early spring radar bombing was used with increasing frequency.<sup>112</sup> Medium bombers—usually B-26's from IX Bomber Command and B-25's from British components of AEF—most often attacked in boxes of from twelve to eighteen aircraft and from heights between 10,000 and 12,000 feet.<sup>113</sup> For visual sighting, weather was always the decisive factor; with the Norden sight the bombardier had to pick up the target at distances of at least six miles.



V-1

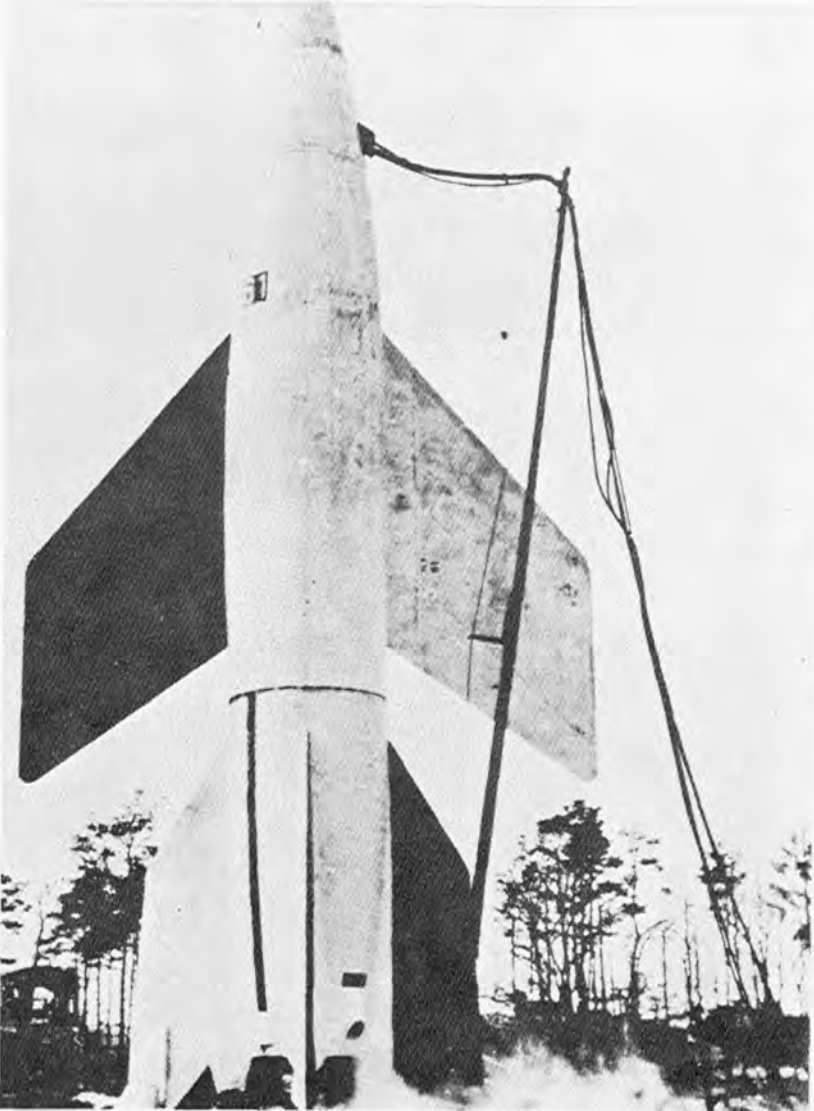

*Left: LAUNCHING V-2*



*Left: LAUNCHING V-2 7-WEAPON SITE IN NORMANDY*



**BEFORE D-DAY: LOW-LEVEL RECONNAISSANCE OF BEACH DEFENSES**



NORMANDY BEACHHEAD UNDER P-38 COVER



The large sites, though fairly conspicuous, were always difficult, for they were most vulnerable at points that required a precise attack. The more inconspicuous and often superbly camouflaged ski sites, even in the best of weather, uniformly presented a most difficult aiming problem, as bombing directives usually called for destruction of a single key building within the ski site itself.<sup>114</sup>

Relying largely on heavy and medium bombers, the Allies inflicted Category A damage on ski sites 107 times (including repeats) between the inauguration of ski-site attacks in December 1943 and the abandonment, early in May 1944, of operations against this type of target. Of this number, the Eighth Air Force accounted for 35, the Ninth for 39, and British components of AEF for 33. B-17's, expending an average tonnage of 195.1 per Category A strike, accounted for 30 of the Eighth's 35 successful strikes, as contrasted with 5 by B-24's, which expended an average of 401.4 tons. B-26's achieved 26 Category A strikes, at an average tonnage of 223.5. B-25's were credited with 10½ Category A strikes for an average of 244 tons, and A-20's (Bostons and Havocs) accounted for 4 Category A strikes, with an average tonnage of 313. Among the fighter-type aircraft employed during this period, the Mosquito led with an average tonnage of 39.8 for 19½ Category A strikes. Spitfire bombers achieved 3 such strikes with an average of 50.3 tons.<sup>115</sup>

On the evening of 12 June, when D-day had come and gone with no sign of offensive activity from the network of CROSSBOW sites, Allied leaders were inclined to feel that the threat had been met and overcome, though at a heavy cost. Since the beginning of December 1943 the Anglo-American forces had expended a total effort of 36,200 tons of bombs in 25,150 bombing sorties, and had lost 771 airmen and 154 aircraft.<sup>116</sup> Of these totals the AAF was credited with 17,600 tons in 5,950 sorties by the VIII Bomber Command, and a large share of the 15,300 sorties and 15,100 tons expended by AEF.\* In these operations the Americans had lost 610 men and 79 aircraft, 462 men and 49 aircraft in heavy bomber operations by the Eighth and 148

\* AEF, which controlled the operations of both the Ninth Air Force and Second TAF, kept combined rather than separate records of sorties and bomb tonnages. Some indication of the scale of the American effort in the total operations is indicated, however, in the fact that the Ninth accounted for more than one-third of the sites neutralized during the period 5 December 1943-6 June 1944. (BAM [AHB], File 77 [reports].) Of the 25,150 sorties and 36,200 tons expended during all CROSSBOW operations prior to D-day, RAF Bomber Command accounted for only 3,900 sorties and 3,500 tons and did not achieve any Category A damage. (Coffin Report.)

men and 30 aircraft in medium bomber operations by the Ninth. Since the conclusion of the Eglin Field tests in February the Allies had expended 16,500 tons of bombs in 11,550 sorties. On 10 June, it was estimated, eighty-three of the ninety-six ski sites had received Category A damage.<sup>117</sup> The modified sites appeared for the moment to offer no real threat and the large sites to be heavily damaged.<sup>118</sup>

During the first phase of Allied CROSSBOW operations there had been conflict of opinion, confusion of policy, and apparent wastage of materiel and effort. Allied nerves had time and again been set on edge, if not frayed, and on the evening of 12 June 1944 no member of the Allied forces, at any level, knew exactly what the new German weapons might accomplish. Nevertheless, because they had responded to the threat as best they could and because they were supplied with enough air power to afford the diversion, the Allies achieved one impressive and undeniable accomplishment in the first phase of their sustained, if wasteful, CROSSBOW operations. Though with remarkable improvisation the Germans did find means for launching large numbers of the new weapons against England, one truly bizarre fact remains. From the vast network of steel and concrete flung out for hundreds of miles along the coast of France the Germans succeeded in launching only a single missile against England, a V-1 that misfired.<sup>119</sup>

To what extent the destruction of the original launching sites along the French coast was responsible for the delay in the inauguration of the V-1 offensive is difficult to determine with any exactitude. The development of the modified launching sites used in firing the V-1 clearly represents a late improvisation designed to meet the threat of Allied bombing, and there is evidence that adequate supplies of the V-1 were available several months before the first launching. But there is also evidence that modified sites, which were of simple construction, existed in considerable numbers by the end of April. Just why the Germans should have waited until after D-day to launch their attack remains thus a mystery unless it be assumed that technical, production, or other difficulties not directly related to Allied bombing contributed to the delay. The cautious conclusion of the U.S. Strategic Bombing Survey that the Allied offensive "probably delayed the beginning of launching by 3 to 4 months" seems to have more justification than does the credit for a six-month delay awarded by almost all other Allied studies.

## CHAPTER 5

\* \* \* \* \*

### *THE NINTH AIR FORCE*

WHILE the Eighth Air Force pressed home the bomber offensive against Germany, the Ninth Air Force prepared for its role in the crowning offensive of the war in Europe—the invasion of Normandy. Though called upon to support the CBO in its later phases and required to assume a major share in the Allied campaign against CROSSBOW targets, the Ninth Air Force had as its primary mission assistance to the amphibious landings in France and cooperation with the ground armies in their subsequent sweep into the heart of Germany. For the accomplishment of that mission this second of the American air forces in ETO was transformed, within a period of seven and one-half months, from little more than a name into the most powerful single tactical air force engaged on any of the world's battle fronts.

Prior to the summer of 1943 it had been anticipated that the VIII Air Support Command, established in 1942,\* would be developed into a tactical air force for support of the invasion. On that assumption Brig. Gen. Haywood S. Hansell, Jr., by July 1943 had drafted for COSSAC a detailed build-up plan which proved to be a remarkably accurate forecast of the tactical forces to be deployed by the AAF in support of the invasion of Normandy.<sup>1</sup> But General Arnold, having in that same month selected Brereton for command of these forces, decided in August on the organization in ETO of a separate tactical air force and the transfer to the European theater of the Ninth Air Force, Brereton's old command in the Middle East.<sup>†</sup>

The combat units and most of the service units currently serving with the Ninth were reassigned to the Twelfth Air Force, while the air force headquarters and three command headquarters prepared for

\* See Vol. II, 634, 642.

† *Ibid.*, 642-43.

## THE ARMY AIR FORCES IN WORLD WAR II

the move to England.<sup>2</sup> On a visit to Eaker in September, Brereton completed arrangements for the movement of his staffs from Egypt and for the transfer of combat and service units from the Eighth Air Force to the Ninth, and then went on to Washington for a briefing on build-up plans.<sup>3</sup> While Brereton was in Washington, the headquarters staffs of the Ninth and of its bomber, fighter, and service commands, plus a handful of small headquarters service units, chiefly signal companies, began the move from Egypt to the United Kingdom. The advance echelon left Cairo by air on 28 September, and additional air echelons followed at intervals until the close-out party under Brig. Gen. Victor H. Strahm, chief of staff of the Ninth, departed on 18 October. Before the end of November, all of the "boys with sand in their shoes" had arrived in England and had been assigned to their stations.<sup>4</sup>

Brereton's return to England and his assumption of command on 16 October was the starting signal for the Ninth, which inherited little more than its name, its commanding general, and the nuclei of four experienced headquarters staffs from its antecedent in the Middle East. On the preceding day the Eighth Air Force had transferred to the Ninth the whole VIII Air Support Command and the VIII Tactical Air Service Area Command. Down to the end of 1943 most of the Ninth's units and men came from the Eighth Air Force.<sup>5</sup> Thereafter, the great bulk of the more than 170,000 troops who manned the Ninth on D-day came from the United States.

### *Organization and Build-up*

The task of placing the Ninth Air Force within the organizational framework of the European theater did not prove to be easy. After 15 December 1943, when AEAFF assumed operational control of the Ninth,<sup>6</sup> the new air force found itself in the position of a vassal owing homage to two suzerains who had conflicting conceptions of their authority, for General Eaker's United States Army Air Forces in the United Kingdom\* retained administrative control, a control which passed in January to USSTAF. General Spaatz assumed administrative control over all American air forces in the theater as of 20 January,<sup>7</sup> and soon found himself in conflict with Leigh-Mallory over the training of Ninth Air Force units for participation in OVERLORD.

Spaatz had no doubts about the extent of his prerogatives. On 24

\* See Vol. II, 643, 743-44.

February he addressed an official letter to Brereton in which he stated categorically: "The Commanding General, USSTAF, will exercise control of all administrative and training matters pertaining to the Ninth Air Force, and will assume direct responsibility to higher headquarters for the proper performance of those functions."<sup>8</sup> Thus was it made clear to both the AEAFF and the Ninth Air Force that USSTAF would suffer no transgression of its sovereignty. For Brereton, who had visions of a Ninth Air Force independent of both USSTAF and the AEAFF, there was no other choice but to comply. For Leigh-Mallory it was another demonstration of the inadequacy of his powers as commander of the Allied tactical air forces.

During 1943 tactical air force planners had assumed that the Ninth Air Force would become increasingly independent of the administrative and logistical control of the theater air headquarters in the United Kingdom. With its lodgment on the continent, it was contemplated that the Ninth would sever its connection with the United Kingdom base and rely directly on the United States for its base support and on theater headquarters for its administration. General Brereton and his service commander, Maj. Gen. Henry J. F. Miller, acted on this assumption during 1943 and early 1944, establishing a base air depot under the IX AFSC and otherwise taking steps to free themselves of reliance on the theater air service command.<sup>9</sup> This tendency was given impetus by the widely current Ninth Air Force belief that USSTAF discriminated against the Ninth in favor of the Eighth Air Force when allocating men, units, aircraft, and supplies. In response to representations from Brereton and Leigh-Mallory, USSTAF maintained that the allocation of men and equipment was governed by operational priorities and that since POINTBLANK held first priority for the air forces in the European theater, the needs of the Eighth Air Force must be met first.<sup>10</sup> In spite of the logic of the situation, this explanation could not satisfy an organization which was under intense pressure to build and prepare a new air force for tactical operations on the continent in the near future. But the Ninth Air Force was in no position to dispute USSTAF's authority, much as it may have been inclined to do so. Spaatz and Brig. Gen. Hugh J. Knerr, USSTAF's deputy for administration, strongly opposed all moves on the part of the Ninth toward self-containment and insisted on retaining unified administrative and logistical control of all American air forces in the theater, even after the move to the continent, in order to avoid pos-

sibly harmful competition between the Eighth and Ninth for supplies. Although as late as May and June 1944 some plans officers at AAF Headquarters in Washington were still recommending that the Ninth Air Force be logistically independent of the United Kingdom base when it moved to France, Arnold agreed with Spaatz and Knerr in July. The Ninth Air Force was destined to remain under the full administrative and logistical control of USSTAF.<sup>11</sup>

There was also a major organizational issue, at least from Brereton's point of view, in relations between the Ninth Air Force and the AEF. Leigh-Mallory wished to establish an Allied tactical air force headquarters, under command of Air Marshal Sir Arthur Coningham, for the operational control of the Ninth Air Force and RAF's Second Tactical Air Force, an arrangement that would leave Leigh-Mallory free to coordinate the efforts of the strategic and tactical air forces at the highest air level in the theater. Brereton vigorously resisted this proposal to interpose another headquarters between himself and the Allied air commander, and not until April 1944 was the issue settled. At that time it was agreed that Coningham should direct the operations of both tactical air forces through an advanced headquarters of the AEF during the assault phase of OVERLORD. Thereafter, Brereton and Coningham would be directly responsible to AEF headquarters for the operations of their respective air forces.<sup>12</sup>

While the Ninth Air Force was seeking to find its place within the organizational framework of the theater, it worked swiftly to develop its internal organization in response to the constant pressure of time. The headquarters at Sunninghill was organized along traditional staff lines with most of the key positions occupied by officers who had come from Egypt or from the headquarters staff of the VIII Air Support Command, which had been long resident at Sunninghill.<sup>13</sup> The merger of the two staffs not only combined the operational experience of the two organizations but preserved the continuity of control over the various subordinate echelons which had been transferred from the Eighth Air Force.

On arrival in England IX Bomber Command headquarters joined and absorbed the headquarters of the 3d Bombardment Wing\* at Marks Hall, Essex. Col. Samuel E. Anderson, whose command of the 3d Wing since July 1943 had afforded him much experience as a medium bomber commander, was appointed commander of the IX

\* See Vol. II, 634.

# ORGANIZATION OF THE NINTH AIR FORCE

6 JUNE 1944

## HEADQUARTERS NINTH AIR FORCE

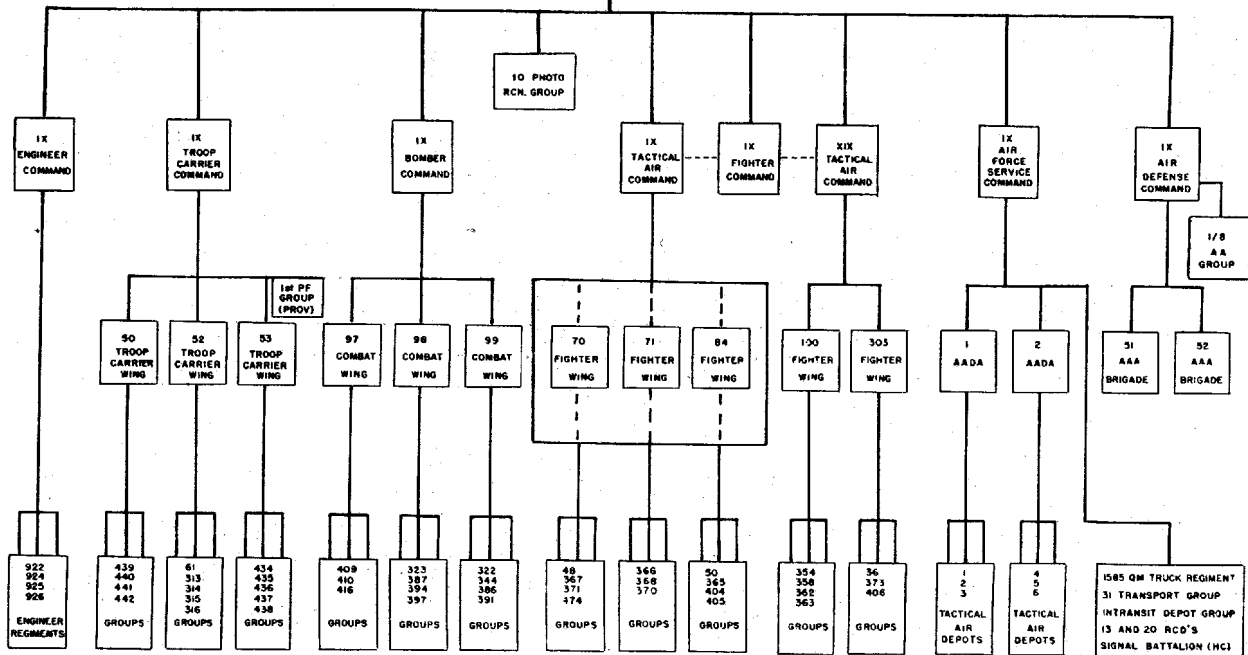

## THE ARMY AIR FORCES IN WORLD WAR II

Bomber Command, a position he retained until the end of the war. The 3d Wing brought with it to the Ninth four medium bombardment groups—the 322d, 323d, 386th, and 387th—which became the nucleus of the bomber command.<sup>14</sup> Until February, these four groups, divided between the 98th and 99th Combat Bombardment Wings, constituted the total operational strength of the bomber command. In a two-month period beginning in February, four more medium (B-26) and three light (A-20) bombardment groups arrived from the United States. The eight medium groups were divided between the 98th and 99th Wings and the three light bombardment groups were placed under the 97th Combat Bombardment Wing. Before D-day the bomber command had reached its full strength of eleven groups\* and more than 21,000 men.<sup>15</sup>

The development of the IX Fighter Command was much more complicated than that of the bomber command. Like the IX Bomber Command, the nucleus of the fighter command's headquarters staff came from Egypt and was augmented by personnel from the Eighth Air Force, in this instance, the headquarters and headquarters squadron of the 1st Fighter Division (Prov.) of the VIII Air Support Command. Brig. Gen. Elwood R. Quesada, who had acquired an outstanding reputation as a fighter commander with the old Ninth Air Force, came from Africa to take command of the IX Fighter Command. By the end of November he had assembled his staff and established a headquarters at Middle Wallop, in Hampshire.<sup>16</sup>

The Ninth Air Force intended from the beginning that the IX Fighter Command should be primarily a training headquarters, preparing fighter groups for combat and aiding in the development of air support commands, of which there was to be one for each of the two U.S. armies participating in OVERLORD. It had been planned that after the establishment of the air support commands the fighter command would cease to be active, that its personnel would be divided between the new air support headquarters, and that IX Air Support Command, under Quesada, would foster the fledgling XIX Air Support Command, of which Brig. Gen. Otto P. Weyland assumed command three days after its activation on 1 February 1944. In the end, however, it was decided to retain the fighter command as an organization under Quesada's command. In February the AEAFF established at

\* The additional groups were the 344th, 391st, 394th, and 397th (B-26) and the 409th, 410th, and 416th (A-20).



Uxbridge, west of London, a combined fighter control center which was to control all fighter operations against the continent. The Second Tactical Air Force was represented by the officer commanding No. 11 Group, an air vice marshal, and the Ninth decided to retain the fighter command with Quesada as commander "simply," as General Strahm put it, "for the purpose of preserving that level to give General Brereton's representative parity with the Composite Group level at Uxbridge."<sup>17</sup> Quesada selected an operational staff from both the IX and XIX Air Support Commands (redesignated in April as the IX and XIX Tactical Air Commands) to man the control center.<sup>18</sup> Through IX Fighter Command, Quesada was able to retain control of the operations and training of all of the Ninth's fighter groups down to D-day.

The build-up of the fighter command and its subordinate tactical air commands was complicated by competition between the Eighth and Ninth Air Forces for the fighter groups arriving from the United States. In the fall of 1943 it was expected that eventually there would be thirty-six fighter groups in the two air forces, of which the Eighth would get fifteen and the Ninth twenty-one. All three major fighter types—P-38, P-47, and P-51—were available in the theater, but it was decided that the Ninth would get the P-51's. The outstanding performance of the P-51 as a long-range escort fighter,\* however, led to a change in allocations. By the end of January, when it seemed likely that there would be only thirty-three instead of thirty-six groups in the theater, USSTAF had decided to allocate the fighters as follows:<sup>19</sup>

<i>Eighth Air Force</i>	<i>Ninth Air Force</i>
Seven P-51 groups	Thirteen P-47 groups
Four P-38 groups	Three P-38 groups
Four P-47 groups	Two P-51 groups

A steady flow of fighter groups began arriving in February, and by May all eighteen Ninth Air Force groups were assigned to five fighter wings: the 70th, 71st, 84th, 100th, and 303d. During the pre-assault period the revived fighter command also controlled miscellaneous photo reconnaissance, tactical reconnaissance, night fighter, and liaison units. All told, the command included approximately 36,000 men and 1,500 aircraft.<sup>20</sup>

Of the operational commands, the IX Troop Carrier Command was the slowest in reaching its ultimate strength because most of its groups did not arrive in the theater until March 1944. When Brig. Gen. Ben-

\* See above, pp. 11-12.

Janin F. Giles, who had been engaged in troop carrier operations in the Mediterranean during 1943, assumed command on 16 October 1943, he had on hand the nucleus of a headquarters staff from the provisional troop carrier command of the Eighth Air Force, which had been in existence since September and was now disbanded. Giles's new command consisted of the 50th Troop Carrier Wing, including the 315th and 434th Groups.<sup>21</sup> In February the 53d Troop Carrier Wing arrived in the theater from the United States, and in March, the 52d Wing came from Sicily with its four groups. The arrival of other groups from the United States brought the total strength of the command to three wings comprising fourteen groups.\* A reshuffling of the command during the spring assigned five groups each to the 52d and 53d Wings and four groups to the 50th. On 25 February, Brig. Gen. Paul L. Williams, who had commanded the XII Troop Carrier Command in the Mediterranean, succeeded General Giles as commander, and augmented the headquarters staff with a number of experienced officers he brought with him from the Mediterranean area. At the beginning of June, the troop carrier command numbered almost 30,000 men.<sup>22</sup>

Unique among the commands of the Ninth Air Force was the IX Air Defense Command, which came into existence as the result of the Ninth's desire for an organization which would leave the tactical air commands free of any rear-area defense responsibilities on the continent. During almost the entire existence of the defense command, it had assigned to it only a headquarters and a few miscellaneous units, chiefly signal air warning battalions, and its actual assigned strength ranged from fewer than 1,400 to a little more than 5,200 men. Nevertheless, it directed, at times, the operations of more than 30,000 men, most of them antiaircraft artillery units attached to the command. These ground force units, much to the disappointment of General Arnold and the Ninth Air Force, remained assigned to the ground forces until almost the very end of the war in Europe.<sup>23</sup> The major elements of the air defense command were the antiaircraft units—signal air warning battalions—and night fighter squadrons. The basic antiaircraft units, the battalions, were organized into groups of three each, and these, in turn, into brigades. The organization of the air force elements of the command was never stable for very long, as conditions changed and units were transferred in and out of the command.<sup>24</sup>

\* The twelve additional groups were the 61st, 313th, 314th, 316th, 435th, 436th, 437th, 438th, 439th, 440th, 441st, and 442d.

In accordance with earlier plans, the Ninth Air Force had set up at Sunninghill, under Brig. Gen. Dale D. Hinman, a staff to plan the organization of an air defense command. In December 1943, Brig. Gen. William L. Richardson, an experienced antiaircraft officer, succeeded General Hinman. After many appeals to the War Department and much shuffling of administrative papers, the IX Air Defense Command was legitimized by the War Department in March 1944 and activated by the Ninth Air Force on the 30th of that month,<sup>25</sup> but not until after the landings on the continent did the IX Air Defense Command come into its own as a combat agency of the Ninth Air Force.

The IX Air Force Service Command\* was more clearly patterned after its Eighth Air Force opposite number than any of the other Ninth Air Force commands. A number of officers and enlisted men had been brought to England from Egypt, but most of the key members of the headquarters came from the Eighth Air Force. General Miller,<sup>†</sup> for most of the past year the commander of the VIII AFSC, took over the IX AFSC in October 1943 and brought with him members of his former staff. From the Tactical Air Depot Area‡ came additional officers and men to round out a headquarters staff rich in experience. In mid-November, the service command headquarters moved into newly constructed quarters across from the Ascot race course, adjacent to the Ninth Air Force headquarters at Sunninghill Park.<sup>26</sup>

The projected size of the Ninth Air Force and the scope of its operations clearly required a large and mobile service command. The service command, in turn, recognized early that its own size and wide-flung operations made decentralization of its organization desirable. Accordingly, borrowing from the experience of VIII AFSC,<sup>§</sup> in October it set up a base air depot area (BADA) and an advanced air depot area (AADA) which were areas in terms of function rather than geography. The base air depot area was intended primarily for supply and aircraft assembly functions. In December the IX AFSC divided the advanced air depot area into a 1st and 2d AADA. This further decentralization of the command was purportedly in prepara-

\* Originally known as the IX Air Service Command, the name was changed to IX Air Force Service Command by an unnumbered Ninth Air Force Memorandum of 29 Jan. 1944. The latter form is used throughout this chapter for convenience.

† On 5 May, Brig. Gen. Myron R. Wood succeeded General Miller as commander of the IX AFSC.

‡ See Vol. II, 644-45.

§ *Ibid.*, Chaps. 18 and 19.

## THE ARMY AIR FORCES IN WORLD WAR II

tion for the move to the continent, where mobile warfare would require decentralized operations. In addition, the two headquarters could be, and were, of value in organizing and training the many service units formed in the United Kingdom by the IX AFSC.<sup>27</sup> General Miller and his staff succeeded in having the service groups, as well as the air depot groups assigned to the service command. All of these groups, in turn, were assigned to the advanced air depot areas, which contained the bulk of the service command strength and performed the major part of its functions. In all, the IX AFSC had twelve air depot groups by the spring of 1944. From the VIII AFSC came five experienced and three inexperienced air depot groups, and the IX AFSC organized four new ones by splitting old ones in two and adding personnel.<sup>28</sup>

The success of the strategic air depots in the Eighth Air Force pointed the way for the organization of the tactical air depots in the Ninth. The air depot groups were paired, usually an experienced and an inexperienced group, and six tactical air depots were established. The two depot groups, although sharing the same stations, remained independent insofar as their actual operations were concerned and no attempt was made to set up a depot headquarters. This type of organization was desirable because it permitted maximum utilization of existing sites and of the specialized types of units which were usually attached to air depot groups—signal companies, military police companies, station complements, etc. Furthermore, the device of two air depot groups working together would produce a continuity of service when the time came to move to the continent, for one group could go ahead and while it was in transit and establishing itself, the other could carry on with the work in England. The tactical air depots theoretically specialized in different types of aircraft, but in practice there was much overlapping. The six depots were divided equally between the 1st and 2d AADA's.<sup>29</sup>

The service groups, which were assigned to and administered by, the advanced air depot areas, were under the technical control of the tactical air depots, each of which supported anywhere from four to fourteen service teams. Like the Eighth, once again, the IX AFSC found it expedient, beginning in December 1943, to split the service group into two equal parts (designated teams A and B),\* each of

\* Each team usually consisted of one service squadron; one ordnance supply and maintenance company; one-half of a supply and maintenance signal company; one-

## THE NINTH AIR FORCE

which was stationed with a combat group. Unlike the Eighth, which was forming subdepots out of its service groups, the IX AFSC retained the service group headquarters, which usually resided with Team A and administered both teams.<sup>30</sup> Once again, this was done with an eye to future operations on the continent, where it might be necessary to operate the service group as an entity rather than as two teams.

The structure of the service command was completed by the organization of several miscellaneous agencies. The 13th and 20th Replacement Control Depots permitted the command to handle the receipt, processing, and distribution of personnel, with the exception of combat crews, for the whole air force. Two truck regiments, one of which was a provisional organization, and an air transport group, also responsible directly to service command headquarters, formed an integral and indispensable part of a command which would depend heavily upon mobility for the performance of its function.<sup>31</sup>

Testifying to the ubiquitous role played by the IX AFSC in support of Ninth Air Force operations was its No. 1 rank in size among the Ninth's commands from the very beginning. Unlike the combat commands, which received from the Zone of Interior groups already organized and trained, the service command had to organize and train in the theater a large number of its units—particularly air depot and service groups. During the "Gold Rush" period of late 1943 and early 1944,\* the service command received thousands of casual officers and men who had to be trained and organized into units in a short period of time. By D-day the command had reached its maximum strength of approximately 60,000 officers and men, ten times its strength of 16 October 1943 and more than a third of the total strength of the air force.<sup>32</sup>

Early tactical air force planning during 1943 had made no provision for an engineer command, but the Ninth Air Force recognized the need for one from the beginning. The example of the North African campaign, where the aviation engineers had functioned as an integral part of the air force, was still fresh in the minds of Brereton and his

---

half of a QM company, service group; one-half of a QM truck company, aviation; four units of the mobile reclamation and repair squadron; one-half of the chemical section of the service group headquarters; and a detachment of the medical section of service group headquarters. Each team contained about 500 men.

\* See Vol. II, 640-41.

commanders. Accordingly, Brereton urged that the AAF secure from the War Department permission for the Ninth to activate an engineer command. In November he directed the engineer section of his headquarters to assume the functions of a command. After a long period of negotiations with AAF Headquarters and the War Department, during which a provisional engineer headquarters directed the training of engineer battalions, the Ninth received permission to activate the IX Engineer Command on 30 March 1944. Early organization, planning, and training were carried out under the direction of Col. Karl B. Schilling; on 25 January, Brig. Gen. James B. Newman assumed command of the provisional organization.<sup>33</sup>

The engineer aviation battalions and regiments in the theater had been under the control of the Services of Supply since 1942 and had been performing construction work on all types of military installations. It was vital that they be trained thoroughly in the type of construction work they would be doing on the continent, and to this end arrangements were made to transfer the units to the IX Engineer Command, beginning 1 December 1943. Even more than the other commands of the Ninth Air Force, the engineer command would have to be mobile and flexible in order to carry out its task of building and repairing airfields in the wake of the Allied armies on the continent. Accordingly, sixteen battalions were grouped under four regimental headquarters and the command headquarters itself retained control of the three airborne battalions and the camouflage battalion.<sup>34</sup>

Although it possessed its own engineer command by the spring of 1944, the Ninth Air Force, like the Eighth Air Force before it, was largely dependent in the United Kingdom on the building program undertaken by the British Air Ministry on behalf of the American air forces. The race between the construction of airdromes and the arrival of combat groups in the theater continued until the Ninth received its last group in April 1944, but at least minimum facilities were always available when needed.<sup>35</sup>

The problems faced by the Ninth in accommodating its units were similar to those which had faced the Eighth during its first twelve to eighteen months in the United Kingdom. The almost daily multiplication of headquarters within the various commands during the fall and winter created a demand for headquarters sites which had not been foreseen in original building plans. Additional facilities were found, but often only at the expense of extra construction work.<sup>36</sup> The lack

of time or means to enlarge bases which were overcrowded caused resort to tent camps which could be erected easily and quickly. Many larger units, particularly service and air depot groups, had to parcel out their men among many small camps in order to house them, and the task of reassembling them at one place sometimes took months. Storage space for equipment and supplies, large quantities of which had to be housed under canvas or left in the open, was particularly inadequate at many depots and bases. Finally, runways on the fighter bases had been built originally for the light British planes, but it was the comparatively heavy P-47 which became the Ninth's chief fighter aircraft. During the winter and early spring of 1944 an extensive program for strengthening and lengthening runways was undertaken.<sup>37</sup>

The advanced landing grounds, the last combat installations to be occupied by the Ninth in England, were especially deficient in facilities of all kinds. Since they were only temporary airfields, most of them had merely grass or Sommerfeld track runways. These proved to be inadequate for the Ninth's fighters and had to be extended or replaced by a more durable surface, usually pierced-steel plank. Most of the landing grounds were crowded to more than twice their capacities, and the units which occupied them lived under virtual field conditions, in tents, short of water, and with difficult sanitation problems.<sup>38</sup>

By May 1944 the tactical disposition of the Ninth Air Force in England was complete. In East Anglia, IX Bomber Command headquarters and its eleven bases—all in Essex—were situated immediately to the north and northeast of London.<sup>39</sup> Fighter bases, divided between IX Tactical Air Command and the newly formed XIX Tactical Air Command, were concentrated in two distinct areas. The IX TAC's eleven fighter and fighter-bomber groups and its 67th Tactical Reconnaissance Group were closely concentrated in the Hampshire area, extending south to the coast. All of the XIX TAC's seven groups were on advanced landing grounds in Kent, the corner of England immediately to the southeast of London and opposite the Pas-de-Calais.<sup>40</sup> The troop carrier command's fourteen combat bases were more scattered than those of the other combat commands. Six bases were clustered in the counties on the western edge of East Anglia, in the vicinity of the command headquarters at Grantham Lodge in Lincolnshire. Five other groups occupied fields in Berkshire and Wilt-

# TACTICAL DISPOSITION NINTH AIR FORCE JUNE 6 1944

## LEGEND

- ♁ FIGHTER WING
- FIGHTER GROUP
- ✈ BOMB WING
- BOMB GROUP
- ✈ TC WING
- TC GROUP

• All Wg Hqs were on  
AIRDROMES occupied by Gp

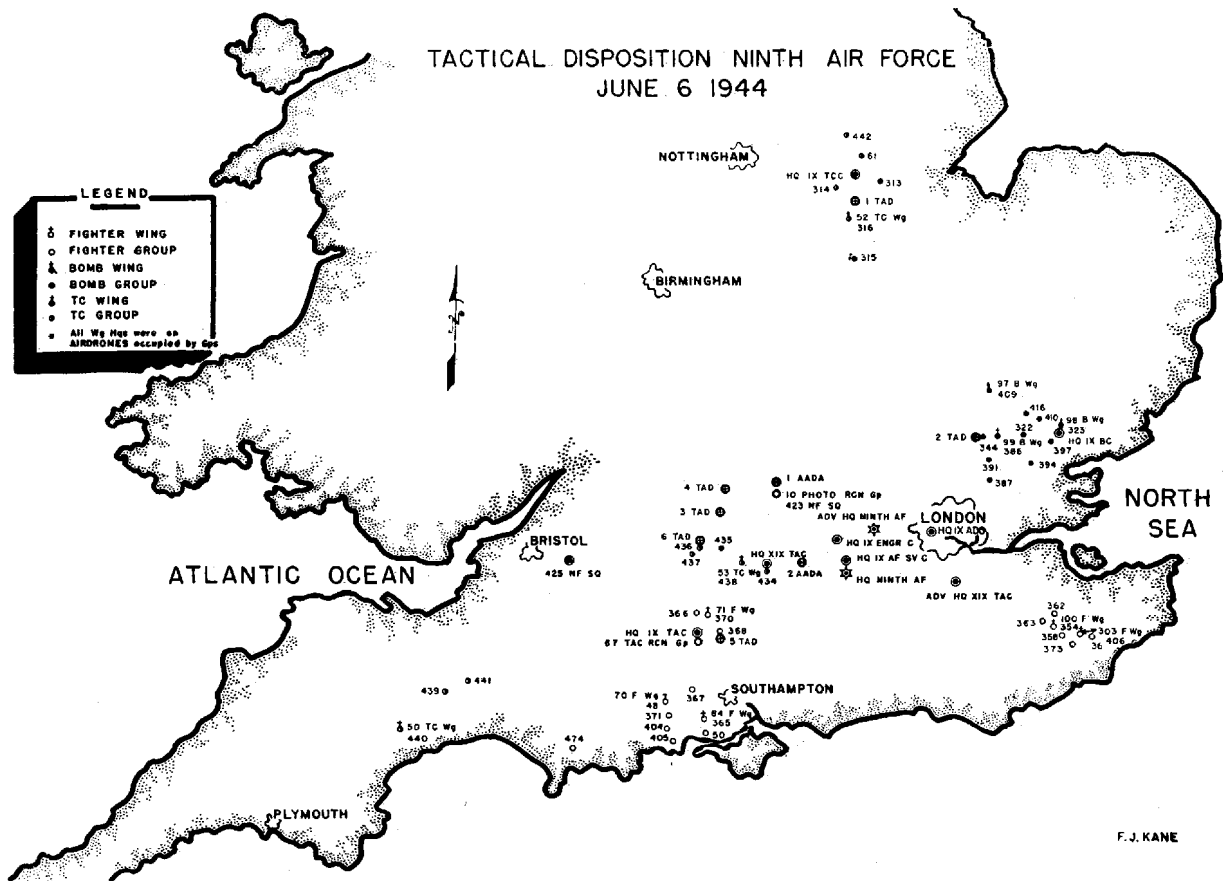



shire, southwest of Oxford; and a third cluster of three stations was still farther to the southwest, close to the coast of Devon and Somersetshire, in accordance with the wishes of the IX Troop Carrier Command.<sup>41</sup>

The service command's depots and other installations were centrally situated with reference to the stations of the tactical commands. Four of the tactical air depots were in Berkshire and Hampshire, west and southwest of London, while the other two were in Essex and Lincolnshire, close to large clusters of combat stations. The other service command installations—minor depots, truck transport stations, replacement depots, etc.—were scattered throughout the area stretching to the coasts south and west of London.<sup>42</sup>

### *Early Operations*

Prior to April 1944, Ninth Air Force operations were dictated largely by requirements of POINTBLANK and CROSSBOW. Directives from the Combined Chiefs of Staff accorded first claim on all the theater's air resources to the Eighth Air Force's climactic campaign against the GAF. While the Ninth's medium bombers struck at enemy airfields and other installations along the coast of the continent in coordination with the deeper penetrations of enemy territory by the heavy bombers, Ninth Air Force fighters flew escort for the bomber formations of the Eighth. The emergence of the V-weapon menace late in 1943 introduced a new set of high-priority targets whose claims for a time also took precedence over operations directly related to the impending invasion of Normandy.

The early combat history of the Ninth Air Force in ETO is largely the story of its bomber command, which in October 1943 took over the four B-26 groups that had been operating under the VIII Air Support Command. These groups, after an ill-fated low-level attack on Ijmuiden in the preceding May,\* had resumed operations on 16 July. The improved showing of the B-26's, now flying at 12,000 to 15,000 feet rather than at the low levels employed in May, helped allay many of the fears concerning the Marauders which had been current after the Ijmuiden operation.<sup>43</sup> VIII ASC reached the peak of its activities in the Anglo-American STARKEY operations of late August and early September† and on 9 October directed its last

\* See Vol. II, 339-41.

† *Ibid.*, 688-89. Between 25 August and 9 September VIII ASC dispatched more than 1,700 aircraft of which number 1,300 actually attacked continental targets with a total loss of 9 planes.

mission—a strike against the Woensdrecht airfield in Holland.<sup>44</sup> When next the B-26's operated, in a minor strike on 22 October against the Évreux/Fauville airdrome, it was under the aegis of IX Bomber Command.<sup>45</sup>

That command found itself bound by the same directives which had previously governed the operations of the medium bombers, and their pattern of operations remained substantially unchanged, except for the addition of CROSSBOW targets beginning in November. Even when the Ninth passed to the operational control of the AEF on 15 December, the basic objective of the mediums remained the same—to reduce the enemy fighter force in northwest Europe by attacking enemy airfields and industrial installations. Operations in support of VIII Bomber Command thus remained the first priority and CROSSBOW operations were placed second.<sup>46</sup>

Against enemy airdromes in France and the Low Countries the B-26's achieved indifferent results, at best merely denying the GAF use of those fields for short periods of time. It had been hoped that the medium attacks would serve to draw enemy fighters away from the heavy bombers, and the heavy and medium missions were accordingly coordinated for that purpose. But the Germans elected to withdraw their fighters from the advanced fields for concentrations against the heavies, and seldom were any enemy aircraft found on the fields under attack. "Never," wrote Brereton in November 1943, "so far as is known, have enemy fighters been drawn from adjacent areas to attack the mediums when a large force of heavies was on the screen."<sup>47</sup> Even when Leigh-Mallory acted on Brereton's suggestion that the efficient escort for medium bombers provided by 11 Group of the RAF be reduced as an invitation to the enemy to engage the B-26's,<sup>48</sup> German fighter reaction showed no great increase and medium bomber losses remained low. Some of the attacks on airdromes produced good results in terms of damage to installations and facilities, as in the attack of 3 November by seventy-two Marauders on the airdrome at St.-André-de-l'Èure. On 1 December successful attacks were made on airfields at Cambrai/Niergnies and Lille/Vendeville in northern France, and on 13 December, in the largest mission yet undertaken by IX Bomber Command, 199 planes dropped almost 400 tons of bombs on the Amsterdam-Schiphol airdrome, inflicting severe damage. But the attrition forced upon the enemy remained small, and in January 1944 only one attack was directed against an airdrome target—at Cherbourg/Maupertuis on the 7th.<sup>49</sup>

The growing concern in December over the V-weapon threat caused Leigh-Mallory to direct the mediums increasingly against V-weapon sites. This change found justification in the feeling on the part of tactical air commanders that the attacks against enemy airfields had proved ineffectual,<sup>50</sup> but the strategic air commanders disagreed. "It is absolutely essential," Spaatz wrote Arnold on 1 February 1944, "that mediums attack airdromes properly timed with our attacks to secure not only the maximum protection to our own formations, but the maximum destruction of the German Air Force."<sup>51</sup> As the result of visits and letters from Spaatz and Fred Anderson, the Air Ministry early in February asked Leigh-Mallory to make it clear to all concerned that CROSSBOW's claim to the services of the medium bombers ranked second to that of POINTBLANK. Nevertheless, Spaatz continued to find during February reason to complain of AEF's refusal to send the mediums against airfields as requested by USSTAF.<sup>52</sup> The failure to achieve cooperation between USSTAF and AEF, coupled with other differences over the training of Ninth Air Force units and over control of the strategic air forces themselves, created an atmosphere of distrust and suspicion between the two headquarters, which was the exception rather than the rule in Anglo-American relations in the European theater. The fact that medium attacks on NOBALL targets (German launching sites) were usually coordinated with heavy bomber missions so as to provide some diversion had little effect in easing the tension.

Whatever the justification for Eighth Air Force complaints regarding the use of the Ninth's medium bombers, there existed no cause for dissatisfaction over the employment of Ninth Air Force fighters. Through January the 354th Fighter Group, which had reached the theater with its P-51's in November and was assigned to IX Fighter Command, operated under the control of VIII Fighter Command. The first operation by Ninth Air Force fighters came on 1 December, when twenty-eight P-51's executed a sweep over northwestern France. On 5 December the Mustangs flew their first escort mission, a comparatively short one to the Amiens area, and on 13 December the P-51's, in company with the Eighth's 55th Fighter Group (P-38's), escorted the B-17's 490 miles by a dogleg course across the North Sea to Kiel and back. This was the longest fighter escort mission yet flown and presaged the loss by the GAF of control of the air over Germany during American heavy bomber attacks.<sup>53</sup> In January the Mustangs flew 325 effective sorties, 36 less than in December—a de-

cline attributable in part to a firing defect in the P-51's guns which caused many abortive sorties.<sup>54</sup> But corrective action had been initiated by the end of the month, and with the addition of jettisonable tanks the P-51 became the outstanding long-range escort fighter—so much so, in fact, that most of the newly arriving P-51 groups thereafter went to the Eighth Air Force.

With only five operational groups—four medium bombardment groups and one fighter group—Ninth Air Force operations continued on a relatively small scale through January, but in February 1944 its operations were marked by a sharp upward swing. In a period of little more than three months after the opening of February, virtually all of the Ninth's bomber and fighter groups became operational. The IX Bomber Command added four more medium and three light (A-20) bombardment groups, and the 354th Fighter Group was joined by seventeen additional fighter groups.\*<sup>55</sup> Contributing further to the increase in the bomber command's operational rate was the development of a pathfinder squadron employing blind-bombing equipment and techniques developed by the RAF and the Eighth Air Force. As early as 21 February pathfinder planes led B-26's of the 322d Bombardment Group to their target—Coxyde airdrome in Holland.<sup>56</sup>

The medium bombers expended the major part of their growing effort against V-weapon sites during February. On 8 February, for the first time, the bomber command sent out two missions on a single day, and on 9 February the first of a long series of attacks on marshalling yards was carried out—against Tergnier in northern France. In coordination with the Big Week operations of the Eighth Air Force against the German aircraft industry the medium bombers, on 24 and 25 February, attacked enemy airfields in Holland—Leeuwarden, Gilze-Rijen, Venlo, and St.-Trond—and NOBALL sites in France. During February the B-26's flew 2,328 effective sorties and dropped more than 3,300 tons of bombs. They lost twenty aircraft, more than the total for the preceding three months.<sup>57</sup> Through the early days of March the NOBALL sites continued to provide the

\* The fighter groups, arranged in the order of the date on which they became operational, were:

358th (P-47), 3 Feb.	405th (P-47), 11 Apr.	404th (P-47), 1 May
362d (P-47), 8 Feb.	371st (P-47), 12 Apr.	36th (P-47), 8 May
365th (P-47), 22 Feb.	48th (P-47), 20 Apr.	373d (P-47), 8 May
363d (P-51), 22 Feb.	474th (P-38), 25 Apr.	406th (P-47), 9 May
366th (P-47), 14 Mar.	50th (P-47), 1 May	367th (P-38), 9 May
368th (P-47), 14 Mar.	370th (P-38), 1 May	

## THE NINTH AIR FORCE

major targets for IX Bomber Command, but by the middle of the month that command had turned its attention primarily to the pre-invasion phase of the operations for which the Ninth Air Force had originally been created. Henceforth targets for its bombers would be selected chiefly in accordance with the program for wrecking the enemy's transportation facilities on the continent.\*

Escort missions still claimed the major share of the fighter effort. During February the number of effective sorties (1,778) was more than four times the number flown in January. The fighter groups, heretofore under the direct control of the VIII Fighter Command for operations, were placed under the 70th Fighter Wing of the IX TAC, and the Ninth moved toward complete control of its air units. On 3 February the 70th Fighter Wing controlled two of its groups in the air for the first time, and in March the fighter command took over operational planning control of its fighter groups. Ninth Air Force fighters played an important role in escorting Eighth Air Force bombers to aircraft targets in Germany during the Big Week of February, and on 4 March the fighters flew over Berlin for the first time.<sup>58</sup> In addition to escorting the heavy bombers the fighters also accompanied the Ninth's medium and light bombers on their missions, replacing in March the RAF Spitfires of 11 Group, which had heretofore provided most of the escort for these missions. More than 4,600 effective sorties were flown by the fighters during March, all but a few hundred of them in escort of bombers. With the advent of April the fighters definitely came into their own, executing strafing and bombing missions greater in number than those involving escort alone. On 9 May, the eighteenth and last of the Ninth's fighter groups, the 367th, became operational.<sup>59</sup>

From being an adjunct of the Eighth Air Force the Ninth had emerged by the end of April as a full-fledged tactical air force. Beginning with a small attack by seven planes of the 366th Fighter Group against St.-Valéry airdrome on 15 March, Ninth Air Force fighters increasingly turned their attention to practicing the techniques of fighter bombing against continental targets.† On 26 March some 240 fighters drawn from five groups attacked marshalling yards and CROSSBOW targets in France. The fighters dropped 102 tons

\* See below, pp. 149-62.

† After 20 May 1944 the Ninth Air Force referred to all fighter groups as fighter-bomber groups. The terms were eventually used interchangeably.

of explosives in March and more than ten times that amount in April.<sup>60</sup> Already the 67th Tactical Reconnaissance Group, an experienced and hard-working organization, had carried out the enormous task of photographing 160 miles of French coast and two inshore strips of 120 miles each under exceedingly hazardous conditions.<sup>61</sup>

### *Logistical Planning*

In preparation for the accomplishment of its primary mission in support of the continental invasion, it was necessary for the Ninth Air Force to divide its attention among a variety of responsibilities, any one of which imposed a heavy burden upon its leaders. The expanding operations of the spring of 1944 depended upon a build-up of forces that proceeded at a rate imposing the heaviest possible administrative and organizational responsibility. These operations served as useful training for newly arriving units, but they frequently interfered with training programs designed to meet the peculiar needs of post-invasion operations. And while adjusting its organization to an unprecedented rate of build-up, the Ninth Air Force was also required to maintain a flexible structure that could be fitted readily to the demands of a highly mobile type of warfare on the continent.

Especially difficult were the tasks of logistical organization and planning, and from its very inception in the United Kingdom IX Air Force Service Command enjoyed a position of eminence within the Ninth Air Force beyond that of the average service command. Not only did air force headquarters divest itself of some of its administrative functions, as with the assignment to the service command of control over all personnel replacement depots,<sup>62</sup> but it was recognized that a war of movement on the continent would require an unusually large, strong, and flexible logistical organization because of the wide dispersion of combat groups and the consequently long extension of supply lines.

Fortunately the IX AFSC, as a result of USSTAF's assumption of administrative authority over both U.S. air forces in ETO, came under the control of the theater's chief air logistical officer, for General Knerr insisted on eliminating all avoidable duplication of effort. Beginning in March 1944, Air Service Command, USSTAF progressively took over all base service functions. The IX AFSC did away with its base air depot area and on 17 May transferred its most important installations (Baverstock and Filton) to ASC, USSTAF,

which continued to use them to provide base services for the Ninth. Knerr actually went still further and assumed responsibility for and authority over service command functions below the level of advanced depots, "with such exceptions as experience may prove to be desirable."<sup>63</sup> During 1943 and early 1944, the IX AFSC had sought to organize a system which would give it maximum control of its own supply procurement. Against the opposition of Knerr this effort made little headway, although, for a while, from December 1943 until March 1944, the Ninth received permission to deal directly with the Air Service Command in the United States and the SOS in the theater for certain items of supply—specifically, Air Corps supplies for aircraft peculiar to the Ninth Air Force (A-20's, B-26's, and C-47's) and certain ordnance, signal, and quartermaster supplies, particularly rations. Burtonwood, having been designated the supply control depot, in March 1944 was "charged with the responsibility for receiving and processing all requisitions for supplies to be obtained from the United States, the SOS, and the British, with such exceptions as may be authorized by ASC Headquarters, USSTAF from time to time." The exceptions were rare.<sup>64</sup>

The Ninth's supply system for both Air Corps and common-user items followed routine channels: from base depots through tactical air depots and service teams to the combat groups. Exceptions were made for certain signal and quartermaster items which the tactical air depots were permitted to secure directly from the SOS depots. Because of the special bomb and ammunition requirements of the Ninth, it was permitted to retain its own ordnance depot at Grovely Wood, Wiltshire, even after it had given up its other base depot functions. The tactical air depots were authorized a ninety-day level of supplies, which was attained or exceeded for some items and never reached for others.<sup>65</sup>

The supply system was bound together by a truck and air transport service which operated under the direction of the Transportation Division of IX AFSC headquarters. The truck companies, drawn from the service and air depot groups and organized into regiments, never reached the number actually authorized for the command; and, indeed, there was delay and difficulty in equipping those on hand. The 31st Air Transport Group was a valuable cog in the distribution machinery of the air force, flying cargo and personnel in support of oper-

ations, playing the same role that the 27th Air Transport Group did for the Eighth Air Force.<sup>66</sup>

Supply problems of the Ninth prior to D-day were similar to those which had faced the Eighth during 1942-43. The unit equipment problem was particularly aggravating because of the approach of D-day, which imposed a more rigid obligation on the Ninth than the Eighth had ever faced. The many special types of units which were activated in the theater complicated the problem because adequate arrangements had not been made for their supply. Then, too, the Eighth Air Force was organizing its subdepots, which were given priority for equipment ahead of the Ninth's units. As late as April 1944 a number of IX AFSC depot and supply squadrons possessed as little as 5 to 15 per cent of their equipment, but the IX AFSC as a whole was more than 80 per cent equipped in March. In April, IX AFSC officers were given permission to visit the base depots and the Eighth Air Force service units in search of any equipment that could be made available. The speeding-up of the supply flow from the United States during the spring enabled the Ninth Air Force to have its units, with few exceptions, ready for full action on D-day.<sup>67</sup>

The higher priority of the Eighth Air Force for fighter planes for a time slowed the flow of aircraft to the Ninth. As fighter aircraft flooded into the theater during the late winter and spring of 1944, however, assembly and modification depots expanded their output and fighter groups received their full complements of planes. The prodigious increase in the rate of operations by both the Eighth and the Ninth led in May 1944 to a shortage of 75-gallon jettisonable tanks, which was remedied only by diverting to England from the United States tanks which had been intended for the China-Burma-India theater. By D-day the Ninth had almost reached its full strength in aircraft, including replacements—more than 4,500 tactical planes plus almost 2,700 gliders.<sup>68</sup>

Other supply problems were solved in similar fashion by the arrival of huge quantities of supplies and equipment in the months before D-day. Bombs and ammunition had to be carefully husbanded, even during the spring, because the stockpiles in the theater were being consumed at a much faster rate than planners in the United States had expected; as a result, the Ninth's bombers could not always have the type of bomb they requested for use against particular targets. Complaints about the shortage of small bombs were frequent. Aviation fuel



## THE NINTH AIR FORCE

presented primarily a distribution and storage problem, particularly at the advanced landing grounds, which had been expanded far beyond their original capacities.<sup>69</sup>

The Ninth's maintenance organization was patterned after that of the Eighth and leaned heavily on ASC, USSTAF for assistance. During its earlier months in England, while it still anticipated that it would be logistically independent of ASC, USSTAF, the IX AFSC made arrangements to perform much of its own assembly and modification work. Assembly depots were constructed in open fields at Filton in Gloucestershire and at Greenham Common in Berkshire, the latter for gliders. Assembly of aircraft increased steadily, reaching a peak of 496 in April and declining to 301 during May, when Filton was transferred to ASC, USSTAF. Glider assembly made slow progress until April when 930 gliders were assembled, and by the end of May the IX AFSC had assembled more than 2,000 gliders for the troop carrier command. By this time arrangements had been made for ASC, USSTAF to take over this work also, but the aircraft and glider assembly program of IX AFSC made a definite and substantial contribution to equipping the combat groups of the air force, for the ASC, USSTAF assembly depots could not have met the needs of both the Eighth and the Ninth at a time when dozens of new groups had to be equipped.<sup>70</sup>

By the end of 1943, when modifications had become a major function of the base air depots in the theater, the IX AFSC, in the interest of a faster flow of aircraft to the fighting units, undertook to modify planes at the tactical air depots. In December 1943 the tactical air depots were modifying B-26's, P-47's, and P-51's; by March 1944 they were also modifying P-38's, C-47's, and gliders. The chief fighter modification involved the installation of jettisonable tanks. Service teams, some of whose combat groups had not yet arrived in the theater or were not yet in combat, were of great assistance in performing modifications on aircraft, using modification kits which had been sent from the base air depots via the tactical air depots. In all, from February through May, the tactical air depots and the service teams modified approximately 2,400 aircraft, more than 1,500 of them in April and May. After the Ninth began to move to France in June, the modification output of its service command declined to a fraction of April and May production and the base air depots of ASC, USSTAF assumed the larger part of the modification load. Thus, after D-day, the

theater air service command, which was already responsible for the receipt of all aircraft in the theater, assembled, modified, and delivered virtually all of the Ninth's planes.<sup>71</sup>

Day-to-day maintenance and repair services remained in the hands of the tactical air depots and the service teams. The depots performed fourth-echelon repair and maintenance, overhauling engines and propellers and doing major repairs on heavily damaged planes; what they could not handle they sent on to Burtonwood and Warton. The two advanced air depot areas specialized in handling the various aircraft of the Ninth: the first area concentrated on bombers and miscellaneous aircraft; the second area handled the fighter aircraft. Service teams, like the Eighth Air Force subdepots, were located on the same stations with the combat groups and handled third-echelon repair and maintenance for them.<sup>72</sup> Each service team had four of the nine self-sufficient and completely mobile units which comprised the reclamation and repair squadron assigned to the service group; the ninth unit was generally assigned to the service group headquarters.\* The several mobile units could be sent wherever needed; they performed on-site repairs and routine maintenance work, salvaged aircraft, and even assisted in glider and aircraft assembly. In the period from February through May 1944 the service command performed maintenance and repair work on almost 2,400 aircraft. Most of the work was done by service teams, for the tactical air depots were largely occupied by the time-consuming modification of aircraft.<sup>73</sup> By D-day the Ninth Air Force itself was completely self-sufficient in the performance of the first three echelons of maintenance, but it would remain partly dependent on the base air depots of ASC, USSTAF for fourth-echelon maintenance.

Meanwhile, a group of IX AFSC officers headed by Col. Vernon M. Babcock, one of the most experienced planning officers in the theater, had worked out in close collaboration with representatives of the British Second Tactical Air Force and of U.S. ground and naval headquarters the Ninth Air Force Administrative Plan for OVERLORD. Issued on 21 April 1944 and, after some revision, reissued on 8 May, this plan was based on three major assumptions: the air force would operate initially from England and would move to the continent as rapidly as possible after D-day; the United Kingdom would be the main base for OVERLORD; and the major repair facilities and the

\* For the composition of these teams, see again p. 116 n.

main reserves of men and equipment would remain also in the United Kingdom. The detailed plan itself was at almost all points subject to factors beyond the control of the air force—the availability of invasion shipping, the movement priority actually accorded the air force, and the rate of build-up.<sup>74</sup>

In preparation for D-day, the service command would pre-stock the combat bases in the United Kingdom about D minus 15 and especially would stock each of the advanced landing grounds of IX and XIX Tactical Air Commands with 90,000 gallons of aviation gasoline, a precaution against the road congestion that would blanket all of southern England in the several weeks preceding D-day. With the supply of the combat bases thus assured, the service command could then use its trucks to help combat groups, airdrome squadrons, and service teams move to the ports of embarkation. The actual movement machinery would be in the hands of other agencies, but at key points in the transportation pipeline the Ninth would provide liaison officers who would help smooth the way for air force units. To replace anticipated losses of noncombat personnel on the continent, the service command would establish a reserve manpower pool of some 3,000 men in England.<sup>75</sup>

The build-up of units on the opposite shore was based on the availability of airfields to be constructed in France by IX Engineer Command. A construction program, worked out by a planning staff under Col. Herbert W. Ehr Gott, called for two emergency landing strips\* to be prepared on D-day, one on each of the two landing beaches. By D plus 3 there were to be two refueling and rearming strips† on OMAHA beach, and by D plus 8, four advanced landing grounds on OMAHA and one on UTAH. On D plus 14 there were to be five advanced landing grounds on OMAHA and three on UTAH; one runway on each beach was to be 5,000 feet, the others only 3,600 feet because of insufficient shipping for construction materials during the early build-up period. It was estimated that if the planned rate of ground advance was attained, a total of thirty-five advanced landing grounds would have to be constructed during the first forty days in order to accommodate all of the Ninth's fighter and reconnaissance

\* Rough, graded strips approximately 2,000 feet long, designed to provide a place for belly landings of aircraft.

† Strips near the front lines, each with a runway and a marshalling area on each end of the runway, designed for use by aircraft whose bases were in England.

## THE ARMY AIR FORCES IN WORLD WAR II

groups. Accordingly, the planned build-up of service forces was as follows:

D plus 3—ground elements for the operation of two refueling and rearming strips.

D plus 8—ground elements for the operation of the roulement system\* for 9 fighter squadrons, 5 fighter-bomber squadrons, and 1 fighter-reconnaissance squadron.

D plus 14—ground elements for the operation on the continent of one fighter-reconnaissance, 11 fighter-bomber, and 12 fighter squadrons.

D plus 24—ground elements for the operation of 37 squadrons.

D plus 40—ground elements for the operation of 58 squadrons.

All of these squadrons would use fighter-type planes; the bomber and troop carrier aircraft would not come to the continent until later when larger and better airfields would be available.<sup>76</sup> Since it was imperative that fighter groups be moved to the continent with a minimum of interference with their operations, it was planned that airdrome squadrons would precede the groups to the beaches and prepare the airfields for operations. After the flight echelons had established themselves in France, the ground echelons and then the service teams would follow. The airdrome squadrons would then move on to still more advanced airfields and the cycle would be repeated.<sup>77</sup>

Specially trained beach squadrons of the VIII AF Intransit Depot Group† would initiate service command operations on the beaches on D-day. Attached to ground force engineer special brigades, these squadrons would operate the air force's supply dumps on the beaches, receiving, sorting, and distributing supplies. Army beach brigades would operate intransit areas on the beaches for the reception of both ground and air units and would route them to their destinations. Overall direction of air service command activities in Normandy was to be in the hands of an advanced command headquarters, made up of personnel from IX AFSC headquarters and 2d Advanced Air Depot Area which, it will be remembered, specialized in serving fighter groups.<sup>78</sup>

Initial Air Corps supply would be in the form of ten-day pack-up kits provided by the service command and carried by the airdrome squadrons. The service teams that were to follow later would bring with them a thirty-day supply for the aircraft they were to service. Prior to the arrival on D plus 29 of the first air depot group, bringing

\* Use of an advanced field for a period of a few days by squadrons whose bases were in England or elsewhere in the rear. When the limits of servicing had been reached the squadrons would return to their regular bases and be replaced by fresh squadrons.

† In spite of the designation this unit belonged to the IX AFSC.

with it the supplies it actually had on hand in England, the flow of supplies would be from the air force dumps on the beaches to the airdrome squadrons or service teams and thence to the combat groups. After the air depot group was set up, it would receive supplies from England via the beach dumps and issue them to the airdrome squadrons and service teams. There was no specific plan to set up a base depot on the continent, but if and when one was established it would come under the control of USSTAF.<sup>79</sup>

The supply of POL (petrol, oil, lubricants) for all forces would be in the hands of the Communications Zone,\* since the air force had no organization for the purpose. The air force would draw its POL from Communications Zone dumps and transport it in its own vehicles. After D plus 20 no packaged aviation POL would be sent to Normandy as the Communications Zone guaranteed that pipeline facilities for bulk gasoline would be in operation by D plus 15. The service command assumed responsibility for flying replacement aircraft to the combat units from its reserve pools at Membury and Chilbolton in England.<sup>80</sup>

The service command's truck companies would go ashore in Normandy with the airdrome squadrons and service teams but immediately thereafter would revert to the control of their own battalion and regimental headquarters. Combat units and service teams would use their own vehicles to meet their needs, but the truck regiments would have to supply the bulk of the transportation for hauling supplies from the beaches and depots to the airfields. To the 31st Air Transport Group was assigned the task of operating a mail carrier service between England and the continent and transporting such materiel and personnel as it could handle.<sup>81</sup>

Aircraft maintenance would be initially in the hands of the airdrome squadrons, to be relieved later by the ground echelons of the combat groups. On their arrival on the continent, the service teams would resume performance of third-echelon maintenance. As much repair as possible would be done on aircraft, but those which could still fly would be sent back to depots in England for repair. All engines in need of overhauling would be sent back to England also, for the air depot groups would not bring their engine overhaul equipment with them. Aside from this, the air depot groups would perform fourth-echelon maintenance and repair once they had established

\* The Services of Supply, ETO was thus redesignated in June 1944.

themselves on the continent. Mobile reclamation and repair squadrons attached to the service teams would be responsible for third-echelon and some fourth-echelon maintenance of field artillery liaison aircraft. Salvage would be held on the continent until ports became available.<sup>82</sup>

### *Training*

The contributions of the Ninth Air Force to the landings in Normandy and the subsequent defeat of the German armies could not have been so impressively successful but for the intensive training in which it engaged during the seven months preceding June 1944. The high degree of readiness of the combat groups and their supporting service units on D-day attested to the energy and speed with which most of them had carried out their training assignments.

Training a tactical air force presented special problems of coordination with the ground armies, and many units required training for complex amphibious operations during the initial stages of OVERLORD. It was particularly important that mutual understanding of the principles of air-ground cooperation should exist between air and ground staffs. Accordingly, the Ninth Air Force conducted at its headquarters several series of lectures on air support operations for both ground and air officers, beginning in December 1943 and running through the spring of 1944. Those attending ranged all the way from ground and air force commanders down to division staff officers. Special attention was paid to the training of ground force officers who were assigned to combat groups as liaison officers for the purpose of interpreting the ground situation for the air force personnel.<sup>83</sup>

Experience in tactical air force operations was at a premium. Some of the commanders—notably Brereton and Quesada—and their staffs had had much combat experience; but all of the combat units, with the exception of four medium bombardment and four troop carrier groups (these last did not arrive from the Mediterranean until March 1944), were new and inexperienced. The tactics and techniques of the European air war had reached heights of refinement not fully incorporated in training programs in the United States and there was need for thoroughgoing indoctrination of all new combat groups in the theater. The Eighth Air Force made available its schools and training aids, which were of special importance to the IX Fighter Command. The Ninth, also, made great use of the RAF's special tactical schools, particularly the gunnery, army cooperation, and low-level attack schools.<sup>84</sup>

One theme ran constantly through the training programs undertaken by Ninth Air Force units, and that theme was mobility. All units were urged to "Keep Mobile" by retaining only a minimum of impedimenta and obtaining a maximum of transportation. All units were required to engage in mobility exercises, which often consisted of overnight moves from home stations to other stations or to bivouac areas and then return—exercises of more value and significance than many of the harassed and exasperated participants realized.<sup>85</sup>

The commands supervised the training programs of their units under the general direction of air force headquarters. The bomber command, thanks to its heritage of four medium bombardment groups from the VIII Air Support Command, possessed a greater reservoir of experience than was available to the other combat commands, but it still lacked experience in air-ground cooperation. Information was sought from the Twelfth Air Force in Italy, and in March and April, General Anderson and members of his staff visited Italy and observed tactical operations there.<sup>86</sup> Much effort was devoted to the training of bomber crews in the use of the radar aids developed by the RAF and the Eighth Air Force, and in January a provisional pathfinder squadron was established. With an eye to future operations on the continent, groups were given experience in night flying. Bomber command units also participated in some of the joint amphibious exercises which were carried out at Slapton Sands, on the southern coast of Devonshire near Dartmouth, at intervals during the winter and spring.<sup>87</sup> Even the four original bombardment groups of the Ninth Air Force, whose bombing incidentally showed diminishing returns in the spring, were withdrawn one at a time from operations in April and May for a week of intensive bombing practice. This training proved its worth in the increased efficiency of the groups during the pre-D-day operations.<sup>88</sup>

The IX Fighter Command retained control of fighter training down to D-day. The unavoidable use of the fighters to support the strategic bombing campaign delayed their training as fighter-bombers until the late winter and spring of 1944, when the Ninth was released from the major part of its commitment in support of POINTBLANK. In February the training program was further retarded by the decision to equip virtually all of the fighter command's groups with long-range tanks. The subsequent slowdown in delivery of aircraft and in training delayed the operational dates of several groups.<sup>89</sup> Beginning in January, when Brig. Gen. Ned L. Schramm, commander of the 71st

Fighter Wing, and ten other officers visited Italy, the fighter command sent several groups of officers to the Twelfth Air Force to learn the lessons of air support. These officers did more than observe; they participated in regular missions and learned from personal experience. Qualified Twelfth Air Force officers were brought to England to help prepare programs and supervise the training of the Ninth's fighter groups. The AEAFF established a fighter leaders' school, where skilled American and British pilots from Italy instructed more than one hundred Ninth Air Force pilots, as well as RAF pilots, by the beginning of May.<sup>90</sup> By the end of that month, a number of groups still needed additional training in air support operations, but they all possessed the minimum necessary for combat.<sup>91</sup>

Since the IX Troop Carrier Command, unlike the other combat commands, engaged in no combat operations prior to D-day, it was able to devote most of its energies to training its groups. Of its fourteen groups, four had gained experience in the Mediterranean before being transferred to the Ninth in 1944. The other ten groups, all new units from the United States, had to be trained in the complexities of large-scale airborne operations. Like the bomber and fighter commands, the IX TCC sent representatives to the Mediterranean to study troop carrier operations. A large number of joint exercises with British and American airborne troops were carried out, particularly during April and May, with as many as three or four groups participating. Additional experience was gained by flying supply and medical evacuation missions within the United Kingdom. Like the bomber command, the troop carrier command established a pathfinder school for selected crews and devoted much time to night exercises in preparation for the pre-dawn D-day airborne landings.<sup>92</sup>

The IX Air Force Service Command had one of the most difficult training tasks because large numbers of its troops arrived from the United States as casuals or fillers, unorganized and with a bare minimum of basic training. Others arrived with their qualifications obscured, and the Ninth had to carry out a major reclassification program which ultimately affected thousands of the new arrivals. The greater part of training was conducted on the job by the units themselves. This training was hampered by a shortage of unit equipment which persisted almost until D-day. The specialized training in RAF and ASC, USSTAF schools was accelerated in March when USSTAF gave the IX AFSC first priority on available technical training facili-



ties for the ensuing ten weeks. Much time was spent in preparing the special type units which would be required on the continent.<sup>93</sup>

The IX Engineer Command training program could not get under way until the SOS began to turn over to the Ninth Air Force the engineer battalions which would compose the command. Many of these had been in the theater for a year or more and were considered proficient in general construction work, but they needed training in advanced landing ground construction and the use of lightweight surfacing materials and, particularly, in basic infantry tactics, for more than any other Ninth Air Force units they would be subject to ground attack. Although there was difficulty in obtaining training sites for the battalions, the program was begun in December 1943 and carried forward steadily down to May 1944 when additional battalions were turned over by the SOS or arrived from the United States. In the course of their training some of the battalions had the opportunity to build or improve advanced landing grounds in East Anglia and in Kent and Southampton areas, but most of them later had to undertake the task on the continent without this experience. About 50 per cent of the training schedule time was devoted to basic infantry and engineering subjects. The command helped train the other Ninth Air Force commands in the use of camouflage and the handling of booby traps.<sup>94</sup>

It could hardly be said that the Ninth Air Force training program was in all particulars a model one, but the job got done and stood the test of critically important operations. If at points there was inefficiency there was also the mounting pressure of many other claims on time, resources, and men. The accomplishment, to be judged properly, must be viewed in the context of the over-all achievement credited to the air force. That achievement bespeaks much careful planning and efficiency of execution; it speaks too of a will that repeatedly overcame the mistakes and the confusion inherent in so large a military effort. More than one of those who shared in the effort can appreciate the comment of a highly experienced supply officer after his inspection of IX AFSC in May 1944: excellent results had been obtained, he observed, "by brute force [and] wasted manpower, transportation, and storage space rather than by efficiency of operation."<sup>95</sup>

## CHAPTER 6

\* \* \* \* \*

### *PRE-INVASION OPERATIONS*

**I**N A general sense all Anglo-American air operations conducted over the continent since the beginning of hostilities had served to prepare the way for the long-awaited invasion of northern France. Especially was this true of the great strategic bombing effort which by the spring of 1944 in its major achievement had eliminated the German Air Force as an offensive power. But there remained a multitude of tasks to be accomplished by the Allied air forces, both strategic and tactical, in immediate preparation for the war's greatest amphibious operation.

The primary mission set forth in the over-all air plan for OVERLORD, issued on 23 April 1944, was the attainment and maintenance of an air situation in which the German Air Force would be incapable of interfering with the Allied landings. The plan in typical air force fashion called for a three-phase program. In the first or preliminary phase, extending from D minus 50 to D minus 30, the stress would be placed on counter-air force operations and on reconnaissance. Air priorities for a second or preparatory phase, running from D minus 30 to D minus 1, were named in the order of (1) the German Air Force, (2) strategic railway centers, (3) selected coastal batteries, and (4) airfields within a radius of 130 miles of Caen.<sup>1</sup> The assault phase would begin on the night before D-day when American paratroops, in numbers not yet determined, would drop on the Cotentin Peninsula and British paratroops descend on chosen points between the rivers Orne and Dives. Over the beaches five Spitfire squadrons would fly low cover while five P-47 squadrons provided high cover. To protect the armada in the main shipping lane, five squadrons of easily identifiable P-38's would be continuously available, flying in relays. In all, fifty-four squadrons of fighters were assigned to beach cover, fifteen to ship-

ping cover, thirty-six to direct support of ground forces, thirty-three to escort and offensive air fighting, and thirty-three to a reserve striking force—a total of 171 squadrons.<sup>2</sup>

In a post-assault phase, air would continue its destruction of the Luftwaffe and maintain bombing pressure on Germany. Other chief tasks would be to delay enemy reinforcements moving toward the invasion area, to provide air transport, to support ground forces, and to perform reconnaissance. It was anticipated that with the development of air facilities on the continent\* it should be possible by D plus 40 to base as many as 116 fighter squadrons in France.<sup>3</sup>

These plans rested upon the assumption that the Allies would enjoy the advantage of overwhelming strength in the air. Estimates in April indicated that the combined forces of the AAF and RAF in the United Kingdom ready for operations as of D-day would equal 1,407 U.S. heavy bombers, 1,180 British heavy bombers, 835 light and medium bombers, 565 fighter-bombers, 2,250 day fighters, 170 night fighters, 175 tactical and 150 photographic reconnaissance aircraft, 1,000 troop carriers, and 120 transports; opposing this vast assemblage of aircraft the Germans might dispose of 1,950 planes of all types, of which number perhaps no more than 855 could be thrown into the battle for Normandy.<sup>4</sup> Actually, these figures proved to be underestimates. By D-day British and American air strength amounted to 3,467 heavy bombers, 1,645 medium, light, and torpedo bombers, 5,409 fighters, and 2,316 transport and troop carrier aircraft—all in combat squadrons.<sup>5</sup> Records now available also indicate that the Germans had as many as 3,222 fighters and bombers in condition for combat on the eve of the invasion,<sup>6</sup> but these revised figures call for no correction of the basic assumption that the invading forces would have an overwhelming advantage in the air.

The nerve center for control of the great air armadas scheduled to serve as the vanguard of the Allied assault was located at Uxbridge, where the RAF had directed its defense of London during the Battle of Britain and where the RAF's Second Tactical Air Force had taken up its headquarters under Air Marshal Coningham. The Ninth Air Force had established an advanced headquarters there in February and shared with the Second Tactical Air Force a combined operations room from which both forces directed their operations in close consultation one with the other. Leigh-Mallory having won out in his insist-

\* See above, pp. 131-32.

ence upon the establishment of an advanced operational headquarters for AEAFF,\* that too was located at Uxbridge with Coningham in command. Its authority, however, tended to be more nominal than real, for Coningham and Brereton worked in constant association to achieve an effective collaboration in the execution of directives which came down from Leigh-Mallory but had their origins in conferences of the tactical air commanders with Tedder, Spaatz, and Harris. Quesada's IX Fighter Command shared with the RAF's 11 Group a combined control center at Uxbridge for the direction of fighter operations, and a combined reconnaissance center supervised another vital phase of air activity. Advanced AEAFF dealt directly with Montgomery, whose 21 Army Group established at Uxbridge an element to relay ground force requests and to provide such information as might be helpful in the development of an effective air-ground collaboration. Leigh-Mallory himself remained at Stanmore to supervise all AEAFF operations and to coordinate the tactical support to be provided by the heavy bombers.<sup>7</sup>

A fantastically complicated system of communications and signals joined Uxbridge to its operating units and to associated forces on land and sea. The over-all air plan provided for ship-to-shore, point-to-point, and ground-to-air signals and the derivative plans of lower headquarters in their communications annexes underscored as perhaps nothing else could the fact that this was a war heavily dependent upon "magic," to use Mr. Churchill's term. On each of the five headquarters ships scheduled to accompany the initial landing force an air representative would be available to advise assault commanders and to direct Allied aircraft to targets in the Channel or on the beaches. In the shipping lanes three fighter-direction tenders would guide the fighters to their targets and provide necessary radar and signal controls. As quickly as possible, ground-control interception stations would go into operation on the continent. Air, ground, and naval headquarters exchanged liaison officers to assure close contact and understanding. Air support parties would accompany the assault forces to facilitate timely air assistance. Until the Allied forces could be firmly established on the continent the diverse lines of communication would be tied together chiefly through the combined control center at Uxbridge.<sup>8</sup> This plan in its essential details was that followed.

\* See above, p. 110.

## PRE-INVASION OPERATIONS

### *The Assignments*

The heaviest and most critical responsibilities assigned to any single air organization fell upon the Ninth Air Force, whose tactical air plan for the invasion, dated 26 April, expanded appropriate sections of AEAFF's over-all air plan. IX Bomber Command would devote the preliminary phase to training and to attacking railway centers, robot-bomb installations, airfields, and coastal batteries. These tasks would continue during the preparatory phase, together with the additional objective of neutralizing airfields within 130 miles of Caen and selected radar stations. Before H-hour on D-day its eleven groups of A-20's and B-26's would attack six heavy gun batteries which were in a position to fire on the assault forces in the Channel, those at Barfleur, Maisy, Pointe du Hoe, Bénerville, and Ouistreham I and II, and, five minutes before touchdown, the mediums would bomb seven defended localities behind UTAH beach. Those operations completed, IX Bomber Command's bombers would return to base to be made ready for any other missions that might be assigned.<sup>9</sup>

IX Fighter Command, functioning through IX Tactical Air Command until the U.S. Third Army was ready to operate in France,\* would provide escort for bombers, perform reconnaissance, and carry out offensive sweeps over France. It was scheduled to provide during the assault phase the five P-47 groups for high cover over the beach area and two P-38 groups which, with four groups of Eighth Air Force Lightnings, would maintain continuous daylight patrol over the invasion armada. Two other P-38 groups and four P-47 groups of IX TAC would bomb enemy gun batteries about H-hour and furnish direct support for the ground forces thereafter as requested. Five fighter groups would be held in readiness as part of the reserve striking force.<sup>10</sup> The pre-invasion operations interfered seriously with plans for training in conjunction with the ground forces, and it was only after a period of intensive combat that air-ground coordination reached the remarkable degree of effectiveness which became so deservedly renowned.<sup>11</sup>

The enormous responsibilities imposed on IX Air Force Service Command have already been indicated, as also those falling to IX Engi-

\* On the IX and XIX Tactical Air Commands, see above, pp. 112-13.

near Command.\* The administrative plan of the Ninth Air Force listed additional details that had to be anticipated as comprehensively as circumstances would allow. All kinds of measures were necessary to mark supplies and equipment with the familiar Ace of Spades insignia of the Ninth, to waterproof property, and generally to comply with that well-titled manual, *Preparation for Overseas Movement: Short Sea Voyage*. There were problems of estimated casualties, resupply, replacement of personnel, emergency reserves, baggage, currency, and many others to be attended to. Probably the most time-consuming and exacting task which confronted the Ninth Air Force planners was the preparation of troop lists.<sup>12</sup> When completed, the aggregate Ninth Air Force plan for the invasion weighed, as General Brereton noted in his diary, ten pounds and three ounces, and it contained 847,000 words on both sides of 1,376 pages of legal-size paper.<sup>13</sup> After the war Brereton judged that the tactical air plans for the invasion could not have been significantly improved.<sup>14</sup>

With the controversies regarding the transportation plan and the command system out of the way, the top SHAEF and strategic air commanders developed a detailed program, which was included in the main in the over-all air plan, for the employment of Eighth Air Force and RAF Bomber Command heavies. The first master SHAEF directive after Eisenhower assumed direction of the heavy bombers on 14 April† called upon USSTAF to continue its campaign to destroy the German Air Force as first priority and as second priority to attack the enemy's rail centers. RAF Bomber Command was to proceed with its general disorganization of German industry and to begin its share, which eventually proved to be the largest of all, of the transportation plan,<sup>15</sup> the term usually used to indicate the Allied scheme for disrupting enemy communications. Soon afterward the Fifteenth Air Force received a directive to bomb marshalling yards in southern Germany and France in conjunction with the pre-OVERLORD attacks.<sup>16</sup> As the time for the invasion approached, other directives, some of which were based on requests by tactical air, naval, and ground commanders, were given the strategic air forces.<sup>17</sup> In addition to the destruction of enemy transportation, heavy bombers were to attack coastal batteries, V-bomb sites, airdromes, and bridges and to continue their deep penetrations of Germany proper in order to pin down the enemy's fighter strength.

\* See above, pp. 130-34.

† See above, p. 81.

With the main campaigns completed by 1 June 1944, the Eighth Air Force was to send 60 per cent of its bombers into the Reich on D minus 3 or D minus 2 as weather permitted and to dispatch the remaining 40 per cent to plaster the Pas-de-Calais area as part of the deception plan. On D minus 1, half of its forces would rest while 25 per cent bombed seven targets in Normandy and the other 25 per cent attacked seven objectives in the Pas-de-Calais. If by that time the Allies knew the Germans had found out where the invasion blow was to land, then the total attacking force would concentrate on Normandy. (When on 4 June, D-day was postponed from 5 June until 6 June, this program for D minus 1 bombings was carried out a second time.) On D-day itself all available British and American heavies were to conduct a massive bombardment of the coast before the landings.<sup>18</sup>

This last commitment was indeed a spectacular one. The RAF would drench the invasion beaches with about 6,000 tons of bombs in the early hours of D-day. In the last half-hour before the actual landing it would be desirable, General Montgomery's headquarters estimated, to place 7,800 tons of explosives on the shore. Of this amount only 2,500 tons could be delivered by naval guns and 500 tons by medium bombers. Thus it fell to the day-flying heavies of the Eighth Air Force to attack with 4,800 tons, and this duty made it necessary to plan on using the record number of 1,200 heavy bombers.<sup>19</sup> In order to allow enough time for such a vast air fleet to assemble in daylight and to bomb for the full thirty minutes before touchdown, H-hour on some of the beaches had to be postponed for ten minutes, although the Eighth had requested a half-hour delay.<sup>20</sup> And because of the congested condition of the airways on D-day, it was decided to allot OMAHA and the three British beaches (JUNO, SWORD, and GOLD) to the Eighth Air Force and leave UTAH to the Ninth. Even so, the problem of routing the thousands of aircraft that would be aloft on D-day was enormously complicated. Each of the three bombardment divisions of the Eighth would have to assemble in a special sky sector over central England, in some cases 100 miles from bases, and fly southward through definite corridors across the Channel. The bombers would approach the beaches at right angles, straight from the sea, deluge them with bombs, and withdraw by way of the Cotentin Peninsula into western England.<sup>21</sup>

Much skepticism prevailed in advance as to the value of this last-minute bombardment, and contrary to a common belief it was the air-

men who held the most conservative views. Ground force commanders tended to overestimate the effect of bomb tonnage on casemated enemy batteries, strongpoints, and the entire hideous apparatus of beach obstacles. Air force leaders were inclined to minimize the importance of driving away the crews who manned those defenses, but they agreed to lay on the attack demanded by the other services.<sup>22</sup> Among the misgivings on the part of the air commanders was the possibility that the beaches might be so cratered the enemy could better defend them. An experiment conducted by the Eighth Air Force indicated this would be the case if the usual 500- and 1,000-pound bombs were used.<sup>23</sup> Consequently, it was decided to attack with 100-pound demolition and fragmentation bombs except for strongpoints and areas where craters would not impede the Allied ground forces. Further concern arose over the danger that even a small degree of inaccuracy in bombing would result in the killing of large numbers of friendly troops in landing craft offshore. Spaatz, Tedder, and Leigh-Mallory accordingly recommended that the invading forces maintain a safety distance of at least 1,500 yards for the duration of the bombardment.<sup>24</sup> Ground and naval commanders were not willing to risk losing the tactical benefits of a stunning beach bombardment, but a demonstration soon convinced General Eisenhower of the peril, and the final plan prescribed that the bombings cease five minutes before touchdown if visual conditions prevailed and ten minutes if the skies were overcast, thus allowing a safety zone of about 1,000 yards.<sup>25</sup>

After the beach bombings were over, Eighth Air Force heavies would return to base for refueling and reloading. Leigh-Mallory, who was to control the tactical operations of the strategic air forces after 1 June 1944, instructed the Eighth Air Force to carry out three other missions during D-day against bridges and such towns as Carentan, La Pernelle, Bénéville, Houllgate, Villerville, and Caen.<sup>26</sup> His purpose was to block transportation chokepoints and thus create obstructions to German military movements,<sup>27</sup> but widespread damage and heavy civilian casualties were likely to be attendant consequences. Both Spaatz and Doolittle regarded such bombing as not only inhumane but as likely to be ineffective except for a temporary interruption of German reinforcement. Indeed, Spaatz declared that the plan for heavy bomber employment on D-day was too inflexible, for it absorbed the entire available effort without allowing for changing battle conditions. He also criticized Leigh-Mallory's plan to retain a large fighter reserve.<sup>28</sup>



At the commanders' meeting on 3 June 1944 Leigh-Mallory stoutly defended his ideas and threatened that he could not accept his responsibility as air commander in chief if the plans were altered.<sup>29</sup> He won his point and the missions were permitted to stand, although SHAEF made a partial concession to Spaatz and Doolittle by giving permission to warn all French towns near the coast by means of leaflets about impending bombings.<sup>30</sup>

The prime function of VIII Fighter Command was to provide escort for the heavy bombers, but during the months before D-day its fighter pilots devoted much effort to low-level strafing, dive bombing, and other types of operations which were useful in preparing them for assisting the ground forces.<sup>31</sup> The general scheme for OVERLORD involved employing these fighters mainly outside the immediate assault area, which was the province of AEAFF.<sup>32</sup> The four P-38 groups flying high cover with Ninth Air Force fighters over the invasion armada would be controlled from Uxbridge, but the remaining fighter groups of VIII Fighter Command would operate under Eighth Air Force direction to protect RAF bombers and IX Troop Carrier Command transports withdrawing from France on D-day, to fly escort for Eighth and Ninth Air Force bomber missions all during the day, and to attack tactical targets in the critical area of France bounded by the Seine, the Loire, and a line running from Paris to Orléans. This last type of operation, divided into phases FULL HOUSE, STUD, and ROYAL FLUSH, would be directed at trains, dumps, troops, airfields, and targets of opportunity past the immediate invasion area.<sup>33</sup>

By the last of May final preparations for the employment of the U.S. 101st and 82d Airborne Divisions and IX Troop Carrier Command in the Cotentin Peninsula had been completed. The British airborne and glider landings in the vicinity of Caen had stood as firm commitments since January, but instructions for the American units were delayed because of uncertainties regarding the arrival of a sufficient number of trained forces and Leigh-Mallory's conviction that the Cotentin landing would probably result in an unacceptable number of casualties. SHAEF received disturbing reports of German reinforcement of the Cotentin area late in May,<sup>34</sup> and it was apparent that the landing was likely to be perilous. The tentative plan was to dispatch pathfinder aircraft very early on the morning of the landings to drop parties who would mark the landing zones with lighted tees and establish radar beacons to guide the main forces. The air trains of unarmed transports

would fly across the Channel at 1,000 feet, skirt the bristling Channel Islands, and cut across the well-defended Cotentin Peninsula from the west. It could be anticipated that drop and landing zones might be difficult to locate, and that antiaircraft defenses would be alerted. Small-arms fire could shoot up the low-flying troop carriers, which did not have leakproof tanks, and the Allies knew the Germans had stakes, spikes, artificially flooded areas, and other traps to catch the descending paratroops and gliders.<sup>35</sup> Furthermore, there was little in the way of air protection which could be given the vulnerable airborne forces except a few Mosquito night fighters. RAF Bomber Command planned to bomb the area just before the airborne attack in the hope of inducing the enemy to expose his searchlights and flak to strafing by night fighters; and a diversionary force of RAF Stirling bombers would drop Window to simulate a troop carrier operation going to a different area, where it would discharge dummy paratroops and noisemakers.<sup>36</sup> Still, the American operation was clearly hazardous and might even prove disastrous. Leigh-Mallory regarded it as a potential holocaust and dutifully informed the supreme commander on 29 May of his views.<sup>37</sup>

General Eisenhower made the lonely decision that the U.S. airborne landing was feasible and in any event vital to the seizure of UTAH beach, which in turn was vital for the conquest of the port of Cherbourg.<sup>38</sup> Then, on 31 May 1944, the final airborne plan was issued. At 0200 on D-day 432 aircraft of IX Troop Carrier Command would begin dropping the 101st Airborne Division in the general area about Ste.-Mère-Église, followed at 0400 by transports pulling 50 gliders. The 82d Airborne Division—which not long before had been scheduled to land on the next night—was instead placed in the initial assault. From 369 aircraft and 52 gliders its parachute and glider infantry would land, beginning at 0121, to the west of the 101st Airborne Division sector. The two divisions were to gather up their guns, jeeps, and other equipment and attempt to organize in time to obstruct German movement toward UTAH beach. On the evening of D-day reinforcements of men and equipment would be flown in.<sup>39</sup>

What if the weather were bad on D-day, bad enough to prevent visual bombing or even flying? That such might be the case was one of the factors General Eisenhower had considered when he recommended the postponement of the invasion from May to June. Predictions for the first few days of June confirmed the worst fears; and if 7 June were allowed to go by, OVERLORD could not jump off for another

month because of the tides. On 1 June, AEAFF headquarters prepared a bad-weather plan for air operations. If visual conditions did not prevail on D-day (and they did not), the Eighth Air Force would have to use H<sub>2</sub>X-equipped pathfinder aircraft to lead the bomber forces to the invasion beaches and the town of Caen, both of which would be bombed blindly. Also, the bombardiers would have to delay releases for a few seconds to make sure the bombs did not fall on the invasion forces.<sup>40</sup> Recent experiences in radar blind bombing had indicated that little accuracy could be expected, although the Eighth Air Force had made notable efforts during the spring of 1944 to train key crews in the use of H<sub>2</sub>X. General Doolittle took the additional precaution of planning to break his heavy bomber forces into 200 six-aircraft formations instead of 40 thirty-bomber boxes and to fuze all bombs for instantaneous detonation so as to avoid unnecessary cratering of the beaches. The medium bombers of the Ninth Air Force were to employ Oboe in the event of adverse weather and attack only the principal targets on the list. Probably they would not even attempt to bomb the other objectives.<sup>41</sup>

There remained even the nightmarish possibility that because of weather conditions no bombers could take to the skies on D-day. General Montgomery said the invasion would not be scrubbed in that event. Accordingly, the air commanders planned to hold their bombers in readiness at base to await a break in conditions and to dispatch half the fighter-bombers available to attack the invasion beaches at H minus 15 minutes. This fighter-bomber operation seemed likely to prove suicidal for most of the pilots involved. But the invasion machinery had to be set in motion forty-eight hours before H-hour.<sup>42</sup> Spaatz, Doolittle, and Kepner privately vowed to protect the doughboys with all the forces they could get into the air, even if they themselves were lost in the process.<sup>43</sup>

The formal presentation of all OVERLORD plans took place on 15 May 1944 at the final full-dress conference held at SHAEF. After that, the various commanders, headquarters, and combat units busied themselves making preparations, checking details, and generally attending to last-minute matters. Doolittle was worried about a possible enemy effort to neutralize English airfields by means of parachutists at the critical period and suggested that defenses be tightened.<sup>44</sup> Urgent messages were sent to Washington to expedite the shipment of small bombs and high-octane gasoline. Washington, in turn, prepared to rush enor-

mous reinforcements of aircraft and crews to Britain if they were needed.<sup>45</sup> Spaatz drafted his recommendation for the eventuality that Hitler might use poison gas to combat the invasion: the Allies should not retaliate in kind on German cities but continue to use the most harmful weapon they possessed, the heavy bomber.<sup>46</sup> The Mediterranean Allied Air Forces had orders to reinforce or assist the northern invasion forces should it prove necessary, and the first shuttle-bombing mission between Italy and the Soviet Union was carried out just before D-day to distract the Germans on the eve of the assault on Normandy.

Preparations reached all the way into the smaller air units, touching such personal matters as mail, leaves and furloughs, rotation, freedom of movement, and rest periods just before D-day. Morale was undoubtedly high, conspicuously so,<sup>47</sup> and tension was great. To be sure, invading continental Europe was nothing new to thousands of airmen who had been engaging in the practice for many months. But the historic importance of the events about to unfold was everywhere sensed. As for OVERLORD planning, it continued until that operation, overwhelmingly successful, merged into other strategic phases of the European war. Only the pre-assault stage of preparations was completed when General Eisenhower decided at 0415 on 5 June 1944 to launch the invasion despite disturbing weather reports, or when General Doolittle gave orders at 2200 that night to prepare the Eighth Air Force's heavies for blind bombing of the beaches, or when at midnight Eisenhower and Brereton watched IX Troop Carrier Command transports take off with blackened paratroops for the Cotentin Peninsula.<sup>48</sup>

During the last few weeks before D-day the leaders and planners, from such august headquarters as SHAEF, USSTAF, AEF, and RAF Bomber Command down to the airplane commanders and crew chiefs, had labored intensely to perfect air preparations for OVERLORD. An unprecedented degree of harmony in purpose, if not always in methods, had prevailed, and the spirit of cooperation among the various headquarters and individuals would later seem one of the more remarkable features of a long war. From the first General Eisenhower had set the pace for mutual trust, friendliness, and determination, and his example was an inspiration. He made a brief statement at the air commanders' meeting on 31 May 1944, where the minutes record:

The SUPREME COMMANDER said that he would like to take this opportunity of saying a few words to the Commanders and their Staffs. He said that

for him, military operations were always a matter of human beings and not of mathematical calculations, and that he would like it to be known by the men who were fighting the battle how much the Commanders reckoned on what they had done and would do. In the preliminary stages of planning a good motto was "Doubts must come up, only enthusiasm must go down." Now that the plans were completed and the battle on, doubts in the minds of the Commanders must not be allowed to reach those who were fighting the operation, and he instanced the airborne operation as one that had been criticised. They must feel that the best plans had been made and that the operation was worth while. He said he would like a message from the Air Commander-in-Chief, and one from himself, to be passed to crews at final briefing.<sup>49</sup>

### *Attrition of Enemy's Railway System*

Until 10 March 1944 the Ninth Air Force had been primarily engaged in assisting the strategic air forces, to the restlessness of both Leigh-Mallory and Brereton, but on that date its bombers were freed for concentration on pre-invasion operations.<sup>50</sup> The Eighth Air Force still had first call on the Ninth's fighters for escort tasks, a prerogative which it used more liberally than tactical air commanders liked.<sup>51</sup> By 1 April, however, the demands of the invasion became paramount in the apportionment of all air effort. USSTAF continued to have as its first priority the over-all reduction of German air strength and RAF Bomber Command carried on its program of attacks on industrial centers,<sup>52</sup> but the heavies, which until 1 June took their assignments from Tedder, found other targets requiring an increasing proportion of their effort. As the weeks went by, the transportation campaign absorbed more and more of the effort, and at times the heavy bombers gave high, even first, priority to attacks on robot-bomb launching sites in France. Priorities for other target systems—airfields in France, oil production, coastal defenses, and ordnance depots—shifted repeatedly.<sup>53</sup> The smaller forces of the AEAFF\* took their orders from Leigh-Mallory, who elected to spread his commitments so that five or six different bombing campaigns would be going on simultaneously, although his new deputy in AEAFF, Maj. Gen. Hoyt S. Vandenberg, advised concentration on one program after another.<sup>54</sup> Each tactical air force worked within a flexible framework permitting adjustment to conditions of weather, problems of training, and other considerations, but the transportation campaign in general held first claim.

The cardinal purpose of the transportation plan approved by Eisen-

\* As of 1 April, AEAFF included 496 American and 70 British medium bombers, 96 American and 38 British light bombers, and 670 American and 1,764 British fighters.

hower on 26 March, after a protracted controversy,\* was to isolate the invasion area. As Leigh-Mallory's railway experts envisaged the task, the isolation was to be achieved mainly through extensive bombing of vital rail centers and repair facilities. Already the French system, the *Société Nationale de Chemins de Fer Français*, or SNCF, was believed to be in a bad way. Aside from the wear and tear it had suffered during several years of wartime use, the SNCF had lost perhaps one-third of its locomotives through expropriation by the Nazis. Deficiencies of track, rolling stock, reliable workmen, coal, and other prerequisites had brought French rail transportation to a condition of severe strain. If two-thirds of SNCF capacity were devoted to carrying German military traffic, as AEAF experts contended, about 45,000 tons of well-placed bombs should produce a chaotic situation for the enemy.<sup>55</sup> The Belgian system was believed to be almost as vulnerable as the French, and a railway attrition campaign in the Balkans carried on by the Mediterranean Allied Air Forces could be expected to aggravate Germany's transportation crisis. When the enemy's railway system had lost its flexibility and much of its capacity from such operations, the Allies would lay on an interdiction program shortly before D-day to seal off Normandy.

The transportation plan singled out as the chief targets routine servicing facilities in the key rail centers, since their destruction would be likely to cripple the entire system immediately.<sup>56</sup> Damage to locomotives, marshalling yards, switches, rolling stock, tracks, and stations would be regarded as a bonus, an incidental contribution to the ruin of the enemy's railway systems. It was planned to concentrate bombing attacks on rail centers in Belgium and the *Région Nord* of the SNCF, where the network was thickest. A rail chaos there would prevent the Germans from reinforcing their counterinvasion divisions at the critical time from the area where most of their reserves were stationed. Also, coal for locomotives might be cut off from the rest of France, and confusion would be created with respect to the site of the invasion. As it was supposed to work out, the Normandy area, far to the southwest, would be isolated while the Germans would be led to believe the Allies were endeavoring to interdict Calais.

When the Ninth Air Force became available for pre-invasion bombing on 10 March 1944, it was assigned thirty targets in Belgium and north central France from the list of the transportation plan, although

\* See above, pp. 72-79.

the plan itself was still under debate and only nine of the targets had been cleared at that time for bombing because of the hesitations of the British War Cabinet about exposing friendly civilians. During March the Ninth went ahead with such missions as were possible for it, attacking four times the rail center at Creil, which was destined to become the most bombed target of this type in France. Brereton's air force also achieved substantial success in bombing the rail centers at Hirson, Amiens, and Charleroi.<sup>57</sup> The Second TAF participated in the transportation campaign by attacking other rail centers in northwestern France and Belgium, and RAF Bomber Command, which was experimenting in methods of attacking railway installations at night without slaughtering the inhabitants in their vicinity, inflicted considerable damage on Le Mans, Amiens, Laon, Aulnoye, Trappes, and Courtrai.<sup>58</sup> By the end of March no spectacular results were apparent in the rail center campaign, but champions of the transportation plan drew encouragement from the havoc wrought on repair installations and marshalling yards and had won, moreover, Eisenhower's acceptance of the plan.

In the first half of April the Ninth Air Force continued to operate with usually good results against the rail centers. Among the chief attacks was an afternoon mission on 8 April to Hasselt, in northeastern Belgium, by 163 B-26's, which dropped 263 tons of bombs, and by 101 P-47's which discharged 120 x 250-pound bombs in diving attacks.<sup>59</sup> Two days later smoke was still rising from the damaged repair shops when 56 P-51's returned to dive-bomb the target. On 9 April a spirited fighter operation, involving 48 P-47's, stopped troop and freight trains moving toward the invasion area and brought damage to rail yards in several towns. Namur and Charleroi, two of the major Belgian targets, received punishment from the Ninth Air Force on 10 April when 148 Marauders dropped 184 tons on the former and 40 Marauders and RAF Mitchells attacked the latter. On the following day 193 Marauders went back to Charleroi and discharged 347 x 1,000-pound bombs and 1,106 x 250-pound bombs in the general area of the rail center with results ranging from poor to good. By this time the Ninth Air Force had worked out very satisfactory methods for attacks such as these. Usually, four or five groups of B-26's with about thirty-seven aircraft per group would bomb a single rail center. Instead of having massive formations drop on signal from a lead airplane, Brereton ordered that the attacking force break up into numerous four- or six-plane sections,

a measure which sharply improved accuracy and consequently reduced the danger to civilians. Furthermore, the Thunderbolts, which ordinarily accompanied the heavy bombers, performed so successfully in strafing and dive-bombing rail targets that Leigh-Mallory directed the use of as many RAF Spitfires as possible for escort in order to release AAF fighters for the transportation attacks.<sup>60</sup>

By the middle of April the Second TAF was regularly sending out Typhoons and Mosquitoes to bomb and shoot up transportation targets near the coast, and Bomber Command heavies were proving that expertly led night formations bombing from low altitudes could approximate the operations of daylight attackers in effectiveness.<sup>61</sup> Scrutinizing the estimates of casualties and concluding they were not too large, Churchill lifted the ban on most of the occupied cities toward the end of April except for such heavily populated areas as Paris, Le Bourget, Nancy, and a few others, which action left Tedder free to assign most of the rail center targets to the air forces.<sup>62</sup> To the Eighth Air Force went twenty-three targets in Belgium, northeastern France, and western Germany. The Fifteenth Air Force received twenty-two targets in southern France and central Germany. RAF Bomber Command's commitment comprised twenty-seven targets (later thirty-nine) in northwestern France, the Paris area, and Belgium. Targets assigned to the AEF numbered about thirty (finally eighteen), scattered about in Belgium and northern France. The system for classifying damage was to be: A, when nothing more was needed than occasional dive bombing to keep the rail center in disrepair; B, where damage was great enough to allow suspension of all but precision attacks; and C, for rail centers which were only slightly affected and where all kinds of attacks were permissible.<sup>63</sup>

The Ninth Air Force achieved excellent results on 19 April when 182 B-26's and more than 50 fighters attacked Malines, Namur, and Hasselt. On 20 April, P-47's dive-bombed Mantes, west of Paris, and Creil. Fighters of the Ninth, which now included considerable numbers of Mustangs as well as Thunderbolts, prosecuted the campaign with conspicuous success on the following three days, attacking Namur, Haine-St. Pierre, Hasselt, Montignies-sur-Sambre, Malines, and St. Ghislain. In all, twenty-two targets received fighter-bomber visitations in the last two weeks of April.<sup>64</sup> Perhaps the most spectacular operation occurred on 23 April, after Eighth Air Force fighter pilots returning from escort missions over the Reich reported an abnormally



large concentration of rolling stock at Namur. More than 100 Ninth Air Force Mustangs and Thunderbolts hurried to the city and inflicted serious damage on the railway installations. And there were other fighter-bomber successes against Louvain, Mantes, Monceau-sur-Sambre, and various other targets, most of which had been attacked earlier by bombers. The B-26's of the Ninth were also active, although bad weather kept them from operating on several days. On 27 April, 100 Marauders dropped about 400 bombs, most of them of the 1,000-pound size, on Cambrai, and on 30 April, 143 mediums attacked Bethune and Somain. The A-20 light bomber entered the Ninth's campaign on 27 April, when 71 of them bombed Arras; on the 30th, the same number attacked Busigny. Eighth Air Force heavies conducted their first missions under the transportation program on 27 April, dropping 342 tons on Blainville and 230 tons on Châlons-sur-Marne, with good results in both cases.<sup>65</sup> As for the RAF, its Second TAF was out almost every day attacking marshalling yards near the Channel, and Bomber Command was piling up a notable series of victories in wiping out rail centers during heavy night attacks.

By the end of April it was evident that enormous damage was being done. Some 33,000 tons had fallen on the rail centers, and at least twelve important targets were already in Category A.<sup>66</sup> The Germans, whose antiaircraft defenses had been very weak, were beginning to concentrate more guns around the rail centers; as yet they had not contested the Allied operations with their fighters. The enemy was also displaying much resourcefulness in repairing the bombed centers, in some cases getting through-traffic re-established within a few hours after the bombings. It was becoming obvious that the Allies would have to re-attack frequently, far more than they had counted on, and that their operations would have to be planned in a most scientific manner if the rail centers were to be kept out of use. Moreover, it was very difficult to assess the real effectiveness of the bombings. With a wealth of intelligence data coming in from occupied Europe and by means of photographic reconnaissance, the Allies might gauge the train count of certain centers and learn the approximate number of locomotives and cars destroyed, the extent of structural damage to facilities, and the length of time it took the Germans to repair main lines. But was physical damage a sound criterion for judging enemy military movements? From evidence at hand by the last of April it seemed that only French and Belgian traffic was being knocked off the rails.<sup>67</sup> The Germans

were still moving their troop and supply trains, which naturally enjoyed priority, without serious delay. But it was well understood that the transportation plan was a long-term program, and less than half the pre-D-day tonnage of bombs had been dropped. Leigh-Mallory issued a paper on 30 April urging the air forces to step up their prosecution of the campaign and calling in particular upon the Eighth Air Force to begin its full participation.<sup>68</sup>

During May 1944, the month of the heaviest pre-invasion bombing, transportation attacks were greatly intensified by all air forces and cunningly focused on routes which led into Normandy while seemingly concentrated on those serving other areas. On 1 May, eleven different B-26 forces of the Ninth attacked Mantes, Montignies-sur-Sambre, Douai, Monceaux, and Valenciennes. Simultaneously, thirty-seven Bostons bombed Charleroi, and Thunderbolts dive-bombed Haine-St. Pierre, St. Ghislain, Amiens, Arras, and Valenciennes. On the same day the Eighth Air Force carried out its first major mission against rail centers, dispatching 328 heavy bombers and 16 groups of fighters to drop more than 1,000 tons on the Troyes, Reims, Brussels, Liège, Sarreguemines, and Metz marshalling yards. Ninth Air Force fighters went out on 2 May in ten different forces of about twenty-eight aircraft each to drop 250- and 500-pound bombs on Le Mans, Aulnoye, Tergnier, Hasselt, Mantes, Tourcoing, Charleroi, Somain, and Péronne while six light and medium bomber forces attacked Valenciennes, Busigny, and Blanc-Misseron. Several days of bad weather interrupted the program until 7 May. Between that day and the 11th the Ninth bombed Calais, Aerschot, Mons, Creil, Tournai, Mézières, Arras, Bethune, Cambrai, and smaller centers. Fighter-bombers usually carried out precision attacks after the B-26's and A-20's had damaged the main parts of the target areas. On 11 May, Eighth Air Force B-17's dropped 600 tons on Saarbrücken, Luxembourg, Ehrang, Konz-Karthaus, Bettemburg, Thionville, and Völklingen while B-24's bombed Mulhouse, Belfort, Épinal, and Chaumont with 440 tons.<sup>69</sup> And the British air forces were equally active. Bomber Command proved so successful, in fact, that it was assigned twelve targets originally allotted to the tactical air forces.

Soon after the middle of May the pre-D-day rail center program was close to completion except for the USSTAF contribution. Occasional reattacks were of course necessary, and fighters conducted regular surveillance over the bombed centers for evidence of activity. But the Eighth and Fifteenth Air Forces still had the bulk of their tonnage to

deliver. On 23 May, six combat wings of Eighth Air Force Fortresses attacked Épinal, Metz, Saarbrücken, Bayon, Chaumont, and Étampes. Two days later fourteen combat wings dropped heavy tonnages on Mulhouse, Belfort, Tonnerre, Sarreguemines, Thionville, Metz, Blainville, Liège, Brussels, Charleroi, and Alost. On 27 May, Ludwigshafen, Mannheim, Karlsruhe, Strasbourg, Konz-Karthaus, Neunkirchen, and Saarbrücken were successfully bombed, this mission proving to be the only one in the transportation program in which the enemy's fighters put up significant resistance to American bombers, nine of which were shot down on this occasion. On 30 May the Eighth attacked Troyes, Reims, and Brussels, and on 4 June it bombed various transportation targets in the suburbs of Paris. Of its twenty-three allotted targets, the Eighth Air Force placed fifteen in Category A and eight in B. Its operations during the last of May had been of devastating effect and brought its total for rail center bombings up to 13,000 tons.<sup>70</sup>

The Fifteenth Air Force had originally been assigned twenty-two rail centers in central Germany and southern France. The German targets were subsequently dropped as unnecessary for OVERLORD, and the Fifteenth actually devoted most of its railway bombings to targets in Italy and the Balkans. USSTAF having on 24 May 1944 issued the necessary orders, 600 of the Fifteenth's heavy bombers from 25 to 27 May ranged over southern France almost without interference, dropping more than 3,000 tons on fourteen different targets. St.-Étienne, Nice, Lyon, Chambéry, Grenoble, Avignon, Marseille, and Nîmes were the chief objectives, and reports of damage to railway installations in those localities were highly satisfactory, five falling in Category A.<sup>71</sup>

By D-day Leigh-Mallory's headquarters estimated that fifty-one of the eighty rail centers in the north were in Category A, of which twenty-two were credited to RAF Bomber Command, fourteen to the AEAFF, and fifteen to the Eighth Air Force. By less rigid standards of measurement, the damage was far more extensive, for practically all of the targets were judged unusable for the enemy's purposes. The total tonnage of bombs amounted to more than 71,000, 46,000 of which were dropped by Bomber Command alone. Losses to attacking aircraft had been very light, especially where the daylight bombers and the fighters were concerned. Accuracy had been high, in some cases outstandingly so.<sup>72</sup> French and Belgian casualties had been far below the estimates of both pessimists and optimists, and the reaction of the occu-

pied populations to the bombings, while it gave the Allies some uncomfortable moments, was not alarming. But in the face of these achievements, by 19 May 1944 railway traffic in the west had declined by less than one-third—just to the point that transportation plan advocates had earlier predicted would begin to interfere with military transportation. Doubtless, the Germans had been hurt and their traffic would fall at an increasing rate before the Normandy landings. But SHAEF G-2 reported on 20 May that the rail center bombings were not yet producing the effects expected.<sup>73</sup>

To supplement the transportation plan, Leigh-Mallory authorized wide-scale fighter sweeps against moving trains on 20 May, when civilian passenger traffic was believed to have ceased.<sup>74</sup> For some time fighters had been shooting up trains, to the nervousness of USSTAF headquarters, where it was feared that civilians were being killed indiscriminately.<sup>75</sup> Now the practice would be carried on openly and on a large scale. In the next two weeks fighters damaged about 475 locomotives and cut railway lines at 150 different points. The most sensational attacks were the CHATTANOOGA CHOO-CHOO missions, the first of which took place on 21 May when 763 AEAFF fighters swept over the northern half of France and 500 Eighth Air Force fighters ranged over Germany firing and bombing at trains.<sup>76</sup> Another occurred on 25 May when three Ninth Air Force fighter groups operated over the Rhineland and northern France and more than 600 Eighth Air Force fighters shot up trains in Belgium and France. Other outstanding CHATTANOOGA missions were carried out by 571 Eighth Air Force fighters in eastern Germany and Poland on 29 May and by the Ninth Air Force in France on 2, 3, and 4 June.<sup>77</sup> These operations furnished good practice for fighter pilots in attacking ground targets, a skill they were to develop to a high degree after the invasion, and they brought about enormous disruption to enemy traffic and ruin to equipment while producing important psychological effects on railroad personnel. French train crews deserted in large numbers, especially after fighters began to drop belly tanks on stalled trains and to set them afire by strafing. This situation caused the Germans to employ crews of their own nationality on the more hazardous runs, and after 26 May railway operations in daylight were sharply reduced even in cases where the lines were unbroken.<sup>78</sup>

Probably the decisive phase of the long transportation program was the brilliantly successful interdiction campaign against bridges. For

## PRE-INVASION OPERATIONS

months before the Normandy landings much doubt prevailed in military circles that enough bridges could be destroyed in time to benefit OVERLORD. River crossings, especially those of steel construction, were difficult to hit from the air, and the enemy could be counted on to discourage precision bombing by arraying antiaircraft guns around them. Moreover, the amount of bomb tonnage necessary to finish off a bridge was thought to be high, almost prohibitive. But during the spring of 1944 General Spaatz began to urge that experimental attacks be carried out on bridges, for it was apparent that success in this matter would greatly contribute to the transportation campaign. General Brereton likewise pressed for efforts to remove bridges leading toward or into the invasion area. Substantiation for the views of these air generals came out of Italy, where operation STRANGLE showed not only that bridge-breaking was feasible but that it was the most effective way to block the enemy's movements. General Eaker made known the successes of his air forces in sealing off part of the Italian peninsula by means of bridge destruction,\* and General Anderson brought back from a visit to Italy enthusiastic accounts of the success of STRANGLE.<sup>79</sup> Pressure for a bridge campaign grew when it was realized that an experimental attack carried out by RAF Typhoons on 21 April 1944 on several French and Belgian bridges had rendered the crossings unusable even if it had failed to destroy them.<sup>80</sup> Soon afterward, on 3 May, Montgomery's headquarters officially requested the air forces to take out several bridges over which the enemy might move reinforcements into Normandy, and his representative subsequently expressed to Leigh-Mallory the view that bridge destruction would be more decisive than "pin-pricking on rail communications."<sup>81</sup> Still there was hesitation. The British railway expert, E. D. Brant, estimated that 1,200 tons would have to be expended on each of the Seine bridges, a costly undertaking which could hardly be afforded in view of other pre-invasion commitments. Leigh-Mallory suggested that Spaatz's heavy bombers attempt the campaign. But Spaatz believed that too much bomb tonnage would be required, since the heavies would have to attack from such high altitudes, and that smaller aircraft, as experience in Italy indicated, were better suited for the task. After discussing the matter thoroughly on 6 May, Leigh-Mallory finally turned to other matters, remarking that he did not care to see a waste of effort at that time.<sup>82</sup>

\* See below, pp. 373-84.

## THE ARMY AIR FORCES IN WORLD WAR II

On 7 May all serious doubts were swept away by a notable Ninth Air Force operation. Eight P-47's dropped two 1,000-pound bombs apiece on a 650-foot steel railway crossing over the Seine near Vernon and demolished it.<sup>83</sup> This attack, which seems to have been made on Brereton's initiative,<sup>84</sup> was one of four executed that day by P-47's and B-26's. While the Vernon operation was the most clearly successful demonstration, bridges at Oissel, Orival, and Mantes-Gassicourt were badly damaged and soon put out of use.<sup>85</sup> Leigh-Mallory, having thus been convinced that the tactical air forces could do the job,<sup>86</sup> on 10 May directed his forces to begin the destruction of bridges over the Albert Canal and the Meuse River, an enterprise that would suggest Allied concern with the Calais region but would nevertheless help cut off Normandy. SHAEF, alarmed by a report of its G-2 that the rail center bombings were causing only "some slight delay" in enemy rail movements, soon prepared an extensive interdiction program for the air forces which called for cutting all bridges up the Seine to Mantes and up the Loire to Blois and at critical points in the so-called Paris-Orléans gap stretching between the two rivers.<sup>87</sup> Because of the ever present and by now paramount consideration of security, the Loire bridges would have to wait until D-day. In order to achieve maximum surprise against the Seine bridges, it was decided that the air forces should withhold their attacks there until shortly before the invasion, and then lay on a series of staggering blows in rapid succession. Since routes over the Seine led into the Pas-de-Calais as well as Normandy, it was not likely that the Germans would guess from these bombings where the Allies were going to land.

Medium bombers and fighter-bombers of the Ninth Air Force conducted several good attacks on Belgian bridges between 11 and 26 May, breaking those at Herentals, Liège, and Hasselt and severely damaging others. On 24 May the ban on the Seine bridges was lifted, and on the 26th they became first priority for the AEAFF.<sup>88</sup> Accordingly, B-26's and P-47's began a spectacular campaign of low-level attacks, striking Le Manoir and Poissy on 26 May, Juvisy, Le Manoir, Maisons-Lafitte, and Le Mesnil Ande on 27 May, and Mantes, Orival, Rouen, and Maisons-Lafitte on 28 May. Conflans, Orival, Juvisy, and Athis caught heavy attacks on 29 May, while Mantes, Rouen, Meulan, Bennecourt, and Conflans were further damaged or broken on 30 May, along with several highway crossings.<sup>89</sup> In these operations it became clear that the

B-26 was the choice weapon,<sup>90</sup> although RAF and Ninth Air Force fighters were frequently employed to finish off damaged bridges and to block tunnels. The combination of B-26's dropping 2,000-pound bombs, P-47's diving with 500-pounders, and Typhoons firing rocket projectiles proved devastating. River crossings over the Seine were falling rapidly to Allied air power, and despite superhuman efforts German reconstruction was not keeping pace with Allied damage.

Even so, by 1 June 1944 the enemy's transportation system had still not reached the final state of collapse desired by the Allies, although the 45,000 tons originally allotted for bombing rail centers had been greatly exceeded. The Germans were repairing their bombed marshalling yards and railroad tracks with admirable efficiency, and they were fairly successful in redistributing their traffic flow so as to avoid the worst-damaged points.<sup>91</sup> It seemed that essential military movements were still taking place although much important work, such as the completion of the Atlantic Wall, had to cease because of transportation difficulties.<sup>92</sup> North of the Seine was Field Marshal General Gerd von Rundstedt's large Fifteenth Army, poised to meet an expected assault on Calais. Unless the line of interdiction became perfect, he would probably be able to shift much of his strength into Normandy after D-day. Thus, the best hope of the Allies to seal off the invasion area was to complete the destruction of all twelve railway and fourteen highway bridges over the Seine.

Last-minute attacks on the Seine bridges produced the maximum results: the impassibility of all crossings below Paris. Marauders, Thunderbolts, Lightnings, and Typhoons attacked every day and night, bombing and rebombing until every bridge was unusable. The Germans, of course, made desperate attempts to repair their shattered bridges, but strafing made it difficult and demoralizing work, and even when reconstruction was successful, the Allies would promptly bomb again. Strafing also interfered with the enemy's efforts to unload freight from trains at the broken crossings for ferrying across the Seine to trains on the other side, and the Allies could strand the trains by cutting lines or destroying locomotives. The line of interdiction along the Seine was a fact by D-day. And the total tonnage expended in the railway bridge campaign amounted to only 4,400, averaging per bridge about one-fifth the weight originally expected. Clearly, the Ninth Air Force had carried off most of the honors for this phase of the transportation plan.<sup>93</sup>

## THE ARMY AIR FORCES IN WORLD WAR II

The battle against enemy transportation was a splendid success on the eve of D-day. It "opened the door for the invasion," as Spaatz later informed Arnold.<sup>94</sup> British-American aircraft had dropped a total of 76,200 tons (on rail centers 71,000, bridges 4,400, and open lines 800) and would aim 78,000 tons more at transportation targets before France was free of the German. Railway traffic in France fell off dramatically between 19 May—when the Allies were somewhat discouraged about the transportation bombings—and 9 June 1944, the index dropping from 69 to 38 (based on 100 for January and February 1944). By mid-July the index would be only 23, and traffic in northern France would be practically at a standstill.<sup>95</sup> Von Rundstedt had been unable to move effective reinforcements into the Seine-Loire triangle at the time of the invasion, and his forces had been committed piecemeal and could not even be deployed as units.<sup>96</sup> Thus the Allies had won their premier objective in the transportation campaign: they were able to build up their forces in Normandy from across the Channel faster than the Germans could reinforce theirs from adjacent areas in France.

Whether the rail center attacks—subject of a long controversy among invasion planners in early 1944—had been necessary or not in accomplishing the wreckage of Germany's transportation system continued to be a subject of some debate. Even the German commanders held varying opinions, and captured enemy records can be interpreted to support several points of view. Von Rundstedt later told interrogators that strategic bombing had little or no effect on the French railway systems until late in July 1944. The German officer who was in charge of military transport on railways in the west stressed the catastrophic effects of Allied interdiction, especially bridge-breaking.<sup>97</sup> Other enemy evidence indicated that the attritional bombings of the railway repair centers and marshalling yards were decisive in stopping traffic. The fact remained that the Germans suffered indescribable and often ludicrous difficulties in moving their troops and supplies, whether in reinforcement or evacuation.\*

Allied opinion about the different aspects of the transportation campaign remained consistent; those who had sponsored the rail center bombings in the first place generally thought they had been right, and the champions of interdiction continued to argue their side of the case. The evidence, Germany's ruined communications, lent itself to a variety of interpretation. In November 1944, shortly before he lost his life

\* See below, pp. 219-27.



on a flight to India, Leigh-Mallory presented to Eisenhower a "despatch" summarizing the AEF's contributions. It is not surprising that he hailed the rail center program as fully realized and claimed that his beliefs had been confirmed.<sup>98</sup> Solly Zuckerman prepared two studies after the invasion in which statistics seemed to prove the higher importance of attrition as compared to interdiction.<sup>99</sup> General Brereton and Air Marshal Harris, both of whom had favored the rail center campaign, looked back upon it after the war as very effective in bringing about the results they had intended. Air Marshal Tedder said the rail center bombings had been the main factor in producing the collapse of German communications, an achievement which he said had come about more rapidly and more completely than he had anticipated.<sup>100</sup> SHAEF G-2 reversed its position of May 1944 to conclude in November that attrition had proved more effective in France before D-day than interdiction.<sup>101</sup> And there was scattered support from other analyses to justify the rail center bombings. Perhaps most telling of all was the decision of the Allies to continue bombing rail centers, which they did until the end of the war, though not without differences over the probable effectiveness of such attacks and doubts about results.

On the other hand, SHAEF G-2 in May and June 1944 assessed the attrition campaign as a severe disappointment, if not an alarming failure.<sup>102</sup> As late as D plus 1 the Germans seemed to possess several times the railway resources they needed, a fact which, if true, refuted the champions of attrition. Two Ninth Air Force studies of July 1944 judged the attrition program as having almost no effect in isolating Normandy, while interdiction was considered decisive.<sup>103</sup> General Spaatz and most USSTAF officers continued to look upon the rail center bombings as much less important than bridge-breaking and line-cutting, and General Arnold seems to have agreed.<sup>104</sup> The U.S. Embassy's railway experts likewise remained consistent by deciding a few months after OVERLORD that interdiction had been the decisive phase of the transportation campaign. A comprehensive study of the U.S. Strategic Bombing Survey compiled under the direction of Gen. Omar N. Bradley soon after V-E Day drew a similar conclusion.<sup>105</sup> Also, the president of the French railway system said rail center attacks were less significant than those on bridges.<sup>106</sup> Finally, an AAF evaluation board report based largely on French railway records concluded after a laborious examination of evidence and balancing of factors: "The pre-D-day attacks against French rail centers were not necessary,

and the 70,000 tons involved could have been devoted to alternative targets."<sup>107</sup>

*Neutralization of German Air Bases*

From the first, OVERLORD planners emphasized the need to neutralize airfields in western Europe from which the German Air Force might operate against the Allied invaders. The minimum objective was to drive the enemy's fighter squadrons back to bases in the east so that they would enjoy no advantage over Allied fighters which flew out of England. But the more the Allies could widen their air supremacy over the enemy the better. The POINTBLANK campaign against German aircraft production and the GAF itself reached a successful climax early in 1944. This victory of the Allied air forces signified that the enemy would not be able to prevent the invasion by air power, as otherwise he might have. Crippled as his air force was, however, he still possessed one. By sheltering it and expending it frugally against the continuous provocation of Allied bomber fleets over the Reich, he might be able to throw an estimated 900 aircraft, including 450 bombers,\* against OVERLORD at the critical time and with telling effect.<sup>108</sup>

Allied apprehension as to the use that might be made of such a force finds confirmation in German plans. In the spring of 1944 Hitler himself ordered the "Baby Blitz" on England in the hope of spoiling Allied invasion preparations.<sup>109</sup> But the Germans did not have enough bombers to do any serious damage in these night attacks on London and the southern ports, especially in the face of good defenses and counter-attacks on their bases.<sup>110</sup> But many of the Luftwaffe's units could be shifted to France once the invasion began—Goering later claimed that he was prepared to have this done, that his organization had even guessed right about the landing site.<sup>111</sup> Since von Rundstedt was resigned to the fact that the Luftwaffe could not protect his communications and installations, he decided that this force would be used alto-

\* If a captured file of the German high command known as *Auswertung der Einsatzbereitsch der fliegenden Verb. vom 1 August 1943 bis November 1944* is correct, the average German air strength in May 1944 for all fronts stood as follows:

	<i>Called for</i> ( <i>Soll</i> )	<i>In Existence</i> ( <i>Ist</i> )	<i>In a State of</i> <i>Readiness</i> ( <i>Einsatzbereit</i> )
Fighters . . . . .	2,680	1,729	1,195
Night fighters . . . . .	1,052	644	434
Twin-engine fighters . . . . .	385	318	153
Light bombers (Schlacht) . . . . .	937	869	639
Bombers (Kampf) . . . . .	1,824	1,259	801

gether for offensive operations to repel the invaders.<sup>112</sup> Fighters might be withdrawn from every front and the Reich itself in order to attack the OVERLORD forces.<sup>113</sup> From bases deep in France German bombers could contribute their power to the counterassault along with the robot bombs that were about ready to function. German plans presupposed the availability of adequate air bases in France.

There were approximately 100 airfields within 350 miles of the Normandy shore from which the German Air Force could operate. Some of these bases were well built up as a result of several years of use by, in turn, French commercial airlines, the RAF, and the Luftwaffe. In the spring of 1944 most of the air bases were empty except for a few antishipping and reconnaissance squadrons which shifted about uneasily from one field to another depending on Allied activities. But the bases existed and could easily be used again. Thus the Allies felt it necessary to damage all of them. Yet airfield attacks were likely to be unproductive under these circumstances. The enemy could fly his airplanes away before the bombings; runways and landing areas thoroughly postholed in the morning could be filled by late afternoon; and damage to hangars, repair facilities, and gasoline dumps would not be permanently crippling in effect. American experiences in the Pacific war had demonstrated how fighters could operate from ruined airfields or even flat stretches of ground with scanty supplies of fuel, ammunition, and spare parts near by. Thus the problem of the Allied air forces was to inflict severe damage on nearly every usable air installation in France, and to do it so near D-day that there would not be time for the enemy to remedy the situation.

The master plan for Allied air supremacy depended upon three main programs: continued policing to keep the Luftwaffe in its reduced state; heavy bomber missions deep into Germany just before and soon after the invasion to discourage the Germans from removing their fighters to France; and wholesale attacks on airfields in France during the three weeks before D-day. If the bombing of air bases were accurate enough to remove vital installations, the shortness of time and German difficulties arising from the transportation chaos would compel the Luftwaffe to abandon any plan to utilize the best-located airfields. By waiting until the last three weeks before D-day to bomb airfields around Caen there would be less danger of giving away the invasion secret. Even so, attacks would be spread out in such a way as to conceal Allied concern with Normandy.

## THE ARMY AIR FORCES IN WORLD WAR II

During April the tactical air forces of the AEAFF conducted enough attacks on airfields outside the invasion area to produce some strain on the Germans and to gain practice. As yet, this type of target held a low priority, and the missions were often carried out when other objectives could not be bombed. So it was when small forces of B-26's of the Ninth Air Force made nine attacks on six air bases during April. Most of the Ninth's attacks were fighter-bomber missions, however, and during the month twenty-eight French airfields were bombed. Usually the pilots reported moderate success in damaging airfield installations, but results were difficult to assess and only on three occasions did pilots claim they had destroyed enemy aircraft on the ground.<sup>114</sup> Meanwhile, the Eighth Air Force continued to attack air bases in France as part of its campaign to deplete the German Air Force. During the last week of April, Lightnings and Thunderbolts strafed and bombed various airfields in northern France while B-17's, operating in forces numbering about 100 bombers, dropped heavy loads of bombs on airfields at Metz, Nancy, Dijon, Le Culot, Avord, Lyon, and Clermont-Ferrand.

By the beginning of May, Leigh-Mallory had his airfield program prepared and in the hands of the various air force commanders. Of the airfields and usable landing grounds in an arc 130 miles around Caen (designated Area I) 8 were assigned to RAF Bomber Command, 12 to the AEAFF, and 20 to the Eighth Air Force. Area II extended from the 130-mile line to an arc 350 miles around Caen, reaching into Germany and the Netherlands, where 59 airfields were to be bombed by the daylight flying heavies of the Eighth and Fifteenth Air Forces. The program was flexible. Each air commander decided for himself when and how to hit the airfields on the basis of the general plans and current reports on target conditions issued by the AEAFF.<sup>115</sup> Fortunately, the air bases were grouped around Paris and Lille in such a fashion that the invasion plans were unlikely to be given away in the bombing pattern if all were bombed. Still, the Allies were to attack the airfields in Normandy on a deliberately lighter scale than the others. The only suspicious airfield from this standpoint was near Brest, which naval commanders insisted be bombed in order to prevent the German Air Force from working with submarines against the invasion fleet.<sup>116</sup>

On 11 May the campaign against airfields was begun in earnest by the Ninth Air Force, which was to drop the most tonnage of all air commands in the critical Area I. Thirty-seven B-26's got good results at Beaumont-le-Roger and eighteen A-20's were successful at Cor-

## PRE-INVASION OPERATIONS

meilles-en-Vexin. Several other forces had to be recalled because of bad weather. On 13 May, forty-two A-20's bombed Beauvais airfield and three Marauder groups attacked Beaumont-sur-Oise, Chièvres, and Abbeville. Eight aircraft were damaged by flak but none was lost in the latter operation, a representative mission of the campaign with regard to cost. Weather and other commitments interfered for several days, during which significant attacks were carried out by fighters and light bombers on only three airfields, those at Creil, Gaël, and Chartres. Early in the evening of 19 May more than 200 P-47's bombed airfields at Beauvais, Monchy, Breton, Abbeville, and Cambrai. On 20 May, seven groups of B-26's attacked Denain, Évreux, Beaumont-sur-Oise, and Cormeilles-en-Vexin while a group of A-20's bombed Montdidier. Two groups of B-26's bombed Abbeville on the following day and Beaumont-le-Roger on 22 May. Also on 22 May, late in the afternoon, two B-26 groups attacked Beauvais and one struck Beaumont while three Boston groups were bombing Évreux and Cormeilles. So it went during the middle of May. The Ninth Air Force quickly completed most of its work of destruction. By D-day it had assaulted thirty-six airfields between Holland and Brittany.<sup>117</sup> After the Marauders and Bostons inflicted major damage, fighter-bombers would rake over the air bases with strafing and dive-bombing attacks.

The Eighth Air Force had continued to devote marginal bombing effort to the Luftwaffe's bases, but large-scale missions of 9 and 23 May 1944 marked its official entrance into Leigh-Mallory's airfield campaign. Laon, Florennes, Thionville, St.-Dizier, Juvincourt, Orléans, Bourges, and Avord received the first blows from the Eighth, the highest tonnage falling on the Orléans airfield. More than 400 heavy bombers attacked airfields in the cluster around Paris on 24 May with generally good results. Potential Luftwaffe bases at Belfort, Nancy, and Brussels were bombed on the 25th.<sup>118</sup> The Eighth Air Force missions were so effective that few repetitions were required, although Ninth Air Force and RAF fighter-bombers worked over all of the important airfields for good measure. By the end of May the Germans still showed no signs of trying to move their air units into France, and it was deemed safe to discontinue or reduce the attacks, even though the program was not completed. The Fifteenth Air Force bombed only two airfields in the south of France, and the Eighth and Ninth, except for last-minute bombings in early June, devoted their efforts to other purposes.

By D-day airfields in Area I had received 6,717 tons, 3,197 of which

were delivered by the Ninth Air Force, 2,638 by the Eighth, and the remaining 882 by the RAF. In some respects the results were disappointing, for many vital installations remained undamaged and only four of the thirty-two targets in Area I were in Category A, with destruction so complete that no further attacks were considered necessary. German aircraft were still operating out of some of the bombed airfields, although they were mere fugitives which had to take to the air for safety every time an Allied air fleet approached. But the principal purpose of the program had been attained. The Germans did not have enough serviceable bases to put their air forces within good striking distance of the beachhead.<sup>119</sup> The Luftwaffe fighter commander, Adolf Galland, recollected after his capture that most of the airfields he had planned to use were so bombed out that he had to improvise landing grounds elsewhere.<sup>120</sup> Because of the ruined air bases and the transportation chaos, as well as of the danger of great British-American fighter fleets ranging over France, the Germans could not possibly move substantial Luftwaffe units to contest the invasion.

Perhaps the chief credit for keeping the German Air Force out of France before D-day belonged, as both Leigh-Mallory and Tedder said,<sup>121</sup> to the Eighth Air Force, whose missions to vital German industrial areas made it dilemmatical for the enemy to remove any more fighters from the Reich, even for such an ominous threat as OVERLORD. As it turned out, German air opposition to the Normandy landings was astonishingly slight, far below the scale anticipated by the Allied air commanders. Indeed, one of the most remarkable facts of the entire war is that the Luftwaffe did not make a single daylight attack on D-day against Allied forces in the Channel or on the beaches.<sup>122</sup>

### *Breaching the Atlantic Wall*

By the spring of 1944 the Nazis had built a wall of intricate and ingenious shore defenses along exposed beaches in the Netherlands, Belgium, and northern France. Most of the work had been performed by the Todt organization, which had constructed the Siegfried Line, under the supervision of the redoubtable Field Marshal Rommel. This so-called Atlantic Wall was supposed to dominate the coast sufficiently to keep Allied landing craft from approaching the continent, thus rendering a seaborne assault impossible. A good deal of its reputation came from propaganda designed to intimidate the western powers, and it is probable the Germans deceived themselves as to its strength. Von

Rundstedt knew the Atlantic Wall was much overrated. He said it had no depth and little surface; it was vulnerable from behind; and one day's intensive assault could break any part of its front.<sup>123</sup> But to Allied commanders it appeared formidable, and they were taking no chances. Fortunately, the Germans had left until last the construction of strong coastal defenses along the shore of Normandy. Only after an inspection tour by Rommel in March 1944 did the Normandy defenses receive much attention.<sup>124</sup>

The Allied planners were most concerned about coastal batteries along the Atlantic Wall, each of which held from two to six guns ranging in caliber from 105 mm. to 400 mm. Perhaps fifty of these batteries, it was estimated, would be functioning in Normandy by June 1944.<sup>125</sup> The guns could command the sea approaches and inflict murderous damage on the assault craft. Camouflaged, cleverly located, and usually buttressed with steel and concrete, these coastal batteries would be exceedingly difficult to neutralize. Even if airplanes got through the flak they would have to place their bombs directly on the emplacements in order to achieve any effect. This being the case, OVERLORD plans prior to April 1944 did not provide for any serious air assault on the Atlantic Wall until a few hours before the invasion forces approached the continent. At that time, a gigantic air-naval bombardment would attempt to silence the guns by knocking them out or by killing and driving off the crews who manned them.

The air forces had expected to employ only medium, light, and fighter-bombers in this manner on D-day. But ground commanders calculated that 4,800 tons would have to be delivered, thus making it necessary to utilize Eighth Air Force and RAF heavies. Plans were accordingly made to send out Bomber Command missions on the night before the assault and for Eighth Air Force operations in the last thirty minutes before the landing craft touched far shore. Ground force requirements went a step further late in March 1944 when General Montgomery drew attention to the importance of making sure the coastal defenses were immobilized.<sup>126</sup> Soon both the Army and the Navy were bringing pressure on the air forces to carry out experiments to determine whether some of the coastal batteries could be destroyed before D-day. If they could, not so much would depend upon the last-minute drenching of gun positions in what might be conditions of poor visibility on D-day.

The air leaders felt that too much was expected by the other services,

which made calculations on the basis of tonnages dropped rather than on accuracy of bombing.<sup>127</sup> In April, however, it was discovered that eight of the major coastal batteries in the invasion area were temporarily vulnerable, since they had not yet been casemated and their lids were not fitted. Leigh-Mallory indicated his willingness to try to knock them out. Air Chief Marshal Tedder opposed expending any great strength in the attempt, as did Lt. Gen. Walter B. Smith, the SHAEF chief of staff. But the naval commander in chief, Adm. Sir Bertram H. Ramsay, urgently insisted that the unfinished batteries be bombed without delay.<sup>128</sup>

The greatest pains had to be taken to conceal from the Germans the special interest which the Normandy batteries had for the Allies. Thus two targets outside the area were chosen for each one inside it, a "wildly extravagant method," as Air Chief Marshal Harris later termed it,<sup>129</sup> but, of course, a necessary precaution. This meant that if all eight of the partially completed emplacements along the Normandy coast were bombed, sixteen completed batteries elsewhere would have to be attacked. The principal targets, both inside and outside the area, were the defenses near Le Havre, Calais, Dunkerque, Dieppe, Fécamp, Fontenay, Bénerville, Étaples, Houlgate, Pointe du Hoc, Ouistreham, La Pernelle, Maisy, and Gravelines. This wide distribution called for a considerable air effort, but so vital did naval and ground commanders regard the attempt that Leigh-Mallory gave it first priority. Naval commanders were to judge whether any of the batteries should be re-attacked.<sup>130</sup>

The Ninth Air Force and the Second Tactical Air Force undertook this campaign on 13 April 1944, with the former command destined to carry out a majority of the attacks. Ordinarily, one group of A-20's or B-26's would concentrate on a single battery. The enemy's anti-aircraft fire was usually effective, enough so that aircraft were occasionally lost and flak damage was frequently very heavy. During the remainder of April all twenty-four targets sustained bombings and 3,500 tons were dropped.<sup>131</sup> While it was very difficult to arrive at a sound estimate of damage, it seemed that fifteen of the batteries had suffered, and Leigh-Mallory was convinced that the attacks might do some good. Certainly the ground and naval commanders insisted that the bombings continue.

While the air forces were experimenting with the bombardment of the coastal defenses, various Allied officials became more and more



concerned about underwater obstacles which the Germans were found to be constructing off the Normandy shore, the last of the vulnerable coastal stretches to be so defended. These obstacles were steel, concrete, or timber stakes, often with mines or shells attached; ramps with mines or blades to tear the bottoms out of landing craft; and curved rails and pyramidal contraptions known as tetrahedra. Leigh-Mallory urged that fighters strafe the beaches while the workmen were putting up these obstacles during low-tide periods. This proposal, a tempting one, General Eisenhower finally rejected for the all-important reason of security.<sup>132</sup> The Allies could not afford to indicate their concern with the Normandy beaches. But ground commanders continued to be troubled about the menace. Another danger loomed when Ninth Air Force bombers accidentally spilled some bombs into the water and set off a strange series of explosions.<sup>133</sup> If this meant the Germans were mining all the beaches, the peril to landing craft would be greatly compounded. But the naval leaders were confident that they could surmount the difficulty and, as it happened, the enemy was unable to complete the mining before D-day.

The experimental attacks of April having indicated some success in damaging or retarding the completion of coastal batteries, operations of this nature continued until the invasion. Usually they had second priority among the AEF's objectives. In May, RAF Bomber Command joined the campaign and, toward the last, so did the Eighth Air Force. The Ninth Air Force sent out six groups of B-26's and A-20's on 4 May and five Marauder groups on 9 May to attack the batteries. Two groups bombed on 11 May and three groups on 12 and 13 May, each group concentrating on one battery. On 19 May six groups prosecuted the campaign, on 20 May two groups, on 22 May three groups, and on 24 May five groups. Altogether, it constituted a serious drain on the Ninth Air Force, but total airplane losses continued to be very light.<sup>134</sup>

The Eighth Air Force contribution to the coastal-battery campaign began on 25 May when fifty-four heavy bombers attacked Fécamp and St.-Valéry. General Doolittle had been encouraging the use of H2X radar blind-bombing equipment with an eye to possible cloudy conditions on D-day, and on the 25 May mission this equipment was employed—but with discouraging results. More success attended the efforts of the Eighth in massive raids of 2, 3, and 4 June, when 4,700 tons were dumped on coastal batteries.<sup>135</sup> It was RAF Bomber Com-

mand which dropped the heaviest tonnage of all on the Atlantic Wall, some 14,000 tons, enduring severe losses in several instances to its slow, low-flying fleets of night bombers. Its most effective single mission prior to the night before the invasion occurred on 28/29 May, when 350 tons fell on guns commanding the proposed UTAH beach with excellent results.<sup>186</sup> And the tactical air forces of the AEAF increased their attacks on the coastal defenses in the days just before the landing.

On the eve of D-day, 5,904 tons of bombs and 495 sixty-pound rocket projectiles had been directed at coastal batteries in the Normandy area, while 17,190 tons had been dropped on batteries outside the invasion sector. At the Allied air commanders' conference of 26 May, Zuckerman had presented evidence that the bombings had not been so effective as expected. Subsequent bombings improved the picture, however, and Leigh-Mallory believed that at least twenty-one of the fifty-odd batteries in the NEPTUNE area had been damaged, aside from those outside the invasion area.<sup>187</sup>

Whether the air effort and bomb expenditure against coastal defenses prior to D-day had been worth while was never satisfactorily determined. Such an enormous weight of bombs and shells struck the batteries shortly before the invasion that it was impossible to segregate the damage as to air or naval, pre-invasion or D-day. It was clear that the efforts to conceal the landing site had been highly successful, for the attacks on the Atlantic Wall had not shown the projected point of assault. It was also true that the scale of effort had been well within the capacity of the air forces and that losses had been very light except for Bomber Command. Reassuring as such factors were, however, they were more or less negative. Most post-invasion surveys concluded that the bombings of coastal batteries before and on D-day destroyed comparatively few gun emplacements, as the air commanders, guided partly by experience in the assault of 1943 on Pantelleria,\* had predicted. But the unbalancing and dislocation of guns, the demoralization of their crews, and delays to the completion of the Normandy beach batteries were accomplishments of no small nature.<sup>188</sup>

The Germans had constructed a very extensive system of radar coverage from Norway to the border of Spain. Between Ostend and Cherbourg their system was especially thick, with major stations every ten miles supported by a less intensive but highly efficient network inland. The Allies were well informed about the location, type, and

\* See Vol. II, 432.

importance of these stations, which could detect airborne and seaborne forces and could set in motion both coastal and flak defenses. Consequently, they considered from the earliest days of invasion planning to the last moment methods of throwing the entire system into confusion. It would be impossible to destroy all of the radar installations by bombing because of their number and stout defenses. Also, it should be unnecessary if countermeasures could jam most of the stations. But the installations between the Channel Islands and Ostend would be difficult or impossible to neutralize by jamming. These stations were really the most important ones, since they could furnish good readings on ships, control coastal guns, and assist the enemy's night fighters in locating airborne forces.<sup>139</sup> Thus it was essential to try to obliterate them by air attack.

The ever present consideration regarding concealment of the landing site made it prudent to plan on bombing two radar installations outside the assault area for each one within it. Most of the attacks were carried out by Second TAF Typhoons, although the Eighth and Ninth Air Forces participated on several occasions and RAF Bomber Command distinguished itself in one brilliantly successful mission. The first attacks took place on 10 and 18 May against the so-called Hoarding long-range aircraft reporting stations. On 25 May the campaign became intense when 42 sites containing 106 installations were assigned for bombing.<sup>140</sup> The tactical air forces of the AEF flew 16,668 sorties against these targets, sometimes using Spitfires and Typhoons for dive bombing, Typhoons for firing rocket projectiles, or light and medium bombers for bombing. And the heavies put several stations out of action in precision attacks involving a small number of aircraft. These missions proved very dangerous and costly but the Allies did not have to abandon the program, a possibility that had been reckoned on when it was about to be undertaken.<sup>141</sup> Because of the high casualties, however, Leigh-Mallory restricted the bombing to twelve targets in the Normandy area after 29 May, six of which were chosen by naval authorities and six by air authorities. All of them were attacked before D-day.<sup>142</sup>

The damage inflicted on the radar network was of the utmost importance. Nearly all of the installations in the invasion area were badly crippled or wiped out. A devastating attack on a station near Cherbourg removed, as the Allies later discovered, the headquarters of the Nazi signals intelligence and reporting service for northern France.<sup>143</sup>

## THE ARMY AIR FORCES IN WORLD WAR II

A USSTAF appraisal regarded as conservative estimated that the bombings had reduced the effectiveness of the enemy's radar system in the crucial area to 18 per cent.<sup>144</sup> When ingenious radar counter-measures were put into effect just before the landing, the figure fell to 5 per cent.<sup>145</sup> The Germans were therefore blind to Allied movements toward the Atlantic Wall, and they were utterly confounded about the nature and intentions of the invasion forces. They were surprised in Normandy, and for days afterward they possessed no trustworthy means of detecting the approach of air and naval fleets.

### *The Beginning of the Campaign against Oil*

During the climax of the pre-invasion bombings the Eighth and Fifteenth Air Forces launched what was to become their most rewarding campaign in the strategic air war, the destruction of enemy oil production. Since the start of the war Germany's oil position had been precarious, although it was never as desperate as Allied planners usually imagined. In the last full year of peace, 1938, Germany had consumed 7,500,000 tons of petroleum products, two-thirds of which she imported. When she invaded Poland in September 1939, her oil reserves were so low that only six months of operations could be permitted. Lightning campaigns and diplomatic victories soon brought the resources of France, Hungary, Rumania, and other countries into Nazi control, however. Drastic measures to restrict consumption were helpful, and the Germans began to develop a huge industry to produce synthetic oil from coal by means of the Bergius and Fischer-Tropsch hydrogenation processes. In 1943 these synthetic oil plants turned out more than 6,180,000 tons of petroleum products, and 2,000,000 tons of crude oil were drawn from Rumania and Hungary. While their reserves were always low, the production of synthetic oil was rising so rapidly by early 1944 that the Germans could contemplate the future with some confidence.<sup>146</sup>

As early as 1940 the British had planned seriously to attack German oil facilities, and American interest had frequently swung to this possibility. But by May 1944 only 1.1 per cent of all Allied bombs had been directed at petroleum targets.<sup>147</sup> The reason why the Allies delayed opening an oil campaign so long was simply that they did not have sufficient air forces available. Oil production centers were widely scattered about in the Axis countries in more than eighty different localities, many of them entirely out of range before the Fifteenth Air Force

was established in Italy. Components of the oil complex were four or five times more numerous than aircraft factories and eight times more numerous than ball-bearing production centers.<sup>148</sup> Not until early 1944 did the Allies possess, in the Eighth and Fifteenth Air Forces and RAF Bomber Command, enough heavy bombers to undertake a systematic attack on oil, and first they had to overcome the dangerously resurgent Luftwaffe. Then there were CROSSBOW commitments and, of course, the unexpectedly large demands of the pre-invasion bombing campaigns. On its part, the Fifteenth Air Force expended most of its effort in POINTBLANK, assistance to the land campaigns in southern Europe, and political raids on Balkan capitals. As late as January 1944 air commanders in both London and Washington, fortified with the views of the operations analysis section of the Eighth Air Force, agreed that oil should receive no priority in the strategic air war.<sup>149</sup> There were too many other things to do.

As the victorious nature of POINTBLANK operations became evident during February 1944, considerable interest developed in attacking oil production. The Joint Intelligence Committee,<sup>150</sup> Lt. Gen. Brehon B. Somervell of the Army Service Forces,<sup>151</sup> and the American Embassy's Economic Warfare Division suggested that the time was opportune to undertake an oil offensive. Most significant of all, General Spaatz came to the conclusion during that month that a strategic attack on enemy oil would flush the German air force and would contribute more to the success of OVERLORD than any other type of campaign within the capabilities of the heavy bomber forces. In his Plan for the Completion of the Combined Bomber Offensive, which he presented to General Eisenhower on 5 March 1944 as an alternative to the AEF transportation plan,\* Spaatz drew attention to the great strides the Germans were making in producing synthetic oil. In the next six months, the USSTAF commander estimated, the enemy might obtain 8,600,000 tons of liquid fuels and lubricants, which would largely relieve him of his embarrassment with respect to oil requirements. Approximately 90 per cent of this output was accounted for by fifty-four crude-oil refineries and synthetic petroleum plants, of which twenty-seven were especially important. These twenty-seven centers had been grouped about Ploesti, in Silesia, and in the Ruhr in the overconfident expectation that the Luftwaffe could protect them. By destroying them the Allies might deprive the Germans of half their gasoline sup-

\* See above, p. 76.

ply. If all fifty-four centers were attacked successfully, German oil production might fall to zero by September 1944. The twenty-seven-plant objective, Spaatz contended, was already well within the capabilities of the Eighth and Fifteenth Air Forces.<sup>152</sup>

Several obstacles stood in the way of an oil offensive at that time. General Eisenhower had before him the recommendations of Leigh-Mallory, Tedder, and many others that the railway system of western Europe should be destroyed in a long-range bombing campaign. The requirements of CROSSBOW were large and growing. Air Chief Marshal Harris of Bomber Command was opposed to the oil project.<sup>153</sup> In AAF Headquarters, Arnold and Maj. Gen. Barney M. Giles supported Spaatz's ideas in general but felt they were premature for consideration by the Combined Chiefs of Staff, that it was up to Spaatz to convince Eisenhower before anything was done in Washington.<sup>154</sup>

There was, however, a chance to open the oil campaign by dispatching the Fifteenth Air Force to attack the crude-oil refineries around Ploesti, already attacked in the famous mission of August 1943. On 17 March 1944, Arnold notified Spaatz that the Combined Chiefs had no objection to his ordering attacks on Ploesti at the first opportunity,<sup>155</sup> but even so it was thought wise to begin the undertaking surreptitiously under the general directive which called for bombing transportation targets supporting German forces that faced the Russians, who were then breaking into Rumania.<sup>156</sup> Such transportation targets stood in the vicinity of Ploesti, and on 5 April 1944 the Fifteenth Air Force administered an attack on the marshalling yards there with 146 B-24's and 90 B-17's. Most of the 588 tons of bombs, with more than coincidental inaccuracy, struck and badly damaged the Astra group of refineries near by. The Americans did not proclaim the opening of the oil offensive, even in their secret intelligence summaries, but on 15 and 24 April large forces of heavy bombers again attacked Ploesti marshalling yards in the expectation that most of the bombs would produce "incidental" damage to oil refineries. This damage occurred, and to a very encouraging extent.<sup>157</sup> Hitler was soon referring petulantly to the whining of the Rumanians about these air attacks,<sup>158</sup> and the Americans were delighted with the results. By 4 May, MAAF headquarters fortified the authority for the Fifteenth Air Force's oil missions by granting permission for them to continue if tactical considerations allowed.<sup>159</sup>

While the Fifteenth Air Force was inaugurating the oil campaign, the way was partly cleared for Eighth Air Force participation. Spaatz

fought hard for his plan of 5 March 1944 and against the long-range transportation plan to bomb rail centers. The cardinal issue, as Spaatz made clear at the time and after the war,<sup>160</sup> was to draw the German Air Force into the skies. He contended that it would expend itself against heavy bomber fleets engaged in attacking oil installations but would conserve its strength while targets of such dubious value as rail centers were being bombed, and he was right. But General Eisenhower's decision in favor of the transportation plan on 25–26 March did not rule out altogether the possibility of attacking oil. Five days after the supposed settlement of the oil–rail center controversy, Spaatz proposed that thirteen synthetic oil plants in Germany be attacked as third priority, coming after the German Air Force and the rail centers. In order to do this the Eighth Air Force and Bomber Command would bomb rail centers by daylight. Also during daylight the Eighth would attack oil plants in the Ruhr while RAF heavies would go to the Stettin vicinity at night.<sup>161</sup> This proposal the RAF rejected because its leaders were unwilling to expose their heavy bombers at that time in daylight operations and, of course, because most of them were not then convinced of the advantages of an oil offensive.

There was still another possibility. Eisenhower's directive to the strategic air forces on 17 April 1944 gave the German Air Force first priority in USSTAF target listings. The Luftwaffe used oil products and, as AAF Headquarters pointed out,<sup>162</sup> attacks on oil installations could come under the general heading of POINTBLANK without disturbing the Combined Chiefs or the British with efforts to change the existing system of priorities; moreover, the destruction of German fighters which rose to defend the oil plants was undoubtedly a major purpose of the Eighth Air Force. Thus the Eighth Air Force could destroy oil targets, at least as an experiment, while pursuing POINTBLANK, and the Fifteenth Air Force could bomb them under the subterfuge of attacking railway objectives.<sup>163</sup> General Eisenhower, who leaned heavily on Spaatz in air matters, granted verbal permission on 19 April for the bombing of German oil targets on the next two days of good visual conditions. The supreme commander emphasized, as did Spaatz, that the fundamental purpose was to determine the willingness of the Germans to send their fighters against attacking bombers.<sup>164</sup> Somehow it seemed important to the two U.S. leaders not to go on record as taking the initiative in opening this new offensive, which soon would be the pride and chief concern of the strategic air forces. Tedder, who was

in charge of strategic air operations for OVERLORD, momentarily jeopardized the project by insisting upon CROSSBOW attacks by the Eighth Air Force instead of the oil missions. But a visit of Spaatz to his office on 20 April resulted in a compromise to the effect that one day's effort would be devoted to CROSSBOW, and that the two days of good bombing weather would remain open for the oil plant assaults.<sup>165</sup> Spaatz accordingly directed Doolittle to plan on attacking as many oil targets as possible in central Germany.<sup>166</sup>

On the following day, 21 April 1944, Doolittle had 864 heavy bombers and 1,040 fighters scheduled to begin the oil offensive.<sup>167</sup> But rapidly deteriorating weather conditions at the bases and target areas compelled him to cancel the mission. Not until 12 May were conditions suitable for the great experimental attack, one which the Germans had been dreading almost above everything.<sup>168</sup> They had foolishly grouped their main synthetic oil plants together, and by now they had no strong Luftwaffe to defend them. Their shortsightedness proved painful on the 12 May mission and during the numerous attacks which followed. On this occasion, 15 combat wings involving 935 heavy bombers, escorted by Eighth and Ninth Air Force and RAF fighters, took off for what was to prove a historic operation.<sup>169</sup> The aircraft proceeded to a point south of the Ruhr, skirting the highly defended sites in that area and around Hannover and Brunswick, and then flew east and northeast toward the target area. Near Frankfurt the GAF rose to intercept the leading combat wings, and the enemy fighter pilots exhibited their usual aggressiveness once they were off the ground. Between 150 and 200 enemy aircraft attacked, mostly in mass, using saturation tactics. In some cases 30 German fighters came in abreast, firing savagely and even ramming the B-17's. One of the combat wings lost half its bombers and became thoroughly disorganized. Before further harm was done, escorting P-47's and P-51's came to the rescue and the bombers proceeded to their targets. Most antiaircraft fire was of moderate intensity. More than 800 heavies attacked, dropping 1,718 tons on the synthetic oil plants at Zwickau, Merseburg-Leuna, Brück, Lützkendorf, Böhlen, and other cities. The targets were slightly obscured by low clouds and ground haze. During the withdrawal phase a force of 50 German twin-engine fighters pressed determined attacks against the bombers for almost a half-hour and smaller groups of single-engine fighters attempted interception. In all, the Eighth Air Force lost 46 heavy bombers on this mission, and 10 Allied fighters failed to return.



Bomber crews claimed 115 enemy aircraft and fighter pilots 75. Certainly the professed objective of the mission was attained: the German Air Force had reacted vigorously to the attacks on oil plants and had suffered severe losses.\* More important in the long run was the fact that all of the targets were damaged, some of them very heavily. Brück, Böhlen, and Zeitz were knocked temporarily out of operation, and the bombing at Merseburg-Leuna happened to destroy a building in which experiments were being conducted with heavy water for Germany's atomic-bomb project.<sup>170</sup> It was an excellent mission, despite the heavy loss of bombers, and an auspicious opening of the Eighth Air Force campaign to deny the Germans oil.

Heavy OVERLORD commitments and weather conditions kept the Eighth Air Force away from oil targets for more than two weeks after the notable operation of 12 May. But the Fifteenth Air Force was by now well launched in the oil offensive. Its chief target in this system was the invaluable cluster of crude-oil refineries at Ploesti, the source of approximately one-fourth of Germany's petroleum even when, as at that time, it was not in full operation. The Fifteenth also included smaller crude-oil targets in Austria, Hungary, and Yugoslavia while its companion air force, the RAF 205 Group, filled the Danube regularly with mines to interfere with barge shipments of oil to the Reich. These Danube mining operations proved more effective than the Allies apparently realized.<sup>171</sup> On 5 May the Fifteenth's bombers, almost 500 strong, fired many of the installations around Ploesti and encountered, as might be expected in view of Germany's need for the refineries, very intensive antiaircraft fire and more than 100 fighters. On 18 May 700 Fortresses and Liberators flew against Ploesti but two-thirds of them could not attack because of adverse visibility conditions. Good results were achieved on 31 May, when 460 heavies of the Fifteenth bombed the refineries, and on 6 June, when 300 B-24's carried out a highly successful attack.<sup>172</sup> Ploesti would remain the favorite tar-

\* As usual, an irreconcilable discrepancy is evident between American calculations and captured German records, and smaller disparities among the several types of data kept by the Nazis. While the Americans claimed 190 enemy fighters on the 12 May 1944 mission, one German source acknowledges that 50 were lost and 10 were missing, and another admits of only 39 lost for a two-day period, 12-13 May, all over the Reich. On the other hand, the Americans are surely correct in their secret reports when they state that 10 U.S. fighters were lost; yet the Germans listed 81 for sure and 10 probables, all apart from their mendacious public announcements. (German statistics on German fighter reaction to Anglo-American bombing attacks. Science Memo No. 15, ADI[K] [USAFE]; Gesamtverluste der fliegende Verbände, in German High Command Quartermaster collection now in the British Air Ministry, AHB 6.)

get of the Fifteenth Air Force until August 1944, when Russian land forces moved into the ruins. And soon after D-day aircrews of the Fifteenth would become very familiar with the route to the synthetic oil plants of eastern Germany.

The Eighth Air Force returned to the oil offensive on 28 May 1944, when more than 400 heavies bombed synthetic oil plants at Ruhland, Magdeburg, Zeitz, Merseburg-Leuna, and Lützendorf, all of them damaged targets still suffering from the raids of 12 May. Results were good everywhere.<sup>173</sup> Zeitz was put out of operation again. Later, a German prisoner reported that Italian conscript workers had helped spread the flames at the giant Merseburg-Leuna plant and that Goebbels and Speer had rushed to the stricken area to deliver inspirational speeches to the demoralized German laborers.<sup>174</sup> On 29 May the Eighth sent 224 Liberators to the vast and distant synthetic oil establishment at Pölitz and damaged it severely.<sup>175</sup>

On both the 28 and 29 May missions the Eighth Air Force had met serious Luftwaffe opposition and had lost forty-nine heavy bombers on the two operations.<sup>176</sup> Undoubtedly, the German high command was profoundly aroused by these attacks on the oil installations and had ordered the Luftwaffe to resist them with all its power. Other heavy bomber missions into the Reich during the weeks before the invasion pinned down Germany's fighter units and overwhelmed them whenever they attempted to interfere. Notable were Eighth Air Force attacks of 18 April against the Berlin area, of 24 April against Friedrichshafen, of 26 April against Brunswick and Hannover, of 29 April and 7 and 8 May against Berlin. The Fifteenth Air Force missions to Ploesti and to Vienna (10, 24, and 29 May) likewise served to discourage German removal of fighter units to meet the threat of OVERLORD. These strategic assaults on the Reich were closely related to the fact that the invading forces were not disturbed by the GAF on D-day. During the spring of 1944 Allied fighter pilots and gunners so increased their pressure on the enemy that Goering received warning in mid-May of Luftwaffe pilot losses critically in excess of replacements.<sup>177</sup> An American appraisal of German records indicates that aircraft losses sustained by the GAF, including planes damaged to the point of requiring replacement, reached their peak in April, the total figures for February being 1,432, for March 2,012, in April 2,540, and during May 2,461.<sup>178</sup>

Forcing the Luftwaffe to remain in Germany and inflicting heavy

losses on it there were important enough, but the injury wrought on oil production centers was exceptionally painful to the enemy. The first two months after D-day would not reveal Germany's plight with regard to oil supplies, but from August 1944 on, all German forces would be greatly hampered by lack of fuel and lubricants. As soon as the synthetic plants were attacked the enemy correctly gauged the Allied intention for a continued offensive and comprehended how serious for the Reich it was likely to be. Albert Speer afterward said that the oil attacks of May 1944 brought about the decision of the war.<sup>179</sup> Only 5,166 tons of bombs were aimed at oil targets during that month. Yet German production for June fell sharply, amounting only to half the figure for March output, and the Germans, appalled at the vulnerability of Ploesti and of their synthetic oil plants, undertook desperate measures to maintain a flow of fuel to their armed forces.<sup>180</sup> It was only the beginning, and both the Allies and the Germans knew it. USSTAF was, of course, jubilant at the effectiveness of these first attacks. Eisenhower was convinced, and the British were won over to the oil campaign by the last of May.<sup>181</sup> On 4 June 1944, an ETO press release would proclaim publicly the oil offensive, and on 8 June, with OVERLORD begun, Spaatz would place oil in first priority for the U.S. strategic air forces. The campaign was off to a splendid start.

### *Air Reconnaissance before the Invasion*

The reconnaissance units of all air forces were heavily employed in vital activities during the pre-invasion period. In addition to the normal photographic coverage of POINTBLANK targets in Germany and watchful tactical reconnaissance of enemy activities in France and the Low Countries, exact information had to be obtained for the impending OVERLORD operation. Considerations of security dictated the scattering of reconnaissance effort over western Europe. AEAFF headquarters supervised the general program for reconnaissance related to the invasion and adjusted air requirements with those of 21 Army Group and the naval forces as well as with those of SHAEF. Furthermore, the photographic units of USSTAF were brought into a close working relationship with the AEAFF so that coverage would be complete and efficient.<sup>182</sup> The Allied air forces were somewhat under-strength in photographic and tactical reconnaissance aircraft but by the spring of 1944 they had much experience and good methods.<sup>183</sup>

As D-day approached, tactical reconnaissance missions took on an

especially urgent character. The Ninth Air Force and the Second TAF flew at least eight missions daily, at times in weather regarded as too hazardous for ordinary air operations, over the area in France north of the Seine. Partly this was to create such a broad reconnaissance pattern that our actual intentions would not be revealed, but the pilots often reported via radio-telephone the movement of trains and other targets which fighter-bombers could attack on short notice. And they would relay timely information on troop movements or activity in repairing bridges and railroad tracks, and sometimes would make photographs of targets when assessment was needed at once. The Ninth Air Force alone dispatched more than 400 aircraft on such visual reconnaissance missions between 15 May and D-day.<sup>184</sup>

It was photographic rather than tactical reconnaissance which assumed the more importance for the invasion leaders as D-day drew near. Already having mosaics of the entire coast line of western Europe and pictures taken of the Normandy and Pas-de-Calais beaches from 3,500 feet, they required still more specific data. Accordingly, the Ninth Air Force and the Second TAF sent out aircraft to photograph the proposed assault beaches from varying distances and at wave-top height so the unit commanders would know exactly what their objectives would look like from several miles out, at 1,500 yards, and from the shore line as they moved in on the crucial day of the landing. Also, the unarmed reconnaissance airplanes made photographs of every possible yard of the beaches and areas immediately behind them, zooming and swerving to avoid cliffs and sand dunes, in order to provide ground force officers with up-to-date information about the shore they would soon find themselves on. It was necessary, moreover, to make low-altitude photographs of the proposed airborne landing areas for assistance in planning these operations.<sup>185</sup> Here, as elsewhere, two missions were prescribed for other areas for each one over Normandy.

The 10th Photo Reconnaissance Group of the Ninth Air Force performed eleven extraordinary missions, all as dangerous as they were vital. The exact nature of the underwater obstacles and beach barricades not being known to the assault commanders, it was decided to make photographs of the shallow water and beaches from altitudes as low as fifteen feet. The photographs obtained were of the utmost value, since they revealed which of the obstacles were timber and which were steel or concrete, how the mines and shells had been affixed, where the concentrations were worst, and how deeply they were anchored. The

## PRE-INVASION OPERATIONS

assault commanders could therefore plan precisely how to avoid or remove the obstacles as they moved toward the French coast. One pilot was killed in these so-called Dicing missions, and the group won much praise and a Presidential unit citation.<sup>186</sup>

In these reconnaissance and other missions it was necessary to avoid tipping the enemy as to the exact nature of Allied plans for the invasion. He could scarcely be fooled as to the fact that one was to occur, for the enormous build-up of Allied forces in the United Kingdom, the intensification of bombing operations, and the inevitable speculation in Britain and America informed him of the chief intention of his foes. But plans built essentially on the common-sense rule of avoiding such a concentration of the air effort as to betray Allied intentions served well the purpose of achieving for Eisenhower's forces on D-day the advantage of tactical surprise. Indeed, the overwhelming bulk of German divisions in the west was deployed to the north of Normandy in the expectation that the attack would come in the Pas-de-Calais, and was cut off from Normandy by the chaotic condition Allied air attack had brought upon the intervening transportation. The enemy, as General Spaatz was able to report, had been thrown completely off guard.<sup>187</sup>

Though the air forces could hardly claim full credit for this achievement, the responsibility rested heavily upon them and added greatly to the burden of their several pre-invasion tasks. In this—as in the transportation campaign, the airfield attacks, the neutralization of the Atlantic Wall, reconnaissance, and the steady blows at Germany's industrial vitals—the Anglo-American air forces did more than facilitate the historic invasion of 6 June 1944. They made it possible.



SECTION II

\* \* \* \* \*

*INVASION OF WESTERN EUROPE*





## CHAPTER 7

\* \* \* \* \*

### *NORMANDY*

WHEN in the preparation of a military history one comes to an event so historically significant as the Allied invasion of Normandy on 6 June 1944, one naturally feels that the occasion calls for dramatic effect. But it is not always possible to achieve such an effect, and this is especially true in the narrating of air operations. So much of air's contribution to the success of the Normandy landings depended upon the cumulative effect of operations extending back through the days, months, and even years which preceded D-day that D-day itself, though providing an obvious climax to this preparatory work, seems almost an anticlimax.

There was drama enough in the loading of thousands of paratroopers for a hazardous drop behind the enemy lines; in the difficult night assembly of hundreds of loaded troop carriers as they formed for the flight across the Channel; in the tense activity on scores of airfields as ground crews readied their planes for the big show; in the fighter sweeps sent out beyond the beaches to flush such of the enemy's planes as might be within reach; and in the massive bombings of the beaches themselves just before the landings. But for all the unprecedented activity of a night and a day in which the American air forces alone dispatched more than 8,000 planes on missions directly related to the invasion, the day proved to be, in one sense, peculiarly uneventful. There were no great air battles—so well had the preparatory work been done and so overwhelming were the Allied air forces that the Luftwaffe refused the challenge. The record of air operations in its most significant aspects points chiefly, therefore, to impressive evidence of a victory already won and to a massive effectiveness speaking first of the singularly undramatic skills of organization and planning.

The record speaks too of adherence to sound principles of air war-

fare. Those principles, drawn from a wide and lengthening experience, gave to the air forces supporting the ground operations begun on D-day clearly defined tactical roles. In order of their priority, as fixed by FM 100-20 of 21 July 1943,\* they were: (1) to establish and maintain control of the air in the critical area for the purpose of eliminating the enemy's capacity to interfere from the air; (2) to isolate the battlefield by interdicting enemy movements of troops and supplies; and (3) to render immediate support to the ground forces on the battle front. Since the first task had been so largely accomplished in advance of D-day, the following pages deal primarily with activities aimed at the second and third of these objectives.

### *D-Day*

The great amphibious assault on Hitler's "Fortress Europe" had been scheduled for 5 June 1944, but forecasts of weather unfavorable to air operations caused a postponement of twenty-four hours. The date was irrevocably fixed as 6 June at a tensely dramatic meeting in the early-morning hours of 4 June. H-hour for the seaborne landings on the American beaches at UTAH and OMAHA was set for 0630 and on the British beaches at times from 0700 to 0730 hours.<sup>1</sup>

It had been a postulate in all Allied planning—from AWPD-1 of September 1941 to the final draft of the NEPTUNE plan—that the success of an invasion of the European continent would depend upon the establishment of supremacy in the air. For that purpose the greatest air armadas known to history had been assembled on British bases. Added to the resources of RAF's Bomber Command and Second Tactical Air Force was the overwhelming power of two U.S. air forces. More than 4,000 aircraft of the Eighth Air Force were available for support of the assault. An equal number of planes, including 1,300 troop carrier aircraft, were at the disposal of General Brereton's Ninth Air Force.<sup>2</sup> There was work for all, and much of it would have to be accomplished well in advance of the beach touchdowns.

While RAF Bomber Command concentrated its attention on coastal batteries from the Cherbourg peninsula east to Houlgate in characteristic area bombings executed during the darkness preceding H-hour, the U.S. air forces staged the largest troop carrier operation yet undertaken. In the closing hours of 5 June great sky trains, carrying the 82d and 101st Airborne Divisions of the U.S. Army, took off from fields

\* See Vol. II, 205-6.

# AIRBORNE OPERATION NEPTUNE 5-6 JUNE 1944

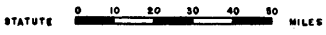
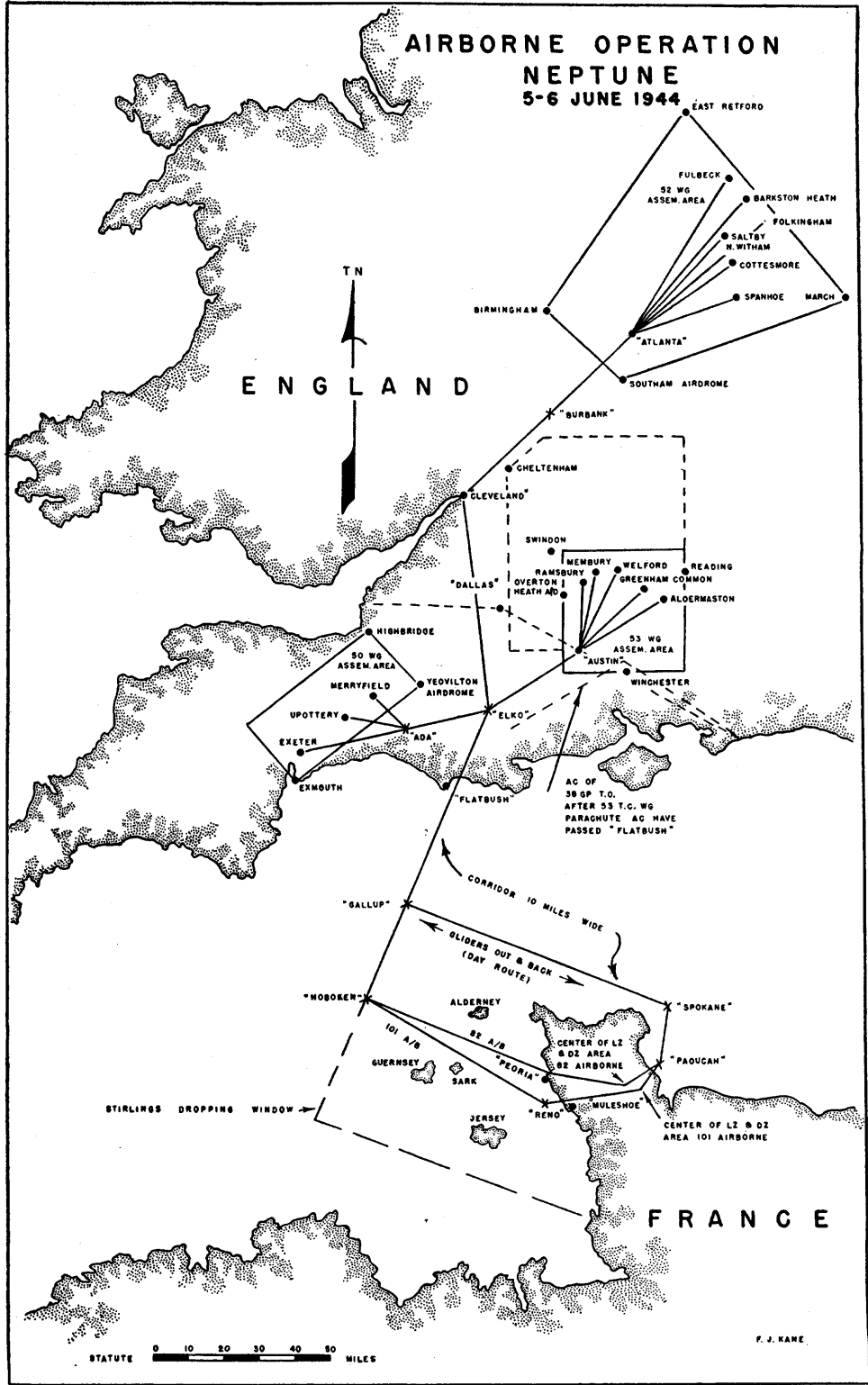

F. J. KAME

ranging from Devon to Lincolnshire for drops behind UTAH beach. Plans called for a total lift of over 17,000 men together with requisite equipment, and to convince those committed to the operation of their full confidence in its success, Eisenhower and Brereton had visited units of the 101st during the evening and witnessed their take-offs.<sup>3</sup>

It was a tribute to training that over 900 planes and more than 100 gliders of IX Troop Carrier Command assembled in darkness, and that the outward flight west of the Cherbourg peninsula was executed according to plan and without incident. RAF night fighters and intruders furnished escort and attacked enemy guns and searchlights, while British Stirlings dropped Window to simulate the movements of airborne serials into an area well south of that in which the drop was to take place. There were no encounters with enemy aircraft during the operation. However, after the enemy coast had been crossed, difficulties swiftly multiplied. German radio gave warning of large formations of planes northwest of Cherbourg by 2354 hours on 5 June. It may or it may not have been heeded,<sup>4</sup> but whatever the extent of surprise achieved, only the leading planes of any formation escaped continuous and heavy antiaircraft fire as they flew inland. Fog and cloud made visual observation uncertain. Formations tended to break up, and even the trained pathfinders experienced difficulty in identifying their drop targets. Parties dropped on two zones west of the Merderet could not mark them effectively with lights owing to the presence of the enemy, and no matter how well the zones were marked, the main drops (made between 0016 and 0404 hours) were generally scattered. A few planes, uncertain of their target's location on their first run, circled back and dropped accurately, but others unloaded too soon or overshot their marks. There were gross errors. Yet some serials dropped accurate concentrations and a ground observer noted that the gliders accomplished "little short of a miracle," since they had encountered heavy enemy fire before making hazardous landings on small and obstructed fields. Glider reinforcement on the afternoon of D-day and on the morning of D plus 1 had to land in an area where battle was already raging.

Losses in flight overland and from enemy fire at the time of landing added to the prevailing confusion among the paratroopers, while Normandy hedgerows multiplied their problems. The confusion of the attacking forces was not reduced, though it was in some measure offset, by the fact that the scattered drops confused the enemy as well,

both as to the extent of the operation and its objective. Dispersion was real—only 2,500 of the 6,600 men of 101st Airborne were under unified control at the end of D-day, and two regiments of the 82d had been widely scattered in marshy ground. But in spite of dispersion many vital missions had been accomplished, often by small and mixed units resolutely led. The bad drops of some units of the 82d allowed the coveted area west of the Merderet to remain under enemy domination, but other elements of the same division, exceedingly well dropped, were able to assemble rapidly and take Ste.-Mère-Église, on the northern flank, by 0430. All four exits from the causeways across the inundations west of UTAH beach were secured by early afternoon, and the southern flank of the invasion area was reasonably secure even if all the desired bridgeheads over the Douve had not been won.

Such was the result of the airborne operation on D-day. Many of the difficulties encountered had been foreseen and accepted. The plan, resolutely adhered to by Eisenhower on 30 May, called for a night drop on a defended area studded with organized positions and was undertaken only because the supreme commander rated it essential to the success of the UTAH beach landings.\* Together with the closely related missions on D plus 1, the operation included a total of 1,606 sorties by aircraft and 512 by gliders, with losses of 41 and 9, respectively. There was instant relief when it became known that losses were far below what the Allied air commander had feared they might be, and Leigh-Mallory was quick to admit the error of his own estimate and to congratulate Eisenhower on the wisdom of his difficult decision of 30 May.<sup>5</sup> Considered judgments agree that “the success of the Utah assault could not have been achieved so conspicuously without the work of the airborne forces.”<sup>6</sup>

As paratroopers hit the silk and gliders cut loose over the Cherbourg peninsula in the early hours of 6 June 1944, ground crews on scores of British airfields readied their planes for other tasks of no less critical importance. Striped invasion markings on the fuselages and wings of the aircraft signified the nature of the missions they were about to perform—air cover for seaborne forces and for the invasion area; air support for the assault itself.

Continuous cover of the vast seaborne armada and of the beaches themselves was furnished exactly as planned. The Eighth and Ninth

\* See above, p. 146.

Air Forces concentrated their P-38's on the protection of the great convoys moving across the Channel toward Normandy; as the assault forces went ashore, the RAF furnished the low and Quesada's IX Fighter Command the high cover over the beaches.<sup>7</sup> Not only were covering operations successful but they proved amazingly uneventful. Three FW-190's chased off by convoy cover were the only enemy aircraft sighted by covering formations during the day, and not until after nightfall, when twenty-two enemy planes attacked shipping, was an Allied vessel touched by air attack. Even then the damage was slight. An early-morning offensive sweep (Operation FULL HOUSE) beyond the periphery of the invasion area conducted by VIII Fighter Command had encountered no opposition.<sup>8</sup> So effective had been the preparatory work of the Allied air forces that the greatest amphibious operation of history could be staged without challenge from the enemy air force.

A masterly pre-dawn assembly had set up the Eighth Air Force's three bombardment divisions for their planned strikes on coastal batteries and shore defenses—chiefly those concentrated on OMAHA and the British beaches—together with chokepoints in Caen. For the moment, the role of the heavies was that of close support, and since their number was so great and their attack was to be delivered in waves, the take-offs ranged from 0155 to 0529 hours. Weather forecasts indicated that bombing must be on instruments through overcast. It was, therefore, provided that the last bombs would be dropped no later than ten minutes before the touchdowns and, in the interest of greater safety and with Eisenhower's approval, pathfinder bombardiers were ordered to delay up to thirty seconds after the release point showed on their scopes before dropping. The danger of shorts was stressed in all briefings. A total of 1,083 of the 1,361 B-17's and B-24's dispatched on this first mission attacked, flying in at right angles to the beaches in formations of six squadrons abreast with H2X pathfinders in the lead. With the loss of only a single plane to enemy action they dropped 2,944 tons of bombs, largely with instantaneous fuzes to avoid heavy cratering which might impede motorized movement on, and inland from, the beaches.

For a moment, it had seemed that low cloud might force the Eighth, better provided than were other forces for nonvisual bombing, to undertake the missions originally assigned to IX Bomber Command against targets in the UTAH area. However, Brig. Gen. Samuel E.

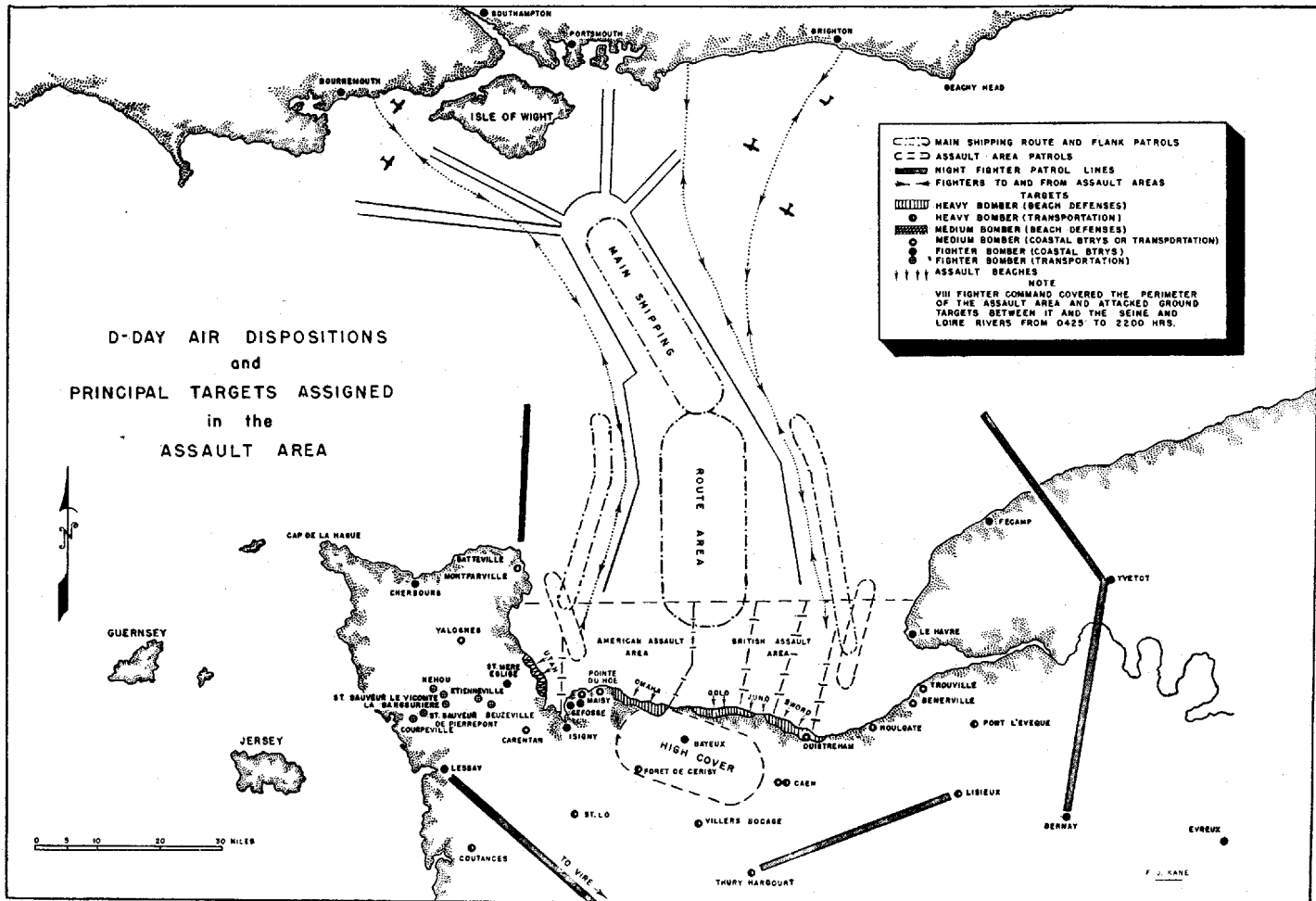

Anderson sought, and received, authority to bomb visually under the 3,500-foot ceiling, and the project to divert the heavies from Caen was abandoned. Accordingly, the mediums took off between the hours of 0343 and 0500, flying in boxes of eighteen planes each. Because of continuing overcast the attacks went in at levels ranging from 3,500 to 7,000 feet. Attacks on outlying targets began at 0517 hours, but those on the UTAH beach targets were concentrated between 0605 and 0624 hours. The 278 aircraft dropped about 550 tons. Meanwhile, fighter-bombers of IX Fighter Command struck at their assigned targets: 33 planes bombed coastal batteries while 129 others attacked transportation targets, chiefly in the Cherbourg peninsula.

Accurate assessment of the effectiveness of these attacks is impossible. Earlier bombardment of some targets, naval and ground artillery fire on D-day and after, clearing operations, and inconclusive strike photographs frustrated later investigators. Fighter-bombers are known to have hit and destroyed the road bridges at Étienneville, but they did little damage to the battery at Maisy, and elsewhere the evidence is limited to the pilots' own inevitably indefinite claims.<sup>9</sup> Where the effects of part of the mediums' effort on UTAH beach could be later followed, 35 per cent of the bombs was reported to have fallen to seaward of high-water mark but 43 per cent within 300 feet of their targets.<sup>10</sup> The deliberately cautious method of bomb release adopted by the American heavies—only one instance of short bombing was reported and it proved harmless—caused their main concentrations to fall from a few hundred yards up to three miles inland. An unexpected dividend was paid in the shape of detonated mine fields, but the beachlines from OMAHA east were left untouched. It is now known that the enemy had been forced to withdraw the threatening batteries at Morsalines, St.-Martin-de-Varreville, and Pointe du Hoe because of previous air bombardment.<sup>11</sup> As for the batteries actually attacked on D-day, they offered no evidence of guns destroyed—a result which had been predicted by air commanders earlier.\* Army reports of fire from German batteries falling on the beaches refer in general, however, to batteries sited well inland and not subjected to air attack immediately prior to the assault.

The cost of taking OMAHA made inevitable the keen disappointment of V Corps that the beach had not been softened by air action, and some of the resulting criticism was sharp.<sup>12</sup> But the prior agree-

\* See above, pp. 167-68, 170.



ment on the necessity for avoiding all risk of short bombing provides an obvious explanation, and it seems fair to insist that the air forces had realized their expectation of contributing heavily to the demoralization of enemy garrisons and to the destruction of their communications. The combined sea and air bombardment, which German prisoners rated as worse than anything they had experienced on the eastern front, appears to have produced both of these results. And if German morale was shattered by the sustained bombardment, to which air made its signal contribution, that of our own troops was heightened. Everywhere, save on the beaches themselves, there was evidence of air's interest in and protection of them. "The moral effect was perhaps of greater value than [the] material results."<sup>13</sup>

Since the war it has become the fashion to give the infantryman more of the credit he so richly deserves and at times to deprecate the air arm, perhaps in revulsion against earlier extravagant claims. But by whatever standards the Normandy landings be judged, the simple fact remains: their success with moderate losses was possible only because of the absolute air domination won by the AAF and RAF in the months before D-day.

The first American air attacks on D-day merely marked the beginning of tactical air action. Throughout that day both United States air forces were tactical, and both engaged in an all-out effort. After dropping warning leaflets for the benefit of the French population, 528 of the Eighth's heavies were dispatched against chokepoints in towns such as Thury Harcourt, St.-Lô, and Caen in the immediate vicinity of the assault area, but target-obscuring cloud, coupled with the lack of pathfinders, caused all save three groups to return their bombs to base. A third mission saw fifty-six B-24's drop on Caen, where the destruction caused by this and other attacks left only a single bridge over the Orne intact and thus delayed the attack of the German 21st Panzer Division upon the British just west of that river. The fourth and final mission of the Eighth again sought out transportation targets proximate to the assault area, ranging from Coutances in the west to Lisieux in the east, which over 550 aircraft bombed.<sup>14</sup> IX Bomber Command operated feverishly, far exceeding its best previous rate of performance, with many crews flying two missions.<sup>15</sup> Coastal batteries on both flanks of the invasion area and chokepoints in towns such as Falaise in the British and Valognes and Carentan in the American zone were hit by the mediums, while in pursuance of

the continuing attack on transportation targets they bombed four freight yards east of the Seine. In like fashion, VIII Fighter Command followed FULL HOUSE by STUD and ROYAL FLUSH—operations designed to interfere with enemy ground movements and to smash any action by the GAF. Moving transport was hit, and claims showed twenty-four enemy planes destroyed in the air and four on the ground.<sup>16</sup> Second TAF was similarly active in its area of responsibility.

With an equal accent on the strenuous life, IX Fighter Command began its long career of close support immediately after flying its planned missions on D-day. As air support parties began to function, ground commanders were quick to make their needs known; the combined control center at Uxbridge received thirteen requests for air support before the day was out. Unavailability of aircraft, weather, or the late hour caused five of these requests to be refused, but the remaining eight led to eleven missions. Gun emplacements in the Isigny, Carentan, and Maisy areas, from which fire was being directed against the beaches, were hit as were transportation targets. If a transport column, the requested target, was not found, a railway train was, and promptly strafed. One call for an artillery-adjustment mission was answered.<sup>17</sup> This first day's experience disclosed that the control mechanism centered at Uxbridge, however logically it may have been planned, was too involved in operation for speedy provision of air support. Accordingly, the plan was revised to the extent that air alert squadrons were placed at the disposal of the air representative on board the *Ancon*, headquarters ship anchored off OMAHA beach. On the basis of intercepted reports of air reconnaissance or the radioed requests of air support parties on shore, he was able speedily to lay on armed reconnaissance of areas and quick strikes against pinpointed targets by messages to "Hoover," "Skylark," "Whisky," or "Killjoy," leaders in the air overhead.<sup>18</sup>

The D-day effort of the U.S. air forces was unprecedented in its concentration and phenomenal in its size. Exclusive of contributing flights to determine weather, drop leaflets, or continue essential reconnaissance, 8,722 aircraft were dispatched by the Eighth and Ninth Air Forces. Losses for the day, which were concentrated in the VIII and IX Fighter Commands and included losses attributed to flak as well as to air combat, totaled seventy-one planes.<sup>19</sup> Claims for enemy aircraft destroyed (a modest total of thirty-three) gave still more striking em-

phasis to the slight opposition put up by the German Air Force, even in areas lying well back from the landing beaches.

A confused mass of German evidence discloses that the GAF on the western front was a negligible force, particularly in respect to fighters. Luftflotte 3 existed, with Jagdkorps II and Fliegerkorps II as its conspicuous tactical units. They early learned of the invasion for, despite the restrictions imposed on their warning system by Allied bombings, the activity of American planes seeking weather data and the assembling of American heavies in the London area were reported late on D minus 1. These reports were followed by information that the invasion was under way, which Fliegerkorps II received at its Compiègne headquarters by 0800 hours on 6 June. But Fliegerkorps II had no operational units. Planes from the reserve in Germany were on their way, but became badly scattered and reduced in number because of their pilots' incompetence. OKL (*Oberkommando der Luftwaffe*) had promised that ten wings would be provided for Luftflotte 3 to use against invasion targets when the landings came, but no reinforcements appeared until D plus 2 or later and the promised total was never furnished. German air commanders rated it essential to catch their enemy in the act of invasion, just as their ground commanders were convinced that the invaders must be defeated on the coast in the first twenty-four hours of the invasion period.<sup>20</sup> But German statistics, with characteristic lack of agreement, give Jagdkorps II on D-day as many as 121 and as few as 50 fighters operational. In either case the total is pitifully low. Furthermore, the efficiency of these fighters was greatly reduced because of the general necessity to use damaged or hastily constructed fields remote from the battle front, thanks to repeated Allied bombings of permanent airfield installations. Under such circumstances, German statements that only twelve fighter-bomber missions were mounted on D-day, with all save two forced to jettison their bombs and fight before arrival in the battle area, or that the GAF attempted only 250 sorties against the landings, become fully credible. Eventually reinforcements arrived. But many of the new and inexperienced pilots had difficulty in finding their bases on returning from missions, and even when successful, they arrived in "badly plucked condition." Combat losses continually attenuated the Luftwaffe's resources.<sup>21</sup>

There had been errors in the planning of German aircraft production, and the Luftwaffe had been forced to fight on the Russian and

Italian as well as on the western front, but the Allied strategic bombing offensives probably merit chief credit for the enfeebled condition of the GAF on D-day. A continuing and mounting effort had forced the Luftwaffe to concentrate in home territory and to fight costly battles against RAF Bomber Command by night and the heavies of the Eighth Air Force by day—the latter increasingly assisted by their “little brothers” of VIII Fighter Command and the Ninth Air Force in recent months. Systematic attacks on enemy airfields and communications had added to the attrition imposed on the GAF and completed the preparation for invasion, with the result that there were no great air battles to be fought on D-day. Instead, the Allies displayed an overwhelming and universally acknowledged air superiority in evidence of battles already fought and won. “Where is the Luftwaffe?” as General Arnold with pardonable pride later declared,<sup>22</sup> would be a question constantly on the lips of the Wehrmacht from D-day onward.

### *Close Support on the Beachheads*

As the Battle of the Beachhead continued to rage from 6 June to 24 July, American air commanders were mindful of the third-priority mission assigned to tactical air forces by FM 100-20: “To participate in a combined effort of the air and ground forces, in the battle area, to gain objectives on the immediate front of the ground forces.” The need for such participation was particularly great in the OMAHA area. By the end of D-day the stiffest sort of fighting had carried penetrations at most a mile and a half inland. Schedules for the landing of supplies and supporting weapons were in arrears, juncture with other beachheads had not been effected, and the situation seemed precarious. It was essential that the beach be placed beyond enemy artillery range, that room be won for maneuver, and that the Allied beachheads be linked up.<sup>23</sup>

Late on D-day, Maj. Gen. Leonard T. Gerow, commanding V Corps, requested “continuous fighter bomber support to search out and attack enemy artillery firing on beaches,”<sup>24</sup> and Quesada telephoned from the Normandy shore further to inform the Ninth and his own group commanders of the nature and significance of the mission. Since the front was fluid and knowledge of the enemy’s exact location was limited, no effort could be made to apply air power directly to the front lines with pinpointed targets assigned. Instead, with the

bomb line fixed on the Aure River, which parallels the coast between Isigny and Bayeux at a distance of from two to five miles inland, IX TAC was directed to provide planes to conduct continuous armed reconnaissance of the area Aure River–Bayeux–Airel in squadron strength from 0600 until 2230 hours on 7 June. The ensuing action involved 467 fighter-bomber sorties in the course of 35 missions flown by the 365th, 366th, and 368th Groups, most of whose squadrons flew four missions in the course of a long and hectic day. The cost was thirteen aircraft, with two pilots saved. Individual squadrons were in the air from two to three hours, but the distance separating their English bases from the battle area restricted the actual time over target of approximately half of the squadrons to less than an hour. In only two reported cases did the headquarter's ship direct attacks on specific targets; the balance were upon those selected by squadron leaders. For the most part the targets were armor and trucks on roads and troop concentrations in Cerisy and Balleroy forests, but five batteries, which this day constituted priority targets, were spotted and attacked.<sup>25</sup>

On this as on other days until 12 June, when OMAHA beachhead had been driven inland fifteen to twenty miles and linked with those to east and west, Army requests were few, for the front remained fluid and communications were difficult. Weather blocked some air operations on 8 June and eliminated them on the 9th. But whenever possible air continued its close support.<sup>26</sup> Thirteen minutes after the forward controller directed a squadron overhead to attack a battery holding up the Rangers on 7 June, the target was reported hit. Under the same control, crossroads near Port-en-Bessin were bombed on 8 June; that very day contact was made between American and British ground forces in that area.<sup>27</sup> Armed reconnaissance by fighter-bombers continued to blast enemy positions and movement by road and rail with such effect that a German soldier was warranted in writing home that "the American fliers are chasing us like hares," while the commander of Panzer Lehr Division later described the road from Vire to Bény Bocage as a "Jabo Rennstrecke" (a fighter-bomber racecourse).<sup>28</sup>

While the situation on the OMAHA beachhead was still serious IX Bomber Command struck at bridges and road chokepoints in towns proximate to the front lines, such as Caen, Isigny, and Aunay sur Odon. General Montgomery commended the 8 June attack on Caen bridges, but though bombings filled the streets of towns with rubble

the effect upon the enemy was small, since detours were easily established.<sup>29</sup> In the Folligny freight yards, however, the full weight of the mediums' attack of 7 June fell on two troop trains filled with young and inexperienced troops. Their loss of approximately 500 killed and more than that number of wounded was enough to have shattered their morale.<sup>30</sup>

At the end of D-day the UTAH beachhead was reasonably secure, although all objectives had not been reached. The VII Corps advance south to capture the key town of Carentan and make a firm junction with V Corps was successfully completed by 12 June. A simultaneous push to the north secured high command on Quineville ridge by the 14th, while four days later a drive westward had carried across the peninsula to the coast at Barneville.<sup>31</sup> Except when weather interfered, the air forces gave consistent support.<sup>32</sup> Fighter-bombers silenced a troublesome battery at Maisy on D plus 1, and between that date and 17 June attacked fifteen gun positions in the northern Cotentin. Evidence of their effect is, as always in such cases, difficult to obtain, but the Army rated those at Quineville and Crisbecq successful.<sup>33</sup> Early attacks on near-by bridges and constant surveillance of roads leading into Carentan helped to force the German commander to call for air supply which came too late to save the town.<sup>34</sup> Air likewise assisted in the taking of Montebourg station, Pont-l'Abbé, and Quineville.<sup>35</sup> Fleeting targets were frequently hit and heavy casualties inflicted, even though later investigations showed the pilots' claims to be excessive.<sup>36</sup> Moreover, at the very moment when the German Seventh Army was broadcasting Hitler's order that "the Fortress of Cherbourg must be held at all costs," the commander of the German 77th Division was killed by roving fighter-bombers as he struggled to direct the escape of his troops to the south.<sup>37</sup> Mediums of IX Bomber Command were directed to support ground action by attacks on Cotentin road centers, where results were devastating but tactically so unimportant that their "deeper significance" remained a puzzle to the enemy. Defense installations were also accurately struck, but later surveys disclosed that not even 2,000-pound GP bombs materially damaged their heavy cement structures.<sup>38</sup>

In pursuance of orders received on 13 June, V Corps limited its offensive action to aggressive patrolling after the fall of Carentan. But the offensive of VII Corps was sustained, and on 19 June, Maj. Gen. J. Lawton Collins opened the drive on Cherbourg, whose value as a port

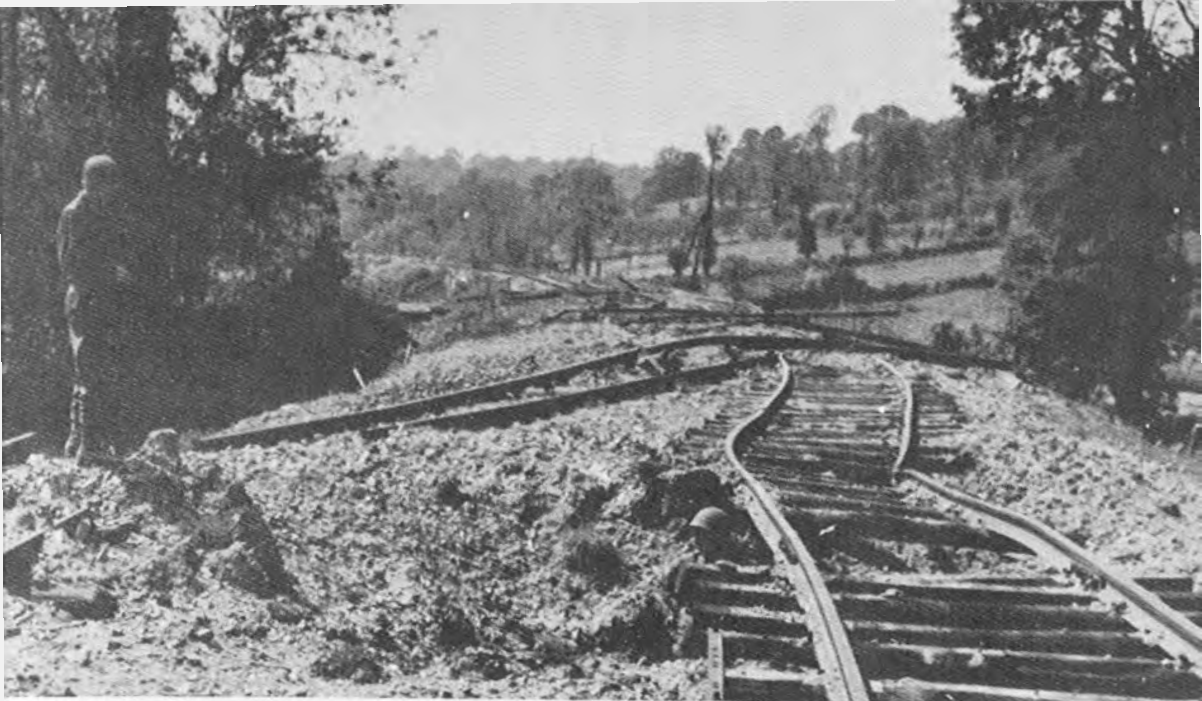

**ISOLATING THE BATTLEFIELD**

*Above:* NORMANDY RAIL CUTS

*Below:* LOIRE BRIDGE AT SAUMUR

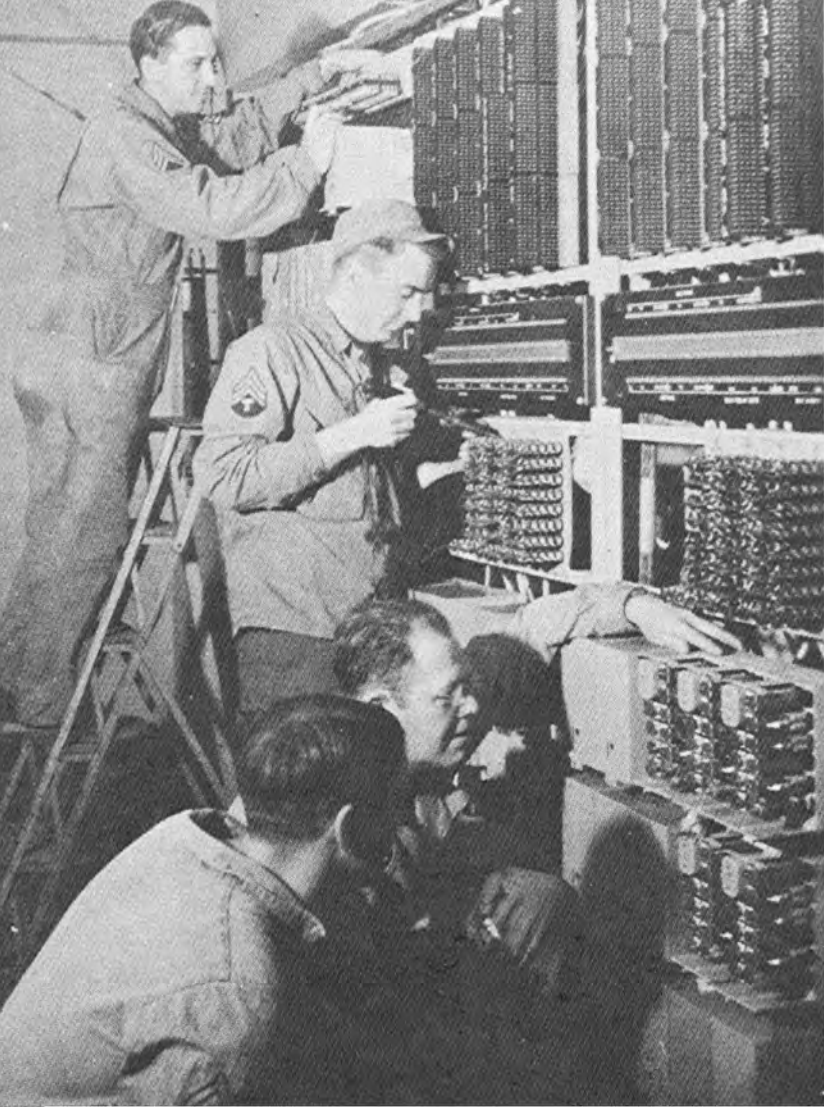

*Left:* HEADQUARTERS INSTALLATIONS

**NINTH AIR FORCE COMMUNICATIONS**



*Right:* TANK TO FIGHTER-BOMBER



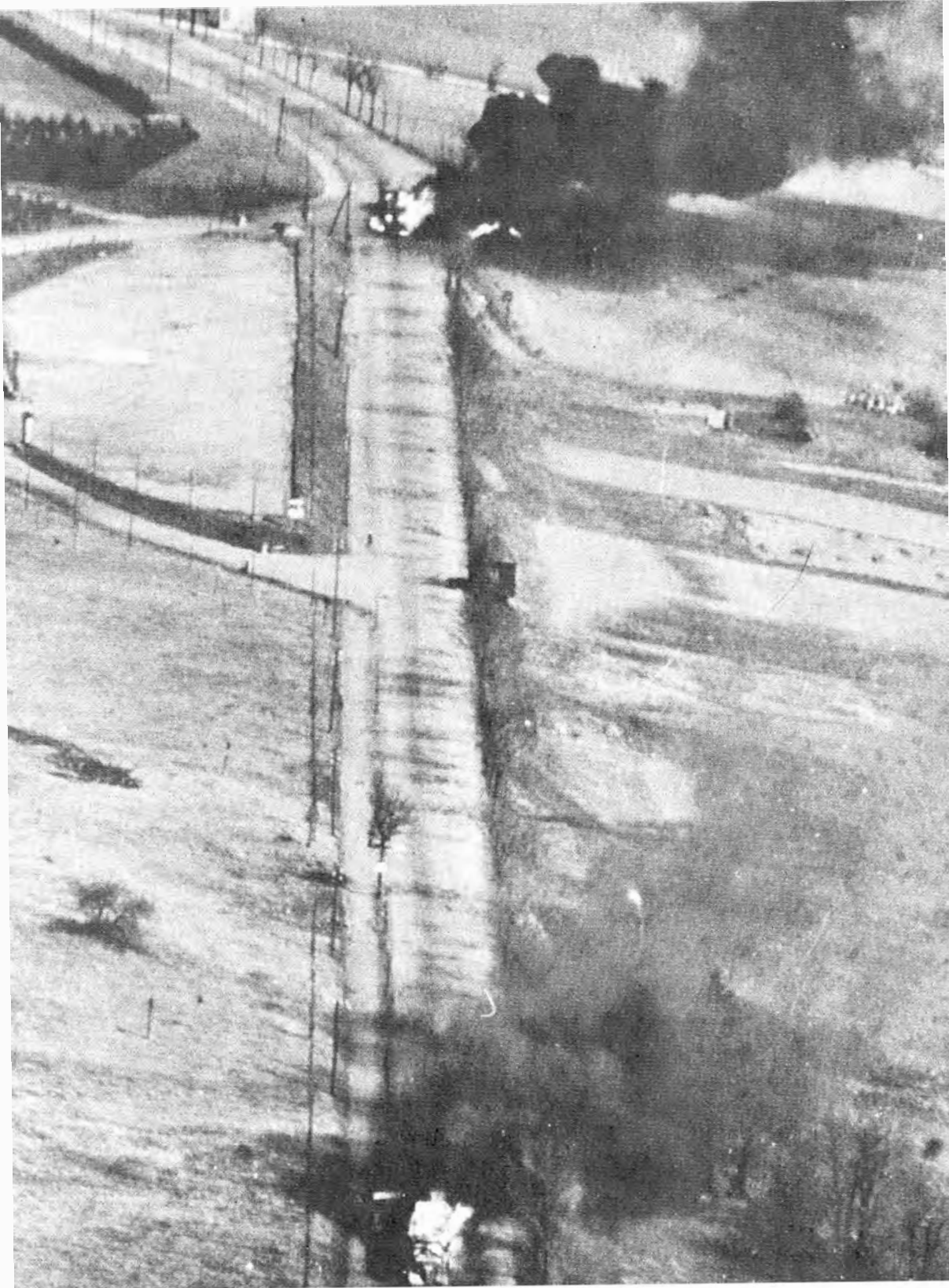

STRAFING MOTOR TRANSPORT IN FRANCE

VON RUNDSTEDT'S HEADQUARTERS AFTER A VISIT BY XIX TAC



of debarkation was heightened by the Channel storm which broke in full fury that same day. Progress toward the German defense perimeter, anchored on high ground well provided with permanent and field fortifications, was rapid; by the evening of 21 June it had been reached throughout its length and crossed at points on the east. The first phase of the attack was over. The second and final phase was scheduled to begin on the 22d.<sup>39</sup>

### *The Drive to Cherbourg*

It was in connection with preparations for the final assault on Cherbourg that Army made its first call for a major air support project since D-day. Such an action had been foreshadowed on the 17th, when Bradley, commanding the U.S. First Army, in conference with Brereton indicated his desire for a special application of air in the forthcoming drive. His expressed thoughts were confined to the suggestion of some signal demonstration by air, to be followed, for morale effect, by leaflet-dropping. Tentative arrangements were formulated on the continent in conference among Bradley, Collins, and Quesada, while in England A-2's and A-3's searched the files for information on enemy positions around Cherbourg and Brereton, anxious to conserve his fighter-bombers for the impending operations, fought off requests for their use as escorts. When American air and ground commanders met on the continent on the 21st, the possibility of naval cooperation was ruled out, Spaatz's offer of his heavies was refused on the ground that there was no "crust" to break through, and tentative arrangements for air support were reconsidered in the light of Collins' request for "air pulverization" of an area of some twenty miles. The purpose would be not so much the direct preparation for ground advance as demoralization of the enemy and disruption of his communications.<sup>40</sup>

Brereton returned to Uxbridge at approximately 1400 hours on 21 June. Time was of the essence, and conferences immediately followed with AEAFF, Second TAF, and Ninth Air Force Advanced Headquarters, all of which were involved in the projected operation. A relatively simple scheme based on area saturation was adopted, despite grave misgivings as to the capabilities of fighter-bombers in such an operation. As fast as decisions became fixed, air units were informed in order that they might promptly begin detailed planning, and details relevant to ground action were forwarded to the continent with equal expedition as planning progressed. Between 0200 and 0300 on 22 June

the over-all plan was completed, and at dawn it was flown to the continent by Brig. Gens. Richard E. Nugent and David M. Schlatter, who explained it to the ground commanders concerned. It should be emphasized, because the procedure stands in marked contrast to that followed in later air support planning, that no Army representative was present at Hillingdon House as the plans were firmed.<sup>41</sup>

H-hour had been fixed as 1400 of that same day, and beginning at H minus 80 minutes the air attack went as scheduled under clearing skies. Second TAF led the way after artillery had engaged in counter-battery fire on enemy flak and had endeavored to mark the south and west boundaries of the target area with white smoke. Four squadrons of rocket-firing Typhoons and six of strafing Mustangs delivered their area attack flying from west to east. Twelve groups of the Ninth's fighter-bombers followed in their wake, bombing and strafing and striving to give special attention to six pinpointed localities. Between 1240 and 1355 hours wave after wave of fighter-bombers made their attacks, often disappearing into the dust and smoke of battle as they dived to levels as low as 200 feet. Time schedules were rigidly observed both by Second TAF's squadrons and by the Ninth's groups. Some fourteen British and twenty-four American planes were lost. Immediately after H-hour all eleven groups of IX Bomber Command swept in to attack as many defended localities. A single bomber was lost. Altogether 557 fighter-bombers and 396 mediums of the Ninth Air Force and 118 aircraft of Second TAF participated in the operation. Such enemy planes as were sighted refused encounter.<sup>42</sup>

The immediate tactical results of the operation were disappointing. Only a small fraction of the area attacked by air had been overrun by 0600 on the 23d, but this included high ground near Chèvres which had been marked for attack by both fighter-bombers and mediums. Although ground formations had been ordered to withdraw until a distance of 1,200 feet separated them from the bomb line, some units were hit by friendly planes. Complaints were lively, but fortunately casualties were slight, and even these may have been in part attributable to the German trick of firing smoke shells over American positions to confuse the attacking pilots as to the bomb line's location. It was evident, furthermore, that ground did not always coordinate its attack properly with that from the air, too great a time lag being permitted between the cessation of the air assault and the infantry's advance. In one case, where later appraisal of the mediums' bombing was

effected, the attack of the 410th Bombardment Group completely demolished an enemy position containing, among other guns, four dual-purpose 88's. But this position was distant from the front lines, and the successful bombing could not immediately affect the situation there.

Pilots' claims of neutralization of gun and machine-gun positions had justification, but the major result of air action on 22 June was to disrupt enemy morale. Some German officers lost control over their men during the attacks. If gun emplacements were not themselves destroyed, their apertures were in instances blocked and their garrisons often dazed. At the time American division commanders, and the corps commander himself, commended the operation if only because of the demoralization produced in enemy ranks. A later, and fully considered, judgment by VII Corps on the operation of 22 June states that the over-all effect on enemy morale and the destruction of his communications were worth while. The U.S. First Army (FUSA) agreed, but its report properly observed that many points of resistance were left in operation.<sup>43</sup>

In spite of disappointment on the 22d, the operation against Cherbourg progressed with reasonable speed. The last stronghold in the city fell into American hands on 27 June, and the remaining sparks of resistance on the northern part of the peninsula were extinguished by 1 July. Missions related to these concluding operations were few in number. But it was becoming increasingly evident that mediums and fighter-bombers could do effective work against specified targets, even if the bombs released on Fort du Roule by mediums left its massive bulk unharmed, and if others delivered by dive bombers within fifty or seventy feet of a German gun might fail to inflict damage. The obstinate defenses at La Mare à Canards—target for both mediums and fighter-bombers on 22 June and for two subsequent dive bombings—were reduced on the 24th when units of the 368th Fighter-Bomber Group scored eighteen direct hits in the target area and thereby helped a final attack to go through in an hour's time. On the same day Army reported phenomenal bombing—twenty-three of twenty-four bombs in the bull's eye—in a P-47 attack near La Glacerie, and credited fighter-bombers with assists at other points. The concussion produced by dive bombing of a fort on the Cherbourg breakwater was the immediate cause for its surrender on 29 June.<sup>44</sup>

Attacks on batteries west of the port succeeded less well, since fire

from them impeded ground's advance until the very end, but batteries at Laye and Auderville were hard hit by mediums, while dive bombing speeded the occupation of Beaumont Hague.<sup>45</sup> The later verdict of the 9th Infantry Division on these final air actions of the campaign is pertinent. "The results of Mediums and Dive Bombers varied from unsuccessful through very satisfactory to excellent. . . . The effects and results were a lowering of enemy morale, and increase in the morale of our own troops, and partial to complete destruction of enemy positions. Overall results—greater ease and less loss of life in taking positions."<sup>46</sup>

The development during June of more flexible controls for supporting operations promised much for the future. Air support operations initially had been directed by Ninth Air Force Adv. Hq. at Uxbridge, subject only to such modifications as might be effected by the controller on board the *Ancon*,\* but on 10 June the 70th Fighter-Bomber Wing, based on the continent, took over the control functions hitherto performed on shipboard and beginning with 18 June IX TAC Adv. Hq., also on the far shore, assumed the major responsibility for the direction of air support. The latter headquarters filtered ground requests for assistance, ordered missions as it saw fit, and transmitted to Uxbridge only such requests as it could not meet with its own resources. This development was possible because of yeoman work on the part of Ninth Air Force signal units. A TAC headquarters required approximately as much in the way of signal installations for its strictly tactical purposes as did an Army headquarters for purposes both tactical and administrative. Members of IX TAC's signal section had landed on OMAHA beach at the close of D-day, and within twenty-four hours of a delayed and inauspicious start the first cross-Channel contact had been made by 70th Fighter-Bomber Wing. More normal facilities were available a day later, and on 9 June a radio-phone channel afforded service from the far shore to IX TAC's Rear Hq. at Middle Wallop and to Ninth Air Force Adv. Hq. at Uxbridge. By the 10th, IX TAC Adv. Hq. at Au Gay had been provided with most of the essential communications equipment, including switchboards and cipher devices, and on the following day the signal section of IX TAC proudly published its first continental telephone directory, which included the numbers of installations in FUSA Hq. with which links had already been established.<sup>47</sup>

\* See above, pp. 139-40.

Other features of the setup at IX TAC Advanced offered further assistance to the close coordination of air and ground activities. Bradley's headquarters was only a hedgerow removed from that of Quesada, who took active command of IX TAC at Au Gay, and in such an environment the welding together of ground and air for the achievement of a common purpose was advanced by the intimate association of the respective commanders and by the closest sort of co-operation between their intelligence sections. Army's G-2 and G-3 were often to be found in IX TAC's operations tent. Mutual understanding and confidence ripened, and a steadily improving efficiency in operations was traced by the supreme commander to its source at Au Gay.<sup>48</sup>

Similarly, Air Marshal Coningham and General Brereton, who had been associated in the desert war,\* developed an even closer relationship as one, detached from Second TAF, commanded AEAFF Advanced at Uxbridge and the other directed the Ninth from its advanced headquarters in the same building. A comparable nexus brought together Quesada and Air Vice Marshal Harry Broadhurst, of RAF's No. 83 Group. If for any reason the forces of one were not available in sufficient number when a call for action came, the other stood ready to furnish aid. They shared targets and exchanged intelligence information and operations orders for the sake of the better briefing of both British and American units. Direct communication between them was the rule, and occasionally the tactical units of one were under the operational control of the other.<sup>49</sup>

The provision of continental airfields was another outstanding development of the month. During the first days of the invasion the necessity of cross-Channel flights from British fields had prevented the full application of air's power, as was conspicuously true in connection with the fighter-bomber missions of 7 June.† But the speedy work of IX Engineer Command in preparing continental strips quickly overcame this disadvantage and thus made possible more prompt dissemination of information and orders and a greater number of daily sorties. Not only might a five-minute flight now carry a plane from field to target but aircraft could operate from continental bases at times when weather had "socked in" the airfields of southern England. Allied

\* See Vol. II, 17, 27-28, 34-35.

† See above, p. 194, and for a more complete account of the activities of IX Engineer Command, see below, Chap. 16.

commanders had desired and enemy commanders feared this development with equal reason.<sup>50</sup>

Aviation engineers had swarmed ashore with the assault waves on UTAH beach and, despite the distractions of combat, had hewed out an emergency landing field on D-day. Construction of more extensive installations began almost immediately. The engineers had occasion to lament the fact that "the phase line stubbornly refused to operate according to plan" and provide them with the real estate requisite for their planned construction,<sup>51</sup> but they were not daunted by this fact nor by the requirement to construct runways longer than had been planned in order to permit all fighter-bombers to take off with full bomb loads. It was frequently necessary to work under fire, as at Cretteville, where the engineers left a hedgerow standing at the southern extremity of the field to screen their bulldozers. Beginning on 19 June fighter-bomber groups became operational on Normandy airfields, and even before that time construction of a few runways was sufficiently advanced to permit their use for roulement, a plan of operation under which the planes took off from a base in England, completed a first mission, and then flew one or more missions from a continental field before returning home. By no means incidentally, a transport field had been put in commission back of OMAHA beach by 8 June.\* Though not planned, the field saw active service in the provision of high-priority supplies by airlift and in the air evacuation of wounded. The aviation engineers themselves profited, receiving critical spare parts by 20 June and on the 27th an air shipment of the first of 5,000 rolls of Hessian mat for runway surfacing.<sup>52</sup>

### *The Push South*

Only two days after the occupation of the Cherbourg peninsula had been completed on 1 July, FUSA began an offensive push to the south. Its objectives were limited to winning elbow room and favorable ground from which to launch the contemplated breakout. VII and VIII Corps on the western flank pressed south into the La Haye-du-Puits area and beyond toward Périers and Lessay, while farther to the east XIX Corps drove southward to the high ground about St.-Lô. The well-emplaced enemy offered stout resistance, making notable use of artillery. Stream and contour lines on maps showed that the terrain was difficult, and on the ground these natural difficulties were infinite-

\* See below, p. 563.



ly heightened by stout hedgerows which obstructed both movement and observation. In the early days of the attack Eisenhower, anxious to clarify his view of the battlefield, flew along the lines with Quesada as pilot and with a fighter-bomber escort.<sup>53</sup>

The operations begun on 3 July continued at a steady tempo until the 20th. Strongpoints, variously described as gun or machine-gun positions or dug-in tanks, figured most prominently among the targets which FUSA requested IX TAC to eliminate. Reputed enemy headquarters and observation posts (OP's), moving columns and troop concentrations, together with dumps and bridges, also appeared in the lists submitted to the daily air-ground conference at Au Gay. The reports of many of the missions flown in response to such requests, and of roving armed reconnaissance as well, are of such a nature that no very definite conclusions can be drawn from them. At the time air felt the need for a better evaluation of targets and for more exact indication of their location,<sup>54</sup> and, whatever the cause, it is clear that many missions failed to accomplish their intended purpose. In other cases, however, the evidence is precise and demonstrates that on critical occasions air support was exceedingly effective.

In the western area, German sources report that air spoiled a counterattack by elements of 2d SS Panzer Division on 6 July, and that on the same day the 367th and 474th Fighter-Bomber Groups so punished and benumbed a strongpoint's garrison that it could not put up an effective defense against the American infantry.<sup>55</sup> Support given VII Corps on the 8th drew favorable comment from Collins, even though an attack had been delivered at a point on the fluid front where no bomb line had been established.<sup>56</sup> Contemporary enemy comment on actions of this sort is valuable alike for its reflection of existing dependency and its indication of the major causes therefor. The war diary of the German Seventh Army records the situation on the front of LXXXIV Corps as particularly critical, "for enemy artillery and continual air attacks against our troops are causing heavy losses in men and material, and sooner or later the time will come when the steady decrease in manpower will make our positions untenable. So far our own fighter planes and antiaircraft artillery have not been able to ease the pressure."<sup>57</sup> Attacks on German headquarters and OP's in this western area appear to have been singularly effective. Especially helpful was the destruction of two church steeples on high ground north-east of Périers, for in hedgerow fighting a good OP was invaluable.

In the XIX Corps area north of St.-Lô, as in that of VII and VIII Corps, adverse weather repeatedly hampered ground operations and exercised an even more limiting effect upon those by air. The weather canceled out all strikes planned for 11 June, and when one urgent request mission was flown against a target duly marked with red smoke, the results involved such danger to friendly troops that no further requests were made for the time being.<sup>58</sup> An attempted mission by two groups of IX Bomber Command against St.-Lô positions on the 16th resulted in only two aircraft attacking, but the mission was rescheduled and delivered with some effect on the following day. Weather was occasionally so bad that German troops were moved in daylight with impunity. But these meteorological conditions had been anticipated. A study of weather conditions over a space of years had disclosed that a maximum of thirteen operational days per month was to be expected in the Calais area and only eight in the region of Le Havre.<sup>59</sup> Moreover, Allied planes repeatedly demonstrated a knack for operating in bad weather, of which capacity they gave an especially effective display on the occasion of the strong counterattack launched by Pz. Lehr on 11 June—a day that had opened with the cancellation of all missions because of weather.

A rude attack by fighter-bombers already had interrupted a staff conference gathered to plan this enemy thrust, and orders for daylight movement of the necessary forces had led to the destruction from the air of a number of self-propelled guns and trucks—particularly the tank trucks for which Allied fighter-bombers had a special affinity. In the attack itself, where American artillery and tank destroyers played a most notable role, the German commander, who previously had observed with amazement that American aircraft operated in unfavorable weather, was given convincing proof of their skill during three consecutive missions flown into the threatened area—that by the 366th Fighter-Bomber Group being laid on under a 1,000-foot ceiling. Claims for twenty-two tanks destroyed were fully substantiated by Army reports at the time and by later survey. The enemy's counterattack was stopped in the vicinity of Pont Hébert and Le Desert after an entire panzer battalion had been engulfed, and Army was left in a mood to forgive the Allied strafing of a knot of its own tanks isolated in advance of the front lines.<sup>60</sup>

On 15 June, with the infantry slugging its way along the Martinville Ridge in a final stage of the drive, air sent several helpful strikes,

and on the following day, when signs of another German counter-attack were observed at about 2000 hours, the Army requested air's support. Isolated American infantrymen marked their lines with panels or their own undershirts, and the 404th Fighter-Bomber Group, briefed in air by the air support party (ASP), delivered a close-in attack at 2105 hours with marked effect. Maj. Gen. Charles H. Corlett, commanding XIX Corps, expressing his appreciation for air strikes delivered on time and on target, added a significant word: "The presence of our aircraft over the front line troops has an immeasurable effect upon their morale. When our aircraft are over the front line the use of close in artillery and mortars by the enemy stops."<sup>61</sup>

On 16 and 17 June, and on request, fighter-bombers of the Ninth attacked bridges over the Vire in places proximate to the battle line. The result threatened to cut off the German 352d Infantry Division and blocked the movement of heavy weapons. Previous to these attacks needed reinforcements for Panzer Lehr, lax in their march discipline during a daylight movement, had suffered heavy casualties and were badly shaken by a swift bombing and strafing attack.<sup>62</sup> Relentless pressure by ground and valuable strikes by air had secured St.-Lô and brought the Americans to positions just north of the lateral highway Lessay-Périers-St.-Lô as the attacks were slackened in the period 14-20 July to allow for the mounting of the coming breakout.

#### *American Support of British Drives on the Caen Front*

Air power is inherently flexible and, under centralized command, capable of great concentration. "From one base it can strike out at a wide variety of targets over a wide area; conversely, from widely separated bases it can strike at a single target. . . ."<sup>63</sup> Operations in the Caen area in July 1944 on the part of the air forces under Eisenhower's command afforded striking examples of both of these capabilities. The British and Canadian armies had been held on the city's outskirts by a heavy concentration of German armor, backed by ample antitank artillery and other defenses of such strength that Arnold was led to express the hope that Caen would not prove to be another Cassino.<sup>64</sup> In preparation for a major attempt on 8 July to break through the enemy's obstinate defenses, both RAF Bomber Command and IX Bomber Command struck at concentrations south of the city, while some of the Ninth's mediums blasted Caen bridges and Second TAF operated continuously in the area.<sup>65</sup> In immediate

preparation for the 8 July attack air was called in at Montgomery's request and with Eisenhower's approval, even as the big guns of the fleet were brought into play. The absence of the GAF had for some time permitted RAF's heavies to operate in daylight, and now toward dusk they laid down a bomb carpet on Caen beginning at 2150 hours on 7 July. Early on the 8th, five groups from IX Bomber Command were dispatched to add their weight to the attack, but only two groups and parts of two others were able to bomb, and the ground attack jumped off at 0420 hours with the disadvantage of a time lag separating the assault from the major part of its air preparation. The strength of the enemy's resistance and heavy cratering produced by air and naval bombardment prevented the full exploitation of the preparatory attacks, but the greater part of Caen soon fell into British and Canadian hands. Such were the results of Operation CHARNWOOD.<sup>66</sup>

Operation GOODWOOD of 18 July had as its purpose a breakout from Caen, to be followed by a push toward Falaise, and like its predecessor, it had its "air prelude." RAF Bomber Command began with a bombing attack by nearly 1,000 heavies at first light on the 18th; the Eighth Air Force followed with 571 of its heavies attacking three areas; and IX Bomber Command sent all 11 of its medium groups against five gun positions. The RAF reported that its bombing was well concentrated and the Eighth recorded that a moderate percentage of its missiles fell in the assigned target areas, but the Ninth's bombers found their targets obscured by the smoke and dust of previous bombardments and their reporting was correspondingly hazy. By arrangement between the commanders of Second TAF and IX TAC the latter "kept the ring" throughout this action, leaving the former free to develop its full energies in the battle area.<sup>67</sup>

Ground forces moved over the 3,000 yards separating them from the nearest bomber target immediately the mediums' attack was completed. Initial gains, which carried straight through the battered enemy crust, were most gratifying. Most of the prisoners taken in the forward positions remained stone-deaf for a period of twenty-four hours in consequence of air's bombardment. But beyond the crust Allied armor ran into a heavy antitank screen, which intelligence had not reported, and as infantry took over, the enemy recovered his capacity for resistance. Gains were made up to seven miles, but GOODWOOD's declared objectives had not been reached when the offen-

sive mired down in the heavy rains which began on 20 July.<sup>68</sup> Both ground and air commanders were concerned that no more substantial result should have been produced by the heaviest single bomber effort of the Normandy campaign, for a total of 7,700 tons had been dropped by the more than 1,600 heavies and 350 mediums committed.<sup>69</sup>

Allied leaders might have been in some measure consoled had they known of the German reaction. On 21 July Field Marshal Günther von Kluge, who had succeeded von Rundstedt on 3 July, wrote directly to the Fuehrer. The marked optimism, so evident upon his sudden arrival to take command in the West two weeks before, had faded. To the Fuehrer he reported: "My conference with the commanders of the units at Caen, held just after the last heavy battle, forced me to the conclusion . . . that there is no way in which we could do battle with the all powerful enemy air forces . . . without being forced to surrender territory. Whole armored units . . . were attacked by terrific numbers of aircraft dropping carpets of bombs, so that they emerged from the churned up earth with the greatest difficulty, sometimes only with the aid of tractors. . . . The psychological effect on the fighting forces, especially the infantry, . . . bombs raining down on them with all the force of elemental nature, is a factor which must be given serious consideration." His letter cannot possibly have quieted the shaken nerves of Hitler, who on 20 July had himself so narrowly escaped the blasting effect of another type of bombing effort, and von Kluge's parting words to the staff conference at Caen could hardly have proved heartening. "We must hold our ground," he said, "and if nothing happens to improve conditions, we must die an honorable death on the battlefield."<sup>70</sup>

### *The Interdiction Program*

If questions had been raised regarding the effectiveness of some parts of the immediate tactical support rendered to the ground forces, there was little room for doubt as to the success with which the air forces met their responsibility, prescribed in FM 100-20, "to prevent the movements of hostile troops and supplies into the theater of operations or within the theater." Indeed, there is good reason for believing that the Allied air forces made their most important contribution to victory in the Battle of Normandy through the performance of their

function of isolating the battlefield or, to use the term more popular at the time, through interdiction of the lines of communication upon which the enemy depended.

Widespread attacks on the German transportation system, begun in March, had been with a view to reducing its over-all resources and crippling its vital functions. In April and May other attacks were delivered against targets so specific and so related that they constituted a clear-cut interdiction line.\* The targets were bridges. The intent of the attacks upon them was to isolate the chosen Normandy battlefield, hence bridges over the Seine were of special moment. But in the period prior to D-day assaults were directed against others east of that river as well, in order to disguise Allied intentions, and for the same reason the bridges over the Loire were not touched. As mention of a general attack on rail transportation facilities and the selection of special targets on a river line suggest, interdiction was a word which came to be used in both a broad and a narrow sense. Narrowly interpreted it involved the establishment of a definite line of destruction to isolate the battlefield by smashing bridges, viaducts, and other critical points on the battlefield's periphery. Rail bridges over the Seine from the environs of Paris to Rouen, rail bridges and viaducts in the Paris-Orléans gap from Mantes on the Seine to Orléans on the Loire, and Loire bridges from Orléans to Nantes were the clearly specified targets here.<sup>71</sup> The broader use of the term embraced these points and added a wide variety of targets which were attacked by the Allied air forces with identical purpose. Freight yards within and without the interdiction line figured as prominently in planned attacks after D-day as before. Attacks on rolling stock, especially on locomotives, in those yards and on the lines radiating out from them received like accent in both periods. Rail-cutting was given heavy emphasis after the assault—cuts within the line of interdiction being designed to prevent movement within the theater of operations, those beyond it to prevent movement into it. Supplementing these attacks on rail transportation were those on all forms of traffic on the highways of the battle area. All parts of the program were closely interwoven. Its over-all effects were both widespread and pervasive, for the actions producing them were long sustained and on a grand scale. Begun before D-day, they continued in mounting crescendo through June and July and into the early days of August 1944.

\* See above, pp. 149-62, and especially pp. 156-62.

The American planes most frequently employed in executing the interdiction program functioned under the immediate direction of Ninth Air Force Adv. Hq. at Uxbridge, which retained control over interdiction when IX TAC Adv. Hq. took over the primary responsibility for tactical air support. The planning and scheduling of operations presented a complex problem. Targets differed in character, they must be sought over a wide area, and attacks on them must be successful. The program, like that of air support, was given the highest priority. To be effective it must be sustained. If bridges essential to the enemy were destroyed, he was certain to attempt their repair. The repairs must not be allowed to proceed to a point where interdiction would be rendered ineffective, and hence repeat missions were in order. Attacks on rails must be regarded in the light of similar logic, and since their repair could be speedily effected, repeat operations were always required. Attacks on freight yards and rolling stock were of more significance for their cumulative than for their individual effects. And always it was necessary to bear in mind that a great rail complex, with many alternative routes, was available for enemy use. Establishment of interdiction was a "must"; the complete maintenance of interdiction was equally mandatory. Constant vigilance was required on the part of the planners not only to bring down bridges but to keep them down, if rail cuts were to be maintained at a level which would stop traffic. It was also essential to spot any marked enemy movement, particularly on lines alternative to those which had been put out of action. The task of the planners of interdiction, and of other operations as well, was in some measure simplified by the early establishment of a tactical area whose outer boundaries lay well behind the enemy lines. The region within its limits constituted the special preserve of Second TAF and the Ninth Air Force, and operations beyond its boundaries became the special, though not exclusive, task of VIII Fighter Command and the heavy bombers of the Eighth and RAF Bomber Command.<sup>72</sup>

The success of a continuing program of interdiction depended heavily upon the provision of accurate information as to the existing status of targets on the lists. Strike photographs recorded the bomb-falls of heavies and mediums, although they did not always permit a correct estimate of the damage done. Fighter-bombers, so frequently employed in interdiction, provided no such photographic evidence but merely the reports by the pilots of attacking planes or by those

waiting their turn to dive. Continuous photographic reconnaissance of a multitude of targets over a wide area was therefore at a premium. But at times in June, and more markedly in July, adverse weather denied activity to photographic reconnaissance (PR) units. For example, no PR was available on the Grande Ceinture rail nexus about Paris from 15 to 19 June,<sup>73</sup> and in the absence of clear evidence as to the status of interdiction objectives, the staff was often forced to reassign targets for attack simply because the estimated time needed to effect their repair had passed. Admittedly, such a policy might involve a waste of effort, as later evidence was to suggest, but during the Battle of Normandy the stakes involved in the interdiction game were high. In spite of possible waste commanders were forced to act on the principle, "when in doubt, take the trick."

Fortunately, great resources were at their disposal. The heavies of the RAF and of the Eighth Air Force were on call, and their escorts, whether from Second TAF, VIII Fighter Command, or the Ninth Air Force, at times were able to double as attack planes. Increasingly, as the heavies began to resume strategic operations in mid-June, the mediums of IX Bomber Command were employed. Throughout the period the fighter-bombers of both the Eighth and the Ninth were omnipresent, attacking vigorously within and without the interdiction line. Only a part of IX Fighter Command's resources had been committed to IX TAC, and the July activities of the latter afford some index to the intensity of the interdiction effort. In 24 flying days this one command flew over 150 interdiction missions, normally in group strength. The daily average was 6.3 missions, and the command celebrated the 4th of July with a record of 20. IX TAC's groups on occasion added their contribution to the destruction of road targets, and VIII Fighter Command concentrated on rails with incidental attention to the highways. Pilots were often assigned specific targets but frequent armed "recces" served the purposes of interdiction equally well. Within an area assigned for offensive patrol, the pilots were free to choose targets on the basis of their own observations. No useful distinction can be drawn between a specific mission assigned to "Rail cutting La Hutte-Colombières-Le Mans" and one assigned to "Armed recce Alençon, Chartres, Cloyes, Le Mans." In both cases leaders of the mission determined the targets to be bombed and strafed; in each case those chosen were certain to include bridges, rails, rolling stock, and road transport singly or, more usually, in combination.



There were two limitations to the use of available resources for interdiction purposes: in general the Ninth's commitments to air support and other missions prevented the use of its entire power; and, for a time, the distance at which Loire bridge targets lay from the mediums' English bases militated against their employment. Not until 7 July were the mediums brought into play against these more distant targets and then only because it was considered essential to block the entry of German reinforcements into the battle area from the south.<sup>74</sup> When so employed many planes were forced to refuel on continental fields or accept the risk of flying directly back to their bases on the minimum supply which remained in their tanks.

A plan so far-reaching and involving such heavy commitments did not prevail without challenge. From late May until mid-August the suggestion was repeatedly advanced in AEAFC conferences that a crippling offensive blow at Luftwaffe bases was so desirable that the interdiction program should be momentarily relaxed to provide for the necessary mass attack, a suggestion growing out of concern lest the Luftwaffe be allowed to develop again its offensive power. The main protagonists of such a diversion from the interdiction program were Doolittle and Spaatz, with Harris on occasion supporting them. In the latter's opinion, the bombing of freight yards was a process involving continued attacks, as indeed it was, and the effort had failed to produce decisive results. Tedder at times agreed in principle, but generally held that the interdiction program had shown its worth. Leigh-Mallory and Coningham expressed confidence in the ability of fighter-bombers to deal with anything that the GAF might put into the air. By mid-July the Eighth had evolved a project for simultaneous attacks on fields in France and Belgium which would require the full available strength of all Allied air forces, but not until August was there agreement on the project's execution.<sup>75</sup> Even then the attack, on 14 August, was limited by the Ninth's commitments in the battle area and by weather which blocked off some of the fields in the Low Countries.

The interdiction plan thus prevailed and its offensive rolled on irresistibly throughout the entire period of the Battle of Normandy. On D-day itself IX Fighter Command made two dive-bombing attacks on the Seine bridge under repair at Oissel and inflicted serious damage, while IX Bomber Command attacked freight yards east of the Seine. On that same day VIII Fighter Command included a heavy toll of locomotives and rolling stock in its claims. On D plus 1, RAF Bomber

Command continued its strikes against freight yards, including targets such as Dreux and Évreux which lay within the tactical area. Likewise, on D plus 1 the Eighth began its work of extending the interdiction line down the Loire from Orléans by bombing bridges, and continued its daylight attacks on freight yards.<sup>76</sup> The tempo thus set was stoutly maintained thereafter. Fighter reaction by the GAF on occasion strongly suggested that the targets which it sought to defend were highly prized.<sup>77</sup> Missions were regularly flown against points in the Paris-Orléans gap, fighter-bombers of the Ninth worked over complicated "ladders of interdiction"—vital sections of rail lines—within the Seine-Gap-Loire boundaries, and the planes of VIII Fighter Command in their roving beyond these boundaries developed the trick of dropping fuel tanks with detonators attached to set fire to stalled trains.<sup>78</sup> Highways were relentlessly patrolled. With RAF and the Eighth and Ninth Air Forces cooperating, attacks on freight yards alone involved over 15,000 Allied sorties and nearly 35,500 tons of bombs dropped in the period from 6 June through 31 July. In the same period, Allied planes flew over 16,000 sorties and directed more than 24,500 tons of bombs against bridge targets.<sup>79</sup>

The French railway system was admittedly below par before the interdiction program went into effect. German controls were inefficient, and while earlier drafts made on French locomotive stocks had been atoned for, in some measure, by replacements from Germany in May, all was not well in that particular. The damage inflicted on the system in advance of D-day, measured statistically, had not reduced rail capacity to less than the enemy's total needs, but the system nevertheless had been hit at critical points.<sup>80</sup> Through lines in freight yards might be restored to use within twenty-four hours of their bombing, but spur tracks and many repair shops had been damaged or destroyed, as had facilities for coaling and watering. Service was further disorganized by such extensive damage to signal apparatus that hand signals had to be employed for control of train movements, and German figures show an alarming rise in the percentage of locomotives damaged by air and a startling diminution in the amount of all types of traffic.<sup>81</sup>

Of more immediate tactical significance was the destruction of rail bridges on the Seine line of interdiction. By D-day all nine of the bridges from Maisons-Lafitte on the western outskirts of Paris to Rouen had been destroyed, chiefly as a result of Ninth Air Force

action, and to heap higher the measure of the enemy's discomfiture, a dozen road bridges between Conflans-St.-Honorine and Rouen had been demolished. The enemy rightly rated the rail bridge at Le Manoir as of no importance, and he early decided not to attempt the repair of three more, but he did attempt to rebuild other rail structures or to provide emergency substitutes for them in an effort destined to be completely nullified by later bombings. Conflans, where reconstruction began on 9 June, was so badly hit on the 12th that a pier was destroyed together with all the new pilings that had been put in place. The bridge was probably "serviceable" again by 15 July, but only in so shaky a condition as to make its use negligible.<sup>82</sup> The third span to be destroyed at Le Manoir, nearer the battle area, was demolished on 14 June and a temporary structure there later suffered the same fate. The crossing at Oissel, to which the German engineers devoted much time, suffered damage when a single-track emergency bridge was hit in air attacks of 6 and 7 June. Fighter-bomber pilots returning from a mission against Oissel on 29 June reported "no results observed," but actually they had destroyed three recently completed spans of the bridge. As the enemy persisted in his repairs, a bridge at this point later became available long enough to permit the crossing of one train. But French railway records indicate that this was the only train to cross the Seine interdiction line during the battle west of that river.<sup>83</sup>

When D-day brought an end to the need to conceal Allied intentions from the enemy, selected points on the Loire were opened for attack.\* Eight of the nineteen highway bridges between Tours and Nantes, though none were officially listed for attack, had been demolished before it was determined to abandon such targets altogether on 17 June. All nine railway bridges between Tours and Nantes, together with three up river from Tours to Orléans, were subjected to methodical assault. Since the Army considered it essential to stop all enemy movement across the Loire, attacks were recurrent and added steadily to the effects earlier produced by the smashing of freight yards at Tours, Orléans, Angers, and Saumur. Only four of the Loire bridges were reported standing on 13 June, and whereas 400 trains had crossed from the south in the first week of April, no more than 14 did so in the week ending on 16 June.<sup>84</sup>

The German obviously set store by most of the Loire bridges, for

\* See above, p. 158.

he increased his flak defenses and engaged in strenuous efforts at repair, despite successive frustrations. "Tallboys" dropped by the RAF on the night of 8/9 June had blocked a rail tunnel just north of the river bridge at Saumur, and before the tunnel was restored to service IX Bomber Command had rendered the bridge impassable. The structure at Les Ponts de Cé, impassable since 1940, was hurriedly repaired by the enemy in July, but it was demolished on the very afternoon that it was opened for traffic and before any train had passed. Further attacks on 31 July and 1 August negated later repair efforts. At Tours-la-Riche, after an attack of 8 June, reconstruction made the bridge passable at the end of nine days for single cars without locomotives—"pushing operations" was the graphic phrase used by the bedeviled Germans to describe their passage. Renewed air attacks on 23/24 and 25 June forced the enemy to attempt further repairs, with the limited purpose of restoring single-track traffic for light locomotives. This hope was for a time fulfilled, but four attacks by mediums between 7 and 31 July, coupled with a dive bombing on the 30th, denied the enemy any effective use of the bridge. On one occasion it was destroyed a half-hour after the chief transport officer of the Seventh Army had completed an inspection. Nine of the sixteen arches of the bridge at Orléans had been destroyed in one attack on 8 June, but its repair was not attempted "because no engineer forces were available." Indeed, available forces were stretched so thin that "pushing operations" formed the modest goal of German railway troops as they strove to rebuild the bridges at Nantes, Chalonnès, and Cinq Mars. The enemy complained too of a shortage of anti-aircraft defenses, as in the following entry in the war diary of the German Seventh Army: "On the evening of July 19 four bridges over the Loire were eliminated because of the lack of anti-aircraft artillery." The reference was to attacks by mediums between the hours of 1920 and 2002 on Nantes, Chalonnès, Les Ponts de Cé, and Tours-la-Riche for which IX Bomber's claims were considerably less than the results thus acknowledged by the enemy.

In the Paris-Orléans gap, where some eight points were marked as interdiction targets, a comparable race between destruction and construction developed. Bridges at Chartres were struck by mediums flying in on six occasions between 14 June and 9 August. The Ninth's fighter-bombers delivered seven attacks on the Chérisy viaduct between 12 June and 18 July, knocking out several spans. The Todt

organization was able to base steel trusses on the piers which remained standing, but these piers were attended to by the French Forces of the Interior after a final dive bombing had merely destroyed the superstructure. German records show that the 391st Bombardment Group's attack on the long viaduct at Maintenon on 6 July interrupted service on the through line to Chartres, and it is evident that a repeat attack again ended its usefulness on the 25th.<sup>85</sup> A more perfect knowledge of the French rail network and of its current use by the enemy might have enabled equal results to have been obtained in this area with greater economy of effort. But although alternative routes were at times available, major hurt was done the enemy, for the six rail routes in the gap were fully closed for 56 per cent of the battle period.<sup>86</sup>

Successful attacks were also made on bridges at Pontorson and Pontaubault, and at points in Brittany. On 18 July the enemy recorded that five spans of the enormously high viaduct at Laval had been destroyed. This was the work of IX Bomber Command, and in a repeat mission of the 21st the mediums destroyed the still incomplete repairs.<sup>87</sup>

Other targets related to the objectives of interdiction were not neglected. Saturation bombing by heavies and follow-up blows by fighter-bombers so flattened freight yards that it was later estimated that these attacks alone had effected by mid-July a 57 per cent reduction in the volume of German traffic.<sup>88</sup> By no means incidentally, these blastings destroyed the normal communications channels used by the German railway administration, which was forced to extemporize a radio substitute for phone service and to send officers out to carry orders and to superintend the entrainment and detrainment of troops. Women clerks at headquarters broke under the strain.<sup>89</sup> The enemy acknowledged the loss of 551 locomotives in June from bombing, strafing, and sabotage. Although many freight cars were destroyed, he experienced no general shortage, save by special types, but "pushing operations" over the single-track bridges at Tours created a grave situation. Movement northward engrossed the full capacity of the bridge, and empties (among them special cars for carrying tanks) accumulated and stagnated north of the river, though badly needed elsewhere. Persistent Allied policing of rail lines by fighter-bombers forced the Germans to issue a strict order that trains be placed on sidings at daybreak, with cars separated and camouflaged, and after 21 June daylight traffic was permitted only on special order.<sup>90</sup>

In rail-cutting operations the American pilots made excessive claims but their work was effective enough. The enemy showed himself resourceful in running shuttle trains on sections which remained passable and engaged in such strenuous effort to maintain repairs that in bad flying weather repair might overtake the work of destruction. But problems of section maintenance were increased by the loss of a bridge or tunnel, and slow speeds were forced upon his engine drivers even where traffic was restored. Cuts also caused traffic jams which offered rewarding targets for attack,<sup>91</sup> and Allied planes, including armed reccees, were quick to spot a target of opportunity. After V-E Day, von Rundstedt described the results of the Allied rail interdiction as "katastrophal" and in terms of a "traffic desert," which soon embraced the entire network of related highways as well.<sup>92</sup>

It is not always possible to measure exactly the effects of interdiction operations, but it is clear that the net result placed the enemy squarely between the upper and the nether millstones. He could not use the rails of northwestern France and the roads there offered a far from satisfactory substitute. Travel by night was the only safe procedure, and at that season of the year daylight prevailed for sixteen hours in each twenty-four. Moreover, night travel forced the wide spacing of convoys on the roads and the use of low speeds, at the very time when the ever increasing distance of railheads from the front increased the mileage which trucks must negotiate.<sup>93</sup> Not even the pooling of truck resources of all arms of the Wehrmacht could overcome the difficulty, for the Germans had entered the struggle with insufficient truck transport and heavy losses increased the scarcity, which became so marked that as early as 7 July German Army Group B insisted on the provision of more trains because of the pinching shortage of trucking.<sup>94</sup> The first report in enemy records that individual cars were not safe from attack on the roads was made on D-day, and German staff cars soon found the roads so perilous that they used spotters, fore and aft, to give warning of the approach of Allied planes.<sup>95</sup> Coningham noted in early June that enemy movement in small concentrations made it difficult for Second TAF to find lucrative road targets, and in July the Ninth's fighter-bombers submitted few claims of road transport destroyed. Possibly this was because of their concentration on rails at that time; more probably it was occasioned by the absence of road traffic.<sup>96</sup>

For the purposes of emphasis it may be useful at this point to note

the illuminating postwar comment of the U.S. VII Corps, for the exact converse of the situation which it describes prevailed on the enemy's side of the front, where the appearance of a solitary motorcyclist was the occasion for remark, and attack, by Allied pilots. "We would never have been able to move so fast and as far as we did if we had had to string out our columns to the extent theoretically required for passive defense against enemy aircraft. Much time was also saved by not having to disperse vehicles and bivouac to the extent that would have been necessary had we not had almost complete air superiority. Same for camouflage. Not having to worry about these things takes a load off the mind of ground troops which is of genuine intrinsic value."<sup>97</sup> The comment serves also to emphasize the extent to which the Allied air forces had met their primary responsibility for the furtherance of ground operations—to establish and maintain a control of the air that would guarantee freedom from interference by the enemy air force. Anyone who saw the Normandy roads north of the battle front in July 1944 carries with him a vivid picture of close-packed vehicles whose spacing seemed to be determined only by the amount of dust kicked up ahead. The Allies required no "broomstick commandos" of the sort employed by the enemy to wipe out the tracks made on roads and fields when their vehicles sought daytime safety under such cover as they might find or improvise.<sup>98</sup>

### *The Test of Tactical Results*

Constant surveillance of roads and rails, repeat blows at targets on the lines of interdiction, and repeated attacks on freight yards as close to those lines as Évreux and Argentan and as far removed as Belfort and Saarbrücken brought results that were both varied and massive. There can be no question that the enemy sustained great physical damage. But since the entire interdiction program was designed to affect the situation on the battlefield, the measure of its success can be determined only by an analysis of the tactical results achieved. Fortunately, the availability of a mass of German evidence makes such analysis possible.

Immediately the landings of 6 June indicated the focal points of Allied attack, von Rundstedt's Seventh Army and Rommel's Army Group B were faced with the necessity of moving troops to reinforce those called upon to face the assault. Their staff officers later remarked that the only real chance for forward displacement existed during

the opening days of the invasion. The situation at that time was bad enough, but it became progressively worse.<sup>99</sup>

The enemy's problem and its development can be illustrated by specific examples. One of the crack units at his disposal was the 3d Parachute Division, which was located in the Brest area on D-day. Its motorized elements left for the front on 7 June and, to their commander's astonishment, moved to Caumont with reasonable speed and without being subjected to air attack. The remainder of the division took up its march on D plus 1, moving by night on secondary roads as a precaution against air attack. Confiscated bicycles provided some assistance, as did also horse-drawn carts, and on the 16th one reinforced regiment was welcomed by Rommel at St.-Lô. Other elements straggled in later, after a march of some 200 miles which consumed from two to ten days.<sup>100</sup> They were to learn of air's power immediately after their arrival, for dive bombers hit the newly established divisional command post on that same day and inflicted casualties. The 265th Infantry Division was in its garrison area near Quimper on 6 June when a Kampfgruppe (combat group) was alerted for movement north. Trains were not available until the 10th, but were then loaded under the supervision of an officer who had been rushed out by road from Le Mans because communications with transport headquarters had been broken. The trains could proceed only in darkness and by way of forced detours. The movement stopped entirely on the 12th, when one train was completely isolated and others were held up by rail cuts; it got under way again on the 14th, but not until two days later did all elements arrive in the Rennes area—still some distance from the battle lines. Although the Kampfgruppe is described as poorly equipped to march, it had to continue its journey by road, after a full week had been consumed in covering less than 100 miles by rail.<sup>101</sup>

Tanks were at a premium in the battle which had been joined, and were indispensable if a counterattack was to be mounted. To provide needed armor the 9th and 10th SS Panzer Divisions, which earlier had been released from the western command for use on the eastern front, were ordered back from the Lwów area in Poland, where they were refitting. Starting on 7 and 10 June they moved with speed from Lwów to Metz. Thence, because overstrained rail capacity would allow no more, only the actual armored units moved by rail to Paris. The balance had to take to the roads, and consumed as much time traveling 200 miles to the battle front as they had spent in covering



1,300 miles by train. Elements of these much-needed divisions did not appear on the Normandy front until late in June.<sup>102</sup> The 17th SS Panzer Grenadier Division had been based at Thouars, south of the Loire. Since it was under the immediate jurisdiction of OKW (*Oberkommando der Wehrmacht*), the division began its movement on the very day of the assault. Tracked elements gained nothing from the flowery code name of MIMOSA bestowed upon their movement by rail transport officers, and after a single day on the rails, cuts produced by bombing forced several sections to detrain at various points from La Flèche in the north to one below Saumur in the south. Other elements, proceeding by road, had hardly begun their march before the "Jabos" twice dived at them and inflicted heavy damage to vehicles, guns, personnel, and morale. Thereafter, the march was continued along secondary roads and only at night. It took five full days to cover the 200 miles separating Thouars from Périers.<sup>103</sup>

Parts of a fourth panzer division played the leading roles in a later epic of frustration. Tracked elements of the 2d SS Panzer Division left Limoges on 11 June, and its Panther (tank) detachment set out from Toulouse several days afterward. The Maquis made the journey through southern France anything but tranquil, but the real trouble began when the nine trains employed in the movement reached the line of the Loire at dates between 14 and 16 June. Broken bridges forced detrainment on the south bank of the stream, whence the units moved across to Angers as best they could. While the only cars north of the river which were capable of carrying tanks—no more than the equivalent of two trains—were forwarded to Angers to freight the armor, some elements of the division moved on by road. Other elements got as far as the rail center at Le Mans by train on dates ranging from the 17th to the 23d, though not without considerable difficulty occasioned by the work of saboteurs and Allied planes. An attempt to continue the rail movements to Le Mans on the 24th ended with the blocking of two trains in open country, and that, so the military chief of railway transport noted, "completed the rail movement." Thereafter, and with important elements of the division still to be moved out of Angers, the order for all was a road march.<sup>104</sup> Not until the closing days of the month were elements of the 2d SS Panzer Division identified on the fighting front.

Such a "pilgrim's progress" was the lot of many other organizations headed for the battlefield. In general, rail movement originating east

of the Seine ended not far west of the French capital. Approximately half of the troops coming in from the south detrained below the Loire barrier, and those who got across advanced no more than 50 miles farther by rail. The German summary of troop movements in June indicates that few trains reached their destination; "*Landmarsch*" is the laconic entry which ends most of its quick descriptions of movement, and on the well-nigh inevitable road march motors could average 30 miles per day and foot 15 miles.<sup>105</sup> In retrospect, von Rundstedt hazarded the opinion that even had a greater number of divisions been available for his use the net result of any effort to bring them into action could only have been an increase in the confusion which prevailed.<sup>106</sup> An entry in the war diary of the Seventh Army has even greater tactical significance, since it was made on 11 June, when the American beachheads had not been firmly joined: "Troop movements and all supply traffic to the army and within the army sector must be considered as completely cut off."

The enemy concentrated the full of his transportation facilities on the movement of troops during the first three weeks of the Battle of Normandy. By the end of that time the demands of units in action forced him to a strenuous effort to replenish supplies exhausted by continuous battle and to provide stocks which the hoped-for counter-attack would require. Rommel in the Caen-Bayeux area and Marx in the Cotentin clamored for resupply, but on 26 June the Seventh Army was forced to confess that it could not guarantee a regular flow of supplies in support even of current operations. The breakdown of the railways and a continuing shortage of road transport were cited as the causes for this tactically perilous situation.<sup>107</sup> Special priorities were created for the movement of ammunition and fuel, and transportation officers were charged both to expedite the shipments and to enforce the security regulations against air attack which experience had shown to be so necessary. Small wonder that the enemy took all possible means to assure the rapid unloading of precious freight that did reach its destination, and that he lamented the fact that the unloading was generally measured by days rather than by hours.<sup>108</sup>

Although it cannot be said that the recently inaugurated strategic bombing campaign against oil refineries\* had as yet affected the enemy's situation on the Normandy battle front, it is clear enough that fuel was regarded there as in short supply. In order to aggravate that

\* See above, pp. 172-79.

shortage and to strike also at supplies of ammunition, AEAF sent repeated attacks against the forested areas sheltering the enemy's forward dumps. Fighter-bombers of the Ninth were frequently employed on such missions, but the mediums of IX Bomber Command constituted the main weapon. Navigators of B-26's and A-20's, as they strove to supplement the work of interdiction, became bitterly familiar with the map locations of the Forêts de Senonches, d'Ecouves, de Conches, and above all, the Forêt d'Andaine. Target areas were generally well hit, but the German's methodical dispersion of his stocks reduced the extent of bomb damage. Exact measurement of the contribution thus made to the enemy's critical shortages can never be determined, but beyond doubt his distress was aggravated. The destruction of two million liters of gasoline at Rennes by mediums and fighter-bombers and the firing of fuel supplies at Vitré and of storage tanks at Tours certainly involved no small local losses.<sup>109</sup>

Since it is an established fact that combat-troop demands for vital supplies were not met, attempts to measure the effects produced by actual destruction of dumps is in a way irrelevant, save for the planner of future operations. What counts is the net result of the total effort, and that is easily demonstrated. The needs of the 2d SS Panzer Division, for example, were such that fuel was ordered flown to its relief on 13 June. Yet, its chiefs were forced two weeks later to report their regret that "the attacking panzer units cannot bring up all their tanks owing to the lack of fuel."<sup>110</sup> Restrictions had been placed on the use of ammunition, even against air attacks, before the invasion and official restrictions on the use of fuel had forced commanders to use horses or bicycles when visiting their units.<sup>111</sup> After the Allied landings, the phone log of the Seventh Army is replete with complaints of shortages, requisitions impossible to fulfil, and notes of planned improvisations for relief. In the face of critical front-line needs, the movement of fuel and ammunition trains in daylight had to be forbidden on 18 June "to prevent their annihilation," and Rommel's last situation report shows conditions unimproved in July.<sup>112</sup> The best that the enemy could do with the three trains he might be able to move into the Seine-Loire area each day, and with the Seine barges which he pressed into service, was to carry some 3,000 tons per day of vital supplies when the quartermaster's demands totaled 7,000. Some shreds of relief may have been afforded by the stocks of both fuel and ammunition carried by incoming units, but in view of the transport difficulties they en-

countered it is unlikely that their stipulated eight-day stock of munitions and gasoline for movements of seventy-five miles or more ever constituted a reserve after their arrival at the front.<sup>113</sup>

The supply of ammunition and fuel was a particularly critical problem for the panzers, whose tanks could not work effectively unless provided with a diet rich in oil and munitions. Claims for tanks destroyed on roads by fighter-bombers were the frequent cause for congratulation to pilots, and congratulations were very much in order in the case of those who participated in the attacks on rails near Mantes on 23 and 24 June, when trains loaded with tanks were hit and fired. But hardly less important was the wear and tear imposed on tanks which managed to reach the front by a *Landmarsch*. There is a limit to the life of treads, and Allied intelligence indicated that German tank engines had an effective lifetime of only 600 hours. Both at the time and later, the enemy stressed the fact that his panzers wore out their tanks on marches to the battle zone. Such was the experience of the units of 9th and 10th SS Panzer Divisions, after detraining at Paris in June; and the extraordinary effort to move the Panthers of the 2d SS Panzer Division from Angers\* by rail rather than by road was explained by the desire "to save fuel and the already badly crippled motors of the heavy tanks."<sup>114</sup> Von Rundstedt made the additional observation that even when tanks were not hit on the road, their journey became both hazardous and wearing because of the craters produced by air bombardment.<sup>115</sup>

The accumulated difficulties of the tankers exhibit in impressive manner the vicious circle into which air's interdiction had placed the enemy. Armored units were forced from the rails to the roads at points distant from the battlefield. Their *Landmarsch* wore them down, and repair became the more difficult because air kept repair depots at inconvenient distances from the front. Once the tanks had reached the front and been committed to action, their appetites added to the loads that sadly depleted rail and road transport were called upon to bear. And thus demands that units and supplies be brought closer to the front mounted at the very time that German transportation resources were being progressively diminished.

The losses, risks, and delays involved in rail and road transportation made it difficult for German staffs to use their resources for major tactical effect. Battle action is seldom as orderly on the field as it appears

\* See above, p. 218.

to be in after-action accounts, but the enemy's inevitable confusions were the worse confounded because of the effects of air action. Uncertainty as to the time when units would be at his disposal made it impossible for him to predict his capabilities with accuracy. On 22 June, for example, Rommel's Army Group B knew that infantry brigades were on their way from Germany but could only guess at the time of their arrival. Later, on 6 July, the Seventh Army could not tell when the balance of the 275th Infantry Division could be brought up. And always there was the problem as to how much transport space might be available and how best to apportion the probable total between troops and supplies of fuel and munitions. Repeated compromise and adjustment were always necessary, for the enemy was well aware that his full needs in both particulars could not be met.<sup>116</sup> Although march tables could be drawn up, there was no assurance that their provisions would be fulfilled, and since Allied pressure on the ground was sustained, the enemy was driven to follow a policy of piecemeal commitment, with elements of units fed into the lines as rapidly as they appeared at the front. As a German authority later observed, "Fighting without pause caused Army Group B constantly to expend forces at the front and prevented any formation of a large reserve, let alone planned relief and rehabilitation of units behind the front."<sup>117</sup> In the midst of the battle, the enemy's hard pressed transportation chief in the West had deplored the fact that movements consumed double the anticipated time, with the result that troops could not be assembled in the strength required for a decisive counter-attack "but had to be thrown into combat piecemeal immediately upon their arrival."<sup>118</sup> Casualties were severe, and replacements were as difficult to provide as were reinforcements. Unable to synchronize the arrival of technical equipment and units trained in its use, the enemy was driven to employ the specialized personnel of signal, engineer, artillery, and panzer units in an infantry role. General Montgomery had prophesied that in Normandy, as in the African desert, Rommel would continually assault with any available forces from division down to company, and air's action left him no real alternative save a further demonstration of his natural tactical bent.<sup>119</sup> But he was denied the opportunity for a major counterattack.

It would be unfair to attribute the enemy's failure seriously to challenge the Allied invasion entirely to the effects of the interdiction program. Equally conspicuous in the causes therefor were the initiative,

courage, and perseverance of the Allied ground soldiers who promptly applied and constantly maintained a relentless pressure at critical points on a growing front. The enemy had been caught off guard in Normandy and his subsequent concern for a second landing prevented his effective redeployment of such forces as were available for reinforcements.<sup>120</sup> For this Hitler himself was in no small part responsible, a fact reminding one of the rotund rhetoric of Goering's later declaration, "You had a great ally in your aerial warfare—the Fuehrer."<sup>121</sup> Although Hitler had anticipated the Allied assault in Normandy,<sup>122</sup> he also cherished the opinion that another landing was in the offing after the Normandy beaches had been stormed. On 6 June he briefly delayed the use of panzer divisions from reserve by Seventh Army, and at a Soissons conference of 16–17 June he rejected the withdrawal proposed by Rommel and von Rundstedt but still refused to permit their substantial relief from the resources of the Fifteenth Army. Even at the end of June, when he admitted that the possibilities of counter-attack were limited, and during the first week of July, he continued to refuse permission for a shortening of the lines to create a reserve or for recommitment of the Pas-de-Calais garrison. As for the transportation chaos created by interdiction, he offered a simple solution—"men of iron courage" should be found to restore order.<sup>123</sup>

While Hitler stood fast and air applied its interdiction, the Allies won the build-up race upon which the success of their entire operation depended. General Morgan in November 1943 had warned that if the French rail and road network were left intact, the enemy would be able to achieve a faster build-up rate than could the Allies;<sup>124</sup> and while the air forces were striking at enemy communications, the port battalions, naval forces, and beach parties worked their miracles to overcome the menace. It was heartening for Allied leaders to note as early as 10 June that the German build-up was lagging behind Allied estimates and to record a week later that German strength, which the planners had anticipated would be twenty-five divisions by that date, actually amounted to only fourteen full-strength divisional units. By 4 July 1944, the Americans had four corps on the front and the millionth Allied soldier had landed.<sup>125</sup> In pointing out the critical importance of the build-up race, the supreme commander was later to affirm that the greatest Allied assets in overcoming the enemy's natural advantages were air and sea power.<sup>126</sup>

The Battle of Normandy had been marked by a signal demonstra-

tion of air power's versatility and flexibility. American air forces employed in a tactical role had accomplished the missions set forth in FM 100-20. They had made their special contribution to the establishment of air superiority, they had reduced to the lowest possible terms the enemy's capacity to move troops and supplies into and within the battle area, and by indirect and direct means they had assisted the ground forces to attain the lines held on 25 July. Allied commanders acknowledged their debt to air in all three particulars.<sup>127</sup> But German opinion on these same points, free from conventional courtesy of victorious generals, affords an even more effective appraisal of the Allied airmen's work. Luftwaffe authorities averred that "the most damaging effect . . . resulted from the paralysis of the railway network, the destruction of all bridges across the Seine [below] Paris, and the considerable dislocation wrought in our aircraft reporting services."<sup>128</sup> Von Rundstedt stressed his inability to mass and to maneuver with Allied planes overhead and, in a singularly intimate interrogation directed by an American air commander, insisted that from his point of view as commander in chief in the West, the devastating "clockwork" attacks on French railroads and road communications were more dangerous than those against front-line installations and troops.<sup>129</sup> He admitted, however, that a field commander might place a different value on the "annihilating effects" of air attacks on tactical units, and it may be well in closing to quote from a contemporary report by Gen. Freiherr Heinrich von Lüttwitz, commanding general of the 2d Panzer Division: "The Allies are waging war regardless of expense. In addition they have complete mastery of the air. They bomb and strafe every movement, even single vehicles and individuals. They reconnoiter our area constantly and direct their artillery fire. . . . The feeling of helplessness against enemy aircraft . . . has a paralysing effect, and during the [bombing] barrage the effect on inexperienced troops is literally 'soul shattering.'"<sup>130</sup>

The date of this top-secret report was 17 July 1944, and at that time SHAEF was perfecting plans destined to give the Germans further occasion to develop their commentary on Allied air power. The breakout at St.-Lô would soon follow.

## CHAPTER 8

\* \* \* \* \*

### *THE BATTLE OF FRANCE*

THE assault of 6 June 1944 on the Normandy beaches was merely the beginning of operations, to quote from Eisenhower's directive of 12 February 1944, "aimed at the heart of Germany and the destruction of her armed forces." The initial phase of these operations ended in mid-July with the winning of the battle of the beachhead which provided sufficient ground for massing and maneuver on the part of Allied forces. The second stage, the breakout, followed immediately.

The use of overwhelming air power to speed the breakout had long been discussed by Allied commanders, but not until 19 July were plans for its application definitely formulated and approved. A conference was then held at AEAFF headquarters at Stanmore with Bradley, Tedder, and representatives of the air forces present. Basic details were firmed, and on that day, and the day following, orders were issued for Operation COBRA.<sup>1</sup> According to an agreement at the Stanmore meeting, both D-day and H-hour were to be determined by air authorities since their ability to act in full strength was rated as essential to the operation. The original agreement tentatively fixed the 21st as D-day, but adverse weather forced postponement of any action until the 24th. The weather forecasts on the night of 23 July were not altogether propitious, but AEAFF determined that preparations for COBRA should commence. Early the next day 10/10 cloud in the St.-Lô area caused Leigh-Mallory to put off tactical air action from 1000 to 1200 hours when, according to AEAFF meteorologists, weather would lift. The postponement was possible since FUSA had earlier signified its willingness to postpone its jump-off to as late as 1500 hours.<sup>2</sup>

But doubts entertained by Eighth Air Force weather men on this score were well founded.<sup>3</sup> Six groups of IX TAC's fighter-bombers took off according to plan to deliver their attack, but three groups



ENGLISH CHANNEL

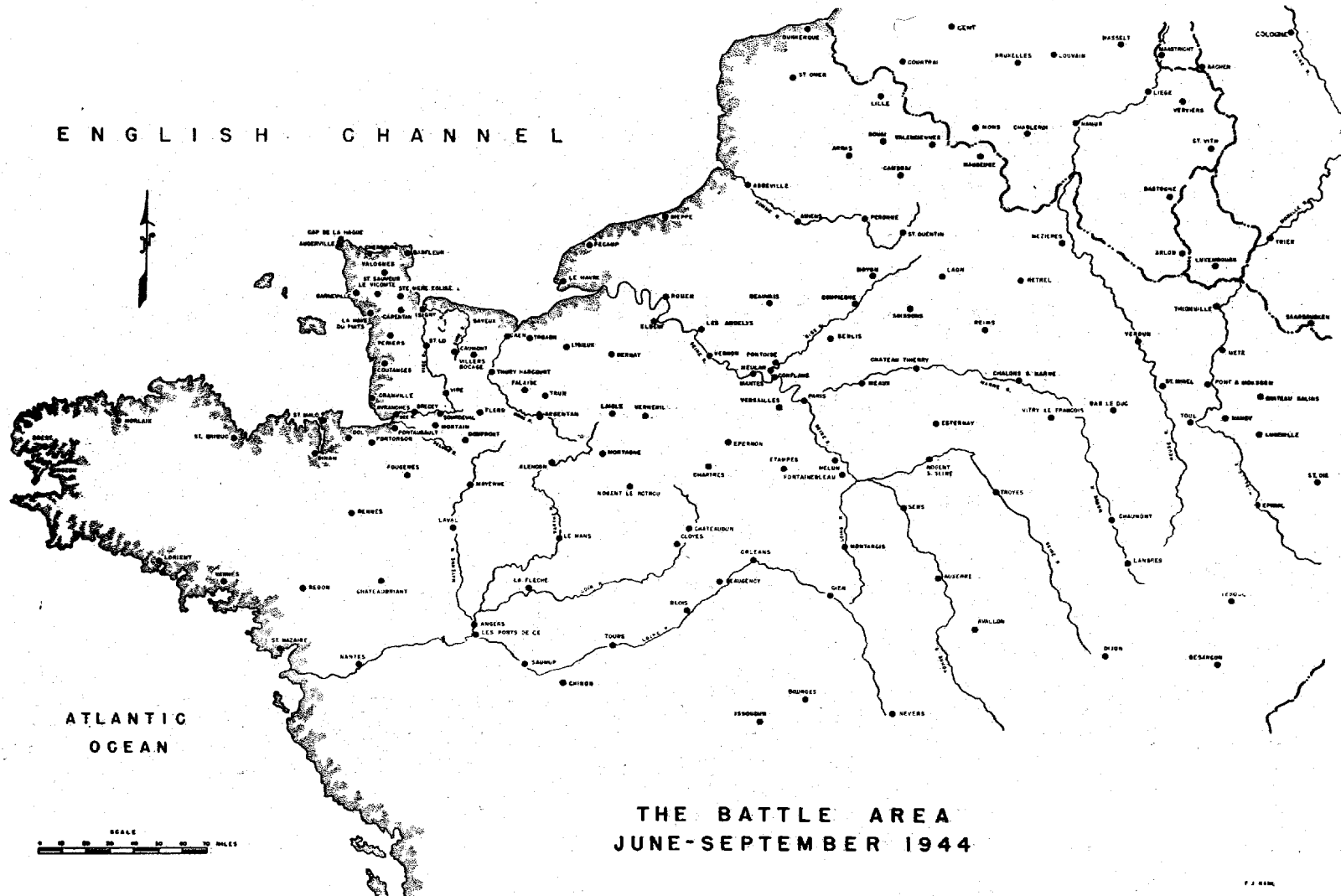

ATLANTIC OCEAN

THE BATTLE AREA  
JUNE-SEPTEMBER 1944

SCALE  
0 10 20 30 40 50 60 70 80 90 100 MILES

were recalled on account of adverse weather and the others could report only that they had bombed their target area with no results observed. Meanwhile, the three bombardment divisions of the Eighth Air Force had dispatched a total of 1,586 aircraft, and as the heavies set course for their target area observers on the far shore heard the roar of their engines from above the overcast. Leigh-Mallory, who was at Bradley's field headquarters, determined to cancel the operation, but word of his decision did not reach the Eighth until a few minutes before the bombing was to commence and the message of recall was received by only a few planes in the last of its three formations. Efforts were made by controllers in France to pass the word to the airborne heavies, but no other means of communication were available save the extemporized use of frequencies on which the heavies might be listening. However, visibility was so poor that the lead formation made no attack on its primaries. The second found cloud conditions bad, and only thirty-five aircraft bombed after making no less than three bomb runs properly to identify their target. Under slightly improved weather conditions the third formation dropped from 317 of its bombers before the recall message was received, for the most part by units which were preparing for a second bomb run. The mediums of IX Bomber Command, which had been scheduled to follow the heavies in their attack, received the cancellation order in good time.<sup>4</sup>

The action of 24 July, ineffective at best, was marred by short bombing. A fighter-bomber caused casualties when it hit an ammunition dump within friendly lines. Its pilot had apparently picked up the wrong landmark to guide his run. A single plane of the 2d Bombardment Division bombed the Ninth's airfield at Chippelle, its bombardier having struck the toggle switch in a reflex induced by the impact of a package of chaff on his nose turret; two planes, bomb-loaded and manned, were destroyed and others damaged. In another instance, the lead bombardier of a heavy bomber formation had difficulty in moving his bomb release mechanism and a portion of his load was inadvertently salvoed. Unfortunately, and inevitably, the other fifteen aircraft of the formation released on their lead ship with their bombs falling some 2,200 yards north of the northern boundary of their target area. Army casualties, chiefly among troops of the 30th Infantry Division, were reported as sixteen killed and four times that number wounded. Three heavies had been lost to flak.<sup>5</sup>

*COBRA*

The misadventures of 24 July gave the enemy information as to the place and approximate time of the impending attack and led him to withdraw some of his heavy artillery as far south as Marigny in anticipation of it. But there was no alternative to carrying out a full-scale COBRA on the first good day. That day proved to be the very next, for late on the 24th the message went out fixing H-hour as "25 1100B" (25 July 1100 hours British double summer time), and the standing orders for the operation went into effect.<sup>6</sup>

These orders and their frequent amendments had been literally streaming from the teletypes in the days following 19 July. Product of continued conferences between air and ground commanders, the complicated orders need here to be stated and explained. They are the more important since they were followed to the letter in the action which ensued. Fighter-bomber groups under IX TAC's command were to begin the operation with a glide bombing and strafing attack on a rectangular target 250 yards deep and 7,000 yards long, with its long northern boundary just south of the St.-Lô-Périers road. This was the air target nearest to American lines, and fighter-bombers were assigned to it because of the Army's confidence in their accuracy. The eight assaulting groups were to fly in column of groups, with all squadrons in column of flights. After assembling over their bases they were to check in with the controller at the Carentan airstrip at three-minute intervals, beginning at 0931 hours, and proceed thence to their targets, which had been divided into eastern and western areas. The first group was to sweep the long axis of the eastern area, the second that of the western, and so on in alternation. As the fighter-bombers completed their blows, the heavies were to appear at 1000 hours and in successive waves deliver a saturation attack on an area one mile deep and five miles long paralleling and lying just south of the fighter-bomber area. The heavies had been chosen for this role because they could deliver a fire more massive than could artillery in the same space of time. The attack would be delivered at right angles to the long axis of the target area in order to reduce the grave problem of flying more than 1,500 heavy bombers over the target within the space of 60 minutes. Even then, and even with the most careful planning of times and runs, congestion was certain, as were the added navigational difficulties of avoiding prop wash and converging courses. At 1100 hours VII Corps

was scheduled to jump off, and at that instant an additional seven groups of fighter-bombers would renew the attack on the eastern and western segments of their assigned area. The mediums then would direct their concentrations on strongpoints and areas behind the German lines which were inaccessible to artillery fire.

Thus American air resources were heavily committed to COBRA—the entire heavy bombardment of the Eighth, the Ninth's mediums, and all of the Ninth's fighters. Fifteen groups of these fighters were assigned to the preliminary bombardment, two of the remaining three groups were marked for offensive fighter operations during the period of the main attack, and the third was assigned to care for special air support requests. With the Ninth entirely pledged to its support role, eight groups of VIII Fighter Command were called upon to give area cover to heavies and mediums alike.

With the experience of the 24th in mind, further safety precautions were added to those originally planned, and their total appeared impressive. A special weather reconnaissance plane was to fly into the assault area at 0800 hours and give the Eighth exact weather data and recommendations. The heavies were ordered to bomb visually, and to fly at the minimum altitude consistent with precautions against enemy flak, which it was expected would be reduced by the Army's preliminary counterbattery fire. The fact that casualties had resulted from the short bombings of the previous day figured prominently among the cautions given bombardiers, and their target boundaries were to be marked with red smoke shells fired at two-minute intervals or less. Finally, although the Army had originally suggested withdrawal of ground troops to a distance of 800 yards from the bomb line and air had urged 3,000 yards, a compromise was struck at a clear zone of 1,500 yards, with the Army's forward lines marked with cerise and yellow panels.<sup>7</sup>

From the first fighter-bomber attack at 0938 hours until the last of the mediums' bombings at 1223, the plans were carried out on 25 July exactly as the intricate time schedule demanded. Watchers on the beaches crossed by the bombers beheld the sky literally filled with the regular formations and had their ears deadened by the steady drum of the motors. A total of 1,507 B-17's and B-24's attacked, dropping over 3,300 tons; over 380 mediums bombed with 137 tons of high explosive and more than 4,000 x 260-pound frags; while 559 fighter-bombers delivered 212 tons of bombs and in addition a special

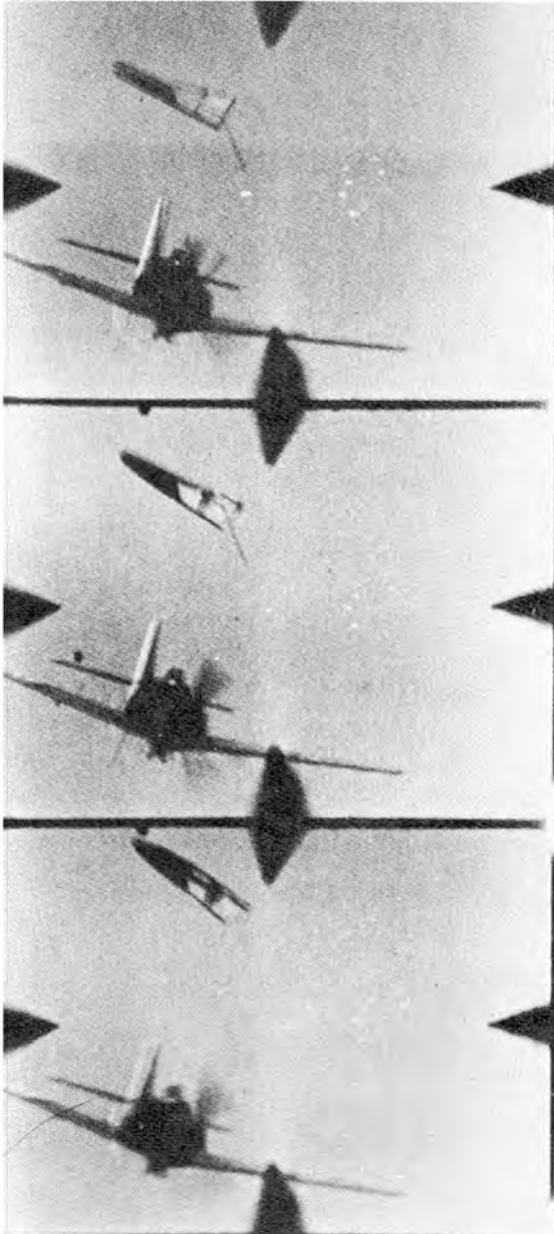

*Left: ATTACK ON ME-109*

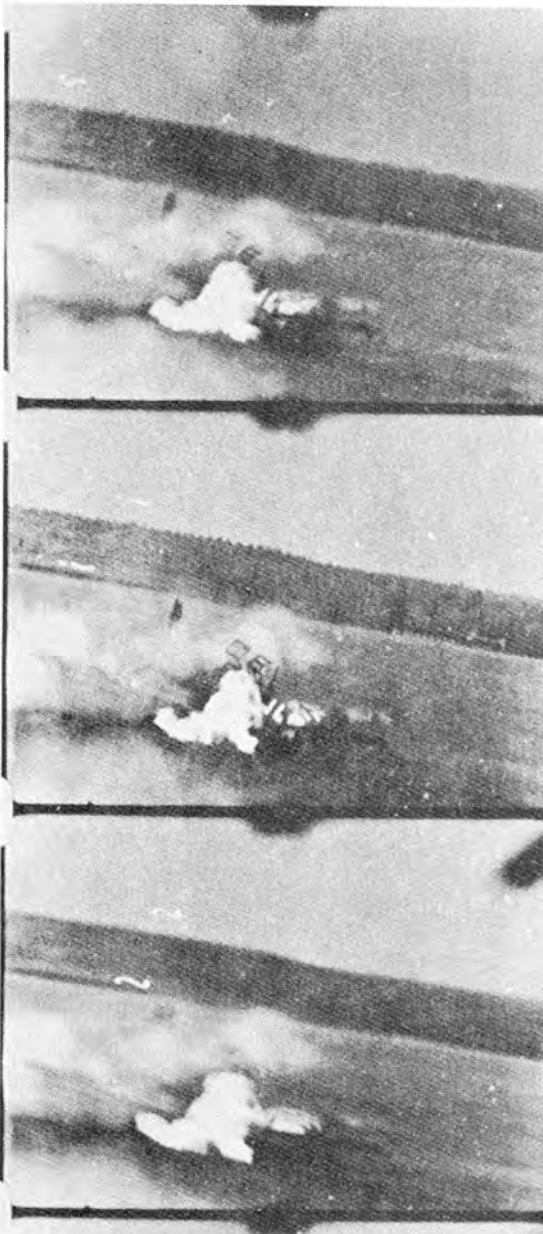

*Right: STRAFING FW-190*

**CAMERA GUNS RECORD VICTORIES**

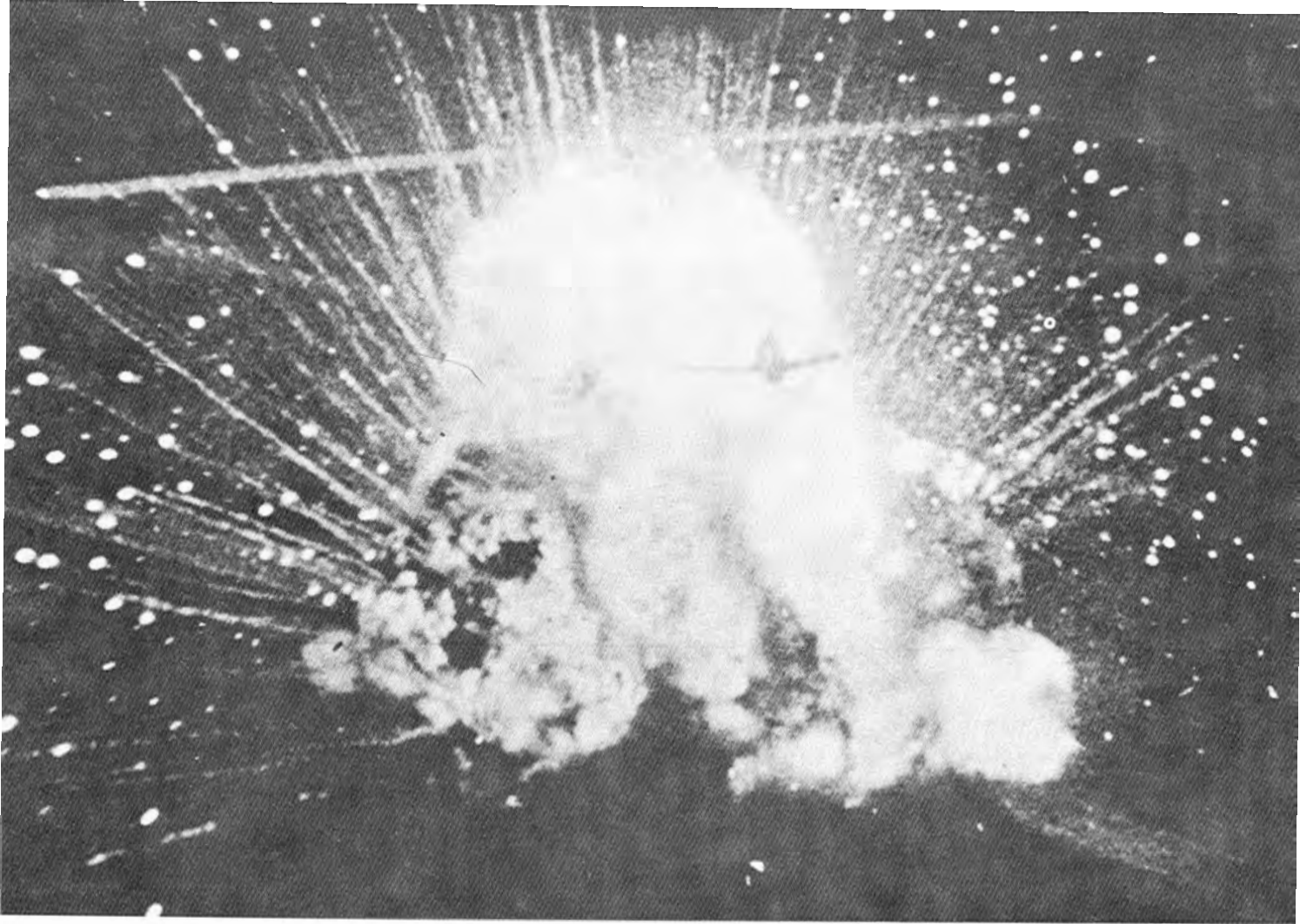

DIRECT HIT ON AMMUNITION TRUCK

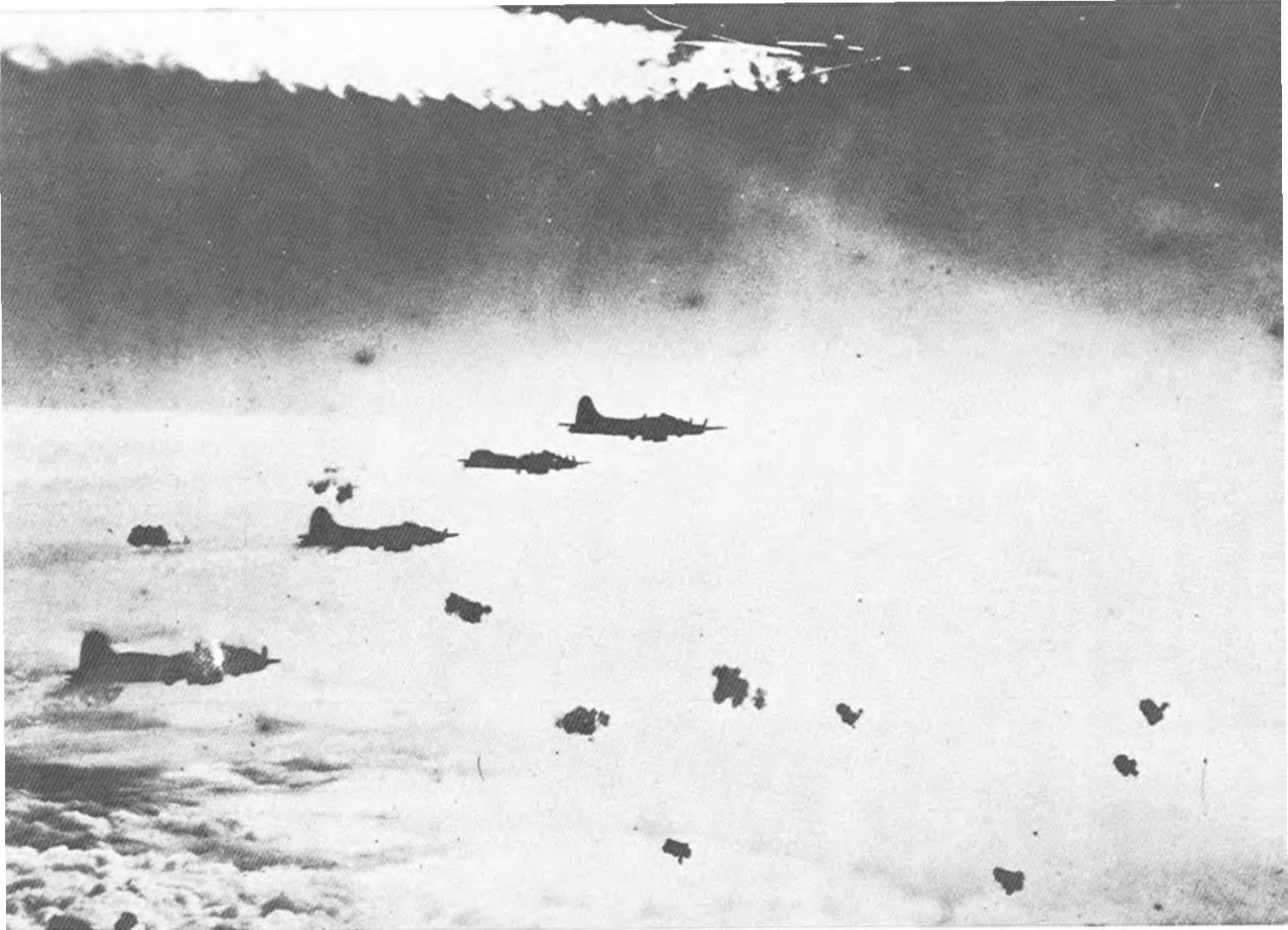

BERLIN FLAK DESTROYS B-17



B-17 BELLY WOUND NOT FATAL



consignment of incendiary napalm.<sup>8</sup> Enemy air opposition was negligible—small German formations made ineffective passes at two of the heavy units, but that was all. The loss of five four-engine bombers and one medium bomber was entirely attributable to ground fire. Fighter-bombers suffered no losses in the course of their swift attacks over the enemy front lines.

Technically viewed, the bombing was good. The mediums concentrated the missiles carried by twenty-one of their thirty formations in the proper target areas. The 1st, 2d, and 3d Bombardment Divisions of the Eighth Air Force likewise covered their targets well, in spite of the fact that they had been confronted with a somewhat perplexing situation. Their preplanned bombing altitudes had been fixed between 15,000 and 16,000 feet, but the known base of medium cloud over the target area on 25 July forced readjustment of these plans after most of the aircraft were airborne. Actually some bombed from as low as 12,000 feet and few if any from the predetermined height; a fact which caused most bombardiers to recompute hurriedly their bombing data and reset their sights. Moreover, the drop to the new and lower bombing levels loosened formations. This added to the strain on pilots and was the more perilous because of the crowded air over the target area. It also tended to produce elongated bomb patterns as units dropped on their leaders. Smoke markers proved of little value. At best they were not visible until their smoke drifted high, and then the prevailing south wind quickly displaced it. Furthermore, once the attack had begun and great clouds of dust and smoke billowed up from the target area, red smoke was difficult to distinguish from shell and bomb bursts or from the muzzle flashes of American artillery. Under such circumstances it is remarkable that ORS experts, after elaborate scrutiny of records and strike photographs, found that bombing errors were actually less than had been anticipated in an operation of this type. This does not mean that all bombs were placed in the target areas. Partly because formations could not be kept tight, and partly because of extreme precautions taken against short bombing, approximately one-half of the 1st Bombardment's loads was delivered south of the prescribed destination. Spillage on the part of other formations extended both to the east and west of their targets, and bombs from seventeen units fell in the clear zone from which American troops had been withdrawn.

Gross errors in bombardment had been anticipated, and the prob-

## THE ARMY AIR FORCES IN WORLD WAR II

ability of their occurrence was known to both air and ground commanders. They occurred on 25 July and they were costly. The lead bombardier of one formation had trouble with his bombsight and released visually with bad results; another failed properly to identify vital landmarks, and the command pilot of a third formation, failing to observe the order that bombing was to be by groups, ordered "Bombs away" when his wing leader dropped in the cleared zone, and his own unit perforce followed his example. Thus frags and HE from a total of thirty-five heavies fell north of the target areas and within American lines. As early as 1040 hours reports from the continent to air headquarters in England told of short bombing as far back as American artillery positions, and though the hour was late, efforts were made again to caution those formations of heavies which had not as yet bombed. Mediums of IX Bomber Command likewise short-bombed, with forty-two aircraft dropping within friendly lines because of faulty identification of target. All the gross errors on 25 July were classified as personnel errors. Their cost was reported to be 102 army personnel killed, including Lt. Gen. Lesley J. McNair, and 380 wounded. Again, as on the 24th, casualties were concentrated in the ranks of the 30th Infantry Division.<sup>9</sup>

Air's effort on 25 July had been great, but military results are measured in terms of accomplishment rather than in terms of energy expended. The results of the air bombardment were definitely not all that optimists hoped for, but foe and friend agree that they were of more than ordinary stature. Enemy casualties were not extensive; in fact, they appeared small in view of the weight of aerial bombardment coupled with artillery's preparatory fires.\* Two factors help to explain this discrepancy. The first is the Germans' use of deep communication trenches and equally deep individual shelters. The second is the desire of the Army to avoid unnecessary cratering, which caused a high percentage of frags to be mixed in with high-explosive GP's. Direct hits were necessary to produce casualties, for a man in a shelter two feet from a crater rim was safe from any effect save that of concussion. Enemy evidence and that of Allied officials who later examined the battlefield indicate that thin-skinned vehicles were shredded and that the treads of armor were broken by flying fragments of steel. Where weapons were not destroyed they could not be

\* The war diary of the German Seventh Army in its entry for 25 July constitutes an exception to this rule for it records heavy losses in the MLR and in artillery.

used until after they had been cleaned of the dirt in which they were sometimes buried. The enemy alleged that much heavy material was withdrawn to the rear after the bombing commenced, but he was emphatic in his insistence that craters on main roads impeded movement both from and to the battle lines.

Prisoner-of-war interrogations are in full agreement that the destruction of communications and of morale was very great. Loss of communications had its immediate tactical effects since it left units without contact with the rear and without knowledge of what was happening on their flanks at a time when the dust cloud limited visual observation. Units fell out of control when men were separated from CP's and from their officers and NCO's; one group of four enemy tanks ran up the white flag before the ground assault had been launched. But above all, the destruction of communications bred a feeling of isolation among forward units which added to the shock effect of the bombardment itself. This shock pervaded the entire bombed area for, as Army Group B laconically recited, the bombardment consisted of "bomb carpets of hitherto unknown dimensions." Battle-trying and raw troops alike appear to have been affected; the younger men of both groups being the quickest to recover. Too easily overlooked, but repeatedly stressed by the enemy, was the shattering effect on morale produced by the very appearance of such a multitude of hostile planes overhead, with no GAF anywhere in evidence. They came on "like a conveyer belt," and Afrika Korps veterans labeled them *Partei-Tag Geschwader*, with reference to the well-aligned squadrons which had flown in dress parade over Nürnberg rallies in the peacetime period of Nazi rule. Morale was thus hard hit even before the "bomb carpets began to unroll in great rectangles."<sup>10</sup>

Maj. Gen. Fritz Bayerlein, commander of Panzer Lehr Division, was later to give a vivid picture of his experiences on this day. He was a seasoned front-line soldier—a tough tanker—and his statements have the hallmark of veracity, although they cannot serve as the basis for broad generalization. His communications had been destroyed in the first air attacks, and as the heavies began to come over soon after 1000 hours, he set out on the pillion of a motorcycle to visit his advanced CP at Le Mesnil Amey. There he observed the later stages of the bombing from a stone tower with walls two meters thick. What he could see of the battlefield he termed a *Mondlandschaft* (a lunar landscape). What he found there and at Hébécrevon and other points

which he personally visited was half of his three batteries of 88-mm. AA guns knocked out and his forward tanks pitched into craters or disabled by direct hits and by blasts which had thrown them on their backs. Communications both with his own regiments and with the corps was by runner only, and 70 per cent of his personnel was "either dead, wounded, crazed or dazed." Not until nightfall, when his forward lines had been overrun, was he able to gather together a small combat group from his scattered and shattered division.<sup>11</sup> In retrospect, von Rundstedt regarded the St.-Lô bombing as "the most effective, as well as the most impressive, tactical use of air power in his experience."<sup>12</sup>

The findings of American ground forces with respect to the results of air's part in COBRA were stated with a moderation both natural and proper. XIX Corps voiced its doubts as to the material assistance rendered the ground assault by air's strikes.<sup>13</sup> Other organizations agreed with the enemy's statements that disorganization was the most apparent result of saturation bombing. The 2d Armored Division noted shortcomings in the operation, among them the fact that the withdrawal to produce a safety zone was closely followed up by the enemy, with the result that the 1,500 yards given up had to be regained by fighting. And American armor, like enemy panzers, regretted the cratering of main highways, where damage done by 500-pound GP's required the services of engineers before advance was possible. This emergency, however, had been foreseen, and the engineers were on hand to do the job.<sup>14</sup> The 4th Infantry Division had been bombed, but in its advance it encountered only small-arms fire. The 30th Infantry Division not only had been short-bombed on two successive days but enemy-inflicted casualties among its infantry and tanks were the heaviest suffered by any American division. One of its leading infantry battalions was delayed in moving until reorganized and reinforced, but its armor was able to move out at once and assist in overcoming Panzer Lehr's resistance at Hébécrévon, in spite of the fact that the division encountered enemy artillery fire from the southeast as it assaulted. Maj. Gen. Leland S. Hobbs, commanding this division, was early at pains to point out that similar, and hence confusing, landmarks, together with the wind which funneled the smoke cloud to the north of the St.-Lô-Périers road, helped to explain the bombers' errors.<sup>15</sup>

Because of casualties inflicted by friendly planes, one leading battal-

ion of 9th Infantry Division also required reinforcements, and its advance was delayed from one to one and one-half hours, during which time German SS troops and paratroopers organized the most serious resistance which the division encountered. The 9th's other assault units attacked immediately after the aerial bombardment, gained ground, and went through their objectives. At the moment of action this division rated air's performance as very unsatisfactory. The division had anticipated that its men would "walk unharmed through the bombed area," but had found that they met with a fair volume of fire. Later judgment was of another order. The 9th observed that its own morale remained high, while that of the enemy "was definitely broken" and his defense installations, communications, and supplies badly disrupted. Even "though the results were not what we had expected, it never occurred to us that we could fail after the use of such mass aircraft."<sup>16</sup> VII Corps chronicled, as it must, losses at the hands of friends and listed the disorganization and the drop in morale which resulted, but voiced the opinion that "our losses would have been infinitely greater, and our success would perhaps never have materialized if it had not been for the all over effectiveness of this heavy bombardment."<sup>17</sup>

Five months after the action, when an airman raised a question as to air's efficacy on 25 July, Eisenhower was to declare that it was impossible "to convince the Army that the battle of St.-Lô had not been won as a result of the direct support given by the Eighth Air Force."<sup>18</sup> Later still, von Rundstedt was to attribute the American success to the air bombardment, the weakness of the battered German ground forces, and to the initiative of Allied armor and infantry.<sup>19</sup> FUSA, in its after-action report, followed the same general line as the enemy commander.<sup>20</sup>

The obvious defects of COBRA were made the subject of immediate and continued study. Means were sought to shorten the time interval between the cessation of bombing and infantry's advance, since at St.-Lô some enemy units had recovered from shock and reorganized their positions before American troops closed with them. A special ORS study on bomb fuzings for this special type of bombing was soon published and became standard. The training of bombardiers was intensified as the desire for heightened efficiency and the steady inflow of replacements alike demanded. The search for better bomb-line and target markers was carried on, and efforts were made

to establish a closer association of Eighth Air Force and ground forces when the former was functioning in a tactical role. The hunt was kept up to find the as yet missing link in communications and control: effective radio contact between ground controllers and bombers flying an air support mission.<sup>21</sup>

Air's role in COBRA was by no means limited to the mass bombardment of 25 July. With the intent of rendering general support, Second TAF had flown armed reces in the battle zone during the morning of the 25th, and in the afternoon it continued them, in some cases operating in what was normally an American area of responsibility.<sup>22</sup> On that same afternoon IX Bomber Command gave its attention to four targets in the line of interdiction, and IX Fighter Command flew four missions of group strength against rail lines well beyond the battle zone, while planes under the operational control of IX TAC pursued their steady course of air support in cooperation with FUSA. The battle front was still too fluid to admit of much close support, and consequently request missions were few. But armed reces in the battle area were constant during the remaining daylight hours of 25 July. Thirteen such missions in squadron strength were flown between 1135 and 2104 hours, with pilots selecting the usual wide variety of targets. They hit a bridge over the Sienne, in the neighborhood of Gavray, and bombed and strafed ammunition and fuel dumps in proximity to the battlefield. When roads near St.-Gilles were dive-bombed, the resulting explosions suggested that a jackpot had been hit. Steeple OP's were again singled out and two in the combat zone were demolished. IX TAC rounded out its day with four missions designed to render enemy night traffic hazardous by dropping bombs fuzed for delays of from one to twelve hours on crossroads in the vicinity of Coutances. Alone among the Ninth's fighter-bombers this day, the 406th Group encountered enemy aircraft. Some of its planes met fifteen of the GAF over Lisieux and claimed four destroyed for the loss of one missing.

### *The Air-Tank Team*

Infantry had figured most conspicuously in breaking the hard crust of the enemy's positions on 25 July, although on occasion armor had "punched its own hole." Planners had anticipated this success and had assigned two armored divisions and one of motorized infantry to exploit it. Their orders were to plunge south along the main road to Marigny

and that to St.-Gilles, and thence drive to objectives lying to the southwest. In anticipation of these movements by two combat commands from each of the two armored divisions committed to the action, IX TAC had developed plans for the closest kind of cooperation with the four armored columns. These plans were put into operation on 26 July as VIII Corps, and then XIX and V Corps together with the British right, joined with VII Corps in the drive south. As IX TAC's orders bearing the date of 20 July were tested, and improvements in their provisions were made in the light of experience, air began to write a new and brilliant page in the history of close support. Armored column cover (ACC) became a standard procedure, and the air-armored team began the swift and effective action which it continued until the Siegfried Line was reached.<sup>23</sup>

A technical innovation had much to do with the new team's success. As the plans for COBRA were maturing, the suggestion was advanced by Quesada that air cover of armored columns would be rendered more effective if an air support party (ASP) were put in each tank column and equipped with an air force type VHF radio to make two-way communication possible between the tanks and their escorting planes.\* Quesada's suggestion was welcomed by Bradley, and Ordnance was directed to send a tank to IX TAC for a trial installation. Through mischance the Sherman was dispatched to an armored division which promptly swallowed it. Its failure to appear at its proper destination caused a second Sherman to roll up to IX TAC's headquarters, but since no one on the spot knew what to do with it, it was returned to Ordnance with thanks. Higher command, now thoroughly agitated, managed to retrieve the second tank and an SCR of proper type was promptly installed. Tests showed that the capabilities of the device were so great that other installations were expedited with a top-priority rating which both Army Ordnance and IX AFSC observed.<sup>24</sup>

The basic principles in the first of the ACC orders remained essentially unchanged throughout the remainder of the war in Europe. "Each of the rapidly advancing columns will be covered at all times by a four ship flight . . . [which] will maintain a close armed recce in advance of the . . . column. They may attack any target which is identified as enemy, directing their attention to the terrain immediately in

\* Air support parties later came to be designated as tactical air liaison officers (TALOS), but the earlier designation, current at this period, is here employed.

front of the advancing column. The combat command commander may monitor [radio] channel 'C' to receive any information transmitted by the flight of FBs which is covering him. [He] may also request this flight to attack targets immediately in front of him. Targets which require more strength than the four ship flight will be passed back through ASP channels, and the mission will be accomplished by FBs on ground alert." The call signs given to ground units were added to flyers' vocabularies—2d Armored Division was "Abtide" and its combat commands "Cutbreak" and "Murphy"; 3d Armored Division was "Instand" and its fighting units "Poodle" and "Bronco." The plan was simple, and possibly on that very account, it worked with a singular perfection.<sup>25</sup>

On the very first day that such cover was provided, four groups dispatched a total of seventy-two squadron missions of the type ordered, with 368th Fighter-Bomber Group alone sending out twenty-five. This rate of performance was maintained, or exceeded, on good flying days during the critical period from 26 to 31 July. IX TAC could not have maintained that rate and at the same time have performed its other tactical duties had not the labors of IX Engineer Command enabled it to base sixteen of its fighter-bomber groups together with P/R and Tac/R units on Normandy airfields by the end of the month. The new fields were plagued with dust which not even Hessian mat could keep down, but ground crews worked their miracles of rearming, refueling, and maintenance notwithstanding.

Detailed records of the methods employed and of the extent of air's achievement in ACC are of an elusive character, for their original form was the conversations between tank commanders and their air advisers on the ground and flight leaders in the air above them. But in the closing days of July, when the procedure was still novel, some records, fortunately, were preserved. "Is the road safe for us to proceed?" was the question radioed on one occasion from tank to plane. "Stand by and we'll find out," came the answer, and in their ensuing sweep the four P-47's spotted as many enemy tanks on the road ahead and put them out of action. Returning to the air over their column, the planes radioed: "All clear. Proceed at will." When radio jammed, tanks used shells or machine-gun tracers to mark the target they desired attacked and got results. On another occasion a single Sherman was threatened with destruction at the hands of German panzers, but the covering planes observed its plight and managed to disperse the



enemy. In response to a column commander's request, the road ahead of him was swept with fire. The planes then radioed, "Go ahead," but instantly recalled that direction. "There's one we missed. Tank at right side of road. Next building up. 200 yards." Dive bombing eliminated the enemy block, and the ground column got under way again. To take one other example, the crew of a German tank fired by strafing was last seen surrendering to the American column. Such evidence of continuous ACC, drawn from the experience of the Ninth Air Force's fighter-bomber squadrons, at least indicates the intimacy prevailing in this growing association of armor and accompanying aircraft.<sup>26</sup>

Pilots diving to attack with bombs or machine-gun fire, and as swiftly regaining altitude, were not in a favorable position to observe the exact results of their own strikes, and their claims were often inexact and exaggerated. But on many occasions apparently inflated reports were proven to be sober truth, and even the exaggerations are meaningful, for they accurately reflect the exaltation of American airmen engaged, as they put it, in "hazing the Hun." Claims poured in, beginning with the first day of ACC, and they mounted steadily. On 26 July individual flights included in their reports such items as fifteen rockets fired, two tanks destroyed, one probably destroyed, one tank destroyed by strafing; eight bombs on two Mark VI tanks, left burning; two Tigers holding up our advance dive-bombed with poor results, then strafed and destroyed. The flyers were catholic in their choice of targets with claim lists for this and the ensuing days including staff cars, buildings, truck convoys, and, increasingly, horse-drawn artillery and horsed vehicles crowded together on the roads leading south.

The armor of VII Corps, together with escorting planes, had taken the lead in the breakout on 26 July, plunging along the roads from Marigny and St.-Gilles to points beyond Percy and Gavray. Thanks to this aggressive thrust to the southwest, VIII Corps, on going into action a day later, encountered less enemy resistance, and once under way, its columns moved even faster than those of the corps on its left. VIII Corps vehicles, with the identifying circled star on their tops freshly painted, pushed straight south along the highway which parallels the western Normandy coast, for FUSA had revised its plans and the pursuit was continued without halt. Lessay and Périers, Coutances and Avranches, Pontaubault and Ducey were successively entered as the enemy's western flank withdrew in disorder. The Germans, per-

force, threw caution to the winds and moved in daylight. No mere solitary motorcyclists on the roads now, but close-packed columns—lucrative targets for IX TAC's fighter-bombers. Air's resources were sufficient to exploit the situation as it developed, and armed recce in the battle area was the standard instrument chosen. The scale on which such action developed is remarkable. On 26 July, sixteen such armed recces were ordered with eight aircraft participating in each. The next day saw seventeen undertaken in varying strength. Ten more were staged on the 28th, six on the day following, and a single one on the 30th. Results were substantial in the case of most missions, but it was the 405th Fighter-Bomber Group which, on 29 July, furnished the highlight of a lively period.<sup>27</sup>

This group had been ordered to fly armed reconnaissance of the battlefield throughout the day, but bad weather barred operations in the morning. In the afternoon it cleared and P-47's took off from Picauville and directed their course to the Villedieu area. There they found few targets, but as the flight circled back toward Coutances they saw a mass of traffic on the roads, at times moving bumper to bumper, and they began to work it over systematically. Between Roncey and St.-Denis-le-Vêtu they discovered one column blocked on the east by elements of 2d Armored Division and on the west by elements from the 3d. Here was a fighter-bomber's paradise. The first flight to attack radioed the home controller to that effect, and operations were immediately laid on which caused the group to rotate its squadrons over the target throughout the long afternoon. From 1510 to 2140 flights attacked, returned to base, refueled and rearmed, and took off to attack again. In the midst of the melee a general shouted over his tank radio: "Go to it! Get one for me!" The target, extending over a road distance of more than three miles, was an extraordinary one. Two days after the action, American columns found the road impassable, and Army reports substantiated the pilots' claim with a list of 66 tanks, 204 vehicles, and 11 guns destroyed, and 56 tanks and 55 vehicles damaged by the combined action of American artillery, tanks, and planes. No wonder that, on returning to Picauville after delivering his attack, one youthful pilot had ejaculated: "I have been to two church socials and a county fair, but I never saw anything like this before!"<sup>28</sup>

The scale of IX TAC's tactical effort in the period from 25 through 31 July was unusual, even for that command. Its operations in that week were at times restricted by weather, yet its sorties totaled 9,840,

of which 655 were reconnaissance flights. It dropped over 2,000 tons of bombs and claimed the destruction of 67 enemy aircraft in encounters. Seventy-eight of its own planes had been destroyed, ten of them in air combat.<sup>29</sup>

### *Pursuit and Encirclement*

American G-2's and A-2's depleted their stocks of grease pencils in their effort to depict the rapidly developing situation of 26 July to 1 August on the acetate coverings of their situation maps. At the outset of that period the German Seventh Army had acknowledged a "serious breakthrough" on the St.-Lô front, and had ascribed it in part to the "enemy's concentrated employment of air power" which checked the concentration of German reserves.<sup>30</sup> At the end of the period, the situation maps left no doubt in anyone's mind that the breakout was solid fact. Aside from one brief interlude, the military themes of the August battles west of the Seine were to be the pursuit and encirclement of a defeated and disorganized enemy.

American forces, ground and air alike, played a major role in developing both these themes. Their action was as swift as their mass was great. They functioned the more effectively because in the early days of August their organization was perfected in a manner long planned. FUSA continued active with three corps under its command, but on 1 August the U.S. Third Army (TUSA), initially comprising four corps, became operational under the command of Lt. Gen. George S. Patton, Jr. On the same day Bradley's 12th Army Group formally assumed immediate command over the two armies from headquarters recently established at St.-Sauveur-Lendelin, and its first letter of instructions<sup>31</sup> contained the following information under the heading "Supporting Forces":

(1) Air Force

Ninth Air Force supports the Twelfth Army Group

IX Tactical Air Command will be in direct support of First Army

XIX Tactical Air Command will be in direct support of Third Army

IX TAC, therefore, continued an old association. A firm plan for air support on the ensuing day issued, as previously, from the daily joint conference at its headquarters at 1930 hours, and in urgent cases Army requests could be answered with a lapse of only sixty to eighty minutes from the time the request was received until planes were over their targets.<sup>32</sup> XIX TAC, under the command of Brig. Gen. Otto P.

## THE ARMY AIR FORCES IN WORLD WAR II

Weyland, became operational according to plan\* on the same day as TUSA, with headquarters established in close proximity to Patton's. From the start, the association of the organizations in the Combined Operations Section and in their respective headquarters was both friendly and effective. Three groups initially were assigned to XIX TAC, but the flexibility of the American air organization was accentuated by the fact that the final allocation of fighter-bomber groups between IX and XIX TAC was left for their commanders to determine.<sup>33</sup>

Under this new dispensation, it was essential that the advanced headquarters of Ninth Air Force be brought into immediate contact with that of the 12th Army Group. Accordingly, its operational headquarters at Uxbridge and the phantom advanced headquarters which had existed at Grandcamp les Bains since 8 June were closed at 2400 hours on 5 August, and a single advanced headquarters was opened at St.-Sauveur-Lendelin at 0001 hours the following day. Army and air signal organizations had provided the many necessary installations, and thereafter the planning and supervision of the Ninth's operations were conducted in close collaboration with the air section of the 12th Army Group. A huge circus tent, with attendant trailers, provided the scene of activity, and its site, in an open field with little or no camouflage, offered indisputable evidence that the associated units enjoyed the full advantage of air superiority. The joint labors of those who toiled within the tent led to the steady perfection of air support, and hence of means to apply air power with tactical effect. A-2's and G-2's, A-3's and G-3's pooled their information and devised joint plans. Briefings twice a day saw Army depict the ground situation and air relate the results of its recent efforts. Ground then presented its requests and with air arrived at an allocation of available strength and a determination of the air plan. Thanks to the existence of full information at advanced headquarters, these plans at army group-air force level were devised in a fashion which allowed an ample exercise of initiative by the associated TAC's and armies.

At approximately the same moment that this reorganization occurred, a change of command was effected in the Ninth Air Force. In June the establishment of an Allied airborne force had been approved, and Eisenhower had signified his wish that an American airman should command it. Teletypes exchanged between Marshall,

\* See above, pp. 112, 141.

Arnold, and Giles in Washington and Eisenhower, Smith, and Spaatz in ETO narrowed down the list of possibilities, as it became evident that certain individuals could not be freed from current duties or lacked the required combat experience. The choice was further restricted by the fact that it was desirable that the American commander should possess a rank equivalent to that of the senior British officers with whom he would be associated. After nearly a month had passed, it was determined that Brereton, who had commanded the Ninth since its inception, should assume command of the new First Allied Airborne Army; that Maj. Gen. Hoyt S. Vandenberg should succeed him in command of the Ninth; and that Maj. Gen. Ralph Royce should follow Vandenberg as Deputy Commander, AEF.<sup>34</sup>

Under its new as under its old commander the Ninth's design and function were supremely tactical. The design was logical, and the tactical functioning of the entire force improved as pilots and ground crews alike gained in experience and as commanders from group to air force learned valuable lessons in the same school. A greater understanding of one another's needs and capabilities was required at all army and air force levels, and a greater tolerance. Both could only be produced by the greater knowledge resulting from the intimate association of all parties concerned, from commanding generals down to the ASP's and ground liaison officers (GLO's) which operated with ground and air units, respectively. No sudden miracle was achieved, but progress was made through a variety of means. Pilots were regularly sent to spend time with ground units at the front. It was styled a rest period, but the results were seen in ensuing tactical operations. The A-3 of the 368th Fighter-Bomber Group spent the better part of a week with 3d Armored Division in an effort to further ground's understanding of air's capabilities.

As armored divisions developed the practice of using a number of combat commands in the course of their advance, the need for an added complement of ASP's became real. Although air force tables of organization made no provision for such officers even for corps and divisions, they were provided for the combat commands through a neat juggling of personnel allotments, even as by similar means they had been made available to the larger army units. Air stressed the need to keep ASP's with the divisions to which they had been assigned, regardless of divisional transfers from one army to another—a change which involved a shift from the responsibility of one TAC to that of

the other. GLO's in their briefings of air personnel assisted in the education of the air units to which they were attached, and in their interrogations of pilots they gathered information useful to Army G-2's. In periods of swift movement and uncertain communications, they were able to gain knowledge of the location of their own forward columns from such sources, a knowledge so valuable that it became standard procedure for returning pilots to report the location of the head of the column which they had just left. Since speed was a prime consideration, the report was sent to Army in the form of a hot news flash. Furthermore, it was soon found that ACC not merely provided a striking force for armor's use but that radio contact allowed the covering flight to serve as the eyes of the advancing column. The intimate day-to-day association, in planning and in combat, bred both increased tolerance and increased efficiency.<sup>35</sup>

In the first weeks of August there was no lack of action to produce such intimacy. Patton's Third Army had been given Rennes and Fougères as its initial objectives, with a drive west into Brittany to follow. On 3 August it was directed to pursue the Breton operation with a minimum of forces and to mass its power for a drive toward Mayenne. Relentless pursuit was the order of the day, for the enemy was clearly off-balance. As FUSA (now under Lt. Gen. Courtney H. Hodges) and the British swung on the Caen pivot and drove against Vire, Domfront, and Falaise, TUSA continued its main movement into the Le Mans area and in subsidiary operations extended its southern flank to the Loire. By 10 August, the Breton fortresses at St.-Malo and Brest were encircled; to the south, Rennes, Angers, and Nantes were occupied; and in its eastward drive, TUSA crossed the Mayenne at Mayenne and Laval and the Sarthe in the vicinity of Le Mans with other of its elements swinging north against Argentan.<sup>36</sup>

German resistance on the western flank was greatly reduced, and the enemy recorded that his own forces were split into small groups, wandering aimlessly in a generally easterly or southeasterly direction. They lacked arms and rations and their morale was badly shaken, thanks in no small part to "enemy command of the air."<sup>37</sup> Nevertheless, the American situation was a little perilous in two particulars. First, its drive to the south had merely opened a narrow corridor some twenty miles wide in the vicinity of Avranches. Through this vulnerable spot an incredible volume of traffic must pass as operations developed to the south and west. Second, as TUSA concentrated its

main effort on the drive east, its lengthening southern flank was left exposed. The latter problem was disposed of when, on 6 August, Patton turned over the task of protecting TUSA's southern flank to XIX TAC. The line of the Loire was thereafter lightly held by Third Army detachments, with planes of XIX TAC mounting guard overhead against possible enemy threats. Concern for the protection of the Avranches bottleneck is seen in Army's request that Weyland's command give protection to the bridges at Avranches—a request that caused five missions to be flown in that area on 2 August. With the same purpose in view, flights engaged in ACC were ordered to make periodic sweeps over the rear of their columns and in the direction of Avranches. Through XIX TAC provision was further made for two P-61's from IX Air Defense Command to be on constant night patrol south of Avranches and in the Pontorson area. To meet these and other requirements, the forces at the disposal of XIX TAC were increased and by 7 August nine groups were under its control. All were veteran units, and the greater part had already operated under Weyland when he was in control of IX Fighter Command in England.<sup>38</sup>

The need for both day and night cover of the corridor, and particularly of the Avranches and Pontaubault bridges, is explained by a recent development of GAF opposition. Up to this point the enemy air force had confined its offensive operations in the battle area almost exclusively to mine-laying. But German fighters struck at an armored column on 2 August, and the GAF on the night of 2/3 August began a series of small raids in the Avranches and Pontaubault area. Subsequently road convoys were attacked, virtually for the first time; and by night, when there was some use of glider bombs, the enemy managed to score near-misses on Patton's headquarters and to destroy an ammunition dump.<sup>39</sup> As this new activity suggested, plans were afoot for a counteroffensive, with the German Seventh Army scheduled to attempt a drive west through Mortain to the sea, and the GAF had been reinforced in an effort to provide much-needed air support.

German statistics are extremely confusing but emphasize the weakness of the GAF at this stage of the war. In July and August Luftflotte 3 appears to have received as replacements a total of 460 Me-109's and 440 FW-190's, but these gains were obviously offset by losses—524 being listed for July alone.<sup>40</sup> Because of numerical inferiority, the Luftwaffe avoided the use of large formations whenever the weather was good or the approach of Allied planes was anticipated.

There is reason to believe, as the German high command had observed in June, that units transferred from the eastern front lacked the experience necessary to oppose the well-trained pilots of the western Allies.<sup>41</sup> And in any event, the planes were forced to operate from bases far removed from the battle lines and subject to repeated Allied attacks. In spite of these difficulties, however, the GAF made its first considerable effort against the invading forces in the early weeks of August with an average of about 400 sorties per day.<sup>42</sup>

The plan for the Mortain drive had been meticulously drawn up in Berlin, where Hitler still demanded the impossible of his generals in the West. Five panzer divisions were to be massed under the control of the Fifth Panzer Army, whose commander, Col. Gen. Joseph ("Sepp") Dietrich (like Gen. Paul Hausser, now commanding Seventh Army), was an SS man. In spite of this affiliation with Nazi zeal, the veteran tanker saw a double danger if the plan were carried into execution. The armored striking force could only be assembled by disengaging the panzers, and although they were to be replaced by infantry, the resultant diminution of strength on the northern flank would imperil Falaise. Furthermore, he considered it "impossible to concentrate so many tanks without inviting disaster from the air." To all such objections Field Marshal von Kluge (C-in-C West) replied: "It is a Fuehrerbefehl (Hitler order)." An order from the German Seventh Army, in an apparent show of resolution, declared that on "the successful execution of this operation . . . depends the decision of the war in the West, and with it, perhaps, the decision of the war itself," but upon receiving Hitler's order on 1 August, von Kluge had warned his superiors that "to the best of my knowledge and conscience, the execution of this order means the collapse of the whole Normandy front." The Fuehrer's will prevailed, however, and what the Germans called Operation LIÉGE was launched on 7 August. Prudently, in view of the air situation, H-hour was placed shortly after midnight.<sup>43</sup>

Although the struggle continued for over a week, the fate of the German offensive was determined in the first twenty-four hours of fighting. FUSA's 30th Infantry Division bore the weight of the initial attack. Although the division had only recently arrived in the area, it held well and two other divisions were rushed to its assistance. Mortain itself was overrun and a battalion of the 117th Infantry was left isolated in that vicinity, but the enemy spearheads were brought to an abrupt halt when still sixteen miles from their Avranches objective.



They struck a strong rather than a weak point in the opposing line, for the Americans had sensed that the attack was coming and were prepared for it. In addition, the weather played the Germans false. The days preceding 7 August had seen air action restricted, and on occasion all but eliminated, by low-hanging cloud. The German assault, begun at night, in its initial stages had moved through mists but, as von Kluge later lamented, "the barometer remained high" from 7 to 18 August and the mists lifted on the first day of action. IX TAC flew 429 sorties on 7 August, chiefly in the threatened area. Its old companion, Second TAF, responded to a request for assistance by directing nearly 300 sorties of its rocket-firing Typhoons into the Mortain region, while XIX TAC, busy as it was in Brittany to the west and in the Argentan-Le Mans area to the east, dispatched a group to strengthen air support and covered the fighting area with P-51's. The entire effort was well coordinated by the tactical headquarters in action which afforded further evidence of the Allies' ability to mass their tactical air strength.<sup>44</sup>

Allied claims of tanks destroyed were undoubtedly exaggerated, but the enemy recorded air's substantial success. The 1st SS Panzer Division, bearing the proud title of *Liebstandarte Adolf Hitler* (Adolf Hitler's Own) reported fighter-bomber attacks of such caliber as it had never before experienced. Von Lüttwitz, commander of 2d Panzer Division, the only German armored unit to enter the battle with normal strength, was more explicit: "We made a swift advance of about ten miles and suffered only three tank losses. 116 Panzer Division made only limited progress. . . . Suddenly the Allied fighter-bombers swept down out of the sky. They came in hundreds, firing their rockets at the concentrated tanks and vehicles. We could do nothing against them, and we could make no further progress."<sup>45</sup> Equally grim were the entries in Seventh Army's war diary: "The attack has been brought to a complete standstill by unusually strong fighter-bomber activity," and later, "The actual attack has not made any progress since 1300 hours because of the large number of fighter-bombers and the absence of our own Air Force."<sup>46</sup> The transportation officer of that same army was to add a pertinent postscript to these notations when he declared that Allied interdiction had prevented the rapid build-up of the German striking force to the strength required to accomplish a breakthrough.<sup>47</sup>

As night closed in after the first day of fighting, Hausser ordered

that "the attack be continued as soon as air situation permits."<sup>48</sup> But steady resistance on the ground, which speedily developed into a counterattack, and air's continued onslaughts in support of both defense and offense rendered this impossible. The isolated American battalion near Mortain, assisted by medical supplies which artillery packed into the emptied bases of smoke shells and fired into its lines and by additional supplies dropped by C-47's and P-47's, held out until relieved on the 11th as the American lines surged forward.<sup>49</sup> The enemy had thrust his concentrated armor into a trap, and by 11 August he was aware that American armored and air concentrations made his position hopeless. Even Hitler was forced to bow to the logic of events and permit a limited withdrawal. Two days later von Kluge, increasingly alarmed at threats to his rear developing from north and south in the direction of Falaise and Argentan, recommended a genuine withdrawal to the Flers area on the ground that if "the widely spread front line remains as it is . . . , it will be broken through and surrounded by the enemy, with his superiority in men and materials, and his mastery of the air, and our units could not fight their way out."<sup>50</sup>

The application of pressure at the Caen hinge had contributed to the distress of von Kluge's northern lines, since Montgomery had ordered an attack in the direction of Falaise as Patton swerved north toward Argentan. To speed his own effort, the British general requested direct support from the heavy bombers, and on the night of 7 August the RAF dispatched over 1,000 planes to bombard areas flanking the projected assault. Artillery then took up the fire, and motorized infantry in their armored "Kangaroos" bounded through the enemy lines. This first phase of the action was fully successful, although weather and smoke blanketing target markers allowed only 637 of RAF's bombers to attack.

The second phase opened on the following day with the Eighth Air Force playing a supporting part. Its bombardment was to be directed against four areas by formations flying parallel to the front lines and delivering their attacks progressively from north to south in the general manner of a creeping barrage. The adoption of this procedure involved a long flight over enemy territory and greatly magnified the ever present problems of navigating in heavy traffic. Hence special precautions were taken against bombing errors. Artillery was to smoke the edges of target areas which were also to be marked by dropped flares. Scouting aircraft were to give information on weather

over the targets and to check on the target markers, while troops were withdrawn nearly a mile from the northern edge of the area to be bombed. The American heavies attacked at about 1300 hours on the 8th, flying straight and level through intense and accurate flak. Good concentrations were effected on three areas; the fourth was not bombed because it proved impossible to make positive identification of the target. Of the 678 bombers dispatched, 492 attacked. In spite of precautions taken, there were errors which resulted in the bombing of points outside the target areas but within enemy lines. Short bombing within friendly lines resulted from gross errors on the part of two twelve-plane groups. In one case, faulty identification of target by the lead bombardier led him to drop near Caen, although fortunately some other bombardiers of the formation cautiously refrained from dropping with him. In the second instance, a badly hit lead bomber salvoed short and the rest of the formation followed in regular routine. Canadian troops were thereby in some measure disorganized, and suffered casualties amounting to 25 killed and 131 wounded. Eighth Air Force losses were counted at 9 heavies destroyed by flak and over 200 damaged in varying degrees. The safety precaution of adding five minutes to the interval between the end of bombing and the jump-off by ground forces, coupled with the depth of the Canadians' preliminary withdrawal, may well have given the enemy opportunity to recover from his initial shock before the ground attack developed. At all events progress was slow. By 11 August, Operation TOTALIZE had gained some eight miles, but Falaise was still as many miles away.<sup>51</sup>

In the course of their attack on 8 August the Eighth's bombers had the novel experience of meeting a small formation of GAF fighters close to the coast.<sup>52</sup> Their presence there, though ineffective, was evidence of the Luftwaffe's current determination to aid the distressed German armies and in some measure to challenge Allied air supremacy. The challenge was sufficiently serious to require extra effort on the part of the TAC's, which were led to provide planes as escort cover to those engaged in ACC. But it was a challenge eagerly accepted by British and Americans alike. The latter certainly had good hunting as they warred on German "bandits" in the days between the opening of the German drive against Avranches on 7 August and the closing of the Falaise-Argentan pocket on the 19th.

It was the XIX TAC which met the enemy in the air most frequently, probably because its assigned mission caused its planes to

range close to the Paris area, where enemy airfields were numerous. On every day but one of the two-week period here involved its units engaged in air combat; a fact which is the more remarkable since on five of these days weather limited the command's operations. On occasion weather played favorites, leaving American bases socked in and pilots restive while German fields remained open. Under such circumstances small enemy formations attacked columns of the 4th Armored Division and 79th Infantry Division with impunity from air countermeasures. But when weather allowed, XIX TAC's P-47's and P-51's were active and generally successful, even when the odds were against them. As the Germans lunged against Mortain on 7 August, four American formations encountered the GAF in the Chartres-Le Mans-Mayenne area, claimed fourteen and lost two. On the same day, attacks on two busy enemy fields near Chartres brought claims of nineteen destroyed on the ground at the cost of three P-51's. The 9th was marked in the annals of XIX TAC by a record high of 780 sorties, and by three enemy encounters. "Exclaim" (the 79th Infantry Division) vectored covering planes to attack two strafing Me-190's, caused their own AA to withhold its fire as the P-47's attacked at 700 feet, and voiced its thanks when one of the Germans was destroyed. One squadron of the 362d Fighter-Bomber Group, operating near Le Mans, was bounced by twenty-five of the enemy and before the German formation broke away, it had lost two aircraft.

A reckless squadron of the 406th Fighter-Bomber Group scattered its adversaries on 11 August by resort to the unusual device of rocket fire. On the 13th, one eight-plane unit from the 363d Fighter-Bomber Group sighted twenty-five enemy dive bombers and drove them off after destroying eight, while another formation blasted four from the skies at the cost of one. The following day saw a quartet of P-47's from the 405th Group bounced by sixteen of the enemy who cut in under the covering formation. Here the Americans destroyed three but lost four. 15 August was the 373d Group's day. As its formations were attacking the base at Bretigny, one of them was jumped by an equal number of the enemy, whose aggressive spirit fortunately was not accompanied by a high degree of skill. The enemy lost five planes. Other XIX TAC units encountered opposition near Chartres and Cernay la Ville and reported eight planes destroyed with half as many lost. In spite of the bad weather which prevailed on 16 August, the veteran 354th Group further distinguished itself. An eight-plane squadron of its P-51's met seventy bombed-up FW-190's and imme-

diately attacked. At a cost of two aircraft, the Americans brought down an equal number of the enemy and dispersed the formation. In a second encounter, a squadron of like size took on twenty of the enemy over Maintenon. The P-51's climbed above their adversaries and struck, whereupon some sixty other German planes swooped out of the clouds to join in the melee. For fifteen long minutes there was a wild fight from 11,000 feet to the deck, and at its close the score was 11-2 in favor of the AAF. The Germans thus occasionally appeared aggressive, but they lacked training and, probably because of their slender resources, they assumed the offensive chiefly when they had superior numbers or expected the advantage of surprise.

On the 19th the enemy learned that it was dangerous to attack an American column when supporting aircraft were within call, for eight planes of the 371st Fighter-Bomber Group were vectored to a point in the Dreux area and destroyed two of eighteen enemy dive bombers. That same day a squadron of the 406th Group, strafing an airfield near Pontoise, was jumped by enemy fighters. A second American squadron came to its aid, but in a series of dog fights with a strongly reinforced enemy five P-47's were lost, though not before as many enemy planes had been shot down. Another squadron of the same group performed notably when bounced by a superior enemy force near Paris. The American planes were out of ammunition and immediately hit the deck, where their skilful maneuvering caused two German ships to crash. At the close of a fight on 20 August between eight planes of the 362d Fighter-Bomber Group and four times that number of enemy, the score stood 6-2, one American pilot being credited with four kills. Even Tac/R planes, habitually operating in pairs, met and vanquished the enemy, and Allied fighters repeatedly proved themselves more than capable of coping with a reviving challenge from the GAF. If the air umbrella over Allied forces leaked a bit in spots, it was so effective that ground troops tended to expect complete protection and to protest vigorously if they were robbed of even a part of their rest at night by bombing, or if their movements by day were even occasionally subjected to air attack. Air had earned the right to have such protests made.

### *The Falaise-Argentan Pocket and Gap*

With the failure of the German thrust toward the coast and with the Falaise-Argentan pocket taking shape, air's mission of close support again became pre-eminent. It also became increasingly difficult

## THE ARMY AIR FORCES IN WORLD WAR II

to accomplish. The fronts were for the most part fluid, and in the prevailing confusion bomb lines were constantly shifting. Since all were naturally concerned to avoid the bombing of friendly troops, the area in which close support missions could be carried out was steadily restricted.

On 17 August the bomb line was entirely removed from the pocket west of the narrowing Falaise-Argentan gap, and theoretically air activity over the beleaguered enemy in that area ceased.<sup>53</sup> Two days previous to this, when German concentrations offered most appealing targets, Spaatz, Tedder, and Harris had signified their desire to "hit the Germans inside the bag" with heavy bombardment. They stressed the fact that such an effort would require careful planning on the spot—not in England—and at an Army level if the obvious difficulties were to be surmounted. The 21 Army Group approved in principle but noted the difficulty of properly warning the advancing Allied troops. Bradley's opinion was sought, and he in turn took counsel with Ninth Air Force. Its opinion, rendered as Harris held his bombers ready, was that while such bombing was a possibility, it was a practical certainty that American and British casualties in large numbers would result. The Ninth, therefore, advised against the project, and the fat targets in both pocket and gap remained the almost exclusive property of the fighter-bombers. Doolittle was keen to use the fighter-bombers of VIII Fighter Command to maximum advantage if general strafing were ordered, but he was averse to employing them within the tactical area because they were not accustomed to working close to troops. Accordingly, the Eighth's fighters continued their useful activities chiefly in the area east of the Seine and south of Paris. In fact, as pocket and gap were progressively constricted, close-in enemy targets came to lie largely in Second TAF's area of responsibility.<sup>54</sup> That vigilant RAF command had been most helpful at Mortain on the 7th, and two days later IX TAC had been able to return the courtesy in some measure by informing RAF 83 Group of rich road targets within the Flers-Argentan-La Ferte Mace triangle, which Typhoons promptly attacked. Coningham later voiced his thanks to Vandenberg for the "big field days" afforded to Second TAF as a result of this Allied team work.<sup>55</sup>

There was, nevertheless, solid work of direct support for American tactical units to undertake, though all the skills which they had amassed were required for its accomplishment. The ground situation

was confused by the existence of enemy pockets of resistance in areas which had been overrun and by deep, but narrow, penetrations into enemy territory on the part of Allied units. "Know your target before you hit it" became the standard maxim, and orders prescribed that there should be no strikes made within the rather uncertain bomb lines unless specifically ordered. Even so there were sufficient instances of Allied attacks on friendly troops to render the latter trigger happy and to add a further peril to those which airmen must normally encounter. On the 15th, American planes strafed the newly established headquarters of TUSA and XIX TAC near Laval, where a pilot of VIII Fighter Command was shot down, and on the same day friendly troops southwest of Carrouges were subjected to attack. Other equally tragic events were burned into the memories of individuals who fought on the ground and in the air in this period of swirling battle but, like the shorts of supporting artillery, they must be set down as the inevitable accompaniment of close support.<sup>56</sup>

Missions flown by American airmen were classified as armed recon or as ACC in the records kept by their commands. But the effectiveness of ground controls in these days stripped any such formal distinctions of their meaning. ACC's were instructed to conduct armed recon in advance of the columns which they escorted if no targets were available; and ground was likely to vector planes assigned the general mission of armed recon to very specific targets. In either case tactical results were achieved. As Patton's columns converged on Argentan, XIX TAC's groups were particularly active. On 10 August ground recorded their destruction of tanks and their silencing of mortar and artillery positions. In the days which followed they were credited with allowing American columns to continue the advance after offending armor had been destroyed or guns eliminated, and on one occasion they even played the leading role in the surrender of enemy ground troops. This last occurred on 14 August, as a squadron of the 405th Fighter-Bomber Group assigned to cover the 7th Armored Division, was busy strafing northeast of Carrouges. When Germans in the road waved white flags, the planes buzzed the road and shepherded the Germans into a column which then marched toward the American lines to surrender.<sup>57</sup>

IX TAC, committed as always to support of FUSA, flew over 6,600 sorties in the period 7-20 August, chiefly in direct support, with a high of 673 and a low of 161 for a single day's operations. Its missions

were almost exclusively those which were planned in cooperation with its ground companion to meet an ever changing situation. Running "flying interference" for its old friend, the 2d Armored Division, the 366th Group bombed woods southeast of Brécy on 7 August, and as the smoke from the ensuing explosions towered to a height of 2,000 feet "Murphy" asked that the planes eliminate a group of concealed enemy 88's and followed through with congratulations on a fine job done. Near Sourdeval, on the 10th, the 50th Fighter-Bomber Group dealt with three antitank and six light guns to ground's satisfaction, and two days later in the same area, IX TAC's formations blasted six smoke-marked positions held by German infantry. At "Poodle's" (3d Armored Division) request, the town of Ranès was twice bombed by the 404th Fighter-Bomber Group on the 15th. Two days previously, battered elements of 1st SS Panzer Division had reached this area after being "held up by waves of Jabos attacking."<sup>58</sup> By way of variety IX TAC struck at enemy dumps in or near the battle area every day from the 8th through the 13th. Its planes also delivered plasma to advanced units of the 3d Armored Division two and one-half hours after the unusual request was received, and aircraft of the 48th Group, escorting troop carriers bearing supplies to the "lost battalion" near Mortain, embraced an opportunity to hit three gun positions.

As the trap gradually closed, new assignments were given to the American armies. On 13 August TUSA's movement through Argentan toward Falaise was halted, and soon after its XV Corps was directed to resume its drive eastward. FUSA took over responsibility for further action to close the southern jaw of the trap, receiving one armored and two infantry divisions which had been under the other army's control. As request missions decreased in number with the diminishing size of the attack area, IX TAC and Second TAF devoted themselves to clobbering German concentrations. On 13 August, when fourteen group-strength armed recces were flown in the battle area, the 366th Group spotted a line of German tank trucks on a road near Carrouges. Camouflage had been attempted, but keen-eyed pilots noted trucks "under trees in the middle of the road," and their strike resulted in explosions and fires along a line one and one-half miles long. The Germans' enforced concentrations on the ground were matched by congested traffic patterns in the skies overhead, but there the traffic was Allied. American pilots took over attacks as the British left off, and on occasion formations were forced to queue up and wait



their turn to strike. Enemy columns were blocked, head and tail, and the immobilized vehicles were worked over at leisure and systematically. Pilots submitted claims of vehicles destroyed which would have been written off as preposterous had they not been attacking such lucrative targets, but as one returning pilot put it on 17 August, "The whole goddam German army is moving through the Gap."

The pocket became a shambles, and the enemy knew freedom from attack only when chance determined that his position lay within the Allied bomb line. To use main roads was fatal, but secondary roads were speedily clogged with the debris of blasted vehicles. Enemy problems of supply, always acute, became exaggerated, and panzers committed *hara-kiri* for lack of fuel or ammunition. Many German prisoners taken in this period expressed a greater dread of artillery's massed fires than of fighter-bomber attacks—shells seemed terribly personal and the fires lasted longer than those resulting from dive bombing or strafing.<sup>59</sup> But General Bayerlein, with the remains of his division now organized as *Kampfgruppe Panzer Lehr*, developed an opposite opinion as he struggled to escape eastward. Allied "Jabos" struck his congested columns on the roads near Habloville with the usual devastating effect. They cut his wire communications and, continuing their attack without respite, made it impossible for his radio to be manned. These attacks became intensely personal for the general, when from a slit trench in which he had sought safety he looked out to see, he felt certain, one low-swooping pilot staring straight at him through the plexiglas.<sup>60</sup> Von Lüttwitz, with only fifteen tanks of his 2d Panzer Division still operable, struggled to break out of Bailleul as the gap closed, but the night movement he had ordered proved impossible because of the debris which cluttered all roads. He was able to extricate only a remnant of his remnant by filtering small detachments through the Allied lines. Organized direction of a more general movement was out of the question amidst the chaos produced by air and artillery bombardment.<sup>61</sup>

Rumor had it that time bombs, dropped by Allied airmen, denied Patton the chance of smashing from Argentan straight through to Falaise. From 10 through 13 August such bombs, fuized to a maximum of a twelve-hour delay, were planted over a wide area by IX TAC and IX Bomber Command with the purpose of rendering enemy movement hazardous "on the routes of retreat he was likely to follow in his effort to escape encirclement." Prior to the last day's missions

the Canadians, who were advancing into the general area thus bombed, were warned of possible danger from this source, and because of fears lest the Allied advance be hindered, the maximum fuzing permitted on the 13th was for a six-hour delay. The known effect of the bombings, however, stands in no demonstrable relationship to the rumored one. If the times of air attacks, together with the location of their targets and their bombfalls, are matched against TUSA's penetrations, it is clear that the halt order of 13 August could not reasonably have been occasioned by fear that delayed-action bombs would take American lives. Furthermore, available evidence indicates that the order was due rather to fears of confusion, or even more calamitous results, if existing inter-army boundaries were changed, and to the desire of the higher command to get the Third Army back on its west-east axis in order to win crossings over the Seine.<sup>62</sup>

#### *Interdiction Revised*

In the August days marked by the fighting around Mortain and in the Falaise-Argentan area, the enemy continued to feel the effects of a sustained interdiction program. Late in July Hitler was at last ready to allow mass movement of infantry from his Fifteenth Army in the Pas-de-Calais. But the decision thus laggardly made came too late to influence the tides of battle, since, in Montgomery's graphic phrase, the newly arrived divisions "found themselves reinforcing failure."<sup>63</sup> They were the less effective because their movements were as haphazard as those of units earlier moved into Normandy. The 331st Infantry Division started by train, but was soon forced to the now usual *Landmarsch* after a roundabout rail journey which carried it close to the Belgian border. The 84th Infantry Division departed from the Le Havre area on bicycles, and four days of frantic pedaling brought the troops exhausted to the Mortain battle. Gen. Eugen-Felix Schwalbe, commanding the 344th Infantry Division, received orders to move west on 3 August. His service troops marched to Rouen in three days, but his infantry, which should have covered the seventy-five miles to the assembly area in twenty-four hours by rail, consumed nine days in a delayed movement over circuitous routes and arrived after the Falaise battle had been lost.<sup>64</sup>

In spite of added evidence of its success, however, the interdiction program was subjected to radical revision in this period. The need for such action was imposed by the swift advance of the American armies,

# INTERDICTION MAY — AUGUST 1944

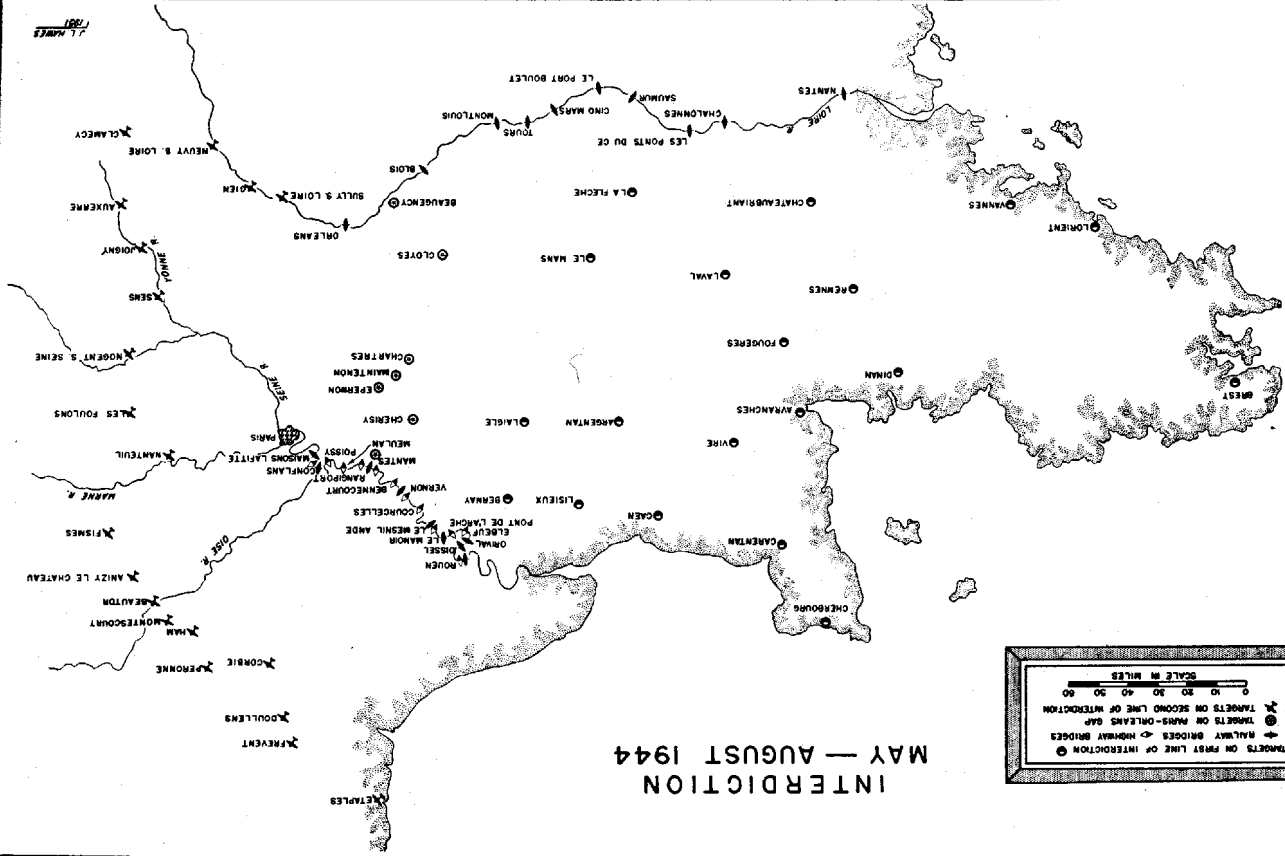
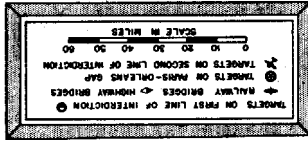

J. L. HARRIS

in particular by that of Patton's Third Army. As VIII Corps began to swing its combat commands into Brittany, it was clear that the destruction of bridges there would impede their advance; hence attacks on them, and on enemy fuel dumps as well, were banned on 2 August. The 12th Army Group's requests of 2 and 8 August ended attacks on all rail targets west of a line from Rouen up the Seine to Mantes, thence through Dreux, Maintenon, Chartres, and Cloyes to the Loire at Beaugency and west along the Loire to Nantes. Initially only the Loire bridges on this line were exempted from bombing, but on the 17th orders from AEAf stipulated that no bridges of any kind were thereafter to be attacked without its express authorization.

Furthermore, in the period marked by these mounting prohibitions, the basic purpose of interdiction underwent a gradual change. Its original intent had been to choke off enemy movements into the battle area. By degrees the purpose of blocking movements out of that very region came to receive major accent. The new accent is to be discerned in the comprehensive revision of the interdiction program announced by AEAf on 9 August. Under the terms of this instruction, Seine rail and highway bridges north of Paris still constituted a first priority, but a second line of interdiction, marked by twenty-one rail bridges, was established with second-priority rating. This line extended from Étampes through Péronne, Fismes, Nogent-sur-Seine, and Clamecy to the Loire at Sully and constituted an arc lying approximately seventy-five miles to the north, east, and south of Paris, the French capital and the hub of the French rail system. Further elaboration of the new program called for air attacks on nine rail bridges over the Oise River and on nineteen rail centers east of Paris, to which lower priorities were assigned.<sup>65</sup>

Bridges on the second line of interdiction had been occasionally attacked in June, and since 1 July they had been in the category of recommended targets. However, the major fraction of the total weight of strikes against them was delivered in August, and not until then were the attacks developed systematically. As VIII Fighter Command conducted particularly devastating attacks on rails and rolling stock east of the Seine, the heavies of the Eighth struck mightily at a wide variety of freight yards extending east through Alsace and Belgium into Germany. The heavies also engaged in attacks on designated bridges along the second line, where they had achieved marked success two months earlier, but because the bridge targets were pin-

points and because weather was often unfavorable, results were not proportionate to the effort made.<sup>66</sup> The Ninth's fighter-bombers were engrossed in their essential work of close support and in attacks on road targets, and hence the major American contribution to the revised program was left to IX Bomber Command. Its attacks on Loire bridges had ended on 2 August, bridges on the Seine were attacked only as repairs to them required, and targets in the Paris-Orléans gap were the objectives of a comparatively small number of medium missions flown through 14 August. Consequently, the mediums could, and did, concentrate their effort on the other bridges listed in the new schedules, beginning their strikes on second-line bridges on the 3d, when the new program was not as yet fully formulated, and continuing them through the 16th. Centering their effort on twelve of the seventeen structures between Frévent in the north and Neuvy-sur-Seine in the south, they claimed that as a result of single or repeated attacks six were rendered unserviceable. The Oise bridge at Conflans had been destroyed in May and remained impassable, but IX Bomber Command bombed seven of the remaining eight over that river between 9 and 15 August and blocked them all at least temporarily.<sup>67</sup> Targets on the second line were thus subjected to systematic attack only in the short period between issuance of the 9 August directive and 16 August, when the advance of Allied columns made the further destruction of bridges "unnecessary and even disadvantageous." The results of the attacks delivered were naturally less than those obtained by the bombing of like targets on the first line of interdiction during a longer period. In the latter case, traffic had been reduced by over 96 per cent; in the former, the traffic cut amounted to but 65 per cent. This meant that fifty trains per day might pass over the twelve routes involved in the second line.<sup>68</sup>

It is noteworthy that in the period when the Germans were trying to escape from the gap and withdraw to the east significant exceptions were made to the rule of no bridge attacks west of the Seine. In those days, and at Army requests, IX Bomber Command not only planted delayed-action bombs on retreat routes but struck in strength at bridges over the Touques and Risle rivers. The latter attacks were concentrated on 14 August and during the three days which followed. Weather canceled one four-group mission, limited the effect of others, and rendered difficult any accurate assessment of damage done. Here the tactical purpose was exclusively that of restraining the enemy's retreat.<sup>69</sup>

*In Brittany and along the Loire*

Although in early August attention was generally fixed on the Normandy battle area and points to the east of it, American air forces were compelled also to find both time and strength to support a decision to reduce St.-Malo and Brest in Brittany. XIX TAC furnished ACC for VIII Corps columns as they rapidly converged on those fortresses, and that command continued to be responsible for rendering the assistance requested by ground troops seeking their reduction. Fortunately, the citadel of St.-Malo was speedily disposed of, but installations on the near-by Île de Cézembre held out until 2 September and enemy forces at Brest persisted in a stubborn defense until 19 September.

The capture of the citadel at St.-Malo on 17 August was one for which ground action was solely responsible. Although IX Bomber Command delivered three attacks, the concrete shelters were so deep that bombs barely made their lights blink and the gun emplacements were so well built that not even 1,000-pound semiarmor-piercing bombs could penetrate them. The Île de Cézembre had such nuisance value that a seaborne assault was suggested. Its guns impeded the progress of the attack on the St.-Malo citadel, commanded the sea approaches to that port and likewise, though in lesser degree, those to Granville on the Cotentin shore. Ground and naval artillery joined with air's repeated bombardment of deep-dug shelters and heavily built emplacements. IX Bomber Command began its attack with the aid of flares on the night of 6/7 August, and returned in some force three times more. XIX TAC used the island as a target of last resort on one occasion and delivered a planned strike on the 23d. Fighter-bombers of IX TAC's 370th Group, diverted from their planned attack on St.-Malo by the citadel's surrender, dropped napalm on the obstinate island on 17 August and again added the spectacular, and much photographed, effects of that new weapon to a ground-air-sea bombardment on the 31st in which RAF Lancasters also joined. By September, the combined effort of the several services had destroyed all of the offending island's surface installations and pockmarked its entire face with craters. Heavy artillery found help in dealing with pillboxes and embrasures through the removal of camouflage and earth coverings by air bombardment, but napalm, though burning out one surface shelter, produced little effect on the garrison, whose casualties

were generally light. The island stronghold's surrender on 2 September was apparently induced by a water shortage resulting from the destruction of its distilling plant.<sup>70</sup>

Operations designed to reduce Brest, a port on which high value had been placed as a potential supply base for the advancing Allied armies, constitute a strange and highly individual story. The operations have been properly described as "curiously independent," for VIII Corps (Ninth Army after 5 September) was left far behind the eastward thrusting armies and appeared to be fighting its own private war. SHAEF and the 12th Army Group, however, set so great store on the action to which VIII Corps was committed that from 25 August until 9 September air strikes in the area were accorded a very high, and at times the highest, priority. In consequence an abundance of air strength was employed.<sup>71</sup>

From the opening of the assault on 25 August until the final capitulation on 19 September, air operated under distinct disadvantages. Its power could only be applied effectively if communications were good, and at Brest they were markedly deficient. In consequence, ground forces were often left without knowledge of air's intentions, while air too often lacked the requisite information upon which to base proper, and of necessity detailed, planning of operations. Intelligence with regard to the exact nature of the targets to be attacked was often sketchy, and on too many occasions air was asked to bomb invulnerable targets. The service of technical experts, to determine what targets could be most profitably attacked and what bombs and fuzings should be used, was not employed, although available, and air-ground assaults were at times badly coordinated.<sup>72</sup>

Since the German garrison could receive neither reinforcements nor supplies, and since enemy planes did not operate in the area, Allied air forces could concentrate their full attention on direct tactical support of the ground attack. Heavy bombers of the Eighth were four times brought into play and those of the RAF twice. The mediums of IX Bomber Command were employed on six occasions, on one of which its new A-26's flew their first mission.

The defenses of Brest were rugged, with concrete pillboxes and emplacements supplementing the perimeter defense built around a series of old forts which had been modernized. In general they were not targets which could be demolished by air attacks—no case was later found of a concrete emplacement so destroyed, and a 12,000-pound

Tallboy dropped by RAF, which created a huge crater 200 yards from a 105-mm. gun emplacement, failed to damage the emplacement itself. Under such conditions, and with information so scanty and communications so poor that it took the better part of two days to lay on a bomber strike, the missions of the heavies and of mediums alike involved a considerable waste of effort. Their attacks, made in strength on six different days between 25 August and 14 September, did no material damage to modern concrete structures, although they destroyed some open emplacements, pulverized old masonry works, and filled ancient moats with debris. In addition, they undoubtedly wore down the enemy, disturbed his communications, and hurt his morale—to what exact extent we cannot know. Thanks to added precautions and the considerable distance which generally separated the bombers' targets from the front lines, there were no casualties suffered by friendly troops in these or other air operations at Brest.<sup>73</sup>

The effort of fighter-bombers at Brest was intense, two or more groups from IX TAC being assigned to the operational control of XIX TAC on each day from 5 to 10 September to strengthen the latter's available forces. With the port accorded top priority on the 2d, it was planned to use all of XIX TAC's nine groups plus five or more of IX TAC's nine, but a personal visit by Weyland to VIII Corps disclosed that the prevailing scarcity of artillery ammunition so limited VIII Corps plans that a force of this size could not be used. On the 5th, however, twelve of the Ninth's eighteen fighter-bomber groups were over Brest.<sup>74</sup> Fighter-bombers functioned whenever flying was possible. Their planned attacks could be delivered two to six hours after requests were received, and the much-used device of placing planes on air alert over the assault area enabled ASP's to direct them to desirable targets almost instantly. It should be added that the P-51's of 10th Photo Reconnaissance Group were present throughout the campaign to direct artillery fires, and that veteran artillerymen rated their work as the best they had ever experienced.

The very presence of fighter-bombers in an area was a signal for enemy guns to cease firing, and even near-misses served at least to keep the enemy under cover. When 5th Ranger Battalion asked fighter-bombers for an attack on its objective, the first sweeps failed to hit the target, but subsequent attacks struck home and leading elements of the Rangers reached the fort six minutes from the time the last bomb fell. The position was taken before its garrison could organ-



ize its defense, and one Ranger, whose assault platoon of 60 men had taken 247 prisoners, declared that "he would never bitch about the Air Corps again." The 29th Infantry Division was assisted by air attacks in its capture of a series of positions. In one defense installation a turret of five-inch steel, mounted flush with the ground, had been unharmed by the near-miss of a bomber's 1,000-pounder, but heavy artillery, coupled with a fighter-bomber attack, allowed its capture. The enemy's position on Hill 100 was well emplaced and provided with excellent observation, but the 38th Infantry Regiment reported that air attack so effectively neutralized the position that it fell without excessive loss to the assaulting infantrymen. The 2d Infantry Division, to which the 38th belonged, later stated that "fighter-bombers afforded the finest air support experienced by this Division in the entire war by striking designated targets from air alert."<sup>75</sup> Such evidence from the three divisions participating in the assault is of the more value because the reports of returning pilots were of necessity indefinite as to actual results obtained in missions which at times operated within 150 to 200 yards of the advancing doughboys.

Since early August the protection of Third Army's southern flank had constituted a distinct mission assigned to XIX TAC, and developments connected with its performance had proceeded along lines quite as individual as the operations at Brest. A minimum force was employed, for XIX TAC was forced to concentrate its strength in support of operations in Brittany and of Patton's rapid drive to the east. Tac/R missions were regularly flown south of the Loire to spot any possible enemy movements, and if information furnished by them demanded, they were followed up by armed recces. In late August there was the greater need for such action since the enemy, impelled by the American landings in southern France on 15 August,\* determined to evacuate that general area and set a series of columns in motion in the direction of Dijon, where lay their only chance to avoid encirclement. XIX TAC, accordingly, developed a project to interdict all rail movements from the south. The better to exercise surveillance over the region of the enemy's retreat it pressed a P/R squadron, equipped for night photography, into the service of Tac/R, and in early September spotted the columns of Maj. Gen. Eric Elster's Foot March Group South making their way into the Poitiers-Châteauroux area. Armed recces flown on 1 and 7 September by the 36th and 405th Fighter-

\* See below, pp. 426-36.

Bomber Groups took heavy toll of the long-drawn-out columns, whose morale had already been undermined by the guerrilla tactics of the French Forces of the Interior and possibly by the propaganda leaflets which XIX TAC had dropped in the area.

On 4 September the newly constituted Ninth Army was charged with protecting the Loire line west from Orléans, but Third Army's 83d Infantry Division, Maj. Gen. Robert C. Macon commanding, still maintained detachments at critical points along the river, and its patrols operated south of it. One such patrol learned that Elster, harried by air and fearful of the French, might be considering surrender. Two men sent to his Châteauroux headquarters confirmed this information, and on the 10th details for his capitulation were worked out in a conference at Issoudun. To impress the enemy commander with the inevitable consequences of delay, a strong formation of the 354th Fighter-Bomber Group swept over Issoudun during the conference, ready to act if the Americans displayed panel signals. Elster, impressed by this further show of air power, agreed to march to Beaugency and there surrender. His troops were allowed to retain their arms until they reached the river, but attendant planes threatened should they show signs either of hesitation or of fight. When negotiations for the capitulation first got under way, Patton asked to be relieved of accepting the surrender, and on 16 September Lt. Gen. William H. Simpson, now commanding Ninth Army, wired Weyland: "Inasmuch as your command has been instrumental in accomplishing this surrender, request that you or your representative be present with General Macon to accept the surrender." Accordingly, and appropriately, the commander of XIX TAC was present at the Beaugency bridge ceremonies on that same day, and later received a consignment of surrendered German Lugers for his unit commanders. When the count was made, prisoners were found to total 754 officers, 18,850 men, and 2 women. XIX TAC's unique mission had been accomplished.<sup>78</sup>

### *From Falaise to the Siegfried Line*

Whether the air-ground effort involved was great or small and whether the operation was accorded a high or a low priority, the actions south of the Loire and around the Breton ports were all subsidiary to the main campaign in northern France. They developed on its periphery; at the center the relentless drive eastward was maintained after the closing of the Falaise-Argentan gap, even as it had

been stoutly sustained before the pocket had appeared on war room maps. While one of Third Army's corps surged into Brittany, another had closed on Argentan, but the third and fourth still moved ahead toward the Seine and Yonne. Even before the gap was closed XV Corps swung away from Argentan and raced away eastward to join its fellows in Patton's epic "end run." With the gap closed, the U.S. First Army and then the British and Canadians of 21 Army Group joined in the drive east. On 19 August, the very day that Polish and American armor struck hands at Chambois, Patton's 79th Infantry Division flung a bridgehead across the Seine near Mantes, and XV Corps pushed north along the west bank of the river. Enemy intelligence appreciated the American intent to cut off the Fifth Panzer Army and the Seventh Army in Normandy and then turn eastward. On the 23d, FUSA took over the American zone north of Paris and Third Army concentrated on forcing Seine crossings to the south where it passed the river barrier at Melun and Fontainebleau on the 24th and at Troyes a day later. At the same time the British and Canadians reached the Seine in their zone and began their crossings on the 25th. That day saw Paris liberated and the area between the Seine and the Loire freed of the enemy. It was D plus 80 and the Allies were now a full ten days ahead of schedule.<sup>77</sup>

First Army drove in the direction of the German frontier with such success that within three weeks its units were in five countries. They passed the Soissons escarpment on 31 August, entered Sedan on 7 September, Liège on the 9th, and liberated Luxembourg on the 10th. On the 11th they crossed the German frontier, and as they freed Maas-tricht on 14 September, they penetrated the outer defenses of the Siegfried Line south of Aachen. Third Army's timetable was even more startling. Its thrusting divisions turned the Somme-Marne line before it could be occupied, crossed the Meuse at Commercy and at St.-Mihiel on 31 August, and farther north at Verdun two days later. Although American patrols were in Metz for only a brief moment on 2 September and the first bridgehead over the Meuse at Pont-à-Mousson was withdrawn the day following the crossing, a small but solid bridgehead was established to the south of Metz between the 7th and the 10th. Farther south, firm contact was established on 11 September with Lt. Gen. Alexander M. Patch's Seventh Army, which had moved rapidly up the Rhone, and five days later Third Army units entered Nancy. In the extreme north, the British captured the commanding

general of the German Seventh Army as they swept into Amiens on 31 August, and leaving forces to contain the German garrisons of Channel ports, they liberated Brussels on 4 September and entered Antwerp on the day following.<sup>78</sup>

During this wild rush to the east, the TAC's were strained to the utmost to fulfil their obligations to their companion armies. Unfortunately, but unavoidably, their capabilities of giving the support desired were reduced throughout this period by the high priorities accorded Brest. Moreover, they were placed at a further disadvantage in respect both to communications and to bases. It was bad enough that directors of operations should be forced to replace their large-scale maps with others offering less detail but on a scale which would allow the battle front to be shown in the limited space available for display. It was infinitely worse for both operations and intelligence when the scale of available communications was similarly reduced, as it must needs be in a period of rapid advance. To make up in part for inevitable deficiencies the Ninth applied Brereton's old maxim, "Keep Mobile." Its own advanced headquarters moved to Versailles with those of 12th Army Group on 6 September, and by the 12th its rear headquarters had moved from its Berkshire home at Ascot to Chantilly.

Such moves, however, were as nothing compared to the enforced mobility of the TAC's. Tactical needs required that their commanders continue in intimate association with their respective armies. The mere existence of a mobile advanced headquarters was not enough to fill the requirements of August and early September 1944, although such units were regularly jumped forward. Special detachments were, therefore, improvised to match the breathless pace set by the forward headquarters of Hodges' First and Patton's Third Army. These detachments managed to maintain at least the essential minimum touch with their own operational headquarters through a sometimes odd assortment of communications links, but as a precaution against communications failure the TAC's wings were kept so fully briefed that they could function autonomously. Armies shortened their communications with their fighting units as their headquarters moved toward the front lines, but the forward movement of air headquarters greatly increased the problem of maintaining the volume of communications traffic necessary for their direction of operations from bases which now lay ever farther to their rear. Enthusiastic cooperation between

Ninth Air Force and 12th Army Group signal officers, who pooled their resources in men and materials for the solution of their joint problem, did much to reduce the difficulties inevitable in days when air was impelled to give signal equipment a priority equal to that enjoyed by bombs and gasoline and when armies devised wire-recovery programs. Happily the need for wire was reduced by the fact that the patient skill of signal troops permitted generous use to be made of the underground cables of both the French civilian and the German military systems. Terminal installations had generally been destroyed, either by bombing or by demolition, but they could be replaced far more easily than miles of wire could be strung. Radio proved a god-send, and to improve its facilities a task force from the Ninth's signal personnel seized the Eiffel Tower on the day Paris was liberated. Thereafter this tourists' mecca served as the most important relay link in that air force's elaborate radio network.<sup>79</sup>

It is a cardinal principle that if the optimum tactical results are to be obtained air bases must be as close as possible to the battle lines. On 9 August the last of the Ninth's eighteen fighter-bomber groups was established on a continental field, and in the closing weeks of that month four groups of mediums began operations from Normandy bases. This was a real gain but after Falaise it was in part offset, for the time consumed in individual sorties increased sharply as the battle lines raced away from existing bases. No one was more conscious of the gravity of this problem and of the need for an adequate solution than the Ninth's aviation engineers. They reconnoitered possible sites from L-4's and on the ground and sought a greater efficiency through decentralizing operational controls. They secured asphalt from local sources and devised top surfacing for crater fills from a compound of old surfacing, new tar, and diesel oil. When the railway from Cherbourg to Paris was opened, they painted an identifying symbol on the caboose of a train bearing precious materials, shadowed the train thus branded from an L-4, and had trucks waiting for the shipment as the train came to a halt in the Paris yards.

By mid-September only one of the Ninth's fighter-bomber groups was based on the continental field it had first occupied, while three had moved four times and one no less than five, in most cases to a newly opened strip. By that same date five groups were disposed fairly well forward in an arc from Péronne to Reims, with two others in the Paris area. But if the lack of ideally sited fields occasioned no

serious delays in operations, it did give rise to difficulties in the conduct of air missions to the east. It was easy enough for planes based on the Cotentin or in Brittany to operate against Brest, but when they were called upon to support Patton's advance, auxiliary fuel tanks or refueling at a more easterly field might be necessary to carry them forward from their home base. Roulement again came into vogue at a time when armies were advancing with such speed that a move from one field to another 200 miles nearer the front did not always obviate the need for belly tanks. Because of the existing transportation crisis, moreover, ordnance supplies on the new strips at times ran perilously low, with pre-stocking and resupply equally difficult to effect, but airdrome squadrons, repeatedly displacing forward, managed to ready the new fields and keep the planes flying, just as armorers serviced their weapons with remarkable efficiency under the most trying conditions.<sup>80</sup>

Everything in condition to fly added its weight to the momentum of the great drive. Tiny L-4's afforded valuable liaison between ground commanders, continued their ever useful functions as air OP's, and found new assignments in assisting to control ground columns and in serving as "horseflies" to guide fighter-bombers to targets selected by ground. Air Despatch Letter Service was never more active. 10th Photo Reconnaissance and 67th Tactical Reconnaissance Groups, their activities on occasion supplemented by reconnaissance units of the Eighth, continued to perform the varied tasks which they had assumed before D-day. In their earlier performance of assigned missions they had not merely observed and photographed but had directed the fires of naval artillery. They had quickly dispelled Army's early fears lest the pilots of high-performance aircraft prove incapable of adjusting artillery fire. In the course of the COBRA breakout such action had made possible the successful engagement of eighty-one targets, and the pilots met all the precise requirements of the highly specialized arm which they served. A special premium was placed on visual reconnaissance as the period of highly mobile warfare began, but the reconnaissance groups continued their photographic missions and on 12 September reported that they had completed the full coverage of the Siegfried Line and the Rhine area which Army had requested. American ground forces regretted that single-seater planes did not allow as effective observation as was wished for, and that facilities available for the mass production of prints and the quick dissemination

of intelligence to ground units, particularly to divisions, were insufficient to meet their heavy requirements. However, as the enemy early remarked, "widespread reconnaissance was almost immediately transformed into attacks."<sup>81</sup>

IX Bomber Command was frequently weather bound. Nevertheless, as German forces were pinned into the forested bends of the Seine about Rouen, the mediums struck at hidden targets there on 20, 26, and 27 August, while every day from the 26th through the 31st they bombed enemy dumps east of the Seine. Only a fraction of the planes dispatched on 11 and 12 September to blast Siegfried Line positions in front of VII Corps were able to attack, but in strikes on the 16th at the viaduct near Arnemuïden they damaged that communication link with the island of Zuid Beveland at the mouth of the Schelde and the mainland.

The services of fighter-bombers were greatly in demand for close support in the extremely mobile type of warfare that became the vogue as columns forced river barriers and moved across the Picardy plains or the rolling countryside of Champagne. The form which such actions took had become somewhat stereotyped since St.-Lô, as mission after mission took off for armed recce or ACC. The only marked variants on the established themes now exhibited were that fuel tanks often replaced bombs on wing shackles and that the tremendous firepower of the P-47 was more than ever conspicuous. The concentrated stream of projectiles discharged by its eight 50-mm. machine guns tore through thin-skinned vehicles and, by ricochet from roads into the soft undersides of tanks or by direct penetration of the air vents in their afterdecks, could even put panzers out of action. Since incendiary bullets were used, gasoline fires often resulted. The effect of strafing attacks directed against personnel was fearful, and the enemy estimated that only 20 per cent of those wounded by air returned to duty as against 40 to 50 per cent of those wounded in ground actions.<sup>82</sup> Air attack often took the place of artillery, which was less readily available under the conditions which prevailed in August and September. But the novelty of armed recce and of ACC had in some measure worn off; hundreds of pilots were actually making history every day, but few of them cared to do more than enter a formal record of the missions which they had flown. Their work had become routine—they were merely doing the expected—and ground forces seem to have shared their mood. Hence the historian conspicuously lacks detailed

evidence of the results achieved on many vital missions, now described as "milk runs."

Nevertheless, ground bore testimony to the fact that airmen were living up to expectations. VII Corps, which IX TAC served, declared: "We could not possibly have gotten as far as we did, as fast as we did and with as few casualties without the wonderful air support that we have persistently had."<sup>83</sup> Patton had early developed an enthusiasm for air support which grew as his drive progressed. Confident of the accuracy of fighter-bomber attacks, he recommended that bomb lines be done away with so far as ACC was concerned, since they could not be advanced with a speed equal to that of his troops. The general declared that the destruction of enemy transport and troop concentrations ahead of his columns, together with the information passed to them from the air, had "saved time and lives," and he classified the cooperation of XIX TAC as "the best example of the combined use of air and ground troops that I have ever witnessed."<sup>84</sup> Not every mission was successful. At times radio performed badly, though this was in part overcome by a reassignment of frequencies for use in ground-air conversations, and at other times empty fuel tanks cut missions short. But on the 20th, to look at the reverse side of the coin, 7th Armored Division west of the Seine gave the eight covering planes of the 362d Group a tank target. Search disclosed six well-camouflaged panzers. Since they were close to American forces the squadron leader searched the target at a very low altitude and then, from a more lofty perch overhead, directed his companions in the individual attacks which destroyed the enemy force.

The enemy was striving mightily to extricate his forces and succeeded in moving a considerable mass of men across the Seine, using a variety of devices at some sixty points along the river. But his loss of equipment was appalling—infantry divisions which escaped to the east carried with them only single guns and were "mobile only to the extent that they had some confiscated horses," while panzer divisions had only from five to ten tanks each.<sup>85</sup> During the days when the roads leading to the Seine were crowded with the fleeing enemy, IX TAC's units submitted mounting claims for road transport destroyed. On 18 August they joined with corps artillery in destroying barges on the Seine and soon brought ferries under attack. Bridges were more than ever essential to the enemy, but Quesada's pilots were old hands at destroying them and they again showed their skill. On the 18th they



blasted a pontoon near Les Andelys, three days later they hit a wooden bridge in process of construction, and on the 25th the 368th Group delivered a final blow at Oissel. The partly repaired emergency rail bridge there was being used for vehicular traffic at the time of the attack, and trucks were bumper to bumper on it when it was destroyed. The resulting road block piled up a line of vehicles extending back into the countryside for at least five miles. Later investigators found them burned, either by strafing or by their crews.<sup>86</sup> Further to harass the enemy, IX TAC also struck at enemy airfields, the majority of which it was itself to occupy before the Battle of France had ended.

The enemy's position on the ground was clearly desperate as August closed, and once again the Luftwaffe attempted to give aid. But in the "Y" service provided by the 3d Radio Squadron Mobile of the Ninth Air Force there were skilled linguists, thoroughly familiar with the colloquial chatter of enemy pilots and ground controllers. Since landing in Normandy on D plus 3, this unit had been regularly credited with kills which their information enabled attacking planes to make. On 24 August they recommended sweeps over German fields at times when the enemy was accustomed to use them heavily. The result helped to make 25 August a red-letter day for the Ninth as regards enemy aircraft destroyed in the air and on the ground, for on the basis of information furnished by "Y," the 367th and 474th Fighter-Bomber Groups flew missions against airfields in the St.-Quentin-Laon area where air combats resulted in total claims of forty-one enemy planes destroyed for a loss of eighteen. On the same day, again acting on intelligence reports, units from the 365th, 367th, and 370th Groups demolished thirty-three planes on fields near Cognac and Dijon, including in their claims thirty Ju-88's which the enemy was known to be using for air evacuation. To round out the day's action, the 354th Group claimed thirteen enemy aircraft destroyed on the ground at Beauvais and Reims and, in three attacks on numerically superior enemy formations in the air east of Paris, claimed thirty-six destroyed for the known loss of five with other aircraft unaccounted for.<sup>87</sup>

Among a myriad of small incidents whose aggregate tactical results assumed impressive proportions, three actions stand out. As First Army drove through Maubeuge and Valenciennes at the rate of sixty miles in two days a mass of retreating Germans were caught behind the converging columns of VII and XIX Corps. The Mons pocket

thus formed by 3 September extended as far back as Compiègne and included troops from some twenty different enemy divisions. IX TAC joined in working over this confused mass and took heavy toll of vehicles and personnel before the pocket was mopped up and over 25,000 Germans made prisoners of war. A second significant series of actions occurred as TUSA's troops forced a crossing of the Moselle between Metz and Pont-à-Mousson between 8 and 11 September. The enemy resisted the crossing stoutly and launched repeated counter-attacks once American troops had reached the east bank. In support, IX Bomber Command struck successfully at bridges north of Nancy to block the movement of possible enemy reinforcements, while fighter-bombers hit at targets indicated by ground in the immediate front of American units and on their flanks, tank concentrations being their favorite assignment. In one attack on such an objective a unit from the 406th Group made forty individual passes at fifteen tanks near Arry on 10 September and was confident that all had been immobilized or destroyed. On the 11th, XX Corps reported that the air attacks of the preceding day had greatly facilitated the assault on the front of the 5th Infantry Division. Emplacements had been knocked out and groups of Germans had surrendered in the midst of the bombardment. The division itself paid tribute to air for help rendered in establishing and consolidating the bridgehead. Ground's only regret was that more fighter-bombers had not been available.<sup>88</sup>

The third special air support action developed in the region covered by the Forêt de la Haye, on the western outskirts of Nancy, simultaneously with the struggle for the Moselle bridgehead. The thickly wooded area was well defended with strongpoints and its garrison had recently been reinforced, but it was cleared by the 15th. Here IX Bomber Command furnished the principal air support. B-26's and A-20's joined in heavy attacks against strongpoints on the 10th and repeated the operation in reduced strength on the 12th. These blows, plus the operations of fighter-bombers which choked off further reinforcement of the enemy, helped to force his almost immediate withdrawal. The results of the action were twofold: added insurance for the growing American bridgehead to the north and the occupation of Nancy itself on 16 September.<sup>89</sup>

On 11 and 12 September the GAF again became active, fighting like the rest of the Wehrmacht to gain time for the development and manning of defense positions along the German border. On the first of

these days, IX TAC's formations sighted seventy hostile planes and engaged in two encounters over enemy territory. On the day following as many more were sighted, though only a single combat eventuated. In these actions by the 365th, 368th, and 474th Groups, twenty-five enemy planes were claimed destroyed for the loss of six. On the 11th, the 406th Group of XIX TAC claimed six for two in an encounter over Landau. The day following, 405th Group claimed five for two, while the 354th, attacking in the Frankfurt-Limburg area, claimed nine demolished on the ground and, as a result of air encounters with larger German formations, added claims of thirty destroyed to its already impressive record. The group's own losses were two planes. Once more its pilots reported that the enemy appeared inexperienced, though aggressive.

### *Air Supply*

In the course of August and the opening weeks of September the Allied armies had pushed nearly 400 miles eastward. Movement meant increased consumption of gasoline, and the arrival of new divisions heightened the demand for all classes of supplies. The expenditure of ammunition was phenomenal—in a single month the armies used eight million rounds of artillery and mortar shells as against the total of ten million used by the American Expeditionary Force in the entire period of the first world war.<sup>90</sup> As soon as the sweep into Brittany began supply officers in all echelons experienced the pressure applied by the lengthening of the routes which their trucks must cover, and they became painfully aware that each mile of advance doubled the problem of supply by trucks, since all computations must be based on a round trip starting at their base. By the end of August the situation had become acute. The 12th Army Group admonished its armies that they must be prepared to extend their own lines of supply to the maximum and demanded rigid economy in the use of supplies.<sup>91</sup>

Communications Zone trucks operated on a 24-hour basis, and Red Ball express highways were created to expedite traffic. By 8 September, the Red Ball service extended to Soissons and precarious rail connections reached from Cherbourg to the vicinity of Châlons, in spite of the damage done by Allied bombings and the havoc wrought by German demolitions. Every conceivable type of transport was brought into play from lumbering tank-recovery vehicles to the light trucks which once had been rated as the property of field artillery

## THE ARMY AIR FORCES IN WORLD WAR II

units, Chemical Warfare Service, or IX Air Defense Command.<sup>92</sup> But the problem remained acute, for the armies continued to put space between the new rail and truck heads and their own front lines, with the result that at the end of the Battle of France the intervening distance was at least as great as it had been in the campaign's early stages. Fortunately, the degree of air supremacy enjoyed by the Allies allowed road transport to operate around the clock and speeded night traffic by allowing the "light line"\* to be carried well forward. After 21 August, First Army never received enough gasoline to cover in full a day's requests, nor could those of the Third Army be answered. Both were able to alleviate the situation a little by making use of captured rations, medical stores, and wire, but the Third bitterly lamented that German gasoline was not suited to propel American tanks. Reserves dwindled and disappeared, and issues were made "on a day to day, or even an hour to hour, basis."<sup>93</sup>

As the crisis developed it was natural that the possibility of providing relief by airlift should be examined. In pre-invasion planning attention had been focused on tactical operations, with little thought accorded air's potential in connection with the logistics of the coming campaigns,<sup>94</sup> and since then air transport facilities had been developed chiefly as an aid to emergency supply of critical items. Beginning on D plus 6, air supply had been used to remedy deficiencies in stocks of mortar shells, and in the period of the great storm which broke on the beaches on 19 June, troop carriers brought in approximately 1,400 tons of critical supplies. But however helpful the planes might be in the supply of special items, they could carry only a small fraction of the armies' total requirement,<sup>95</sup> and the emphasis, with reference to air operations, continued to be placed on tactical support. Even in the emergency of late August, tactical needs came into sharp conflict with those of supply. Between 19 August and 6 September, special airfields were hurriedly constructed or reconditioned for transport use near Le Mans, Orléans, and Reims.<sup>96</sup> But the operations of troop carrier aircraft, which constituted the bulk of the planes suitable for transport, depended upon a decision by supreme headquarters as to whether supply of the advancing ground armies or pending airborne operations, intended to speed the collapse of German resistance, should receive priority. Three times before it was determined to carry out the Arnhem drop after 10 September plans were made for use of the newly

\* I.e., the point behind the lines up to which trucks might use their lights.

created First Airborne Army and as often abandoned. Only on occasion, therefore, could air's full resources be applied to the relief of ground's distress, for when plans called for an air drop the troop carriers necessarily stood by.<sup>97</sup>

Air transport efforts, however, were by no means inconsiderable. As the ground forces threatened to run off the eastern edges of available maps and the need developed for detailed planning of operations in German territory, over 200 tons of maps, hurriedly provided by civilian presses in Great Britain and by the engineer topographical battalions of the Eighth Air Force, were lifted to their destinations by air.<sup>98</sup> In the attempt to meet the need for gasoline, the B-24's of the Eighth Air Force were also pressed into service, each bomb bay being loaded with 200 five-gallon cans of the precious fluid. The assistance thus rendered the ground forces was substantial, but the heavy bombers, by breaking up advanced runways, imposed a new burden on the hard pressed aviation engineers and the diversion of the B-24's unavoidably restricted the Eighth's strategic activity.<sup>99</sup> Intermittently, the troop carriers were made available for full-scale operations. Their best effort came in the ten-day period extending from 5 through 14 September with a total of over 5,200 sorties flown, 851 being the high for a single day and 35 the low. During this period the troop carriers alone delivered over 15,000 tons of freight, including nearly 2,500,000 gallons of gasoline; but at that time First Army, which enjoyed a supply priority, had a consumption rate averaging 571,000 gallons per day and Third Army's daily requests exceeded 1,000,000 gallons.<sup>100</sup> It is clear that had air transport's best effort been sustained, without interruption by weather or the claims of other activities, it could not have been enough. And only more careful planning in anticipation of the need could have substantially increased the capacity available.

As early as 27 August, the 12th Army Group had decided that "the armies will go as far as practicable and then wait until the supply system in rear will permit further advance."<sup>101</sup> By mid-September the limit was just about reached. To quote the group's own report: "The Third Army was grinding to a stop, not from enemy resistance, but from lack of fuel. . . . Spent by a month and a half of continuous fighting and movement in which it had advanced more than 400 miles across France and Belgium, Twelfth Army Group . . . had been brought to a halt along the line of the Moselle River and the Siegfried defenses."<sup>102</sup>

## CHAPTER 9

\* \* \* \* \*

### *THE STRATEGIC BOMBER STRIKES AHEAD*

THE contribution of the strategic air forces to the initial success of OVERLORD had been decisive. The long and costly offensive against German air power had produced the air supremacy required by the liberating armies, and the destruction of railway centers, airfields, and coastal defenses—vital preliminaries to the invasion—had been for the most part the work of the Eighth Air Force and RAF Bomber Command. And the strategic air forces would continue to play a conspicuous part in making possible the progress of the land armies until the war was won.

During the summer of 1944, most of the bombing effort expended by the heavies went into so-called tactical operations for the benefit of the ground forces: attacks on marshalling yards, bridges, airfield installations, and supply dumps behind German lines, as well as the spectacular saturation of enemy positions at Caen on 18 July and near St.-Lô on 25 July.\* Also, they were called upon for extensive CROSSBOW operations,† and late in the summer some of the strategic bombers were converted into transports in order to remedy the supply emergency brought about by Patton's brilliant drive across France. Even the most staunch proponents of strategic air warfare usually appreciated the necessity of furnishing direct assistance to the land forces, and the praise of ground force commanders was gratifying.<sup>1</sup> But it was clear that the offensive against German war production suffered whenever the heavy bombers devoted their tonnages to tactical targets. As the strategic air commanders judged the situation, they were now for the first time in a position to implement a truly systematic campaign directed at Germany's war-making capacity. They possessed sufficient

\* See above, pp. 208, 231-33.

† See below, pp. 527-34.

forces for such an undertaking, they ruled the air, and they had amply fulfilled their commitments to blast the way for a successful D-day. However greatly the strategic bomber could contribute to the success of the land campaign, its primary role was to weaken and destroy the enemy's ability and willingness to wage war.

The temptation of land and tactical air commanders to demand assistance was particularly strong during the discouragingly protracted period when the armies were confined to the narrow lodgment area in Normandy. General Spaatz became quite concerned about the urgent insistence of Montgomery and Leigh-Mallory that the heavy bomber commands be made continuously available for plowing up battle areas.<sup>2</sup> The armies did not always make significant advances once the bombings were over, and their slowness in breaking out of the beach-head evoked considerable criticism in air force and other circles to the effect that ground commanders were too hesitant in spirit and too reluctant to take advantage of favorable situations which air effort had brought about.<sup>3</sup> Spaatz insisted to General Eisenhower that the bombing of Germany should take overriding priority whenever visual conditions were satisfactory, except for major emergencies on the battlefield and for attacks on rocket-firing installations.<sup>4</sup> Air Chief Marshal Harris of RAF Bomber Command was also uneasy about the long respite from strategic bombing.<sup>5</sup> Fortunately, General Eisenhower fully comprehended the importance of strategic air warfare and he favored giving USSTAF and Bomber Command their opportunity,<sup>6</sup> as of course did Headquarters AAF, the Air Ministry, and the U.S. component of the Allied Expeditionary Air Force.<sup>7</sup>

As early as 10 June 1944, USSTAF had drawn a plan defining the objectives of a renewed strategic campaign.<sup>8</sup> The priorities it recommended were in the order of oil production, the ball-bearing industry, tank production and ordnance depots, and the motor transport industry. The German Air Force would be policed as frequently as seemed necessary. General Eisenhower gave his assent and, except for battle emergencies and reservations concerning CROSSBOW, he left Spaatz, Doolittle, and Harris free to develop their strategic bombing campaign as they thought best. Priorities during the summer of 1944 for industrial targets were usually in the rank of oil, GAF and jet, V weapons, ball bearings, and tanks. RAF Bomber Command continued its general campaign to disorganize German production areas, and like the Eighth Air Force responded to every call for assistance from the

ground forces that cleared SHAEF. The arrangement, in other words, was a flexible one based on the mutual esteem and common purposes of the top officers in SHAEF and in the strategic air commands, and it worked extraordinarily well. Not only did the armies receive vital support whenever they needed it but a huge bombardment of Germany was begun. Fortunately, forces were at full strength. In terms of heavy bombers on operational status in combat units, the Eighth Air Force at the close of June 1944 possessed 2,100, the Fifteenth Air Force almost 1,200, and the RAF 1,100.<sup>9</sup> As events were to prove, this was strength enough for the task.

It was none too soon to resume the strategic bombing of Germany. By D-day only three important production systems had been seriously affected by air attack: oil, aircraft, and ball bearings. The oil campaign was only in its first stage and the Germans could soon restore their position. USSTAF believed the German Air Force would never again be as dangerous as it had been in 1943, but the Germans were making vast efforts to disperse their aircraft factories and they were producing twice the number of fighters estimated by the western Allies.<sup>10</sup> Furthermore, the enemy had a new jet-propelled fighter which might appear in the skies any day and which, the Americans knew, could outperform any aircraft they or the British possessed.<sup>11</sup> As for ball-bearing production, USSTAF had overestimated the effects of its previous bombings, for production of this item did not decline in proportion to the unmistakable physical damage wrought on plants.\* Finally, German armaments production in nearly all categories had increased sharply in early 1944 and promised to rise to very impressive peaks during the second half of the year.<sup>12</sup> No one knew what further V weapons might be forthcoming, and German propaganda was full of threats. If the resilient and expanding production of the enemy was only partly understood by the Allies,<sup>13</sup> they found in their optimistic belief that the German economy was badly stretched an equally strong argument for the renewal of strategic bombardment.

### *The Oil Campaign*

Since March 1944 General Spaatz had kept his eye on the enemy's oil production as the most promising objective for strategic attack, and the vast damage ensuing from Fifteenth Air Force missions against Ploesti and the Eighth Air Force operations of 12 and 28-29 May†

\* See above, p. 45.

† See above, pp. 172-79.



had now served to overcome serious RAF opposition to an oil campaign.<sup>14</sup> Only two days after the Normandy landings, on 8 June 1944, Spaatz issued a historic order to both component air forces of USSTAF that their primary strategic aim henceforth would be to deny oil to the enemy's armed forces,<sup>15</sup> an order which remained in force until the strategic air war ended. The general arrangement was to assign to the Fifteenth Air Force the crude-oil refineries around Ploesti, Vienna, and Budapest, together with such synthetic petroleum plants in Silesia, Poland, and the Sudetenland as Brüx, Oswiecim, Blechhammer North, Blechhammer South, and Odertal. The RAF's 205 Group, which operated from southern Italy with the Fifteenth, continued its immensely effective work in mining the Danube so as to obstruct oil shipments to the Reich. The Eighth Air Force undertook to destroy synthetic oil plants in central and eastern Germany (Pölitze, Zeitz, Magdeburg, Merseburg-Leuna, Ruhland, etc.) and crude-oil refineries around Hamburg, Bremen, and Hannover. RAF Bomber Command entered the offensive with an initial list of ten synthetic oil plants in its familiar target area, the Ruhr Valley.<sup>16</sup>

For the Fifteenth Air Force the new campaign represented no more than the continuance of a task already begun, albeit somewhat unofficially. By June 1944 that air force had inflicted at least partial damage on twenty-nine of the sixty-odd oil refineries which lay within its range,<sup>17</sup> in an arc extending northward and eastward some 700 miles from its chief base at Foggia, Italy. And within a week after Spaatz had named oil as the first of its objectives, the Fifteenth carried out large-scale attacks on the major Hungarian refineries, all of the Yugoslav producers, and all but one of the Italian refineries.<sup>18</sup> To the Fifteenth belonged also the premier oil target of the continent, which was the fabulous oil field in central Rumania near Ploesti from which the Nazis drew approximately one-fourth of their petroleum supplies. The largest refineries in this area were already well known to Fifteenth Air Force intelligence officers and flyers, who found in the stout defense put up by the enemy there convincing evidence that their commanders had chosen wisely in selecting oil as the first priority. Following the ruinous attacks of April and May 1944, the Germans began to experiment with a new defensive measure, one which proved very satisfactory to them for some time. Whenever their warning system indicated the approach of air fleets over Yugoslavia toward Rumania, the Germans would use the forty minutes available

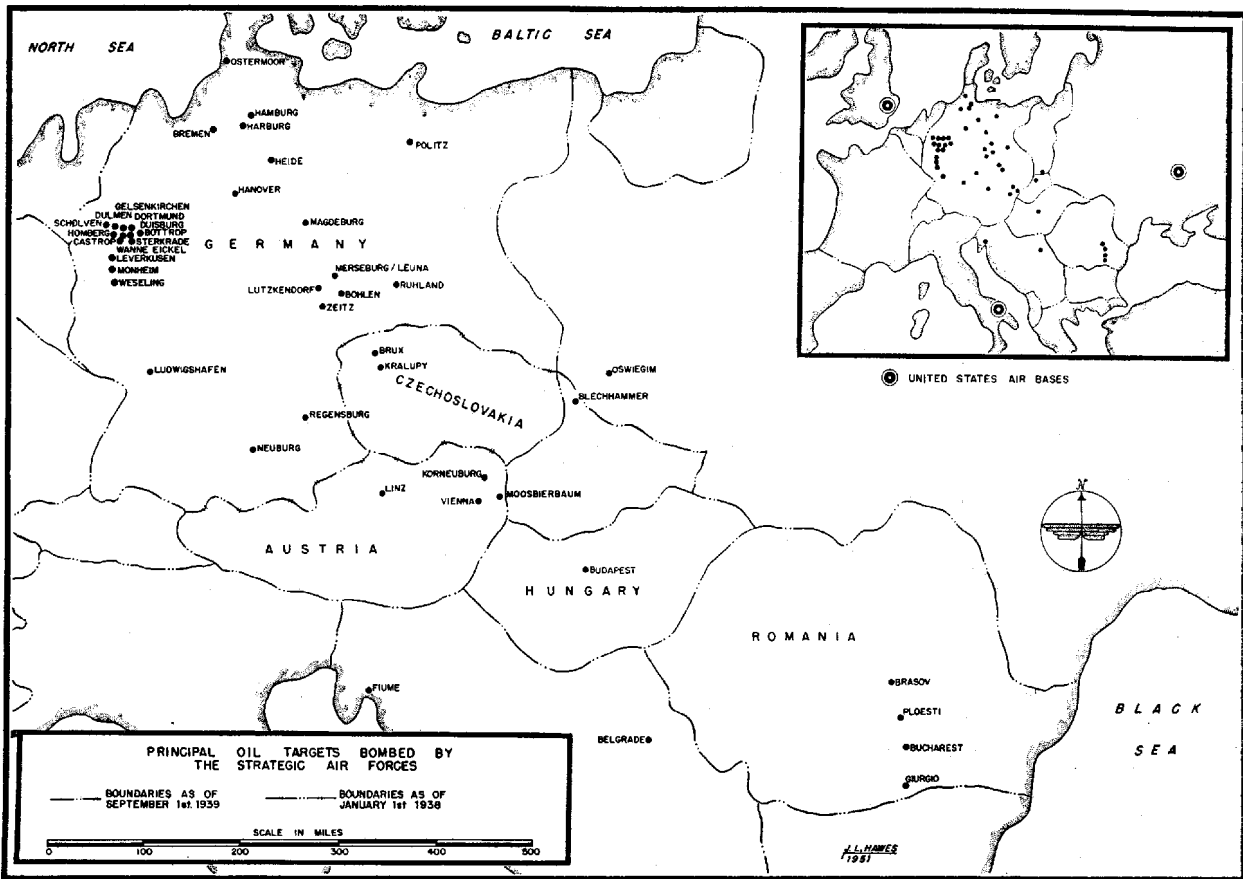

## THE STRATEGIC BOMBER STRIKES AHEAD

to them before the attack to light hundreds of smoke pots around the Ploesti fields, with the result that most of the area would be concealed by the time the bombers arrived. Thus precision attack was impossible. In an effort to overcome this obstacle the Fifteenth dispatched on 10 June 1944 not bombers but P-38's, thirty-six of which dived on the refineries with 1,000-pound bombs while thirty-nine others fended off the pugnacious fighter units which the Germans always kept around Ploesti. At best this experiment was only an equivocal success.<sup>19</sup> Captured records subsequently revealed that three of the refineries received partial damage;<sup>20</sup> but twenty-three Lightnings were lost, some of them to flak, which was worse than ever, for Ploesti by now had become the third best-defended target on the continent.<sup>21</sup> Second place was held by Vienna, where five crude-oil refineries were attacked on 16 June with moderately good results by a force of 658 heavy bombers and 290 fighters. Losses showed fourteen heavies and six fighters shot down, for which a toll was exacted of at least twenty-three German fighters.<sup>22</sup> It would soon become evident that bombers of the Fifteenth suffered a considerably higher loss ratio than did those which flew from English bases.<sup>23</sup>

Ploesti was the object of attack again on 23 June, when the Fifteenth Air Force sent 761 bombers to Rumania. While they damaged an oil storage installation at Giurgiu, the smoke screen at Ploesti forced resort to blind bombing with results unobserved.<sup>24</sup> On the next day, 377 heavies went back to Ploesti and again dumped their bombs blindly into the smoke. Later it was learned that one refinery suffered hits.<sup>25</sup> Oil storage facilities in the south of France were targets on 25 June, along with objectives preparatory to the invasion of southern France. On 26 June approximately 550 Fortresses and Liberators ranged over Hungary, attacking marshalling yards and aircraft plants, and penetrated the Vienna area to bomb the large Moosbierbaum, Löbau, and Floridsdorf oil refineries. Bombing results were generally satisfactory, and 44 or more German fighters were shot down around Vienna. Marshalling yards in Hungary and Yugoslavia which served German front lines caught substantial tonnages from 331 heavy bombers on 27 June, and on the 28th more than 200 Liberators bombed oil refineries at Bucharest.<sup>26</sup> From the Spanish border to the Russian lines the Fifteenth Air Force during June busily carried its share of the air offensive.

The Eighth Air Force at this time could spare only a few missions

## THE ARMY AIR FORCES IN WORLD WAR II

for strategic bombing. Not only did multitudinous tasks in connection with OVERLORD and CROSSBOW interfere but the weather, which caused unexpectedly poor visual bombing conditions over Germany, prevented a steady prosecution of the air campaign even on a limited scale. The first opportunity for a large mission against oil targets came on 18 June. Weather forecasts were far from encouraging, but fifteen combat wings of B-17's were dispatched against eleven oil installations in northwestern Germany. Nine of the wings attacked the Hamburg area, where no fighter defenses were in evidence but flak was the heaviest many of the flyers had ever seen. While it was necessary to drop the 1,150 tons on pathfinder indications, a practice at which the Eighth Air Force was not expert, results at Hamburg were considered good. The other wings also ran into poor visual conditions and bombed blind with little effect on objectives near Bremen and Hannover.<sup>27</sup> On 20 June the Eighth sent a record force of 1,361 heavy bombers and 729 escorting fighters against oil targets at Hamburg, Harburg, Ostermoor, Misburg, Pölitz, and Magdeburg. Antiaircraft barrages were intense and accurate at most of the targets, and the bomber force attacking Pölitz had to beat off about 120 enemy fighters. Forty-eight heavy bombers were lost and 468 suffered damage on this mission, one of the rare operations after 1943 in which the GAF enjoyed a temporary air superiority. But twenty-eight German fighters were destroyed, all of the primary targets were attacked visually, results were excellent, and the synthetic oil plants at Magdeburg and Pölitz were forced to shut down for extensive repairs.<sup>28</sup>

A mission to Berlin was the order for 21 June 1944. In the background of this operation, the largest American attack yet mounted on the Nazi capital, lay a conflict of views between the RAF and the AAF. Long devoted to area bombing and suffering from the cruel V-1 bombardment of London, the British proposed to send 1,000 heavies along with every available American bomber to smash Berlin in an unprecedented daylight raid. The proposal made Spaatz uneasy, for he looked with strong disapproval on projects to break German morale through what he considered terror bombing,<sup>29</sup> and he won the support of Eisenhower and AAF Headquarters in Washington in his determination to direct his own forces only at legitimate military targets. Accordingly, the American target plan for the projected mission meticulously singled out aircraft factories, railroad facilities, and governmental areas in the enemy capital as the objective. Even so, it

was evident that the raid would probably be devastating to much of the city. Nearly 3,000 heavy bombers, flying in twos instead of in standard formations and protected by enormous fighter forces, would drop about 6,000 tons on the city. As it turned out, the British withdrew from the mission when Harris concluded that fighter escort, which was unexpectedly drained by tactical demands from the French battlefields, would be insufficient to defend his heavies in daylight.<sup>30</sup> Since the American plan was not contingent on RAF participation, nearly 2,500 aircraft—twenty combat wings of heavy bombers and twenty-three fighter groups—took off and flew over the North Sea to Jutland and then turned southeastward to Berlin. There they dropped more than 2,000 tons from 25,000 feet and started large fires and scored direct hits on most of the primary targets; 400 of the heavies bombed successfully various aircraft engine factories and railroad centers in the outskirts of the city and the oil plant at Ruhland. Flak was exceedingly heavy, as was to be expected, but serious fighter opposition materialized only during the penetration phase of the operation, when ninety German aircraft attacked. Forty-four of the heavy bombers failed to return to England, and twenty-two German fighters were shot down.<sup>31</sup>

During the last of June the Eighth Air Force was chiefly absorbed in CROSSBOW and in operations against French airfields and bridges. On 24 June it was possible to send six B-17 combat wings against an oil refinery at Bremen, which was selected because of its favorable location with respect to H<sub>2</sub>X identification landmarks. This particular mission was not at all encouraging in the tedious course of experiments being conducted by the Eighth to overcome weather and smoke-pot obstacles by means of radar devices. The bombs missed the oil refinery completely, although docks, railways, and an aircraft factory received hits.<sup>32</sup> On 29 June the Eighth dispatched almost 1,000 B-17's and B-24's against the synthetic oil plant at Böhlen, the V-1 (formerly Volkswagen) works at Fallersleben, and eleven small targets in the Leipzig area involved in aircraft production. Enemy fighter reaction was unaccountably limited, although the bombers were widely scattered and in one phase formed a stream 200 miles long. Only twenty aircraft were lost. While twenty-one targets were bombed, and V-1 work ceased at Fallersleben, General Doolittle thought the total results of the mission were disappointing.<sup>33</sup>

By the first of July the Allies were highly enthusiastic about the

oil offensive. During the month of the Normandy invasion 20,000 tons had been dropped by the strategic air forces on oil-producing installations. The two American forces had delivered most of this tonnage, but RAF Bomber Command had conducted very successful attacks on Gelsenkirchen and Buer. The amount of petroleum available to Germany declined to 472,000 tons in June, compared to 715,000 tons in May and 927,000 tons in March, as the Allies learned after the war.<sup>34</sup> Contemporaneously, they estimated with unusual accuracy that about half of Germany's production had been destroyed.<sup>35</sup> It had been agreed to keep estimates secret, and some embarrassment arose when General Arnold announced at a press conference that enemy oil production was down to 30 per cent.<sup>36</sup> Afterward, the Allies guarded their estimates carefully, and comparison with captured records was to show that they came remarkably close to the truth.

As mounting evidence, from all sorts of intelligence sources and from observation of ground movements, indicated that the Germans were suffering desperate local shortages, the tactical air forces intensified their attacks on oil trains and storage dumps near the front lines.<sup>37</sup> The Eighth and Fifteenth Air Forces showed improvement in the use of H<sub>2</sub>X radar devices, and RAF Bomber Command was employing Gee-H to better advantage as its crews became more experienced.<sup>38</sup> It was discovered that synthetic oil plants lent themselves to successful air attacks more easily than oil refineries, since the former could be put out of action by relatively small damage to critical parts of their complicated machinery. Furthermore, the synthetic plants were much larger than the refineries and were more likely to appear on radar screens because they usually stood some distance outside of cities. The Fifteenth Air Force sharply raised its level of accuracy and developed techniques, such as the use of diamond-shaped formations, which insured more safety for the bombers as well as greater precision in attack.<sup>39</sup> A further strengthening of the effort came from the Joint Oil Targets Committee set up in London to supervise the oil campaign more scientifically. This organization, which drew membership from USSTAF, the Air Ministry, and the Ministry of Economic Warfare, evaluated methods of attack and checked data from the continent concerning German oil difficulties. One of its first decisions was to recommend intensification of attacks on gasoline production, thus giving highest priority to the Bergius-type synthetic oil plants and to crude-oil refineries in Rumania, Hungary, Poland, and Germany—in that order.<sup>40</sup>

The Germans were far from apathetic in the face of the oil offensive. As Albert Speer, the Nazi minister of armaments and war production, later declared, the Eighth Air Force attack of 12 May 1944 made real what "had been a nightmare to us for more than two years."<sup>41</sup> Speer rightly feared that this mission was the beginning of a planned campaign, and he poured a series of apocalyptic memoranda upon the Fuehrer, who was properly alarmed. Hitler was particularly wrathful because Germany's synthetic oil plants had been built in clusters which the Allies could easily bomb now that the Luftwaffe was so distracted and weak. But the Nazis were not beaten. With Hitler's full backing, Speer put the capable Edmund Geilenberg in charge of a vast reconstruction and dispersal program, for which he had the highest priorities in materials and labor. Soon he had 350,000 workers, most of them foreign slaves, engaged in repairing damage as soon as the plants were bombed and in building smaller units in places difficult for the Allies to find and attack.<sup>42</sup> The entire program was carried through with a speed and efficiency that compelled admiration from the British and the Americans, whose intelligence officers were taxed and frequently confounded in seeking out the new plants, and whose air forces had to bomb and rebomb the old installations far more often than they had expected to. Thus the individual targets became more resilient and the target system itself multiplied.

### *The GAF, Rockets, and Oil*

In July, Allied air commanders began to worry about the resurrection of the German Air Force. It had made a pitiful showing against OVERLORD, and its opposition to strategic bombing had been feeble or nonexistent during most missions for weeks past. Yet, the GAF occasionally had put up ferocious resistance to heavy bombers, particularly around Vienna, Pölitz, and Ploesti, where the Fifteenth Air Force had run into spirited and skilful opposition on several of its recent missions. Spaatz soberly considered the possibility that the GAF might recuperate.<sup>43</sup> His experts differed widely about the production figures of German aircraft and grossly underestimated them,<sup>44</sup> but there was evidence that the GAF had some life left, and key members of his staff knew acute concern over the threat of jet-propelled fighters. It was known that a few Me-163's and Me-262's were active, although none as yet had interfered with the bomber fleets. USSTAF estimates of their probable effects varied radically, ranging from the opinion that they would not be a factor for many months to the fear

that they might soon drive all daylight bombers from the skies.<sup>45</sup> Doolittle's dire predictions on this matter disturbed General Arnold, and Spaatz pressed Washington for rapid development of American jets as the best counterweapon.<sup>46</sup> Meanwhile, the strategic bombers could attack such GAF production facilities as were identifiable. While USSTAF bombers had aimed only 2,842 tons on such targets in June, they would drop 7,398 tons in July and 8,442 tons in August.<sup>47</sup>

Illogically, it seems, German aircraft production had continued to rise during the months immediately following the great POINT-BLANK successes of early 1944. The impressive nature of the aerial victory is clear only when the figures for planned production are compared with those for actual production (not overlooking the "missing" 26,000 fighters which cannot be accounted for except as an effort of certain German officials to lull the fears of their superiors)<sup>48</sup> and when the GAF of mid-1944 is weighed against the air force the Germans had intended to dispose. The GAF accepted 2,177 single-engine fighters in June 1944, compared to 1,016 in the preceding February, and acceptances during July, August, and September amounted to 2,627, 2,779, and 3,031, respectively.\* Much of the credit for this resurgence went to the ubiquitous Albert Speer, whom Goering not inappropriately called "a great genius."<sup>49</sup> When Speer brought aircraft production under the control of his ministry, he began to disperse the entire industry and to accelerate the repair of bombed plants. Dispersal may have proved ultimately to have been wasteful, but until late 1944 it was highly successful. The factories were so small, concealed, and scattered that Allied intelligence found it exceedingly difficult to locate them and bombers often failed to hit their vital parts. Allied air leaders failed to assess the German effort with complete accuracy, and with some reason were often uneasy and occasionally pessimistic during the summer of 1944.

Another source of concern was the V-1, which had come into operation on 12 June and was joined in September by the V-2 rocket. The German V campaign against the London area might be described properly in military terms as a harassing operation, but the anguish and danger endured by the English people caused British officials to insist urgently upon all possible countermeasures. The only permanent remedy was to overrun the launching sites on the coast of France and Belgium, which the armies did not accomplish in any considerable

\* See above, p. 61.



measure until late summer. Until then, other methods had to be tried. The launching sites were almost impregnable to bombing, now that the Germans had rebuilt them following the Allied raids earlier in the year.<sup>50</sup> But some good might be achieved, although American air leaders generally doubted it, by covering them regularly with bombs and by destroying everything around them. General Spaatz protested to Eisenhower about the disproportionate share awarded the Eighth and the apparent precedence which Leigh-Mallory intended for CROSS-BOW to take over the strategic bombing of Germany.<sup>51</sup> In view of Spaatz's reluctance, RAF Bomber Command took on most of the targets and the Eighth Air Force agreed to attack launching sites whenever it could not operate against German industry. The aggregate tonnage directed by the two forces at all phases of V manufacture or firing sites during the summer of 1944 would amount to better than 70,000.<sup>52</sup> No doubt the diversion of bombing effort was of serious proportions, as the Germans had probably planned for it to be, and ultimately it was judged that it had been of little effect in crippling the V campaign.<sup>53</sup>

While higher headquarters pondered these problems and shifted the emphasis of bombing from time to time, the bombers continued to go out as frequently as possible on missions which seem monotonously repetitious when chronicled in short spaces, although each sortie for the aircrew involved was a hazardous and often costly experience. The Eighth Air Force devoted the first week of July mostly to tactical operations over France. On the 7th it dispatched 1,103 heavy bombers to attack synthetic oil plants at Böhlen, Merseburg, and Lützkendorf, which were recovering from previous bombings, and to various aircraft factories in the Leipzig area. On the way to the target areas Liberators which comprised one of the three main forces ran into deadly opposition from German fighters and suffered the loss of an entire "clay pigeon" squadron and painful destruction in others, and GAF resistance might have proved even more serious but for a simultaneous operation by the Fifteenth Air Force against Silesian oil targets which drew off enemy fighter strength.\* In all, the Eighth lost thirty-seven heavy bombers and six fighters. All of the bombing was visual and the results ranged from fair to excellent; on the whole it was a very successful attack.<sup>54</sup>

The Eighth Air Force operated over northern France with large

\* See below, p. 291.

forces on 8 July, with small forces on 9 July, and was altogether grounded by the weather on the 10th. On 11 July, a break in the overcast seemed likely to develop around Munich, where abundant aircraft engine plants and marshalling yards offered attractive targets. It was a mission of considerable length and it was expected that the GAF would attack at the point of greatest strain for the fighter escort. But the Luftwaffe was not at all in evidence. Nor was a break in the overcast. The bombers had to employ H<sub>2</sub>X on all the targets; Munich and Augsburg received 2,353 tons from the 1,048 attacking bombers. On the next day the Eighth hoped to revisit Berlin, which the RAF had recently bombed, but weather conditions were too forbidding. Accordingly, 1,117 of its bombers returned to Munich, where 2,708 tons fell on the center of the city. Again the bombers used H<sub>2</sub>X and again they encountered no GAF fighters. For the third successive day, on 13 July, the Eighth dispatched more than 1,000 heavies to Munich and bombed it by H<sub>2</sub>X methods and attacked marshalling yards at Saarbrücken as well. While forty German fighters showed up on the 13 July mission, they made only reluctant and ineffective efforts to intercept the bombers.<sup>55</sup> Losses of the Eighth Air Force on all three of these Munich attacks amounted to fifty heavy bombers, most of which were victims of anti-aircraft guns and operational troubles. When the weather cleared up sufficiently to make assessments, it appeared that the railway facilities in the city and the great Bayerische Motorenwerke aeroengine plant were very severely damaged.<sup>56</sup>

Meanwhile, the Fifteenth Air Force was heavily engaged in operations to facilitate the advance of the ground forces in Italy and in preparing for the invasion of southern France.\* But its strategic bombing was also impressive, and its battle losses in July reached the total of 318 heavy bombers, the worst month of the war for the Fifteenth and a higher ratio of loss than the Eighth was suffering.<sup>57</sup> In the first week of July, Fifteenth Air Force bombers attacked a wide variety of targets from France to Rumania. On 2 July, 712 B-17's and B-24's bombed Budapest, which contained oil refineries, aircraft factories, and railway targets. Reinforced by Eighth Air Force Fortresses temporarily based in Italy after a shuttle mission to Russia,† the Fifteenth sent almost 1,000 aircraft over the Balkans on 3 July. The targets most successfully bombed were oil and transportation objectives in Bucharest and Belgrade. On the 4th, 656 heavy bombers attacked various

\* See below, pp. 420-26.

† See below, pp. 314-15.

small oil refineries in Yugoslavia and Rumania, achieving conspicuous success at the Brasov installation notwithstanding the opposition of 50 enemy fighters. The largest mission of the week took place on 5 July, when southern France was subjected to a softening-up process in anticipation of DRAGOON. The most colorful results of the day's bombing were firing the inactive French battleship *Dunquerque* and covering the submarine pens at Toulon with explosives. On the 6th, the Fifteenth's bombers turned their attention to targets in Italy: bridges, steel works, marshalling yards, and ports. Coordinating with the Eighth Air Force mission to central Germany on 7 July, the Fifteenth sent more than 1,000 B-17's and B-24's against synthetic oil plants. Approximately 300 German fighters attempted to prevent the bombing of the precious oil producers, and they shot down 25 bombers. While the synthetic oil plants at Blechhammer North, Blechhammer South, and Odertal received damage, the results of the Fifteenth Air Force mission were on the whole disappointing.<sup>58</sup>

The weight of attack was directed at Vienna on 8 July, where good blows were administered to oil refineries, airdromes, and oil storage depots. As was usual in a mission to Vienna, the bombers were threatened by about 100 aggressive German fighters, 18 of which fell to the American guns.<sup>59</sup> On the 9th the Fifteenth Air Force attempted again to damage the Ploesti fields and refineries. On this mission the bombers used H<sub>2</sub>X methods in the hope of overcoming the smoke screen, but subsequent assessment showed that hits had been haphazard. And the Germans still employed flak and an unusually combative force of fighters to advantage.<sup>60</sup> After four days of bad weather and employment on tactical commitments, the Fifteenth resumed the bombing offensive on 14 July with gratifying success against four oil refineries and a marshalling yard in Budapest. Six hundred heavies returned to Ploesti on the 15th and again tried to bomb the area by means of H<sub>2</sub>X. While the mission seemed only partly successful at the time, captured records later revealed that most of the refineries had sustained damage.<sup>61</sup> Vienna was punished on 16 July when the Fifteenth Air Force bombed oil storage facilities, aeroengine works, and marshalling yards. The crews correctly claimed they had shot down half of the ninety or more intercepting German fighters, and American bomber losses came to nine.<sup>62</sup>

After bombing railway targets in France on 17 July, the Fifteenth Air Force undertook on the next day to destroy a complex of factories

at Friedrichshafen, in southern Germany, where jet aircraft plants were concentrated. The GAF sent up nearly 300 fighters to contest the 500 American bombers but the mission was carried out with good results, and at least 45 enemy aircraft were destroyed, with claims for a total of 54.<sup>63</sup> On 19 July aircraft factories around Munich received attacks from 222 heavies. Since the ruinous Eighth Air Force attacks of 11, 12, and 13 July, the Germans had greatly increased their flak defenses, and many of the bombers suffered damage. The campaign against Friedrichshafen was concluded, at least temporarily, when 200 B-24's of the Fifteenth Air Force bombed the jet factories again on 20 July. A postwar survey estimated that these bombings of Friedrichshafen deprived the Germans of 950 jet aircraft.<sup>64</sup> The destruction of an estimated 350 German aircraft on the ground at the Memmingen base on 18 and 20 July constituted a substantial bonus.<sup>65</sup>

Throwing its power back into the oil campaign, the Fifteenth Air Force struck the large Sudeten synthetic oil plant at Brüx on 21 July, where 143 bombers produced excellent results. Tactical bombings in southern France and in Italy absorbed most of the Fifteenth's effort for the remainder of July, but Ploesti was not neglected. A heavy attack on 22 July by almost 500 bombers was not regarded as successful because of failure to overcome the smoke obstacle. But good results, including the interruption of work at two refineries, were obtained on 28 July, one reason being the employment of a weather ship to reconnoiter the region in time to inform the main fleet of 325 bombers where the smoke screen was thickest over the refineries. The same tactic was employed on 31 July, when bombing again proved fairly effective. Not only were three refineries hit but the crews deluged the countryside with pamphlets, "Rumania under a smoke screen," urging the population to revolt.<sup>66</sup> The determined bombardment of the great Ploesti concentrations was slowly disrupting this key source of Axis oil, even though individual missions seldom seemed to achieve conspicuous success.

During the last of July the Eighth Air Force and RAF Bomber Command received many special missions to assist the land armies in breaking out of the Normandy beachhead. Air force operations involved heavy commitments in the way of bridge and railway destruction, airfield attacks, CROSSBOW, supply missions, and occasional attacks upon naval objectives in the Channel. Absorbing as such operations were, the promise of the oil campaign and the imperative need

to keep the GAF down demanded that pressure on the Reich not be relaxed. Hence the heavy bombers would fly against tactical targets in France or strategic targets in Germany depending on weather forecasts for the best visual bombing conditions, and on many days the forces were split between the two types of objectives. The scale of operations mounted impressively; the seven days following 15 July 1944 surpassed the celebrated Big Week of February 1944 in the tonnage dropped by USSTAF. And RAF Bomber Command likewise eclipsed its previous records during this period by attacking France or Germany or both almost every day.<sup>67</sup>

The Eighth Air Force mission of 16 July illustrated the twin tactical and strategic commitments of the heavy bomber forces. Since weather conditions seemed suitable for visual bombing only in parts of southern and western Germany, approximately 450 B-24's were dispatched to bomb marshalling yards at Saarbrücken, which served the German forces in France, while almost 650 B-17's departed on the familiar route to Munich. The Liberators found Saarbrücken covered with clouds and had to bomb with H<sub>2</sub>X, and some of them got mixed up with the B-17 force and followed it almost to Munich before grasping the error. Ground fog in England delayed some of the fighter escorts from taking off and thus unhinged the schedule for support, but luckily German fighters were not available to take advantage of the situation. As for the B-17's, they encountered an unpredicted cloud front which reached up to 30,000 feet and made flying exceedingly hazardous. Two of the eleven B-17 combat wings had to abandon the primary target and attack secondaries. But, in spite of the bad luck and complications, the bombers achieved at least fair results at both Munich and Saarbrücken. Spaatz congratulated the crews who went to Munich for their excellent performance under highly difficult flying conditions.<sup>68</sup>

Bridges and other tactical objectives in France engrossed Eighth Air Force effort on 17 July, and on the 18th carpet bombing near Caen required the attention of the RAF and nearly 600 American B-24's.\* But on that day 750 B-17's conducted a strong assault on the ominous scientific establishments at Peenemünde and Zinnowitz and on a synthetic oil refinery near Kiel. The Fortresses took an overwater route to Jutland, where the Kiel force turned off to attack its objective with good results notwithstanding an undercast. Bombing was

\* See above, p. 208.

visual at Peenemünde and Zinnowitz, where the Germans were known to be producing rocket fuel and devising V weapons. The results were considered good, and operations were not disturbed by the presence of enemy fighters. The evidence of structural damage was unmistakable and Spaatz commended the Eighth Air Force for what he called the finest example of precision bombing that he had ever seen.<sup>69</sup>

A gigantic operation took place on 19 July, when weather conditions were promising over most of the Reich. Aside from the aforementioned Fifteenth Air Force mission to Munich on that day,\* the Germans had to contend with almost 1,250 bombers of the Eighth Air Force and its full fighter strength. The England-based heavies fanned out to bomb aircraft engine factories, fighter assembly plants, airfields, marshalling yards, ball-bearing works, chemical establishments, and numerous targets of opportunity all over southern and western Germany. Most of the bombing was good, and the loss of twenty-nine bombers was not excessive in view of the breaking up of the bombing forces into small units and of spirited German fighter opposition which cost the enemy seventeen airplanes.<sup>70</sup> A wide-scale attack of comparable size, coordinated with the Fifteenth Air Force operation against Friedrichshafen, took place on the next day, 20 July. One force of the Eighth bombed aircraft factories in Saxony; another struck the key synthetic oil plants at Merseburg-Leuna and Lützendorf; a third bombed a variety of railway and aircraft installations in south-central Germany; and the last damaged an important motor vehicle works at Rüsselsheim. Results were for the most part good and only ten heavy bombers failed to return, while thirty German fighters were shot down, two more than were claimed. Although the GAF was active in a few cases, it was clear that the enemy's defense system had been hopelessly distracted by the American attacks.<sup>71</sup>

On 21 July all continental targets were expected to be overcast except those in central and southern Germany. Even the carpet bombing laid on for St.-Lô prior to an assault by the U.S. First Army had to be called off for that day. Thus, 1,068 heavy bombers were dispatched to attack airfields and aircraft factories in southern Germany and the dubiously significant ball-bearing targets at Regensburg and Schweinfurt. Only 414 of the heavy bombers were able to bomb their primary objectives, and one force encountered 80 German fighters. But losses were not heavy and the prime objectives, Regensburg and Schwein-

\* See above, p. 292.

furt, seemed very badly damaged. USSTAF announced that its heavies had dealt a staggering blow to the enemy, and Spaatz regarded the Regensburg bombing as exceptionally good. But, as was usual in the ball-bearing campaign, the destruction of factories led to exaggerated estimates of the effect on production.<sup>72</sup>

On 23 July, Eighth Air Force heavies plastered German airfields in France on the eve of the great breakthrough of the Allied armies. Then, on 24 and 25 July, they participated almost 1,600 strong on each day in the carpet bombing ahead of the First Army's path near St.-Lô.\* Exhaustion from these stupendous operations in France fortunately coincided with a two-day spell of bad weather and gave the Eighth Air Force a welcome respite. On 28 July, 569 Fortresses conducted a highly successful assault on the synthetic oil plant at Merseburg-Leuna, although other attacks that day against oil targets were frustrated by poor bombing conditions. The sixty or so enemy fighters that were airborne around Merseburg did not cause serious trouble for the bomber fleets, but a highly disquieting feature of the day's operations was the long-feared introduction of jets into the air war. Although the seven Me-163's sighted by the Americans refrained from attack and confined their activity to tricks seemingly intended to demonstrate the jet's superiority to Allied aircraft, these antics served to warn USSTAF commanders that daylight supremacy in the skies might not be theirs much longer.<sup>73</sup> Jets were not in evidence, however, on the next day, 29 July, when 647 B-17's went back and definitely placed the Merseburg-Leuna oil installation on the inactive list for a period of several weeks, but opposition from conventional-type fighters was unusually vicious. The Americans were fortunate in losing only seven heavy bombers, and the gunners, who claimed twenty-six, certainly shot down no less than nineteen of the enemy. Also on that day 444 Eighth Air Force bombers attacked crude-oil refineries in the Bremen area, but bombing was blind because of smoke and clouds and results were poor or at best fair. Noting the extremely difficult bombing conditions under which the Eighth operated on 28 and 29 July, Spaatz concluded that the flyers deserved much credit for accomplishing as much as they did.<sup>74</sup> Weathered in on 30 July, the Eighth sent 1,169 bombers out on the 31st to southern Germany, the only area where good visibility might be expected. As had happened before, however, cloud cover forced a resort to blind bombing.

\* See above, pp. 228-33.

About 2,500 tons were dropped on Munich and Ludwigshafen by means of pathfinder indications.<sup>75</sup>

As the American armies raced across France early in August, tactical considerations again took precedence over strategic bombardment. The Eighth Air Force devoted most of its effort to keeping German airfields out of condition, to destroying bridges and railway installations, to carrying emergency supplies to forward ground units which had outrun their normal means, and to CROSSBOW. But bombing conditions were poor in France on 4, 5, and 6 August and propitious in Germany. Accordingly, strategic missions were carried out while the opportunity lasted.

The targets for the 4 August mission were oil refineries at Bremen, Hamburg, and Harburg; aircraft plants at Rostock and elsewhere in northern Germany; the V-weapon experimental works at Penne-münde; and a torpedo plant at Kiel suspected of manufacturing jet parts. In four separate forces 1,246 bombers and all of the Eighth's fifteen fighter groups reached the targets. Bombing was visual only at Peenemünde and Kiel; elsewhere H<sub>2</sub>X was employed. Accuracy was not particularly good at any of the targets, but the 3,000 tons dropped that day caused many fires and explosions. On the following day 1,146 heavies revisited the Reich, this time happily encountering visual conditions and inflicting notable damage to oil refineries and aircraft and armament plants in the Magdeburg-Brunswick-Hannover region. On this mission the Americans fought off some 100 enemy fighters, 29 of which they destroyed (claims that day were 30) while losing 14 of their own bombers and 6 fighters.<sup>76</sup> The outstanding mission of early August occurred on the 6th, which proved to be one of the best days the Eighth had ever experienced in bombing. A total of 999 heavies with twelve supporting fighter groups attacked visually four oil refineries in Hamburg, two in Harburg, the torpedo plant at Kiel, and a number of factories in the suburbs of Berlin which produced parts for airplanes, tanks, and V weapons. A USSTAF press release could proclaim without exaggeration that ten major targets had been severely damaged.<sup>77</sup>

The Fifteenth Air Force, meantime, had continued to operate on an impressive scale. During the latter part of the summer its twenty day-light missions against Ploesti, with the aid of the four night missions flown by the RAF's Italy-based Wellingtons, would deny the Ger-



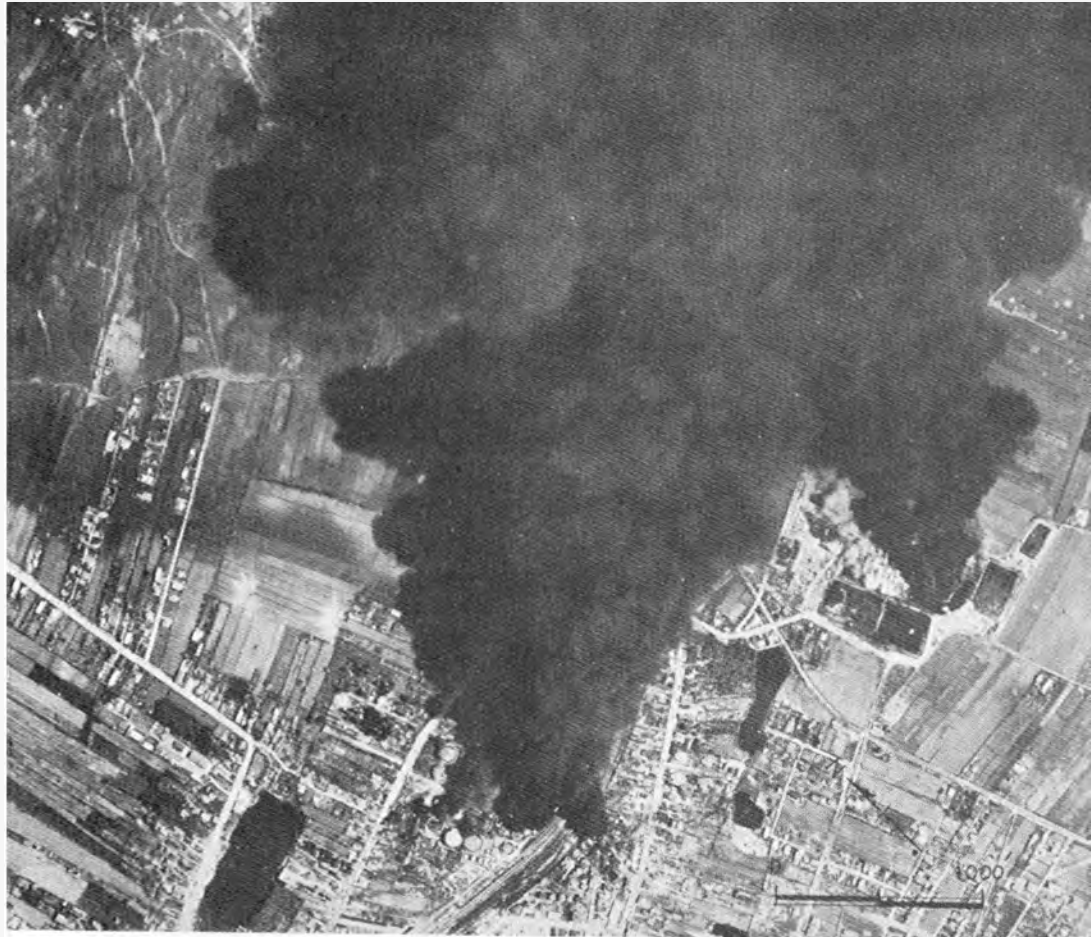

**FIFTEENTH AIR FORCE WRECKS PLOESTI REFINERIES**

*Above:* STELLA ROMANA

*Below:* CONCORDIA VEGA

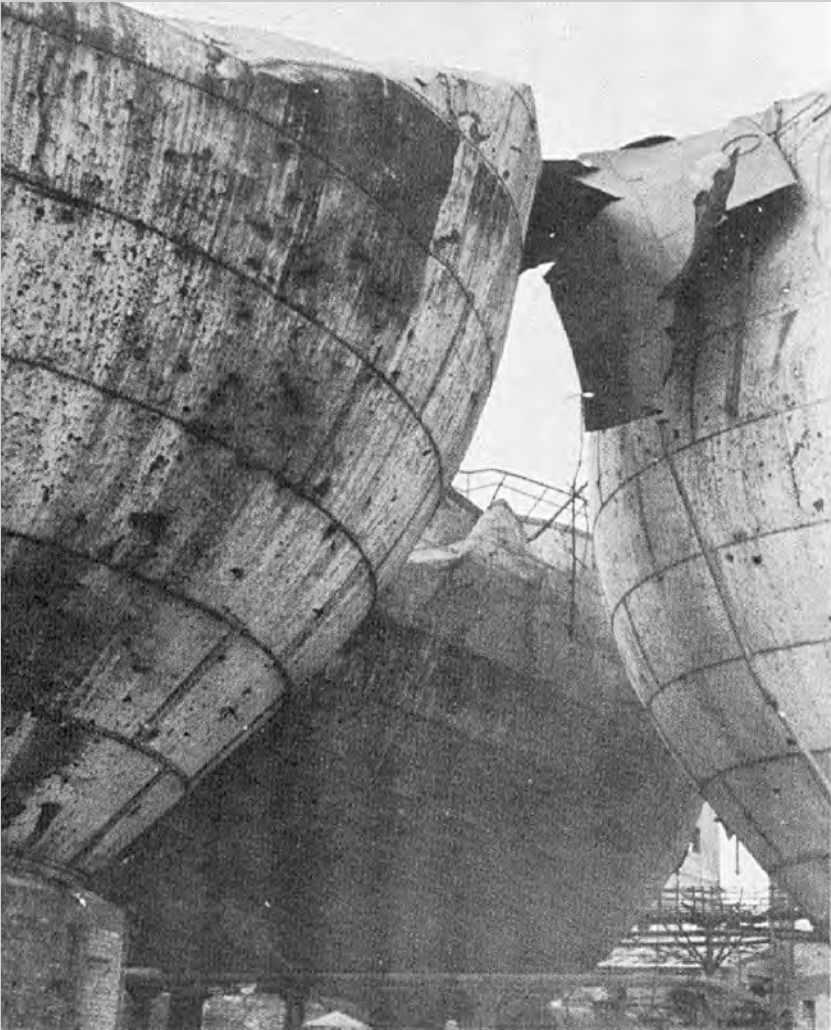

**EIGHTH AIR FORCE ATTACKS OIL REFINERIES**

*Left:* MERSEBURG-LEUNA

*Right:* HARBURG



**FRANTIC: B-17'S EN ROUTE TO RUSSIA**

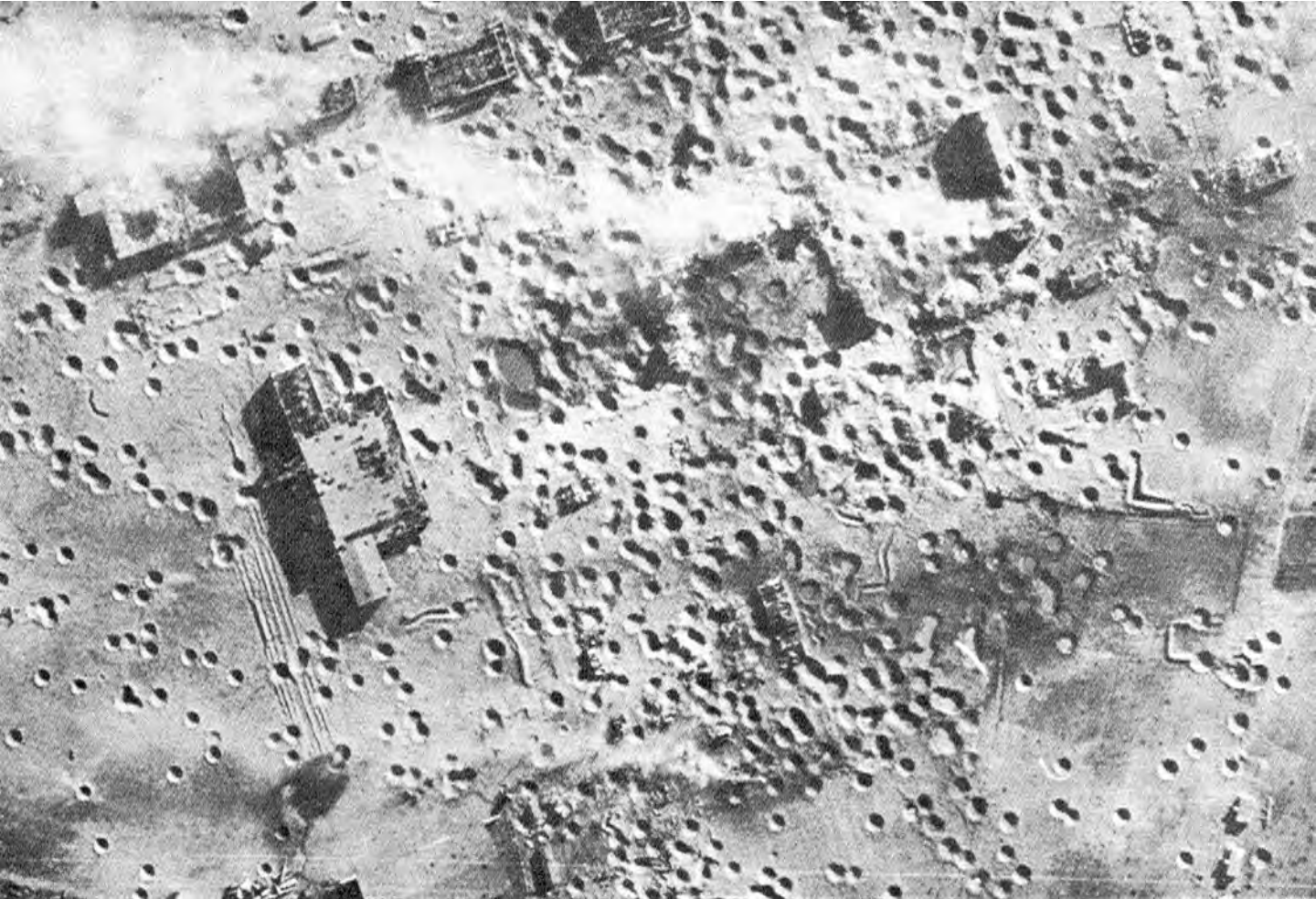

FIFTEENTH AIR FORCE RUINS AIRDROME AT NEUBURG, AUSTRIA

mans an estimated 1,800,000 tons of crude oil,<sup>78</sup> and the steady pounding of oil refineries and synthetic petroleum plants scattered widely about Poland, Germany, Czechoslovakia, Austria, Hungary, and Yugoslavia vastly aggravated the fuel crisis faced by the Axis. At the same time, frequent bombings of aircraft factories in southern Germany, Austria, and Hungary complemented the work of the RAF and the Eighth Air Force in assuring continued Allied air superiority—at least until the jets were ready.

With Ploesti in shaky condition following the July bombings, the Fifteenth on 3 August sent more than 400 of its heavies against four aircraft factories in southern Germany while other forces attacked railway targets in the Brenner Pass in the hope of cutting German lines into Italy. After an interval of tactical bombings, 365 bombers on 7 August attacked the great synthetic oil plants in Silesia, Blechhammer North and Blechhammer South, where damage was disappointing although production was temporarily stopped.<sup>79</sup> On 9 August, more than 250 heavies ranged over Hungary attacking refineries, oil storage depots, and airfields with a fair degree of effectiveness. Nearly 300 B-17's and B-24's took the well-known course to Ploesti and greatly damaged five of the refineries. The once aggressive German fighter defense had suddenly deteriorated with the result that the bombers were able to attack in a long stream which took so much time to pass over the target that the smoke screen thinned out considerably.<sup>80</sup> A few more blows of this type and Ploesti would be inoperative.

All of the refineries in the rich cluster had been damaged or knocked out, the Russians were closing in on Rumania, and the region was by now isolated from Germany because of broken railways and the effective mining of the Danube River. It remained only to smash the refineries completely to make certain that the Germans could not withdraw machinery or finished oil products as they retreated before the Russians. Fortunately, the invasion of southern France on 15 August went off so successfully that little diversion from the strategic air campaign was required after the landing, and the Fifteenth Air Force was able to mount large assaults on Ploesti on each of the three days from 17 through 19 August. With the aid of a night attack by the RAF, these assaults brought production down to an estimated 10 per cent of original capacity, and by 24 August all work had ceased. Soon afterward the Russians occupied the region and allowed American survey parties to examine the wreckage and look over the records—

one of the few instances in which the Russians were cooperative in such matters.

The opportunity thus provided for an immediate check of the results of strategic bombardment against a critically important target was unique, and General Eaker, who himself flew to Ploesti in August, gave to the study his own close personal attention. In addition to the mute testimony offered by the devastated area, there was other information available concerning the results of the campaign. Unfortunately, the evidence found does not afford a detailed picture of the effects of each bomber mission. What does seem to be clear, however, is that the Fifteenth's sustained attack hurt the enemy both early and badly, that by the end of the campaign in August destruction, in terms of productive capacity, was virtually complete, and that the key to this success lay in the sustained character of the offensive. The Fifteenth's own statistics relating to that offensive offer impressive evidence of the cost of such a sustained effort. If the repeat performances of many crews be not considered, a total force of 59,834 airmen had flown against Ploesti. A total of 13,469 tons of bombs had been dropped, and 350 heavy bombers had been lost.<sup>81</sup>

Happily, not all airmen shot down beyond enemy lines remained permanently on the casualty lists. When Rumania abruptly changed sides in the world struggle late in August 1944, the rescue and repatriation of American airmen from that country provided a buoyant episode in the grim Balkan war. AAF flyers held in prison camps near Bucharest were in danger of being evacuated to Germany or having to spend a long period of time in Russian hands before they got home. Taking advantage of the general confusion, one of the internees, Lt. Col. James A. Gunn III, squeezed into the radio compartment of an Me-109G, which had been painted judiciously with stars and stripes, and with a Rumanian officer as pilot, flew to Italy in the hope of getting assistance for his fellows. There, with the situation in Rumania explained, men of the Fifteenth Air Force hurriedly converted fifty-six Fortresses into transports and flew to Popesti airport, outside Bucharest. At no great distance from falling shells the former prisoners crowded into the bombers and flew back to Italy in relays, 1,162 of them in three days. Deloused, fattened up, and mightily cheered, these beneficiaries of Operation REUNION, as it was called, were soon on their way to the States.<sup>82</sup>

The recovery of aircrews imprisoned in Bulgaria, Operation FREE-

DOM, was a less heartening affair. When that nation surrendered in September 1944, the Fifteenth Air Force immediately made plans for the rescue of the 303 AAF prisoners in Bulgaria. But the Bulgarians precipitately placed the men in railway cars and sent them to Turkey, a neutral country, from which they went on by train to Aleppo and from there to Cairo via ATC. The Fifteenth was then able to fly the former prisoners from Egypt to Italy, but it was evident that they were in wretched condition. Their bodies were weak and their spirits were low as a result of months of beatings, insults, inadequate food, and crude medical treatment. A small party led by the deputy commander of the Fifteenth Air Force, Brig. Gen. William E. Hall, went to Sofia to investigate the atrocities and to apprehend the guilty Bulgarian authorities. The Americans filed charges against various individuals but left Bulgaria early in 1945 with the feeling that the new government would not exert itself in prosecuting the cases.<sup>83</sup>

With Ploesti off the target list after mid-August, the Fifteenth Air Force was able to pay closer attention to Germany's remaining oil resources. On 20 August almost 500 B-17's and B-24's bombed oil refineries in Poland and Czechoslovakia with gratifying results. Since only four aircraft failed to return, this mission was hailed as the least costly operation of such depth and size in that air force's history.<sup>84</sup> On the 22d a still larger mission brought damage to widely scattered targets, chief among which were the synthetic oil plants at Odertal and the Blechhammers. Vienna's oil, aircraft production, and railway targets received a heavy load of bombs in a well-executed operation of 23 August.<sup>85</sup> And a vast Eighth-Fifteenth assault on oil refineries throughout Czechoslovakia and western Germany on 24 August, which will be described below, brought praise from General Spaatz, who called it the most effective coordinated attack yet conducted on enemy oil production.<sup>86</sup>

For more than a week after its very effective effort of 6 August, the Eighth Air Force had contributed little to the strategic air offensive. Allied ground forces were sweeping across France from Normandy and were about to pour in from the Mediterranean. The might of the air forces necessarily went into tactical operations in order to complete the liberation of France and in the hope of finishing the war before autumn. One attempt to carry through a large strategic operation against aircraft and tank plants and oil storage depots in southwestern Germany on 9 August proved unrewarding. On that occasion 824

heavy bombers went out in three forces. But one of the forces turned back because of a 28,000-foot cloud front, and the others bombed with poor or fair results a few of the secondary targets.<sup>87</sup> On 14 August, while B-24's operated over France, 730 B-17's attacked aero-engine and jet plants in Stuttgart and Mannheim and the synthetic oil establishment at Ludwigshafen. Bombing results were rated good.<sup>88</sup> Another opportunity for a strategic mission came on 16 August, when 1,090 heavies visually attacked several vital oil refineries and aircraft plants in central Germany. Chief among the former targets were Zeitz, Rositz, Böhlen, and Magdeburg, while the aircraft plants were those at Halle, Schkeuditz, Dessau, Köthen, and Magdeburg. Dampening the cheer over the unusually good bombing was the fact that 200 German fighters had intercepted the bomber fleets and shot down 24 heavies. Returning crews claimed 36 of the enemy, whose records support a claim for at least 27, but by either count the trade was uneven. Notable also was the fact that German interceptors included six jet Me-163's which made passes both at the B-17's and P-51's.<sup>89</sup>

When next, on 24 August, the Eighth became free to conduct another assault on strategic targets in the Reich, it proved possible to stage in coordination with the Fifteenth Air Force one of the AAF's largest efforts of the war. More than 1,300 Eighth Air Force heavy bombers attacked synthetic oil plants at Merseburg-Leuna, Ruhland, Brüx, Misburg, and Freital and aircraft plants in Brunswick and Hannover, while the 600 planes committed by the Fifteenth divided their attention between the oil refineries of western Germany and Czechoslovakia. Severe damage to targets resulted, and enemy opposition to the widely spread attack was generally slight and ineffective.<sup>90</sup> Eighth Air Force gunners claimed in all 30 planes shot down, of which number enemy records concede 19; it has not been possible to check the Fifteenth's claim of 43 planes, all of them destroyed outside the Reich.

Good visual conditions prevailed for the Eighth again on 25 August with the result that 1,191 heavy bombers attacked aircraft plants and component factories at Rostock, Lübeck, Schwerin, and Wismar and badly damaged the synthetic oil plant at distant Pölitz just after it had resumed operation following the knockout blows of June.\* Also, the experimental stations at Rechlin and Peenemünde caught punishing bomb loads. The mission of 26 August was less successful. Bombing was poor at the giant I. G. Farbenindustrie oil-chemical complex

\* See above, p. 284.



at Ludwigshafen and good at two minor oil refineries near the Dutch frontier. The entire operation of 27 August involving 1,202 heavy bombers had to be canceled because of high clouds on the route to the objective, which was Berlin, and bad weather kept the Eighth Air Force away from all strategic targets on 28 and 29 August. On the 30th, 637 B-17's achieved moderately good results against the low-priority U-boat and shipyard targets at Kiel, but their accuracy was dismally low when they bombed aircraft and motor plants in Bremen.<sup>91</sup>

Weather conditions continued to be unfavorable into September. On the 3d of that month 325 B-17's got through to Ludwigshafen, where they inflicted some damage to the chief synthetic oil plant, and on 5 September 277 Fortresses rebombed this target with satisfactory results.<sup>92</sup> But not until 8 September did a long overdue spell of good weather begin. On each of the following six days the Eighth Air Force dispatched 1,000 or more bombers against Germany, thus enabling USSTAF public relations officers to celebrate another Big Week.<sup>93</sup>

The great oil-chemical works at Ludwigshafen was attacked effectively on 8 September, when tank and armored vehicle factories near Mainz were also bombed, but with only fair results. On 9 September the large armaments plant at Düsseldorf was severely damaged, and on the 10th a variety of jet, tank, ordnance, and aircraft targets in such German cities as Nürnberg, Gaggenau, Sindelfingen, and Stuttgart were bombed by 1,145 heavies.<sup>94</sup> On 11 September an eventful mission involving 1,131 heavy bombers and all Eighth Air Force fighter groups brought substantial damage to synthetic oil plants at Ruhland, Böhlen, Brüx, Merseburg-Leuna, Lützkendorf, Misburg, and Magdeburg, a military vehicle plant at Chemnitz, engine works at Hannover, and an ordnance depot at Magdeburg. For the first time since 28 May 1944 the GAF rose in great strength to meet this full-scale attack. Perhaps 400 enemy fighters were sighted by the bombers, and 125 broke through the protective fighter screen to shoot down 20 heavies, at a cost to the defenders of 97 planes. Jets, this time estimated at about 25 in number, zoomed about menacingly, easily outdistancing the American P-51's, but as on previous occasions when they put in their appearance, they refused combat.<sup>95</sup> Enemy opposition was vigorous again on 12 September, when 888 heavy bombers visually attacked oil targets at Ruhland, Brüx, Magdeburg, Böhlen, Misburg, and Hem-

mingstedt. Twenty-three Fortresses were known to fall to the enemy fighters and 22 others did not return to base. Gunners' claims to 108 German planes, though exaggerated to the extent of the difference between that figure and 41, bore testimony to intense air battles.<sup>96</sup> The GAF exhibited strength again on 13 September, as 748 heavies attacked aeroengine factories in Stuttgart and synthetic oil plants at Ludwigshafen, Merseburg, and Lützkendorf and the ordnance depot at Ulm. But American losses were light and 23 of the 150 or more attacking fighters were destroyed by crews who claimed a total of 33.<sup>97</sup> Thus, the summer phase of the strategic air war was terminated with a series of gigantic missions which brought critical injury to German industries and to American air commanders new cause for apprehension regarding the GAF.

The Fifteenth Air Force brought its summer campaign against the German oil complex to completion with large and successful attacks on the Silesian Blechhammers and the main Austrian refineries at Moosbierbaum, Schwechat, and Löbau. Otherwise, most of its effort went into an attempt to hasten the collapse of the Balkan front which by September seemed, deceptively, imminent. In addition to stepping up aid to partisan groups and demolishing whatever remained of Axis oil installations on that peninsula, the Fifteenth gave its attention largely to key points along the railway trunk line between Athens and Belgrade in the hope of preventing German evacuation. These rail attacks hampered and reduced enemy troop movements, it became clear, but they failed to interdict the traffic to the desired degree.<sup>98</sup> Despite extensive air operations by the Americans and a strenuous effort on the ground by the Russians, the Germans managed to avoid a rout and succeeded in stabilizing the Balkan front for a few more months.

### *Bombing Results, Tactics, and Morale*

During the summer months of 1944 the Eighth Air Force, the Fifteenth Air Force, and RAF Bomber Command had exerted their maximum power against the German enemy. The bomb tonnages dropped by the Eighth alone amounted to 36,000 in May, 60,000 in June, 45,000 in July, 49,000 in August, and 40,000 in September. Even though the weather was perversely unseasonable for some weeks after D-day the Eighth's bombers flew on 28 days during June, 27 in July, and 23 in August. The ratio of losses was correspondingly high, notwithstanding the weakened state of the Luftwaffe, because flak was

more deadly now and because bombers often went out under conditions that would have been regarded as unflyable a year before. Out of its 2,100 operational heavy bombers, the Eighth Air Force lost 280 in June, 324 in July, and 318 in August. VIII Fighter Command losses for those months were 242, 153, and 279 out of about 900 fighters that were constantly available for combat units.<sup>99</sup> The 1,100 operational heavy bombers of the Fifteenth Air Force suffered a still higher ratio of losses, considerably exceeding staff planning estimates.<sup>100</sup> After the record loss of 318 heavy bombers in July, General Eaker estimated in August that 30 per cent of the Fifteenth's crews who engaged the enemy were brought down on hostile territory, and MASAF actually lost more men during that month than did the Fifth and Eighth Armies in their ground fighting.<sup>101</sup> RAF Bomber Command's losses were comparably high. Air Chief Marshal Harris pointed out that the casualties of his forces exceeded those of the British Second Army for some weeks after the invasion, and Ambassador John G. Winant commented with much feeling on the terrible rate at which RAF operations were consuming Britain's young manhood.<sup>102</sup>

If the human and material cost of the summer's operations was great, so were the achievements. The bombardment of German oil refineries and synthetic petroleum plants, together with the final exclusion of the Germans from any of the resources of Ploesti, brought the enemy's fuel position to the point of catastrophe by September. USSTAF estimated that German oil production in that month was only 32 per cent of the pre-attack level;<sup>103</sup> and later and better evidence placed the percentage at 23, with gasoline production several points lower.<sup>104</sup> For some weeks the decline of oil output had signified more to the Germans than portentous statistics. At the battle of Caen they had been compelled to employ their stranded tanks merely as small forts dug into the ground they could not traverse for lack of fuel and lubricants. Later in the summer they were abandoning their tanks and motor vehicles all over France, fleeing on foot, rescuing what equipment they could with horses, or surrendering in droves.<sup>105</sup> Training in tank warfare became for the Germans a luxury beyond reach, and even the Luftwaffe reduced its training period to a few insufficient weeks because aviation gasoline could not be spared.<sup>106</sup> The scientifically planned Allied bombings were strangling the German war machine, leaving to the enemy no hope as he desperately

rebuilt his damaged plants, save that the autumn and winter weather might shield his oil production system.

The threatened resurgence of the Luftwaffe was thwarted, or at least postponed, by the combined effect of the oil attacks and of seventy-six Eighth and twenty Fifteenth Air Force raids on aircraft industry during the summer.<sup>107</sup> German bombers were now rare sights, and Allied leaders were confident that conventional German fighters would never endanger the strategic bombing program. Even when Allied claims of German aircraft destroyed in the air or on the ground are discounted as being too full of duplications and insupportable optimism, captured enemy records show that approximately 500 aircraft were destroyed each week during the summer of 1944.<sup>108</sup> And combat losses in the Luftwaffe (killed and missing) rose from 31,000 to 44,000 between 31 May and 31 October 1944.<sup>109</sup> Jets, however, were another matter. That deadly jet fighter forces could make Allied losses intolerable in the near future was a possibility frankly faced by both SHAEF and USSTAF.<sup>110</sup> All the Allies could do was to smash suspected jet plants wherever they could be found and speed up the development of the American P-80. Both programs they pursued with an air of urgency.

The operations of the heavy bomber commands against other target systems had brought less satisfying results by September than the oil and aircraft campaigns. The several missions against ball-bearing plants were effective in terms of mechanical destruction, but not in preventing or seriously delaying German armaments production. A few raids on tank manufacture and assembly marked the beginning of an inconclusive campaign which lasted until November 1944. And several attacks on ordnance depots were likewise the start of an offensive of dubious wisdom.

The management of the strategic air offensive after D-day posed no special problems that had not been anticipated. The directives throughout the summer were very similar, all of them giving first priority to assisting the land campaign, second priority to depriving the enemy of oil and gasoline, and usually a third priority to counter-air force operations. Special instructions regarding tank production and ordnance depots came out toward the end of the summer.<sup>111</sup> CROSSBOW occupied an uneasy and uncertain priority among the objectives of the American air forces in fact, if not always on paper, until its demise at the end of August. Air Chief Marshal Tedder complained on several

occasions that insufficient American effort was going into this campaign,<sup>112</sup> but USSTAF rightly believed that most of the CROSSBOW bombings at this stage were ineffective. Ordinarily, it was the weather and not formal lists of target systems which governed the day-to-day selection of objectives. In the long run all of them were duly bombed. Spaatz steadfastly resisted all proposals to attempt to terrorize the Germans into capitulation. To Doolittle and Twining, he explicitly restated the AAF doctrine of precision bombing,<sup>113</sup> and it was adhered to. Altogether, his command relationships with Eisenhower and the RAF were highly satisfactory. The commanders directed the war with all their skill, and the crews performed with a dogged heroism that had become by this time routine among them.

A few problems of logistics arose. In July it seemed that the supply of air fuel was dangerously low, and in the same month Eisenhower warned Marshall that expenditure of bombs was critically exceeding imports from the United States.<sup>114</sup> Neither situation became serious, however. Theater opinion strongly favored the B-17 over the B-24<sup>115</sup> and preferred the P-51 to the P-38 and the P-47. As a consequence, five groups of heavy bombers in the Eighth Air Force exchanged Liberators for Fortresses by September, and five fighter groups were converted from Lightnings and Thunderbolts to Mustangs. Finally, General Arnold suggested in August that a number of heavy bomber groups make use of bases in France. But both Eisenhower and Spaatz believed that the facilities of French ports would be overtaxed if this were done and that English bases were adequate.<sup>116</sup>

The tactics of the huge bomber fleets of the Eighth were slightly altered in view of the continued weakening of the Luftwaffe and the increasing effectiveness of German flak. Smaller formations were often used in order to reduce exposure to antiaircraft fire, and fighter escorts ranged out more aggressively than ever in search of airborne foes instead of covering the bombers closely. Also, the Eighth Air Force began to use flights of fighter aircraft with bomber pilots flying them to lead the main bomber forces around weather fronts and persistent condensation trails.<sup>117</sup> The Fifteenth Air Force, on the other hand, meeting stronger opposition from FW-190's and Me-109's over its targets, had to devise more compact formations to safeguard its bomber fleets.<sup>118</sup> The bombing accuracy of both the Eighth and the Fifteenth increased markedly, partly because of better visibility afforded by summer weather. The percentage of bombs falling within

1,000 feet of the target grew from 18 in April 1944 to 32 in June and 50 in August in the case of the Fifteenth Air Force, and from 29 to 40 and 45 for the Eighth in those months.<sup>119</sup> In both air forces more was learned about the proper mixture of fragmentation, incendiary, and high-explosive bombs for each individual objective, a matter of precise adjustment which had to be worked out painstakingly for every mission. Of greater significance was the growth and improvement of pathfinder forces employing H<sub>2</sub>X to lead the bombers to targets hidden by cloud or smoke. By autumn USSTAF had abundant experience in the use of H<sub>2</sub>X and a fair supply of these valuable instruments.<sup>120</sup>

Low morale among the aircrews, particularly in the Eighth Air Force, was a nagging problem during the middle of 1944. The intensive scale of operations, high operational losses and wastage, the absence on occasions of sufficient fighters for escort, and the almost unbearable pace of missions on consecutive days all contributed to fatigue and a pessimistic outlook on the part of the flyers. The suspension of the rotation program before the Normandy invasion caused many of them to feel that they were being unnecessarily exposed. When, later in the summer, a well-intended program of temporary duty for rest and recuperation in such stateside resorts as Atlantic City, Miami Beach, and Santa Monica was instituted, the reactions of the men were unfavorable. Most of them did not enjoy their vacations, or so they said, because of the prospect of an early return to combat. And they often expressed their resentment of civilians and of military personnel who had not yet been sent overseas. Some of their remarks were interpreted as revelations of bitter hatred of their senior officers and as opposition to the prosecution of the war.<sup>121</sup> An investigation undertaken on General Arnold's order indicated that such inferences were extreme or unwarranted.<sup>122</sup> But the AAF soon abandoned the program and resumed rotation. Arnold himself had long planned to provide two crews for each bomber so that every man would feel that he had an even chance of surviving his tour.<sup>123</sup> By July 1944 the Eighth Air Force attained this ratio, and by December so did the Fifteenth.<sup>124</sup> Another measure to raise morale was the expansion of Special Services activities, which General Doolittle ordered when he observed that ground crews as well as airmen were suffering from weariness and overwork.<sup>125</sup> An informal investigation carried out for General Arnold in September concluded that the morale

of forces in England showed much improvement. Not only were the airmen confident of their airplanes, their methods, and themselves, but they felt sure they were doing more to win the war than either the ground forces or the RAF.<sup>126</sup>

A situation that gave rise to mischievous interpretations was the growing number of forced landings or parachutings by American bomber crews in neutral Sweden and Switzerland. By the end of July 1944 there were 94 Eighth Air Force crews interned in Sweden and 101 in Switzerland,<sup>127</sup> and rumors of the comfortable sojourn enjoyed by the flyers circulated literally on a global scale, wherever U.S. armed forces were. Diplomatic officials who interrogated the men reported that a disproportionate number of the emergencies which caused the forced landings were not genuine, that cowardice was a major factor. Spaatz grew indignant when he read such reports, which he labeled as base slander, and he demanded that air officers as well as civilians be permitted to interview the internees.<sup>128</sup> When this was done, in August 1944, practically all, if not all, of the charges were dispelled. Neutral officials were able to confirm in most cases that the bombers had been too badly damaged to return to England. Also, the investigations supported Spaatz's conviction that few if any of the flyers had gone down deliberately in order to avoid further combat. As late as mid-September 1944 not a single instance of unnecessary internment had been proved.<sup>129</sup> Military authorities were convinced that diplomatic interrogators had been misled by the characteristic nonchalance and contempt for heroics displayed by most American airmen in World War II. One report indicated that the main problem was nearer that of dissuading the internees from escaping their benevolent hosts.<sup>130</sup> General Eaker, in commenting on this question and on the morale problem in general for Arnold, seems to have hit the nail on the head: "Our crews, like all normal human beings, do not want to get killed. They therefore look upon this business very grimly and they are happy when they get through what they consider all that a man can be asked to stand, and all of them, almost without exception, are glad to return home when their time comes up for rotation. This does not mean low morale. It means they are normal human beings."<sup>131</sup>

Still another aspect of the morale situation remained in the back of most airmen's minds: the plight of the caged warbirds. Every aircrew member knew that he might at almost any time find himself in a *Stalag Luft*, and the number of flyers who reached the enemy's prison com-

pounds increased heavily as a result of the steadily mounting air offensive. To the older prisoners many of the new arrivals seemed conspicuously youthful, cocksure, uncooperative, and invariably convinced that the war was on the point of terminating. The prison camps bulged and took on more of a character reminiscent in superficial ways of stateside army life, with military formations, compulsory exercise, games, reading, improvised entertainment, arguments, fights, criticisms of the British, speculation about escape, prophecies (always optimistic) about the end of the war, and other familiar aspects. But there were also overcrowding and underfeeding and a lurking fear of what the Nazis might do when their doom became imminent. The sight of Fortresses and Liberators would throw a compound into exultation; older prisoners would marvel when they saw American long-range fighters over eastern Germany. News and rumors about the aircrews who had been lucky enough to reach Sweden or Switzerland would make them envious. United Nations victories would produce a surge of optimism. But by the end of the summer of 1944 it became clear to most "Kriegies" that their liberation would not take place in the immediate future. Morale sagged, and they became bitter and gloomy while they prepared to stretch their Red Cross parcels and rations through more dismal months.<sup>182</sup>

### *The AAF in Russia*

Since the early days of the war AAF leaders had been attracted by the idea that shuttle bombing between widely separated bases might pay huge dividends. The experience gained with shuttle operations between British and North African bases, notably in the Regensburg-Schweinfurt mission of 17 August 1943, had introduced a note of caution into AAF planning, but opportunities for shuttle bombing were among the reasons advanced for the establishment of the Fifteenth Air Force in the fall of 1943\* and by that time the United States was urging upon the U.S.S.R. the use of Russian bases for the same purpose. It was well known that the Germans were relocating many of their plants in the east, and it seemed reasonable to expect that American bombers operating out of Russia could strike targets in eastern Germany which were beyond the reach of aircraft flying from England or Italy. It would be helpful, moreover, to compel the Axis to spread out its defenses against air attack and to impress upon the enemy high command

\* See Vol. II, 64-65, 564-65, 684-87, 724, 741.



at about the time of OVERLORD that Germany was exposed from all directions. Perhaps of even more importance was the desire to demonstrate to the Russians how eager the Americans were to wage war on the German enemy in every possible way and to gain from the Russians a fuller appreciation of the contribution of the strategic air forces to the war effort, for to date they had revealed scant regard for the work of the heavy bombers. And if these shuttle operations proved effective, it might be easier to secure Soviet approval for the use of Siberian bases later on in the war against Japan—a consideration seldom lost sight of by the American high command. The manifold advantages expected from FRANTIC, as the project came to be called, were considered ample justification for the effort and expense involved.

It was in October 1943 that General Arnold secured CCS approval for inclusion of the shuttle-bombing proposal as one of the objectives of a U.S. military mission about to be established in Moscow under the leadership of Maj. Gen. John R. Deane. General Deane and Brig. Gen. Hoyt S. Vandenberg, who accompanied him, stopped off in London on their way to Moscow and discussed the FRANTIC project with Eighth Air Force and RAF officials. RAF authorities, though promising cooperation, could see little advantage for their own night bombers in having Russian bases available; in fact, they seem to have regarded the whole project as something of a stunt,<sup>133</sup> but American air officers were quite receptive. In Moscow, Deane and Vandenberg found Soviet air and army officials unresponsive. Apparently startled by the proposal, they declined to discuss it further until they had discovered the wishes of their superiors.<sup>134</sup> Within two days Foreign Minister V. M. Molotov, however, made known Soviet "approval in principle" for FRANTIC to the premature rejoicing of the Americans,<sup>135</sup> who were not then aware of the obscurities often implied in the Russian usage of this phrase.

The most earnest importunities of Deane and his staff having failed to persuade the Russians during November 1943 to translate their formal approval into cooperative action, Ambassador W. Averill Harriman and Col. Elliott Roosevelt at the Tehran conference in December secured from Stalin himself what seemed to be assent for shuttle bombing.<sup>136</sup> Later in that month Molotov again told Harriman and Deane that the Soviet staff had no objection in principle to the project,<sup>137</sup> but January 1944 was to pass without any definite steps on the part of the Russians to implement FRANTIC, notwithstanding the persistent ef-

forts of Arnold, Deane, Harriman, and, by now, Eisenhower and Spaatz, to get things under way.<sup>138</sup> But finally, on 2 February, Harriman had a long conversation with Stalin in which he stressed the advantages of shuttle bombing in destroying German industries and in facilitating the progress of the Red army, to which the Soviet ruler bluntly responded: "We favor it." He then gave instructions for six airfields to be made ready to accommodate 200 American aircraft, and assured Harriman that in time the Americans could operate at least 300 heavy bombers from the coveted Siberian bases.<sup>139</sup>

As the situation thus suddenly thawed out and Russian air officials became cooperative, the Americans hastened to institute their plans. Spaatz, having received authority to communicate directly with Deane, sent to Russia a party of USSTAF officers to select the six airfields agreed upon, a smaller number, incidentally, than the Americans had originally hoped to obtain.<sup>140</sup> It turned out, actually, that only three airfields would be made available: Poltava, Mirgorod, and Piryatin, not far from Kiev, and all three lay farther to the east than the Americans had desired. Because the three sites had been subjected to the Russian scorched-earth policy and to a vengeful German retreat, much reconstruction was required. Longer runways were needed for heavy bombers, moreover, and extensive steel mats, hangars, control towers, and other facilities would have to be provided.<sup>141</sup>

Work went ahead very rapidly during April and May. American supplies poured into Russia by way of the Murmansk convoys and the Persian Gulf Command. The Russians labored with visible enthusiasm to put the bases in readiness, employing female workers in some cases, but they were able to assign to the task only a fraction of the labor force originally agreed upon.<sup>142</sup> Sometimes the Americans chafed at having to adjust Yankee plans to the more ponderous pace of the Russians, and irritation flared up occasionally. But the job was accomplished with a thoroughness which won praise from Deane and USSTAF.<sup>143</sup> The most troublesome problem was that of bringing in AAF personnel to service the bombers and to handle other technical matters, since it had been agreed that Russians would maintain and defend the bases and that a minimum number of Americans would be admitted. Not only was the number of AAF technicians excessively restricted, but the 1,200 "bodies" permitted to come were held up in a very exasperating fashion until Deane finally pushed through an agreement to enter them under a group visa, a device which greatly disturbed

the lower echelon of Russian officialdom.<sup>144</sup> Even then, key officers were sometimes delayed mysteriously at Tehran for days on end, a matter over which General Arnold expressed annoyance as late as 30 May 1944.<sup>145</sup> Another difficulty arose from Russian unwillingness to let the AAF control its own communications in operational matters. Eventually the Russians relented, however, and they even granted permission for American aircraft to fly certain types of supplies straight into Russia.<sup>146</sup>

By the end of May 1944 the bases were in adequate condition to accommodate heavy bombers. A recent inspection by Maj. Gen. Fred Anderson and Colonel Roosevelt of USSTAF had revealed that things were going well and that shuttle reconnaissance flights preparatory to bombing missions could begin.<sup>147</sup> USSTAF had established a branch organization, known as Eastern Command, on Soviet soil and placed it under the command of Maj. Gen. Robert J. Walsh, who in turn reported to General Deane in Moscow.<sup>148</sup> It was considered of the first importance that the initial shuttle-bombing mission, dubbed FRANTIC JOE, should be a veritable model of air warfare in order to inspire the Russians with admiration and confidence. Since the Eighth Air Force was absorbed in preparations for the very imminent OVERLORD, Spaatz assigned the operation to the Fifteenth Air Force. Late in May 1944 he went over the details in London with General Eaker, who chose to lead in person the first mission.<sup>149</sup> Nothing, the air generals felt, had been left to chance. All was in order to make a good impression on the Russians and to distract the Germans on the eve of the Normandy invasion.

A disconcerting problem arose, however, with regard to the targets to be bombed on the shuttle from Italy to Russia, from the new bases in Russia, and then on the return flight to Italy. Since the avowed purpose of FRANTIC was to enable the strategic air forces to attack objectives they could not ordinarily reach, it was planned to bomb the Heinkel aircraft works at Riga and at Mielec, a town near Lwów, in Poland.<sup>150</sup> More as a courtesy to the Russians than anything else, Spaatz consulted Moscow about his choice of objectives. The Russian general staff replied that there were strong, but undefined, objections to his selection of targets. Instead, the Russians recommended that the first mission concentrate on various minor targets in Hungary and Rumania which were in easy range of Fifteenth Air Force bases in Italy. Harriman remonstrated vigorously, and so did Deane.<sup>151</sup> But the Russians would

not clear Riga and Mielec for the bombings. Deane inferred that the Russians feared an attack on Riga might disclose Soviet intentions of beginning an offensive in that direction,<sup>152</sup> but he never knew for sure why the target was not acceptable. Voicing his disappointment at the Russian attitude, he advised Spaatz to choose the targets he desired and merely to inform the Russians of his intentions.<sup>153</sup>

General Eaker was also disturbed, feeling that the Russians had not cooperated in the selection of targets as well as the AAF had a right to expect,<sup>154</sup> but he spared no pains to make FRANTIC JOE a success. Four experience-hardened groups of B-17's from the 4th Wing of the Fifteenth Air Force and a reinforced P-51 group from the 306th Wing were organized into a task force to fly to Russia on the first clear day after June 1. On the way they would attack a railway center in Debrecen, Hungary. All of the 130 bombers would land at Poltava and Mirgorod and the 70 fighters would base at Piryatin. They would remain on Russian soil for several days, during which time Eaker hoped to clear up the problem of additional targets and secure permission to bomb Riga and Mielec. Then, the task force would return to Italy, if possible attacking strategic targets on the way. Unusual care was taken regarding security, discipline, and personal conduct among the crews, who were instructed not to talk politics in Russia.<sup>155</sup>

At 0655 on 2 June 1944 the FRANTIC JOE task force took off from Italy. After an uneventful flight over Yugoslavia it reached Debrecen soon after 0900 and dropped a thousand 500-pound bombs from altitudes ranging from 21,000 feet to 25,000. All tracks in the main marshalling yards were cut and a large quantity of rolling stock was damaged or destroyed. The bombs blasted or fired the central railway station and the chief buildings of an engineering establishment. No enemy fighters appeared and there was no flak over the target, but one Fortress in Eaker's squadron unaccountably exploded. It was the only loss.<sup>156</sup> By early afternoon the main group of B-17's, led by a flight of three in a triumphant V formation, landed at Poltava, where a large crowd of dignitaries stood in a light rain to witness the historic occasion.<sup>157</sup> As prearranged out of deference to Russian sensibilities,<sup>158</sup> Moscow made the first announcement of the inauguration of shuttle bombing. Deane thought the mission had been a huge success,<sup>159</sup> and Eaker was very pleased with the bases. The general himself was most cordially received by his Russian hosts.

Eaker quickly obtained permission from the Russians to bomb the

originally scheduled target at Mielec. There seemed reason to believe there would be no further misunderstandings about target selection, and Eaker was mightily pleased at the cooperative attitude he found.<sup>160</sup> But weather conditions prevented an attack on Mielec for several days. Finally, on 6 June, a force of 104 B-17's and 42 P-51's attacked an airfield at Galatz, Rumania, with moderately good results and no bomber losses. Two Mustangs were shot down, however, and the Americans claimed eight enemy aircraft.<sup>161</sup> The weather showed no signs of clearing up sufficiently to allow the Americans to bomb Poland or eastern Germany, but Spaatz cabled Eaker to remain in Russia for a few more days in order to pose a threat, psychological if nothing more, to the Germans during the Normandy invasion.<sup>162</sup> Since there was no flying, the crews wandered about the bases and the devastated towns near by. They made friends with Russian civilians, who were hospitable and willing to go out of their way to entertain the visiting airmen.<sup>163</sup> Despairing of a break in the weather, Eaker finally led his task force back to Italy on 11 June. On the way it bombed Foscani airfield in northeastern Rumania, where the Americans achieved fair results and lost one B-17.<sup>164</sup> The return to Italy was an occasion for commendations and jubilant publicity, as well as optimistic plans for the future. Eaker felt certain that the Russians admired the Americans greatly and that they were deeply appreciative of the assistance being offered them.<sup>165</sup>

On 21 June 1944 the Eighth Air Force began its participation in FRANTIC with a mission that was to prove historic in more than one respect. It began well. As part of the previously described operation on that day,\* a task force composed of 114 B-17's and 70 P-51's bombed the synthetic oil plant at Ruhland, south of Berlin, in perfect weather and proceeded to the Russian bases. Unknown to the Americans, a German He-177 trailed the Fortresses to Poltava. Within five hours the Russian warning system reported that a large force of German bombers and fighters was crossing the front lines, and shortly after midnight these airplanes were over Poltava. The Germans dropped great numbers of flares which illuminated the airfield and the B-17's on it. Then they deposited approximately 110 tons of bombs—demolition, incendiary, and fragmentation—and fairly wrecked the target area. Some of the German aircraft flew low over the airdrome, strafing it thoroughly and scattering murderous antipersonnel bombs. The enemy's blow was

\* See above, pp. 284-85.

brilliantly successful.<sup>166</sup> Forty-three B-17's were destroyed and twenty-six were damaged. Besides, fifteen Mustangs and miscellaneous Russian aircraft were destroyed, American ammunition dumps were fired, and 450,000 gallons of gasoline which had been brought into Russia so laboriously were ignited. Only one American was killed, but the Russians, who fought the fires heroically and refused to let the Americans endanger themselves, suffered twenty-five fatalities. And not a single German aircraft was brought down. A few months later Spaatz told Hermann Goering that this was the best attack the Luftwaffe ever made against the AAF, and the prisoner reminisced, "Those were wonderful times."<sup>167</sup>

The Poltava disaster was not the end of the story, for the elated Germans returned on the following night to punish Mirgorod and Piryatin. They were unable to locate the latter airdrome, however, and the Americans flew their airplanes away from Mirgorod before the enemy arrived. But considerable damage to bomb dumps and gasoline supplies was inflicted at Mirgorod,<sup>168</sup> and Eastern Command was temporarily immobilized. The Russians had demanded that they alone be responsible for the defense of the bases, and they had made a very poor showing during the German raids.<sup>169</sup> But both the Americans and the Russians were careful not to indulge in recriminations, and they labored together to salvage and repair the remaining aircraft. They took steps to provide hospitals in the area, to disperse airplanes and supplies, and to set up machine-gun defenses—all in a cooperative spirit which helped reduce the embarrassment both sides felt.<sup>170</sup> The Americans, however, were determined not to expose their airplanes unnecessarily, and on 27 June, Harriman thought he had obtained Stalin's approval to establish an AAF night fighter unit to protect the bases,<sup>171</sup> but somehow nothing ever came of the matter. The Soviet authorities postponed and obstructed until the project was dead. Without additional protection, it was evident that American bombers should not remain more than one night on Russian bases,<sup>172</sup> and plans for the expansion of FRANTIC which had looked forward to the basing of three AAF heavy bomber groups permanently in Russia began to cool.<sup>173</sup>

The surviving Eighth Air Force bombers and fighters, seventy-one Fortresses and fifty-five Mustangs, some of which had been patched up after the German raids, had left Russia on 26 June. On the way to Italy they severely damaged a synthetic oil plant at Drohobycz, Poland.<sup>174</sup> In Italy they flew one mission with the Fifteenth Air Force and

then returned to their bases in England. An entire month passed before another FRANTIC mission took place, a delay arising partly from the preoccupation of the strategic air forces with the land campaigns and the urgent need to neutralize German industrial targets within reach of the principal bases. But another factor was the continuing inadequacy of defenses at Eastern Command and the reluctance of the Russians to permit significant operations by the Americans from FRANTIC bases.

Finally, not willing to see FRANTIC lapse altogether, USSTAF decided to send a task force of fighter-bombers to Russia. On 22 July, seventy-six Lightnings and fifty-eight Mustangs of the Fifteenth Air Force carried out a devastating attack on Rumanian airfields while bombers of that organization were operating against Ploesti. After destroying fifty-six enemy aircraft, according to pilots' claims, the task force continued on to Russia. From FRANTIC bases the American fighters attacked the airdrome at Mielec on 25 July and wrecked seven enemy aircraft. Flying back to Italy on the 26th they swept over the Bucharest-Ploesti region and destroyed twenty more enemy airplanes.<sup>175</sup> Another task force, this time composed only of P-38's, operated on 4, 5, and 6 August between bases in Italy and Russia in an eager attempt to comply with the first direct Soviet request for assistance the AAF had received, this in the way of attacking airfields and railroads in Rumania.<sup>176</sup> At the conclusion of these operations Eastern Command advised USSTAF that, balancing losses and battle damage against the relatively unprofitable targets, fighter-bomber attacks from FRANTIC bases were proving too costly.<sup>177</sup>

On 6 August 1944, soon after the Fifteenth Air Force Lightnings left Russia, an Eighth Air Force fleet of seventy-six Fortresses and sixty-four Mustangs flew in, having bombed a Focke-Wulf aircraft factory at Gdynia, Poland, on the way. After spending an uneventful night on Soviet territory, part of this force raided oil refineries at Trzebinia, Poland, with good results and no losses. On 8 August the entire force took off for Italy, bombed Rumanian airdromes on the way, and eventually completed the triangle back to England. Not until 11 September did the Eighth Air Force engage in another shuttle mission. On this occasion seventy-five Fortresses and sixty-four Mustangs attacked an armament plant at Chemnitz on the way to Russia. Spending 12 September at FRANTIC bases, this force left on 13 September, bombed steel works at Diosgyör, Hungary, and landed in Italy.<sup>178</sup> This was the

last of the shuttle-bombing missions. Autumn was setting in, and by now FRANTIC bases were so far to the east of Soviet lines they were of scant value as springboards for bombing Germany.

The tragic finale to FRANTIC operations was the protracted effort, expended largely in appeals and negotiations, to deliver supplies to the besieged patriot force in Warsaw during August and September 1944. This army, led by Gen. Tadeusz Bór-Komorowski, rose against the Nazis on 1 August 1944 upon receipt of what the Poles in Warsaw and London regarded as authentic radio orders from Moscow. The Soviet armies were approaching Warsaw and it seemed that the Polish capital might be delivered in a matter of days after Bór's uprising. The Russian advance in that direction mysteriously halted, however, and came no closer to the city than ten kilometers for months thereafter.<sup>179</sup> The rebellious Poles, facing powerful and vengeful German forces, fought on with typical bravery, and on 15 August General Eisenhower received a message from Washington urging him to undertake a supply-dropping mission to the beleaguered city.<sup>180</sup> Heavy bombers were unable to complete an England-Warsaw-England flight, and it was very difficult to carry out a round-trip mission from Italy to Warsaw. Hence a shuttle to FRANTIC bases seemed in order.

But at this point the course of events took a dismaying turn. Russian officials suddenly denounced the Warsaw forces as reckless adventurers who had risen prematurely and without Soviet incitement, and refused to permit a FRANTIC operation in behalf of Warsaw. Strong pressure from the American and British ambassadors failed to alter the Soviet attitude, as also did an appeal from President Roosevelt and Prime Minister Churchill.<sup>181</sup> The British, employing the Italy-based RAF 205 Group with volunteer aircrews, between 14 August and 16 October sent seven exceedingly difficult and costly relief missions to drop supplies by night.<sup>182</sup> But while the Germans were beating down the Poles and destroying Warsaw stone by stone, as they had said they would, the Russian army did not budge from its position ten kilometers away, and some high-ranking officers in USSTAF were of the opinion that further insistence on supply-dropping could only endanger Russo-American relations with no other effect.<sup>183</sup>

By early September the situation had become so tragic, however, that the western Allies renewed their appeals for a FRANTIC mission to Warsaw. The Russians gave their approval on 11 September and, perhaps as a concession to the western Allies, they themselves com-



menced dropping supplies on the Polish capital on 13 September.<sup>184</sup> The only American mission of this nature, and the last of all FRANTIC operations, was carried out by the Eighth Air Force on 18 September. One hundred and seven B-17's circled the area for an hour and dropped 1,284 containers with machine-gun parts, pistols, small-arms ammunition, hand grenades, incendiaries, explosives, food, and medical supplies. While at first it appeared that the mission had been a great success, and so it was hailed, it was later known that only 288, or possibly only 130, of the containers fell into Polish hands.<sup>185</sup> The Germans got the others.

A strong disposition remained in Allied circles to send another daylight shuttle mission to Warsaw. The Polish premier-in-exile, Stanislaus Mikolajczyk, made a heart-rending appeal to Prime Minister Churchill, who telephoned USSTAF on 27 September to repeat and indorse the Pole's message and to add his own request for another supply mission, "a noble deed," as he called it.<sup>186</sup> From Washington, President Roosevelt ordered that a FRANTIC delivery to Warsaw be carried out, much to the discomfiture of the War Department and its air staff which regarded such missions as both costly and hopeless.<sup>187</sup> The second supply operation was never cleared by the Russians; Stalin himself seems to have refused permission on 2 October 1944.<sup>188</sup> A few days later the Nazis extinguished the Warsaw insurrection, which had cost the lives of perhaps 250,000 Poles. Not until January 1945 did the Russians take over the city, or what remained of it.

The fortunes of Eastern Command never recovered from the German attacks on Poltava and Mirgorod on 21-22 June 1944. Contrary to American hopes,<sup>189</sup> the disaster did not make the Russians easier to deal with. Nothing came of the project to base permanently on Soviet soil a night fighter squadron and heavy bombardment groups. In fact, the Russians gave scant indication of being impressed with strategic bombing, or of desiring to facilitate the bomber offensive, or even of using heavy bombers for their own purposes. While a few FRANTIC missions were carried out after the 21-22 June affair, the impression grew among the Americans that the Soviet authorities wanted the AAF to pull out of Russia altogether. This feeling was not slaked when Molotov, in late August 1944, pointedly indicated the Russians needed the three air bases which had been turned over to the Americans.<sup>190</sup> General Arnold, as yet not prepared to abandon FRANTIC, made determined efforts to persuade the Russians to allow heavy bombers

to operate from bases in Poland and Rumania so they could attack targets during the winter that would otherwise be awkward to reach, but General Spaatz felt that the complications would outweigh the advantages.<sup>191</sup> In any event the Russians were not willing to agree to Arnold's proposals, and there was nothing to do but shut down Eastern Command for the winter. The possibility of relieving Warsaw postponed this process, but by the last of October 1944 all but 200 American caretaker personnel had left Russia and supplies were stored up. For those who remained, unpleasant incidents became more frequent and more meaningful. Soviet authorities rigidly segregated the Russian and American soldiers, and in a disagreeable atmosphere the forlorn remnant of the AAF units spent the winter of 1944-45 in the Soviet Union.<sup>192</sup>

Was FRANTIC a success? The prevailing opinion in responsible circles at the time of its termination was that probably it had been. AAF officers had conferred frequently with Soviet leaders and had come to know them as individuals. They had gone to great lengths to show the Russians that the United States was fighting the Germans with all its will and might, and they had repeatedly offered to cooperate as closely as possible with the Soviet war effort. They believed they had established a good precedent for friendly collaboration in the future. As long as there remained any possibility that Russia might conclude a separate peace with Germany, or that American bombers could operate from Siberia against Japan, these experiences could not be regarded as wasted. On their part, the Russians had been sometimes friendly and sometimes cold, sometimes stubborn and sometimes cooperative, and always mysterious. As for the targets that had been bombed on FRANTIC missions, all of them could have been reached without utilizing Russian bases and with a smaller expenditure of effort. Some of the attacks would probably not have been regarded as worth making but for the desire to use those bases. USSTAF intelligence, however, estimated that perhaps a few airplanes and men had been saved because of the shuttle method.<sup>193</sup> The much-vaunted purpose of frightening and distracting the Germans did not materialize at all. The German high command was not fooled; it did not even redeploy its fighters. Field Marshal Wilhelm Keitel afterward said he had regarded the whole affair as a demonstration to show how closely the Russians and Americans were collaborating, and a captured GAF

general indicated that FRANTIC was evaluated by his organization as a mere propaganda stunt.<sup>194</sup>

Whatever hope survived of closer cooperation with the Russians, the end of the shuttle-bombing experiment was accompanied by evidences in higher American echelons of a widening sense of estrangement. General Spaatz regarded the Russians by late August 1944 as most difficult to deal with, and Eaker complained that "we are breaking our necks" to get along with the Russians, who were not reciprocating at all. In September General Arnold reported to Deane and Harriman in connection with the dismantling of FRANTIC that Harry Hopkins had agreed that the United States should match the Russians when it came to getting tough.<sup>195</sup> There would be, however, more months of tactful approaches and protracted negotiations—and no Russian concessions.

#### *The Strategic Air Forces Revert to CCS Control*

The agreement of March 1944 to place the strategic air forces operating out of England under the direction of General Eisenhower included, it will be recalled, a proviso to review the command situation as soon as OVERLORD was established on the continent.\* There was little inclination to reopen the matter, however, even after the invasion forces were not only firm on continental soil but had driven the Germans from most of France. It was apparent that Bomber Command and the Eighth Air Force were contributing mightily to the progress of the land armies, and their assistance was likely to be needed at unpredictable but critical junctures until the Nazis surrendered. Besides, the arrangement was working extraordinarily well. General Eisenhower was fully in sympathy with the strategic bombing program and he never thought of abusing his power to summon the heavies to assist the land armies. He got on splendidly with Air Chief Marshal Harris of Bomber Command, who not only responded to every request but took the lead in developing methods of air bombardment to further the land campaigns.<sup>196</sup> Eisenhower was, of course, on intimate terms with Spaatz and Doolittle; Spaatz even moved USSTAF headquarters to France in September so that he could continue to cooperate closely with the supreme commander. Air Chief Marshal Tedder, who oversaw SHAEF's air operations, was an officer much liked and trusted by other airmen. On possibly no more

\* See above, pp. 80-81.

than one occasion did Tedder divert heavy bombers from strategic to tactical targets in a manner that provoked AAF criticism.<sup>197</sup>

The general satisfaction of SHAEF and air force officers in the theater with the command situation was shared, after due consideration, by Headquarters AAF. In reply to a request from General Arnold early in August for comment, his plans officers indicated that the existing command arrangements were agreeable and that, if any changes were to be effected, Eisenhower should be endowed with command rather than mere direction of the strategic air forces.<sup>198</sup> Not long afterward General Eisenhower himself expressed to the CCS his conviction that the air command had worked exactly as planned, with no friction and no hitches, and General Spaatz wrote Arnold on 27 August that Eaker and he were agreed that both the Eighth and Fifteenth Air Forces should continue to operate as they were unless the control of General Eisenhower could be strengthened.<sup>199</sup> Spaatz added the hope that the troublesome Leigh-Mallory organization could be eliminated and warned against any move to consolidate the AAF and RAF. Reassured by such opinions as these, General Arnold decided not to disturb the prevailing arrangement for the control of the strategic air forces. He was fully convinced, as he had always been, that all forces should be dedicated to Eisenhower's mission, and he was never forgetful of the advantage with reference to postwar organization of gaining the good will of the ground forces.<sup>200</sup>

A change, however, soon was to come and with aid from Arnold, despite the unchanging convictions of Spaatz. When, on 31 August 1944, Sir Charles Portal, the RAF chief of air staff, told Spaatz that he wanted the power of directing the strategic air forces removed from SHAEF and returned to the CCS, thus restoring the pre-OVERLORD situation, Spaatz promptly urged Arnold by letter to see that Eisenhower's control was strengthened.<sup>201</sup> Eisenhower himself cabled Marshall that he would urgently oppose Portal's proposed change. And on the following day, at Spaatz's request, the supreme commander cabled General Arnold in a similar vein. In reply, Arnold expressed wholehearted agreement, and later in September he showed skepticism as Portal, at the second Quebec conference, developed the arguments for a return to CCS control.<sup>202</sup> But subsequently, as Arnold himself described it, he "flopped over" to Portal's views.<sup>203</sup> Perhaps the crucial issue was one not mentioned in the official British proposal: a desire of the Air Ministry to re-establish its control of Harris'

Bomber Command. Ever since April 1944, Harris had worked closely with Eisenhower, Tedder, and Spaatz without being harassed, as he later phrased it, by the Air Ministry,<sup>204</sup> which could easily restore its former control through the device of reverting to the CCS the nominal power of supervising heavy bomber operation, for Portal and Arnold would then serve as agents for the CCS in managing the British and American strategic air forces respectively. Arnold, who always made his own ideas felt in overseas air headquarters regardless of command chains, could easily sympathize with the desire of the Air Ministry to resume direction of its Bomber Command.<sup>205</sup> The change, moreover, would tend to elevate General Spaatz, as Arnold's delegate in the execution of CCS authority, toward a parity with Portal and would put Spaatz in better position to become the titular as well as the actual American air commander in Europe, a post which Arnold endlessly but vainly sought for him.<sup>206</sup> General Arnold made certain, however, that the directive was worded in such a way as to insure beyond all question Eisenhower's right to obtain heavy bomber assistance any time he needed it. The formal agreement came in the form of CCS 520/6, 14 September 1944.

The new directive produced consternation at SHAEF. Eisenhower privately thought the arrangement clumsy, awkward, and inefficient.<sup>207</sup> Spaatz seemed especially perturbed and bewildered, for he and Eisenhower had been certain that their own views accorded with Marshall's and Arnold's. But things quickly calmed down. General Marshall assured Eisenhower that he could have on simple demand all he wanted, when he wanted it, from USSTAF and Bomber Command, and the supreme commander characteristically replied that he had no qualms at all about the change.<sup>208</sup> He took occasion to commend Spaatz and Doolittle for the very effective and prompt support their forces had given SHAEF in the past and to express the hope "that every member of the SAF may have personal assurance of my lasting gratitude and will realize that this whole Command feels indebted to them for examples of unexcelled courage, skill and perfection in cooperation."<sup>209</sup> Spaatz and Harris feelingly promised that the strategic air forces would redouble their efforts to see that all possible support was given the land forces,<sup>210</sup> and the supreme commander wrote General Marshall that he believed Harris was quite disappointed to see his command lose its status as an integral part of SHAEF.<sup>211</sup> In his postwar book Harris more than supported this belief by denounc-

ing the September 1944 directive as unfortunate all the way around.<sup>212</sup> For the American air forces, however, the new system did not involve drastic readjustments. Actually, it made little difference. The heavy bombers continued to wage their strategic offensive against German industry while dropping more than half their tonnage on targets requested by the ground forces, and the arrangements continued to be based on understandings between Eisenhower and Spaatz.

SECTION III

\* \* \* \* \*

*ITALY*





## CHAPTER 10

\* \* \* \* \*

### *ANZIO*

THE concentration of Allied effort after 1943 on the invasion of western Europe unavoidably had relegated military operations in the Mediterranean area to a position of secondary importance. Following the final expulsion of Axis forces from North Africa in May 1943, the Allies by their rapid conquest of Pantelleria, Sicily, and the southern half of the Italian mainland had forced Italy out of the war, seized the key port of Naples, and captured the great complex of airfields around Foggia by 1 October. With the additional insurance provided by the occupation of Sardinia and the conquest of Corsica, it had been possible to reopen the Mediterranean to Allied shipping and to move forward to the Italian mainland an expanded strategic bomber force for a major share in the climactic phase of the Combined Bomber Offensive. At the close of 1943 plans were also being shaped for an amphibious thrust (ANVIL) from Mediterranean bases into southern France that would coincide closely with the landings in Normandy. Though no longer the main theater of operations, the Mediterranean nevertheless would support an active participation in the final assault on the main centers of German power. Such at any rate was the expectation.

That hope proved well enough founded in the case of the heavy bombers. Certainly from the spring of 1944, and especially in operations against the enemy's oil targets, the Fifteenth Air Force played a major, even a distinguished, part.\* But by December 1943 the Allied ground campaign in Italy had come to a halt just above the Volturno

\* For the sake of unity in the story of the CBO and of subsequent strategic operations, that part of Fifteenth Air Force activity is recounted elsewhere. (See above, Chaps. 1, 2, 6, 9, and below, Chaps. 18, 20, 22.) In this section, the primary concern with Fifteenth Air Force operations is to record the support provided for the Italian ground campaigns.

and Sangro rivers in the face of smart German resistance, a rugged terrain, and wretched weather. Thereafter a winter of bitter frustration so delayed the Allied advance that the occupation of Rome did not come until 4 June 1944, just two days prior to the invasion of western France, and the scheduled invasion of southern France would not be mounted until the middle of August. The story recounted in the following section thus becomes for the most part the narrative of a distinct and separate phase of the European war—a phase more frequently having its effect on the main theater of activity by indirect than by direct influence.

### *The Administrative Structure*

When Lt. Gen. Ira C. Eaker reached Italy in mid-January 1944 to assume command of the Mediterranean Allied Air Forces (MAAF),\* he took over a job much more complex than the one he had held in the United Kingdom. There he had only one major program, to bomb the German war potential in western Europe, and this he did with one air force, the Eighth. In the Mediterranean he had three primary tasks—to share USSTAF's responsibility for the Combined Bomber Offensive, to support the ground campaign in Italy, and to keep the sea lanes open and provide protection for logistical establishments. For the accomplishment of these tasks he depended upon three distinct air forces—Strategic, Tactical, and Coastal (MASAF under command of Maj. Gen. Nathan F. Twining, MATAF under Maj. Gen. John K. Cannon, and MACAF under Air Vice Marshal Sir Hugh P. Lloyd)—each a combined RAF-AAF command with its own distinct mission but each, under certain conditions, obligated to work closely with the others. Eaker also had many secondary tasks: he must expand Allied aid to the Balkan partisans, continue the build-up and utilization of French and various other Allied elements of his command, complete the reorganization instituted by the establishment of MAAF, move forward from Africa and Sicily into Italy and Corsica important elements of his command, and whip into shape the rapidly expanding and still somewhat disorganized Fifteenth Air Force. Not only were his duties diverse but his responsibility extended from Casablanca to Cairo (RAF Middle East now was under MAAF) and from Tripoli to Foggia, and his command was not restricted to American units as it

\* For discussion of the steps leading to establishment of this command, see Vol. II, 744-51.

had been in England but he now commanded units representing more than half a dozen nations.<sup>1</sup>

The organization of Allied forces in the Mediterranean long had been one which provided true unity of command for operations but preserved national distinctions for purposes of administration, and key commanders, be they British or American, usually wore two hats. Separate from the operational chain of command which ran from MAAF to its several combat elements were two administrative chains, one American, the other British. These were headed respectively by Eaker, in his capacity as commander of the Army Air Forces, Mediterranean Theater of Operations, and by Eaker's deputy in MAAF, Air Marshal Sir John C. Slessor. In actual practice each of these top administrative headquarters was run by a deputy, Maj. Gen. Idwal H. Edwards for Eaker and Air Marshal Sir John Linnell for Slessor. Under Edwards for administrative purposes thus came the Fifteenth Air Force (commanded by Twining as the AAF element of MASAF) and the Twelfth Air Force (under Cannon as the American element of MATAF). Eaker as commanding general of AAF/MTO fitted into an administrative chain of command running down from Headquarters, North African Theater of Operations (NATOUSA), of which Lt. Gen. Jacob L. Devers had recently assumed command. Devers served also as deputy to Gen. Sir Henry Maitland Wilson, the British officer who on 1 January 1944 had succeeded Eisenhower at Allied Force Headquarters and to whom Eaker was responsible as the commander of MAAF.<sup>2</sup>

For General Eaker there was an additional complication arising from the commitment of the Fifteenth Air Force to the CBO, an operation controlled entirely by agencies outside the theater. The CCS on 5 December had designated POINTBLANK as the "air operation of first priority" for the Fifteenth, and the JCS directive of 5 January 1944, setting up USSTAF as the agency for coordinating the strategic operations of the Eighth and Fifteenth Air Forces, had confirmed an arrangement which left Eaker responsible to two masters insofar as the operations of his heavy bombers were concerned.<sup>3</sup> A message of inquiry to Arnold brought back a directive: Eaker was the boss of all Allied air forces in the Mediterranean; he would receive operational directives for the U.S. Twelfth Air Force from Wilson; for Fifteenth Air Force operations his directives would come from Spaatz at USSTAF, except in the event of an emergency proclaimed

by Wilson.<sup>4</sup> On paper this arrangement promised many opportunities for disagreement, but actually there would be no trouble at all. Eaker and Spaatz were in full agreement on the overriding priority that should be given strategic bombing, and before Eaker's departure from England it had been agreed that USSTAF would communicate with the Fifteenth only through MAAF, a policy confirmed by USSTAF's first operational directive of 11 January 1944.<sup>5</sup> The principal threat—that Wilson might be forced to proclaim an emergency in conflict with the claims of strategic operations—came in February, in the midst of the "Big Week" of operations against the GAF and while Allied ground forces fought a desperate battle on the beachhead at Anzio. But by agreement Eaker managed to meet both of his obligations, thus setting a pattern for the future.\* In fact, Wilson was at no time to proclaim a formal tactical emergency, although on two occasions he broached the subject to Eaker.<sup>6</sup>

Tedder and Spaatz had set up the framework for MAAF but, knowing that they soon would leave for the United Kingdom, they had left the details to be worked out by Eaker. The latter, who assumed command just on the eve of the Allied landing at Anzio on 22 January, was forced to divide his attention between questions of organization and the pressing demands of combat, with the result that the administrative changes required longer to work out than would otherwise have been the case.<sup>7</sup> On his arrival in the Mediterranean, Eaker found MAAF (Rear), consisting chiefly of the Plans section, located at Algiers, close to AFHQ. MAAF (Advance), a jumble of British and American staff officers organized half along British lines and half along American, was at La Marsa, near Tunis. Most of MAAF's combat units were physically in Italy and the islands, and Eaker promptly set up a third headquarters at Caserta, Italy. For about two weeks this caused additional confusion, chiefly because the new headquarters was initially referred to as MAAF Advance Command Post, but the confusion was cleared up early in February when Eaker directed that the Caserta headquarters be designated Headquarters MAAF, that the La Marsa branch was to be only an *ad interim* administrative section until it could move to Caserta, and that the Algiers element was simply a "rear echelon." Henceforth, there was to be but one Headquarters MAAF.<sup>8</sup>

\* See above, pp. 31-43, and below, p. 358.

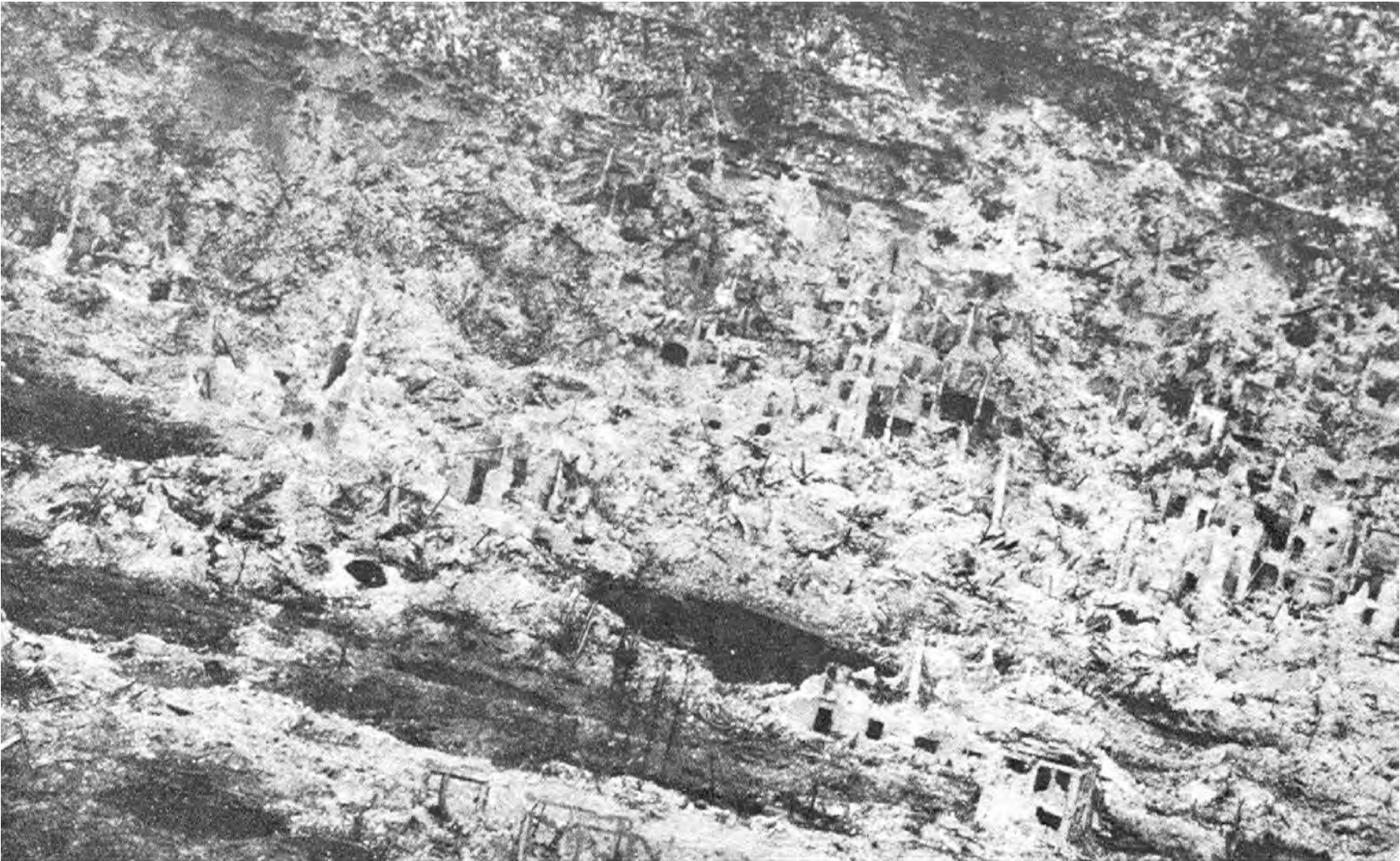

MONTE CASSINO: THE ABBEY IN RUINS



CASSINO: THE TOWN UNDER ATTACK

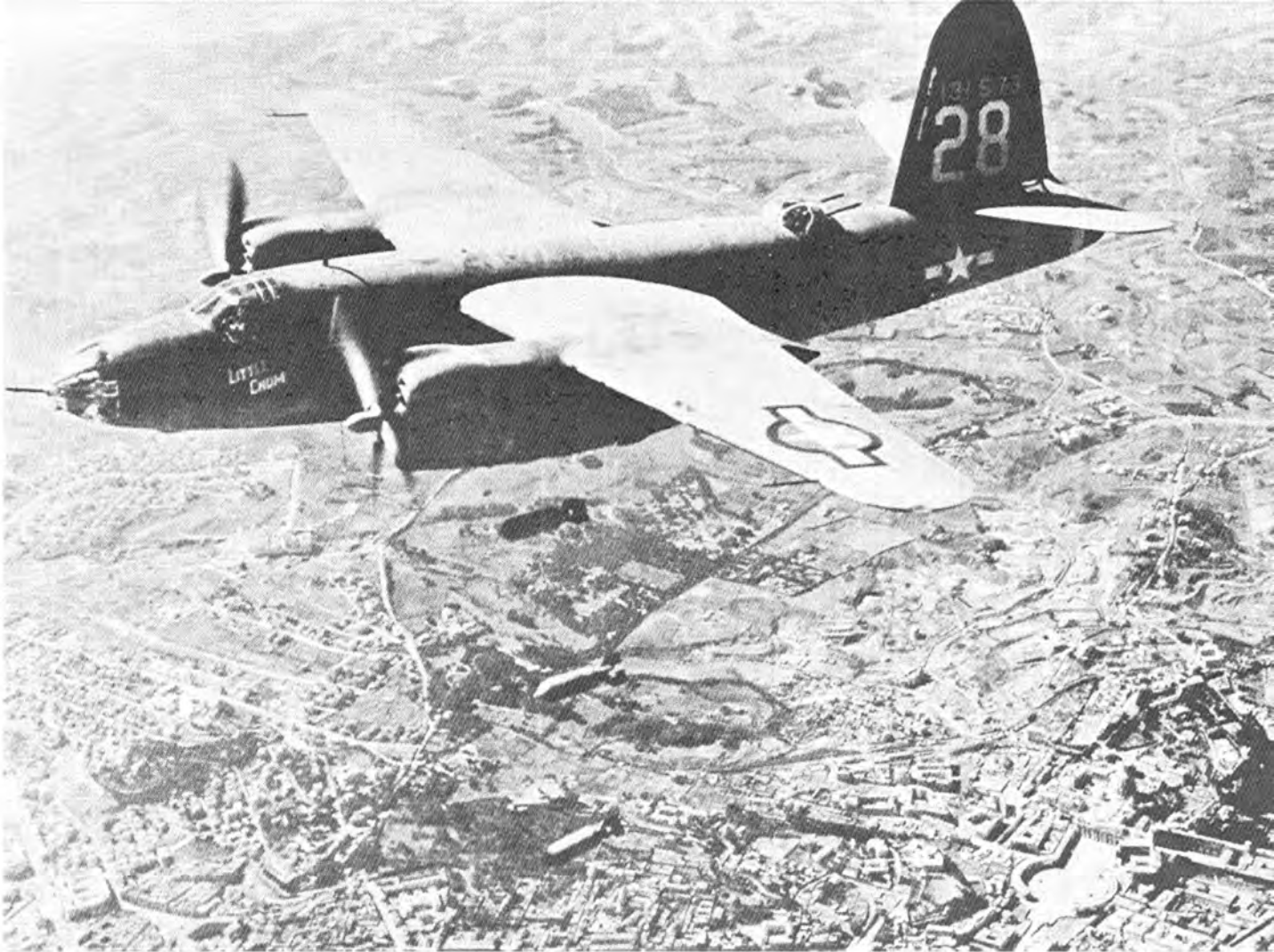

**ALL ROADS LEAD TO ROME**



**BRIEFING PILOTS OF 332D FIGHTER GROUP IN ITALY**



The next step was to organize the headquarters so that it could most efficiently handle the direction of the air war in the Mediterranean. Top members of General Eaker's staff already had worked out the details, and early in February an organizational chart was approved which established the structure that MAAF was to keep until the end of the war. In MAAF headquarters only the Operations and Intelligence section and the Signals section contained both American and British personnel; these sections were the operational links with Strategic, Tactical, and Coastal Air Forces, each of which in turn had a combined Anglo-American operations section and staff. The nerve center for air operations throughout the theater was Operations and Intelligence, which directed and controlled all purely operational matters coming within the authority of the air commander in chief. It was headed by Brig. Gen. Lauris Norstad until 16 July 1944, thereafter by Brig. Gen. Charles P. Cabell. Following the principle of an integrated Anglo-American command, Norstad's deputy was a Britisher, Air Cdre. H. D. MacGregor. The section was subdivided into intelligence, plans, and combat operations, in each of which the key positions were divided between American and British officers.<sup>9</sup> Procurement of the personnel necessary to staff MAAF and its subordinate headquarters presented some difficulty. The War Department declined to authorize tables of organization recommended by a special committee of survey, apparently because it was unwilling to recognize a setup as unorthodox as AAF/MTO.\* A flat rejection was circumvented, however, by granting a bulk allotment of officers and men, their distribution being left to General Eaker's discretion.<sup>10</sup>

\* It should be remembered that in the case of standard organizations, such as components of Twelfth and Fifteenth Air Forces, regular T/O's already were in effect.

† Three months after its activation as of 10 December 1943, MAAF completed the theater air organization by redesignating its major combat elements. After the creation of MAAF the titles Northwest African Strategic Air Force-Mediterranean Allied Strategic Air Force, NATAF-MATAF, and NACAF-MACAF had been used interchangeably, indiscriminately, and often carelessly because the old titles had not been officially assigned, nor had the various components of these organizations been officially assigned. On 17 March, MAAF put the record straight: Mediterranean Allied Strategic Air Force (MASAF), MATAF, MACAF, and Mediterranean Allied Photographic Reconnaissance Wing (MAPRW) were established, constituted, and assigned to MAAF for operational control, with effect from 10 December 1943. These were simply redesignations, for the four elements continued to carry out the functions and responsibilities which had been charged to them while they had been under NAAF. (See Hq. MAAF GO 3, 17 Mar. 1944; Hq. MAAF Adv. Organization Memo 3, 7 Jan. 1944.)

## THE ARMY AIR FORCES IN WORLD WAR II

Before 1 November 1943, supply and maintenance for American air units had been ably handled by XII Air Force Service Command and its three air service area commands. After the creation of the Fifteenth there were two American air forces, each with its own service command, and in addition the air units of other nations which depended largely on American supplies.\* The advantage of an over-all "theater" air service command was quickly recognized, and because XII AFSC enjoyed a long experience as just such a command it was entirely logical for it to serve in that capacity under the new organization which went into effect on 1 January 1944. Accordingly, on that date the old XII AFSC became AAFSC/MTO without change of station or headquarters personnel and with no material alteration in its basic duties of procurement, receipt, storage, and distribution of items peculiar to the air forces and of maintenance, except that the requirement of coordinating the needs of the service commands of the Twelfth and Fifteenth Air Forces, together with the assumption of several new responsibilities, made the duties somewhat more numerous and complex.

AAFSC/MTO started its career with its headquarters organized along the normal air service lines of command, general staff, and special staff sections. But developments during January and February so altered the extent of many of its responsibilities that in March its headquarters was reorganized into a fivefold structure consisting of command, personnel, services, air supply, and air maintenance divisions. All of the old general and special staff sections moved into the new divisions but without losing any of their previous functions. The new organization revealed a strong trend toward centralization and a definite recognition of the importance of supply and maintenance.<sup>11</sup> Concurrently, three functions which AAFSC/MTO had tentatively assumed on 1 January became firm commitments. The first was administration and control of all AAF permanent depot installations, including all dumps in the vicinity of base depots, which previously had been divided between service command and the Twelfth and Fifteenth Air Forces. The new arrangement relieved the two air forces

\* MAAF was responsible for several such units: French, Italian, Yugoslav, Polish, Brazilian, and Russian. Considered individually, none of these, except the French, was of much moment, but each presented a variety of problems, and in sum they represented a real responsibility which further proved the wisdom of having an over-all headquarters.

of the burden of supervising installations\* which often were far removed from their headquarters and zones of combat activity.<sup>12</sup> The other duties, assumed in full during March, were the administration and movement of replacement personnel, a responsibility formerly handled by the XII AF Training and Replacement Command,<sup>13</sup> and the control of all AAF rest camps, originally a duty of the Twelfth.<sup>14</sup> AAFSC/MTO also supervised I Air Service Area Command (I ASAC), Adriatic Base Depot, Allied Air Force Area Command (AAFAC), Italian service units, Ferry Pilot Service, and—to a limited extent—Mediterranean Air Transport Service (MATS). With the exception of the Italian units, all of these organizations had been under the original XII AFSC, although AAFAC did not become fully operational until after 1 January 1944.

Prior to 1 January there had been three air service area commands, each responsible for U.S. air service duties in a large section of that part of the Mediterranean which was under Allied control. In the last two months of 1943, II ASAC had devoted most of its time to the needs of the new Fifteenth, III ASAC had worked closely with the Twelfth, and I ASAC had taken care of North Africa west of Tunisia. In the reorganization of 1 January it was logical and easy for II ASAC to be made XV AFSC and III ASAC to become the new XII AFSC. I ASAC, left under AAFSC/MTO, continued to operate in North Africa, where its primary duties were to supervise field units and installations; erect aircraft; service Air Transport Command (ATC), the training command, and rear elements of Coastal Air Force; provide Air Corps supplies for units and installations in North Africa; transship personnel, supplies, and equipment; assist the French Air Force; and organize and control Italian service units.<sup>15</sup>

Adriatic Base Depot was a unique organization. It was an air force agency doing the work normally done by a ground force base section; it was a USAAF installation in an area controlled by the British army. The depot's principal job was to procure, store, and issue common items of supply to the American air units in eastern Italy, which through the first half of 1944 steadily increased in number and personnel. Its sections, such as quartermaster and ordnance, performed full base section functions; it sped up the construction of a 650-mile pipe-

\* The Twelfth and Fifteenth were to continue to operate advance depots in which fourth-echelon supply and maintenance could be accomplished.

line system for the delivery of 100-octane gasoline direct from ports to the bomber and fighter fields around Foggia, Bari, and in the Heel; it smoothed out operations at the port of Bari; it even set up modern laundries. By the end of March it was supplying the needs of close to 100,000 USAAF personnel.<sup>16</sup>

Allied Air Force Area Command in some respects was even more unusual than Adriatic Depot. It, too, was an AAF organization in an area administered by the British army, but, more remarkable, it was virtually an American "kingdom" in the heart of Italy. AAFAC's job was to administer from its headquarters in Foggia the civil affairs of that section of eastern Italy in which the USAAF combat units were concentrated. In carrying out this complicated task AAFAC controlled such matters as civil affairs, labor, sanitation and health, defense and security, traffic, discipline, engineering projects, and local resources and supplies. In the beginning, AAFAC had to work with far too little personnel, AAF/MTO would not officially recognize its existence, and AAFSC/MTO tried to get rid of it, but the command managed to survive. At the end of March AAFAC was given a T/O, and on 19 May, AAF/MTO officially took cognizance of its existence and issued a directive which outlined its duties and responsibilities. With written authority for its activities, AAFAC, under the direction of AAFSC/MTO and the command of Col. Roland Birnn, continued to operate with great success until the end of the war in Italy.<sup>17</sup>

AAFSC exercised direct control over Italian service units. Twenty-two of these—quartermaster, ordnance, and engineer, composed of POW's in North Africa—were activated in January by IASAC.<sup>18</sup> The command also exercised a very limited control over French service units, and during the first half of the year was responsible for supplying the French Air Force with items peculiar to the air forces. Even after the FAF took its place alongside American and British combat units under MAAF and took control over its service units, AAFSC/MTO continued to coordinate with the French on supply and technical matters until the FAF was transferred to USSTAF in September 1944.<sup>19</sup>

Ferry Pilot Service had been responsible since its establishment under the old XII AFSC early in 1943 for the delivery to depots and combat units within the theater of all replacement or repaired aircraft. On 26 January 1944 its activities were combined with the intratheater cargo and mail-carrying services of AAFSC/MTO to form the Ferry Trans-

port Service (FTS). AAFSC/MTO was then directed to plan aircraft assembly, handle repair, and, through the FTS, deliver all aircraft. The last responsibility ended in April when FTS was transferred both operationally and administratively to Mediterranean Air Transport Service. MATS itself, since its establishment in May 1943 to handle the air movement of personnel, supplies, and mail above 30° N latitude and to operate service command's aircraft engaged in that movement, had been administratively under XII AF Service Command. After the reorganization of 1 January 1944, AAFSC/MTO continued to exercise a limited administrative control over MATS until late in April, when the transport agency was assigned to AAF/MTO as an independent command.<sup>20</sup>

Next to the service command, the Twelfth Air Force had the largest number of problems to work out after the reorganization of 1 January. Since the launching of TORCH the Twelfth had been the supreme AAF organization in the theater, and its commander the top American air officer. Its old importance is attested to by the fact that each of the major commands under AAF/MTO on 1 January 1944 had been a part of the Twelfth. But the Twelfth had been hit hard by the numerous developments between 1 November and 1 January. It not only had been reduced from the ranking AAF organization to a lower echelon but had been changed from an all-purpose to a tactical air force. The number of commands under it had been reduced from eight to six: XII Bomber Command (retaining cadre only), XII Air Support Command, XII Fighter Command, XII Troop Carrier Command, XII AF Training and Replacement Command, and the new XII Air Force Service Command. Gone was much of its personnel: to AAF/MTO, Fifteenth Air Force, XV AFSC, AAFSC/MTO, I ASAC, Engineer Command, and Photographic Reconnaissance Wing.

For six months XII Bomber Command had a checkered career. On 1 January it was reinstated as an administrative headquarters and given the 42d and 57th Bombardment Wings with six groups of medium bombers; but the groups were attached for operations to Tactical Bomber Force, which had been established late in March 1943 as a means of collecting in one command all of the Northwest African Air Forces' medium bombers, USAAF and RAF.<sup>21</sup> This setup continued until the end of February 1944, at which time it was decided to disband TBF.<sup>22</sup> The unit had proved highly adaptable to the needs of the air arm during the late Tunisian, the Sicilian, and the southern

TWELFTH AIR FORCE  
29 JANUARY 1944

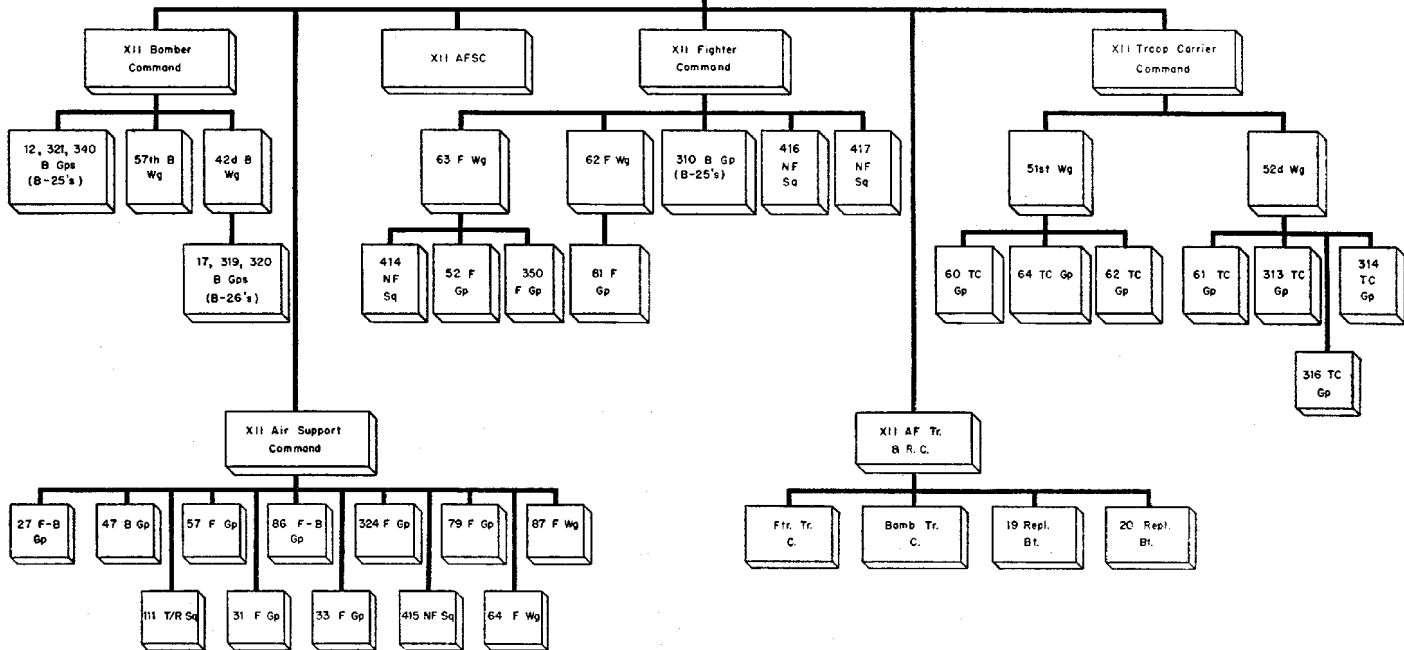

Italian campaigns, but by this time no RAF units remained in TBF and there was no longer any need for a combined headquarters. Accordingly, its two medium bombardment wings, the 42d and 57th, were put under the immediate operational control of MATAF and the direct administrative control of Twelfth Air Force. TBF then ceased to exist,<sup>23</sup> while XII Bomber Command existed only as a retaining cadre until it was inactivated on 10 June 1944.<sup>24</sup>

XII Air Support Command was redesignated XII Tactical Air Command on 15 April. In the first half of 1944 it lost several of its fighter and bomber groups, but because of its importance in the Italian campaign it was kept up to normal strength by being given an approximately equal number of units from other commands; also, in March, it received the 87th Fighter Wing, newly arrived in the theater. XII Fighter Command, the USAAF side of Coastal Air Force, grew less important as German offensive strength in the Mediterranean declined, and the command lost three fighter groups and a bomb group which were not replaced.\* By the end of the spring it had only one fighter group, the 350th, and except for that and a few night fighter squadrons was largely an air-raid warning command. In both XII Air Support Command and XII Fighter Command the losses were mostly to other commands under MAAF, but a few were to other theaters.<sup>25</sup>

XII Troop Carrier Command lost the 52d Wing with four groups by transfer to the United Kingdom on 14 February, which left it with only the 51st Wing and its three groups. On 5 March the command was disbanded and the 51st Wing was assigned administratively direct to the Twelfth; it remained operationally under MATAF. XII AF Training and Replacement Command lost its replacement battalions to AAFSC/MTO, leaving it with only its fighter and bombardment training centers. On 20 July 1944 it and its centers were inactivated.<sup>26</sup>

While the Twelfth was contracting, the Fifteenth was expanding. In January, four new groups of heavies joined it and became operational; in February, two; in March, three; and in April, three. This accretion brought the Fifteenth up to twenty-one groups, the strength allotted to it at the time of its establishment six months before. Six of the groups, equipped with B-17's, were assigned to the 5th Bombardment Wing. The other fifteen groups were equipped with B-24's and

\* XII ASC lost the old 31st and 33d Fighter Groups and the 99th Fighter Squadron, but acquired the 57th and 79th Fighter Groups and the RAF 244 Wing. XII FC lost the 52d, 81st, and 332d Fighter Groups and the 310th Bombardment Group. Lost also, by XII BC, was the 12th Bombardment Group.

were divided among the 47th, 49th, 55th, and 304th Bombardment Wings. Two other wings, the 305th and 307th, were assigned but were used only as sources of personnel for Headquarters, Fifteenth Air Force, and never contained any combat bombardment units; nor did the 306th Bombardment Wing, which was inactive from its arrival on 15 January until 26 March, at which time it was given four fighter groups. In June it was redesignated the 306th Fighter Wing.<sup>27</sup>

The Fifteenth started the year with only four fighter groups, all of them at half strength, and did not receive its full complement of seven groups until May 1944. As late as March, in fact, it had to fight to prevent a transfer to the United Kingdom of three of its fighter groups. This lag in fulfilling the fighter commitment so handicapped the air force that Generals Eaker and Twining ranked it second only to the weather among the factors limiting the Fifteenth's participation in POINTBLANK.<sup>28</sup> During the first part of 1944 the air force suffered not merely from a shortage of fighters but also from the lack of adequate range in the planes inherited from the Twelfth Air Force. By June 1944, however, old-model P-38's had been largely replaced by late models, the 31st Fighter Group had switched from Spitfires to P-51's, the 52d was in process of being re-equipped with P-51's, and the 332d had changed from P-40's to P-47's. With more fighters and more modern fighters, it was now possible to provide escort for the bombers as they struck at distant targets.<sup>29</sup>

If the numerous and sometimes complicated administrative and organizational developments of the first quarter of 1944 were burdensome to the men whose real interest was to get on with the war, at least they resulted in a structure so sound that in the final year of the Mediterranean conflict MAAF was able to devote full time to its operational duties.

### *Air Preparations for Anzio*

When General Eaker arrived in the Mediterranean on 14 January 1944 the projected landings at Anzio (Operation SHINGLE) were only a week away. SHINGLE was designed as an end run around the right flank of the powerful German Winter and Gustav lines, which by the close of December had effectively stopped the advance of Fifth Army and had created a stalemate which threatened to upset the entire Allied timetable in MTO and ETO. In deciding upon an invasion of southern France, Allied leaders had stipulated as a condition governing



the new operation that their armies in Italy should be driving toward the Pisa-Rimini line. If this was to be accomplished, and if men and materiel were to be made available for ANVIL by May, the deadlock on the Italian front must be quickly broken. As it became increasingly evident during December that Fifth Army's frontal attacks could not turn the trick alone, the top commanders, meeting in Tunis on Christmas Day (with Churchill in the chair) decided to combine a Fifth Army offensive with landings at Anzio. It was confidently believed that the latter operation would force Kesselring to pull so many troops out of the Gustav Line to protect his rear that Fifth Army could break through into the Liri Valley—which, with Cassino, was the key to an advance on Rome; or, if the Germans decided not to weaken their lines, the Anzio troops could cut them off from their bases and catch them in a trap. In either case, the Italian stalemate would be broken and the way cleared for ANVIL and OVERLORD without—as Churchill put it—leaving a half-finished and, therefore, dangerous situation in Italy.<sup>30</sup>

Plans for the new offensive effort were completed by 12 January. They called for three amphibious landings around Anzio on the 22 by American and British troops which, with follow-ups, would total about 110,000 troops. The ground forces were to secure a beachhead and then advance on Colli Laziali, a hill mass some seven miles inland which commanded both the Anzio plain and Highways 6 and 7, the enemy's two principal lines of communication from Rome into the western battle area. Just prior to the landings, Fifth Army would launch a strong attack designed to break the Gustav Line and to pull in enemy reserves, with the ultimate expectation of driving through the Liri Valley and linking up with the landing forces. Eighth Army would demonstrate along its front in eastern Italy so as to prevent the transfer of German troops to the other two fronts.<sup>31</sup>

The responsibilities for air support fell very largely upon Tactical Air Force and were in addition to TAF's responsibilities to main Fifth Army and Eighth Army.<sup>32</sup> When the plan appeared Tactical already had put in almost two weeks of attacks on behalf of the two air tasks which were basic to the success of the venture: bombing of airfields to insure that the enemy's air arm would be unable to interfere with the landings, and bombing of lines of communication between Rome and the north (including the relatively unimportant sea lanes) and between Anzio and the main battle area so that enemy reinforcements

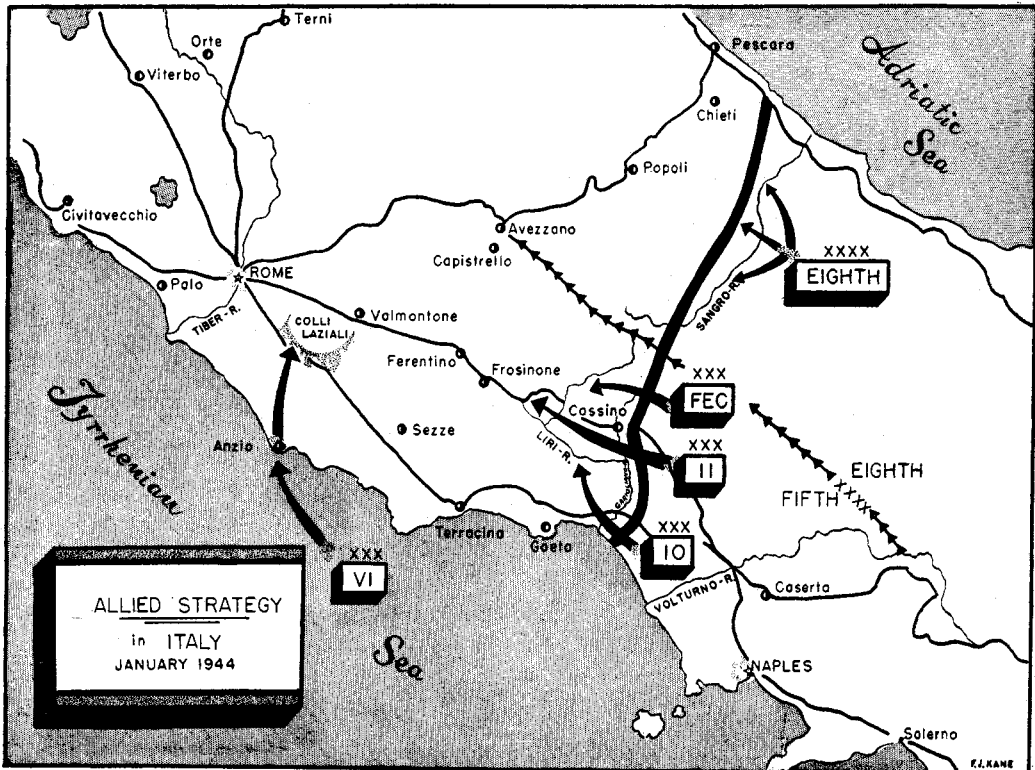

and supplies could neither be brought in nor shifted from one front to another and so that the enemy would be deceived as to the exact location of the landing.<sup>33</sup> Strategic had given some assistance during these preliminary operations, although at the time it was not committed to any specific task for SHINGLE. Even at this early date General Wilson had indicated a desire to declare a "tactical emergency" and thus bind Strategic to the Anzio operation. However, representatives of Tactical, TBF, and the Fifteenth felt that TBF's six groups of U.S. B-25's and B-26's could handle the interdiction program between Rome and the Pisa-Florence line, and after Wilson was assured by his air commanders that all units of MAAF would be made available if the situation demanded, he dropped the matter.<sup>34</sup>

The first phase of the pre-SHINGLE air operations officially began on 1 January—after MATAF had issued operational directives on 30 December to its subordinate commands—and ran through the 13th. Actually, it got under way on the 2d when forty-three of the 57th Bombardment Wing's B-25's bombed the Terni yards while seventy-three B-26's from the 42d Bombardment Wing attacked four places on the railway east of Nice; results were good, especially at Taggia where the railway bridge was destroyed and at Ventimiglia where two spans were knocked out. The following day, fifty B-17's from the Fifteenth Air Force's 97th and 301st Bombardment Groups severely damaged the Lingotto marshalling yards (M/Y's) at Turin, while fifty-three others from the 2d and 99th Groups struck a blow for POINTBLANK by plastering the Villa Perosa ball-bearing works, twenty-five miles to the southwest. B-26's bombed the Pistoia yards and the Bucine viaduct, cutting all lines leading out of the two yards. On the two days about fifty A-36's of XII Air Support Command hit the docks at Civitavecchia, long a favorite target because it was the nearest port to Rome and the battle front and now of added importance because the Allies were trying to make it appear that they might undertake a landing there.<sup>35</sup>

For the next ten days, in spite of unsatisfactory flying weather, TBF's bombers steadily hammered the Italian railway system. Their efforts were concentrated in the western and central parts of the peninsula and around Ancona in the eastern. Principal targets were the M/Y's at Lucca, Pontedera, Siena, Grosseto, Arezzo, Foligno, and San Benedetto, the railway bridges at Orvieto and Guilianova, and the junction at Fabriano. In all, the mediums flew close to 340 sorties. Of

thirteen places attacked, the lines were blocked at eight. The most notable examples of failure were at Lucca, Prato, and Foligno. At many of the targets there was heavy damage to rolling stock and repair facilities, neither of which could be restored as quickly as could trackage in the yards, the Germans having developed repair of the latter into a fine art. On the 8th, 23 Wellingtons and 109 Fortresses chimed in with an attack on Reggio Emilia which severely damaged rail lines and a fighter factory; this was Strategic's only operation against the Italian rail system during the period.<sup>36</sup> Coastal, busy with convoy protection and strikes against enemy shipping and submarines, found time to attack a few land targets along the west coast of Italy.<sup>37</sup>

Through the 13th the air attacks on communications had been designed to retard the building up of supplies and to effect a general dislocation of the enemy's system of transportation. But in the final week before the landings it was essential that the lines both above and below Rome be thoroughly blocked; the battlefield had to be isolated, for if SHINGLE were to have any hope of success, the enemy must not be permitted to rush down reinforcements from Rome and the north nor be able to move large quantities of supplies either to the Anzio or Liri Valley sectors. Tactical did not feel that it alone could accomplish the desired interdiction, and on 10 January it asked that the Fifteenth take care of the northernmost communications targets in addition to rendering assistance with counter-air operations, the latter being a commitment already agreed upon.<sup>38</sup> Some misunderstanding arose, and it was several days before it was clear to what extent the heavies would be employed in SHINGLE. Apparently, the trouble was that Tactical was waiting for a blanket order from MAAF to the effect that Strategic would be used, while MAAF was waiting for a bombing plan from Tactical so that it could issue a directive to Strategic. An exchange of messages on 14 and 15 January cleared up the question, and plans for coordinating all of MAAF's bombers in a pre-D-day assault on lines of communications were quickly made.<sup>39</sup> At first Strategic was to hit targets far to the north while Tactical's bombers went for rail lines within an approximate rectangle bounded on its four corners by Florence, Pisa, Civitavecchia, and Terni. Then Strategic was to attack, in order of priority, the lines Florence-Arezzo, Empoli-Siena-Arezzo, Pisa-Florence, and Rimini-Falconara, while Tactical was to take care of lines nearer Rome, notably those between that city and Arezzo, Viterbo, and Leghorn. Wellingtons of 205

Group were to operate in the Pisa-Florence-Rome triangle with the twin objectives of interrupting night rail movement and hampering repair work on lines already damaged by the day bombers.<sup>40</sup>

This plan for joint operations, issued by MATAF on the 15th, was approved by MAAF, and Strategic was informed on the 16th that its No. 1 priority of counter-air force operations now was temporarily suspended in favor of the destruction of rail lines on behalf of SHINGLE.<sup>41</sup> The Fifteenth wasted no time. Between the 16th and the 22d, its heavies flew around 600 effective sorties, to which Wellingtons added 110. Principal targets were the yards at Prato, Certaldo, Arezzo, Pisa, Pontedera, Pontassieve (each of which was hit by more than 170 tons), Rimini, Pistoia, Poggibonsi, and Porto Civitanova. Montalto di Castro, Orvieto, and Civitavecchia were attacked when bad weather precluded operations farther to the north. In the same six days Tactical's bombers flew over 800 sorties, most of them south of a line through Perugia. In general, B-25's went for chokepoints and M/Y's, the main targets being Terni, Foligno, Orte, Piombino, Avezzano, Viterbo, and Chiaravalle; photographs showed that the lines were blocked everywhere except at Foligno and Chiaravalle. B-26's attacked both yards and bridges.\* Their heaviest assaults were against bridges around Orvieto on the Rome-Florence line, the Orte bridge at the center of the Rome-Florence and Terni-Ancona routes, the Montalto di Castro bridge on the west-coast line, the bridges at Carsoli between Rome and Sulmona, and the Terni viaduct. Each of these targets was either knocked out or damaged.<sup>42</sup>

A review of the interdiction program from 1 to 22 January shows that MAAF's planes dropped more than 5,400 tons of bombs against lines of communication<sup>43</sup> and achieved good results at the principal points where interdiction was desired. On the Florence-Arezzo-Orvieto-Rome line the Orte yards were closed from the 15th through the 19th but were open on the 20th and 21st; the bridge south of Orvieto was serviceable, but the one to the north was closed by a raid of the 21st. On the Arezzo-Foligno-Terni-Orte line the Terni yards were open on the 23d after having been closed for a week. The Foligno yards appear to have been serviceable, but the bridge at Orte had been cut since the 17th. On the Leghorn-Civitavecchia-Rome line the Mon-

\* Apparently, one of the reasons for using B-26's rather than B-25's against bridges was that the 26's now were equipped with the Norden bombsight while the 25's still were using the less precise British MK IX E sight. (See MAAF, Operations in Support of SHINGLE, pp. 9-10.)

talto di Castro bridge was knocked out on the 18th and remained so; the Cecina bridge, long a wreck, would not be repaired for weeks. On the Terni-Sulmona line the Terni yards were—as noted—closed until the 23d, and the Carsoli bridge was blocked on the 17th and remained so through D-day. On the Viterbo by-pass lines the Viterbo yards were blocked on the 17th and were still closed on the 22d. Thus, on D-day there was at least one point of interdiction on each of the four first-priority lines; out of nine primary points of interdiction, four bridges (out of five) and one yard (out of four) were unserviceable and the other yards were damaged.<sup>44</sup> Obviously, the bombing effort did not completely interdict the enemy's supply routes, but just as obviously it seriously interfered with his movements immediately before and after D-day.

In addition to attacks on rail lines, mediums flew a number of sorties against other targets in preparation for the Anzio landings. Eleven small missions were sent against Liri Valley bridges at Roccasecca and Pontecorvo. The latter, after four months of periodic attacks, was still intact, and the mediums did not break the hex which it held on them. Four missions were flown against the Liri River and Isoletta dams, also in the valley; the dams were not hit but the road approaches were destroyed. These minor operations were designed both to support the Fifth Army as it prepared for its drive against Cassino, the most important point in the German defense line, and to create blocks against the transfer of troops from the Gustav Line to Anzio after the landings had been made.<sup>45</sup>

It was unnecessary for MAAF to conduct a full-scale pre-invasion counter-air offensive against the Luftwaffe—such, for example, as the blitzes which had preceded the invasion of Sicily and the landings at Salerno. Estimates indicated that the enemy had only about 550 operational aircraft in Italy, southern France, the Balkans, and the Aegean. Almost all of his big bombers had been withdrawn from the Mediterranean so that the only long-range striking forces available to him for use against SHINGLE were some fifty Ju-88's in Greece and Crete and sixty Ju-88's, He-111's, and Do-217's in southern France. Most of his fighters (some 230 Me-109's and FW-190's) were in Italy, with slightly more than one-third of them on fields around and south of Rome. It was considered unlikely that the GAF would be able materially to reinforce either its fighters or its bombers. Consequently, during the period prior to 14 January only a few attacks were made on

airfields. On the 7th, forty-eight B-25's from the 12th and 321st Bombardment Groups bombed Perugia, a main base for reconnaissance Ju-88's and Me-410's, with limited results; both a night attack by Wellingtons on 12/13 and a follow-up day raid by B-24's were largely abortive because of bad weather. A visit by Wellingtons to Villaorba on the night of the 8th had better luck, leaving five aircraft burning and several fires at hangars. The heaviest blow was struck on the 13th by 100 B-17's and 140 B-25's and B-26's which showered over 400 tons of bombs on airfields at Guidonia, Centocelle, and Ciampino in an effort to drive the enemy's fighters back to fields north of Rome and, if possible, all the way to the Grosseto-Siena area. The heavies, escorted by fighters, dropped 500-pound demolitions to smash up the runways, while the mediums, coming in an hour later, dropped frags on the grounded planes. The sharp attacks brought up fifty to sixty enemy planes, of which seven were destroyed at a cost of two mediums and three fighters.<sup>46</sup>

In the last week before SHINGLE, MAAF's bombers intensified their counter-air offensive with a series of heavy attacks on airfields. On the 16th, SAF heavies hit Villaorba and Osoppo (homes of a number of Me-109's) in northeast Italy, and that night Wellingtons returned to Villaorba; a total of 286 tons was dropped with good results. On the 19th and 20th heavies (mostly B-17's) blitzed fields in the Rome area, dropping 700 tons of bombs in 191 effective sorties against Ciampino North and South, 103 against Centocelle, and 56 against Guidonia. The raids on the 19th were designed in part to drive the GAF back to the Grosseto and Viterbo areas, so MATAF immediately sent 163 U.S. mediums against the Viterbo and Rieti fields. Although no more than sixteen enemy planes were destroyed on the ground, the primary purpose of this one-two punch, which was to render unserviceable both the first and second lines of main fields from which the enemy could attack Anzio, was accomplished. Strategic further protected the landings by flying on D minus 1 (21 January) thirty-seven sorties against Salon airfield and thirty-five against Istres/Le Tubé, two long-range bomber bases in southern France.<sup>47</sup>

The most valuable counter-air operation was an attack on the 19th on the long-range reconnaissance base at Perugia. Only twenty-seven B-24's (of the 449th Bombardment Group) found the field and they dropped just sixty-five tons, but the attack was so successful that for four days the Germans were unable to use the field for reconnaissance

flights.<sup>48</sup> The complete tactical surprise which was achieved at Anzio was due in large measure to this blinding of the enemy.<sup>49</sup>

While MAAF's heavies and mediums were pounding lines of communications and airfields, its light bombers and fighter-bombers were busy over and beyond the battle areas. Normally, most of Desert Air Force's targets would have been close to the Eighth Army battle line, but mud, snow, and mountains had so effectively stopped the Eighth that air attacks against gun positions, fortifications, and the like seldom were either practicable or necessary. A few such missions were flown but by far the larger part of the effort was against rail and road communications, which materially furthered the interdiction campaign being waged by the heavies and mediums. An outstanding operation came on 2 and 3 January when Spitfires of RAF 244 Wing and P-40's of the USAAF 79th Fighter Group caught snowbound enemy transport on the roads and rail lines between Avezzano, Pescara, and Chieti; when the shooting was over, the fighters claimed the destruction of 57 vehicles and 2 locomotives and the damaging of almost 200 vehicles, 5 locomotives, and 8 cars. On the 13th and 14th a total of 35 Baltimores and 119 P-40's destroyed a major tank-repair shop at Loreto; some of the Kittyhawk fighter-bombers featured this operation by carrying 2,000 pounds of bombs each. Shortly before SHINGLE was launched, seven DAF squadrons moved to western Italy to reinforce XII Air Support Command. Air operations north of the eastern front then declined sharply, although on the 19th and 20th, fighters and fighter-bombers knocked out the railway stations at Sulmona and Popoli, both of them key spots in the enemy's east-west line of communications. Meanwhile, on the 16th, P-40's began a series of attacks against advanced positions as a prelude to the Eighth Army's holding action in support of SHINGLE and the Fifth Army offensive. Throughout the period from 1 to 22 January so few GAF planes appeared over the eastern battle front that DAF flew a daily average of only sixty to seventy defensive patrol sorties; the enemy's biggest effort, on the 13th, was an eighteen-plane mission, of which number Spitfires shot down three and damaged two, without loss to themselves.<sup>50</sup>

In the west, XII ASC flew more than 5,500 sorties in the three weeks prior to the Anzio landings, most of them by fighters flying defensive patrols and close support missions for the Fifth Army which had been attacking steadily since 4 January. But more than 1,000 of the sorties



were against communications, as fighter-bombers pounded rails and roads in the area between the front lines and Rome. Among their targets were the Cassino and Cervaro road junctions, yards at Aquino and Ceccano, the railway and roads at Formia and Fondi, the important junction at Frosinone on Highway 6, roads at Sora, and a tunnel entrance at Terracina. Not content to strike only near-by targets the fighters ranged to Rome and beyond, hitting communications targets as far away as Civitavecchia. In the last few days before SHINGLE, A-20's, A-36's, and P-40's concentrated on lines of communication between the Fifth Army front and the Anzio area, hitting Colleferro, Velletri, Palestrina, Frosinone, Ceccano, Roccasecca, Aquino, and Pontecorvo, and, east of Rome, Avezzano and Carsoli. As in eastern Italy the GAF's effort, whether offensively over the battle area or defensively against XII ASC's attacks, was too small to be of any consequence; enemy close-support planes averaged around eighty sorties per day, most of them escorted fighter-bomber attacks on targets close behind the Allied lines.<sup>51</sup>

The extensive operations of XII ASC in this period were made possible in large measure by aviation engineers. In spite of bad weather they built three new fields at Marcianise, Lago, and Castel Volturno, all north of Naples, in time for them to be used in pre-SHINGLE operations. Without them, XII ASC and TBF would have been severely handicapped, for even when the new fields were added to the eight already available—Pomigliano, Capodichino, Caserta, Cercola, Gaudio, Pompei, Vesuvius, and Trocchia—every combat airdrome was filled to the limit of parking space.<sup>52</sup> It was fortunate for MAAF that it enjoyed so marked a degree of air superiority.

In the midst of the pre-landing air assault the main Fifth Army launched its offensive against the Gustav Line. On 12 January the French Expeditionary Corps drove against the German left flank above Cassino. Then the British 10 Corps struck across the lower Garigliano.\* Both the French and the British made some progress, but in spite of successive assaults, aided by sharp attacks by Tactical's light and fighter-bombers on defended positions, guns, and junctions, they could not break the enemy's lines. The Luftwaffe, only moderately active, was held firmly in check by fighter patrols of the 31st and 33d Fighter Groups and RAF 324 Wing. In the center, the U.S. II Corps, after a series of lesser attacks in coordination with 10 Corps, launched a major

\* The FEC and British 10 Corps were assigned temporarily to Fifth Army.

assault on the 20th in an effort to secure a bridgehead across the Rapido, but after two days of severe fighting, heavy losses forced it to withdraw; planes of XII ASC, having to divide their efforts among II Corps, 10 Corps, and preparations for Anzio, could provide only moderate support. By D-day at Anzio the attack on the Gustav Line had bogged down, without Fifth Army having broken through into the Liri Valley. However, the Germans had been forced to commit most of their Tenth Army reserves, and the Allies still hoped that a continuing Fifth Army offensive, together with the landings at Anzio, would break the stalemate on the Fifth Army front.<sup>53</sup>

At best, SHINGLE was a risky venture; when the Fifth Army offensive failed, it became an even greater gamble. Only the absolute superiority which the Allies enjoyed on the sea and in the air allowed them to take the risk. MAAF had more than 4,000 aircraft, of which some 3,000 were operational, on hand in tactical units. Already they had flown 23,000 effective sorties since 1 January. The GAF, on the contrary, had no more than 550 combat planes, and they were scattered from southern France to Crete. The margin in favor of the Allies guaranteed control of the air,<sup>54</sup> the first requirement for an amphibious operation.

### *Anzio*

The SHINGLE forces, well supplied with maps and mosaics furnished by Photo Reconnaissance Wing,<sup>55</sup> sailed from Naples at 0500 hours on 21 January. During the short run they were protected as far as Ponziane Island by fighters of Coastal; from Ponziane to the beaches fighters of XII ASC, carrying long-range tanks, had the responsibility; all planes operated from bases around Naples. The GAF did not appear over the convoys, either because it had been blinded by the loss of its reconnaissance planes at Perugia or because—according to the Air Ministry Historical Branch—the German radar system had broken down on the night of the 21st, or both.<sup>56</sup>

At 0200 hours, 22 January, the troops hit the beaches to the north and southeast of Anzio. There was no strategic surprise, for Kesselring long had expected an Allied landing back of Tenth Army. But so complete was the tactical surprise that the troops met only token resistance and there was no enemy air reaction for several hours.<sup>57</sup> Thus favored, troops and supplies poured ashore. About midmorning the GAF appeared, and by the end of the day had flown perhaps 50 sorties over the

**THE ANZIO LANDING  
and the  
INITIAL EXPANSION  
of the  
BEACHHEAD  
JANUARY 1944**

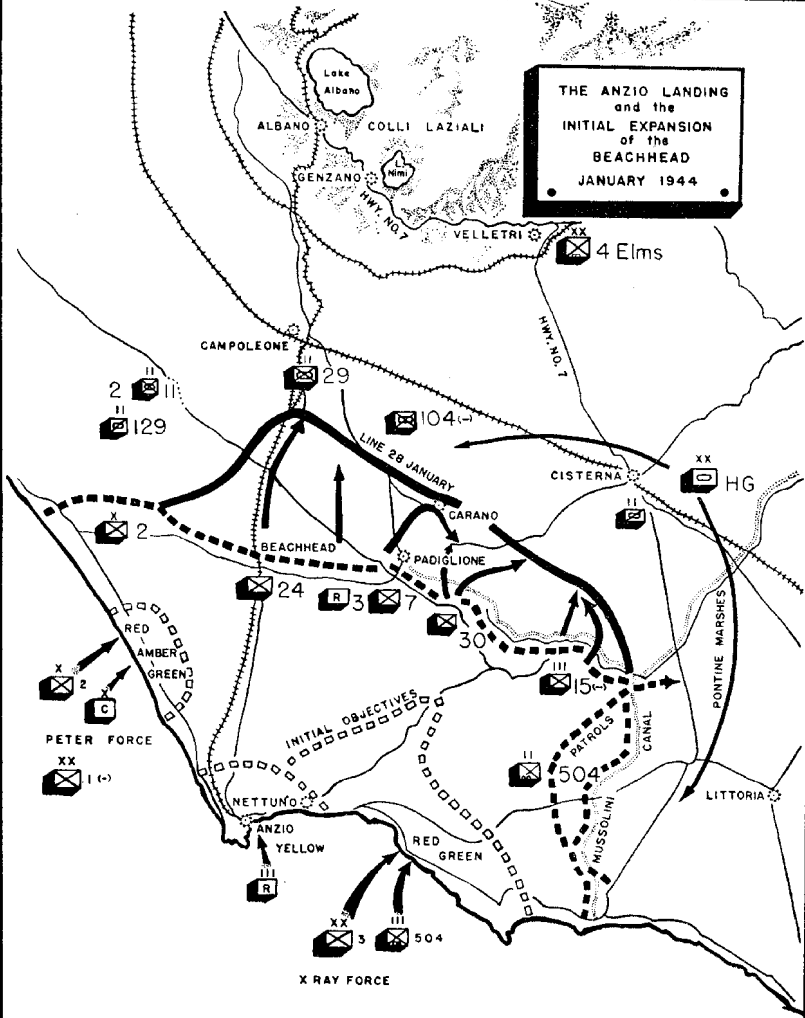

area, but Allied fighter patrols of Spitfires at high (22,000 to 25,000 feet) and medium (12,000 to 16,000 feet) and P-40's at low (6,000 to 8,000 feet) levels over the beaches and convoy lanes kept the Luftwaffe from interfering with the landing operations. In the course of some 500 patrols over the beaches and 135 over the convoy lanes, XII ASC's fighters intercepted six GAF fighter-bomber missions and shot down at least seven planes and damaged seven others for the loss of three Allied fighters.<sup>58</sup> The same defensive pattern was followed on D plus 1 and 2, except that the fighters and fighter-bombers bombed targets on the perimeter of the beachhead before beginning their patrols and strafed such targets as troops and vehicles before returning to their bases. The planes, under the general control of the 64th Fighter Wing at Naples, were directed while on patrol by a control ship off the assault beaches and a control unit set up on the beachhead. U.S. P-51's spotted gunfire for the troops, and RAF Spitfires for the warships offshore. Throughout the day mediums attacked road junctions behind the beachhead, while heavies bombed communications in the Florence and Rome areas and in the Liri Valley. In addition, Allied planes dropped 2,000,000 leaflets over the German lines in front of the Fifth Army, announcing the landings at Anzio. These missions brought to more than 1,200 the number of MAAF sorties for the day in cooperation with the landings.<sup>59</sup>

On the 22d, 23d, and 24th the ground forces, meeting no real opposition either on the ground or from the air and with the beachhead area largely denied to the enemy as a result of the air interdiction program, firmly established themselves ashore. Occupying a beachhead seven miles deep they were in an excellent position to move swiftly inland, control Highway 7, and drive either on Rome or Kesselring's rear.<sup>60</sup> The Allies did none of these things—which, if one may be allowed to speculate, may have been just as well, for in over ten days of bloody fighting the Fifth Army had failed to break the Gustav Line. The enemy not only had held at that point, he now had begun to shift troops to Anzio against the threat to his rear. Had the Anzio forces immediately rushed inland they might have been cut off from the sea by a combination of enemy troops moving up from the south and rushing down from the Rome area and, without supplies and equipment, have been wiped out.<sup>61</sup>

In the face of these considerations VI Corps stopped to consolidate its gains. Then on 30 January it pushed out toward Colli Laziali with

the intention of seizing the intermediate objectives of Cisterna and Campoleone. But Kesselring, with his lines holding firmly against Fifth Army's attacks and with the Eighth Army so inactive that it did not constitute a threat, had continued to move in troops from both ends of his trans-Italian front, from northern Italy, and even from southern France and Yugoslavia.<sup>62</sup> Although the air interdiction of lines of communication had been good enough—in the two weeks before the invasion the enemy had got not more than one-seventh normal use of his principal lines into the battle area—and had been kept up long enough for the landings to be made and consolidated virtually without opposition, and although the medium bombers struck hard at rail lines on the 27th, 28th, and 29th and thereby slowed down the enemy's build-up enough to save SHINGLE, the interdiction was not so absolute that it could stop the movement of troops to the bridgehead.<sup>63</sup> So it was that when the troops at Anzio resumed the offensive on a large scale, it was too late; not only had they lost the initial advantage which they had held but the enemy had strongly fortified the key objectives and heavily reinforced his defenses. After three days of fighting against the fast-growing German forces the offensive was abandoned. The Anzio forces now found themselves restricted to the bridgehead and seriously threatened by troops and armor which had the advantage not only of numbers but of position.<sup>64</sup>

From 23 January (D plus 1) through 1 February (the end of the Allies' Anzio offensive) the Allied air arm vigorously carried out, insofar as weather permitted, its principal assignments of direct cooperation with the Anzio forces and attacks on lines of communication. Light bombers and fighter-bombers and fighters of XII ASC took care of the first of the assignments and helped with the second. Through the 30th, they flew steadily, averaging some 700 sorties per day. Bad weather then all but stopped them on 31 January and 1 February—days when air cooperation was especially needed by the ground troops—but on 2 February, with flying conditions far from ideal, they recorded 648 sorties, many of them against the enemy's ground troops, who were counterattacking. During the period XII ASC also cooperated with main Fifth Army in its repeated but unsuccessful attempts to break through the enemy's lines along the Rapido River and at Cassino.<sup>65</sup>

The activities of the mediums against lines of communication were limited partly by Anzio's requirements for direct tactical cooperation and partly by the weather. On D plus 1 they put in a good day around

the beachhead, and on the 25th divided their missions between targets close to the beachhead and a return to the railway interdiction program. On the 27th, as the German build-up became increasingly evident, they devoted most of their effort to railways, and on the 28th and 29th went exclusively for such targets. From the 30th through the 4th—as on the 24th and 26th—weather grounded the planes except for a few B-25's which operated around the beachhead.<sup>66</sup>

In the period from D-day through 4 February, the mediums flew a total of forty-five missions, twenty-four of them against roads on which the Germans were depending heavily because of the damaged condition of their rail lines. Fifteen of these were designed to create road blocks in the Colli Laziali area and were directed against road junctions at Frascati, Albano, Palestrina, Marino, Mancini, Lariano, and Genzano. Three missions were against road and rail junctions between the bridgehead and the Liri Valley, and six against the road bridge at Ceprano, which was inside the valley at the junction of Highways 6 and 82. The other twenty-one missions were a part of, or closely allied to, the railway interdiction effort; twelve of the missions hit marshalling yards and six hit bridges. The principal targets were along the main railways from Rome to the north, with the Florence-Rome line receiving the major attention. In general, results were good.<sup>67</sup>

On D plus 1, Strategic, although not bound to SHINGLE because no emergency had been proclaimed, again struck at communications in the north, except for thirty-nine of its B-17's which finally knocked out the Pontecorvo bridge. Thereafter, to the end of the month, it operated regularly against the enemy's supply routes, with more than 90 per cent of this effort directed against marshalling yards. Targets were located all the way from Terni in TAF's territory to Verona on the Brenner Pass line; major objectives were Bologna, Verona, Pontedera, Siena, Arezzo, Rimini, Porto Civitanova, Terni, and Foligno where results were excellent, and Poggibonsi, Ancona, and Fabriano where they were poor.<sup>68</sup>

It was of vital importance in the first ten days of SHINGLE that the German Air Force be kept under control. Although it was not strong enough to pose a serious threat, by D plus 1 the GAF had started a definite effort against the beachhead and its tenuous supply line. Bombers attacked shipping, notably at Anzio on the 23d, 24th, and 26th and at Naples on the 23d and 24th; although they usually struck at dusk when MAAF's fighters had left for their hundred-mile-

distant bases and although they used controlled glide bombs in the course of almost a week of operations, they achieved only the scantiest success while losing fifteen of their number to Allied fighters and flak.<sup>69</sup> The bombers came mostly from southern France, so on the 27th, 132 B-17's bombed Montpellier and Salon and 29 B-24's of the 450th Bombardment Group hit Istres/Le Tubé, inflicting heavy damage on planes, runways, and installations at all three places, especially at Istres.<sup>70</sup>

Each of the GAF bomber raids against Anzio and Naples had been carried out by from 50 to 60 planes; heavier attacks were delivered on the 29th by around 110 Do-217's, Ju-88's, and Me-210's. Collectively, these constituted the greatest German bomber offensive since the landings in Sicily in July 1943.<sup>71</sup> It was made possible because the enemy had strengthened his weak Italy-based bomber units by moving in two Ju-88 groups from Greece and Crete and returning a number of bombers which had been withdrawn from the peninsula in December and January (and which had bombed London as recently as 21 January). These transfers placed some 200 long-range bombers within reach of Anzio. No substantial fighter reinforcements were moved in, but a sufficient flow of replacement aircraft was maintained.<sup>72</sup> To counter these developments MAAF directed a series of devastating blows against Italian fields. After small raids on Rieti and Aviano on 23 January, the Fifteenth blasted fighter fields in the Udine area near Austria on the 30th, using one of the cleverer tricks of the air war. B-17's and B-24's from the 97th, 99th, 301st, 449th, and 450th Bombardment Groups, well escorted by P-38's from the 1st, 14th, and 82d Fighter Groups, flew at normal altitude so as to be plotted by enemy radar. P-47's of the 325th Fighter Group took off after the bombers had left, went out over the Adriatic, flew on the deck, and when they overtook the bombers, climbed high and headed for the target area. They arrived fifteen minutes ahead of the bombers and caught the enemy's fighters, warned of the bombers' approach, in the act of taking off and assembling for combat. The surprise was complete, and the P-47's had a field day, destroying thirty-six aircraft, including fourteen Me-109's, and probably destroying eight other fighters, for the loss of two P-47's. When the bombers arrived they met almost no opposition and covered the fields with 29,000 frag bombs. For the entire operation the Fifteenth's bombers and fighters claimed the destruction, in the air and on the ground, of about 140 enemy planes; Allied losses were six bombers and three fighters.<sup>73</sup> On the same day, the Fifteenth hit

Lavarino in Italy and on the 31st ended its counter-air force operations for the month by striking hard and successfully at Klagenfurt airfield in western Austria and at Aviano and Udine in Italy. Thereafter, Anzio saw very few enemy bombers.<sup>74</sup>

The beachhead and its environs had been plagued by an average of around seventy enemy fighter and thirty fighter-bomber sorties per day. Targets were shipping, motor transport, troops, and gun positions. On 25 January the Navy inferred that it was losing an average of four ships a day to these attacks and to long-range bombers, but an investigation revealed that up to that date only three vessels had been sunk and one damaged. In fact, at the end of the first ten days of SHINGLE the Allies still had lost only three ships,<sup>75</sup> for the enemy's efforts were rendered ineffective by the strong patrols which XII ASC's 31st, 33d, 79th, and 324th Fighter Groups and 244 Wing kept over the area; flying a daily average of around 450 defensive sorties, the command's day fighters claimed the destruction of fifty enemy planes and its night fighters claimed fifteen bombers, against a total Allied loss of fewer than twenty fighters.<sup>76</sup> Before the invasion the air forces had planned to base a large number of fighters within the bridgehead, but shipping limitations, the easy range from the fields around Naples, and the fact that the enemy soon contained the beachhead caused the plan to be abandoned. However, further to combat the enemy's raids, engineers renovated an old strip at Nettuno and laid down a steel mat 3,000 feet long. Spitfires of the 307th Fighter Squadron moved in on 1 February to furnish "on-the-spot" cover.<sup>77</sup>

In the period through 1 February, Desert Air Force had continued to carry out its normal tasks of protecting the Eighth Army and flying tactical missions over eastern Italy. But it also found time to get in a few blows on behalf of the Fifth Army and the beachhead. Its most useful effort in this direction was a series of attacks on roads, vehicles, and traffic around Popoli and Sulmona for the purpose of interfering with the movement of enemy troops from eastern Italy to the Liri Valley and Anzio sectors. The attacks inflicted severe damage on the enemy but did not stop his movements. When targets in the east were hard to find DAF's fighter-bombers and night-flying A-20's crossed the Apennines to strike at road transport in the Rome and Frosinone areas.<sup>78</sup>

It was expected that the Germans would launch full-scale counter-attacks against the Anzio salient immediately after stopping the Allied



offensive on 1 February. In fact, Hitler had ordered Kesselring to wipe out the bridgehead within three days at all costs, and Kesselring had planned to open his attack on the 1st. Nevertheless, a major blow did not fall until the night of 15/16 February. The delay in the counterthrust was caused largely by the air forces' interdiction program. Before, during, and for almost a week after the landings each of the four main rail lines from the north to the Rome area had been cut in one or more places. The week of bad weather which began on 28 January so hampered the air forces that the Germans thereafter were able to keep open at least one through line to Rome,<sup>79</sup> and with this limited rail traffic, together with extensive use of motor transport, the enemy built up enough troops and supplies to launch an offensive on 15 February—but not on 2 or 3 February, as he probably could have done had he had full use of the rail lines. It was of the greatest importance that the enemy was so long delayed in gathering the strength necessary for his attack; if large reinforcements and an adequate supply of ammunition had reached the assault area before VI Corps had fully prepared its defenses and built up its supplies, the Anzio landing conceivably might have ended in a major disaster for the Allies.

Between 3 and 15 February, while preparing to launch his all-out attack, Kesselring hit the weary Anzio troops with a number of local blows designed to regain key terrain features. The efforts generally were successful. After bitter fighting the Allies lost the Campoleone salient, Aprilia (commonly called the "Factory"), and Carroceto Station.<sup>80</sup> The American air forces made a valiant effort to turn the scales for their friends on the ground, but the weather was too much German. In the fight for Campoleone (3–5 February) close support planes were almost entirely grounded, while heavies, mediums, and light bombers were able to get in only a handful of interdiction missions. To add to MAAF's difficulties the enemy heavily shelled the Nettuno airstrip on the afternoon of the 5th, forcing a decision that planes would use the field only during the day, returning each night to bases near Naples; this procedure—frequently interrupted when enemy shells damaged the strip—was followed until the end of February when the strip was abandoned except for emergency landings.<sup>81</sup>

The 6th was quiet on the ground; the perverse weather was good, enabling XII ASC to fly 630 sorties against enemy positions and communications in and close to the battle area and mediums to hit the road junction at Frascati and rail lines at Orte. On the 7th, when the Ger-

mans started their attack on the Factory, weather grounded all planes of Strategic and Desert Air Force and all B-25's, although B-26's and some of XII ASC's A-20's (47th Bombardment Group) and A-36's (27th and 86th Fighter-Bomber Groups) were able to hit communications and movements in the enemy's rear. On the 8th, MAAF's planes were out in force: heavies bombed three airdromes and three yards in central and northern Italy, mediums hit yards, bridges, and Cisterna, and light and fighter-bombers attacked communications, concentrations, and guns back of both fronts while giving close support to the Anzio troops. But on the 9th when the battle for the Factory was at its height, weather grounded Strategic, held TBF to fewer than 100 sorties, and curtailed XII ASC's efforts against motor transport, troops, towns, and assembly areas along the Anzio perimeter. The Factory was lost, as was Carroceto on the morning of the 10th when the weather held MAAF's planes to a handful of sorties. For the next forty-eight hours Allied ground forces tried to retake the Factory, but failed. The air arm gave little help, the weather permitting no missions on the 11th and only a few on the 12th, although those few were highly effective.<sup>82</sup>

During this period the Fifth Army had launched (on 1 February) its second major assault on the Gustav Line. II Corps penetrated the line and even fought into Cassino, but the Allies were unable to break through into the Liri Valley. After 7 February there was almost no forward progress, to the great advantage of the Germans at Anzio.<sup>83</sup> To their advantage, too, was the inability of the Eighth Army to launch an offensive. After the landings at Anzio, Gen. Sir Harold L. Alexander had pressed Gen. Sir Oliver Leese to strike a heavy blow, but the Eighth's commander—pointing to the weather and terrain, the strong German defenses, the weariness of the British troops, and the fact that six of his divisions had been transferred to Fifth Army—insisted that he could get nowhere with an offensive. On 30 January, Alexander had agreed.<sup>84</sup>

Since the Fifteenth's heavy counter-air assault on the 30th, the GAF had been relatively inactive, although small numbers of its planes rather regularly struck at the beachhead. On 6 and 7 February, however, the enemy flew around 120 sorties each day over Anzio and main Fifth Army. At Anzio his attacks caused considerable damage and many casualties, although on the 7th alone defending fighters got seventeen certain and twelve probables and AA knocked down seven, probably got another six, and damaged nine.<sup>85</sup> MAAF promptly countered the

GAF's blows by sending 110 B-24's from the 376th, 450th, and 454th Bombardment Groups against Viterbo, Tarquinia, and Orvieto airfields. Enemy bombers then stayed away until the 12th when thirty to fifty came over the Anzio area from southern France; on the 13th some twenty Italy-based Ju-88's attacked. Damage was slight in both instances. Fourteen B-17's retaliated on the 14th by bombing the Verona airdrome and Piaggio aircraft factory.<sup>86</sup>

From the 13th through the 15th, there was only limited ground fighting at Anzio, while the Germans regrouped and waited for last-minute reinforcements before launching a full-scale offensive and the Allies dug in to receive the blow. The air forces, enjoying three consecutive days of improved weather, hit hard at communications in an effort to re-establish the interdiction of the lines. In particular, RAF Wellingtons, which had flown very few missions during the previous week, made several highly successful attacks on roads and transport. On the 15th heavies and mediums joined forces to fly the biggest mission in weeks, a 229-plane attack which showered the Abbey of Monte Cassino (ahead of the main Fifth Army) with almost 600 tons of bombs.\* Other heavies and mediums hit yards, bridges, and the Campoleone sector. XII ASC flew 1,700 sorties in the three days, most of them against targets around Anzio and on patrols over the beaches. Particularly useful were its efforts against guns and concentrations. These operations brought to some 26,000 the number of effective sorties flown by MAAF since the landing at Anzio on 22 January, virtually all of them directly or indirectly related to the land battle.<sup>87</sup>

On the 16th the Germans exploded against the Anzio bridgehead. For three days they hammered at the Allied lines, pounding them with artillery, wave after wave of infantry and tanks, and greatly increased air support.† On the 18th the main Allied line bent, but it refused to break. By the evening of the 19th the German drive had failed.<sup>88</sup> It had good reason to succeed. The Germans had nearly ten divisions against less than five Allied divisions;‡ the Allies had to defend a front of almost thirty-five miles and at the same time maintain an adequate reserve and bring in supplies; yet the constricted nature of the bridge-

\* See below, pp. 362-64, for details.

† This was one of the few instances during all of the long Italian campaign when the GAF really came to the aid of the German ground troops. (See Kesselring Questions.)

‡ This is not, however, a true index of comparative troop strength, for the German divisions were not at full strength.

head allowed the enemy to cover it with his artillery and offered a fine target for his aircraft. With all of these advantages he could not win, for the Allies had other and greater advantages: ground troops who refused to be whipped, superiority of artillery, supremacy in the air; further, the enemy was never able to make full use of his tanks. In the face of stubborn resistance by the Allied ground forces, heavy artillery fire, and blasting from the air, the enemy's morale broke and the bridgehead was held.<sup>89</sup>

The Allied air forces went all-out against the German offensive. A-20's, A-36's, and P-40's attacked guns, tanks, troops, vehicles, dumps, bivouacs, communications, and buildings along the battle lines, while DAF Baltimores struck blows against strongpoints at Carroceto and communications west of Albano and at Valmonte. USAAF mediums put part of their bombs on towns, dumps, and refueling points back of the enemy's lines and part on bridges and yards around Orte, Orvieto, Marsciano, and Abbinie; Wellingtons hit roads, and Bostons attacked supply dumps and road traffic south of Rome. Heavies, flying mostly without escort, hit lines of communication, but also unloaded 650 tons on troops, vehicles, and storage areas close behind the enemy's lines at Campoleone, Rocca di Papa, Frascati, and Grottaferrata. The peak of these operations was reached on the 17th, when an estimated 813 aircraft of all types dropped almost 1,000 tons of bombs on front-line positions. More than one-third of the sorties were by heavies which—as in the critical days at Salerno—operated in a strictly tactical role, as did mediums, some of which bombed within 400 yards of the Allied front lines. The tonnage represented the heaviest weight of bombs dropped up to that time in a single day of close support. Interrogation of prisoners revealed that the bombing from 16 to 20 February caused few casualties but was “solely responsible” for the destruction of command posts, dumps, gun emplacements, and assembly areas, for breaking up tank concentrations, and for knocking out secondary battle units and installations. Moreover, the blistering attack did much to bolster the morale of our own ground troops.<sup>90</sup>

Throughout the critical period fighters were masters of the air over the battle area and the bridgehead, although with the Nettuno airstrip unusable all fighters had to operate from bases in the Naples area. P-51's and Cubs spotted targets, especially gun and troop concentrations. Even Coastal, usually concerned almost wholly with defensive patrols and missions against subs and shipping, got very much into the land

battle as its planes heavily attacked west-coast rail lines and flew fighter sweeps in the Lake Bolsena area in the greatest offensive effort yet made by that command. The great difference between the total offensive effort of the GAF and MAAF in this critical stage at Anzio is indicated by the fact that the enemy, by straining his resources, was able to put between 150 and 185 aircraft over the lines each day, while the Allies flew from seven to ten times that many sorties. The GAF lost forty-one planes while MAAF lost only thirteen.<sup>91</sup>

General Devers said that the close air support on the 17th disrupted the enemy's plan to launch a large-scale attack and that the German assault when it did come was stopped by "combined artillery and air action." Later, Fifth Army summed up the value of the air assault:

Bomber effort . . . contributed greatly in keeping enemy attacking troops pinned to the ground, retarding movement, preventing full power of attack to be felt by front-line units and interfering with battlefield supply. During air attacks enemy artillery did not change position and gun crews went into and stayed in dug-outs. Air attacks created fear among enemy personnel. . . . Estimated that many casualties to personnel and much damage to vehicles and loss of supplies resulted in weakening offensive effort. Wire communications were interrupted, causing confusion and some loss of control. Communication centers . . . were heavily damaged, interrupting and slowing down movements. . . . Bombing contributed greatly to morale of our own troops, giving confidence in defensive effort, and to the success of stopping the German attack.<sup>92</sup>

For ten days after the 19th the German forces around the bridgehead limited their activities to small probing attacks while they recuperated from their heavy losses of men and supplies and regrouped in preparation for another full-scale effort to liquidate the Anzio bridgehead. With enemy prisoners beginning to talk of interrupted communications, delayed reinforcements, and shortages, MAAF's medium bombers continued to strike lines of communications and airfields, its light and fighter-bombers to attack troop and gun concentrations, and its fighters to protect troops and shipping—all of them operating within severe limits imposed by the weather, which was particularly bad.<sup>93</sup> For Strategic, the period was one of the busiest, most interesting, and—as events proved—one of the most significant of the war.

Since the first of the year both the Eighth and the Fifteenth Air Forces had been conducting long-range operations against purely strategic targets. But the Fifteenth had flown only a few such missions: bad weather had interfered and the demands of the Italian campaign had forced it to operate largely against quasi-tactical objectives. Its

principal blows under the POINTBLANK program had been attacks on the Villa Perosa ball-bearing plant and the Reggio Emilia fighter aircraft plant (both in northern Italy), the Maribor aircraft factory (Yugoslavia), the torpedo factory at Fiume, the Messerschmitt plants at Klagenfurt (Austria), and Toulon harbor (French home of the Vichy fleet and an important submarine base). In addition, heavy blows against targets which were not strictly strategic were delivered—as noted above—against airfields in southern France, the Rome-Viterbo complexes, and the Udine area (primarily to protect Allied ground forces and installations from the Luftwaffe), against communications in northern Italy, and against Sofia for political reasons and because it was a rail center. In its intermittent efforts on behalf of the CBO, the Fifteenth was aided by Strategic's RAF Wellingtons which struck at Maribor, Reggio Emilia, and Fiume.<sup>94</sup>

Especially disturbing to General Eaker was the prospect that the demands of the hard pressed ground forces at Anzio might interfere with the Fifteenth's participation in the all-out attack on the German aircraft industry which USSTAF, after several postponements, decided to open on 20 February.\* General Spaatz had authority to direct the use of Fifteenth Air Force planes in coordination with the planned attacks of the Eighth Air Force, but the call for this assistance came during the German counterattack of 16–19 February on the beachhead at Anzio and General Wilson by the proclamation of a state of emergency could command for his own purposes the full power of the Fifteenth Air Force. Both Generals Clark and Cannon, believing that the 20th would be a critical day at the bridgehead, were most anxious for assistance from the Fifteenth's heavies, for Cannon felt that Tactical by itself could not take care of Fifth Army's needs.<sup>95</sup> Spaatz continued to press the prior claims of the CBO mission, but after Churchill took the side of the tactical demands, he decided to leave the decision to Eaker's "discretion."<sup>96</sup> The last thing that Eaker wanted was for General Wilson to declare a tactical emergency, since he believed wholeheartedly in the importance of the combined offensive against the German Air Force. So he decided to meet both the needs of the ground forces and the wishes of General Spaatz. Splitting his heavy bomber force between SHINGLE and ARGUMENT, he sent 105 planes against the enemy at the beachhead and 126 against Regensburg.<sup>97</sup> As it happened, the heavies could not get through to Regensburg because of icing condi-

\* See above, pp. 31–32.

tions over the Alps so that the Eighth had to carry the offensive alone—although it seems certain that the Fifteenth's appearance so far north held hundreds of enemy fighters in southern Germany and away from the Eighth.<sup>98</sup>

For the remainder of the Big Week the enemy relaxed his pressure at Anzio while Kesselring regrouped for another assault, and the weather repeatedly proved unfavorable for large-scale air operations in Italy. Consequently, it was possible without further debate over priorities for the Fifteenth Air Force to play an important part in USSTAF's climactic attack on the GAF. On the 21st bad weather grounded all Italy-based heavies. But on the 22d, with Anzio obscured by low clouds, southern Germany was clear and the Fifteenth sent every available bomber (183 of them, with 185 escort fighters) against Regensburg in coordination with the Eighth Air Force. On the 23d, with the Eighth weathered in, the Fifteenth hit the Steyr (Austria) aircraft and ball-bearing factories. On the 24th the air forces again coordinated, when 113 heavies of the Fifteenth revisited Steyr and the Eighth slugged Gotha and Schweinfurt. The climax of the so-called Big Week came on the 25th when both air forces hit Regensburg.<sup>99</sup> If ARGUMENT proved something less than 100 per cent successful, it nevertheless marked a victory over the enemy air force of the greatest significance to Allied operations through the critical months which followed. And those who had claimed that the opportunity to deal a fatal blow to the GAF should be given priority over any tactical emergency would be in position to point out that the Luftwaffe never thereafter posed a real threat in the Mediterranean area.

As for the stalemate in which the Anzio landing soon ended, it would be difficult to argue that the heavies sent north against the GAF could have made any substantial difference in the outcome of SHINGLE. The local weather drastically limited all air operations in support of the beachhead during that week and afforded Kesselring an opportunity to bring up reinforcements and to regroup his forces. On the morning of the 29th, he launched a second major attack against the bridgehead. Some penetration of the Allied lines was achieved, but determined counterattacks, ably supported by artillery and air bombardment and protected by fighters, checked the drive.<sup>100</sup> It was evident, however, that the offensive would be renewed immediately, and Fifth Army called for a maximum air effort on 2 March against the enemy's assembly areas, communications, guns, and supply installations. Al-

though the weather was not good the air forces answered with around 800 bomber and fighter-bomber sorties and 600 tons of bombs: heavies flew more than 300 sorties against targets along the front, mediums and light bombers hit targets around Cisterna, Carroceto, Campoleone, and Velletri, fighter-bombers smashed gun positions, and fighters of DAF destroyed 61 vehicles between Rome and the beachhead.<sup>101</sup> The bombing pinned down enemy troops, wrecked communications, broke up units and installations, and materially disorganized the enemy's plans to continue the offensive. When on 3 March he attempted to exploit his earlier gains an Allied counterattack, strongly supported by MATAF's planes, wiped out the effort, and on the 4th the Germans took up defensive positions. This last attempt to destroy the beachhead had failed, but the Allies had won nothing more than a beachhead.

Both sides now settled down to await the coming of good weather, and for two months there were no major operations on the ground, either at Anzio or along the Gustav Line, except for main Fifth Army's final assault at Cassino between 15 and 23 March.\* Over both fronts, however, there was constant air activity, for the Luftwaffe often plagued Allied troops, especially those at Anzio, with small raids, while MAAF's planes flew defensive patrols, reconnaissance, and frequent offensive missions for its partners on the ground.<sup>102</sup> Anzio, said Kesseling, was the Allies' "epic of bravery."<sup>103</sup> But it also was a failure. No primary objectives had been gained, and the Fifth Army now was tied to two fronts. The theater burden of supply and maintenance was increased. The air forces were faced with the necessity of dividing their strength between two fronts, one of which consisted largely of exposed beaches, for an indefinite period.

It is not within the province of this study to pass judgment on the failure of SHINGLE or to say what should have been done to make it a success, but it is important to observe that some of the AAF's leaders were not happy over the operation. Though feeling that MAAF—in spite of so much bad weather—had met its commitments, they also felt that with respect to the over-all plan the air forces were open to criticism. There is no evidence that the air arm had protested against becoming involved in a situation in which the Allied forces, already bogged down, undertook a second and difficult operation; but Eaker, who had reached the theater after plans had become firm, felt that the capabilities of air power had not been calculated closely enough. Air

\* See below, pp. 366-70.



cooperation was absolutely essential to the success of SHINGLE, yet bad weather could so affect the air effort as to defeat or seriously retard the effort. Moreover, it should have been anticipated that it might be necessary to divert bombers from their primary mission of participation in POINTBLANK and that it would certainly be necessary to divert many offensive planes to what in reality were defensive missions.<sup>104</sup> These criticisms undoubtedly were sound, but they were made in retrospect and they overlooked the fact that the planners fully expected that the Anzio forces would so quickly join with the main Fifth Army that the period of air cooperation with SHINGLE would be very short.<sup>105</sup>

General Arnold also was critical of the employment of air power in SHINGLE. He pointed out that the air forces did not always concentrate their available air power so as to hit selected areas with sustained mass attacks. He also noted that no systematic, complete, and enduring isolation of the battlefield was possible without more night operations than had been employed.<sup>106</sup> But neither he nor anyone else suggested that MAAF's planes and crews had not done a fine job.

Many lessons were learned from the air operations on behalf of Anzio. Most of them were minor, involving such things as the allocation of special ships for the movement of air force supplies, the need for greater care by AA gunners in firing at aircraft, the advisability of undertaking a greater number of weather flights, and the necessity of fixing better-defined aiming points for heavies engaged in close support. Two lessons, however, were of special interest. For lines of communication to be properly interdicted and troop and supply movements effectively limited it was necessary for light bombers to continue to maintain the pressure at night and for mediums to supplement them by flying missions around the clock. Secondly, large-scale air support must be followed up immediately by the ground troops, who must be ready to take quick and full advantage of any rupture of the enemy's defenses.<sup>107</sup> The latter lesson would be re-emphasized at Cassino only ten days after the fighting at Anzio died down.

### *Cassino*

From shortly before the landings at Anzio until early in March—a period of six weeks—the Fifth Army had hammered at the Gustav Line in a gallant but futile attempt to break through and effect a junction with the Anzio forces for a drive on Rome. The failure of the Fifth was

not the fault of its troops; it was simply a case of the physical impossibility of routing a tough, skilful enemy who exploited his many advantages: strong defensive positions, steep and barren mountains, rain, snow, mud, and flooded streams.

If the ground troops failed to accomplish their primary objectives, at least they achieved some local successes. Near the coast Minturno was taken and a substantial bridgehead established across the lower Garigliano. Farther north around Sant' Ambrogio the river could not be crossed, but some progress was made toward establishing positions in the hills overlooking the stream and an attempt to break out of the southern bridgehead picked up around six square miles east and northeast of Castelforte. Nearer Cassino, the very heart of the enemy's lines, the 36th Division was stopped in its attempt to cross the Rapido River, but Allied troops pushed into the northeast corner of the town and on the north took Sant'Elia and Cairo.<sup>108</sup>

The air forces contributed heavily to what few successes the Fifth Army gained, in spite of their heavy obligations to SHINGLE and in spite of bad weather which pinned down Desert Air Force in the east and seriously interfered with XII Air Support Command in the west. In general, P-40's concentrated their efforts against battlefield objectives while A-36's worked on communications in the enemy's immediate rear. Targets shifted with the several phases of the ground operations, the shifts being not only from one sector to another but among different types of objectives, which included roads, tunnels, bridges, strongpoints, guns, concentrations, supply points, tanks, and infantry.<sup>109</sup> Heavies and mediums, as has been noted above, were engaged largely against lines of communication and the GAF; while their missions were flown primarily in behalf of SHINGLE, they served also to interfere with the movement of enemy supplies into the Gustav Line.

The principal operation by heavies and mediums in direct cooperation with main Fifth Army prior to 1 March was an attack of 15 February on the Abbey of Monte Cassino, which was situated atop Monastery Hill and overlooked the town of Cassino at the base of the mountain.<sup>110</sup> In the more than seven years which have elapsed since that day the question of whether the Germans were using the abbey for military purposes and, accordingly, whether General Wilson was justified in ordering Eaker to level it, has been one of the most controversial subjects growing out of World War II. On the one hand, there is the evidence of Eaker who, with Devers, flew over the abbey in a Piper

Cub at a height of less than 200 feet (the Germans ignored small planes for fear of drawing attacks by fighter-bombers) and who has stated flatly that he and Devers saw a radio aerial on the abbey and enemy soldiers moving in and out of the building. On the other hand, there is the recently expressed conviction of Gen. Mark Clark of the Fifth Army, who, having set forth in his book *Calculated Risk* his opposition to the plan to bomb the abbey, gives evidence from the German side to show that the enemy at no time before 15 February used the historic old building for military purposes. Actually, the controversy is somewhat academic, for the question of whether or not the Allies were justified in bombing the abbey may be resolved by asking and answering one very simple question: on 15 February 1944 did the Allied leaders, after careful investigation, believe that the abbey was being used for military purposes? The answer is: they did. Their belief was summarized in a cable from Wilson to the British chiefs of staff in which he stated that he had "irrefutable evidence" that the abbey was part of the main German line of defense, that observers used it to direct artillery fire, that snipers fired from it, and that gun emplacements, pill-boxes, and ammunition dumps were located within its shadows.<sup>111</sup>

Even though Wilson had sufficient reason to consider the abbey as a military objective it is altogether possible that it would never have been bombed (for the Allies throughout the war made every effort to avoid damage to buildings of historical and religious significance) had not the New Zealand Corps\* under Gen. Bernard C. Freyberg been ordered to storm the high ground north and west of the town of Cassino on the night of 16/17 February. The assault was to be the pay-off blow of the month-long and heretofore futile effort to break the Gustav Line, and Freyberg insisted that the destruction of the monastery was a military necessity. Generals Wilson, Alexander, Devers, Eaker, and others did not agree, but eventually Freyberg's arguments that military exigencies outweighed historical and sentimental considerations prevailed and Wilson ordered the air forces to destroy the abbey.<sup>112</sup>

The aerial bombardment began at 0900 hours on the 15th when the first wave of Allied bombers swept in. By noon B-17's, B-25's, and B-26's had dropped 342 bombs, and at the end of the day a total of 142 heavies and 112 mediums had unloaded 576 tons of high explosives.

\* Including the New Zealand 2 Division, Indian 4 Division, and British 78 Infantry Division.

Between successive bomber attacks heavy artillery fired on the target.<sup>113</sup> The combined pounding destroyed the abbey as a historical monument, but only impaired its usefulness to the enemy. Nor were the ground forces, in spite of careful planning and hard fighting, able fully to exploit the effects of the bombardment when they tried on the 16th and 17th to take Monastery Hill; although mediums again attacked the abbey and its environs and more than 100 P-40's and P-51's bombed with great precision just ahead of the troops, the infantry, which got its attack under way slowly and in a piecemeal fashion, was unable to reach the monastery. The best that could be accomplished was to establish a small bridgehead across the Rapido River and seize about a third of Cassino town. After four days of fighting, it was obvious that the key position in the Gustav Line could not then be taken, and the battle which had raged along the Fifth Army front for more than a month died down.<sup>114</sup> For the next few weeks ground activity was restricted to patrolling while both sides regrouped and planned future operations. Insofar as the air forces were concerned, the lull came at a convenient time, for it coincided with the main enemy offensive against the Anzio beachhead which required the full attention of MAAF's planes.

The failure of the Allied forces to break the stalemate in Italy was a matter of sharp disappointment and concern in Washington and London, as well as in the theater. Of immediate importance was the possibility that the Germans might yet wipe out the Anzio salient. In the longer view there was the danger that the plans made for OVERLORD and ANVIL, both of which were scheduled to take place late in May or early in June, might be upset. When the Anzio-Fifth Army operations failed to produce results the planners realized that ANVIL might have to be postponed, perhaps abandoned, while a prolongation of the stalemate might even delay the launching of OVERLORD. Troops earmarked for ANVIL were fighting at Anzio and could not be withdrawn until the two Allied fronts were joined; troops on both fronts were in short number and battle-weary; there were not enough landing craft to support both SHINGLE and ANVIL. To undertake a new operation in the Mediterranean before the Italian land battle had been cleared up would be unwise, if not impossible.

Certainly General Wilson thought so. On 22 February he recommended to the British chiefs of staff that ANVIL be canceled and that he be given a new directive to conduct operations designed to contain

the maximum number of German troops with the troops available to him. This he proposed to do by keeping pressure on the enemy, for which purpose he would maintain the Anzio beachhead, forcing the Germans to use up manpower and supplies. Believing that operations in Italy "must be conditioned mainly by the air factor," he planned to use his air forces to deprive the enemy of the ability either to hold present positions or to withdraw units from Italy until after OVERLORD had been launched. Staff studies and consultation with subordinate commanders had convinced Wilson that MAAF, with the aid of good weather during March and April, could so disrupt the enemy's communications as to make the maintenance of a line below Rome impossible, and that a combined Allied air and ground offensive could compel withdrawal to a Pisa-Rimini line.<sup>115</sup>

Concurrently, the Italian situation was under discussion in Washington where the dangers inherent in the stalemate were thoroughly appreciated. General Arnold believed that the proper application of air power would aid greatly in breaking the impasse. He pointed out that there were around 4,100 combat aircraft in the Mediterranean but that they had been used sporadically and piecemeal on behalf of the ground campaign; there had been no true mass air assaults. If available air power were properly applied almost 2,900 planes could be brought to bear directly on Cassino or Anzio; for a short period these aircraft could fly over 5,600 sorties and drop close to 6,200 tons of bombs (not to mention strafing) per day in cooperation with a ground offensive. Arnold believed that the best course was to hurl heavy and concentrated air attacks against the Cassino sector, isolate the battle area, and blast a passage in the enemy defenses through which the ground troops could pass and exploit northward. This should be done, however, only if the ground forces were positive that they were capable of taking full advantage of the air assault. They must be able to regain the initiative and launch a strong offensive.<sup>116</sup>

Arnold's confreres in the JCS approved the suggestion, feeling that his plan for the immediate employment of air power en masse was superior to Wilson's long-range plan.<sup>117</sup> The British chiefs agreed in principle but felt that the ground troops were too exhausted to take "corresponding offensive action" along with the air attack. The matter was compromised by changing "corresponding offensive action" to "vigorous offensive action on land," which was to be "related" to the air assault. On 8 March the CCS called General Wilson's attention to the

possibilities inherent in mass air operations, but left to his discretion whether the effort should be applied at Cassino or in the Anzio area.<sup>118</sup> It so happened that for more than two weeks Wilson had held in readiness a plan comparable to the one suggested by Arnold and had only been awaiting favorable weather to put it into effect. Clark had been pressing for such an operation as a means of breaking out his stalled Fifth Army, and as early as 20 February, Alexander had advocated a massive bombing of Cassino to be followed by attack with ground troops. Accordingly, Wilson informed the CCS on 9 March that a maximum air and ground assault would be made on the Cassino front as soon as weather permitted.<sup>119</sup>

General Eaker was not enthusiastic over the plan. The failure of the ground troops to achieve success after the bombing of the abbey on 15 February, plus the bad weather which now had the ground forces mired down and the Rapido out of its banks, made him feel that the Fifth Army was not in a position to take full advantage of a mass air attack. He wrote to Arnold that little useful purpose would be served "by our blasting the opposition unless the army does follow through," and he warned his chief not to expect a great victory as a result of the operation because, in his opinion, the air assault would not throw the enemy out of his present position "completely and entirely." Eaker and Brig. Gen. Gordon P. Saville also pointed out to General Freyberg, whose New Zealand troops again would lead the ground attack, that bomb craters would negate the use of tanks, but Freyberg asserted that bulldozers could quickly clear a path.<sup>120</sup>

Final plans called for the entire strength of Tactical and powerful elements of Strategic to flatten the town of Cassino in one overwhelming air assault, scheduled to last from 0830 to 1200 hours on D-day. Immediately, the New Zealanders were to move in on Cassino from the north, seize the town and Castle Hill, and set up a bridgehead over the Rapido along Highway 6. The Indians then were to take Monastery Hill and cut Highway 6, and the Fifth Army was to exploit into the Liri Valley. The proper execution of the plan demanded a favorable combination of weather conditions: operational conditions at 14,000 feet over the target; flyable weather at all bomber bases in Sardinia and in the Naples and Foggia complexes and between bases and the target; and ground dry enough for tank operations.<sup>121</sup>

Bad weather regularly postponed the operation—as it had done since 25 February, the original date set by Wilson<sup>122</sup>—but finally on 15

March the desired combination came up. Before dawn Allied troops pulled back from Cassino a distance of about 1,000 yards. Promptly at 0830 B-25's launched the air assault, which then proceeded according to schedule (with a few exceptions) until noon, when the last formation of B-26's hit the target and turned away. In the three and a half hours of bombardment more than 275 heavies and close to 200 mediums dropped over 1,000 tons of 1,000-pound demolition bombs.<sup>123</sup> Bombing accuracy and adherence to the timetable laid down for each wave were below par for the heavies (several bombs fell among our own troops). From an exhaustive investigation conducted by General Edwards on orders from General Eaker it appears that the poor showing of the heavies was caused by a combination of circumstances: poor air discipline on the part of two new groups, malfunction of bomb racks in one formation, lack of specific aiming points,\* and the heavy pall of smoke and dust which obscured the target after the first few attacks. Mediums, on the contrary, maintained fine discipline and achieved remarkable bombing accuracy in spite of the fact that the target was largely hidden. The B-26's (17th, 319th, 320th Bombardment Groups), which put close to 90 per cent of their bombs on the target, "stole the air show at Cassino." Heavies and mediums together dropped about 50 per cent of their bombs within the 1,400-yard x 400-yard confines of the town, which was not a bad over-all average.<sup>124</sup>

The tremendous attack destroyed Cassino. Shells of buildings still stood, but most of the town was a twisted mass of rubble. Eaker reported that the ground commanders "felt without exception that the air bombardment had given the measure of destruction which they had hoped for."<sup>125</sup>

Immediately following the mass air attack, Allied artillery laid down a heavy barrage on the town. As it crept forward, a small force of New Zealand infantry, strung out over several hundred yards, and tanks attacked from the north. They promptly ran into trouble. The tanks were stopped at every approach by huge craters which held them until engineers, working under fire, could build bridges—some as long as seventy feet—across the gaping holes,<sup>126</sup> while the streets were so full of rubble that one New Zealand brigadier estimated that under ideal conditions it would have taken bulldozers forty-eight hours to clear a single path through the town.<sup>127</sup> In the beginning the infantry met

\* Specific aiming points purposely were not assigned, in keeping with the fundamental object of saturating the defenses.

no real opposition—General Eaker's photographer walked over many of the streets taking pictures without drawing so much as a rifle shot—but the infantry's attack moved in so slowly that an hour passed before it had secured a foothold in the town. These delays gave the enemy, who beyond a doubt had been temporarily confused and disorganized by the bombing,<sup>128</sup> just enough time to recover and to crawl out of dugouts, holes, pillboxes, and a tunnel which ran under the town and take up strong sniping and machine-gun positions in the ruins. Even so, at midafternoon the situation seemed hopeful and by nightfall, in spite of increasing resistance by the enemy (a special group of Nazi fanatics, with very high morale), the Allied troops had penetrated well into the northern part of the town. Deteriorating weather during the afternoon canceled planned attacks by heavy and medium bombers which would have assisted the ground assault by pinning down the defenders; however, light bombers, fighter-bombers, and fighters managed to get in below the overcast and drop around 100 tons of bombs on the south side of the town, the railway station, the slopes of Monastery Hill, and on other miscellaneous targets. MAAF planes also covered lines of communication, especially those between Cassino and Rome-Anzio, in order to prevent the movement of reinforcements and supplies.<sup>129</sup>

Plans called for continuing the ground advance during the night of the 15th but the troops were stopped cold by hard rains. The enemy took advantage of this breather to reorganize and to reinforce a number of vital positions. The rain further assisted him by leaving the ground sodden and sticky and by turning every crater into a miniature lake. The Allies made considerable progress on the 16th, but the enemy held on to the Continental Hotel and other strongpoints and on the 17th was able to counterattack at one point. At the end of the day the Allies had two-thirds of the town and most of the ridge from Castle Hill to Hangman's Hill, but they had not taken Monastery Hill and the abbey or penetrated the town from the south. Five more days of fighting produced indecisive results, and at the end of the 23d, Alexander ordered the New Zealanders to call off the battle.<sup>130</sup> The breaking of the Gustav Line would have to wait for dry ground and for Allied troops less weary. Devers and Eaker had been right when they had warned early in March that the Cassino operation would not result in a large-scale breakthrough.<sup>131</sup>

In the eight days from the 16th through the 23d air activity over Cassino was limited to the maintenance of air cover and to meeting re-



quests by the ground troops. These matters were handled by fighters and fighter-bombers; mediums made a few attacks close to Cassino, but most of their efforts after the 15th were against lines of communication well to the north of the battle line. The smaller planes hit communications and concentrations near Cassino, but their main targets were gun positions on the heights which overlooked the battlefield, more than 500 sorties being flown against them. Another important close-in operation was that of dropping supplies to troops which were isolated on Hangman's Hill and Point 202; A-36's handled most of the missions, flying 154 sorties in four days.<sup>132</sup> Air cover was not much of a problem, although the weak Luftwaffe came to the aid of the defenders of Cassino, and at the same time tried to help Kesselring's troops at Anzio, by flying more sorties over the two sectors than at any time since mid-February. On several days the enemy's effort over both areas ranged from 60 to 100 sorties (on the 19th and 24th it was around 150) compared to a normal daily operation of around 50 sorties. The effort accomplished little and the enemy lost forty-two planes as against ten Allied planes.<sup>133</sup> After the Allies' Cassino offensive came to an end on 23 March, MAAF confined its activities over the battlefield to patrols. Actually, the real air war already had moved north to above Anzio and Rome.

An evaluation of the mass air attack on Cassino indicates that the air forces met their commitment of smashing the town. The most serious criticism was the failure of the heavy bombers to keep on the time schedule, which, with some inaccurate bombing, gave the enemy several periods of respite up to forty minutes in length. Had the bombing been as continuous as had been planned, the demoralization of the defenders would have been more nearly complete. It is extremely doubtful, however, that this would have materially affected what happened after the bombing ceased, for the enemy still would have had the same length of time in which to recover. Nor can it be supposed that any other benefits would have accrued even had the air attack been perfectly executed. The deep cellars and tunnels still would have limited the number of casualties, and certainly any additional damage to the town could only have hindered the Allied ground forces.<sup>134</sup>

The failure of the infantry to take Cassino after the great air assault proved two things. One was that a mass air attack can be a double-edged weapon. It flattened Cassino and temporarily stunned its defenders, but it created obstacles in the form of craters and masses of

rubble which made the speedy use of armor impossible and handicapped the infantry.<sup>135</sup> The weapon may have been double-edged in another respect: the forward elements of the Allied infantry were only 1,000 yards from the town during the bombardment and some bombs fell among them; it may have been that this circumstance had something to do with the slowness with which the infantry moved to the attack. The second thing proved was that a ground attack which is to follow a mass air attack must be launched immediately, vigorously, and on a large scale.<sup>136</sup> The assault by the New Zealanders on 15 March was characterized by none of these features, the best proof being that their total casualties for the day were only four officers and thirteen men.<sup>137</sup>

Speaking strictly from the point of view of air operations, the bombing showed again that the shoemaker should stick to his last. Tactical's mediums put on a superior performance because the mission was the sort to which they were accustomed; the poorer showing of the heavies was the result primarily of undertaking a job which was out of their line.<sup>138</sup>

The mass air attack on Cassino was a spectacular affair, and because it did not result in a breakthrough (as so many people had decided it would do) it has been called a spectacular failure in the use of aircraft as artillery.<sup>139</sup> Such a view can be justified only in part. After all, the operation was a failure not because the air forces did not carry out their assignment; as directed, they pulverized Cassino.<sup>140</sup> It was a failure because the ground commanders expected complete reduction of resistance from the air attack and because the combined air and artillery bombardment resulted in more destruction than was desirable but, above all, because the ground forces attacked too late and with too little.

## CHAPTER 11

\* \* \* \* \*

### ROME

THE failure of the Anzio landings to achieve substantial results and the unsuccessful attempts of the Fifth Army to break the Gustav Line focused attention on the idea of using air power to disrupt the enemy's lines of communication to an extent that would deny him the power to stop a major Allied ground offensive. The possibility and advantage of such a program had been pointed out by General Eisenhower at the Cairo conference in December 1943, and thereafter General Wilson in February had formulated a plan for an operation of that type.<sup>1</sup> Air leaders had been urging the program for several months. General Spaatz, during a visit to the theater in February, declared that with good weather the air forces could so thoroughly interdict communications that the breaking of the ground stalemate would be inevitable.<sup>2</sup> General Eaker, early in March, assured General Arnold that powerful air attacks on the enemy's rail, road, and sea communications could interdict them and keep them interdicted, with the result that the enemy would be driven past Rome to the Pisa-Rimini line.<sup>3</sup> Such opinions were not pulled out of thin air: in the closing weeks of the Tunisian campaign, throughout the Sicilian campaign, during the drive of the Fifth and Eighth Armies past Naples and Foggia, and as a preliminary to SHINGLE, the air forces, although directing only a part of their total effort toward cutting lines of supply, had so successfully interfered with movement as to indicate that an all-out air offensive would result in very nearly complete interdiction of the enemy's lifeline.

A study prepared by the British bombing survey unit headed by Professor Solly Zuckerman on the results of air interdiction in the Sicilian and southern Italian campaigns bore out the collective opinion of Eisenhower, Wilson, Spaatz, and Eaker.<sup>4</sup> However, the so-called Zuck-

erman thesis, which had been accepted as air doctrine even before it was published on 28 December 1943 and which had the indorsement of the Air Ministry and Tedder's strong support, insisted that communications targets should be large rail centers, where tracks, locomotives, rolling stock, warehouses, and repair sheds were concentrated, and held it categorical that rail and road bridges were "uneconomical and difficult targets" which in general were not worth attacking.<sup>5</sup>

With the latter contention the MAAF Target Section, XII Bomber Command, G-2 of AFHQ, A-2 of Twelfth Air Force, and others were in sharp disagreement. They conceded that in the Italian campaign up to the present battle line it had been entirely logical to concentrate on rail centers, for all traffic into southern Italy had to pass through only a few yards, notably those at Naples and Foggia; but they argued that in central and northern Italy the rail system contained so many yards that it would be very difficult to knock out all of them, whereas every important line ran over bridges and viaducts, many of them in isolated sections and few of them capable of being by-passed. They noted that the purely military needs of the German forces in the field could be supplied by only about 5 per cent of the normal Italian rail traffic and that this amount could be moved without using extensive marshalling yard facilities. It seemed apparent that to be effective an interdiction program would have to cut all lines quickly and simultaneously—which could not be accomplished solely by knocking out rail centers. They pointed to a brief period of bridge-busting in late October and early November 1943\* which had so successfully cut the main rail lines in central Italy that, according to General D'Aurelio, former chief of the Italian liaison staff with Kesselring, the Germans were "mentally preparing themselves" for a withdrawal to above Rome—and might well have done so had not the Allies abandoned the program before the end of November because of other commitments and bad weather.<sup>6</sup> The exponents of attacks on bridges received a strong boost early in March when an OSS report concluded that an air assault on marshalling yards and repair shops by any force likely to be available in the theater would not produce significant military results, and asserted that "nothing in the record to date shows that a simultaneous interdiction of all north-south rail lines by bombing bridges is beyond the capabilities of MAAF, given a scale of effort comparable to that currently being expended against other transport targets."<sup>7</sup>

\* For the details, see Vol. II, 554-58, 580-86.

Topographical and railway maps of central and northern Italy gave strong support to the arguments of the anti-Zuckerman school. In both areas mountains, valleys, and streams had forced the engineers who built the rail system to resort to use of an enormous number of bridges, viaducts, tunnels, and embankments, most of them highly vulnerable to air attack. On the other hand, in German-held Italy there were in March 1944 at least 48 major marshalling yards, more than 100 others with 10 tracks or more, and countless small sidings. To achieve real interdiction by knocking out yards appeared to be too big a job, especially since operations from late October 1943 to the end of January 1944 had shown that an average of 428 tons of bombs had to be dropped for every complete blockage of an M/Y, whereas only 196 tons were required to destroy a bridge. Moreover, experience had shown that tracks were much more easily repaired or replaced than were bridges.<sup>8</sup>

The question of whether rail centers (which usually meant yards) or bridges offered the better objective was not nearly so important as the fact that both air and ground leaders believed that the best way to insure a successful ground offensive up the Italian peninsula was for the air forces to disrupt the enemy's lines of supply to the point where he could not maintain his armies in the face of a powerful assault by the Allied armies. Hence, it was not the yards-versus-bridges controversy which delayed until after the middle of March the initiation of an all-out air assault on communications but the demands of Anzio and the Fifth Army front and the hindering effects of consistently bad weather. After the failure of the ground troops at Cassino and the stabilizing of the Anzio sector, both fronts became quiet and so remained while the Allies began to regroup for a big offensive to be launched as soon as the winter rains were over. This freed almost all of the tactical air units from operations on behalf of the ground troops. At the same time flying conditions began to improve.<sup>9</sup> On 19 March, MATAF issued a definitive directive for the interdiction program, which in code soon was appropriately designated Operation STRANGLE.<sup>10</sup>

### *Operation STRANGLE*

The directive of 19 March, which followed in most respects earlier ones of 18 and 25 February, stated the purpose of STRANGLE as follows: "to reduce the enemy's flow of supplies to a level which will make it impracticable for him to maintain and operate his forces in Central Italy." It gave first priority to the destruction of marshalling

yards and repair facilities and charged Tactical's medium bombers with carrying out the major part of this phase of the program. Specifically, their primary task was to attack railroads south of and including the Pisa-Florence-Pontassieve line and west of and including the Pontassieve-Arezzo-Orvieto-Orte line; secondary objectives (and weather alternates) were ports on the west coast and rail targets between Ventimiglia and Spezia. Strategic, whose first priority still would be POINT-BLANK, was to hit marshalling yards in a few major cities in northern Italy through which flowed the bulk of men and supplies from beyond the Alps but which were outside the effective range of the mediums. Coastal would harass coastal supply routes.

The most interesting feature of the directive was the provision that XII ASC and DAF were to participate in STRANGLE. XII ASC was assigned to work on rail lines from Rome to Terni, Viterbo, Montalto di Castro, and south to the battle areas and from Orte to Orvieto. These operations were to be the primary mission of the light and fighter-bombers located around Naples, taking precedence even over cooperation with the ground forces.\* In addition, the 57th Fighter Group was to move to Corsica with orders to attack rail and road communications south of the Pisa-Pontassieve line and west of and including Arezzo and Chiusi as well as a coastal strip from Spezia to Montalto di Castro. DAF was to hit lines from Terni to Perugia, Fabriano, and Pescara and from Pescara to Ancona.<sup>11</sup>

The decision to employ large numbers of fighter-bombers was based upon the principle that the success of STRANGLE would depend upon "simultaneous interdiction,"<sup>12</sup> a phrase which meant that, irrespective of whether yards or bridges got top billing, complete interdiction could be achieved only if all lines leading south from the Po Valley were cut simultaneously. It was felt that to accomplish this the work of the mediums must be supplemented by that of fighter-bombers, which could operate on days when weather precluded missions by the mediums, cut stretches of open track, and smash motor transport when the enemy shifted the bulk of his supply from rails to roads. The scheme thus to employ the fighter-bombers was one of the significant experiments of the war in the use of a tactical air force to prepare the way for a large-scale ground offensive.

Another significant principle followed by the mediums and fighter-

\* With the entire battle front static and with the GAF very inactive, the ground forces needed little more than moderate defensive patrols.

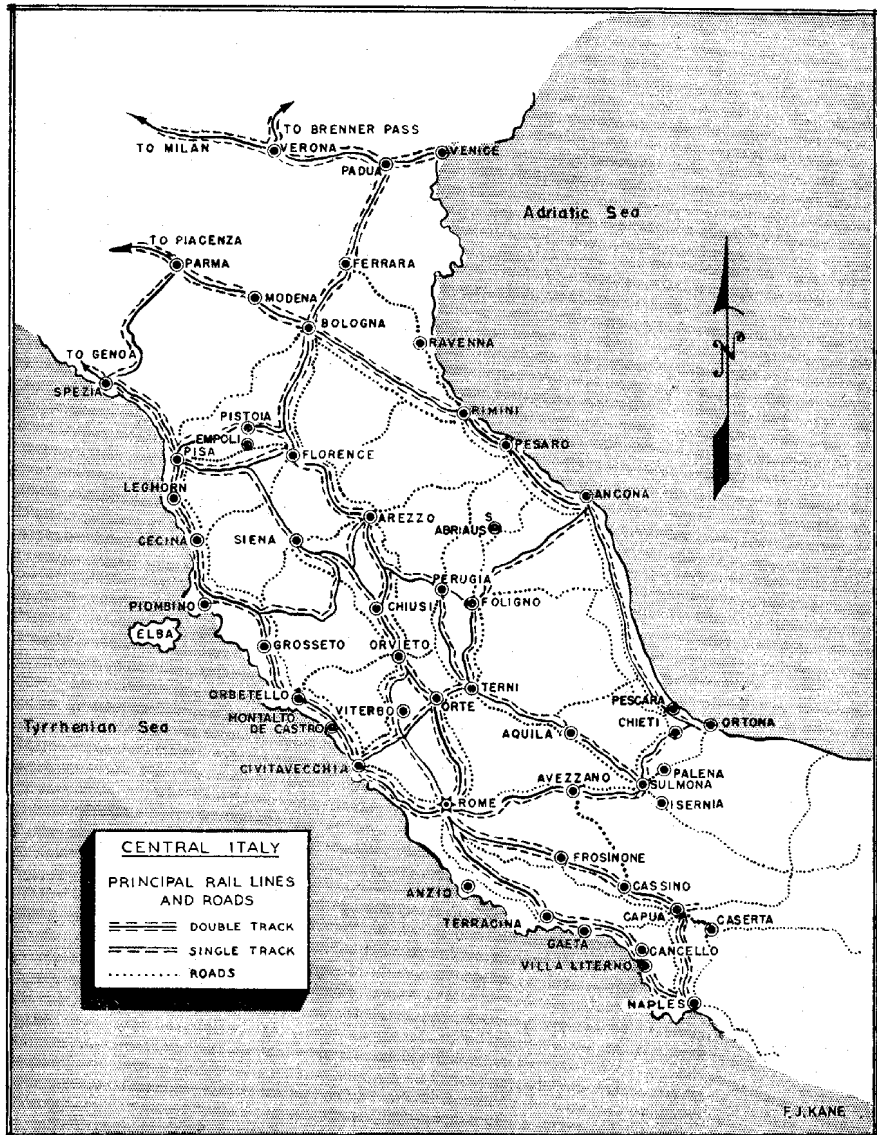

bombers in STRANGLE—and one which made this interdiction program different from earlier ones—was that of attacking whole sections of rail lines rather than concentrating on a particular type of rail target.<sup>13</sup> Instead of directing the effort primarily against bridges or yards, a whole system of bridges, yards, tunnels, defiles, even open stretches of track, was brought under more or less simultaneous attack. This plan of action indicates a failure by Zuckerman to win full approval for his idea of concentrating principally on rail centers. Although the directive of 19 March gave the mediums a first priority of hitting yards and repair facilities, as STRANGLE progressed the mediums paid more and more attention to bridges, and before the campaign ended their main effort was being directed toward that type of target. When STRANGLE was no more than two weeks old, Eaker reported that experience had shown the best way to cut lines of communication was by attacks on bridges and viaducts.<sup>14</sup>

Railways received primary consideration because in the last analysis road transportation in Italy was nothing more than a continuation or supplement of rail transportation, and since the invasion of Italy the maintenance and use by the Germans of railways had been “the main issue of all transport questions.”<sup>15</sup> The objective of STRANGLE was to interdict rail transportation to the point where it could not supply the enemy’s needs and, when he turned to roads, to concentrate on that system of transportation. With both types of communications interdicted the enemy could not meet the supply requirements of a major campaign.

Because MAAF’s bombers had been working on lines of communication in central Italy since early in January in connection with SHINGLE and the Fifth Army offensive, it is difficult to give a specific date for the beginning of STRANGLE. In a sense, it represented simply a sudden and very large expansion of the old program, which, in spite of the constant demands on the air forces by the Anzio and Cassino fronts, had been carried on steadily—as is evidenced by the fact that in January and February more than one-third of the tonnage of bombs dropped by MAAF’s planes had been directed against communications and that between 1 January and 19 March the heavies had expended more than 2,500 sorties and mediums 133 missions against rail targets.<sup>16</sup> For convenience, 19 March (date of the directive which set up STRANGLE) may be used. Almost two months later, on 11 May,



the operation merged into *DIADEM*, a ground and air offensive that broke the *Gustav* and *Hitler* lines.

During *STRANGLE* both fronts were quiet, which allowed the air forces to devote a full effort to communications. Medium bombers flew 176 missions against rail targets, 113 of them against objectives on the Florence-Rome line. This, the most important line in central Italy, was attacked at twenty-two different points between Florence and Orte; at nineteen of these points there were bridges. Nineteen attacks were directed against the Perugia-Terni-Orte line at five points of interdiction: four bridges and the yard at Terni. Seventeen attacks were delivered on the Empoli-Siena line; again four out of five points of interdiction were bridges. The mediums hit nine targets on the Pisa-Rome line a total of fifteen times; only four of the missions were against yards. The only low-level attack by mediums during *STRANGLE* was sent against this line on 15 April, when four B-25's of the 310th Bombardment Group went in at 400 feet against a tunnel north of San Vincenzo.<sup>17</sup>

No other rail line received major attention from the mediums, although they flew four missions against three bridges between Marseille and Genoa, two against bridges near Acquaviva on the Sinalunga-Chiusi line, and one each against bridges at Pontedera and Fano and the yards at Prato and Avezzano. Mediums also attacked west-coast harbor installations as a part of the interdiction program, flying six missions against the ports of Leghorn and five against Piombino and San Stefano.<sup>18</sup>

As early as 24 March the mediums had cut every through rail line which supplied the German front, and with able assistance from fighter-bombers they kept them cut right through the last day of *STRANGLE*.<sup>19</sup> Because of the demands of the ground forces, especially around Cassino, planes of XII ASC and DAF did not really get into full swing against lines of communication until April but thereafter they fully supplemented the work of the mediums.<sup>20</sup> Their primary targets were bridges and open stretches of track, but they also went for supply centers, tunnels, and viaducts. On many days the fighter-bombers and light bombers were able to operate on a large scale when the mediums were grounded by weather. The extent of XII ASC's operations is indicated by the more than 4,200 sorties which it flew against communications between 1 April and 12 May.<sup>21</sup> Closely

allied to these attacks were missions by fighter-bombers and light bombers against supply dumps. Thirty such missions were flown in March, sixty-two in April, and seventy in May. Slightly more than half of these missions in April and May were flown by A-20's of the 47th Bombardment Group, which were rarely employed in STRANGLE against rail or road targets.<sup>22</sup>

Desert Air Force, besides hitting targets similar to those attacked by XII ASC, harassed the enemy's road movement by night attacks. But, whereas day attacks to cut communications were handled by as many as six groups of mediums and six of fighter-bombers, the same task had to be accomplished at night by only two squadrons of Bostons and two of Baltimores.<sup>23</sup> The lack of a strong night bomber force was one of the principal handicaps to carrying out a fully effective interdiction program.<sup>24</sup>

Results of the operations by XII ASC and DAF were excellent, bearing out the belief that only by their supplementary efforts could "complete, simultaneous, and continuous" interdiction be achieved. The "little fellows" were remarkably successful against bridges—so long as they stayed away from the more massive ones—averaging 1 hit for every 19 sorties while the best that the mediums could average was 1 hit per 31 sorties. On one particularly good day the 57th Fighter-Bomber Group alone knocked out 6 bridges. On some days the fighter-bombers put as many as 100 cuts in rail lines, and for all of STRANGLE they averaged 30 cuts per day. On a number of days the combined efforts of the mediums and fighter-bombers resulted in more than 100 definite interdiction points on rail lines, and before STRANGLE was over the average number of cuts per day was 75.<sup>25</sup>

An examination of Tactical's operations against rail lines shows that it worked largely against bridges; only about 12 per cent of its missions were against marshalling yards. This was a complete reversal of the pattern of operations from 1 January to 19 March, when two-thirds of all attacks by mediums had been against yards. The bridge-busting campaign justified the expectations of its proponents: as early as the middle of April no fewer than 27 bridges had been knocked out; on the vital Rome-Florence line (to use a single example), mediums and fighter-bombers had accomplished full interdiction well before the beginning of the Allied ground offensive in May simply by cutting the main bridges.<sup>26</sup> Authentic reports from the Italian ministry of communications show that the most effective results in STRANGLE came

from the destruction of bridges rather than of yards because there was so little marshalling of trains. General Eaker considered that the campaign against bridges had been highly successful, as did Maj. Gen. Fred Anderson of the Eighth Air Force after a visit to Italy.<sup>27</sup>

Weather during STRANGLE was intermittently bad so that on almost one-half of the fifty-three days the mediums were grounded or their missions aborted; they achieved their fine total of some 200 missions only because on a number of days the crews flew several missions.<sup>28</sup> In compensation, Tactical's planes conducted their operations without too much interference from the enemy. AA fire was light and spasmodic up to about 20 April, after which it was still generally spasmodic but at a number of points became intense, accurate, and heavy. Opposition by the Luftwaffe was not serious. Enemy fighters were encountered consistently only over the sector between Rome and Orvieto, and even there the fifteen to thirty-five fighters which usually came up seldom offered battle.<sup>29</sup> In fact, throughout the seven weeks of the interdiction program MATAF's planes were so little bothered by the GAF that mediums flew with no escort, or very little escort, and fighter-bombers were able to go out in small flights, some of which contained only four to eight planes.<sup>30</sup> This allowed an almost constant stream of aircraft to operate over the interdiction area, a vitally important factor in the success of the program because it permitted simultaneous and continuous interdiction, while at the same time it gave the enemy's trains and vehicles little chance to move without being attacked. One result was that bombing accuracy steadily improved; in three B-26 groups, for example, the average effort needed in November 1943 to achieve 1 hit on a bridge had been 59 sorties and 106 tons of bombs, whereas at the end of March 1944 it was only 31 sorties and 68 tons.<sup>31</sup>

One reason for the lack of opposition by the GAF could be traced to a well-planned and ably executed blow on 18 March by Strategic against fields around the head of the Adriatic. Three hundred and seventy-three heavies dropped more than 43,000 x 20-pound frag bombs on Udine, Villaorba, and three smaller airfields on which enemy fighters were heavily concentrated as the result of a preliminary sweep by Allied fighters and a clever ruse by a part of the bomber force. Claims were fifty-six enemy aircraft destroyed on the ground and twenty-three in the air by the bombers and seventeen shot down by the escorting fighters. Strategic lost seven bombers and three fighters.<sup>32</sup>

While Tactical bore the brunt of STRANGLE (in the last month of the operations its planes flew around 22,000 sorties)<sup>33</sup> both Strategic and Coastal assisted with the program, although both had duties which carried higher priorities. Strategic worked largely against yards in northern Italy which were beyond the range of TAF's planes. These provided increasingly lucrative targets, for supplies accumulated in the yards as a result of cuts in the rail lines south of the Pisa-Rimini line. The principal targets were at Padua, Verona, Bolzano, Turin, Genoa, and Milan, and these and other rail centers were attacked whenever weather or other conditions forbade operations on behalf of POINTBLANK. The high point in Strategic's campaign was a series of seven missions in five days flown by the Fifteenth at the end of March. Three of the attacks—on the 22d, 28th, and 29th—were especially heavy, involving a total of close to 1,000 effective sorties by heavies and featuring (on the 28th) the Fifteenth's first "thousand-ton" raid laid on by planes from the 2d, 97th, 98th, 99th, 301st, 376th, 449th, 450th, 451st, 454th, 455th, 456th, and 459th Groups. The seven raids inflicted tremendous damage on yards and adjacent industrial targets at Verona, Mestre, Turin, Bolzano, Milan, Bologna, and Rimini, while a number of through lines were blocked. These daytime operations were complemented by the night-flying Wellingtons and Liberators of RAF 205 Group. On the 28th, six heavies from the Fifteenth tried low-level (200 feet) attacks on the Fano and Cesena bridges, but the experiment was such a signal failure that thereafter the heavies stayed at their proper altitude.<sup>34</sup>

In April good weather over German industrial targets and Balkan rail centers allowed Strategic's heavies to devote most of their effort to POINTBLANK and to cooperation with the Russian armies. This resulted in two changes in the pattern of SAF's operations against Italian lines of communication. The emphasis was shifted from day attacks by heavies to night attacks by mediums, and from yards to ports. During the month heavies struck only three major blows against rail lines: on the 7th against yards on the Udine-Florence line, on the 20th against bridges at Fano and near Udine and the yards at Ancona, and on the 30th against very congested yards at Milan and Alessandria. Results everywhere were good. Meanwhile, Wellingtons operated against ports on almost half of the nights in the month; targets were San Stefano, Piombino, Leghorn, and to a lesser extent Genoa, Spezia, and Mal Falcone. Day attacks by Strategic on ports were few in number, but in-

cluded a major assault on 28 April when 168 heavies hit San Stefano with 418 tons, 108 hit Orbetello with 267 tons, and 188 hammered Piombino with 563 tons, the blow on Piombino being supplemented by 34 B-25's and 98 P-47's which dropped 100 tons. On the 29th, 573 heavies dropped 1,312 tons on Toulon harbor; the mission involved the largest number of bombers dispatched and the greatest weight of bombs dropped on a single target in the theater to date.<sup>35</sup> In the first eleven days of May bad weather so hampered Strategic that it flew only one heavy bomber mission against Italian communication targets, and that was largely spoiled by that same weather.<sup>36</sup>

A recapitulation of the Fifteenth's operations during STRANGLE shows that its heavies dropped more than 5,000 tons of bombs on communications. They hit ten major targets, damaging trackage, rolling stock, and installations and blocking—at least temporarily—most through lines. At Milan, in particular, the attacks were most successful. It is important to note, however, that Strategic's attacks on yards accomplished only a small reduction in the enemy's flow of supplies, for main through lines were quickly repaired or traffic was diverted to bypass lines. The truth is that it was the work of Tactical's mediums and fighter-bombers against bridges, rail lines, and M/T that made STRANGLE a success.<sup>37</sup>

Coastal Air Force rounded out the interdiction program by taking care of ports and coastal shipping. During the whole of STRANGLE it laid on around fifty attacks on nineteen ports; fighter-bombers delivered most of them. B-25's of the 310th Group added to the pressure during March, and Wellingtons and Beaufighters made it an around-the-clock offensive with night raids.<sup>38</sup> The latter type of operation assumed increasing importance as Tactical's successful interdiction of rail lines forced the enemy to put more dependence on transport by sea, especially in F-boats\* which moved mostly at night so as to take advantage of a principal Allied weakness, MAAF's lack of night bombers. For all of STRANGLE, Coastal claimed the sinking of more than 50 craft and the damaging of over 100 in the coastal stretches of the Ligurian and Tyrrhenian seas and along the coast of southern France. It was estimated that this offensive, together with Strategic's blows against ports, kept to less than 700 tons per day the amount of waterborne supplies reaching Italy. Equally important, these operations against ports contributed to Coastal's steady campaign against sub-

\* A shallow landing craft, about 120 feet long.

marines, which by the end of April had been pretty well eliminated as a threat in the Mediterranean.<sup>39</sup>

Coastal also paid some attention to land communications. It attacked motor convoys and hit rail targets. It made sixty-three attacks, most of them by the 350th Fighter Group, on bridges; nineteen structures were left impassable, fifteen were damaged, and eight had their approaches blown up. Meantime, 242 Group, which was the wholly British element of Coastal, carried out from its bases in eastern Italy a strong offensive which covered the Adriatic Sea from end to end.<sup>40</sup> 242 Group—as well as Troop Carrier, which was dropping supplies and personnel to Yugoslav Partisans—found useful a landing strip built on the Dalmatian island of Vis by engineers; as many as 120 planes were refueled in a day at this forward base. The extent of Coastal's operations is indicated by the fact that in March its several elements flew 3,500 sorties, and in April around 2,250; and that for the whole of STRANGLE it claimed the destruction of more than 100 motor vehicles, locomotives, and surface craft and the damaging of over 200.<sup>41</sup>

After the war Kesselring expressed the opinion that STRANGLE might have come closer to achieving absolute interdiction if MAAF had concentrated its attacks on certain key points.<sup>42</sup> The opinion is highly debatable, especially since the system which MAAF used certainly blocked the lines most effectively—just how effectively is demonstrated by the fact that before STRANGLE came to an end all rail lines as far north as the line Cecina-Fano were blocked and no through traffic approached closer than fifty miles above Rome.<sup>43</sup>

The accomplishment becomes the more impressive when it is remembered that as STRANGLE progressed the enemy made frantic and skilful efforts to repair his rail lines and to construct by-passes. He tried transshipping around breaks and shuttling trains over open segments of track, but neither scheme greatly improved his situation, for he was never quite able to keep up with the damage inflicted by MAAF's planes. Then he began to depend more and more on motor transport which he first used to "bridge" cuts in rail lines by carrying supplies from one train to another. When, in time, the strain on his repair facilities and the damage to his lines became so great that he had to abandon whole sections of track, he turned very largely to roads in order to move troops and supplies over long stretches. Well before the end of STRANGLE the rail lines were in such bad shape that most

movement below the Pisa-Rimini line was by motor transport alone, and a large part of that was over secondary roads.

As soon as the Germans began to shift from rails to roads Tactical's fighters and fighter-bombers, bombing and strafing, ripped into the enemy's motor transport. By 11 May they had destroyed an estimated 800 vehicles and damaged close to 1,000. Although the Germans supplemented their own M/T with several thousand requisitioned Italian vehicles (whose drivers proved to be distressingly unreliable), by the end of STRANGLE the destruction wrought by MAAF's planes, together with overuse and inadequate repairs, had taken such a heavy toll that the enemy's road transport was incapable of handling the demands of both the forward and rear zones of communication. Nor could he improve the situation by an increase in coastal shipping, for MAAF's attacks on ports and surface craft had reduced that type of transportation to an unimportant minimum.<sup>44</sup>

It is true that the enemy's shift of much of his transportation from rail to road in the month before the Allies renewed their ground offensive enabled him to maintain extensive lines of communication, but it is equally true that this was at the expense of local distribution immediately behind the front and at the cost of hundreds of vitally important motor vehicles. It could be expected, then, that when the Allies unleashed their ground offensive Kesselring would find himself unable to shift men and supplies into, out of, or along the battle front quickly enough to meet constantly and rapidly changing situations. Too, with the enemy depending so heavily on motor vehicles, MAAF could concentrate on roads during the ground offensive to the further discomfiture of a Wehrmacht which could not always wait until night to move.<sup>45</sup>

After the Allied armies launched their ground offensive in Operation DIADEM on 12 May and swept past Rome, the results of STRANGLE became a matter of record, and even before that many of them were evident. Up to the very end of STRANGLE, a static battle front permitted the enemy, by carefully husbanding his stores, obtaining food at the expense of the Italians, and moving in supplies under cover of darkness by whatever means, to retain and maintain all of his forces on the peninsula.<sup>46</sup> But the air attacks had so disrupted transport that the enemy was existing on fewer than 4,000 tons per day—which was 1,000 to 1,500 tons less than he would have to have during

an Allied ground offensive. With his lines cut and his transport crippled, it would not be possible to meet the full needs of a protracted battle. Already he lacked enough food and clothing. Motor fuel and some types of heavy ammunition were severely rationed, fuel being down to a ten-day supply. Military transport and heavy equipment were either in short supply or badly scattered, and the movement of supplies and reserves was exceedingly difficult. Units coming down from the north were forced to proceed by motor transport, horse-drawn vehicles, or on foot for long distances and were so often under air attack that they reached the battle area only after suffering heavy casualties, losing much of their equipment and vehicles, and being so dispersed that unit integrity was impossible. Many tanks, unable to get gasoline because of the shortage of transportation, had to be towed by oxen.<sup>47</sup>

For almost two months Tactical, Strategic, and Coastal had staged the largest program of interdiction of lines of communication ever attempted up to that time.\* The purpose of the program was to make it impossible for the Germans to stop an all-out Allied ground offensive. When STRANGLE came to an end on 11 May, such an offensive was ready to jump off. The effectiveness of the interdiction program was to be given an immediate test.

### *DIADEM and the Capture of Rome*

The decision to launch a full-scale ground offensive on 12 May† and to press the offensive beyond Rome had been made less than a month before D-day, and made then only after sharp disagreement between the Americans and the British. The basic reason for the difficulties over DIADEM was that all operations on the peninsula were tied up with the projected invasion of southern France (Operation ANVIL) which was to complement the cross-Channel invasion of France, currently scheduled for some time in May. In large measure the Anzio landings and the strenuous efforts to break through at Cassino had been for the

\* During STRANGLE (19 March–11 May) MAAF's operations against lines of communication, including ports, totaled about 50,000 effective sorties and around 26,000 tons of bombs. In all operations during the period its planes flew close to 65,000 effective sorties and dropped 33,000 tons of bombs. Of these the USAAF accounted for 36,000 sorties and 26,000 tons. (MAAF, Operations in Support of DIADEM, Vol. VII, Annex V.)

† Technically, DIADEM started at 2300 hours on 11 May, when the Allies began a forty-minute artillery barrage. But because the ground troops did not push off until the morning of the 12th this writer prefers that date for the beginning of the offensive.



purpose of clearing the way for ANVIL; their failure further complicated an already complex situation by giving the Fifth Army two fronts instead of one, tying down troops earmarked for ANVIL, increasing logistical problems, and adding to the burdens of the air force. By March these conditions demanded that plans for future operations in the Mediterranean be re-examined.

General Wilson, as has been noted above,\* had recommended in February that ANVIL be canceled, but Roosevelt, Churchill, Eisenhower, and the U.S. and British chiefs of staff had decided instead that it would stay on the planning agenda as first alternative to the Italian campaign at least until 20 March, at which time the situation in the Mediterranean would be reviewed.<sup>48</sup> By that date matters had not improved, and Wilson again pressed for cancellation of ANVIL, with the warning that there was no hope of a junction of the two Fifth Army fronts before 15 May, which would be too late by several weeks to permit ANVIL to be launched concurrently with OVERLORD. Wilson was supported by Eaker, who was afraid that ANVIL would take so many long-range fighters out of Italy that it would jeopardize the Fifteenth's strategic bomber offensive, and by Slessor, who "hated" ANVIL and preferred an offensive in the Balkans.<sup>49</sup> The British chiefs also agreed with Wilson. But the American chiefs insisted that ANVIL be deferred, not canceled; they proposed to start an offensive in Italy earlier than 15 May, unite the main front with Anzio, continue heavy pressure on the Germans in Italy, threaten southern France with an amphibious operation while OVERLORD was being launched, and then set the real ANVIL in motion not later than 10 July. Because of the need for an immediate decision, however, the Americans accepted an indefinite postponement of the invasion of southern France and agreed that the land battle in Italy should remain the mission of first priority.<sup>50</sup> On 18 April, General Wilson was given a directive to that effect and told to launch an all-out offensive in Italy as soon as possible for the purpose of giving maximum support to OVERLORD.<sup>51</sup>

Wilson already was well along with preparations for such an offensive, the most important of which involved moving the greater part of the Eighth Army into the Cassino sector alongside the Fifth Army as a preliminary to an assault from Cassino to the Tyrrhenian Sea. It was also decided that a part of DAF would operate in the west with XII Tactical Air Command (XII TAC, formerly XII Air Support Com-

\* See above, pp. 364-65.

mand), the latter to be responsible for coordination with the Fifth and Eighth Armies until the course of the land battle allowed the re-establishment of the old Fifth Army–XII TAC, Eighth Army–DAF combinations.<sup>52</sup>

The decision to launch *DIADEM* as soon as practicable caused no change in the activities of the air forces, which kept right on hitting lines of communication. By mid-April the success of *STRANGLE* had become so evident that clearly the best contribution which the air arm could make to the approaching ground offensive was to continue the program.<sup>53</sup> Accordingly, when the outline air plan for *DIADEM* was issued on 28 April, two of the three principal jobs given to the air forces were simply continuations of *STRANGLE*: to keep the GAF in its present state of ineffectiveness; to maintain the current interruption of supply lines and by increased activity so to reduce the supplies available to the enemy's forward troops that they could not possibly offer sustained resistance to the ground offensive. The third job, which would only begin with *DIADEM*, was to assist the land battle by normal close support. Tactical Air Force, which would bear the brunt of the air phase, would operate generally from the battle line to the Pisa-Rimini line, Strategic north of it; Coastal would attack shipping and ports. Later directives made no important changes in these basic assignments.<sup>54</sup>

Beginning at 2300 hours on the night of 11 May, the main Fifth Army and a part of the Eighth listened to a barrage from more than a thousand guns roll across the front from the Tyrrhenian Sea to Cassino.<sup>55</sup> Early on the 12th the ground troops jumped off along the narrow front. Polish troops drove into the ruins of the Abbey of Monte Cassino; the British and Canadians swept across the Rapido and into the Liri Valley; the French made spectacular gains across the Garigliano, breaching the Gustav Line; the Americans, on the Tyrrhenian flank, moved forward against stubborn resistance. By the 14th the enemy was in retreat, although slowly; by the 19th all of Cassino was in Allied hands and the Gustav Line was thoroughly broken, while along the coast the U.S. II Corps had taken Formia and Itri. On the 22d the British and the French broke the Hitler Line, and Kesselring went into full retreat.<sup>56</sup>

With nice timing, Fifth Army's VI Corps at Anzio launched an attack on the 23d against German forces stripped of reserves to support the southern front. Aided by more than 700 air sorties the troops

quickly broke out of the bridgehead, cutting Highway 7 below Cisterna. Next day, the town was virtually encircled. On the 25th it fell, and during the day patrols from Anzio and the main Fifth Army front linked up. Now Anzio was paying dividends. The German retreat threatened to become a rout.<sup>57</sup> With his established defense lines lost, his reserves fully but vainly committed, his transportation inadequate, and his forces under constant air attack, the enemy was faced with the delicate task of attempting a coordinated withdrawal on a fluid front. The task proved not only delicate but impossible.

By 1 June the Allies had captured Frosinone, Arce, Sora, and Carroceto. Kesselring now hoped to check the Allied advance at a hastily formed defensive line extending from Velletri to Valmontone, and General Alexander thought that his own forces might have to halt, rest, and regroup before the tired divisions of the Fifth and Eighth Armies could break through. But at this point the full impact of the air force's long interdiction campaign hit the Germans: their reserves of the two all-important commodities—fuel and ammunition—had fallen below the danger point and the state of their transport made adequate distribution from depots impossible; this, with the delays and disorganization imposed on reserve units by air attacks broke the enemy's back. The Americans quickly overran both Velletri and Valmontone, and early on the 4th seized Centocelle, just east of Rome. Farther to the east, British troops took Alatri, Indians took Veroli, and New Zealanders drove up Highway 82 toward Avezzano. On the evening of 4 June American troops entered Rome.<sup>58</sup>

For the first three days of this advance the combat elements of MAAF worked not only to maintain the destruction and disruption already caused to lines of communication but also directly to support the ground forces driving against the Gustav Line. MAAF's great superiority over the GAF—its almost 4,000 combat aircraft outnumbered the Luftwaffe in Italy by at least 10 to 1—allowed it to operate with almost complete freedom. On D-day, Strategic struck briefly but viciously at Kesselring's headquarters and the headquarters of his Tenth Army, then went for northerly yards and ports, hitting Spezia, San Stefano, Piombino, Civitavecchia, Trento, Bologna, and a dozen other targets in an assault which lasted through D plus 2. Results generally were good. Tactical's mediums\* and fighter-bombers pounded

\* Except for a few B-26's in the RAF's Desert Air Force all B-26's were flying from Sardinia, and all B-25's from Corsica. Both were given fighter escort by Tactical's 87th Fighter Wing (based on Corsica), which also attacked targets in western Italy south of Florence. Thus the Allies had a bomber and a fighter force operating off the

objectives close to the front: command posts, strongpoints, gun positions, concentrations, bridges, defiles, and towns. A major accomplishment was the creation of road blocks to restrict the enemy's mobility. Light and fighter-bombers worked in close coordination with the ground troops, their principal task being to silence the enemy's two main gun areas, in the Liri Valley and around Atina. Tac/rece squadrons, flying almost continuous patrols, kept the guns under constant observation. Fighter-bombers, operating directly with the ground forces, were aided materially by spotters (Rover Joes and Davids);\* one such element, atop Mt. Trocchio, controlled nine fighter-bomber missions on 12 May alone. Fighters patrolled the entire front but found the GAF little in evidence. For the three days MAAF's planes averaged 2,700 sorties per day.<sup>59</sup>

As soon as the ground troops were rolling (14 May and after) Tactical's mediums returned to operations which were simply a continuation of STRANGLE. Its B-25's raised their sights to rail lines between Spezia and Rimini; the B-26's did likewise, then shifted temporarily to road junctions, then returned to the railways. The most important lines in the Spezia-Rimini area were from Bologna to Florence and from Parma to Pisa. These were attacked and blocked by the end of the first week of DIADEM.<sup>60</sup> Below them the fighter-bombers of XII TAC and DAF reblocked lines which the enemy had repaired since the end of STRANGLE; by 20 May cuts were claimed at ninety-two points. Bad weather from the 20th to the 23d hindered the mediums, and in spite of all that they and elements of Strategic could do the Germans were able to reopen the Florence-Arezzo-Rome line as far south as Orte and to clear the Perugia-Spoleto by-pass. But on the 24th, a day which saw Tactical's planes set a new record of 1,791 sorties, B-25's reclosed the Florence-Orte line by cutting the Pontassieve bridge, and the next day blocked the line at eleven different points. By this time MAAF's three "specialist" groups of bridge-busting mediums (310th, 321st, 340th) were putting one direct hit on bridges for every twenty sorties.<sup>61</sup>

During the last week of May the mediums divided their attention

---

enemy's right flank. (See 87th Ftr. Wing Historical Records, in MATAF Operations Record Book, 1944, pp. 16-19, 21, 23, and History, 57th Bomb. Wing.)

\* Rover Joes (U.S.) and Rover Davids (British) were spotters who used a jeep equipped with a VHF set which put them in communication with aircraft, airdromes, or air headquarters and with ground troops; operating from an observation post overlooking the battle area they coordinated air-ground operations.

between targets just below Rome and objectives on the west-coast, east-coast, and northern Apennine rail routes as well as the more immediately important lines in central Italy. Their work south of Rome helped to make an enemy stand impossible, while above that city on 1 June, in spite of excellent repair work by the Germans, there were 124 cuts (47 of them major bridge cuts), which was the highest point of interdiction yet achieved.\* For a time, only one route was open between the Po Valley and central Italy. By the end of May the enemy had abandoned large sections of lines and was concentrating his repairs on a few key segments, notably the main lines Chiusi-Florence-Bologna and Foligno-Fano-Rimini-Bologna, which had both a supply and an escape value. Nonetheless, in the first week of June, MAAF maintained the interdiction of the western and central sectors. All lines in the central area were thoroughly blocked, except for the line Florence-Terontola-Orvieto, where single-line traffic was possible. On the east coast, where lines were less heavily attacked, the enemy was able to effect repairs which kept rail traffic moving at least as far south as Rimini.<sup>62</sup>

In the first week of *DIADEM* light and fighter-bombers had worked mostly against close-in targets such as command posts, strongpoints, guns, and troop concentrations. In the second week, as the Anzio and southern front forces approached one another, intensive and effective air-ground coordination was achieved.<sup>63</sup> When the two fronts were joined the light bombers went back to dumps while the fighter-bombers began the armed reconnaissance missions which were to be their principal type of operation for the next several weeks. Mostly, the fighter-bombers sought targets of opportunity, which turned out to be motor transport and troop concentrations on the congested roads, for targets such as supply dumps, command posts, and strongpoints became scarce as Allied ground troops overran German positions and kept the enemy in constant retreat. Fighter-bomber attacks on roads, rails, and bridges powerfully implemented the medium's interdiction program. The planes gave Kesselring's reserves, moving down from the north, a severe mauling; in fact, as Slessor later pointed out, the inability of the Germans to establish the so-called "mass of reserves or to coordinate

\* An analysis by MAAF's Operational Research Section of medium and fighter-bomber attacks on railways between 17 March and 31 May revealed that pilots' reports of damage were usually too low in comparison with reports from the Italian state railways, Partisans, and photo interpretation.

divisional counter-attacks, both of which are so vital to the halting of an offensive," was the result of the Allies' destructive air attacks. Occasionally, elements of XII TAC and DAF were called on to assist in breaking up some particularly stubborn bit of resistance or in checking a local counterattack; and before each major ground attack, aircraft destroyed the enemy's system of control by bombing headquarters and also restricted his power of movement close to the battle area by attacking signals systems, command posts, communications, dumps, vehicle parks, and repair shops.<sup>64</sup> Cooperation between ground and tactical air forces was excellent. Mediterranean Allied Photographic Reconnaissance Wing (MAPRW) further aided the ground forces by flying in the first week of DIADEM around 160 direct cooperation sorties, half of them at the request of the ground troops, a scale of operation which was maintained throughout the next several weeks.<sup>65</sup>

After the first few days of DIADEM, Strategic's participation in the Italian campaign dropped off sharply as it returned to its primary objectives: POINTBLANK targets around Vienna, oil and communications in the Balkans, and support of Yugoslav Partisans. However, up to the fall of Rome, it aided Tactical's campaign against supply lines by a few attacks on yards between Piacenza and Bologna and Faenza and Cesena, and on the trans-Alpine supply routes, particularly the Brenner Pass line. These attacks, which were closely coordinated with the operations of Tactical in central Italy, resulted in cutting the two main lines into northeast Italy: B-17's cut the Brenner Pass line; Wellingtons cut the Tarvisio line, and when the enemy partially repaired it the 483d Bombardment Group's B-17's promptly recut it by knocking out two spans of the Casarsa bridge. In addition, two attacks on Spezia and two on Porto Marghera damaged both communications and oil tanks, while sharp blows on the night of 16/17 May by Wellingtons and on the 17th by B-24's of the 98th, 376th, 450th, 451st, 460th, 461st, 464th, 465th, 484th, and 485th Bombardment Groups laid heavy destruction on Piombino, San Stefano, and Porto Ferrario (Elba) harbors.<sup>66</sup>

Strategic also flew two special sets of missions on behalf of the ground offensive. From the 22d to the 26th of May as VI Corps broke out of Anzio, Strategic devoted most of its effort to troop movements, communications, and other military targets in the rear of the battle area and in central Italy.<sup>67</sup> On 25 May, when heavies hit three yards in the Lyon area and one at Toulon, Strategic began a series of attacks on lines of communication in southern France. On the 26th and 27th the Fifteenth, with every bombardment group participating, dropped more

than 3,000 tons of bombs on eight yards (and two airfields) between Lyon and Marseille. Then on 4, 5, and 7 June a total of 1,400 heavies with plentiful escort hit the Antheor viaduct near Nice, the Var River bridges north of that city, the Recco and Vado viaducts south and west of Genoa, yards at Genoa, Bologna, Turin, Forli, and Novi Ligure, port facilities and shipping at Genoa, Voltri, and Leghorn, and other communications targets. Damage was severe to the viaducts and bridges and to the yards at Genoa and Bologna and effective, although moderate, elsewhere except at Antheor. The attacks between Lyon and Leghorn were for the purpose of interfering with the movement of reinforcements from southern France to Italy; at the same time they were an important part of the Allied preparations for OVERLORD<sup>68</sup> and, in the long-range view, were preliminary to ANVIL.

Although Tactical carried the brunt of the interdiction and support programs, it received strong assistance from Coastal Air Force. Coastal's primary responsibility was to protect the sea lanes from Gibraltar to Greece, but MAAF's bombing of submarines and facilities had so reduced the German threat to Allied shipping by the beginning of DIADEM that CAF was able to devote a very large part of its activities to offensive operations over the Italian mainland and to the enemy's effort to supply his troops by sea. The 63d Fighter Wing (USAAF, but including units of RAF, SAAF, RAAF, and FAF), flying from Corsica, hit shipping in the Ligurian and Tyrrhenian seas, the western Mediterranean, and along the coasts of western Italy and southern France; over the Italian mainland it attacked installations, dumps, docks, warehouses, yards, gun positions, radar stations, headquarters, bridges, trains, airfields, factories, motor transport, and other targets. Its British counterpart, RAF 242 Group, based in eastern Italy, hit similar targets along both sides of the Adriatic; it also aided Tito's Partisans until July when a special air force\* took over that responsibility.<sup>69</sup>

During the advance on Rome, Troop Carrier's principal job was the evacuation of wounded. Its only offensive mission in DIADEM was to fly one small paratroop mission (Operation HASTY), in which eleven aircraft dropped sixty-one paratroopers near Trasacco on the night of 1 June. The drop was successful but the troops were unable to accomplish their objective of preventing the destruction of bridges on the Sora-Avezzano road by the fleeing Germans.<sup>70</sup>

The tasks of carrying out the interdiction program and of cooperat-

\* See below, p. 399.

ing with the ground advance from 11 May to 4 June were made infinitely easier by the weakness of the German Air Force. There were only about 325 enemy aircraft in central and northern Italy at the beginning of *DIADEM*, as contrasted with close to 4,000 Allied planes in the Mediterranean.<sup>71</sup> Obviously the Luftwaffe could not pose much of a threat either to Allied ground troops or to mediums and fighter-bombers flying against communications. Nevertheless, MAAF played safe by occasionally blasting airfields. On 14 May the 99th, 463d, 456th, and 459th Bombardment Groups, escorted by P-51's of the 31st Fighter Group, dropped 368 tons on Piacenza airfield and 135 tons on Reggio Emilia. These were the only large-scale counter-air attacks against Italian bases until July, although many forward fields as well as some farther north were targets for bombing and strafing attacks, mostly by fighter-bombers.<sup>72</sup> Outside of Italy the largest collection of GAF offensive planes within reach of the battlefield and Allied convoys was in southern France, where the enemy had an estimated 210 planes, 155 of which were long-range bombers. On 27 May, primarily as a diversion for *OVERLORD*, 246 B-24's mauled Montpellier/Frejorgues and Salon airfields with 515 tons. This was the only significant attack on French landing grounds until after the fall of Rome.<sup>73</sup> Nor were more attacks necessary, for the GAF effort over Italy never reached 200 sorties a day throughout *DIADEM*, and averaged scarcely more than 50.<sup>74</sup> The enemy's outstanding bomber operation came on the night of 12/13 May when Ju-88's hit the Corsican fields of Poretta and Alesan in a powerful and effective double attack, destroying twenty-three planes and damaging close to ninety and killing more than a score of personnel. Even so, B-25's of the badly injured 340th Bombardment Group at Alesan flew a mission the day after the attack. Other GAF offensive operations consisted of a single raid on a convoy off Algiers, a few weak and ineffective passes at Allied bases (such as Naples), some small raids on communication points, and one or two attacks during the first week of *DIADEM* by Ju-88's on ground targets around Minturno—the first time the enemy had used such planes in direct support of his troops. Targets included road movement, concentrations, and communications centers. For a time the night-flying Ju-88's continued this limited aid to the ground forces, but early in June they were withdrawn for use in France. Their place was taken by some forty shorter-range Ju-87's, whose activities steadily diminished in the face of losses inflicted by Allied night fighters and AA. Both the Ju-88's



and 87's worked on such a small scale that they accomplished little.<sup>75</sup>

German fighters made little effort to interfere with the activities of MAAF's medium and light bombers, fighters, and fighter-bombers. Even Strategic's heavies saw few fighters over northern Italy and those which did appear were remarkably lacking in aggressiveness. On the eve of the fall of Rome the GAF had begun to withdraw its planes to fields around Perugia, Siena, and Pistoia, and its fighters had all but disappeared from the battle area by day.<sup>76</sup> As a result, MAAF's claim of enemy aircraft destroyed rarely exceeded five in any one day, and totaled only 176 claimed destroyed, 44 probably destroyed, and 93 damaged for the period 12 May–22 June. Against these small losses, MAAF lost 438 planes, virtually all of them to flak, as the enemy concentrated his AA guns at key points on his lines of communication.<sup>77</sup> Actually, MAAF's losses in terms of sorties was small. In the first week of *DIADEM*, for example, it dispatched around 20,500 aircraft. From the beginning of *STRANGLE* to 22 June its planes flew some 137,000 sorties and dropped around 84,000 tons of bombs in all types of operations, better than two-thirds of its effort being against lines of communications and ports in Italy. Since the first of May the Fifteenth, although only about one-half the size of the Eighth in heavy bomber strength, had almost equaled the latter in number of sorties and bomb tonnage.<sup>78</sup>

The weakness of the GAF, together with MAAF's counter-air operations, gave the Allies real air supremacy during the drive on Rome. Troops, supplies, even headquarters, moved with complete freedom—a matter of the greatest importance in the fast-moving campaign. Headquarters of Tactical, for example, was at Caserta on 11 May, moved to Frascati around 15 June, and at the end of the month was at Lake Bolsena. Headquarters of XII TAC, within a 30-day period, was successively at San Marco, Sermoneta, Rome, and Orbetello.<sup>79</sup> Combat air units also moved steadily northward, thanks to the rapidity and skill with which new airfields were made available. Only a few of the fields captured from the enemy met the operational requirements of Tactical's planes—as late as July only two such fields were being used and they had undergone alterations—and, in addition, all were badly damaged, so that the only answer to the demand of the fighters and fighter-bombers for more northerly fields was to build new ones. On an average the engineers built a field in five days. Many were constructed within range of enemy guns; on one occasion an engineer survey party

actually got ahead of the infantry, was captured by Fifth Army troops and was held prisoner for a time, it being difficult to persuade the ground troops that anything could get ahead of them.<sup>80</sup>

While the Allies moved with complete freedom, every move of the enemy was made with the keenest difficulty and usually was attended with severe losses. This was especially true after 24 May. Then, with the enemy's rail lines in such bad shape that he was forced to depend almost wholly on M/T and with his ground forces so close to disaster that he could not wait for darkness to move them, Allied bombers created road blocks which forced traffic jams; fighters and fighter-bombers blasted the jams with bombs, cannon, and machine guns.<sup>81</sup> Allied armies in Italy noted after the fall of Rome that the success of the air attacks on transport "is now obvious from the wreckage to be seen all along the road"; yet so great was the destruction that the airmen's reports of vehicles and equipment destroyed would not have been credited had not their claims frequently been confirmed by ground force survey parties. For example, the air force claimed the destruction of 117 motor transport and armored vehicles on a short stretch of road near Forlì; the ground forces counted 122 blown up or burned out by air attacks.<sup>82</sup> In three days (4, 5, 6 June), as the Germans took wholly to roads in a desperate effort to escape to the Pisa-Rimini line, almost 1,100 vehicles were destroyed and more than 1,100 damaged.<sup>83</sup> Thereafter, the toll of motor transport fell off rapidly; the enemy simply had lost so many of his M/T that very few were left to serve as targets. By the end of DIADEM (22 June) the air forces claimed to have destroyed more than 5,000 vehicles and damaged another 5,000 in the six weeks since 12 May.<sup>84</sup>

In April, General Eaker had predicted that the interdiction campaign would so weaken the enemy that when the ground forces struck they would simply "be following a German withdrawal made necessary by his inadequate supply."<sup>85</sup> Events had proved that there was much truth in his prediction, although it cannot be forgotten that when the Allied armies did strike it was on such a narrow front and with such superior strength that it is doubtful if the Germans could have prevented a breakthrough. But it is certain that the collapse of enemy transport, especially the breakdown of local distribution immediately behind the front, greatly accelerated the Allied breakthrough as well as the pace of the advance on Rome which followed, a fact which the ground forces fully recognized and appreciated.<sup>86</sup> As the Allies swept

into and then beyond Rome, it was evident that the enemy's front line troops were seriously short of fuel, ammunition, clothing, food, and M/T. So much of his M/T was committed to the haul of supplies south from the Po Valley and Florence that not enough remained to take care of the needs of his forward troops; nor could Kesselring move his troops—or bring in reinforcements—with the speed and certainty which the battle demanded. Local shortages, of men as well as supplies, became common, and when the Germans, in a desperate effort to relieve the situation, put their M/T on the roads during daylight, MATAF's fighter-bombers simply made the enemy's transportation problem the more critical.<sup>87</sup>

DIADEM did not end officially until 22 June, but as early as the 4th of the month (when Rome fell) it was possible to draw several conclusions from the air phase of the operation and its predecessor, STRANGLE. The first point to note is that the ultimate objective of STRANGLE, which was to make it impossible for the enemy to maintain his armies south of Rome, could not be achieved until the Allied armies in Italy forced him into a real battle. As Slessor put it, air power "can not by itself enforce a withdrawal by drying up the flow of essential supplies" when the enemy "is not being forced to expend ammunition, fuel, vehicles, engineer stores, etc. at a high rate."<sup>88</sup> But as soon as the Germans were involved in a major fight it was immediately evident that STRANGLE had fully accomplished its purpose: the interdiction of supplies, the cutting of rail lines, and the destruction of motor vehicles had so crippled the enemy that he speedily used up his stores and motor transport, lost his mobility, and had no choice but to retreat. The effects of STRANGLE then turned an orderly withdrawal into a rout. The second point is that bombing policy against lines of communication must not be oversimplified. Zuckerman was wrong when he limited targets to one type, rail centers; but MATAF would have been equally wrong had it attacked bridges to the exclusion of everything else. Sound bombing policy calls for a balanced program of attacks, with emphasis at any one time to be dictated by geographic, economic, and military considerations.

Two other points are worth mentioning. When the ground forces are rolling and when they are encountering no effective enemy air opposition, it is best for their own tactical air force to concentrate on the enemy's supply lines rather than on close support of ground operations. DIADEM also proved again the principle which had been dem-

onstrated repeatedly during the past year—that tactical air operations are most effective when air and ground are coequal partners, neither dominated by the other but both working toward a common objective.<sup>89</sup>

*From Rome to the Arno*

Prior to the capture of Rome the Fifth and Eighth Armies had advanced along a narrow front, roughly from the west coast to Highway 6, while 5 Corps of Eighth Army had moved up the east coast. After the fall of Rome the Fifth Army moved north-northwest along the axis Rome-Viterbo-Siena, with its principal objectives the Viterbo airfields, the ports of Civitavecchia and Leghorn, and the Arno River; the Eighth advanced northeast along the line Rome-Terni-Foligno-Perugia, with its main objective the city of Florence, while its 5 Corps continued up the east coast, ultimately rejoining the main Eighth.<sup>90</sup> Hence, in the second phase of the drive from the Gustav to the Gothic line the main battle front expanded laterally so that the operational areas of the Fifth and Eighth became distinct and separate. It then was more efficient to divide operational control of the units of Tactical Air Force between two commanders, each responsible for air operations in support of a separate army. Under this arrangement XII TAC again became responsible for operations with the Fifth Army and Desert Air Force for the Eighth and its 5 Corps.\* The operational boundary separating the two air forces was identical with the boundary between the two armies, and each of the air organizations set up its headquarters in close proximity to that of the army with which it was working. But XII TAC and DAF maintained close liaison, and each was prepared to support the other when the situation demanded and resources permitted.<sup>91</sup>

The division of responsibility between XII TAC and DAF was concerned primarily with direct tactical operations by fighters and fighter-bombers. But since the first duty of all elements was to impede the enemy in his efforts to escape the Allied armies, they not only worked closely with the two armies but also with MATAF's mediums which, while hampering the German withdrawal, were primarily concerned with disrupting communications in the general area above Pisa-Arezzo-Fano.<sup>92</sup> From 4 to 17 June, while the ground forces drove beyond

\* The 87th Fighter Wing was to attack sea communications along the Italian west coast and communications above the Pisa-Rimini line; DAF was to take care of sea communications on the east coast.

Rome toward Viterbo and Rieti, Tactical's planes kept interdiction in a very satisfactory condition. On the 15th, for example, there were seventy-eight effective rail blocks. All lines between the Po Valley and Florence were blocked, while the east-coast route was cut at three points. The very important Florence-Orte and Empoli-Siena lines, in spite of strenuous German efforts to repair them, were kept blocked by mediums and fighter-bombers. As a result of the continuing interdiction Kesselring's forces found themselves increasingly short of supplies, especially fuel and transport.<sup>93</sup> Then ten days of bad weather from 17 to 28 June so interfered with Tactical's operations—its planes flew only 175 to 200 sorties on the 18th—that the enemy was able to open the Bologna-Pistoia and Bologna-Prato lines. However, the other central Italian routes and the east- and west-coast routes remained cut to the end of the month so that the enemy was unable materially to improve his wretched supply situation.<sup>94</sup>

Strategic, which on 2 June had made history by inaugurating shuttle bombing via Russian bases,\* concerned itself very little with Italy in the two weeks following the fall of Rome. The ten days of bad weather at the end of the month grounded its planes even more thoroughly than Tactical's, so that it was able to operate only on two days. But on one of them it struck a mighty blow against Italian lines of communication. The enemy was taking full advantage of the weather to rush repairs on his battered lines, and Strategic's blow came at the right time. On the night of 21/22 June, 55 Wellingtons, 8 Halifaxes, and 2 Liberators hit the Ventimiglia yards with excellent results. Next day 580 heavies, protected by 513 fighters, dropped close to 1,400 tons of bombs on yards at Parma, Modena, Bologna, Ferrara, Castel Maggiore, and Fornova di Taro, rail and road bridges at Neversa della Battiaglia and Rimini, the Turin motor transport works, and the Chivasso motor transport depot. The bombing ranged from good to excellent. After this operation, and with the return of good flying weather at the end of June, Strategic, now at full fighting strength with 21 heavy bombardment groups, 7 fighter groups, 1,957 aircraft, and 81,000 personnel, turned its attention so fully to the Combined Bomber Offensive that its activities over Italian targets consisted only of an occasional mission when weather precluded operations elsewhere.<sup>95</sup>

Strategic was not the only air organization operating outside of Italy.

\* See above, p. 312.

FIFTEENTH AIR FORCE  
15 JUNE 1944

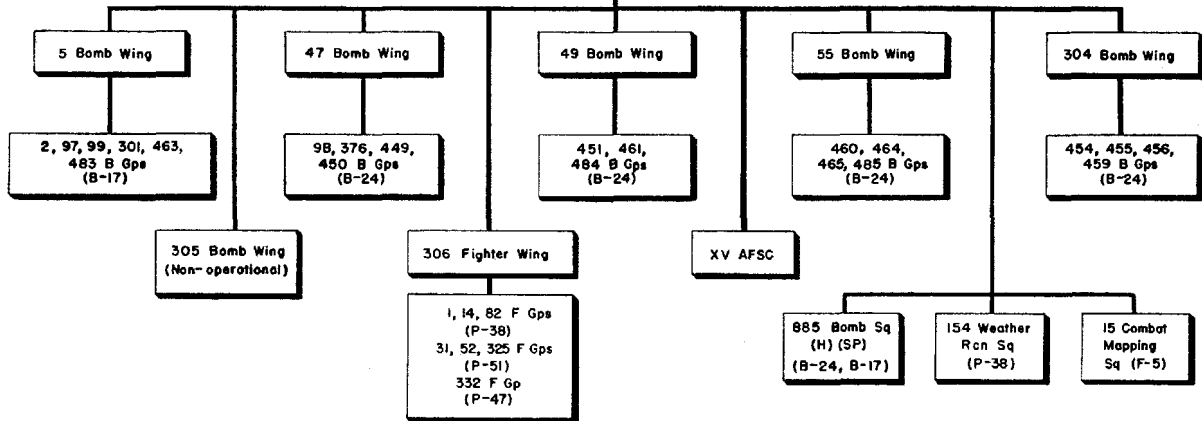

During the winter and spring of 1944 the Allies had added to their strategic bombing of oil refineries at Ploesti, fighter factories in Austria, and rail centers at Sofia and elsewhere, a steadily growing support of Marshal Tito and his Yugoslav Partisans. This latter activity, which had begun in the fall of 1943,\* had involved air attacks by Tactical and Coastal against shipping and ports on the Adriatic, marshalling yards in and beyond Yugoslavia, airfields, transport, warehouses, dumps, camps, headquarters, and RDF stations, as well as the delivery of thousands of tons of supplies. The increasing importance of such operations led to the establishment on 4 June of the Balkan Air Force (BAF), consisting of two offensive fighter wings, a light bomber wing, and a Special Operations Wing. The units, taken largely from Coastal's 242 Group and Tactical's Desert Air Force, were mostly RAF, but there were several USAAF elements (always on detached service from Troop Carrier), a number of Italian Air Force units, a Yugoslav squadron, a Greek squadron, and a Polish flight. They brought with them a wide assortment of planes, including P-39's, P-51's, Spitfires, Baltimores, Halifaxes, Macchis, C-47's, and Hurricanes. The new air force was allotted six airfields in eastern Italy and the landing ground and fighter control on the island of Vis, off the Dalmatian coast.<sup>96</sup>

When BAF, under Air Vice Marshal W. Elliot, became fully operational early in July, it took over all of MAAF's activities across the Adriatic except strategic bombardment, air-sea rescue, and sea reconnaissance.† During the month, it increased activities over the Balkans to almost 2,400 sorties. Its principal targets were rail traffic on the Zagreb-Belgrade-Skopje and Brod-Sarajevo-Mostar routes (where it claimed the destruction of more than 250 locomotives), steel and chrome works, repair shops, river craft on the Danube, and shipping on the Adriatic. The dropping of supplies and the evacuation of wounded Partisans and women and children also were stepped up.<sup>97</sup>

Just as the Fifth Army reached and passed Grosseto and the Eighth took Foligno (16-19 June) the Allies swung wide to seize the island of Elba. The operation (coded BRASSARD) was originally scheduled to take place soon after 25 May, with the French supplying the invading forces, but preoccupation with DIADEM pushed it into the

\* See below, pp. 472-77.

† AOC, BAF, in addition to being responsible (under the air C-in-C, MAAF) for air operations over the Balkans, was charged with coordinating the planning and execution of trans-Adriatic operations by air, sea, and ground forces.

background, and command difficulties with the French soon caused the project to be postponed. On 12 June, General Alexander urged that it be canceled, on the ground that it could serve no useful purpose in view of the rapidity of the German retreat north of Rome. This reasonable opinion did not suit the French, and AFHQ agreed that the invasion should take place on the 17th.<sup>98</sup>

BRASSARD involved an amphibious assault by French troops, with Tactical's 87th Fighter Wing providing air cooperation, Coastal protecting the convoys and (at night) the assault troops, and the Royal Navy furnishing landing craft, escort vessels, and mine sweepers. In order not to jeopardize surprise there was no pre-assault air bombardment, although on the night of 16/17 June twenty-six Wellingtons softened up Porto Ferraio and Porto Longone.<sup>99</sup> At first light on the 17th the French went ashore. Resistance was stubborn but Porto Ferraio fell on the 18th and twin drives into the northeastern part of the island completed the conquest on the 19th. Tactical's 87th Wing took care of the air phase of the operation without having to call on the mediums of the 57th Wing—a contingency which had been provided for. Twenty-four dive-bombing and fifty-eight patrol missions were flown, in the course of which ten barges and twelve motor vehicles were destroyed, two ships sunk and nineteen damaged, and two heavy guns silenced. The GAF failed to put in an appearance. On 20 June the 87th stepped out of the picture and Coastal's 63d Fighter Wing assumed responsibility for the defense of the island.<sup>100</sup> BRASSARD really was an unnecessary operation—the advance of the Fifth Army beyond Grosseto made Elba untenable—but it boosted French morale, which probably made it worth while.

The beginning of the period of bad weather near the end of June which so handicapped the air forces also marked a break in the steady sweep of the Allied ground forces toward the Arno River and the cities of Pisa, Florence, and Ancona. Between the fall of Rome and 20 June the Fifth Army had added Civitavecchia, Grosseto, and the Viterbo airfields to its bag; the French, on Fifth Army's right, had reached the south bank of the Orcia River; in the center, the Eighth was at the line Lake Trasimeno—Chiusi and farther east was above Perugia; on the Adriatic coast Pedaso had fallen.<sup>101</sup> By the 20th, Kesselring, considering the Allied threat to his center as the most dangerous one, had managed to draw up hastily formed defense lines in that sector; he also had contrived to restore some semblance of order to his forces farther to



the west; in both areas his troops offered the strongest resistance since the first week of *DIADEM* a month before. Temporarily, but only temporarily, he checked the Allied advance, the delay coinciding with the onset of the period of bad weather.<sup>102</sup>

The Allies promptly lashed back. The Fifth Army took Piombino on 25 June and occupied the strongpoints of Cecina and Cecina Marina on 1 and 2 July; the French were in Siena on 3 July, and the British were within a few miles of Arezzo. For the next month, in spite of stubborn resistance and extensive use of demolitions by the enemy, the Allied ground troops pushed steadily toward the Arno. Leghorn fell on 18/19 July, Pontedera on the 18th, and that portion of Pisa south of the Arno on the 23d. The going was slower in the center, where the terrain was tougher and where the Eighth Army had to take over the French sector when the French troops were withdrawn on 22 July for reassignment to the Seventh Army and *ANVIL*, but by 4 August Eighth Army units had occupied the southern half of Florence. On the Adriatic, Polish and Italian troops were south of Ancona. Thus, by early August the battle line ran along the south bank of the Arno from Pisa to just east of Florence, thence southeast to a few miles above Perugia, and from there to above Ancona. For the next two weeks there was little fighting while the Allies prepared to renew the assault with the object of crossing the Arno and driving into the Pisa-Rimini line (officially the Gothic Line), twenty miles to the north at its closest point.<sup>103</sup>

Tactical's fighters and fighter-bombers moved forward almost as rapidly as did the ground forces—thanks to the aviation engineers who fixed up advance bases and to Troop Carrier which flew in personnel and supplies.\* Thus the planes were enabled to cooperate closely with the ground forces during the period from 20 June to the first week of August. Even during the ten days of bad weather at the end of June they were fairly active against transport and gun positions as well as against rail and road communications close to the enemy's rear, where they cut or damaged several bridges, notably at Cattalia and Fano, blocked rail tracks, hit a tunnel six times, and bombed dumps. Night bombers hit the harbor and shipping at Ancona, Rimini, and Senigallia, on the east coast, and roads in the Arezzo, Pistoia, Bologna, and Prato areas.<sup>104</sup> When the weather cleared the efforts were increased—the

\* General Clark also credits Troop Carrier with the evacuation of some 8,000 ground force casualties during the advance to the Arno. (Clark, *Calculated Risk*, p. 378.)

night-flying light bombers, for example, in spite of a limited force put in over 300 sorties during the first week of July—but there was a shift in emphasis. Military transport targets had about disappeared, partly because so many had been destroyed and partly because the vehicles were hard to find in the hills south of the Arno, so the fighters and fighter-bombers went for lines of communication, ranging as far north as the Po Valley in missions against rails, bridges, yards, roads, and trains in the Pisa-Rimini sector, Cremona-Bologna area, and Spezia-Parma-Florence-Leghorn rectangle. XII TAC's effort was down considerably, however, from what it had been in the *DIADEM* period, not only because of the weather but because of the loan of the 79th Fighter Group to DAF and the return to that air force of two of the RAF wings which XII TAC had borrowed earlier in the year.<sup>105</sup>

Beginning with the second week of July, XII TAC and DAF switched the main part of their offensive from rearward communications to the battle area. In the six days prior to the Eighth Army's entrance into Arezzo (16 July) Kittyhawks and Mustangs flew around 900 sorties against gun positions and troop concentrations in front of the Eighth. Baltimores, Marauders, and Spitbombers added to this assault, while Spitfires directed a strong effort against roads and supply dumps close to the battle line. Night bombers continued armed reconnaissance of rear areas, attacking roads, strongpoints, and harbors.<sup>106</sup>

By 18 July, XII TAC had moved its units to Corsica,<sup>107</sup> from where it was to participate in the invasion of southern France (formerly Operation *ANVIL*, now Operation *DRAGOON*) which again had been set, this time definitely and for mid-August. The move left DAF with the job of cooperating with both the Fifth and Eighth Armies, although for the next two weeks XII TAC, flying from its new bases, operated almost entirely over the western half of Italy north of DAF's target area, which allowed DAF to concentrate on the battle area during the period of hard fighting from 20 July to 4 August in which the Allies reached the line of the Arno.<sup>108</sup>

DAF met its commitment, even though it was operating with only thirteen squadrons of fighters and fighter-bombers, four of mediums, two of light bombers, and one of night fighters.<sup>109</sup> The impotence of the Luftwaffe in Italy helped, for it allowed DAF to devote only a small part of its effort to defensive patrols. Its principal fighter and fighter-bomber targets were close to the battle front: gun positions, observation posts, assembly areas, and communications. Its medium and

light bombers went for yards, shipping, supply centers, and, on a few occasions, airfields.<sup>110</sup>

During July, Tactical operated under a new directive which authorized it to attack targets, especially bridges, between the Apennines and the Po River. These operations were assigned to TAF rather than SAF because the heavies were fully occupied with targets in Germany, the Balkans (especially Ploesti), and southern France, as well as because XII TAC from its bases in Corsica could operate to, and even beyond, the Apennines.<sup>111</sup> In the first week of July the mediums hit viaducts at Piteccio, Ronta, and between Florence and Faenza, bridges at Villafranca, Pontremoli, and on the Pistoia-Bologna, Parma-Spezia, and Bologna-Prato lines, cut at least three rail bridges north of Florence, successfully attacked the Lugo and Imola yards, cut the tracks on the Spezia-Pisa line at Pietrasanta, blocked the tracks and tunnel at Caneto, and hit the lines between Parma and Piacenza.<sup>112</sup>

The second week of July marked the beginning of a sustained offensive against the Po River bridges by mediums of the 42d and 57th Bombardment Wings. For some time it had been apparent that, despite the damage inflicted on his rail lines, the enemy still would have access to all places of importance on his Gothic Line unless certain key bridges across the Po were cut.\* Air leaders had been urging this program for almost a month, having come to the conclusion that the destruction of six railway bridges across the Po and one across the River Trebbia at Piacenza, together with the viaduct at Recco on the west coast, would stop all rail traffic from Germany, Austria, and France into the area south of the river and east of a line from Genoa to Florence.<sup>113</sup> Plans for the operation (coded MALLORY) were ready on 17 June, but bad weather first stopped the operation and then the plan was dropped because General Alexander and his ground leaders hoped for a quick breakthrough of the Pisa-Rimini line and a sweep up to the Po, in which event his troops might seize some of the bridges intact.<sup>114</sup> The air leaders did not believe that a breakthrough was possible within a measurable period of time unless the enemy's supply lines were fully interdicted—which meant that the bridges must be knocked out. By the second week of July, following the decision to invade southern France

\* The Germans fully appreciated the importance of the Po bridges. Generalmajor Karl Koerner, chief of transportation, said that if the Allies had attacked the Brenner Pass and the Po bridges in 1943 as steadily as they did after mid-1944, "German resistance in Italy would have collapsed." (Karl Koerner, *Rail Transportation Problems in Italy*, 8 Apr. 1947.)

with troops from Italy, it became obvious that the ground forces could not achieve a quick breakthrough. Whereupon MALLORY was revived, re-coded MALLORY MAJOR, and put into effect.<sup>115</sup>

The final plan called for the destruction of five rail bridges, two rail and road bridges, and fourteen road bridges over the Po between Piacenza and the Adriatic, the destruction of the rail and road bridges over the Trebbia between Piacenza and Genoa, and the continuation of the interdiction of rail and road bridges between Spezia and Genoa which had been constructed as the result of the destruction of viaducts at Recco, Zoagli, and Bogliasco. Half of the bridges were of permanent construction; the remainder were pontoons. The actual job of knocking them out was assigned to Tactical's mediums, while its fighter-bombers were to prevent repairs and to destroy reserve pontoons.<sup>116</sup>

The mediums went into action on 12 July. Flying conditions were ideal, and an average of almost 300 sorties was flown each day against the twenty-one bridges east of Piacenza. Although half of the bridges were of steel or concrete and were the strongest and heaviest in Italy,<sup>117</sup> the mediums achieved an amazing degree of success. At the end of two days, one bridge was completely destroyed, three were at least one-half destroyed, and seven others were impassable. At the end of the fourth day, twelve bridges were either totally destroyed or had gaps in them more than 500 feet long; eight were cut, blocked, or otherwise so damaged that they were closed to traffic; only one, a reinforced concrete and steel structure at Ostiglia on the Bologna-Verona line, was open (in spite of four attacks), but the line itself was cut at a second bridge a little south of the Po. From Piacenza eastward all north-south through rail traffic was stopped.<sup>118</sup>

MALLORY MAJOR as such was limited to the attacks during the four days of 12-15 July. But Tactical immediately expanded the scope of its medium bomber operations in an effort to interdict completely all north-south traffic by cutting the Po bridges west of Piacenza and to paralyze east-west traffic by cutting a number of key bridges throughout the Po Valley. On the 16th mediums knocked out three arches of the Bressana bridge and put a 600-foot gap in the bridge at Torreberetti, and on the 17th they left the Monferrato bridge unserviceable; these blows interdicted southbound rail traffic from Milan. Concurrently, B-25's and B-26's interrupted east-west rail connections north of the Po by destroying the bridge at Bozzolo on the Cremona-Mantova line and cutting the viaducts at Brescia, and disrupted lateral traffic

south of the river by cutting bridges at Sassuolo and Piacenza and four bridges between Piacenza and Turin. As of 20 July the bridge-busting program had brought to ninety the number of cuts in rail lines in northern Italy.<sup>119</sup>

Continuous interdiction required close observation and frequent return visits. The mediums therefore continued to bomb the primary bridges. After 26 July all rail bridges over the Po east of Torreberetti were impassable; by 4 August, Genoa was isolated, communications from Turin eastward were limited, all rail lines from Milan to the south and east were cut, and all routes along the northern Apennines were useless, except that the Bologna-Pistoia line was open to Piteccio and there was only one cut on the Bologna-Prato line. Road communications east of Piacenza were almost as completely—although not as permanently—cut as were the rail lines. By 23 July every main bridge from Ostiglia to Cremona had been destroyed.<sup>120</sup>

The bridge-busting plan called for fighter-bombers to supplement the work of the mediums by preventing repairs and destroying pontoons.<sup>121</sup> Actually, they do not seem to have operated against pontoons, but they did fly a large number of missions against bridges and open stretches of track. Their efforts against the heavy, permanent structures across the Po proved ineffective so that most of their operations were against smaller bridges above and below that river on lines leading to the main bridges. Even against smaller bridges they were not too successful, but they did a good job of cutting and blocking tracks—for example, the 87th Fighter Wing alone put 221 cuts in tracks during the last three weeks of July—and strafing and bombing motor transport and rolling stock. Most of the fighter-bomber operations were from Corsican bases, the 27th, 79th, and 86th Fighter-Bomber Groups and the 47th Bombardment Group (L) having joined the 87th Fighter Wing there in mid-July in anticipation of ANVIL.<sup>122</sup>

In the interdiction program from 1 July to 4 August the mediums and fighter-bombers received a small amount of assistance from Strategic's heavies. Their first mission of the period was flown by 711 bombers and 292 fighters on 6 July when weather barred all targets except those in northern Italy. In addition to hitting oil installations and the Bergamo steel works the bombers plastered the yards at Verona and cut the Tagliamento River-Casarsa rail bridge in two places and rail lines to Venice in twelve places, but apparently failed to inflict serious damage on the Avisio viaduct.<sup>123</sup> On the night of 10/11 July, sixty-

seven RAF 205 Group Wellingtons and a few Halifaxes and Liberators flew a successful mission against the Milan-Lambrate yards.<sup>124</sup> On the 13th—which was the second day of MALLORY MAJOR—Strategic's entire effort was directed against Italian oil storage facilities and communications. Soon after midnight twenty-two Wellingtons and Liberators, with Halifax pathfinders, dropped 62 tons on the Brescia yards; later in the day 196 of the Fifteenth's heavies severely damaged yards at Mestre, Verona, Brescia, and Mantova, and the rail bridge at Pinzano. On 2 August, heavies dropped 312 tons on the yards at Genoa, scoring heavily on rolling stock, buildings, and sidings, while on the 3d other heavies knocked out two spans and damaged two others of the Avisio viaduct and damaged the Ora bridge below Bolzano, which disrupted traffic on the Brenner Pass line for some ten days.<sup>125</sup>

Coastal also aided in the interdiction program. It operated against shipping and ports on both sides of the peninsula, and attacked supply centers, factories, and communications in northwest Italy. Its efforts were on a much smaller scale than in the early spring, owing to the transfer of a large number of its squadrons to Tactical and to the newly created Balkan Air Force. However, by taking over the defense of the western one-third of the peninsula as far north as Piombino it freed many of Tactical's planes for offensive operations. Coastal could afford to assume this responsibility because of the extreme offensive weakness of the Luftwaffe.<sup>126</sup>

By 4 August the combined efforts of Tactical, Strategic, and Coastal toward interdicting the enemy's supply lines in northern Italy had achieved such remarkable success\* that Kesselring was finding it extremely difficult to supply his front-line troops. At times he was virtually isolated from the rest of Europe. Direct rail traffic across the Po between Piacenza and the Adriatic was not possible; farther west he had the use of only a few lines, with Genoa isolated and traffic generally disrupted, especially east of Turin and south of Milan. All routes from France were closed, as was the Tarvisio line from Austria. The Brenner Pass line was temporarily blocked. Between the Po and the Arno there were around ninety cuts in rail lines. Roads also were badly battered, all but three permanent bridges over the Po between Torreberetti and the Adriatic being cut. With almost all rail lines in the Po Valley closed, with the road system disrupted, and with motor trans-

\* Some of the credit must go to the Italian Partisans, whose activities steadily increased throughout the summer.

port shot to pieces, the enemy was faced with a tremendous problem in trying to maintain his army in front of the Gothic Line.<sup>127</sup>

Yet the enemy's defenses south of the valley did not disintegrate. That they did not was attributable to the German's skill, ingenuity, and to his strenuous repair efforts. Railway repair and construction units were reinforced by Italian labor units, which were dispersed along the most important lines; repair material was scattered along the rail lines. The enemy assembled pontoon bridges at night, used them, then broke them up before dawn. He used ferries at more than fifty points along the Po. He moved mostly at night and in rainy weather, and went in heavily for camouflage, especially at the Po bridges.<sup>128</sup> The very complexity of the lines of communication in northern Italy helped him, for the air forces could not achieve that basic requirement of simultaneous interdiction on all lines, as had been possible in central Italy. The Allies helped him, too, by withdrawing during June and July nine full infantry divisions from Fifth Army for use in an invasion of southern France, which lessened the pressure on the Wehrmacht.<sup>129</sup> In spite of the great success of the air campaign, it cannot be claimed that the Allies completely won the logistical battle of the Po Valley, for the Germans maintained their forces well enough to stop the Fifth and Eighth Armies at the Gothic Line.

With Fifth Army already denuded of many of its troops, the Allied armies in Italy on 5 August began a two-week period of regrouping, and the land battle died down. At the same time, MAAF turned its attention very largely away from Italy and toward southern France. For the next six weeks air and ground operations on the Italian peninsula would be secondary in importance to operations on behalf of ANVIL-DRAGOON.

## CHAPTER 12

\* \* \* \* \*

### *INVASION OF SOUTHERN FRANCE*

THE invasion of southern France was the last of a long series of Allied triphibious assaults in the Mediterranean. After TORCH and the conquest of Tunisia the Anglo-Americans had taken Pantelleria and Sicily and then had successfully invaded southern Italy; along the way they had picked up the islands of Lampedusa, Sardinia, and Corsica. Stopped below Cassino they had launched yet another triphibious operation to establish the Anzio bridgehead, after which, in May 1944, they had jumped off from three fronts—main Fifth Army, Eighth Army, Anzio—to sweep, in less than a month, past Rome; by August they were at the line of the Arno from Pisa to Florence, beyond Perugia in the center, and above Ancona on the east coast. Then, on 15 August, while continuing to maintain steady pressure against the Germans in Italy, they stepped across the Ligurian Sea to land on the coast of southern France and in a month swept up the valley of the Rhone to a junction with Patton's Third Army.

To most of the American planners the invasion, coded Operation ANVIL (after August, DRAGOON), was a logical part of the grand strategy whose ultimate purpose was the complete defeat of the Nazis. But to most of the British planners it was an operation which forbade another which they preferred: an advance into the Balkans—either through Greece or Albania or out of northeast Italy—and thence into Austria and, perhaps, into southern Germany and even Poland. There was much to be said for both sides. The American view discounted certain political considerations; the British gave to them much more weight. The Americans were thinking primarily of the quickest way to end the war; the British, of postwar eventualities. Because of the dif-



ference in opinion, together with other factors such as the slow progress of the Italian campaign up to May 1944, lack of landing craft, and shortages of certain resources, both human and material, ANVIL-DRAGOON was launched only after some six months of indecision—a period in which the operation was off-again, on-again, not once but several times.

### *Plans and Preparation*

As early as April 1943 there had been some talk of a landing in southern France, and at the QUADRANT conference in August 1943 the CCS had decided on a diversionary attack there in coordination with a major invasion in northern France.<sup>1</sup> But it was not until December 1943 at the SEXTANT conference that the Allies decided that such an undertaking would be the next full-scale triphibious venture in the Mediterranean. At Cairo the CCS, together with President Roosevelt and Prime Minister Churchill, agreed that OVERLORD and ANVIL would be the supreme Anglo-American operations for 1944, a decision which received the hearty approval of Generalissimo Joseph Stalin.<sup>2</sup> The CCS directed General Eisenhower, then commander in chief in the Mediterranean, that ANVIL and OVERLORD should take place, simultaneously, in May; Eisenhower's headquarters, AFHQ, in turn, on 29 December issued a directive as a basis for planning, and by 12 January 1944, Force 163 had been set up near Algiers to plan the operation and was at work.<sup>3</sup>

The decision to mount ANVIL in May had been based on the assumption, among others, that the Allied armies in Italy at that time would be approaching the Pisa-Rimini line, and on the strong presumption that the assaulting divisions for ANVIL would come from Italy.<sup>4</sup> But despite the most strenuous efforts the Allies were unable to break the Italian stalemate during January and February, while the Anzio affair not only failed to improve the situation but actually worsened it by tying up shipping, combat aircraft, and the 3d and 45th Divisions, both of which under the original plans for ANVIL had been scheduled to begin training early in February for the invasion of France. After numerous discussions in January and February the CCS on 23 February had been forced to admit that ANVIL could not be launched in May concurrently with OVERLORD; they then decided that the campaign in Italy should have overriding priority over all other operations in the Mediterranean at least until 20 March, at which time the

situation would be reviewed; in the interval, planning for ANVIL would continue.<sup>5</sup> The President and Prime Minister agreed, as did Eisenhower, who now was in England as supreme Allied commander.<sup>6</sup>

The decision, although it did not liquidate ANVIL, greatly reduced its importance—a result especially pleasing to General Wilson and to the British chiefs of staff. Wilson had opposed the idea of an invasion of southern France almost from its inception. In support of his position he pointed to the limited resources, especially in landing craft, which were available, and he fortified his objections with the argument that the best way to support OVERLORD would be to contain thousands of German troops in Italy by pushing the Italian campaign. Eaker, Slessor, and other theater commanders—but not Wilson's deputy, General Devers—also preferred the Italian campaign.<sup>7</sup>

When 20 March came around neither side had changed its position. Wilson and the British chiefs insisted, and the American chiefs agreed, that no operation in the Mediterranean could be undertaken until the main Fifth Army and the forces at Anzio were joined—but at that point agreement ended. The British held that when an all-out offensive was launched in Italy it should be continued without diversion until June, at which time a final decision on ANVIL could be made in the light of the situation on the Normandy front, the progress of the Russian summer offensive, and the status of the Italian campaign; at that time, they said, the tactical situation might well call for an operation other than ANVIL. The U.S. Joint Chiefs on the contrary insisted that once the two Italian fronts had been joined nothing should be planned or attempted which would interfere with an invasion of southern France.<sup>8</sup>

After ten days of rather fruitless discussion, the Joint Chiefs on 30 March insisted that a firm decision on ANVIL be made at once. But with the joining of the main Fifth Army—Anzio fronts generally accepted as a *sine qua non* to ANVIL, with the Allied situation on the two Fifth Army fronts not improved (despite the costly efforts at Cassino during February and in the middle of March), and with Wilson opposed to the operation and Eisenhower convinced that “as presently conceived” it was “no longer possible,” the CCS had little choice except to agree that ANVIL could not take place concurrently with OVERLORD.<sup>9</sup> After further discussions the American chiefs on 8 April gave in to the British point of view that no preparations for ANVIL should be made which would affect the Italian campaign and that no final decision on the operation should be made before June. So

far as can be determined the Americans took this action simply because the Anglo-American deadlock threatened to stagnate Mediterranean operations: any action was better than no action. Ten days later\* Wilson was authorized to continue the Italian campaign as the mission of first priority; he was to start an all-out offensive as soon as possible; ANVIL was postponed indefinitely, and OVERLORD would have to go it alone.<sup>10</sup> A month later, on 12 May, the Allies launched DIADEM, soon broke the Italian stalemate, captured Rome, and by the end of June were driving through central Italy.

Throughout the last half of April and all of May scant attention was paid to ANVIL (although planning went on and American leaders continued to hope that the operation could be mounted, while Wilson continued to voice objections to it and to think of the Balkans),<sup>11</sup> but after the Fifth Army had swept into Rome on 4 June and the Allies had gone ashore in Normandy on the 6th, serious consideration again was given to the question of future strategy in the Mediterranean. On the 11th the CCS, meeting in London, decided that an amphibious operation of approximately three-division strength would be mounted about 25 July, but they did not decide on the objective.<sup>12</sup> Because the primary reason for the operation was to assist OVERLORD and because ANVIL would have to borrow landing craft and troop carrier planes from the United Kingdom, Eisenhower was brought into the picture. SHAEF recommended that ANVIL or a similar operation be mounted at the earliest possible date, in any event not later than 10-15 August; if such an operation were not to be launched then OVERLORD should be strengthened by giving it divisions from Italy.<sup>13</sup>

Influenced by the fluid situation in Italy, the progress of the fighting in Normandy, and other factors, the CCS declined to make a firm decision, but in a cable to Wilson on 14 June they outlined three possible courses of action which could be followed *after* the enemy had been driven back to the Pisa-Rimini line. One was ANVIL, the second an operation against western France, and the third an amphibious landing at the head of the Adriatic. The final choice, said the CCS, would be determined later by the status of OVERLORD and the success of the Russian offensive; in the interim Wilson would build up for "an" amphibious operation to be set in motion around 25 July.<sup>14</sup> After Wilson

\* Hitherto, Churchill had not intervened in the debates between the U.S. and British chiefs over ANVIL, but on 12 April he wired Marshall his strong preference for concentrating on the Italian campaign. (See CM-OUT-22575, Marshall to Eisenhower, 13 Apr. 1944.)

and his staff had considered the CCS directive they promptly advanced a fourth plan of action: to continue the Italian campaign into the Po Valley, then drive either against southeastern France or northeastward (in conjunction with an amphibious operation) through the Ljubljana Gap into Austria, southern Germany, and the Danubian basin. They felt not only that this plan offered the best means of containing the maximum number of enemy forces but also that it might even result in drawing troops from northern France and do so more quickly than would any other operation; further, once the Allies were in the valley they could uncover either the French or the Austrian frontiers.<sup>15</sup> Field Marshal Alexander and General Clark favored the idea of a drive through the Po Valley and into northeast Italy; so, too, did airmen Eaker, Slessor, and Cannon who believed that the air forces could participate more easily, economically, and effectively in a single continuing advance than in two separate campaigns.<sup>16</sup>

On the contrary, General Devers pointed out that ANVIL, and only ANVIL, could open up ports outside Normandy through which there could be moved vitally important men and supplies for reinforcement of the divisions now fighting in France—a consideration he thought even more important than the containing, or even the drawing off, of enemy troops. Furthermore, Devers was not at all sure that the Allied armies in Italy could meet Alexander's optimistic timetable of the Po River by August and the Ljubljana Gap by September and, if they could not, then ANVIL would give the earliest possible aid to OVERLORD.<sup>17</sup> Devers got strong support for his views from General Marshall, who, with General Arnold and others, had arrived in the Mediterranean from England on 17 June, and from Maj. Gen. Thomas T. Handy, chief of War Department Operations Division, who quoted Eisenhower as saying that he must have either Bordeaux or Marseille before he could hope to deploy all available forces in the minimum of time. Wilson, however, was adamant; he continued to argue for a drive toward the Danubian basin. The question of the ability of the air forces to support simultaneously two operations was raised in conference, and the ensuing discussion revealed still another difference of opinion between the American chiefs and the Allied leaders in MTO. Wilson pointed out that the success of DIADEM had been "largely due to the destruction of enemy communications and dumps and the breaking up of reinforcing formations by concentrated air action," and he questioned that the air forces could continue their decisive role in the Italian

## INVASION OF SOUTHERN FRANCE

campaign if faced with the task of supporting two concurrent campaigns. Eaker and Slessor agreed; the former felt that to assign almost the whole of Tactical Air Force to ANVIL—as was planned—would reduce the air effort over Italy almost to purely defensive operations. Marshall and Arnold took exception to these views. Both felt that MAAF had so many planes and such complete air superiority that it could support both campaigns. They expressed the opinion that after a few days of intense air operations over ANVIL it should be possible to split the air effort between ANVIL and the Italian campaign.<sup>18</sup>

After the conference Wilson recommended to the CCS and Eisenhower that ANVIL be replaced by an advance to the Ljubljana Gap with a coordinated landing at Trieste. Eisenhower, concerned because his operations in Normandy were behind schedule and noting that the spectacular drive in Italy was slowing down, countered on 23 June with a recommendation that ANVIL be launched by 15 August so as to give him an additional port, open a direct route to the Ruhr, and aid the Maquis.<sup>19</sup> The disagreement between the two theater commanders tossed the matter squarely in the laps of the CCS, but after a week of argument the American and British members were no nearer agreement than they had been in February.<sup>20</sup> That left the decision up to the President and the Prime Minister, each of whom at first stood firmly behind his military chiefs. Not all that transpired between the two men is known, but on 1 July, Churchill, apparently at Roosevelt's insistence and influenced by Eisenhower's strong desire, agreed to ANVIL, although he was thoroughly unhappy about it.<sup>21</sup> The opposition of the British chiefs to ANVIL died hard. As late as 4 August the British chiefs suggested that the troops assigned to the invasion be sent into northern France through a Brittany port, but in the face of complete disagreement by the Americans and objections from Wilson they dropped the argument.<sup>22</sup> On 2 July the CCS had directed Wilson to launch ANVIL at the earliest possible moment and to make every effort to meet a target date of 15 August.<sup>23</sup> Thus, after six months of uncertainty, ANVIL became a more or less firm commitment only six weeks before it was to be launched.

Fortunately, planning within the theater had never stopped and by 2 July was so far advanced that over-all plans were practically complete; in fact, on 28 June, AFHQ had ready a thorough outline plan for the operation. Helpful, too, was the fact that beginning immediately after the fall of Rome various units of Fifth Army had been released to

Seventh Army,\* which, comparatively inactive from the end of the Sicilian campaign, had been revived late in December 1943 and made responsible for the invasion of southern France. So it was that when General Wilson announced on 7 July that ANVIL would be launched, the Naples-Salerno staging area already was congested with American, French, and British troops.<sup>24</sup> Moreover, the principal commanders had been selected: Maj. Gen. Alexander M. Patch for the ground forces, Vice Adm. Henry K. Hewitt for the naval task force, and Maj. Gen. John K. Cannon in charge of tactical air plans. On 11 July, the fourth major assignment, that of the air task force commander, went to Brig. Gen. Gordon P. Saville, commanding general of XII Tactical Air Command.<sup>25</sup> In spite of all the progress which had been made, however, the long months of uncertainty, the late date at which the final decision had been reached, and the swiftly changing fortunes of the Italian campaign had left countless details to be worked out.

The final plan called for the assault to go ashore east of Toulon and over beaches scattered between Cavalaire Bay and Cap Roux. This was the only area which could be covered satisfactorily by fighters from Corsica and which also had good beaches, proper exits, terrain suitable for the rapid construction of fighter strips, an anchorage, and was reasonably close to a good port. Before H-hour American and British paratroopers would be dropped north and east of Le Muy and north of Grimaud to prevent the movement of enemy troops into the assault area and to attack enemy defenses from the rear; American Special Service Forces would neutralize the small offshore islands of Port Cros and Levant, then capture the island of Porquerolles; and French Commandos, after destroying enemy defenses on Cap Nègre and seizing high ground and the coastal highway near by, would protect the left flank of the assault. The main invasion force, consisting of three divisions of the Seventh Army, would be American. French troops totaling seven divisions would go ashore on and after D plus 3 and drive on Toulon and Marseille, capture of the latter being the primary objective of the initial assault. The Americans and French, all of whom would be under the command of General Patch, would exploit toward Lyon and Vichy, with the ultimate objective a junction with Eisenhower's forces.<sup>26</sup>

\* Some of the units were released to Force 163, the planning group for ANVIL. Force 163 dropped its title when Seventh Army headquarters moved from Algiers to Naples on 4 July.

The Western Naval Task Force would bring the Seventh Army ashore, support its advance westward along the coast to Toulon and Marseille, and build up and maintain the ground forces until ports had been captured and were being utilized. To meet these requirements the large naval task force (plans called for 843 ships and craft and 1,267 shipborne landing craft) would be divided into six forces, each with a particular task. One of the forces was the Aircraft Carrier Force which was to cooperate with MAAF's planes by providing fighter protection, spotters, and close support missions; to avoid possible confusion its planes while in the assault area would operate under the control of XII TAC. It was anticipated that around 216 Seafires, Wildcats, and Hellcats would be available and that, in addition to normal defensive operations, they could add to XII TAC's effort some 300 offensive sorties per day until the carriers retired.<sup>27</sup>

Under the provisions of MAAF's final air plan, issued on 12 July, XII TAC, reinforced by RAF units, would carry the burden of air operations in support of ANVIL, leaving Desert Air Force to take care of the needs of the Allied armies in Italy. MATAF's medium bombers would be kept "flexible" for operations in either France or Italy, as circumstances might demand. MASAF and MACAF would do little more than carry out their normal routine tasks, except that Coastal would cover the convoys to within forty miles of the beaches and would conduct special overwater reconnaissance. The basic assignments—neutralization of enemy air forces, cover for the convoys and for the landings, interdiction of enemy movement into the battle area, support of ground fighting, the transport of airborne units, and the maintenance of air-sea rescue services—had become familiar ones through the experience gained in earlier assaults on Sicily and at Salerno and Anzio. To these familiar duties one new one was now added: air supply and support for French Partisan forces.<sup>28</sup> Eaker, in contradistinction to his earlier position, assured Arnold that these numerous commitments to ANVIL would not keep MAAF from giving ample support to the Italian campaign, while Slessor cabled the British that MAAF's forces could handle the two campaigns simultaneously because the Luftwaffe could "virtually be ignored."<sup>29</sup>

The three forces involved in DRAGOON—air, ground, and navy—were commanded by coequal and "independent" commanders operating under the direction and coordination of the theater commander. This arrangement, the validity of which had repeatedly been demon-

strated during the past year, allowed MAAF to take full advantage of air's great qualities of flexibility and concentration. The plan for pre-D-day operations called for attacks on GAF-occupied airfields and very heavy attacks on lines of communication in southern France from D minus 30 to D minus 1; on D minus 1 every effort would be made to isolate the assault area. From D-day onward operations—against enemy troops and strongpoints or for the protection of shipping and the assault forces—would be determined by the progress of the ground forces.<sup>30</sup>

After the air plan had been issued, Army and Navy commanders argued for heavy pre-invasion air attacks on coastal guns, the assault to begin well ahead of D-day, but air leaders vigorously objected. They argued that a long pre-invasion bombardment would have to include attacks on guns all along the French coast, in order to avoid disclosure of Allied plans for the assault, and that any such program necessarily would be at the expense of the air war against the enemy's oil, communications, and air force; they insisted that a terrific air assault on the guns on D minus 1 and D-day, together with a heavy naval bombardment on D-day, would achieve the desired neutralization. But Fleet Adm. Sir A. B. Cunningham of the Navy and Patch of the Army won the argument, the air forces being somewhat mollified when it was decided to provide cover by pre-D-day bombing of coastal defenses all the way from Genoa to Sète (Cette).<sup>31</sup> MATAF issued a bombing plan on 4 August which divided the period from D minus 10 (5 August) to 0350 hours of D-day (15 August) into two parts: in part one, D minus 10 to D minus 6, the primary tasks of the air arm would be to neutralize the GAF, interdict communications, and attack submarine bases; in part two, the chief jobs would be to neutralize the main coastal defense batteries and radar stations (Operation NUTMEG) and, with whatever forces were not being used for NUTMEG, to put the finishing touches to the target systems which had been under assault in part one.<sup>32</sup>

Among the tasks left for MAAF to do before D-day was that of putting Corsica in complete and final readiness to handle a large number of combat and service units, for it was from that island that the bulk of ANVIL's air units would operate.<sup>33</sup> Fortunately, only the finishing touches were necessary, for the island had been an active Allied air base ever since its conquest early in October 1943. Since its location put planes based there within easy reach not only of the enemy's sea lanes but of central Italy and the Po Valley, engineers of XII Air Force Engi-



near Command and units of XII Air Force Service Command had promptly been sent ashore to repair and service four old fields and to build new ones along the east coast from Bastia to below Solenzara and on the west coast around Calvi and Ajaccio. A few combat units from Coastal then had moved in; from their bases they had patrolled the waters of the Ligurian and upper Tyrrhenian seas and, by the beginning of 1944, they were flying a few tactical missions ahead of the Fifth Army.

Even with this solid beginning a great deal of work had been necessary in the winter and spring of 1944 before the island was ready to accommodate all of the men and planes which were to participate in ANVIL. Corsica was a pesthole of malaria, Bastia was the only good port on the east coast, facilities for overland transportation were poor, and the number of usable fields was inadequate. Medical officers, engineers, and atabrine took care of the malaria; engineers and air service troops constructed roads, bridges, and fields and ran pipelines down the east coast from Bastia to the airdromes; signal troops laid 2,500 miles of telephone wire. AAFSC/MTO was charged with stocking the island but because most of ANVIL's air strength would come from the Twelfth Air Force, XII Air Force Service Command was responsible for receiving, storing, and issuing the thousands of tons of supplies made available by AAFSC/MTO. The service commands prepared and carried out a detailed plan for the support of the combat units based on their own experience in earlier amphibious operations in the Mediterranean, on certain fixed premises received from MAAF, and on detailed requirements submitted by service units. In February the Corsica Air Sub-Area had been established at Bastia; it was responsible for administration, supply, and service for all air force units on the island.\* Because it was a long-term job to ready the island and because Corsica would continue to be an important base for operations over central and northern Italy—even if ANVIL should never materialize—large quantities of fuel, lubricants, belly tanks, bombs, and other supplies were regularly shipped in from January on, so that by summer Corsica already was so well stocked that until D-day it was necessary only to maintain existing levels. By mid-June, AAFSC/MTO could report that it had met all requirements; to give a few examples—it had stocked on the island more than 136,000 bombs, 3,500,000 rounds of ammunition,

\* The director of Supply and Maintenance, MAAF, was responsible for the supply to all RAF units on Corsica of items peculiar to the RAF.

and 2,500 belly tanks. Thereafter, not only were the levels required for the invasion maintained but current demands were always met.

By mid-August there were five service groups on Corsica, besides one group in Sardinia to care for the 42d Bombardment Wing's B-26's and the 414th Night Fighter Squadron and five groups in Italy to serve Troop Carrier's planes, all of which were scheduled to participate in the invasion. Most of these service squadrons had come in after 2 July, and although their move had been a hurried one it had been carried out most efficiently.<sup>34</sup>

The combat units of MATAF and MACAF which were to operate from Corsica had arrived before mid-July. Their move occasioned but slight interference with operations: the planes simply took off for a mission from their old field in Italy and after completing it landed at the new base in Corsica which had been put in readiness by an advance echelon. Before 15 August, MAAF had the following units on the island: twelve squadrons of the USAAF 57th Bombardment Wing (B-25's), four of the USAAF 47th Bombardment Group (A-20's), twenty-one of USAAF fighters (fifteen of P-47's and six of P-38's, the latter on loan from MASAF); eleven squadrons of RAF fighters (Spits) and one of tac/recces; and four squadrons of French Air Force fighters (three of P-47's and one of Spits). In addition, the island held two photo reconnaissance squadrons, one squadron of night fighters (Beaus), and—from Coastal Air Force—the 350th Fighter Group (P-39's and P-47's).<sup>35</sup> The planes, numbering more than 2,100, occupied fourteen airfields (seven all-weather and seven dry-weather), capable of accommodating eighteen combat groups; eight of the fields were new, while the other six were old fields which had been rebuilt with extended runways. As had happened before in the Mediterranean the unsung aviation engineers had done an outstanding piece of work, and done it in spite of severe handicaps of rain, poor communications, and shortage of shipping.<sup>36</sup>

The move to Corsica of XII TAC's combat elements meant that Desert Air Force alone would be responsible for air operations on behalf of the Fifth and Eighth Armies in Italy. Since both air elements were under MATAF, it was found advisable to split that headquarters: Headquarters Main, which opened in Corsica on 19 July, was to direct the invasion operations while retaining over-all control of all MATAF units; Headquarters Italy was to represent MATAF on the

peninsula in the settlement of day-to-day questions. Slessor strengthened DAF by transferring to it several units from Coastal Air Force and from the eastern Mediterranean and by retaining fighter personnel due for relief. In the end thirty squadrons, all British, were left to support the Italian campaign, and sixty-four squadrons were assigned to ANVIL.<sup>37</sup>

The employment of airborne troops as an adjunct to the main assault depended, as was so generally true of air's preparation for the invasion of southern France, heavily upon preliminary planning, but much remained to be accomplished after 2 July. During January and February so many troop carrier units had been sent to the United Kingdom that Troop Carrier Command had been abolished and its one remaining wing, the 51st, was placed directly under the administrative control of the Twelfth Air Force and the operational control of MATAF. When the commanding general of MATAF began in March to implement that part of MAAF's outline air plan for ANVIL which dealt with airborne operations, he found the task an exceedingly difficult one, owing to the shortage of troop carrier planes and airborne troops. The planes of the 51st Wing were so heavily committed to air evacuation, general transport, and special missions that only a few aircraft could be allotted to necessary training, and the major airborne units were fighting as ground troops alongside the Fifth and Eighth Armies. By May, however, the paratroopers had been withdrawn from the line and had begun an intensive training program; the entire 51st Wing had been moved to Italy from Sicily, which allowed one full group to be allocated to the training center; and the War Department had agreed that Wilson should receive a number of airborne units from the United States. There still were not enough planes to carry out the projected airborne operations on a scale which would insure the maximum accomplishment or enough airfields to accommodate all of the planes should the number presently available be increased by a loan from the UK, but by the end of June both of these limitations had been removed. The rapid ground advance in Italy had made a number of fields available in the Rome area, while Eisenhower had offered to send down 416 tow planes and 225 glider pilots, which would give MAAF a total of three troop carrier wings.<sup>38</sup> After the arrival of the planes from ETO (the move was completed on 20 July), and before the invasion, the entire troop carrier strength in the theater moved more than 2,200,000 pounds of cargo, evacuated 15,662 patients, carried 21,334

passengers, and put in close to 39,000 hours of training in preparation for its role in the invasion. Concurrently, AAFSC/MTO, in one of the most skilfully and efficiently handled jobs of the war, assembled almost 350 gliders.<sup>39</sup>

### *Preliminary Operations*

When on 2 July the CCS ordered Wilson to undertake the invasion of southern France they also provided that all his resources not required for that operation would be used to continue the Italian campaign. Wilson then directed Alexander to drive through the Apennines to the line of the Po.<sup>40</sup> As a result, in the month after the directive of 2 July, MAAF's tactical planes were so busy on behalf of the Fifth and Eighth Armies and its strategic bombers were so occupied with the campaign against oil\* that they operated only infrequently over southern France. Mediums did not attack targets in the ANVIL area until 2 August, when fifty-seven B-25's hit the Var River bridges, although many of their operations over Italy during July were so close to the French frontier that they promised to affect future German movements between Italy and southern France. On 3 August—the last day before MAAF would turn its attention fully to preparations for the invasion—a few mediums again bombed the Var River road bridge but with only fair results. Like the mediums, XII TAC's fighter-bombers were so busy over Italy that they went to southern France only twice, on 25 and 26 July, when they flew a total of forty-two effective sorties against airdromes.<sup>41</sup>

In the same period Strategic flew six outstanding missions in preparation for ANVIL. On 5 July, 228 B-17's and 319 B-24's heavily and successfully bombed Montpellier and Bezier yards and sub pens and installations at Toulon. Again on the 11th, B-24's gave Toulon harbor a good concentration with 200 tons of bombs. Next day, 315 Liberators dropped 760 tons on yards at Miramas and Nîmes, and 106 others hit bridges at Théoule sur Mer and across the Var River. On the 17th, 162 B-24's scored many hits on rail bridges at Arles and Tarascon and on bridges and yards at Avignon. One week later 145 B-24's dropped 30,700 x 20-pound frags on airfields at Chanoines and Valence, and that night 22 RAF Liberators with 6 Halifax pathfinders got fair coverage of the airfield at Valence/La Trésorerie. The final mission, flown by heavies on 2 August, created ten rail cuts between Lyon and the mouth

\* See above, pp. 290-98.

## INVASION OF SOUTHERN FRANCE

of the Rhone. All of the Fifteenth's fighter groups participated in these missions, but the 52d and 332d carried the brunt of the work.<sup>42</sup>

The rather limited operations over southern France prior to 4 August were greatly augmented by the activities of the French Maquis who wrecked trains, blew up bridges, sabotaged installations, sniped at German troops, and in various other ways made themselves a nuisance to the enemy. The Maquis depended for their arms and other equipment largely on air drops by planes of MAAF and the Eighth Air Force. Most of the supply missions from the Mediterranean originated at Blida, near Algiers, and were flown by B-24's of the USAAF 122d Bombardment Squadron (later the 885th) and the RAF 624 Squadron, with assistance from 36 Squadron (Wellingtons), which was no longer needed for antisubmarine duties.<sup>43</sup>

When the final bombing plan appeared on 4 August, MAAF's planes stepped up to the status of a full-scale assault their operations against lines of communication in southern France.<sup>44</sup> Bad weather on the 5th canceled all missions by heavies and mediums, but fighters and fighter-bombers of XII TAC attacked three bridges and a number of guns near Nice. On the 6th, Strategic dispatched 1,069 heavies against rail lines and oil storage installations. Their attack on the oil installations was only moderately successful, but they inflicted severe damage on bridges at Arles, Tarascon, Lavoulte-sur-Rhône, Givors, and Avignon and yards at Portes-les-Valence and Miramas. On the same day five B-26 missions successfully bombed the Tarascon bridge and two the Arles bridge, while B-25's hit the Lavoulte and Avignon bridges and two Var River bridges with good results.

The assault was continued on the 7th. B-25's knocked out three spans of the Lavoulte bridge, one span at Avignon, and one at Livron. Fighters and fighter-bombers hit bridges, locomotives, rolling stock, and tracks in the Marseille area. As a part of the effort to conceal the real assault area B-26's went for communications targets around Genoa, but bad weather interfered to prevent any striking results; fighters and fighter-bombers had better luck in the area. On the 8th, B-25's inflicted heavy damage on Pont-St.-Esprit and bridges at Avignon, and planes of XII TAC struck at shipping off the French coast. B-26's successfully bombed bridges at Asti and Alessandria but failed to damage Pontecurone; XII TAC had a good day against communications in the western part of the Po Valley. On the 9th, bad weather canceled every mission over the Rhone Valley, but in Italy, B-25's damaged the Ventimi-

PRINCIPAL RAIL LINES  
SOUTHERN FRANCE



glia bridge and fighters and fighter-bombers had a profitable day against communications and motor transport in the Po Valley.

The results of the early interdiction program in southern France were good. On D-day five of the six major railway bridges across the Rhone between Lyon and the coast were unserviceable; energetic repair efforts on the sixth bridge, at Avignon, gave the enemy restricted traffic across the Rhone for two or three days before the Allies landed. The double-track rail lines on either side of the river were cut, each line at two or more places between Lyon and Avignon. The effective bombing operations were supplemented by the activities of the Maquis who cut secondary rail lines in the Grenoble area and west of the Rhone between Limoges and Marseille.

In the planning stage of DRAGOON it had been decided that in addition to taking care of communications and the cover plan MAAF would go for enemy airfields in the last two weeks before D-day. There were three main airfield areas which demanded attention: Toulon, Udine, and the Po Valley. Strategic was given the responsibility for neutralizing the first two and Tactical the third. In the event, only a few Allied counter-air operations were necessary against the sadly depleted GAF. Fighters and fighter-bombers touched off the offensive late in July with bombing and strafing missions against fields in the Po Valley and continued to hit targets there and in southern France at frequent intervals through 10 August. Only once during this period, however, was there a major attack on an airfield: on the 9th when ninety-nine heavily escorted B-26's from the 17th, 319th, and 320th Bombardment Groups dropped 118 tons of bombs on Bergamo-Seriata, probably the most important enemy air installation in northern Italy. The mediums postholed the field, started numerous fires in dispersal areas, and claimed the destruction of nine aircraft and the damaging of eight on the ground, to which number the escorting fighters added two. Not a bomber was lost, owing—at least in part—to a preliminary and highly successful attack on the field's AA guns by P-47's of the 57th, 86th, and 324th Fighter Groups.<sup>45</sup> The final task of the air forces prior to 10 August was to attack submarine bases. An intensive campaign was not required, so that only one attack was laid on. This came on the 6th when 158 heavies dropped about 360 tons on the Toulon pens, severely damaging docks, facilities, and four submarines.\*<sup>46</sup>

\* Between 28 April, when bombers attacked Toulon, and 10 August, MAAF's planes flew 6,000 sorties and dropped 12,500 tons of bombs on southern France. (SACMED Report, Southern France, p. 21.)

## THE ARMY AIR FORCES IN WORLD WAR II

The GAF offered almost no opposition to MAAF's planes, not even over the Rhone Valley. On several days there was no enemy air reaction; on days when the Luftwaffe was up, it was in small force and invariably took a beating from Allied escort fighters.<sup>47</sup>

Beginning on 10 August (D minus 5) MAAF initiated the heavy pre-invasion bombing program (Operation NUTMEG) designed to neutralize the main coastal defense guns and radar stations in the assault area and to reduce the effectiveness of the enemy's troops. Targets were in four general areas: Sète, Marseille, the landing beaches, and Genoa. Careful and scientific studies set forth the exact scale of bombing effort to be directed against batteries in each of the four areas. Other studies, based largely on experiences during the assault phase of OVERLORD, resulted in a decision that the fighter escort would take care of radar stations.<sup>48</sup>

Bad weather interfered with this final phase, limiting the operations of the heavies to three days and the mediums to four; fighter-bombers operated on each of the five days, although not according to their pre-arranged schedule. In fact, after the weather canceled all bomber missions and reduced the fighter-bomber effort to 105 sorties on the first day, it was necessary to make several changes in the original program. For example, on 11 August, 218 mediums originally assigned to the Genoa area, bombed guns in southern France which were to have been attacked by heavies on the previous day. In the final analysis the several shifts do not seem to have affected adversely the efforts of the air arm to achieve its objectives, although the loss of the 10th as a day of operations reduced the total accomplishments up to D-day.

In addition to the attacks by mediums on the 11th, escorting fighters strafed radar stations in France and fighter-bombers hit guns in the Genoa area. On the next day 234 heavies dropped almost 1,400 tons on batteries in the Sète area and 307 other B-24's and B-17's unloaded on guns around Genoa, Savona, and Marseille; mediums in force hit guns at Île de Porquerolles, Cap Nègre, and Cap Cavalaire; fighter-bombers struck batteries in the Genoa-Savona sector; and escort fighters strafed radar installations from Genoa to Marseille. On 13 August mediums went for gun positions in the Marseille area, as did fighters and fighter-bombers in the Genoa area, and heavies in the Genoa, Sète, and beach areas. The attacks by the heavies involved 292 B-24's and 136 B-17's which together dropped more than 1,100 tons of bombs on twenty-one gun positions with results ranging from fair to good. Another force of



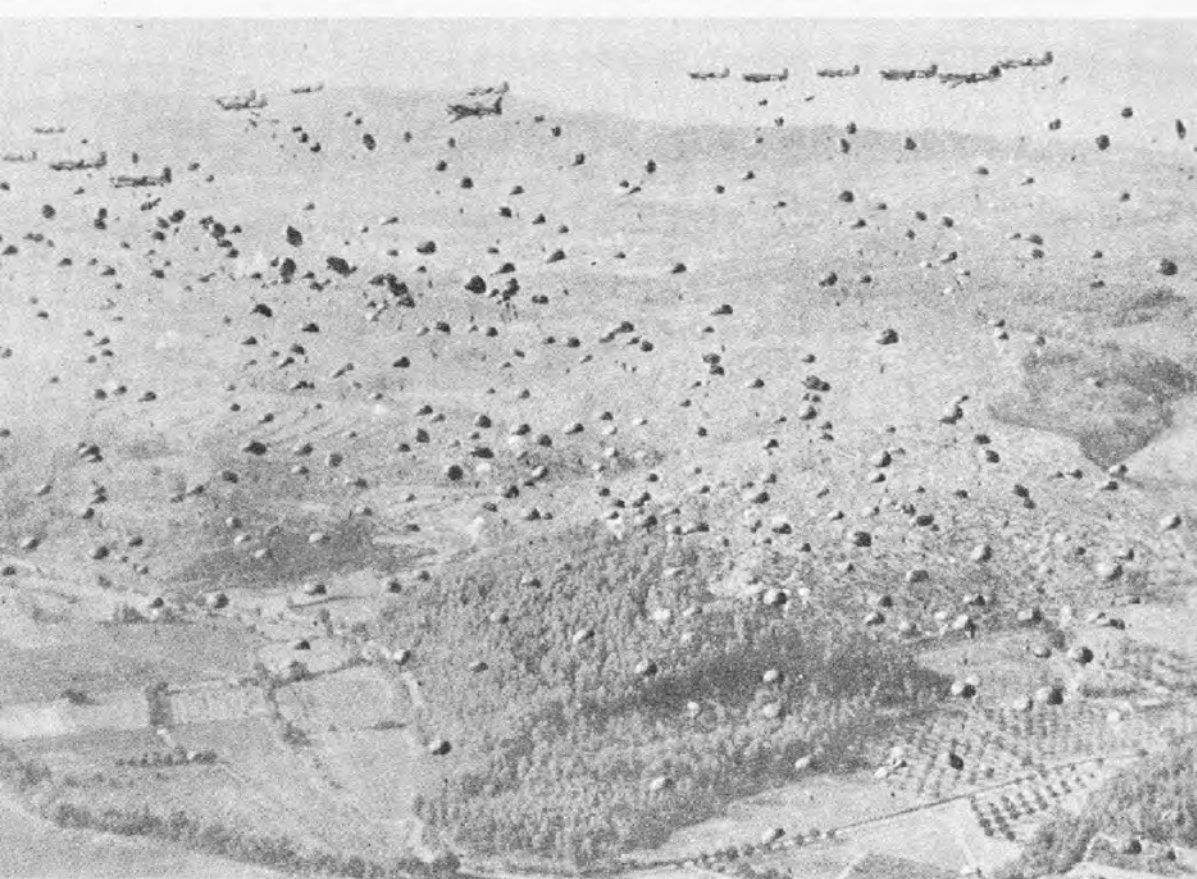

*Above:* RUN-IN

**AIR DROP FOR DRAGON**

*Below:* BAIL-OUT

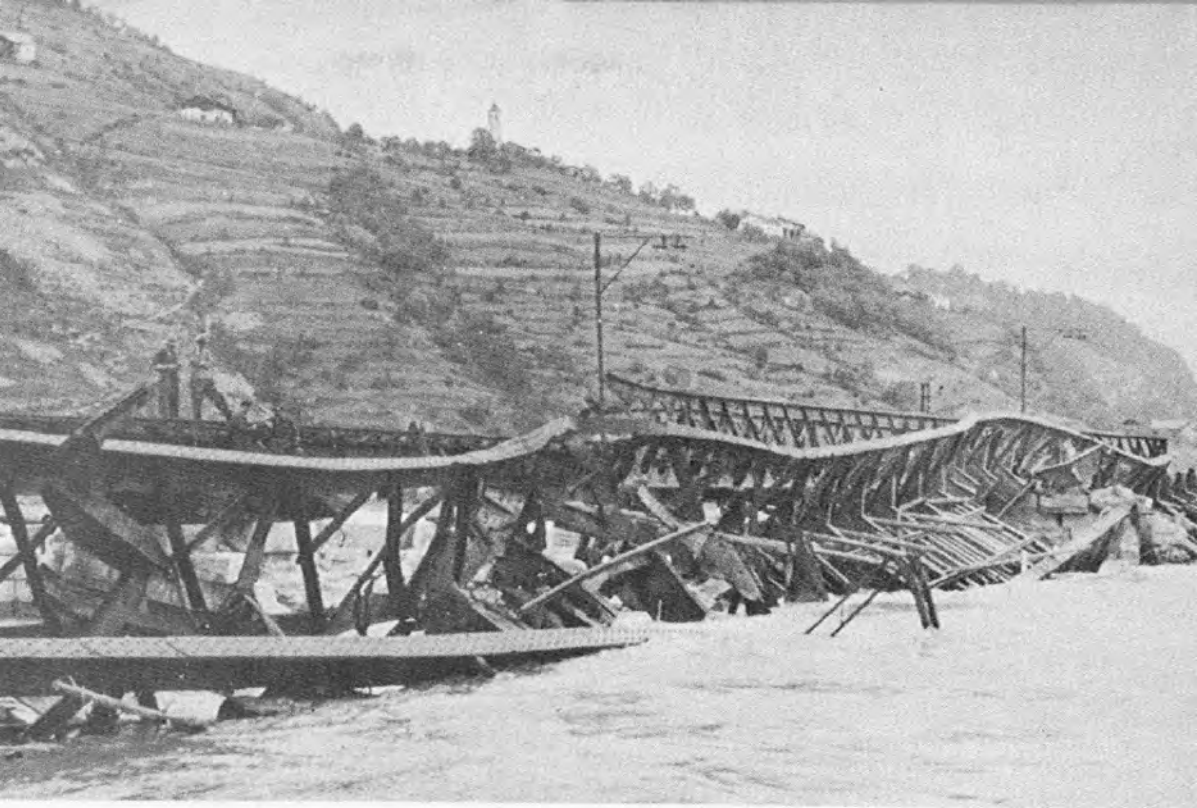

*Upper Left: BRESSANONE*  
*Lower Left: PIAZZOLA*

**BROKEN BRIDGES**

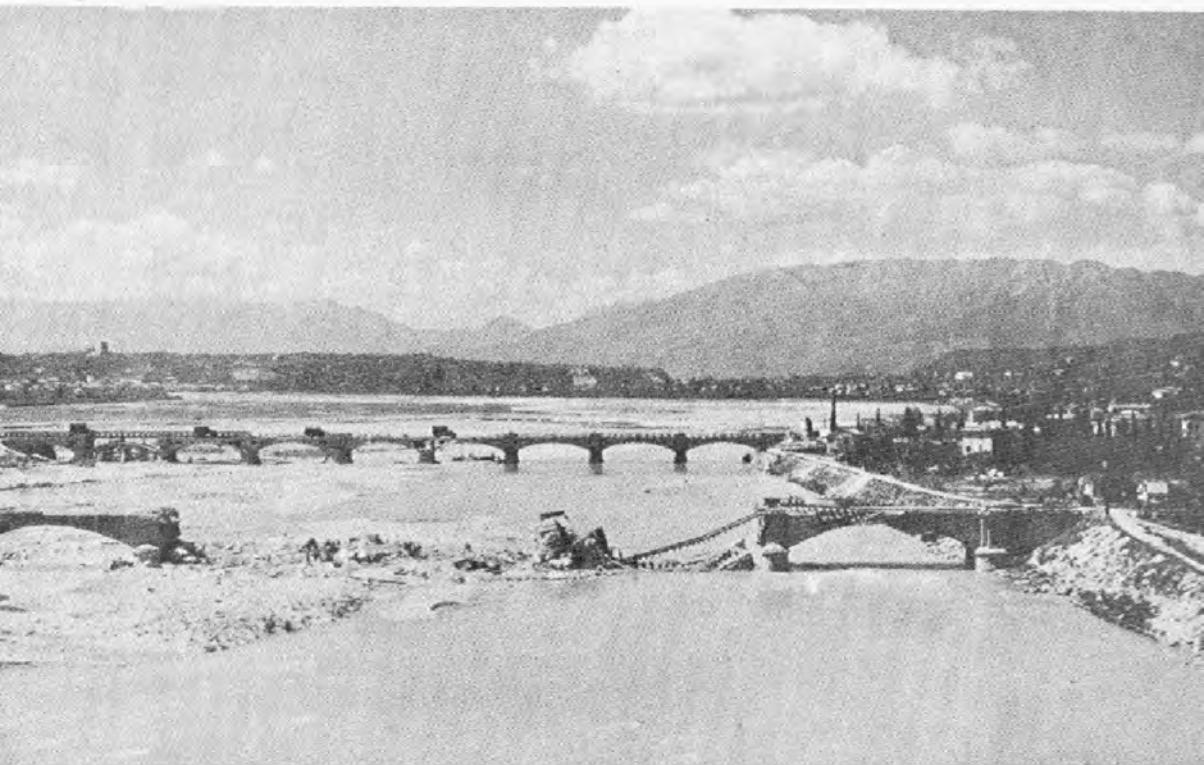

IN ITALY

*Upper Right: PONTE DI PIAVE*  
*Lower Right: NERVESA*



MAQUIS RECEIVING SUPPLIES IN CARPETBAGGER MISSION

## INVASION OF SOUTHERN FRANCE

132 B-24's dumped 324 tons on bridges in southern France but with limited success.

Because of the sad state of the GAF it was unnecessary for the Allies to stage a major counter-air program. However, on the 13th some 180 P-38's of the Fifteenth Air Force and P-47's of XII TAC dive-bombed and strafed seven airdromes in the Rhone delta and northern Italy with great success, claiming the destruction of eleven enemy aircraft, the possible destruction of four, and the damaging of twenty-three. The Allied fighters lost ten planes and had twenty-four damaged, most of the casualties being attributed to flak. On the same day thirty-one P-38's of the 82d Fighter Group bombed Montelimar airfield—which was reported to have the largest concentration of Ju-88's in southern France—and strafed three guns of a coast-watcher station into silence. Forty-eight Wellingtons and two Liberators of Strategic's RAF 205 Group topped off the activities of the 13th with a night attack on the port of Genoa.

On the 14th (D minus 1) both MATAF and MASAF struck hard at all four of the target areas in a final pre-invasion assault on coastal defenses, guns, radar stations, and airfields. Tactical's mediums concentrated on the beach area, 144 B-25's and 100 B-26's bombing a total of nine gun sites with good results. Fighters and fighter-bombers of XII TAC hit radar installations around Marseille and strafed guns at numerous coast-watcher and radar stations in the invasion area. Heavies attacked gun positions: 306 B-17's and B-24's put fourteen out of thirty-six positions completely out of commission in the Toulon area, while 205 Liberators obtained good results on seven out of sixteen positions around Genoa. That night the air preparation was brought to a close when Wellingtons and Halifaxes attacked shipping and docks at Marseille and A-20's of the 47th Bombardment Group dropped frag bombs on three airdromes in southern France. Over-all totals showed 5,400 effective sorties, divided about equally between Strategic and Tactical, and 6,700 tons of bombs.<sup>49</sup>

Because of the loss of the 10th as a day of operations, together with the extra effort of the 14th against defenses in the actual assault area (which was required when assessments indicated that earlier attacks had not achieved the desired results), NUTMEG had not been carried out strictly according to plan. But it was a most successful operation, not only because it severely damaged the enemy's defenses but because—as it was intended to do—it confused him as to the location of the

actual assault area. This confusion was multiplied on the night before D-day when two naval forces simulated assaults at Ciotat and between Cannes and Nice, the sectors being just beyond the two flanks of the actual invasion area. The deception was strengthened by the activities of three Wellingtons which simulated a convoy by flying three advancing elongated parallel orbits while dropping special packages of Window.<sup>50</sup> To add realism five C-47's of RAF 216 Squadron carried out an airborne diversion near Ciotat in the course of which they dropped quantities of Window, miniature parachute dummies, and exploding rifle simulators, while employing Mandril jamming in a manner similar to that used in a genuine airborne operation. The five planes met no opposition and carried out the mission effectively and accurately.<sup>51</sup>

Efforts to conceal from the Germans the actual landing area seem to have been quite successful. For the first two days after the invasion, enemy announcements credited the Allies with landings over a wide front and with having dropped thousands of paratroopers northwest of Toulon; prisoners of war stated that the fake landing around Ciotat had held mobile units in the area.<sup>52</sup> Too, the airborne diversion served as a nice screen for the real airborne operation which was taking place at the same time.

### *The Landings*

When, early in July, the decision had been made to invade southern France, the over-all military situation in Europe was not too favorable to the Allies. The campaign in northern France was behind schedule, and the Allies were stalled before Caen and the hedgerows around St.-Lô; the Russian summer offensive was just getting under way; in Italy, tightening enemy resistance south of the Arno was slowing down the previously rapid advance of the Fifth and Eighth Armies. But when the Mediterranean forces set sail for southern France the picture everywhere had brightened. Eisenhower's troops had broken through at St.-Lô, the German Seventh Army had been all but wiped out, and Patton's Third Army was sweeping toward Paris. The Russians were at Warsaw and the boundaries of East Prussia. The Allied armies in Italy were across the Arno and at the outer defenses of the Pisa-Rimini line. The effect of these Allied successes had been an appreciable weakening of the German defenses in southern France. Four complete infantry divisions, major elements of two others, and two full mobile divisions

had been pulled out and started toward the Normandy front. Their places had been only partly filled, and then by divisions of low caliber, so that when DRAGOON was launched the enemy had only six or seven divisions—most of them understrength—between the Italian and Spanish frontiers, a part of one division moving north near Bordeaux and one division in the Lyon-Grenoble area, already largely engaged with French resistance forces. Nor could the enemy hope to reinforce southern France. He was too heavily engaged on three other fronts to spare many troops, while the battered lines of communications below Lyon, together with MAAF's complete superiority in the air, insured that any troops which the Germans might in desperation send down would have little hope of reaching the threatened area in time or in condition to influence the battle.<sup>53</sup>

About the only thing the enemy had in his favor was a terrain well suited for defense—particularly in the area chosen for the assault, where the coast was rugged, with rocky promontories overlooking small beaches—and sizable coastal defenses. The latter advantage, however, had been appreciably reduced by the steady and severe pre-invasion air assault which MAAF's planes had directed against the defenses. Although the enemy had some 450 heavy guns and 1,700 light AA guns between the Italian and Spanish borders, most of them along the shore, only a small number were located in the area of the planned invasion and many of these had been knocked out or damaged by MAAF's bombers.<sup>54</sup> Thus, as the invasion fleet steamed toward southern France from its bases at Naples, Taranto, Oran, and other Mediterranean ports the Allies had every reason to feel confident that the landings would be accomplished and bridgeheads established without serious loss or delay.

As the convoys, fully protected by Coastal Air Force,<sup>55</sup> neared the coast in the early hours of 15 August, MAAF touched off the invasion with an airborne operation. "Covered" by the airborne diversion at Ciotat, screened by 8 planes operating transmitters designed to jam the enemy's radar, and protected by night fighters, 396 planes of Provisional Troop Carrier Air Division (PTCAD),\* loaded with more than 5,100 American and British paratroopers, took off from ten fields between Ciampino and Follonica on the west coast of Italy and flew to the

\* Commanded by Brig. Gen. Paul L. Williams, sent down from IX Troop Carrier Command in ETO especially to handle DRAGOON's airborne operations. PTCAD was composed of the Mediterranean theater's 51st Troop Carrier Wing and ETO's (Ninth Air Force) 50th and 53d Wings and IX TCC Pathfinder Unit. It was activated on 16 July, Williams having arrived on the 13th.

## THE ARMY AIR FORCES IN WORLD WAR II

initial point (IP) at Agay, east of Frejus, and thence to drop zones (DZ) close to the town of Le Muy, a few miles inland from Frejus. The airborne force had been preceded by pathfinder teams which, in spite of overcast and fog, had been dropped with great accuracy on the DZ's as well as on landing zones (LZ) which were to be used later by a glider force. The teams had set up Eureka beacons and lighted tees on each DZ and also beacons, smoke signals, and panel tees on the LZ's. Aided by these devices the planes carrying the paratroopers so effectively overcame the adverse weather conditions that troops from only twenty aircraft missed their DZ's by an appreciable distance, and they did so because of a mix-up in signals which caused them to jump two minutes ahead of the green jump light. The last of the paratroopers spilled out at 0514, almost three hours before the first wave of ground troops was scheduled to go ashore. At 0926, after weather had canceled an earlier mission, forty C-47's loosed an equal number of gliders, all but two of which landed on the LZ's.<sup>56</sup>

By the time this second airborne operation had been carried out the main invasion was well along. Before H-hour small forces had landed at two points where they cut communications and captured certain coastal positions, while still another force had gone ashore on the islands of Port Cros and Levant to neutralize defenses. Two of the parties met little opposition, but the third, a French demolition party, was discovered and almost wiped out.<sup>57</sup> Between 0550 and 0730 the air forces had attempted to lay a very heavy attack on the assault beaches (Operation YOKUM) to paralyze coast and beach defenses. Twelve groups of escorted heavies, Tactical's two wings of mediums, and the full resources of XII TAC participated, but one-third of their 959 sorties were aborted by a severe ground fog and haze over the target area. In the first phase of the assault, against guns, only the fighter-bombers were effective, and they only partly so, but the final bombardment—which was against the assault beaches—was more successful: underwater obstacles and beach defenses were destroyed or damaged, defending troops disorganized, and a number of coastal guns, previously missed, were covered.\* Devers called the bombing of the batteries “unbelievably accurate.” However, because of the weather the several beaches received very unequal treatment.<sup>58</sup>

\* In this operation the heavies, for the first time in the Mediterranean, took off in force during the hours of darkness. Their training had been brief but only six planes suffered take-off accidents.



## INVASION OF SOUTHERN FRANCE

In the course of the air assault the Navy moved in close behind mine-sweepers to throw thousands of projectiles of all types against the beach defenses.<sup>59</sup> The combination of aerial and naval bombardment severely damaged guns and obstacles, demoralized the enemy, and cut paths through the wire entanglements—but it was notably ineffective in exploding the mines which the Germans had sowed on the beaches.<sup>60</sup>

As a result of the air and naval bombardment the main landings—which began at 0800—met little opposition except on one beach. Most of the coastal batteries were silent, but there was some fire from small arms, mortars, and machine guns. Only a few casements and pillboxes had been destroyed but many had been neutralized by damage to observation posts and communications and by casualties and demoralization of personnel.<sup>61</sup> Allied casualties were very light; Lt. Gen. Alexander M. Patch and his corps commander, Maj. Gen. Lucian K. Truscott, credited the air assault with saving the ground forces “many losses.”<sup>62</sup> MAAF could also claim most of the credit for so misleading the enemy as to the time and place of the landings that the initial ground assault was opposed only by a single division of poor quality, for the almost total absence of the GAF which flew not more than sixty sorties in the invasion area in the whole of D-day, and for the inability of the enemy to move in reinforcements over routes blocked by MAAF’s bombers.<sup>63</sup>

Beginning at H-hour, and until 1940 hours, USAAF P-38’s and P-47’s attacked gun positions in the assault area, then flew patrols over the beaches; in the latter operation they joined Spitfires of three RAF wings which were flying continuous patrols. From 0815 to 2000 hours fighter-bombers attacked strongpoints and road bridges between Nice and Hyères, flew armed reconnaissance over the area from Cannes to Toulon where they strafed and bombed troops, guns, and vehicles, and attacked targets reported by controllers. During the afternoon heavies first bombed coastal defenses along Camel Red Beach (264A) where the enemy’s defenses had remained sufficiently intact to thwart the attempted landing (which eventually took place over another beach), then joined with mediums and fighter-bombers in an assault on bridges as a part of the over-all plan to isolate the battlefield. They knocked out or damaged a large number of road bridges, which, with the damage inflicted on rail bridges before D-day, made it extremely difficult for the Germans to reinforce the battle area. For all of D-day MAAF flew 4,249 effective sorties, of which 3,936 were in direct support of the

landings.\* It was the greatest one-day air effort in the Mediterranean to date.<sup>64</sup>

Profiting from lessons learned at Salerno and Anzio, MATAF had divided among several ships the control of its fighters and fighter-bombers. Offensive fighter-bomber missions were controlled from USS *Catoctin*, posted off the assault area, where personnel of the Navy and of the 2d Air Combat Control Squadron (Amphibious) handled the aircraft by direct contact; data for the planes came fresh from flash reports made by tac/recce pilots, carrier planes, and returning fighter-bomber missions and from the ground forces. The *Catoctin* also handled air-raid warnings, furnished information on movement and status of planes, and served as stand-by for fighter direction. The control by the ship of offensive operations proved most effective, permitting full use of fighter-bombers by diverting them to more lucrative targets and at the same time protecting Allied troops from being bombed when the fluid ground operations suddenly placed a briefed target inside the bomb safety line. The system continued in use until noon of D plus 4, at which time XII TAC Advance, then established ashore, took over the direction of fighter-bomber and tac/recce operations. Similarly, defensive fighter operations on D-day were directed by Fighter Control Ship No. 13 (a converted LST), flanked by two LST's with GCI which passed plots to No. 13. Brig. Gen. Glenn O. Barcus, commanding general of the 64th Fighter Wing, with other AAF personnel directed all defensive operations except those by night fighters which were handled by RAF controllers. The system worked extremely well and was continued until a complete sector operations room (SOR) had been established ashore; on D plus 7 the SOR took over control of day fighters, and on D plus 10 of night fighters.<sup>65</sup>

Aided—as well as protected—by MAAF's tremendous operations the ground forces quickly consolidated their several beachheads, then moved inland. At the end of D-day all positions were secure, and the 45th Division had pushed close enough to Le Muy for its patrols to contact the airborne troops. The latter had been strengthened during the afternoon by a paratroop drop from 41 planes and by two glider missions, the second of which (Operation DOVE) was the main glider

\* The figure includes 117 sorties by fighters and fighter-bombers from two U.S. escort carriers and an undetermined number of sorties from seven British escort carriers. (Report of Naval Comdr., Western Task Force, Invasion of Southern France, 29 Nov. 1944; U.S. Eighth Fleet, Action Report of Comdr. TG 88.2 for Opn. DRAGOON, 6 Sept. 1944.)

operation of DRAGOON, involving 332 towed gliders and 2,762 paratroopers. The three missions, like the two which preceded H-hour, were well executed; losses were extraordinarily small, and no plane was lost to enemy or friendly fire. In all of the day's missions Troop Carrier landed 9,000 paratroopers.<sup>66</sup> Airborne operations had come a long way since those unhappy days in Sicily.

On the night of D-day the air arm continued to harass the enemy, although without accomplishing anything of note. The following day, 108 heavies bombed four rail bridges in the upper Rhone Valley, with disappointing results. Mediums had much better luck with rail and road bridges between Livron and Tarascon. XII TAC's light and fighter-bombers put in around 1,250 sorties against concentrations, guns, barracks, communications, M/T, and road bridges; carrier-based planes added 96 fighter-bomber and 32 fighter sorties against M/T and trains, chiefly in the Rhone delta. Fighters flew about 700 sorties on escort, patrol, and reconnaissance missions. XII TAC's operations against communications were principally in the Durance Valley and were designed to halt enemy reinforcements which might cross the Rhone north of Avignon or might come down from Grenoble.<sup>67</sup>

The Seventh Army, enjoying the protection of complete air supremacy and meeting only scattered ground opposition, swiftly overran southeastern France. Its advance was so rapid that it left its supplies behind, and on the 16th and 17th a total of thirty-nine Troop Carrier planes dropped 123,000 pounds of rations, gasoline, and ammunition to the troops.<sup>68</sup> MAAF's bombers had so badly broken the enemy's lines of communication that he could not bring up reinforcements, while his hope of effective resistance was further lessened when the rapid advance of the Allies further separated his already scattered divisions and drove them into isolation.<sup>69</sup>

Throughout the first week of DRAGOON, the air arm continued to protect convoys and the assault area, to coordinate effectively with the rapidly advancing ground forces, and to attack the enemy's lines of communication. Now that the German U-boats no longer posed a serious menace, it was easy for Coastal to take care of convoys, night fighter defenses, enemy submarines and reconnaissance planes, and air-sea rescue. XII TAC worked offensively almost entirely against guns in the bridgehead area and communications targets immediately beyond the battle line; defensively, its Spits, P-38's, and P-47's (with carrier planes protecting the Aircraft Carrier Force) maintained high, medi-

## THE ARMY AIR FORCES IN WORLD WAR II

um, and low cover, with from twenty-eight to thirty-two planes constantly on patrol. Extremely light activity by the GAF and the swift advance of the ground troops resulted on D plus 5 in a reduction of defensive patrols; in fact, by D plus 6 the situation was so favorable that the two P-38 groups on loan to XII TAC from the Fifteenth were returned to their Italian bases. Meanwhile, on D plus 4, engineers had finished their first fighter field and units of XII TAC were beginning to fly from southern France.<sup>70</sup>

So pronounced was the weakness of the GAF that MAAF directed little effort toward enemy airfields. On D-day and D plus 1 it ignored the fields except for one unsuccessful strike by Wellingtons on Valence/Trésorerie and occasional passes by fighters while on armed reconnaissance missions. On D plus 2, fighter-bombers of U.S. 14th, 27th, and 86th Fighter Groups and the FAF 4th Group diverted considerable effort to counter-air operations, as a result of which they claimed the destruction of eighteen aircraft and the damaging of sixteen. On D plus 3 and 4 the fields again were ignored, but on D plus 5, thirty-five B-25's dropped ninety-five tons of bombs on Valence/Trésorerie. On D plus 6 (21 August), General Saville requested that fields east of the Rhone and south of Lyon not be bombed as he expected to use them "very shortly." Actually, there was no need for further attacks, for the combination of earlier bombing plus the rapidly deteriorating ground situation had forced the GAF by the 19th to withdraw its units. After that date there appear to have been only about fifteen single-engine fighters within range of the Allied ground troops; certainly Seventh Army was not bothered by enemy air activity.<sup>\*71</sup>

In the first week of DRAGOON—the period of consolidation of the beachheads and initial inland penetration—MAAF's mediums continued to work principally on communications. Saville stressed the importance of knocking out bridges across the Rhone and keeping them knocked out; on the 20th, for example, he declared that the ground forces had the situation under complete control and could keep it that way if the air forces would maintain the interdiction of the crossings over the Rhone and the Alps. Attacks on communications initially had been designed primarily to stop the movement of reinforcements to the east side of the Rhone—and there they had been wonderfully successful—

\* There is no better proof of the incredible weakness of the GAF over southern France than MAAF's claims of enemy aircraft destroyed in combat between 10 August and 11 September: ten certain, two probable. (MAAF, Operations in Support of DRAGOON, XI, 4.)

## INVASION OF SOUTHERN FRANCE

but as the ground campaign resolved itself into a pursuit of the Germans, air operations shifted to those bridges and other targets whose destruction would best aid the ground forces to trap the enemy's scattered, retreating divisions. Strategic, having returned after 16 August to CBO objectives, did not participate in this campaign. B-25's of the 57th Wing handled most of the operations, largely because the B-26's, after attacking five bridges with notable success on 17 and 18 August, had to be used for a time against troublesome gun positions which were holding up the capture of Toulon and Marseille. Between 17 and 20 August the B-25's attacked some nine bridges, damaging all of them but leaving completely unserviceable only those at Tussilage and Valence. Their efforts, together with the damage levied in pre-D-day attacks, permitted General Cannon to report that all but one of the rail bridges south of Valence were unserviceable and all road bridges except one at Avignon were cut.<sup>72</sup>

The mediums' bridge-busting program was interrupted on the 21st and 22d when they were diverted to a series of attacks on communications north of Florence in an effort to prevent enemy movement from that area to the battle front in Italy. Since the launching of DRAGOON, DAF alone had handled operations against supply lines in northern Italy, and although it was doing a good job it had to divide its strength among patrols, close support, communications, and other missions so that it lacked the power to create the degree of interdiction needed by the Fifth and Eighth Armies as they pushed slowly across the Arno and Foglia rivers toward the Gothic Line.<sup>73</sup> After the attacks on the 21st and 22d the mediums returned to southern France where, in spite of being required to lay on additional attacks back of Kesselring's troops and the presence of some unfavorable weather, they managed in the next week to damage or knock out several bridges.<sup>74</sup>

At the end of the first week of DRAGOON the direction of enemy traffic had been reversed: troops no longer were moving south as reinforcements but were moving north in an effort to escape. During the next week the battle line was so completely fluid that MATAF's planes could not be used for close support, but its fighters and fighter-bombers, many of them flying from bases in southern France, had a Roman holiday against the enemy's fleeing troops. The hurrying, crowded German columns, given no protection by the Luftwaffe and hindered by broken bridges, were easy targets, and the Allied planes, bombing and strafing almost constantly during the daylight hours, cut

them to pieces and wrecked their transport. On the 25th, Saville reported that in the previous two days around 400 M/T had been destroyed; for the period 23-29 August, XII TAC claimed the destruction of 1,400 M/T, 30 locomotives, and 263 rail cars.\* The heaviest toll was taken along Highway 7 in the bottleneck between Montelimar and Valence where Seventh Army on 31 August reported 2,000 destroyed vehicles in a thirty-mile stretch.<sup>75</sup>

During the last week of August, XII TAC's planes flew just over 3,000 offensive sorties, to which number Navy planes added 250 before being withdrawn from DRAGOON at the end of the 29th. XII TAC's sorties were only about half of the number flown during the previous week (15-22 August), the decline being caused by a considerable reduction in defensive patrols, the withdrawal of the two P-38 groups on the 20th (they were no longer essential to DRAGOON, while the Fifteenth, seriously understrength in its P-38 groups, needed them), and by the fact that by the 25th the fleeing Germans were beyond the range of Corsica-based planes. The number of sorties would have been even smaller but for fine work by aviation engineers in making available a number of fields on the mainland and equally fine work by air service command in stocking the fields with gasoline, bombs, and other essential items which enabled MATAF to move its fighters and fighter-bombers ashore with great rapidity.<sup>76</sup>

By 25 August, it appeared that the German Nineteenth Army might be encircled. Saville, in agreement with Patch, then correctly reversed his earlier position which had called for heavy attacks on bridges. On the 25th and 27th, he asked that MATAF no longer bomb the Rhone bridges; on the 30th, he insisted that the mediums not be sent over southern France, for the Seventh Army did not want additional cuts in communications. "Any bombing in France now within range of medium bombers," he said, "hurts us more than the Germans."<sup>77</sup> Too, he preferred that his fighters be employed in offensive operations, not in escort. While Saville was protesting against the further use of mediums against bridges, the enemy's fleeing Nineteenth Army had reached the Lyon area whence it would pass eastward. Coming up from southwestern France was a hodgepodge of some 100,000 enemy troops who hoped to escape through the narrowing gap between the Seventh Army on the south and the Third Army to the north. Allied air forces operat-

\* During the previous week while the Germans were moving south TAC's claims were 843 M/T, 42 locomotives, and 623 rail cars. The jump in M/T from 843 to 1,400 indicated the effectiveness of MAAF's program of knocking out rail bridges.

## INVASION OF SOUTHERN FRANCE

ing from the United Kingdom and northern France had undertaken to hamper this movement by creating a belt of rail interdiction from Nantes eastward to northwest of Dijon. On 30 August, Cannon informed Saville that the medium bomber operations from Corsica and Sardinia were designed to supplement the northern line of interdiction but that, except for operations of that type, no further missions by mediums would be scheduled for southern France unless specifically requested. Actually, DRAGOON already had moved beyond the effective range of mediums on Sardinia and Corsica, so that after the 28th only XII TAC operated against the fleeing Germans.<sup>78</sup>

In the midst of the Cannon-Saville exchange of messages the Allies took Toulon and Marseille. It had been assumed during the planning stage that the two cities would not fall before D plus 40, but the combined efforts of French Army B, MATAF, and the Western Naval Task Force turned the trick on D plus 13 (28 August). Toulon and Marseille had good defenses and determined garrisons; in particular, their coastal guns were a serious threat to the Navy, so that it was necessary for both the air and naval forces to lay on pulverizing bombardments. On the 17th and 18th, a total of 130 B-26's pounded guns at Toulon; on the latter day, 36 B-25's of the 321st Bombardment Group sank the battleship *Strasbourg*, a cruiser, and a submarine. For the next several days air operations in the Toulon area were closely coordinated with the Army. Mediums and fighter-bombers struck at gun positions, most of which were on the St.-Mandrier peninsula; the heaviest attack was on the 20th when B-26's flew 84 sorties and fighter-bombers approximately 120. This was MATAF's last major effort over Toulon, but in the next week the Navy hurled hundreds of tons of shells against guns on the mainland and on near-by Île de Porquerolles. After Toulon fell on the 28th, examination revealed that the combined air and naval bombardment had done little harm to personnel (who were protected by underground shelters) but had badly damaged surface communications and had knocked out numerous guns. According to a German admiral captured at Toulon, it was the aerial bombing rather than the naval and artillery fire which broke up the defenses of that city.<sup>79</sup>

As part of a three-way assault on Marseille fighter-bombers on 20 and 23 August attacked with more than a hundred 500-pound bombs coastal guns on Île de Ratonneau and Île de Pomegues, two islands which dominated the seaward approaches to the city. When the guns continued to interfere with Allied operations Cannon ordered heavy

## THE ARMY AIR FORCES IN WORLD WAR II

attacks on the 24th and 25th against Ratonneau. The mediums' effort effected excellent concentrations but no direct hits on primary targets. Concurrently, the Navy shelled both islands. When they continued to hold out, MATAF and the Navy increased the tempo of assault. On the 26th, eighty-five B-26's plastered Ratonneau; next day ninety-three B-26's and fifty-eight B-25's hit the island, while eighteen B-25's bombed Pomegues. On the 29th the two tough islands surrendered, thus clearing the approaches to Marseille, which had capitulated the previous day.<sup>80</sup> The immediate objectives of DRAGOON had been accomplished; Eisenhower had his ports.

By 1 September those units of XII TAC which still remained on Corsica had returned to the Italian campaign. The others had moved to fields in southern France—only to find that the front line again had all but moved out of range. The enemy had squeezed through the Montelimar-Valence bottleneck, and had hastily abandoned Lyon (3 September). By the 6th the pursuing French were within twenty miles of Belfort and the Allies again were in position to trap the enemy between the Seventh and Third Armies before he could slip through the Belfort Gap, his last avenue of escape. But the desperate Germans struck back at the French on the east flank below Montbéliard, drove them from their forward positions, and stabilized one end of the battle line long enough to permit an orderly withdrawal and the establishment of a defensive line west of Belfort. The action ended the pursuit phase of the campaign in southern France.<sup>81</sup>

In this last swift, fluid stage the task of hammering the fleeing Germans fell entirely to units of XII TAC, for—as noted above—MATAF's mediums, after their attacks of 28 August on bridges, had returned to the Italian battle.\* TAC's units moved forward as rapidly as aviation engineers could restore enemy airfields to use; by 3 September many of the coastal fields had been left behind while fields as far north as

\* In the month of August, MAAF's Strategic and Tactical Air Forces in operations over Italy, France, and the Balkans, piled up a great record. Strategic's bombers operated on thirty out of thirty-one days, Tactical's were out every day. Together they flew around 53,000 sorties, in the course of which they claimed to have destroyed or damaged 27 oil refineries and synthetic plants, damaged 9 aircraft assembly plants, destroyed or damaged 400 enemy planes on 22 fields, cut 150 rail and 75 road bridges, destroyed or damaged 330 locomotives and 1,100 cars in 60 yards, and destroyed or damaged 1,500 motor vehicles. In the process Strategic lost 2,426 aircrewmembers and Tactical 316, which was more than the number of Fifth and Eighth Army men killed in the same month. (See CM-IN-1631, AFHQ to WD, 2 Sept. 1944, and ltrs., Eaker to Arnold and Eaker to Giles, 31 Aug. 1944.)



## INVASION OF SOUTHERN FRANCE

Valence had been occupied and were in use; between 6 and 15 September planes were based on fields throughout the Lyon area.<sup>82</sup> From these, TAC's planes steadily bombed and strafed the enemy's columns. The roads were congested, the enemy disorganized, and there was no opposition from the GAF; Tactical's fighters and fighter-bombers were hindered only by some bad weather and by the time lost in moving to new fields. The toll of enemy M/T ran into the thousands, of locomotives and rail cars into the hundreds. The destruction of personnel was great—but just how great cannot be determined with complete accuracy.<sup>83</sup>

On the night of 10/11 September, French troops from Eisenhower's armies met other French troops from Patch's; on the 12th there was a continuous front from the Channel to Switzerland. On the 15th the Seventh Army and French Army B became 6th Army Group, XII TAC moved from the operational control of MATAF to that of USSTAF and Ninth Air Force, and the responsibility for DRAGOON passed from SACMED to SHAEF.<sup>84</sup>

The invasion of southern France was the last of a long series of triphibious operations in the Mediterranean—North Africa (TORCH), Pantelleria, Sicily, southern Italy, Anzio, and Elba. None was more swiftly or completely successful than was DRAGOON. Certainly the weakness of the enemy—who not only had inadequate ground forces but lacked any real semblance of air and naval strength—was in large measure responsible for the ease with which DRAGOON was executed. But no less certainly was its success predicated upon planning, preparation, and execution based on tested doctrines and upon the wise application of the many lessons learned in the half-dozen invasions which had preceded it. TORCH and its exploitation hammered home for all time the absolute need for sound logistics and ended the old wasteful system of parceling out tactical air power among small ground units. The conquest of Pantelleria produced valuable lessons on aerial pinpoint bombardment of gun positions and demonstrated the importance of pre-invasion air attacks on a defended area. Sicily taught the value of a pre-invasion counter-air offensive, showed the promise of airborne operations, and brought near to perfection the methods of close air-ground cooperation. The invasion of Italy gave experience in rapid airfield construction immediately behind the battle line, pointed up the utility of cover plans, and showed—even more clearly than Sic-

ily--the importance of aerial isolation of the battle area. Anzio was the final pre-DRAGOON proving ground for the closely knit air, ground, and naval assault team and the final demonstration of the lesson learned at Salerno: that a serious ground situation can be saved by genuine air superiority.

So it was that DRAGOON was easy, not only because the enemy was weak but because the Allies had added to their superiority in men and materiel the lessons learned in earlier invasions.

## CHAPTER 13

\* \* \* \* \*

### *BATTLE OF NORTHERN ITALY*

**D**URING the late summer of 1944 the military situation in Europe was everywhere favorably inclined toward the Allies. In the east, Russian armies were overrunning the Nazi-dominated Balkan states. In France the swift conquest of the territory between Normandy and the Moselle River, coupled with the almost unbelievably rapid advance of Seventh Army up the Rhone Valley, had pushed the enemy back to the very borders of Germany. In Italy, too, after a pause at the Arno River to regroup, the Allied armies had renewed their offensive on 26 August and by 21 September had breached the vaunted Gothic Line.

However, the new offensive in Italy did not proceed with the vigor that had characterized the spring and summer fighting. The rapid pursuit of a fleeing enemy which had featured *DIADEM* came to an end as extended supply lines, demolitions, and stiffening German resistance slowed the movement of Allied troops. After pushing across the Arno and breaking through the Gothic defenses the Italian campaign bogged down. It became, during the winter of 1944-45, an unpleasant replica of the previous winter's experience as the open country of central Italy, suitable to a war of movement, gave way to the mountainous country of the northern Apennines. Furthermore, the dramatic rush of the Seventh Army up the Rhone Valley had been made at the expense of the Italian campaign, both in ground and in air resources. France, long since chosen as the decisive combat area in Europe, henceforth would be of such overriding importance that the battle in Italy would have to get along on whatever remained after the requirements in France were met.<sup>1</sup>

Indeed, movement of the entire Twelfth Air Force into France was repeatedly under discussion from midsummer to the close of 1944. It

had been planned at the end of July that after DRAGOON was well along the Twelfth would follow Seventh Army into southern France, where eventually it would pass to the control of SHAEF,<sup>2</sup> and until the last week of August planning went forward on that basis.<sup>3</sup> At that time the British expressed grave concern over the proposed move, insisting at a supreme Allied commander's meeting on 20 August that such a move would not leave adequate air resources, especially in the category of medium bombers, in the Mediterranean. It was also pointed out that there was no authority from the Combined Chiefs of Staff to turn the Twelfth Air Force over to SHAEF. General Eaker, feeling that no decisive action could be expected in the Mediterranean and fearing that the air and ground troops would stagnate if the Italian front became static, advised Arnold on the following day to support in the CCS the plan to move the Twelfth out of Italy and recommended that the Fifth Army be moved to France to reinforce General Devers' 6th Army Group.<sup>4</sup>

By the end of August, however, the ground situation in Italy had taken a hopeful turn. Eighth Army's offensive on the Adriatic flank, which began on 26 August, initially met such success that the prospect of breaching the German defenses during the next phase of the operation, when Fifth Army would launch a drive toward Bologna, looked good.<sup>5</sup> Thus, Fifth Army, on the basis of its current commitments alone, would be required in the Mediterranean at least for the next several weeks. Accordingly, late in August, Generals Wilson, Eaker, and Spaatz, meeting in the Mediterranean to discuss the allocation of air forces between southern France and Italy, agreed that so long as U.S. ground forces remained in Italy the bulk of the Twelfth Air Force should also remain but that a few of its air units, already operating in France as XII TAC, would stay with 6th Army Group. Settlement of the ultimate disposal of the Twelfth should be postponed until the outcome of the current offensive was known.<sup>6</sup> The decision of course actually belonged to Eisenhower, who was advised on 6 September by General Marshall that he should not hesitate to draw on the Mediterranean for such additional air resources as he felt were needed.<sup>7</sup> Eisenhower agreed that for the moment neither ground nor air elements should be moved from Italy, but he recommended that the Twelfth be moved to France as soon as practicable. As an interim measure, the Ninth Air Force should assume operational control of Headquarters XII TAC together with one of its fighter-bomber groups, one tacti-

cal reconnaissance squadron, and corresponding service units, which, when reinforced by units from ETO, would serve as the air arm for 6th Army Group. All other units of XII TAC and XII Air Force Service Command currently in France would remain with the Twelfth and would be returned to Italy as soon as the Ninth was in position to assume full responsibility for air support of the armies in southern France. According to Eisenhower's recommendation, the Ninth would assume operational control of XII TAC on 15 September, the date on which operational control of DRAGOON forces would pass from AFHQ to SHAEF.<sup>8</sup> The Combined Chiefs of Staff immediately gave their approval to these proposals.<sup>9</sup>

As the Combined Chiefs assembled with their respective heads of state at the OCTAGON conference in the second week of September, the British chiefs renewed their advocacy of a continuing offensive through northeastern Italy and into the Balkans. U.S. chiefs, influenced by the favorable situation in Italy, agreed to postpone for the time being any further major withdrawal of their forces, but they continued to oppose pursuing the campaign into northeastern Italy and on into the Balkans, where they felt no decisive action could take place. Instead, they recommended that as much of Fifth Army as could be profitably employed in the attack against Germany be transferred to France as soon as the outcome of the current battle in Italy was certain.<sup>10</sup> The Combined Chiefs agreed finally that no further major withdrawals would be made from the Mediterranean until the outcome of the current offensive was known, after which the redeployment of the American Fifth Army and Twelfth Air Force would be reconsidered. In these August and September discussions regarding the redeployment of American forces in Italy, the U.S. Fifteenth Air Force had come in for very little consideration, it being generally agreed that at least for the moment the Fifteenth could best perform its strategic mission from its bases in the Foggia area.<sup>11</sup>

Later in the fall of 1944, as the Italian offensive lost its momentum, American leaders again pressed for the move of the Twelfth Air Force. In December they even suggested the advisability of moving the Fifteenth Air Force to France for a concentrated knockout blow against Germany.<sup>12</sup> But, because of the difficulty of supporting additional units in France and the lack of suitable airfields there, the continuing close support requirement for Fifth Army in Italy, and the proximity of the Fifteenth's Foggia bases to German industrial targets, both the Twelfth

and Fifteenth Air Forces were destined to remain in Italy until the final victory. Not until February 1945 did the CCS finally decide to reduce the Italian campaign to a holding effort and to transfer the bulk of Mediterranean resources to France.<sup>13</sup> Because of the swift denouement of the war, the move was never completed. Instead, in April 1945, 15th Army Group (formerly Allied Armies in Italy) and MAAF once again combined their resources in a shattering offensive which culminated in the complete defeat of the Germans in Italy.

### *Breaking the Gothic Line*

Air power was a vital factor in bringing about the final defeat. In fact, during the closing months of the war it was by far the most potent Allied weapon in the Mediterranean.\* From late August through late October 1944, when it seemed that Kesselring had no alternative but to retire across the Po, the air forces operated under a double-edged strategy: they created a series of blocks in the enemy's escape routes by knocking out bridges and other elements on his rail and road lines, and then combined their efforts with those of the ground forces in an attempt to drive the enemy back against these blocks where he could be annihilated.

The Po River constituted the first and most dangerous trap for the enemy should he be forced to withdraw from his mountain defenses. The MALLORY MAJOR operation of July† had proved that the permanent crossings over that river could be interdicted, and although their earlier destruction had been designed to separate the enemy from his major supply dumps, their continued destruction could now serve to hamper him in any attempt to withdraw. Consequently, the main striking power of MATAF, as it shifted back to Italy from southern France late in August, was devoted to two primary tasks: close support of the armies and interdiction of the Po.<sup>14</sup>

During the early stages of the ground-air offensive, from 26 August through 8 September, Desert Air Force handled the close support commitment. When XII TAC had been withdrawn from Italy in July for the approaching invasion of southern France, DAF had been given the responsibility for air action on both Eighth and Fifth Army fronts;

\* The ground forces, short on manpower and ammunition, were not able to generate an offensive until April 1945, while the Navy's functions were "largely auxiliary to the other two forces." (Report by Field-Marshal The Viscount Alexander of Tunis on the Italian Campaign, 12th December 1944-2d May 1945, draft, p. 6.)

† See above, pp. 403-5.

then, on 10 August, coincident with the opening of the pre-assault phase of DRAGOON, it also had assumed responsibility for communications targets in the area bounded by the Genoa-Pavia railway on the west and the Po River on the north (both inclusive) and the east coast.<sup>15</sup> During a period of relative quiet on the Italian front (4-25 August) and while MATAF's other elements were busily engaged with the invasion of southern France, DAF had worked largely to soften the Gothic Line defenses and disrupt enemy lines of communication immediately beyond the front lines.<sup>16</sup> When Eighth Army began its assault against the left flank of Kesselring's forces on 26 August almost the entire effort of DAF was concentrated in direct support of the advance. On the opening day DAF flew approximately 664 sorties, the majority of which were flown against defenses guarding Pesaro, the eastern terminus of the Gothic Line.<sup>17</sup> Day and night operations set the pattern for DAF's day-to-day close support operations as Eighth Army closed in on Pesaro (which was entered on the 31st) and penetrated the Gothic Line. While Kittyhawks, Mustangs, and Spitfires maintained pressure against tanks, troops, and guns, Marauders and Baltimores attacked fortifications between Pesaro and Rimini and marshalling yards at Cesena, Budrio, and Rimini. By night Bostons and Baltimores attacked communications in the Rimini, Ravenna, Forlì, Prato, and Bologna areas as well as defenses south of Rimini while night fighters flew defensive and battle-area patrols. On three consecutive nights, 26/27, 27/28, 28/29 August, Wellingtons and Liberators from SAF's 205 Group pounded enemy troop and equipment concentrations in support of Eighth Army's attacks on Pesaro.<sup>18</sup>

Meantime, MATAF's two bombardment wings and those units of XII TAC which were still based in Corsica had returned to Italian targets. By 21 August, XII TAC had begun to divide its effort between southern France and Italy, and by the last week of the month the campaign in southern France had passed beyond the range of its Corsica-based planes; then the 57th and 86th Fighter Groups, the 47th Bombardment Group, and the FAF 4th Fighter Group (until the latter two were moved to France early in September) turned to Italy altogether.<sup>19</sup> As for the mediums, it was obvious by the last week of August that their attacks on bridges in the upper Rhone Valley were hampering Seventh Army's advance more than they were hindering the German retreat,<sup>20</sup> so after 28 August the mediums, too, returned to Italian targets. In addition, by late August the 350th Fighter Group had been

TWELFTH AIR FORCE  
31 AUGUST 1944

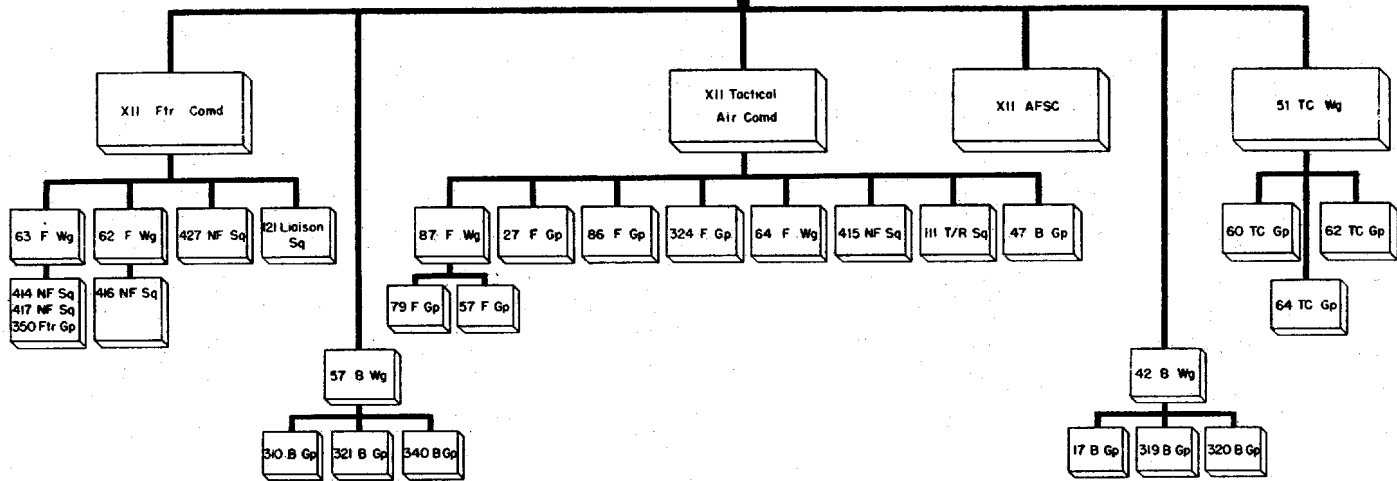



## BATTLE OF NORTHERN ITALY

re-equipped with P-47 type aircraft (from P-39's) and had turned from its defensive coastal role to offensive operations in Italy.<sup>21</sup>

Owing to the necessity for concealing the main point of Fifth Army's attack, which was to be launched as soon as Kesselring had weakened his center to contain Eighth Army's threat to his left flank,<sup>22</sup> the medium bombers and the Corsica-based fighter-bombers, plus those of the 350th Group, concentrated until 9 September, when Fifth Army jumped off, on communications targets. The mediums struck in force at the Po River crossings with the dual purpose of nullifying the German repair efforts on permanent bridges knocked out during MAL-LORY MAJOR and of extending the interdiction of the Po westward. After 112 B-25's cut rail and road bridges at Casale Monferrato, Chivasso, and Torreberetti on the 3d and 99 B-24's destroyed the rail bridge at Ponto Logescuro just north of Ferrara (the bridge was too heavily defended for Tactical's low-flying aircraft) on the 5th, all crossings over the Po from Turin to the Adriatic were blocked. To strengthen interdiction at the Po, mediums struck at numerous other communications targets north and south of the river. In an effort to isolate the rich industrial area of northwest Italy, with its several enemy divisions, the bombers blocked traffic on the Milan-Turin line by destroying all five rail bridges over the Ticino River between Lake Maggiore and the Po and maintained a block on the Milan-Verona line at Peschiera bridge. Fighter-bombers, meanwhile, concentrated on roads and rail lines leading to the Gothic Line; at the same time they supplemented the medium bomber's interdiction by keeping lateral rail lines north and south of the Po cratered.<sup>23</sup>

When Fifth Army opened its assault on 9 September, the mediums shifted their attacks on communications from the Po to railroads leading directly into Bologna with the object of isolating the battle area. On the 9th and 10th, B-26's created cuts on the four lines leading from Bologna to Piacenza, Rimini, Ferrara, and Verona.<sup>24</sup> But the bulk of both the fighter-bomber and the medium bomber effort was devoted to blasting a path through the Gothic Line for Fifth Army. Beginning on the 9th and continuing until a spell of bad weather began to restrict operations on the 20th, fighters flew approximately 240 sorties daily against bivouac areas, command posts, troop assembly areas, and supply depots in La Futa and Il Giogo passes, the focal points of Fifth Army's assault.<sup>25</sup> During the same period, medium bombers devoted the major portion of their daily effort to the two army fronts. This included 337

sorties flown on the 9th and 11th in Operation SESAME,<sup>26</sup> designed to neutralize selected enemy barracks, supplies, and gun positions which guarded both the Futa and Giogo passes. By the 12th, Fifth Army had overrun the SESAME targets,<sup>27</sup> and 113 B-26's and 33 B-25's bombed Firenzuola, the supply and communications center for enemy troops in the Giogo area, with devastating effect. Fifth Army's penetration then removed Firenzuola as a target,<sup>28</sup> and for the next two days *Marauders* and *Mitchells* shifted their efforts to defenses north of the passes.<sup>29</sup> 169 mediums bombed in the Futa Pass area on the 13th while on the following day the entire effort of the 42d Wing, consisting of 204 sorties, was devoted to enemy defenses on Mount Oggiolo and Mount Beni, both north of the Giogo Pass. Weather brought the operations of the mediums to a halt on the 15th; and although on the 16th, 132 B-25's divided 237 tons of 500-pound and 100-pound phosphorus bombs between Bologna M/T repair and supply depots, Budrio storage depots, and Casalecchio fuel dump—multiplying enemy supply problems on both army fronts—the bulk of medium bomber close support operations had already passed to the Eighth Army front.<sup>30</sup>

The offensive on the Allied right flank, which had begun so auspiciously on 26 August, soon was slowed down along the last mountain ridges guarding the approach to Rimini by determined enemy resistance and early September rains. By 6 September enemy troops holding the Coriano ridge had succeeded in stabilizing the line; moreover, in the first two weeks of September, Kesselring continued to concentrate troops opposite Eighth Army until some ten divisions had been grouped in the Rimini area. German defenders held firm until the Eighth launched an all-out assault on the night of 12/13 September, which, by overrunning Gemmano, San Savino, and Coriano—all key points on the ridge—forced the enemy to fall back toward Rimini. Although Eighth Army was now overlooking that city, a week of steady fighting, accompanied by sustained efforts by DAF and TAF's two medium bombardment wings, remained before the city was taken. At its strongest in mid-September, the formidable concentration blocking the advance of Eighth Army gradually weakened as Fifth Army's threat to Bologna became increasingly serious. Nevertheless, by temporarily stabilizing the line south of Rimini the enemy won an important strategic victory by denying Eighth Army entry into the Po Valley until fall rains prevented full exploitation of the breakthrough.<sup>31</sup>

During the period of hard fighting for Rimini, DAF's operations

were raised to new levels for sustained effort. They reached their peak on the 13th when aircraft flew more than 900 sorties and dropped in excess of 500 tons of bombs. The more than 800 sorties flown on the 14th paid particular attention to enemy movements which were increasingly noticeable. After a day of reduced effort on the 15th, DAF's operations rose to more than 700 sorties daily for the next three days, the majority of them devoted to Army demands. For example, on 17 September, Eighth Army troops had pushed forward to a heavily defended ridge, known as the Fortunate feature, which had to be stormed before Rimini could be invested; accordingly, from first light to 0745 hours on the 18th, DAF Kittyhawks and Spitbombers kept up ceaseless bombing and strafing attacks on guns, mortars, and strongpoints along the ridge in order to soften the opposition to the ground assault which followed. Close support missions, characterized by effective use of Rover Joe, were maintained throughout the day.<sup>32</sup>

On the 14th medium bombers threw their weight into the battle for Rimini. The rapid overrunning of Pesaro in the first week of the offensive had obviated the necessity for a medium bomber operation, planned since 25 August under the code name CRUMPET, against defenses and troop concentrations there.<sup>33</sup> After this operation had been called off, stiffening enemy resistance before Rimini presented an opportunity for adapting the plan to a new locality. In fact, medium bomber reinforcement of the DAF effort against the Rimini defenses had been requested and planned under the code name CRUMPET II since 5 September,<sup>34</sup> but owing to a period of unfavorable flying weather between 5 and 8 September and the heavy effort allocated to Fifth Army between 9 and 13 September, the operation was postponed until the 14th. Plans called for both wings of mediums to attack enemy troops, defenses, and gun positions on the hill feature three miles west of Rimini,<sup>35</sup> but as it was necessary for the 42d Wing to continue the pressure on the Futa Pass area, only the 57th Wing carried out CRUMPET II. In three missions its planes flew 122 sorties and dropped 10,895 x 20-pound frag bombs and 215 demolition bombs, totaling 163 tons, covering approximately 60 per cent of the target area. On the same day DAF Raiders and Baltimores flew eighty-four sorties against gun areas and defended positions outside Rimini.<sup>36</sup>

On the 15th weather grounded all mediums and limited DAF to some 500 sorties, but on the 16th and continuing for three days, DAF and the medium bombers laid on a heavy aerial assault. With CRUM-

PET II targets already occupied by the 16th, this medium bomber effort was applied to the area immediately north of the battle area, particularly along the banks of the Marecchio River. Marauders and Baltimores of DAF added their weight to the attacks on each day. Although bad weather on the 19th brought to a halt operations by the two bombardment wings, DAF Spitfires and light and medium bombers continued to attack in the Rimini area. On the 20th the weather completely deteriorated, bringing air operations to a virtual standstill for the next several days.<sup>37</sup> On the 21st the stubborn defense of Rimini was broken as elements of Eighth Army occupied the town. Gen. Sir Oliver Leese, commanding Eighth Army, expressed appreciation for the part played by the air forces in the assault, particularly their bombing of gun positions on the 16th and 17th, to which he attributed the negligible shelling received by Eighth Army in its attack on the 18th.<sup>38</sup>

The capture of Rimini coincided with Fifth Army's successful breaching of the Gothic Line at Giogo and Futa passes. As Fifth Army moved through the breach to the Santerno Valley the stage was set for the next phase of the second winter campaign: the assault on Bologna by Fifth Army and exploitation of the breakthrough into the Po Valley north of Rimini by Eighth Army.

At this juncture it was felt in Italy, as it was at SHAEF, that the end of the war was near. Early in September, General Wilson had expressed the hope that the combined offensive by Fifth and Eighth Armies would result in reaching the line Padua-Verona-Brescia within a few weeks, thus securing the destruction of Kesselring's armies and preventing their withdrawal through the Alpine passes.<sup>39</sup> This seemed a distinct possibility as Fifth Army continued to push toward Bologna and Eighth Army fanned out toward Ferrara, the immediate objectives of the current offensive. AFHQ Weekly Intelligence Summary optimistically reported on 25 September:<sup>40</sup> "There can now no longer be any question of the enemy's reestablishing himself on the line of the Apennines . . . tenacious as he is, Kesselring must now be exploring the prospects of conducting an orderly withdrawal." But Kesselring proved the optimists wrong. Taking every advantage of terrain and favored beyond measure by torrential early fall rains, he stabilized his line and forced the Italian battle into an extra round of seven months.

Until near the end of October, however, there was still hope that a breakthrough might be achieved. Consequently, interdiction of the Po, the first barrier to enemy movement, remained as MATAF's primary

communications objective,<sup>41</sup> and after the period of intensive effort on the Army fronts, 9-18 September, medium bombers returned to the Po River crossings and to communications targets in northwestern Italy. The few attacks leveled at Po River bridges during the last ten days of September were designed to inflict fresh damage on crossings already cut and to counteract the German repair effort. A notable operation was that of B-26's on the 26th when they completely destroyed a new bridge at Ostiglia after it had been in operation for not more than three days. At month's end, all except one or two road and rail bridges between Turin and the Adriatic were cut.<sup>42</sup> The success of these September attacks, coupled with the apparent German inability to keep pace with the destruction at the Po, permitted a considerable decline in medium bomber effort at this line during October. Five missions of 113 sorties were sufficient to maintain the interdiction of the permanent crossings until late in the month when the rail bridge at Casale Monferrato was restored to use. The mediums also kept the lateral lines north of the Po blocked at the line of the Ticino River and other points until the latter half of October when weather brought their operations almost to a full stop, allowing the Germans to repair some of the damage.<sup>43</sup>

In the meantime, both Eighth and Fifth Armies had continued to inch forward, the former supported—as always—by Desert Air Force and the latter by XII Fighter Command, formerly the AAF element of Mediterranean Allied Coastal Air Force. Owing to the recent and extensive ground advances in Italy and southern France and the disappearance of German air and sea threats in the Mediterranean, MACAF, charged since February 1943 principally with a defensive role, had lost much of its one-time importance.<sup>44</sup> MAAF, therefore, to absorb the loss of XII TAC and to provide a working partner for Fifth Army, withdrew XII Fighter Command from Coastal and reconstituted it on 20 September as a tactical air command under Brig. Gen. Benjamin W. Chidlaw. By mid-September, Fighter Command's 350th Group and three night fighter squadrons had been strengthened by the assignment of XII TAC units remaining in Corsica: 57th and 86th Fighter Groups and 47th Bombardinent Group (L), though the latter's air echelon was in France.<sup>45</sup>

Fighter Command was later augmented by units of XII TAC no longer required in France, although the return of these units was delayed until after the CCS on 16 September approved the split of the

Twelfth between Italy and France. Representatives from ETO and MTO then met in a series of conferences to work out the details of the division of units already in France.<sup>46</sup> The choice of combat units to remain with XII TAC was readily made, but the question of service units was complicated by the fast-moving campaign in France which had multiplied the problems of service, as well as of airfield construction, and had led naturally to higher demands on the Mediterranean for service and engineer units than had originally been anticipated. Too, the impending return to Italy of Twelfth Air Force units from France and Corsica limited the number of service units which leaders in the Mediterranean felt could be spared. Consequently, it was not until 27-28 September, at a conference at Caserta, that final agreements were reached regarding the division of air units between France and Italy.<sup>47</sup> By the terms of this agreement, Headquarters XII TAC, together with 64th Fighter Wing, the 324th Fighter Group, the 111th Tactical Reconnaissance Squadron, and fourteen supporting units were to remain in France; all other Twelfth Air Force elements were to return to Italy, the combat units by the 10th of October and the service units by the 15th. Consequently, early in October units began returning from France, and XII Fighter Command's operational strength was swelled by the addition of the 27th and 79th Fighter Groups. On 19 October the command, now composed of twenty-five squadrons, was officially redesignated XXII TAC\* and, fully established in Italy, assumed the character it was to keep for the next several months.<sup>48</sup>

Meanwhile, early in September, Fighter Command had begun to change from its old defensive function to its new offensive role, although not until it was reconstituted a tactical air command on 20 September did it officially assume responsibility for close-support operations on the Fifth Army front. DAF retained its responsibility for this function on the Eighth Army front.<sup>49</sup> This arrangement provided more intensive air efforts on both fronts. Yet the two air commands were mutually supporting when the situation required and when resources permitted, and in this regard, because there was a shortage of night intruder aircraft (always a serious problem in the Mediterranean)

\* XXII TAC had lost the 79th Group with its three squadrons to Desert Air Force and the 417th Night Fighter Squadron to Headquarters Twelfth Air Force, but compensating for these losses, and giving the command an international flavor, RAF 225 and 208 Tactical Reconnaissance Squadrons, 324 Wing with its four squadrons of Spitfires, and the Brazilian 1st Fighter Squadron had been placed under the operational control of the command early in October. Thereafter, the only significant change that occurred in the new TAC until February 1945 was the replacement of 324 Wing with SAAF 8 Wing in November, the RAF element reverting to DAF.

pending the return of the 47th Bombardment Group from France, DAF's 232 Wing operated over both armies. Although close support was the primary mission of Fighter Command and DAF, both were ordered to employ "the maximum force possible against communication targets compatible with the effort required for close support."<sup>50</sup> The communications for which the fighter-bombers had primary responsibility lay between the Po and the battle area from the Adriatic coast to Piacenza. The dividing line between Fighter Command and DAF was generally the inter-army boundary. Second priority was assigned the area north of the Po as far as Verona; here the boundary ran south from Verona along the Adige River to Legnano, thence due south to the Po River.<sup>51</sup> Actually, the dividing lines were not strictly enforced and by mutual consent each of the commands often operated in the other's area of responsibility.

On 20 September only the six squadrons of the 57th and 350th Fighter Groups and one night fighter squadron were in Italy. The remainder of Fighter Command's new strength was either in process of moving from Corsica or was in France awaiting replacements from the Ninth Air Force.<sup>52</sup> Nevertheless, the build-up of the command's combat strength,\* together with a break in the weather during the last six days of the month, allowed its planes to fly 457 missions, totaling 1,904 sorties, in the first ten days of its operation as a tactical air command.<sup>53</sup> These missions were devoted largely to support of Fifth Army as it pushed from the Futa Pass northward toward Bologna and northeastward toward Imola. In addition to attacks on troop concentrations, strongpoints, and storage depots, with particular emphasis on enemy positions along Highway 65 south of Bologna, fighter-bombers hit enemy communications in the Po Valley from the bomb safety line as far north as Lake Maggiore; especially hard hit were enemy rail and road communications from Bologna northward through Reggio and Piacenza. Furthermore, as the Germans made increased use of ferries and pontoon bridges over the Po at night to counteract the medium bomber bridge-busting program, fighter-bombers attacked reserve pontoons stored along the banks and potential bridge sites. But the German's clever use of camouflage made it difficult to locate the latter targets and the attacks were not particularly effective.<sup>54</sup>

\* Consisting of the 350th, 57th, and 86th Fighter Groups, 414th and 416th Night Fighter Squadrons, and the 47th Bombardment Group, reinforced by DAF's 7 SAAF Wing by month's end. The latter unit remained under Fighter Command's operational control only until 4 October.

DAF, likewise, was brought to a virtual standstill on five out of the last ten days of September by the unfavorable weather. Nevertheless, on the five operational days, it put in some telling blows for Eighth Army, which was driving along the narrow corridor between the mountains and the Adriatic. The fall of Rimini on 21 September widened the scope of DAF's operations, for after that date specific strongpoints, guns, and concentrations became fewer and the advancing ground troops had less need for saturation bombing and strafing of specified points. DAF, therefore, raised its sights to communications targets immediately beyond the front lines in operations intended to hinder enemy movements, regrouping, and bringing up of supplies. Its principal bridge-busting activities took place along the Savio River. In addition, fighter-bombers cut railway tracks with particular emphasis on those in the triangle Ferrara-Bologna-Ravenna, while light and medium bombers attacked marshalling yards on the Bologna-Faenza-Cesena route.<sup>55</sup>

During October the operations of all of MATAF's elements were severely restricted by the weather, which steadily worsened. Despite the restricting weather, aircraft from both DAF and XII Fighter Command (XXII TAC after 19 October) were airborne on every day of the month except one, although on seven days operations were held to less than 100 sorties a day. For the month DAF flew something over 7,000 sorties and XXII TAC about 5,000.<sup>56</sup> Although the bulk of these operations was devoted to the Eighth and Fifth Army fronts, some effort was applied to communications. In fact, DAF's attacks on communications continued to be closely identified with Eighth Army's advance as bridges across the Savio River, the enemy's next line of defense, absorbed a portion of the air effort on every operational day until 15 October when all of the bridges across that river, save one spared at Army request, were down; primary rail-cutting operations continued to take place south of the Po River along lines leading into the battle area, particularly those from Ferrara.<sup>57</sup> XXII TAC concentrated its communications attacks, which became more numerous after the middle of the month, in the Cremona-Mantova area and on rails and roads radiating north, east, and west from Bologna, with particular emphasis on the Bologna-Faenza rail line; roads were cratered most extensively between Ferrara and Parma. Farther to the west, its fighter-bombers cut rail lines in the Milan and Genoa areas. Late in the month, as fighting died down on the Fifth Army front, XXII TAC penetrated



the lower part of the Venetian plain where it hit rolling stock in the marshalling yards of Verona and Padua and cratered tracks on the lateral Verona-Brescia line. A considerable effort continued to be applied to the Piacenza-Bologna line south of the Po.<sup>58</sup>

The primary commitment of both commands, however, was assistance to the land battle. DAF devoted the largest share of its effort for the month to Eighth Army's advance, paying particular attention to troop and supply concentrations near the battle area; favorite targets were Cesena, until it was captured, and then Forlì, the Army's next objective. In addition, on the first four days of the month, its Kittyhawks and Mustangs and one Spitbomber wing flew most of their sorties over XXII TAC's area on behalf of Fifth Army's thrust toward Bologna.<sup>59</sup>

During the first half of October, XXII TAC had been busily engaged on the Fifth Army front. General Chidlaw had brought from XII TAC to his new command a thorough knowledge of the working arrangement that had existed between General Clark, Fifth Army commander, and General Saville of XII TAC, and he organized the new TAC to conform in principle to the old pattern. The same mutual respect that had existed between Clark and Saville soon existed between Clark and Chidlaw; air-ground relations were excellent, and close support operations on the Fifth Army front improved.<sup>60</sup> Nevertheless, and in spite of the fact that almost the entire effort of XXII TAC during the first eleven days of October was given over to support of Fifth Army's offensive, the adamant German defense held. And by holding, the Germans threatened to wreck the Allied strategy, which hinged on Fifth Army's breaking through the center of Kesselring's line and fanning out north of Bologna to form the left prong of the pincers which would catch the German armies in Italy. Eighth Army was already along the line of the Savio River and was slowly pushing toward Ravenna and Faenza, but Fifth Army, stopped some twelve miles south of Bologna by increasing German strength as Kesselring swung divisions away from the Adriatic flank to stem the threat to his center, was far from the breakthrough which was necessary to complete the strategic plan. Consequently, in mid-October, in far from favorable flying weather, MATAF and MASAF combined their resources in a new assault, given the name PANCAKE, which had as its object the destruction of enemy supplies and equipment in the Bologna area, the annihilation of enemy forces concentrated on the approaches to the

city, and the limited isolation of the battle area. The 42d Wing's B-26's, taking advantage of a break in the weather on the 11th, divided 1,000-pound and 500-pound demolition bombs among three road bridges and an ammunition factory. The peak of the operations came on the 12th, when 177 B-25's (out of 213 dispatched) dropped 1,011 x 500-pound bombs on four targets, including two supply concentrations, a barracks area, and a fuel dump, while 698 heavy bombers (out of 826) divided 1,271 tons of 20-pound fragmentation and 100-pound, 250-pound, and 500-pound bombs among ten assigned targets; unfortunately, only 16 out of 142 B-26's airborne were effective, most of the remaining 126 being unable to locate specified targets because of cloud cover.<sup>61</sup> During the three-day period XXII TAC flew some 880 sorties, concentrating on strongpoints, guns, troop concentrations, and occupied buildings in the battle area. Fighter-bombers also flew area patrols for the medium bombers but no enemy air opposition was encountered.<sup>62</sup> A Fifth Army G-2 summary described the air support provided on 12 October as eminently successful.<sup>63</sup> Assigned targets had been attacked in a timely, accurate, and most effective manner, thus aiding materially the advance of Fifth Army to take important positions. In addition, the air assault was credited with raising the morale of Allied soldiers and, conversely, with a demoralizing effect on the German defenders.

Unfortunately, Fifth Army, in its weakened condition and in the face of the bad weather, was not able to exploit fully the advantage gained by the air assault. U.S. II Corps made some progress; by 14 October it had occupied the southern half of the town of Livergnano on Highway 65. Nevertheless, the combined assault failed to take Bologna, although Fifth Army continued until the 26th a desperate attempt to break through the stubborn German defenses. From 14 through 20 October, when weather brought air operations to a virtual standstill, XXII TAC's aircraft flew more than 300 sorties a day in support of the assault.<sup>64</sup> By 26 October the weariness of the troops—they had been fighting steadily for six weeks—the shortage of replacements in the theater, the strength of the enemy, the status of available ammunition stocks, and the weather had combined to stop Fifth Army cold and there was no alternative but for it to pass temporarily to the defensive and make preparations for resuming its offensive in December.<sup>65</sup>

The weather was so bad during the last few days of the drive that it not only brought air operations virtually to a standstill but even blotted out artillery targets. Medium bombers, in fact, were grounded on all

but three days in the period 14 October–4 November, while XXII TAC's effort from 21 October until early in the next month was reduced to less than 100 sorties a day, save on the 25th.<sup>66</sup>

With the collapse of the offensive south of Bologna little hope remained of securing in the immediate future "the destruction of Kesselring's army by preventing its withdrawal through the Alpine passes." Even if the present line should be broken, the weather, which was swelling the rivers of the Venetian plain and making the mountainous country of northern Italy well-nigh impregnable,<sup>67</sup> militated against a successful campaign during the winter.\* This, however, left unchanged the mission of the Allied forces in the Mediterranean, which was to contain or destroy enemy troops.<sup>68</sup>

### *Revision of the Interdiction Campaign*

Throughout November, while Fifth Army was making preparations to resume its offensive in December, Eighth Army continued to maintain pressure against the Germans and to make some progress. DAF, assisted on occasion by MATAF's two medium bombardment wings, supported these operations. Forlì fell on the 9th, after DAF had devoted approximately 800 sorties to defenses in the area on the 7th and 8th, and 92 B-26's had bombed buildings, Nebelwerfer positions, and troop concentrations northeast of the town on the 7th.<sup>69</sup> Eighth Army's next objective along Highway 9 was Faenza, but before it could be taken it was necessary to establish a bridgehead over the Cosina River and then to exploit to the Lamone River. DAF, in addition to supporting the drive up to the Cosina, attacked roads and rails leading to the front lines. As a supplement to DAF's effort to isolate the battle area,

\* In view of the obvious difficulties of conducting a winter campaign in northern Italy, General Wilson, late in October, proposed that plans be made to take advantage of the favorable situation developing in the Balkans. It seemed that the Russian advances on the southeastern front would force the Germans to evacuate Yugoslavia, thus opening the Dalmatian ports to the Allies and giving them relatively easy access to Trieste and Fiume. He suggested therefore that the Italian campaign be halted as soon as his armies reached the Ravenna-Bologna-Spezia line; six divisions would then be withdrawn from the Italian battle, and in February 1945 be sent across the Adriatic and up the Dalmatian coast toward Fiume and Trieste as the right prong of a pincer movement (the left prong would be the forces remaining in Italy) which would trap Kesselring in Italy. The Soviet's Balkan offensive, however, swung from west to northwest late in October and the consequent German strength massed in northern Yugoslavia was far more formidable than Wilson had anticipated; furthermore, the decision that SHAEF would give the Germans no winter respite in France barred any relaxation of pressure in Italy. Consequently, late in November, Wilson cabled the CCS that his October proposal was no longer feasible.

the 57th Wing's 340th Group flew 114 effective B-25 sorties on 16, 17, and 19 November against bridges across the Lamone River at Faenza.<sup>70</sup> Beginning on 21 November and continuing through the 24th, B-25's turned their attention to three areas farther to the east in an effort to neutralize guns which could be brought to bear on 5 Corps troops crossing the Cosina River (Operation HARRY);<sup>71</sup> on three days, 21, 22, and 24 November (weather rendered an attempt on the 23d completely abortive), B-25's flew 262 effective sorties in the three target areas. During the four-day period, DAF devoted some 1,200 sorties to battle-area targets.<sup>72</sup>

Attempts to cross the Cosina on the 21st and 22d were repulsed, but on the night of the 22d, following the two days of devastating fragmentation bombing by the mediums and bombing and strafing attacks by DAF's aircraft, Eighth Army established a bridgehead across the river and stopped the expected German counterattack. Following this all-out effort, the weather closed in, bringing air operations on Eighth Army front virtually to a stop until the end of November. Even so, by the end of the month the British army had reached the line of the Lamone River.<sup>73</sup>

In the meantime, the failure of Fifth Army to take Bologna at the end of October, coupled with a variety of other factors, had resulted in a revision of the air forces' strategy of interdiction. As already noted, throughout September and October, in anticipation of a German withdrawal, interdiction efforts had been concentrated on the Po River crossings, where the destruction would impede the retreat of the greatest number of German divisions.<sup>74</sup> But that was not enough, for the optimistic view that Kesselring would have no alternative but to retire across the Po and attempt to re-establish a line at the Adige River or at the foothills of the Alps dictated that interdiction of the Po be reinforced by blocking the enemy's escape route farther to the north. This could be accomplished, first, by having MASAF interdict the Brenner, Tarvisio, Piedicolle, and Postumia rail routes (the only frontier lines available to the Germans, save those through Switzerland, after the rapid advance in southern France had closed the Franco-Italian routes) which passed through the mountainous country north of the Venetian plain and connected Italy with Austria and Yugoslavia, and, second, by having MATAF destroy the bridges which carried the complex rail network of the Venetian plain over the Brenta, Piave, Livenza, and Tagliamento rivers.<sup>75</sup> All of these lines lay north of the Po.

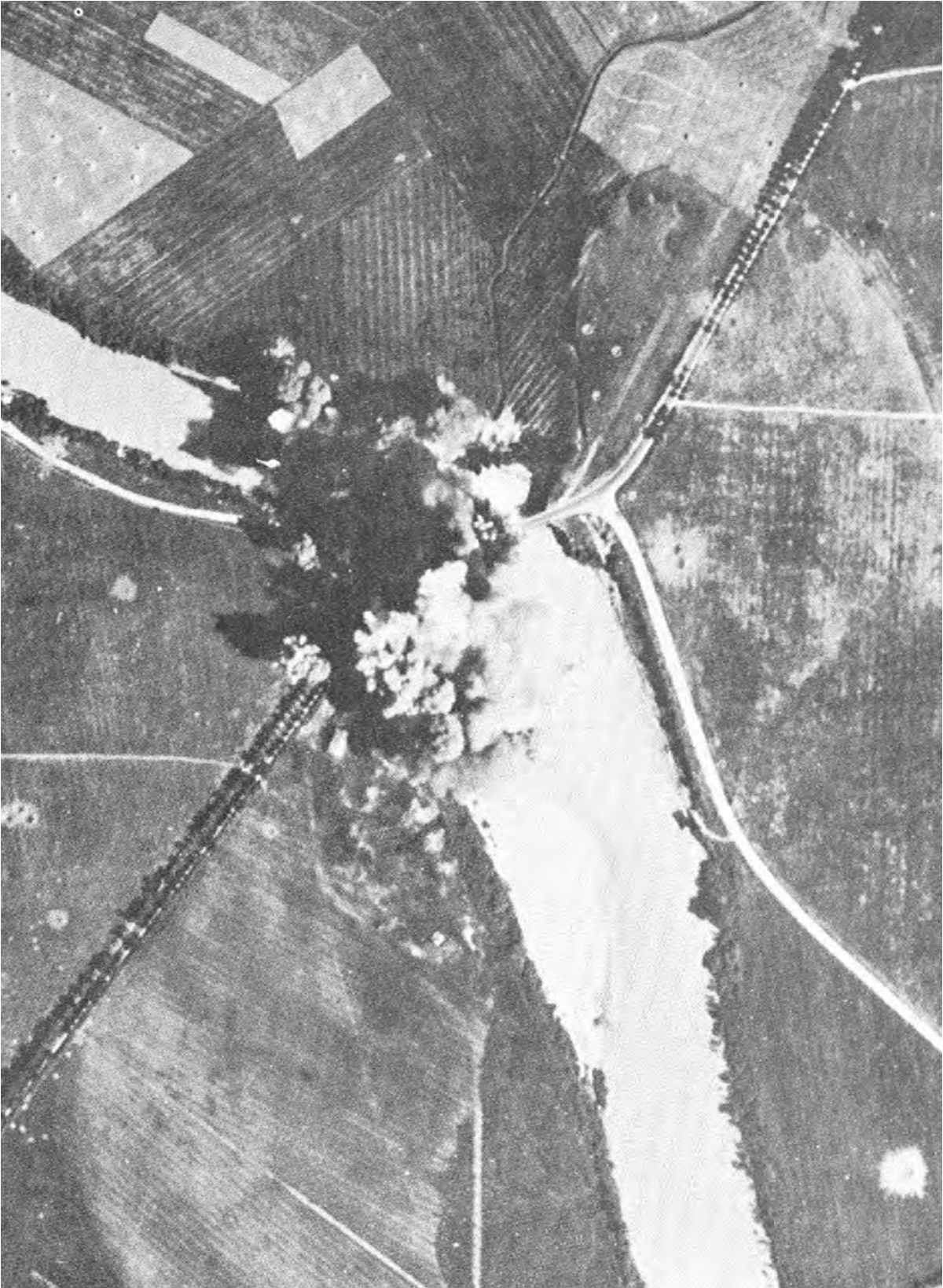

DIRECT HIT ON HIGHWAY BRIDGE IN ITALY



CATHEDRAL AND BRIDGE: ROUEN



**CATHEDRAL AND BRIDGE: COLOGNE**



**B-25 HITS BRIDGE AT BRIXLEGG**



# PRINCIPAL RAIL LINES NORTHERN ITALY



	DOUBLE TRACK
	SINGLE TRACK
	RIVERS
	BOUNDARIES
	ADVANCE OF 5th-8th ARMIES

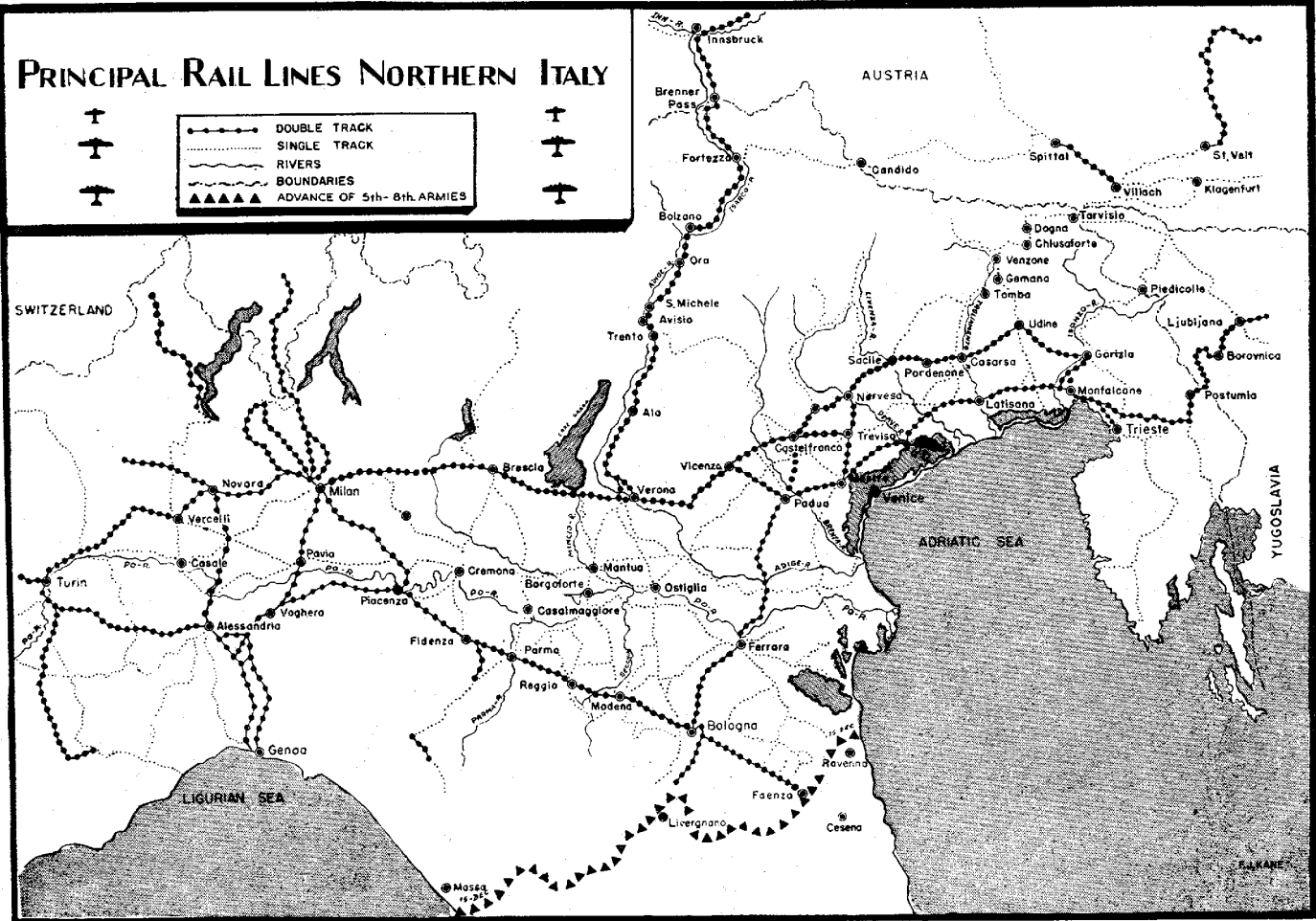
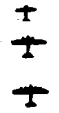

Orders to add these more northerly lines of communication to other commitments had gone out to Strategic and Tactical late in August,<sup>76</sup> and for the next two months MAAF's bombers paid some attention to the lines. Between 26 August and 4 September MASAF created one or more blocks on each of the four main frontier routes, and between 29 August and 1 September, MATAF's medium bombers inflicted varying degrees of damage on the principal rail bridges over both the Piave and Brenta rivers. As a result, all through traffic in northeastern Italy was blocked at the Piave for perhaps as long as two weeks.<sup>77</sup> Owing to the commitments of the heavies in the Balkans and of the mediums at the Po, no further pressure was applied to the northern routes for the next three weeks. But in view of the favorable ground situation after 21 September, MATAF, in addition to maintaining interdiction of the Po, sent its medium bombers back to the Brenta and Piave crossings on the 22d, 23d, 26th, and 30th (the only operational days for medium bombers in the period 20-30 September).<sup>78</sup> In addition, in view of the enemy's strenuous repair efforts, MASAF, on the 23d, dispatched 350 B-24's to the four main lines. Weather interfered with the attacks and no effective results were achieved at the primary targets; however, the heavies materially aided Tactical's campaign against the Piave River crossings by the destruction of the Ponte di Piave and S. Donà di Piave, which were hit as alternate targets.<sup>79</sup>

By the end of September, as a result of the medium bombers' successful attacks at the Piave and Brenta, there was a growing feeling that MATAF could take over the job of interrupting the northeastern routes, leaving Strategic free to concentrate on the more difficult Brenner route. Consequently, on 1 October, MASAF, on MATAF's recommendation, was relieved of all responsibility for Italian communications except for interdiction of the Brenner.<sup>80</sup> Although attacks by Strategic on the other routes would be welcomed, Tactical was given continuing responsibility for interdicting traffic from the northeast at the Piave and Brenta.

Despite bad weather in October, B-26's during the month flew twelve missions of 187 sorties against crossings over the two rivers. These blows, coupled with heavy bomber attacks on targets on the Venetian plain (hit as alternates) on the 10th and 23d, kept all three of the northeastern routes blocked at the Piave, and sometimes at other points as well, for sixteen days in October.<sup>81</sup>

MATAF felt that difficulties of terrain and heavy flak defenses at

the vital bridge targets precluded medium bomber attacks on the northern section of the Brenner. Late in September, however, MATAF had suggested that its mediums could supplement Strategic's primary cuts by postholing the southernmost sections of the rail line above Verona; these same sections could be kept cratered by limited fighter-bomber action. The suggestion was put into effect, but neither Strategic nor Tactical could cope with the bad weather of October which, by obscuring targets or tying down the bombers at their bases, so handicapped operations against the Brenner that it was interdicted only spasmodically. On the 4th, MASAF damaged the Ora bridge and created numerous cuts in the fifty-six miles of railroad between Trento and Mezzaselva. On 3 October, MATAF's mediums made their first efforts against the Brenner. Between that date and the 20th, B-26's flew five missions of eighty effective sorties to the Ossenigo and Dulce rail fills on the southern, bridgeless extremity of the line; each mission cratered tracks and effected temporary blocks.<sup>82</sup>

Weather rendered abortive attempts by SAF to bomb the Brenner on the 10th and 20th. But later in the month, in view of the enemy's repair effort and the report that two Italian Republican divisions were to be sent over the Brenner from Germany between 20 and 25 October as reinforcements for the Italian front, Strategic again attempted to block the line. Unfortunately weather again proved a hindrance and only 54 of the 111 B-24's completed the mission, inflicting only temporary damage at various points along the line.<sup>83</sup>

These September and October interdiction operations in northern Italy had been on a small scale and had been laid on primarily to supplement the heavier effort at the Po. But by the end of October it had become obvious that the anticipated retreat across the Po Valley would not soon materialize. This new situation, with a stalemate developing on the ground, demanded that the air forces revert to their previous policy of interdicting to deny supplies to a stubborn foe. This could now be best accomplished by shifting the main interdiction effort to the Venetian plain and the frontier routes.<sup>84</sup>

By late October, although all of the bridges over the Po were down, the Germans by ingenious use of pontoon bridges and ferries at night, and even pipelines, were continuing to meet their immediate supply requirements from depots north of the Po. Indeed, it was all too apparent that Kesselring had won the battle of logistics at the Po. On the other hand, operations against the Brenner and in northeastern Italy

had been effective enough to cause considerable delays in the shipment of materials from Germany and to create many additional fighter-bomber targets among the accumulations of rolling stock. But even here interdiction was being neutralized; the rate of repair on the Brenner was quickening, and after almost two months of interdiction, lines across the Piave were being reopened by restoring bridges and by constructing by-passes.<sup>86</sup> Furthermore, in September, the Germans (perhaps in anticipation of being forced out of Italy) had greatly accelerated their looting of the Po Valley, and trains moving toward the frontiers over the Brenner and Tarvisio routes became more numerous.<sup>86</sup> Obviously then, if the removal of Italian industries were to be stopped, a stricter interdiction of the frontier routes would have to be imposed; likewise, if the enemy forces at the front were to be denied supplies, traffic would have to be halted before it reached the Po. But in the face of a growing German skill in effecting repairs this could be accomplished only by a greater concentration of effort against the four principal rail routes connecting Italy with the Reich.

These considerations led to the announcement of a new bombing policy on 3 November. The Po River was reduced from first to third priority in the interdiction scheme. In its stead, interdiction of the Brenner was to be maintained on a first-priority basis, followed by interruption of traffic over the northeastern lines at the Piave, Brenta, and Tagliamento rivers, in that order of priority. Although the Po Valley was to remain the principal commitment of fighter-bombers, they were given for the first time a commitment farther north: "When weather prevents medium bomber operations in Italy and it is considered that the Brenner or northeastern rail routes are in danger of being repaired, fighter-bombers will be directed . . . , against vulnerable targets on these routes until such time as renewed medium bomber effort is possible."<sup>87</sup>

The new bombing program was inaugurated on 6 November by an all-out attack on the electrical system of the Brenner line.<sup>88</sup> The events of October had provided sufficient evidence that long spells of non-operational weather precluded maintaining the bombing schedule necessary to keep the Brenner blocked. Air tacticians, searching for some means of reducing the capacity of the Brenner to an extent that would deny to the enemy full use of the line even in extended periods of bad weather, came up with the idea of forcing him to change from electrical to steam power. With electrical equipment the Brenner route

had a capacity of twenty-eight to thirty trains a day in each direction, representing up to 24,000 tons that could be transported daily when the line was in full working order. By forcing the Germans to switch to steam locomotion, which is less efficient on the long and steep grades of mountainous country, it was estimated that the capacity of the Brenner would be reduced to from eight to ten trains daily, thereby lowering the daily tonnage transported over the line by some 6,750 tons. Since this figure represented approximately twice the estimated daily tonnage required by the German forces in Italy, it was assumed that, with steam locomotion, it would be necessary for the enemy to keep the Brenner fully open at least 50 per cent of the time in order to maintain his supply levels.<sup>89</sup> The targets for air attack would be transformer stations, of which there were fourteen between Verona and the Brenner Pass spaced some twenty miles apart where gradients were less severe and ten miles apart in the steeper sections of the line. Such was the arrangement of the system that not less than three consecutive stations would have to be destroyed in order to make the use of electric power impossible on any one section of the line. MATAF, therefore, ordered its medium and fighter-bombers to execute coordinated attacks on the four transformer stations between Verona and Trento. MASAF was requested to support Operation BINGO, as the plan had been coded, by attacking the stations at Salorno, Ora, and Bolzano, farther to the north.<sup>90</sup>

On 4 and 5 November weather conditions were favorable for extensive bomber operations along the lower Brenner line, and mediums cut the section between Trento and Verona at twenty-five to thirty points. Hundreds of units of rolling stock were trapped between these cuts and all rail traffic was completely disorganized on the southern section of the line. The time seemed appropriate for executing BINGO. Consequently, on the morning of 6 November, 102 B-25's, 60 P-47's, and 22 Kittyhawks struck the four MATAF targets. Thunderbolts and Kittyhawks of DAF put the station at Verona out of commission, while B-25's, drawn from all three groups of the 57th Wing, and P-47's of the 57th Fighter Group rendered completely useless the stations at Domegliara, Ala, and Trento. Closely coordinated with these operations were attacks by 103 B-26's on vulnerable rail targets between Verona and Trento, at Ossengo, Sant' Ambrogio, Dulce, Morco, and Ala; the Marauders created seven blocks on the line.<sup>91</sup> The enemy apparently despaired of the task of repairing the shattered transformers

and never regained the use of electric locomotion on the line from Verona to Trento.<sup>92</sup>

On the same day, MASAF dispatched twenty-three B-24's, escorted by forty-six P-38's, to the three targets on the northern end of the line, but no permanent damage was inflicted on the transformer stations and the enemy was able to continue to use electric power on that section of the track. On 7 and 12 November, SAF made amends for this failure by carrying out a series of successful attacks on bridges along the Brenner. In view of the enemy's proved ability to repair minor damage very quickly, it was necessary to knock out one or more spans to give any permanence to the interdiction of bridges; therefore, bridges which had long spans were chosen as the most vulnerable targets, and they received the heaviest weight of the attacks. The bombers knocked out such bridges over the Adige at Ora and Mezzocorona; they also hit the crossing over the Isarco River at Albes, but the temporary damage was speedily repaired. On the 11th, although clouds obscured the Brenner, 35 Liberators out of 207 dispatched supplemented MATAF's campaign against the northeastern routes by rendering impassable bridges over the Tagliamento River.<sup>93</sup>

MATAF's October operations against the Brenner's lower reaches were considered as supplementary to MASAF's attacks on the more crucial part of the line north of Trento. But Strategic's operations even against this vital part of the Italian communications system were destined soon to end. Since September, when the Allied armies in France drew close to the German borders, there had been proposals for concentrating strategic bombardment against the railway system of Germany itself,<sup>94</sup> and by November that system had been given a priority second only to oil\* in the list of strategic targets.<sup>95</sup> Accordingly, on 11 November, General Eaker relieved MASAF of all responsibility for attacking communications targets in Italy, including the Italian side of the Brenner, although it was to maintain dislocation of traffic at Innsbruck in Austria, the important control center for rail traffic into the Brenner from the north.<sup>96</sup> A few days later, when Strategic's new commitment crystallized in a directive from MAAF, MASAF's role in the isolation of Italy from the Reich was further reduced, for now the railway lines between southeast Germany and the Danubian plain were to be given precedence over those between southern Germany and Austria and Italy.<sup>97</sup> Indeed, after 16 November, MATAF was fully respon-

\* See below, p. 653.

sible for the selection of targets and air operations everywhere in Italy; and no target on the peninsula was to be attacked except upon request by or approval of MATAF. Thus, although MASAF and MACAF carried out occasional attacks in northern Italy at MATAF's request (primarily on a weather-alternate basis), after mid-November air operations in Italy rested with MATAF.<sup>98</sup>

MATAF did not at once expand the scope of its operations to cover the targets heretofore considered Strategic's responsibility in northeastern Italy, but bridges on the lower and middle Brenner became increasingly favorite targets. Medium bombers pushed past Trento to attack rail bridges over the Adige at San Michele and Ora on the 11th and the long viaduct at Lavis over the mouth of the Avisio River on the 17th, and attacked small bridges and fills south of Trento. From 1 through 19 November some forty-four medium bomber missions were flown against the Brenner, including those flown during BINGO. As a result of these operations, plus the damage inflicted by SAF and by an increasing effort by fighter-bombers against the lower Brenner after the 19th, the route remained closed to through traffic by multiple cuts (which reached as many as thirty-five at one time) until the last day or two of the month. From 1 through 25 December, however, the weather limited medium bombers to twelve missions against the Brenner. Bridges at Ala, Rovereto, Calliano, and San Michele were targets on 2 and 10 December, but ground haze, smoke screens, and flak prevented the mediums from inflicting structural damage to any of the rail crossings, although in each case temporary cuts were made in the tracks.<sup>99</sup> Though this effort, combined with additional cuts in tracks created by fighter-bombers, gave German repair crews no respite, interdiction of the Brenner was intermittent and short-lived during the first twenty-five days of December.<sup>100</sup>

In addition to attacks on the main Brenner line in November, mediums also struck hard at the loop line running southeast from Trento to Vicenza, and by the 13th had cut the line at Calceranica, Castelnuovo, and Engeo. This route remained blocked for the next six weeks, for although the mediums were able to bomb the line only once during December, fighter-bombers kept a constant check on repair efforts and it was not until 3 January 1945 that the line was reported open.<sup>101</sup>

The interdiction of the rail routes across the Venetian plain was maintained through most of November, and by the middle of the month October's interdiction of the northeastern routes at the Piave

## THE ARMY AIR FORCES IN WORLD WAR II

and Brenta rivers had been reinforced by additional cuts at the Tagliamento and Livenza rivers. By month's end, the Nervesa bridge was the only one open between Udine and Padua across the Brenta, Piave, Livenza, and Tagliamento rivers. Swift repair and nonoperational weather permitted increased activity on the northeastern routes during the last week in November, but the number of cuts on the various lines and the consequent necessity of repeated transshipments over an eighty-mile zone continued for a time to interpose a barrier against transportation of heavy supplies into Italy.<sup>102</sup> But other air commitments late in November—the most important of which was a substantial medium bomber effort at Faenza for Eighth Army from 21 through 24 November—and nonoperational weather in December, which limited the mediums to five missions against the northeastern routes, allowed the Germans to open at least one bridge or by-pass over each river barrier, so that although the enemy was frequently denied the most direct connections and was forced to resort to roundabout routes from early in December until the 25th, through traffic moved southward at least as far as the Brenta River.<sup>103</sup>

There was one other factor which accounted for the weakening of the interdiction campaign after 19 November: the loss to ETO of the 42d Bombardment Wing headquarters with two of its B-26 groups. After the OCTAGON conference, at which the CCS had agreed that there would be no further withdrawals from Italy until the outcome of the current offensive was known, American air leaders, fearing that the 6th Army Group in southern France did not have adequate air resources, had continued to press for the move of the entire Twelfth Air Force.<sup>104</sup> But when General Spaatz brought up the matter in mid-October at a conference at Caserta with Generals Wilson, Eaker, Cannon, and others, it was agreed that the conditions which had prevented an earlier move still prevailed: Twelfth Air Force could not be supported logistically in France and the requirement of air support for Fifth Army still remained. Since the Twelfth could not be spared, the alternative of forming a provisional tactical air force for 6th Army Group was proposed. Requirements from the Mediterranean included Headquarters 63d Fighter Wing (at cadre strength), which was to serve as the headquarters for the new air force, and the 42d Bombardment Wing, plus service units to support the latter. Plans were already under way to convert one B-26 group to B-25's, and General Spaatz agreed to accept the two remaining B-26 groups.<sup>105</sup> Consequently, on 5 November the 319th



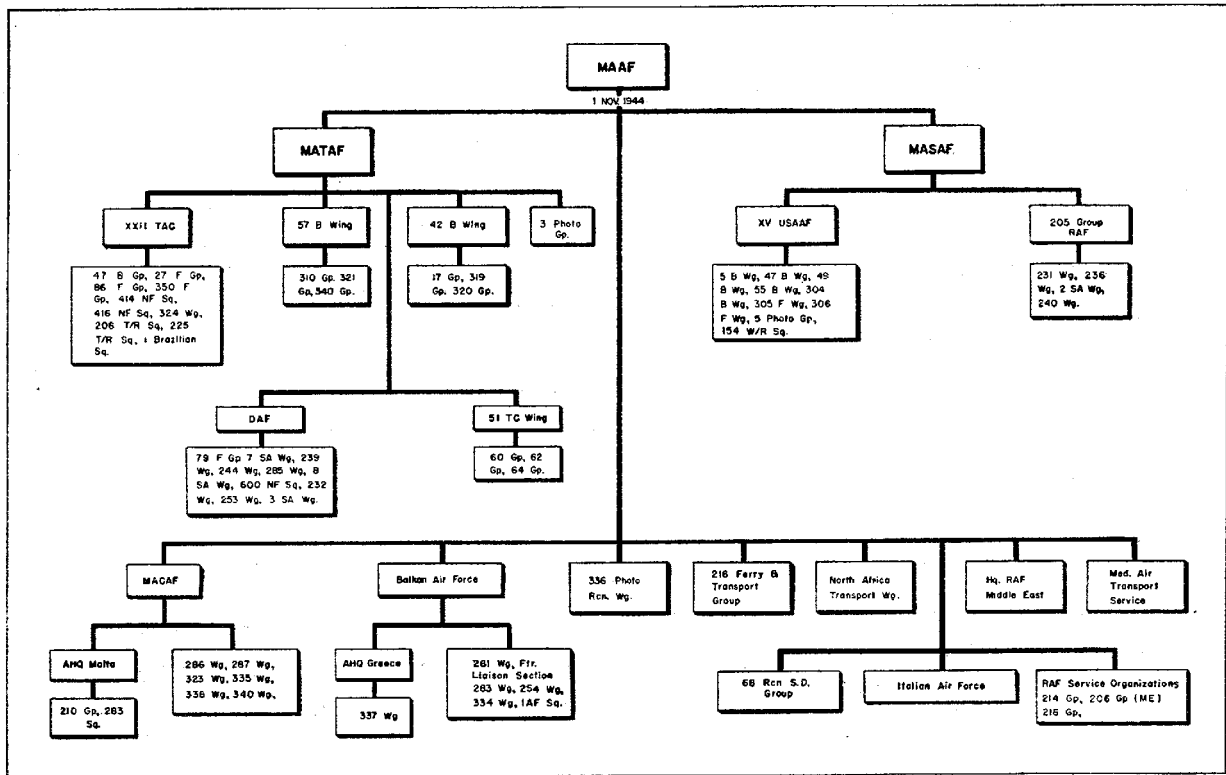

Bombardment Group was transferred from the 42d to the 57th Wing, and on the 15th, Headquarters 42d Bombardment Wing with the 17th and 320th Groups, the entire 310th Air Service Group, and Headquarters 63d Fighter Wing were transferred to ETO.<sup>106</sup>

MATAF's waning medium bomber strength suffered another loss the following month when the War Department decided to withdraw one B-25 group and a service group for redeployment against the Japanese.<sup>107</sup> Although MATAF was concerned lest this withdrawal render ineffective its interdiction campaign, which depended largely on medium bombers, General Eaker felt that in view of the static condition on the Italian front, another group could be spared. He urged, however, that no further withdrawals from the tactical air force be made in view of the necessity for keeping up the interdiction of the extensive rail and road nets supporting the German armies in Italy.<sup>108</sup>

The diminishing medium bomber strength increased the importance of fighter-bombers in the interdiction campaign. Although fighter-bombers from both XXII TAC and DAF had participated on 6 November in Operation BINGO, no further attempt was made to employ them against the Brenner until later in the month. Thereafter their efforts were indispensable to the maintenance of the blockade of Italy. The redeployment of the 42d Wing coincided with deteriorating weather which prevented the B-25's from reaching the international routes for the remainder of November so that it was necessary to call upon XXII TAC to maintain cuts on the lower end of the Brenner and to direct DAF to employ a good portion of its fighter-bomber effort against the northeastern routes.<sup>109</sup>

XXII TAC's effort against the Brenner route commenced on 19 November when fighter-bombers postholed the tracks between Verona and Ala. From the 26th through 2 December, 148 sorties were flown against the line; concurrently, the zone of operations was extended north of Trento. On one of the early flights a strafing attack near Sant' Ambrogio blew up a train and blasted 280 yards of trackage from the roadbed. Attacks were most devastating on 28 November, when forty-six P-47's blew ten gaps in tracks over a forty-mile stretch near the southern extremity of the line. During December an average of twenty P-47's ranged up and down the Brenner route daily, on occasion reaching as far north as San Michele, cutting tracks and attacking marshalling yards; pilots claimed 149 cuts on the line for the month. In addition, XXII TAC's aircraft supplemented DAF's and the 57th Wing's efforts

on the Venetian plain by bombing crossings over the Brenta River on twelve occasions.<sup>110</sup>

In the meantime, DAF had begun to supplement the medium bomber attacks in northeastern Italy. On 22 November, Tactical made DAF responsible for the rail lines Mestre-Portogruaro, Treviso-Casarsa, and Nervesa-Casarsa, which were sections of the three coastal routes which crossed the Piave and Livenza rivers. On the same day DAF began cutting the line from Padua to Castelfranco and to Vicenza. But the heavy effort at Faenza, 21-24 November, and bad weather thereafter for the remainder of the month, hindered DAF's first ten days of operations in northeastern Italy, although on the 29th its fighter-bombers struck bridges across the Livenza River. In December, the Venetian plain was the scene of a large part of DAF's blows against communications. Particularly good results were achieved against rolling stock along the northern route to Udine, and, in addition to numerous attacks on open stretches of track, some eighteen attacks were made on rail bridges across the Piave and Livenza.<sup>111</sup>

Having called in its fighter-bombers to support the interdiction campaign, MATAF, on 1 December, also took action to strengthen the program by providing for round-the-clock attacks on targets north of the Po.<sup>112</sup> Previously, the 47th Bombardment Group, XXII TAC's night intruder group, had devoted most of its A-20 effort to the area south of the Po which was bounded on the west by Piacenza and on the east by the DAF/XXII TAC boundary; a lesser effort had covered the area north of the Po up to Verona.<sup>113</sup> As the emphasis of bombers and fighter-bombers shifted farther to the north, it was appreciated that enemy night movement and repair effort would increase on the four main routes. Consequently, on 1 December, MATAF directed the employment of a portion of XXII TAC's night bomber effort to the Brenner and of DAF's to northeast Italy. XXII TAC responded by assigning several A-20's to cover the Brenner line nightly as far north as Trento. Weather, however, rendered the effort largely ineffective. DAF's night effort against the northeastern routes was limited owing to its duties on the Eighth Army front and to a commitment acquired on 3 November which called for the employment of three wings of medium and light bombers and four squadrons of fighters against Balkan targets on a first-priority basis to assist the Balkan Air Force to impede the German retreat from Yugoslavia.<sup>114</sup>

To complement the interdiction campaign, MATAF stressed the

importance of destroying the enemy's accumulations of supplies in dumps. Because of the over-all fuel shortage among the German armed forces, it was believed that Kesselring's quota of POL would be limited; hence the destruction of fuel in conjunction with the interdiction of supply lines entering Italy would have a major effect on the mobility of the German armies opposing the AAI.<sup>115</sup> Although some effort had been applied to targets in this category in September and October, it was not until 3 November that dumps were assigned a definite priority, coming last after the Brenner line and bridges over the rivers of north-eastern Italy and the Po. MATAF then launched a large-scale assault on dumps and stores. Medium bombers, because of extensive commitments, limited their attacks on dumps to sixty sorties, all flown on 10-11 November against the Porto Nagaro supply dump and the Mestre fuel dump. But XXII TAC took up the task, and in the week of 16-22 November carried out a sustained campaign against enemy supplies, concentrating on fuel centers north of the Po, especially between the Po and the Brescia-Verona rail line, and ammunition dumps closer to the battle front, particularly in the vicinities of Bologna, Imola, and Faenza. Some eighteen fuel dumps, ten ammunition dumps, and sixteen others of the approximately fifty attacked were reported destroyed.<sup>116</sup>

Because of their value as alternate targets when communications were obscured by bad weather, dumps received greater attention during December, some 629 sorties being devoted to them.<sup>117</sup> The anticipated resumption of offensive operations by Fifth Army in December and the German counterthrust in the Serchio Valley accounted for the concentration of these efforts on dumps (primary ammunition) in the Imola, Bologna, and La Spezia areas.

Enemy shipping did not have to be seriously considered in the interdiction campaign in the fall of 1944. The advance of the Italian front to north of Pisa and Rimini and the invasion of southern France had reduced the zone of enemy coastal shipping, limiting it primarily to small ships plying the waters between Savona and Genoa and to the ports of Trieste, Pola, Venice, and Fiume in the upper Adriatic. Too, the German evacuation of Greece and the Aegean Islands in September and October had further reduced the need for water transportation in the Adriatic. Indeed, by September 1944, MACAF's tasks of protecting rear areas and convoys, of antishipping strikes in the Gulf of Genoa and the northern Adriatic, and of air-sea rescue had become so reduced in importance that after the withdrawal of XII Fighter Command in

September, MACAF became and remained a small British organization.<sup>118</sup> Although it continued until the end of the war to fly regular patrols, as its targets became increasingly scarce, its strength and effort showed a marked decline. From its August strength of 34 squadrons, with approximately 700 aircraft of all types (fighters, night fighters, bombers, and air-sea rescue craft), it was reduced by the end of October to 16 squadrons with a strength of approximately 380 aircraft. It remained at approximately that size until the end of the war.<sup>119</sup> As the enemy submarine threat and air operations came to a virtual halt in the Mediterranean late in 1944—thereby ending Coastal's defensive role—and as surface vessels became increasingly scarce—thereby lessening its normal offensive role—its fighters and bombers turned their attention almost exclusively to assisting MATAF in its interdiction campaign.<sup>120</sup>

Only occasionally was it necessary for MAAF's other elements to supplement MACAF's antishipping strikes. On 4 September, 164 B-17's dropped 490 tons of 500-pound bombs on the Genoa harbor, the base for the few remaining enemy submarines in the Mediterranean. By German admission, the attack destroyed seven submarines nearing completion, four submarines used for special operations, one transport submarine, and other small vessels; the submarine bases at both Genoa and Spezia were closed following the attack. Heavy bombers also made an occasional attack on the ports of Fiume, Trieste, and Pola, where they not only damaged port facilities and shipbuilding installations but destroyed important stores of oil. Pola was attacked several times for the further reason that it held concentrations of small motorboats which the enemy used against Allied naval units operating off the Dalmatian coast.<sup>121</sup>

Twice during the fall medium bombers prevented the Germans from blocking ports of potential value to the Allies. In September, Admiral Cunningham, naval commander in chief in the Mediterranean, requested that the air forces sink the Italian liner *Taranto* which, it was believed, the Germans intended using as a block ship at La Spezia harbor. By sinking the vessel before it could be moved into position, the harbor could be saved for Allied use when captured. In response to the request, General Cannon called upon the highly efficient 340th Bombardment Group. On 23 September, the group, using an eighteen-plane formation, six of which were briefed to hit the stern, six the middle, and six the bow, executed a perfect attack. Bomb strike photos revealed three separate clusters completely covering the vessel; the

## THE ARMY AIR FORCES IN WORLD WAR II

*Taranto* sank twenty-five minutes after the attack.<sup>122</sup> General Cannon reported that this was the sixty-second consecutive pinpoint target which the 340th Group had attacked without a miss.<sup>123</sup> On 28 November, seventeen B-25's, this time from the 310th Group, sank another vessel at La Spezia harbor before it could be moved into position to block the channel.<sup>124</sup>

For the first time in several months it was necessary in November to carry out a series of counter-air force operations and to provide fighter escort for medium bombers. Actually, the air war in Italy had long since been won, and enemy aerial opposition to Allied operations, both air and ground, was so slight as to be scarcely worth mentioning. In fact, in mid-September when the GAF's air strength was down to an estimated thirty Me-109's at Ghedi, MATAF adopted the unprecedented\* policy of sending out its mediums without fighter escort. The low rate of replacement of enemy aircraft, crews, and supplies precluded offensive tactics against Allied bomber formations and, furthermore, continuous fighter-bomber activity in the Po Valley was deemed reasonable protection to bombers from isolated attacks.<sup>125</sup> By the middle of October, however, the 2d Gruppo of the Italian Fascist Republic Air Force, trained and equipped in Germany, had become operational in Italy, and during the latter half of the month, MATAF's crews, both fighter and bomber, reported encounters with hostile aircraft.<sup>126</sup> The primary mission of these enemy fighters seemed to be the defense of the northern lines of communication and their efforts were concentrated over the Brenner. Small, scattered, and generally unaggressive enemy formations in October were replaced in November by aggressive forces ranging in size from fifteen to twenty and forty to fifty aircraft, and on the 5th, three B-26's were lost and six damaged as twelve to fifteen enemy aircraft jumped a formation just as it reached its targets at Rovereto. Although no further losses were sustained for the next two weeks, there were almost daily sightings of and a few skirmishes with enemy aircraft.<sup>127</sup>

Though not carrying out a sustained campaign against this resurgence of enemy air power, MATAF arranged to keep the principal airdromes under surveillance. Daily fighter sweeps began to include patrols over the area from which enemy aircraft were operating. A-20's

\* Unprecedented to the extent that it was the first time a directive was issued on the subject. On earlier occasions enemy air forces in Italy had been so weak that mediums had flown without escort.

of the 47th Bombardment Group on their night intruder missions flew over one or more of the enemy fields on almost every night from 11 through 23 November, and on a few occasions chose enemy airdromes as their primary target. On 14 November MATAF rescinded its previous policy of not requiring fighter escort for medium bombers and ordered XXII TAC to provide either target-area cover or close escort for missions where enemy fighters were likely to be encountered.<sup>128</sup>

The necessity for escort was short-lived, however, as MASAF soon climaxed the counter-air campaign. On several occasions early in November heavy bomber crews had reported encounters with enemy aircraft based in northern Italy, and on the 16th, SAF aircraft, returning from southern Germany, met the first serious opposition from these planes. Some thirty to forty enemy fighters, contacted in the Udine area, concentrated on stragglers from the bomber formation, and despite the efforts of P-51 escorts, fourteen heavy bombers were reported missing from the operation. The P-51's accounted for eight enemy aircraft destroyed, two probably destroyed, and two damaged; bombers claimed one destroyed.<sup>129</sup> By that time approximately 100 enemy fighters had been located on the airdromes at Aviano, Vicenza, Villafranca, and Udine. In view of the increased size and aggressiveness of the enemy's air strength, SAF decided to devote a day's effort to reducing the threat. Actually the enemy's bases were in MATAF's area of responsibility but as they were located at the limit of range for TAF's aircraft General Twining felt that assistance from SAF would be welcomed, and on the night of 17 and the day of 18 November, Strategic carried out a series of devastating attacks on the four fields. No opposition was encountered although 186 P-51's patrolled the target areas to take care of any reaction that might develop.<sup>130</sup>

Although by the last week of November enemy air opposition had become almost nonexistent, it was appreciated that perhaps the bad weather which was playing such havoc with Allied air operations prevented a fair evaluation of the enemy's air potential. But when clearing skies allowed a resumption of Allied air activity, the Luftwaffe was noticeably absent. It would never again be a factor in the Mediterranean war.

The 51st Troop Carrier Wing, after completing its assignments during DRAGOON, had turned its two groups, of four squadrons each, to their routine tasks of medical evacuation and of moving troops and supplies within Italy or between the peninsula and Corsica and France.

In November, Troop Carrier took on additional duties when MATAF assumed responsibility for supplying the Partisans in northern Italy.<sup>131</sup>

### *Over the Balkans*

In the meantime, Italy-based aircraft had become increasingly active in the Balkans. On 20 August, Russian troops crashed through Rumania, forced a capitulation of Bulgaria, and by the end of September had developed two offensives into Yugoslavia in conjunction with increased Partisan activity. Then Soviet forces, after joining with Marshal Tito's guerrillas to capture Belgrade on 20 October, turned north into Hungary. This rapid Russian drive up the Danube made necessary a German withdrawal from Greece, southern Yugoslavia, and eastern Hungary.<sup>132</sup>

From the last week in August until early November, MASAF devoted considerable effort to assisting the Russian advance. On 23 August, Rumania announced her withdrawal from the war, and three days later Bucharest was subjected to a retaliatory attack by GAF elements from the Bucharest/Otopeni airfield; too, German forces at near-by Baneasa were a threat to the city. In response to an urgent appeal from the Rumanian general staff, MASAF on 26 August devoted a portion of its effort to the two targets: 114 heavy bombers dropped 205 tons of bombs on barracks, military stores, and gun positions at Baneasa, destroying parked trucks, tanks, half-tracks, barracks, and workshops and inflicting casualties on enemy troops, while 115 B-24's dropped 258 tons of bombs on the airfield, leaving it unserviceable.<sup>133</sup>

The attack on Bucharest/Otopeni field was one of a series undertaken to abate the German air menace both to Strategic's operations in the Balkans and to the Russian armies in the southeast. On six out of the seven days from 19 through 25 August airfields in Yugoslavia, Hungary, Czechoslovakia, and Austria were attacked; crews claimed the destruction of 133 enemy planes. By far the most notable attack on airfields during the period, and probably the most successful strafing campaign waged by Fifteenth Air Force fighters during the war, occurred in the three days 30 August-1 September, when a total of 193 P-51's claimed the destruction of 211 enemy aircraft and damage to another 131 at Grosswadein, Kechskement, Debrecen, and Reghin airfields, the latter being the base on which German air units retiring from Rumania were concentrating.<sup>134</sup> Although claims may have been optimistic, the attacks undoubtedly reduced substantially the enemy's air



threat to Russian forces and to SAF's operations in the Balkans during the following month.

After the Russians began their offensive, there was a growing feeling that MASAF could best assist by interdicting the German lines of communication to the southeastern front. The routes were comparatively few, were well defined, and crossed both the Danube and Tisza rivers; and all routes, including those coming up from Yugoslavia, converged on Budapest. During September, Strategic concentrated on vulnerable targets at the Hungarian capital: the north and south rail bridges and the marshalling yards, against which some 852 effective sorties were flown and about 2,000 tons of bombs were dropped. In addition to blocking traffic at these points throughout most of the month, the heavies also cut the main rail bridges over the Tisza at Szolnok and Szageb and the two main rail bridges over the Danube at Szob and Baja; for varying periods of time they blocked through lines in marshalling yards at Debrecen, Hatvan, Cegled, Subotica, Szekesfehervar, and Györ. In October as Soviet forces thrust into Hungary and toward Budapest, the bulk of MASAF's communications effort shifted to western Hungary where the dense rail network was less suitable for purposes of interdiction because of the absence of any major river system; too, the arrival of winter weather permitted less visual bombing, making it necessary to choose larger targets. Consequently, MASAF's effort in October, which was less than that applied in September, went mainly to Szekesfehervar marshalling yards and several rail centers on the main line from Vienna to Budapest. A lesser effort was applied to yards at Szombathely and smaller rail centers to the south and east. The Hungarian interdiction program was supplemented by attacks along the main Budapest-Györ-Vienna railroads and on yards at Vienna, Graz, and Linz.<sup>135</sup> Although lack of information prevents an adequate evaluation of the tactical success of these operations, it seems evident that the destruction of vast amounts of supplies in the marshalling yards and the dislocation of the German lines of communication in part accounted for the success of the massive Russian sweep.<sup>136</sup>

In the meantime, during the first week of September, MASAF's fighters and bombers had combined with Balkan Air Force to inflict varying degrees of damage on the German's exit routes from Greece and southern Yugoslavia.<sup>137</sup> Between 1 and 8 September, Strategic flew 1,373 heavy bomber sorties against these routes in the course of which it dropped approximately 3,000 tons of bombs, concentrating on the

more distant and larger targets, such as Nis, Mitrovica, Karljevo, Novi Sad, Brod, Sarajevo, and bridges on the two main lines from Athens to Belgrade and Belgrade to Ljubljana. BAF, in some 600 sorties, disrupted traffic by attacks on marshalling yards and bridges at Konjic, Zenica, Karlovac, and Kostegnica, railroad stations at Caprica, Miska Banja, Bradina, Konjic, and roads in the vicinities of Sarajevo, Mostar, Bugono, Bangaluka, Knin, Kmdmorasav, and Mitrovica. The heaviest attacks came early in the week and as enemy troops and vehicles began to accumulate between the rail cuts, DAF and SAF turned to these targets. Two hundred and seventy-one Fifteenth Air Force fighters claimed the destruction of up to 112 locomotives, 243 M/T, and 413 rail cars as results of strafing attacks during a three-day period along the well-loaded roads and railroads between Belgrade and Nis and Skopje-Krusevac-Belgrade. On the 6th, 102 B-24's bombed troop and M/T concentrations at Leskovac, where enemy troops withdrawing from Bulgaria were reported to be concentrating. As a result of these operations DAF henceforth was able to keep the German escape routes interdicted by reattacks on targets before repairs had been completed. The increased use of M/T by the Germans in their evacuation and the mounting claims of vehicles destroyed by both DAF and SAF fighters indicate that the enemy never completely overcame the cumulative effects of this week of all-out air effort.<sup>138</sup>

Late in September the backlog of supplies at Salonika and Larissa, created by interdiction farther to the north, were targets for three small attacks, one night and two day, by MASAF. Hit much harder and with greater success were the three airfields at Athens, from which the Germans were operating an aerial ferry. Strategic claimed the destruction of more than 100 enemy transport planes as a result of two night and two day attacks.<sup>139</sup>

The bad weather of October handicapped the air arm in its efforts to hinder the German retreat from Greece and southern Yugoslavia. Balkan Air Force flew some 1,956 sorties during the month, as compared with 2,436 in September. SAF's efforts in Yugoslavia amounted to only four attacks: on the 14th, day bombers cut the Drava River bridge at Maribor, interdicting the main line to Vienna for the remainder of the month, while night bombers attacked marshalling yards at Zagreb on 16/17, at Vinkovci on 17/18, and Maribor on 21/22 October. Farther south, meanwhile, British troops had landed in Greece. Small-scale landings in September, one by sea on Kythera on the 16th and

another by air on Araxos airfield on the 23d, were followed in mid-October by a more ambitious operation in which the 51st Troop Carrier Wing participated. From 13 through 18 October, 224 C-47's dropped or landed 2,000 personnel and 327 tons of equipment\* during Operation MANNA.<sup>140</sup>

By the end of October the Germans had virtually completed their evacuation of Greece and the Aegean, but they were still having difficulties in Yugoslavia. The capture of Belgrade by the Russians and Partisans, the Partisan occupation of communications centers to the south on the rail line Belgrade-Nis, the advance of Partisans (supported by Russian artillery) westward along the Sava River toward the line Novi Sad-Mitrovica, and the enemy's withdrawal from Split and other smaller Dalmatian ports, all had combined to force the Germans to secondary escape routes through the mountainous, Partisan-infested country of central Yugoslavia.<sup>141</sup> To add to their troubles, good flying weather in November permitted a considerable increase in air operations against the German forces as they made their way through the difficult terrain. On 3 November MATAF came to the assistance of the Balkan Air Force on a continuing basis by ordering DAF to make three wings of medium and light bombers and four squadrons of fighters available for employment against Balkan targets. DAF was to cover northern Yugoslavia, leaving BAF free to concentrate its efforts along the Dalmatian coast and in the central section. These operations were given first priority despite the implied reduction of DAF activity for Eighth Army.<sup>142</sup> On fifteen days of the month DAF struck at Yugoslav communications targets, concentrating at first on rolling stock in an area within fifty miles north and west of Zagreb and turning after the 6th to bridges on the Zagreb-Brod railway. Later in the month, DAF's activities were extended to cover lines running north from Ljubljana and the secondary routes running north to the Zagreb-Ljubljana line. These bridge-busting activities received powerful support on three days when B-25's attacked three bridges on the Zagreb-Brod line, one on the Sarajevo-Brod line, and two northwest of Brod. In view of the situation, MASAF also resumed its operations over Yugoslavia and its fighters and bombers began to attack troop concentrations and communications by day and night.<sup>143</sup>

\* In December when civil strife broke out in Greece, 190 planes ferried some 1,500 personnel to Salonika and Athens and moved large quantities of ammunition to British garrisons.

The accelerated Balkan operations from September on had been carried out in the midst of difficulties arising from the fact that Russian troops had moved into the orbit of MAAF's daily operations. Previously, on the few occasions when MAAF had operated in close proximity to Russian troops, liaison had been established through Maj. Gen. John R. Deane, chief of the U.S. military mission at Moscow. But such a channel of communications in no way met the existing need for effective liaison between MAAF and the Russian armies in the field, and early in October, General Eaker, without waiting for clearance from Moscow, sent a small liaison staff, headed by Col. John F. Batjer, to Bucharest to coordinate MAAF's operations with those of the Russian armies in that sector. Colonel Batjer was able to establish cordial relations with the Ukrainian Third Army, but the Russian high command never officially recognized the arrangements, and Batjer, despite the friendly attitude of the Russians in the field, was not permitted to advance with the armies and was never able to effect air-ground coordination.<sup>144</sup> Although Generals Wilson and Eaker continued to press for the establishment of proper liaison, the Russian high command remained adamant<sup>145</sup> and finally there occurred the long-feared incident of a clash between Soviet and MAAF forces. On 7 November, a formation of Fifteenth Air Force P-38's, because of a navigational error, strafed a Russian M/T column between Nis and Aleksinac in Yugoslavia.<sup>146</sup> The Russians reported that as a result of the "unwarranted" attack a lieutenant general, two other officers, and three enlisted men had been killed and twenty vehicles with equipment set on fire. They requested that henceforth Allied aircraft not be allowed to fly over Soviet zones of operations without preliminary agreement with the Red army general staff.<sup>147</sup>

Although proper liaison might not have prevented the incident, the unfortunate occurrence was a harsh reminder of the urgent necessity for closer coordination between MAAF and the Soviet armies. Until some agreement could be reached, MAAF ordered MASAF's bombers not to attack targets within forty miles or its fighters within eighty miles of known Red army forward positions.<sup>148</sup> It was hoped that the Russians would recognize the need for liaison between the air forces in the west and Soviet ground forces in the east, or in the absence of liaison that they would establish a definite bomb line between the two forces. The Russians never accepted the principle of liaison, but apparently they seized upon the idea of a bomb line as a happy alternative, for on

22 November General Deane received a proposal to establish a bomb line Stettin-Forlitz-Zagreb-Sarajevo southward through Preilep to the southern border of Yugoslavia, thence east along the southern border of Yugoslavia and Bulgaria. Although the northern end of the suggested bomb line was totally unacceptable to the CCS—it excluded important oil and industrial targets—in the interest of safety the line from Sarajevo south was accepted on 24 November until a better arrangement could be made. North of Sarajevo the earlier forty-eighty-mile safety feature was to be observed.<sup>149</sup>

Acceptance of this bomb line came over the strenuous objections of General Wilson, for it excluded air attack on the principal German escape routes from Yugoslavia. In view of the Russian refusal even to discuss a liaison arrangement, Wilson proposed that the bomb line be arbitrarily moved eastward to include certain recognizable features (rather than the straight map line drawn by the Russians), such as the rail and road lines which constituted the enemy's escape routes, and that the Russians be notified that the new line would become effective 3 December 1944. The CCS, realizing the urgent necessity of seizing the fleeting opportunity to attack heavy German concentrations between the two lines proposed by Russia and Wilson, concurred with Wilson and ordered him to make his bomb line effective 0100Z hours, 3 December. Owing to Russian procrastination in the matter of working out a better plan of coordinating the efforts of their ground forces and the western Allied air forces, both in Italy and the U.K., on 15 January 1945 the CCS pushed a step further what was apparently the only workable plan by granting SACMED authority to make necessary changes in the bomb line south of Vienna and by allowing the commanding general of USSTAF and RAF chief of air staff to take similar action north of Vienna, advising the Russian high command through the military missions of the actions taken.<sup>150</sup>

### *Another Winter in Italy*

In the meantime affairs had not been going well in Italy. By the end of December, Eighth Army had crossed the Lamone River and had pushed the enemy behind the Senio River, but because of its failure to reach the Santerno River it was necessary repeatedly to postpone a planned offensive by Fifth Army. Then on 26 December the Germans launched an offensive (whether or not in conjunction with the Ardennes offensive is yet to be determined) on the heretofore relatively

quiet western flank of Fifth Army. Although the Germans probably hoped to reach the Arno, and may even have dreamed of seizing the vital port of Leghorn, their thrust never became a serious threat, reaching the limit of its advance on the 27th, after which the Germans began to fall back, in the face of a strong counterblow by the Indian 8 Division, supported by XXII TAC. Nevertheless, the move, if it accomplished nothing else, upset Allied plans: the proposed Fifth and Eighth Army offensive against Bologna was indefinitely postponed and on 2 January 1945, in view of the depleted state of both armies, was canceled. General Alexander, who had replaced General Wilson as supreme Allied commander in the Mediterranean in mid-December, notified the CCS that strategy in the Mediterranean had been altered; the armies were withdrawing as many troops as possible from the line and were reverting to a defensive role in order that ammunition stocks might be accumulated and troops rested and reorganized in anticipation of a renewal of the offensive in the following spring.<sup>151</sup> For the next three months there was little ground activity in Italy.

The mission of the Mediterranean command—that of destroying or containing Kesselring's forces in Italy—remained firm, however, and in the absence of strong pressure by the Allied ground forces, the air forces, numbering some 280 squadrons, now became the most potent weapon in the Mediterranean. Their aim was dual: to starve the forces which the enemy might choose to leave in Italy and to prohibit the escape of those which he might wish to withdraw. These designs crystallized on 9 January 1945 when MATAF assigned to its units as their first-priority mission the disruption of enemy communications. XXII TAC was committed to the Brenner; DAF to the lower reaches of the Tarvisio and Piedicolle lines; the 57th Wing, in addition to continuing its efforts against the Brenner and the railroad bridges over the Brenta, Piave, Livenza, and Tagliamento rivers, was committed to the Tarvisio, Piedicolle, and Postumia rail lines.<sup>152</sup>

By the time this directive appeared the situation in Europe had already led MAAF into a series of operations which were directly in line with its new program. As the German Ardennes offensive mounted in intensity in December, it was feared that Kesselring might be forced to furnish fresh divisions to the desperate gamble on the western front, and on Christmas Day, Eaker relayed to Cannon and Twining an urgent request from Spaatz that the Brenner and Tarvisio routes be kept as fully immobilized as possible, that being the most important contri-

bution which MAAF could make to the western battle.<sup>153</sup> A similar request came also from the Russian high command, which was contemplating resumption of the offensive on the eastern front.<sup>154</sup>

Fortunately a return of good bombing weather coincided with the receipt of these requests. Although MASAF had been supplementing MATAF's isolation of Italy by occasional attacks on the northern terminus of the Brenner at Innsbruck, it had not hit communications targets inside Italy since 12 November. Now, however, it turned with vigor to the three northeastern routes, and from 26 December through 4 January heavy bombers carried out twenty-five attacks on these targets, ending with a shattering blow on the Verona marshalling yards, delivered by 197 aircraft.<sup>155</sup> For the next month SAF found its targets outside Italy, but its increasing emphasis on communications in Germany and Austria tended more than ever, as its zone of operations began to constrict, to supplement the internal blockade of the Germans in Italy. Medium bombers, enjoying the first good weather in three weeks, struck hard at the distant northeastern frontier routes during the last six days of December. By the end of that month they had cut each of the three lines in at least one important place: the Postumia at Burovnica where the viaduct was demolished; the Tarvisio at Chiusaforte where a span of the bridge was knocked out; and the Piedicolle at Canale d'Isongo where a span of the bridge was destroyed. Simultaneously, in addition to the damage inflicted by heavy bombers on the Brenner, B-25's and fighters from XXII TAC kept up steady pressure against the line throughout the last week of the month, largely negating the intensive German repair effort and allowing no through traffic on the line from the 26th to the end of the month.<sup>156</sup>

While the B-25's were busy with the Brenner and northeastern routes, other planes of MATAF were hitting lines of communication which fed into these routes. On 26 December three attacks by B-25's and ten by fighter-bombers on bridges laid a solid belt of interdiction across the Venetian plain. Beginning on the 21st, DAF day bombers began a series of attacks on marshalling yards at Tarvisio, Castelfranco, Udine, Conegliano, and other points which further snarled traffic along the feeder lines. These Marauder and Baltimore attacks supplemented fighter-bomber activity over the plain.<sup>157</sup>

The weather turned bad in January. Consequently, on only twelve days could B-25's reach the Brenner and on only five could full-scale efforts be carried out, and these met generally with disappointing re-

sults. XXII TAC, however, now shifted from open stretches of track to bridges and diversions and in twenty-four attacks kept the Brenner blocked at several points on most days during the month.<sup>158</sup> Away from the Brenner the mediums found more favorable weather. Sixteen attacks were successfully directed against the Tarvisio and Piedicolle routes and bridges over the rivers of the Venetian plain. But the most striking development of the interdiction campaign during the month consisted of the devastating attacks by fighter-bombers on bridges and diversions in northeastern Italy. Relieved of close support operations, these aircraft flew more than 2,500 sorties against communications. XXII TAC put its heaviest effort on the main double-track rail line from Vicenza to Casera, striking bridges at Cittadella, Casera, and Nervesa. DAF concentrated on the Postumia line from Latisana to Sesana.<sup>159</sup> As a result of these attacks, the Germans were denied through traffic in and out of northeastern Italy during the entire month. Although the Tarvisio route was considered open after 18 January, interdiction into the Po Valley at the transverse rivers across the Venetian plain was secure. Evidence of the effectiveness of the attacks on railways, and of an additional advantage gained thereby, was found in signs of heavier M/T traffic by late January in the region of the Brenner as well as in northeastern Italy, which meant that the enemy was having to burn up in increasing measure his scarce and precious supplies of motor fuel.<sup>160</sup>

On 23 January the anticipated redeployment of German forces began as the 356th Division, withdrawn from the line for service on the eastern front, entrained in the Padua area, and in February the enemy undertook to withdraw also the 16th SS Panzer Grenadier Division. MATAF had promptly ordered its units to intensify both day and night efforts in their respective zones,<sup>161</sup> and this intensified program continued through February, as the German divisions were making their tortuous way past obstructions on the Venetian plain and across the broken Brenner and Tarvisio routes. It took fifteen days for the 356th Division to reach the Italian frontier. MATAF's aircraft flew approximately 6,364 sorties to the Brenner and Venetian plain alone during February. After sweeping north of Bolzano on the 14th to cut the line at Bressanone in the heart of the Alps—and thereby proving the feasibility of medium bomber operations at such distance over rugged country—B-25's steadily extended the range of their coverage until, on 25 February, they knocked down two spans of the



## BATTLE OF NORTHERN ITALY

bridge at Vipiteno, six miles from the Brenner Pass.<sup>162</sup> MASAF, called in<sup>163</sup> during the last week of February, added some 3,000 tons of bombs to targets on the Brenner, concentrating on the Verona marshalling yards, the chief entraining point for German divisions attempting to get out of the country.<sup>164</sup> As a result of the combined effort of MATAF and MASAF the Brenner was closed to through traffic throughout February and by the end of that month interdiction of the northeastern routes was the most successful yet achieved. Enemy units frequently required a month to move out of Italy and had to leave much equipment behind.<sup>165</sup>

In the meantime, the whole question of the Mediterranean had been reviewed by the Combined Chiefs of Staff in the light of General Alexander's proposal of early January that he pass temporarily to the "offensive-defense." When the decisions reached at the Malta conference of late January were announced it was clear that as far as the CCS were concerned the Italian campaign had served its usefulness. Five divisions of infantry and two fighter-bomber groups of the Twelfth Air Force were to be withdrawn immediately from the Italian battle and the Italian campaign was to become a holding front with the threefold mission of (1) holding the existing line; (2) containing German forces currently in Italy by such limited offensives as were possible with the resources available after the withdrawals and by skilful use of cover; and (3) preparing to take advantage of any weakening or withdrawal of enemy forces.<sup>166</sup>

The immediate transfer of two fighter groups to France actually was considered the preliminary step in the planned move of the entire Twelfth Air Force.<sup>167</sup> Details for the move were to be worked out between MTO and ETO, but at a conference at Cannes early in February, MTO representatives objected to the transfer of the main striking power of its tactical air forces; they agreed that the two fighter-bomber groups would be sent but suggested that further moves, particularly of the headquarters of Twelfth Air Force and XXII TAC, be postponed pending future developments. ETO representatives agreed to a further delay but with the proviso that in addition to the fighter groups First TAF (Prov.) would be reinforced by certain Mediterranean service units.<sup>168</sup> Consequently, in mid-February the veteran 27th and 86th Fighter-Bomber Groups and Headquarters 319th Air Service Group departed for France.<sup>169</sup>

Although it was understood by both MAAF and USSTAF that

these units would eventually be followed by the entire Twelfth Air Force, the move was never completed because of the swift denouement of the war. As early as February, even while Allied strength was being materially reduced in Italy, German leaders had approached the Allies with the suggestion of a surrender in Italy. These negotiations broke down before terms acceptable to the Allies could be reached, and it was clear that unconditional surrender of the Germans in Italy could be brought about only by force of arms.<sup>170</sup>

### *The Final Offensive*

Planning for what was destined to be the final offensive of the Italian war began in March. It called for a resumption of the strategy attempted the preceding fall. Eighth Army was to lead off with the object of crossing the Senio and Santerno rivers and exploiting toward Argenta Gap and Ferrara. After the Eighth had arrived at the Santerno, Fifth Army would launch a drive toward Bologna with its principal effort to be made west of Highway 65. This was the familiar tactic of threatening the enemy's flank, so as to draw off his reserves, and then delivering a hard blow at his center. The Allies had used the strategy before in Italy, especially where the terrain and the communications did not favor a solid concentration against a single point, and, as General Alexander has pointed out, this strategy was the more promising because he enjoyed in the overwhelming superiority of his air forces "one form of concentration which is not hampered by considerations of terrain." By staggering the ground assault each of the two armies could be given maximum air support, and Alexander was confident that MAAF's planes would open wide holes in the enemy's defenses, through which the Allied troops would sweep. Concurrently, MAAF's interdiction program would deny the enemy all hope of reinforcement or supply.<sup>171</sup>

Before air plans for the spring offensive were completed, a reshuffling of air commanders took place. On 24 March, General Eaker, who had guided the destinies of MAAF since January 1944, turned over his Mediterranean responsibilities to General Cannon and returned to Washington as deputy commander of the Army Air Forces and chief of Air Staff. Cannon's place as commander of MATAF and Twelfth Air Force was taken by General Chidlaw, who was replaced in his old command at XXII TAC by Brig. Gen. Thomas C. Darcy. Simultaneously, Air Marshal Slessor was replaced as deputy commander of

## BATTLE OF NORTHERN ITALY

MAAF by Air Marshal Sir Guy Garrod, previously acting commander in chief of Air Command, Southeast Asia.<sup>172</sup>

The new commanders were, with the exception of Air Marshal Garrod, old hands in the Mediterranean and planning for the final offensive was easily completed by early April. In fact, planning for the air phase of the spring offensive was briefer than for any other operation undertaken in the Mediterranean, indicating not only that the Allies had complete mastery of the air but that long experience in the theater had welded the ground forces and air forces into a nearly perfect team. Indeed, MAAF issued only one major directive for the whole operation and it is significant for its brevity, consisting of but five paragraphs.<sup>173</sup> MATAF, charged with the detailed planning, published the final plan on 7 April, naming the operation WOWER and setting forth its purpose as "the employment of maximum air effort in coordination with 15th Army Group during the initial stages of the Ground Forces' forthcoming Spring Offensive."<sup>174</sup> After the initial assault the primary task of MATAF would be to maintain the isolation of Italy in accordance with current directives.

The plan did not call for a sustained pre-assault softening-up program by the air forces. Consequently, the air forces during March and, indeed, right up to the beginning of the final drive, concentrated on severing the enemy's lines of communication with the object of denying him supplies and at the same time of preventing his escape from 15th Army Group. By far the largest share of Tactical's March effort was devoted to communications targets, and before the end of the month the primary routes north of the Po were so thoroughly interdicted that there were no longer suitable targets in Italy and medium bombers began to attack rail lines in northern Yugoslavia and southern Austria. As a result of these intensive efforts and increasing assistance from MASAF early in April, on D-day (9 April) of the spring offensive every major rail line north of the Po was cut at multiple points. The enemy could not depend on his rail net either to sustain or to evacuate his troops. It should be noted also that although emphasis in the interdiction campaign had long since passed to north of the Po Valley, from January onward a sufficient number of medium and fighter-bomber missions had been directed against the Po River bridges to keep that barrier to enemy mass movement completely interdicted. Furthermore, dumps had continued to be priority targets for XXII TAC and DAF, and beginning late in March and continuing with

rising intensity early in April, the greatest effort MATAF had yet applied to these targets was carried out.<sup>176</sup>

Until April, MASAF was governed by directives that placed targets in Italy last in its priority list and limited such attacks to those specifically requested by MATAF.<sup>176</sup> Pursuant to such a request, Strategic had flown a series of missions against Verona marshalling yards in February, but by 6 March the need for attacks against that city on a continuing basis had passed and for the next month the heavy bombers again left targets in Italy to Tactical. By early April, however, the more distant strategic targets were becoming limited, and MASAF turned with increasing emphasis to objectives specified by MATAF, with first priority given to targets on the Brenner.<sup>177</sup> In fact, just as the Italian battle swung into its final phase, General Spaatz on 16 April declared that the Combined Bomber Offensive was over\* and that the mission of the U.S. Strategic Air Forces in Europe was now that of "direct assistance to the land campaign."<sup>178</sup> Thus, MASAF's last operational efforts were devoted in large measure toward assisting the ground forces to wind up the Italian campaign.

Without change of pace the air forces moved into their final assignment of the Italian campaign. The enemy undoubtedly was aware of an impending attack but he was given no inkling either by a prolonged air or artillery bombardment of where or when the blow would fall. Even on the morning of 9 April fighters of both MASAF and MATAF went about their task of enforcing the blockade.<sup>179</sup> Just after midday, formations of heavy bombers droned northward over the Adriatic, to all intents and purposes bound for some distant communications target. But upon reaching Cesenatico, on the east Italian coast, the flights turned west over the mainland and unloaded their bombs on the enemy's Senio River positions. The final battle for Italy was on. Beginning with the attack on the afternoon of the 9th, in two days 1,673 heavy bombers, aided by a carefully worked out system of navigational aids,<sup>180</sup> completely drenched specific target areas opposite British 5 Corps and Polish 2 Corps, concentrating first on guns and troops opposing the establishment of a bridgehead over the Senio and turning on the second day to crossing sites on the Santerno River. In the same two days, approximately 624 medium bombers, including Marauders of SAAF 3 Wing placed under the operational control of 57th Wing for the offensive, in closely coordinated attacks with the heavies, cov-

\* See below, p. 754.

## BATTLE OF NORTHERN ITALY

ered enemy defenses and troop concentrations, first along each side of Highway 9 between the Senio and Santerno rivers, and then north of the latter river in the vicinities of Lavezzola, Lonastrino, Lombarda, Conselice, and Mentu. As soon as the heavier aircraft completed their missions of the 9th, fighter-bombers of DAF and XXII TAC set about their many tasks of close support. XXII TAC had as its chief targets enemy command posts and divisional headquarters. DAF concentrated on gun positions, strongpoints, and battalion and company headquarters. So thorough were the operations of the fighter-bombers that they even attacked dispatch riders, and so overwhelming was the Allied air superiority that as many as fifteen planes would gang up on a single enemy tank.<sup>181</sup>

Prior to the ground attack, Army commanders feared that the estimated 180 guns within the immediate assault area might hold up the advance but stated that if the air forces would neutralize these guns the Army could take care of German infantry and light weapons. In view of the limited gunfire which opposed Eighth Army's advance, the air attacks, particularly those on gun positions, obviously were extremely effective, and subsequent events indicated that the air forces did neutralize the guns. The Eighth Army lived up to its end of the bargain and, in fact, exceeded its estimated rate of advance.<sup>182</sup> Following the saturation attacks on the afternoon of the 9th, New Zealand and Polish troops crossed the Senio between Lake Comacchio and Highway 9; by noon the next day Lugo was taken, and by evening of the 11th, Eighth Army had reached the general line of the Santerno on a three-divisional front and New Zealand troops were across the river. By the 13th, progress up Highway 9 pushed the enemy back across the Sillaro River, east of Bologna, while near the Adriatic coast Argenta had been captured and troops were moving through Argenta Gap toward Ferrara, whose capture would threaten encirclement of the entire German position. On Eighth Army's west flank, other forces were fighting toward the Idice River and Bologna.<sup>183</sup>

Aircraft of DAF, flying around the clock, averaged more than 500 sorties a day on enemy targets during the drive. Fighters by day attacked strongpoints, guns, and concentrations while at night Baltimores and Bostons, in addition to hitting similar targets north of Imola, Bastia, and Argenta, also bombed road junctions immediately behind the battle line at Sesto Imolese and Lavezzola and ammunition and supply dumps near Medicina, Argenta, Poggio Renatico, and Marradi.<sup>184</sup> On every

night save one from 9 through 14 April, SAF's 205 Group contributed to Eighth Army's progress. Its attacks, conforming to the ground advance, hit enemy positions along the Santerno River on the night of 9/10 April as a part of the over-all assault plan, then shifted to troop concentrations north of the Santerno at Lavezzola on 11/12, at Argenta on 12/13, and at Porto Maggiore, southeast of Ferrara, on 13/14. Even on the night of 10/11 April, 205 Group assisted the campaign, at least indirectly, by going after accumulations of supplies backed up at Innsbruck behind the blockade.<sup>185</sup>

After their hard blows ahead of Eighth Army on 9 and 10 April medium and heavy bombers on the 11th returned to the Brenner line, which the Germans apparently were hoping to restore to use. They thoroughly interdicted the line by cuts at Campo di Trens and Isarco-Albes bridge on the northern end, by knocking out all three San Michele bridges (two on the main line and one on the diversion) and the Lavis viaduct and diversion farther south, and by cutting bridges at Rovereto, Ala, and Parona, south of Trento. On the northeastern routes, the Germans maintained strong repair efforts, but they were watched so carefully that new air attacks invariably brought new cuts before previous damage could be overcome.<sup>186</sup>

In the meantime, Fifth Army had completed its preparations. General Clark had set 12 April as D-day but bad flying weather caused him to postpone the assault until the 14th, when U.S. IV Corps launched an attack preliminary to the main effort. XXII TAC, which since 10 April had been engaged in disrupting enemy lines of communications immediately in front of Fifth Army, now turned to close support. Its planes preceded the actual ground assault by a series of missions against guns and accompanied the subsequent action by bombing and strafing guns, occupied buildings, strongpoints, headquarters, and command posts, some by prearrangement and some by Rover Joe technique. XXII TAC continued to support the 10th Mountain Division of IV Corps throughout the next day, flying some 520 sorties.<sup>187</sup>

U.S. II Corps was to enter the ground battle on 24 hours' notice after IV Corps had launched its assault and straightened out the line.<sup>188</sup> Consequently, on 15 April, in anticipation of Fifth Army's main push, the weight of MAAF's effort was switched to Fifth Army front. This marked the beginning of the most sustained heavy bomber close support effort ever undertaken in the Mediterranean. Although only two days of operations were called for, MASAF devoted four days to the

## BATTLE OF NORTHERN ITALY

effort, and between 15 and 18 April 2,052 heavy bombers struck a variety of targets between Bologna and the front lines along Highway 9, the main axis of Eighth Army's advance, and Highways 64 and 65, along which Fifth Army was advancing.<sup>189</sup>

XXII TAC meantime maintained 24-hour pressure on the enemy in front of Fifth Army. The command's planes flew more than 1,500 sorties from 16 through 19 April, the largest portion of the effort being devoted to front-line targets, including guns, troop concentrations, strongpoints, and occupied buildings.<sup>190</sup> B-25's, leaving enemy defenses to SAF and XXII TAC, devoted the bulk of their 274 effective sorties on 15 and 16 April to reserve areas and to the enemy's escape routes in the immediate vicinity of Bologna, destroying in addition to road and rail bridges on the outskirts of Bologna itself, the road bridge at Casalecchio on Highway 64, southwest of Bologna. Although continuing to devote a portion of their effort to these targets for the next three days, the B-25's expanded their operations to include reserve areas on the Eighth Army front and, in view of the urgent necessity of maintaining interdiction of the Brenner, to targets there as well.<sup>191</sup>

In the meantime, rapid progress had been made by Fifth Army. A week after the offensive opened the fate of Bologna was sealed. II Corps, advancing along the axis of Highway 65, by 20 April had captured Gessi, Casalecchio, and Riale, just west of Bologna, and 10th Mountain Division of IV Corps had cut the main German lateral artery south of the Po by crossing Highway 9; these advances, coupled with Eighth Army's drive from the east along Highway 9 and the threat to Ferrara in the north, left the enemy no alternative but to accelerate his withdrawal. The Germans now undertook a general withdrawal to the Po.<sup>192</sup>

Once the enemy was driven from his defensive positions, it was necessary to establish as many blocks as possible north of the Po so as to hamper the retreat of any formations which might be able to run the gauntlet at that river. The Brenner line was a shambles, as were all of the other rail lines which the enemy might have wanted to use, and the time had now come to concentrate on road bridges over the Adige and Brenta rivers in northeastern Italy. The assignment was given to MASAF, under the code name of Operation CORNCOB, and in two days, 20 and 23 April, MASAF knocked out all nine road bridges over the Adige save one at Cararzere; medium bombers took care of it on the 24th. With the bridges destroyed the Germans north of the Po at-

tempted to use some thirty-one ferry crossings available over the Adige, but patrolling fighters from DAF and from SAF made any large-scale crossing of the river virtually impossible. Crossings over the Brenta were not so successfully blocked, only seven out of the thirteen bridges receiving damage.<sup>193</sup>

Important though these operations were, in that they denied the enemy exit from Italy across the coastal plain, the Italian campaign actually was being won at the line of the Po River. The breakthrough west of Bologna and the rapid advance northward virtually split the German Tenth and Fourteenth Armies, and the enemy, recognizing that disaster was upon him, made a bolt for the north and attempted to scramble across the Po. Once again, driven from strongly prepared positions, he raced pell-mell northward, attempting to reach a rear area suitable to defense, but the cumulative effects of Allied aerial warfare could not be overcome. Disruption of communications not only had seriously curtailed his efforts to accumulate stocks of ammunition and other supplies but had forced him to rely increasingly on local production in Italy which was extremely vulnerable to Allied air attacks. Thus when the break came the enemy had neither the means to make a rapid withdrawal nor the ability to stave off the onrushing disaster. When he did reach the Po, he was finished. Since July 1944, the permanent Po crossings had been destroyed; in April 1945 their absence not only greatly hindered the German escape but left the Allied air forces free to concentrate on the congested ferry sites and pontoon bridges. On 21 April, following aerial reconnaissance of the previous night which revealed that the entire area from Ostiglia to Crespino was active with pontoon bridges and ferry activities, medium, light, and fighter-bombers of MATAF threw almost their entire effort, both by day and night, against the Po crossings, and continued the effort until the 24th.<sup>194</sup> The amount of destruction between Bologna and the south bank of the Po will probably never be known, but that the battle of Italy was finally lost at the line of the Po was recognized by at least one German commander. The commander of 14 Corps, Fourteenth Army, when questioned after the surrender about the effectiveness of the destruction of the Po River crossings, replied:

That is what finished us. We could have withdrawn successfully with normal rear guard action despite the heavy pressure but due to the destruction of the ferries and river crossings we lost all our equipment. North of the river we were no longer an Army.<sup>195</sup>



## BATTLE OF NORTHERN ITALY

By 25 April, with elements of both Fifth and Eighth Armies across the Po, the port of Genoa taken by Partisans, Mantova in Partisan hands and by-passed by Allied troops, and forward elements of Fifth Army within five miles of Verona, the enemy was all but finished. Not the least of his difficulties was the fact that the heavy destruction of M/T and the shortage of fuel forced him to rely on foot and animal transport. Under the circumstances, fighter-bombers began to find troop concentrations more profitable targets than vehicles. During the remaining days of the month, while both Eighth and Fifth Armies pushed triumphantly north, east, and west, cracking the Adige line and occupying city after city between Genoa and Venice, the situation remained fluid, with resistance spasmodic on the part of a broken foe. Fortunately for him, the weather, which completely grounded the medium and heavy bombers after 26 April, also limited the operations of the fighter-bombers.<sup>196</sup> On 2 May, MATAF reported: "Due to lack of targets and weather MATAF's operations were held to a minimum."<sup>197</sup> Actually, the war in Italy was over. On 2 May, as a culmination of negotiations begun on 29 April, hostilities in Italy ceased when the Germans signed terms of unconditional surrender. And so ended, abruptly and in complete defeat for the enemy, the Italian campaign, exactly twenty months to the day from the date when the Allies first landed on the peninsula. As Field Marshal Alexander has observed in his report on the last five months of the war: "The soldiers, sailors and airmen of so many nationalities who fought in Italy never had the pleasure of a conquering advance into the heart of Germany; they had none of the obvious targets before them which buoyed up the spirits of their comrades on the Western Front, but only one more mountain range or river to cross in the face of an enemy resistance which never seemed to weaken. Perhaps not very many of them realized how vital was the part they played but all could feel pride in the way in which they played it and in the sense of duty well performed."



# SECTION IV

\* \* \* \* \*

## *SUPPORTING OPERATIONS*



## CHAPTER 14

\* \* \* \* \*

### *AIR SUPPORT FOR THE UNDERGROUND*

THE collapse of formal resistance to German aggression over most of the European continent early in the war had forced into exile or “underground” patriotic elements of the population which refused to accept defeat. To maintain contact with these persons, to encourage them in the organization of effective resistance, and to draw upon them for sorely needed intelligence from an enemy-dominated continent had been a major concern of the Allied governments since 1940. In that year the British government had established a Special Operations Executive (SOE), in whose office lay the over-all responsibility for a variety of operations that were conveniently and most safely described as “special.” Similar in function was the U.S. Office of Strategic Services (OSS), established in 1942, whose Special Operations (SO) branch in London cooperated with SOE. Special Force Headquarters (SFHQ), a joint organization staffed by SOE/OSS personnel, was charged with developing resistance in France and the Low Countries. The story of these organizations and of the underground movement itself falls outside the province of this history, but a large part of these special operations depended upon the airplane for their execution, and the assistance provided by the RAF and AAF constitutes a chapter in the history of air warfare as significant as it is unique.

Operating in an element beyond the control of surface forces, the airplane enabled the Allied governments to reach across borders that were otherwise closed to them. The RAF had begun special operations early in the war, and as all preparations for OVERLORD were stepped up in the fall of 1943 the AAF assumed a major share of the work. Chiefly it delivered freight—guns, ammunition, explosives, med-

ical supplies, and other items valuable in guerrilla warfare—from bases in Britain, Africa, or Italy to the Maquis in France and to the Partisans of northern Italy or the Balkans. But the task was also marked by an infinite variety of duties. Regular or specially equipped planes carried secret agents—"Joes" and an occasional "Jane"—to points within enemy lines, and brought out, in addition to agents whose jobs had been accomplished, Allied airmen forced down in enemy territory, escaped prisoners of war, or wounded Partisans for hospitalization. The success of the entire program of special operations depended upon establishing liaison and channels of information between SOE/OSS and the resistance movements and upon coordination of underground activities with Allied plans. These objectives were accomplished by foreign and native agents who dropped or landed from special-duty aircraft and gave direction to resistance movements or served in less prominent but still significant roles. Agents bent on sabotage or espionage, organizers of patriot groups, weather observers, radio operators, aircrew rescue units, and formal military missions made up most of the "bodies" transported by aircraft devoted to special operations. The reverse process, evacuation of personnel from enemy-occupied countries, provided opportunities for firsthand reports, further training of agents, and refinement of plans through consultation with experienced personnel. And to these varied activities was added the task of delivering psychological warfare leaflets in territory wholly or partly occupied by the enemy.

### *Leaflet Operations from the United Kingdom*

Dropping leaflets by aircraft was one of the more novel means of waging warfare during World War II. This method of delivering information and propaganda to friend and foe in enemy-occupied areas was used in every theater, but western Europe, with its many large centers of population and its concentrations of Axis troops, promised the greatest returns. In every area of the European theaters—from North Africa to northern Norway and from the Channel Islands to eastern Germany and Yugoslavia—Allied aircraft in thousands of sorties dropped billions of leaflets. The British, skilled in the coinage of military slang, called these leaflets "nickels," and the process of delivering them by aircraft became known as "nickeling."

Civilian agencies were responsible for leaflet production in England before the Normandy invasion; but after D-day, when tactical and

strategic factors were even more important than political considerations, most of the leaflets were produced by the Psychological Warfare Division of Supreme Headquarters Allied Expeditionary Forces (PWD SHAEF). The leaflet section of PWD had its own writing team, controlled the operations of a special AAF squadron, and had a packing and trucking unit to service Britain-based aircraft with packages of leaflets and packed leaflet bombs.<sup>1</sup>

Many types of nickels were used in psychological warfare. Classified according to general purpose, there were strategic and tactical leaflets. Strategic leaflets dropped before D-day were intended to weaken the will of the German people to resist and to raise morale in conquered nations. After D-day, this type of leaflet was used to deliver the supreme commander's communications to civilians, to provide accurate and contemporary news of the campaign, and to guide widely spread subversive activities behind the enemy's lines. Before D-day, 43 per cent of the strategic leaflets went to France, 7 per cent to the Low Countries, and most of the remainder to Germany; after D-day, 90 per cent of the strategic leaflets were dropped over Germany, and the remainder fell to the French, Belgians, and Dutch.<sup>2</sup> Many of the strategic leaflets were small single sheets which bore brief but pointed messages.<sup>3</sup> Newspapers, such as the *Frontpost*, and single sheets in great variety made up the tactical leaflets; but three sheets were considered as basic: the "Passierschein" or safe-conduct, "One Minute Which May Save Your Life," and "This Is How Your Comrades Fared."<sup>4</sup>

Nickeling operations from the United Kingdom had their beginning in a small RAF mission over Kiel on the night of 3/4 September 1939. Four years later, in August 1943, the Eighth Air Force began to participate in this form of psychological warfare and by 6 June 1944 had dropped 599,000,000 leaflets over the continent. Although both medium and heavy bombers carried leaflets on regular combat missions, the task fell chiefly to the Special Leaflet Squadron, which had reached the theater in 1942 as the 422d Bombardment Squadron (H) of the 305th Group and was transferred to special operations in the fall of 1943.\* By June 1944 it had become an experienced night-flying unit, and between the Normandy invasion and the end of the war it dropped over the European continent a total of 1,577,000,000 leaflets. The total

\* It flew its missions out of Chelveston until 25 June 1944, when it moved to Cheddington. A final change of station took it to Harrington in March 1945. The squadron was redesignated as the 858th Bombardment Squadron (H) on 24 June 1944, and on 11 August 1944 it changed numbers with the 406th Squadron.

distribution for the same period by heavy bombers on regular daylight missions was 1,176,000,000. With an additional 82,000,000 dropped by Ninth Air Force mediums, the grand total for the AAF after D-day greatly exceeded the 405,000,000 dropped during the same period by the RAF. Indeed, at the end of hostilities AAF units had dropped more than 57 per cent of the 5,997,000,000 leaflets carried to the continent by aircraft based in the United Kingdom.<sup>5</sup>

The earliest method of leaflet distribution consisted of throwing broken bundles from windows, doors, or bomb bays at high altitudes. In the first leaflet raids, pilots of B-17's and B-24's threw out leaflets when the planes were seventy-five miles away from a city, trusting that the wind would do the rest. Some of the propaganda dropped over France was picked up in Italy.<sup>6</sup> A slight improvement came when leaflet bundles were placed in crude boxes and released through a trap-door attached to a bomb shackle; but it was not until Capt. James L. Monroe, armament officer of the 422d Bombardment Squadron, invented the leaflet bomb that a fully satisfactory method of distribution was found.<sup>7</sup> The new bomb, which came into regular use on the night of 18/19 April 1944, was a cylinder of laminated wax paper, 60 inches long and 18 inches in diameter. A fuze that functioned at altitudes of 1,000 to 2,000 feet ignited a primer cord which destroyed the container and released the leaflets. Each bomb could hold about 80,000 leaflets which would be scattered over an area of about one square mile. The Special Leaflet Squadron's bombers were modified to carry twelve leaflet bombs, two more than the load of a regular bomber. Early in the summer of 1944, a metal flare case was converted into a leaflet bomb for medium and fighter-bombers.<sup>8</sup>

The Special Leaflet Squadron began operations on the night of 7/8 October 1943 with a mission of four aircraft to Paris. By the end of December, the squadron had completed 146 sorties and had dropped 44,840,000 leaflets, most of them over France, Belgium, and the Netherlands. Only three missions crossed over into western Germany during this period.<sup>9</sup> During the first quarter of 1944, the Special Leaflet Squadron devoted most of its efforts to France, where Paris, Rouen, Amiens, Reims, Lille, Orléans, and Rennes were especially favored. Sorties went as far south as Toulouse and southeast to Grenoble.<sup>10</sup> From 1 January to 31 March 1944, the Eighth Air Force dropped 583 short tons of propaganda.<sup>11</sup> The 422d Bombardment Squadron extended the scope of its operations considerably in April and "attacked" Norwegian tar-



gets with the leaflet bomb. The number of cities nicked per mission also increased until it was common for fifteen to twenty-five to be scheduled as targets for a five-plane mission.<sup>12</sup> In May, the last full month before D-day, four of the leaflet-droppers were attacked by enemy planes. These attacks caused a few casualties, damaged one bomber, and resulted in destruction of one FW-190 and one Ju-88. Still the Special Leaflet Squadron had not lost a plane in 537 credit sorties over a period of eight months.<sup>13</sup>

The 422d Bombardment Squadron was, in a sense, the spearhead of the Normandy invasion. Led by the squadron commander, Lt. Col. Earle J. Aber, early on the morning of 6 June its planes went over the beachheads singly and unescorted to drop warnings to the people of seventeen villages and cities. That night the squadron set a new record with twelve B-17's nickeling thirty-four targets in France, Belgium, and the Netherlands.<sup>14</sup> Missions of eight to ten planes were not uncommon in June and by the end of the month the squadron had set a record of 209.6 tons. This total was surpassed in July, when the first plane was lost. Beginning in August 1944, a large proportion of the squadron's sorties was flown to drop combat leaflets over the battle areas and strategic leaflets to the German home front.<sup>15</sup>

The campaign to disseminate propaganda to the German people was further intensified in November. The 406th Bombardment Squadron, as the 422d had now been designated, was raised in strength to twenty-one aircraft and twenty-four crews, a change made possible by transferring seven planes and crews from the 492d Bombardment Group. The result was to increase the squadron's tonnage to 315.3 for the month, a record that was not surpassed until March and April 1945.<sup>16</sup> Two factors exercised a decided influence on leaflet activities in December—bad weather and the German offensive in the Ardennes. The first hampered activities and the second made the usual tactical “leaflet-ing” inopportune. The 406th Squadron dropped no leaflets at all in the salient but flew four missions to other parts of the front from 16 to 27 December. Then, when the German offensive had been stopped, it delivered 3,250,000 copies of *Nachrichten* to the enemy's scattered forces. Special leaflets, rushed into print to aid the Allied counter-offensive, were also delivered by the RAF and AAF strategic bombers in large quantities.<sup>17</sup>

Both the regular bombers and the Special Leaflet Squadron set new records for leaflet-dropping during the last four months of the war.

The all-time high for the AAF came in March, with 654.9 tons; in April, the total was 557.3 tons. German, French, Dutch, and Belgian targets were visited frequently. Colonel Aber was killed by "friendly" flak over England on 4 March 1945 while returning from a mission to the Netherlands, thus ending a brilliant career as leader of a unit to which had been assigned a difficult and important role in the air war. In spite of this loss and a move from Cheddington to Harrington, the 406th Squadron dropped 407.9 tons of leaflets in March.<sup>18</sup> When its operations ended on 9 May 1945, the Special Leaflet Squadron had flown 2,334 sorties and had dropped about 1,758,000,000 leaflets. Losses were low, with only three planes missing and sixteen flyers killed.<sup>19</sup>

### *CARPETBAGGER Missions to Western Europe*

Although AAF special operations from the United Kingdom began in October 1943 with a leaflet-dropping mission by the 422d Bombardment Squadron, the major effort was to be devoted to the delivery of supplies, under the code word CARPETBAGGER and in accordance with a CCS decision of the preceding September.<sup>20</sup> When plans to implement this decision were being made, General Eaker had available the 4th and 22d Antisubmarine Squadrons of the 479th Antisubmarine Group, which had been disbanded following the dissolution of the AAF Antisubmarine Command in August.\* From these two squadrons came the personnel and some of the B-24's for the original CARPETBAGGER squadrons. The Eighth Air Force activated the 36th and 406th Bombardment Squadrons as of 11 November 1943 and attached them as a subgroup to the 482d Bombardment Group (Pathfinder) at Alconbury. Several changes, both in station and in organization, occurred in February and March 1944. Shortly after having moved to Watton in February, the CARPETBAGGERS were assigned to the VIII Air Force Composite Command, with the 328th Service Group as administrative headquarters. On 28 March, the 801st Bombardment Group (H) (Prov.) was established as a headquarters under command of Lt. Col. Clifford J. Heflin, and the two squadrons moved to Harrington.<sup>21</sup> At the end of May 1944, two more squadrons, the 788th and 850th, joined the CARPETBAGGERS and raised their strength to more than forty B-24's.<sup>22</sup> In an extensive shifting of unit designations in August 1944, the 801st Bombardment Group became the 492d Bombardment Group and the squadrons were numbered 856th, 857th, 858th, and 859th.<sup>23</sup>

\* See Vol. II, 409.

Equipment peculiar to antisubmarine or routine bombing missions was discarded for such new installations as Rebecca, a directional air-ground device which records radar impulses on a grid to direct the navigator toward a ground operator whose sending set is called Eureka, and the S-phone, a two-way radio which provides contact with a ground phone. By December 1944, practically all special-duty aircraft were equipped with Rebecca sets, although as yet a sufficient number of Eureka's could not be delivered to the resistance forces on the continent.<sup>24</sup> On the CARPETBAGGER planes the ball turret was removed and a cargo hatch, called the "Joe-hole" because parachutists dropped through it, was made by placing a metal shroud inside the opening. Other modifications included installation of a plywood covering to protect the floor, blackout curtains for the waist-gun windows, blisters for the pilot's and co-pilot's window to provide greater visibility, and separate compartments for the bombardier and the navigator. All special navigational equipment was rearranged to provide greater ease of operation, waist and nose guns were removed, and the planes were painted a shiny black. Crews were required to spend some time in familiarizing themselves with the modified bomber and with the use of its special equipment.<sup>25</sup> The CARPETBAGGERS flew their first mission to France from Tempsford on the night of 4/5 January 1944, and by 1 March they had completed twenty-nine supply sorties.<sup>26</sup>

In the next three months, CARPETBAGGERS completed 213 of 368 attempted sorties, most of which were flown to supply patriot groups in France north of the Loire River.<sup>27</sup> The number of successful sorties rose sharply after the 788th and 850th Squadrons joined the 801st Bombardment Group at Harrington on 27 May in anticipation of the greater demands for support of the French patriots that would follow the landing of Allied armies on the continent. During July, when the peak of operations was reached, the four squadrons in 397 sorties dropped at least 4,680 containers, 2,909 packages, 1,378 bundles of leaflets, and 62 Joes.<sup>28</sup> The shiny black B-24's flew on twenty-eight nights, sometimes through weather normally considered impossible for flying. August operations were somewhat smaller than the record set in July, since much of the area theretofore served had fallen into Allied hands. Occupation of most of France and Belgium by September 1944 brought full-scale CARPETBAGGER operations to an end with missions flown on the night of 16/17 September.<sup>29</sup> In addition to its supply and leaflet-dropping missions, the unit flew a few C-47 landing sorties. The first of these missions took place on 8 July and the last on 18

August. During this period the group's four C-47's completed thirty-five sorties to twelve landing fields in liberated territory, delivered sixty-two tons of arms and ammunition, took in seventy-six passengers, and evacuated 213.<sup>30</sup>

Upon completion of its full-scale supply operations to the patriots, the 492d Bombardment Group turned to delivery of gasoline and other items for the Allied armies and to medium-altitude night bombing. One squadron, the 856th, was held available for further CARPET-BAGGER sorties and received the group's C-47's for the evacuation of Allied aircrews from Annecy. This squadron operated practically as an independent unit under the Eighth Air Force, performing such OSS missions as were required. Although the 856th Squadron flew two sorties to the Netherlands in November and early December, its CARPETBAGGER missions were not resumed to any extent until 31 December. Then one B-24 dropped supplies and personnel in Norway and two flew to Denmark. By 5 March 1945, the squadron had completed forty-one sorties to these countries. The 856th was returned to control of the 492d Group on 14 March, and thereafter all three squadrons—the 859th had gone to Italy in December 1944—were to be available for both special operations and standard bombing.<sup>31</sup> Detachments of the 856th and 858th Squadrons flew out of Dijon, France, from 19 March to 26 April to drop agents into Germany, but the rest of the CARPETBAGGERS at Harrington continued to concentrate their effort on Norway and Denmark.<sup>32</sup> Many of the Norwegian missions were for the purpose of dropping small parties of Norwegian-speaking paratroopers on the Swedish border.<sup>33</sup>

A statistical summary of the CARPETBAGGER project does not reveal its intensely dramatic character. Some of that drama came from encounters with night fighters, from the deadly flak of concealed anti-aircraft batteries, and from the exploits of crews in escaping capture or in fighting as members of the Maquis. Far greater interest centers upon the reception committees waiting tensely for the sound of a B-24's motors, on German patrols attempting to break up the underground organization, and upon the acts of sabotage made possible by airborne supplies. The CARPETBAGGERS alone are credited with having delivered 20,495 containers and 11,174 packages of supplies to the patriots of western and northwestern Europe. More than 1,000 agents dropped through Joe-holes to land in enemy territory. To accomplish these results, the CARPETBAGGERS completed 1,860 sorties out of 2,857

## AIR SUPPORT FOR THE UNDERGROUND

attempted. From January 1944 to May 1945, twenty-five B-24's were lost, an average of one to every 74.4 successful sorties, and eight were so badly damaged by enemy action or other causes that they were no longer fit for combat. Personnel losses totaled 208 missing and killed and one slightly wounded.<sup>34</sup> Many of those listed as missing parachuted safely and later returned to Harrington with patriot assistance in escaping from Europe.

All CARPETBAGGER missions were planned in minute detail to insure maximum coordination of effort. Requests for supply drops originated either with field agents or at various "country sections" at the Special Force Headquarters in London where there was a section for each country that received airborne supplies. The chief of Special Operations, OSS, and his counterpart in SOE determined the priority of missions. Targets were pinpointed and then forwarded to Headquarters Eighth Air Force for approval. Upon receipt of an approved list, the air operations section, OSS, sent it on to the CARPETBAGGER group headquarters where the S-2 plotted the targets on a map. The group commander then decided whether the proposed missions were practicable, selected targets for the night's operations, and the S-2 telephoned the information to OSS, which might suggest changes. After the target list had been settled, the appropriate country section notified its field agents to stand by and to listen for code signals broadcast by the BBC. Upon receipt of these signals, reception committees went to the designated drop zones to receive the supplies.<sup>35</sup>

An OSS liaison officer with the CARPETBAGGERS arranged for containers and packages to be delivered to the airdrome from the packing station near Holme. Packages, leaflets, and parachutes were stored in Nissen huts on the "Farm" near the airdrome perimeter; containers for arms and munitions and other supplies were stored at the bomb dump. The group armament section loaded packages and leaflets on the aircraft while containers were being fitted with chutes and loaded by the ordnance section. The OSS liaison officer checked each aircraft to be certain that the proper load was in place. The leaflets, usually carried as part of each load, were delivered to the field under direction of PWD SHAEF from the warehouse at Cheddington. Personnel to be parachuted, escorted by OSS agents, were fitted with their special and cumbersome equipment by the armament section and then placed in charge of the dispatcher who was to supervise their drop through the Joe-hole. When fully loaded, a B-24 CARPETBAGGER carried

about three tons of supplies, one or more Joes, and six to ten 4,000-leaflet bundles.<sup>36</sup>

In the end, success of the effort depended upon nearly perfect coordination at the point of delivery between the aircrews and reception committees. The latter groups varied in size according to the enemy interference expected, the quantity of supplies to be delivered, and other factors of a local nature. The Maquis committee usually had twenty-five men for each fifteen containers, which was the standard load of one supply bomber.<sup>37</sup> The committees prepared drop zones, lighted signal fires or laid out panels, maintained contact with the aircraft and with resistance leaders, and arranged for recovery and removal of the supplies. Identification of the DZ was one of the principal problems. Pilots were guided to the pinpoint by S-phone contact and by the help of Rebecca/Eureka equipment; signal fires at night generally were burning before the aircraft reached the DZ and served as an invaluable aid. Many times, however, the DZ was either surrounded by the enemy or was in danger of being detected. On such occasions the fires were not lighted until identification signals had been exchanged. The aircraft, whether fires were lighted or not, circled over the pinpoint flashing the letter of the day. Upon receiving the proper response by Aldis lamp or flashlight, the crew prepared for the drop. The pilot let down to 700 feet or less, reduced his air speed to about 130 miles per hour, and flashed the drop signal to the dispatcher. Several runs over the target were required to drop the entire load, and some accidents were unavoidable while flying on the deck at near-stalling speeds. A steady stream of reports from reception committees provided a check on accuracy and revealed the reasons for unsuccessful sorties. Most of the reports told of missions completed, but some revealed the chagrin of patriots whose work had been nullified by betrayal to the Gestapo, appearance of a strong enemy patrol, or aircrew errors.<sup>38</sup>

#### *Mass Drops of the 3d Air Division to the Maquis*

The Eighth Air Force greatly increased the quantities of supplies delivered to the Maquis during the period 25 June–9 September 1944 by diverting heavy bombers from bombing operations. These critical weeks in the invasion of France found the Maquis fighting in ever increasing strength to divert enemy troops and committing numerous acts of sabotage to hinder German military movements to the main battle areas. In the struggle for St.-Lô, which ended on 18 July, French

Forces of the Interior (FFI) prevented large numbers of German troops from reinforcing the front, and in the Seventh Army's later drive northward toward Lyon, the FFI protected the right flank. Supplies previously received from the United Kingdom and North Africa were insufficient to support the desired scale of activity, but the Eighth Air Force, by diverting B-17's from strategic bombing for mass drops on selected targets, delivered the additional materials required.

Shortly after the Normandy invasion (on 13 June, to be exact), SHAEF had received word that the Maquis lacked only supplies to enable them to play a major role in the battle for France. The underground already controlled four departments and fighting was in progress in several others. A conservative estimate placed the number of armed Maquis at 16,000, and the number awaiting arms at 31,800. Potential recruits might raise the total to more than 100,000.<sup>39</sup> By extending the range of their missions to Châteauroux and the Cantal area southeast of Limoges, the CARPETBAGGERS could maintain about 13,500 Maquis in south-central France; but it was estimated that by diverting B-17's to supply operations an additional 34,000 could be maintained by some 340 sorties monthly. Virtual control of all southern France seemed possible, and even partial control promised to threaten enemy communications in the area, endanger the German position on the Franco-Italian border, divert enemy troops from Normandy, and provide an airhead on the continent for use by Allied airborne troops.<sup>40</sup>

These arguments convinced SHAEF that the effort should be made. On 15 June the Eighth Air Force was ready to provide 75 B-17's for the task, and three days later 180 to 300 B-17's were promised. The 3d Air Division, to which the job went, assigned five wings of thirty-six aircraft each to deliver the supplies. Crews received hasty training in CARPETBAGGER methods while Special Force Headquarters transported loaded containers to airdromes, arranged for communications and signals with the Maquis, and selected the targets most in need of supplies. Each of the five wings, it was estimated, could arm 1,000 to 1,200 men with rifles, machine guns, rocket launchers, ammunition, grenades, and side arms.

Five target areas were selected for Operation ZEBRA, the first of the mass drops by B-17's to the Maquis. In the Cantal region west of the Rhone, heavy fighting had been going on since 3 June. Southeast of Limoges an uprising by the Maquis had stopped rail traffic on D-day, but subsequent fighting had exhausted FFI supplies. In the Vercors, the

entire population was in revolt. Southeast of Dijon, Maquis were unusually active in disrupting traffic. The mountainous Ain area west of Geneva had been practically liberated by 14 June, when the Maquis were forced to fall back to more inaccessible ground, and the department of Haute-Savoie south of Geneva was almost entirely in FFI control by 18 June. Fighting in these regions had reduced Maquis supplies to a dangerously low level.<sup>41</sup>

Originally scheduled for 22 June, Operation ZEBRA was postponed for three days because of unfavorable weather. Then, with fighter escort provided at set rendezvous points, 180 B-17's took off at about 0400 on 25 June in clear weather. One plane was lost to flak, another fell to an enemy fighter, and two others failed to complete the mission. In all, 176 B-17's dropped 2,077 containers on four targets. Lack of reception at the Cantal target caused the wing scheduled for that point to drop with another wing southeast of Limoges.<sup>42</sup>

Operation CADILLAC, the second mass drop by B-17's of the 3d Air Division, took place on 14 July. At this time with the battle for St.-Lô reaching its climax, the Maquis could give valuable assistance by continuing to disrupt enemy troop movements and by engaging the maximum number of German forces. Fighting was heavy in the Vercors, where the Nazis were making a strong effort to eliminate the threat to their communications northward in the Rhone and Saône valleys, southwest of Chalon-sur-Saône, and in the area of Limoges. Operation CADILLAC was planned to deliver supplies to seven points in these three principal regions. Nine wings of thirty-six B-17's each were assigned to the operation and each wing loaded six spares to insure a maximum drop. The bombers took off at about 0400 from nine airbases, picked up a fighter escort of 524 P-51's and P-47's, and flew to their targets in daylight. The only opposition was that offered by some fifteen Me-109's which attacked southwest of Paris. The bombers and fighters together claimed nine of the Me's shot down, two probables, and three damaged. Two of the B-17's landed in Normandy, and all told only three planes suffered major damage. Two wings of seventy-two B-17's dropped 860 containers on the Vercors plateau, and one wing of thirty-six B-17's dropped 429 containers southwest of Chalon-sur-Saône. The remaining 214 B-17's dropped 2,491 containers on five targets in the Limoges-Brive area. Practically all of these 3,780 containers, loaded with nearly 500 tons of supplies, were recovered by reception committees.<sup>43</sup>



A third mass drop, Operation BUICK, occurred on 1 August 1944. The 3d Air Division assigned five wings of thirty-nine B-17's each to drop on four targets. One wing went to the Chalon-sur-Saône area, where the FFI had won control over the Saône-et-Loire department by using the munitions delivered on 14 July; another wing dropped 451 containers west of Geneva. In Savoie in the Alps, 5,000 Maquis had fought an eight-day battle with an equal number of the enemy in January 1944. The patriots had been forced to disperse because their supplies were exhausted; but they reorganized in May and had 5,500 waiting for arms. To this group, thirty-nine B-17's dropped 463 containers, and seventy-five B-17's delivered 899 containers to Haute-Savoie. In all, 192 B-17's made successful sorties to drop 2,281 containers at a cost of six planes slightly damaged.<sup>44</sup>

One other Eighth Air Force operation, which supplemented regular supply-dropping, is worthy of note. This took place on 9 September to a drop zone twenty-five miles south of Besançon. By this time the FFI controlled a score of departments and were growing stronger. The rapidly moving Seventh Army had overrun many of the drop zones; but the Besançon area, on the route to Belfort and Colmar, was not yet cleared of Germans. To this drop zone, six groups of twelve B-17's each dropped 810 containers.<sup>45</sup>

These four mass drops, important though they were, lend particular emphasis to the significance of the earlier and continuing effort by special units, both of the RAF and the AAF, to keep alive the resistance movement and to prepare it for a major part in the expulsion of the Germans from France. And to that effort organizations operating from Mediterranean bases had made their own special contributions.

### *Special Operations in MTO*

Special operations from Mediterranean bases to southern France had been conducted on a very limited scale prior to September 1943, when SOE/OSS agents operating among the Maquis pressed Allied Force Headquarters for greater deliveries. The RAF stationed a detachment of 624 Squadron at Blida near Algiers for aid to the Maquis, but from 1 October to 31 December 1943 this unit succeeded in only seven of its attempts.<sup>46</sup> A Polish flight of four Halifaxes and two Liberators arrived in North Africa in November, primarily for missions to Poland, and in that month the British formed 334 Wing as headquarters to command nearly all special-duty aircraft in the theater.<sup>47</sup> The RAF and Polish

units moved to Brindisi in southeastern Italy in December 1943 and January 1944, leaving a detachment of 624 Squadron at Blida.<sup>48</sup>

The question of AAF participation in supply operations having been under consideration in the Mediterranean theater before 334 Wing was organized, General Eaker, on his transfer from ETO, gave close attention to the problem. The 122d Liaison Squadron, a remnant of the Twelfth Air Force 68th Reconnaissance Group, had participated in special operations on a very limited scale since November 1943,<sup>49</sup> and General Eaker in January 1944 requested authority to reorganize the 122d Squadron into a heavy bombardment unit for assignment primarily to missions in support of the Maquis.<sup>50</sup> General Arnold approved the request, and the 122d Bombardment Squadron (in June redesignated the 885th) was activated on 10 April 1944, under command of Col. Monro MacCloskey. Based at Blida, the unit was attached to the Fifteenth Air Force.<sup>51</sup> In February the British had concentrated 624 Squadron at Blida, to which base other RAF units later were assigned. A liaison section, called Special Projects Operations Center (SPOC), coordinated RAF and AAF activities, determined target priorities within the area selected by squadron commanders for a night's missions, and contacted field agents who prepared the reception parties.<sup>52</sup>

By May 1944 the 122d Bombardment Squadron was in full operation. During that month it completed forty-five sorties in seventy-two attempts. Weather and poor navigation were responsible for some failures, but inability to contact reception committees was the principal explanation for missions listed as incomplete.<sup>53</sup> An increase in the supply of Eureka's to the Maquis brought an improvement of the record thereafter, and further help came from the designation of dumping grounds to be used as alternate targets when contact with reception committees failed. In areas selected for dumping, there were few Germans and the Maquis could be informed as to the exact location of the drop by radio. This practice ended in August when German withdrawal gave the Maquis greater freedom of movement.<sup>54</sup>

Since missions to the Maquis differed little except in details, one experience of the 885th Bombardment Squadron may be taken as typical. On the night of 12/13 August, less than three days before the Seventh Army invasion, the squadron was assigned the task of delivering last-minute supplies and dropping leaflets over French cities to alert the FFI of the Rhone Valley and along the coast. Eleven aircraft took off from Blida on a moonless night, flew individually to assigned pin-

## AIR SUPPORT FOR THE UNDERGROUND

points, and dropped 67,000 pounds of ammunition and supplies, eighteen Joes, and 225,000 leaflets. For that night's work the squadron received the Presidential unit citation.<sup>55</sup>

As was true with the CARPETBAGGERS, Allied success in France reduced the number of sorties flown from Mediterranean bases to the Maquis after the middle of September 1944. The 885th Bombardment Squadron, in its operations from 5 June to 13 September, had completed 484 sorties out of 607 attempts, dropped 193 Joes and 2,514,800 pounds of arms and ammunition. Additional deliveries were made after the 885th was moved to Brindisi in September, but the move itself gave notice of the greater importance now given to northern Italy and the Balkans. The combined RAF/AAF effort from MTO in behalf of the French resistance movement resulted in 1,129 successful sorties out of 1,714 attempts, the dropping of 578 Joes, and the delivery of a gross tonnage of 1,978. The RAF suffered eight aircraft lost, while the 885th Bombardment Squadron lost but one B-24.<sup>56</sup>

Two squadrons (7th and 51st) of the 62d Troop Carrier Group had been sent from Sicily to Brindisi in February 1944 for operations in support of the Balkan Partisans. The AAF squadrons were attached to 334 Wing of the RAF, which had been delivering supplies to the Balkans for several weeks. Wing headquarters prepared flexible daily target lists with stated priorities within each list. Squadron or group commanders and operations officers attended daily meetings to select targets for their squadrons from the list, after which an operations schedule was prepared.<sup>57</sup> Weather and availability of aircraft determined the number of targets for each mission. On night missions, the number of C-47's averaged about thirty-five from April through October 1944; occasionally as few as four and as many as fifty were airborne. The number of targets averaged about fifteen for this period, and one to three planes dropped on each target.<sup>58</sup>

Supplies carried to the Balkans consisted principally of guns, ammunition, dynamite, food, clothing, medical supplies, and specialized equipment; but gasoline, oil, jeeps, mail, and even mules were included in the cargo when landing operations later became frequent. The weight of stores carried by a C-47 varied from 3,000 to 4,500 pounds net, and there was usually an additional 150 pounds of propaganda leaflets.<sup>59</sup> Stores were kept in warehouses at Brindisi where Partisans, generally evacuees who had come to Italy for medical care, packed the supplies. A stock of some 8,000 bomb-rack containers and 25,000 fuse-

BALKAN AREA SERVED  
BY A.A.F  
SPECIAL OPERATIONS

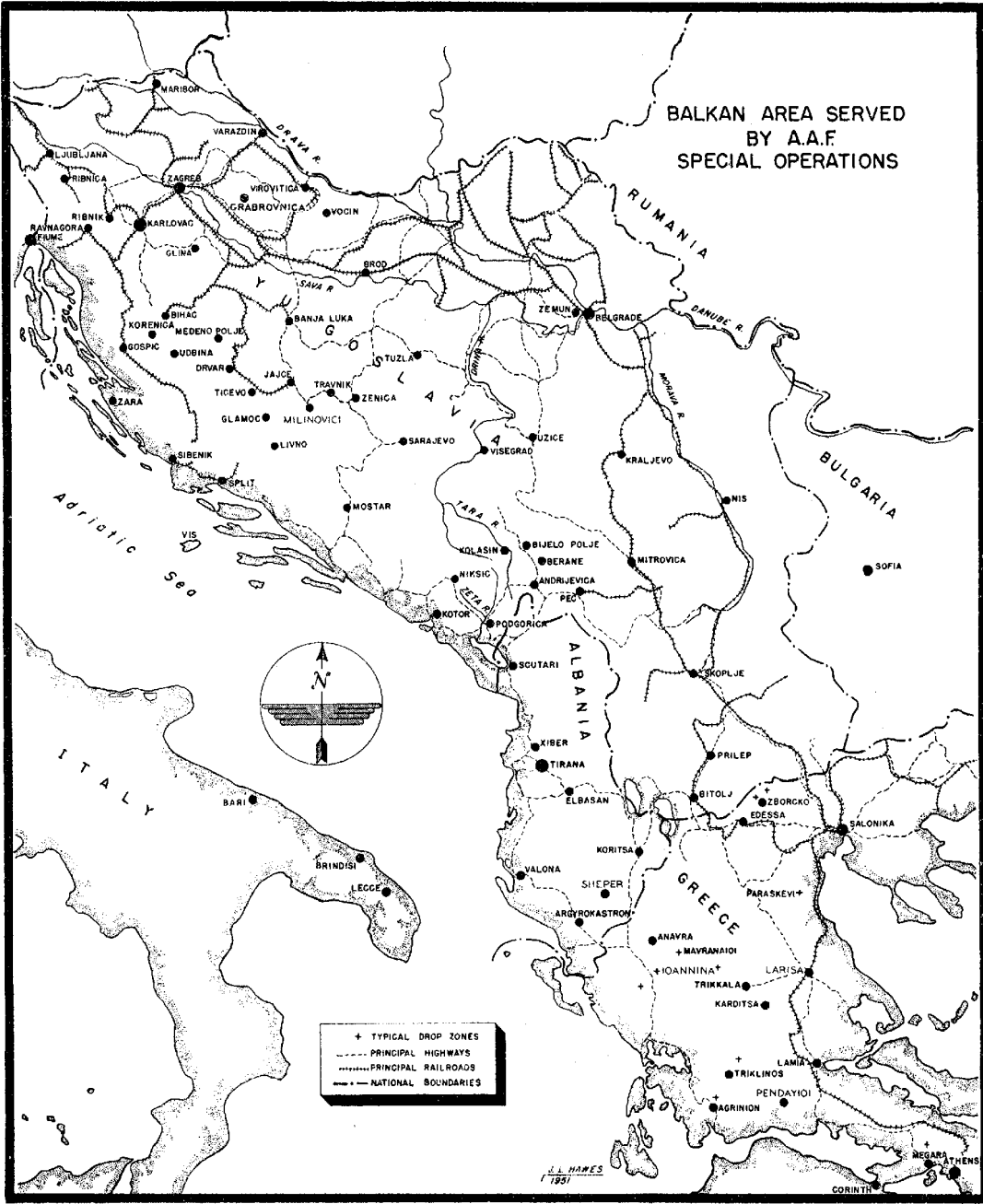

- + TYPICAL DROP ZONES
- PRINCIPAL HIGHWAYS
- ..... PRINCIPAL RAILROADS
- NATIONAL BOUNDARIES

J. L. HAMES  
1951

CORINTH

## AIR SUPPORT FOR THE UNDERGROUND

lage packages, known as standard packs, was kept on hand in anticipation of field requests.<sup>60</sup> Each morning the air loads section at Paradise Camp, as the warehouse area was called, assembled maximum loads for scheduled sorties according to data received from SOE/OSS headquarters. Each load was picked up by a truck, checked at the loads control hut, and delivered to the designated aircraft where a British checker supervised a Partisan loading team. Whereas C-47's were loaded under British supervision by Partisans, the 885th Bombardment Squadron upon its removal to Brindisi was supplied from an OSS dump located adjacent to the dispersal area and operated by squadron personnel.<sup>61</sup>

Assignment of AAF C-47's to supply operations had helped to solve a critical situation for the rapidly growing Yugoslav Partisans. No. 334 Wing had been unable to meet all of the requests for missions, primarily because there were not enough special-duty aircraft under its control. Unfortunately, the 7th and 51st Troop Carrier Squadrons experienced a period of bad weather in February and March which caused 62 failures in 186 sorties and required another 97 scheduled sorties to be canceled. Nevertheless, the two squadrons succeeded in 82 attempts and dropped a gross weight of 374,900 pounds of supplies, leaflets, and personnel to all targets. Most of the targets lay in central and southern Yugoslavia, but sorties were flown to Albania, Greece, Bulgaria, and northern Italy. Lack of reception and incorrect signals combined to cause 41 failures, but pilots made every attempt to deliver their loads, even at the risk of inviting enemy action.<sup>62</sup> On the night of 1/2 March, for example, two C-47's of the 7th Troop Carrier Squadron took off for a drop zone seven miles north of Tirana in Albania. The first pilot to arrive located the pinpoint, flashed the signal, but received an incorrect reply. He "stooged" for nearly ninety minutes waiting for a correct signal, then returned to base with his load. The other pilot located the signal fires some distance from the pinpoint, but during his runs on the target the reception committee moved the fires to a new location.<sup>63</sup> These two experiences bore eloquent testimony to German vigilance and to Partisan audacity in defying enemy patrols.

The four C-47 squadrons of the 60th Troop Carrier Group arrived at Brindisi between 16 March and 5 April 1944 to replace the 7th and 51st Squadrons, and they flew their first sorties on the night of 27/28 March to drop leaflets over Italy and the Balkans. Supply missions, beginning the following night, initiated a period in which the troop car-

riers were to deliver more than 5,000 short tons of supplies to the Balkans.<sup>64</sup> A month's operations by each of two squadrons may be taken as typical of the 60th Troop Carrier Group's activities from 29 March to 17 October 1944. In April the 10th Troop Carrier Squadron flew 74 sorties and completed 42, all but 9 of which went to Yugoslavia.<sup>65</sup> In June the 11th Troop Carrier Squadron flew 142 of its 170 successful sorties to Yugoslavia to deliver more than 246 short tons of supplies.<sup>66</sup>

The technique of supply-dropping to the Balkans varied little from that used by the CARPETBAGGERS, except for a heavier dependence on landing rather than dropping operations. Unlike most of the drop zones in western Europe, those in the Balkans, and in northern Italy as well, frequently were located in narrow valleys surrounded by peaks and ridges. Transport pilots rarely failed to find their assigned pinpoints, and the Partisans, in no small part because of the munitions supplied by air, were able to set up definite lines of resistance which gave protection to a number of semipermanent and well-organized strips that remained under Partisan control for considerable periods of time.<sup>67</sup> The first AAF transports to land in the Balkans, two C-47's of the 60th Troop Carrier Group, came down on a rough strip near Tito's headquarters at Drvar on the night of 2/3 April 1944.<sup>68</sup> Subsequently, MAAF organized special service teams for the development and maintenance of strips as a part of the Balkan Air Terminal Service (BATS), which was placed under control of the Balkan Air Force on its organization in June 1944.\* Most of the thirty-six landing grounds used at various times in Yugoslavia were prepared and operated by BATS teams.<sup>69</sup> There was no way, however, to eliminate the special hazards of night operations. In addition to danger from enemy night fighters and ground fire, most of the fields were so located that only one approach was possible. Failure on that one attempt meant a wrecked plane and death or injury for its occupants. No night-flying facilities existed, except for fires to mark the rude runways and an occasional electric flare path. Nevertheless, night landings, as well as escorted daylight sorties, steadily increased in number, and in the period 1 April-17 October 1944 the 60th Troop Carrier Group completed 741 landings, practically all of them in Yugoslavia.<sup>70</sup>

The Partisans made heavy demands upon 334 Wing from May to September 1944, a period in which the Germans endeavored to liqui-

\* See above, p. 399.

date Marshal Tito's forces. One enemy offensive began late in May and was directed against Tito's headquarters at Drvar and other points in Slovenia and Bosnia. When these efforts failed, the Germans turned their attention to Montenegro in a July offensive which coincided with the beginning of operations by the Balkan Air Force.<sup>71</sup> The BAF not only gave considerable tactical aid to the Partisans but also escorted transports on daylight landing missions. Maximum effort by the BAF, which exercised operational control over 334 Wing, could not prevent the Partisans from losing ground in Montenegro during August, when the 60th Troop Carrier Group delivered more than 620 short tons of supplies to Yugoslavia or about 75 per cent of its total Balkan effort.<sup>72</sup> In 145 successful landings, most of them in Yugoslavia, the 60th Group also evacuated more than 2,000 persons to Italy.<sup>73</sup> An unusual feature of the month's operations was the delivery of twenty-four mules and twelve 75-mm. guns to two very difficult landing grounds in Montenegro. The weather was exceptionally bad, and the landings required flying on instruments between two jagged peaks at the destination.<sup>74</sup>

The strategic situation changed suddenly between 23 August and 5 September, when Rumania and Bulgaria capitulated before the swiftly advancing Russians. As the Germans directed their attention to extricating their exposed forces, the Allies endeavored to take full advantage of this turn of events during September, the last full month of the 60th Troop Carrier Group's tour at Brindisi. Tito's divisions in Montenegro and Serbia began to drive northeast to link up with the Russians advancing on Belgrade from western Rumania, and the BAF flew more than 3,500 sorties that resulted in heavy damage to German communications and transport.<sup>75</sup> No. 334 Wing delivered 1,023 short tons of supplies to Albania and Yugoslavia, more than one-half of which was carried in AAF C-47's. The 60th Troop Carrier Group made about 125 landings on Yugoslav grounds and evacuated some 1,500 persons.<sup>76</sup> Three of the squadrons were withdrawn from Partisan supply missions on 8 and 10 October to take part in Operation MANNA, the British occupation of southern Greece. The 10th Troop Carrier Squadron continued its assistance to the Partisans until 25 October.<sup>77</sup>

Operation MANNA became possible because of the German withdrawal, and not because of successful Partisan activity on any considerable scale. The RAF had started supply missions to Greek patriots late in 1942, and by March 1943 a more or less regular flow of material was arriving for resistance groups organized by SOE agents. AAF C-47's

completed 367 dropping and landing sorties to Greece between February and November 1944, and the 885th Bombardment Squadron flew 35 successful sorties to the peninsula in October. Together the transports and bombers delivered about 900 short tons of supplies, which was approximately one-third of total Allied deliveries to Greece.<sup>78</sup>

A review of the 60th Troop Carrier Group operations for the period 29 March–17 October 1944 reveals the cumulative importance of its supply missions. More than 5,000 short tons of supplies were delivered to the Balkans, of which approximately three-fourths went to Yugoslavia and Albania. Some of these supplies were to maintain Allied missions and agents, but diversion for that purpose represented a comparatively small percentage of the total. Landing operations began on a small scale in April with eighteen successful attempts, then increased rapidly: 50 in May, 125 in June, 194 in July, 145 in August, and 128 in September. In view of the hazards encountered, the loss of ten C-47's and twenty-eight men was very low. This average of one C-47 lost for each 458 sorties was a remarkable record that testified to the pilots' skill in evading enemy flak, night fighters, and mountain peaks and to the faithful performance of ground crews. Of about 1,280 incomplete sorties, only 58 were attributed to mechanical failure, 661 were caused by bad weather, and 486 by reception failures.<sup>79</sup>

During the last period of supply operations to the Balkans, from 17 October 1944 to the end of the war, the AAF assigned both transports and heavy bombers to the work. The 885th Bombardment Squadron completed its move from North Africa to Italy early in October; its primary mission thereafter was to supply distant targets in northern Italy and Yugoslavia. The 7th Troop Carrier Squadron, which had taken part in Operation MANNA, resumed special operations from Brindisi on 22 October and was followed five days later by the 51st Troop Carrier Squadron. The 7th left Brindisi early in December, but the arrival of the 859th Bombardment Squadron from the United Kingdom partially compensated for this loss. Replacing the 51st Troop Carrier Squadron at the end of March 1945, the 16th Troop Carrier Squadron of the 64th Troop Carrier Group continued supply-dropping until the end of the war.<sup>80</sup> Three AAF squadrons, therefore, were available for missions to Yugoslavia through March; thereafter, the 16th Troop Carrier Squadron was the only AAF unit thus engaged.<sup>81</sup>

Squadrons flying supplies to the Balkans encountered a period of bad weather which canceled many missions during the third week of Octo-



ber 1944, and in November less than one-half of the days were operational. In spite of this handicap, the two C-47 squadrons succeeded in putting up 312 sorties during the period ending 30 November, of which more than 75 per cent were successful, and about 386 short tons of supplies were landed or dropped on widely separated drop zones.<sup>82</sup> Among the more notable landings were those at the Zemun airdrome on the edge of Belgrade. Zemun was rough, but not as bad as a strip near Skopje, where on one occasion twenty oxen were required to pull a C-47 out of bomb craters. In December, the 51st Troop Carrier Squadron completed forty-four landing sorties to a ground some fifteen miles north of Gjinokastër, Albania.<sup>83</sup> While the 51st Troop Carrier Squadron was concentrating its attention on close targets in Albania, the 885th Bombardment Squadron served the more distant Yugoslav drop zones. Most of its 256 successful sorties from 18 October to 31 December 1944 went to the Zagreb and Sarajevo areas, although on 3 December the squadron flew a thirteen-plane daylight mission to supply Partisans near Podgorica in the south.<sup>84</sup>

Division of responsibility among the supply-droppers was more carefully drawn early in January 1945, in time to meet the critical situations that developed in connection with the German withdrawal from the Balkans. The 51st Troop Carrier Wing, assigned to MATAF, was given a primary responsibility for the 15th Army Group's area in Italy. The 15th Special Group (Prov.) operated under MASAF until the middle of March and was then transferred to MATAF and redesignated 2641st Special Group. The 859th and 885th Bombardment Squadrons of this group served both Italy and the Balkans, although the 859th was to give first priority to the Balkans and the 885th was to concentrate its effort on Italian missions. Units under 334 Wing devoted their attention to the Balkans primarily, with second priority to northern Italy. One AAF troop carrier squadron, the 51st and then the 16th, remained on duty with 334 Wing.<sup>85</sup>

During the period 1 January–11 May 1945, AAF C-47's and bombers flew nearly 1,000 sorties to Yugoslavia and Albania, although missions to the latter practically ceased in January, and delivered 1,685 short tons of supplies by landing and dropping.<sup>86</sup> The 16th Troop Carrier Squadron in April set a new record for C-47 performance over the Balkans when it completed 183 of 196 sorties.<sup>87</sup>

Receipt of supplies from southern Italy was an important factor in Partisan successes in Yugoslavia and Albania. Although the Partisans

captured large quantities of stores from the enemy and significant amounts were taken in by surface craft, special-duty aircraft delivered the supplies that made the difference between victory and defeat. More than 18,150 short tons of supplies were flown to Yugoslavia and more than 1,320 tons to Albania. To accomplish this, Allied supply planes flew 9,211 successful sorties in 12,305 attempts. Eighteen aircraft were lost in Yugoslav operations and seven on Albanian missions.<sup>88</sup> At least ten AAF C-47's and two B-24's are included in this total.<sup>89</sup> The 51st Troop Carrier Wing and the 2641st Special Group (Prov.) delivered somewhat less than one-half of the total tonnage to Yugoslavia, while C-47's dropped or landed 65 per cent of the supply taken to Albania.<sup>90</sup>

The Germans were unsuccessful in the countermeasures adopted to decrease the flow of airborne supplies to the Partisans. Their difficulty may be understood when one recalls that there were at least 322 drop zones and landing grounds in Yugoslavia alone.<sup>91</sup> These grounds were by no means secret; but enemy patrols and armored columns sent out to capture them, bombers dispatched in attempts to crater the landing strips, and night fighters undertaking to intercept the transports achieved only limited success.<sup>92</sup>

#### *Aid for Italian Partisans*

Poorly organized and scantily supplied, the Italian resistance movement was far less important to the Allies than its counterpart in Yugoslavia. Italy was a major battleground with well-defined combat lines manned by regular troops. These conditions, so different from those that prevailed in the Balkans, severely restricted Partisan activities except in limited areas. Not until the enemy had lost Bologna and was in full retreat across the Po Valley did the Partisans of town and country find opportunities to make a material contribution to Allied victory. While waiting for these opportunities, bands of anti-Fascist guerrillas harassed the enemy's communications, perfected their own organization, harbored Allied agents, transmitted information to the Allies, and aided flyers in escape and evasion.

Organization and supply of these Partisan groups were functions of SOE and OSS. Until after the Salerno invasion in September 1943, the only special-operations flights to Italy were for the purposes of dropping agents or of delivering supplies to escaped prisoners of war. During the period extending from June to November 1943, 624 Squadron (RAF) completed twenty-nine of forty-two attempted sorties to

Italy from Blida. Dropping and reception techniques used in connection with these flights were so faulty that many agents were captured and supplies often fell into the enemy's hands. Improper location and identification of drop zones continued throughout the war to be a handicap, although well-trained officers dropped for assistance of the Partisans managed to accomplish a very real improvement in operating procedures.<sup>93</sup>

The AAF played a minor role in the support of Italian Partisan activity prior to September 1944.<sup>94</sup> Squadrons of the 51st Troop Carrier Wing at Brindisi had completed eleven sorties to Italian targets by the end of May and flew another nineteen sorties in June.<sup>95</sup> That the Italians were putting these supplies to good use is indicated by Marshal Kesselring's announcement on 19 June 1944 that guerrilla warfare was endangering the German supply routes and the armament industry. He demanded that the guerrillas be suppressed with the utmost vigor, and hundreds of the Partisans were killed or captured in the resulting drive but the resistance movement was far from crushed.<sup>96</sup> During the summer of 1944, when resistance groups in France were exerting maximum pressure on the enemy and Tito's Yugoslav Partisans were engaged in critical battles, northern Italy was of necessity neglected. With the liberation of southern France, however, the 885th Bombardment Squadron became available for other assignments. The squadron moved from Blida to Maison Blanche, just outside of Algiers, and flew a first mission to northern Italy on the night of 9/10 September 1944. In less than two weeks it had completed thirty-six sorties which dropped nearly fifty-nine tons of supplies in the Po Valley. During the last week of September, the squadron, now operating from Brindisi, completed nine more sorties to the same area.<sup>97</sup> Although transferred to Brindisi primarily for missions to Italian targets, the 885th often flew daylight missions to the Balkans. The weather during October seriously reduced the deliveries to northern Italy, which were usually made by night. Unfortunately for the Partisans, this period of bad weather coincided with determined German efforts to crush guerrilla activity in the Udine area in northeastern Italy and in the Ossola Valley in the northwest. The 885th Bombardment Squadron tried eighty-five sorties on the seven operational nights, but only thirty-three were successful and two B-24's were lost in the effort to relieve the Partisans.<sup>98</sup>

Delivery of supplies in Italy increased sharply during November 1944 and remained on a high level to the end of the war. This result was

achieved by assigning the 62d and then the 64th Troop Carrier Group to these operations and by the arrival of the 859th Bombardment Squadron from England in December. The 205 Bombardment Group (RAF), the Polish 301st Squadron, and 148 Squadron (RAF) all contributed in occasional missions to the total; but AAF units delivered practically all of the airborne supplies reaching the Italian Partisans after November 1944. Deliveries to Yugoslavia continued to be far greater than those to Italy, but the discrepancy became progressively less as the war drew to a close.<sup>99</sup> The C-47's, flying from Tarquinia, Malignano, and Rosignano, confined their attention largely to the area south of Turin and Piacenza, west of Modena, and north of Pisa, Lucca, and Pistoia. It was estimated that the Partisans in this area were keeping some 40,000 second- and third-rate enemy troops on police duty.<sup>100</sup> The Ligurian and Maritime Alps in the region, as well as more distant targets, were visited by the supply bombers in November and December.<sup>101</sup>

The 62d Troop Carrier Group, stationed at Malignano and Tarquinia, loaded all of its planes at Malignano. Its first mission to north Italy was flown on 22 November when six C-47's of the 4th Squadron, with an escort of two P-47's, flew to a DZ near Massa. The 8th Squadron joined the 4th in this type of effort on 28 November, and the 7th followed suit on 10 December. The three squadrons completed their daylight missions to northern Italy by 9 January 1945, having delivered more than 494 short tons of supplies.<sup>102</sup> Most of the group's sorties had been to DZ's in the mountains 20 to 100 miles northwest of Pistoia, although some flights went west of Turin. Target LIFTON, about twenty-five miles north of La Spezia, received particular attention. The 7th Troop Carrier Squadron sent out thirty-eight sorties from 11 to 20 December in vain attempts to supply this target but finally succeeded in dropping no more than sixteen tons of supplies.<sup>103</sup> Bad weather, as usual, was the principal cause of incomplete missions, while enemy interference and improper reception accounted for about one-tenth of the failures to drop after the planes had reached the DZ's. An escort of four P-47's or Spitfires, which generally met the C-47's over Marina di Pisa, provided protection from hostile aircraft but no opposition was encountered except for occasional bursts of flak.<sup>104</sup>

Italian Partisans, supplied on a scale never before attempted, increased their activities materially in December 1944. In the last week of that month, the Germans countered with a drive to clear their lines

## AIR SUPPORT FOR THE UNDERGROUND

of communication, especially around Piacenza where two Partisan divisions had organized and armed some 7,000 men. The offensive scattered the Partisans and opened the roads temporarily; but while bands were reassembling northwest of La Spezia, activity increased in such distant areas as Udine and Vittorio Veneto.<sup>105</sup>

The 64th Troop Carrier Group, operating under MATAF at Rosignano, began its supply operations on 11 January 1945. When its missions ended on 7 May, the group had completed more than 1,000 sorties in which there had been dropped better than 1,800 short tons of supplies.<sup>106</sup> During this same period the 2641st Special Group (Prov.) dropped nearly 1,260 tons.<sup>107</sup> Most of the missions continued to be flown during daylight hours and, as before, weather and reception difficulties accounted for most of the failures. The January experience of the 16th Troop Carrier Squadron was typical: of twenty-four sorties, twelve failed to receive the correct signals.<sup>108</sup> Weather caused 50 to 142 failures for the 64th Group in February.<sup>109</sup> Enemy opposition, on the other hand, was insignificant and but one C-47 was lost.<sup>110</sup>

Swift disintegration of the German position in April provided the Partisans with splendid opportunities to aid the Allied advance. Guerrillas captured large quantities of enemy material, thus freeing themselves of a heavy dependence on air supply, but far to the north there were more or less isolated groups which continued to depend upon supplies dropped by the 2641st Special Group. New targets were opened for the B-24's in the Alps, where Partisans were disrupting traffic toward the Brenner Pass, and in the Po Valley. Other Partisan groups were attacking the Verona-Udine-Villach withdrawal route from strongholds in the Adige and Piave valleys.<sup>111</sup> Even after hostilities had ceased, on 2 May 1945, the supply-droppers continued to receive calls from units that had been cut off from other sources. But special operations may be considered as having ended in Italy by 7 May. During the period of hostilities, Allied special-duty aircraft had completed 2,646 of 4,268 attempted sorties to Italian targets and had dropped more than 6,490 short tons of supplies. The AAF flew 70 per cent of the completed sorties and dropped 68 per cent of the tonnage.<sup>112</sup>

Leaflets dropped by aircraft over Italy and the Balkans were similar to those delivered to western Europe. The principal purposes were to inform isolated peoples of the march of events, to counteract enemy propaganda, and to maintain morale. Among strategic leaflets dropped over Italy after the Salerno invasion were those that urged the preser-

vation of art treasures, informed enemy soldiers of Allied successes on other fronts, and encouraged and directed Italian Partisans in works of sabotage.<sup>113</sup> Bombers on strategic missions and supply planes in the course of their normal operations were able to meet the need without the aid of a special leaflet squadron or the assignment of special bombers to the work. Tactical aircraft, the medium and fighter-bombers in particular, and artillery "shoots" were used extensively to nickle the enemy's front-line positions and rear areas. Supply-droppers from North Africa, both of the RAF and the AAF, carried propaganda to southern France, and a number of purely nickeling sorties were flown to that area, most of them just prior to the Allied invasion of August 1944.<sup>114</sup>

MASAF dropped appropriate leaflets on large cities in Italy and the Balkans. Its attacks on Rome, for example, were preceded and accompanied by nickeling, and leaflets urging a general strike and sabotage of enemy communications preceded the Salerno invasion.<sup>115</sup> Most of the nickeling by MASAF after September 1943 was carried out by the 205 Bombardment Group (RAF).<sup>116</sup>

Nearly every C-47 of the 60th Troop Carrier Group carried from 150 to 450 pounds of propaganda to the Balkans or north Italy on supply missions. Written in many languages, the leaflets were dropped on Germans, Greeks, Albanians, Yugoslavs, Bulgarians, and Italians while the planes were en route to or from their targets. A sufficient number of nickeling sorties, on each of which some 4,000 to 4,500 pounds of leaflets were carried, were flown to keep the monthly total at forty-five to sixty-eight tons. In the period 12 February–31 December 1944, the 51st Troop Carrier Wing dropped 414.4 tons on the Balkans and Italy. After the 885th and 859th Bombardment Squadrons entered Italy, they also carried nickels for PWD. In two typical months of operation, the 2641st Special Group flew 209 successful sorties to the Balkans and 152 to northern Italy, during which its two squadrons dropped a total of 34.6 tons of leaflets.<sup>117</sup>

### *Infiltration and Evacuation*

Infiltration of special agents by air began in 1940 when the RAF dropped operatives over France<sup>118</sup> and grew rapidly as Allied intelligence agencies expanded and as the preliminary work of Partisan organizers began to bear fruit. The presence of "Joes" and "Janes" in C-47's and B-24's became common. CARPETBAGGERS from the

## AIR SUPPORT FOR THE UNDERGROUND

United Kingdom dropped 617 Joes from January to September 1944, and by April 1945 had raised the total to 1,043. Units of the MAAF dropped or landed 4,683 Allied agents and Partisans in various European countries from 1943 to 1945.<sup>119</sup>

Most of the infiltration work was mere routine for the air forces, however dramatic the experience might be for the agents, although interesting assignments appeared from time to time. The 492d Bombardment Group participated in a few missions in 1945 that departed from the ordinary. The 856th Bombardment Squadron, operating from a base at Lyon, dropped parachutists in Germany on 21 January and, with the 858th Bombardment Squadron, flew out of Dijon from 19 March to 26 April. During this period the two squadrons dropped eighty-two agents, equipped with radios, at key locations in Germany. Another interesting variation was the "Red Stocking" series in which pilots flew Mosquito aircraft from Dijon. These planes, equipped with recording devices, were flown at high altitudes over designated pin-points to pick up and record messages transmitted by agents on the ground.<sup>120</sup>

Supply-droppers in Italy were called upon at times to execute special infiltration missions that varied considerably from their usual work. Operation ORATION, infiltration of the Maclean military mission\* to Yugoslavia by parachute, was carried out by the RAF in January 1944.<sup>121</sup> Another special mission, Operation MANHOLE, infiltrated a Russian military mission by glider on 23 February 1944. The Russians had arrived in Italy in two C-47's, and General Wilson, the theater commander, agreed to facilitate their entrance into Yugoslavia. This mission was at first assigned to the RAF, which planned a daylight landing mission with C-47's at Medeno Polje, but snow covered the strip and compelled a revision of plans. The assignment was then given to the 51st Troop Carrier Squadron, which was to provide three C-47's for the tow of the same number of Waco (CG-4A) gliders. Twenty-four P-40's from the Desert Air Force and twelve Fifteenth Air Force P-47's flew as escort. The transports, carrying a gross load of 10,500 pounds of supplies to be dropped, took off from Bari with the gliders in tow on the morning of 23 February. Twenty-three Russian and six British officers were in the gliders, which made perfect landings.<sup>122</sup> The third mission, Operation BUNGHOLE, also had been assigned

\* Brig. F. H. Maclean headed a British liaison mission attached to Tito's headquarters in September 1943.

to the RAF, but it was flown by the 7th Troop Carrier Squadron on 27 February. This required two C-47's to drop American meteorologists and their supplies at a drop zone near Ticevo. A heavy snowstorm prevented one of the planes from locating the DZ, but the other dropped successfully.<sup>123</sup> Landings in Yugoslavia, Albania, and Greece increased in number as the war drew to a close, and the 51st Troop Carrier Wing in effect operated an air transport service at Brindisi. Outgoing traffic consisted primarily of Allied agents and supplies; incoming traffic was largely made up of Balkan nationals and Allied airmen.

Flying agents into enemy territory was an easy task in comparison with getting them out again. The return trip was especially difficult from western Europe and Poland, although there are a few cases of successful pickups by the RAF and AAF from these areas. Most of the pickups from fully clandestine fields, as distinguished from well-established strips under Partisan control, were carried out by British Lysanders.<sup>124</sup> But the number of agents who escaped from enemy territory by this means was far less than the number brought out of the Balkans on regular sorties.<sup>125</sup>

The principal reason for evacuation of Partisans from the Balkans was the inability of guerrilla forces to care properly for their wounded and to protect women and children threatened with extermination by Nazi and satellite forces. Although a few Partisans had been evacuated at an earlier date, chiefly it seems by the RAF, Capt. Karl Y. Benson and Floyd L. Turner of the 60th Troop Carrier Group are credited with having initiated large-scale evacuations from Medeno Polje, a strip in use since February, on the night of 2/3 April 1944. The two planes took out thirty-six evacuees, most of them wounded Partisans.<sup>126</sup> By the end of the month fifteen transports had landed and evacuated 168 personnel, among whom were members of the Maclean mission and a Yugoslav delegation to MAAF. These operations were so successful that MAAF sent a flying control and unloading party, forerunner of the BATS, to Medeno Polje in the interest of better service.<sup>127</sup>

Successful transport landings in Yugoslavia increased by 400 per cent in May when 60 completed sorties evacuated 1,098 persons, 777 of whom were Partisan wounded. All but thirty-seven of the evacuees were brought out by the 60th Troop Carrier Group.<sup>128</sup> Although reliable statistics are incomplete, the total number of persons evacuated from the Balkans in the period 1 April 1944-30 April 1945 was about



19,000, of which about one-half were evacuated by the 60th Troop Carrier Group in the period 1 April–30 September 1944.<sup>129</sup> Thereafter most of the Balkan evacuation sorties were flown by the RAF, since the major effort of AAF C-47's had been directed to northern Italy. The importance of evacuation to Tito is indicated by the record for August and September 1944, when 418 successful landings evacuated 4,102 wounded Partisans.<sup>130</sup>

Landing sorties were far more interesting and dangerous than routine supply drops and frequently required a high degree of courage and skill. Capt. Homer L. Moore, 28th Troop Carrier Squadron, won the DFC for his exploit on the night of 3/4 June 1944. His target was a crude strip in the bottom of a narrow valley surrounded by 300-foot hills. Captain Moore let down successfully through a thick overcast, delivered his supplies, and carried twenty-two wounded Partisans to Italy.<sup>131</sup> Lt. Robert H. Cook, 10th Troop Carrier Squadron, lost an engine at 10,000 feet on the night of 7/8 July when he was flying a load of wounded Partisans to Italy. Losing altitude all the way, Lieutenant Cook set course for the island of Vis where he crash-landed without injuring his passengers. Lt. Harold E. Donohue, of the 28th Troop Carrier Squadron, seems to have set a record of some sort on 3 July when he loaded sixty-six Yugoslav orphans and three adults in his C-47 and delivered them safely in Italy.<sup>132</sup>

On at least three occasions special-duty aircraft responded to urgent calls from Marshal Tito for mass evacuations. The first of these occurred in late May 1944 at the time of the so-called seventh German offensive in Yugoslavia, a drive which nearly succeeded in its attempt to capture Tito and his staff. Intensive enemy air reconnaissance on 24 May had aroused Tito's suspicions, and he moved a part of his headquarters from the vicinity of Drvar back into the mountains;<sup>133</sup> but the move had not been completed when the Germans struck early on the morning of 25 May. Tito and the foreign missions fled to the hills while Partisans fought off the attack. MAAF responded to Tito's calls for aid with bomber and fighter sorties to strike enemy concentrations, shipping, dumps, and transport.<sup>134</sup> No. 334 Wing flew emergency supply missions and prepared to rescue the Partisan and Allied fugitives who were being encircled in the Prekaja Mountains. A BATS party prepared an emergency strip in the Kupresko Valley, and while Tito's party was assembling, C-47's were on their way. A Russian transport from Bari landed at 2200 on 3 June, took on Tito and other

## THE ARMY AIR FORCES IN WORLD WAR II

important officers, delivered them safely at Bari, and returned for another load.\* Three C-47's of the 60th Troop Carrier Group took out seventy-four persons on the same night. The group continued operations until the night of 5/6 June. The last C-47, loaded with wounded Partisans, took off just a few hours before the Germans captured the field.<sup>135</sup>

The German offensive in the Drvar area failed to achieve its objective and the principal attack then shifted to Montenegro. In the severe fighting that followed in July and August, Partisan casualties were heavy. Some 900 of the wounded finally assembled at Brezna, ten miles north of Niksic, where patriots cleared cornfields to make an emergency landing ground. On the morning of 22 August, escorted RAF Dakotas evacuated 219 of the seriously wounded. Then twenty-four AAF C-47's arrived with emergency supplies and evacuated 705 wounded and 16 Allied flyers. A Russian air unit, currently attached to 334 Wing, took out 138 Partisans on the night of 22/23 August, raising the total to 1,078 persons evacuated. All but nineteen of this number were wounded Partisans. The Yugoslav commander, relieved of his casualties and resupplied with arms, ammunition, and food, was able to check the enemy offensive and to recover most of the lost ground.<sup>136</sup>

The next large-scale evacuation, known as Operation DUNN, took place on 25-26 March 1945. Tito requested on 21 March that about 2,000 refugees, in danger of annihilation by the retreating Germans, be evacuated from an area northeast of Fiume.<sup>137</sup> At this time the only AAF unit at Brindisi was the 51st Troop Carrier Squadron, commanded by Maj. Bruce C. Dunn. The squadron moved to a temporary base at Zemonico airdrome, Zara, and began to fly shuttle evacuation missions on 25 March. In two days the twelve C-47's rescued 2,041 persons and delivered more than 118 short tons of supplies. Operation DUNN completed a twelve-month period in which special-duty aircraft had rescued well over 11,000 Yugoslav refugees and casualties.<sup>138</sup>

One of the problems facing MAAF was the evacuation of Allied aircrews from the Balkans. These men were survivors who had parachuted or crashed while over enemy territory on combat missions. The problem was especially acute through most of 1944, when heavy air strikes were made on such targets as Ploesti, Klagenfurt, Sofia, and

\* Marshal Tito was back in Yugoslavia by the middle of June, presumably having been returned by a Russian plane.

## AIR SUPPORT FOR THE UNDERGROUND

other objectives in or near the Balkans. Chetniks and Partisans both aided aircrews who escaped capture, fed them and tended to their wounds as well as possible, and frequently gave them assistance in reaching the Adriatic coast. From September to December 1943, the Fifteenth Air Force processed 108 evaders who had made their way back to base from Italy and the Balkans. During the next five months, more than 300 evaders were brought back, most of them in April and May.<sup>139</sup> This great increase in the spring of 1944 was a direct result of landing operations by special-duty aircraft.

Allied agencies in the Balkans participated in the rescue and evacuation of aircrews in addition to their other duties, but it was not until 24 July 1944 that a unit was created solely for this work. On that date General Eaker directed the Fifteenth Air Force to establish Aircrew Rescue Unit (ACRU) No. 1.<sup>140</sup> The first ACRU field party was dropped on the night of 2/3 August in chetnik territory about fifty-five miles south and slightly west of Belgrade. About 100 American flyers, with several refugees of various nationalities, had assembled in that area during July and were awaiting evacuation. The ACRU field party prepared a landing strip while other evaders gathered, and on the night of 9/10 August four C-47's landed with supplies. A total of 268 men, all but 42 of whom were Allied flyers, were evacuated from the strip.<sup>141</sup>

Special-duty aircraft continued to evacuate Allied aircrews for the duration of the war, but most of the work was in conjunction with regular supply missions. Aircrew evacuation by all agencies in the Mediterranean theater reached a peak in September 1944, although August was the heaviest month for special-duty aircraft. In September alone, over a thousand Americans were evacuated from Rumania by B-17's in Operation REUNION,\* and nearly 300 Allied flyers were taken out of Bulgaria by B-17's.<sup>142</sup> By 1 October 1944, 2,694 Allied flyers had been rescued from the Balkans. Of this number 1,088 came from Yugoslavia, 46 from Greece, and 11 from Albania in special-duty aircraft. Chetnik territory in Yugoslavia yielded 356 flyers and Partisan territory gave up 732.<sup>143</sup> During the period from 1 January to 30 April 1945, 310 Allied flyers were evacuated by special-duty aircraft from Yugoslavia and Albania.<sup>144</sup>

Such, in general, was the nature of the special operations. With special organizations, equipment, and techniques adapted to their peculiar

\* See above, p. 298.

## THE ARMY AIR FORCES IN WORLD WAR II

operational problems, units engaged in air support for the underground took on a certain character which set them apart from normal combat units. The security measures which shrouded their activities in secrecy while bomber and fighter missions made daily headlines emphasized that separateness. There was good-humored skepticism, both within the special operations squadrons and without, as to the efficacy of nickeling, the results of which could not readily be assayed. But the delivery of supplies and agents and the evacuation of Allied personnel and U.S. flyers brought results immediate and tangible enough to bolster morale. Certainly by V-E Day there was cause for satisfaction in the successful execution of the over-all mission, hazardous and important if unsung at the time.

## CHAPTER 15

\* \* \* \* \*

### *CROSSBOW—SECOND PHASE*

FOR six days after the launching of OVERLORD, the CROSSBOW areas in the Pas-de-Calais and on the tip of the Cherbourg peninsula had remained silent. The great network of ski sites lay in ruins and the seven large sites were visibly shattered. Though the Allies had confirmed by the end of April earlier reports that the Germans were preparing in large numbers new, small, and superbly camouflaged modified sites for launching pilotless aircraft, these lately discovered installations had raised a minimum of concern in most Allied quarters.<sup>1</sup> The tense days of anxiety and alarm over the V-weapon threat to the safety of England and the execution of OVERLORD appeared to be over.\* Allied airpower—earlier and reluctantly diverted to neutralizing the V-weapon danger—now gave massive support to ground operations and, on a limited scale, bombed strategic targets in Germany.

The continued silence of the rocket and flying-bomb sites confirmed the judgment of those who had from the beginning regarded the threat as only a gigantic hoax, a last-minute and desperate effort to bewilder and dissuade the Allies from launching the cross-Channel invasion. If V weapons had ever been a genuine threat, the threat was now surely over, or so minimized as to be only negligible. So ran the thought of most Allied authorities during the first week of post D-day operations.<sup>2</sup> On 11 June, for instance, the British Air Ministry noted, and filed without action, a report that a trainload of V-1's had passed through Belgium two days earlier, and treated similarly a signal (dated 11 June) indicating that aerial reconnaissance had revealed intense activity at six modified sites.<sup>3</sup> And on 12 June, reporting on the day's

\* See above, Chap. 4.

events, USSTAF informed AAF Headquarters in Washington that there was "no change" in the CROSSBOW situation.<sup>4</sup>

But that night—the night of 12/13 June—the silence of the Pas-de-Calais was interrupted. Catapulted from the steel rails of a modified-site launching ramp hidden near a farmhouse on the French coast, the first V-1 fired in combat broke from its steam-propelled carriage and began its noisy, fiery journey to London. Eleven V-1's were fired that night, though only four struck the British capital.<sup>5</sup> For another four days the German batteries remained inoperative. And then, on the night of 15/16 June, there began an entirely new phase of the war in Europe, one that opened a new epoch in the technique of warfare—the "Battle of the Flying Bomb." In a little more than twenty-four hours the Germans fired approximately 300 V-1's against England.<sup>6</sup> Of this number, 144 crossed England's Channel coast. Seventy-three missiles struck London, and with their remarkably effective shallow-blast explosions caused alarming property damage and fairly severe civilian casualties.<sup>7</sup> The V-1 was clearly not a hoax. It had with startling suddenness<sup>8</sup> and at a most inopportune moment become a dismaying actuality—worse yet, a potential threat of the first magnitude.

### *Beginning of Second-Phase Operations*

On the morning of 13 June the British War Cabinet met to discuss the new situation. Simultaneously, in Washington, there was an immediate expression of the necessity of "full cooperation" between British and American agencies in the ETO and elsewhere, in order that the sometimes conflicting, sometimes disjointed efforts characteristic of the first phase of Allied CROSSBOW countermeasure operations could be altogether avoided.<sup>9</sup> Since the ski and large sites were considered almost certainly inoperative, the best method of attack seemed to be air strikes against supply sites and possibly against the modified sites, "apparently" the source of the V-1's fired against England. The War Cabinet therefore proposed—with understandable caution—that it would be "desirable to recommend to the Supreme Allied Commander" an immediate heavy attack on V-weapon supply sites in the Pas-de-Calais and that all launching sites believed to be operable should be attacked "whenever effort . . . can be spared without prejudicing in any way the urgent needs of the Battle of France."<sup>10</sup> Apparently, however, little air effort could be spared from the critical operations on the Normandy beachhead and elsewhere, for only one strike

—thirty-six sorties and 101.2 tons by the Eighth Air Force against a supply site—was made during the next several days.<sup>11</sup>

The firing of nearly 300 V-1's against England on 15/16 June made any further postponement impossible. Early in the morning of the 16th, as V-1's continued to strike London, the Prime Minister assembled his entire War Cabinet, together with Air Chief Marshal Tedder, Field Marshal Brooke, chief of the British Imperial Staff, and others who were to have a voice in one of the war's fateful decisions. Though little was known about the number and capabilities of the modified sites, it was agreed that London would have to withstand whatever was in store for it—the Battle of France was to remain the primary concern of the Allies. Nevertheless, General Eisenhower would be asked to take all possible measures to neutralize the supply and launching sites, and long-standing plans for deployment of balloons, fighter aircraft, and radar-controlled anti-aircraft against the flying bombs would be put into effect at once by the Air Defence of Great Britain.<sup>12</sup>

General Eisenhower's response was swift. On his orders, a comprehensive plan was drafted for the bombing of V-weapon sites by units of the Eighth and Ninth Air Forces and by the RAF Bomber Command.<sup>13</sup> An informal order, first given on 16 June, was reaffirmed through a memo for Tedder, dated 16 June, in the following explicit terms:

In order that my desires, expressed verbally at the meeting this morning, may be perfectly clear and of record, with respect to CROSSBOW targets, these targets are to take first priority over everything except the urgent requirements of the battle; this priority to obtain until we can be certain that we have definitely gotten the upper hand of this particular business.<sup>14</sup>

The Eighth Air Force could not for several days be reorganized to undertake large-scale CROSSBOW bombings, though on the 16th it dispatched four very small missions against targets in the Pas-de-Calais.<sup>15</sup> The RAF Bomber Command, which had been lending less support, proportionately, to the Battle of France, went into immediate action on a more significant scale against the new threat. On the night of 16/17 June the British flew 315 sorties and dropped 1,423.3 tons on a variety of targets, principally large and supply sites.<sup>16</sup> By the end of the month the RAF Bomber Command had dispatched 4,057 effective CROSSBOW sorties for a total of 15,907.2 tons, and though bombing conditions were unfavorable during the period there was only one day (the 26th) when the British failed to sustain their effort

to reduce the V-1 firings.<sup>17</sup> On 19 June the Eighth Air Force began a concerted offensive against V-weapon sites. Though the unfavorable weather was an even greater handicap to the Eighth than to the RAF, the former in eight days of operations flew 2,149 heavy bomber sorties for a tonnage of 5,524.<sup>18</sup> The Ninth Air Force, which did not resume CROSSBOW operations until the week beginning 23 June,<sup>19</sup> had considerably more success in achieving significant damage than did the Eighth or the British Bomber Command. With 1,500 medium bomber sorties and a tonnage of 2,000, the Ninth was credited with achieving Category A damage to six, perhaps nine, ski and modified sites.<sup>20</sup>

Considering the varied demands upon Allied air power—both strategic and tactical—during the critical weeks after D-day, the dispatch of 8,310 bomber sorties and an expenditure of 23,431.2 tons of bombs in CROSSBOW operations during the second half of June indicated that the Germans had again created for the Allies a diversionary problem of the first magnitude. The significance of the renewed diversion was particularly evident in operations of the RAF Bomber Command which had, in the two-week period, expended 29 per cent of its total bomber sorties and 28 per cent of its tonnage for the month against CROSSBOW targets.<sup>21</sup> Moreover (and aside from the effect of V-1's on life, property, and civilian morale), CROSSBOW air operations were having little apparent effect in diminishing the V-1 bombardment. Once they had begun their major offensive (on 15/16 June), the Germans continued to launch an average of 100 missiles per day against England.<sup>22</sup> Very obviously, the CROSSBOW problem in its second phase called for a more satisfactory solution—if possible—than had been provided by Allied operations prior to D-day.

By the end of June there was serious, sometimes intense, debate among Allied authorities—particularly among the air commanders—on (1) the place CROSSBOW should occupy in the entire pattern of Allied air operations and (2) the most efficient means of applying the air power withdrawn from other critical operations. There were, to be sure, only a very few air commanders, British or American, who did not recognize the serious nature of the V-1 offensive against England. But conversely there were almost none who felt assured that the increasingly massive and patently ineffective bombing operations against CROSSBOW targets in France were either permissible or possible in the light of the over-all war situation.



Concerning the first issue at debate, the Allied air commanders directly responsible for conducting bombing operations were disturbed by CROSSBOW's priority over everything except the battle in France.<sup>23</sup> In effect, this priority jeopardized the grand strategic design of completing the CBO. And tactically, CROSSBOW now took precedence over such tasks as the bombing of French railroad bridges and marshalling yards, fuel and oil dumps, airfields, and electrical and radar installations not in the immediate area of the Normandy beach-head.<sup>24</sup> On the second issue, there was intense and openly voiced dissatisfaction over the selection of CROSSBOW targets and the ensuing instructions for carrying out bombing assignments.

For the operations of 16/17 June (the first concerted response to the V-1 offensive) the Air Ministry\* had established the priority of four supply sites, eleven ski sites, and twelve modified sites.<sup>25</sup> Within a few days several large sites were given first priority, followed by supply, ski, and modified sites.<sup>26</sup> Since it was reasonably certain that no V-1's were being fired from ski sites, that the large sites were to be used—if ever—for some other purpose, and that the modified sites (rapidly increasing in numbers) were exceptionally poor targets,<sup>27</sup> the Air Ministry's target schedules were vigorously protested by the two principal bombing commanders, Air Chief Marshal Harris of RAF Bomber Command and General Doolittle of the Eighth Air Force.<sup>28</sup> After the British had attacked supply sites on 16 and 17 June, Harris indicated that he was "unwilling" to send his forces on similar missions until photographic reconnaissance showed evidence of significant results.<sup>29</sup> Harris' view, shared by Doolittle, was firmly supported by

\* Until very late in the campaign the allotment of all CROSSBOW targets and the preparation of bombing directives were in the hands of the Air Ministry—a situation that almost continually distressed the air commanders. The Air Ministry had been made responsible for CROSSBOW intelligence and countermeasures in October 1943 (COS [43] 278th Mtg.); after that time and until June 1944, CROSSBOW was—except for a very brief period—the responsibility of the director of operations (SO). On 19 June, Churchill established the War Cabinet CROSSBOW Sub-Committee, which was instructed to meet daily, with the Prime Minister in the chair—something no other "special" War Cabinet committee (including the Night Air Defence Committee and the "Battle of the Atlantic" Committee) had been requested to do. Other notable members of the committee established 19 June were several of the principal War Cabinet secretaries, the three British chiefs of staff, and the DSAC (Tedder). On 20 June, Churchill decided to withdraw from the CROSSBOW Committee and to transfer to it "representation," rather than direct participation, by the dignitaries mentioned above. Direct control of *all* CROSSBOW intelligence and countermeasures was in the hands of this lesser committee (which worked through the Air Ministry) until 28 Oct. 1944, when a portion of its control was transferred to SHAEF Continental.

Brig. Gen. Frederic H. Smith, Jr., deputy senior air staff officer, AEAf, who informed Air Chief Marshal Portal that "subject to . . . approval" he intended to apply the bomber forces against oil dumps and bridge targets in France rather than to repeated CROSSBOW attacks unjustified by prior photographic reconnaissance.<sup>30</sup>

While Smith waited for approval to ignore, at least in detail, the Air Ministry's bombing directives, two other proposals were offered. The prevailing weather over the target area in mid-June forced the Eighth's B-24's to resort to radar bombing at a time when the average accuracy achieved by that method was estimated to be within approximately 500 yards of the aiming point. Since this promised very ineffective results against the small CROSSBOW targets, it was proposed that all but a few harassing attacks be withheld until improved weather permitted a single, devastating attack on the entire CROSSBOW network.<sup>31</sup> It was also suggested that, in lieu of attack on the sites, a massive "reprisal" raid be immediately flown against Berlin by 1,200 heavy bombers from the Eighth and 800 from the RAF Bomber Command.<sup>32</sup> Air Marshal Coningham, commanding the Second TAF, meanwhile was seeking permission to withdraw his forces from CROSSBOW activities in order to concentrate entirely on support of the land battle.<sup>33</sup>

Air Chief Marshal Tedder appeared to be in favor of the proposal for a mass raid against Berlin, particularly as it would invalidate the fantastic propaganda accounts of the Goebbels ministry on the "absolute success" of the so-called "vengeance" weapons,<sup>34</sup> and would thereby be an indirect CROSSBOW attack.<sup>35</sup> But because of increasing pressure from the British government, which was deeply concerned over public reaction to the continued V-1 bombardment and was already considering large-scale evacuation of the London populace,<sup>36</sup> Tedder did not regard the Berlin raid as a substitute for continued strikes against the CROSSBOW network proper. In fact, he instructed the bombing commanders to increase rather than diminish the frequency of their attacks against the sites in France.<sup>37</sup> In the end, the Eighth Air Force on 21 June staged a massive attack on industrial targets in Berlin,\* and RAF Bomber Command that night struck CROSSBOW targets in France.<sup>38</sup>

During these early debates, General Spaatz, representing the American view at its highest air force level in the theater, offered a variety of proposals. As always, General Spaatz took the strategist's view,

\* See above, pp. 284-85.

even in matters of immediate moment. Certain that the large sites could withstand any conventional bombing methods, including the 12,000-pound Tallboy bombs the British had begun employing in CROSSBOW attacks on 19 June,<sup>39</sup> Spaatz suggested, first, the bombing of the Pas-de-Calais electrical system, without which he was certain neither the large nor the supply sites could function, and second, the development of an entirely new bombing technique for attacks against the large sites and other targets of a similar magnitude.<sup>40</sup> On 20 June, Spaatz urged Arnold to direct General Gardner of the AAF Proving Ground in Florida to begin experiments with radar-controlled war-weary heavy bombers which, with excess loads of explosives, could be expended as single "missiles" against otherwise impregnable targets.<sup>41</sup> Concurrently, Spaatz initiated in the theater a far-reaching experiment—variously coded APHRODITE, BATTY, CASTOR, ORPHAN, and WEARY-WILLIE—for developing and using every promising form of radar-controlled conventional bomber aircraft as a "guided missile."<sup>42</sup> At the end of June, Spaatz offered two other proposals for reducing the rate of V-1 firing without expending massive bomber forces in futile attacks against modified sites and in the even more wasteful operations that were still under way late in the month against the inactive ski sites.<sup>43</sup> By this time a considerable amount of information had been collected on the V-1 and on the ground organization that fired it. Spaatz therefore suggested attacks on German factories making the gyro compasses that guided V-1's in flight; also attacks, in France, against recently discovered V-1 storage depots that were large enough to provide satisfactory bombing targets.<sup>44</sup> All of Spaatz's concrete proposals were, in some measure, incorporated into the bombing program.<sup>45</sup> But his most searching contribution to the general debate was—though ineffective—a remarkably strong letter, personally delivered to General Eisenhower on 29 June, in which Spaatz laid down a set of principles that should, he felt, place the problem in its proper perspective.<sup>46</sup>

He reminded General Eisenhower that the primary—and successfully accomplished—task of the strategic air forces in preparation for

\* Though the experimental phases of APHRODITE were not completed in time for the new technique to be employed with success against the large sites, remotely controlled B-17's loaded with 20,000 pounds of TNT or a similar amount of jellied gasoline (napalm) were dispatched against Mimoyecques, Siracourt, Watten, and Wizernes on 4 August and against Watten on 6 August. Thereafter the APHRODITE project was consolidated and developed for other purposes.

OVERLORD had been the weakening of the German Air Force to the point where it could not hinder the Allied invasion. The present primary task of the strategic air forces, he went on, was denial to the German ground armies of the means with which to continue effective resistance and continued neutralization of the GAF. To achieve this dual task a new policy decision was required. Bombing operations over Germany (weather permitting) should have "overriding priority" with two exceptions: a major emergency involving Allied ground forces and attacks against the large sites. Attacks against V-1 launching sites, Spaatz declared, could not be sufficiently decisive to justify diversion of the strategic air forces from their primary task. He asked, therefore, that the policy decision he suggested "be made immediately."

Eisenhower made the decision immediately; but not in accordance with Spaatz's proposals. On the 29th of June (the day he received Spaatz's letter) the supreme commander ordered that bombing of V-weapon launching sites should "continue to receive top priority."<sup>47</sup>

### *The Critical Period*

The two most critical months of the CROSSBOW campaign were July and August 1944. During this period the V-1 offensive against England reached its climax and—with the withdrawal of the German firing organizations from ground launching sites in France—greatly diminished in significance; the Allies expended their most massive air effort against the V-weapon sites in France and undertook for the first time a concerted strategic bombardment of V-weapon industrial plants in Germany proper, while at the same time the debate on CROSSBOW policy entered its most intense stages; and the imminence of attack by V-2's was for the first time definitely established.

Eisenhower's decision to continue "top priority" bombing of the V-1 launching sites appeared, at least immediately, to be justified, for beginning at dusk on 2 July the Germans, in a 24-hour period, succeeded in firing 161 missiles that approached the English coast or passed overland to fall on the London area.<sup>48</sup> In the seven-day period ending on 8 July, 820 V-1's were plotted approaching England.<sup>49</sup> The Allied response to this marked increase in the rate of firings was three-fold. The deputy supreme commander instructed the Air Ministry to request an increase in bombing operations against the sites in France,

particularly against the modified sites. The British War Cabinet went into prolonged consultations on the wisdom of undertaking large-scale reprisal measures to counteract, if not diminish, the increased tempo of the V-1 offensive against England.<sup>50</sup> And the air strategists, certain that an even greater V-1 offensive could have "no bearing on the outcome of the war unless we are foolish enough to divert too much of our effort to its neutralization,"<sup>51</sup> renewed their efforts to meet the CROSSBOW threat by redirecting Allied bombing countermeasures and by devising new lines of strategic operations against the true sources of the weapons—manufacturing plants in Germany.

Though the Eighth Air Force was called upon to increase its bombing operations against CROSSBOW sites in France, the brunt of the new offensive was borne by the RAF Bomber Command. During all but two days in July the Bomber Command attacked sites in the Pas-de-Calais. On 102 missions it dispatched 5,832 effective heavy bomber sorties for a total tonnage of 24,292.2, representing 30.7 per cent of the bomber sorties and 42 per cent of the tonnage expended during the month in all Bomber Command operations.<sup>52</sup> Operating continuously against V-weapon sites for the first thirteen days of August and flying CROSSBOW missions on eleven days during the second half of the month, the Bomber Command expended 5,745 effective heavy bomber sorties and 25,328.8 tons—27.7 per cent of its total sorties and 30.8 per cent of its tonnage for the month.<sup>53</sup> Thus, in fifty-three days' operations during July and August the Bomber Command expended the impressive totals of 11,577 effective heavy bomber sorties and 49,616 tons in CROSSBOW operations. To this effort the Eighth added 4,266 heavy bomber sorties for a tonnage of 10,891.6, the tactical forces (otherwise engaged in supporting the land battle) 400 sorties and 400 tons, and the Fifteenth Air Force, called upon for the first time in the CROSSBOW campaign, dispatched in two missions of 3 and 16 August 323 heavy bombers for a total of 773.7 tons against V-weapon manufacturing at Ober Raderach in Germany.<sup>54</sup> The grand total of the Allied air effort against CROSSBOW targets in July and August, excluding the air efforts of ADGB against V-1 missiles in flight and other ADGB defensive operations, was 16,566 bomber sorties and a tonnage of 61,681.3. The Eighth and RAF Bomber Command expended on these targets a fifth (20.4 per cent) of the effective heavy bomber sorties and a fourth (27.8 per cent) of the tonnage of their combined effort in all combat operations during

the period.<sup>55</sup> Unfortunately, this massive air effort produced only a very slight reduction in the scale of German V-1 operations, if indeed it contributed at all to diminishing the V-1 rate of fire.<sup>56</sup> During the period 15 July–15 August the Eighth and Bomber Command expended 9,566 heavy bomber sorties for a tonnage of 28,662 in CROSSBOW operations,<sup>57</sup> principally in France.\* Yet, during this time the number of V-1's plotted as successfully launched was 2,667, only 267 less than the number during the period 12/13 June to 14 July, when the combined air effort was 11,136 effective heavy bomber CROSSBOW sorties for a tonnage of 40,417.5.<sup>58</sup>

The essentially unhindered rate of V-1 firings, which actually were intensified during the first few days of July, led British authorities to give further consideration to the possibility of large-scale reprisals that might counteract the effects or decrease the scale of the V-1 bombardment of England. But proposals for use of gas warfare against launching sites and for saturation bombing of cities to be selected for purposes of retaliatory attack, with advance announcement of the attack, were rejected. Once initiated, gas warfare could hardly be confined to Allied use against CROSSBOW targets, and advance announcement of bombing objectives (apart from the moral hazard of replying in kind by indiscriminate civilian bombings) would be nothing less, it was agreed, than negotiating with the enemy and admitting at least a degree of defeat from the effects of the new German weapons. Moreover, and still on the practical side, it was agreed that saturation bombing of nonmilitary targets would be only a further diversion of Allied air power from its prime objectives, already in jeopardy from CROSSBOW operations currently in progress. In firm agreement with these conclusions, Eisenhower informed the British chiefs of staff: "As I have before indicated, I am opposed to retaliation as a method of stopping this business. . . . Please continue to oppose."<sup>59</sup>

Aside from furnishing Allied authorities with an opportunity for declaring against reprisal measures, the deliberations of early July provided the occasion for an effort by the air commanders to reorganize the entire CROSSBOW intelligence and countermeasures program. On 6 July, Maj. Gen. Frederick L. Anderson, USSTAF's deputy commander for operations, forwarded to Lord Beaverbrook, a member of the War Cabinet, a comprehensive paper calling for a reassessment of the problem. This document had been prepared by Brig. Gen.

\* The Eighth conducted one strategic mission against a V-weapon factory in Germany during this period.

Charles P. Cabell, military air adviser of the European Advisory Committee.<sup>60</sup> Agreeing that retaliation “for *vengeance* alone . . . has no place in sound military schemes,” and recognizing that the effect of the V-1 on civilian morale justified strong measures against the weapon, the paper nevertheless urged that the Allies should avoid losing their perspective to the extent of “throwing everything in blind fury at this target alone.” Instead, a “balanced” program of countermeasures was proposed, one that would employ only efficient and economical attacks against all V-1 launching facilities (not against firing sites alone), attacks against V-weapon manufacturing facilities and fuel sources (principally in Germany), and an intensification of defensive countermeasures by the ADGB.<sup>61</sup>

Two days later, on 8 July, General Anderson proposed to Tedder the organization of a joint CROSSBOW committee that would be composed of authorities (three from the British air staff, three from USSTAF) familiar with problems of intelligence and operations “*at the working level*”; that would take over from the Air Ministry intelligence interpretation and operational planning; and would be directly responsible for assuring General Eisenhower that the best possible intelligence guided the assignment of the right weapons in the correct role against the proper objectives.<sup>62</sup>

Spatz sent Tedder a strong covering memorandum, urging support of Anderson’s recommendations,<sup>63</sup> and on 10 July addressed a second direct plea to General Eisenhower for a definitive policy statement.<sup>64</sup> On 15 July Spatz again urged Tedder to establish a joint CROSSBOW committee that could achieve “greater clarity and effectiveness of operations” and provide the Americans, who were bearing a considerable share of the operational burden, an articulate voice in the analysis of intelligence and in operational recommendations made to the supreme commander.<sup>65</sup> That same day, Brig. Gen. George C. McDonald, USSTAF’s director of intelligence, informed Air Vice Marshal Frank F. Inglis of the Air Ministry that nothing less than a joint and balanced Anglo-American committee could solve the problem of CROSSBOW offensive countermeasures.<sup>66</sup>

These continued American proposals bore some fruit, for on 21 July there was established the Joint CROSSBOW Target Priorities Committee, thereafter generally known as the Joint CROSSBOW Committee.<sup>67</sup> The new committee contained American representation and its members were largely drawn from working levels, as requested by Spatz and Anderson, but it had only advisory powers, was still

under the jurisdiction of the Air Ministry,<sup>68</sup> and its recommendations could be—and frequently were—set aside by Tedder, who continued to be considerably influenced by opinion in the Air Ministry and War Cabinet.<sup>69</sup> At its first meeting the Joint CROSSBOW Committee advised the suspension of all but light harassing attacks on modified sites, of all attacks on ski sites, and of all except APHRODITE attacks on large sites, and recommended that attacks against three storage depots in France and seven V-weapon production centers in Germany be given first priority.<sup>70</sup> In a simultaneous meeting, on 21 July, the Combined Operational Planning Committee, which had been directed to consider operational plans for reducing the scale of V-1 attacks, concluded that no specific plan could be guaranteed to do more than prevent a *rise* in the scale of V firings, and recommended that all attacks on launching sites be suspended in favor of attacks against V-weapon production centers in Germany, on storage depots, and against ground transportation supporting the V-1 offensive.<sup>71</sup> Though an American representative proposed employment of the Eglin Field technique of fighter-bomber minimum-altitude attacks\* on the modified sites, the COPC declined to recommend this method.<sup>72</sup> The pattern of day-to-day CROSSBOW operations continued to differ from that suggested by the air commanders and from recommendations of the COPC and the Joint CROSSBOW Committee.<sup>73</sup>

The chief area of disagreement continued to be the value of attacks on V-1 launching sites. Repeatedly the air commanders and the Joint CROSSBOW Committee advised the suspension of these attacks,† but with continuing firmness Tedder insisted that they could not be abandoned.<sup>74</sup> Subsequently, on at least two occasions, General Doolittle seems to have declined to commit his forces to CROSSBOW operations requested. On 15 August he was asked by Tedder to send the Eighth against CROSSBOW targets the following day. The American commander replied that his forces would that day be attacking industrial targets in the Leipzig area. Questioned as to why CROSSBOW targets were not scheduled, in accordance with directives, Doolittle informed the deputy supreme commander that there were no such targets near Leipzig.<sup>75</sup> Three days later the Eighth did attack

\* See above, pp. 97-99.

† COPC made only the one general recommendation on CROSSBOW operations; the Joint CROSSBOW Committee prepared a series of recommendations over a period of six weeks.



CROSSBOW targets, but these included no launching sites and the tonnage was less than 200. In simultaneous operations it expended nearly 1,300 tons on other targets.<sup>76</sup> On 17 August, Tedder inquired of Doolittle why he had scheduled only two light CROSSBOW attacks while reserving his main forces for a heavy strike against railroad bridges in France. Doolittle's answer was that he considered bridges to be the more important targets. To this Tedder replied that CROSSBOW must come first.<sup>77</sup> Nevertheless, the Eighth conducted only two more CROSSBOW operations (114 sorties and 351.2 tons) before 30 August, the day of its last direct participation in the CROSSBOW offensive.<sup>78</sup> While there were less open differences between Harris and Tedder over CROSSBOW, the British bombing commander continually shared Doolittle's (and other Americans') opinion that the best answer to the V-1 bombardment was to shatter Germany's war economy by concentration on strategic operations and by support of the land battle, which could provide the most immediate means of stopping the V-1's through capture of the ground launching sites.<sup>79</sup>

Strategic attacks against V-weapon plants and fuel sources, recommended by Spaatz on the renewal of CROSSBOW operations in June and subsequently by the Joint Committee and the COPC, were carried out on a relatively limited scale, though with some success, principally by the Eighth Air Force and the Bomber Command. The RAF attacked Rüsselsheim, a V-weapon manufacturing center, on 12/13 and 25/26 August for a total of 699 sorties and 2,524 tons. In ten missions against six targets in Germany—flown with two exceptions between 18 July and 25 August—the Eighth expended 1,198 sorties for a tonnage of 3,002.7.<sup>80</sup> The most notable of these raids were directed on 18 July and 2 and 25 August against the Peenemünde experimental station and V-weapon factory, first attacked in August 1943 by the RAF. The raid of 18 July was one of the outstanding examples of daylight precision bombing during the war in Europe. Three hundred and seventy-nine heavy bombers, with full fighter escort, dropped 920.6 tons on eight separate aiming points within the concentrated target area, with the result that Peenemünde was seriously damaged.<sup>81</sup> The effects, however, of this and the two following raids, in which, all told, 811 heavy bombers dropped 1,899.1 tons on Peenemünde, were not immediately apparent in V-1 operations against England, and the cost of these strategic attacks was high. In

its two raids against Rüsselsheim, RAF Bomber Command lost 35 bombers, as against the loss of 100 in all its other CROSSBOW operations during July and August, and in the ten strategic missions flown by the Eighth, 23 heavy bombers were lost (10 in the Peenemünde raid), in contrast to only 14 in its other CROSSBOW operations during the two months.<sup>82</sup>

After 10 July 1944 there hung over the Allies the constant threat of the opening of V-2 operations by the Germans. Originally regarded as a more imminent and more serious danger than the V-1, concern about the giant supersonic rocket—against which there could be no defensive countermeasures—had for a time given way to immediate preoccupation with offensive and defensive countermeasures against the smaller weapon that had become an actuality in June.<sup>83</sup> But during the second week in July, coincident with the intensified V-1 bombardment of England, it was finally established that the V-2 existed in operational form and could soon be used against England.<sup>84</sup>

Some weeks earlier Spaatz had urged the development of APHRODITE on the assumption that the Germans would make some attempt to use the large sites for V-2 firings.<sup>85</sup> In mid-July, Anglo-American authorities began negotiations with the Russians for sending a group of technical experts to obtain information from a V-weapon experimental site at Blizna, Poland, in the path of advancing Russian ground forces.<sup>86</sup> And at intervals during July and August the British expended quantities of the largest conventional bomb, the 12,000-pound Tall-boy, against the more active large sites with indeterminate results.<sup>87</sup> But it was not until late August, with the falling off of V-1 firings following withdrawal of German launching activities from the area south of the Somme,\* and with new intelligence at hand on the imminence of V-2 operations,<sup>88</sup> that a specific plan was prepared for offensive countermeasures on a large scale—once firings should begin—against the entire V-2 organization.

On 25 August the "Plan for Attack of the German Rocket Organization when . . . Attacks Commence," prepared by the Joint CROSSBOW Committee, was forwarded by SHAEF to the commanders of USSTAF, the Eighth and Ninth Air Forces, and the British Bomber and Coastal Commands.<sup>89</sup> The plan proposed, in addition to air attacks

\* The scale of V-1 attacks fell off by approximately a third, to a total of 1,115 missiles reported between 16 August and 1 September, when V-1 attacks against England from ground firing sites in France came to an end.

already under way on large sites and storage depots thought to be associated with the rocket, armed reconnaissance of launching points and primary forward and rearward storage depots as the first priority; air attacks against secondary forward and rearward storage depots as second priority; against primary and secondary liquid-oxygen plants as third priority; the SHAEF plan for destruction of the "third ring" of rail bridges as the fourth; air attacks against the system of canal locks in Belgium and western France as the fifth; and, as the last priority, air attacks against fifteen V-weapon production centers in Germany and Austria—in all more than 250 major targets. This plan was the most comprehensive one prepared for CROSSBOW operations during the course of the campaign. With the flying of seven missions totaling 173 sorties and 454.5 tons by the Eighth on 30 August, followed by an attack on the 31st by 603 RAF heavy bombers for a tonnage of 2,401.7 against nine targets thought to be associated with the V-2, the critical period of Allied CROSSBOW operations came to an end.<sup>90</sup>

During this two-month period, the Eighth had made 164 attacks in operations against a total of 67 CROSSBOW targets (75 attacks in July and 89 in August—operating continuously the first 11 days in August). The U.S. heavy bombers had attacked modified sites 116 times, storage depots (or fuel dumps) 15 times, strategic targets in Germany 9 times, 6 liquid-oxygen plants in France and Belgium 1 time each, airfields in France and Holland 6 times, supply sites 4 times, 1 ski site 6 times, and 1 marshalling yard 1 time. For its attacks against targets in the Pas-de-Calais the Eighth had used visual sighting 117 times and Gee-H bombing 24 times (in contrast to 64 visual-sighting and 49 Gee-H attacks in the second half of June); in all CROSSBOW operations outside the Pas-de-Calais visual sighting was used.<sup>91</sup>

The RAF Bomber Command used Tallboy bombs for the first time in CROSSBOW operations, initially on an experimental basis, later as a common method of attacking large sites.<sup>92</sup> Otherwise, the RAF followed routine patterns of bombing during the critical period of CROSSBOW operations, though it is to be noted that its heavy bombers—in particular the Lancaster—were capable of transporting a considerably greater tonnage per sortie than were the Eighth's B-17's and B-24's on comparable missions. Operating on 29 days in July and 24 in August (and, as before noted, striking continuously the first 13 days of August), the Bomber Command attacked a variety of CROSS-

BOW targets—large sites, supply sites, airfields, V-1 firing organization headquarters, a V-weapon factory in Germany—but principally modified sites and storage depots.<sup>93</sup> The infrequent operations of AEAFF during the period were largely confined to fighter-bomber attacks on electrical installations and against ground transportation of V-weapon equipment. The Ninth Air Force participated in only one operation of consequence; on 27 August it dropped 47 tons on an electrical installation near Boulogne. Of the Fifteenth's two raids on Ober Raderach (3 and 16 August), the first was less successful than the return raid on the 16th, when a concentration of bombs on target was achieved.<sup>94</sup>

The CROSSBOW campaign of the summer of 1944 must be regarded generally as having failed to achieve its objectives. Indeed, it seems to have been the least successful part of the over-all effort. The RAF attack on Peenemünde in August 1943 probably had hastened, if it did not cause, the dispersal of V-weapon manufacture, and it is possible that the V-2 experimental and production program was set back by some months. Certainly the attacks on the large and ski sites executed during the months preceding D-day had achieved the essential aim of CROSSBOW operations during the first phase, which was destruction or neutralization of the network of permanent launching sites along the Channel coast, although the practical advantage gained may be debated in view of the enemy's subsequent success with his modified launching sites. But it is apparent from the record of V-1 launchings during the summer of 1944 (6,716 missiles were plotted between 12/13 June and 1 September),<sup>95</sup> as measured against the magnitude of Allied efforts to neutralize them by offensive air power, that the Germans had found in their improvised modified sites a launching method that was impervious to conventional attacks by heavy bombers. Though the Allies did neutralize or destroy a fair number of the modified sites, the Germans could build new ones faster than they could be destroyed by the air power committed to their attack.<sup>96</sup> The suspension of the V-1 offensive toward the close of summer bears a more obvious relationship to the enemy's disastrous defeat in France by Allied ground forces than to the CROSSBOW air attacks.

Perhaps the Allied air forces should have directed at least one all-out and concentrated attack on the entire modified-site system and on the supporting supply and transportation system. Tedder did, on several occasions, urge such an attack, but he was unsuccessful in gaining support from Eisenhower or from the air commanders for an operation

that would have withdrawn, even for a brief period, nearly all heavy bombers from support of the land battle and from strategic operations.<sup>97</sup> The effect of such an effort must therefore remain a matter of conjecture. The use of the Eglin Field technique of minimum-altitude attack by fighter-bombers against modified sites might possibly have provided a better solution than the dispatch of multitudes of heavy bombers in essentially ineffective operations. But for a variety of reasons, the most significant of which perhaps was the solidified objections that had denied any consistent use of that technique in the first phase of CROSSBOW operations, the Eglin Field technique was never tried against the modified sites.<sup>98</sup> The technique was, however, continually in use with conclusive results against bridges, railways, and other targets in some ways comparable to modified sites.<sup>99</sup>

There were serious faults in the handling of intelligence and in the organization of controls over the campaign. The records contain many evidences of seemingly inexcusable malfunctioning of intelligence services.<sup>100</sup> Intelligence estimates, usually some distance behind the operational situation, tended often to be grossly optimistic or unduly pessimistic. As to the failure in organization, below the supreme commander's immediate staff, CROSSBOW channels were in their complexity and their gradually fading dispersion of authority hardly to be rivaled.<sup>101</sup> Competing interests, differing views, and the unconcealed reluctance of air commanders to execute unwelcome policy—once decisions were made—were more often than not fostered rather than diminished by the multiplicity of strands in the CROSSBOW organizational pattern.

In general, then, the large-scale CROSSBOW operations during the critical period were a failure. But from another perspective the organization and its operations appear in a different light. CROSSBOW air operations in the summer of 1944—despite their shortcomings—offered firm evidence that the Allies could respond too generously rather than too niggardly to whatever threats might arise to jeopardize the execution of the grand strategic designs so carefully prepared and so skillfully executed in the pursuance of one objective—defeat of the enemy in Europe.

### *The Final Phase*

The last V-1 fired from a launching site in France fell in Kent on the afternoon of 1 September 1944.<sup>102</sup> With the cessation of V-1

firings, the rapidly deteriorating German ground situation on the continent and the continued delay in the inauguration of V-2 attacks led British authorities to conclude that—except for the possibility of sporadic attacks by air-launched V-1's\*—the CROSSBOW danger was over. On 1 September the British civil defense halted its planning of precautionary measures in the case of V-2 attack.<sup>103</sup> On the 3d all operational air commands in the ETO were informed that every type of CROSSBOW offensive countermeasure was to be suspended pending further notice.<sup>104</sup> The next day ADGB discontinued the extensive reconnaissance sweeps it had conducted on a 24-hour basis for weeks past. On the 5th the chief of the British air staff advised abandonment of bombing attacks on the V-2 storage depot and transportation system, and on the following day the British chiefs of staff, convinced that “there should shortly be no further danger” from either ground-launched V-1's or the as yet unheard from V-2, agreed that all bombing attacks against CROSSBOW targets should cease, except for occasional strikes against airfields that might be used for the air launchings of V-1's. On the 7th, Duncan Sandys of the War Cabinet announced to the press that the “Battle of London” was over, except “possibly . . . a few last shots.”<sup>105</sup> As had been the case during the week following D-day, the danger appeared to be over.

But the cycle was to repeat itself, for at the dinner hour on the evening of 8 September the first of more than a thousand 10-ton rockets (traveling at more than five times the speed of sound) that were to strike England fell and exploded at Chiswick. Six seconds later a second V-2 struck at Parndon Wood, Epping.<sup>106</sup> On that same day the Germans fired V-2's against Paris, and before late March 1945 they were to fire an additional 2,786 V-2's and 8,659 V-1's, of which 1,951 missiles—1,113 V-2's and 838 V-1's—were launched against England, the rest against continental targets, principally Antwerp.<sup>107</sup>

Neither the British public nor the outside world was informed† that the Germans had at last put into combat one of the two most feared new weapons of World War II (the other, of course, the atomic bomb) as—on the morning of the 9th—the British chiefs of staff and

\* Limited attacks by air-launched V-1's were first suspected on 9 July but were not verified until 3 August, when it was learned that He-111's, flown from bases in Holland, were the source of a relatively small number of V-1's that approached London from the Thames Estuary.

† Both the British and German governments withheld notice, the Germans until 8 November, the British until 10 November, that London was being attacked by V-2's.

other Allied councils deliberated what action should be taken following the opening of Germany's long-threatened V-2 offensive.<sup>108</sup> As is so often the case (the atomic bomb again the exception), the fear in anticipation of a dreaded event is more harrowing than the event itself—and so with the response of Allied authorities to the now operational V-2. Countermeasures had to be taken, but the threat itself appeared to be of far less magnitude than it had seemed only a few weeks earlier, when SHAEF had distributed the Joint CROSSBOW Committee's formidable "Plan for Attack of the German Rocket Organization when Rocket Attacks Commence." Spectacular as was the scientific achievement apparent in the V-2, the weapon had been committed to battle too late, its military effectiveness was more limited than had been anticipated (with a warhead similar in weight, it produced—as investigations on the night of the 8th showed—less blast damage than the much cheaper and more primitive V-1), and on the basis of reliable intelligence reports recently received, it seemed unlikely that the Germans had produced sufficient quantities of the weapon to constitute a long-continuing danger of significant proportions. The effect of the weapon on civilian morale had yet to be gauged (and this was the reason for withholding from the public knowledge of its use), but only two rockets had thus far struck England. Moreover, the currently rapid advances of Allied ground troops on the continent had to be considered in assessing the new problem. It was this combination of factors, all of which were quickly evaluated in the Allied deliberations of 9 September, that led to the decision—it proved to be a sound one—that only limited and essentially defensive countermeasures should be taken to meet the V-weapon threat in its third and, as it proved, final phase.<sup>109</sup>

Except for one attack (32 sorties for 170.9 tons) by RAF Bomber Command on 17 September, none of the elaborate plans prepared for use when rocket attacks should commence was carried out.\* In its last operations of the CROSSBOW campaign, all in September, the Bomber Command dispatched 703 heavy bomber sorties which dropped 3,876.3 tons on airfields in Holland associated with the air launching of V-1's against England.<sup>110</sup> The Eighth conducted minor operations in September (100 sorties and 300 tons) and again in December (75 sorties and 100 tons) which, although not listed by the

\* In advance of the V-2 attack, Bomber Command on 1 September had sent two attacks (113 sorties and 498.2 tons) against rocket storage depots.

Eighth as **CROSSBOW** operations, were an indirect contribution to the campaign in its final phase and were the last such operations undertaken by American heavy bombers.<sup>111</sup>

The more significant operations of the period were in large measure the responsibility of the ADGB and do not fall, therefore, within the scope of this narrative.<sup>112</sup> In the closing months of the campaign, elements of the Ninth Air Force participated with Second TAF in armed reconnaissance operations against the V-weapon firing and transportation system on the continent, though the largest share of the work was carried by British units. Operations of Second TAF against **CROSSBOW** targets were confined to the first four months of 1945. In January, 75 fighter-bomber sorties were flown for 100 tons; in February 100 sorties for 75 tons; in March 2,300 sorties (principally fighter sweeps against fleeting targets) for 800 tons; and in April 1,600 sorties for 700 tons.<sup>113</sup> The intensified operations of March reflected both a temporary rise in the rate of V-weapon firings against England and continental targets and the opportunity presented by the increasing concentration of all German forces within a diminishing land area. April's operations represented an effort to destroy the remnants of the V-weapon field organizations.<sup>114</sup> The last V weapon that struck London (a V-2) had fallen on 29 March, the last on Antwerp a day earlier when both a V-1 and V-2 reached that target.<sup>115</sup> By the end of April the final air countermeasures, limited defensive patrols by ADGB and Second TAF, had been completed, and on 2 May 1945 the campaign was formally declared to be at an end.<sup>116</sup>

Since the beginning of September 1944 the Allies had expended 991 heavy bomber sorties for a total of 4,774.5 tons, and in 10,270 fighter and fighter-bomber sorties an additional 1,857 tons.<sup>117</sup> The decreased scale of operations in this final phase finds no small part of its explanation in the following figures: between 1 September 1944 and 29 March 1945, 831 V-1's and 1,115 V-2's reached England, as against the 6,716 V-1's plotted in the summer of 1944.<sup>118</sup>

Administration and policy continued to be active issues during the final phase of **CROSSBOW**, though, like operations, the debate was on a reduced scale. The Belgian port of Antwerp, captured on 4 September and a logical target because of its vital importance to the development of Allied ground operations in the north, lay within easy reach of the German firing organizations that had moved northward from the French coast at the end of the summer. Early in October,



Lt. Gen. F. E. Morgan advised SHAEF that before firings began on Antwerp and other key centers in the north the Allied forces in Europe should profit from the experience of the past summer, when "the affair [CROSSBOW] was made far more difficult than it need have been owing to the failure in organization at the start."<sup>119</sup> He urged that intelligence and operational planning should be centered at once in one organization directly responsible to the supreme commander for all continental CROSSBOW operations. Approving Morgan's proposal, Eisenhower on 9 October requested the Air Ministry to transfer to SHAEF control of all aspects of CROSSBOW intelligence and operations that did not affect the local interests of ADGB. The British chiefs of staff, aware that the threat from V weapons was now greater in Europe than in England, took action on 24 October to yield the requested control.<sup>120</sup>

Nevertheless, the endeavor to centralize CROSSBOW responsibility and operations on the European mainland moved very slowly. It was not until 15 December, after a series of conferences had been held and several committees and commissions had come and gone, that there was established a working organization, generally designated the Continental CROSSBOW Organization, with headquarters at SHAEF Main. The core of the new agency was the Continental CROSSBOW Collation and CROSSBOW Intelligence (Interpretations and Operational Recommendations) Section, responsible throughout the remaining months of the campaign for the functions indicated in its generous nomenclature.<sup>121</sup> Like earlier agencies, the Continental CROSSBOW Organization suffered continuing proliferations of function and responsibility.<sup>122</sup> But because its problems concerned only a very minor part of Allied air operations during the period, there was—with one exception—no high-level debate on policy and organization.

The exception involved a series of discussions in December 1944 and January 1945 regarding the policy that should be adopted in consequence of intelligence reports indicating that the Germans were preparing to use a third V weapon, variously designated the V-3, V-4, and the "final weapon." Early in December, American agents in Argentina and Turkey reported that "reliable sources" had revealed the Germans would, within 30 days, begin bombardment of American cities on the Atlantic seaboard with stratospheric rockets capable of demolishing forty square kilometers around the point of impact.<sup>123</sup> Since the Germans had produced and used the V-2 (once regarded as

a technical impossibility), since there was authoritative intelligence that they had prepared designs for a rocket capable of transatlantic flight, and since the Allies were not fully aware of the state of German efforts at nuclear fission, these reports could not be dismissed. Moreover, the large sites, though no longer in the possession of the Germans, were still regarded as "unsolved mysteries."<sup>124</sup> Though they could not be used by the Germans, it was not possible, at the time, to dismiss the idea that they might have some bearing on the weapons reported as nearly ready for operational use. After painstaking investigations, the War Department and AAF Headquarters in Washington concluded that while such rockets and warheads might be in the experimental stage in Germany, it could be assumed that they were not ready for use in combat.<sup>125</sup> In Europe, General Spaatz came to a similar conclusion.<sup>126</sup> And thus ended the discussions of policy with reference to the German V weapons.

Those discussions, extending back over a period of more than a year, had reflected the uncertainty and divided councils with which the Allies moved to meet a new and startling development in the war. The effort to cope with the danger is only in part a story of AAF activity, and any summary must give prominent place to the fortitude of the British people under this final assault upon their morale and to the increasing assumption by the RAF, after the attacks began, of the major responsibility for countermeasures. If some AAF leaders had been at first too much inclined to discount the danger and if they had begrudged the cost of CROSSBOW to other air operations, they found substantial support for their views in the failure of the methods of air attack employed to prevent the enemy's use of the weapon on a significant scale. Those of an opposing view, however, were able to point to a delay in the inauguration of the enemy's offensive that had robbed it of any major military effect, and for that delay the intensive bombing of launching sites during the first half of 1944 may well have been the decisive factor.

## CHAPTER 16

\* \* \* \* \*

### *LOGISTICAL MOBILITY*

BY THE end of September 1944 the Ninth Air Force had moved all of its major headquarters and most of its troops from British bases to the continent, and at the close of October more than 90 per cent of that air force's total strength was deployed on continental bases.<sup>1</sup> For most Ninth Air Force units, moreover, the movement from England to the continent represented only the first in a succession of moves undertaken in the continuing effort to give tactical air power the mobility that is so fundamental to the accomplishment of its supporting mission. The Ninth's experience, of course, was in no sense unique; the necessity for mobility can be documented by the experience of other air forces whose mission called for the support of advancing ground forces, and no small part of this history has been devoted to the devices, organizational and otherwise, through which in other parts of the world the AAF sought to discharge its responsibilities to the ground arm. But the experience of the Ninth Air Force in ETO, because of the time, place, and scale of its efforts, acquires a special significance which provides the warrant for a separate discussion here.

#### *Movement to the Continent*

The most complicated of the Ninth's movements was the initial move from England to the continent. By May 1944 a build-up schedule had been carefully constructed to meet the tactical situation which was expected to develop on the continent. The IX Tactical Air Command, charged with air support for the U.S. First Army, would be the first of the combat commands to move to Normandy. After it would come the XIX TAC, which was to begin operations on 1 August, simultaneously with the unleashing of the U.S. Third Army against

the Germans. The IX Bomber Command and the IX Troop Carrier Command would come to the continent later, when sufficient airfields became available. But before even the fighter-bomber groups could move into Normandy, landing fields would have to be constructed, communications set up, and supply and maintenance furnished. Most of these tasks would have to be performed by the IX Engineer Command and IX Air Force Service Command. Consequently, the build-up schedule was an immense jigsaw puzzle made up of bits and pieces of almost every type of organization in the air force. In keeping with the requirements thus established, units of all types were shipped to the continent in as many as five or six detachments or echelons, and they often remained widely scattered for several months before being reunited somewhere in France or Belgium.

Some Ninth Air Force units had been alerted for movement as early as March, in order that they might have plenty of time to make all necessary preparations for the move.<sup>2</sup> Air force units followed the same movement channels as ground force units except that the home station usually served as the concentration area, an arrangement which permitted combat groups to fly their missions almost without interruption during the course of the move. Combat crews, of course, flew their planes to the new fields in France, and some key personnel were flown from England to France in transport planes.<sup>3</sup>

The first Ninth Air Force men to land in France were apparently weather and communications specialists from the 21st Weather Squadron and the 40th Mobile Communications Squadron who parachuted with the 82d and 101st Airborne Divisions in the first hours of D-day. Air support parties went ashore in the morning with early waves of infantrymen. The first Ninth Air Force unit ashore was Company A of the 819th Engineer Battalion (Avn.), part of which was led onto UTAH beach at 1050 hours (H plus 260 minutes) by Lt. Herbert H. Moore. A detachment of the 834th Engineer Battalion was prevented from landing at OMAHA beach by enemy fire and beach obstacles but finally got ashore on 7 June at St.-Laurent-sur-Mer, east of its originally scheduled landing place.\*<sup>4</sup> The "YF" detachment, composed of weather and communications personnel, was also turned back from OMAHA on D-day, but managed to get ashore the next day and was followed by two other detachments on 8 and 9 June. Meanwhile, an advanced echelon of the VIII Air Force Intransit Depot Group, which

\* See below, p. 563.

landed on 7 and 8 June, began the organization of beach supply, although it did not get into full operation until 9 June because of the delay in landing supplies on OMAHA.<sup>5</sup>

Advanced echelons of various headquarters began going ashore on 7 June, when a detachment of the IX Air Force Service Command headquarters, including some personnel from 2d Advanced Air Depot Area, landed on OMAHA. The IX AFSC opened its advanced headquarters at Cricqueville on 9 June. An echelon of the advanced headquarters of IX TAC's 70th Fighter Wing, which directed fighter-bomber operations over the beachhead during the early days of the assault, landed on 7 June and achieved radio contact with England by 2200 hours. On 8 June the first echelon of the advanced headquarters of the Ninth Air Force landed, and on 9 June it located at Grandcamples-Bains, from where it quickly established radiotelephone service with Middle Wallop, headquarters of IX TAC in England. Also on 9 June, IX TAC's advanced headquarters was set up at Au Gay.<sup>6</sup> By 10 June more than 6,000 men and 1,000 vehicles from the Ninth Air Force had been landed in France, virtually all of them on OMAHA beach. Among the units ashore by 10 June were engineer battalions, airdrome squadrons, truck companies, signal units, and other service organizations which would prepare the way for the later arrival of the combat groups.<sup>7</sup> By 20 June, more than 18,000 men and 4,000 vehicles had left England for the continent.<sup>8</sup>

The airdrome squadrons, of which three went ashore during the first week of the assault, moved to landing strips being prepared by the engineers and established fuel and ammunition dumps for the use of fighter-bomber squadrons operating on the roulement system.\* The first combat squadrons began using continental strips on 13 and 14 June on a regularly scheduled basis and were serviced by the airdrome squadrons. The 395th Squadron of the 368th Fighter-Bomber Group, which began operating from Cardonville (Field A-3) on 19 June, was the first combat squadron permanently based on the continent. By 25 June, the 50th, 366th, and 368th Fighter-Bomber Groups, with three squadrons each, were conducting operations from their new bases in Normandy. Once the groups had established themselves, usually within a few days of their arrival, the airdrome squadrons moved on to other strips and the cycle was repeated.<sup>9</sup>

During the first two months of the invasion, both tactical air com-

\* See above, p. 132.

mands moved to France *in toto* although later than originally scheduled. By the end of June, in addition to the three complete groups, the 310th Tactical Reconnaissance Squadron of the 67th Tactical Reconnaissance Group and parts of six other fighter-bomber groups were in Normandy.<sup>10</sup> As of 31 July the 67th Tactical Reconnaissance and the 10th Photo Reconnaissance Groups and all but one of the eighteen fighter-bomber groups were in France; by 8 August that group had arrived.<sup>11</sup> Initially, all groups on the far shore were placed under the control of Maj. Gen. Elwood R. Quesada of the IX TAC, but on 1 August, Brig. Gen. Otto P. Weyland, whose XIX TAC had opened its advanced headquarters in Normandy on 7 July, assumed control of a number of groups simultaneously with the debut of Patton's U.S. Third Army, for which it provided air support.<sup>12</sup>

Maj. Gen. Samuel E. Anderson did not begin to move the groups of his IX Bomber Command to France until the tactical air commands had completed their movements. In order to get some of the medium bombardment groups closer to the main arena of action in Normandy, the bomber command moved the 98th Bombardment Wing, with its four groups, from Essex to fields in the Bournemouth area in southern England during late July and early August. After scarcely two weeks at its new stations, the 98th began to move to France, and by early September had established itself on four fields in the Cherbourg peninsula.<sup>13</sup> Here, as a result of the rapid German retreat across France and Belgium, it soon found itself almost as far from the enemy as were the bombardment wings in Essex. In September and October the 97th and 99th Wings moved to France, the 97th occupying fields to the south of Paris and the 99th to the north, between Paris and Amiens. The 98th, too, moved into this area, stopping for a brief time at fields around Orléans and in October shifting to a group of fields in the Cambrai-Laon area, north of Paris. The 9th Bombardment Division\* headquarters moved to Chartres in September and on to Reims in October, from where it directed the operations of its eleven groups.<sup>14</sup>

Immediately behind the combat groups in all of these movements came the service teams. Emphasis was placed on moving the mobile reclamation and repair squadrons to the continent, for they were ideally suited for use under the conditions which existed there. Truck companies were given high priority in shipment, for without their services no supply lines could be established and maintained. By the end of

\* The IX BC was thus redesignated, effective 25 September 1944.

June there were three incomplete service groups in France, and as of 31 July all or part of nine service groups operated under 2d AADA on the continent. By 1 September there were twenty-five service teams, the equivalent of twelve and one-half service groups, in France; and additional teams arrived with groups of the 9th Bombardment Division in September and October.<sup>15</sup> The air depot groups, which were responsible for fourth-echelon supply and maintenance, did not begin moving until early July, and then only slowly. Their heavy impedimenta prevented them from being really mobile and special arrangements were necessary to move them. The 10th Air Depot Group moved to France early in July and was followed within a few weeks by the 16th and 42d. By 1 September the 86th Air Depot Group had arrived and the four groups supported the twenty-five service teams on hand.<sup>16</sup> Of the IX AFSC's remaining subordinate organizations, the 20th Replacement Control Depot sent an advanced echelon ashore on D plus 10 and proceeded to build up a pool of some 3,000 replacements in France during the next several weeks.<sup>17</sup> The 31st Air Transport Group began ferrying personnel and supplies to Normandy on D plus 4, and had transferred most of its activities to France by the end of the summer.<sup>18</sup> The service command build-up was a steady one, progressing from 11,000 men either on hand or on the way at the end of June to more than 26,000 at the end of July and 35,000 at the end of August. At the end of September, 82.5 per cent of the service command's 51,000 men were on the continent. This included virtually all of the service teams and all of the air depot groups but two.<sup>19</sup>

By this time the combat command headquarters organizations were all established and operating in France. The service command's chief subcommands, the AADA's,\* set up their own headquarters, the 2d AADA on 14 July and the 1st AADA in September, when the bombardment groups came to the continent. 1st AADA and 9th Bombardment Division headquarters were located side by side at Chartres, a situation that was mutually satisfactory since 1st AADA was responsible for the air depot groups and service teams which supported the bombardment groups. The IX AFSC headquarters was set up at Creil, thirty miles north of Paris, on 20 September, and the advanced and main echelons of the headquarters were at last joined in one. A rear headquarters remained at Ascot in England to supervise the IX AFSC units there and maintain close contact with ASC, USSTAF agencies.

\* See above, pp. 115-16.

Also in September, the Ninth Air Force reunited all of the scattered echelons of its headquarters at Chantilly, some twenty miles north of Paris. On 25 September it closed its rear headquarters at Sunninghill in England.<sup>20</sup>

### *Mobility on the Continent*

From D-day until V-E Day the progress of the land campaign determined the extent and frequency of the moves undertaken by Ninth Air Force organizations, for the tactical air commands were closely tied to the operations of the ground armies and moved as close behind them as the availability of airfields permitted. Following hard on the heels of the ground troops, the aviation engineers were almost invariably in the vanguard of a Ninth Air Force movement. Immediately behind them came the airdrome squadrons, whose task it was to provide supplies and to service the fields for the initial operations of combat groups, after which they passed on to other fields but the same task. By the end of 1944, most of the airdrome squadrons on the continent had moved as many as seven or eight times since leaving England.<sup>21</sup> The combat groups with their accompanying service teams sometimes occupied a field even before it had been made ready by the engineers and airdrome squadrons. The air depot groups, encumbered with heavy machinery and huge stocks of supplies, were the least mobile of all of the Ninth's units and moved less often than most of the others. Other service units—particularly truck and signal construction battalions—found themselves scattered over western Europe, moving as the constant demands for their service warranted.<sup>22</sup>

Factors other than availability of fields also affected the rate of movement of the Ninth's groups. The heavy fall and winter rains, coupled with the shortage of airfield surfacing materials, sometimes forced the occupation of a single field by two combat groups. Many movements were the results of organizational changes called forth by the tactical situation, as when the XXIX Tactical Air Command (Provisional), established on 14 September 1944,\* drew its combat units from the older IX and XIX TAC's.<sup>23</sup> In addition to such transfers as these, temporary shifts of groups between commands were so common that within a period of a few months a command might have as few as three or as many as ten fighter-bomber groups.<sup>24</sup> These changes, which usually reflected the relative intensity of ground operations along the several Army fronts, often required movement to new bases

\* See below, p. 597.



## LOGISTICAL MOBILITY

of operations. Because of the coordination required in planning the location of airfields and in securing the necessary transportation, Ninth Air Force headquarters retained control of all movements, except for those of IX Engineer Command.\* The responsibility for over-all planning was shared by that headquarters with interested Army groups and with AEAF, which controlled the allocation of airfields at the air force–army group level.<sup>25</sup>

The movements of the Ninth Air Force on the continent may be divided into four phases, of which the first, the beachhead phase, lasted for about two months after D-day. By 10 August all of the combat groups of the IX and XIX Tactical Air Commands and a host of engineer, air defense, and service units had been crowded into the limited area of the Normandy beachhead. In spite of the narrow confines, movements by Ninth Air Force units were frequent, particularly among engineer units and airdrome squadrons, most of which moved several times during this brief period.<sup>26</sup> But all of these moves were short in terms of time and distance, and the strain on transportation was not great.

With the American breakthrough at St.-Lô and the subsequent withdrawal of the Germans across France and Belgium, the Ninth Air Force entered on the second and most hectic phase of its existence on the continent—one which lasted into October, well after the land battle had become stabilized in September. Within a matter of weeks after the breakout from the beachhead, fighter-bomber groups found themselves hundreds of miles behind the front lines instead of within hearing, and sometimes range, of artillery fire, but with the coming of August these groups began to advance steadily toward the German frontier. From Normandy they moved to clusters of airfields in the Le Mans–Chartres area and thence to the Paris area in September. By October most of the fighter-bomber groups were well to the north and east of Paris, and some of IX TAC's groups were occupying fields in Belgium after their third move since leaving Normandy.<sup>27</sup> IX TAC headquarters moved five times within a period of six weeks in August and September and XIX TAC headquarters, by the end of September, had moved at least eight times.<sup>28</sup>

The halt which succeeded these months of unceasing movement gave

\* Because of the extremely mobile character of its mission, the IX Engineer Command was permitted to deal directly with the Communications Zone on transportation matters.

time for rearward units to be brought forward and for regrouping of commands and wings. During this period, which lasted into March 1945, organizations which for months had been scattered over France and Belgium in several echelons or detachments were at last united in one place and given a much-welcomed breathing spell. The 9th Bombardment Division completed its move to fields in the general area of Paris early in November and remained there throughout the winter. XIX TAC occupied fields in the northeast corner of France, south of the Belgian and Luxembourg borders. IX and XXIX TAC's were to the north, east of Brussels in Belgium, spilling over into the Dutch Appendix (Limburg).<sup>29</sup> The First Tactical Air Force, whose units had been continually on the move since landing in southern France, advanced from the Lyon area to fields along a Dijon-Nancy axis, behind the 6th Army Group front. From its headquarters at Vitte, the First Tactical Air Force directed its medium bomber and French units, which were to the south in the Dijon-Besançon region, and XII TAC's fighter groups to the north, in the area between St.-Dizier and Lunéville.<sup>30</sup>

Beginning in March 1945, the Ninth Air Force followed the advancing Allied armies across the Rhine and to the Elbe. The three tactical air commands, with most of their groups, moved into Germany, lining up with the XXIX TAC at Brunswick on the north and the IX TAC at Nürnberg on the south. The First Tactical Air Force, too, moved into Germany and had advanced as far as Stuttgart by V-E Day. The 98th and 99th Bombardment Wings of the 9th Bombardment Division found their new bases in northeastern Belgium and across the frontier in Holland as fields were vacated by the advancing fighter-bomber groups. The 97th Bombardment Wing, with its three light bombardment groups, remained in a cluster of fields northwest of Reims, to which it had moved in February.<sup>31</sup>

The IX Troop Carrier Command\* remained in England after most of the Ninth Air Force had moved to the continent. Its chief functions of hauling supplies to the continent and transporting the airborne divisions, which were still in England in September 1944, kept the IX TCC on its English bases. But in October, the 52d Troop Carrier Wing, with its four groups, moved to bases in the Le Mans area, and from there to the Chartres area in November. Beginning in February 1945, the other two troop carrier wings began to move to France.

\* Transferred to USSTAF at the end of August 1944 for use in the First Allied Airborne Army.

In April, when the move was completed, the 53d Wing had established itself in the Orléans region, southeast of Paris, and the 50th Wing was in the Amiens region, north of Paris. These fields had become available when Ninth Air Force and British combat units moved on to more advanced areas.<sup>32</sup>

The mobility required of the Ninth Air Force by the campaigns on the continent made transport the key to the very existence of the air force. Of the major means of transport, two—water and rail—were controlled by the Communications Zone. The former was of importance chiefly in the movement of men and supplies across the Channel from England or across the Atlantic from the United States. It is true that supplies were also transported along the extensive inland waterway systems of France and Belgium, but this constituted only a fraction of the total. The use of rail transportation was greatly hampered and delayed by the extensive dislocation of the French and Belgian rail systems caused by Allied bombings. From the fall of 1944, when the French and Belgian rail systems began to revive, the Communications Zone made extensive use of the railroads to haul the large bulk of heavy supplies and equipment needed by the ground and air forces, but the trains were painfully slow. In late August it was estimated that the rail time between Cherbourg and Le Mans, some 200 miles apart, was two days, and it was hoped that the round-trip time, which loading and unloading increased to eight days, could be reduced to four.<sup>33</sup>

On the other two major means of transport—air and motor—the Ninth could draw from its own resources. The organic motor transport possessed by the major combat and service units had never been intended to be sufficient to meet all of their needs for hauling supplies and personnel, for this transportation too often consisted largely of jeeps and special-purpose vehicles, such as bomb-lift trucks and refueling units. The thirty-six vehicles allowed to a light bombardment squadron included twelve jeeps and fifteen bomb-lift or bomb-service trucks, and of the service squadron's twenty-six vehicles, no less than fourteen were jeeps.<sup>34</sup> For the hauling of supplies from depots and dumps and the movement of units, the Ninth had to rely on its truck companies and such assistance as it could get from the Communications Zone. Most of the Ninth's truck companies, of which there were fifty-eight in October 1944, had originally been attached to the service and air depot groups, but early in its history in the European theater the air force had recognized the need for a centralized trucking organiza-

tion. Accordingly, approximately half of the truck companies attached to the service and air depot groups were withdrawn and organized into two truck regiments of three battalions each, under the IX AFSC. In August 1944 the regiments were redesignated as QM Truck Groups (Avn.).<sup>35</sup>

The major task of the truck companies on the continent was to haul supplies, including bombs and gasoline, from the depots and dumps to the combat stations. From the time that the first Ninth Air Force truck company went ashore on D plus 1 until the Allies broke out of the beachhead, motor transport for the Ninth was adequate to handle supply-hauling because of the small confines of the area. But with the extension of supply lines from the beaches and ports to the farther reaches of France and Belgium, the task of motor transport became increasingly difficult. The ground forces, of course, faced a transportation problem even more acute than that of the air force, and received accordingly a higher priority for both transportation and supplies. The Communications Zone even pressed into its service part of the truck pool of the Ninth Air Force during the breakneck race of the U.S. First and Third Armies across France and Belgium during August and September. With the necessity for these measures there can be little quarrel, but the effect on the air force was to put it on short supply and retard its movements.<sup>36</sup> In addition, unavoidable delays in the construction of gasoline pipelines made it necessary for the Ninth's trucks to assume the burden of hauling gasoline longer distances than had been anticipated. From the 1,461,700 gallons hauled by IX AFSC truck battalions to combat stations in Normandy in July, the quantity rose sharply to 7,750,000 in September, almost 10,000,000 in December, and more than 19,000,000 in April 1945.<sup>37</sup>

Supply tonnages hauled by these battalions also remained high with the exception of September 1944, when higher ground force priorities for gasoline and other supplies limited the cargoes hauled for the air force to less than 40,000 tons compared with more than 62,000 tons carried in August. In December, the month of the Battle of the Bulge, the tonnage rose to more than 87,000, a figure it did not reach again until the closing days of the war in April.<sup>38</sup> A heavy load was also thrown on the organic transportation of the combat and service units, particularly the service teams, which had to supplement the work of the truck companies in hauling air force men and supplies over the lengthening distances between depots and combat stations. The estab-

## LOGISTICAL MOBILITY

lishment of a base depot north of Paris in December, under a subcommand of ASC, USSTAF, relieved some of the pressure on the IX AFSC truck pool by bringing the chief supply depot closer to the forward units.<sup>39</sup>

The greater distances that had to be covered in moving units forward after August also increased the strain on motor transport. Often, fighter groups and their service teams had to move hundreds of miles, using only their own organic transportation, without assistance from the overworked truck companies of the central pool. During this period, according to 2d AADA, a fighter group and its service team, using only their own organic transportation, required three weeks to complete a move of 150 miles.<sup>40</sup> Later in the fall, when the truck battalions were available for assistance, the movement time was much reduced. In the early months of the invasion, when the area held by the Allies was small, movement of personnel was usually by foot or truck. With the build-up of personnel and the much longer moves from station to station, it was found desirable to shift much of the burden from trucks to trains and aircraft. From a total of almost 33,000 men carried by the central truck pool in July-August the number fell to less than 4,000 for September-October. Thereafter, it rose once more until it reached a peak of more than 18,000 in February 1945.<sup>41</sup>

Although ground transport carried almost all of the burden, air transport proved itself a vital part of the transportation system, not only of the Ninth Air Force but of the whole Allied war machine in Europe. The huge scale of combat, the vast arena in which it took place, and the mobile situation which prevailed for extended periods put a premium on transportation, and particularly on air transport. The major airlift problems which emerged between D-day and V-E Day were the result of the vastly expanded demands of the ground armies and the air forces for supply by air, far greater than had been anticipated or planned for OVERLORD.

On D-day there were no less than five separate American air transport organizations in the theater: a small naval air transport service; the European Division, AAF Air Transport Command; the IX Troop Carrier Command; the 31st Air Transport Group of the IX AFSC; and the 27th Air Transport Group of ASC, USSTAF. Each was responsible to a different headquarters and was charged with a variety of functions which limited its use in time of emergency.

The naval air transport service and the European Division, ATC

played only minor roles in intra-theater movement. IX Troop Carrier Command was unique among the air transport organizations in that its prime function was not logistical but tactical—the transport and re-supply of airborne troops. Sometimes the IX Troop Carrier Command remained alerted for weeks waiting for an operation to be mounted, and at such times most of its groups were not available for logistical purposes. It was unfortunate that this command, which was many times larger than the total of all of the other air transport units in the theater—it had up to 1,400 C-47's, C-53's, and C-109's, 2,000 gliders, and 40,000 men—could not make a greater contribution to airlift than it did.<sup>42</sup> It suffered from a split personality in which the tactical dominated the logistical.

The two other air transport organizations, the 27th and 31st Air Transport Groups, were, prior to D-day, used almost exclusively for the logistical support of the air forces. On 1 September 1944, as a result of General Knerr's recommendation to General Spaatz and in spite of strong opposition by Brig. Gen. Myron R. Wood, commander of the IX AFSC, both groups were assigned to the 302d Transport Wing, which was designated as the central air transport agency for USSTAF under the control of ASC, USSTAF. This reorganization of USSTAF air transport was in keeping with Knerr's doctrine of a centralized logistical control, but the application of the principle was immediately vitiated when Spaatz gave the Ninth Air Force permission to retain twenty-four C-47's and twenty-four C-46's for its own use. These planes the IX AFSC formed into the 1st Transport Group (Provisional), providing the necessary personnel from its own resources.<sup>43</sup>

The 302d Transport Wing remained responsible for all of the functions which had been carried out previously by its two groups. These functions had increased and intensified with the inauguration of OVERLORD. The 31st had begun its flights to the far shore on D plus 4, and by the end of August had shifted virtually all of its operations from the United Kingdom to France. By contrast with the well-ordered state of things in England, there was need on the continent for the utmost flexibility in meeting sudden and continual emergency requests. As the rapid and frequent movements of the fighter groups made them dependent on air transport for their very existence as combat units, it became obvious that the transport plane was the only carrier which could keep pace with them. The 302d added the major part

of the effort of the 27th Air Transport Group, which previously had confined its activities to the United Kingdom, to that of the 31st on the continent, and placed the latter group under the operational control of the Ninth Air Force, which fixed priorities for it. In October the wing moved its headquarters from England to Paris.<sup>44</sup>

Major limitations on air transport operations resulted from a shortage of aircraft and landing fields on the continent. The 27th and 31st had long had to eke out their strength with assorted British aircraft and converted heavy bombers. In August 1944, in response to USSTAF's urgings for planes to alleviate the critical situation in France, the AAF sent 100 ATC C-47's from the United States. Even with this addition, the 302d's strength in September was only 184 aircraft and 5,000 men. It became necessary from time to time to raise the maximum load limits in order to meet requirements.<sup>45</sup> The difficulty of securing satisfactory landing fields in the early days stemmed from the omission of such fields from the OVERLORD plan. Even though the 31st, which faced the problem initially, secured a field (A-21C) for its own use before the end of June, it was still necessary for it to share other fields with combat units which were often loath to permit transport planes to land on their runways during operations. In July the 31st acquired its main transport field in Normandy at Colleville (A-22C). Quite properly, the Ninth gave first priority on airfields to tactical units, after which provision was made for the 31st. Later, when most of France and Belgium came into Allied hands and the importance of air transport—even ahead of tactical operations at times—was realized, the necessary fields were usually available.<sup>46</sup>

The 302d carried out the basic function of ferrying aircraft for all of the air forces in the European theater. The wing also maintained regular passenger and mail routes throughout the theater, including a special air-dispatch letter service (ADLS) to and on the continent. After D-day the number of passengers carried rose sharply in response to the needs of both air and ground forces for quick passage to the continent. Between June 1944 and May 1945 the 302d and the 1st Transport Group carried a total of 336,183 passengers. This compared favorably with the much larger IX Troop Carrier Command, which between October 1943 and May 1945 carried 342,162 passengers other than tactical troops.<sup>47</sup>

A major function of the 302d was the evacuation of wounded soldiers from the continent to the United Kingdom and later to rear

areas on the continent. Although this was a primary responsibility of the IX Troop Carrier Command, the 31st Air Transport Group to the end of August 1944 evacuated most of the casualties from the continent—a total of 26,000. By September, however, the IX TCC had acquired ten air medical evacuation squadrons which assumed the major part of the burden. Nevertheless, by the end of the war, the 302d had evacuated more than 171,000 patients by air as compared with some 210,000 by the IX TCC.<sup>48</sup>

The need for continuous and rapid movement by the Ninth Air Force required that the air transport groups help units move their men and equipment from one base to another. During July and August the 31st helped many of the fighter groups fly their key men and equipment to their new bases in France. From September onward it was routine for the 302d to move parts of units by air. Fortunately, at times the wing was able to call for assistance from the IX TCC.<sup>49</sup>

By far the most important task of the 302d was to carry cargo for the air and ground forces, particularly the Ninth Air Force. By the end of August the 31st Air Transport Group alone had carried 6,800 tons of cargo to the far shore. Between June 1944 and May 1945, the 31st and 27th together carried almost 82,000 tons of cargo, most of it to or on the continent, and most of it for the Ninth Air Force. To this may be added 7,600 tons carried by the 1st Air Transport Group, for a total of almost 90,000 tons. For the period October 1943–May 1945, the IX TCC carried more than 232,000 tons of freight, exclusive of tonnage carried in airborne operations.<sup>50</sup>

The dependency of the air forces on air transport was highlighted in November when almost half of the 5,000 tons of Air Corps supplies sent to the continent by the base air depots in England traveled by air. For many months the Ninth Air Force received a portion of its fuel supply by air. In September, the wing flew 3,500 tons (including weight of containers) of gasoline to air and ground units on the continent, and in November almost 1,200 tons to the 12th Army Group alone. The variety of cargo carried by the 302d reflected the origins of the emergency requests it received. In November, for instance, it carried such diverse items as medical supplies, blankets, overshoes, flares, rockets, tires, ammunition, cigarettes, communications equipment, heaters, aircraft engines, gas pumps, and packaged petroleum products.<sup>51</sup>

From time to time during the war the 302d Transport Wing found



itself among the air transport agencies thrown into the breach created in the supply lines of the ground armies in times of crisis. The first such crisis occurred in September, when the armies of Hodges and Patton far outran the capacity of ground transport to supply them. The potentialities of air supply of the ground armies had been considered by SHAEF prior to D-day and an organization to coordinate airlift had been established at the end of April, under AEAFF, but this Combined Air Transport Operations Room (CATOR), as its name implied, was not a real headquarters and lacked sufficient control over airlift agencies. Its function was to receive requests for airlift from ground and air forces and allocate them among British and American air transport agencies.<sup>52</sup> The September crisis made apparent CATOR's ineffectiveness and led to a proposal to SHAEF by the Communications Zone that it be given administrative responsibility for all airlift and that a single air force agency, either the Ninth Air Force or IX TCC, be charged with technical operation. This proposal significantly ignored ASC, USSTAF and its 302d Transport Wing, and both Spaatz and Knerr resisted vigorously what they considered the Communications Zone's attempt to usurp an air force function. Knerr proposed that USSTAF be given responsibility for all airlift for the support of air forces and ground armies in the theater.<sup>53</sup> The proposal was not acted on by SHAEF; and air transport continued on the same basis during the remainder of the war, with only CATOR acting as a partially unifying influence.

Nevertheless, the air force transport agencies did make notable efforts on behalf of the ground armies. During September 1944, the 302d Transport Wing and a complete wing of Eighth Air Force B-24's helped haul the precious motor fuel which carried the American and British armies to the German border. The IX TCC, unfortunately, could not bring its fleet of transports fully to bear because from late August onward it was either awaiting or participating in the Arnhem-Nijmegen airborne landings. At CATOR's request, on 9 September, the 302d suspended all airlift to the air forces, except for basic mail and passenger service, and devoted virtually all of its planes to the supply of Patton's army. At the end of September, when the Allied armies had come to a standstill on the western front, the 302d and the Eighth Air Force's B-24's returned to their normal duties. The total airlift to the ground forces during September was close to 40,000 tons, almost a fourth of it by the Eighth Air Force heavy bombers, which

had been severely handicapped in their efforts by the lack of forward airfields capable of accommodating their heavy weight. Unfortunately, the tonnage lifted was not enough to keep the armies moving.<sup>54</sup>

Another strong airlift effort for the ground forces occurred in December, during the Battle of the Bulge. The IX Troop Carrier Command carried more than 15,000 tons of cargo during the month and also transported the whole 17th Airborne Division, totaling 13,397 troops, from England to forward bases in the Reims area between 23 and 29 December. The 302d's chief contribution was to transport more than 2,000 tank specialists and mechanics from Marseille to the U.S. Third Army in the Luxembourg-Belgium sector within a period of twenty-four hours on 24-25 December.<sup>55</sup>

By far the greatest airlift came in March-April 1945 when the Allied armies found themselves in a tactical situation strikingly similar to that of September 1944, but were favored with better weather and more landing sites. Ground armies had far outstripped their earth-bound transport systems and once more had to look to air transport for the fuel, ammunition, and rations which could keep them moving. The agencies under CATOR's direction at this time, IX TCC and the RAF 38 and 46 Groups, carried more than 68,000 tons, of which more than 50,000 tons were fuel. The contribution of the 302d Transport Wing was smaller than it had been in September.<sup>56</sup>

The potentialities of air transport in the European theater were never fully realized, in large measure because of the failure to establish a single responsible air transport headquarters, but the strategic and tactical significance of air supply had been forcefully brought home to both ground and air forces by the end of the war. Knerr, convinced by experience, wrote Arnold in May 1945: "Supply by air is a permanent adjunct of military operations." He urged that the function be established "*as an Air Force responsibility* before some other agency grabs this ball and runs with it."<sup>57</sup>

### *Building the Airfields*

To be truly effective a tactical air force must operate from airfields as close to the front lines as it can get, and to IX Engineer Command, which prepared the fields for American air organizations as they moved across western Europe and into Germany, belongs a major share of the credit for the victory that was won. In all, that command built or rehabilitated 241 airfields in France, Belgium, Holland, Lux-

embourg, and Germany,<sup>58</sup> under conditions sometimes dangerous, often difficult, and usually uncertain.

On D-day, Brig. Gen. James B. Newman's IX Engineer Command consisted of sixteen engineer aviation battalions divided equally among four regiments, three airborne engineer aviation battalions, an engineer aviation camouflage battalion, and miscellaneous smaller units—all told, numbering 17,000 men. Most of the battalions were veteran organizations with more than a year of heavy bomber airfield construction experience in the United Kingdom. Thanks to the lessons learned in two years of warfare in other theaters, the battalion, which was the basic operating unit, was provided with enough men and equipment to build an airfield with maximum efficiency. Each regiment, in addition to its four attached battalions, had a headquarters and service company whose heavy construction equipment was used to supplement battalion equipment whenever needed. Additional specialized units, concentrated under command headquarters, were also used to help battalions on construction projects.<sup>59</sup>

The airfield construction program for the first forty days of the invasion had been carefully outlined in advance.\* But the initial units soon found out that it was not always possible to follow prescribed building schedules. The first engineers ashore, members of the 819th Engineer Battalion (Avn.), did meet their D-day schedule. They landed on UTAH beach on the morning of D-day, reconnoitered a site at Hébert under enemy fire, and after the battle had advanced beyond the site, completed a sod emergency landing strip by 2115 hours.<sup>60</sup> On OMAHA beach the schedule was considerably retarded. Detachments of the 834th Engineer Battalion (Avn.) could not get ashore until 7 June because of enemy fire and beach obstacles, and when finally landed they found that the two initial landing sites planned for development were still in enemy hands. A new site was chosen at St.-Laurent-sur-Mer and by 2100 hours of 8 June the engineers had built a 3,500-foot earth runway capable of accommodating transport planes. Although St.-Laurent-sur-Mer (A-21C) was not a previously planned field, it became the first operational American field in France and developed into one of the more important transport fields in Normandy during the early months of the invasion.<sup>61</sup>

Advanced landing fields which could accommodate fighters were the pressing need, and the 816th and 820th Battalions joined the

\* See above, pp. 131-32.

# STATUS OF U.S. AIRFIELDS IN WESTERN EUROPE AS OF 8 MAY 1945

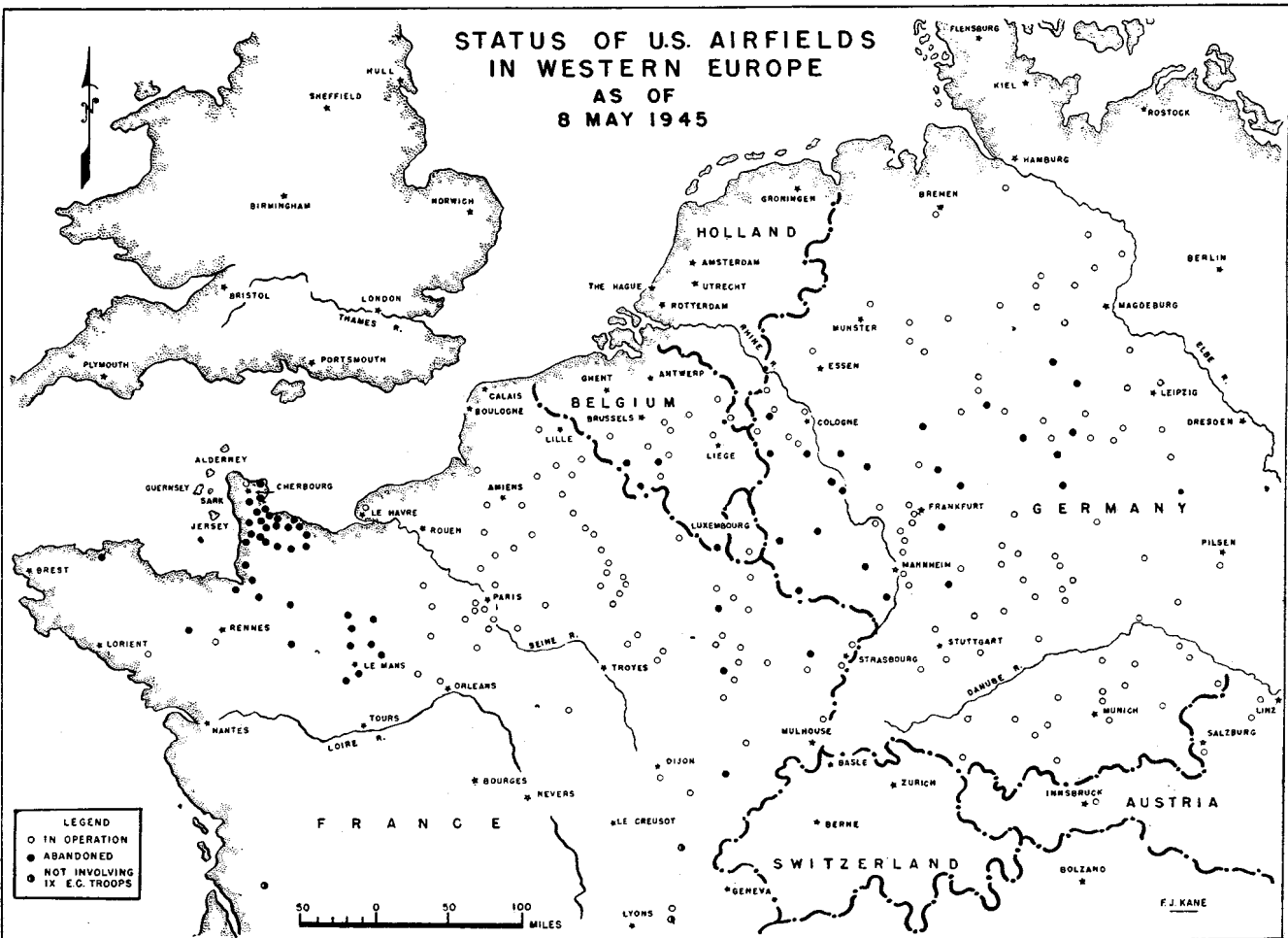

819th and 834th in reconnoitering sites as fast as they were uncovered by the advance of the ground units. On 8 June the 819th began work on an advanced landing ground at Beuzeville (A-6) on UTAH beach, and at OMAHA on the next day the 834th laid out a 3,600-foot runway at St.-Pierre du Mont (A-1), thus achieving its first objective.<sup>62</sup> British airfield construction groups were likewise prompt in their service to RAF's Second TAF, and the Allied air commanders received word as early as 11 June that four strips were in operation and two under construction in the British beachhead and that three were in operation and three under construction in the American sector.<sup>63</sup> Additional battalions came ashore during June and by the end of the month eleven American fields were in operation, including the emergency landing strip at Hébert, and five more were under construction.<sup>64</sup>

Original plans had called for two-thirds of the fields to be built to fighter specifications, with runways of 3,600 feet, but the failure of the German Air Force to react strongly to the invasion permitted the Ninth to use all of its fighter groups as fighter-bombers. Accordingly, in mid-June it was decided that all runways should be 5,000 feet in length.<sup>65</sup> This decision, which also imposed additional requirements as to the strength of the strips, led to a shortage of surfacing materials—the British-developed square-mesh track\* (SMT) and later the prefabricated hessian (burlap) surfacing (PHS).† Usually, therefore, only 3,600 feet of a newly developed 5,000-foot runway would be “tracked,” the other 1,400 feet depending on sod or earth until such time as better materials became available. Even so, these “summer” fields required as much as 750 tons of tracking, while strips built to better specifications with a view to semipermanent use consumed an average of 3,500 tons of tracking in addition to large quantities of locally procured materials.<sup>66</sup> By 5 August, when all but one of the engineer battalions were at work in Normandy, seventeen fighter-bomber fields had been surfaced with square-mesh track or prefabricated hessian surfacing and two medium bomber fields with pierced-steel plank, a third type of prefabricated surfacing. Seven additional fields were under construction in Normandy, but with completion of

\* Heavy wire welded in three-inch squares.

† PHS was an asphalt-impregnated jute or similar material, delivered in rolls 300 feet in length and 36 or 42 inches in width. Both PHS and SMT were light, easily transportable, and more readily available. They were often used in combination, with SMT on top.

these the engineers would reach the saturation point for landing grounds there.<sup>67</sup>

The timetable set in pre-invasion plans had called for construction of thirty-five advanced landing grounds within sixty miles of the front lines by D plus 40, but this program was predicated on the achievement of maximum ground advances and the delay in breaking out of the bridgehead made it neither possible nor necessary for the engineers to fulfil the contract. Perhaps it was just as well, for many units had landed behind schedule and heavy seas had delayed the unloading of equipment as well as men. Fortunately, the weather was good and the fair-weather fields, of sod or square-mesh track, stood up well during the early weeks.<sup>68</sup> The Germans, impressed by this first work of the engineers, regarded the "rapid, large scale construction of airfields" as a notable activity of the Allied air forces.<sup>69</sup> That so much was accomplished is attributable to the extraordinary efforts of the men of the engineer battalions, who during these first weeks worked on an average as much as sixteen or seventeen hours per day through all seven days of the week. Units withdrawn from construction work to perform maintenance on other fields, where the workday ran from ten to twelve hours, described the assignment as a "rest." In spite of the backbreaking work, morale remained high because results were clearly and immediately evident in the form of fighter-bomber operations. Casualties were few, although many units were subject to enemy small-arms or artillery fire and air attack. Thorough training in England had minimized the dangers from the numerous mines and booby traps encountered.<sup>70</sup>

The explosive Allied advance across France and Belgium, touched off by the breakthrough at St.-Lô in late July, came at an opportune moment for the Ninth Air Force. Not only were the engineers running out of airfield sites for development, but the older fields (none more than seven or eight weeks' old) were steadily deteriorating under constant use and required a great deal of maintenance, especially those covered with square-mesh track. Before the end of July more than half of IX Engineer Command's battalions were engaged in airfield maintenance, a task originally assigned to IX AFSC. On 8 August the IX Engineer Command organized out of its own resources and attached to the IX AFSC the 1st Airfield Maintenance Regiment (Provisional) to maintain the airfields in the rear areas while the other regiments forged ahead and constructed new fields.<sup>71</sup>

Within the narrow limits of the beachhead it had been possible for command headquarters to exercise close control over its units, but it became apparent as the period of rapid movement approached that a measure of decentralization of operational control would be necessary. Two small operational brigade headquarters were established at the end of July, and the four regiments were divided equally between them in an action coinciding with the formal entrance of the U.S. Third Army and the XIX Tactical Air Command into battle on 1 August. The 1st Engineer Aviation Brigade, under Col. Karl B. Schilling, was charged with construction of airfields in the U.S. First Army zone of advance; the 2d Brigade, under Col. Rudolph E. Smyser, performed a similar function in the U.S. Third Army area.<sup>72</sup> After the breakout from the beachhead it became policy to develop airfields in clusters of four or five which together could provide for the needs of all the groups of a tactical air command or a medium bombardment wing plus an air depot group. Such "clutches" were greatly desired by the combat commands, for they permitted a high degree of control with a minimum of communications.

The engineers had more than enough to do in their effort to keep apace with these combat demands, but their task was greatly magnified during August and September by the addition of a responsibility for construction of supply and evacuation strips immediately behind the fast-moving armies. The Ninth Air Force, moreover, had decided to move its medium and light bombers to France as soon as possible, and for the use of these units no ordinary strip could serve. In July the command had begun the construction of four fields within the beachhead for the 98th Bombardment Wing which on completion had used up all of the pierced-steel plank sent to France as a stockpile for the construction of bomber fields in the area of Paris and for the "winterization" of fighter-bomber fields.<sup>73</sup> To meet this new demand it was necessary to devote much effort to the rehabilitation of captured hard-surfaced fields.

The Brittany peninsula became the first major region to be liberated after the breakout, but the eastward advance proceeded so quickly that Brittany, like the original beachhead area, was soon far behind the ground spearheads. Accordingly, only a few fields for the XIX TAC were developed on that peninsula.<sup>74</sup> Early in August, the 1st Brigade, followed shortly after by the 2d, moved eastward into the region about Le Mans, where development of a clutch of fighter-

bomber fields was begun. Poor soil, rainy weather, and an inadequate supply of surfacing materials prevented the completion of these fields until early September, by which time the battle area had been carried so far beyond that it lay at the extreme limit of effective fighter-bomber radius.<sup>76</sup> The unavailability of rail transportation and the virtual monopoly of Communications Zone truck transportation by the ground armies had forced the engineers to depend on their own inadequate truck resources and whatever trucking the IX AFSC could spare for the transport of surfacing materials from Cherbourg and the beaches to the airfields under construction. The resulting shortage of surfacing was destined to remain a chronic problem throughout the continental campaigns.<sup>76</sup>

It was planned next to develop virgin sites in the Chartres plain, but the armies moved so swiftly that Chartres, too, was soon left far behind and instead the many fields around Paris were reconnoitered in the latter part of August, while the Germans were still withdrawing. By the end of August, six fields in the Orléans-Paris areas had been made ready for supply and evacuation work. On these fields the planes bringing food from England to the Parisian populace landed during the last days of August and the first days of September.<sup>77</sup>

The demand for advanced supply and evacuation landing strips was intensified toward the end of August as the U.S. First and Third Armies cleared Paris and plunged toward the German frontier. Units of the 2d Engineer Aviation Brigade, operating in the Third Army area, reached Reims on 3 September and St.-Dizier on 7 September. Other 2d Brigade units prepared fields in the Melun-Coulommiers area for medium bombers. So rapidly did the Third Army advance that the engineers passed up good fields around Romilly in order to keep close to the advancing ground forces. By 19 September, when the Third Army had reached the limits of its eastward advance for the time being, a sod strip at Toul was in operation and additional sites were being sought in the neighborhood of Toul, Verdun, and Nancy. The 1st Brigade, meanwhile, was following the advancing First Army to the German frontier at Aachen, rehabilitating airfields primarily for the use of fighter-bombers and medium bombers. By 9 September the 1st Brigade had reached the Florennes/Juzaine airfield in Belgium, from where it pushed on to Luxembourg on 13 September and to Liège/Bierset on 19 September.<sup>78</sup>

During the dash from Normandy to the German frontier, IX Engi-



neer Command put into operational condition a total of sixty airfields,\* in spite of the immense difficulties.<sup>79</sup> Some units had to move as much as 200 miles from one job to another, and as communications lines lengthened and transportation facilities thinned out, the problem of supplies became ever more acute. Fortunately, signals communications managed to keep pace, but extraordinary efforts had to be made to secure sufficient quantities of prefabricated hessian surfacing. The Communications Zone operated supply dumps in the beachhead from which the air engineers drew their construction materials and IX EC and IX AFSC trucks hauled the materials from beaches and ports to airfield sites. Later in the year, when improvement in rail transportation provided new assistance, it was possible for each brigade to establish a forward supply dump, but throughout the summer their existence was on a hand-to-mouth basis. Asphalt was secured locally whenever possible, and use was made of civilian labor in France and Belgium.<sup>80</sup>

By the end of September the operational organization of the command was well in hand. The IX EC headquarters, which was the hub of planning and liaison for the whole command, had been divided into an advanced echelon, which accompanied the advanced headquarters of the Ninth Air Force and the 12th Army Group, and a rear echelon, which remained in the vicinity of Paris. On the basis of requests from the Ninth Air Force and other agencies which required airfields, the advanced headquarters decided when and where airfields would be built and what types of materials would be used, while the rear headquarters provided the necessary administrative and logistical support. The brigade headquarters maintained close liaison with the tactical air commands and other organizations for whom they built fields and directed the operations of their regiments. The regiments, which controlled the battalions operationally and administratively, assigned construction projects and controlled reconnaissance in their areas.<sup>81</sup>

During the period extending from the fall of 1944 to the spring of 1945, the aviation engineers were freed of the pressure imposed by a rapid extension of the area of Allied occupation, but the load remained heavy. It was necessary to enlarge many fields and to winterize all of them by use of large quantities of pierced-steel plank, the only surfacing, other than concrete, that would stand up through the winter.

\* As of 15 September the RAF had built a total of seventy-six airfields, of which forty-nine were still operational.

Rain and snow also greatly increased the work of maintenance.<sup>82</sup> The 1st Brigade worked on fields in Belgium, Luxembourg, and Holland, preparing them for occupation by fighter-bomber groups. Unfortunately, there were not enough forward fields to accommodate all of the groups and it became necessary for several fields to house two groups. The first two-group field in this area, at Asch, Belgium, was occupied on 18 November. The 2d Brigade during the fall and winter prepared fields in the Nancy, Toul, and Verdun regions and developed fields for the First Tactical Air Force.<sup>83</sup>

Engineer battalions from Italy had built fields for the XII TAC in its advance up the Rhone Valley from the southern coast of France, but these battalions were recalled to Italy in October and IX Engineer Command then inherited the assignment of building and maintaining fields for the new First Tactical Air Force. Substantial relief was provided by the three battalions of the 923d Engineer Aviation Regiment brought from England and constituted the Engineer Command (Prov.), First Tactical Air Force, but the 2d Brigade, with which the new command worked closely, continued to bear a heavy additional responsibility. There were new demands also from the 302d Transport Wing and from IX Troop Carrier Command which served to emphasize that the provision of continental airfields had become a theater air force problem. Accordingly, General Knerr in October established the Engineer Command (Prov.), USSTAF. This command, to which there were assigned two battalions in England and three airborne engineer battalions, assumed responsibility for construction and maintenance of a large number of airfields in the rear areas and particularly around Paris, where transport and troop carrier fields were concentrated. IX EC provided for the development of medium bomber fields and the maintenance of other Ninth Air Force fields in the rear areas by forming the 2d Airfield Maintenance Regiment (Prov.) in October.\* Battalions from regiments in the forward areas were rotated to this regiment from time to time.<sup>84</sup>

The two new engineer commands, both of them small and lacking adequate communications facilities and liaison, remained dependent on the IX EC for supply and administration. To General Newman and his staff also fell the responsibility for coordinating the operations of the three engineer commands, and in February 1945 the over-all organization was given more logic by disbanding the two smaller com-

\* The 1st Airfield Maintenance Regiment had been disbanded on 1 September.

mands and transferring IX Engineer Command from the Ninth Air Force to USSTAF. This action placed all American aviation engineer units under one command and established the function of constructing and maintaining airfields as a responsibility of the theater air force rather than of the Ninth Air Force. In March 1945 the 3d Engineer Aviation Brigade (Prov.) was added for the construction and maintenance of airfields in the rear area, which usually corresponded with the area of the Communications Zone. A final reorganization in April re-established the Engineer Command, USSTAF (Prov.), with the IX Engineer Command and the 3d Engineer Aviation Brigade as its operational components. The IX EC with its own two brigades performed all construction for the Ninth and the First TAF in forward areas, while the 3d Brigade performed all airfield construction and maintenance in rear areas west of the Rhine.<sup>85</sup>

Having found time during the winter for reorganization and consolidation of gains, the engineers were ready for the final thrust into Germany. The German counteroffensive in December had forced abandonment and demolition of only one American field—Haguenau in First TAF's sector. Elsewhere some air force units, chiefly engineers, had drawn back in the face of the German advance but no airfields had been overrun. February brought a great thaw which multiplied the problems of maintenance, but the use of French and Belgian civilians—10,000 were employed by the end of the war—eased greatly the pressure of this part of the work.<sup>86</sup>

With the resumption of the Allied advance late in the winter and the crossing of the Rhine in March 1945, the aviation engineers found themselves faced with a situation strikingly similar to that of the preceding summer. Early in March the first fields in Germany were developed, the one at Trier becoming operational on 10 March. The great demand from this time until V-E Day was for supply and evacuation strips immediately behind the vanguards of the American armies. Fortunately, the good weather which prevailed throughout the spring of 1945 permitted use of the many sod fields which were overrun in Germany. By 17 April the engineers had constructed or rehabilitated fifty-two operational fields in Germany, thirty-nine of them east of the Rhine. Thirteen engineer battalions were then east of the Rhine and another five were in Germany west of the Rhine.

The development of many of the fields in Germany for the use of fighter-bombers required large quantities of prefabricated surfacing

materials which had to be brought up by truck since the German railroads could not be used. By early April, however, sufficient surfacing had been received to get the fighter-bomber clutches under way east of the Rhine. Additional clutches were developed still farther eastward and by V-E Day the easternmost tactical field was at Straubing, in southeast Germany near the Czech frontier. The more easily prepared supply and evacuation strips were pushed forward during April to Leipzig, Nürnberg, and the Czech border. Munich became a main center for supply and evacuation flights, and on V-E Day a strip had become operational in Austria—at Salzburg. In all, 126 airfields were put into operation east of the Rhine, of which 76 were used only for supply and evacuation. These 126 airfields, rehabilitated in a period of little more than two months, were greater in number than all of the airfields constructed and rehabilitated by the IX EC in France, Holland, Belgium, and Luxembourg. Good weather and the good condition of the fields on capture were, of course, invaluable aids in this work. On V-E Day there were 182 operational American fields on the continent, the largest number available at any one time after the invasion.<sup>87</sup>

In addition to the 241 airfields constructed or rehabilitated by the IX EC, ground force combat engineers and engineer battalions from Italy built 32, and the U.S. Navy built 1 airfield on the continent. The materials used varied with the period in which the fields were built, and during the final months of the war all types of surfacing were used, often in combination. In all, approximately 295,000 tons of prefabricated surfacing materials had been transported by V-E Day, of which 190,000 were pierced-steel plank.<sup>88</sup> About 30 per cent of the fields were developed from virgin sites. Some 125 earth and sod fields on the continent were used by the American air forces between D-day and V-E Day without the addition of any other surfacing.<sup>89</sup> Thirty fields were built completely of pierced-steel plank, which was often difficult to get in sufficient quantity, and it was also used in combination with other surfaces on many other fields. Thirty-two medium and light bomber fields, most of them concrete, were developed by the engineers. About twenty fields were built or rehabilitated for the use of the IX AFSC and its air depot groups.<sup>90</sup>

The close relationship and mutual confidence between the Ninth Air Force and the IX Engineer Command contributed much to the successful operations of both. Colonel Ehr Gott, the command's chief

of staff, in retrospect wrote: "The remarkable success achieved by the IX Engineer Command is ascribable in large measure to the great degree of freedom of action granted by the Ninth Air Force and the wholehearted support given the IX EC in the form of liaison aircraft and signal communications equipment over and above TE equipment."<sup>91</sup>

### *Materiel*

The vast expansion of combat operations in Europe after D-day produced significant changes in the logistical requirements and organization of the American air forces in the theater. The Eighth Air Force, secure on its bases in East Anglia for the duration of the war, was least affected by these changes, for it had reached full maturity by D-day, and only a few of its problems thereafter transcended the routine. The Ninth Air Force, on the other hand, as a mobile air force faced a variety of problems which helped persuade USSTAF to shift the emphasis of its administrative and logistical direction from the United Kingdom to the continent. General Spaatz also desired that USSTAF remain close to the major sources of authority in the theater, ETOUSA and SHAEF, with the result that in September 1944 his headquarters was established at St.-Germain, on the eastern outskirts of Paris, only eight miles from SHAEF at Versailles.<sup>92</sup> And with USSTAF came also the headquarters of ASC, USSTAF.

Shortly after USSTAF's move to France the final adjustment in the theater air logistical organization was made. In response to pressure from air force commanders, especially from Doolittle and Vandenberg, ASC, USSTAF ceased to function as the administrative side of USSTAF\* and became a separate headquarters. The separation was more apparent than real, for although Knerr ceased to command ASC, USSTAF, he remained as USSTAF's deputy commanding general for administration and in this role continued to exercise all of the functions he had formerly discharged in his dual capacity. ASC, USSTAF, redesignated Air Technical Service Command in Europe (ATSCE) on 10 February 1945, continued to reside in the same offices at St.-Germain and remained a part of the administrative side of USSTAF headquarters in all but name. Knerr continued to lend the prestige of his position as Spaatz's deputy commander to the operation of

\* See Vol. II, 752-55, for a discussion of these headquarters.

ATSCE, which remained directly responsible to him through its commander, Brig. Gen. Clarence P. Kane.<sup>93</sup>

Meanwhile, additional combat organizations had called for the creation of new service units. The First TAF included a First Tactical Air Force Service Command, under Brig. Gen. Edmund C. Langmead, which drew its logistical support from IX AFSC until early 1945, when it began to deal directly with a new base depot at Compiègne. First TAF had a French contingent operating in support of the French First Army, and for this contingent a separate French Air Service Command was organized during the winter.<sup>94</sup> After the IX TCC had been transferred to the First Airborne Army, Maj. Gen. Paul L. Williams set up his own service organization, the IX Troop Carrier Service Wing (Prov.), in September 1944. His troop carrier groups were divided between England and France until April 1945, when the last groups moved to the continent. In England the troop carrier command received adequate base support from the base depots long established there, but in France the Ninth Air Force could not furnish such support and it was eventually secured from ATSCE.<sup>95</sup>

Even the Eighth Air Force found itself increasingly confronted with logistical problems on the continent. Proposals during 1944 for the movement of Eighth Air Force heavy bombardment groups to the continent were rejected,\* but during the fall the Eighth began to send special communications and fighter control units to France and Belgium to provide advanced facilities for the assistance of its strategic operations. In January 1945, VIII Fighter Command headquarters moved to Charleroi, Belgium, and in February, the 352d and 361st Fighter Groups moved to Chièvres, Belgium (A-84).<sup>†96</sup> Meanwhile, the progressive liberation by the Allied armies of most of France and Belgium made it possible for many Eighth Air Force bombers and fighters, handicapped by weather, damage, or lack of fuel, to land or crash-land in friendly territory. Since the IX AFSC found it increasingly difficult to provide service for these planes, the logical result was first the dispatch to the continent of VIII AFSC service personnel and units, beginning in July 1944. Eventually, in January 1945, an advanced VIII AFSC headquarters was established at Brussels and the 5th Strategic Air Depot was set up at Merville in France, with the express function of salvaging or repairing Eighth Air Force planes

\* See above, p. 305, and below, pp. 668-69.

† These groups moved back to England in April.

forced down on the continent. At its peak, in March 1945, Eighth Air Force strength on the continent was more than 8,000 men.<sup>97</sup>

The existence of all or part of several different American air forces on the continent reinforced USSTAF's intention to establish base depot facilities in France. ASC, USSTAF began planning for a base depot in France as early as July 1944, and in succeeding months it took over the port intransit depot function from the IX AFSC and set up an intransit depot at Compiègne. On 10 December, ASC, USSTAF set up the Continental Air Depot Area (CADA)\* with headquarters at Compiègne, with the expectation that it would eventually become the continental counterpart of the base air depot area in the United Kingdom. The importance of continental base depot operations was underlined by the transfer of Brig. Gen. Isaac W. Ott from command of BADA in Britain to command of CADA. The intransit depot at Compiègne was expanded into a base air depot, which handled supplies for all of the air forces on the continent.<sup>98</sup>

The IX AFSC also adjusted its organization to meet changing conditions, beginning in the fall of 1944. The constant movement of combat groups and the development of airfields in clutches made it difficult to retain the tactical air depots which had been typical of the IX AFSC organization in England. It was found desirable to place an air depot group within the clutch of airfields occupied by each tactical air command or medium bombardment wing and to make it responsible for the service of all units not otherwise provided for within the given geographical area. The success of this system made clear the superfluous nature of the advanced air depot areas and the service group headquarters. The number of air depot and service groups within the command had already been materially reduced by transfers to the IX TCC and the First Tactical Air Force. The 1st AADA was left with only the IX Bomber Command as its responsibility, and the 2d AADA also found itself with a smaller number of air depot groups and service teams to administer. In addition, the geographical dispersion of the tactical air commands reduced the 2d AADA to an unnecessary link in the chain of command. The smaller number of air depot groups could be administered directly from IX AFSC headquarters. As for the service groups, many of their teams had become separated by hundreds of miles as the result of transfer of combat groups, accompanied by their service teams, from one command to another, and even from one air force to

\* On 6 February it was redesignated Central Air Depot Area.

# HEADQUARTERS IX AIR FORCE SERVICE COMMAND

30 APRIL 1945

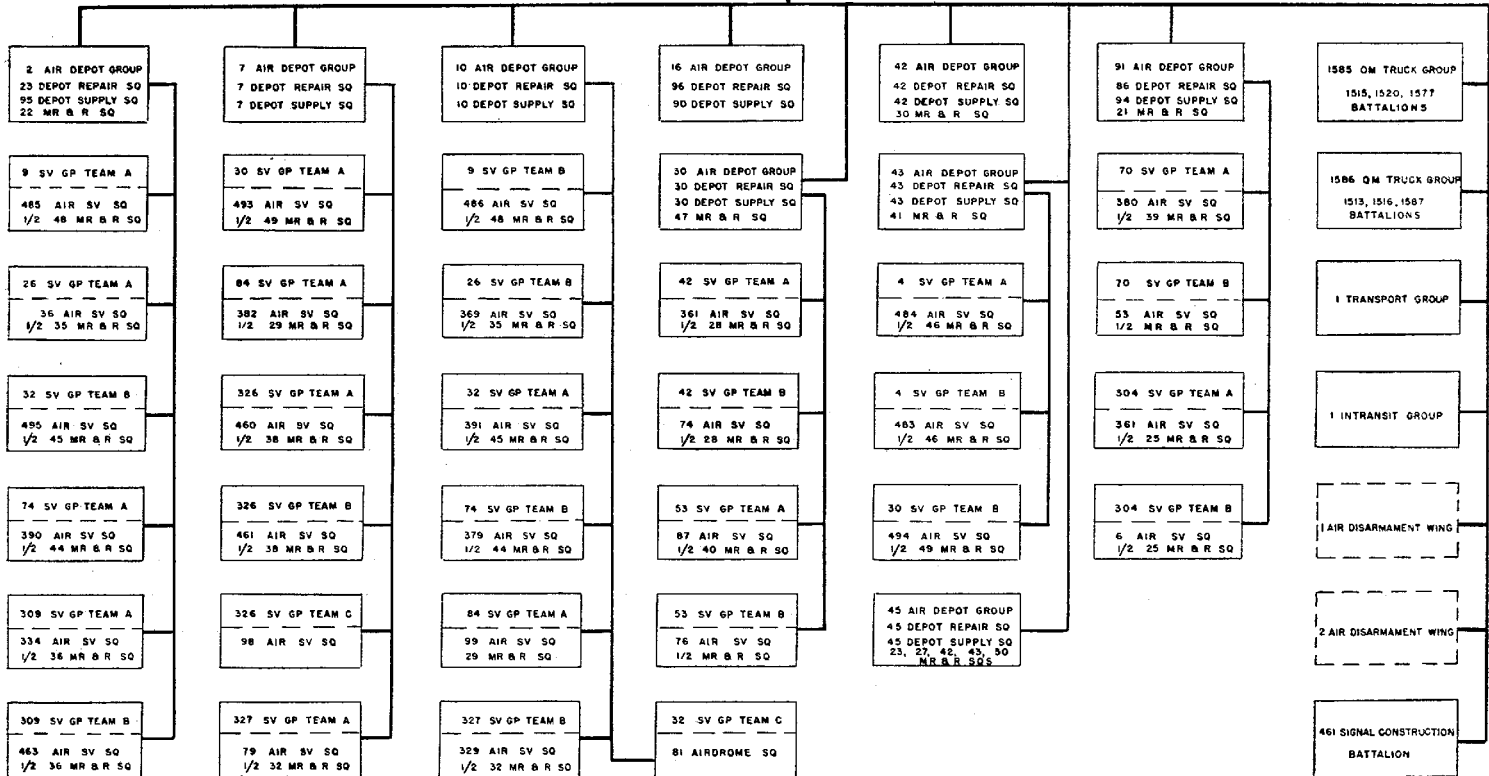



another. The obvious was finally acted upon early in 1945 when the two AADA's were disbanded and the service group headquarters were eliminated and their personnel divided among the service teams and air depot groups. The latter now became miniature service commands, charged with the administration and operation of the service teams within their areas. IX AFSC headquarters\* exercised direct supervision of the air depot groups.<sup>99</sup>

But this relatively efficient organization was not in existence in 1944 when the Ninth Air Force was faced with its greatest logistical problems. By the end of September the Ninth Air Force operated a supply line which stretched 600 miles from the Normandy beaches to the Siegfried Line. BADA routed all Air Corps supplies destined for France through the 4th Base Air Depot at Baverstock. Until ports were opened in July, all supplies arriving from the United Kingdom were brought in over the UTAH and OMAHA beaches. Here they were received by the VIII AF Intransit Depot Group,† which was attached to the Army Engineer Beach Brigade. The intransit depot group personnel identified and segregated air force cargo and prepared it for dispatch to forward areas.<sup>100</sup> Because of bad weather and the difficulties of beach operations, unloading of ships ran well behind schedule. Even after Cherbourg was finally opened on D plus 38 and minor Normandy ports at Isigny, Barfleur, St.-Vaast, and Grandcamp were made operable, it was impossible to meet the supply schedules laid down in the OVERLORD plan. Fortunately, fighter operations during the first ninety days after D-day did not approach the rate anticipated in planning, so that the Ninth's fighter-bombers suffered little from shortages of basic materiel items.<sup>101</sup>

In September, ASC, USSTAF began to extend its base depot functions to the continent by taking over the intransit depot responsibilities at the ports and beaches, thereby freeing the 1st Intransit Depot Group for use along the Ninth Air Force's supply line. Detachments of the intransit depot group operated railheads, airheads, and dumps along the supply line, unloading trains and planes and loading trucks which carried the supplies to depots or combat bases,<sup>102</sup> but not until October did an opportunity come for reorganization of the badly

\* Late in 1944 the IX AFSC was also given the function of disarming the German Air Force, absorbing for this purpose the personnel of the disbanded Air Disarmament Command (Prov.) which had been set up by USSTAF in September.

† This group was disbanded in August 1944 and the IX AFSC organized the 1st Intransit Depot Group to replace it.

strained supply system. As tactical air commands and bombardment wings settled down, many of them until the spring of 1945, on clutches of fields, the service command stationed air depot groups at strategic points within each clutch. The establishment of the base air depot at Compiègne by ASC, USSTAF in December and its gradual assumption during the winter of base depot supply functions permitted the Ninth Air Force to concentrate its supply effort in the forward areas. Supplies which were not sent direct from ports to air depot groups were brought to Compiègne by truck and train, and from there they were dispatched, usually in trucks, to the air depots and dumps operated by the Ninth Air Force, First Tactical Air Force, and IX Troop Carrier Command. The service teams requisitioned their authorized ten-day level of supplies from the air depot groups, thus completing the supply chain from the ports to the forward airfields. Until well into 1945 the air depot groups continued to call directly on the base air depots in England for AOG (aircraft on ground for lack of spare parts) supplies, which were often flown directly to the air depot groups.<sup>103</sup>

The Communications Zone, as in the United Kingdom, underwrote the air force supply system. It operated depots from which the air force depots drew common-user items—ordnance, signal, quartermaster, etc. Communications Zone troops operated the ports and unloaded ships; they operated the rail system throughout the American zone and the largest fleet of trucks on the continent. In August 1944 the Communications Zone accepted responsibility for hauling air force supplies to within forty miles of airdromes, usually to depots, dumps, and railheads, from which points the air force was responsible for delivery to the airdromes. But it was difficult for the Communications Zone to fulfil this commitment because of the enormous elongation of the supply line within a period of a few weeks and the inadequacy of the terribly damaged railroad system.<sup>104</sup>

The problem of replacement aircraft acquired special importance because of the higher attrition rate which obtained in France and Belgium. This higher rate was not only the consequence of heavier combat losses stemming from the increased rate of operations but also the result of a lower level of maintenance, which was inevitable under the mobile field conditions on the continent. Fighter aircraft which flew three and four missions per day wore out quickly; moreover, planes piled up on bad runways, dust rendered other planes inoperable,

and recurrent shortages of spare parts held up repairs. The need for more replacement fighter aircraft on the continent was recognized by AAF Headquarters during the summer of 1944, when it increased the replacement rate for fighters in the ETO from 20 to 30 per cent per month,<sup>106</sup> but the full benefits of this increase were not felt for some time. The flow of fighter planes to the tactical air forces, moreover, was affected by problems of allocation within the theater. The outstanding qualities of the P-51 as a long-range escort fighter induced USSTAF to continue to give the Eighth Air Force first priority on these planes for the purpose of increasing its P-51 groups from seven to fourteen by converting seven P-38 and P-47 groups between June and December 1944. The Ninth's two P-51 groups complained almost constantly of a lack of adequate replacements during this period. Many of the old P-38's and P-47's, rendered surplus by the Eighth's conversion program, were sent as replacements to Ninth Air Force groups, which frequently complained of the poor condition of these planes and sometimes rejected them as unserviceable. The Ninth also found it necessary to convert some of its fighter groups from one type of aircraft to another in order to adjust itself to the flow of fighter planes from the United States. In general, Ninth Air Force and First Tactical Air Force fighter groups were under their authorized strength in aircraft during the greater part of the continental campaigns.<sup>106</sup>

Bomber and transport aircraft represented less of a problem than did fighters. The flow of heavy bombers to Eighth Air Force groups was steady and assured, only bad weather occasionally preventing prompt replacement. The 9th Bombardment Division and the 42d Bombardment Wing (M) of the First Tactical Air Force were able to maintain their groups at authorized strength or above, although for a while during the fall of 1944 the 42d was below strength. Between November 1944 and February 1945, the 9th Bombardment Division converted its three A-20 groups to A-26's and planned to convert its B-26 groups also, but the war ended before the project could be undertaken. The IX Troop Carrier Command enjoyed a surplus of C-47 and C-53 aircraft much of the time after D-day, and was actually able to lend some of its planes to needy organizations like the 302d Transport Wing.<sup>107</sup>

The number of planes on hand in a combat group, while ultimately determined by the flow of aircraft from the United States, was more

## THE ARMY AIR FORCES IN WORLD WAR II

immediately affected by the efficiency of the distribution system within the theater. The frequent complaints of Ninth Air Force groups about the lack of replacement aircraft sometimes stemmed from the inability of the ferrying organization to make rapid delivery within the theater, usually because of bad weather or lack of ferrying pilots. Planes had to be brought from BADA replacement pools in the United Kingdom to central points in France, from which places they were distributed to the using units. The 302d Transport Wing flew aircraft to fields operated by the air forces on the continent. Service teams and air depot groups drew planes from these replacement pools.<sup>108</sup>

The successful use of the jettisonable fuel tank by Eighth Air Force fighters had resulted in its adoption by the Ninth, but the Eighth retained first priority for most types of jettisonable tanks because of its long-range escort commitments. An increased demand for tanks which accompanied the rising rate of fighter operations during the summer of 1944 was hard to meet, particularly on the continent. In October the IX AFSC limited each of its service teams to a maximum stock of 150 tanks. Even the Eighth Air Force felt the pinch in February 1945 when United Kingdom production of 108-gallon tanks fell behind consumption. Arrangements were made with the French to undertake production of tanks, but the end of the war obviated the need for this new production.<sup>109</sup>

Supply of spare parts to both combat and service units was of great importance in keeping aircraft operational. Lack of parts like dust filters, wings, paddle-blade propellers, hydraulic pumps, and booster control assemblies for the various types of aircraft caused planes to remain out of operation for days or even weeks. These shortages usually occurred because of a failure by supply units to keep up with the movement of combat units, which often found themselves hundreds of miles from the nearest air depot group, and when the air depot group moved it was often forced to suspend supply services for as much as two weeks. Although some critical shortages of spare parts could be met by sending aircraft to the base depots in England for the needed items,<sup>110</sup> the AOG rate of the Ninth Air Force on the continent remained higher than it had been in England, or than it was for the Eighth Air Force.<sup>111</sup>

The air forces in the European theater had begun to complain about the shortage of suitable bombs even before D-day, and after D-day the complaints became more frequent and more prolonged. The basic

difficulty appeared to be lack of sufficient and selective production in the United States. The ground forces, too, encountered a shortage of ammunition during the fall of 1944 and appealed to Washington for greater production to meet growing requirements.<sup>112</sup> The failure of the United States to meet demands from the theater for certain types of bombs may be ascribed, in part, to what Knerr called the "historical method" of computing future expenditure. Apparently bomb and ammunition production was planned on the basis of current expenditure per aircraft rather than on possible future expenditure. The enormously expanded operations of the air forces in Europe from the spring of 1944 onward meant a correspondingly enormous expansion in the use of bombs and ammunition. In addition to the increased overall expenditure, differences in the nature of operations undertaken on the continent greatly increased the demand for particular types of bombs, of which there were recurrent shortages to aggravate the general tightness of bomb stock. In May 1944, when the Eighth and Ninth reached their maximum strengths, they expended more than 56,000 tons of bombs. In June, without the addition of any more groups, they dropped over 85,000 tons of bombs. During the remainder of the war, expenditure ranged from 51,000 tons in November 1944 to 118,000 tons in March 1945.<sup>113</sup>

If theater ground and air spokesmen stressed the inadequacy of production and the consequent insufficiency of the theater bomb supply, staff officers in Washington felt that improper distribution in the theater should share the blame. There was a certain amount of justification in this feeling, but transportation difficulties could throw awry even the best-laid plans for distribution of materiel. Bombs and ammunition were carried to the continent by air, but major reliance had to be placed on other means. Knerr characteristically pointed out that Washington planners had not considered the "distribution factor involved in supplying more than 150 installations, spread over both England and the Continent . . . the problems involved in transportation tie-ups due to congested railroad systems in the UK and the crippled railroad system on the Continent . . . the lack of adequate berths for ships arriving on the Continent."<sup>114</sup>

Although efforts were made to overcome the uncertainties of transportation by pooling bomb stocks at almost every echelon of organization,<sup>115</sup> the harmful effects of the bomb and ammunition shortage were discernible from time to time throughout 1944-45. In July 1944

an investigating officer from AAF Headquarters concluded that the status of bomb supply was unsatisfactory "to the degree that supply of bombs is dictating to tactical operations to a material extent, with some resultant decrease in bombardment effectiveness." The record operations of February and March 1945, when 198,000 tons of bombs were dropped, depleted bomb stocks in the theater to the point where all air forces either had to use substitute bombs frequently or restrict operations. In March 1945 the Eighth Air Force had to use second- and third-choice bombs on many of its targets, and the Ninth had to limit its effort to visual bombing in order to insure the most effective use of its limited bomb stocks. The First Tactical Air Force reported in March that lack of bombs had reduced its fighter-bomber operations by 25 per cent, and on one occasion it actually used depth charges with instantaneous fuzing against land targets. Spaatz reported in March "a critical shortage of specific bomb tonnage by type which prevents the proper selection of bombs for the targets to be attacked."<sup>116</sup>

The extraordinary expenditures of bombs during February and March impressed Washington with the necessity to increase diversified production of bombs. Although besieged with demands for bombs from all theaters of operations, AAF Headquarters made special efforts to meet USSTAF's needs, and when the war ended in May the bomb stocks in the theater totaled 307,500 tons, of which 180,000 tons had arrived in April. Ironically enough, only 368 tons of bombs were released on enemy targets in May. A large portion of the bomb tonnage on hand at the end of the war consisted of types like the 20-pound semiarmor-piercing and armor-piercing bombs and the 260-pound fragmentation bomb for which there had been no use in the theater for a long time but which had continued to pile up in the depots because of continued shipments from the United States. It is apparent that bomb production and distribution did not permit the establishment of an adequate reserve supply in either the United States or the European theater.<sup>117</sup>

As with bombs, difficulty in the procurement of aviation gasoline appeared to be chargeable to insufficient production in the United States, partly because of underestimates of future expenditures by the air force and partly because of production difficulties. Estimated consumption of aviation gasoline exceeded estimated production during most of the war, and reserve stocks in the United States and in over-

seas theaters were considered insufficient during 1944-45. In the European theater the Allied air forces had never succeeded in securing the forward stockage they considered necessary and as the rate of aerial operations rose steadily the stocks on hand declined because of insufficient replacement.<sup>118</sup>

In the United Kingdom the British Petroleum Board had evolved an efficient system of aviation gasoline distribution, utilizing pipelines, railroads, and tank trucks. USSTAF was dependent on the Petroleum Board for its gasoline supply and had no organization of its own for the distribution of POL. The Communications Zone, on the other hand, possessed an organization for the distribution of POL, and when OVERLORD was planned it became apparent that this organization would have to assume responsibility for the distribution of aviation gasoline, both in bulk and in packaged form, to the American air forces on the continent. The British would establish their own POL organization on the continent.<sup>119</sup>

Initial stocks of aviation gasoline and oil which were landed on the continent during the first three weeks after D-day were in packaged form and could easily be transported by truck from the beaches to the near-by airfields, which were then few in number. As a result of the Communications Zone's promise to begin bulk delivery of aviation gasoline after D plus 15, the Ninth Air Force had limited its supply of packaged gasoline. The Communications Zone was unable to fulfil its pledge, but fortunately there was no critical shortage of gasoline because the Ninth's rate of operations fell well below planning estimates. This was partly the result of delay in moving fighter groups to France and partly the result of the failure of the German Air Force to put in an appearance over the beachhead. On 20 June there was an estimated ten-day forward supply of aviation gasoline and oil on hand. After an inspection of POL facilities and stocks in the beachhead, Col. Bernerd F. Johnson, chief air force petroleum officer in the theater, reported on 22 June that he had found the "aviation fuel supply on the Continent . . . in excellent shape . . . in considerably better shape than any of the other Air Corps supplies."<sup>120</sup>

Although packaged gasoline was sufficient to meet needs during June, the great expansion of operations from continental airfields, which began in July, made distribution of bulk gasoline absolutely imperative. The Communications Zone prepared one of the minor Normandy ports, Port-en-Bessin, for the receipt of bulk gasoline and

erected storage facilities and loading points, and IX Engineer Command provided storage facilities on the airfields. Small collapsible storage tanks known as Mareng cells, with capacities ranging from 750 to 3,000 gallons, were set up on airfields and served until larger facilities could be made available. When unloading of bulk aviation gasoline began at the end of June, the problem of transportation to the airfields arose. Since the Ninth did not yet have any of its bulk gasoline truck companies ashore, the combat and service units, assisted by Communications Zone trucks, had to haul both bulk and packaged gasoline to the airfields. Fortunately, operations continued at a lower rate than had been estimated, and until well into July packaged gasoline and oil remained the chief source of POL supply for the Ninth, outnumbering bulk stocks by as much as five to one.<sup>121</sup>

By 23 July the supply of bulk gasoline to the airfields was under way, and all airfields except one had bulk storage space. Use of packaged gasoline was discontinued by units as soon as bulk gasoline became available, and packaged fuel, amounting to some 2,000,000 gallons early in August, was retained as a reserve stock. For several days in late July and again in early August, when stocks fell dangerously low because of the failure of deliveries of bulk gasoline, it became necessary to borrow from the RAF stocks. Consumption of gasoline by the Ninth Air Force in France increased steadily once operations began from continental bases but remained well below anticipations. Through D plus 19 little more than 350,000 gallons were used; during the third week in July consumption averaged 90,000 gallons per day and by early August it was 180,000 gallons.<sup>122</sup> The pipeline and the railroads were the main answers to the problem of bulk distribution. Cherbourg became the chief POL port in July and the Communications Zone began construction of a pipeline from there. Pipelines carrying motor transport fuel outran the aviation gasoline pipeline, which reached St.-Lô by 22 August. From the terminus of the pipeline or loading points along its way, IX AFSC and Communications Zone trucks hauled the gasoline to forward storage points. The advance of the fighter groups was too rapid for the pipeline to keep pace, and tank trucks were not sufficient in number to keep the airfields supplied. The more advanced fields were kept supplied with packaged gasoline carried by truck and plane when it was not possible to deliver bulk gasoline.<sup>123</sup> As a result of feverish work on the railroads, tank-car trains were operating to Paris by early September, but the con-



*Above: Square-Mesh Track*



## AIRFIELD CONSTRUCTION

*Below: Pierced-Steel Plank*

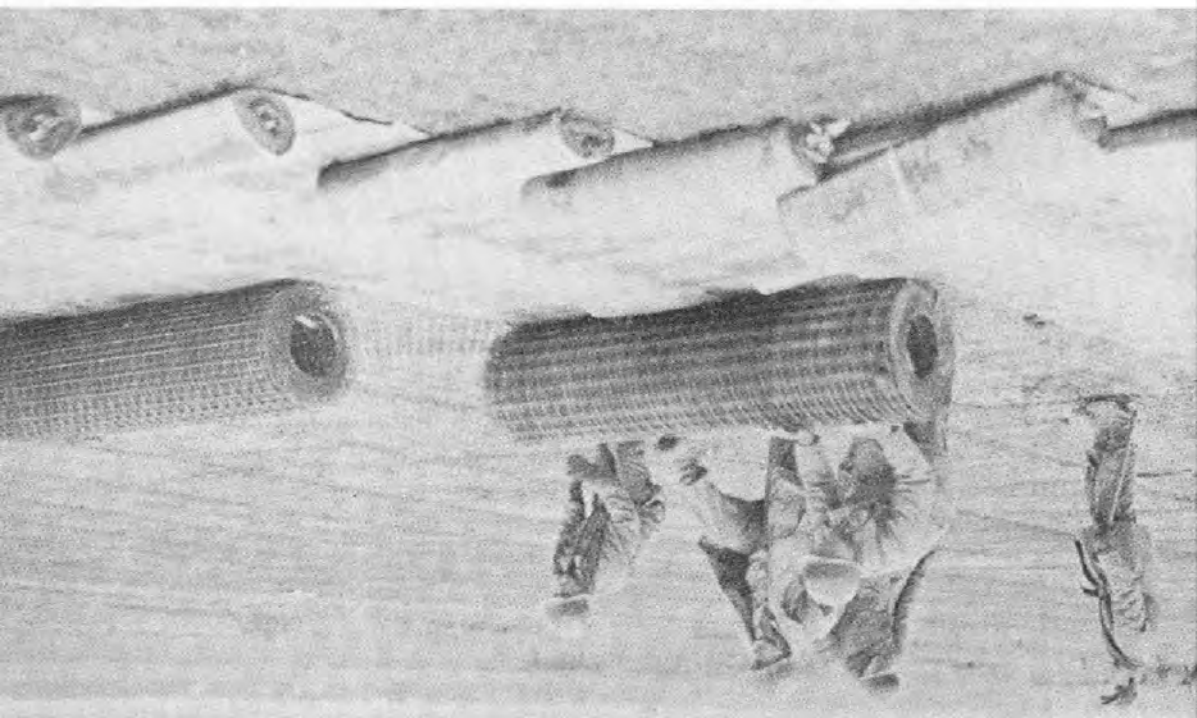



**HAULING GAS FOR PATTON'S TANKS**



**AIRFIELD CONSTRUCTION: HESSIAN MAT**

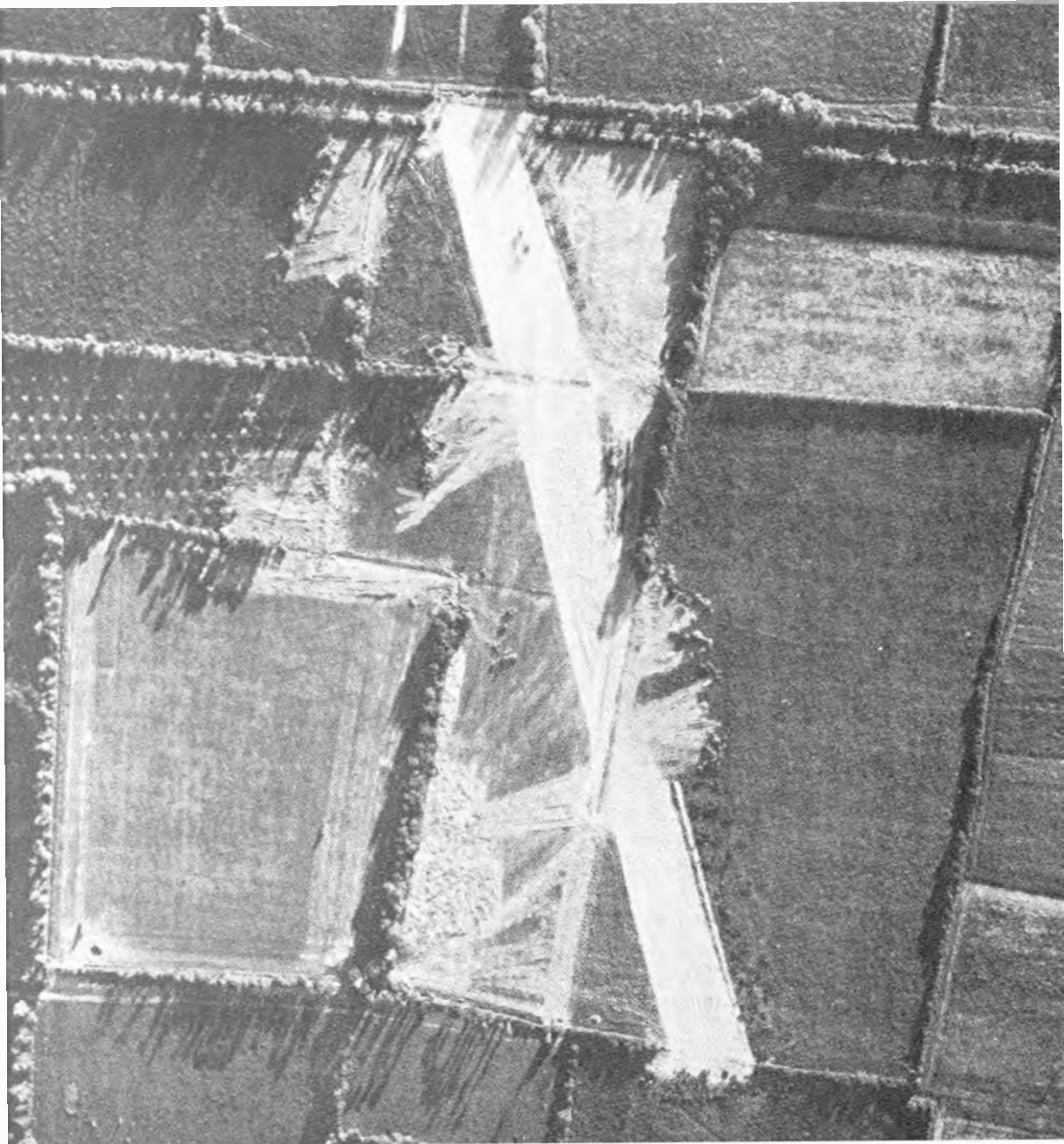

EMERGENCY AIRSTRIP IN THE NORMANDY HEDGEROWS

tinuing advance of the Allied armies increased still further the distance traveled by tank trucks in spite of the establishment of forward storage centers around Paris. The longest haul in mid-September was 850 miles round trip by truck.<sup>124</sup>

Capacity for receipt and storage of POL at Cherbourg and Port-en-Bessin was limited, and in October the newly captured ports of Le Havre and Ostend were opened for bulk gasoline receipt. The pipeline from Cherbourg reached Chartres at the end of September and Châlons, some eighty miles east of Paris, early in 1945. This was the farthest extent of the aviation gasoline pipeline, although motor transport pipelines were extended beyond and eventually reached Thionville, from where a single line was thrust forward to the Frankfurt neighborhood. Antwerp was opened in November and construction of pipelines inland was begun immediately. By February the aviation gasoline pipeline from Antwerp had reached its farthest extent—Maastricht—and was supplying the British and American air forces in Belgium and Holland. The British constructed pipelines across the English Channel to France, first to Cherbourg during the summer and later to other ports closer to England.<sup>125</sup>

Distribution of gasoline from the ports and from the pipeline termini remained major problems throughout the war. Tank cars had to be brought from England and from the United States to increase the carrying capacity of the railroads. The IX AFSC had to organize additional bulk truck units and called regularly on the Communications Zone for supplementary carrying capacity. During the closing months of the war, when the swift advance of the Allied armies once more stretched taut the supply lines which had been carefully strung during the preceding months, truck and air transport had to bear the burden of carrying gasoline to the forward airfields. By April 1945 the POL distribution system could transport 150,000 barrels (6,300,000 U.S. gallons) of gasoline per day.<sup>126</sup> Considering the tremendous forward lunges made by the Allied armies and air forces during the summer of 1944 and again in the spring of 1945, the trucking units of the IX AFSC and the Communications Zone, and the latter's military pipeline

## EMERGENCY AIRSTRIP IN THE NORMANDY HEDGEROWS

### *Maintenance*

During the planning of OVERLORD the Ninth Air Force realized that it would be extremely difficult, if not impossible, to achieve as

high an order of aircraft maintenance on the continent as it had enjoyed in England, and so it proved. The reasons were obvious. Aside from the difficulties in the supply system, which were reflected in the higher AOG rate, and the difficulties resulting from frequent movements, there was never established on the continent a base depot for maintenance work. Since the base depot at Compiègne was primarily a supply depot, throughout the continental campaigns the air forces on the continent remained dependent on the United Kingdom for base depot maintenance of aircraft.

Even before D-day, BADA had begun to assume base supply and maintenance functions for the Ninth Air Force in accordance with announced decisions of Spaatz and Knerr to assume administrative and logistical control of all American air forces in the theater. The final step was taken in July when it was agreed that BADA would assume the remainder of the base depot functions which the tactical air depots had been performing but could not be expected to carry on in France. To its responsibility for reception, storage, and delivery of all aircraft arriving in the theater, BADA would add responsibility for assembly of all and modification of most Ninth Air Force planes. It would continue to perform the heavier echelons of overhaul work on aircraft components, instruments, accessories, and other equipment and some additional work which the tactical air depots had been doing, for the air depot groups did not take their heaviest equipment with them across the Channel.<sup>127</sup>

When the Ninth moved to France, the combined 2d AADA-IX AFSC advanced headquarters was charged with responsibility for the maintenance of all American aircraft on the continent, including Eighth Air Force planes which were forced down. In September, when the IX AFSC headquarters was established at Creil, it divided maintenance responsibilities between the 1st and 2d AADA's. But the AADA's were merely headquarters organizations and such fourth-echelon maintenance as was done on the continent was done by the air depot groups.<sup>128</sup> When the AADA's were eliminated early in 1945, the air depot groups became the chief link in the maintenance organization between the service teams and BADA. Divested of much of the work which had taken up so much of their time in England, they were able to work closely with the service teams, which they supervised directly, and to devote the greater part of their maintenance effort to the repair of aircraft, accessories, and equipment. Particularly

## LOGISTICAL MOBILITY

invaluable were the mobile reclamation and repair squadrons,\* which came into their own on the continent and often proved the difference between success and failure in keeping aircraft operational. The mobile squadrons under the direction of the air depot groups could be dispatched on short notice to any station within a given area, thus lending to the maintenance organization a degree of mobility which was necessary if maintenance was to keep up with the frequent moves and fluctuating needs of the combat units. The service teams and the ground crews of the combat units, both on the combat stations, performed the first three echelons of maintenance on aircraft. They tended to perform a greater variety of work than they had done in England, largely because needs were more pressing and assistance more distant.<sup>129</sup>

By D-day all of the combat groups of the Eighth and Ninth Air Forces had been fully equipped and put into operation, and the task of aircraft assembly thereafter was limited to replacement aircraft. The time lag between arrival of aircraft in the theater and delivery to the air forces after assembly and modification at BADA increased during the summer, but this was an inevitable result of the increase in the number of modifications, the greater number of planes to be modified by BADA, and the extension of operations to the continent.<sup>130</sup> The IX AFSC retained responsibility for the assembly of liaison aircraft (L-4's and L-5's) used by the ground forces. BADA eventually took over this responsibility for such aircraft arriving in the United Kingdom, and in February 1945, CADA assumed a similar responsibility for liaison planes arriving on the continent. In March it was decided that all liaison aircraft could be received and assembled by CADA at Rouen. Such liaison planes as continued to arrive in England would be handled by BADA.<sup>131</sup> In June, when BADA took over the IX AFSC's assembly responsibilities, it was intended that this should also include gliders. Instead, the IX AFSC retained the glider assembly depot at Crookham Common until September when it turned it over to the IX Troop Carrier Service Wing (Prov.), which continued to assemble gliders there until February 1945. At that time, when the IX TCC was engaged in moving the remainder of its groups to France, BADA undertook to assemble all gliders, either at Warton or on the continent.<sup>132</sup>

\* The Ninth had one of these squadrons for each of its air depot and service groups, to the total of at least twenty-five during its continental operations.

Meanwhile, BADA was justifying the huge investment in manpower\* and equipment it represented. Some idea of the scope of its responsibilities may be gained from statistics concerning aircraft in the theater. From September 1944 until May 1945, USSTAF always had more than 10,000 tactical aircraft; the peak number was more than 11,000 in April 1945. During 1944-45, with the exception of December 1944 and January 1945, monthly tactical aircraft arrivals from the United States were never less than 1,000 and reached almost 2,000 in July 1944. The number of planes modified by BADA also exceeded 1,000 aircraft during every month of 1944, reaching a high of 1,535 in August and a total of almost 15,000 for the year. Many of the smaller aircraft were simultaneously assembled and modified by BADA, a saving of time which was of particular benefit to the Ninth. Finally, statistics for engine and propeller overhaul and other production work reveal that BADA's contribution was equally impressive in those respects. Engine overhaul production ran to more than 2,000 monthly during 1944-45.<sup>133</sup>

The transfer of responsibility for most modification to BADA in July provided relief for the Ninth Air Force but also created new problems. In May, Knerr had ruled that all aircraft would be modified to one standard at the base depots "in order that they may be furnished promptly on demand to either the Eighth or Ninth," but experience led the Ninth in September to request separate modification lines for each air force. ASC, USSTAF, although barring the establishment of separate modification lines, agreed to a policy which would modify the various types of aircraft to the standard set by the air force possessing the greater number of each type of plane. Under this policy, therefore, P-47's, which were the Ninth's chief problem, would be modified as desired by the Ninth. The Eighth Air Force would have to make such additional changes as it desired on the P-47's at its own strategic air depots. The converse would be true of the P-51's, of which the Eighth had a huge majority. Results of the new policy were apparent on the replacement aircraft arriving on the continent from BADA in October.<sup>134</sup> It had been hoped in the spring of 1944 that replacement aircraft, particularly fighters, arriving from the United States thereafter would possess most of the new features which had been developed in the theater during the preceding year, and this hope was indeed realized, but there was no letup in the demand for

\* More than 40,000 men were assigned to BADA.



modification within the theater. Improvements made on aircraft in the United States, either in manufacture or at modification centers, were often outdated by the time they reached the theater, either because of changes in combat conditions or changes in the missions of planes. The pressure of intensified operations after D-day produced a steady increase in the number of modifications requested, particularly from the Ninth Air Force.<sup>135</sup>

The major modifications were on fighters, the Ninth's chief weapon. Most important of the changes made immediately after groups began operating from fields in Normandy was the addition of engine filter ducts. The "appalling dust conditions" in France had caused an abnormally high consumption of oil, which in turn had produced an excessive number of engine failures. Directly attributable to changed combat conditions after D-day was the installation on fighters of rocket-firing equipment and "droop snoots," this term meaning the use of a Norden bombsight in the nose of a P-38. Through the use of special radio equipment, lead planes could control the release of bombs by a whole group, and by the end of October 1944 most of the planes in the Ninth's three P-38 groups carried the equipment required for droop-snoot bombing.<sup>136</sup> Installation of rocket launchers and electric bomb releases was begun in July, but the work proceeded slowly because of a shortage of kits and parts. Another major modification was the conversion of a large number of P-51's to F-6's for use as photo reconnaissance planes.<sup>137</sup>

Most fighter fields on the continent were of a temporary nature, without hangars, with widely separated dispersal areas and with poor runways. These conditions not only made maintenance more difficult for the service units; they also created more maintenance work by causing additional wear and tear on aircraft, especially to the wings of P-51's and P-47's, many of which tended to wrinkle under rough taxiing and landing conditions.<sup>138</sup> Weather conditions aggravated the hazards of poor airfields. The dust of summer and the mud of fall and winter added greatly to the work required of maintenance personnel. In one short period during July 1944, one fighter group had twenty-four engine failures, twenty-three of them the result of high oil consumption caused by dust conditions. Winter mud, which froze in the wheel wells, caused the nose wheels of planes to lock. This same mud, together with that which froze on the underside of wings, reduced the speed of planes and caused damage to accessories.<sup>139</sup>

## THE ARMY AIR FORCES IN WORLD WAR II

In addition to the demands for Ninth Air Force maintenance, IX AFSC was responsible for the supply and maintenance of liaison aircraft belonging to the ground forces. This duty, involving hundreds of small planes belonging to the armies, was handled by mobile reclamation and repair squadrons, which were well suited for serving the many dispersed sites from which the planes operated. 2d AADA assigned five mobile squadrons to this work in September 1944. The First Tactical Air Force performed the same service for the 6th Army Group.<sup>140</sup>

Finally, the increased rate of operations after D-day was accompanied by a rising rate of battle damage. Repair and maintenance production by the IX AFSC increased from 1,029 planes in May 1944 to 1,842 in June. Repair of battle-damaged planes increased from 154 in May to 744 in June. Repair production continued high during the summer, but fell during the autumn, when the Ninth's tactical effort declined sharply. Beginning in November, repair output by the air depot groups and the service teams rose again, once more in response to the increased operational rate, reaching more than 1,600 in March 1945.<sup>141</sup> In the absence of base depot repair facilities on the continent and because of a tendency for air depot groups to function more efficiently for purposes of supply than for maintenance, service teams were thrown chiefly on their own resources. The air depot groups were often out of operation for weeks at a time when engaged in moving, their facilities for maintenance work were frequently inadequate, particularly during the earlier months after D-day, and at times they were hundreds of miles behind the service teams they were supporting. The inevitable tendency was for the service units on the combat fields to perform as much maintenance and battle-damage repair as possible. Consequently, the service teams were responsible for the work done on considerably more than two-thirds of all aircraft undergoing maintenance and repair work in the IX AFSC after D-day.<sup>142</sup> Fourth-echelon maintenance by the air depot groups and by the base depots in England actually declined, although the IX AFSC continued to send many damaged planes back to the rear areas. After 16 November 1944 all aircraft transferred between air forces, usually as a result of the conversion of groups from one type of plane to another, were sent through BADA, which was made responsible for insuring their fitness for combat. BADA found that most of its fourth-echelon maintenance man-

## LOGISTICAL MOBILITY

hours were being spent in manufacturing AOG parts and modification kits and in the overhaul of engines and component parts. Battle-damage repair took much less time than formerly. To a considerable extent this development was the result of having on hand in replacement pools a large reserve of aircraft. It became much easier and less time consuming to replace a badly damaged plane with a new one than to repair it.<sup>143</sup>

The service teams, with the aid of mobile reclamation and repair squadrons from the air depot groups, performed a noteworthy job of maintenance. In the early months after D-day maintenance and repair work on the continent was especially difficult because of increased loss rates and poor working conditions. In July, losses and write-offs were exceeding replacements on the continent and IX AFSC stressed its need for assistance. Additional technicians were flown to the continent, and IX AFSC had moved all of its service units to the continent by October 1944.<sup>144</sup>

Over-all serviceability rates for Ninth Air Force aircraft on combat stations compared favorably with the former rate of the Ninth in England and, indeed, even with that of the Eighth Air Force. Except for July, serviceability of fighter aircraft present on the combat stations actually averaged higher than it had before D-day, i.e., over 80 per cent, climbing steadily after November 1944 until it exceeded 90 per cent in April 1945, when German opposition had almost disappeared. The serviceability rate of Ninth Air Force bombers also continued high after the move to the continent, exceeding 80 per cent in every month except February and March 1945, a period of exceptionally heavy operations. The First Tactical Air Force never achieved as high a serviceability rate for its aircraft on combat stations, largely because it lacked sufficient service units, particularly during the early months of its operations, and because of the wide dispersal of its stations. However, from a low of only 69.1 per cent in December 1944 the serviceability rate for bombers rose steadily to a high of 88.7 per cent in April 1945. The serviceability rate of fighters followed a similar course, rising from 65.1 per cent in December 1944 to 77.3 per cent in April 1945. The Eighth Air Force, with the best facilities available to any of the air forces in the theater, actually had a slightly lower serviceability rate than the Ninth for its aircraft after D-day. Its average of over 80 per cent for fighters for the period was lower than that of the

Ninth, while its bombers' serviceability was a bit higher than that of the Ninth after the mediums moved to the continent, beginning in September.<sup>145</sup>

Salvage of aircraft was a major problem on the continent, since for the first time the Americans had to rely on their own efforts. The RAF had performed most of the salvage function for the Americans in the United Kingdom. The Ninth had responsibility for the salvage of Eighth Air Force planes as well as of its own until the VIII AFSC Service Center was set up in October 1944. A mutual RAF-Ninth Air Force reporting system took care of planes which came down in each other's zones of operations.<sup>146</sup> The versatile mobile reclamation and repair squadrons once more proved their value in this work as they had in almost every other phase of maintenance. They were among the best of the many service units which enabled the Ninth Air Force to attain a high degree of logistical mobility on the continent.

SECTION V

\* \* \* \* \*

*THE GERMAN FRONTIER*



## CHAPTER 17

\* \* \* \* \*

### *CHECK AT THE RHINE*

**B**Y MID-SEPTEMBER 1944 the spectacular Allied advances across France and Belgium had come to a halt at or near the borders of Germany. Virtually the whole of France and Belgium, a small part of Holland in the Maastricht region, and nearly all of Luxembourg had now been liberated. In addition, the U.S. First Army had broken through the outer defenses of the Siegfried Line in the vicinity of Aachen and had penetrated into Germany for some ten to fifteen miles. But there the Allied armies were stopped, chiefly because they had outrun their logistical support.

Although the Germans had suffered heavy losses in men and equipment during their disastrous retreat, they were still able to muster formidable forces for defense of the Fatherland. It is difficult to arrive at an exact estimate of the losses sustained in the summer's fighting, but the German armies, though badly beaten up, had not been annihilated. The September lull in the battle gave time for regrouping and redeployment. Once more the divisions on the western front were under the capable leadership of von Rundstedt, who had taken over from Field Marshal Walter Model as C-in-C West on 5 September.<sup>1</sup> In addition to the assistance promised by the prepared defenses of the Siegfried Line, there were helpful water barriers in the north and on the south the Vosges Mountains. If Luftflotte Kommando West, as Luftflotte 3 was redesignated with some shuffling of staffs on 15 September, could show ten days later a fighter strength of no more than 431 planes,<sup>2</sup> it at least could anticipate some advantage from the fact that it now operated closer to the German sources of its strength. A drastic "combing out" of civilians hitherto exempt from military service for occupational reasons, of convalescent and replacement centers, of rear headquarters, of nonflying services of the GAF, and of naval person-

THE ARMY AIR FORCES IN WORLD WAR II

nel, together with the calling up of youngsters barely old enough to fight, gave von Rundstedt additional manpower. A recently undertaken offensive by Allied air forces against the German ordnance and motor vehicle industries interfered but little with efforts to re-equip his armies.\* Taking skilful advantage of his resources, von Rundstedt would make the autumn fighting a battle along the water line of the Meuse, Roer, Ourthe, and Moselle instead of one fought along the Rhine.

Against the Germans the Allied command deployed greatly superior forces both in the air and on the ground. The average daily air strength of Allied air forces during the month of September is summarized in the accompanying table.† In addition, General Eisenhower had at his

	<i>Bombers</i>		<i>Fighters</i>		<i>Reconnaissance</i>	
	<i>Total</i>	<i>Opnl.</i>	<i>Total</i>	<i>Opnl.</i>	<i>Total</i>	<i>Opnl.</i>
Ninth AF . . . . .	1,111	734	1,502	968	217	178
Second TAF . . . . .	293	254	999	879	194	164
Eighth AF . . . . .	2,710	2,045	1,234	904	...	...
Fifteenth AF . . . . .	1,492	1,084	559	402	...	...
RAF BC . . . . .	1,871	1,480	...	...	...	...
TOTALS . . . . .	7,477	5,597	4,294	3,153	411	342

disposal the IX Troop Carrier Command and RAF 38 and 46 Groups as components of the First Allied Airborne Army (FAAA), organized on 8 August 1944 under the command of General Brereton. The First Airborne Army included the U.S. XVIII Corps (consisting of the 17th, 82d, and 101st Airborne Divisions), the British Airborne Troops Command (composed of 1 and 6 Airborne Divisions), and the Polish 1st Independent Parachute Brigade. After 14 September, Eisenhower no longer had legal command of the AAF and RAF heavy bombers, but that fact would have little if any practical effect on the subsequent conduct of air operations.‡

The line of battle on 15 September, when Eisenhower took over direct operational control of all Allied forces on the western front, ran generally along the Albert, Escaut, and Leopold canals, from there along the eastern boundaries of Belgium and Luxembourg, following roughly the Siegfried Line from Aachen to Trier, and thence along

\* See below, pp. 646-49.

† Statistics of average daily strength for the several air forces are difficult to reconcile because of different systems of classification, methods of compilation, etc. The figures given above have been taken from statistical summaries prepared by the individual commands and AAAF.

‡ See above, p. 321.



the Moselle River to the Montbéliard-Lure region southeast of the Belfort Gap. The 21 Army Group, commanded by Field Marshal Sir Bernard L. Montgomery, formed the left of the Allied front. Bradley's 12th Army Group (Hodges' First, Patton's Third, and Simpson's Ninth Armies) held positions to the right of Montgomery, with Hodges on the left and Simpson's army still largely engaged in the reduction of German forces in Brittany. This mission would be accomplished with the fall of Brest on 18 September and the German capitulation in the entire peninsula on the next day. Thereafter, Ninth Army moved into positions between the First and Third Armies. The 6th Army Group of Lt. Gen. Jacob L. Devers (Patch's Seventh and Gen. Jean de Lattre de Tassigny's French First Army) in mid-September was pushing up from the south toward the Belfort Gap.

Each of the American armies had a tactical air command in direct support, and for the assistance of 21 Army Group there was the veteran Second TAF. To the IX and XIX TAC's, which had supported the U.S. First and Third Armies in the drive across France, there had just been added the XXIX TAC (Provisional), activated on 14 September in anticipation of the Ninth Army's move from Brittany to the main line of battle.<sup>3</sup> With Brig. Gen. Richard E. Nugent in command and with headquarters at Vermand, near St.-Quentin, XXIX TAC was attached temporarily to IX TAC for purposes of organization and operation. After the Ninth Army's forward movement to the German frontier, the new air command on 1 October became operationally independent. Cooperating with the 6th Army Group was Brig. Gen. Gordon P. Saville's XII TAC, which had moved into southern France with Patch, and the French First Air Force, organized and equipped by the Americans in MTO.\* In October an agreement would be reached to consolidate the two forces under the First Tactical Air Force (Provisional), an organization which became operational early in November with Maj. Gen. Ralph Royce in command.<sup>4</sup> Of the average of fourteen to fifteen fighter-bomber groups controlled by the Ninth Air Force during the fall of 1944 (exclusive of XII TAC), each of the TAC's was assigned a variable number—normally four to six groups but with the actual count at any one time depending upon the importance assigned by SHAEF to the current operations of the associated armies. With shifts of emphasis in ground strategy, the Ninth Air Force transferred units from one command to another. It also at

\* See above, pp. 415, 418, 430-37, 440-41.

times combined the fighter-bombers of the several commands to meet critical situations as they arose.

The only real weakness in the Allied position was one of supply, and an especially critical aspect of that problem was the lack of adequate port facilities to support the extended lines of communication. The German strategy of clinging to the Channel ports at all cost and then completely wrecking their facilities before surrendering them was paying huge dividends. It was inevitable, therefore, that the consideration of port facilities should have loomed large in the reappraisal of Allied strategy which marked the closing days of August and the first part of September.

### *The Arnhem-Nijmegen Drop*

As early as 24 August, General Eisenhower had recognized the necessity to choose in some measure between the northern and eastern approaches to Germany.<sup>5</sup> Prior to landings in Normandy his staff had selected a line of advance north of the Ardennes as the most direct and advantageous route to the heart of Germany. Not only did this route lead to the Ruhr, industrial center of modern Germany, but it promised to bring the Allied armies on to the broad plain of western Germany with many advantages for purposes of maneuver.<sup>6</sup> AEAFF supported this choice partly on the ground that the Allied air forces, much of whose striking power would continue to be based in England, could provide a greater margin of air superiority over that approach than would be possible elsewhere.<sup>7</sup> A more favorable prospect with reference to airfield development for tactical support of the land armies strengthened the argument, as did also the location of V-weapon launching sites in the Pas-de-Calais. This last consideration had received new weight after 12 June from the V-1 attacks on England, and early in August, SHAEF planners were urging the need to "reduce the heavy diversion of bomber effort at present required to neutralize" these launching sites and to "secure greater depth for our defenses in the event of the enemy introducing a longer range weapon." The danger, it was concluded, justified "higher risks than would normally be the case in order to expedite our advance into this area and beyond."<sup>8</sup> In short, Eisenhower's much-debated decision of late August to give the highest priority to a drive by Montgomery's armies toward the Ruhr had been foretold by previous decisions.

These earlier decisions on strategy, however, had rested also upon

the assumption that a "broad front policy," which might "keep the Germans guessing as to the direction of our main thrust, cause them to extend their forces, and lay the German forces open to defeat in detail," should be followed.<sup>9</sup> Consequently, Patton's Third Army had been launched upon a drive that led toward Metz, Saarbrücken, and thus into the Saar Basin. As the supply problem became critical in late August, both Montgomery and Patton pressed for a directive that would place the full resources of the Allied command behind a single thrust into Germany, each of them favoring the avenue of approach lying immediately ahead of his own forces.<sup>10</sup> But Eisenhower on 29 August directed a continued advance along the entire front, with the principal offensive to be undertaken north of the Ardennes.<sup>11</sup> Already the U.S. First Army had been ordered to advance in close cooperation with the 21 Army Group toward the lower Rhine, and on 2 September, Patton received approval for an attempted crossing of the Moselle. As he moved to get his forces under way, the news from the northern front was especially encouraging. On 4 September, the British Second Army after one of the most spectacular advances of the entire summer, entered Antwerp. Its harbor facilities were left practically intact by the withdrawing enemy, but the Schelde Estuary connecting Antwerp with the sea remained in German hands.

That same day Eisenhower issued another directive.<sup>12</sup> Reflecting the optimism apparent in the directive of 29 August and reaffirming the policy of a two-pronged attack, the new directive ordered Montgomery's forces and those of Bradley operating north of the Ardennes to make secure for Allied use the port facilities of Antwerp and then to seize the Ruhr. The First Allied Airborne Army would assist in the attainment of these objectives. The 12th Army Group, having reduced Brest, was to occupy the sector of the Siegfried Line covering the Saar and then to seize Frankfurt as soon as logistical support became available. The supreme commander's strategy was clearly understood and accepted, if reluctantly, at Bradley's headquarters, but the situation at Montgomery's headquarters required some "tidying up." After further consultations and after the promise of additional supplies to be delivered to the British at the expense of American organizations, Eisenhower amplified his directive of 4 September in still another directive issued on 13 September.<sup>13</sup> The northern armies would move promptly to secure the approaches to Antwerp or Rotterdam and then push forward to the Rhine. The central group of armies would give strong sup-

port to the right flank of 21 Army Group, drive with its center toward the Rhine in an effort to secure bridgeheads near Cologne and Bonn, and push its right wing only far enough to hold securely a footing across the Moselle, a task on which Patton's forces already had been launched.

To assist the ground forces in their drive to the Rhine, the strategic air forces undertook to break up German rail centers, and the TAC's, under orders of 14 September, were sent on rail-cutting operations designed to prevent reinforcement of the Siegfried Line. Fighter-bombers of IX TAC would concentrate on seven lines extending westward from Rhine crossings at Düsseldorf, Cologne, Remagen, and Coblenz. The responsibility for eleven lines running west from crossings at Bingen, Mainz, Worms, Ludwigshafen, Speyer, Germersheim, and Karlsruhe and, in addition, for eleven lines lying east of the river fell to XIX TAC.<sup>14</sup>

The decision to give priority to Montgomery's drive would have lessened the interest attaching to AAF operations for a time had it not been for the vital part in that drive assigned to the First Allied Airborne Army. Montgomery issued his directive on 14 September 1944.<sup>15</sup> The ground phase of the campaign—coded GARDEN—had two major objectives: first, a rapid advance from the British Second Army's bridgehead across the Meuse-Escaut Canal northward to the Rhine and the Zuider Zee, thus flanking the Siegfried Line; second, possession of the area between Arnhem and the Zuider Zee, preparatory to an advance across the Ijssel River on to the North German Plain. The initial advance was to be along a very narrow front in the direction of Eindhoven, Veghel, Grave, Nijmegen, Arnhem, and Apeldoorn. In the words of Montgomery, the drive was to be rapid and violent, one made without regard for what was happening on the flanks.<sup>16</sup> The task fell chiefly to the Guards Armoured Division and to the 43 and 50 Infantry Divisions. To facilitate and expedite their advance General Brereton's newly organized command undertook the largest airborne operation yet attempted.<sup>17</sup>

Operation MARKET had as its purpose the laying of airborne troops across the waterways on the general axis of advance and the capture of vital road, rail, and pontoon bridges between Eindhoven and Arnhem. Committed to the achievement of these objectives were the U.S. 82d and 101st Airborne Divisions, the British 1 Airborne Division, the Polish 1st Independent Parachute Brigade, and a number of

smaller units of specialized personnel, including aviation engineers. The 101st Division was to seize the city of Eindhoven and the bridges (river and canal) near Veghel, St. Oedenrode, and Zon; the 82d Division was to capture several bridges at Nijmegen and Groesbeek; and the British 1 Airborne Division, supported by Polish paratroopers, was to gain control of road, rail, and pontoon bridges at Arnhem.<sup>18</sup> After the ground forces had established contact with the airborne troops, the latter were to protect the sides of the corridor. The available airlift, much of which would be required for missions of resupply after D-day, forbade any attempt to commit all of the airborne forces at once. Consequently, the schedule called for delivery of about half the strength of the three airborne divisions on D-day, with movement of 1 Airborne Division to be completed on D plus 1 and the movement of the two American divisions spread over three days. The Polish paratroopers were scheduled for a drop in support of the British before Arnhem on D plus 2. The American airborne troops were to be evacuated to the United Kingdom as soon as possible in order to prepare for possible assistance to Bradley's 12th Army Group. The airborne troops were under the command of Lt. Gen. F. A. M. Browning, deputy commander under Brereton, until a firm link-up with Montgomery's forces had been effected. Maj. Gen. Paul L. Williams, commanding IX Troop Carrier Command, would direct the entire troop-carrying phase of the operation.<sup>19</sup>

A series of conferences extending from 11 through 15 September fixed the final assignments for supporting operations.<sup>20</sup> The chief assignments were: attack on enemy airfields, particularly those in the proximity of the intended drop and landing zones, by RAF Bomber Command; destruction and neutralization of light and heavy anti-aircraft defensive positions along the selected airborne routes and the drop and landing zones by ADGB and Eighth Air Force, with the assistance of Ninth Air Force if needed; escort and cover of the troop carriers by ADGB and VIII Fighter Command; protection of zones of operation from air attacks, except for the time when ADGB and the Eighth were operating in the area in connection with troop carrier activities, by Second TAF and ADGB; cover of drop and landing zones and support of the ground fighting by Second TAF; maintenance of air-sea rescue service by ADGB; dummy paratroop drops in the cover area by Bomber Command; and, finally, diversionary operations, by Coastal Command. In addition, Eighth Air Force promised 252 B-24's for as-

sistance in dropping supplies to the airborne troops on D plus 1. AEAFF held the responsibility for coordination and control of these supporting operations.

It was confidently expected that the chief opposition to be overcome would be not from the Luftwaffe but from enemy flak. It was felt, however, that Allied air strength was sufficient to accomplish a substantial reduction of the flak hazard before the launching of the operation. And since it was also believed that the enemy's day fighter strength had been more heavily depleted than his night fighter force, the decision was reached to stage the operation by day. Of the two approaches considered, the most direct route to the targets passed over Schouwen Island and required a flight of approximately eighty miles over enemy-held territory. The alternative route followed a more southerly course with the passage over enemy-controlled territory limited to about sixty miles. In the end, it was concluded that no appreciable difference between the hazards existed and that both corridors should be used in order to eliminate the danger of heavy congestion in air traffic.<sup>21</sup>

Even the weather, whose interference forms a monotonous theme running throughout the history of air operations over western Europe, lent encouragement to the optimism with which operation MARKET was launched on Sunday morning, 17 September 1944. The initial blows had been struck during the night of 16/17 September by 282 aircraft of RAF Bomber Command in attacks on flak defenses along the northern route at Moerdijk bridge and on airfields at Leeuwarden, Steewijk-Havelte, Hopsten, and Salzbergen, all lying within easy striking range of the drop and landing zones. Six RAF and five American radio countermeasure aircraft preceded the heavy bombers in order to jam the enemy's detecting apparatus. During the course of the morning, 100 RAF bombers, escorted by 53 fighters, hit coastal batteries in the Walcheren area and attacked shipping near Schouwen Island. Late in the morning 852 B-17's of the Eighth Air Force, escorted by 153 fighters belonging to the same force, attacked 112 antiaircraft positions along both routes the carriers were to follow. As yet no enemy aircraft had interfered, but one fighter and two B-17's were lost to flak and 112 B-17's sustained battle damage from the same cause. Subsequent assessment of these air attacks indicated only moderate success.<sup>22</sup>

The vast fleets of carrier aircraft and gliders, which had taken off from their English bases carrying approximately half the strength of

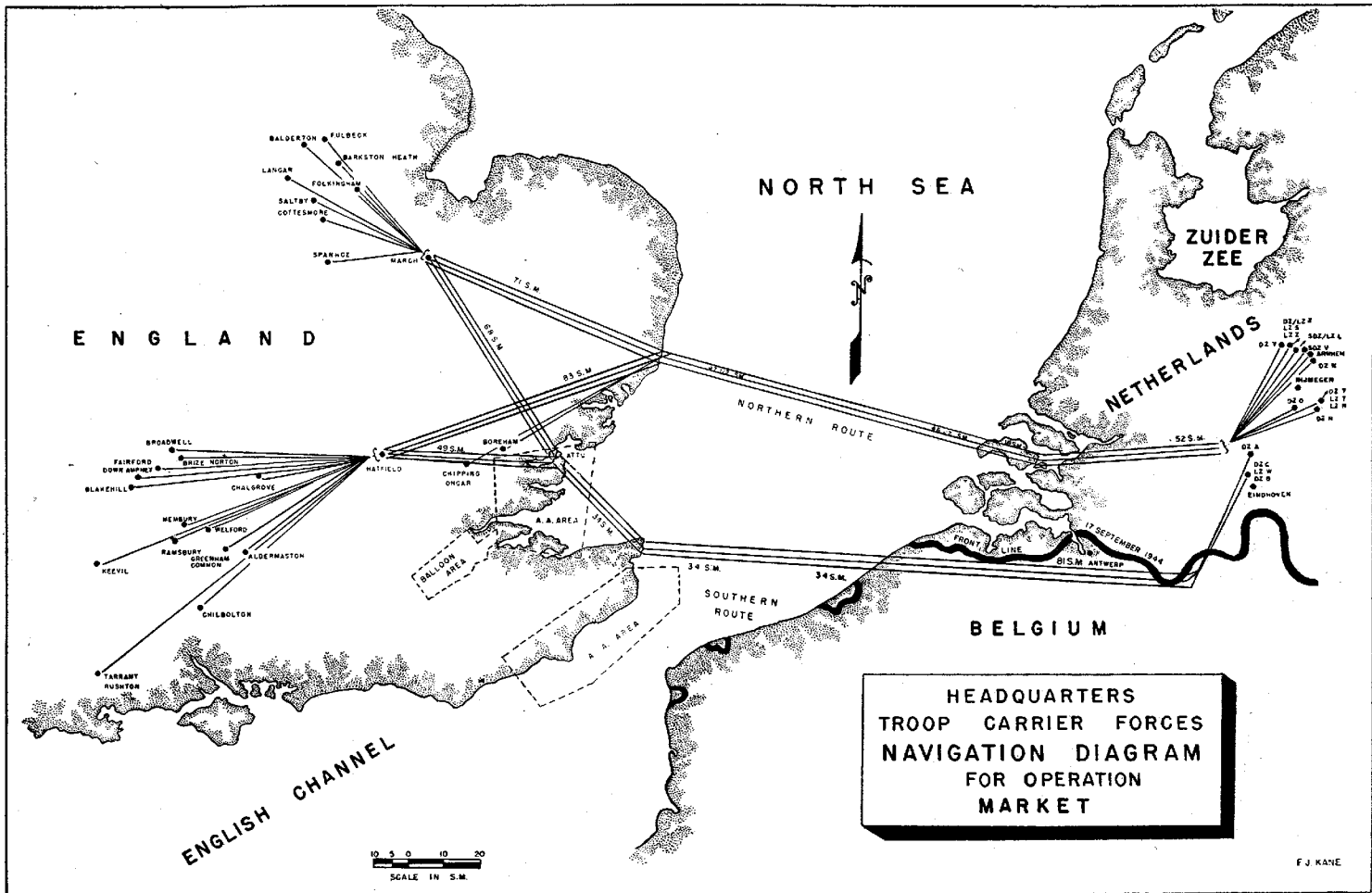

BALDERTON  
FULBECK  
BARKSTON HEATH  
LANGAR  
FOLKINGHAM  
SALTRY  
COTTESMORE  
SPANHOE  
MARCH

BROADWELL  
FAIRFORD  
DORR APPLEY  
BLAKENHILL  
CHALSDRIVE  
MEMBERSY  
WELFORD  
RAMSBURY  
GREENHAM COMMON  
KEEVIL  
CHILBOLTON  
TARRABY  
HULSTON

HATFIELD  
CHIPPARD  
ONGAR  
BOREHAM  
A.A. AREA  
A.A. AREA

DE/27  
L11  
L12  
L13  
L14  
L15  
L16  
L17  
L18  
L19  
L20  
L21  
L22  
L23  
L24  
L25  
L26  
L27  
L28  
L29  
L30  
L31  
L32  
L33  
L34  
L35  
L36  
L37  
L38  
L39  
L40  
L41  
L42  
L43  
L44  
L45  
L46  
L47  
L48  
L49  
L50  
L51  
L52  
L53  
L54  
L55  
L56  
L57  
L58  
L59  
L60  
L61  
L62  
L63  
L64  
L65  
L66  
L67  
L68  
L69  
L70  
L71  
L72  
L73  
L74  
L75  
L76  
L77  
L78  
L79  
L80  
L81  
L82  
L83  
L84  
L85  
L86  
L87  
L88  
L89  
L90  
L91  
L92  
L93  
L94  
L95  
L96  
L97  
L98  
L99  
L100

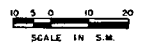

the British 1 and U.S. 82d and 101st Airborne Divisions, converged on their designated drop and landing zones during the noon hour. Of the 1,546 aircraft and 478 gliders dispatched, 1,481 of the former and 425 of the latter were highly successful in their drops and landings. The loss of thirteen gliders and 35 aircraft was far less than had been anticipated. Escorting fighters of ADGB and of the Eighth and Ninth Air Forces, flying respectively 371, 538, and 166 sorties, suffered the loss of only 4 aircraft, all of them American.<sup>23</sup> Luftwaffe reaction (comprising an estimated 100 to 150 sorties) was feeble and generally ineffective.<sup>24</sup>

Paratroops of the U.S. 101st Division, having landed between Veghel and Eindhoven, quickly established their position at Zon, about half-way between St. Oedenrode and Eindhoven. After slight opposition from German tanks, which was quickly overcome with the assistance of Second TAF, the paratroopers seized intact the bridge at Veghel. The bridge at Zon over the Wilhelmina Canal was destroyed by the enemy with the paratroopers still a few hundred yards from it. Some thirteen miles farther north, the U.S. 82d Division had landed in two zones southeast and southwest of Nijmegen. The Americans captured the bridge over the Maas River at Grave and two small bridges over the Maas-Waal Canal, but their attempts to secure the Nijmegen bridge proved unsuccessful. At Arnhem, ten miles north of Nijmegen, British troops of 1 Airborne Division, having been put down west of the town, succeeded in capturing the northern end of the bridge across the Neder Rijn only to experience failure in the effort to seize the bridge's southern end. The paratroopers had landed directly in the path of the 9th SS and 10th SS Panzer Divisions, of whose presence in this area Allied intelligence had given insufficient warning, and consequently faced both unexpected and exceedingly strong opposition.<sup>25</sup>



Given thus an initial advantage in recovering from the surprise with which the airborne operation seems to have caught them, the Germans quickly fathomed Allied intentions. At the Fuehrer's conference on D-day it was concluded that the Allied armies would attempt to cross the Maas, Waal, and Rhine and that their ultimate objective was the Zuider Zee.<sup>26</sup> Steps were taken to contain and annihilate the paratroops, against whom strong counterattacks were immediately ordered. These attacks in the next few days grew in intensity, particularly those launched from the Reichswald in the Nijmegen vicinity.

Fortunately, FAAA came through with scheduled reinforcements



**OPERATIONS IN HOLLAND**  
17 SEPT.-3 DEC. 1944

1. Garden-Market Operation Gains  
17-30 Sept 1944
2. Advances From 30 Sept.-3 Dec. 1944

 FRONT LINE 17 SEPT  
 FRONT LINE 30 SEPT  
 FRONT LINE 3 DEC.

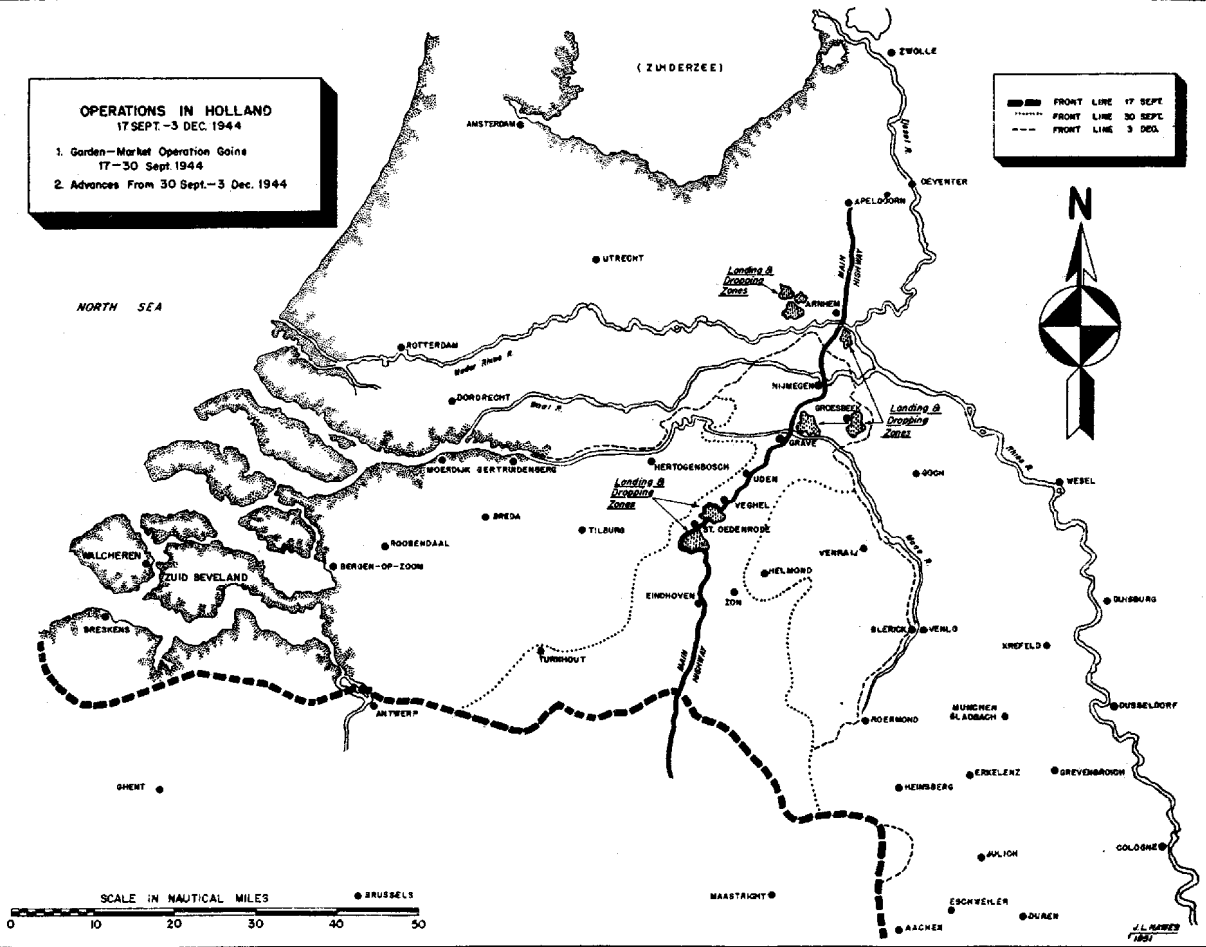

NORTH SEA

(ZUIDERZEE)

SCALE IN NAUTICAL MILES



J.L. HARPER  
1951

## THE ARMY AIR FORCES IN WORLD WAR II

and supplies on D plus 1, though with some delay. Owing to poor visibility at the bases in England, the airlift had to be postponed until the afternoon, but during the remainder of the day a total of 1,306 aircraft and 1,152 gliders accomplished their assigned missions at a cost of 22 aircraft and 21 gliders destroyed or missing. Out of the 674 ADGB and Eighth Air Force fighters providing escort for the troop carrier forces only 13 failed to return. Some 246 Eighth Air Force B-24's, escorted by 192 fighters, dropped supplies and equipment for the American paratroopers at a cost of 7 bombers and 21 fighters. The Luftwaffe reacted in greater strength than on the preceding day, but once more all losses to enemy action were attributed to flak. As a safeguard for friendly ground forces, Allied aircraft had been strictly prohibited from attacks on ground installations until fired upon, and this gave the enemy antiaircraft crews a distinct advantage. Even so the losses were low enough, and at the close of the second day FAAA, despite some inaccurate supply drops, had reason to congratulate itself on the manner in which it had discharged its initial responsibilities.<sup>27</sup> The British 1 Airborne Division and most of the U.S. 82d and 101st Divisions had been delivered to the battle area at costs which in no way seriously diminished the capacity of the Allied air forces to provide such continuing assistance as might be required. Only the weather promised to impose serious limitations on further aid for the heavily engaged paratroopers.

How costly was the delay from morning until afternoon in the delivery of reinforcements on D plus 1 is a question properly left to those historians who undertake a final estimate of the ground situation. It may be pertinent here to note that the German high command in reviewing its victory at Arnhem attributed it partly to a failure of the Allies to drop the entire British airborne division at once,<sup>28</sup> but that was the result of a command decision for which, like the weather on D plus 1, FAAA did not carry a primary responsibility. The assistance that could be provided over the ensuing four days was drastically cut down by the unfavorable turn of the weather. Not until 23 September was it possible to resume large-scale operations, and by that date the issue had been settled.<sup>29</sup> The weather also reduced the effectiveness of supporting fighter operations. Especially serious was the inability of Second TAF to provide continuous close support for the paratroopers and to interdict effectively the enemy's reinforcement routes. This helped the Germans repeatedly to cut tentatively established lines of communi-

cation with Montgomery's forces and occasionally to place themselves in strength astride the axis of the Allied advance.

It seems clear, however, that these unavoidable limitations imposed on air action were definitely secondary in importance to the delays experienced in the effort to link up Montgomery's advance with the positions seized by the paratroopers. The Guards Armoured Division had moved out from its bridgehead across the Meuse-Escaut Canal on 17 September approximately an hour after the paratroop landing at Eindhoven. Though supported by a heavy artillery barrage and strong assistance from the air, the attack met unexpectedly stiff resistance and by nightfall the advance had reached only some six miles to the village of Valkenswaard. Not until the next day was contact established with the main elements of the 101st Division and the Guards did not reach the 82d Division until the 19th. Through five more days of bitter fighting, which proved especially costly to the British near Arnhem, the Allied forces managed to establish no more than the most tenuous hold on a narrow salient some 20 to 25 miles in width and extending across the Neder Rijn west of Arnhem. The American airborne forces had to divert much of their effort from the attempt to consolidate and enlarge their positions in order to reopen lines of communication repeatedly cut by enemy attack, and Montgomery's main advance never developed sufficient strength to push through effective relief for the increasingly exhausted paratroopers. On the night of 23 September the British Second Army authorized withdrawal of the British troops from the Arnhem spearhead, a withdrawal accomplished on the night of 25 September.<sup>30</sup> As the Allied line was readjusted, U.S. paratroopers held on at Nijmegen,\* but Leigh-Mallory on 29 September released ADGB, Second TAF, and the Eighth and Ninth Air Forces from any further commitments to MARKET.<sup>31</sup> The air-ground operation which carried the chief hope of an early Allied victory over Germany had ended in failure.

General Montgomery, writing after the war, has insisted that the MARKET-GARDEN operation was 90 per cent successful, because it resulted in the permanent possession by his forces of crossings over four major water obstacles, including the Maas and Waal rivers. Especially helpful was the possession of the Waal bridgehead, which proved to be of vital importance in the development of the subsequent thrust into the Ruhr.<sup>32</sup> But long-term advantages, such as these, offered at the

\* Not until mid-November, after bitter protest from Brereton, were they withdrawn.

time little compensation for the vanished hope of an early termination of hostilities. Consequently, the plan and its execution promptly became the object of much criticism.

Late in the fall of 1944 General Arnold dispatched a special group of officers to Europe for a comprehensive review of the entire operation. The resulting report singled out for particular criticism the following points: first, overly optimistic intelligence estimates of the chance for an early German collapse; second, insufficient and incorrectly balanced British ground forces; third, the timing of the operation—a prior opening of Antwerp would have contributed to an improvement of the logistical situation and therefore have increased the possibilities for a successful drive to the Rhine; and, fourth, the advisability of concentrating on this northern drive in view of the mobility which Bradley's armies possessed at the time.<sup>33</sup> Montgomery, on the other hand, has blamed weather-induced delays in airborne resupply and reinforcement, the inaccurate dropping of supplies and of the Polish paratroopers and parts of the 82d Airborne Division, and the lack of the full air support anticipated.<sup>34</sup>

To measure exactly the cost of air force failures is impossible. That there were failures must be admitted. Montgomery has correctly stated his reliance "on a heavy scale of intimate air support, since the depth of the airborne operation carried it far beyond artillery support from the ground forces."<sup>35</sup> But Second TAF, to which this task fell, operated under a variety of difficulties. Its bases were too distantly located, especially for attacks at Arnhem. Its fighters were forbidden to operate over the battle area during troop carrier reinforcement and resupply operations, and since the weather imposed delay and uncertainty on the scheduling of these operations, the interference with air support became greater than had been anticipated. The prohibition of all save retaliatory attacks upon ground installations proved another handicap. And the restrictive influence of the weather itself suggests that this and other factors beyond the control of the air forces had not been sufficiently discounted in drafting the over-all plan. One point is clear: except for a few days at Arnhem the ground fighting was free, save for an occasional nuisance attack, of interference from the GAF.<sup>36</sup>

How effective were the cover, escort, antiflak, perimeter patrol, and various other sorties flown by the Allied air forces for the airborne operations? On the basis of known flak positions and the feverish build-up of new flak positions in the areas of the intended air corridors, losses of

from 25 to 40 per cent had been predicted prior to the operation.<sup>37</sup> The actual losses sustained by the transport aircraft of IX Troop Carrier Command during the ten days' operation amounted to less than 2½ per cent, while 38 and 46 Groups suffered losses of about 4 per cent. IX Troop Carrier Command, in summarizing and evaluating the work of the Allied air forces in behalf of the airborne operations, states:

The above agencies performed their assigned tasks with an exceptional skill and efficiency which contributed vitally to the success of the Troop Carrier Forces and kept the percentage of casualties very low. . . . In addition, losses due to flak and ground fire were held to a minimum by the constant harassing attacks of supporting aircraft on flak positions, transport, barges, and enemy installations. . . . From the standpoint of IX Troop Carrier Command, the air support was carefully planned and brilliantly executed.<sup>38</sup>

Chief credit for the small losses sustained belonged to Eighth Air Force and Air Defence of Great Britain. The advisability of diverting so large a force of the former's heavy bombers and fighters from their usual strategic bombing role may be seriously questioned. According to General Doolittle, this diversion cost his force four major and two minor heavy bomber missions.<sup>39</sup> The use of the Eighth's fighters for anti-aircraft neutralization along the airborne corridors, operations for which they were not particularly specialized, is also subject to doubt. Ninth Air Force units, assigned to the support of Patton's secondary effort, were more experienced.

As for troop carrier operations, there is little room for complaint. It is true that there were delays, but for these the weather was responsible. It is also true that there were inaccurate drops both of supplies and of paratroopers, but it should be noted that these failures for the most part came at a time when, in addition to the influence of unfavorable weather, there was an unanticipated constriction of the areas held by previously landed airborne troops which added to the difficulties of accurate dropping. The chief complaints were made regarding the later drops at Arnhem, where the actual ground situation was for much of the time imperfectly understood because of failure in communication. All told, it would seem that the air phases of MARKET-GARDEN were decidedly the most successful of the entire operation. Something of the scale of that air effort is indicated by the table on the following page.<sup>40</sup>

Though MARKET, on the whole, represented a very successful effort, certain lessons in detail of execution were drawn from it for the benefit of later operations. First, it had been made clear that airborne

operations derive their success from the speed with which they exploit the surprise achieved over the enemy and, since surprise offers only a fleeting advantage, the initial drop must be of such strength that the airborne troops can promptly achieve their immediate objectives. Second, there was need for a more adequate system of communication between the various forces involved in such an operation. The lack of these facilities had kept British Airborne headquarters for several days in almost complete darkness on the critical Arnhem situation.<sup>41</sup> Third, in view of the record with the air dropping of supplies, greater effort would have to be made toward the initial securing of air landing areas

SUMMARY OF AIR OPERATIONS 17-26 SEPTEMBER 1944

	IX TCC†		Dropped or Landed	8 and 46 Gps.		Bomber Command		Eighth AF	ADGB	Second TAF	Ninth AF	TOTALS	
	A/C	GII.		A/C	GII.	A/C	GII.					A/C	GII.
Dis-patched*	4,242	1,899		1,340	699	392	4,269	1,746	898		501	13,388	2,598
Successful	3,880	1,635		1,200	627	392	3,943	1,677	860		385	12,337	2,262
Cost	98	137		55	2	2	58	12	13		2	240	139
E/A Claims†							139	5	15				159
Troops		30,481			4,395								34,876
Vehicles		1,001			926								1,927
Army Wpns.		463			105								568
Tons of Equip. and Supplies (Inc. gas.)		3,559			1,668								5,227

\* Number of sorties and losses of photo and weather reconnaissance, dummy-dropping, etc., not included.

† A/C destroyed only.

‡ Includes 246 B-24 supply operations of Eighth Air Force.

and the development of larger transport aircraft for delivery of heavier equipment in support of the sharp but relatively fragile weapon represented by airborne forces. In connection with the largely unsuccessful supply-dropping operations at Arnhem, Second TAF and 46 Group felt strongly that use should have been made of fighter-bombers equipped for supply-dropping.<sup>42</sup> Fourth, it was found that much closer liaison should be established between the airborne troop headquarters in the rear in order to coordinate plans and operations. Lastly, the American airborne division commanders found glider pilots in their midst a definite liability which they were very anxious to see removed by adoption of a system of training and organization along the British pattern for forming these pilots into effective combat units.<sup>43</sup>

While the fighting in the Arnhem salient moved toward its disheartening end, the U.S. First Army of General Hodges pressed forward on Montgomery's right flank. By 25 September, XIX Corps had advanced several miles into Germany west of Geilenkirchen and in the vicinity of Aachen. VII Corps, fighting actually within the fortifications of the west wall, had seized Stolberg, east of Aachen, by 22 September.<sup>44</sup> But Aachen itself, for the time being at least, remained out of reach. Patton's Third Army, with its XII and XX Corps across the Moselle in an offensive designed to seize Frankfurt, ran into strong resistance and felt again the pinch of supply shortages. By 25 September, Bradley had ordered Patton to assume a defensive attitude.<sup>45</sup>

With ground fighting tending thus to turn into a generally static state of warfare, and with frequently adverse weather conditions prevailing, Ninth Air Force operations during the latter half of September were reduced in scale if not in variety.<sup>46</sup> Attempts to prevent the enemy from building up his already strong defenses remained a primary concern, and total AEF claims for the period showed the destruction of 339 locomotives, 1,045 railway cars, 905 motor transport and armed vehicles, and 136 river barges.<sup>47</sup> Medium and fighter-bombers assisted in the sieges of fixed defensive positions at Brest, Metz, and in the Siegfried Line, often with little direct effect on fortifications of modern construction.<sup>48</sup> A large measure of success attended attacks against gun emplacements, pillboxes, and other strongpoints in the enemy lines. The strafing of wooded areas at times contributed to inducing the enemy to abandon positions in the forests. Fighter-bombers helped overcome stubborn enemy rear-guard action and counterattack.<sup>49</sup> Neutralization of flak defenses called now for more attention than had been

required during the summer fighting. The heavily outnumbered GAF, concentrating its efforts in support of the counterattacks in the Nijmegen-Arnhem area, appeared in strength along Bradley's front only on 16, 18, and 19 September.<sup>50</sup>

*The Disappointments of October*

The failure at Arnhem could leave no doubt as to the necessity for placing first in Allied plans a solution of the logistical problem. Existing port and transportation facilities, strained to the breaking point, had proved inadequate and the advent of bad weather with the fall season promised further aggravation of the difficulty. The port of Brest had been left by the Germans in total ruin; ports still in enemy hands faced a similar fate. Moreover, their distance from the current theaters of combat offered no prospect of relief for the Allied forces. These considerations lifted the opening of the port of Antwerp by seizure of the Schelde Estuary to a paramount place in Allied strategy.

On 22 September, Eisenhower held an extraordinary conference at SHAEF Forward with his chief commanders and principal staff officers to discuss the current military situation and the course of future operations. With the exception of Montgomery, who was represented by General de Guingand, all the key ground, naval, and air officers were in attendance. For the benefit of the champions of a single-thrust policy, the supreme commander firmly demanded "general acceptance of the fact that the possession of an additional major deep-water port on our north flank was an indispensable prerequisite for the final drive into Germany."<sup>51</sup> In accordance with this dictum, the decisions reached at the meeting provided that the main effort during the current phase of the campaign would be made by Montgomery with the objective of clearing the Schelde Estuary and opening the port of Antwerp as a preliminary to operations designed to envelop the Ruhr from the north.<sup>52</sup> The field marshal's forces at the moment being badly scattered over Holland, Bradley was directed to continue his campaign toward Cologne and Bonn and to strengthen his extreme left flank in immediate proximity to the British Second Army. The remainder of his forces were not to take any offensive action except as the logistical situation might permit once "the requirements of the main effort had been met," but the 12th Army Group was to be prepared to seize any favorable opportunity for crossing the Rhine and attacking the Ruhr from the south. Devers' armies, which were supplied from the Medi-



terranean, would continue operations for the capture of Mulhouse and Strasbourg.<sup>53</sup>

The conference of 22 September did not discuss the current operations of the tactical air forces. It was inevitable, however, that the relative immobility of the Allies along most of the western front, and particularly the slow progress of their major drive in the Arnhem area, would require intensification of the attempt by the tactical air forces to interfere with the enemy's transport of troops and equipment to the battle area. Already on 21 September, IX and XIX TAC's had been directed to concentrate a greater effort upon the enemy's rail system west of the Rhine. This was followed four days later by a new order making rail-cutting a first priority for fighter-bomber operations. The closing days of September witnessed further changes in the interdiction program. All the lines thus far singled out for cutting were located within the current tactical boundary\* and comprised what was generally referred to as the inner line of interdiction. On 29 September an outer line of interdiction, embracing a series of rail lines farther east, was established. In view of the fact that the latter lines lay outside the existing tactical boundary, attacks upon them required coordination by AEAFF with other air forces. Many of these lines, situated as much as 40 to 50 miles east of the Rhine, were at this time almost beyond the reasonable limit of fighter-bomber range; however, it was hoped that even a limited number of cuts effected on them would reinforce the dislocation achieved within the inner line. In order to make the interdiction program even more complete as well as to enable its own fighter-bombers to concentrate more effectively upon the enemy's communications network in front of the central and southern groups of armies, the Ninth Air Force, on 29 September, requested AEAFF to allocate to Second TAF the task of cutting the rails on the northern extensions of both the inner and outer lines.<sup>54</sup>

The Canadian First Army opened its campaign for the clearance of the Schelde Estuary on 1 October. This operation involved the seizure of the so-called Breskens Pocket (situated between the south bank of the Schelde and the Leopold Canal), the peninsula of South Beveland, and Walcheren Island. With the aid of British troops, the Polish Armored Division, and the U.S. 104th Infantry Division, and with very effective air cooperation (especially in RAF Bomber Command's attacks on the sea walls and dikes of Walcheren Island), the Canadians,

\* See above, p. 211.

after very hard fighting, overcame all enemy resistance in this area by 8 November. It was not, however, until 28 November that the first Allied ships were at long last able to dock in the port of Antwerp,<sup>55</sup> and Montgomery had been forced to put off until some time in November a projected drive by the British Second Army toward the Ruhr. Air support for these operations was furnished almost exclusively by aircraft of Second TAF, but the medium bombers of 9th Bombardment Division flew several very successful supporting missions, notably against the bridges and causeways leading to Walcheren Island, against the Venraij road junction, and against the Arnhem bridge.<sup>56</sup> In view of its very heavy commitment to cooperation with the ground forces in the immediate battle area, Second TAF limited its October participation in the interdiction program to attacks on the IJssel River bridges.

On 2 October Hodges' First Army renewed its offensive effort in accordance with a plan to advance XIX Corps east of Deurne and north of Aachen, and thence to Linnich and Jülich. The VII Corps was to reduce Aachen and then advance to Düren. Upon completion of regrouping in its zone, V Corps was to be prepared to advance in the direction of Bonn.<sup>57</sup> Despite the very heavy resistance of enemy forces, recently reinforced,<sup>58</sup> progress was made in both sectors of the attack. On 10 October, the commander of VII Corps issued an ultimatum to the Aachen defenders to surrender; upon receiving their refusal, he ordered a very heavy artillery and air bombardment of the city, commencing on 11 October and continuing through the 13th. On 16 October, Aachen was completely surrounded. Five days later, with much of the city in complete ruins, and with bitter house-to-house fighting in the city proper, the garrison commander agreed to an unconditional surrender.

The air support for this advance had been spotty and incomplete. During the week preceding the offensive, when heavy work had been scheduled for IX TAC and 9th Bombardment Division, the weather proved most unfavorable. Medium bombers, slated to attack marshalling yards, rail and road junctions, bridges, "dragons' teeth," and other targets in the Aachen area, had all missions canceled from 24 through 26 September. Fair weather on the 29th enabled 243 mediums to strike at a number of communications targets and fortified positions, but aside from inflicting considerable damage upon the marshalling yards at Bitburg and Prüm, the results achieved elsewhere in the battle area were negligible.<sup>59</sup> Nor did the ground forces profit from medium bomber

operations on D-day. Of 363 mediums dispatched by the 9th Bombardment Division, only 60 attacked designated targets. Weather, in certain cases poor navigation, and especially faulty preliminary planning by lower ground echelons accounted for the poor showing. Inability to reach agreement between demands for saturation and pinpoint bombing resulted in a pattern of requests which dissipated the available air support over too large an area. A tragic instance of "poor navigation, poor headwork and misidentification of target" led one medium group to drop its entire load of bombs on the little Belgian town of Genck, with seventy-nine resulting casualties and heavy property destruction.<sup>60</sup> Fair weather from 6 to 8 October enabled the medium bombers to execute very successful interdiction missions, attacking ammunition dumps, marshalling yards, road and rail junctions, and bridges at Düren, Linnich, Euskirchen, Jülich, Eschweiler, and a number of other targets in the battle area. But during the remainder of the battle of Aachen their efforts contributed little, since most of their missions were either canceled, abandoned, or recalled because of bad weather at their bases, cloud cover at target, equipment failure of pathfinder aircraft, and other causes.<sup>61</sup>

The fighter-bombers of IX TAC flew approximately 6,000 sorties during the period of the Aachen campaign, the majority of them in close cooperation with the ground troops. The most common targets were pillboxes, strongpoints, artillery and troop concentrations, and defended road junctions. In general, the operations were unspectacularly effective. A few examples will suffice to illustrate the cooperation rendered. On 2 October, when elements of the 30th Infantry Division encountered stiff resistance from pillboxes in a wooded area, fighter-bombers of the 370th and 478th Groups responded to an urgent call for assistance with fire bombs which destroyed several pillboxes and set the woods afire. The ground report described the bombing as "excellent." A notable example of the help given in breaking up repeated enemy counterattacks occurred on 12 October, when the 373d Fighter Group with the aid of three squadrons drawn from other groups succeeded in breaking up a particularly strong enemy counterattack in the XIX Corps area of operations. After the German garrison refused a proposal for its surrender on 11 October, the VII Corps commander launched a three-day air and artillery attack on the city in which fighter-bombers dropped, usually in response to specific requests, over 170 tons of bombs, including many incendiaries. When the ground forces had no

## THE ARMY AIR FORCES IN WORLD WAR II

immediate targets for attack, fighter-bombers on armed reconnaissance were requested to fly over the city and unload their bombs in designated areas. The 12th Army Group attributed the capture of Aachen almost wholly to ground fighting but generously recognized air's contribution, especially in the maintenance of air superiority over the battle area, to a speedier fall of the city.<sup>62</sup>

While Aachen was being reduced and only small gains were registered in the surrounding area, fighting elsewhere in First Army's sector was confined to costly local action in the areas of the Hürtgen and Rötgen forests southeast of Aachen. Here, too, fighter-bombers rendered valuable assistance to the hard pressed infantry, as on 14 October, when elements of the 9th Infantry Division requested help in overcoming strong enemy counterattacks from the town of Udenbreth. Artillery having neutralized most of the flak defenses, the fighter-bombers had a clear run and destroyed or damaged almost every building in the town. In commending IX TAC for this action, Maj. Gen. Edward H. Brooks of V Corps described the support as "of the greatest assistance in repelling vicious German counterattacks."<sup>63</sup>

As sustained fighting on First Army's front came to another halt shortly after the capture of Aachen, IX TAC's air activity also declined. Weather canceled all operations on five of the remaining days of the month and greatly reduced their number on three other days. Of the 997 sorties flown during this period, 795 took place on 28 and 29 October, when, aside from a few attacks on supply dumps by the 474th Group and a small number of defensive patrol and several night intruder missions by the 442d Night Fighter Squadron, the major part of the effort was directed against rail lines and bridges within the inner line of interdiction west of the Rhine. The Remagen-Ahrdorf, Modrath-Nörvenich, and Bedburg-Düren rail lines were temporarily put out of commission.<sup>64</sup>

General Simpson's Ninth Army front saw no important action during October, and the recently created XXIX TAC, operating for much of the time under the supervision of IX TAC, contributed the bulk of its some 2,000 sorties to support of the First Army advance on Aachen.<sup>65</sup> On the Third Army front, where Patton had received authority to press a limited, if subsidiary, offensive designed to enlarge the bridgehead across the Moselle and to hold the maximum number of enemy forces on its front, XIX TAC saw more action.<sup>66</sup> Attacks on the fortifications of Metz continued to be generally unavailing, but after

the decision of 11 October to abandon the direct assault on these targets the fighter-bombers repeatedly proved their worth against enemy armored vehicles, troops, gun positions, command posts, and airfields. During the month a total of thirty-seven attacks were made against troop concentrations and other strikes were directed against tanks and armored vehicles. Success attended the efforts near Fort Driant on 2 October, on the 6th east of Nancy, on the 12th southwest of Château-Salins, on the 14th in the Saarbrücken area, and on the 16th near the Forêt de Parroy. On 2 October fighter-bombers of the 405th Group silenced several gun positions during the attack on Fort Driant, and on the 12th aircraft of the 406th Group successfully attacked a number of similar targets in that area at the time of the forced withdrawal of XX Corps. That same day the 378th Squadron of 362d Group destroyed four command posts southeast of Château-Salins.<sup>67</sup> On reconnaissance missions, in the protection of ground troops from enemy air attack, and especially in attacks on the enemy's supply and communications, XIX TAC fought with its accustomed effectiveness. The weather on seven days prevented operation, but the command got in 4,790 supporting sorties for the month.

One of its more notable achievements was scored on 20 October, when it had been decided to break the Étang-de-Lindre dam south of Dieuze in order to forestall such an action by the enemy for the purpose of obstructing a later advance by the Americans. P-47's of the 362d Group breached the dam with several direct hits by 1,000-pound bombs.<sup>68</sup> This, like so much else undertaken on the Third Army front in October, however, was in preparation for offensive action that could not yet be undertaken. The immediate objectives of the 6th Army Group were also limited, and for XII TAC the month was a relatively quiet one.<sup>69</sup>

Ninth Air Force directives of 5 and 8 October had greatly expanded the interdiction program and effected extensive changes in the assigned rail lines between the several commands concerned.<sup>70</sup> The inner line of interdiction was extended to cover twenty-five roads, seventeen of which lay west and eight east of the Rhine River. Roads within this area were assigned as follows: IX TAC was to concentrate on cutting seven rail lines in the region extending from Baal south through Jülich, Düren, and Nörvenich, and thence eastward to Euskirchen; aircraft of the XXIX TAC were assigned two lines south of this area in the vicinity of Daun and Mayen; fighter-bombers of XIX TAC were di-

rected to accent their effort on eight lines in front of Third Army's sector of operation, in the general area of Coblenz, Hermeskeil, Kaiserslautern, and Landau; finally, to XII TAC were allotted eight lines in the general vicinity of Graben, Pforzheim, Calw, Freiburg, and Neustadt. The outer line of interdiction comprised eighteen railroads east of the Rhine, with four lines each assigned to IX and XXIX TAC's and ten roads to XIX TAC. It was perhaps a token of the declining hope for an early Allied breakthrough that the prohibition of air attack on railroad bridges was lifted at the beginning of October. On 7 October all bridges west of the Rhine from Grevenbroich in the north through Euskirchen, Ahrweiler, Mayen, Simmern, Kaiserslautern, and Nonnweiler in the south were declared subject for destruction. Ten days later rail and road bridges across the Rhine were added to the program.<sup>71</sup> On 19 October, as a halt in the advances on all fronts approached, the four TAC's received instructions giving interdiction a priority over all other commitments. The medium bombers of 9th Bombardment Division since the beginning of the month had been under orders to concentrate upon attacks on bridges.<sup>72</sup>

In line with these directives the medium bombers and fighter-bombers devoted much time and effort to attacks on the enemy's transportation system.<sup>73</sup> Rail-cutting missions of IX TAC were concentrated upon the inner system of interdiction on fifteen days during October, and operations on eight days were devoted largely to the outer system. As a rule the missions were carried out in group strength. A total of 217 rail cuts were claimed. A number of very successful attacks on bridges were executed on 11 to 14 and 28 and 29 October in the areas of Cologne, Remagen-Dumpelfeld, Nörvenich-Modrath, Ahrdorf, and Euskirchen. Interdiction operations of the XXIX TAC were also largely confined to First Army's sector of the front. Notably successful rail-cutting missions were flown on 13 and 14 October with temporary interruption of all traffic on several lines in the vicinity of Cologne-Düren. Several successful cuts were also achieved east of the Rhine on the Soest-Lippstadt and Stauffenburg-Colbe lines. A substantial number of bridges had also been attacked; however, only three were claimed destroyed. Most of the 315 rail cuts claimed by aircraft of XIX TAC were made on the railways in the general vicinity of Trier and Coblenz in the north, Kaiserslautern and Landau in the east, and Pirmasens, Saarbrücken, and Strasbourg in the south. Rail and road bridges also were frequently attacked. However, their location over the numer-

## CHECK AT THE RHINE

ous water barriers or in the deep defiles of the Saar, Rhine, and other rivers made attacks on them difficult, since often they were hidden by mist or covered by cloud. The thirty-three bridges attacked during the month resulted in pilot claims of seventeen destroyed. One of the most successful attacks appears to have been that on a bridge at Hermeskeil, executed on 13 October. Aircraft of the XII TAC claimed to have effected 116 cuts on the enemy's rails west and east of the Rhine. Rail bridges and marshalling yards were the chief communications targets of the medium bombers, a total of 721 attacking the former and 140 the latter. In addition to successful bridge attacks in Holland, the mediums struck at a large number of similar targets in First Army's sector, but nowhere with conspicuous success. The attacks on bridges at Bad Münster and Dillingen in Third Army's zone resulted in destruction of the latter and the leaving of the former temporarily impassable. The 237.5 tons of bombs unloaded by the mediums on marshalling yards scored no outstanding success, except at Düren and Jülich.

Fighter-bombers also struck at marshalling yards on virtually every day that they were able to fly and they also kept watch for targets along the highways. The IX and XIX TAC's, which together accounted for the major portion of the month's sorties, claimed the destruction of 393 military transport, 316 armored vehicles and tanks, 493 locomotives, and 1,755 railway cars. But despite these substantial claims, effective isolation of a given battle area was nowhere achieved. That this was the case was attributable to the enemy's extraordinary ability to effect rapid repairs on damaged lines, yards, and bridges; the exceedingly dense network of rails which enabled the use of alternate routes; and the inability of the fighter-bombers, because of the weather, to maintain the continuous policing action which a successful interdiction program required. That the enemy was able to escape the full penalty without the benefit of air coverage is suggestive of the other advantages he enjoyed.

Much of the reconnaissance effort was spent in endeavors to locate weak spots in the enemy's line of fortification. To this end, the photo reconnaissance squadrons, especially of the IX and XIX Commands, mapped the entire Siegfried and Maginot lines and defensive positions which the enemy had constructed along the Moselle, Saar, Rhine, and other rivers. Medium bombers and fighter-bombers attacked stores and fuel dumps, gun positions, barracks and headquarters, fortified villages, and river and canal shipping. The fighter-bombers also flew escort for

the heavy bombers and carried out extensive leaflet- and Window-dropping sorties. Even so, the total number of sorties flown by Ninth Air Force aircraft in October—21,120—showed a marked decrease from September's 25,843. Encounters with enemy aircraft took place on relatively few days, despite the fact that the enemy was steadily increasing his front-line strength of fighters. The month's claims of German aircraft destroyed amounted to 172, while the Ninth's own losses were 177—a loss accounted for almost entirely by the opponent's exceedingly concentrated antiaircraft defenses.<sup>74</sup>

### *Exit AEF*

The month of October, which had brought a not altogether unwelcome opportunity for many air organizations to catch up on problems of administration and maintenance after the summer's breathless pace,\* brought also a change in the Allied air command. AAF leaders had never been fully reconciled to Leigh-Mallory's AEF. Viewing it from the first as a potentially British-dominated headquarters, they had helped in some measure to make it just that by their own disinclination to contribute to its strength and influence.† The actual authority it exercised over tactical operations had been considerably less than was originally anticipated, and yet its place in the command structure gave it real power. Considerations of space forbid any attempt at detailed analysis of the varied factors, including the personality of Leigh-Mallory himself, which might serve to explain the unhappy history of AEF. Suffice it to say that the problem merits a closer study than can be given it here as possibly the least successful venture of the entire war with a combined Anglo-American command.

Proposals for the deactivation of AEF had been prompted late in the summer by plans for discontinuing Montgomery's responsibility for the coordination of ground operations. With Montgomery, Bradley, and Devers answering directly to Eisenhower for the operations of their several army groups, American air officers considered it appropriate that their own forces similarly should be placed in a "separate pocket" and be made free of responsibility to any command below that of the supreme commander himself. It was suggested that Spaatz, who already through USSTAF possessed administrative control, might also assume operational direction of all U.S. air forces in northern

\* See above, pp. 553 ff.

† See especially Vol. II, 735-40; also above, pp. 5-6, 80-83, 108-10.



Europe as the senior American air officer. Since each of the army groups, which followed national lines in their organization, already was being supported by its own national tactical air force, it was agreed that coordination of effort between RAF and AAF forces properly belonged at the level of SHAEF. There thus would be achieved a desirable parallel in air and ground organization.<sup>76</sup>

RAF members of AEF's staff took an opposing view, and in this received the support of Tedder. The British counterproposal was to create a new Allied air command that would be responsible to a small air staff at SHAEF—in effect, to continue AEF under another designation, perhaps with some thought of the opportunity in the reshuffling for a change of commanders that might remove the irritations of past controversy. But Spaatz and Vandenberg continued firm in their opposition. The former, while conferring in late August with Eaker at MAAF headquarters, urged on Arnold, with Eaker's concurrence, the argument that the operations of the U.S. Ninth Air Force and the British Second TAF required no more coordination than did the operations of Bradley's 12th Army Group and Montgomery's 21 Army Group. In either case, the proper level for coordination was at SHAEF. Spaatz urged also that Arnold should give due weight to the distaste of "American Air Force personnel" for service "under British Command."<sup>76</sup> Vandenberg, with Quesada and Weyland concurring, detailed for Spaatz the reasons for his own opposition. Additional headquarters imposed an unnecessary load on already overtaxed communications facilities and on resources available for staff work. Actual coordination of tactical operations to date had been accomplished along "lateral" lines and consisted of agreements as to boundaries and invitations occasionally "to participate in a good house party." There was no problem that Tedder could not take care of as needed.<sup>77</sup>

In Tedder's mind, however, the question involved consideration of a desirable unity and flexibility of control in the direction of air operations. To Spaatz he argued the need for some coordinating agency that would be located far enough forward to be in close contact with army group commanders. Should the agency created be merely an outpost of SHAEF, its authority with group commanders would be gravely affected and so lead to frequent requests for air support direct to the supreme commander. On 28 August he asked of Spaatz, therefore, agreement on the organization "we agreed upon in our previous discussions."<sup>78</sup> It is not clear what that agreement may have been, but it is

clear enough that U.S. officers at AEAF took Tedder's views as an indication of the ideas that in large measure would prevail in whatever reorganization might take place. Accordingly, during the closing days of August they set down their own ideas of how best to assure American control of whatever organization might be established at SHAEF. They envisioned a staff patterned after the air staff in Washington, except that it would be operational instead of administrative. Its chief *must* be an American with the rank of lieutenant general. The chief of operations *must* be an American with the rank of major general. Signals and plans *should* be headed by U.S. officers with the rank of brigadier general. The chief of intelligence *might* be a Britisher with the rank of air commodore, but the camp commandant *must* be an American in the rank of colonel.<sup>79</sup>

This hope for a major revolution was destined to disappointment. Arnold threw his support, as he explained to Spaatz in a letter of 19 September, to the idea of a small AAF-RAF staff at SHAEF in accordance with a suggestion he had already made to Eisenhower,<sup>80</sup> and Spaatz seems to have had actually a greater concern for the decisions which that same month terminated SHAEF's control over the strategic bombers. When AEAF was disbanded on 15 October 1944, its place was taken by Air Staff, SHAEF. Air Chief Marshal Leigh-Mallory, re-assigned to the CBI, lost his life soon after in an air accident on the way to his new post. At SHAEF, Air Marshal James M. Robb headed the new air staff, which was both large and largely composed of RAF officers. Brig. Gen. David M. Schlatter, as deputy chief, proved to be an able and helpful representative of American opinion,<sup>81</sup> but the history of Air Staff, SHAEF speaks chiefly, like that of AEAF before it, of a failure to achieve an effective subordination of national interest to the requirements of combined warfare. Fortunately, this failure was the exception rather than the rule. Fortunately, too, the gift that Eisenhower, Tedder, Spaatz, Coningham, and Vandenberg so frequently displayed for effective cooperation without reference to the legalities inherent in a defective command structure left lesser men to do the squabbling. That this squabbling imposed an unnecessary burden upon the Allied air effort seems beyond dispute, but that effective cooperation, though at substantial cost, was achieved is also indisputable.

### *Operations MADISON and QUEEN*

By mid-October it had become apparent that the badly battered and sadly depleted forces of Montgomery's 21 Army Group were in no

position to undertake an effective drive toward the Rhine. On the 16th of that month, in fact, he decided to concentrate his resources on clearing the Schelde Estuary, and Eisenhower faced a necessity to revamp his plans accordingly. A conference with Montgomery and Bradley on 18 October resulted in a decision which limited the responsibilities of 21 Army Group, after the opening of Antwerp, to a drive by the British Second Army southeastward (between the Rhine and the Meuse) to the line of Venraij-Goch-Reis, with 10 November as a possible D-day. Simpson's Ninth Army, having been shifted to the First Army's left flank, would cover the First in a push to the Rhine and then cooperate in the encirclement or capture of the Ruhr. Third Army, "when logistics permit," would advance in a northeasterly direction on the right flank of First Army. A directive from Bradley on 21 October set a target date for commencement of operations by Hodges and Simpson at 5 November and by Patton at 10 November. Devers' two armies, protecting Bradley's right flank, would breach the Siegfried Line west of the Rhine and secure crossings over the river.<sup>82</sup> The plan in general looked toward destruction of the enemy's forces west of the Rhine, together with seizure of every opportunity to get across the river and into the heart of Germany should the hope for an early destruction of enemy forces fail of achievement. The effort would depend largely on American forces.

Ninth Air Force followed with a series of orders on 21 and 23 October calling for reallocation of interdiction assignments among its fighter and medium bomber forces. XII TAC was relieved of its rail-cutting commitments and directed to concentrate upon destruction of the Rhine River bridges between Speyer and Basle and on attacks upon a number of designated airfields. The railways currently marked for cutting within the inner line of interdiction were redistributed between IX, XIX, and XXIX Commands; 9th Bombardment Division was to confine its major efforts to attacks on the Moselle River bridges and those west of the Rhine between Euskirchen in the north and the Moselle River in the south. Since Second TAF was currently restricting its efforts to attacks on the Ijssel River bridges, IX and XXIX TAC's were directed to accent their attacks upon rail bridges, fills, and viaducts in the areas of the Ninth and First Armies' intended drives, more specifically west of the Rhine between Cologne and Düsseldorf.<sup>83</sup> To lend assistance to the tactical air forces, whose activities in the front areas would undoubtedly be seriously impeded by rain and snow, a number of conferences were held at SHAEF and Air Ministry during

the latter half of October to discuss the possibilities for assistance from the heavy bombers, especially with reference to suggestions for sealing off the enemy's forces west of the Rhine by destruction of its major bridges.\*

Montgomery's forces, having completed their mopping-up operations in the Schelde and Maas estuaries by mid-November, succeeded in eliminating the last German-held position west of the Maas River on 3 December. In the Geilenkirchen area, 30 Corps assisted troops of Ninth Army in the capture of that city on 19 November, but no further combat of consequence took place on the British front until the Battle of the Bulge.

A protracted siege of unfavorable weather in the Aachen region resulted in a decision to strike the first major blow (Operation MADISON) of the new offensive on 8 November by Patton's forces against the southern and northern flanks of the Metz salient. To the south of Metz, XII Corps was to launch an attack on D-day from the vicinity of Pont-à-Mousson, by-pass the most formidable forts, advance rapidly northeastward to the Rhine, and establish a bridgehead in the Darmstadt area. Elements of XX Corps were to contain the tip of the enemy salient west of the Moselle, while its major forces were to cross that river on 9 November in the Thionville vicinity, take the city of Metz by encirclement and infiltration, and gradually reduce the forts. Subsequently this corps was to advance to the Saar and Rhine rivers in the direction of Mainz and Frankfurt. To assist the advance of the two-pronged attack, but especially to facilitate the by-passing of the formidable Metz-Thionville defenses, heavy bombers of the Eighth Air Force, the mediums of the 9th Bombardment Division, and fighter-bombers of XIX TAC were to execute large-scale attacks on 8 and 9 November.

Preparatory to the launching of the ground offensive, fighter-bombers during 1 to 7 November flew approximately 1,000 sorties, successfully attacking ordnance and supply dumps at Haguenau and Saargemünd (Sarreguemines). A series of bombing and strafing attacks on a number of airfields, including those at Gotha, Schwabisch Hall, and Sachsenheim, resulted in claims for the destruction of thirty-one enemy aircraft. On 3 and 4 November weather limited operations to 131 escort sorties for medium bomber attacks on rail bridges at Konz-Karthaus and Morscheid and on the Kaiserslautern overpass, attacks which in-

\* See below, pp. 649-53.

**OPERATION MADISON**  
**3rd Army Advance: 8 Nov-15 Dec.**

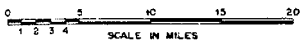
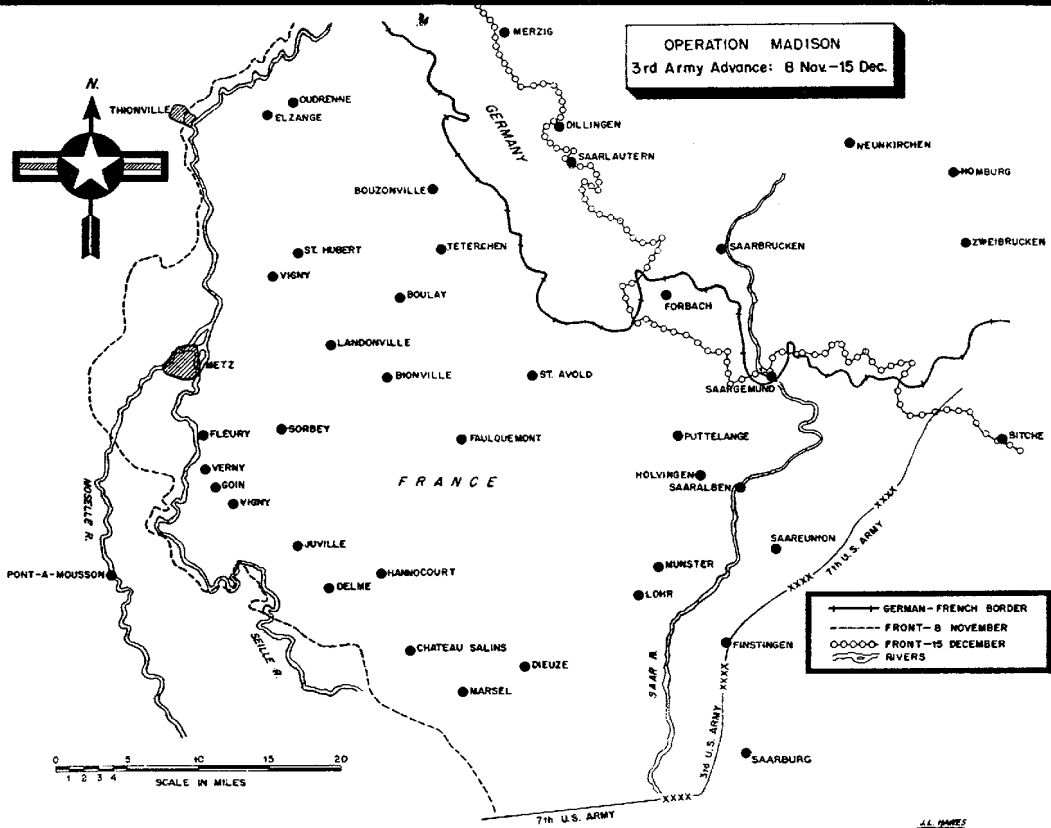
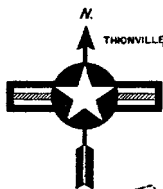

——— GERMAN-FRENCH BORDER  
 - - - - FRONT - 8 NOVEMBER  
 ○○○○ FRONT - 15 DECEMBER  
 ~~~~~ RIVERS

flicted little damage. Three forces of heavy bombers, dispatched on 5 November to attack the Metz-Thionville fortifications, found all primary targets cloud-covered and went on to attack secondary targets deep in Germany. Weather during this seven-day preparatory period was generally poor, preventing all fighter-bomber operations on 2, 6, and 7 November and limiting air operations to a few reconnaissance missions.<sup>84</sup>

Preceded by a tremendous artillery barrage, the offensive of XII Corps was successfully launched on 8 November. In support of this attack, fighter-bombers flew 471 sorties, attacking command posts, gun positions, troop concentrations in woods, bridges, road and rail traffic, and airdromes in the enemy's rear as far east as Wiesbaden, Sachsenheim, and Darmstadt. Tonnage dropped included thirty-five tons of GP, eighty-one tons of fragmentation bombs, and thirty-one tanks of napalm. The day's claims included nine motor transport, three tanks, fourteen gun positions, four command posts, twenty-two locomotives, one bridge, and numerous buildings and rail cars. The incendiary bombs dropped on foxholes and trenches achieved good results. Enemy air opposition was feeble, but the weather, which during the course of the morning grew progressively worse, resulted in the recalling or cancellation of all medium bomber operations and drastically reduced the number of fighter-bomber sorties planned for the afternoon.

To assist the XX Corps advance, heavy, medium, and fighter-bombers were to carry out widespread attacks on 9 November (with the objective of killing or stunning enemy troops in exposed or semiexposed positions in the zone of the infantry attack), to destroy a number of forts or to interdict their fire, and to attack a large number of other targets which would facilitate the advance. More specifically, the heavies were to attack seven forts south and southeast of Metz and a number of other targets at Thionville, Saarbrücken, and Saarlautern. The mediums received the assignment to strike at four forts in the Metz vicinity and a number of defense installations, supply dumps, and troop concentrations in wooded areas near by. Fighter-bombers were to carry out prearranged low-altitude missions against nine enemy headquarters and command posts and maintain armed reconnaissance within the main area of the ground attack. Fighters of the Eighth were to bomb and strafe a number of airfields east of the Rhine. There was to be no withdrawal of troops from their existing positions. In order to avoid "shorts," General Patton insisted that all bombing must be at least four

## CHECK AT THE RHINE

miles from the nearest friendly troops. Extensive safety measures were set up to guide the bombers.

The air operations took place as scheduled. Preceded by a chaff-dropping force of 10 bombers, 1,120 heavies out of a total of 1,295 dispatched attacked primary and secondary targets in the battle zone. The first force of heavy bombers, sent to the Thionville area, found visual bombing impossible. As a result, only 37 of them dropped 104 tons of bombs in the assigned tactical area while 308 dropped 964 tons by H2X on their secondary target, the marshalling yard at Saarbrücken. The primary targets of the second and third forces were in the vicinity of Metz. Here a total of 689 bombers succeeded in dropping 2,386 tons on targets in the tactical area, and 86 unloaded their 366 tons on various targets of opportunity. Bombing was both visual and by Gee-H. In addition to the 576 escorting fighters, 30 fighters operated as weather scouts and 208 engaged in bombing and strafing of airfields and other ground targets. Enemy aircraft encounters were negligible. Only 5 bombers, 1 fighter, and 2 fighter-bombers were lost, either to flak or to causes unknown. A total of 443 medium bombers were dispatched by the 9th Bombardment Division, but cloud conditions enabled only 111 to attack. They dropped 158 tons of bombs on road junctions and barracks at Dieuze, the artillery camp and ordnance arsenal at Landau, the storage depot at St. Wendel, and other targets. Success was achieved only at Dieuze, where heavy damage was done to buildings.

Bombing accuracy was low in both the Thionville and Metz areas, only a few of the forts having sustained any real damage. However, the intensity of the air attacks effected excellent results. The density of the defenses was such that bombs dropped anywhere within the tactical area were bound, inevitably, to hit some vital installation, whether it be a strongpoint, open gun position, road or rail junction, barbed-wire entanglement, or wire communications. The generally confused and dazed condition of the enemy troops in the attacked area helped the ground forces to effect two crossings over the Moselle on D-day and to capture a number of villages. Fighter-bombers, flying 312 sorties in cooperation with the ground force of the two corps, bombed enemy troops, tanks, flak positions, towns and defended villages, marshalling yards, and other targets. The targets attacked received a load of 61 tons of GP and 145 tons of fragmentation bombs and 34 tanks of napalm, the latter starting large fires at Bezange and Manderen. Destruction of

many armored vehicles, much motor transport, and numerous gun positions was claimed.

After 9 November the ground offensive continued to make good progress on both prongs of the attack, in spite of soggy ground, atrocious weather which greatly reduced air cooperation, and fierce enemy resistance. By 15 November the battle had moved slowly eastward along a sixty-mile front. Metz was formally encircled and by-passed on the 19th of the month. By the end of November resistance had ended in all but four of the forts. The Siegfried Line had been reached between Nenning and Saarlautern and the Saar River in the vicinity of Hillbringen. During the first two weeks of December, Third Army continued its advances despite very heavy resistance. By 15 December it had seized almost the entire Saar region, including the capture of most of its larger cities, and in several places had crossed the German frontier.

Fighter-bomber cooperation during the period of 10 November to 15 December was frequently limited by the weather. Twelve days of this period were totally nonoperational, sixteen partially so. On only eight days did the number of sorties flown exceed 200 per day. The most successful days were 17, 18, and 19 November, with 317, 347, and 403 sorties, respectively. Attacks on these days were concentrated almost entirely against the enemy's rail and road transportation systems, tactical reconnaissance having reported intense activity on the lines leading to Third Army's front and into the Schnee Eifel. A tremendous harvest of enemy transport was reaped, the three days' claims amounting to 842 motor transport, 60 armed-force vehicles, 162 locomotives, 1,096 railway cars, and 113 gun positions destroyed or damaged. Clear skies on 2 and 12 December, when a combined total of 537 sorties were flown, also accounted for the destruction of a large amount of rolling stock, especially in the vicinity of Zweibrücken. Medium bombers occasionally staged successful attacks in connection with Third Army's operations during the period under consideration. Their attacks on 19 November against strongpoints at Merzig in the Metz area were successful enough to elicit commendation from General Patton. On 1 and 2 December, 360 mediums engaged in special operations against the Siegfried Line defenses in the Fraulautern, Enseldorf, Saarlautern, and Hülzweiler areas, where 5th, 90th, and 96th Infantry Divisions were trying to breach the line. The attacks on 1 December were not particularly successful, but on the next day most of the dropping of



bombs on railroads, roads, buildings, and other assigned targets was highly accurate. The defenders were so dazed and disorganized that when the attacking troops entered the bombed areas, they encountered very little opposition.<sup>85</sup>

During the forty-five day period extending from 1 November to 15 December, the fighter-bombers of XIX TAC flew 5,195 sorties, night fighters 99, and reconnaissance aircraft 563 within the zone of Third Army's operations. Approximately half of the 5,133 sorties flown by the mediums of the 9th Bombardment Division during that same period were also executed on this sector of the Allied front. The U.S. Army's official history of the Lorraine campaign has paid generous tribute to air's cooperation, selecting for special comment the effective partnership of Patton and Weyland, the interdiction of enemy movements during October, the assistance provided at the inauguration of the November offensive, and the tactical mobility which Third Army continued to enjoy because of the general air supremacy maintained by the Allied air forces.<sup>86</sup>

On Patton's right flank, Seventh Army, having opened its attack on 5 November with initial thrusts in the Forêt de Parroy and in the direction of the Meurthe River, began to roll on 13 November. Two days later the Americans broke through enemy defenses south of Blâmont and then drove forward behind the French 2d Armored Division to seize the Saverne Gap and Strasbourg on the 23d. Four days later the Alsatian plain was reached, and by 15 December the German border was crossed on a twenty-two-mile front between Wissembourg and Lauterbourg.<sup>87</sup> The French First Army began its main offensive, on the right of Seventh Army, on 15 November. Advancing in extremely difficult terrain and against very powerful defenses, the French forced their way through the Belfort Gap on the 20th and two days later occupied Mulhouse. During the next ten days they forced a withdrawal of the Germans from Strasbourg and at Ribeauville, and in mid-December they were engaged in attempts to press the Germans back across the Rhine from the so-called Colmar Pocket. Air support for these operations was furnished principally by fighter-bombers of the First Tactical Air Force, its medium bombers being grounded much of the time by unfavorable weather. A total of 6,445 sorties were directed chiefly against the enemy's transportation leading to the battle area. Although these operations resulted in substantial claims, the ground offensive derived only limited assistance from the air. Medium bombers of the 9th

# SIXTH ARMY GROUP OPERATIONS 5 NOV - 16 DEC 1944

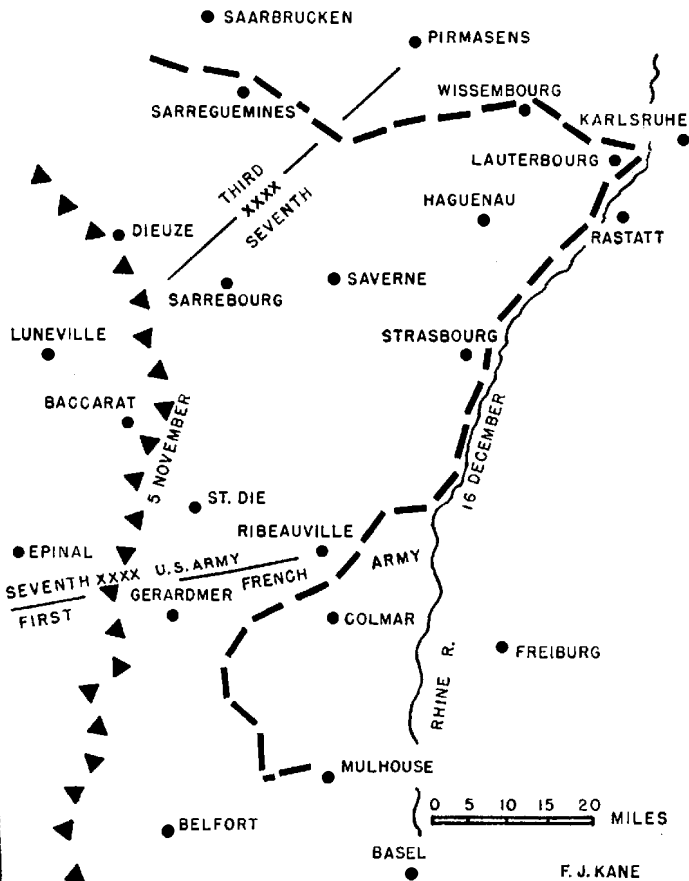

F. J. KANE

Bombardment Division were on several occasions dispatched to this front in attacks on storage areas, ordnance depots, ammunition dumps, and one bridge, but generally with indifferent results.<sup>88</sup>

To VII Corps of the U.S. First Army had fallen the responsibility for conducting the major Allied offensive (Operation QUEEN) in the direction of Eschweiler-Düren-Cologne, with V Corps on its right flank prepared to advance on Bonn as soon as VII had succeeded in penetrating the enemy's main defenses. In Ninth Army's zone, a thrust was to be staged by XIX Corps in close conjunction with that of VII Corps. The target date, after repeated postponement, was finally set for 16 November.

To meet practically every possible variation in weather, three different air plans had been worked out, but happily the weather permitted operations to follow the first choice. Three divisions of the Eighth's heavy bombers were assigned to attack the Langerwehe and Eschweiler areas. Since these areas were located in the immediate line of advance of the ground forces, fragmentation bombs were to be used to secure maximum effect on personnel and field installations with minimum cratering. The attack was to take place between 1115 and 1230 hours on D-day. Jump-off for the ground forces was to be 15 minutes after cessation of the bombing. RAF Bomber Command would also attack in the general area of Jülich, Düren, and several towns in their vicinity. Here the aim was complete destruction of buildings and every strongpoint, with blocking of all roads and intersections. Eleven groups of Ninth Air Force medium bombers were assigned the areas of Aldenhoven and Linnich (where complete destruction of the towns was to be the objective) and the towns of Luchem, Echtz, and Mariaweiler (where the purpose sought was the same as in the areas assigned to the Eighth Air Force). Three groups of IX TAC's fighter-bombers were to furnish cooperation to VII Corps, while three additional groups were to bomb supply and ammunition centers, observation posts, gun positions, and numerous other targets in front of the advancing troops. Four groups of XXIX TAC were to attack towns and villages, road junctions, and other targets, to provide armed column cover, and to carry out armed reconnaissance in Ninth Army sector. In order to secure greater accuracy of bombing, and especially to prevent a repetition of the tragedy at St.-Lô, an exceedingly elaborate marking plan was adopted.<sup>89</sup>

Operation QUEEN, the largest air-ground cooperative effort yet

undertaken by the Allied air forces, took place as scheduled. A total of 1,191 Eighth Air Force heavy bombers reached their target areas between 1113 and 1248 and dropped 4,120 tons of fragmentation bombs on Eschweiler, Langerwehe, Weisweiler, Dürwiss, and Hehlrath. Escort was furnished by 482 fighters of the same force. RAF Bomber Command's 1,188 heavies, escorted by 275 RAF fighters, unloaded 5,640 tons of bombs on Düren, Jülich, and Heinsberg. Eighty Ninth Air Force mediums, escorted by fighters of the Eighth Air Force, attacked four assigned targets with a total of 150 tons of bombs. Fog at most of the bases of IX and XXIX TAC's permitted their craft to fly only some 350 sorties, in which 187 tons were dumped on several of the assigned areas and on targets requested by ground control. These air operations achieved complete surprise, only one enemy aircraft having been sighted throughout the day. Antiaircraft fire was meager and generally ineffective: only 10 planes of the attacking 2,809 were lost and comparatively few sustained battle damage.<sup>90</sup> Weather at many heavy bomber and fighter bases in the United Kingdom, and at almost all medium and fighter-bomber bases on the continent, prevented take-off of some 300 heavies, more than 500 mediums, and a much larger number of fighters and fighter-bombers.

The accuracy of the bombing operations in the entire battle zone did not measure up to expectations because clouds, haze, smoke, and snow in some of the areas obscured a great many of the targets. Effectiveness of bombing operations was further reduced by the reluctance of the air forces to bomb "short"; as a consequence, the defenses directly in front of the ground troops were not sufficiently softened. Moreover, withdrawal of the troops for their protection at points delayed their advance until the psychological effects of the bombing carpet had been lost. Nevertheless, the destruction wrought by the 10,000 tons of bombs dropped over a relatively small area was enormous. Jülich was almost completely destroyed. In Düren and Eschweiler the results were similar. Several fortified villages were virtually obliterated.<sup>91</sup> Enemy casualties from bombing appear to have been relatively light, since the number of prepared shelters was so large that protection for troops caught in the open was within fairly easy reach. Strafing by the escorting fighters, according to enemy statements, was ineffective, because the strafing planes did not attack the enemy's MLR directly but went too far beyond the front line.<sup>92</sup>

Four divisions of VII Corps launched an attack at 1245 hours, against

relatively light resistance at first. Several hours later, the advance having been slowed by extensive mine fields, the enemy's resistance stiffened noticeably. Altogether, an advance of about a mile was registered on the VII Corps front during the afternoon. The V and VIII Corps did not attempt to advance on the 16th. In Ninth Army's sector the deepest progress for the day was up to 3,000 yards. On 17 November the weather was not favorable for air operations. Only 129 sorties were flown by IX TAC against Hürtgen with good results and four other defended localities. Only 78 planes of the XXIX TAC were able to take off in support of troops on Ninth Army's sector. Ground fighting was restricted chiefly to repelling counterattacks, and such advances as were made were measured in yards. On the 18th and 19th, clear weather prevailed until early afternoon and enabled 293 mediums of 9th Bombardment Division to attack a number of villages on the VII Corps front with good results, while 1,737 fighter-bombers of the two tactical air commands furnished almost continuous air-ground cooperation. Primary targets were troop concentrations, gun positions, and fortified villages. Ground operations were limited to small advances toward Eschweiler, consolidation of positions gained, and the warding off of counterattacks elsewhere on the front.<sup>93</sup>

During the next eleven days, the ground forces made slight progress along the Eschweiler-Düren road. By 30 November, which marked the end of Operation QUEEN, a dozen villages had been captured and the VII Corps front had been pushed forward from four to ten miles. Elsewhere on First Army's front no important changes had taken place. In Ninth Army's zone small gains were made in the vicinity of Würselen, Bourheim, and Aldenhoven. With the exception of 22 and 24 November, when foul weather precluded all air operations, medium and fighter-bombers rendered every assistance possible, flying a total of 4,230 sorties and unloading 3,251 tons of bombs on the usual types of targets. The first two weeks of December saw the advance toward Cologne slowly pushed to the Roer River, from Linnich in the north to the outskirts of Düren in the south. The main fighting during these dreary days, however, took place in the difficult Hürtgen Forest area. Fairly strong thrusts made here and farther north toward the Roer River dams on 13 December had made little progress when the Germans started their counteroffensive three days later. With the exception of 7 December, when weather precluded all flying, the IX and XXIX TAC's rendered their usual support to the troops on the ground, with

over 5,000 sorties flown and nearly 2,500 tons of bombs dropped on the enemy within the battle area. The forty-five-day struggle on First and Ninth Armies' front had inflicted heavy attrition upon the enemy's manpower but had not succeeded in wresting much space from him or in breaching more than the outer crust of his virtually impregnable defenses in this area. The Allied hope of destroying the German armies west of the Rhine had once again failed of realization, despite very heavy expenditure of men and materiel.

The two tactical air commands and the 9th Bombardment Division had flown approximately 16,200 sorties during this period, dropping nearly 11,000 tons of GP and fragmentation bombs, hundreds of tanks of napalm, and about 300 tons of leaflet bombs. These aerial operations for the most part were unspectacular but they made a number of important contributions to whatever success the ground forces achieved. In the first place, they supplemented the weight of fire which artillery was able to bring to bear upon the innumerable strongpoints which blocked every avenue of advance. Second, armed reconnaissance and rail- and road-cutting efforts impeded the enemy's movement of troops and supplies into the immediate battle area. Third, air operations had helped to break up numerous enemy counterattacks. Finally, the complete domination of the battle area by Allied air forces assured tactical mobility for U.S. ground forces. The scale of enemy air effort against U.S. ground forces was negligible; on very rare occasions was the Luftwaffe bold enough to resort to ground strafing with mortar, cannon, or machine-gun fire. Aerial combats were even fewer, a total of 106 aircraft having been lost, almost entirely to anti-aircraft fire. Claims of enemy aircraft destroyed were 147 in November and 10 for the first half of December.

The preoccupation of the tactical air commands with air-ground cooperation and the frequently nonoperational weather greatly reduced the number of attacks upon the enemy's communication system during November and the first half of December. Prior to the launching of QUEEN, fighter-bombers had concentrated upon rail-cutting and the destruction of bridges in the Jülich, Aachen-Cologne, and Euskirchen areas. The outer line of interdiction also received some attention, but operation reports show relatively small claims for cuts effected or bridges destroyed. Upon completion of QUEEN, the fighter-bombers resumed their attacks upon rails, roads, bridges, and other types of targets associated with static fighting on the ground. The brunt of their

effort, however, was devoted to destruction of defended towns and villages, among which the names of Langerwehe, Hürtgen, Kleinau, Pier, Gey, Heinsberg, Grevenbroich, Elsdorf, Euskirchen, Schmidt, Wengerohr, Schophoven, and a host of others, appear with monotonous regularity. Reconnaissance missions—tactical, photographic, night photo, and weather—were flown whenever weather permitted.<sup>94</sup> The medium bombers, when not engaged in efforts of air-ground support, had to some extent taken up the slack in the Allied attack on enemy communications,<sup>95</sup> and the strategic air forces in November had given the German railway system a priority second only to oil.\* But this program, continued into December, covered the very weeks in which the enemy built up his forces for a major counterattack on 16 December in the Ardennes.

That attack caught the Allied command in the midst of preparations for one more all-out effort to force an early decision. With the port of Antwerp now open, the 21 Army Group, reinforced by the U.S. Ninth Army, would stage the main attack against the Ruhr. In the south, the Third and Seventh Armies would break through the Siegfried Line. Air support for these ground operations would be provided on a scale hitherto unknown by an unprecedented commitment of the strategic as well as the tactical air forces. But of these plans there will be more in succeeding chapters.

\* See below, p. 653.

## CHAPTER 18

\* \* \* \* \*

### *AUTUMN ASSAULT ON GERMANY*

IF THE period extending from early September 1944 to the end of that year had brought disappointment not untouched by tragedy to the cause of the western Allies, these months also witnessed notable progress. The valuable port of Antwerp fell into Allied hands and Aachen, in the Reich itself, was taken. Hitler's seizure of the initiative as he sent his forces plunging through the Ardennes in December brought dismay to the Allied world and set back the timetable for projected operations by at least six weeks,<sup>1</sup> but this desperate gamble would end with the Allies having managed to drain the reserves of genuine vitality from what remained of Hitler's western forces. And finally, the strategic air forces during the last quarter of 1944 achieved their long-sought objective of undermining the sources of Germany's war power. In the grim aftermath of the Battle of the Bulge not even the air commanders themselves realized how much they had accomplished, but it soon would be apparent that their strategic offensives had been much more successful than in January 1945 they seemed to have been. The bottom was about to drop out of Germany's war effort.

That air commanders, at the very moment of their triumph, shared the general disillusionment is easily explained, for in common with other Allied leaders they had known high hopes for a victory in 1944. During the summer rush across France, the Allies had dared to hope that Germany might dissolve as a fighting power by the beginning of autumn. When that expectation failed to materialize, they tried to get their armies across the lower Rhine in late September. That operation failing, they undertook to defeat the German armies west of the Rhine and to penetrate the Ruhr basin. Plans were then drafted to secure Ger-



many's surrender in advance of January 1945 by joining renewed pressure on the ground with unprecedented air attacks, and when that prospect faded, the Allied command early in December made ready for a push to the Rhine only to have Hitler steal the initiative in the Ardennes. Air force leaders do not seem to have been among those who recorded prophesies that later appeared too sanguine,<sup>2</sup> but they undoubtedly had shared the general optimism of late summer.

As the effort to cross the Rhine in September ended in a failure that meant the loss of any real chance to end the war before the Germans rallied from their disasters of the summer, AAF opinion in general held that the gamble had been worth while. The failure of the MARKET operation was attributed to excessive optimism regarding German weakness and to a lack of balance in the ground forces which tried to rescue and bolster the stranded airborne units.<sup>3</sup> Arnold, late in September, frankly confided to Spaatz his disappointment that the ground campaigns in western Europe had not gone ahead more rapidly. Spaatz replied with an explanation that becomes all the more significant because of postwar controversies over the strategy pursued.<sup>4</sup> Of that strategy Spaatz had no general criticism. He thought that the armies had been too slow in forcing their way out of the Normandy bridgehead, and the heartening advance across France later in the summer he attributed mainly to Patton's aggressive tactics. Patton had been stopped, however, not by the enemy or because of misdirection on the part of SHAEF but simply because his lines of supply could not support further advances. Strenuous efforts by B-24's to remedy the supply emergency had been only moderately successful because of a shortage of necessary airfields, but this drain on the strategic air effort Spaatz regarded as entirely justified, even if some of his subordinates begrudged it.<sup>5</sup> The French railway system had been too badly shattered by Allied bombing to be of much assistance,\* and Cherbourg was the only major western port of entry that could be used at the time. Thus it was apparent to Spaatz, as it was to Doolittle,<sup>6</sup> that the ground forces had no choice but to halt in order to consolidate their logistical position. Now, in early October, Spaatz felt that another massive breakthrough might yet bring the Allies to the Rhine within a short time. "If that proves sticky as a barrier," he concluded with a note of caution that proved to be only too soundly based, "it may still be possible to beat up the insides of Germany enough by air action to cause her to collapse

\* For Spaatz's prediction of this result in the preceding spring, see above, p. 78.

next spring, particularly if the Russians continue pressure against the eastern area.”

*Proposals for Special Air Action*

In General Spaatz's mind, “beating up the insides of Germany” meant no more than the intensification of a well-conceived program of strategic bombardment, but there was no shortage of proposals from other sources for special employment of the overwhelming air power at the disposal of the Allied command. Some of the proposals were British in origin and some were American, and some of them tended to become an issue between the AAF and the RAF. Especially was this true of proposals to bomb Germany so terrifyingly that it would sue for peace, somewhat as the Japanese were to do after the atom bombs fell on Hiroshima and Nagasaki.

It is not surprising that proposals for all-out attacks on Berlin, the Ruhr, or other critical areas of Germany always seemed to come from the British, who had undergone the German air raids of 1940-41 and were now enduring the punishment of V-1's and V-2's. All proposals frankly aimed at breaking the morale of the German people met the consistent opposition of General Spaatz, who repeatedly raised the moral issue involved, and AAF Headquarters in Washington strongly supported him on the ground that such operations were contrary to air force policy and national ideals. On more than one occasion Eisenhower backed Spaatz's insistence that his own forces be sent only against what he considered legitimate military targets. At times, SHAEF yielded to other pressures.

The first serious question arose from a project, appropriately called HELLHOUND, to wipe out Hitler's sanctuary at Berchtesgaden. In June 1944 the AAF had succeeded in sidetracking this plan on the ground that it would prove too costly and would probably increase rather than diminish German support of the Fuehrer, who would surely survive it.<sup>7</sup> At about the same time, AAF circles experienced relief over the abandonment of a proposed joint mission against Berlin,\* but on 5 July SHAEF approved a project suggested by the British chiefs of staff to break German civilian morale through epochal bombardments. While USSTAF drafted its part of the plan, Spaatz secured directly from Eisenhower an indorsement of the AAF policy that the Americans should not be deflected from precision bombing.<sup>8</sup> A month

\* See above, pp. 284-85.

later SHAEF again issued instructions to prepare a plan to wipe out as much of Berlin as was possible in a huge AAF-RAF mission. Operation THUNDERCLAP, as it was called, brought strong objections from Spaatz and Maj. Gen. Laurence S. Kuter, General Arnold's chief planning officer, and Spaatz again took the matter to Eisenhower. Nevertheless, orders came down on 9 September 1944 to have the Eighth Air Force prepared at a moment's notice to carry out THUNDERCLAP as an area bombardment. Doolittle and Harris planned the operation as a joint daylight assault to be conducted by all available American and British heavy bombers. The uneasy moment passed. Harris was not able after all to send his bombers on the mission because it became clear that fighter escorts, absorbed in the Battle of France, would not be available in sufficient numbers.<sup>9</sup> Also, the Psychological Warfare Division of SHAEF denounced THUNDERCLAP as terroristic, and in a JCS meeting both Arnold and Adm. William D. Leahy expressed opposition to morale bombing in general.<sup>10</sup>

Perhaps, Arnold seems to have reasoned at this juncture, there were other ways to impress the German people vividly with the might of the Allied air forces and without the risks entailed in morale bombing. In mid-September, he proposed that every available British and American airplane be used on some clear day to swarm all over the Reich, attacking military objectives in towns that had hitherto been unmolested by the air forces.<sup>11</sup> This type of operation, he felt, would afford the enemy population an opportunity to witness at firsthand the might of the Allies and to reflect on their own helplessness. But clear days that opened up the entire expanse of Germany to such a venture were rarities, especially during the autumn, and not until February 1945 was this plan, by then called CLARION, given a try.\*

The British counterproposal to General Arnold's scheme was to concentrate the power of all the Allied air forces, strategic and tactical, over the Ruhr in accordance with a plan coded HURRICANE I. While this project had much in common with Arnold's proposal, there were some aspects of it that the Americans feared. RAF Bomber Command was going to burn out what remained of several key German cities in the Ruhr while the Americans would fly in from Italy, England, and France to smash objectives they regarded as legitimate in two days of furious operations. The project was scheduled to begin on 15 October 1944. As the hour approached, however, the Fifteenth Air

\* See below, pp. 732-35.

Force, which could scarcely reach the Ruhr even under the most favorable conditions, had to call off its mission because of the weather, and at the last minute the RAF concluded that conditions were too unpropitious and scrubbed its mission too. With evident relief, so did the Eighth Air Force.<sup>12</sup>

With HURRICANE canceled and the ground effort reduced after the failure of MARKET, it became possible during October 1944 for the Eighth Air Force to devote almost all of its energies to strategic operations. The Fifteenth Air Force was called upon on 12 October to help prepare the way for a push to Bologna, and thereafter it continued to operate against railroads, bridges, and airfields in the Balkans. Churchill had spoken hopefully at the recent Quebec conference of running the Germans out of Italy and driving for Vienna,<sup>13</sup> but General Eaker had been a better prophet in predicting no such impressive results.<sup>14</sup> And as the Italian and Balkan campaigns came to a stalemate during the fall,\* the Fifteenth Air Force also found itself free to devote most of its effort to the strategic offensive against Germany, which it did with great skill and heartening success.

After the strategic air forces reverted to CCS direction in September 1944,† directives governing the operations of USSTAF and RAF Bomber Command were drafted by Spaatz and Air Marshal N. H. Bottomley, delegates for Arnold and Portal, respectively. Their first directive, dated 23 September 1944, had named oil as first priority and had placed ordnance depots, armored fighting-vehicle assembly plants, and motor-vehicle assembly plants in a composite second priority. German transportation was listed as a special priority which might rise or fall as conditions dictated. The GAF was to be policed when necessary, or to be more precise, whenever its supporting establishments could be located.<sup>15</sup> The directive reflected the widespread hope in Allied circles that the enemy could be prevented from refitting his armored units withdrawn from France. But it spoke even more noticeably of General Spaatz's persistent belief that oil should stand first on the list, a position it was destined to hold throughout the fall.

### *Pursuit of the Oil Campaign*

Whether other target systems could be neutralized or not, and whether the land forces moved slowly or rapidly, AAF leaders were

\* See above, p. 454.

† See above, pp. 319-22.

confident that Germany could be immobilized as a fighting power if she lost beyond recovery her ability to obtain fuel and lubricants. In this belief, the strategic air forces had pounded away at synthetic petroleum plants and crude-oil refineries throughout Axis Europe all during the summer,\* and by September it was believed with good reason that the enemy's oil situation was nothing less than desperate. The destruction and then the occupation of the Ploesti fields had cost him approximately one-fourth of his supply. For a brief period in September 1944 it seems that no German oil installations of any type were operating, and by the end of the month the evidence indicated that of the ninety-one still in German hands only three were in full production and twenty-eight in partial production.<sup>16</sup> The Germans secured for that month less than 300,000 tons of oil from all sources, about 23 per cent of their monthly supply before the concentrated air attacks had begun.<sup>17</sup> Their expenditures of fuel during the summer campaigns, of course, had been enormous and their supplies were down to minute proportions. The high command, in fact, had abandoned hope that it could maintain adequate gasoline and lubricants for its air forces and field armies.<sup>18</sup>

The Allies knew, however, they would have to struggle to keep their oil victory from slipping away, for they were by now aware of the far-reaching program of the Speer ministry and Edmund Geilenberg to restore a minimum oil production. With 350,000 laborers devoted to this purpose, the Nazis were able to reconstruct their bombed plants and refineries at a much faster rate than Allied air commanders had considered possible. The Germans were also dispersing their entire synthetic oil industry in such a way that bombers would not be able to locate the targets, as already had happened to a large extent in the case of the aircraft industry. The enemy was displaying his usual skill in the use of smoke and camouflage, and was concentrating heavy flak guns around the chief oil installations in numbers that probably would have made Berlin's inhabitants resentful had they known of it. Speer, moreover, could count on the approaching bad weather of the autumn and winter months to keep the bombers away, and only a few weeks of immunity might allow German oil production to rise to as much as 60 per cent of normal.<sup>19</sup>

During the last half of September, accordingly, the Eighth Air Force utilized its rare days of freedom from commitments to help the land

\* See above, pp. 280 ff.

forces by bombing oil targets. In three different attacks almost 600 tons were aimed at the I. G. Farben oil-chemical complex at Ludwigshafen and more than 1,000 tons at refineries in the Bremen area. Also, the synthetic petroleum plants at Merseburg-Leuna and Magdeburg received 1,000 tons in two missions and Lützkendorf got 188 tons. The RAF continued to operate chiefly against cities in the Ruhr basin in which stood installations that produced benzol, an oil substitute made from the by-products of coke ovens. The Fifteenth Air Force sent bomber fleets of from 100 to 150 aircraft which dropped 287 tons on Blechhammer North, 272 tons on Odertal, 235 tons on Oswiecim, and 253 tons on Budapest.<sup>20</sup> Since all of these plants had been attacked before, and since smoke and cloud conditions made assessment difficult, it was not always possible to determine how effective any one mission had been. For the most part, however, it was evident that fresh damage to buildings and machinery had resulted.<sup>21</sup>

In October the campaign went ahead with as much force as operating conditions permitted. The Eighth Air Force was able to carry out no more than four extensive oil missions. The best flying day was 7 October, when more than 550 heavy bombers attacked Pölitz, Ruhland, Böhlen, Lützkendorf, Merseburg-Leuna, and Magdeburg. Except for Pölitz, which evidently was put out of operation for about three weeks, the results of this mission from the standpoint of bombing were only moderately good. The supervising oil committee of the Combined Strategic Targets Committee deduced soon after this attack that bombs would have to be placed more concentratedly on the plants in order to achieve worth-while damage.<sup>22</sup> A raid of 11 October on Wesseling by fifty-seven Fortresses produced significant damage. On the 15th, a synthetic plant at Düsseldorf was bombed with 160 tons but destruction was not serious; severe hits were achieved at Monheim on that day, however, by sixty-four Liberators.<sup>23</sup> On 25 October blind-bombing missions led by pathfinder airplanes brought 800 tons on each of two crude-oil refineries in Hamburg. The same targets received almost 200 tons each, again in blind attacks, on 30 October, when Buer-Scholven got 246 tons. RAF Bomber Command continued its campaign during October against ten Ruhr cities which contained benzol plants. These massive night attacks were generally effective, although benzol production was not cut off for a few more weeks. The Fifteenth Air Force had a good month. It hit the synthetic plant at Brück, which had been rated as out of production for four months,<sup>24</sup> and it unloaded large ton-

nages on Blechhammer South on 13 and 17 October. Blechhammer North was bombed effectively on 14 October, as was Odertal. And three major centers in Austria were attacked on the 7th, 13th, and 16th. In all, the three strategic air forces directed 12,592 tons of bombs at oil targets during October 1944, just under 10 per cent of their total effort.<sup>25</sup>

The oil experts in the Combined Strategic Targets Committee estimated that German production had risen seven points during October, or to 30 per cent of the pre-attack level,<sup>26</sup> but it appeared that only two of the twenty-four known synthetic plants had been in operation during the month. It was concluded, therefore, that Germany was drawing her petroleum supplies mainly from benzol plants and from what remained of her crude-oil refineries. Although the danger that the Allied campaign against oil might fall seriously behind in October because of bad weather had not materialized, there were several recognizable flaws in the offensive which had to be removed. Heavy bombers were not proving effective in attacks on tiny storage facilities; hence the task would have to be turned over to mediums and fighter-bombers.<sup>27</sup> The benzol plants were very difficult to hit because they were small and hidden away in complex urban centers that ran together when viewed from the air or on radar screens.<sup>28</sup> Daylight attacks were going to be necessary to supplement the RAF's night missions, and AAF blind bombing had not achieved the accuracy hoped for. A visual attack with 250 tons was usually more profitable than a radar mission involving 1,000 tons.<sup>29</sup> More practice, more equipment, and new techniques were required. Also, reconnaissance could not keep up with the bombing missions; the weather, camouflage, artificial smoke, and the inadequacy of reconnaissance forces made timely assessment impossible, and reconnaissance aircraft often failed to return, probably because jets picked them off. Already in mid-October, it had become a settled policy to attack and reattack regardless of reconnaissance data.<sup>30</sup> Finally, the Allies realized they still had much to learn about the size and type of bombs which would produce maximum damage. As General Eaker pointed out, much opinion but little factual knowledge was available to help out in arriving at the correct mixtures.<sup>31</sup> A study of the Ploesti refineries had indicated that small bombs were probably best, but postwar surveys concluded that larger bombs and a higher percentage of incendiaries should have been used.\* And a melancholy

\* See below, p. 795.

situation not fully understood until after the war was that American bombing accuracy was even lower than USSTAF realized.<sup>32</sup>

November 1944 was the prime month of the war for the offensive against German oil production, with a total of 37,096 tons being dropped by the three strategic air forces.<sup>33</sup> The Eighth, sometimes operating in weather that would have been regarded as unflyable a year earlier, carried out large missions on thirteen days against enemy oil targets. Gelsenkirchen caught nearly 700 tons on 1 November. Merseburg-Leuna received 1,400 tons on the 2d, 477 on the 8th, 475 on the 21st, 1,390 on the 25th, and 1,015 on the 30th. Castrop and Sterkrade got more than 700 tons together on 2 November, and Sterkrade suffered again on the 6th when Liberators dropped 434 tons. New damage was inflicted on 4 November at Hannover, Hamburg, Harburg, Bottrop, and Gelsenkirchen, but the law of averages worked on the next day to make the mission against Ludwigshafen largely a failure. Two plants at Hamburg were bombed again on the 6th, as was a benzol plant at Duisburg. On the 11th Gelsenkirchen caught 236 tons and Bottrop, which recently had been plastered by the RAF, was put entirely out of action when Liberators dropped 344 tons. Hamburg-Rhenania received 476 tons on 21 November, and fair results were achieved at Gelsenkirchen on the 23d. Misburg sustained fresh moderate damage when Fortresses dropped 710 tons and Liberators attacked with 152 tons on 26 November.<sup>34</sup> A tremendous assault on 29 November by nearly 400 Fortresses dropping 1,152 tons completed the wreckage at this plant. The 30th of November was a good day for the Eighth, which dropped 166 tons on Böhlen, 320 on Zeitz, 419 on Lützkendorf, and the afore-mentioned 1,015 tons on Merseburg-Leuna.

The Fifteenth Air Force initiated its November oil bombings with one of the greatest efforts it had yet carried out: 1,100 tons dropped by 500 bombers on the large crude-oil refinery at Floridsdorf on the 5th and on the next day 403 tons on Moosbierbaum, both of these producers in the Vienna area. Because of forbidding flying conditions over the Alps no significant missions in the oil campaign proved possible again until 17 November, when Blechhammer South received 199 tons and Floridsdorf got 402. Then, Floridsdorf and Korneuberg caught 510 tons on the 18th. Vienna-Löbau received fresh new damage when 214 tons struck it on the 19th, and the benzol plant at Linz was a target of 104 tons that day. The last oil mission of the month, a combined visual and blind attack on 20 November, brought 314 tons down on Blech-



hammer South, where the Germans were making energetic efforts at reconstruction.<sup>35</sup>

Early in November a USSTAF general had hinted to Air Marshal Bottomley that the RAF was not carrying its share of the oil offensive, even though it had enjoyed more clear nights for such missions than the Eighth Air Force had clear days.<sup>36</sup> Before the month was out, however, Bomber Command was exceeding the American air forces in the tonnage dropped on oil targets. Gigantic night missions and occasional daylight attacks by this force brought ruin to the synthetic oil plants and benzol works of the Ruhr. Nordstern, Scholven, Wesseling, Homberg, Wanne Eickel, Sterkrade, Castrop, Kamen, Bottrop, and Dortmund were the chief sufferers, and by the last of November all of the RAF's synthetic oil targets were suspended because they were no longer operating.<sup>37</sup> Whereupon Air Chief Marshal Portal demanded that the British share the losses the Eighth had been taking by assuming responsibility for two of the largest and most distant targets, Pölitz and Merseburg-Leuna.<sup>38</sup> The crippling of Germany's warning system in the west as a result of the Allied victory in France and the increased efficiency of blind-bombing techniques made such RAF missions possible, and they proved generally successful. Indeed, Speer subsequently reported to Hitler that the night attacks were more effective than the daylight missions, because heavier bombs were used and greater accuracy had been attained.<sup>39</sup> On the average British operation against oil targets during the autumn, 660 tons fell as compared with 388 tons for a USSTAF mission.<sup>40</sup>

Germany's oil production for November was estimated at 31 per cent of the monthly average in the preceding spring, with most of the supply coming from the benzol plants, which had not been regarded as worth attacking until the autumn.<sup>41</sup> Pölitz and Merseburg-Leuna were listed as heavily damaged but in partial operation. All of the synthetic plants in western Germany, however, were reported out of action and the crude refineries around Hamburg, Bremen, and Vienna as functioning only on a small scale. In fact, the evidence indicated that only one sizable crude-oil refinery was operating anywhere in Germany.<sup>42</sup> Since the beginning of the oil offensive the Eighth Air Force had dropped 45,000 tons, the Fifteenth Air Force 27,000 tons, and Bomber Command 22,000 tons on oil-producing targets, and the campaign had been more effective in terms of destruction than most Allied experts had ever dared to hope.<sup>43</sup> It was clear that Speer's ambition to

restore German production by two-thirds during the winter of 1944-45 was hopelessly behind schedule. Yet the Allies were aware that German reconstruction often surpassed their own rate of destruction. It took several missions in most cases to wreck a German plant, and it could be restored to operation in from four to six weeks.<sup>44</sup> Before the bombers could ruin it again, the Germans would be able to squeeze out a few thousand tons of petroleum supplies.

During the first two weeks of December, however, the Eighth Air Force was either weathered in or forced to devote its major effort to preparation for the projected land offensives scheduled for the second half of the month. It was able to carry out two major oil missions, dropping 1,075 tons at Merseburg-Leuna on 6 December and on the 12th nearly another 1,000 tons upon that extremely important if stubborn target. But the German ground offensive launched four days later put the Eighth completely out of the oil campaign until the very last day of the month. Fortunately, the Fifteenth Air Force, which had sent approximately 450 heavy bombers against Blechhammer North, Blechhammer South, Odertal, and Floridsdorf on 2 December and had bombed the synthetic plant at Moosbierbaum on the 11th, Blechhammer South again on the 12th, and Brüx and Linz on the 16th, was able to continue a sustained effort against its own oil targets.\* Fortunately, too, the German oil position already had been rendered desperate enough to allow the Allies to break the full stride of their campaign without paying too high a price. The enemy's Ardennes offensive had been made possible only by garnering every drop of fuel he could find over a period of weeks, and even then his supply was no more than equal to the demands of five days of continuously heavy operations.<sup>45</sup> His last great gamble, in other words, depended for its ultimate success upon the capture of Allied stores.

### *Ordnance and Motor Vehicles*

From August to November 1944 the strategic air forces waged a rather inconclusive offensive against German ordnance depots, tank assembly plants, and motor vehicle factories in the hope that the German armies could be denied heavy equipment as they reorganized behind the Siegfried Line. It would clearly be impossible to keep the enemy from obtaining guns and ammunition, since the German armament industry was both huge and efficient, but a systematic bombard-

\* See below, p. 670.

ment of key factories and depots might deprive him of such critically important items as tanks, self-propelled guns, and trucks. Heretofore German manufacture of these items had suffered only haphazardly from RAF area bombings and perhaps to some degree from the ball-bearing campaign of the AAF. An order in August from General Spaatz to the Eighth and Fifteenth Air Forces calling for the bombing whenever possible of twelve ordnance depots, eight tank assembly plants, and seven truck works gave notice of a new interest, and under the directive of 23 September this target system rose to second priority.<sup>46</sup>

Since the beginning of the European war the German army had made extensive and successful use of armored vehicles. After the debacle at Stalingrad the industry which produced the "panzer" types—tanks, tank destroyers, and self-propelled guns—underwent a tremendous expansion. It turned out almost 9,000 units during the first half of 1944 and showed promise of attaining a rate of 2,500 per month by December 1944.<sup>47</sup> To Allied air commanders the surest way of frustrating the purpose behind this effort was to deprive the enemy of fuel and lubricants, but USSTAF also determined to obstruct the assembly of panzers by attacking with enormous tonnages eight key plants: Henschel und Sohn at Kassel, Maschinenfabrik at St. Valentin in Austria, Krupp Grusonwerke at Magdeburg, Daimler-Benz and Alkett in the vicinity of Berlin, and three assault-gun works in Brunswick and Berlin. In the automobile and truck industry of Germany, which had been widely scattered even in peacetime, USSTAF decided to attack seven plants which produced medium and heavy trucks: Ford at Cologne, Saurer at Vienna, Daimler-Benz at Gaggenau, Bussing at Brunswick, Borgward at Bremen, Adam Opel near Berlin, and Daimler-Benz at Mannheim. As for the ordnance industry, there were hundreds of small plants all over the Reich. But the largest depots were thought to offer attractive targets, such as those at Ulm, Hannover, Vienna, Berlin, Magdeburg, Kassel, Ingolstadt, Munich, Breslau, Bielefeld, and still others if the campaign went well.<sup>48</sup> At this stage, as later, Allied intelligence could offer only an uncertain and sometimes contradictory picture of the new target system.<sup>49</sup> Yet hopes were fairly high that significant results would be obtained.

It was difficult to fit the campaign into the rare good bombing days at a time when tactical commitments were heavy and the oil offensive

held first priority. In August the Eighth Air Force was able to attack only four targets of this type: the Adam Opel works near Berlin on the 6th, where highly encouraging structural damage was wrought, Mannheim on the 14th, and Brunswick and Hannover on the 24th. More attacks were possible in September, when 4,406 tons fell on tank assembly plants alone,<sup>50</sup> and it seemed as though the offensive might be a striking success.<sup>51</sup> The Eighth bombed Berlin and Brunswick again, and the Fifteenth hit St. Valentin. Tank engine production seemed in a very bad way after RAF missions against Berlin and Friedrichshafen. Various tank component works at Berlin, Kiel, Ulm, Brüx, Linz, Düsseldorf, and Brunswick showed evidence of notable damage. The great Henschel complex at Kassel suffered very heavy destruction from Eighth Air Force bombings of 22, 27, and 28 September, all of which were blind missions involving more than 600 bombers and 1,600 tons,<sup>52</sup> and Daimler-Benz at Gaggenau had to stop production after two precision raids.<sup>53</sup> By the end of September the Eighth Air Force apparently had inflicted notable damage, the Fifteenth was just beginning to participate heavily, and Bomber Command was busily burning out cities in which targets of this system were located. At USSTAF headquarters the hope prevailed that a concentrated assault on ordnance depots might finish off the campaign and prevent the Germans from re-equipping their forces.<sup>54</sup>

Consequently, the effort was stepped up in October. Eleven major strategic air force missions brought 2,165 tons on ordnance depots, 3,931 tons on tank plants, and 3,548 tons on truck works.<sup>55</sup> In two attacks of 2 and 7 October the Eighth Air Force finished off Kassel, a success so signal that Albert Speer later praised it;<sup>56</sup> but, unfortunately, this was about the only one worthy of his memory or anyone else's. The Eighth produced what seemed to be good damage to plants and depots around Berlin on 6 October, and after several missions had aborted, the Ford works at Cologne caught 232 tons on 18 October. Nürnberg, Gaggenau, Mannheim, Brunswick, Hannover, and Bielefeld all received large tonnages during the month. Even the Schweinfurt ball-bearing works was included on 9 October, when 329 Fortresses dropped 820 tons, the largest amount yet to fall on that sturdy target, but, as had happened before, enormous structural damage did not interfere seriously with production.<sup>57</sup> The Fifteenth Air Force bombed St. Valentin and Steyr on 16 October, and the Skoda works at Pilsen on the 23d. Small forces of this organization also attacked the

sprawling ordnance depot in Vienna four times and damaged factories at Graz, Linz, and Milan during the month.

It seemed clear by the end of October that the offensive was not affecting decisively the re-equipment of the German armies, a conclusion that received ample support from evidence available after the war. The fact was that these air attacks had not blocked production seriously, even though they had often destroyed or damaged buildings in the target area. The German output of tanks actually rose in December to a total of 1,958. Speer had planned, it is true, on a production of 2,500, but the discrepancy is attributable more to transportation difficulties than to direct bombings. Except for Kassel, tank plants bombed were soon repaired.<sup>58</sup> The 5,600 tons dropped on ordnance depots did not hamper the Germans to any serious degree, although loss of stocks from time to time magnified local problems.<sup>59</sup> As for motor vehicle production, it began to decline in August, more because of transportation troubles than because of the bombings just then beginning.<sup>60</sup> Even so, German leaders on their surrender a few months later were not unflattering in their estimate of this part of the Allied air offensive, and there is some reason to believe that the attack, if begun sooner and executed on a fuller scale, might have produced the results expected of it.<sup>61</sup>

The virtual abandonment of the effort after October is only partly explained by the declining faith in its effectiveness. During that month, General Marshall on a visit to the European theater had taken the initiative in formulating plans to bring about the defeat of Germany by 1 January 1945.<sup>62</sup> The chief of staff in discussions with air leaders made it clear that he was not satisfied that full pressure had been put in the right places, and he suggested that long-range objectives of strategic bombardment be abandoned for an all-out effort to force an early victory.<sup>63</sup> And if the German army was to be forced into surrender within two months, it mattered little how many tanks might be produced for its equipment during the interim. Tanks, trucks, and ordnance depots received little attention in November and were the object of U.S. attack only once in December and once in January.

### *German Railways*

As top headquarters in Versailles, London, and Washington gave thought to a reshaping of the general effort, several points of view had to be reconciled. Eisenhower continued to plan on concentrating

his forces against the Ruhr and on a drive from there deep into Germany, but the question of how best the strategic air forces might contribute to the attainment of this objective became a subject of debate. The British Air Ministry inclined toward wrecking the vast railway and water transportation system of western Germany, as did Eisenhower's deputy, Air Chief Marshal Tedder, who had always been a railway advocate.\* General Spaatz, on the other hand, repeatedly insisted that the oil campaign remain in first priority, for it was manifestly successful and it would be risky to give it up. Aside from this, he was willing to place his bombers at Eisenhower's disposal for anything that might prove decisive.<sup>64</sup> In Washington, Arnold's advisers developed little enthusiasm for the transportation plan and recommended instead that all forces be placed under Eisenhower for an epic air-ground dash to Berlin, with many of the heavy bombers serving as troop and supply carriers.<sup>65</sup>

The debate found its focus in the question of whether to undertake in Germany another transportation program. The railway network of the Reich proper had received a heavy weight of Allied bombs long before Eisenhower's armies had reached its borders. But the bombings had been sporadic and unsystematic, usually the incidental results of spillage from other targets or attacks made as a last resort. The hesitation of the Allies to make this transportation system a major target is readily understandable, for the German complex was possibly the finest in the world—modern, a model of efficiency, and with more than four times the track mileage for the area than the average in the United States.<sup>66</sup> Furthermore, the Germans had an abundance of rolling stock, rails, and locomotives which amounted to a comfortable excess. The wear and tear on their system during several years of war had been more than offset by the plunder of conquered neighbors, and in the autumn of 1944 Germany's transportation establishment was still functioning exceedingly well.

In planning a systematic assault the Allied air forces could draw upon a wide experience in Italy, France, and Belgium. It had been demonstrated that an enemy's transportation system could be wrecked through bombardment campaigns both of the attrition type, which meant destroying rail centers and repair facilities, and of the interdiction type, which involved line-cutting and bridge-breaking. This experience, however, did not lend itself to undisputed interpretation,

\* See above, p. 77.

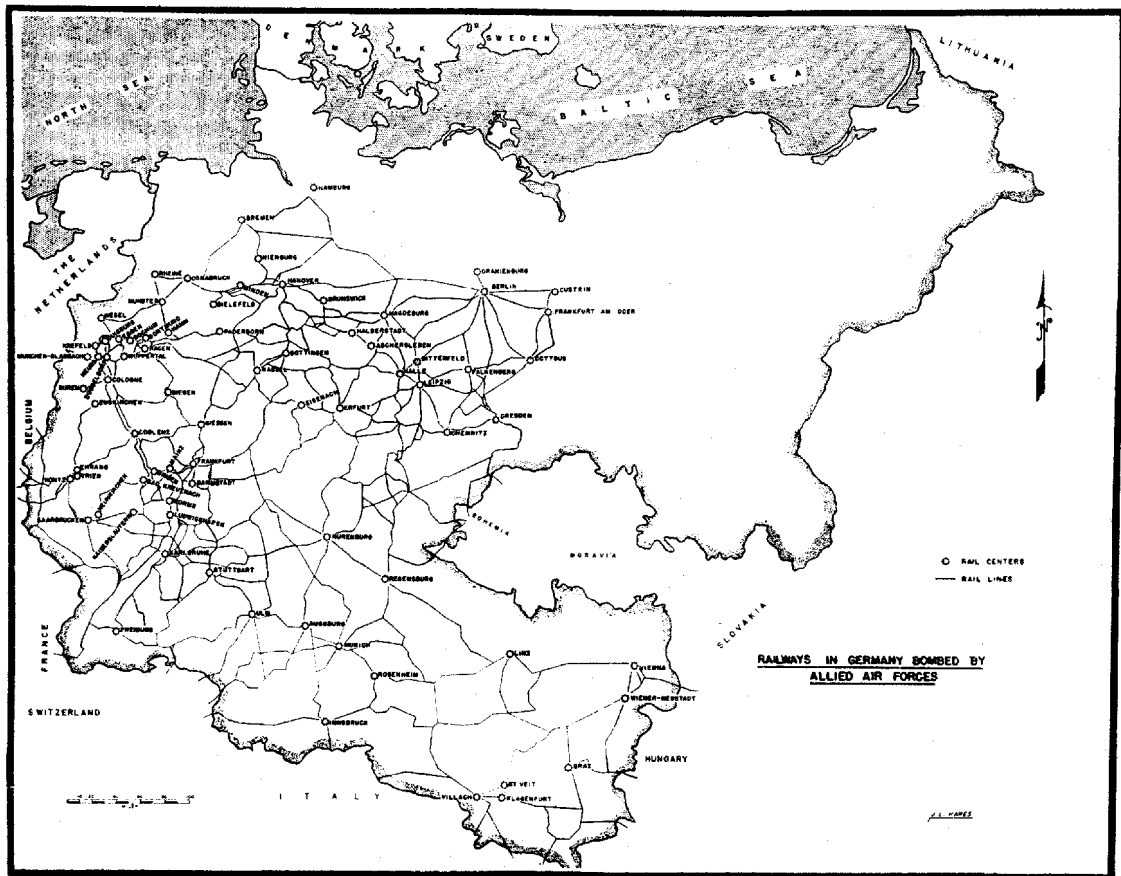

since in all three cases there remained considerable disagreement as to whether attrition or interdiction had been decisive. The only conclusion on which everybody, including the Germans, agreed was that air power had magnified the transportation problem to the point of disaster for the defense, and it remained to determine how such a result could best be produced in the Reich proper. Though following no clear-cut plan, the air forces had begun attacks on marshalling yards in Germany as the Allied land forces moved toward its borders in the late summer of 1944. In particular, those marshalling yards which supported the retreating German armies, such as Stuttgart, Karlsruhe, Mainz, and Frankfurt, had received heavy tonnages. Subsequently, as the Allies were attempting to cross the lower Rhine at Arnhem in September, they bombed repeatedly some twenty-five German rail centers and sent fighter-bombers to cut railway lines in five hundred places. Yet the military results seemed inconsequential for all the effort that had been expended. The Germans effected quick repairs on their through lines, and their retreat did not become a rout.<sup>67</sup>

With the coming of October 1944, the air forces had intensified their efforts against Germany's railways and waterways, but still with no grand plan. The strategic air forces during the month dropped 19,000 tons on marshalling yards, damaging very severely those at Cologne, Münster, Mainz, Saarbrücken, Munich, Vienna, and Essen.<sup>68</sup> The tactical air forces, now based in eastern France and Belgium, cut lines in the Reich at 1,300 points and destroyed a thousand locomotives. RAF Bomber Command undertook to break the canal embankments along Germany's highly important waterways; it was to prove a long and discouraging campaign, though eventually a successful one, for the Germans again proved themselves efficient at making repairs. The Fifteenth Air Force not only bombed Vienna and Munich but also rail centers in Italy and the Balkans, thus reducing the over-all capacity and flexibility of the German system, and it cut tracks along sixty miles of the line through the Brenner Pass connecting Germany and Italy.<sup>69</sup> Despite the variety and frequency of all these attacks, however, the German war effort did not suffer seriously. The enemy repaired his vital lines or rerouted his traffic. Sometimes he resorted to bus transportation until rail lines were restored, and essential trains continued to go through, as the Allies well knew.<sup>70</sup>

Discussion of plans to repeat in Germany the great railway attrition program which had produced good if controversial results in France,



Belgium, and Italy revealed definite opposition in the Eighth Air Force, USSTAF, SHAEF, and Headquarters AAF.<sup>71</sup> But the plans of late October 1944 for speeding up the war necessarily directed attention to the chance of wrecking German transportation, and Tedder vigorously pressed the issue. In a paper of 25 October 1944 "on air policy to be followed with a view to rapid defeat of Germany,"<sup>72</sup> he complained that current air attacks on Germany constituted a "rather patchwork" effort and argued that the one factor common to the entire German war effort was the country's rail and water communications system. If the Allies directed the entire weight of their air power against this target in the western Reich, they would have a good chance to produce the collapse of the Nazis within a matter of weeks.

A group of railway experts and intelligence officers who met in London to consider the question of transportation attacks regarded Tedder's plan as too optimistic. All of them agreed that Germany's rail facilities in the west were greatly in excess of her military requirements, so much so that no appreciable effect "could possibly be achieved within the envisaged time period."<sup>73</sup> Even E. D. Brant, who had promoted the pre-OVERLORD air campaign against rail centers earlier in the year, expressed the opinion that SHAEF did not realize how few trains the Germans really needed for essential military purposes.<sup>74</sup> The Joint Planning Staff in Washington doubted that railway traffic in the Ruhr-Rhineland region could be decisively restricted by air effort.<sup>75</sup> When the top commanders met at SHAEF on 28 October 1944, however, the Tedder proposal became second priority, thus dislodging tanks, trucks, and ordnance depots.

The meeting, which had been called to determine a way to finish the war before 1945, ended with a decision to continue oil in the first priority. With German transportation elevated to the second place, all other target systems would recede into the background and the strategic air forces could anticipate heavy calls from ground for carpet bombings of the St.-Lô type.<sup>76</sup> Spaatz was not displeased. Not only had he saved the priority for oil, but he was cautiously optimistic about the new program, believing that it would bring about maximum coordination of the tactical and strategic air forces and that it would fit in with the capabilities of the Fifteenth Air Force. It might work as well as Tedder said it would.<sup>77</sup> The CCS having ratified the decision on the same day, Spaatz and Bottomley promptly issued the appropriate directive.<sup>78</sup>

The Combined Strategic Targets Committee, some of whose members regarded the transportation plan simply as an act of faith,<sup>79</sup> early in November established a special group to formulate and supervise the new program. Germany was divided into nine zones ranking in this order: northeastern approaches to the Ruhr, Frankfurt-Mannheim, Cologne-Coblenz, Kassel, Karlsruhe-Stuttgart, Magdeburg-Leipzig, Upper Silesia, Vienna, and Bavaria. In those areas the three strategic air forces would attack marshalling yards, using both visual- and blind-bombing techniques and reattacking sufficiently to keep them in disorder. Medium and fighter-bombers would participate in the program, as they had in previous campaigns of this type, by polishing off small objectives within the main rail centers when the heavies had failed to demolish them. Repair installations and power centers for the electrified lines would also be prime objectives for these forces, and fighter-bombers would continue to cut lines and shoot up rail traffic whenever opportunities presented themselves. RAF Bomber Command was to prosecute its campaign against German waterways with full vigor, and the Italy-based air forces were to continue to mine the Danube.<sup>80</sup>

The Eighth Air Force hurriedly assembled target information on the German rail centers, and during the first two weeks of November its bombers struck marshalling yards and repair facilities at Bielefeld, Cologne, Coblenz, Frankfurt, Hamm, Hamburg, Ludwigshafen, Minden, Neunkirchen, Oberlahnstein, Rheine, and Saarbrücken. Such missions had to be sandwiched between oil attacks, carpet bombings, and five unflyable days, but as bombing operations they seemed generally effective. In the same period the Fifteenth Air Force made its way through difficult flying conditions over the Alps to bomb marshalling yards in Austria, only one of which sustained severe damage.<sup>81</sup> RAF Bomber Command operated in great force at night on Rhineland rail targets, and the tactical air forces carried their share of the burden. In the second half of November the Eighth put heavier efforts into the campaign, attacking Bielefeld, Bingen, Duisburg, Hamm, Münster, Neunkirchen, Offenburg, Osnabrück, and several viaducts on main lines that led to the front. The Fifteenth Air Force bombed Munich four times but concentrated on cutting lines between Germany and Italy and Hungary. Bomber Command attacked five important rail centers in the west and inflicted further damage on the Dortmund-Ems canal. Over a two-week period, the tonnages of the strategic air forces on transportation targets exceeded to a considerable degree those directed

at the more vital oil targets. The tactical air forces continued their regular operations against moving traffic and supplemented the campaign of the heavies by attacking surviving targets within marshalling yards.<sup>82</sup> A SHAEF study at the end of November indicated that the German railway system was suffering from exhaustion of locomotive reserves, strain of servicing and repair facilities, and lack of trained and loyal personnel, and that these problems had been immensely aggravated by the air attacks. But the familiar conclusion still mocked the Allies: the Germans were able to move their vital military traffic over the rails.<sup>83</sup>

In view of the discouragingly small progress of the Allied land armies in November, various proposals were now brought forward for the use of drastic measures, one of them being a scheme to seal off the German armies west of the Rhine by destroying nine rail and twelve road bridges over that stream. That such a proposal might be insisted upon had caused alarm among air commanders during October.<sup>84</sup> The bridges were highly formidable, both as to structure and defenses. Because of their size and heavy concentration of flak, it would be almost impossible for the tactical air forces to knock them out, and if heavies attempted it, most of their bombs would be wasted because of the high bombing altitude necessary. Days for visual bombing were all too rare even for targets of proved value, and General Doolittle estimated that this undertaking would preclude visual bombing of oil and other objectives for one or two months. Other Eighth Air Force estimates put the time length at four months, and Tedder, who calculated it at three months, warned that possibly 14,000 heavy bomber sorties would be required.<sup>85</sup> Even then, the chance of demolishing the Rhine bridges, air commanders believed, would be very slight. At the end of November, SHAEF G-2 judged that the attempt was worth making, however extravagant its costs,<sup>86</sup> but the air leaders pressed their objections and gained their point. After the war Albert Speer expressed amazement that such targets had been passed up, and a study edited by General Bradley suggests regret that the operation was not carried out.<sup>87</sup>

November had been on the whole a month of disappointment on the ground, and with Washington still pressing for victory by January, the chief leaders in Europe convened again at SHAEF on 5 December to deliberate upon ways to employ the strategic air forces in breaking the stalemate. The discussion brought out the general conviction that the transportation plan should be continued. Vandenberg quoted Gen-

eral Bradley to the effect that the plan was sound only as a long-range program and that the heavy bombers might better be employed to provide more immediate assistance for the ground forces. Eisenhower identified himself with this position at least to the extent of insisting that the heavies be prepared to pour unprecedented tonnages in front of his armies in their projected offensives to the Rhine. But Tedder favored a widespread and continuous bombing campaign against transportation in the hope of isolating German forces west of that historic river. Spaatz, as always, emphasized the importance of keeping oil inviolate as a first priority, but he was also inclined to accept the conclusion of SHAEF G-2 that rail attacks had produced encouraging results. Accordingly, he favored continuance of the program. The conference ended with the strategic air forces committed to all three programs, in the order of oil, carpet bombing, and transportation.<sup>88</sup>

This shift of transportation to a lower priority, however, had little or no effect on subsequent operations. Bombings continued through the first two weeks of December on almost the same scale, as the Eighth Air Force and the RAF attacked forty rail centers on routes leading into the Ruhr and Rhineland. The Fifteenth Air Force carried out many harassing raids on Austrian marshalling yards and substantially large missions against Germany proper in mid-December. Effects could seldom be determined because of poor visual conditions for reconnaissance and photography, but a final judgment could be inferred from the early success of the Germans in breaking through the Ardennes on 16 December. Clearly, the Allies had not wrecked Germany's transportation system to a decisive degree, even in the west and even if von Rundstedt did later declare that his counteroffensive had been delayed by fourteen days because of resulting transportation difficulties.<sup>89</sup>

The air force remedy for the Bulge was the application of stronger doses of the medicine that had failed to prevent it in the first place. Both the Eighth Air Force and Bomber Command virtually abandoned all other efforts to concentrate on German communications. Of the 23,000 tons the Eighth dropped during the latter half of December, 22,000 were aimed at transportation targets.<sup>90</sup> Traffic bottlenecks, bridges, railway lines, and thirty-nine marshalling yards serving the endangered area became overriding top priorities for those two weeks and, undoubtedly, the transportation attacks of the air forces were highly important in frustrating the German gamble. Albert Speer afterward said they were decisive.<sup>91</sup> But the railway experts ruefully noted

again the fact that was becoming almost an axiom: no matter how furiously the air forces bombed railroads, the Germans were able to repair their lines and usually to move essential military traffic.<sup>92</sup>

After the reconquest of most of the Bulge in January 1945 the Combined Strategic Targets Committee carefully examined the effects of the transportation plan.<sup>93</sup> In only one zone, Cologne-Coblenz-Trier, had German traffic been brought to a standstill. In one other zone, Coblenz-Saarbrücken-Frankfurt, the Germans had suffered a drastic and fateful curtailment of rail movements. Otherwise, necessary traffic got through, even though local complications and delays were suffered. It was apparent that the Allies had tried to do too much, that they had spread their effort too thin. In the future they would concentrate all types of aircraft over very limited areas in order to produce railway deserts of the Cologne-Coblenz-Trier type wherever the land armies needed such paralysis for their own advances.

The disappointments of November and December notwithstanding, it would soon become evident that Germany's solid railway system had been seriously shaken. In the coming months there would be all kinds of evidence of its injuries: undelivered coal and raw materials, stranded manufactured parts, delays in troop movements, and finally, utter collapse.

### *The GAF Again*

The German fighter force once more became a menace of serious proportions to Allied air power in the last quarter of 1944. Each week USSTAF intelligence uneasily recorded an increase in the number of hostile fighters available to contest the British and Americans flying in from the west. With their wartime estimates according almost exactly with postwar German records,<sup>94</sup> the Allies rightly marked the rise in single-engine pursuits from 1,260 in September to about 1,700 in early November and then to 2,040 by the middle of the latter month. Twin-engine fighters for those periods increased from 675 to 800 and then to 855. Now that Germany had lost so many bases in France, Belgium, and the Balkans, she concentrated her fighters in the Reich; perhaps 85 per cent of her single-engine types faced the western Allies,<sup>95</sup> and by late September the Luftwaffe had almost abandoned the Wehrmacht to devote such fighting power as it had left to the Allied bomber fleets.<sup>96</sup> Practically all pretense at maintaining a bomber force was gone, and bomber pilots now flew fighters. Deployed from west to east for

hundreds of miles, Luftwaffe fighters could engage the Allies for almost the whole width of the Reich whenever their commanders chose to consume their scanty gasoline supplies in this fashion,<sup>97</sup> as sometimes they did.

This turn of affairs was unexpected. For months the Allies had been looking upon the GAF as a beaten arm, capable only of rare and ineffective retaliation. Not only was the German aircraft industry supposedly shattered beyond hope of significant recovery but the Luftwaffe had seemed almost helpless as the Allies liberated France and breached the Fatherland itself. During the late spring and summer of 1944 American bomber fleets had occasionally met interference on their daylight missions against the most vital targets, but more frequently their reports repeated the familiar line: "No enemy air opposition encountered." To be sure, USSTAF had not ignored aircraft production during the summer of 1944. Its air forces had directed 18,500 tons at aircraft factories, particularly those which produced twin-engine fighters and jets.<sup>98</sup>

It was the standard single-engine fighter, however, which loomed as the real threat to Allied air forces in the fall of 1944. Notwithstanding the devastation of much of Germany's aircraft industry in POINT-BLANK, Speer's ministry had worked its usual magic. Skilfully mobilizing materiel and manpower, it concentrated on the Me-109 and FW-190 types and effectively dispersed aircraft production from 27 main plants to 729 smaller ones, some of which were located in quarries, caves, mines, forests, or just in villages. In doing this, the Germans abandoned mass production methods and greatly increased their costs, but they also concealed most of their production centers from both the bombardiers and intelligence officers of their enemy. In the long run, the effort defeated itself, particularly when the transportation chaos of early 1945 paralyzed so much of the Reich, but the immediate effects were spectacular. The number of single-engine fighters accepted by the German Air Force rose from 1,016 in February 1944 at a steady rate month by month until it reached 3,013 in September, after which a slow decline set in.<sup>99</sup> The total number of fighters of all types produced in September 1944, Germany's peak month of the war in this respect, amounted to 4,103, which compared favorably with Speer's schedule calling for 5,372.<sup>100</sup> It was altogether an amazing feat of industrial planning and management, but fortunately the gasoline and pilot shortage forbade the use of fighters in any such numbers.

Not fully aware of the extent or of the exact nature of this recuperation, Allied air leaders tended to worry chiefly about jets. For some months USSTAF leaders had been nervously watching the enemy's activities in this matter, gleaning what data they could from intelligence sources and from high-altitude photographs of jet airfields. They were in possession of only spotty information about the construction and performance of the new airplane, but it was enough to make them highly uncomfortable. They knew that the stubby Me-163 could fly about 600 miles per hour at 25,000 feet, that an Ar-234 with high-altitude twin jet engines was likely to appear soon, and that an Me-262 with twin engines could outfly any British or American airplane.<sup>101</sup> All of these aircraft were known to be formidably armed. Not until July 1944 had the Allies made positive identification of jets in the air, and as yet the Me-163's occasionally found around Leipzig or the Me-262's hovering about the Munich area seldom fired at the heavy bomber formations. Though evidently attacking stragglers and reconnaissance aircraft, jet pilots ordinarily merely taunted the American flyers by showing off the superior performance of their airplanes from a safe distance.<sup>102</sup> While the jets cavorted menacingly the strategic bombers went about their missions. Their crews took care to experiment with new gunnery and formation tactics, and ample fighter escorts were always available in case the jets chose to offer battle. Some Allied gunfire must have been effective, for German records now available show eleven jets lost through "enemy action" in November and December 1944.<sup>103</sup>

The alarm felt at SHAEF and USSTAF had led Spaatz to place jet plants in a priority second only to oil in early September.<sup>104</sup> During the two-week period this priority was observed, several suspected jet establishments at Kiel, Leipheim, Stuttgart, and a few other localities were bombed with what seemed to be good results,<sup>105</sup> but later evidence showed no real interference with German production.<sup>106</sup> The industry was too well dispersed and concealed, as Spaatz soon realized. He then dropped the priority rating but determined to attack jet installations whenever and wherever they could be detected.<sup>107</sup> It was not without reason that the Americans, who could not plan on using jet fighters of their own until about October 1945, continued to worry about German jet production. While the enemy was experiencing many difficulties resulting from shortages, transportation problems, and bureaucratic mismanagement,<sup>108</sup> he might have attained his goal, understood

## THE ARMY AIR FORCES IN WORLD WAR II

by the Allies to be 500 planes per month by January 1945,<sup>109</sup> but for a circumstance not fully appreciated until after the war. This was the interference of one of Mr. Churchill's favorite strategists, "Corporal" Hitler. Against the almost solid will of his air advisers the Fuehrer had ordered a conversion of the Me-262 from a fighter into a light bomber for support of German land forces,<sup>110</sup> and thus delayed the effective appearance of jet aircraft in the air war until March 1945, when there was little war left for them to wage.

Ominous as seemed the threat of German jets during the last months of 1944, the very real presence of conventional fighters in growing numbers compelled immediate attention. Here too, the Germans had vacillated until September 1944 between using their fighters against Allied land forces and for interception purposes,<sup>111</sup> but after that the day-flying heavies of the Eighth Air Force seemed to bear the brunt of the enemy's fighters, with the Fifteenth continuing to run into nasty opposition at times over Vienna or Poland. On 27 and 28 September the Eighth encountered major fighter forces, losing sixty-four aircraft on the two days and shooting down from fifty-five to ninety Germans according to Nazi admissions and American claims, respectively. On October 6 a Fortress formation heading for Berlin lost the high squadron from its last combat wing when thirty-five German fighters dived out of the clouds and closed in from the rear before the escorts could deal with them. Air combats on the 7th cost the Eighth Air Force forty-one aircraft and the Germans at least a fourth of the eighty fighters they put up.<sup>112</sup>

Then a lull ensued. For more than three weeks the Eighth's flyers seldom saw a German fighter and made no claims whatsoever. The Fifteenth had difficulty only once, when on 16 October its bombers ranged over Czechoslovakia and Austria and shot down sixteen (admitted) or nineteen (claimed) Germans. Having hoarded sufficient gasoline the Nazis rose on 2 November 400 strong, the largest number they had been able to get into the air at one time since early June. One combat force from the Eighth about to bomb the synthetic oil plant at Merseburg-Leuna was shielded effectively by its escorts, but another force was less fortunate. Before its protecting Mustangs could interfere, some sixty German fighters closed in to shoot into the rear bomber formations.<sup>113</sup> But for a lucky chain of circumstances and almost perfect fighter cover, Spaatz wrote Arnold, many more bombers would have been lost than the twenty-six that fell to the Nazis.<sup>114</sup>



## AUTUMN ASSAULT ON GERMANY

This experience of 2 November made a deep impression on AAF leaders. It confirmed their suspicions that the Germans were quite capable of doing enormous damage to their bomber fleets. General Doolittle estimated that the enemy might even be able to bring down 100 American bombers on any deep penetration of the Reich. The Me-109's and FW-190's had new and heavier armament and were employing extremely effective explosive and incendiary projectiles. It might soon become possible for them to fire safely at American bombers from out of range of the U.S. .50-cal. guns. Doolittle found further cause for alarm in new German tactics, especially the line-abreast approach they were then using, and he complained of an Eighth Air Force shortage of fighters. The fighter-to-bomber ratio was "appalling low," only 1 to 2, with 1 to 1 very desirable and 2 to 1 the ideal. Doolittle also hoped for a movement as far east perhaps as Luxembourg of radar installations upon which the Eighth depended.<sup>115</sup> While registering these opinions with Spaatz, Doolittle told his staff in mid-November that the Eighth soon might have to drop its strategic objectives in order to beat the GAF again.<sup>116</sup>

General Spaatz warned Arnold on 5 November, soon after the big combat over Merseburg-Leuna, that a real likelihood existed of a dangerous GAF resurgence in the near future.<sup>117</sup> German fighters were obviously becoming more numerous, and the long spells of inactivity gave them an opportunity to hoard gasoline for occasional but wicked blows. Although the bomber strength of the Eighth had increased significantly since early 1944, there had been no corresponding rise in the number of fighter escorts. This had not mattered during the summer campaigns, when the Germans were preoccupied with the land battle, but now that the front was stabilized, enemy fighters might operate in almost full force against the strategic bombers. Spaatz hoped to meet the problem without upsetting prevailing bombing priorities. Probably the best measure would be to hammer away remorselessly at oil production until the Germans had no fuel to fly with at all, but he agreed with Doolittle that movement of radar installations to the continent was vitally necessary. He was prepared to reduce the size of bomber forces which operated in deep penetrations should this undesirable step be necessary in view of Luftwaffe resistance. These views brought gloomy reactions in Washington.<sup>118</sup>

While persistently holding to oil as the top priority and according the German aircraft industry no specific priority, USSTAF did not

ignore that target system entirely. The tonnages dropped on it by the Eighth and Fifteenth Air Forces during September, October, November, and December 1944 amounted to 2,026, 3,409, 356, and 350, respectively.<sup>119</sup> The bombs were more or less evenly distributed between airframe and engine production. The Fifteenth operated against an Me-109 components factory at Győr, Hungary, on 20 September and damaged engine plants at Munich on the 22d. The Eighth Air Force sent 381 Fortresses to attack Focke-Wulf plants at Hemelingen and Hastedt on 26 September, but no fresh damage of importance ensued. On 12 October, 238 B-17's of the Eighth achieved considerable success at Hastedt. The Eighth struck at the Junkers aeroengine factory at Magdeburg on 23 September, severely damaging this source of one-third of the Junkers engines. On 6 October large Eighth Air Force missions destroyed the Arado assembly plant at Neubrandenburg, hit all major buildings at the Bayerische Motorenwerke near Berlin, damaged the Klochner-Humboldt-Deutz engine works at Hamburg, and struck workshops and hangars at a jet airfield near Wenzendorf. On 7 October, 118 Fortresses wrecked many buildings at the Basser aircraft repair factory in Zwickau and destroyed three of five large workshops at the Henschel factory in Kassel. The Eighth dealt still another hard blow on 12 October, when 238 B-17's bombed the Focke-Wulf components factory at Bremen. Missions of 9 and 19 October against the Gustavsburg assembly plant were less successful. Meanwhile, the Fifteenth Air Force bombed aircraft production installations at Klagenfurt five times, though with discouraging effects, and did severe damage to an engine plant at Graz on 16 October.<sup>120</sup> Intelligence toward the last of October having revealed that the Germans were repairing their bombed plants with their customary speed and, more significantly, were dispersing others to unknown localities with great efficiency, attacks on aircraft plants tapered off to inconsequential raids for the next four months.

Attention was also directed to another target possibility: airfields where German warplanes lay idle most of the time for lack of fuel. As early as 22 September, Spaatz had expressed the belief that heavy bomber attacks on these airdromes might be useful as a measure to keep the GAF from flying.<sup>121</sup> Accordingly, nine USSTAF missions took place during that month against air bases in Germany. The pace was increased in October. Small forces of heavy bombers did considerable damage to airfields at Paderborn, Stade, Nordhausen, Lippstadt, Han-

dorf, Speyerdorf, and Wenzendorf. Surveying the results at the end of the month, USSTAF intelligence advised that it would be useless to try to demolish the 350 or more airfields available to the Germans, even if a number of aircraft were destroyed in the raids. Rather, left-over bombing effort should be used and applied only to selected bases in the west.<sup>122</sup>

During November the strategic air forces devoted more effort to German operational bases than to aircraft production plants. The chief targets of the Eighth Air Force in this category were Nordholz, Hanau, Ostheim, Cologne, and Wiesbaden. The Fifteenth concurrently bombed bases in Greece, Austria, northern Italy, and others occasionally in southern Germany. In most cases the pilots reported damage to hangars, workshops, landing areas, and it was apparent that the raids somewhat complicated the problems of the GAF. But at best this was a halfhearted offensive, not really sustained or carried out on a large scale and nothing like the pre-OVERLORD bombings of air bases in France. Besides, it was easy enough for the Germans to repair their bombed fields or make use of alternate bases. Only on a short-term tactical basis could airfield attacks be considered worth the effort.<sup>123</sup> The Allies guessed rightly, as is now known from German records,<sup>124</sup> that the number of Nazi airplanes wrecked on the ground was relatively small.

No less accurate was the Spaatz report to Washington in December that the enemy possessed a very formidable fighter strength,<sup>125</sup> for in fact the GAF was numerically larger in December 1944 than it had ever been.<sup>126</sup> Fortunately, its effectiveness was not commensurate with its size, and Spaatz's plan to counter chiefly by maintaining pressure on the German fuel supply showed an accurate estimate of the GAF's chief weakness. He hoped also soon to base Eighth Air Force fighters on the continent and indicated to Washington that he would be very much pleased to receive about 500 more fighters.<sup>127</sup>

On several occasions during November and December the Luftwaffe showed that its new strength could be brought to bear against American bomber formations. Adolf Galland, the commander of the fighter arm, began to employ his forces in large, concentrated air battles instead of dissipating them in isolated efforts at interception. This measure was costly in gasoline and could therefore be attempted only rarely, but in such an operation the Germans had hopes of bringing down as many as 400 or more bombers. While he fiercely demanded such a success,

Hermann Goering seems to have done nothing toward improving morale by raging at his fighter commanders, calling them cowards and threatening to transfer them to the infantry.<sup>128</sup> Nevertheless, the GAF staged several impressive efforts. Eighth and Fifteenth Air Force bombers would bomb the Reich at will for weeks at a time without any air opposition. Then, unpredictably, German fighters would attack them in great force and become dormant again for a long period. On 21 November, after almost three weeks of inactivity, some 400 German fighters rose to intercept Fortresses in the Leipzig area. Fortunately, the Nazis were unusually awkward in assembling their forces for the attack and Mustangs were able to protect all of the bomber formations but one, which lost five B-17's.<sup>129</sup> Five days later nearly a thousand Fortresses and Liberators stimulated one of the largest Luftwaffe reactions on record. About 550 enemy fighters, some of which were drawn from the tactical air forces, brought down 25 heavies near Hannover. The German attacks were unusually vicious, and the dangerous line-abreast approach proved deadly to one entire bomber squadron.<sup>130</sup>

The largest sighting of German interceptors on any one day to that point came on 27 November 1944, when perhaps as many as 750 were airborne. But luck was with the Americans. The Germans stupidly mistook a huge force of P-51's for bombers and tangled with the Mustangs, after which it was too late to rectify their error. In the ensuing air battles the Mustangs lost only eleven aircraft and claimed ninety-eight Nazis. Meanwhile, the bombers proceeded to Bingen and Offenburg without sighting a single enemy airplane.<sup>131</sup> There was sporadic German opposition on 30 November, when 1,200 Eighth Air Force heavies attacked oil targets in central Germany. On 2 December the Germans made their first serious effort in months to defend targets west of the Rhine, sending about 150 fighters to intercept the Liberators, eight of which they shot down.<sup>132</sup> Three days later, when the Eighth bombed Berlin, 300 German fighters attempted to interfere. The result of this battle was four bombers shot down and claims of ninety German fighters destroyed.<sup>133</sup> And then a lull set in. For more than two weeks the Eighth encountered no German air opposition, not even when it dispatched a record force of 1,467 bombers to the Reich on 11 December. Nor did the Fifteenth Air Force report any important conflicts with enemy fighters.

An unpleasant explanation of the Luftwaffe's inactivity became evident soon after the Ardennes counteroffensive began. Obviously, the

Germans had been saving up their gasoline for this blow. Weather conditions prevented almost all aerial activity in the west for the first few days, a factor on which the German ground commanders were counting heavily. Fighters gave the Fifteenth Air Force some opposition over Poland on 17 December, but it was not until the 23d that a real break in the weather came in the west. On that day 800 German fighters tried without much success to interfere with the Allied heavy bombers which were desperately smashing at railheads and transportation choke-points. Similar opposition occurred on 24 December, when the Eighth Air Force broke all records by sending 1,900 heavy bombers into Germany to attack tactical targets in excellent flying weather.<sup>134</sup> On Christmas Day the Germans once more offered battle.<sup>135</sup> The experience, however, evidently convinced the enemy that he could not oppose the well-escorted daylight bomber with any hope of success.<sup>136</sup> The Eighth Air Force lost only 13 heavy bombers in those three days to fighter attacks, and its consolidated claims of about 220 German fighters do not seem at all unreasonable when matched with German figures for losses in the west for the month.<sup>137</sup> Goering resumed his tirades against his fighter commanders.<sup>138</sup> Plainly, the German Air Force had failed again, and for the next five days it licked its wounds.

But again, the lull was followed by a blitz, an effective interception of Fortresses on 31 December near Hannover, which cost the Americans fourteen bombers. On the next morning, 1 January 1945, the Luftwaffe dealt a savage New Year's Day blow at Allied air bases in the Netherlands and Belgium. Between 0800 and 1000 about 700 German aircraft (Goering later said 2,300)<sup>139</sup> laid on a stunning attack. It was an ugly surprise for the Allies, who lost 156 airplanes, 36 of which were American.<sup>140</sup> Spaatz paid tribute to the careful planning that lay behind the German operation.<sup>141</sup> Again the Luftwaffe had demonstrated its versatility and aggressiveness. Yet the Fuehrer, who had fathered the idea,<sup>142</sup> lost far more than he gained. While he was able to replace his losses of airplanes readily, just as the Allies could, he had expended some of his last remaining capable pilots and key squadron leaders. The evidence indicated in fact that 1 January 1945 was one of the worst single days for human and aircraft losses the Luftwaffe ever experienced, and the military effect on the Allies, save for some embarrassment, was truly negligible.<sup>143</sup>

As the Bulge was closed in January 1945, Allied leaders soberly reappraised the prospects of winning the European war. Plans for an

offensive to the Rhine had been set back for weeks, and other aspects of the situation were discouraging. General Arnold thought the Germans might have 3,000 to 4,000 single-engine fighters of the conventional type by spring, and felt it might even be necessary for the CCS to issue an overriding directive aimed at the reconquest of the Luftwaffe.<sup>144</sup> USSTAF intelligence assessed the German fighter force as more formidable, confident, and aggressive than it had been since the Big Week of February 1944.<sup>145</sup> And everyone knew it was entirely possible that jets could upset the balance of air power in Europe if the war lasted beyond summer. General Spaatz, unlike Arnold, regarded jet fighters as more threatening in the near future than the Me-109's and FW-190's. He confided to Arnold, furthermore, that he was inclined sometimes to worry about a death ray or a motor-stopping beam which the Germans had been hinting mysteriously about.<sup>146</sup> Doolittle urged that the strategic air forces at once concentrate on rooting out jet plants, a stand which General Anderson strongly supported.<sup>147</sup>

### *Radar Bombing and the Weather*

The strategic air forces operated against Germany during the last quarter of 1944 in almost as great strength as they had in the preceding summer. This was all the more remarkable since the weather was, of course, much worse in the autumn and winter months and may have been, as the Allied leaders repeatedly and bitterly complained, the most disagreeable known in that part of the world for a generation. That tonnages of great weight could be poured on the enemy during these months is explained chiefly by the use of radar-bombing techniques.

A series of experiments conducted over Oxford, England, in August and September had substantiated the belief that H<sub>2</sub>X, the main dependence of the AAF bombers, could be used with some accuracy over cities, although individual targets in built-up areas would be very difficult to isolate.<sup>148</sup> Air officers in the theater clamored for more H<sub>2</sub>X instruments. Washington dispatched them steadily throughout 1944 but governed the flow by the availability of trained radar operators, somewhat to the exasperation of USSTAF, which wanted the sets at a faster rate and believed that the operators could be trained overseas.<sup>149</sup> The Eighth Air Force tried to equip two bombers in each group with H<sub>2</sub>X for service as pathfinders, and by the end of the year 78 per cent of the Eighth's heavy bombardment groups had them.<sup>150</sup> The Fifteenth Air Force followed a different scheme, dividing its bomber groups into Red

and Blue forces. The Reds had four pathfinders per group and were assigned all fighter escorts for attacks on major targets in Germany. The Blues ordinarily bombed visually and without fighter escort objectives closer to the Italian bases.<sup>151</sup>

Additional use was also made of Gee-H, an outgrowth of other Gee types that had not proved overly successful before 1944, which enabled an aircraft to establish its position by impulses emanating from Gee stations on the ground. Determining thus his position over Germany, the pilot could set a course toward the target and make a timed run, the bombardier releasing his bombs when a stop watch indicated the termination of the run. The Eighth Air Force had employed Gee-H extensively in its CROSSBOW operations, and when it became possible to establish Gee ground stations on the continent in September 1944 the heavies used this method in several tactical bombings and on a few strategic missions over western Germany. RAF Bomber Command found Gee-H particularly helpful in its night attacks.<sup>152</sup> Micro-H, a further refinement combining Gee-H and H<sub>2</sub>X, came into use in November 1944. The bomber would be guided to within about thirty-five miles of its targets by Gee, when operators through H<sub>2</sub>X picked up pulses transmitted by special stations at Namur and Verdun for assistance in setting a straight course to the target. Eventually, Micro-H became the monopoly of the 3d Bombardment Division, whose Liberators ordinarily attacked the targets in western Germany which were closest to the ground stations.<sup>153</sup>

Approximately 80 per cent of all Eighth Air Force and 70 per cent of Fifteenth Air Force missions during the last quarter of 1944 were characterized by some employment of blind-bombing devices.<sup>154</sup> Without these aids, important objectives might have enjoyed weeks or even months of respite, and on several occasions major task forces still failed even with radar to reach their targets because of adverse weather.<sup>155</sup> Constant study and assessment continued to show the not unanticipated conclusion that radar bombing was far less accurate than visual. For the last three months of 1944 the percentage of Eighth Air Force bombs that fell within 1,000 feet of the target was 38, 25, and 25, respectively; in the same months the Fifteenth Air Force score was 40, 36, and 36, and that air force continued to do much better than the Eighth in this respect.<sup>156</sup> In mid-November, operations analysts of the Eighth estimated that slightly more than half the blind missions of that organization were near failures or worse, and Spaatz was fully aware that radar

bombing was conspicuously less effective than visual attacks.<sup>157</sup> But radar bombing was better than no bombing. When days for visual missions might be as few as four per month, as in November 1944, radar devices were a godsend, even though their shortcomings were such as to offer a ready explanation for the determination of Spaatz and Doolittle to exploit every good flying day for all it was worth.<sup>158</sup>

Other problems demanded attention during the last of 1944. It became clear that too many heavy U.S. bombs were not exploding,<sup>159</sup> a fact which the Germans later confirmed with some pleasure. Considerable study and experimentation went into efforts to reduce this type of waste. Air discipline relaxed somewhat during the autumn and navigational errors became overly numerous, with the result that Doolittle tightened up on the crews in December.<sup>160</sup> USSTAF complained that the American heavy bombers were carrying more than their share of leaflets.<sup>161</sup> Flak was much deadlier now that the Germans had withdrawn most of their guns from lands they once occupied. A great wall of antiaircraft shells greeted the Allied bombers as they crossed into western Germany, and vulnerable targets and cities had more flak than ever before. While flak thus became a greater source of concern,<sup>162</sup> over-all losses remained much lower than they had been earlier in the year. The Eighth Air Force, for example, had lost 371 heavy bombers in April 1944 but only 117 in October, 174 in November, and 96 in December.<sup>163</sup> Finally, the flow of airplanes and crews from the United States declined in the autumn of 1944 after the widespread optimism of the late summer regarding an early termination of the war. This reduction caused a few Eighth Air Force units to operate at less than full strength until late in the year.

Among the proposals made during the fall for outwitting the weather was one to move the Fifteenth Air Force from southern Italy into the south of France. Thus its bombers would seldom have to vault the Alps, where flying conditions were so often prohibitive.<sup>164</sup> Spaatz and Eaker energetically opposed the plan on the ground that it would require too much time and logistical effort to create satisfactory French bases.<sup>165</sup> It was also pointed out that the Fifteenth could not reach from France some of its most vital targets in Czechoslovakia and eastern Germany. The proposal died as a result of this opposition, although a hope lingered that a few groups of the Fifteenth might move to Russian-controlled bases in Hungary. Similarly, General Arnold's suggestion that Eighth Air Force bomber bases be established in northern France<sup>166</sup>



met insurmountable resistance in the theater, again because of factors of time and logistics. By the end of 1944, however, French and Belgian bases were in a state of advanced preparation for the use of Eighth Air Force fighters, which long had made emergency use of RAF and Ninth Air Force airfields in France. Finally, Arnold and Spaatz talked about using French bases for very heavy bombers (B-29's) if the war lasted far into 1945,<sup>167</sup> but Germany was not destined to feel the power of those aircraft.

### *The Germans Postpone Defeat*

After the commanders conference at SHAEF on 5 December had committed the heavy bombers to extensive carpet-bombing operations,\* it had been clear that USSTAF's forces would devote much of their energies in the near future to direct support of ground. After the meeting Spaatz made a tour of army headquarters at the front in order to help arrange for the several offensives designed to bring the Allies to the Rhine. On 6 December he visited Patton and agreed to have his bombers carry out a gigantic blitz of two or three days within the next week or so. On the 7th he coordinated this plan with General Devers, and on the 8th he visited Bradley and promised to soften up the area in which the U.S. First and Ninth Armies expected to attack. Finally, he talked over the prospects of the several saturation bombings with Tedder on 9 December.<sup>168</sup> Nearly everyone was optimistic and thought the Germans weak.<sup>169</sup> General Arnold confidently looked for a historic victory in the tradition of Medjez-el-Bab and St.-Lô, and Doolittle thought it was going to be the greatest single air effort of all time.<sup>170</sup>

But the offensive was to be German. After German forces drove through the Ardennes in Hitler's last bid for victory in the west the U.S. strategic air forces were to devote much more of their effort to ground support than had been anticipated. One of the Eighth's three bombardment divisions was turned over to General Vandenberg of the Ninth Air Force as a "fire brigade." The other two divisions were placed under Eisenhower's immediate direction for the duration of the emergency. The heavies performed admirably, sometimes in weather that was theoretically unflyable. Almost 30,000 Eighth Air Force tons fell on communications targets such as bridges, marshalling yards, chokepoints, and road junctions.<sup>171</sup> The heavies also bombed towns which were believed to be used by the Germans as ordnance centers or

\* See above, p. 656.

transportation focal points. One such town, Malmédy, was the scene of a tragic error, for it was held by Allied troops at the time it was bombed.<sup>172</sup> By the day after Christmas, 1944, the Allies could breathe more easily, for it was then clear that the Germans were being contained. Still, the great majority of air force bombs for several weeks thereafter went on targets requested by the ground forces. It was a slow and costly task to close the Bulge, and strategic air plans like all others had to be rescheduled.

Fortunately, Germany's oil installations did not enjoy the respite from bombing that might have been expected during the Ardennes campaign. This was due to the Fifteenth Air Force, which covered itself with glory during this otherwise grim period. In one of the most remarkable series of sustained operations in the whole air offensive this command immobilized the chief refineries and rendered inoperative all of the synthetic petroleum plants on its list. The two Blechhammers, Odertal, Oswiecim, Brüx, and the several Austrian installations suffered heavy attacks in the days when von Rundstedt was astounding the Allies in the west. Even when the bombings were blind and the weather extremely adverse the Fifteenth's bombers achieved excellent results. And their losses were light, although they encountered spirited resistance on several missions.<sup>173</sup> The Eighth Air Force got in one good day's oil attack on 31 December at Misburg and Hamburg, and Bomber Command struck the recovering synthetic oil plant at Pölitz on the 21st, Scholven on the 29th, and Bochum on the 30th. By the end of 1944 only four crude-oil refineries and possibly five or six synthetics in the entire Reich were operating, and they were doing so on a reduced scale. Air Chief Marshal Tedder likened the German fuel position at the end of December to that in September, when the enemy was down to his last reserves.<sup>174</sup> Portal and Bottomley were likewise enthusiastic.<sup>175</sup> And Spaatz, looking with satisfaction at the oil situation, condemned the remaining targets to a "shellacking" at the first opportunity.<sup>176</sup>

Thus the oil campaign emerged in an hour of darkness as one bright feature. This strategic offensive alone had produced spectacular results in the last months of 1944, results which were felt in almost every area and type of German activity, and the assistance the heavy bombers had rendered in the emergency gave further cause for satisfaction. But other aspects of the air situation were less pleasing to contemplate. The bombings of tank and truck plants and ordnance depots had brought

## AUTUMN ASSAULT ON GERMANY

about little more than minor problems for the enemy; certainly he had been sufficiently equipped to drive alarmingly into the Ardennes when he chose. Attacks on German cities, which had killed 80,000 people and destroyed 130,000 buildings in the last four months of 1944, had not yet produced the panic or wide-scale economic disorganization so long prophesied by Air Marshal Harris and others. Radar bombing had not proved as effective as the American air leaders had expected. The German Air Force was more formidable than it had been for almost a year. And the enormous tonnages dropped on German communications had not prevented the Ardennes counteroffensive, although they surely helped to thwart it.

In ways not too evident at the beginning of 1945, Germany had been vitally injured by air power and her final collapse was not far off. Still, the mood in top army and air force circles just after the dark December of 1944 was not one of satisfaction but one of searching self-criticism.

## CHAPTER 19

\* \* \* \* \*

### *BATTLE OF THE BULGE*

THE shattering attack which the Germans unleashed in the early morning hours of 16 December 1944 against the weakly held Allied positions in the Ardennes had been in preparation for several months.<sup>1</sup> Plans for a large-scale counteroffensive were discussed at Hitler's headquarters in East Prussia early in September, as the Allied armies drew close to the German border. The original hope that such an attack might be made from the vicinity of Metz against the rear of Patton's Third Army, then approaching the Moselle, was soon surrendered, and on 25 September, when Montgomery was withdrawing his airborne troops from the Arnhem bridgehead, Hitler approved an outline plan of OKW for a thrust through the Ardennes. The detailed plan, approved by Hitler on 11 October and on the 28th of that month revealed to Field Marshal von Rundstedt, called for an offensive to be launched between 20 and 30 November in the Schnee Eifel on the approximately 75-mile front extending from Monschau to Echternach—a sector of the Allied line held in December by battle-worn American divisions. Striking with overwhelming force, the Germans would drive through the hilly and heavily wooded country to the Meuse and thence race for Antwerp.

If successful in getting across the Meuse, the Germans saw a chance to sever the communications lines of the U.S. First and Ninth Armies and of 21 Army Group and thus the possibility of destroying twenty to thirty Allied divisions. There does not seem to have been an expectation on the part of any of the planners that the offensive could possibly lead to another Dunkerque, but even a partial success would postpone Allied offensive action for a minimum period of six to eight weeks and bolster tremendously the morale of the German people and army.<sup>2</sup>

To reduce the effect of Allied air superiority, OKW had determined

to launch the attack during a protracted period of bad weather. In addition, to meet the demand of the field commanders for air support, Hitler and Goering gave assurances that the strength of the supporting tactical air arm was being raised to some 3,000 fighters.<sup>3</sup> Fearing that such rash and absolutely irresponsible promises were bound to add further fuel to the bitterness already felt by many field commanders against the Luftwaffe for its "sins" of August and September,<sup>4</sup> Air Force Command West deemed it imperative to inform C-in-C West and the commanding general of Army Group B on 2 December of the fact that its available fighter strength was at most 1,700 planes, of which number possibly 50 per cent were operational.<sup>5</sup> A sober postwar German estimate placed the strength of Air Force Command West on 16 December at 2,292 planes of all types, of which only 1,376 were then operational.<sup>6</sup> The successful execution of the enemy's plan, it is clear, depended much more upon the weakness of opposing ground forces, upon the promise of favorable weather, and upon the achievement of surprise than upon any hope of wresting control of the air, even momentarily, from the Allied air forces.

*Allied Intelligence Concerning the German Build-up*

Although the German attack caught the Allied high command and its battle-weary troops in the Ardennes with complete and devastating surprise, evidence of rapidly mounting enemy preparations on First Army's front had been gathered and reported during the latter part of November and the first two weeks of December by both air reconnaissance and ground intelligence.

Reconnaissance flights for Hodges' army were performed by the 67th Tactical Reconnaissance Group of IX TAC. During the period under consideration the 109th Squadron was responsible for most of the visual reconnaissance missions. The area of the group's operation encompassed, in the main, the region west and east of the Rhine extending roughly from München-Gladbach and Düsseldorf in the north to the line of the Moselle River in the south. In addition to the information gathered by this group, First Army also depended upon the observations reported by the 363d Tactical Reconnaissance Group and the 10th Photo Reconnaissance Group of XXIX and XIX TAC's respectively. Since the 363d Group covered chiefly Ninth Army's currently very narrow front of twelve to fifteen miles, its evidence of enemy movements, though valuable, served largely to complement the

GERMAN PREPARATION FOR  
THE  
ARDENNES COUNTEROFFENSIVE

- BATTLE LINE IS DEC.
- NATIONAL BOUNDARIES
- RAILROADS
- HIGHWAYS

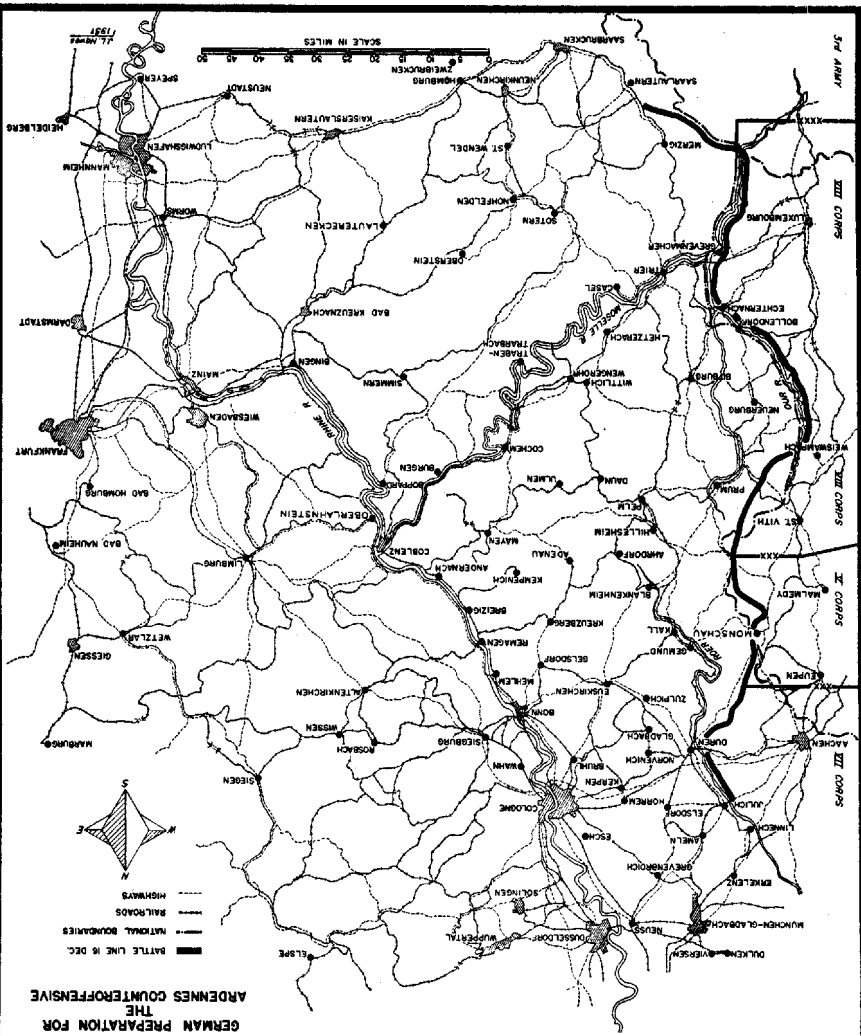
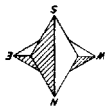

## BATTLE OF THE BULGE

information gathered by the 67th Group; but the observations of the 10th Group west of the Rhine covered approximately the area situated between the south bank of the Moselle and a line running eastward from Pfalzburg, through Rohrbach, Pirmasens, and Speyer, and on the east side of the Rhine extended from the vicinity of Giessen in the north to the neighborhood of Stuttgart in the south. Air reconnaissance thus not only had its eyes trained on the enemy's moves immediately in front of First Army but also beyond the Rhine and to a considerable depth on both of its flanks.<sup>7</sup>

The bad weather during the twenty-nine-day period running from 17 November to 16 December greatly hampered the effort of reconnaissance units of IX and XIX TAC's, each of which commands had ten totally nonoperational days, and the malfunctioning of navigational equipment upon occasion resulted in abortive missions. But 242 of the 361 missions flown by 67th Group aircraft were successful, while the record of 10th Group was 267 successful missions out of a total of 410 missions flown.<sup>8</sup> It should also be noted that additional air information about enemy activity was made available by the fighter-bombers, whose pilots on armed reconnaissance flights and offensive and defensive patrols over the front often reported the presence of enemy armor on rails and roads or hidden in villages and near-by woods.<sup>9</sup> Since so much of the enemy's movement took place under cover of darkness, it was unfortunate that the two night fighter squadrons (the 422d of IX TAC and the 425th of XIX TAC) were at this time, as they had been throughout the autumn, very seriously handicapped by an insufficient number of P-61 aircraft. The average operational strength of each squadron consisted of about ten P-61's and some worn-out A-20's.<sup>10</sup>

The enemy had carefully chosen his main assembly areas for the counteroffensive at a considerable distance north and south from the selected breakthrough sectors in order not to disclose the true intent of his far-reaching preparations. The divisions selected to constitute the first wave of the attack assembled in the areas of Rheydt, Jülich, and Düren in the north, along the Rhine between Cologne, Bonn, and Coblenz, and southwestward along the Moselle to the vicinity of Trier. Most of the troops of the second wave assembled south of the Moselle.

On 17 November aircraft of the 67th Tactical Reconnaissance Group were restricted by weather to six missions. Although all were reported as abortive with respect to achievement of their primary ob-

jectives, several planes reported steady vehicular traffic, composed mainly of motor transport and ambulances, between Jülich and Düren. Twenty-four missions of 10th Photo Reconnaissance Group reported scattered road traffic in various areas between the Rhine and the Moselle and considerable rail activity in the vicinity of Merzig, St. Wendel, Worms, and Mainz.

Improved weather on 18 November permitted IX TAC aircraft to fly thirty-two missions which disclosed heavy rail movement east of the Rhine in the area of Hamm, Münster, and Wuppertal, west of the Rhine between Coblenz and Mayen and in the vicinities of Euskirchen, Rheinbach, Hergarten, Gemünd, Gerolstein, Dahlem, Ahrdorf, and numerous other localities in the assembly areas of Sixth and Fifth Panzer Armies. Tracks in the snow at Gemünd indicated heavy road activity in that area. At Golzheim, situated a few miles northeast of Düren, fifteen to twenty large objects were noted in a field, objects which the pilots suspected to be canvas-covered trucks or supply piles. At Kreuzberg there appeared to be a supply dump. At several places camouflaged motor transport were observed. Tanks and flak guns were seen in many fields. The most significant information gathered on the forty-seven missions of Weyland's XIX TAC reconnaissance aircraft was the report of heavy rail activity at Fulda, Marburg, Limburg, and a number of other railheads and on railroads east of the Rhine. Rail movement west of this river appeared to be particularly notable at Saarbrücken, Merzig, St. Wendel, Bingen, Bad Kreuznach, and Zweibrücken. Numerous marshalling yards on both sides of the Rhine contained much rolling stock, including some engines with steam up. Flat cars on several rail lines were loaded with trucks and ambulances, possibly also some tanks. On this day, as was to be the case on every succeeding day, barge traffic on the Rhine, especially between Cologne, Bonn, and Coblenz, was decidedly heavy.

On 19 November the weather again permitted a substantial number of reconnaissance missions, IX TAC flying forty-three and XIX TAC thirty-eight. In the former's zone rail activity was found to be heavy throughout the area between the Rhine and the front, especially in and around Ichendorf, Nuttlar, Gerolstein, Mayen, Geseke, and Bitburg. Marshalling yards, particularly at Coblenz and Siegburg, were very active. Road movement was heavy. Truck convoys were seen heading south from Kordel and Gerolstein. At Lecherich approximately fifty haystacks were noted and suspected by the pilots to represent camou-



flaged vehicles in view of the fact that the vicinity showed no other haystacks. At another place tank tracks were noted leading up to haystacks. In numerous other places vehicular tracks were seen leading into wooded places. Supply stacks were noted at Rheinbach and Schleiden. Aircraft of XIX TAC reported intense activity throughout the day on most major railroads east of the Rhine and in numerous marshalling yards on both sides of that river. Rolling stock, including engines and box and flat cars, filled many marshalling yards to near capacity. Particularly was this the case at Fulda, Frankfurt, Hanau, Limburg, and Darmstadt, all situated to the east of the Rhine, and at Speyer, Bingen, Hamburg, Saarlautern, St. Wendel, Landau, Neustadt, and numerous other places west of the Rhine. An indication of the intense activity on the rail lines, not only of this day but of practically every day in this period, is to be had from the fact that one flight of reconnaissance aircraft would report a given railroad or center free from all activity while another flight over the same area a few hours later would observe several long trains with steam up or moving westward.

Bad weather from 20 through 24 November canceled all but half a dozen missions. During the following six days eighty-six reconnaissance missions were flown by IX TAC. On 25 and 26 November, heavy rail traffic was observed on the right bank of the Rhine, just east and north of Cologne, and between Coblenz, Bonn, Wahn, and Cologne. Several days later, especially on 30 November, rail movement west of the Rhine increased very noticeably, particularly in the area west of Cologne, from Neuss in the north to Münstereifel in the south. Twenty-five flats loaded with tanks were seen just to the east of Rheydt. The Cologne-Euskirchen-Kall rail line showed a total of fifteen freight trains. Twenty flats loaded with Tiger tanks were seen on the Euskirchen-Münstereifel railroad. Still another road near Euskirchen also contained a score or so of tank-loaded flats. Other centers of increased rail activity were Derkum, Kirchheim, and Kerpen. The marshalling yards of the major rail centers on both sides of the Rhine were heavily crowded. Road traffic was on a much-increased scale throughout the area west of the Rhine. Every day pilots were impressed with the size of this movement: at Zülpich, Hergarten, and Rheder (25 November); between Düren and Zülpich (26 November); and at Vossenack, Soller, Blatzheim, and a number of other villages in their vicinity (27 November). On the 28th, twenty-five trucks were seen on a road between Wollersheim and Stockheim, and pilots were under the impression that

there was a great deal of other activity on this road. The same day some twenty-five ambulances were observed going southwest from Blatzheim; twelve to fifteen tanks were seen near Oberzier moving off the road into a near-by wood; further, an undetermined number of camouflaged tanks were noticed near Hürtgen. Two days later, all sorts of vehicles, including ambulances, half-tracks, and trucks, were noticed either on the roads or parked in the towns of Nideggen, Berg, Vlatten, Buir, Vettweiss, Blatzheim, Bitburg, Udingen, and numerous other towns, villages, hamlets, and isolated farmsteads throughout the area. Many dug-in positions were noticed along both sides of the roads from Hollerath, Hellenthal, Harperscheid, Dreiborn, and Wollseifen, all places in the area from which Sixth SS Panzer Army's right flank struck some two weeks later against Elsenborn. Stacks of supplies were reported on both sides of the superhighway between Limburg and Siegburg (26 November) and at Rheinbach, Schleiden, and several other places west of the Rhine a few days later. The sixty-one missions flown by reconnaissance aircraft of XIX Tactical Air Command during this period disclosed pretty much the same pattern of enemy activity at Giessen, Fulda, Limburg, Alsfeld, Hanau, Frankfurt, and other rail centers east of the Rhine and in the area north and northeast of Merzig west of the Rhine.

The weather was atrocious during the first half of December. No reconnaissance flights were made by 67th Group on 1, 6, 7, 9, 12, and 13 December, while 10th Group's aircraft had no operations on 3, 7, 11, and 13 December. The evidence produced by the 174 missions flown by both commands on the other days of this period continued to emphasize the increased tempo of enemy preparations, not only on both flanks of First Army's front but more and more in the areas of the intended breakthrough attacks.

Very heavy rail movements were observed on 3 December east of the Rhine, from Münster, Wesel, and Düsseldorf in the north to Limburg in the south. Traffic was particularly heavy on the lines between Siegen and Cologne and Limburg and Cologne. Much of the cargo carried appeared to consist of tanks and other motor vehicles. For example, 170 flat cars seen between Cologne and Limburg were, for the most part, thought to carry tanks and motor vehicles. In the area of Sinzig, Coblenz, and Gerolstein pilots reported an additional seventy-two flats suspected to be loaded with the same type of cargo. The reports for 4 and 5 December also disclosed intense rail activity. But more and

more the center of this reported movement shifted to the west of the Rhine, in such rail centers as Grevenbroich, Düren, Cologne, Euskirchen, Liblar, Horrem, and Zülpich. Much significant road activity was also reported during these days. From twenty to thirty trucks and half-trucks were seen on 3 December moving in a southwesterly direction between Drove and Nideggen, all trucks bearing the American white square panel markings. On 4 December motor traffic appeared to be heaviest in the Schmidt area.

Weather precluded all reconnaissance missions during the daylight hours on 6 and 7 December. However, pilots of the 422d Night Fighter Squadron reported an unusual number of hooded lights along some roads on both banks of the Rhine during the evening of 5 December. They were thought to be road convoys. During the night of 6/7 December pilots of this squadron again reported that they had seen numerous lights, unshielded and spaced about half a mile apart farther west of the Rhine. Some of the lights seemed to follow road patterns, while others dotted the countryside at random.<sup>11</sup>

On 8, 10, 11, 14, and 15 December virtually every reconnaissance mission flown reported numerous trains, stationary or moving, on almost every line east and west of the Rhine. In addition to the many reports of "canvas-covered flat cars, loaded with tanks or trucks," there were, significantly, frequent reports of hospital trains seen west of the Rhine. As far as road movement is concerned the reports made more frequent mention of all sorts of vehicular traffic taking place nearer the front. Thus on 10, 11, 14, and 15 December such traffic was noticed at one time or another in or near Münstereifel, Wollseifen, Einruhr, Heimbach, Gemünd, Olzheim, Dahlem, and many other places in the same general area. On the 14th several trucks and a 200-yard-long column of infantry were reported on the side of a road near Einruhr (vicinity of Monschau). On 15 December more than 120 vehicles were noticed proceeding south from Heimbach, while a number of trucks were seen moving west from Dahlem forest. There were also increased reports of loading sites noticed in wooded areas (at Prüm, for example) and flak and gun concentrations near the front. For instance, on 14 December, twenty to twenty-four dual-purpose guns were seen on a hill in the vicinity of Einruhr. None of the guns were camouflaged.

A similar story of feverish enemy activity is to be found in the reconnaissance reports of XIX Tactical Air Command. On 2 December, for example, a great deal of rail movement was noted east of the Rhine at

such centers as Karlsruhe, Darmstadt, Limburg, Wetzlar, and Lahnstein, and at Bingen, Ludwigshafen, Homburg, Kaiserslautern, Saarburg, Merzig, and Trier west of the Rhine. Stacks of lumber (probably intended for bridging purposes) and a great many vehicles were observed north of Trier, not far from Echternach. Very heavy rail traffic was reported three days later in the vicinities of Frankfurt and Hanau and between Bingen and Bad Kreuznach. Such notations by pilots as "20 plus loaded flats, canvas covered, possible MT," "flats appeared to be loaded with tanks and trucks," or "flats were loaded with what appeared to be armor," recur in the reports with monotonous regularity. Road traffic was also on a very heavy scale. During the night of 6/7 December, aircraft of the 425th Night Fighter Squadron detected large motor convoys moving in various directions in the areas of Traben-Trarbach, Homburg, Neunkirchen, and Kaiserslautern. Again, on 12 and 14 December extremely heavy transport movements were observed during daytime in the general area of Saarlautern, Völklingen, Merzig, Ottweiler, Nohfelden, St. Wendel, and Neunkirchen. The traffic moved in all directions and on all main and secondary roads. Aside from this intense road traffic, pilots during these December days also reported stacks of large boxes along many roads in the Moselle area. Finally, to mention but one more item of equipment which caught the eye of the pilots, there was the discovery on 6/7 December of fifty searchlights in the Kaiserslautern area, equipment which, by the way, was used in the early morning hours of 16 December to light up the attack area of Fifth Panzer Army.

Such, then, was the evidence of increased German activity which air reconnaissance observed and reported. On the ground, the elaborate German precautionary measures notwithstanding, Allied intelligence also picked up information. During November and the early days of December it had been noticed that a number of divisions and considerable armor were being withdrawn from the front line, particularly on the Cologne sector, a movement which was usually regarded merely as a withdrawal for rest and not as a protracted disengagement in preparation for offensive action. Gradually, however, as the withdrawal stopped and a general westward movement of troops, armor, and supplies commenced on an ever increasing scale, as news of the establishment of new armies and/or army headquarters was received, as the general whereabouts of the Sixth and Fifth Panzer Armies was pieced together from a variety of sources of information, these German moves



**BATTLE OF THE BULGE: NINTH AIR FORCE HITS ST.-VITH**



**BATTLE OF THE BULGE: BOMBED-OUT PANZER**

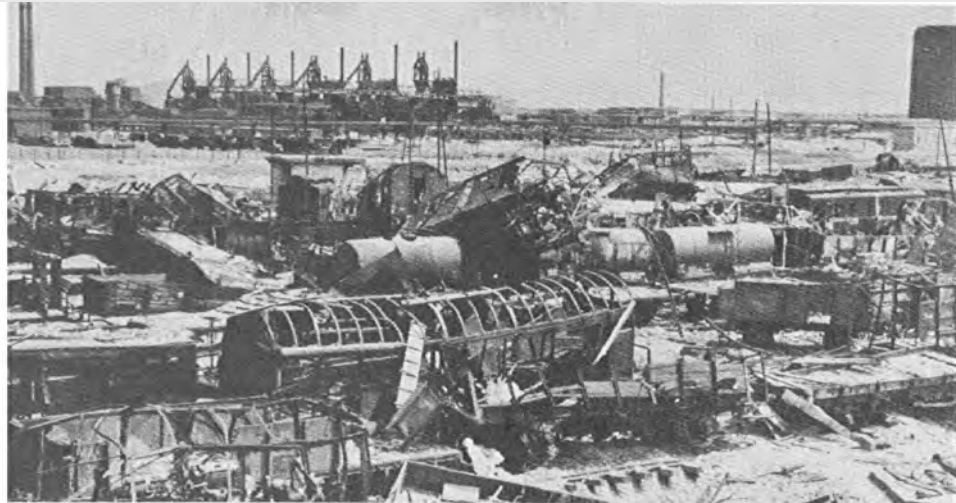

**MARSHALLING YARDS**

*Top: LINZ*

*Middle: DASBURG*

*Bottom: SALZBURG*



NAZIS WATCH AS EIGHTH AIR FORCE BOMBS FACTORY AT KASSEL



became the subject of much speculation in the intelligence reports of 12th Army Group, SHAEF, First Army, and, though to a lesser extent, of Third Army.<sup>12</sup>

Just why, in the light of the mounting information regarding the enemy's preparations and the noticeable shift of his activity into the area opposite the Ardennes, the Allies should have been surprised by the German offensive of mid-December remains something of a mystery. It is clear enough that the failure was one primarily of interpretation, but the lines of responsibility are so blurred and the failure is so complete as to leave no other choice than the assumption that all organizations charged with processing the raw materials brought back by the reconnaissance pilots fell down on the job. The ultimate responsibility for interpretation lay with the ground forces, except on points pertaining to enemy air potentialities, but the air force was responsible for the initial screening of the results of its own reconnaissance. Perhaps the chief fault was one of organization, for there seems to have been a twilight zone between air and ground headquarters in which the responsibility had not been sufficiently pinned down.

General Arnold was prompt in asking of Spaatz a report on the effectiveness of air reconnaissance. In a letter of 30 December 1944 he requested specifically the latter's

careful appraisal of the exact part played by the Army Air Forces. What was reported by our units? Did the Army Air Forces evaluate any of the raw data received from our reconnaissance? If you feel that the record is clear on the Army Air Forces performance, please let me know confidentially any further details that will help to understand how the overall system functioned in this period.<sup>13</sup>

In his answer of 7 January 1945, Spaatz admitted that the German counteroffensive "undoubtedly caught us off balance" and detailed at some length the effort which the Eighth and Ninth Air Forces had expended in assisting the ground forces to stop the German attack, but he touched only briefly upon General Arnold's inquiries before pointing out that the Ninth Air Force had kept its tactical reconnaissance aircraft on all parts of the battle front to the extent that weather had permitted and that because of adverse weather only occasionally had portions of the Ardennes area been open to visual and photographic reconnaissance.<sup>14</sup>

The enemy activity reported by reconnaissance had not, of course, gone free of Allied attention. Indeed, the Ninth Air Force during the period of 1-16 December had employed, in accordance with priorities

fixed by 12th Army Group, almost all of the fighter-bombers of IX TAC and a good portion of the medium bombers of the 9th Bombardment Division on attacks against the innumerable towns and villages on First Army's front with the objective of destroying the troops housed in them and the equipment and supplies stored there. Thus, to mention but a few examples, the fighter-bombers bombed and strafed, usually in squadron or group strength, Zülpich ten times, Euskirchen nine, Bergstein six, Nideggen four, Schleiden three, and Wollseifen, Rheinbach, and Kreuzau twice. The preponderance of the medium bomber attacks fell, among a number of others, upon such villages and towns as Münstereifel, Nideggen, Oberzier, Harperscheid, Schleiden, Hellenenthal, and Dreiborn. Mention should also be made of the fact that the fighter-bombers of XXIX TAC during this period accented their attacks on Ninth Army's front upon the many villages and towns in the area. Finally, the Eighth Air Force, currently operating under a directive which placed transportation targets second in priority only to oil,\* struck heavily during the first half of December against such marshaling yards as Münster, Soest, Kassel, Hannover, Giessen, Oberlahnstein, Mainz, Frankfurt, Hanau, Darmstadt, and Stuttgart east of the Rhine, and Bingen and Coblenz west of the Rhine.<sup>15</sup> But all these operations, so far as the evidence shows, represented nothing more than a standard response to enemy activity or the attempt to meet the requirements of previously established directives.

On 15 December, some eighteen hours before the Germans launched their attack, Eisenhower's G-3, in briefing the air commanders on the ground situation, dismissed the Ardennes with a simple "nothing to report."<sup>16</sup>

### *The German Breakthrough*

The German forces launched their offensive in the early morning hours of Saturday, 16 December. In the north, on the right and left flanks of V and VIII Corps, respectively, the Sixth SS Panzer Army, composed of five infantry and four panzer divisions, attacked with four infantry divisions on a twenty-five-mile front between Monschau and Krewinkel. Although the attack was preceded by a very heavy artillery barrage, the Germans, in order to maintain the element of surprise as long as possible, attacked initially, as they did in all breakout areas, with

\* See above, p. 653.

## BATTLE OF THE BULGE

small forces in order to give the impression of a reconnaissance in force.<sup>17</sup> This assault had been preceded by that of the Fifth Panzer Army which attacked with two infantry and four panzer divisions on a thirty-mile front roughly between Olzheim and Bitburg. Finally on the left flank, the enemy's Seventh Army, comprising four infantry divisions, attacked on a fifteen-mile front between Vianden and Echternach. Its chief mission was the establishment of a defensive line for cover of the main drives.

Utterly surprised, hopelessly outnumbered, and cleverly outmaneuvered, the front-line Allied troops, especially in the areas of the 106th, 28th, and 4th Divisions, were almost everywhere overwhelmed and were either cut off completely or forced to beat a hasty and disorganized retreat. Even so, the enemy's advance on this first day fell short of his expectations. Nowhere had the panzers succeeded in achieving quite the spectacular results so confidently expected by the German supreme command. Moreover, on the extreme southern and northern flanks progress had been unexpectedly slow. Failure, for example, of German infantry and armor to crush the stubborn resistance of elements of the 2d and 99th Divisions in the area of the Elsenborn ridge was particularly serious and was to have a decisive effect upon the ultimate failure of Sixth SS Panzer Army to accomplish any of its major objectives. The valiant resistance offered by encircled troops on a few roads or road junctions also helped to slow down the speed of the advance. Unfavorable weather early on the 16th had forced postponement until that night of a paratroop drop for seizure of several crossroads, and the effort then was so badly executed that the widely scattered paratroopers nowhere represented a real danger.<sup>18</sup>

During the next three days, 17-19 December, the whole VIII Corps area continued to be one of very fluid and confused fighting. The enemy continued to make very substantial progress. Here and there, small American units put up determined resistance only to be overwhelmed by vastly superior forces. At other places, notably at the exceedingly important road center of St.-Vith, retreating Americans, hastily reinforced by elements from divisions on other sectors of Hodges' front, fought for days so doggedly and heroically that the enemy's timetable was seriously upset. At still other places, retreating units were thrown into near panic by constant infiltration of enemy infantry. By the close of the first four days of the enemy's counteroffen-

# BATTLE OF THE BULGE

## 16 DEC. 1944-31 JAN. 1945



- NATIONAL BOUNDARIES
- MAIN HIGHWAYS
- FRONT 31 JAN. 1945
- MAXIMUM GERMAN PENETRATION 24 DEC. 1944
- ←-----→ FRONT 31 DEC. 1944
- FRONT 16 DEC. 1944
- ×○×○×○ FRONT 19 DEC. 1944

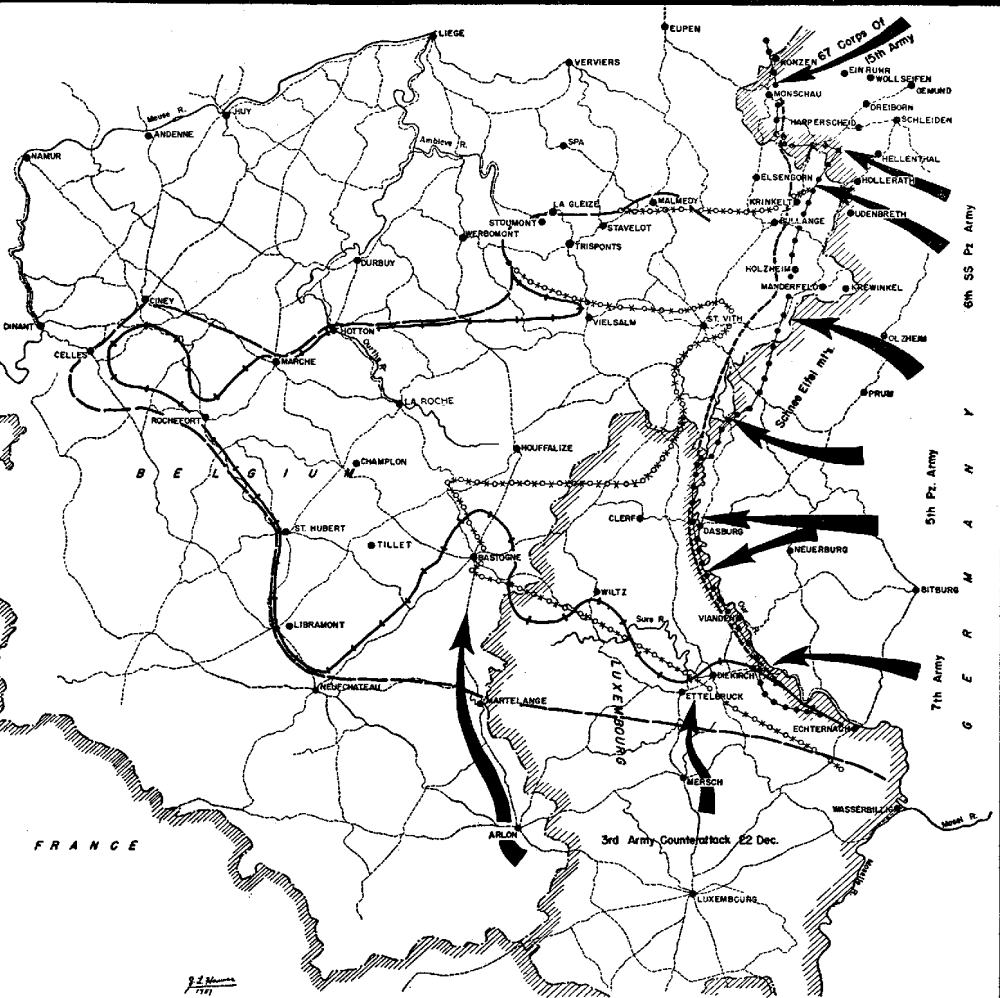

9-2  
1/41

sive, even though he had not made it to the Meuse as provided in his plans, the swift moves of Fifth Army's armored columns had made very deep penetrations in the south in the direction of Bastogne and in the north were within five miles of Werbomont.

Generals Eisenhower and Bradley had been in conference at Versailles on 16 December when the first news of the attack reached SHAEF headquarters. Both of them appear to have been convinced that a major enemy offensive was getting under way and as a precautionary measure agreed to undertake an immediate shift of some forces from Hodges' and Patton's armies to the Ardennes.<sup>19</sup> During the next few days, as news from the front disclosed the magnitude of the German effort and its success, measures to meet and counter the threat were quickly taken. The countermeasures had a fourfold purpose: first, to bolster the American troops on the northern and southern flanks of the penetration in order to confine the enemy to as narrow an area in the Ardennes as possible and thereby to restrict his maneuverability to difficult terrain and an inadequate network of roads for large-scale mobile warfare; second, to defend as long as possible key communications centers on the axis of the enemy advance, notably the road centers of St.-Vith and Bastogne; third, to establish an impenetrable defense line along the Meuse; and fourth, to regroup forces in preparation for a counteroffensive. All offensive action north and south of the enemy salient was halted, and infantry, airborne, and armored divisions were rushed to the shoulders of the penetrated area or into the battlefield itself.<sup>20</sup> By 19 December major elements of twenty-one divisions were engaged in attempts to halt the enemy offensive. Since Hodges' army had no reserves left to cope with the situation on its extreme right flank and SHAEF had no reserve of its own with which to relieve the dire emergency, it was obvious that assistance could be obtained only from Patton's Third Army. The latter was poised for a strong offensive of its own, and Generals Spaatz, Vandenberg, and Weyland joined Patton in the hope that it would not be necessary to scrub the operation.<sup>21</sup> But by 19 December it had been decided that Patton would pull out two corps for a swiftly executed counterattack northward against the flank of the enemy salient. General Patch's Seventh Army (the American component of Devers' 6th Army Group) was directed to halt its advance toward the Rhine and, sidestepping northward, to take over the Third Army's right flank.<sup>22</sup>

The enemy penetration had already put a serious strain upon Brad-

ley's communications from his headquarters at Luxembourg with Hodges' forces in the north. Eisenhower, therefore, on 20 December decided to split the battlefield through the middle of the enemy salient, the dividing line running generally due east from Givet on the Meuse to Prüm in the Reich. Field Marshal Montgomery was placed in charge of all the forces north of this line, including the entire U.S. Ninth Army and virtually the whole of U.S. First Army. General Bradley was left for the moment in command of the straggling remnants of VIII Corps and Patton's Third Army.<sup>23</sup> Simultaneously, the IX and XXIX TAC's were temporarily transferred to the operational control of 21 Army Group's air partner, Second TAF. Several days later, in order to effect a more equal distribution of tactical air power between Montgomery's and Bradley's forces, three fighter groups, the 365th, 367th, and 368th, were transferred from IX to XIX TAC, and both of these commands were subsequently reinforced by the transfer to each of them of one P-51 fighter-bomber group from the Eighth Air Force. The striking power of the Ninth Air Force was still more augmented when the entire 2d Bombardment Division of the Eighth Air Force was also placed temporarily under the former's operational control.<sup>24</sup>

During the first seven days of the battle the weather severely limited the help that could be rendered by Allied air power. The medium bombers of the Ninth were able to operate on only one day, 18 December. Fighter-bombers had no operations on the 20th and 22d and very few sorties on the 19th and 21st. Only on the 17th and 18th were they able to operate in any real strength. Virtually continuous fog over the bases in England prohibited assistance from the Eighth except for 18 and 19 December, and the operations of those days were in less than full strength.

As far as the fighter-bombers of the IX and XXIX TAC's were concerned, 16 December was just another typical winter day with foul weather limiting the day's operations to slightly over 100 sorties. There were the same routine targets—countless villages and numerous woods where enemy troops were known or suspected to be in hiding. A few of the missions also involved attempts at rail-cutting and bridge destruction, sorties which, because of low cloud and fog, all too often resulted in "unobserved results." In XIX TAC's zone of operation slightly better weather permitted the flying of 237 sorties. Traffic on railroads and highways between Coblenz, Homburg, and Trier was found to be heavy, and the fighter-bombers reported very lucrative

results from their strafing and bombing of trains and road convoys.

The GAF effort that day—of perhaps 150 fighter sorties—seems to have been restricted not only by the weather but by a desire not to disclose prematurely the full force of the offensive. On the next day, however, Luftwaffe fighters came out in real strength, flying between 600 and 700 sorties in support of the German ground forces, most of them in the vicinity of St.-Vith.<sup>25</sup> On the 17th, AAF fighter-bombers flew a total of 647 sorties in the First Army area, mostly on the Ardennes battle front and in most instances with a primary mission to render direct assistance to the ground forces. However, the Luftwaffe's aggressiveness on this and on the succeeding day frequently forced the pilots to jettison their bombs in order to fight enemy planes. The day's claims were 68 enemy aircraft destroyed at a cost of 16. The counteroffensive having been successfully started, and the Luftwaffe for once furnishing substantial cover in the battle area and its approaches, the enemy's armor and reinforcements of troops, equipment, and supplies came into the open, thereby offering the fighter-bombers very profitable hunting. Every fighter group engaged in the day's fighting in the Ardennes-Eifel region reported finding vehicular columns, occasionally bumper to bumper, on roads throughout the area. Bombing and strafing of the columns resulted in substantial claims of destruction of armored, motor, and horse-drawn vehicles. There were also moderate claims of rolling stock destroyed on several rail lines near the base of the attack sector of the front.

The 422d Night Fighter Squadron during the night of 17/18 December attacked the marshalling yards of Rheinbach, Gemünd, and Schleiden, with unobserved results, and flew several uneventful intruder patrol missions in V and VII Corps area.<sup>26</sup>

Fighter-bombers of IX TAC operated throughout the day of 18 December in support of the ground forces in the Ardennes, but deteriorating weather in the afternoon permitted the accomplishment of only about 300 successful sorties. One of the most successful achievements of the day was the bombing and strafing of an armored column along the road from Stavelot to La Gleize to Stoumont. The column had been sighted by air reconnaissance, and in response to the call for air attack, the 365th Fighter Group, with the help of three squadrons from two other groups, attacked the column repeatedly from one end to the other. The attack, carried out under exceedingly low ceiling, achieved excellent results, among the important claims being the destruction of

32 armored and 56 motor vehicles, in addition to damage to a large number of others. Ground and antiaircraft units in the area thereupon succeeded in stopping this particular thrust. Additional achievements of the day included successful attacks upon road and rail traffic from München-Gladbach in the north to Euskirchen, Zülpich, and Schleiden in the south. A number of aircraft were also successfully engaged, resulting in claims of 34 destroyed as against a loss of 4. Twelve night fighter sorties involved uneventful defensive patrols and the bombing of Dreiborn and Harperscheid.<sup>27</sup> Aircraft of the XXIX and XIX TAC's on this day flew only a few sorties in the Ardennes battle area, but 165 medium bombers dropped over 274 tons of bombs with good results on the defended villages of Harperscheid, Hellenthal, Blumenthal, Colef, Dreiborn, and Herrenthal.<sup>28</sup> The Eighth sent 963 heavy bombers against marshalling yards at Coblenz-Lützel, Cologne-Kalk, Ehrang, and Mainz and against road chokepoints between Luxembourg and the Rhine. On the following day 328 heavies attacked the Ehrang marshalling yard and a number of road centers west of Coblenz.<sup>29</sup>

During the four days beginning with 19 December, the low ceiling over bases and rain and snow throughout the battle area kept the operations of IX and XXIX TAC's to a few close support missions, several strafing attacks upon troops and armored vehicles at the front and at Dahlem and Zülpich, and a small number of attacks upon defended villages. The fighter-bombers of XIX TAC flew a total of 214 sorties, escorting RAF heavies on 19 December and during the night of 21/22 December in attacks against communications centers at Trier, Bonn, and Cologne.<sup>30</sup> Reconnaissance sorties, including photo, visual, and tactical in the Ardennes region and in the area immediately east from the base of the enemy salient to the Rhine, were flown on a substantial scale only on 17 and 18 December.<sup>31</sup>

On 22 December, though the weather over Second TAF's bases lifted to permit its planes to contribute some 80 sorties on patrols between Aachen and Trier, virtually all other operations had to be scrubbed. And so closed the first period of the enemy's counteroffensive. Indicative of the advantage he had gained from the weather is the fact that the Ninth Air Force with an average daily operational strength of 1,550 planes had been able to fly only 2,818 sorties of all types, of which number hardly more than 1,800 sorties had been flown in the actual battle area.<sup>32</sup> Because a substantial part of this effort had been devoted on 17 and 18 December to aerial combat, the close sup-



port provided the ground forces fell still further below the level to which they had become accustomed. Yet, aggregate claims for the two-day attacks by fighter-bombers on 18 and 19 December stood at 497 motor or other type enemy vehicles. Of more immediate consequence was the fact that the Luftwaffe, despite its new aggressiveness, achieved at no time and in no place even temporary air supremacy. Nowhere was it capable of breaking through fighter-bomber patrols to furnish even passing cover for the advanced panzer spearheads. Neither did its nightly effort result in disrupting Allied troop and supply movements; nor did it succeed in interfering seriously with the plans or operations of our own ground forces, although occasionally it did manage under cover of darkness or during foul weather to inflict casualties upon the troops. The Luftwaffe's effort had fallen off on 18 December from the preceding day's level to perhaps some 450 to 500 sorties, and on the following day it flew only about half as many. The weather undoubtedly was partly responsible, but fighter claims for 124 enemy aircraft shot down and claims by anti-aircraft crews to another 105 may be worth noting in this connection. Grounded on 20 and 21 December, the Luftwaffe got in less than 100 sorties, mainly in the area of Bastogne, on the 22d.

### *The Weather Breaks*

That the Luftwaffe had by no means used up all of its new strength was to be forcefully demonstrated when the weather changed on 23 December. The so-called "Russian High" (i.e., an eastern high-pressure area) had moved westward during the preceding night with the result that for five days the weather was superb for flying. The GAF sent out an estimated 800 fighter sorties that first day but half of these were assigned to defensive missions, for now it was possible for the Allies to bring to bear the full weight of their greatly superior air forces.

On 24 December enemy ground forces penetrated to within five miles of the Meuse, the nearest to that objective they were to get. But at Bastogne, the 101st Airborne Division with elements of the 9th and 10th Armored Divisions, aided by air supply from 23 to 27 December, gallantly fought off every enemy attack, and by the 26th the 4th Armored Division had pushed through a corridor for relief of the beleaguered garrison. Patton had launched his drive northward against the German Seventh Army on 22 December and thereafter steadily

slugged his way forward. Meanwhile, other Allied forces had gathered on the perimeter of the enemy's salient, and during the last five days of the month forced him slowly back on almost every sector. By 31 December the crisis had passed and Allied forces were assured of the ultimate victory.<sup>33</sup> In this change of fortunes the five days of "victory weather" for Allied air forces were of fundamental importance.

Since 19 December, Ninth Air Force had had ready, in accordance with 12th Army Group requests, a plan for medium bombers to interdict enemy movement into the critical area by destruction of rail bridges at Euskirchen, Ahrweiler, Mayen, and Eller and of marshalling yards and facilities at thirteen selected communications centers.<sup>34</sup> It was to supplement the strength of 9th Bombardment Division for this purpose that the Eighth's 2d Division of heavy bombers was made available to Ninth Air Force without reference to normal command channels.\* Increased effectiveness in this interdiction program would be sought by fighter-bomber attacks upon five connecting rail lines running from Wengerohr to Coblenz, Daun to Mayen, Ahrdorf to Sinzig, Euskirchen to Ehrang, and Pronsfeld to Gerolstein. Also, the Eighth Air Force would attack marshalling yards at Homburg, Kaiserslautern, Hanau, and Aschaffenburg.

For the 9th Bombardment Division, 23 December was a memorable day unequaled in the number of sorties flown since the days of Normandy. Of the 624 bombers dispatched, 465 reached their primary or secondary targets—the railroad bridges at Mayen, Eller, Euskirchen, and Ahrweiler, the railhead at Kyllburg, a road bridge at Saarburg, the marshalling yard at Prüm, and a number of communications centers, among them Neuerburg, Waxweiler, and Lunebach. A total of 899 tons of bombs was unloaded with good results. The day also marked the most furious encounter which the medium bombers had ever experienced with enemy fighters. Particularly noteworthy was the record of the 391st Bombardment Group. On its morning mission, having been unable to make contact with its fighter-bomber escort, aircraft of this group proceeded to attack the Ahrweiler bridge in the face of terrific flak and most determined enemy fighter opposition. Although sixteen bombers were lost in this action, the group successfully executed its afternoon mission, and for the day's work won a Presidential unit citation. Altogether the mediums lost 35 bombers during the day's operations and sustained damage to another 182.<sup>35</sup> The day's outstand-

\* See above, p. 686.

**INTERDICTION OPERATIONS**  
23 DEC. 44 TO 31 JAN. 45

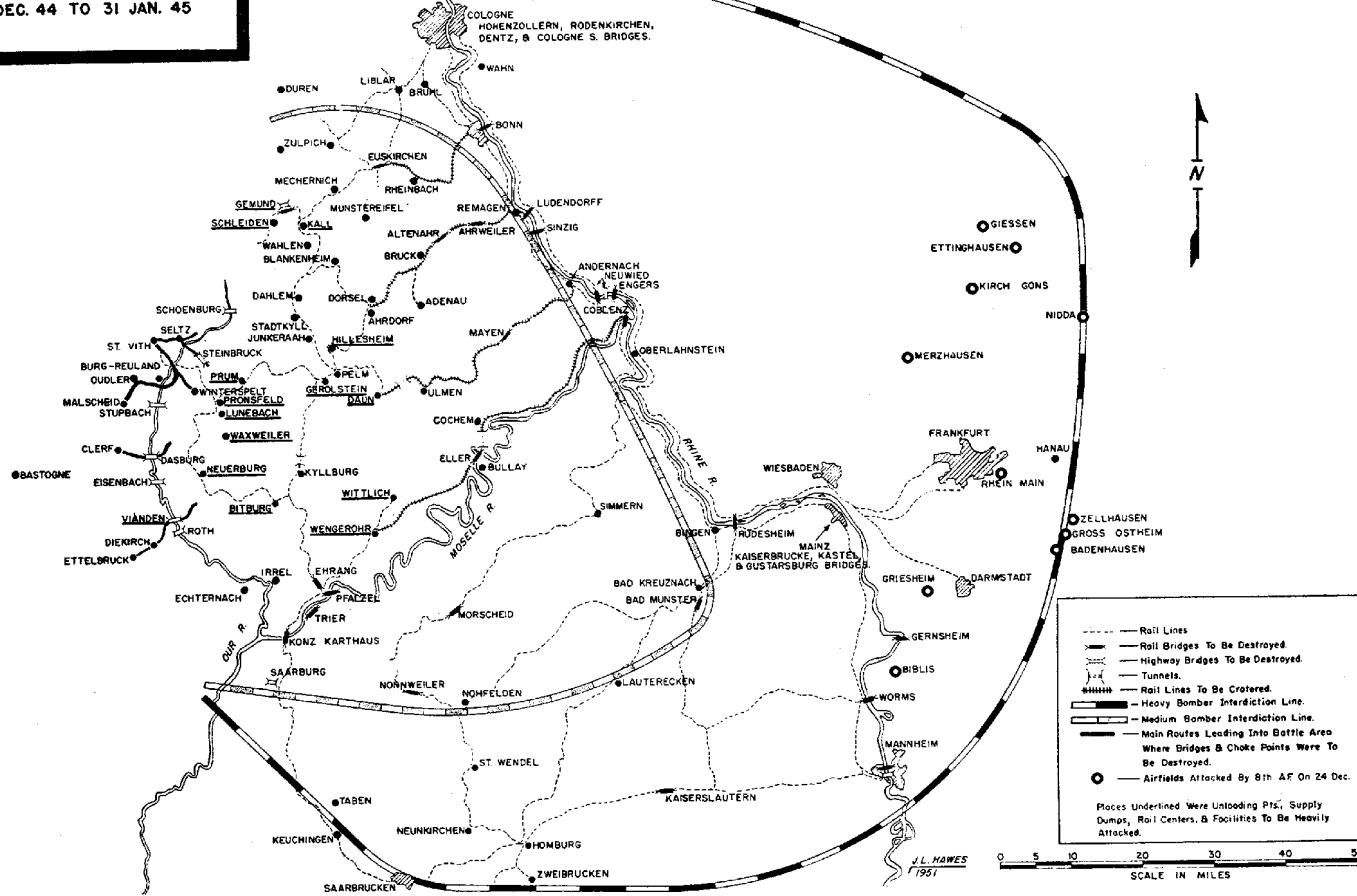

- Rail Lines
  - Rail Bridges To Be Destroyed
  - Highway Bridges To Be Destroyed
  - ▨▨▨▨ Tunnels
  - Rail Lines To Be Cratered
  - ▬▬▬▬ Heavy Bomber Interdiction Line
  - ▬▬▬▬ Medium Bomber Interdiction Line
  - Main Routes Leading Into Battle Area
  - Where Bridges & Choke Points Were To Be Destroyed
  - Airfields Attacked By 8th AF On 24 Dec.
- Places Underlined Were Unloading Pts., Supply Dumps, Rail Centers, & Facilities To Be Heavily Attacked.

0 5 10 20 30 40 50  
SCALE IN MILES

ing record unfortunately was marred by the bombing by five American aircraft of the Arlon marshalling yards in Belgium at a time when they were filled with tank cars loaded with gasoline for Third Army.<sup>86</sup>

The medium bomber effort was supplemented by 417 heavy bombers of the Eighth Air Force with attacks on marshalling yards on an outer interdiction line (Homburg, Kaiserslautern, and Ehrang), the communications centers of Junkerath, Dahlem, and Ahrweiler, and a number of targets of opportunity, all situated to the west of the Rhine. Approximately 1,150 tons of bombs were dropped with fair to good results. The 433 escorting fighters fought off an attempted interference by 78 enemy fighters, claiming destruction of 29 of them as against a loss of 2 bombers and 6 fighter aircraft. Another 183 Eighth Air Force fighters, while on free-lance sweeps over the tactical area, also encountered a very large enemy fighter force in the vicinity of Bonn. The ensuing combat ended with claims of 46 enemy aircraft at a cost of 9.<sup>87</sup>

Fighter-bombers under the operational control of Ninth Air Force flew a total of 696 sorties on 23 December. The 48th and 373d Groups of XXIX TAC (the other two groups having been unable to take off because of poor weather over their bases) concentrated their operations upon the installations, runways, and dispersal areas of the Bonn-Hangelar and Wahn airfields, destroying nine aircraft on the ground, demolishing seventeen buildings and two hangars, and damaging a number of other installations. Day fighters of IX TAC divided their effort between close cooperation with the 3d and 7th Armored Divisions in the Marche-St.-Vith area and on armed reconnaissance missions throughout the northern sector of the enemy penetration. XIX TAC had the major part of three fighter-bomber groups on escort for C-47's of IX Troop Carrier Command in supplying the surrounded troops at Bastogne, two groups on escort of medium bombers, while two other groups, with elements from the other five groups, supported Patton's advancing troops. All fighter-bomber sorties encountered considerable enemy opposition, especially in the areas of Euskirchen, Münstereifel, Mayen, Coblenz, and Trier. The day's claims of enemy aircraft destroyed amounted to ninety-one, as against a loss of nineteen. Chief ground claims included destruction of some 230 motor transport and armored vehicles, many buildings occupied by enemy troops, a sizable number of gun positions, much rolling stock, and seven rail cuts.

The two night fighter squadrons were able to mount only thirteen sorties, strafing the railhead at St.-Vith, attacking several towns in the

Nohfelden area, and destroying or damaging a small number of road transport in the tactical area. One P-61 was lost. Aircraft of the three reconnaissance groups (the 67th and 363d Tac/Recce Groups and the 10th Photo/Recce Group) flew a total of 113 sorties.<sup>38</sup> In addition, the RAF Bomber Command attacked rail centers on the outer line of interdiction and the railroad workshops at Trier, while the fighter and medium bombers of Second TAF attacked road targets in the Malmédy-St.-Vith area and several rail junctions east of the base of the salient, especially those at Kall and Gemünd. To relieve the Bastogne garrison, 260 C-47's of IX Troop Carrier Command dropped 668,021 pounds of supplies in parapacks on several dropping zones inside the besieged American positions.<sup>39</sup>

The resolute enemy fighter opposition of 23 December called for effective countermeasures on the following day. The heavy bombers of the Eighth were therefore directed to execute an exceedingly severe attack upon eleven airfields east of the Rhine. An even 1,400 heavy bombers, escorted by 726 fighters, dropped 3,506 tons of bombs on the airfields of Giessen, Ettinghausen, Kirch Gons, Nidda, Merzhausen, Rhein-Main, Zellhausen, Gross Osteim, Badenhausen, Griesheim, and Biblis and near-by targets of opportunity with generally good results. The operation was accomplished at a loss of 31 bombers and 12 fighters, but 84 enemy fighters were claimed destroyed and German fighter sorties over the Ardennes fell that day to perhaps no more than 400. In addition to the airfield attacks, 634 heavy bombers of the Eighth attacked 14 communications centers west of the Rhine, with an expenditure of 1,530 tons of bombs on Wittlich, Eller, Bitburg, Mayen, Ahrweiler, Gerolstein, Euskirchen, Daun, and other targets in the tactical area. Thirteen aircraft were lost in these operations. Claims against the enemy stood at eight fighters destroyed.<sup>40</sup>

The medium bombers continued their attacks within the inner zone of interdiction. Railroad bridges at Konz-Karthaus and Trier-Pfalzel and the Nideggen and Zulpich communications centers, together with several targets of opportunity, were on the receiving end of 686 tons of bombs dropped by 376 mediums. Generally good results were claimed for the attacks. Neither the mediums nor the escorting fighters of the 373d and 474th Groups suffered any losses, since enemy opposition was nil. The escort claimed good hunting of enemy motor transport at Rochefort and Hotton and in the areas of Malmédy, St.-Vith, and Schleiden.<sup>41</sup> The day's fighter-bomber sorties, including armed recon-

naissance, ground support on the northern and southern perimeters of the bulge, fighter sweeps, and escort missions, totaled 1,157. Approximately 506 tons of bombs were dropped on assorted targets, mainly road transport. Enemy opposition was encountered primarily on the southern flank, near Trier. Chief ground claims included destruction of 156 tanks and armored vehicles, 786 motor transport, 167 railroad cars, 5 ammunition dumps, 31 rail cuts, and successful attacks upon 85 gun positions. Night fighters again flew only a handful of sorties (14), mainly on patrol between the Meuse and Monschau. The three reconnaissance groups flew 161 successful sorties during the course of the day. Heavy road traffic was reported leading to all three enemy armies: to Sixth and Fifth Armies from Gemünd, Stadtkyll, Prüm, and Pronsfeld, and to Seventh Army from Neuerburg to Echternach. In the battle area itself the St.-Vith and Houffalize crossroads showed very heavy activity. Rail movement appeared to be significant mainly east of the Rhine.<sup>42</sup> Bastogne was resupplied with 319,412 pounds of supplies, dropped by 160 IX Troop Carrier Command aircraft.<sup>43</sup> Clear weather over most of the continental bases on Christmas Day enabled the Ninth Air Force to fly 1,920 sorties, of which number nearly 1,100 were executed by fighter-bombers, 629 by the medium bombers, 177 by reconnaissance aircraft, and about a score by the night fighters. The weight of the 1,237 tons of bombs dropped by the mediums was once more designed to interfere with the enemy's rail and road movement within his base area. Primary targets were the Konz-Karthaus and Nonnweiler rail bridges, road bridges at Taben and Keuchingen, and the communications centers of Bitburg, Wengerohr, Irrel, Vianden, Ahrdorf, Ahutte, Hillesheim, and Münstereifel. Escort was provided by the 352d Fighter Group. Enemy opposition was encountered chiefly in the Coblenz area. Only three bombers were lost, but heavy concentration of flak at almost all the targets resulted in damage to 223 medium bombers.

Two of XXIX TAC's groups, the 48th and 404th, were entirely weather-bound, but the 36th and 373d flew 170 sorties on armed reconnaissance in the St.-Vith-Stavelot and Euskirchen-Ahrweiler areas and attacked successfully the Bonn-Hangelar airfield. The fighter-bombers of the other two commands cooperated with their associated corps north and south of the breakthrough and ranged far and wide over the enemy's rearward areas as far east as the Rhine, exacting a tremendous toll of enemy road transport. The day's claims for all fighter-

## BATTLE OF THE BULGE

bombers amounted to 813 motor transport and 99 tanks and armored vehicles destroyed, in addition to claims resulting from attacks upon gun positions, ammunition dumps, buildings, rolling stock, rail cuts, and other targets within the entire tactical area. Enemy fighter encounters were on a reduced scale in comparison with previous days. In most instances the adversary showed much less inclination to tangle in combat. The day's claims were 24 enemy fighters destroyed at a cost of 18, mostly to antiaircraft fire. Night fighter activity consisted of uneventful defensive patrols in the St.-Vith-Monschau-Kall-Dahlem-Euskirchen areas. The reconnaissance missions reported heavy vehicular movement due west from Euskirchen toward the northern flank of the enemy salient, in the center from Prüm to Bullange, and in the south toward Bastogne. With two fighter-bomber groups of XXIX TAC grounded by weather, 371 aircraft of Second TAF's 83 Group carried out comprehensive armed reconnaissance between Düren in the north and Prüm in the south and westward to Stavelot. Their attacks upon road movement in the St.-Vith area resulted in claims of destruction or damage to 170 motor transport and 6 armored vehicles. Thirty-six medium bombers of this group also attacked the communications center of Junkerath.<sup>44</sup> Bad weather over most of England precluded all resupply missions to Bastogne and limited the Eighth Air Force to 422 heavy bomber attacks upon six communications centers in the tactical area and on five railroad bridges on the periphery of the outer line of interdiction west of the Rhine.<sup>45</sup>

By 26 December the tremendous effort of the tactical and strategic air forces of the preceding three days began to show its effect upon the enemy's ability to continue the offensive. Incessant cratering and cutting of the main highways and railroads, the destruction or serious damage done to a number of road and rail bridges, the blocking of chokepoints and narrow passes, and the heaping of huge piles of rubble upon the narrow streets of innumerable villages through which the enemy's movement had by now been canalized, all added to his supply difficulties. And this condition was still further aggravated by the loss of vast quantities of every type of vehicular transport. As Maj. Gen. Richard Metz, artillery commander on Fifth Panzer Army's front, put it rather discouragingly: "The attacks from the air by the opponent were so powerful that even single vehicles for the transport of personnel and motorcycles could only get through by going from cover to cover."<sup>46</sup> As the Allied defense in the northern perimeter and

at the nose of the salient stiffened and Third Army's counterattack gradually gained momentum, it was merely a question whether in a day or two the enemy would be forced to retreat. Already on 26 December, the 2d Panzer Division, which had pushed to within a few miles of the Meuse River, was surrounded and completely smashed when the bulk of its armor and transport ran entirely out of gasoline in the vicinity of Celles. Prisoners of war from almost every forward area of the penetration began to report increasing shortages of ammunition, fuel, and food.

Operations of the American tactical and strategic air forces during the remaining days of December continued on the pattern set during the three preceding days of superb flying weather, but after the 27th slowly deteriorating weather over much of France and Belgium resulted in a gradual decline of the number of sorties flown. The medium bombers had no operations on 28, 30, and 31 December, while on the 29th only six of their aircraft were able to attack. Fighter-bombers were totally nonoperational on 28 December, and on the other three days were able to mount only a total of 1,675 sorties. Weather over the heavy bomber bases in England, however, continued to be fair, enabling the Eighth Air Force to push relentlessly its attacks against marshalling yards, railheads, and bridges within both interdiction zones.

The medium bombers concentrated their attacks of 26 and 27 December upon the communications centers of La Roche and Houffalize, the railheads of Kall and Pronsfeld, and the rail bridges of Ahrweiler, Bad Münster, Eller, Konz-Karthaus, and Nonnweiler. Of the total of 879 medium bombers dispatched on these two days, 663 were able to attack their primary and secondary targets with 1,277 tons of bombs. With the exception of the Nonnweiler bridge, which was demolished and the approaches to it heavily damaged, and the Konz-Karthaus bridge, which was made temporarily unserviceable by direct hits on its east and west approaches, the rail-bridge attacks during these two days achieved only fair results, and those primarily through cutting of the tracks on the bridge approaches. However, when viewed in the light of the very considerable damage done by the medium and heavy bombers in their previous three days of attacks against rail bridges at Euskirchen, Mayen, Eller, Ehrang, Trier, Pfalz, Altenahr, and Morscheid and road bridges (including those at Taben, Keuchingen, and Saarb), it is evident that the bridge interdiction program was on the way to real success. More productive of immediate success were the



medium bomber attacks upon communications centers and railroads, where the heavy bomb loads would often blanket a huge area and dump enormous piles of rubble from the pulverized buildings upon the main tracks, sidings, and streets, thereby blocking all through traffic for days.<sup>47</sup>

The weather on 26 and 27 December enabled the fighter-bombers to fly 2,343 sorties over the battlefield and the enemy's base area. Their effort during the two-day period consisted of close cooperation with the operations of the ground forces, of armed reconnaissance over specifically designated areas or free-lance fighter sweeps throughout the Bulge area and as far east as the Rhine, of escort to medium bombers, and escort of transport aircraft on resupply missions to Bastogne. While attacks upon towns and villages were by no means neglected, motor transport and armored vehicles received particular attention with most gratifying results. Fighter-bombers of XXIX TAC performed mostly armed reconnaissance missions in the general area bounded by Düren in the north, Clerf in the south, and westward (roughly from Gemünd, Schleiden, Dahlem, and Clerf) to Marche, Rochefort, and St.-Hubert. The primary objective of their operations was maximum interference with the enemy's rail and road transport, especially the latter in Sixth SS Panzer Army's sector of the front and on the right flank of Fifth Panzer Army. Since much of this traffic was canalized through narrow streets of numerous towns and villages, these centers became the focal point of a very considerable portion of the 364 tons of bombs (GP, frag, and incendiary) dropped in the course of the 651 sorties flown during the two days. Road traffic was successfully attacked in the areas of St.-Vith, Malmédy, Clerf, Houffalize, and St.-Hubert and along several crowded highways leading to the Ardennes. Claims for the two days' operations were destruction of 191 motor transport, 49 tanks and armored vehicles, and 207 buildings and the achievement of 23 rail and 53 road cuts. Enemy air posed no problem, but 11 aircraft were lost to the enemy's concentrated and ever dangerous anti-aircraft fire.

Day fighter aircraft of IX TAC flew 590 sorties during this two-day period. The 289 sorties flown on the 26th were almost entirely on armed reconnaissance in the enemy salient, with a small number given to area cover and escort to medium bombers. Heavy damage was inflicted upon the built-up sections of the towns of Houffalize and La Roche. The next day's 301 sorties were devoted almost exclusively to support of the ground forces in First Army's sector of the Bulge. In

addition to attacks upon specific villages and towns requested by the ground forces, the fighter-bombers reaped a heavy harvest of enemy vehicles on the roads between Prüm, St.-Vith, and Houffalize. Enemy air opposition over the battlefield was insignificant, but on both days the 352d Fighter-Bomber Group encountered numerous enemy fighters while escorting medium bombers to targets in the inner interdiction zone. Combat with the enemy in the vicinities of Euskirchen, Mayen, Bonn, and Prüm resulted in claims of forty-five Luftwaffe fighters destroyed for a loss of five. An additional six fighter-bombers were lost to enemy flak.

The XIX TAC flew 1,102 fighter-bomber sorties during the period in question. On 26 December, three fighter-bomber groups (362d, 406th, and 405th) flew in close cooperation with the operations of III, VIII, and XII Corps, and two groups (354th and 367th) flew armed reconnaissance missions in the areas of Saarbrücken, Merzig, Trier, and St.-Vith. Object of the latter two groups was to disrupt the enemy's movement of reinforcements and supplies from his rearward area to the battlefield, particularly to Bastogne. The 354th Group also provided escort for troop carrier transports to Bastogne. The 361st Group escorted medium bombers and carried out fighter sweeps. Two groups (the 365th and 368th) were nonoperational because of fog and haze at their bases. The following day three groups again supported the counterthrusts of Patton's three corps, while the other five groups were out on armed reconnaissance throughout the battle area. The enemy's concentration of large forces against Bastogne provided the fighter-bombers with abundant targets on every rail and road leading to that city from the north, east, and southeast. Approximately 450 tons of bombs were dropped on a wide assortment of targets, but particularly upon the enemy's communications system. The most significant claims were: 690 motor transport, 90 tanks and armored vehicles, 44 gun positions, 143 rail cars, 2 bridges, 5 highway cuts, and 33 rail cuts. On both days there was little enemy air opposition. Twenty-five enemy aircraft were claimed destroyed with a loss of seventeen fighter-bombers. Only four of the latter were caused by aerial combat with the enemy.

There were no fighter sorties on 28 December, and on the following two days only aircraft of XIX TAC were able to operate.<sup>48</sup> The 949 sorties were divided about equally between ground support in the Echternach, Bastogne, and Arlon areas and armed reconnaissance over the

## BATTLE OF THE BULGE

St.-Vith and Bastogne battlefields and the southeastern perimeter of the interdiction zone, especially in the Coblenz-Mayen region. The Luftwaffe was not in evidence. Nine of the twelve aircraft lost on the two days' operations were to flak, one to friendly antiaircraft fire, and two to causes unknown. Bombing and strafing of the enemy's road and rail movements continued to produce very gratifying results as the following claims indicate: 234 motor transport, 101 tanks and armored vehicles, 31 gun positions, 301 railroad cars, and 69 rail cuts.

Weather improved slightly over the bases of the other two tactical air commands on the last day of the month. The combined effort of the three air organizations was 703 sorties. Operations of Nugent's XXIX TAC were largely on armed reconnaissance in the St.-Vith, Hollerath, Münstereifel, and Euskirchen areas and on escort to Eighth Air Force bombers. Weather in the battle area precluded execution of all prearranged ground support by Quesada's IX TAC fighter-bombers. Most of their operations therefore were directed to attacks on enemy road movement east of the base of the enemy salient. Fighter-bombers of XIX TAC were also precluded from effective and consistent cooperation with Patton's three corps because of the very poor weather in their respective attack sectors. Armed reconnaissance between Saarbrücken and Coblenz and free-lance sweeps as far north as Cologne therefore received their major attention. The usual harvest of enemy traffic was claimed for the day's operations: 501 motor transport, 23 armored vehicles, 168 railway cars, 58 rail cuts, 19 road cuts, and 3 bridges.

The two depleted and battle-worn night fighter squadrons were able to fly only 111 sorties during the period from 26 to 31 December, largely on defensive patrol over the battle area. Three of their aircraft were lost on these operations, while claims of enemy night fighter aircraft destroyed amounted to fourteen.<sup>49</sup> Fighter-bomber aircraft of the First TAF operated almost exclusively in support of U.S. Seventh Army, although occasionally a small escort force would accompany the medium bombers of the 9th Bombardment Division. The medium bombers and fighter-bombers of the Second TAF flew a substantial number of interdiction and armed reconnaissance sorties in the critical battle area, but separate figures for their operations are not available.<sup>50</sup>

The three AAF reconnaissance groups flew 541 sorties during the period in question. Their effort produced valuable information concerning enemy movement in the Bulge area (e.g., the shift of the

enemy's attack toward Bastogne commencing with 26 December), in the tactical area between the base of the salient and the Rhine, and occasionally also of his important rail movement in the strategic area east of the Rhine. The evidence gathered by photographic reconnaissance was of special value to the medium bombers in their interdiction program.<sup>51</sup> Resupply missions on 26 and 27 December to Bastogne by transport aircraft of the IX Troop Carrier Command, under fighter-bomber escort, dropped a total of 965,271 pounds of supplies and equipment within the area held by American troops. An additional 139,200 pounds were landed on those two days by forty-six gliders of the same command.<sup>52</sup>

After 26 December, when only 151 heavy bombers were able to attack the marshalling yards at Niederlahnstein, Neuwied, and Andernach and the railroad bridges at Sinzig and Neuwied, the Eighth Air Force operated in very great strength on the remaining five days of December in continuous attacks upon the enemy's communications system outside the inner lines of interdiction. Altogether 5,516 heavy bombers successfully attacked between 26 and 31 December, cascading 14,177 tons of explosives upon key railway centers, marshalling yards, and rail bridges. The focal points of attack were located in the main in a rough quadrangle, from Coblenz to Mannheim on the east, Coblenz to Trier on the north, Trier to Saarbrücken on the west, and thence eastward through Neunkirchen, Homburg, and Kaiserslautern to Mannheim. Every important communications center and rail bridge within this area as well as the rail centers and marshalling yards of such cities as Fulda, Frankfurt, and Aschaffenburg and the rail bridge of Bullay outside the perimeter of the primary target area were repeatedly subjected to very heavy attack. In addition to the destruction wrought by the heavy bomber raids, the 2,883 escort fighters and the 620 fighters giving free-lance support attacked road and rail traffic with great success. To reinforce the interdiction campaign of the medium bombers, the Eighth Air Force also attacked a number of communications centers and rail bridges north of the Moselle River. Noteworthy here were the attacks upon Rheinbach, Brühl, Lünebach, Bitburg, Gerolstein, Hillesheim, and Euskirchen. Losses sustained on these operations were 63 bombers and 23 fighters. A total of 128 enemy fighters was claimed destroyed.<sup>53</sup> RAF Bomber Command staged one very heavy attack in the battle area on 26 December, with 274 bombers striking at St.-Vith and its immediate vicinity.

Ninth Air Force aircraft, including the two Eighth Air Force fighter-bomber groups under its temporary operational control, flew 10,305 sorties between 23 and 31 December. An approximate 6,969 tons of bombs were dropped in operations which cost 158 aircraft. Claims of enemy aircraft destroyed amounted to 264. On the ground the Ninth claimed destruction of 2,323 motor transport, 207 tanks and armored vehicles, 173 gun positions, 620 railroad cars, 45 locomotives, 333 buildings, and 7 bridges.<sup>54</sup>

*Operations, 1-31 January 1945*

Toward the close of December the enemy, having been forced to abandon the offensive toward the Meuse, concentrated his strongest forces in the Ardennes against Bastogne and the slowly widening III Corps salient in that area. The heavy seesaw battle continued unremittingly during the first week of January. The weather had once more come to the aid of the enemy. Heavy snow and icy roads impeded the movement of Patton's armor, and low cloud, snow, and intermittent rain precluded effective fighter-bomber cooperation on all but a few days. Meanwhile, four other American corps, the XII, VIII, VII, and XVIII Airborne, kept up their determined pressure against the southern and northern enemy flanks, and British 30 Corps pushed against the nose of his penetration. With no further reserves to throw into the battle, the Germans commenced a slow, orderly retreat, everywhere fighting fierce rear-guard action and obstructing the opponent's follow-up by numerous road blocks, mines, and booby traps.

In order to ease the relentless pressure upon his retreating troops, the enemy launched a strong diversionary counteroffensive in 6th Army Group's sector of the western front on 1 January 1945. The main thrust was directed toward the Alsatian plain to the north and south of Strasbourg, accompanied by an attack in strength in the Bitche and the Colmar areas and by small-scale feints in the Saar region and in the north against U.S. Ninth Army. Preceded in the area of the main drive by heavy artillery and mortar fire and with considerable support from the Luftwaffe, the Germans were able to effect several crossings of the Rhine north and south of Strasbourg and to force Seventh Army to retreat some distance. Mindful of the totally unexpected strength of the 16 December surprise attack and faced with a threatening political and military crisis in France over a possible loss of Strasbourg, Eisenhower was forced to bolster Devers' strength in order to hold the enemy thrust

to minimum gains. The reinforced U.S. Seventh Army and French First Army, with strong support from the First Tactical Air Force and diversion of many of Eighth Air Force's heavy bomber attacks to targets in southern Germany, succeeded in early containment of the enemy offensive. Early in February all the lost territory was once more in Allied hands.<sup>55</sup>

While the enemy diversion in Alsace was being successfully met, the Ardennes salient was slowly but relentlessly reduced. On the southern flank Patton's three corps kept up their steady pressure through deep snow and ice and in bitterly cold weather. On the northern perimeter of the salient the VII Corps opened its offensive on 3 January with a determined drive between the Ourthe River and Marche, supported on its left and right flanks, respectively, by the XVIII Airborne Corps and the British 30 Corps. Heavy snow, slippery roads, poor visibility, and extreme cold, coupled with obstinate resistance by the enemy, made the advance everywhere slow and exceedingly costly. The continuing Russian advance in Hungary and the opening of a new powerful offensive from Poland into East Prussia on 12 January forced the enemy to accelerate the withdrawal of the armored and motorized elements of Fifth and Sixth Panzer Armies to meet the new threat from the east. By 14 January, VII Corps troops had made considerable progress and cut the St.-Vith-Vielsalm road, while 30 and VIII Corps were mopping up isolated points of resistance and clearing mine fields in their respective zones of operation. On 16 January patrols from Hodges' and Patton's troops established contact in the town of Houffalize. The western tip of the German penetration had now been eliminated, but no large units of the enemy had been cut off. Vielsalm was recaptured on 18 January, and on 23 January the 7th Armored Division drove the enemy out of St.-Vith, the place where a month earlier this division had made such a magnificent stand against the German advance. The converging corps (III, VIII, VII, XVIII Airborne and elements of V Corps) now wheeled to the east and by 31 January had advanced generally to the line of the breakthrough between Dasburg and Elsenborn. The 30 Corps had meanwhile been withdrawn to British Second Army's front in Holland. South of Dasburg, XII Corps had also eliminated all enemy opposition up to the Our River. On the extreme northern flank of the ex-Bulge, where V Corps had been mainly preoccupied with active defense and aggressive patrolling until the middle of January, a general attack was also commenced and by the end of the

month most of the area between Elsenborn and Monschau was recaptured.<sup>56</sup>

So ended the last German attempt to regain the initiative on the western front. And even though the enemy had succeeded in effecting an orderly withdrawal and extricating all of his surviving forces without a single major unit having been trapped by Allied counterattacks, the adventure had been terribly costly to him in manpower and the air forces had inflicted a frightful toll upon his road and rail transport.

Shortly after units of Hodges' and Patton's forces had joined hands at Houffalize on 16 January, Eisenhower restored Bradley's control over First Army (effective midnight 17/18 January), though leaving U.S. Ninth Army under the operational control of Montgomery. With the enemy now in full retreat in the Ardennes and the diversionary offensive in Alsace being safely contained, Montgomery at last found the situation on the main sector of his front, the Roer River line and Holland, "tidy" and safe to resume offensive action east of the Maas, in the vicinities of Sittard and Geilenkirchen (British Second Army) and between Zülpich and Düren (Ninth Army).

The Luftwaffe commenced its operations of the new year with a large-scale attack on 1 January upon a number of Allied airfields in Holland and Belgium and one in France.\* Thereafter the daily average was no more than 125 to 150 sorties. The only exceptions came on 6 January, when approximately 150 to 175 sorties were flown in support of the Alsace offensive, and on 16 January, when the enemy offered very determined opposition to fighter-bomber operations in the tactical area. Meanwhile January weather prevented full employment of American strategic and tactical air power. The Eighth Air Force and XXIX TAC each had eleven totally nonoperational days. The fighter-bombers of IX TAC and the medium bombers of the 9th Bombardment Division were unable to operate on thirteen days, while XIX TAC saw its fighter-bomber aircraft weather-bound on twelve days. On a number of other days each force was able to fly less than 100 sorties. However, on the days when the weather permitted large-scale operations, aircraft of the Ninth Air Force wrought tremendous havoc within the steadily shrinking salient and in the tactical area west of the Rhine, while Eighth Air Force bombers and fighters inflicted very serious damage upon the enemy's rail transportation system in the outer zone of interdiction.

Air operations during January varied little from those of December.

\* See above, p. 665.

The consensus at the 12th Army Group-Ninth Air Force level was that air power could continue to make its greatest contribution to the eventual defeat of the enemy by relentlessly pursuing the same program of action, since operations which had so materially contributed to the undernourishment of the enemy's offense could lead with equal facility to the starvation of his defense. Accordingly, it was agreed that medium bombers would continue their interdiction program by persistent bridge attacks along the periphery of the inner zone of interdiction and upon a number of communications centers located in close proximity to the base of the salient. Attacks upon the former would impede the flow of reinforcements and of supplies into the tactical area, while the latter would seriously interfere with the movement of troops and supplies into the battle area and so help to bring about a gradual attrition of the enemy's forward positions. Concerning the bridge interdiction campaign it was felt that the original list of selected bridges west of the Rhine would suffice to achieve the desired results except for the area southeast of the Moselle River, where the addition of the Simmern railroad bridge was regarded as essential to the success of the program. A greatly expanded interdiction program east of the Rhine was to supplement the medium bomber operations west of that river. The heavy bombers of the Eighth Air Force were to extend their attacks to four Rhine River bridges between Cologne and Coblenz and to a large number of communications centers and marshalling yards west as well as east of the Rhine. The fighter-bombers were to give close support to the operations of the ground forces whenever weather permitted and to continue relentlessly their attacks upon armor and to harry the enemy's every move on road and rail.

In line with these plans, the medium bombers of the 9th Bombardment Division continued their program of isolating the breakthrough area. Major attention throughout the month was accorded to rail bridges. The three Konz-Karthaus bridges which had been considerably damaged during late December were attacked on 1 January. The cumulative effect of the damage done this day on two of the bridges obviated the need for a further attack during the rest of January. The Bad Münster bridge which also had previously been damaged was destroyed on 2 January. Similar successes were not so readily achieved elsewhere. Toward the close of January the status of the bridges attacked by the medium bombers was reported to be as follows: (1) *unserviceable*—Ahrweiler, Bad Münster, Bullay, Coblenz-Lützel, Konz-Karthaus



## BATTLE OF THE BULGE

(east), Konz-Karthaus (south), Simmern, and Mayen; (2) *unknown*—Annweiler, Eller, Kaiserslautern, and Nonnweiler; (3) *possibly or probably serviceable*—Euskirchen (west junction), Coblenz-Güls, and Neuwied; (4) *serviceable*—Morscheid and Konz-Karthaus (west); (5) *approaches out*—Euskirchen (east); and (6) *probable damage*—Sinzig.<sup>57</sup> Field Marshal von Rundstedt, upon conclusion of hostilities, summed up the effectiveness of these bridge attacks as follows:

The cutting of bridges at Euskirchen, Ahrweiler, Mayen, Bullay, Nonnweiler, Simmern, Bad Münster, Kaiserslautern devastatingly contributed to the halting of the Ardennes offensive. Traffic was hopelessly clogged up and caused the repair columns long delays in arriving at the destroyed bridges.<sup>58</sup>

Road bridges over the Our River and on several main roads near the base of the salient were added to the interdiction program when the enemy's withdrawal from the Ardennes began in earnest near the middle of January. The bridges singled out for attack were those at Roth, Vianden, Dasburg, Eisenbach, Stupbach, and Schoenberg over the Our River and those at Steinbrück and Gemünden. Fighter, medium, and heavy bombers attacked these bridges at one time or another between 10 and 22 January. The most successful attack was staged by the medium bombers on the Dasburg bridge during the morning of 22 January when serious damage to the bridge led to a terrific traffic congestion on all exit routes in the area of Clerf, Dasburg, and Vianden. The resultant havoc which fighter-bombers of XIX TAC wrought among the enemy's stalled columns far surpassed the destruction in the Falaise gap of August 1944.

As the enemy's withdrawal from the Bulge became more pronounced, particularly after 12 January, the medium bombers, with strong assistance from the fighter-bombers, were directed to accent their attacks upon communications centers within the battle area. The places singled out were of the chokepoint type along the main routes of retreat. Fairly successful results were achieved at Champlon, Vielsalm, La Roche, St.-Vith, Houffalize, Salmchâteau, Gouvy, Clerf, Vianden, and Dasburg. Since the communications centers close to the base of the salient had already been hammered into virtual uselessness, both medium and fighter-bombers during the second half of January were directed to attack at every opportunity the marshalling yards closer to the Rhine. Among those singled out for destruction were those at Stadtkyll, Schleiden, Gemünd, Kall, Brühl, Zülpich, Bitburg, Hallschlag, Kempenich, Mayen, Cochem, Andernach, Linz, Bad

Godesberg, Remagen, Sinzig, and Boppard. Total medium bomber sorties for January amounted to 2,515. Bomb tonnage dropped on the various assigned targets was 4,685. Thirteen aircraft were lost during the course of these operations as against no claims of enemy aircraft destroyed.<sup>59</sup>

To supplement the medium bomber interdiction effort west of the Rhine, the heavy bombers of the Eighth Air Force continued their attacks upon numerous marshalling yards and communications centers west of the Rhine as well as in the outer interdiction zone east of that river. A total of 24,496 tons of bombs was dropped during the course of the month on these two types of targets. Among the places which were subjected to particularly heavy attacks were Fulda, Aschaffenburg, Cologne, Coblenz, Homburg, Zweibrücken, Neunkirchen, Landau, Pforzheim, Schleiden, Gemünd, St.-Vith, Gerolstein, and Prüm.

Special attention was also given to numerous Rhine River bridges. At the beginning of the month the heavy bombers were asked to attack the rail and road bridges between Coblenz and Cologne. This was done on two successive days, 1 and 2 January, when a total of 569 heavy bombers attacked the Coblenz-Lützel, Coblenz-Engers, Neuwied and the Remagen bridges. Four days later, a heavy attack was staged on the road and rail bridge at Bonn and on two rail bridges at Cologne. The bridges at Cologne (Rodenkirchen, Hohenzollern, Deutz, and Cologne South) were again attacked on 7 and 10 January. To impede the movement of German armor and troops from west of the Rhine to the Russian front, especially after commencement of the Russian offensive on 12 January, the heavy bombers were directed to extend their attacks to all main road and rail bridges north of Cologne at Düsseldorf, Duisburg, and Wesel. When the enemy diversionary offensive in Alsace threatened to make continued progress, the bombers of Eighth Air Force were called on to strike at the rail and road bridges between Coblenz and Mannheim and eventually as far south as Karlsruhe. Since bridge bombing frequently had to be carried out through overcast, General Doolittle regarded the effort as futile and felt that "the continued direction of Eighth Air Force against bridges was the result of undue enthusiasm where they had succeeded."<sup>60</sup> A total of 6,759 tons of bombs was aimed at the various bridges singled out for attack. Considerable damage was inflicted at one time or another on the bridges at Cologne, Remagen, and Coblenz, for example, but as a rule the damage caused merely temporary impassability.<sup>61</sup> Very heavy

losses were inflicted upon the Luftwaffe, the fighters claiming destruction of 315 enemy aircraft and the heavy bombers an additional 41. Losses during the month consisted of 93 bombers and 44 fighters.<sup>62</sup>

The limiting effect of the bad January weather on operations of the XXIX Tactical Air Command has been mentioned above. There were eighteen days on which the command's fighter-bomber aircraft were either completely nonoperational or were able to fly less than fifty sorties per day. And even the best five operational days—1, 2, 5, 14, and 22 January—permitted the execution of only 1,148 sorties. Thus total sorties for the entire month, inclusive of the effort of reconnaissance aircraft, amounted to only 2,453. Seventeen aircraft were lost as a result of these operations. The enemy's air losses were estimated at four.

During the first half of the month the fighter aircraft, aside from a few escort missions for medium bombers, were preoccupied with armed reconnaissance on the northern perimeter of the enemy salient, the specific area of their responsibility covering the territory between Lieurieux and Houffalize in the west and Wahlen and Pelm in the east. Main objectives of their attacks were disruption of enemy traffic through cutting or cratering of roads and rail lines and destruction of facilities in communications centers. Gun positions, strongpoints along roads and within towns and villages, supply dumps, and troop concentrations were also favored targets. Considerable success was claimed against enemy road traffic for the operations of 2, 5, 13, and 14 January.

Strong offensive action by all of First Army's corps during the second half of January resulted in the strengthening of this army's air partner, IX TAC, by transfer of two additional fighter-bomber groups from XXIX Command. This left General Nugent with only two fighter-bomber groups during the major part of the remainder of the month. Accordingly, the area of his responsibility was shifted farther to the north of the main American counterattack, embracing approximately the region between the Roer and Rhine rivers, from Gemünd to Neuwied in the south and Erkelenz to Düsseldorf in the north. Though this was a less active front, the accelerated German withdrawal from the Ardennes east and northeastward to the Rhine presented the fighter-bombers with excellent targets. Chief claims against ground targets for the month of January included 705 motor vehicles, 72 tanks and armored vehicles, 45 locomotives, 1,293 railroad cars, 522 buildings, 23 gun positions, and 7 bridges. Claims of rail and road cuts stood at 242 and 81, respectively.<sup>63</sup>

Day fighters of IX TAC found January's weather only slightly less restrictive than did XXIX Command. Thirteen days were entirely nonoperational. Six days permitted the flying of less than 100 sorties per day. The only interlude of good flying weather was the five-day period from 21 through 25 January when 1,649 sorties were flown. This represented slightly more than half of the total effort (3,267 sorties) for the entire month. Inclusive of reconnaissance and night fighter aircraft, the total number of planes dispatched during January was 3,951 as against 6,046 for December. Aircraft losses during the month amounted to 26, while claims of enemy fighters destroyed totaled 50. Coincident with First Army's return to General Bradley's control, IX TAC reverted to General Vandenberg's command at midnight of 17/18 January.

Close coordination missions with ground operations were few in number and took place mainly on 13, 14, and 16 January in the St.-Vith-Houffalize area. Escort missions for medium bombers on 1, 5, 14, 16, 22, and 25 January were largely uneventful. Encounters with a sizable number of enemy fighters took place only on the 14th when fighter-bombers escorted Eighth Air Force heavy bombers on withdrawal from targets in northern Germany. The major effort of the month was on armed reconnaissance. During the first half of January the fighter-bombers operated largely within the enemy salient, their main area of attack encompassing the region between Bullingen, St.-Vith, Lieurneau, Vielsalm, La Roche, Houffalize, Clerf, and Dasburg. In addition to heavy attacks upon the above towns, principal objectives of attack were the enemy's transportation systems and his supplies. During the last ten days of the month, as the bulge was compressed by the ground forces, the fighter-bombers shifted the main weight of their attack to the area between the German boundaries of Belgium and Luxembourg and the Rhine. Road and rail traffic, despite extensive attempts at concealment of all forms of transport during the daylight hours in the many villages, towns, and woods, furnished most profitable targets, especially along the routes leading east from the vicinities of Gemünd, Schleiden, and Prüm in the direction of Hillesheim, Münster-eifel, Euskirchen, and thence to the Rhine crossings at Cologne, Bonn, Remagen, and Coblenz. Between 21 and 25 January fighter-bombers claimed destruction of 1,995 motor vehicles, 134 tanks and armored vehicles, and 317 railroad cars. Troop concentrations among the retreating convoys were subjected to repeated strafing and heavy loads

## BATTLE OF THE BULGE

of fragmentation bombs, in consequence of which large personnel casualties were claimed by the attacking fighter aircraft. Increasingly, too, as the battered enemy columns made their exit from foreign soil and wearily plodded eastward toward the Rhine, they were showered with leaflet bombs urging them to surrender in view of the utter collapse of what undoubtedly had been the last German offensive action on the western front.

The 67th Tactical Reconnaissance Group, like the fighter-bombers, experienced thirteen nonoperational days in January. A total of 451 planes was dispatched during the other eighteen days of January on visual and photographic reconnaissance and artillery adjustment missions. The 422d Night Fighter Squadron was able to send out only 35 aircraft during the entire month.<sup>64</sup> The XIX TAC, operating with eight fighter-bomber groups, flew 5,937 sorties. This represented 714 sorties less than the number flown during December, despite the fact that the command's fighter-bomber strength had been greatly augmented by transfers from other air organizations. As everywhere else on the western front, poor weather accounted for this decline. Only five of the first twelve days of the month were operational. Fortunately, superb flying weather from 13 through 16 January and passably fair weather on 22 through 26 January provided most welcome respite from the all too frequent conditions of "intermittent snow showers, low ceilings and ten-tenths cloud." A total of 3,616 sorties was flown on these nine days, representing slightly over 61 per cent of the total effort for January. Operating mainly in the Bastogne area and on the southern flank of the German withdrawal, fighter-bombers carried out sustained operations against enemy road and rail transport, gun positions, and concentrations of troops and supplies. Very successful attacks were also staged upon numerous enemy-held places in Luxembourg and upon German towns and villages north and south of the Moselle. In addition to these armed reconnaissance operations, the fighter-bombers furnished close support to Patton's forces in the Ardennes and the Saar regions, flew occasional escort sorties for medium bombers in the inner zone of interdiction, and also attacked several airfields east of the Rhine. Finally, in conjunction with the medium bomber bridge interdiction program, they attacked a number of road bridges south of the Moselle and along the Our River.

The command's most successful day was the 22d of January when its aircraft found the roads near Vianden and Dasburg choked with every

sort of enemy vehicle—motor, armored, and horse drawn. This congestion had been brought about by the medium bombers' infliction of heavy damage on the Dasburg road bridge earlier that morning. Attacking the bumper-to-bumper columns with rockets, high explosives, and incendiaries, and repeatedly strafing them from one end to the other, the fighter-bombers inflicted frightful losses upon the enemy. The pilots claimed 1,177 motor vehicles destroyed and damage to another 536. The havoc inflicted upon the enemy was achieved at a loss of only eight fighter aircraft, although not one of the attacking planes escaped varying degrees of damage from the enemy's motorized flak units which tried in vain to ward off the devastating aerial blows. The day's success elicited special messages of recognition from Generals Arnold, Spaatz, and Vandenberg.

Enemy fighters were encountered mainly during the operations of 14 and 16 January. Total claims for the month were thirty-four fighters against a loss of sixty-four.<sup>65</sup> Aside from the losses suffered in the 1 January attack upon the Metz airfield, which resulted in destruction of twenty-two aircraft, the losses of January were due almost entirely to enemy flak. Claims against ground targets were as follows: 3,510 motor transport, 228 tanks and armored vehicles, 1,328 railroad cars, 164 gun positions, 316 buildings, 250 rail cuts, 2 bridges, 56 locomotives, and 12 road cuts.<sup>66</sup>

The 10th Photo Reconnaissance Group flew a total of 732 successful sorties during January. Four aircraft were lost on these operations. One enemy aircraft was claimed destroyed. Similar to the effort of the 67th Tac/Recce Group, the information and evidence gathered by this group were of inestimable value to the success of the operations of the fighter and medium bombers. The effort of the 425th Night Fighter Squadron consisted of forty-seven sorties mostly of uneventful patrol over the battle area.<sup>67</sup> It is of interest to note that captured German officers, interrogated after the war, stated that they had greatly enjoyed the freedom of movement during the hours of darkness because of American lack of night fighters.<sup>68</sup>

Despite the unfavorable weather conditions during much of January, the fighter-bombers had inflicted fearful losses upon the enemy on the ground. For the three tactical air commands, claims added up to 7,706 motor transport, 550 tanks and armored vehicles, 101 locomotives, 3,094 railroad cars, 1,125 buildings, 234 gun positions, 10 bridges, 556 rail cuts, and 207 road cuts. The ground claims for the entire period

## BATTLE OF THE BULGE

of the counteroffensive (16 December 1944–31 January 1945) advanced by Ninth Air Force aircraft and by Eighth Air Force bombers and fighters while operating in the tactical area reached staggering totals. They were: 11,378 motor transport, 1,161 tanks and armored vehicles, 507 locomotives, 6,266 railroad cars, 472 gun positions, 974 rail cuts, 421 road cuts, and 36 bridges.<sup>69</sup>

It is impossible to substantiate all of these claims, compiled from reports based on observations made under the trying conditions of battle. But of the general results there can be little doubt. Whatever the numerical score may have been in these several categories, U.S. air power had contributed heavily to the defeat of the Ardennes counteroffensive. The enemy's bid for temporary air superiority over the battle area had suffered a crushing defeat. The combined efforts of the strategic and tactical air forces had paralyzed virtually all rail traffic west of the Rhine and thereby brought about a supply crisis which, together with the heroic resistance at St.-Vith and Bastogne, doomed the counteroffensive to an early failure. In the immediate area of battle, littered roads bore eloquent testimony to the unmerciful beating which all forms of enemy transport had received.<sup>70</sup>





SECTION VI

\* \* \* \* \*

*GERMANY*



## CHAPTER 20

\* \* \* \* \*

### *THE CLIMAX OF STRATEGIC OPERATIONS*

THE Germans in their Ardennes offensive had suffered heavy casualties and the loss of much materiel, and they had failed. But the ugly surprise which they had sprung on the Allies was not easily forgotten. Hence during January 1945 the atmosphere in the several Anglo-American headquarters was one of extreme caution and even of pessimism, in contrast to the overconfidence which had prevailed in early December. It seemed that Germany might last for most of 1945 if not longer. She controlled valuable sections of Europe, and her population gave no sign of casting off the Nazis. Her industries could still turn out substantial quantities of weapons from repaired or underground installations, a capacity which the respite from bombing during the Battle of the Bulge had done nothing to diminish. The German Air Force might soon employ enough jet fighters to spoil Allied air supremacy. New types of submarines might have a similar effect on the naval war. Even the German army seemed stronger in some respects, since twenty-three divisions had been added recently and a peoples' force was being trained to defend the Reich. By means of an active and skilful defense the Germans could hope to gain time, wear out their enemies, and await deliverance in the form of miraculous new weapons or a wartime cleavage among the United Nations.<sup>1</sup>

In AAF circles hopes for an early victory had distinctly cooled. The Assistant Secretary of War for Air, Robert A. Lovett, raised the question with General Arnold whether they had been trying to do too much too soon. Germany seemed formidable in nearly every respect, he said, and the recuperative power of her industry had exceeded AAF expectations. The Germans were fighting a total war on their own borders with shortened lines of communication, they excelled in cer-

tain types of weapons, and the fighting quality of their ground forces was still very high. Air power, the only field in which the Allies enjoyed complete superiority on the continent, faced the menace of jet aircraft and improved enemy defensive measures. The war might become a slow, costly affair. Lovett's solution at this time was an idea which General Quesada had planted in his mind some months earlier, the employment of fighter-bombers on a large scale against the most vulnerable targets instead of the more exposed and less accurate heavy bombers. This "Jeb" Stuart plan, as Lovett labeled it in honor of the Confederate cavalry hero, might enable the air forces to injure Germany where it would hurt the most.<sup>2</sup>

Even General Arnold had doubts about how effective the air war had been. The British-American strategic air forces had blasted factories and cities from one end of the Reich to the other. Unquestionably a huge amount of structural damage had resulted. Yet it was clear that this destruction had not had the effect on the enemy's war effort that Arnold had expected and hoped for, the effect "we all assumed would result."<sup>3</sup> He asked AC/AS Intelligence to re-evaluate its estimate of bomb damage, and he told his chief of air staff that "we have either been too optimistic in our ideas of what we could do with bombing attacks, or we have missed tremendously in our evaluation of the effect that the destruction which we did cause would have on the German war machine."<sup>4</sup> To General Spaatz the AAF commanding general wrote feelingly: "We have a superiority of at least 5 to 1 now against Germany and yet, in spite of all our hopes, anticipations, dreams and plans, we have as yet not been able to capitalize to the extent which we should. We may not be able to force capitulation of the Germans by air attacks, but on the other hand, with this tremendous striking power, it would seem to me that we should get much better and much more decisive results than we are getting now. I am not criticizing, because frankly I don't know the answer and what I am now doing is letting my thoughts run wild with the hope that out of this you may get a glimmer, a light, a new thought, or something which will help us to bring this war to a close sooner."<sup>5</sup> Arnold was not as inclined as his planning officers were to sweep Lovett's proposal aside. There might be something in it. Whatever the answer, air power must not let the war in the west become a stalemate.<sup>6</sup>

The gloom was also thick at SHAEF and USSTAF in January 1945. There was, of course, no faltering and no despair. But it seemed prob-

able that the war would last through the summer. At a conference of air commanders held at Versailles, Fred Anderson delivered what the minutes called a long and impassioned plea for a general replanning of the strategic air offensive on the assumption of a longer war than had been expected previously. The Ardennes battle, he pointed out, had upset not only the Allies' plan for ground offensives but their program of aerial bombardment. The month-long devotion of Eighth Air Force and RAF Bomber Command to the tactical situation had allowed the enemy to recover significantly in oil production, V-weapon construction, and jet manufacture; even submarines and ball bearings were back in the picture. Anderson's conclusion that the strategic air situation was "very sad" received the indorsement of General Doolittle to the degree of "100% or possibly even more."<sup>7</sup>

General Spaatz was also pessimistic about the chances of ending the war before the last of the summer. New German submarines were about to appear, the jet danger was greater than ever, and a secret weapon might be in the offing. Clearly, it was going to be necessary to reorient the strategic bomber offensive on the basis of a longer war, which would mean embracing new target systems while catching up with the arrears on the old ones.<sup>8</sup> Spaatz's letter stirred up some support in AC/AS Plans in favor, once more, of concentrating all elements of air power on destruction of the enemy's field armies.<sup>9</sup> Behind what was tactfully called the issue of quality versus quantity bombing lay an attitude, found in Eighth Air Force as well as in Headquarters AAF,<sup>10</sup> which regarded the strategic air offensive to date as disappointing and which favored finding new methods of exploiting air power.

### *Recasting the Strategic Air War*

As it turned out, revolutionary changes were not necessary, for the Germans were in much worse condition than the Allies thought they were in early 1945. There was no real basis for disillusionment about the oil campaign, although critics could argue that it had gone far beyond the point originally expected to produce collapse and that Germany had staged a dangerous counteroffensive with a war machine supposed to be starved for fuel. But the Germans had quickly run out of gasoline and lubricants, and the recuperation of their bombed refineries and synthetic plants during the Battle of the Bulge was not as serious as it seemed at the time, thanks largely to the brilliant campaign

of the Fifteenth Air Force in the last of December.\* Even Bomber Command and Eighth Air Force had turned from their tactical operations at the height of the land battle to attack the chief oil producers in western Germany, and on 8 January 1945 General Eisenhower agreed to release the heavy bombers from the land campaign in order to knock out the more important oil plants which were coming back into operation following earlier bombings.<sup>11</sup> This decision pleased the Combined Strategic Targets Committee, whose members were aware of their reputation as oil fanatics, and they planned the resumption of a full-scale offensive against five synthetic plants in central Germany and benzol plants in the Ruhr.<sup>12</sup> They might have selected some of the identifiable underground oil plants which the Nazis were constructing according to the Geilenberg plan, but already it was becoming apparent that the German program was far behind schedule, in fact proving hopeless.<sup>13</sup> The faith of Allied air leaders in the oil campaign would soon be vindicated, also behind schedule but overwhelmingly.

There were grounds too for sober reappraisal of transportation as a target system. After the Allied air forces had pounded German railways for almost two months, dropping several times the tonnage they aimed at oil targets,<sup>14</sup> the enemy had undertaken a stunning offensive. The whole of this target system had proved discouragingly resilient to air attack. The Fuehrer expressed his amazement at the effective improvisation by his people in repairing their bombed railways, and he ventured, with a trace of smugness, the observation that "other countries had been crippled in less than a week by attacks which had been child's play in comparison."<sup>15</sup> Yet the pre-Ardennes rail attacks had produced economic chaos in western Germany. If they had not prevented the offensive they had crucially affected enemy troop movements. And during the Battle of the Bulge the combined weight of heavy, medium, light, and fighter-bombers had isolated sections of the battlefield in a memorable demonstration of the flexibility of air power.<sup>16</sup> In the light of such developments the inclination in Allied circles was not to abandon the air effort against railways but to correct the weaknesses in planning and prosecution which an assessment of the autumn campaign revealed. In particular, this meant concentrating all types of aircraft on interdiction rather than spreading the air effort too thin over large areas of Germany in an attempt to deplete her railway capacity.† The so-called Interim Plan, initiated by the Combined Strategic Targets

\* See above, p. 670.

† See above, p. 657.

Committee in January for this purpose, directed the strategic air forces to neutralize railways west of the Rhine, to intensify attacks in transportation centers leading into the Ruhr, and to assist the tactical air forces in dislocating railways in the area east of the Rhine between the bridge at Cologne and Stuttgart.<sup>17</sup> While the new program was more scientifically devised to cripple Germany's economy and hamper her armies, it became evident later that the original transportation plan had been considerably more effective than was believed in January 1945. German economic traffic in the west had already been choked off from the rest of the Reich to a dangerous degree.<sup>18</sup>

The German Air Force seemed more menacing than it had for a year. During the last quarter of 1944 it had grown unaccountably in number of aircraft if not in fighting quality and had delivered some deadly blows during the Ardennes offensive. By the first of 1945 the Luftwaffe's best pilots were dead and its airplanes grounded most of the time for lack of fuel, but the airplanes existed and could be used on occasion. The fighter commanders, especially Gen. Maj. Dietrich Peltz, had the respect of General Spaatz and other Allied air leaders. And the threat of jet fighters<sup>19</sup> was becoming more serious each week. Already the Germans had manufactured 700 Me-262's and 100 Ar-234's, USSTAF believed.<sup>20</sup> If the war lasted beyond June 1945 the GAF might again control the skies over the Reich. The deep uneasiness felt in Allied headquarters was reflected in the agreement of General Spaatz and General Smith of SHAEF on 9 January 1945 to elevate jet production to a first priority, coequal with oil.<sup>21</sup> There was no opportunity for the Eighth Air Force to bomb jet plants in January, and jet engine factories, considered the most crucial objective, lay outside the range of Fifteenth Air Force planes. But by the end of the month confidence again reigned that German jets were not going to affect the air war decisively. There had been cause for the earlier concern. On the day following Spaatz's decision, Adolf Hitler referred to B-29 operations over Japan and nervously predicted a similar misfortune for Germany. Already, he said, the Allies were attacking the Reich with practically no losses, as though they were carrying out an exercise in bright sunshine. The answer must be "swarms of jets" with heavy cannon.<sup>22</sup> But the hour was late and events would justify the renewed confidence of Allied air leaders.

The likelihood of a retarded V-day in Europe brought back into prominence a composite target system which had been left largely un-

disturbed for two months: tank, truck, armored vehicle, and ordnance production. Bombardment of this category had been terminated abruptly on 1 November 1944 in order to begin the transportation attacks.\* It now seemed important to interfere with German refitting of regular forces and equipping of a peoples' army. While there was little expectation of blocking German armament, damage of any type to the main production centers, such as those in Berlin, Ulm, Kassel, Magdeburg, Vienna, and Nürnberg, might have important effects. SHAEF was particularly insistent on renewing the campaign, and General Doolittle was a strong advocate among the air force leaders.<sup>23</sup>

A marginal, almost forgotten, target system which also loomed in January 1945 was German submarine construction. The unhappy results of previous bombing campaigns against U-boat pens and yards had left little inclination in air circles to waste bombs and effort in a new offensive.† It was only too clear, however, that the German submarine fleet was again formidable by the beginning of 1945. Furthermore, new types of U-boats—large, fast, radar-proof, and able to fire upon convoys without visual sighting and to remain under water for lengthy periods because of the schnorkel apparatus—were causing much damage to Allied shipping in the Channel.<sup>24</sup> These new submarines posed some danger of bringing back 1942 conditions in the Atlantic, as Churchill later judged.<sup>25</sup> As early as September 1944 the Air Ministry had requested USSTAF to participate in attacks on pens at Bergen and Trondheim, Norway, which were believed to be temporarily vulnerable.<sup>26</sup> The Americans rejected this assignment on the grounds that Bomber Command could be spared for such an effort more readily than the Eighth Air Force and that it was undesirable to bomb such dubious targets in a friendly occupied country.<sup>27</sup> In the following month the U.S. Navy advised the AAF that perhaps 300 of the new U-boats might soon be operating.<sup>28</sup> Spaatz still refused to bomb Norwegian pens,<sup>29</sup> but on 9 December he gave the Eighth Air Force permission to devote marginal effort to U-boat objectives in Germany proper.<sup>30</sup> No American attacks followed, however, and soon after the Ardennes battle the Joint Intelligence Committee issued an alarming study dealing with the new submarine menace.<sup>31</sup> For the strategic air forces to bomb U-boat yards and pens would be costly in effort, and there was no assurance that it would be worth while. But Spaatz decided to give this system a low priority which, to the amaze-

\* See above, pp. 646-49, 653.

† See Vol. II, 251-54.



## THE CLIMAX OF STRATEGIC OPERATIONS

ment and great relief of his deputy for operations,<sup>32</sup> satisfied both the U.S. Navy and the British. Also, the President and the Prime Minister agreed that the time had not yet come to take drastic measures in the U-boat war at the expense of other operations, although it might become necessary to do so.<sup>33</sup>

The deliberations on both sides of the Atlantic concerning the strategic bombing program in the light of early 1945 conditions led General Spaatz and Air Marshal Bottomley to draft a new directive governing the operations of USSTAF and Bomber Command. This Directive No. 3 they issued on 12 January 1945.\* The over-all mission of the strategic air forces remained the same: the progressive destruction and dislocation of the German military, industrial, and economic systems and the direct support of land and naval forces. Oil continued as first priority officially, although Spaatz had just sent out instructions for the American heavies to regard jet production as a parallel obligation. In second place came the German lines of communication, with emphasis on railways leading into the Ruhr. The third priority was meant for the RAF: raids on industrial areas in blind attacks whenever weather or tactical conditions prevented operations against higher priority objectives. This listing permitted attacks on tank factories, however, which the Americans intended to make. In fourth priority came counter-air force action, a misleading category in view of the temporary first priority for jets, which in turn was misleading because no attacks were made on jets until still another directive came out. Support of land and naval operations was a continuing commitment of the strategic air forces. Listed in this directive in fifth place, such support would become the foremost concern of the air forces upon a request from Eisenhower. Finally, as sixth priority, came attacks on the enemy's submarine yards.<sup>34</sup>

These directives, as has been seen, were often little more than formal memoranda for the record. The CCS could order the strategic air forces to attack any objective or target system it chose. Theater commands were authorized to call upon the heavy bombers for assistance whenever they needed it. Air force commanders actually enjoyed great latitude in waging the air war and sometimes paid scant attention to the official priority lists drafted with such care in higher echelons.<sup>35</sup> And the weather was final arbiter in any case. Insofar as the Directive No. 3 possessed significance, General Spaatz regarded it with some satisfac-

\* For preceding directives in this sequence, see above, pp. 640, 653.

tion as fulfilling his ideas concerning a postponed victory in Europe.<sup>36</sup> AAF Headquarters felt it was too vague and that USSTAF had conceded too much to the RAF.<sup>37</sup> Portal, on the other hand, accepted the new directive with some reluctance, since he believed the war might be won by May 1945, in which event the effort expended on jets and the marginal target systems might drain some of the force from a decisive campaign against oil and transportation.<sup>38</sup> The RAF chief of air staff insisted upon securing specific CCS confirmation of the new priorities, a circumstance which resulted in a major alteration of Directive No. 3 toward the end of January.\*

### *January Operations*

While in no month after the Normandy invasion had it been possible for the heavy bombers to concentrate on a "pure" strategic offensive, January 1945 was a period of unusual absorption with the land battle. Approximately three-fourths of USSTAF effort went on tactical targets,<sup>39</sup> and RAF Bomber Command was similarly taxed. Eighth Air Force mission reports for most of January show enormous numbers of heavy bombers, sometimes as many as 1,500, going out day after day to bomb targets whose neutralization would benefit Allied ground forces but would not directly accelerate the dislocation of Germany's industries. The preponderant weight of such air effort went on what was officially a secondary objective, enemy communications. Some 147 rail and road targets—rail centers, marshalling yards, repair shops, junctions, bridges, and traffic bottlenecks—received USSTAF raids during the month. It was seldom possible to evaluate the damage inflicted because of the confusion of battle and the overstrained condition of photographic reconnaissance units.<sup>40</sup> The Germans continued to repair their bombed railways and bridges expeditiously,<sup>41</sup> but the delays were sometimes determining factors in winning a tactical advantage, and the cumulative effect on German transportation was slowly mounting to the point of disaster. Thus, transportation bombings in behalf of the ground forces helped wreck Germany and were by no means wasted even from the most extreme strategic air point of view. Meanwhile, the Fifteenth Air Force was prosecuting its long campaign against railways in Yugoslavia, Austria, Hungary, and Italy.

The relatively small number of missions directed at strategic targets during January 1945 were very successful in keeping oil production

\* See below, p. 725.

low and in hampering tank manufacture. On 1 January a force of 109 B-17's of the Eighth Air Force bombed an oil refinery at Dollbergen with signal effectiveness.<sup>42</sup> For about two weeks thereafter Germany's oil producers received no visits from the heavies. In the middle of January, Bomber Command delivered several heavy blows in mass area raids at night upon the major synthetic oil plants in central Germany which were coming back into production: Pölitze, Brüx, Zeitz, and Leuna.<sup>43</sup> There was unaccustomed air activity over Germany on 14 January, when 10 Eighth Air Force groups ran into 350 GAF conventional-type fighters, half of which the Americans claimed to have shot down to their own loss of 5 fighters and 9 bombers.<sup>44</sup> Bombing results that day were reasonably good. A crude-oil refinery at Hemmingstedt was knocked out of operation, several oil depots were struck, and fair success was achieved against a benzol plant in the Ruhr and a synthetic oil plant at Magdeburg.<sup>45</sup> Magdeburg required another attack, which it received on 16 January along with Ruhland and tank plants at Bitterfeld and Buckau. The Eighth struck at oil refineries in Hamburg and Harburg on the 17th to some effect<sup>46</sup> and bombed the Blohm and Voss U-boat yard in Hamburg with less success.

Weather conditions during the last of January greatly restricted the air war. Because of difficult icing conditions over the Alps the Fifteenth Air Force was able to fly on only eight days in the entire month, and Bomber Command had to cancel missions because of treacherous flying weather. Even when parts of Germany were open to bombing, Eighth Air Force aircraft were often hampered by late-morning fog at their bases or by heavy clouds in the early evening.<sup>47</sup> The air forces had made much progress in the past year toward overcoming their worst opponent, the weather, but radar-bombing methods continued to prove disappointing. The Eighth Air Force had an average circular probable error of about two miles on its blind missions,<sup>48</sup> which meant that many of its attacks depended for effectiveness upon drenching an area with bombs. With identical equipment the Fifteenth Air Force was doing twice as well—or half as poorly—as the Eighth, possibly because of a more thorough training program in preparing lead crews for winter bombing.<sup>49</sup> The only answer seemed to be to provide more radar operators and equipment and to build up experience. AAF Headquarters determined that one-fourth of each heavy bombardment group should be composed of radar-equipped aircraft, an aim which was reached early in March 1945, whereupon the Eighth and Fif-

teenth Air Forces requested that twice this proportion be provided.<sup>50</sup> Although new methods of radar bombing were under development during the winter of 1945, they were not introduced into the European air war in time to improve accuracy sharply.

Good bombing conditions or not, the air forces operated during the last few days of January 1945 as well as they could. The Fifteenth managed on 20 January to place 228 tons on the large oil storage depot at Regensburg, its first oil mission for three weeks.<sup>51</sup> On the next day it sent 189 B-17's to bomb two oil refineries in the Vienna area while 50 P-38's shot up a refinery near Fiume. For nine days thereafter the Fifteenth was grounded. Then, on 31 January, it delivered a heavy blow at the vast Moosbierbaum synthetic plant in Vienna with 217 Fortresses and 407 Liberators. The Eighth Air Force got 36 Fortresses through on 20 January to bomb the synthetic oil plant at Sterkrade, which was reattacked on the 22d. A tank factory at Aschaffenburg received a blind attack from 66 Fortresses on 21 January. Toward the last of the month, on 28 and 29 January, the Eighth again undertook small strategic missions. On the 28th, 115 Liberators bombed two benzol plants in the Ruhr and on the next day 93 Fortresses inflicted fresh damage on the Henschel tank works at Kassel.<sup>52</sup> These January missions were very difficult to carry through and unimpressive in size. Yet, with the area raids of the RAF, they were successful in restraining German industrial output. The transportation chaos, largely brought on by the air forces, continued to aggravate the enemy's problems.

The war situation was much improved when the CCS convened on 30 January 1945 at Malta, just prior to the Yalta conference of Roosevelt, Churchill, and Stalin. In the west the Allies had removed the Bulge and were preparing to resume the march to the Rhine. More promising was the massive Russian advance in the east. For a few days it looked as though East Prussia, Silesia, and even Berlin itself might be overrun. At that point, just when the CCS had tacitly approved the Spaatz-Bottomley Directive No. 3 for strategic air operations,<sup>53</sup> the Malta conferees decided to throw the weight of the heavy bombers into the battle in the east. Perhaps this decision grew out of foreknowledge of a formal Russian request for such assistance which was put forward a few days later at Yalta.<sup>54</sup> At any rate, the western Allies and the Russians were in strong agreement that the strategic air forces might prevent German reinforcement of the crumbling eastern front. Primarily, this assistance was to take the form of blocking the major

transportation centers through which the Germans might send units from west to east, such as Berlin, Leipzig, Dresden, Cottbus, Chemnitz, and others. There was also a hope that heavy air raids would increase the panic and confusion already prevalent in those cities, which were thoroughly frightened by the sudden Russian advance and full of refugees. Pandemonium in Berlin, particularly, might have a decisive effect in speeding up the disintegration of Hitler's regime. Accordingly, the air leaders at Malta issued with the strong approval of General Marshall, and with what they took to be the concurrence of AAF Headquarters, a revised directive.<sup>55</sup> As second priority (after synthetic oil plants) came "Berlin, Leipzig, Dresden, and associated cities where heavy attack will cause great confusion in civilian evacuation from the east and hamper reinforcements." As a third priority the heavy bombers would direct their efforts on communications in the Ruhr-Cologne-Kassel area to keep the Germans from withdrawing forces in the west to bolster the east.<sup>56</sup>

The Eighth Air Force was braced for several days awaiting an opportunity to blast Berlin, which had gone for two months without a major bombardment. Always a prime target because of its industries and government offices, the capital was especially important now because of its transportation. Accordingly, marshalling yards and railway stations throughout the vast urban center were the chief objectives.<sup>57</sup> Underlining the urgency of bombing Berlin at this time was the belief that the Sixth Panzer Army was moving through the city on its way to the Russian front and the feeling that a good attack on the eve of the Yalta conference might help convince the Soviet Union of American willingness to assist it. Another consideration was the possibility of demoralizing the Nazi government with a smashing bombardment. Accordingly, the Eighth Air Force planned to put its full B-17 force on Berlin, attacking transportation and governmental targets heavily in what would probably be radar, and therefore inaccurate, bombing. It was recognized that the Germans on the receiving end might regard it as a terror raid, but the Americans made careful preparations to conduct as precise an attack as possible.<sup>58</sup>

The mission took place on 3 February 1945. Nearly 1,000 Fortresses flew to Berlin while 400 Liberators simultaneously attacked railway and oil targets around Magdeburg. The B-17's reached the capital without interference and found most of it exposed to visual bombing. Hence accuracy was fairly high, although the bombers unloaded their

tonnages from 24,000 to 27,000 feet and had to take evasive action to avoid murderous German flak, which brought down 21 heavy bombers. P-51 escorts were entirely effective in keeping the German Air Force from troubling the bombers, and they shot up locomotives and strafed railway cars with spectacular success while the bombers inflicted severe damage on marshalling yards and railway stations throughout the Berlin area. Furthermore, the bomb pattern was heavy in the government district. The Reichschancellery, Air Ministry, Foreign Office, Ministry of Propaganda, and Gestapo headquarters all sustained many hits. Before long, German officials and state documents began to flow to other cities and Berlin lost many of its functions as a capital. Finally, civilian casualties were exceedingly high, the number of fatalities reaching perhaps 25,000,<sup>59</sup> and Swedish newspaper accounts were full of lurid details about the horror in Berlin.

This Berlin raid and the scheduled attacks on other population centers turned attention briefly again to the question of terror bombing, about which the Nazi propaganda machine was having much to say. The leaders of the AAF had long been on record in opposition to indiscriminate attacks on civilians.\* If bombardiers were sometimes less circumspect in this matter, or if Germans found it hard to differentiate between spillage and terror bombing, it nevertheless seemed important during those pre-Hiroshima months not to deviate from the stated policy of attacking legitimate military objectives. But were the current and planned bombardments of German cities which served the eastern front deviations from that policy? General Kuter, who was representing General Arnold at the Yalta conference during Arnold's convalescence from a recent illness, asked Spaatz whether the revised directive of 31 January 1945 authorized indiscriminate attacks on cities.<sup>60</sup> From Washington, Lt. Gen. Barney M. Giles cabled his support to Kuter's query,<sup>61</sup> a question which must have seemed inappropriate to direct at Spaatz, who had steadfastly upheld the principle of precision bombing in the face of much pressure. He replied that USSTAF was really observing Directive No. 3 and not the revision of 31 January: what had occurred was not a change in priority but a shift of emphasis. The Americans were not bombing cities indiscriminately, but attacking transportation facilities inside cities in missions which the Russians had requested and seemed to appreciate.<sup>62</sup>

While this exchange was taking place, the RAF and Eighth Air

\* See above, pp. 284, 638-40.

Force were carrying out extensive and shattering attacks against railway junctions in Dresden, Cottbus, Magdeburg, and Chemnitz which resulted in widespread ruin to surrounding areas and tragedy to thousands of German civilians. At the height of this campaign a news story widely printed in the United States proclaimed that the senior American air commanders had determined to terrorize the German people into submission. This account, which cleared SHAEF but not USSTAF, grew out of a SHAEF press conference in which an RAF officer described how the air forces planned to bomb large population centers and then attempt to prevent relief supplies from reaching and refugees from leaving them—all part of a general program to bring about the collapse of German economy.<sup>63</sup> In any event, the news story exaggerated the burden of the press talk and grossly misrepresented the purposes of the AAF. General Arnold was disconcerted about the publicity and by this time was confused in his own mind as to which directive USSTAF was observing. He cabled Spaatz to resolve the matter, implying that he would like to know whether there was any significant distinction between morale bombing and radar attacks on transportation targets in urban areas. Spaatz hastened to reply that he had not departed from the historic American policy in Europe, even in the case of Berlin, and Arnold expressed himself as entirely satisfied with the explanation.<sup>64</sup> As the discussion died down, Spaatz straightened out his public relations outlets, Eisenhower heard all about the issue, and AAF Headquarters, aware of the damaging impression the recent publicity had made, took steps to prevent another break.<sup>65</sup>

That opposition in the AAF to area bombardment had actually weakened, the exchange of communications on the question in February 1945 notwithstanding, is indicated not only by the almost simultaneous launching of sustained B-29 attacks on Japanese cities but by proposals for the use of robot-controlled B-17's in Europe. A program to make use of "war-weary" B-17's, stripped of armor and armament and loaded with 20,000 pounds of explosive, had occupied considerable attention both in the European theater and in the AAF Proving Ground Command. Undoubtedly, the project was technically feasible.<sup>66</sup> Pilots would get the drone bomber off the ground and bail out, leaving it to be guided toward a German target by means of radio control emanating from a "mother" bomber. Before the first of 1945 six different missions involving eleven robot B-17's had been carried out, mainly against Helgoland, Heide, and Oldenburg. None of them was

successful in hitting specific targets, and there was some danger that the equipment had been compromised.<sup>67</sup> But the method was promising and, with glide and Azon-controlled bombs, might furnish useful experience for the Pacific war while inflicting some injury upon Germany. The British, pointing out that the Germans had large numbers of planes that could not be used because of the shortage of fuel and trained pilots, objected that the project invited retaliation in kind, and at the Malta conference Portal firmly opposed the project.<sup>68</sup> The Americans reluctantly gave in, but toward the end of March the AAF reopened the question with the British since by that time the Germans had already tried to send such robots into London. Churchill's reply was nominally favorable but couched in such unmistakable terms of opposition that President Truman, who had just taken office, did not press the question further.<sup>69</sup>

### *A Month of Steady Blows*

During February 1945 the strategic air forces destroyed any serious possibility that Germany might unduly protract the war. The heavy bombers expended their greatest efforts since June 1944. Although flying conditions in the first half of the month were the worst ever experienced and 80 per cent of the missions were blind attacks,<sup>70</sup> the Eighth and Fifteenth Air Forces each carried out large-scale operations on twenty days during the month. The results were impressive in every respect. The oil campaign, into which USSTAF and Bomber Command poured 24,800 tons during the month,<sup>71</sup> remained well under control with complete victory coming into view. The Germans failed utterly to make anything out of the Geilenberg program for underground plants, largely because of the breakdown in transportation. The Russians having reduced the number of available oil production centers by conquering large sections of Poland, Hungary, and Silesia, nothing remained to the Nazis but synthetic plants in central Germany and Austria, a few crude sources, and benzol plants in the Ruhr. The air forces would watch them and smash them as soon as repairs were completed. Attacks on storage dumps by both strategic and tactical air forces would not only deplete oil reserves but wreck certain fuel processing activities which were being carried on in such installations.<sup>72</sup> Also, the February operations of the heavies helped postpone for another month the serious participation of German jet fighters, dispelling the nightmare that Hitler might yet produce a miracle. More-



over, in February came unanswerable justification of the long and discouraging campaign against German rail transportation. The enemy's economy became paralyzed and his armies fatally restricted. And marginal air effort against tanks, ordnance, and submarines was generally effective. Meanwhile, the RAF, whose bombers now operated frequently in daylight, continued to pile ruin upon ruin in German cities, immobilizing millions of workers and extinguishing economic life. By the end of February Nazi Germany was no longer an industrial nation.

The Eighth Air Force opened the month's bombings with a typical blind mission against railway targets in Mannheim and Ludwigshafen and bridges over the Weser on 1 February, an operation involving about 700 heavy bombers. On 3 February occurred the memorable Berlin attack already considered. Weather prevented Eighth Air Force operations on the 4th and 5th, and on the 6th compelled a diversion from synthetic oil plants which needed treatment to marshalling yards at Chemnitz, Magdeburg, and a number of targets of opportunity in central Germany.<sup>73</sup> The bombings at Chemnitz and Magdeburg, undertaken in compliance with Russian wishes, brought approximately 800 tons on each city. The ruins at Magdeburg included not only the chief transportation and industrial area but structures of cultural and historic importance as well.<sup>74</sup> On both 7 and 8 February heavy bomber forces left for Germany but had to be recalled while in flight because of rapidly worsening weather conditions. Then, on the 9th, six forces totaling 1,296 heavies attempted again to strike at high-priority targets in central Germany but, except for Lützkendorf and three viaducts, only secondaries and targets of opportunity could be reached. The wreckage at Lützkendorf, however, was sufficient to place that objective on the inactive list.<sup>75</sup> And damage to an oil storage depot at Dülmen and an ordnance plant at Weimar seemed substantial. For the first time in many weeks the dreaded Me-262's attacked Eighth Air Force bombers on this mission of 9 February. Exploiting their superior speed the twin-jet aircraft made wide S's around the bomber formations, eluding the bursts fired by the gunners but also spoiling their own aim. P-51 pilots believed they destroyed two of the nine or more attacking jets, and only one bomber came down.<sup>76</sup> Only minor operations were possible on 10 and 11 February, the sole important target being the Dülmen oil depot, which caught 750 tons in two attacks. Weather closed in altogether on the Eighth on the 12th and 13th, preventing missions in behalf of the Red army or the oil offensive.

With the Fifteenth Air Force, as with the Eighth, obligations to assist the Anglo-American and Russian land forces involved much attention to the German transportation system. In particular, marshalling yards in Vienna, around which the Russians were beginning to close, and railway installations in Hungary, Italy, and Yugoslavia required heavy tonnages. Heavy base fog or disturbances over the Alps kept the Fifteenth out of Germany for the first four days of February. On the 5th, despite high clouds and generally poor flying conditions on the route, 589 heavies got into Germany and dumped more than 1,100 tons on the Regensburg oil storage plant, which was very severely damaged. After a day of prohibitive flying weather, the Fifteenth vaulted the Alps again on 7 February to bomb several crude-oil refineries around Vienna; in addition, the synthetic plant at Moosbierbaum caught 528 tons and the greatest damage.<sup>77</sup> Follow-up bombings of 9 and 14 February were believed to have left this vast establishment half destroyed in productive capacity.<sup>78</sup> Railway targets in Austria received moderate raids on 8 and 9 February, after which a three-day lull ensued because of unflyable conditions. On the 13th almost the full weight of the Fifteenth Air Force, 837 heavies, struck at Vienna, concentrating on the south ordnance depot, repair shops, freight yards, oil refineries, and railway depots, as well as marshalling yards in western Hungary and Austria. After a light day of bombing railways leading toward the former Austrian capital, the Fifteenth returned in full force on 15 February to reattack marshalling yards and freight stations inside the city. General havoc was wrought in Vienna stations. In parts of the city all railway lines were blocked.<sup>79</sup> But it was the kind of damage that would not stay done.

With Vienna temporarily under control, the Fifteenth turned on 16 February to German jet aircraft. It was the day General Eaker had been waiting for to "crack the jets,"<sup>80</sup> and approximately 700 heavies flew into southern Germany. Flying conditions were not helpful, however, and only one weighty attack was carried out, when 263 Liberators unloaded 559 tons on the jet airfield and adjacent Me-262 plant near Regensburg. Perhaps 23 jets were destroyed on the ground and 19 were severely damaged. Curiously enough, the Germans could not get their jets off the ground in time. It looked as though new damage was inflicted on the factory, and results of a much smaller bombing at Neuburg seemed good.<sup>81</sup> Scattered effort on 17 February brought damage to naval objectives in Trieste and Fiume as well as to the benzol

plant and marshalling yards at Linz, Austria. The Linz benzol installation caught 417 tons on the 18th, otherwise an inconspicuous day in the air war. On the 19th, strong head winds kept the heavies from reaching Vienna, with the result that the Graz and Klagenfurt marshalling yards were attacked.<sup>82</sup> Well over 550 Fifteenth Air Force heavies were out on 20 February, bombing oil refineries and railways in Vienna and attacking harbor areas at Trieste, Fiume, and Pola. A similar number of bombers wound up this phase of the long air offensive against Vienna on 21 February with a furious bombing of railways and stations. Vienna was almost done for. Its oil, industrial, and transportation establishments were largely demolished. The Fifteenth Air Force would visit the pathetic former capital again before the Russians fought their way through it, but for the time being Vienna was eliminated from the strategic air war.

The Eighth Air Force devoted two days' effort beginning with 14 February to the central German railway centers which were believed to serve armies opposing the Russians in the east. Three hundred and eleven Fortresses dropped 771 tons on Dresden, 294 dropped 718 tons on Chemnitz, and 340 Liberators unloaded 811 tons on Magdeburg, while small forces struck targets of opportunity in this general area. Dresden, which the heavy bombers had left alone until 1945, had received a terrible bombing from the RAF on the previous night. Smoke was still rising to 15,000 feet by the time the Americans arrived to make their attack by instrument.<sup>83</sup> It was this blow which helped set off the flurry about terror bombing already described. The Secretary of War had to be apprised of Dresden's importance as a transportation center and the Russian request for its neutralization.<sup>84</sup> Even the RAF report on the attacks went to unusual length to explain how the city had grown into a great industrial center and was therefore an important target. But if casualties were exceptionally high and damage to residential areas great, it was also evident the city's industrial and transportation establishments had been blotted out. Results at Chemnitz were less decisive, though it too received two extremely severe RAF-AAF bombings within the space of a few hours; its railways were scarcely damaged at all.<sup>85</sup>

On 15 February over 1,100 Eighth Air Force bombers undertook to bring the oil offensive up to date by attacking reviving refineries and plants. Unusually poor visibility caused most of the bombers to unload on marshalling yards, however. Cottbus caught over 1,000 tons from

435 Fortresses and Dresden received 461 tons from 210 Fortresses, all dropped blind, and results were unassessable because of previous or subsequent raids. The only primary target to be attacked was the Magdeburg synthetic oil plant, where 900 tons achieved fair damage.<sup>86</sup> The missions of 16 February were necessarily directed against western Germany. Benzol plants at Gelsenkirchen and Münster-am-Stein, refineries at Dortmund and Salzbergen, and marshalling yards at Hamm and Osnabrück received most of the tonnage. Of three forces dispatched on 17 February only one carried out its mission without being recalled: an attack on marshalling yards at Frankfurt and Giessen. The heavies were grounded altogether on 18 February. Shallow penetrations were possible on the 19th when targets included a tank plant and benzol installations in the Ruhr, a bridge over the Weser, and marshalling yards at Osnabrück, Münster, and Rheine. Attention then shifted to Nürnberg, which had not been attacked for some time by the Americans and was now crammed with supply trains.<sup>87</sup> On 20 February the Nazi shrine city received 2,000 tons and on 21 February almost 1,800 tons from the Eighth Air Force. Photographs showed widespread damage to the railways and industrial areas.<sup>88</sup>

By the middle of February the several Allied land armies were prepared to resume the offensive toward the Rhine which von Rundstedt had interrupted in December. The period just before this massive push was one of great anxiety, mainly because of German-manipulated floods in the Roer valley.<sup>89</sup> In order to refine the extensive preparations already made, SHAEF requested the air forces to mount CLARION, a plan of long standing designed to utilize all available Anglo-American air power in a blow at German communications which would affect both economic life and the tactical situation.\* CLARION called for British-American bombers and fighters to range over most of the Reich simultaneously on a clear day to attack all sorts of transportation targets: grade crossings, stations, barges, docks, signals, tracks, bridges, and marshalling yards. Most of the objectives were located in small towns that had never been bombed before. Hence they would not be well defended, and injury to hundreds of ligaments in the German economic body might, at its best, produce a stupefying effect on morale on the eve of the land offensive. In general, CLARION was a substitute for the "Jeb" Stuart operation championed in Washington† and as such was presented to General Marshall

\* See above, p. 639.

† See above, pp. 715-16.

## THE CLIMAX OF STRATEGIC OPERATIONS

at the Malta conference,<sup>90</sup> although CLARION involved the large-scale employment of strategic bombers as well as fighters.

The direct ancestor of plan CLARION was HURRICANE, the project of the autumn of 1944 to impress the German people with a terrifying display of Allied air might. The plan had met objections based on opposition to terror bombing. On 1 January 1945, General Eaker had advised Spaatz against sending heavy bombers to attack transportation targets in small German towns, for there would be many civilian casualties and the German people might be convinced the Americans were barbarians, just as Nazi propaganda charged. Eaker concluded that "you and Bob Lovett are right and we should never allow the history of this war to convict us of throwing the strategic bomber at the man in the street."<sup>91</sup> There were other objections to CLARION, chiefly with regard to its probable effectiveness. Portal and Bottomley counseled against the plan as one unlikely to injure the enemy seriously and as an undesirable diversion from the oil offensive. CLARION involved a diffusion of effort over wide areas, which had been singled out by the Combined Strategic Targets Committee in January 1945 as the chief flaw of transportation attacks in the past. There was some objection to exposing heavy bombers to ground fire by sending them at low altitudes over minor targets.<sup>92</sup> But the skeptics were outnumbered where it counted, in SHAEF, and Spaatz himself was not averse to giving CLARION a try.<sup>93</sup>

The opportunity came on 22 February, when most of Germany was expected to be vulnerable to visual-bombing attacks. The tactical air forces received assignments in western and northwestern Germany, the Fifteenth Air Force was to operate over a wide area in southern Germany, RAF Bomber Command retained its semimonopoly over the Ruhr, and Eighth Air Force planned to bomb several dozen towns in the middle and north central part of the Reich. The Eighth Air Force had to depart from its usual operating procedures in several respects. Most important of all, the heavy bombers attacked from about 10,000 feet or even lower instead of the customary 20,000- to 25,000-foot altitudes. Also, the heavies formed small attacking units instead of organizing into the usual large formations. All the Eighth's fighters went along, mainly for independent strafing and bombing operations. The GAF had not undertaken a serious interception since the New Year's Day disaster, and seventy-odd German fighters which were airborne on this day caused no serious problem for the American escorts.

Bombing was good, although low clouds spoiled most of the primary targets for the 3d Air Division of the Eighth. The 1st and 2d Air Divisions dropped 2,408 tons from 875 heavies on 25 different targets. Only 7 of the 1,411 Eighth Air Force bombers which left England were lost, although 85 sustained battle damage from flak, which was not surprising in view of the low bombing altitudes. Meanwhile, the tactical air forces operated as planned in their area, and Bomber Command managed to attack two Ruhr oil plants in addition to its objectives. The Fifteenth Air Force also had a good day although it had to bomb a number of last-resort targets. Over 700 of its heavies and 350 fighters bombed 30 different towns in an area 300 miles long and 100 miles wide.<sup>94</sup>

CLARION seemed highly gratifying, so much so that another operation of the same nature was prescribed for 23 February. Bomber Command singled out Gelsenkirchen and Essen for daylight bombing and Berlin for a night mission. The Fifteenth Air Force sent 455 heavies to attack eight transportation targets in the south, and the tactical air forces repeated the pattern of 22 February. The Eighth Air Force planned to finish off the objectives which had escaped on the day before. It seemed incredible that GAF reaction would not be stimulated, so all fifteen fighter groups again went along, this time with more expectation of tangling with German fighters. Yet the GAF scarcely appeared at all, and when sighted, the Germans, even the jet aircraft, evaded combat. The Eighth struck twenty-six of its targets with 3,327 tons. Of its 1,193 bomber sorties only 2 heavies failed to return; one of them ditched in the North Sea and the crew of the other parachuted safely in friendly territory.<sup>95</sup> All the news seemed good at first. Accuracy was unexpectedly high, losses were slight, and the German people had received an unforgettable demonstration of Allied air power. Moreover, at least 150 marshalling yards were damaged, perhaps 500 railway cuts were effected, and about 300 locomotives had been destroyed.<sup>96</sup> The enemy's communications system had apparently suffered a staggering blow, and railway traffic was at a standstill in many parts of the Reich.

Subsequent assessment of the two CLARION operations greatly slaked the enthusiasm of the moment. It was never possible to evaluate all of the structural damage inflicted on German railways, for the reconnaissance and photographic effort was insufficient for such a survey. But there was no sign of a general breakdown, no evidence of the

Reichsbahn's repair facilities being saturated or of German train crews deserting in significant numbers.<sup>97</sup> Nothing in particular happened after the German people beheld Allied warplanes striking towns which usually escaped bombings. Perhaps it was a case, as a SHAEF press conference was told in a slightly different connection, of trying to injure the morale of a people who had no morale.<sup>98</sup> The depressing refrain which followed so many Allied air efforts against German transportation again seemed sound: high-priority military traffic continued to go through, the bombings having had only local and temporary effects.<sup>99</sup> The Joint Intelligence Committee concluded that CLARION had not seriously affected Germany's capacity to resist, and Portal, in indorsing this opinion, advised against any further attempts with this type of operation.<sup>100</sup> Tedder, Spaatz, and Doolittle were inclined to disagree with these judgments,<sup>101</sup> but they launched no further CLARION operations. Authoritative postwar studies also differed radically in assessing CLARION.<sup>102</sup>

A sidelight of the first CLARION mission was the accidental bombing of the Swiss town of Schaffhausen, which one year before had been an innocent recipient of an Eighth Air Force attack. USSTAF crews were supposed to observe a safety belt around Switzerland of 50 miles for visual and 150 miles for blind bombing in which they could not hit any but positively identified targets. Nevertheless, reports of violations, mainly when fighters were chasing trains or when Friedrichshafen was bombed,<sup>103</sup> continued to reach the attention of General Marshall. The incident of 22 February 1945 at Schaffhausen provoked the U.S. Army chief of staff to send a personal cable to Eisenhower and McNarney asking them to look into the matter.<sup>104</sup> A few days later, on 4 March 1945, the most flagrant breach of all occurred when nine B-24's bombed Basle and six others attacked Zurich. These Eighth Air Force bombers dropped thirty-four tons in all on the Swiss. In both cases the squadrons had wandered from accompanying formations on an exceptionally cloudy day and bombed what they mistook for Freiburg, twenty-five miles from Basle and forty-five miles from Zurich, through holes in the sky which were not as opportune as the crews thought.<sup>105</sup>

As soon as he heard of the violations General Marshall cabled Spaatz to go to Switzerland very secretly and make a formal apology and explanation—something more than a mere expression of regret. The USSTAF commander made his visit and received a few days later

messages from the Army chief of staff and from General Arnold thanking him for trying to make amends for the blunder.<sup>106</sup> USSTAF took more care in indoctrinating its crews, and there were no further reports of violations.

The general success which attended the Allied land offensive toward the Rhine after 23 February enabled the heavy bomber commands to return to the strategic air offensive. The goals remained the same: deny oil products to the enemy, ruin his communications, reduce the number of weapons he could use in land battles, and, if there remained marginal effort, attack his budding jet aircraft force and new submarines. With the stabilization of the eastern front, commitments to bomb large population and communications centers dropped down the priority list. The air battle against German transportation was shaping into a new phase, however, and attacks would continue in great weight. With the Ruhr marked as the next strategic objective for the land forces, the several air forces began an ambitious campaign to isolate that valley from the rest of Germany. The purpose was to cut at least one vital bridge or viaduct on every line of communication in a wide arc extending from Bremen in the north down the Weser River through Bielefeld to Coblenz in the south. In all, eighteen bridges or viaducts were involved, six of which were assigned to the strategic air forces. Then, every marshalling yard of any importance between the broken bridges and the Ruhr had to be attacked repeatedly in order to insure interdiction.<sup>107</sup> Fighter-bombers would operate against rolling stock as they had ten months before in northern France. The major portion of the plan devolved upon the tactical air forces, and the principal purpose of the whole program was tactical: to prevent the Germans from building up their forces in the Ruhr prior to the Allied assault. Nevertheless, the isolation of the Ruhr, if successful, would vastly influence the strategic air war against Germany's war-making capacity, particularly in denying hard coal and steel which were now so vital to the Reich since Silesia had fallen to the Russians.<sup>108</sup> Because the plan was expected to produce this significant strategic result, General Vandenberg had insisted that the strategic air forces take a substantial part.<sup>109</sup>

Eighth Air Force returned to the bomber offensive on 24 February with a large but not very successful mission against northwestern Germany. Cloud conditions were even worse than anticipated, so that nearly all the bombs were dropped by H2X. The 1st Air Division con-



## THE CLIMAX OF STRATEGIC OPERATIONS

centrated on oil refineries in Hamburg, the 2d Air Division struck marshalling yards and an oil refinery at Hannover, and the 3d Air Division aimed at a submarine pen in Bremen, two bridges near Minden, and the industrial area of Osnabrück. Only 2 of the 1,090 heavy bombers failed to return; German anti-aircraft fire, like American bombing, was inaccurate that day.<sup>110</sup> The missions of 25 February constituted a substantial if not outstanding assault on Germany. A generally unfavorable forecast left only southern targets open to bombing, and 1,177 bombers with eleven fighter groups reached the Bavarian area. Marshalling yards at Munich and Ulm, various airfields for jets, the oil storage depot at Neuburg, the tank assembly plant at Aschaffenburg, and a tank engine factory at Friedrichshafen were the chief objectives. Losses were light—only five bombers and five fighters. Bombing was good at the airfields, railway yards, and the oil depot. And an almost complete failure at Friedrichshafen was matched by the destruction of practically all the buildings at the Aschaffenburg tank plant and severe damage at Neuburg.<sup>111</sup> Such missions as these, which seemed inconclusive in some respects and which were often not carried out as planned, had a way of producing significant results. In the long run the stubborn policy of dispatching bombers over Germany at every possible opportunity brought about the effects envisaged by the Allied leaders.

Berlin came in for another Eighth Air Force visitation on 26 February, since a predicted overcast covering the Reich ruled out visual operations planned against southwestern Germany. All forces were thus directed against the most suitable area for instrument bombing: railway targets in east central Berlin, especially the Schleisicher, Alexander Platz, and North railroad stations. Each air division took one of the three stations for its main target. The bombers reached "Big B" 1,102 strong, dropped 2,879 tons, and, as anticipated, encountered no enemy fighters. Five bombers and five fighters were lost to flak or because of operational difficulties. Assessment showed that only the Schleisicher station of the three main objectives was severely damaged. But enormous fires burned in many parts of the city intensely enough to dispel the clouds, and that night RAF Mosquitoes were able to make good visual sighting on their regular raid. It was apparent that moderate damage had been inflicted on railway targets and power stations. Also, the Reichstag building was hit, a wing of the Ministry of Propaganda was destroyed, and other public buildings were dam-

aged. Spillage from the transportation bombings damaged industrial plants and scattered sections in the business and residential areas.<sup>112</sup> Admiral Doenitz assured his Fuehrer a few days afterward that Berlin had been bombed only for political reasons. He said he thought sea-ports like Stettin and Swinemünde, full of supplies and crowded with refugees, would have been better targets for the Allies.<sup>113</sup>

The operational commanders chose for 27 February, on the customary basis of weather predictions at the 1600-hour conference the day before, a complex of targets in the Leipzig area, mainly aeroengine plants, a tank factory, and marshalling yards. Nearly 1,100 bombers and the full fifteen fighter groups sortied. Visibility proved even poorer than had been anticipated, with the result that only railway targets at Halle and Bitterfeld and the central transportation point in Leipzig itself received attention. The bomb fall was not accurate, but spillage on adjacent industrial and residential areas in Leipzig caused considerable destruction. On 28 February the only exposed section of Germany was the west central part. Accordingly, bombings of that day were mainly in fulfilment of the over-all transportation program to isolate the Ruhr. Good attacks were also made on the Henschel tank plant at Kassel and a castings factory at Meschede.<sup>114</sup> The attacks on marshalling yards, even though most of them were nonvisual, were unusually good, and several targets were suspended or removed from the list.

The Fifteenth Air Force had fine weather during the last few days of February over its bases and routes, although conditions at targets usually made it necessary to employ blind-bombing techniques. Nearly all of the Fifteenth's objectives were tactical: railway targets in northern Italy, Austria, and in southern Germany, most of which would benefit the Russian land forces gradually moving up toward Vienna. On 24 February the Fifteenth carried out a phase of the long and inconclusive campaign to break the Brenner Pass railway line, in which the tactical Twelfth Air Force concentrated on bridges and lines and the Fifteenth on main marshalling yards. On the 25th the familiar benzol plant at Linz received a light bombing, as did the ordnance depot in that city; marshalling yards there also caught significant tonnages. Bombers were not able to surmount the Alps obstacle on 26 February, but on the next day 430 B-17's and B-24's dropped almost 1,100 tons on Augsburg's marshalling yard. The Brenner Pass line received most of the effort of 28 February, when 533 B-24's and 222 B-17's bombed

bridges and rail centers on the Italian side. In terms of tonnage, the last week of February was one of the most notable in the history of the Fifteenth Air Force.<sup>115</sup> For the aircrews another pleasant aspect was the almost complete absence of the enemy's fighter force. The Germans could no longer fly their conventional fighters, and their jets were not quite ready for full-scale participation in the air war. During this interval both the Eighth and the Fifteenth suffered minimum losses. Flak was more concentrated than ever before, however, now that Germany had shrunk in area. But Allied countermeasures were better than ever before, too, and the use of 27-plane instead of 36-plane formations after February 1945 seemed a main factor in keeping flak damage low in the Eighth Air Force.<sup>116</sup>

As March opened, the only air force problem was to maintain the offensive along the lines set by February's operations. Allied land forces were moving forward. German oil supplies were adequate only for a fitful, uncertain defense, and the three Allied strategic air forces were to direct 36,000 tons, the second largest amount in the entire oil offensive, at refineries and storage dumps in March. The only setback occurred when the Germans surprisingly recaptured some of the Hungarian oil fields from the Russians.<sup>117</sup> The protracted campaign against enemy transportation was now paying off in economic and military paralysis, perhaps long overdue but nonetheless final. Shortage of all sorts of equipment and weapons for waging war—largely the accumulated result of the long series of RAF-AAF bombings—now hampered the German armies. Even if new jet and submarine forces were about to appear, the Allies were no longer worried about the war. The strategic air offensive had only a few more weeks to go before victory was secure. At the beginning of March the air forces had no new directives. They needed none. A steady application of blows for a few weeks would leave the Third Reich helpless, ready for occupation.

The 1 March 1945 mission of the Eighth Air Force required dispatching 1,219 heavies, a normal effort by this date of the war, to southern Germany. Targets were mainly marshalling yards in that section of the Reich. Ulm caught over 1,300 tons, but disappointing weather conditions made it necessary to bomb many secondary objectives that day. Even so, German transportation was reaching a state of collapse which made almost any bombing effective. Several jets jumped the lead bomber box and a straggler without success. The possibility of such attacks made it necessary to dispatch enormous and otherwise in-

congruous numbers of fighter escorts with the bomber formation these days. On 2 March such precautions again proved valuable. All fifteen fighter groups went along with 1,210 bombers which carried out unusually heavy and effective attacks on synthetic oil plants at Magdeburg, Ruhland, and Böhlen, a tank plant at Magdeburg, and marshalling yards in Dresden and Chemnitz. Deducing that another Berlin raid was about to take place, the Germans put up three large formations of fighters to protect the capital, where they cruised for some time. Finally, about seventy-five of them headed out toward Dresden and Ruhland to attack B-17's of the 3d Air Division and shot down six of the bombers. AAF fighters and bomber crews claimed about half of the attacking fighters, and results of other engagements in the air made the attempted interceptions disastrous for the Germans.<sup>118</sup>

The opposition on the following day, 3 March, came from the dreaded jets. More than fifty Me-262's and Me-163's playfully encircled the slower P-51's, making a few attacks and eluding the Mustangs without apparent difficulty. Finally, the jets shot down six American fighters and three bombers before allowing themselves to be driven off by the P-51's.<sup>119</sup> The Germans seemed to be experimenting with formations and tactics and were not prepared for another two weeks to challenge the Allies again. The 1,048 Eighth Air Force bombers got in good blows that day against widely scattered targets in central and western Germany: synthetic oil plants at Magdeburg and Ruhland, oil refineries at Dollbergen and Misburg, tank plants in Brunswick, and several marshalling yards on the Ruhr interdiction list.<sup>120</sup> The mission of 4 March was generally unproductive except for 657 tons dropped on the ordnance depot at Ulm. Most of the bomber formations encountered very unfavorable weather conditions and struck targets of opportunity.<sup>121</sup> An operation against oil objectives in Hamburg and Ruhland scheduled for 5 March was also inconclusive. Because of exceptionally poor visibility, railway targets of low priority and a Hamburg refinery received blind attacks from the 500 heavies that were airborne that day.<sup>122</sup> One good piece of news at this time was that American bombers were often not being shot at when they flew over the Ruhr.<sup>123</sup> The enemy was at last feeling severe shortages in flak.

Grounded on 6 March, the Eighth Air Force sent 926 heavies on 7 March to bomb through the overcast important oil and transportation targets in the Ruhr. Benzol plants at Dortmund and Castrop and an oil refinery at Dortmund received fairly effective attacks, but the railway

## THE CLIMAX OF STRATEGIC OPERATIONS

targets were mostly secondary or last-resort targets. 8 March was a better day for bombing if not for weather. About 1,340 heavy bombers ranged over the western extremity of the Reich, bombing by instrument various marshalling yards on the Ruhr interdiction list, the Gelsenkirchen oil plant, and five different benzol plants. The 3,773 tons were unloaded on most of the primaries, and there were no losses on the mission. Breaks in the cloud-covered continent developed on 9 March in the Kassel-Frankfurt area. Over 1,000 bombers finished off the great tank plant at Kassel, which was abandoned after the mission, and inflicted notable damage on a castings work at Frankfurt and several important marshalling yards on the transportation list.<sup>124</sup> Operations were much the same on 10 March except for greater emphasis on railway targets. Thirteen hundred and fifty-eight heavy bombers with ten groups of fighter escorts left England to bomb by H2X numerous transportation targets, a task they accomplished with no losses and with "customary good results," as Doolittle boasted.<sup>125</sup> The monotonous pounding of western German railways, most of which was carried out on cloudy days when oil and jet targets were not in need of urgent treatment, was rapidly compounding Germany's troubles.

The offensive shifted northward on 11 March. Germany was still protected by clouds and effort could be spared for a marginal target system, submarine yards. Accordingly, Eighth Air Force sent its three air divisions at normal strength to attack, one division to each objective, U-boat yards at Kiel, Bremen, and Hamburg. Bombing was entirely blind and first reports indicated considerable success in covering the target areas with about 3,000 tons, but Doolittle soon afterward assessed the mission as a failure.<sup>126</sup> Exceptional accuracy was required to harm these difficult and well-concealed targets. The mission of 12 March brought an exciting variation from the normal routine. A last-hour Russian request for an operation against Swinemünde, a Baltic port assuming tactical importance as a German center of seaborne reinforcement now that the Russians were moving into eastern Germany, brought a vigorous Eighth Air Force response. About half the operating strength of each air division was pulled off planned operations and dispatched to Swinemünde, a total of 671 bombers making sorties. Although the city was only fifteen to twenty miles from the Russian lines and ordinarily too close for an H2X mission, it was decided to use the radar device because the area was so easily identified on screens. The attacks were good, 1,609 tons falling on vessels in the harbor,

quays, slipways, and a large number of buildings in the port and on industrial areas. Flak was meager and inaccurate, and the only bomber which failed to return made for Sweden. Doolittle hailed the mission as successful in spite of the 10/10 cloud. The Americans requested the Red air force to photograph the results of the Swinemünde attack. After a three-week delay came a brief reply minimizing the effectiveness of the bombing, but no photographs. British photographs taken later showed substantial damage.<sup>127</sup>

Bomber Command's contribution to the last phase of the war steadily grew in weight. Often flying in daylight, the RAF heavies unloaded vast tonnages on the marshalling yards in western Germany and kept the familiar benzol and oil targets in the Ruhr immobilized. On 11 March the greatest weight of bombs ever dropped in a single strategic attack fell on Essen, when 1,079 bombers deposited 4,738 tons. This record stood for only one day, for on 12 March Dortmund received 4,899 tons from 1,107 aircraft. Also, the 12,000-pound Tallboy bombs were dropped successfully for the first time on the Bielefeld and Arnsberg viaducts, difficult targets against which bombing effort had hitherto been of scant effect. The ruined cities of the Ruhr were kept in ruins. Casualties, unemployment, and primitive conditions had become commonplace in many formerly busy areas. Mosquitoes continued their regular attacks on Berlin which had been going on almost nightly for many weeks. Mine-laying and antishipping operations remained as a major function of the RAF. As the war in the air drew to a close Bomber Command, like the American strategic air forces, poured out the heaviest tonnages of its long history, eclipsing its own impressive records as it rained explosives on the Reich.<sup>128</sup>

The Fifteenth Air Force was expending approximately two-thirds of its effort on transportation targets and one-third on the oil campaign. As strategic targets vanished more attention could go toward aiding the Allied and Russian advances. In the second week of March it was the Russian land offensive which claimed most assistance, and the Russians sent in a stream of requests for bombings which would benefit their ground forces.<sup>129</sup> Thus marshalling yards, airfields, bridges, and strong-points in western Hungary, southern Austria, and northern Yugoslavia absorbed heavy tonnages. The most spectacular Fifteenth Air Force mission at this time was the 12 March assault on the massive Floridsdorf oil refinery near Vienna. A force of 225 B-17's and 522 B-24's dropped 1,667 tons on this objective in the largest single operation yet carried

out by the Italy-based heavies. On the next day a force of almost 600 heavy bombers dropped 1,200 tons through a complete undercast on the marshalling yards at Regensburg, severely damaging an important transportation center which had largely escaped significant injury before. The results of nearly all the bombings were satisfying.<sup>130</sup> Tactical and strategic objectives alike were succumbing to these repeated assaults. The air forces bombed at will, restricted only by weather and maintenance. And bombing accuracy was becoming high.

A long-awaited opportunity for a visual mission enabled 1,246 Eighth Air Force heavies on 14 March to attack high-priority objectives. Oil refineries in the vicinity of Hannover received considerable damage, and the Panther tank works in that city was knocked permanently out of action. Also, effective bombing wrecked a jet castings plant at Hildesheim and more marshalling yards and bridges in the Ruhr interdiction program were damaged.<sup>131</sup> The chief target of 15 March was a tempting objective, the headquarters of the German high command at Zossen, twenty-eight miles from Berlin. Long regarded as invulnerable to bombing even with the heaviest explosives,<sup>132</sup> and for that reason not systematically attacked, there seemed to be a chance now to interfere with the evacuation of this citadel by the OKW. Then, too, the Russians had requested an Allied air attack, which was carried out as a gesture of collaboration.<sup>133</sup> Another target decreed for the day was the railroad center at Oranienburg, not far from Berlin on a main route leading toward the Russian front. More than 1,340 heavy bombers with fifteen fighter groups took off, half destined for each objective. Jets appeared at a number of scattered points in the Reich and occasionally fired rockets at the formations but made no organized efforts at interception. The bombers dropped almost 1,400 tons visually on Zossen, blanketing the area with bombs and destroying most of the buildings above the ground. The force attacking Oranienburg inflicted considerable damage with 1,327 tons on the railways and the city itself.<sup>134</sup> On 17 March blind attacks were made on the Ruhland oil plants, and on Böhlen, whose synthetic plant was reported about to return to operation. The weather proving worse than anticipated, secondary targets such as power stations and marshalling yards absorbed the remainder of the bombing effort that day.<sup>135</sup>

For two weeks the Allied air forces had encountered practically no German air opposition,<sup>136</sup> but the mission of 18 March revealed that the long-hovering menace of a jet air force finally had materialized.

## THE ARMY AIR FORCES IN WORLD WAR II

On that occasion the Eighth Air Force, while projecting a limited penetration operation into western Germany, received orders from USSTAF to mount a 1,200-plane assault on Berlin, which was again the goal of moving Russian armies. As it turned out, 1,250 heavies with fourteen fighter groups of P-51's (the P-47 group was converting from the D to the M series and was not operable) reached the German capital and dropped over 3,000 tons by H<sub>2</sub>X indications on transportation and industrial areas. It was the biggest daylight raid ever made on Berlin. Damage was widespread and distributed throughout the whole of the city, but twenty-four bombers and five fighters were lost, mainly to jet fighters which attacked in formations as large as thirty-six aircraft and displayed a range of interception greater than the Americans had expected. The aggressive German attack on the bombers promised a new phase of the air war. Moreover, flak had been heavy and accurate enough to damage more than half the bombers, and sixteen were so badly damaged they crash-landed behind the Russian lines instead of trying to reach England.<sup>137</sup>

Danger from the jets was expected on the mission of the following day, 19 March, when nearly 1,000 bombers and fourteen fighter groups set out for the Leipzig area to bomb high-priority oil and jet objectives. The jets appeared on schedule, shot down three B-17's, and attempted, apparently, to force the P-51's to drop their extra tanks. On this operation the Germans even tried to send up the old-fashioned Me-109's, but AAF fighters managed to keep most of them from getting far off the ground. Bombing was not generally successful around Leipzig because of dense haze and contrails; thus secondaries such as marshalling yards caught a substantial tonnage. But a timely attack on jet airfields at Leipheim and Neuburg and two jet components plants justified the mission.<sup>138</sup> With most of the Reich covered by a 10/10 overcast on 20 March, only a shallow penetration by limited forces was feasible. The Eighth sent 415 bombers to strike U-boat yards at Hamburg and oil refineries in that city and at Heide-Hemmingstedt. As it turned out, most of the 700 or more tons were strung out unevenly over the general dock area at Hamburg, but the Heide-Hemmingstedt refinery was very severely damaged.<sup>139</sup> About forty jet aircraft challenged the P-51's and shot down two of the bombers. The jet pilots seemed less skilful than those who had operated against the Americans two days before. But it was only too clear that the time had come for an all-out attack on the new GAF, as Doolittle and Ted-



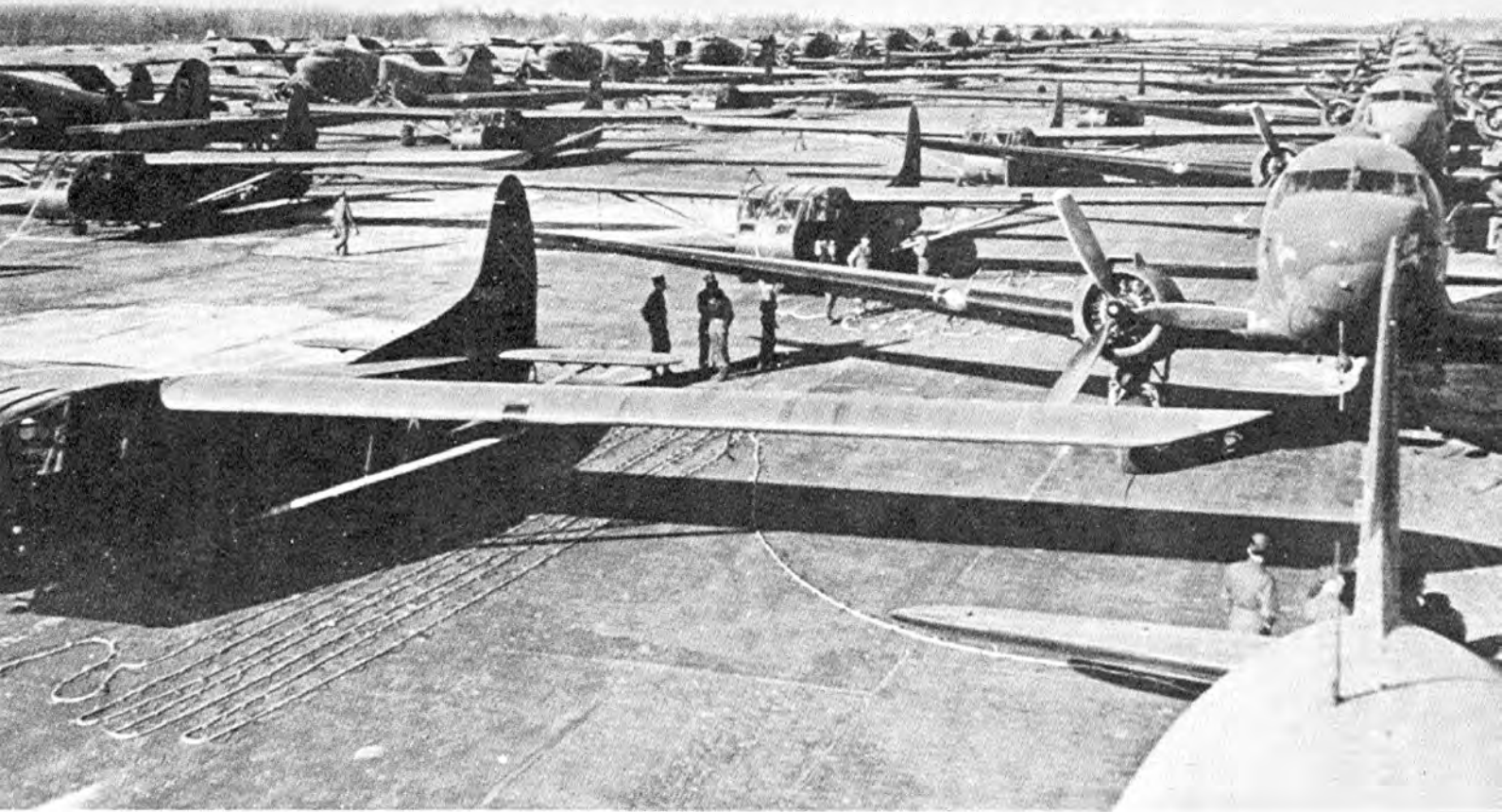

Varsity Line-up, 24 March 1945

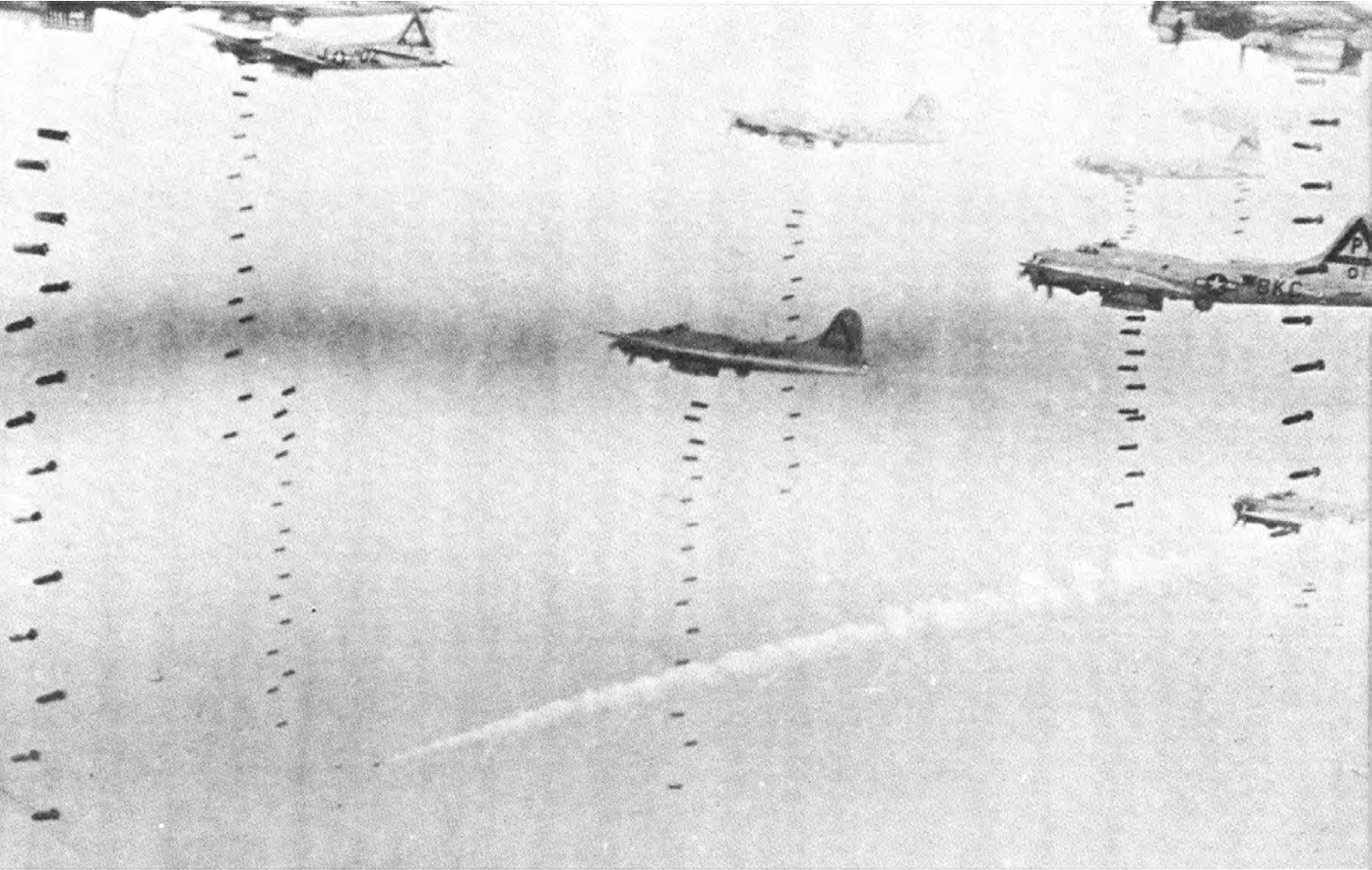

EIGHTH AIR FORCE BOMBS DRESDEN

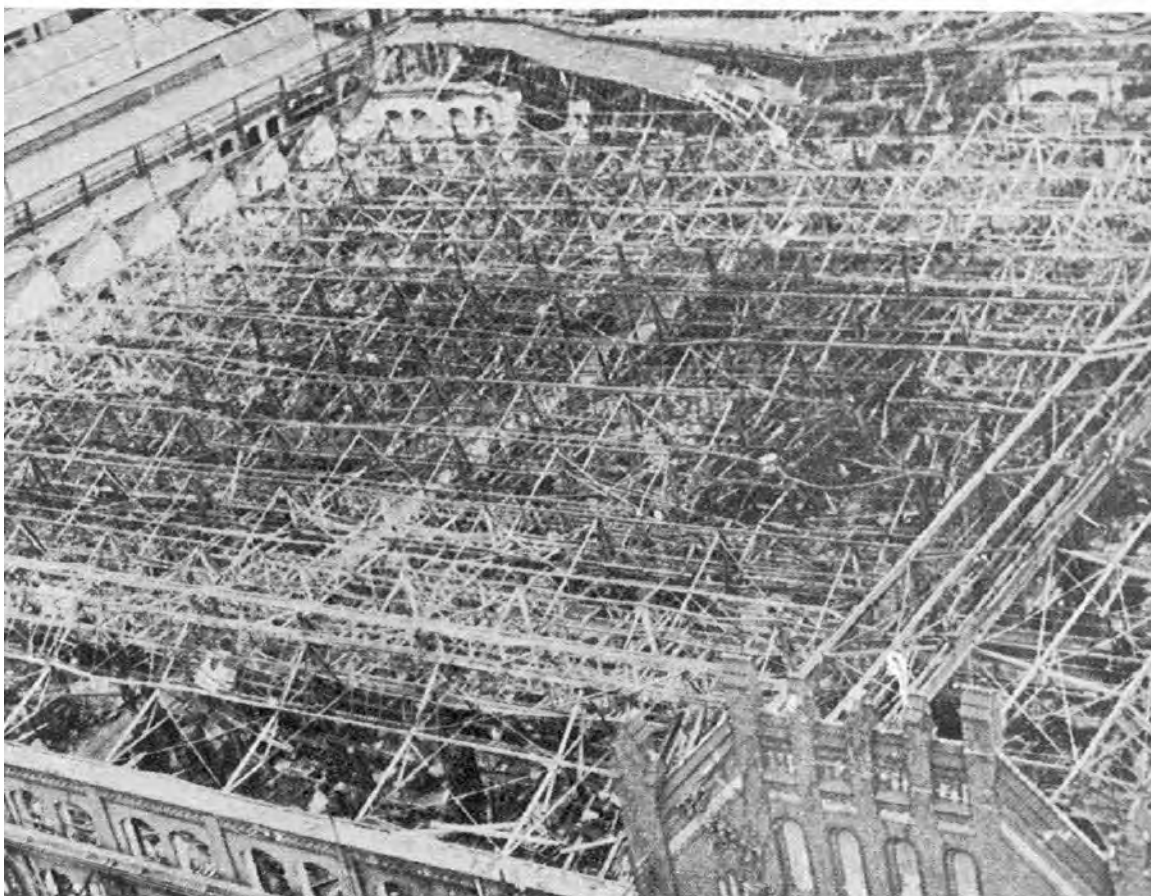
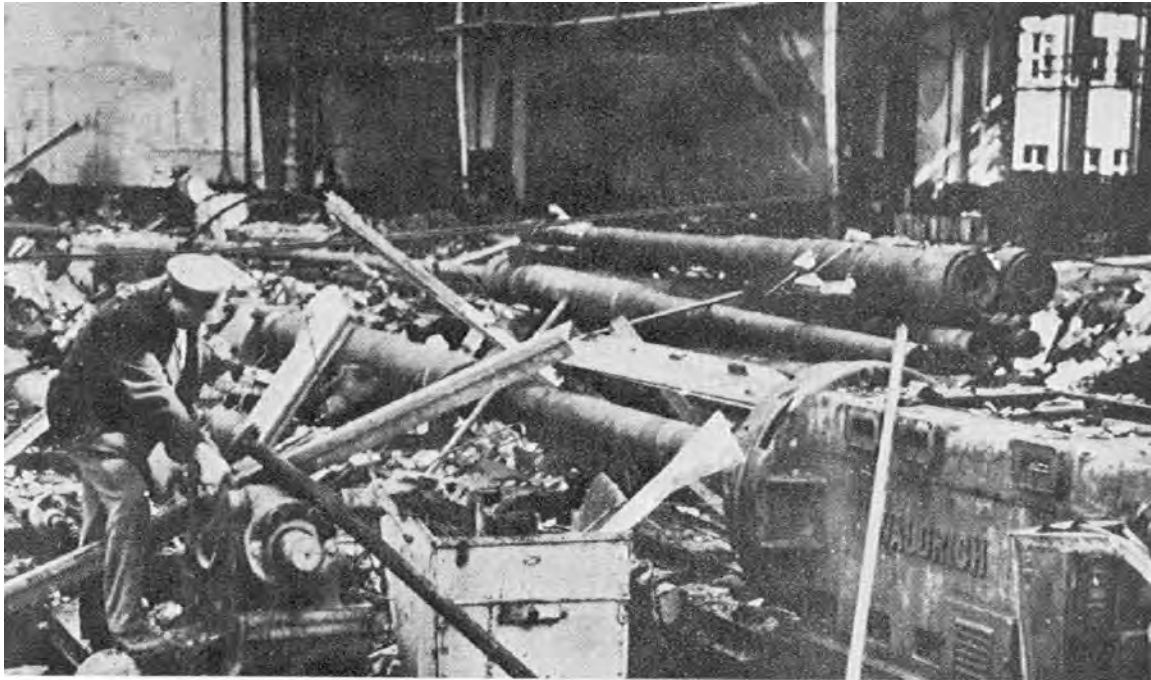

BERLIN FACTORIES HIT BY EIGHTH AIR FORCE, 18 MARCH 1945



## DEATH OF THE LUFTWAFFE

*Above:* STRAFING ATTACK BY 353D FIGHTER GROUP, 16 APRIL 1945

*Below:* BAD ABLING AIRDROME, MAY 1945

## THE CLIMAX OF STRATEGIC OPERATIONS

der agreed on the following day.<sup>140</sup> Before March was out close to thirty Eighth Air Force bombers were known to have been lost to the enemy's jets.

The Fifteenth Air Force was operating at full strength in mid-March, winding up its part of the strategic air war. Fortunately, it seldom encountered jets or any other type of fighter, although the Germans possessed sizable forces in the south and would certainly have employed them if they had had the fuel. On 15 March the Fifteenth carried out its longest mission of the war when 109 B-17's bombed the synthetic plant at Ruhland, Germany's leading producer at that time. Similar forces worked over the familiar Vienna oil targets: Floridsdorf, Moosbierbaum, and Korneuberg. Perhaps the Vienna plants were out of operation by that time, but rubble and ashes were stirred up to assure complete cessation. These same refineries caught similar punishment on 16 March, when marshalling yards in Austria leading toward the Russian front were also reattacked. After a two-day lull the bombers resumed the offensive against transportation in and around Vienna by depositing the largest tonnage of the Fifteenth's history, more than 2,000. On the next day production at Korneuberg oil refinery definitely ceased. Then, on 21 March, 366 Liberators carried out one of the most effective raids of the war, an 800-ton visual bombardment of the jet plant and airfield at Neuburg, which had been damaged by the Eighth Air Force two days before. The jet center was almost obliterated, and three days later when 271 Liberators returned to finish off the destruction, they killed an estimated 25 jet fighters on the airfield.<sup>141</sup>

A period of excellent weather enabled the Fifteenth to complete its strategic air offensive. On 22 March, 136 Fortresses flew again to Ruhland and damaged it severely. Another visit on the 23d by 157 Fortresses assured the prostration of that stubborn target. On the first mission the Germans resisted energetically, sending up perhaps forty jets which shot down three B-17's. On the second mission to Ruhland there was no air opposition at all. Meanwhile, 124 Liberators put a Czech oil refinery at Kralupy out of operation and, on 23 March, 157 B-24's poured 437 tons on the disintegrating St. Valentin tank works in Austria. The Fifteenth Air Force conducted its first assault on Berlin on 24 March, while thousands of American and British aircraft were operating to the west of that target. Nearly 150 Fortresses dropped 357 tons visually on the Daimler-Benz tank engine works

in the suburbs of the Nazi capital and damaged other industrial objectives. The Germans sent a force of jets up to intercept the bombers and succeeded in shooting down two B-17's, the last aircraft positively known to be lost by the Fifteenth to jets.<sup>142</sup> On the same day three large Liberator forces of the Fifteenth bombed jet centers at Neuburg, Munich-Riem, and Budejovice. Airfields and tank plants were the leading targets of 25 March, when the Prague area, seldom touched by the Allied air forces,<sup>143</sup> absorbed the last real strategic air assault of the Fifteenth Air Force. There were missions enough remaining for the Fifteenth to fly, but they were tactical and local in effect. Its oil targets were overrun or devastated beyond recovery, and time was running out rapidly for all aspects of Germany's war-making capacity.

The victory drive against Nazi Germany was about to begin. Russian forces were crowding Vienna and Berlin and Eisenhower's armies in the west were making ready to cross the Rhine on a wide front and finish off German resistance. Air preparations for the western operation had been going on for more than a month. As has been seen, the strategic air forces had devoted a majority of their tonnage toward paralyzing German transportation and, in particular, sealing off the Ruhr from the rest of the Reich. This last program was completely successful, although the ground force encirclement of the Ruhr a few days later overshadowed the extent of the air victory. The tactical and strategic air forces of America and Britain had, by the third week in March, broken fourteen of the eighteen bridges on the target list and interdicted the other four. Twenty of twenty-five main marshalling yards were not functioning.<sup>144</sup> German traffic in and out of the Ruhr was at a standstill, and even within that unhappy valley there was little movement. Hence Germany's most valuable industrial section no longer served her war effort. It could not even be reinforced by troops in the face of the Allied onslaught. And behind the Ruhr lay a demoralized population, a stricken industry, a beaten army, and a fading government.

Just before the great airborne and land assault over the Rhine (VARSITY and PLUNDER), the air forces undertook a gigantic operation lasting four days to perfect the isolation of the Ruhr and to pulverize German defenses. Furthermore, the Eighth Air Force set out in particular to neutralize airfields in northwestern Germany from which jets might fly to shoot up the transports of the First Allied

Airborne Army. For these purposes the entire strength of the Eighth Air Force was turned over to the demands of the Rhine crossing, along with the RAF Bomber Command, the tactical air forces, and diversionary assistance from the Fifteenth Air Force. On the first day, 21 March, the Eighth sent 1,254 heavies to bomb ten airfields in excellent weather. They followed up this assault on 22 March with missions against five more airfields and about 2,000 tons on military encampments, defended villages, and store areas close to the expected site of the crossing. In view of the splendid flying weather the twenty B-17 groups attacking the ground objectives attempted to obliterate rather than to harass them as first planned. On the third day of the pre-crossing bombings the Eighth sent 1,240 heavies to finish off a large number of marshalling yards in and around the Ruhr.<sup>145</sup> Meanwhile, Bomber Command was conducting similar operations, on one occasion sending 700 heavies in daylight for a devastating blow. On D-day, 24 March, the tempo increased. Bomber Command's attack on Wesel was saluted by Montgomery as "a masterpiece."<sup>146</sup> More than 1,000 Eighth Air Force heavies laid on a stunning attack against the airfields again, rendering most of them unusable for days. Liberators supplied the airborne troops which had jumped earlier in the day and subjected airfields to reattack. The crossing proved magnificently successful. The enemy was isolated and battered, and of the 200 GAF sorties that day, none reached the battle area.<sup>147</sup> As Eisenhower told his press conference a few days later, Germany was a "whipped enemy."<sup>148</sup>

### *The U.S. Air Forces and the Soviet Ally*

Early in 1945 several attempts were made to secure Russian cooperation in air matters. These efforts failed; little came of them but infuriating deadlocks. By this time, however, American officials were more accustomed to Russian rebuffs than they had been in 1944 and perhaps they had become more philosophical about accepting them. The chief issues affecting the air forces were bases near Vienna and Budapest for the Fifteenth Air Force, bomb lines between Russian and Allied forces, and the establishment of radar stations in Soviet-occupied territory. The air base project had been under consideration since the late summer of 1944, when it seemed for a time that Russian land forces were going to overrun Hungary and Austria very speedily. The advantages of placing a few Fifteenth Air Force groups there

were compelling: the Alps would no longer be an obstacle to the bombing of Germany, flying distances would be much shorter, and more disabled airplanes and distressed crews might be saved. At a meeting of top air commanders from ETO and MTO at Cannes in late November 1944 the project received warm indorsement.<sup>149</sup> The Russians who were approached on the subject exhibited an indifference bordering on hostility. After some weeks of stalemate General Spaatz considered hinting to the Russians that further inaction might cause the removal of some Fifteenth Air Force groups to England. It soon became clear, however, that a threat of this type would be unwise. Perhaps the Russians would be only too pleased to see American air strength in southern Europe reduced.<sup>150</sup>

Since the military had made no progress in the Vienna-Budapest base matter, President Roosevelt talked it over with Stalin at the Yalta conference. On 12 February 1945 news of "agreement on highest level" came through.<sup>151</sup> Yet a month passed before the Soviet officials could be induced to act. Finally, in mid-March, General Eaker was allowed to tour eastern Hungary and to pick out an air base at Debrecen.<sup>152</sup> Difficulties and practical problems could not be resolved, however, although the Americans thought they made modest and reasonable requests. Eaker could not even get permission to go to Moscow to make arrangements, although he went to Belgrade and was lionized by Marshal Tito.<sup>153</sup> More weeks went by without any genuine Russian move to implement the agreement. It was the usual matter of procrastination, bland stalls, refusal to negotiate, and unanswered correspondence.<sup>154</sup> In April the Americans dropped the whole question.<sup>155</sup>

The bomb line had a more protracted and painful history. When Soviet armies first broke into the Balkans, in the spring of 1944, the Allies undertook to set up machinery to coordinate MAAF operations with those of Russian air and ground forces. It seemed to both the British and the Americans a matter of urgency that the MAAF and Red air units not mistake each other for Germans or get in the way of one another.<sup>156</sup> And a bomb safety line in front of the Russian land forces seemed essential if important German targets were to be bombed or strafed without jeopardizing friendly troops. Yet the Russians steadfastly refused to establish liaison except in Moscow.<sup>157</sup> At length Maj. Gen. John R. Deane secured permission to designate the line Constanza-Bucharest-Ploesti-Budapest as a temporary boundary



## THE CLIMAX OF STRATEGIC OPERATIONS

between MAAF and the Red air force, and the Russians finally consented to a loose supervision from Moscow by the Red army general staff and an AAF officer.<sup>158</sup> General Eaker in October succeeded in establishing an unofficial liaison unit with one of the three Russian armies operating in the Balkans. It worked well until Moscow found out about it. Then, the liaison unit was not allowed to advance as the Russian front moved into Hungary and Austria but sat helpless in Bucharest.<sup>159</sup> The whole bomb-line question flamed up in November 1944 when P-38's of the Fifteenth Air Force strafed a column of Soviet troops in Yugoslavia and killed a Red army lieutenant general.<sup>160</sup> The Russians acted as though the tragedy might have been something more than the accident it was, and they still refused to permit close liaison. General Eaker finally took matters into his own hands and adjusted the bomb line on a day-to-day basis ahead of the Russian front lines. He would notify the U.S. military mission in Moscow, which would in turn inform the Russians 24 to 48 hours ahead of time. The CCS objected to the principle involved in such arbitrary methods, but they guardedly accepted Eaker's plan, which worked out reasonably well for the rest of the war.<sup>161</sup>

Late in 1944, as Allied and Russian armies moved closer to each other, the bomb-line issue began to affect General Eisenhower's command. Again the Russians were invited to exchange liaison units among the air and ground headquarters concerned, and again they declined, confusing or pretending to confuse bomb lines with theater boundaries.<sup>162</sup> In December they startled the Allies by recommending that no targets east of a bomb line running from Stettin to Berlin be bombed. Since the Red army was far to the east of this line and some of the prize German oil and jet targets lay beyond it, the Allies rejected the proposal. General Deane soon discovered the real Russian purpose, which was to prevent the RAF from arming partisans who adhered to the hapless Polish government in London.<sup>163</sup> For some weeks there seemed little possibility of coordinating the air war with the Russian offensive. At the Yalta conference, however, when the Russians were requesting air assistance from the western Allies, an agreement seemed within reach. On 6 February 1945 the Russians were believed to favor an Anglo-American proposal to set a bomb line at Stettin-Berlin-Ruhland-Dresden-Brno-Vienna-Maribor-Zagreb. The Allies said they would notify the Russian high command 24 hours before carrying out a mission east of that line<sup>164</sup> and, unless the Russians

objected, would go ahead with the attack. Three days later, however, the Russians gave a new twist to the proposal: unless they approved, the mission would not be carried out.<sup>165</sup> The Allies could not agree to this arrangement, since it would take weeks for a request to go through Russian channels, if it were answered at all. So they continued to bomb what they wished at the discretion of Spaatz and Eaker, notifying the Russians ahead of time if the attack were close to Soviet lines. As the strategic air war drew to a close in March almost every bombing had to be coordinated in this fashion,<sup>166</sup> and the Russians finally accepted the original Yalta proposal.<sup>167</sup>

A third problem which concerned the American air forces and the Soviet Union had to do with the unrewarded effort to set up on Soviet soil three pairs of Micro-H stations. From these installations radio impulses of very high frequency could be sent out to bombers in flight up to 180 miles away. The conjunction of these impulses on H<sub>2</sub>X equipment in the bomber would allow far greater accuracy in attacking twenty-six high-priority oil, jet, tank, and railroad targets in Germany. Meanwhile, the British desired to establish small stations for their Gee and Gee-H equipment. Both the American and British units would require the services of a small number of their own nationals, about 100 individuals in the case of the Micro-H stations.<sup>168</sup> Russian objections of a technical nature were transparently spurious; it was clear they did not want foreign personnel within their lines.<sup>169</sup>

The Russians were also unwilling to designate certain airfields behind their lines as bases for crippled American bombers. Instead, damaged aircraft were free to land wherever they could in Soviet-controlled areas, but they were likely to turn up later with Red air force insignia.<sup>170</sup> The recovery of American aircrews from Russian zones continued to offer difficulties, many of which arose less from deliberate ill-will than from physical problems and perhaps a low regard among the Russians for human life. Finally, the AAF was anxious to survey the chief targets which it had bombed. At Yalta Marshal Stalin gave President Roosevelt written, broad approval for survey teams to operate in the Russian occupied areas.<sup>171</sup> For some time before V-E, however, it became clear that American teams were not going to be allowed to examine bombed targets in regions held by the Red army. In all of these matters a certain amount of rancor was apparent. It was hard for AAF officials to understand why the Russians usually refused their offers for assistance—which the Americans regarded as altogether

sincere and unselfish—and deprecated it when it was given, or why such bad feeling and frustration resulted when the western powers made requests.

### *Victory*

After the success of VARSITY-PLUNDER the Eighth Air Force returned to its dwindling strategic targets. Only a few remained. Recuperating oil refineries and storage depots were still in top priority. Jet production had to be watched, for the GAF could still do mischief to Allied airplanes and ground forces if a fanatical last-ditch resistance were to be made. Otherwise, the Eighth was concerned with keeping weapons from reaching the German armies and in delivering a blow or two at submarines. During the VARSITY-PLUNDER bombings one force of 107 B-17's had bombed a tank plant at Plauen, in central Germany, and on 26 March a reattack reportedly put this works out of operation.<sup>172</sup> On 28 March nearly 400 Fortresses attacked tank and armaments plants in suburban areas of Berlin through 10/10 cloud, inflicting, as it turned out, little fresh damage.<sup>173</sup> Good weather had been used up in VARSITY-PLUNDER. Now there were bad days and, as on 29 March, days when the Eighth was grounded. On 30 March a mission into northwestern Germany was possible, and the very low-priority U-boat targets at Wilhelmshaven, Hamburg, and Bremen received their largest tonnage from the Eighth Air Force, approximately 2,500 tons. The spillage of bombs at Wilhelmshaven proved fortunate, since it struck nineteen German ships in the harbor. Thirty German jets took to the air around Hamburg but made no attacks on the bombers. The enemy reaction was almost the same on 31 March, when 1,338 Eighth Air Force bombers hit oil storage tanks in central Germany, Brandenburg, and various targets of opportunity. Jets appeared in large numbers but in only one case was a bomber formation attacked.<sup>174</sup> One Liberator was shot down. Meanwhile, RAF Bomber Command exceeded its August 1944 rate of operations by dropping 67,365 tons during the last week of March. Hannover, Paderborn, Münster, Hamburg, and Osnabrück were punished. As March ended, the strategic air forces were almost out of targets.

The fine weather of April 1945 was all the more gratifying to the Allies because of the unmistakable smell of victory. The Ruhr was entirely encircled by the beginning of the month. Armies of the United Nations began to move rapidly into the compressing Reich, sometimes

## THE ARMY AIR FORCES IN WORLD WAR II

fighting their way through well-defended regions, occasionally bypassing such areas, and often plunging through weak opposition. The strategic air offensive was practically over by the first of April. The Fifteenth Air Force was now devoted to purely tactical objectives. Air Chief Marshal Harris complained that his Bomber Command was practically out of targets; the red streaks on the map of Germany, he said, showed how well the heavies had done their job.<sup>175</sup> General Arnold, back from a period of convalescence, saluted Spaatz in a personal note: "One of the things that made me feel better since my return was reading the reports of your air forces in the past month. With no equivocation I believe that you have definitely established the strategic air force for all time to come as the spearhead of any offensive."<sup>176</sup>

The Eighth Air Force carried out ten last strategic missions in Germany before redirecting its effort entirely to the land battle. Official priorities now amounted to little; they were shuffled up almost every day. But old target systems had to be neutralized in order to prevent desperate, last-ditch Nazi defense. On 3 April the Eighth delivered a 2,200-ton attack on the naval dockyard at Kiel. The mission was judged as very successful even though most of the bombing was by instrument.<sup>177</sup> Nearly 900 heavies bombed in the Hamburg area on 4 April, striking airfields which jets might use and U-boat yards inside the city. During this attack some 50 jet fighters shot down 5 American bombers.<sup>178</sup> But for overwhelming fighter escort the mission might have been disastrous for the bombers. On 7 April a still more sobering indication of jet potentialities came when the Nazis launched a furious attempt at mass interception by 130 conventional Luftwaffe fighters and 50 or more jets. The Germans were expending their last remaining good pilots in a suicidal, frenzied effort. Exhortations over the radio were desperate and yet somehow pathetic. Only 7 American heavy bombers were lost, and American claims of German fighters, substantiated later as being little exaggerated, passed 100.<sup>179</sup> Two more efforts and the German Air Force was through. On 10 April about 50 jets shot down 10 American bombers in the Berlin area, the largest loss of the war to jets in a single mission, and on 17 April approximately 30 Me-262's were able to bring down 1 B-17.<sup>180</sup> But until the very end the Allies refused to take chances. Lavish fighter escort flew with the bombers even when operations were a matter of roaming over the

## THE CLIMAX OF STRATEGIC OPERATIONS

prostrate Reich looking for targets. This escort was available to a high degree now that Doolittle had taken his fighters off strafing tasks lest friendly troops or prisoners be killed.<sup>181</sup> Most of Germany was not enemy territory any longer.

Meanwhile, the Eighth had a few more strategic missions. Ordnance depots in central Germany were bombed on 5 April, and marshalling yards in Nürnberg and Bayreuth caught severe attacks. On the 6th transportation centers in central Germany, notably at Halle and Leipzig, were targets for 650 heavies. Northwestern German airfields, explosives plants, ordnance dumps, and oil storage depots were targets for 7 April, and objectives of this nature in central Germany were attacked on the 8th. Turning southward on the 9th to interfere with attempts to build up the national redoubt, the Eighth sent 1,212 heavies to bomb Munich, Memmingen, Lechfeld, Neuburg, and other cities with major airfields and marshalling yards. The Berlin area received a widespread attack on 10 April from 1,232 heavies, which hit airfields, jet assembly plants, ordnance depots, an ammunition factory, airfields, and marshalling yards. There were no more oil targets, Bomber Command having taken out the last one on the night of 8/9 April with a raid on Lützkendorf. German factories were no longer a menace. The air forces had done their bit for the Navy in bombing submarine yards. Only tactical bombings in behalf of the onrushing ground forces remained, and the commanders were ready to call an end to the strategic air war.

On 7 April Portal warned that further destruction of German cities would magnify the problems of the occupying forces,<sup>182</sup> and the RAF discontinued area bombing. From SHAEF came demands by Tedder to throw the weight of the strategic air forces on German transportation, for so long his favorite target. If the Combined Strategic Targets Committee had other ideas, he said, it should be reminded that its function was to choose targets and not to settle policy.<sup>183</sup> But no controversy was going to develop. Plainly, the requirements of the land forces were the topmost consideration for the air forces. Accordingly, Spaatz and Bottomley issued their last formal directive, No. 4, on 13 April 1945.<sup>184</sup> For the first time in seven months the main mission of the strategic air forces was to give direct assistance to the ground campaign. With a touch of playfulness the JOCKEY committee, which directed the campaign against German aircraft production, had al-

ready sent out its last signal: "Jockey has unsaddled and weighed in. Sic transit gloria Tuesday."<sup>185</sup> The other committees wound up their work and prepared to analyze the strategic campaigns just completed. Then, on 16 April 1945, from his headquarters at Reims, General Spaatz sent out a personal message to Doolittle and Twining:

The advances of our ground forces have brought to a close the strategic air war waged by the United States Strategic Air Forces and the Royal Air Force Bomber Command.

It has been won with a decisiveness becoming increasingly evident as our armies overrun Germany.

From now onward our Strategic Air Forces must operate with our Tactical Air Forces in close cooperation with our armies.

All units of the U.S. Strategic Air Forces are commended for their part in winning the Strategic Air War and are enjoined to continue with undiminished effort and precision the final tactical phase of air action to secure the ultimate objective—complete defeat of Germany.

The above is order of the day number 2 and is to be released by this Headquarters at 2200 hours tonight.<sup>186</sup>

And so the strategic air war was over. It had not been the perfect attack which air theorists had dreamed of, an undistracted campaign against the enemy's vitals finally terminating in his appeal for surrender. But it was decisive and, with the onrush of ground forces toward a juncture with the Russians, altogether victorious. The oil campaign was the brightest phase of the triumph. German production of fuel and lubricants had virtually ceased. Desperate and ingenious efforts to conceal, defend, repair, and disperse oil production centers had finally failed. The Germans could not move their aircraft, tanks, trucks, or provide for minimum needs of their economy.

The German Air Force was gone. Up through the last dangerous stage of that organization's combat life the Allied strategic air forces had been heavily concerned with it. But for all the success achieved in the enemy's effort to maintain aircraft production, the Germans lacked pilots, gasoline, protected airfields, and every other basic requirement to operate an effective air force. No one challenged the airmen's claim that victory over the Luftwaffe made all other victories in Europe possible. The enormous tonnages poured on German transportation had begun to restrict economic life fatally by the last of 1944, and by the closing weeks of the war the enemy's railroads and canals were practically useless. Germany was back to the foot and horse stage in most respects, and this breakdown compounded every other difficulty which beset the Reich.

## THE CLIMAX OF STRATEGIC OPERATIONS

It was not possible as yet to assess precisely the damage inflicted by the heavy bombers on other target systems, but the appalling desolation of Germany's industrial cities was all too apparent as the Allies moved into the Reich. Even Spaatz, who had studied so painstakingly the results of the air offensive he had led, was surprised by the magnitude of the chaos. The Reich was strangled and paralyzed. Even without the final ground invasion, it seemed, the Germans could not have continued the war.<sup>187</sup>

## CHAPTER 21

\* \* \* \* \*

### *FROM THE RHINE TO THE ELBE*

SINCE the second week of January, when the complete elimination of the enemy salient in the Ardennes had become merely a question of time, General Eisenhower and his subordinates had been making plans for the resumption of offensive ground action. The strategy agreed in all essentials with the campaign plans of early December 1944. Projected operations fell into three general phases. During the first phase, while Bradley's U.S. First and Third Armies continued their systematic pursuit of the enemy in the Ardennes area and General Devers' U.S. Seventh Army and French First Army eliminated German resistance west of the Rhine on the Alsace-Lorraine front, Field Marshal Montgomery was to launch the major offensive toward the Rhine north of Düsseldorf. The immediate aim in all areas was to achieve a maximum destruction of the German forces west of the Rhine. Once the Allied armies had reached the Rhine, the establishment of strong bridgeheads across that river would be the next task. The last phase of operations envisaged powerful drives into the heart of Germany, the destruction of all her remaining forces, and finally a junction with the advancing Russians.<sup>1</sup>

#### *The Advance to the Rhine*

Field Marshal Montgomery had three armies at his disposal for the offensive in the north. On his left flank was the Canadian First Army, holding the front from Boxmeer to Nijmegen and thence to the North Sea. In the center was the British Second Army, occupying the front from Boxmeer south to Roermond. The right flank was held by the U.S. Ninth Army, occupying a line generally along the Roer River between Düren and Roermond. The Canadians were to open the offensive (Operation VERITABLE) on 8 February, moving south-



east from their forward positions in the vicinity of Nijmegen, and clear the enemy out of the area between the Rhine and Maas rivers as far south as Geldern and Xanten. General Dempsey's British Second Army was temporarily to hold the Maas River line in its sector, to advance subsequently in the Venlo area, and to provide reinforcements to the Canadian First Army as required. General Simpson's American forces were to commence their attack (Operation GRENADE) on or about 10 February, driving east and northeast across the Roer from the vicinities of Jülich and Linnich to eliminate all German resistance west of the Rhine between Düsseldorf and Mörs. Strong support for these operations was to be furnished by the U.S. First Army, which was to secure the Roer River dams, to eliminate enemy resistance on the upper reaches of the Roer, and thence to press its attack northeastward to the Rhine in order to protect the right flank of the Ninth Army.<sup>2</sup>

The Canadians started their offensive on the scheduled date in spite of the wretched condition of almost all roads in the battle area. The attack, having been preceded by extensive air interdiction operations during 1-7 February against the enemy's rail and road network west and east of the Rhine and launched with very strong support from heavy, medium, and fighter-bombers on D-day, initially made substantial progress. On their northern flank the Canadians captured Cleve on 11 February, and two days later a small force reached the Rhine opposite Emmerich. Elsewhere on the front, despite extensive mine fields and the quagmirish condition of the low, marshy ground, the attacking forces made fair gains. By 13 February the entire Reichswald was cleared of enemy troops.

Enemy resistance, however, began then to stiffen. Reinforced by a hasty shift of several divisions from other sectors of the western front, the Germans contested viciously every foot of the Allied advance and impeded its progress further by the breach of a number of dikes. Although Goch had been cleared of all enemy resistance on 21 February, Xanten, less than ten miles to the east, was not captured until 8 March. During the next two days the Germans, hard pressed by the Canadians from Xanten, the British from Sonsbeck, and the Americans from Rheinberg, withdrew across the Rhine at Wesel, destroying the bridge behind them. The weather during 6 to 10 March, except for 9 March, was very unfavorable for flying and prevented the fighter-

bombers from taking advantage of the traffic congestion at the Wesel bridgehead.<sup>3</sup>

Air cooperation during the VERITABLE operation was furnished almost exclusively by Second TAF except for the night of D-day and several subsequent days when heavy, medium, and fighter-bombers of other air forces operated in strength in the immediate battle area. During the preparatory period, 1-7 February, aircraft of Second TAF flew over 3,000 sorties, attacking road and rail movement, supply and communications centers, POL depots, bridges and ferries west and east of the Rhine. During the night of 7/8 February more than 700 heavy bombers of RAF Bomber Command dropped over 2,000 tons of bombs on the defended towns of Cleve and Goch, while night fighters of Air Marshal Coningham's Second TAF carried out wide-spread harassing attacks against the enemy's movements on roads and rails leading to the intended assault area. On the day of the ground attack fighter-bombers of this tactical air force flew 1,211 sorties in direct support of the ground forces and on armed reconnaissance. Except for a few days in late February and early March when weather curtailed operations sharply, the tempo of air cooperation never slackened and afforded the enemy no respite from constant harassing by day and night. Altogether 21,976 sorties were flown by Second TAF in support of this campaign from 1 February to 11 March.<sup>4</sup> At the end of the first three weeks of February, rail-cut claims stood at 444 and the destruction of locomotives and motor transports was listed at 205 and 503, respectively.<sup>5</sup>

Heavy bombers of 38 Group, fighter-bombers of XXIX TAC, and medium bombers of the 9th Bombardment Division joined the attack for several days. The RAF heavies attacked Calcar, Udem, and Weeze on 8 February and on subsequent nights staged repeated attacks on Rees, Isselburg, and other defended villages. The fighter-bombers for the most part operated just south of the battle area, cutting rails at strategic points on the lines leading north from Rheydt, Neuss, Krefeld, and Kempen. The mediums attacked communications centers, marshalling yards, and defended villages on six days between 8 and 21 February. Materborn, Xanten, Geldern, Calcar, Cleve, Emmerich, Kempen, and Rees were among the primary targets in medium attacks intended not merely to wreck the enemy's defenses in these towns and villages but to destroy them as communications centers. Despite weather conditions which often necessitated blind bombing,

the damage wrought was very heavy, especially at Rees and Geldern where fire destroyed nearly 90 per cent of the built-up areas and at Xanten where half of the residential area was severely damaged.<sup>6</sup>

Enemy air opposition throughout the period was negligible. Only on 14 February, when aircraft of Second TAF flew 1,890 sorties and when the ground forces were already in complete control of the Reichswald area, did the Luftwaffe react in some strength, flying over 100 sorties by conventional day fighters and a sizable number of jet planes. Neither type of aircraft displayed any eagerness to engage in combat. But as everywhere else on the western front, flak was very heavy at almost every target attacked. The American medium bombers suffered few losses on their operations, though flak caused damage to over 400 planes.

Ninth Army's offensive got under way late. The build-up of the army had been accomplished with great speed, despite atrocious weather and appalling road conditions. First Army's V Corps, under orders to take over part of Ninth Army's front in the Düren sector and to capture the Roer dams, also met its time schedule. Pushing forward in deep snow through the extremely difficult terrain of broken hills, over roads which were heavily mined, and through numerous villages each of which required stiff fighting before the advance could continue, V Corps cleared the Monschau Forest on 6 February, captured Schmidt in the Hürtgen Forest on the 8th, and two days later captured the dams, but not before some damage had been done to the control gates of one. The resultant heavy flow of water from the upper reaches of the Roer, aggravated by thaw and heavy rains, caused the river to overflow its banks downstream in the Düren-Jülich area, thus necessitating a postponement of the main offensive until 23 February.

During late January and early February, while Ninth Army was readying its plans and moving into position, XXIX TAC had drawn up a comprehensive program of air action in support of the ground offensive. The plan called for the use of large forces of heavy bombers and of every available medium and fighter-bomber of the Ninth Air Force which could be spared from other sectors of 12th Army Group's front.<sup>7</sup> Because of prior commitments other air organizations showed little disposition to direct the major part of their forces to this operation. Moreover, second thought suggested that some features of the plan represented an overestimate of the need. A new plan adopted

## THE ARMY AIR FORCES IN WORLD WAR II

on 5 February called for a concentrated effort west of the Rhine by medium bombers of the 9th Bombardment Division and by the fighter-bombers of XXIX and IX Tactical Air Commands.

To XXIX TAC went the primary responsibility for road and rail bridges at Kapellen, Noithausen, and Grevenbroich; for railroad bridges at Buir, Morken, Neuss, and Geistenbeck; for road bridges at Zieverich and Lippe; for marshalling yards at Lippe and Harff; for the Dülken road center; and for the rail chokepoint at Horrem. This program west of the Rhine was to be reinforced by armed reconnaissance missions against transportation east of the Rhine from Duisburg in the north to Bonn in the south. The air-ground cooperation program provided for one fighter-bomber group to be assigned to each of Ninth Army's three corps and one group to each of its two armored divisions. In order to enable the command to meet such extensive commitments, Ninth Air Force assigned to it on 8 February two additional fighter-bomber groups, bringing its combat strength to five fighter groups. General Nugent's request for an additional two groups was turned down, although an arrangement was effected whereby, in case of real need, he could call upon two groups of Weyland's XIX TAC.<sup>8</sup> Since Nugent's command was under the operational control of Second TAF, and thereby 21 Army Group, both Ninth Air Force and 12th Army Group were reluctant to assign the command more units than absolutely necessary on the ground that whatever came under the control of Field Marshal Montgomery was difficult to get back.<sup>9</sup> To IX TAC were assigned transportation targets affecting the enemy's capacity to resist the VII Corps drive toward the Roer River dams.

Virtually unflyable weather during the first week of February limited XXIX TAC's operations to a small number of armed reconnaissance missions between Düren and Cologne. As during the second week flying conditions improved, the fighter-bombers made every effort to destroy the rail and road bridges assigned to them. While success was achieved against some road bridges, only slight damage was inflicted upon the rail bridges. The latter, of concrete construction and of very short span, were found to be beyond the capabilities of the fighter-bomber pilots, whose skill at dive bombing appeared to be very low. A decision was therefore reached that the command would henceforth concentrate upon rail-cutting on the dense network of lines joining Cologne, Grevenbroich, Rheydt, Neuss, München-Gladbach, Viersen, Krefeld, and Kempen and upon communications

centers, marshalling yards, strongpoints, and command posts west of the Rhine. By 22 February the pilots had claimed destruction of 217 motor transports, 15 tanks and armored vehicles, 819 railroad cars, 132 locomotives, 322 buildings, and 43 gun positions in addition to 342 rail cuts and 108 road cuts.<sup>10</sup> Area cover had also been maintained during Ninth Army's moves into position and many escort missions had been flown for protection of the medium bombers.

IX TAC continued the interdiction program west and east of the Rhine which had contributed so effectively to the defeat of the enemy's Ardennes offensive. During the early days of February, when the enemy was making large-scale withdrawals from the Ardennes, the fighter-bombers found very fruitful targets along the lines leading to Bonn and Cologne. Particularly successful were the attacks on the Sinzig-Ahrweiler-Dumpelfeld and Bonn-Euskirchen-Kall lines on 2 February. Six days later an exceedingly heavy harvest was reaped on the rail lines east of the Rhine between Cologne, Bonn, and Coblenz. As the target date for GRENADE neared, the fighter-bombers accentuated their armed reconnaissance in the immediate rear of the enemy's Roer positions. Bridge attacks proved to be no more successful than those of XXIX TAC. Consequently, the effort was shifted to rail-cutting and to attacks on rolling stock, highway vehicles, marshalling yards, and buildings. Precaution was taken not to disclose the forthcoming river crossings by laying on attacks upon targets farther south, especially in the Zülpich, Euskirchen, Liblar, and Rheinbach areas.<sup>11</sup>

Operation CLARION on 22 February\* served in some measure to take the place of the heavy pre-assault operations originally planned by XXIX TAC. Although the heavies operated in areas generally remote from the immediate seat of the ground battle, the tactical air forces were out in strength all along the front of their respective armies in attacks which helped, by the disruption of enemy communications, to ease the way for the ground offensive launched the next day. The heavies were out again in a repeat performance of the preceding day's attacks when the Ninth Army began its offensive on 23 February. The ground movement had begun under cover of darkness in the early morning hours after forty-five minutes of intense artillery bombardment. Some difficulty was experienced with the swift current of the Roer, but once across the river the troops met

\* See above, pp. 732-35.

only moderate resistance. Accurate German artillery fire at times hampered bridging operations, but strong air support was provided throughout the day and bridgeheads established by both the Ninth and First Army troops expanded rapidly.

XXIX TAC on 23 February flew 613 sorties, a new record for the command. Its 405th and 373d Fighter Groups, cooperating with XIII and XIX Corps respectively, attacked the communications centers and defended areas of Lövenich, Titz, Katzen, Setternich, Hambach, and Paderm among others. The day's armed reconnaissance undertaken by the five fighter-bomber groups resulted in claims to the destruction of 52 locomotives, 755 railroad cars, 254 motor transports, 15 tanks or armored vehicles, and 7 gun positions. In addition, over 100 rail cuts were claimed. With the exception of four days (26 February and 4, 5, and 6 March), the weather continued to permit the maximum employment of the command's striking power.

The following reports from XIII Corps are typical of numerous expressions of appreciation by ground force commands:

On the afternoon of 23 Feb, elements of the 84 Infantry Division were advancing from Rurich to Baal. No adequate anti-tank weapons had as yet crossed the Roer. Enemy tanks were seen in Baal. Flying conditions were poor with low ceiling and limited visibility. A squadron of the 405 Group attacked these tanks. Ground reports that two of these tanks were destroyed, two were damaged. Baal was occupied that night.

During the night of 23-24 Feb, XIII Corps bridges in the vicinity of Linnich were attacked by GAF planes and two bridges were destroyed. . . . Cover for the bridges was requested. Squadrons of the 405 Group kept cover over the bridges despite a ceiling of only 1500 feet. No further attacks were made. Critical equipment, tanks, artillery, and anti-tank guns passed safely over the remaining bridges. Air superiority, temporarily lost, was restored and with it freedom of movement behind our own lines.<sup>12</sup>

Determined enemy resistance in Jülich, aided by the rubble resulting from artillery and air attacks, was overcome on 24 February. Two days later the bridgehead had been expanded to a depth of ten miles and a width of twenty miles. Thereafter the Ninth Army advance gained momentum in every direction. München-Gladbach and Neuss were cleared of the enemy on 2 March. Krefeld fell two days later. By 6 March, Ninth Army was in control of the west bank of the Rhine from Neuss to Rheinberg and in position to assist the British Second Army. Meanwhile, all enemy resistance to the rear in the Roermond-Venlo area had been taken care of by the Ninth's XVI

Corps.<sup>13</sup> The fighter-bombers of XXIX TAC, counting operations dating back to 1 February, had flown a total of almost 7,000 sorties in support of this advance to the Rhine. Claims for destruction or serious damage to 22 bridges, 89 gun positions, 1,323 buildings, 2,808 railroad cars, 77 tanks and armored vehicles, and 838 motor transports, together with 156 highway and 843 railway cuts, summed up the statistical evidence of the command's accomplishments.<sup>14</sup>

Very few missions of direct support were flown by the fighter-bombers of IX TAC in connection with First Army's drive toward the Roer River dams. The hilly and heavily forested area in which the fighting took place and the absence of appreciable enemy movement on the few available roads made such cooperation generally unprofitable. The fighter-bombers therefore concentrated their effort on a continuation of the interdiction program west and east of the Rhine which had contributed so effectively to the defeat of the earlier German counteroffensive. On 23 February, when VII Corps launched its attack across the Roer, they flew 661 sorties, the largest day's effort by the command since the summer of 1944. During the course of the days, the towns of Arnoldsweiler, Merzenich, Oberzier, Stockheim, Golzheim, Bergheim, and Eller were severely damaged. In addition to 63 rail cuts, good results were achieved against gun positions and road and rail transport. VII Corps captured Düren on 25 February, established bridgeheads over the Erft River on the 28th, and by 4 March had patrols at the Rhine, south of Cologne. Several suburbs of that city were captured on the following day, and by 7 March the entire city was in American hands. Inclement weather on 6 and 7 March shut down on all air operations, thus permitting the enemy to effect a fairly orderly withdrawal across the Rhine and to destroy all bridges behind him.<sup>15</sup>

The operations of the fighter-bombers during the Ninth Army-VII Corps thrust to the Rhine were greatly reinforced by medium bombers of the 9th Bombardment Division. The 1,576 medium bomber sorties flown from 23 to 28 February inclusive were expended almost exclusively in support of these two ground organizations. Communications centers east and west of the Rhine served as the chief targets.<sup>16</sup>

SHAEF in January had prescribed for First Army (excepting its VII Corps) and for Third Army the maintenance of an aggressive defense along their existing lines of battle. Probing attacks designed to

improve positions suited to future offensive action, or to prevent the withdrawal of enemy forces to Montgomery's front, would be undertaken as circumstances permitted and in coordination with limited offensive action by 6th Army Group along the southern sector of the Allied line. Elimination of the Colmar pocket, which since early December had been a source of irritation and concern to SHAEF, was the immediate task of 6th Army Group.

To the undermanned French First Army in Alsace fell the responsibility for opening the attack on the Colmar pocket. The French I Corps launched Operation CHEERFUL on 20 January with an assault against the southern side of the pocket in the Thann-Mulhouse area. This drive, handicapped by blizzards and generally foul weather, soon bogged down in the face of tenacious German resistance. On the northern side of the pocket French II Corps, strengthened by American units, jumped off on the night of 22/23 January with the initial objective of clearing the region north of the Colmar Canal. After five days of hard fighting, the second drive also had fallen short of success. The pace of the offensive quickened, however, when the U.S. XXI Corps moved into the line between the two depleted French corps and on 29 January began to batter its way southeast toward Neuf-Brisach. The pocket was soon shredded: Colmar fell on 3 February; two days later XXI and I Corps linked up at Rouffach; and on the following day XXI Corps reached the Rhine near Neuf-Brisach. By 9 February the remnant of the German Nineteenth Army had been cleared out of southern Alsace.<sup>17</sup>

American and French aircraft of First Tactical Air Force made notable contributions to the execution of Operation CHEERFUL despite poor weather, which—especially during the early phase of the offensive—hindered air operations, and despite initially weak liaison between French air and ground commanders, which provoked a protest from General de Lattre. Mediums of the U.S. 42d Bombardment Wing and the French 2<sup>e</sup> *Brigade de Bombardement*, the latter operating under American control, struck at road and rail bridges, marshaling yards, barracks areas, and supply dumps with some success but failed to knock out the two vital Rhine River rail spans at Brisach and Neuenburg. Fighter-bombers of the U.S. XII Tactical Air Command and the French First Air Force, aided by Ninth Air Force units, carried the brunt of the aerial assault and achieved more impressive results. Badly hampered at first by unfavorable flying conditions, the



fighter effort mounted sharply as the campaign progressed. French and American Thunderbolts, ranging over the pocket and beyond the Rhine, smashed at enemy fortifications, guns, armor, and troop concentrations in close-support missions and created havoc in close and wide interdiction attacks against motor transports, horse-drawn vehicles, bridges, rail lines, and marshalling yards. A commendation from U.S. 3d Infantry Division and laudatory statements by the commanding generals of U.S. XXI Corps and French First Army testify to the general effectiveness of First TAF's close-support work; and the fact that German Nineteenth Army could extricate only 4,000 of its combat infantry from the pocket indicates the potency of General Saville's\* interdiction campaign.<sup>18</sup>

While General de Lattre's French First Army was reducing the Colmar pocket, the U.S. Seventh Army front in northern Alsace and the Saar remained relatively quiet. After 9 February, with its rear and right flank now secure, Seventh Army prepared for a limited drive designed to shorten the XV Corps line, eliminate bulges near Gros Réderching and Welferding, and win advantageous jump-off positions for the major assault to follow. The slow, unsensational push to the north got under way on 15 February; by early March all objectives had been achieved. General Patch's forces were now in position for a joint offensive with Third Army against the last German salient west of the Rhine.<sup>19</sup>

Though XII TAC's fighter-bombers had furnished close support to this preparatory offensive with rocket, bombing, and strafing strikes against enemy strongpoints in the Gros Réderching area and at Hartungshof and other places, Webster's First TAF† during this period concentrated on medium and fighter-bomber attacks against transportation objectives, particularly the rail network north of Seventh Army's front, in an attempt to reduce the flow of supplies to German Army Group G in the Saar-Rhine-Moselle salient. Systematic hammering at railway cars, locomotives, rail bridges, and marshalling yards cut German rail traffic critically and forced the enemy to take to the roads where his convoys were pounded by fighter-bombers. When intelligence reported that German ammunition supplies were

\* Brig. Gen. Gordon P. Saville succeeded Maj. Gen. Ralph Royce as commander of First Tactical Air Force on 29 Jan. 1945.

† Maj. Gen. Robert M. Webster assumed command of First Tactical Air Force on 22 Feb. 1945 and remained in command for the duration of hostilities.

dangerously low, American and French Marauders diverted part of their effort, beginning 25 February, to a series of effective raids on ammunition dumps at Siegelbach and Kirkel.<sup>20</sup>

Meanwhile, the probing operations of 12th Army Group had slowly gained momentum. Aided by the enemy's commitments to Montgomery's front, the First and Third Armies forced upon the Germans a retreat from one position to another, and on 3 March both armies received authorization for drives to the Rhine. By 12 March, except for a few enemy pockets, the west bank of that river north of the Moselle had fallen into American hands.

During most of February, when Third Army was slowly pushing forward through the mud and slush of melting snows in the rugged Eifel terrain and along the north bank of the Moselle, the primary program of XIX TAC's fighter-bombers was rail and road interdiction. There were the usual missions of armed reconnaissance against defended localities and marshalling yards, rail-cutting, bomber escort, alert patrol, and as the month wore on, attacks against airdromes, fuel and ammunition dumps, and motor transport depots. Notable success was achieved against road and rail bridges in the area along the Moselle, especially at Bullay, Eller, and Nonnweiler. Many successful sorties were also flown in direct cooperation with the ground forces, particularly in connection with the establishment by VIII and XII Corps of bridgeheads over the numerous rivers where heavy enemy fire and swift currents made crossing operations difficult. The steadily mounting destruction of enemy transport and equipment was highlighted by attacks on 23 February, when an aggregate of 527 sorties was flown, and 269 tanks and armored vehicles, 1,308 railroad cars, and 724 motor vehicles were claimed destroyed or damaged.

When toward the close of February, Third Army plunged through the Siegfried Line and then in March commenced lightning-like drives across the Moselle into the enemy's rear, the fighter-bombers were presented with a happy hunting ground. The disorganization and confusion wrought among the enemy by the three converging attacks from the north, west, and south brought about a precipitate attempt at evacuation. The resultant congestion of all types of vehicles on roads leading eastward was tremendous. Fortunately, with the exception of the period from 4 through 8 March when a total of only fifty-nine combat sorties was flown, the weather permitted large-scale opera-

tions daily. Alert tactical reconnaissance kept a vigil of all roads, spotting large concentrations of retreating enemy transport and then leading fighter-bombers to the kill. Records of sorties flown and claims of destruction of transport were established one day, only to be surpassed within a few days.<sup>21</sup>

Interesting testimony to the effectiveness of the fighter-bomber is furnished by an order issued by Field Marshal Model in February, addressed as follows:

TO ALL DRIVERS AND PASSENGERS.

WHOEVER CAMOUFLAGES LIVES LONGER!

CARBINES AND MARCH DISCIPLINE VERSUS STRAFING!

10 DAYS SPECIAL FURLOUGH FOR SHOOTING DOWN ENEMY STRAFER!

The Anglo-American ground-attack aircraft are the modern highwaymen. They are searching not only for columns of traffic, they are hunting down every gasoline truck, every truck with ammunition.

Our fighters and anti-aircraft have had considerable success during the days of the great winter battles. But fighters and anti-aircraft cannot be everywhere. . . . EVERY SOLDIER CAN AND MUST JOIN IN THE FIGHT AGAINST GROUND ATTACKERS! . . .

SPECIAL FAVORS WILL BE SHOWN SUCCESSFUL GUNNERS AND UNITS. EACH SOLDIER WHO KNOCKS DOWN AN ENEMY STRAFER WITH HIS INFANTRY WEAPON RECEIVES 10 DAYS SPECIAL FURLOUGH! UNITS WHICH HAVE BEEN PARTICULARLY SUCCESSFUL IN SHOOTING DOWN ENEMY GROUND-ATTACKING AIRCRAFT WITH INFANTRY WEAPONS WILL RECEIVE SPECIAL RATION ALLOTMENTS!

Therefore: SEEK COVER FIRST,

Then: FIRE AWAY! . . . <sup>22</sup>

On 11 March, General Patch outlined his objectives in Operation *UNDERTONE*—a combined Third Army–Seventh Army assault on the triangle of the Saar-Palatinate. Seventh Army, with attached French elements, was to attack to the north, smash through the Siegfried Line, destroy German First Army, race to the Rhine, and establish a bridgehead on the east bank of the river. But even before Seventh Army unleashed its offensive on 15 March, the fate of German Army Group G in the triangle had been sealed when Third Army's XII Corps suddenly wheeled south, crossed the lower Moselle on 14 March, and thrust at the rear of the enemy forces facing Seventh Army. The collapse of the northern side of the triangle did not, however, appreciably lighten enemy resistance to Seventh Army's onslaught, which began on schedule. During the first five days of the offensive, Seventh Army's biggest but least vital gains were on the right flank, where VI Corps advanced twenty miles from the Moder River to the Siegfried Line and then ground to a halt. To the west,

XV and XXI Corps slowly chewed their way through the Siegfried defenses. Saarbrücken fell to XXI Corps on 20 March. On the same day the 254th Infantry of 63d Infantry Division broke through the line near Oberwürzbach. Other penetrations followed in quick succession along the XXI and XV Corps sectors as German resistance crumbled. The entire western end of the front now broke up: on the left, XXI Corps units linked up with Third Army's XX Corps at Neuenkirchen on 20 March; in the center, on the following day Combat Command A of 6th Armored Division led the XV Corps lunge from Homburg past Kaiserslautern to Bad Dürkheim on the Rhine. By 25 March, Seventh and Third Armies had destroyed the triangle and shattered German Army Group G.<sup>23</sup>

First Tactical Air Force, which had been held by wretched weather to 1,980 sorties during CHEERFUL, went all out during the ten days of UNDERTONE and chalked up a remarkable total of 12,392 sorties by pushing its flyers to the limit of their endurance. During the first forty-eight hours of the ground offensive, the aerial onslaught was devoted largely to close-support missions. Fighter-bombers, smashing at strongpoints, defended villages and troop concentrations along the entire front, achieved fine results and so disorganized some German units as to make them easy prey for advancing U.S. infantry. Mediums, working with superb precision, saturated enemy fortifications with 628 tons of bombs in an area measuring 7,000 by 3,800 feet near Zweibrücken and dropped 246 tons more on other Siegfried Line targets east and west of the town. These attacks did little actual damage to the fortifications but almost totally demoralized the German defenders. Though the Marauders again bombed enemy defenses—this time southwest of Landau—on the 19th, they concentrated during the last seven days of UNDERTONE on rail and road escape routes in the Saar and transportation objectives in the Mannheim and Heidelberg areas east of the Rhine. As the front began to cave in and the enemy attempted to flee across that river from the Saar-Palatinate trap, First TAF fighter-bombers had a succession of field days. Lack of usable rail lines forced the Germans to jam the few main roads that funneled into Germersheim on the Rhine. Day after day, XII TAC planes relentlessly ripped and pounded at the long columns of trucks, tanks, and horse-drawn carts. Claims of vehicles destroyed or badly damaged soared over the 4,000 mark. The climax came on 22 March when VI Corps credited the air arm with the destruction of a German infantry division near Dahn.<sup>24</sup>

*Across the Rhine*

First Army's advance to the Rhine at Cologne had been followed by one of the major breaks of the war. On the morning of 7 March units of the 9th Armored Division, driving hard along the west bank of the river south of Bonn, found the Ludendorff Bridge at Remagen left intact by the withdrawing enemy. The bridge had been the object of repeated air attack during the Battle of the Bulge and had only recently been repaired after a long period of unserviceability. It had been scheduled for attack that morning by IX TAC's 36th Fighter Group, but the mission had been canceled because of the weather.<sup>25</sup> A last-minute attempt at demolition by the enemy, undertaken in the absence of the senior officer responsible, had left the bridge but slightly damaged.<sup>26</sup>

With dash and daring, infantry and tank units seized the unexpected prize by racing across the bridge to the eastern bank of the river. On orders from General Bradley all available forces pushed across with utmost speed, and by the close of 8 March the bridgehead had been enlarged to something like a mile and a half in both depth and width. The Germans, taken completely by surprise, initially offered only slight resistance but by the 9th they had brought the area under long-range artillery and dive-bombing attack and had inaugurated moves by ground units designed to contain or destroy the bridgehead. On both 7 and 8 March the weather made it impossible for IX TAC to lend the support of its fighter-bombers, and for the rest of the first week of fighting the ground forces had to depend almost entirely for cover on their own antiaircraft units. German aircraft, attacking below the consistent cloud cover, managed to inflict occasional casualties on the ground troops but were never able to hit the bridge.

It had been at once agreed by First Army and IX TAC that the primary responsibilities of the latter would be to provide cover, by day and night, and to maintain an intensified armed reconnaissance for the purpose of interdicting enemy reinforcements. Only with the 13th did the weather permit any consistent fulfilment of the first obligation, and not until 9 March could the fighter-bombers make their weight felt in interdiction. But the 9th Bombardment Division, though bombing blind, went to work on the 8th.

Because of the enemy's shortage of fuel and motor transport, rail lines, especially those leading south from the Cologne area, west from

the Siegen-Wetzlar area, and northwest from Frankfurt, were considered the most critically important. On the 8th some 300 mediums bombed the marshalling yards at Altenkirchen, Berg-Gladbach, the communications centers of Eitorf, Troisdorf, Geistingen, and Siegburg, and the *Autobahn* overpass at Buisdorf. On the next day a stronger force was dispatched against similar targets south of Remagen, with concentration on the marshalling yards at Wiesbaden, Butzbach, and Niederhausen and armored-vehicle store depots at Dotzheim and Wiesbaden. The weather still forced resort to blind bombing and results were satisfactory only at the marshalling yard of Wiesbaden North and at the Dotzheim depot. For four more days most of the work was done blind, but by 14 March it was deemed safe to release the mediums for interdiction in the Ruhr. On 11 and 13 March they had struck a number of airfields from which the enemy operated against the bridgehead, especially those at Lippe, Breitscheid, and Ettinghausen.<sup>27</sup>

A favorable break in the weather on 13 March had enabled IX TAC's fighter-bombers to take over the major responsibility. Beginning on that day and continuing through the 24th, the command flew over 6,000 sorties and dropped more than 2,000 tons of bombs on a wide assortment of rail and road targets. Claims included over 1,700 motor transport, over 200 tanks and armored vehicles, nearly 200 locomotives, better than 3,500 railway cars, and nearly 500 railroad cuts. In addition, the fighter-bombers attacked enemy strongpoints, gun positions, troop concentrations, supply and ammunition dumps, and defended villages. Area cover over the bridgehead was maintained whenever the weather permitted. The GAF's chief intrusion came on 13 March, when approximately 130 sightings were reported, but few of the enemy were willing to accept combat. Heavy attacks were laid on GAF bases at Lippe, Ettinghausen, Kirthorf, Würzburg, and Neustadt.<sup>28</sup> By 20 March interdiction of the bridgehead was almost complete. Between 9 and 17 March the enemy had made desperate attempts to move up the main elements of eleven divisions, but he had been unable to mount an all-out counterattack. By 24 March First Army's bridgehead was ten miles deep and thirty-five miles long and extended in an arc of varying depth from north of Bonn to south of Neuwied. And on the next day First Army was in position to take the offensive out of its bridgehead.<sup>29</sup>

Two days earlier Patton's rampaging forces, after a rapid drive from

their Moselle River bridgehead, had crossed the Rhine at Oppenheim. Very few of the enemy's completely demoralized forces in the Saar and Palatinate had managed to get across the river. The ceaseless pounding which his communications centers had received by air attack and the steady build-up of the Remagen bridgehead had argued that the Germans would not be able to offer an effective resistance to this new crossing of the Rhine. But to make doubly sure, XIX TAC had hurriedly initiated on 21 March a program of rail interdiction extending from Limburg southward to Mannheim.<sup>30</sup> After a crossing effected during the night of 22/23 March without the benefit of aerial support, XII Corps rapidly expanded its bridgehead on the following day. On 25 March two additional crossings were effected farther south, one at Boppard and the other in the vicinity of Lahnstein, and Patton stood ready to launch a major thrust into the heart of Germany.

Already, in the north Montgomery had hurled across the lower Rhine the large forces which represented the principal Allied bid for an early victory. Preceded by elaborate air preparation, the drive got under way on schedule during the night of 23/24 March. The plan called for the British Second Army to strike across the Rhine between Wesel and Rees and thence to attack north and northeastward between Münster and Rheine, and for the U.S. Ninth Army, having crossed below Wesel, to strike eastward toward Münster and Paderborn. First Allied Airborne Army in Operation VARSITY was to drop and airland two British airborne divisions in the path of the Second Army to facilitate the deepening of its bridgehead and the link-up with Ninth Army. Profiting from the experience with the Arnhem drops of the preceding year, the airborne troops were to be dropped after the main assault forces had crossed the river and in close enough proximity to the river to be within range of supporting artillery on its west bank. Virtually the entire strength of the Allied strategic and tactical air forces was committed to supporting operations, which included a three-day softening up of the battle area immediately before D-day.<sup>31</sup>

The major targets assigned for the preparatory period had already been subjected to more or less continuous attacks since mid-February with the adoption of a program for the "Interdiction of Northwest Germany." This plan provided for the sealing-off of the Ruhr from the rest of Germany by an interdiction line commencing at Bremen and then running in a rough arc south and southwest through fifteen

key communications and transportation centers and ending at Neu-wied on the Rhine. Destruction of seventeen rail bridges and rail viaducts along this line, combined with attacks on several canals linking this vital industrial area with the rest of Germany, would, it was hoped, have a paralyzing effect upon the enemy's economic and military potential, particularly since his industries and coal resources in the east were either in Russian hands or in immediate danger of capture. West of this interdiction line, attacks were to be staged against every important communications center, marshalling yard, repair and maintenance center, industrial and production area, and many other targets.

The work was begun in mid-February and continued to 21 March, with virtually every air weapon, when it could be spared from other operations, contributing to the effort. The transportation system within the Ruhr alone was the target for 31,635 tons dropped by 10,948 heavy and medium bombers of the RAF and USAAF between 1 and 21 March. Bridges and viaducts along the periphery, having experienced occasional heavy bombing prior to 21 February, were subjected to almost incessant attacks thereafter. From 21 February to 21 March, a total of 5,657 tons was dropped on them in 1,792 heavy and medium bomber sorties. Despite energetic repairs, by the latter date ten of the bridges had been destroyed and five rendered unserviceable. The remaining two, though heavily damaged, appeared to be still passable. To the devastation wrought by the heavy and medium bombers was added the very successful fighter and fighter-bomber operations of Second TAF and XXIX TAC. With the completion of their VERITABLE-GRENADE operations on 10 March, the fighter aircraft of these two organizations switched their main effort from close cooperation to attacks on the Ruhr. Most of the 7,311 sorties flown between 11 and 21 March were directed against the Ruhr's rail and road transportation systems.<sup>32</sup>

To reduce the threat of enemy air action during the forthcoming river crossings, the Eighth Air Force attacked ten airfields to the north of the intended assault on 21 March, and on the following day an additional five air bases to the south of the Ruhr. The known jet fields were singled out for especially heavy saturation in attacks delivered by a grand total of 1,730 bombers. Most of the fields were rendered inoperative for several days, and escorting fighters in strafing attacks claimed the destruction of numerous aircraft on the ground. In addition to these airfield attacks, the heavy bombers attacked barracks



and military camps on 22 March and strategically situated marshalling yards on the following day. A total of 3,859 heavy bomber and 1,584 fighter sorties represented the Eighth's contribution to Montgomery's offensive during the three days immediately preceding the jump-off.<sup>33</sup> During these same three days over 2,000 medium bombers of 9th Bombardment Division concentrated their main effort upon the destruction of communications centers, marshalling yards, and flak positions. Particularly devastating results were achieved against the towns of Dinslaken, Schermbeck, Coesfeld, Stadtlaken, and Borken. Very successful also were the attacks on flak positions, as is evidenced by the declining rate of aircraft damaged during the operations. On 21 March, 179 planes were damaged by anti-aircraft fire, the following day 125, and on the 23d of March only 96. Only five bombers were lost on all these operations.<sup>34</sup>

The fighter-bombers of XXIX TAC, flying 1,413 sorties, had as their major tasks the destruction of rail facilities and road transport, the escort of medium bombers, and attacks upon airfields. Particularly successful were the attacks of 22 March and especially those directed against the airfields at Münster and Handorf. Rail cuts and the destruction of much rolling stock and motor transport were achieved on armed reconnaissance missions.<sup>35</sup>

The heavy bombers of RAF Bomber Command attacked several communications centers, achieving especially good results on their daylight operations of 22 March when 2,869 tons of heavy explosives and incendiary bombs were dropped on the towns of Bocholt, Dorsten, Dülmen, and Hildesheim, and on the Bremen-Arndorf bridge. The mediums and fighter-bombers of Second TAF, flying 3,290 sorties, attacked transportation targets, strongpoints, troop concentrations, airfields, ammunition dumps, and other targets within the northern part of the Ruhr. RAF Fighter Command flew a total of 1,242 escort, rail-cutting, and patrol sorties.<sup>36</sup> The total air effort during this three-day "processing of the terrain" amounted to some 11,000 sorties. Apart from the physical destruction wrought and the casualties inflicted, the unremitting bombing and strafing attacks achieved a shattering effect upon the morale both of the civilian population and of the troops.

Preceded by a tremendous artillery barrage—according to Field Marshal Montgomery the two attacking armies were supported by over 1,900 medium and heavy guns—the British Second Army commenced its assault at 2100 hours on 23 March and the Ninth Army at 0200

hours on the following morning. The crossings were effected against light opposition, and firm footholds were immediately secured and expanded.

The stage was thus quickly set for the airborne assault. Half an hour before the arrival of the airborne trains, which had been scheduled to take place at 1000 hours, medium and fighter-bombers of Second TAF and Ninth Air Force carpeted the vicinities of the selected drop and landing zones with fragmentation bombs in order to immobilize the flak batteries which might have escaped destruction in the previous days' attacks. At 0953, seven minutes ahead of schedule, the first pathfinder aircraft of the 2½-hour-long airborne train appeared over the target. Escort to the target area had been provided by 213 fighters of RAF Fighter Command and by 676 fighter-bombers of the Ninth Air Force. Around the target area itself Second TAF had a screen of 900 aircraft, furnishing front-line cover, escort, and patrol. The southern flank of the battle sector was patrolled by fighter-bombers of IX TAC, while in the eastern sector 1,253 Eighth Air Force fighters guarded against any intrusion of hostile aircraft, some of them even providing cover for 150 heavy bombers of the Fifteenth Air Force which bombed Berlin as a diversionary operation. The landing and dropping of the two airborne divisions was accomplished without enemy air interference and suffered very little from antiaircraft fire. Of the 2,046 aircraft and gliders dispatched by the U.S. IX Troop Carrier Command, 2,029 accomplished their mission successfully. The operations of the RAF's 38 and 46 Groups were crowned with equal success, 832 of the 880 aircraft and gliders dispatched reaching their designated areas. The load carried on this initial operation comprised 14,365 troops, 109 tons of ammunition and explosives, 645 vehicles, 113 artillery weapons, and other equipment and supplies.<sup>37</sup> An hour after the drops and landings had been completed 237 bombers of the Eighth Air Force dropped 598 tons of additional supplies to the airborne troops with excellent results.<sup>38</sup>

During the day Eighth Air Force also smashed again at the airfields from which the GAF might seek to interfere, sending over 1,406 of its bombers against sixteen different air bases. Medium bombers of 9th Bombardment Division and of Second TAF, in addition to anti-flak operations, attacked communications centers, marshalling yards, bridges, and troop concentrations. Fighter-bombers of XXIX TAC flew 716 sorties in bridge cover for Ninth Army's assaulting troops

and in attacks against flak positions, troop concentrations, supply and ammunition dumps, airfields, defended villages, and rail and road traffic. Second TAF gave prearranged cooperation to Second Army and carried out armed reconnaissance throughout its assigned zone of operations. The punch-drunk Luftwaffe, after the punishing blows of the preceding days, managed to put up about 100 to 150 sorties, but only a few of the 62 Allied losses sustained in the day's 7,000 sorties were chargeable to aerial combat. No less indicative of the overwhelming mastery enjoyed by the Allied air forces is the fact that claims to enemy aircraft destroyed stood at the modest total of 81, and most of them on the ground.<sup>39</sup>

By the afternoon a firm link-up had been effected between the airborne troops and Second Army. Contact was also established with Ninth Army, whose two divisions had established a strong bridgehead south of the Lippe Canal. The lower Rhine was bridged at last.

### *Overrunning Germany*

When, on 26 March, 6th Army Group effected several crossings of the Rhine in the Worms area, the stage was set for a final drive into the heart of Germany from Mannheim in the south to Emmerich in the north. In Ninth Army's sector of the front the bridgehead was slowly but steadily expanded during the closing days of March in the face of heavy small-arms, machine-gun, and artillery fire. On 31 March a breakthrough was achieved by the 2d Armored Division, which that day advanced 35 miles eastward and on the following day (1 April) made contact with First Army's 3d Armored Division at Lipstadt, near Paderborn. Effective as of midnight of 3 April, Ninth Army was restored to General Bradley's command. The encirclement of the Ruhr had been achieved, and XVI Corps was directed to assist First Army's VII Corps with the reduction of enemy resistance in the so-called Ruhr Pocket. The enemy was given no chance to form a cohesive plan of defense, and on 18 April all organized resistance ceased with the surrender of over 300,000 troops.

Meanwhile Ninth Army's two other corps, the XIII and XIX Corps, kept up their drives eastward. Overcoming small-scale but fierce resistance, especially by Hitler Youth and flak troops, both corps drove hard across the Weser, capturing Hannover on 10 April, Brunswick on the 12th, and Magdeburg on the 17th. Ninth Army's mission was

accomplished and it was now directed to remain on the defensive along the Elbe River.<sup>40</sup>

While First Army's left flank in early April was engaged in reducing the enemy garrison in the Ruhr, the rest of General Hodges' forces were rapidly driving eastward. As almost everywhere else on the fluid front, the enemy's plight was desperate, and, except for rare local situations, the disorganized and scattered remnants of his armies were able to halt but momentarily the armored thrusts toward the Harz Mountains and the Elbe. On 14 April the Mulde River was reached. Halle and Leipzig were captured on the 19th. The newly formed German Eleventh Army, which had been encircled in the Harz Mountains during the course of these advances, surrendered on 21 April after a fierce but brief and futile attempt to break out of its encirclement. Four days later, patrols of the 69th Division established contact with the Russians at Torgau on the Elbe. The western and eastern fronts were now linked and Germany was cut in two.<sup>41</sup>

Third Army's offensive east of the Rhine recalled to mind its dashing drive of the preceding summer. Except for occasional brief halts to overcome local resistance or to effect side-slipping moves in accordance with directives from headquarters, the drive became a sweeping end run across the enemy's southern flank. Darmstadt had been captured on 25 March. That same day three crossings were made over the Main River, and by 1 April, with 4th, 6th, and 11th Armored Divisions in the lead, thrusts were rapidly developing to the northeast and southeast. On the northern flank Kassel was seized on 4 April. In the center, Mulhouse, Gotha, and Eisenach were captured on the 5th. Equally swift were the advances on the southern flank where Weimar fell on 13 April and Jena and Erfurt on the following day. Bayreuth was seized on the 15th. Three days later the Czechoslovakian border was reached. Further south, Regensburg was taken on 26 April. By the close of the month Third Army had pushed deep into Czechoslovakia and into the Danube Valley. Enemy opposition on German soil in Third Army's zone of operation had ceased to exist.<sup>42</sup>

Beyond the Rhine, from the last days of March to mid-April, General Devers' 6th Army Group surged forward to carry out its initial mission of protecting Patton's onrushing right flank. On Seventh Army's left, XV Corps on 28 March moved out of its bridgehead and cut to the northeast in the direction of the Hohe Rhön. Despite bitter local resistance at such points as Aschaffenburg and Gemünden, XV

Corps hurdled the Main River, knifed through the Spessart Mountains to the Hohe Rhön, and, after cleaning out most of the Hohe Rhön hill mass by 9 April, swerved southeast for a drive on the Nazi holy city of Nürnberg. XXI Corps, in Seventh Army's center, rolled easily through the Odenwald but was forced to annihilate the entire garrison at Würzburg before it could take the ruins of the city on 5 April. The ball-bearing manufacturing center of Schweinfurt also offered terrific opposition before it fell on 12 April. XXI Corps now turned southeast to keep pace with XV Corps. On Seventh Army's right, XI Corps seized Heidelberg without a fight but had to slug its way through the streets of Heilbronn for nine days until the enemy finally yielded that Neckar River rail center on 12 April. Meanwhile, VI Corps units which had thrust rapidly to Crailsheim were almost cut off and forced to pull back temporarily. To the south, French First Army overcame initially stubborn opposition to capture Karlsruhe on 4 April and Baden-Baden eight days later.<sup>43</sup>

In mid-April, Seventh Army turned south and southeast, won Nürnberg on 20 April after four days of hard house-to-house fighting, broke past the Danube River line at various points in the next few days, took Ulm on the 25th and Munich on the 30th. To Seventh Army's right, French First Army made equally rapid progress as its spearheads dashed to the Swiss border at Basle, isolated the enemy in the Black Forest, seized Stuttgart on 23 April, and swept past Lake Constance into the western corner of Austria. The end came when troops of Seventh Army's VI Corps captured Innsbruck in the Austrian Tirol on 3 May, and at 1051 the following morning met U.S. Fifth Army near Vipiteno on the Italian side of the Brenner Pass.<sup>44</sup>

Except for occasional morning fog which restricted operations to the afternoon and for a few totally nonoperational days, good flying weather obtained throughout the month of April, permitting Ninth Air Force to record over 32,000 sorties for the month. And with that the job was for all practical purposes done, as a drop to little more than 2,000 sorties during the first eight days of May indicates. For the fighter-bombers the primary duty was to provide cover and support to the rapidly moving armored columns and other forward elements. The chief difficulty arose from the fact that the pace of the ground advance often left the bases from which the planes operated so far behind as to restrict their time over the battle area. Armed reconnaissance flights roamed virtually without interference in search of pri-

ority targets—marshalling yards, rail and motor transport, and enemy airfields. The chaos occasioned by the enemy's hurried withdrawals presented the fighter-bombers with fat targets on road and rail. When the claims were totaled for the period extending from 1 April through 8 May they showed 10,136 motor transport, 1,290 horse-drawn vehicles, 1,418 locomotives, 6,683 railway cars, and 591 armored vehicles and tanks. Rail cuts were 532 and road cuts 133.

The Luftwaffe, flying an average of 150 to 200 sorties per day, gave little trouble. Its effort was concentrated on Third Army's front during the last days of March and in early April, when Patton's offensive was getting momentum. In mid-April, when 21 Army Group was beginning to register swift advances, GAF efforts shifted somewhat to the north, only to be shifted back again to the south toward the end of April. Lacking fuel and skilled pilots, the Luftwaffe also quickly felt the effect of a serious "housing problem" as one complex of airfields after another fell into Allied hands. Increasingly, its surviving strength was crowded into a relatively small area in west and south Germany, northern Czechoslovakia, and Austria. The congested fields there made inviting targets, and the Ninth's fighter-bombers claimed over 1,400 planes destroyed on the ground during the last month of operations.

The primary mission of each tactical air command came to a close when the army with which it was associated reached its final objectives or was prevented from further advances on orders from higher headquarters. In the case of XXIX TAC this took place on 20 April, after Ninth Army had reached the Elbe. Thereafter the fighter-bomber activities consisted mainly of uneventful cover over Allied airfields, an occasional escort of medium bombers, and patrol flights over the front-line troops. Combat operations of the IX TAC were brought to virtual conclusion on 25 April, when First Army made junction with Russian troops on the Elbe. Operations during the remaining few days of April and early May were largely confined to escort missions, airfield cover for loading or unloading transport aircraft, front-line patrols, and an occasional attack upon the few remaining enemy airfields. Since Third Army engaged the enemy until the day of the final surrender, XIX TAC's combat activity was not concluded until 7 May. However, unfavorable weather during the last ten days of the war and lack of targets had sharply curtailed the number of sorties flown.<sup>45</sup>

Medium bomber operations during this closing phase of the war

showed a very sharp decline from the record established in March, when 13,642 sorties had been flown. In April, because of ten totally nonoperational days and rapidly disappearing targets, the corresponding figure stood at 7,133. Attacks during the first nine days of April were directed chiefly against oil refineries, petroleum storage areas, ordnance and supply depots, and marshalling yards. The heaviest attack on such targets took place on 9 April, when 729 aircraft struck oil storage facilities at Bad Berka, the ordnance depot at Amberg Kammersbrück, the ordnance and armored-force vehicle storage depots at Naumburg, and the marshalling yards at Jena and Saalfeld. The rapid disintegration of German resistance in First and Third Armies' sectors of the front after 9 April and the Allied belief that a desperate last-ditch resistance might possibly develop in the so-called National Redoubt (the mountainous areas of south Germany and Austria) brought about a change of target priorities for the medium bombers. The accent was now placed upon hastening the process of enemy disintegration through attacks on ordnance depots, motor transport and tank factories, and interdiction of the National Redoubt. Very serious damage was caused at the ordnance depot at Kempten on 12 and 16 April. The motor transport assembly plant at Bamberg suffered nearly 50 per cent destruction on 11 April. Severance of the National Redoubt from the rest of Germany was the object of a number of missions on 12, 18, 19, and 20 April when very successful attacks were made against the rail and *Autobahn* bridges at Hof, the rail junctions at Falkenburg and Jüterbog, the marshalling yards at Ulm and Neu Ulm, and the rail center at Wittenberg. In addition to these operations, the mediums carried out leaflet missions in the Ruhr area, attacked several jet airfields in southern Germany, and, in response to direct army requests, staged several very successful attacks against communications centers or defended cities blocking or seriously interfering with the advance of the ground forces.<sup>46</sup>

The reconnaissance groups of the three tactical air commands flew 3,980 sorties during the month of April, the effort consisting of 2,727 visual and tactical reconnaissance sorties, 99 weather, 970 photo, and 180 miscellaneous reconnaissance sorties. Except for the first week of the month when weather severely hampered operations, the reconnaissance aircraft furnished the air and ground forces detailed and up-to-date information on the position and movement of enemy troops and materiel in all major areas of interest to them.<sup>47</sup>

The experience of the First Tactical Air Force, which included medium bomber units, may be taken as representative of the last phase of the air-ground war. Even before the last German salient west of the Rhine had been completely obliterated, First TAF planes were active east of the river in support of Third Army's bridgehead at Gernsheim. Thunderbolts and Spitfires hammered at front-line towns as far north as Coblenz and cut all of the rail arteries leading into Mannheim. On 23 March, the day that Third Army crossed the Rhine, American Marauders belonging to First TAF successfully bombed the crowded marshalling yards at Heidelberg and French mediums hit railroad bridges on the Neckar River, thereby depriving the Germans of badly needed railborne supplies. Four more medium attacks on Neckar rail targets the next day added to the enemy's logistical griefs. When Seventh Army established its bridgehead east of Worms, fighter-bombers swarmed over the front and beyond to the Stuttgart area in an assault against rail and road bridges and other objectives. The fighters hacked at a convoy of 150 motor transports at Sinsheim and claimed 50 vehicles destroyed and 25 damaged. Similarly, when French First Army vaulted the Rhine, Allied aircraft on armed recce gave valuable support by lashing at enemy strongpoints, troop trains, and trucks.<sup>48</sup>

Up to 28 March, the mediums concentrated the greater part of their effort on such normal interdiction targets as key bridges, rail embankments, and marshalling yards; armored-vehicle repair shops and supply depots received only secondary attention. Communications objectives were dropped to second place on 28 March, when top priority was given ordnance installations used for armored-vehicle repair, storage, and supply; POL refinery and storage installations reappeared in third place on the list of B-26 targets. The change in medium bombardment policy was based upon an awareness of the crucial importance of repair and supply depots to the Germans, who, unable to maintain a continuous ground defense line, had no choice but to fall back from one strategic reserve center to the next. An equally cogent reason for the policy change was the probability that further major assaults on rail communications in southern Germany would be more damaging to General Devers' swiftly advancing armies than to the enemy.<sup>49</sup>

After 28 March communications targets actually dropped to the bottom of the priority list. The last rail mission flown by First TAF mediums came on 31 March, when B-26's of 42d Bombardment Wing effectively bombed the rail yards and quay sidings in Heilbronn. On



the same day, French Marauders signaled the opening of the new campaign with an attack on a motor transport depot at Böblingen, southwest of Stuttgart. During the first nine days of April, the campaign went into high gear as American and French mediums pounded supply depots at Vaihingen, Tübingen, and in the Ludwigsburg area, oil stores at Geislingen and Weissenhorn, and ammunition dumps at Kleinengstingen, Gailenkirchen, and near Poppenweiler. After taking time out on the 10th for a devastating battering of enemy strongpoints in beleaguered Schweinfurt, the B-26's returned to their main task; they revisited the oil storage depot at Geislingen and twice bombed an ammunition dump at Strass, near Ulm. In mid-April, the medium effort was diverted for several days to support of the offensive against German forces in the Gironde estuary area of western France; but thenceforth, with the exception of attacks on airdromes in the vicinity of Ulm and two more missions in the west, the Marauders again concentrated on depots and dumps during the last days of operations. Characteristically, in their final raids against targets in the Reich, First TAF's B-26's on 25 April bombed ammunition factories and storage areas at Schwabmünchen and Ebenhausen. The April campaign, which robbed the enemy of desperately needed fuel, munitions, and other supplies, also shattered all previous records as the mediums flew 3,434 sorties and dropped 4,983 tons of bombs. Seven bombers were shot down: one by flak and six by enemy aircraft.<sup>50</sup>

During 6th Army Group's drive from the Rhine River bridgeheads to the mythical National Redoubt, fighter aircraft of XII Tactical Air Command and French First Air Force furnished close support to the ground offensive, carried out armed recce forays, escorted the mediums, flew night fighter and photo reconnaissance missions, and conducted counter-air force operations against the suddenly revived Luftwaffe. At Aschaffenburg, where XV Corps ran into furious and protracted resistance, P-47's hammered at enemy defenses for more than a week. On 31 March the air effort reached a peak when 331 aircraft were dispatched against Aschaffenburg and gave troop concentrations, armor, motor transports, and heavy-gun positions a severe beating. Similarly, during the bitter battle for Nürnberg, fighter-bombers helped to crush the defending garrison with a series of dive-bombing and strafing attacks on machine-gun nests and other enemy strongpoints. After Nürnberg fell, First TAF planes swarmed over Bavaria and harried the hapless Germans all the way south to Munich. On 27 April, for example, one squadron of Thunderbolts scored a spectacular suc-

cess against a concentration of about 200 motor vehicles in woods southwest of Augsburg; the P-47's strafed and dive-bombed relentlessly until, after fifteen passes, the Germans surrendered. The fighters maintained an aerial guard over the area while Allied infantry moved up to take over the prisoners. But generally, as the war entered its last days, fighter activities dropped sharply, though some attacks were made against such familiar targets as ammunition dumps, motor transports, and isolated pockets of resistance in southern Bavaria and the Redoubt itself.<sup>51</sup>

In late March and April, after the ground situation had already become hopeless, the German Air Force came to life for the first time on this front since January. The Luftwaffe's final effort—a feeble one at best—was brought about primarily by the forced transfer of jet and conventional enemy air units from the north into southern Germany. There, even as 6th Army Group's advance pushed them into a retreat from one air base to the next, Luftwaffe elements went over to the attack. The enemy, perpetually plagued by fuel shortages, disrupted communications, and hasty changes of station, was incapable of more than sporadic spurts of activity against First TAF medium bomber formations and Allied ground forces. The Luftwaffe's last bid, led by *Jagdgeschwader-53*, was not impressive. Though the enemy managed to fly over seventy-five single-engine daylight sorties on 7 April, for example, his daily operations rarely had more than nuisance value. Luftwaffe fighters did succeed, however, in knocking down four Marauders as late as 26 April.<sup>52</sup>

Following carefully formulated plans and aided by photographic reconnaissance and intelligence reports, Allied fighters systematically patrolled and attacked active German airfields. Six airdromes in the Stuttgart area received constant attention from First Tactical Air Force planes beginning 26 March. In April, when the Luftwaffe units pulled back to the southeast, Allied planes followed them and kept up the assault. Day by day, the enemy became more constricted and resorted to increasingly desperate measures such as attempting to hide his planes in woods near airdromes and alongside *Autobahns*. The futility of the GAF's last stand is indicated by First TAF's counter-air claims for the period 23 March to 8 May: in the air, 87 destroyed, 11 probable, 53 damaged; on the ground, 793 destroyed, 47 probable, 681 damaged. In the same period, the cost of the aerial offensive in support of 6th Army Group was approximately 100 American and French aircraft of all types.<sup>53</sup>

## CHAPTER 22

\* \* \* \* \*

### *MISSION ACCOMPLISHED*

**I**N THE weeks following the official proclamation that the strategic air war was over, the various air forces of the United Nations continued to be active. They were needed from time to time to remove strongpoints in the way of advancing ground forces, to block enemy railway movements, and to make certain that surviving Luftwaffe units could not deliver farewell blows of retaliation against the conquerors of Germany. The vast forces of the Eighth Air Force were on call for whatever missions SHAEF might require. During the last three weeks of the war the Fortresses and Liberators occasionally assisted the tactical air forces in bombing airfields and marshalling yards. There were not many demands of this nature, however, for Germany was rapidly becoming friendly territory and all Allied aircraft were strictly limited to targets that seemed sufficiently distant from the lines of the Russians and the western powers.

Two important special missions devolved upon the Eighth in the last of April. On 14 through 16 April more than 1,200 American heavies went out each day to drop incendiaries, napalm bombs, and 2,000-pound demolition bombs on stubborn German garrisons still holding out around Bordeaux.<sup>1</sup> The bombing was effective, and French forces soon occupied the region. The last attack on an industrial target by the Eighth Air Force occurred on 25 April, when the famous Skoda works at Pilsen, Czechoslovakia, received 500 well-placed tons. Because of a warning sent out ahead of time the workers were able to escape, except for five persons. American aircrews grumbled a little at what seemed to be more concern for civilian safety than their own,<sup>2</sup> but the Luftwaffe was no longer able to take advantage even of such an obvious opportunity. In fact, the few prize jet aircraft that appeared during these last weeks offered no opposition but hopped almost comically from one airfield to another or to the empty *Autobahnen* behind Ger-

man lines. By the beginning of May the Eighth Air Force had no further combat assignments. Instead, mercy missions to drop food to the famished population of the Netherlands became the overriding priority. Excellent hits were made on the race track outside The Hague and a golf course near Rotterdam.<sup>3</sup> Then, the weight of effort turned to the heartening task of evacuating liberated prisoners of war, thousands of whom were flown out of the defeated Reich within a few weeks. And more than 30,000 ground personnel of the Eighth Air Force whose overseas duties had been limited to England were taken on aerial sightseeing tours over Germany to see with their own eyes the results of their efforts.<sup>4</sup> Much of the Eighth Air Force was by that time on its way to Okinawa.

The Fifteenth Air Force was absorbed in tactical air force operations after March 1945. On 9 and 10 April this command dispatched 825 and 848 heavy bombers, respectively, to attack German positions prior to the ground force operation of crossing the Senio River.<sup>5</sup> On 15 April the largest operation ever undertaken by the Fifteenth Air Force proved a smashing success. This was Wowsers, the air phase of the breakthrough at Bologna. Practically every flyable heavy bomber, in all 1,235, took to the air and bombed troop concentrations, gun positions, and strongpoints which faced the ground forces.<sup>6</sup> After this huge mission, the efforts of the Fifteenth were directed at preventing German escape from Italy.<sup>7</sup> Marshalling yards in Austria received repeated bombardments, and the Brenner Pass line was finally broken for good.<sup>8</sup> When the Germans in Italy surrendered on 2 May 1945, the Fifteenth Air Force was concerned with dropping food to the inhabitants of northern Italy and evacuating prisoners of war. Never overly publicized, the Fifteenth had fought a hard war and had completed its assignment neatly.

The chief tactical air operations in Germany during the last weeks of the war were carried out by the U.S. Ninth Air Force. To the end its fighter-bombers provided close air cover for the armored columns that pierced the Reich. For a time during April the Allies were worried about a possible redoubt for the die-hard Nazis, and the Ninth planned to bomb bridges along the Danube and Lech rivers from Vienna to the Swiss border. But it became clear that the Germans were not going to be able to entrench themselves in the south, and the bridge campaign was not necessary. Interdiction of enemy north-south traffic, much of which was designed to prevent German reinforcement of the Russian

front, occupied much effort and was generally successful. When, toward the last of April, the U.S. First and Ninth Armies reached the positions where they had been ordered to await the Russians, the Ninth Air Force shifted its attention to southern Germany and Czechoslovakia, the scene of the U.S. Third Army advance. Ground force requests for attacks in that area came in rapidly and were met with dispatch, but targets there, as elsewhere by that time, were quickly engulfed by the armies and bomb lines sometimes became out of date ten minutes after they had been established.<sup>9</sup> The air forces were soon left with nothing to do but conduct surveillance over the dying Wehrmacht. Fittingly, General Spaatz and other air officers participated in the surrender ceremonies at Reims on 7 May 1945 and at Berlin two days later.

### *Germany, the Subject of an Autopsy*

The interrogation of captured enemy personnel was an opportunity long and eagerly awaited by air force leaders. The war they had fought had been of a weird, unprecedented type, one which had been costly to the British and American nations, and one from which lessons might be deduced for the bombing of Japan. Furthermore, as Air Chief Marshal Harris said,<sup>10</sup> the air war had placed an unusually frightful strain on the commanders, whose forces had to be risked and engaged almost every day for years. They were anxious to find out from the enemy, beyond what they knew already, precisely how their efforts had contributed to the victory and what mistakes they had made. Lengthy questionnaires and skilled interrogators were ready when the forlorn leaders of Germany's lost gamble surrendered in May 1945. The mood of these prisoners at that time seemed generally to conform to Dr. Hjalmar Schacht's lament that Germany was forever ruined.<sup>11</sup> Therefore, there was little to be gained by withholding information. And while their attitudes varied from sullen reserve to eager ingratiating, most of them were willing eventually to tell what they knew, and more. A professional approach to the art of war was often a factor in inducing even the most frigid German general to discuss the recent past. A desire to find a scapegoat, usually Hitler or Goering, was apparent, and doubtless some of the prisoners hoped to win better treatment for themselves by being cooperative. In any event, their statements could be matched against each other and checked by the vast piles of documents that fell into the hands of the Allies. When used

critically, these interrogations were a priceless source of information.

Adolf Hitler was not available for comment. Hermann Goering, however, was extremely voluble and, when he knew what he was talking about, informative. He told Spaatz and Vandenberg that the Allied selection of targets had been excellent, that precision bombing had been more effective than night raids.<sup>12</sup> Yet, the bizarre Luftwaffe commander, who had failed to break England in 1940-41, said he believed Germany could never have been defeated by air power alone.<sup>13</sup> In another interview he described the Fuehrer, with his ignorant interfering and bungling, as a great ally of the Anglo-American air forces. For that matter, Goering himself had many detractors among his former subordinates and various other German officials. But it was the size, skill, and methods of the Allied air forces that wrecked Germany, he admitted, and he corroborated most of the beliefs of the commanders of those forces regarding the various successes and shortcomings of the air war.<sup>14</sup> Other Luftwaffe officers, such as Sperrle, Galland, Junck, Milch, and Koller, filled out the history of the mistakes and failures of their arm, a story that officers from other organizations were only too eager to enlarge upon, and paid tribute to the effectiveness of the Allied air forces.

Germany's second and last Fuehrer, Grand Adm. Karl Doenitz, said the air power of the Allies was the decisive element in the failure of the Nazi submarine war.<sup>15</sup> Field Marshal Gerd von Rundstedt listed air power as the first of several ingredients in the triumph of the United Nations.<sup>16</sup> Col. Gen. Alfred Jodl said the winning of air superiority altogether decided the war and that strategic bombing was the most decisive factor.<sup>17</sup> Field Marshal Wilhelm Keitel assigned to the Allied air forces the chief credit for the victories in the west.<sup>18</sup> Of a dozen German generals who surrendered in Italy, all but one regarded air power as chiefly responsible for the defeat.<sup>19</sup> Albert Speer, the redoubtable minister of armaments production and by far the most valuable source for the effects of strategic bombing, emphatically stated his opinion that such bombing could have won the war without a land invasion.<sup>20</sup> The list of interrogated German generals and industrial officials was long. From Goering and Doenitz down to division commanders and factory managers they praised the achievements of Allied air power. Most of them regarded it as the decisive factor in Germany's defeat.

The picture of Germany's war effort that emerged from the interro-

gation of captured leaders and the examination of enemy ruins and documents underlined the magnitude of the strategic air success. Germany had been much stronger economically than the Allies had ever realized. Her industrial capacity was so huge that she had been able to mobilize at a leisurely pace, winning spectacular victories as she did so, and then, when Hitler's diplomatic madness arrayed the world against her, she set about strengthening her war machine to a point that seriously threatened her enemies. As her war production progressed to its peak in mid-1944, so the strategic air offensive against that production increased in weight. Of all the bombs that struck the Reich during the war, 72 per cent fell after 1 July 1944.<sup>21</sup> In the following nine months USSTAF and RAF Bomber Command wrecked this enlarged German economy until it could not support military operations or supply the basic needs of the population. Actually, Germany had been almost paralyzed economically by January 1945, and she was ruined by April.

The greatness of Germany as an industrial power became all the more evident with the postwar surveys of her former resources. It was her abundant strength that enabled her to arm so vigorously when she finally concentrated, far too late, on the task. She had, for example, a comfortable sufficiency in capital equipment.<sup>22</sup> Quite unlike the United States and Great Britain, she seems never to have suffered from a shortage of machine tools. She had rarely found it necessary to depart from the single-shift basis in most of her industries at any period of the war.<sup>23</sup> The Germans possessed ample capacity in factory space, enough to carry out complicated dispersal programs without being handicapped in this respect.<sup>24</sup> These factors alone had greatly compounded the problem of the strategic air forces because they allowed the Germans such a large cushion for expansion or conversion after they had been bombed out of certain areas. Also, Germany disposed of adequate labor forces during all of the war period. She did not mobilize her manpower, and still less her womanpower, to the degree her chief enemies did.<sup>25</sup> The availability of foreign workers and prisoners permitted considerable flexibility in manpower resources, and Allied destruction of industrial areas created labor surpluses which finally amounted to large-scale unemployment. Germany's supply of raw materials was usually adequate for war purposes, at least until late 1944, except for oil and rubber, which were obtained partly by the synthetic industries until air bombardment demolished them.<sup>26</sup> Finally, the level of civilian goods remained considerably above minimum requirements, compar-

ing favorably with Germany's enemies, at least until 1944.<sup>27</sup> And food supplies for Germans were astonishingly well maintained until the general transportation collapse late in the war.<sup>28</sup> The magnitude, resilience, and reserve strength of the German economic system enabled it to withstand enormously heavy air raids and forced the Allies to expend their greatest efforts before they finally crushed it.

Turning from the destruction of this target system to a study of its remains, the victors were surprised to find out how tardily Germany had built it up. The Germans had begun the war in 1939 with many misconceptions about the probable reaction of the rest of the world, and for several years afterward they amazingly refused to prepare for the prolonged struggle they had precipitated. Their brilliant successes in 1939-41 seemed to confirm the opinion of optimists that there was no need for a truly drastic mobilization, and none took place. Meanwhile, in the dark Allied years of 1940, 1941, and 1942, Great Britain alone surpassed Germany in most categories of armaments output, including aircraft.<sup>29</sup> Hitler even ordered a reduction in war production in 1941, a year in which the Germans improved on their 1940 record by a mere 1 per cent while the anti-Axis world was straining desperately to turn out weapons for a protracted war.<sup>30</sup> In December 1941, however, when Germany declared war on the United States and suffered setbacks in Russia and the Middle East, the overconfidence of the Nazi leaders began to subside. They talked a great deal about total mobilization, but actually they undertook only to tighten up the war effort. In February 1942, Hitler took the important step of appointing his personal architect, Albert Speer, as minister of armaments production, thus inaugurating the so-called Speer period in Germany's war effort.

Speer became one of the favorite subjects for Allied interrogation in the weeks following the German surrender. His extraordinary memory, willingness to talk, and obvious mastery of the facts made him a prize authority. Other German leaders, as well as the impounded documents, furnished an even more flattering appreciation of his career than he himself offered. It was largely because of his efforts that intelligent planning succeeded the optimistic improvisations of the early war years. German war production trebled under Speer's supervision, the most significant rise beginning in December 1943 and reaching its peak in July 1944, when the index hit 322 and gave promise of going much higher.<sup>31</sup> It was the German intention to produce enough weapons to fight off the United Nations until political developments or V agents



rescued the Reich. The appearance in 1944 of jet aircraft, impregnable and fast submarines, and V-1 and V-2, along with the impressive increase in armaments output through July, reveal how formidable was Germany's final challenge. The growing weight of Allied bombings Speer hoped to counter by dispersing Germany's most vital plants or by placing them underground, and he was making great progress in this direction. A few weeks after the Normandy invasion the strategic air forces of the western powers and Germany's resurgent war economy began the crucial phase of their strange combat. The victory that went to the Allied air forces was not won by default.

### *The U.S. Strategic Bombing Survey*

For more than a year before the end of the war in Europe the Americans had been preparing to conduct a comprehensive study of the effects of the bomber offensive on Germany when that indispensable piece of evidence became available for an autopsy. Common sense suggested the importance of an undertaking of this nature, since the true potentialities of air power needed to be measured against actual achievement, and curiosity about the real effectiveness of strategic bombing was high in view of the cost, publicity, and heavy share of the war effort associated with this new type of warfare. Besides, the wreckage of the European Axis might yield lessons for the war against Japan and for postwar national defense. Toward the end of March 1944, both AAF Headquarters<sup>32</sup> and USSTAF<sup>33</sup> began to formulate proposals for a survey of bombed German targets and a critique of the bomber offensive. General Spaatz was the first to approve and sponsor the suggestion, which became the subject of a "Dear Hap" letter of 5 April 1944. Spaatz's original idea was to invite a well-known personage of unimpeachable reputation for intelligence and integrity to head a small committee composed of military and civilian experts who would know what to seek and how to interpret what they found. Everything was to be done to make their work acceptable to the government and the public alike as an unbiased appraisal of the bomber offensive.<sup>34</sup> Arnold readily agreed to the proposal,<sup>35</sup> and planning began under the direction of General Anderson in USSTAF and General Kuter in AAF Headquarters.

It was going to be necessary to draw to some extent upon British agencies for technical assistance and to secure, if possible, permission from the British and the Russians to survey targets located in their

probable zones of occupation. But the air forces strongly hoped to keep the inquest in American hands.<sup>36</sup> A British offer to participate was parried,<sup>37</sup> and eventually the RAF developed its own survey in the Operational Research Section, which unfortunately never attained the size of the U.S. Strategic Bombing Survey and was not able, it seems, to do justice to Bomber Command's lengthy war against Germany.<sup>38</sup> It was not so easy for the AAF to resist the wishes of its sister services to share in the survey, and on 6 June 1944 the Joint Chiefs informally approved the idea of allowing a somewhat autonomous group with senior officers from the Navy, the Army Ground Forces, and the Army Service Forces to conduct the examination of the bomber offensive.<sup>39</sup> Thus, such officers as Gen. Omar N. Bradley, Vice Adm. Robert L. Ghormley, Lt. Gen. Lucius D. Clay, Rear Adm. Richard E. Byrd, and Maj. Gen. Orvil A. Anderson (chairman) were included as military advisers to an organization which became known as the U.S. Strategic Bombing Survey. By the end of the summer it became clear that the USSBS would transcend the sphere of the Army Air Forces and make its report directly to the Secretary of War and the President, an arrangement which accorded with the wishes of Spaatz and Anderson.<sup>40</sup> One final area of possible conflict disappeared when the AAF evaluation boards, which were composed of officers dispatched to various theaters to study the air war, were subordinated to the USSBS and made responsible for the study of tactical rather than strategic bombing.<sup>41</sup>

President Roosevelt signed the directive which cleared the way for establishing the survey on 9 September 1944.<sup>42</sup> A few weeks later Franklin D'Olier, president of the Prudential Insurance Company, accepted the invitation of Stinson<sup>43</sup> and Arnold<sup>44</sup> to become chairman of USSBS. Soon afterward D'Olier went to London and set up his headquarters in the former SHAEF seat at 20 Grosvenor Square. Authorized 350 officers, 350 civilians, and 500 enlisted men, the survey spent the winter of 1944-45 recruiting and preparing personnel for the task ahead. By April 1945 trained teams were entering Germany with or just behind the military forces to pick up government and business records and to locate prisoners who could reconstruct the history of the bomber offensive as experienced by the Germans. During the three months following V-E Day the survey engaged in extensive field work, supervised from a forward headquarters at Frankfurt, which involved dispatching specialized groups to examine the ruins of cities and factories, to gather statistics and data, and to interview thousands of for-

mer officers, officials, businessmen, and technicians.<sup>45</sup> Except for several forays just after the surrender the survey was not allowed to enter the Russian zones of Germany, despite a Yalta promise that targets behind Soviet lines would be available for inspection.<sup>46</sup> In the late summer of 1945 most of the survey transferred to Washington in order to prepare more than 200 reports, which were submitted to the Secretary of War as soon as they were completed and, in some cases, published. Meanwhile, the American air headquarters in Europe drew up its own recapitulation of the war, the voluminous and admirable study known as *The Contribution of Air Power to the Defeat of Germany*. The USSBS reports, however, were regarded as the definitive findings concerning the effects of strategic bombing.

With candor and objectivity USSBS brought out both the achievements and the mistakes of the air war. It publicized various unflattering aspects of the American strategic bombing campaign, such as the failure of the attacks on submarine pens, the misdirection of the campaign against ball bearings, mistaken choices of key targets in major systems and of aiming points within those targets, the relatively low degree of bombing accuracy, occasional failures of intelligence to grasp the interconnections of important systems, and the lamentable lack of continuity in prosecuting various offensives that might have brought about decisive results sooner if they had been waged more persistently and skilfully. While the air leaders knew or suspected many of these points, the criticisms of USSBS could not be shrugged off as mere hindsight; clearly, some of the errors could have been avoided. Yet it was painful to see several famous raids which had been difficult and costly dismissed as unnecessary or ineffective. And the deprecating tone with regard to the contribution of the RAF which ran through much of the survey's work, especially its specialized reports, did not reflect a judicious appraisal of the RAF effort. From his retirement in Rhodesia, Sir Arthur Harris, the outspoken former chieftain of Bomber Command, took spirited exception to some of the survey's conclusions.<sup>47</sup> After laying bare the weaknesses of the prosecution of the air war, however, the survey's final report affirmed with much more authority than could be claimed by any other agency that the victory in the air was complete and that Allied air power had been decisive in the war in western Europe.

So emphatic is the statement of this conclusion, and so marked has been the inclination of some writers to cite particular criticisms made

by the Strategic Bombing Survey without reference to its over-all conclusion, that there would seem to be some reason for restating in full the final judgment here:

Allied air power was decisive in the war in western Europe. Hindsight inevitably suggests that it might have been employed differently or better in some respects. Nevertheless, it was decisive. In the air, its victory was complete; at sea, its contribution, combined with naval power, brought an end to the enemy's greatest naval threat—the U-boat; on land, it helped turn the tide overwhelmingly in favor of Allied ground forces. Its power and superiority made possible the success of the invasion. It brought the economy which sustained the enemy's armed forces to virtual collapse, although the full effects of this collapse had not reached the enemy's front lines when they were overrun by Allied forces. It brought home to the German people the full impact of modern war with all its horror and suffering. Its imprint on the German nation will be lasting.<sup>48</sup>

### *The Strategic Achievement*

Of all the accomplishments of the air forces, the attainment of air supremacy was the most significant, for it made possible the invasions of the continent and gave the heavy bombers their opportunity to wreck the industries of the Reich. Defeating the Luftwaffe had demanded the best in Allied airmen and planes. No other phase of the war had quite the deadly earnestness and multiple peril for participants as the lonely duels fought miles above Europe during 1943 and early 1944. Such aerial combat and the steady toll of German fighters taken by gunners in the bomber fleets wrecked Hitler's fighter force by the spring of 1944. After this, though Allied leaders at times feared a revival of the Luftwaffe, U.S. bombers were never deterred from bombing a target because of probable losses. The best German pilots were dead or crippled; they could not be replaced, for Germany was never again able to provide proper training, even when she could assemble the aircraft. The industry which produced and supported the German fighter force did not fully recover from the shattering bombings of early 1944 which destroyed or damaged three-fourths of the plants.<sup>49</sup> Under Speer's direction the Nazis worked wonders in the reconstruction and dispersal of the aircraft industry, so that production rose rapidly until September 1944, but their efforts did not eventuate in an effective Luftwaffe and therefore were failures. Also, from the summer of 1944 on, the attacks on synthetic oil plants deprived the German Air Force of aviation gasoline so that operations were possible only on rare occasions. German bombers practically disappeared from

the air, and whenever fighters tried to interfere with Allied air fleets they invariably got the worst of the battle. And the Luftwaffe performed very inadequately when it presented itself at Anzio, Normandy, the landings in the south of France, the Battle of the Bulge, and the Weser crossings. Even the much-dreaded jets failed to disturb the pace of Allied air operations. With no small degree of satisfaction men of the air forces could look upon their mastery of the air as an overwhelmingly important factor in attaining the final victory over the Axis.

Although claims of German airplanes shot out of the air amounted to 11,481 in the case of the Eighth Air Force<sup>50</sup> and 3,946 in that of the Fifteenth,<sup>51</sup> and countless thousands were destroyed in the air by other air forces, on the ground, and by antiaircraft guns, the main strategic attack was directed at the aircraft industry. This gigantic complex, which manufactured 40 per cent of all Germany's munitions and which had been laid out in the 1930's with a view to reducing exposure to aerial bombardment,<sup>52</sup> was the target for 29,000 tons from the RAF, 47,671 tons from the Eighth Air Force, and 14,000 tons from the Fifteenth Air Force.<sup>53</sup> The magnitude and location of this system made it exceedingly difficult to injure. Yet, faulty strategy and blunders of the Germans had played their part. Hitler and Goering refused for years to believe the most definite evidence of the air offensive being prepared by their enemies. When they finally accepted the reality of this danger, it was too late.\* Even with their last chance to retrieve air supremacy by means of jet aircraft, the Germans had first dawdled with developing the new weapon and then had erred foolishly in plans for use of the jets as bombers instead of fighters. No amount of good management or energy on the part of the Speer ministry in 1944-45 could overcome the fateful mistakes of the earlier years. Probably nothing would have saved Germany from Allied air power, but advantages were needlessly thrown away.

The Allied air campaign against the German aircraft industry was not without its flaws, some of which were apparent contemporaneously but most of which became evident with the postwar surveys. Intelligence of the German system, after proving reliable for the early war years, became faulty in 1944. In that crucial year the Allies underestimated German aircraft production by half, and they were largely ignorant of the extent and details of the vast dispersal of the industry which was being carried out.<sup>54</sup> After the war, Goering, Speer, and many other

\* See the discussion above, p. 60.

qualified Germans said that aeroengine plants would have been better targets for the air offensive in early 1944 than the airframe assembly installations, a judgment confirmed in most respects by the U.S. Strategic Bombing Survey.\*<sup>55</sup> Also, the Allies tended to overestimate the amount of damage they had inflicted on German plants<sup>56</sup> and to make optimistic assessments regarding the amount of production denied their enemy because of structural damage.<sup>57</sup> Furthermore, it became clear with the postwar surveys that larger demolition bombs than the usual 500-pound variety would have brought about more damage to industrial machinery and that more incendiaries should have been used.<sup>58</sup> But air force leaders had been limited during most of the war in the matter of bomb supply and had found it necessary to use what they had rather than what was choice. In any event, they defeated German air power. The Allied air forces enjoyed a thorough mastery of their own element after the spring of 1944, and because of this advantage the initiative passed completely to the United Nations.

The air offensive against German oil production was the pride of the U.S. Strategic Air Forces. Initiated through the insistence of its officers, effective immediately, and decisive within less than a year, this campaign proved to be a clear-cut illustration of strategic air-war doctrine. In April 1944, Germany possessed barely adequate supplies of crude oil and was producing a growing volume of synthetic oil. In the following year the Eighth Air Force aimed 70,000 tons, the Fifteenth Air Force 60,000 tons, and RAF Bomber Command 90,000 tons at oil targets. By April 1945, when Germany was being overrun by the ground forces, her oil production was 5 per cent of the pre-attack figure.<sup>59</sup> She had been starved for oil, as her captured commanders and officials testified, often with genuine emotion, for the last year of the war. Her air force seldom flew after the first concentrated attacks on synthetic oil plants, which produced aviation gasoline. Tanks and trucks had to be abandoned. Toward the last, even the most august Nazis in the hierarchy were unable to find gasoline for their limousines. Germany's industries were badly crippled, and an enormous amount of effort was absorbed in the furious attempt to defend and rebuild oil installations. The Allied oil offensive had been quite as devastating as Spaatz had predicted in March 1944,<sup>†</sup> but it had taken longer than he and the British had expected to produce collapse.<sup>60</sup> The Germans, never easily beaten, used passive and ground defenses skilfully in protecting

\* But see above, p. 65.

† See above, p. 78.

their oil producers, and they reconstructed their bombed plants faster than the Americans anticipated. Nevertheless, the offensive had gone on as a first priority until the desired results were attained.

The USSBS was able to find defects and imperfections in the offensive waged by the air forces against German oil production. A serious mistake had been the failure of intelligence to comprehend how closely the German oil, chemical, and rubber industries were related. As it happened, accidental damage to methanol and nitrogen plants proved exceedingly harmful to German production of synthetic rubber and explosives.<sup>61</sup> A systematic attack on such targets undertaken earlier in the war might have been far more decisive. And if five plants which produced ethyl fluid had been bombed out, the effects on Germany's fuel situation would probably have been catastrophic.<sup>62</sup> The USSBS suggested, as did a number of captured Germans and, emphatically, many USSTAF officers, that the oil offensive should have been begun sooner. The German Air Force, in fact, might have been restricted more by attacks on its sources of aviation gasoline in early 1944 than by the bombings of the aircraft industry.<sup>63</sup> To fuel experts of the USSBS it seemed that more bombs should have gone into the oil campaign and fewer into blind attacks on industrial areas.<sup>64</sup> To the economists it appeared that the crude-oil refineries and the Fischer-Tropsch synthetic plants, which made only a small percentage of gasoline, had been bombed beyond the point of diminishing returns.<sup>65</sup> Accuracy had certainly not been high. In three major plants carefully studied it seemed that perhaps only 3 per cent of all bombs dropped actually struck damageable targets.<sup>66</sup> On the other hand, most of the raids took place at night or were carried out through clouds and smoke, from extreme altitudes, and in the face of worse flak than such bristling targets as Berlin could put up. The Americans used too many small bombs, too few incendiaries, and too many (about 14 per cent) defective bombs.<sup>67</sup> British raids were often more effective, because the RAF used larger bombs and more incendiaries and because it remained over the target so long the Germans could not emerge from shelters in time to extinguish fires.<sup>68</sup> While intelligence concerning synthetic oil plants was usually good, the planners did not know enough about the targets to choose the best aiming points and structural damage was usually overestimated.<sup>69</sup> And the Allies allowed too much time between bombings of the plants, for the Germans often enjoyed two weeks or so of production before they were bombed out again.<sup>70</sup> Yet, when every mistake

and omission had been underlined, the USSBS conceded the heartening conclusion: "The Allied air offensive effectively stopped oil production with decisive military consequences."<sup>71</sup>

The air forces also had wrecked Germany's transportation system. By the spring of 1945 only the highest-priority military movements could be started with any prospect of getting them through to their destination. Economic traffic, even such essential movements as bringing in food to stricken cities, was at a standstill following a precipitous decline which began in the autumn of 1944. With or without other forms of attack, Germany would surely have collapsed within a short period because of her transportation paralysis, a result of her enemy's air power. Soon, captured German leaders were chorusing their lamentations about the transportation bombings, which sometimes caused them to overlook other factors in the defeat of their nation, including their own mistakes. There was no question about this devastation by the spring of 1945, nor of its effects. Yet, the air campaign against German communications had been begun only after much debate in Anglo-American circles and had been carried out in spite of frequent periods of discouragement. Ironically enough, it had been projected not so much for its strategic effect on Germany's economy, which proved to be the most notable result, as for its influence on land battles, where its effects had usually been disappointing.

Germany had begun the war with one of the finest systems of railways in the world. This system bore up easily, partly because of plundered stocks from conquered neighbors, through all the campaigns of the war until the late spring of 1944, when its efficiency in various respects began to decline very slowly. This complication probably was a result of the increased wear and tear on the system caused by the vigorous land campaigns and the air offensives against Axis-controlled railways in the Balkans, Italy, and the western countries. By September 1944, when Allied ground forces reached the borders of the Reich, the air forces undertook to damage marshalling yards in western Germany preparatory to the offensives toward the Rhine. While the tactical effect of these bombings was very slight,<sup>72</sup> since until the very last the Germans were able to move their troops more or less on schedule, the economy of western Germany began to suffer severely almost immediately.<sup>73</sup> The attacks continued, usually when weather conditions prevented raids on higher-priority objectives, and in November German transportation became a second priority for the strategic air forces.



## MISSION ACCOMPLISHED

Again, the purpose was tactical, to isolate the German ground forces, and again, as the Ardennes counteroffensive proved, this purpose was not attained.<sup>74</sup> Yet, the strategic effect on Germany's industry and war effort in general was overwhelming. The decline in carloadings and marshalling capacity in the chief industrial areas of western Germany spelled catastrophe for the Germans. Meanwhile, the RAF successfully blocked the main north German canals, which had usefully supplemented the railway system, and river traffic on the Rhine was interdicted. During the Battle of the Bulge itself the air forces achieved one of their rare successes in interdicting military traffic over a large area, but in January 1945 the Allies took a very sober view of the transportation campaign and determined to concentrate on certain key regions so as to reduce what seemed to be wastage. Nevertheless, the impact of the earlier raids continued to magnify Germany's problems. The products of the Ruhr, especially its hard coal, found their way to other parts of the Reich with increasing difficulty. By mid-March 1945 the Ruhr was economically isolated by air power, but this victory lost significance in view of the rapid envelopment of that valley by the ground forces. Meanwhile, the bombings of rail centers leading to the Russian front, low-priority attacks on marshalling yards in all parts of Germany, and Fifteenth Air Force missions against southern European railways piled up calamity for the Germans. If they produced they could not haul. Their dispersal programs strangled, and the country became helpless. The Germans did not give up easily. Their will to operate the railroads was strong to the very last, and they worked furiously and efficiently to keep up their most vital movements. But nothing could save their transportation system.

The price of the transportation victory was huge. A total of 603,464 tons of American and 272,355 tons of British bombs was directed at land communications targets. The Eighth Air Force had aimed approximately one-third of its bombs, 235,312 tons, and the Fifteenth Air Force almost half of its lift, 149,476 tons, at such targets.<sup>75</sup> The tactical air forces had played a considerable and sometimes critical part in these campaigns, breaking bridges, lines, and shooting up facilities. The mine-laying campaigns of the RAF in the Danube had been successful and, after much discouragement, so had the British mine-laying enterprises in the North Sea. It was clear toward the end of the war that the transportation campaign had paralyzed Germany. The USSBS pointed out that certain areas had been overbombed, that the marshalling-yard

raids usually failed to achieve the desired tactical effects, and that the campaign had not been scientifically based on the flow of German economic traffic.<sup>76</sup> But the over-all success was so great that, in retrospect, it seemed reasonable to suggest that the attacks on Germany proper should have been begun sooner, thus saving the French and Belgian systems and bringing about at an earlier date the long-sought progressive dislocation of Germany's war-making capacity.<sup>77</sup> As it was, the USSBS concluded, the attack on transportation was the decisive blow that completely disorganized the German economy.<sup>78</sup>

The air offensive against German tank and truck production and ordnance depots did not bring about the consequences that might have followed a more sustained effort. Before August 1944 only occasional bombings and spillage from area or other types of attacks had injured this composite target system. Possibly the Germans had been denied several hundred units of armored vehicles by these raids before the beginning of a concerted offensive in the late summer of 1944. This campaign was undertaken mainly because the German armies had lost enough equipment in France and Poland to make large-scale refitting necessary before they could defend the homeland. With the hope that this process could be hampered or even prevented, and also because they were aware of gigantic expansion programs, the Anglo-American air forces bombed assembly plants and ordnance depots often as a second priority between August and 1 November 1944. The raids were usually successful as air operations, and conspicuous ruin was wrought on several of the leading tank assembly and truck plants. But the Germans succeeded in supplying their combat units with essential equipment in time to meet the invaders of the Reich.<sup>79</sup> Hence the priority was dropped on 1 November in favor of the transportation campaign, and there was a tendency in air force headquarters to look upon the offensive as inconclusive or worse. Thereafter, very few raids on this system were carried out until March 1945, when a considerable tonnage fell on the plants and depots. In all, 14,000 tons were directed at tank assembly plants, 2,600 tons at tank components plants, 1,780 tons at tank engine plants, 11,452 tons at motor vehicle installations, and 9,516 tons at ordnance depots.<sup>80</sup> Such tonnage had been effective in many individual cases but did not seem to restrict the German armies in the field in defending the Reich vigorously to the last.

After the war the USSBS studied the remains of several plants and indorsed the conclusion that the bombings had been very severe, de-

stroying possibly 64 per cent of the tank plants and a larger percentage of the truck plants.<sup>81</sup> Undoubtedly, the attacks had prevented the fulfilment of Speer's ambitious expansion program, and it was calculated that they had deprived the Germans of 2,250 tanks, assault guns, and self-propelled guns and 40 per cent of the motor vehicles they had planned to turn over to their combat units.<sup>82</sup> Also, the destruction of tanks and trucks by the tactical air forces had been great, amounting in the ETO to 5,293 tanks and 70,631 motor vehicles,<sup>83</sup> and therefore more effective than the strategic bomber offensive against the sources of production.<sup>84</sup> While air force headquarters had a low opinion of this offensive, encouraging testimony came from captured German leaders. They offered no picture of catastrophic breakdown in obtaining their equipment, but one of manifold and infuriating difficulties. The forty raids or more had apparently proved of some effect in crippling the German armies, and it seemed clear that a determined campaign undertaken earlier in 1944 and pursued without interruption might have been decisive.

Against three other important target systems—German steel production, submarine assembly, and V weapons—Allied air power achieved considerable but not complete success. Germany's steel-producing plants suffered a loss in output of approximately one-fourth during 1944 because of the direct and indirect effects of aerial attacks, and large plans for expansion were blocked.<sup>85</sup> Steel itself was never an important priority during the bomber offensive, and most of this damage came about from RAF area attacks and USSTAF blind bombings of urban industrial areas. After the war a number of qualified Germans said they had regarded steel plants as highly vulnerable,<sup>86</sup> supporting the belief of the Committee of Operations Analysts (COA) in March 1943.<sup>87</sup> As for the submarine industry, it was obvious that air attacks had achieved notable effects. The misdirected bombings of submarine pens in France in 1943 was by no means the whole story of the offensive. In all, more than 100,000 tons had been dropped on targets that contributed to U-boat warfare, and Germany had been delayed and hampered in many ways in producing the underwater craft.<sup>88</sup> Of 423 planned Types 21 and 23 submarines, the huge fast type the Allies never learned to contend with, only 180 were built.<sup>89</sup> The chief cause of the discrepancy between scheduled and actual production was aerial bombardment, and Admiral Doenitz' previously cited tribute to air power was altogether sound. With reference to the attack on V weap-

ons, air bombardment probably had delayed by from three to four months the launching of the V-1 assault on Britain.\*

The campaign against Germany's antifriction-bearing industry, mainly a phase of the offensive against aircraft production, illustrated the varied factors which must govern the selection of targets for strategic bombardment. The German ball-bearing plants, few in number and well concentrated, seemed to offer an ideal opportunity. The COA had singled them out as outstandingly vulnerable to air attack and had estimated that their destruction would have immediate and critical effects that would pervade the enemy's entire industrial system.<sup>90</sup> A mission of 17 August 1943 had achieved impressive results at Schweinfurt, but the destruction was not complete and the cost was high.† A return attack, delayed until 14 October, proved considerably less damaging than the earlier one and cost no less than 60 of the 229 bombers attacking.<sup>91</sup> An exposed target system such as this one called for simultaneous and sustained assaults, but it was concluded that the Eighth, which as yet lacked long-range escort, did not dispose of sufficiently large forces at that time to fly in the face of such prohibitive losses. Renewal of the attack was postponed until the spring of 1944. German production meanwhile declined by 40 to 50 per cent,<sup>92</sup> chiefly as a result of moves to disperse the industry. In this effort at dispersal the enemy was largely successful, as he was also in acquiring substitutes for his own ball bearings when needed. Though missions flown during the remainder of the war, most of them in 1944, ran up the bomb tonnage to an impressive total, German armaments production suffered no serious effects from a shortage of antifriction bearings.<sup>93</sup> After the war several captured commanders attributed the high level of tank unserviceability to defective bearings,<sup>94</sup> but this was almost the only comfort for those Allied air officials who had begun the ball-bearing campaign with such hope.

It is not surprising that the Germans were able to inform the Allies after the war of several target systems that might have been easy to destroy and whose destruction would have been gravely serious. For example, Goering<sup>95</sup> and Speer<sup>96</sup> believed the electric power stations of Germany had been highly vulnerable to air attack. Their point was fortified by the findings of the USSBS<sup>97</sup> and the conclusions of *The Contribution of Air Power to the Defeat of Germany*.<sup>98</sup> Yet the system

\* See above, p. 106.

† A total of 36 out of 183 bombers attacking. See Vol. II, 682-86.

## MISSION ACCOMPLISHED

was never selected as a primary bombing objective, although AWPD-42 of September 1942\* had recommended it for fourth priority and the COA report of March 1943 had underlined the fact that the power stations were mainly concentrated in the Ruhr. Apparently, American air authorities in England believed the system was more highly developed, and therefore less vulnerable, than it really was,<sup>99</sup> or they expected the numerous raids on industrial cities to produce whatever damage to power stations that was possible. In the case of powder and explosives plants, too, strong presumptive evidence came to light after the war that they would have constituted an excellent target system for strategic bombing.<sup>100</sup> Officers of the German quartermaster general department said they would have rated it second only to oil.<sup>101</sup> Another missed opportunity, as it was judged after the war, was the failure to conduct a full-scale aerial offensive against Germany's chief chemical plants, especially those which produced nitrogen and methanol.<sup>102</sup> As it was, they suffered considerably but only incidentally from attacks on synthetic oil installations.<sup>103</sup> And the USSBS pointed out that concentrated attacks early in the war on synthetic rubber plants would probably have proved effective.<sup>104</sup> In considering these matters, however, it should be emphasized that Allied intelligence was often uninformed of potential German weaknesses that seemed very obvious once the war was won, and that systematic campaigns against any of the exposed target systems would probably have produced the same energetic and often successful countermeasures that served the Germans so well in other instances.

Aside from the complete and partial victories of air power against specific target systems, the ruined cities of Germany offered mute testimony to the effectiveness of the bombings. Obviously, the burning and blasting of the chief industrial areas in cities had seriously diminished war production, although the precise effects could never be measured. The tremendous requirements of air-raid defense had absorbed German manpower, scientific energies, and guns and ammunition from war activities that might have been much more dangerous to the United Nations.<sup>105</sup> The air raids on cities had brought death to perhaps 305,000 Germans and serious injury to 780,000, and approximately 25,000,000 had been subjected to the terror of the bombings.<sup>106</sup> Yet the humanitarian protest might be parried by pointing out the far more fatal effects to civilian populations of the naval blockade of the

\* See Vol. II, 277, 368.

first world war.<sup>107</sup> While the Allies would undoubtedly have been pleased if German civilian morale had broken under the bombings, this morale had not been the primary target. The RAF was primarily interested in destroying the sources of German war production, which logically enough were located in the main industrial cities, and the homes of workers were considered legitimate objectives. The AAF, which repeatedly enunciated its opposition to terror bombing (although it is unlikely the Germans ever gave it credit for this stand) had also produced wide-scale damage to dwellings and nonmilitary targets during blind-bombing raids on industrial plants and marshalling yards. German morale had not broken, as captured leaders proudly pointed out after the war. Nor had it been stiffened and inspired. So tight was Nazi police control and so complete were the docility and discipline of the population, men and women continued to perform war work as long as the plants and machinery existed, no matter how fully they had despaired of the national cause or cursed their rulers.<sup>108</sup> Thus the hideous ruin visited on German cities by Allied bombers was in both purpose and result not a matter of breaking morale but of depriving the enemy of the means to produce and transport the materials of war.

### *Claims*

The problem of checking claims of German aircraft destroyed in combat proved vexatious and, in the last analysis, impossible of resolving in any definitive way. Eighth Air Force claims, since the early days of operations in ETO, had been viewed with marked skepticism within the AAF as well as by the general public. As part of a continuing effort to tighten up the system of interrogation and reporting and thus to reduce to a minimum the unavoidable duplication of claims among crews fighting in ever larger bomber formations, the Eighth repeatedly revised its estimates downward. Even so, a preliminary check of GAF records undertaken at the request of the U.S. Air Force Historical Division by the British Air Ministry for the second volume of this history indicated that official claims through 1942 and most of 1943 remained altogether too high. A comprehensive investigation by this writer on two visits to London in 1949 and 1950 confirmed this conclusion, although by examination of the worksheets from which final reports of the General Quartermaster Department of the Luft-

## MISSION ACCOMPLISHED

waffe<sup>100</sup> were compiled, it proved possible at points to establish a probability somewhat closer to the official Eighth Air Force claims.\* The hope that it might be possible to follow one such authoritative source through the entire war for purposes of comparison ended in disappointment, for the above-mentioned quartermaster file in possession of the Air Ministry is incomplete. All entries for 1944 and the first two months of 1945 are missing, and a search for those records in the air historical office at Wiesbaden and the army historical files at Karlsruhe proved unproductive. Other GAF records available are both incomplete and contradictory. It was possible, however, to place some boundaries around the problem by comparing American claims for a given period of time with several sets of consolidated German records.<sup>110</sup> The results of this approach, as in the case of the critical air battles of February 1944,<sup>†</sup> established a strong probability that the claims advanced by U.S. strategic air forces from the close of 1943 were not too far off if allowance be made for the trying circumstances under which the original observations were made.

As 1944 wore on, the claims of these air forces diminished in relation to the losses admitted in the German files. Several explanations immediately occur. S-2 officers, upon whose interrogations the final claims depended, were by then both better trained and more experienced. The continuing effort of higher headquarters to bring about improvement of interrogation and reporting had had its effect. American fighters, whether on escort duty or on tactical missions, were over Germany in increasing numbers and took a heavy toll of German defensive planes; fighter pilot claims, especially when confirmed by camera gun photos, tended to be more accurate than those of flexible gunners in bomber formations and thus to narrow the gap between AAF and GAF statistics. By the last quarter of the year most of the German records play out and efforts to segregate losses by type of aircraft reflect the confusion which beset the Reich. Statistics summarizing the losses for the year 1944 are, however, available. A file of the Luftwaffe's chief of

\* Thus in the Lille mission of 9 October 1942 (see Vol. II, 220-22) while the final record compiled by the General Quartermaster Department showed only 1 fighter destroyed in that action, the worksheets indicate a probable loss in the west that day of 11 fighters with 11 more damaged as much as 60 per cent. The original American claims were 56 fighters destroyed, 26 probably destroyed, and 20 damaged for a grand total of 102, but were revised downward to 21/21/15.

† See above, pp. 46-47.

staff, based on the records of his intelligence reporting section, lists 3,057 German fighters as destroyed and 649 as missing in the daylight defense of the interior zone of the Reich.<sup>111</sup> This evidently records victories for the most part of the Eighth and Fifteenth Air Forces, since night losses and those sustained on the various ground fronts are listed separately. Those organizations claimed almost 10,000 air victories during the year. Their claims include planes not counted in the Luftwaffe file: German fighters shot down outside of the Reich, fighters of other Axis air forces destroyed, and even bombers which the GAF sometimes had to use for interception. Perhaps the conclusion is warranted that during 1944 the U.S. strategic air forces shot down half the number of enemy airplanes they thought they had.

And whatever the disparity in the figures for the earlier period may be, it is evident enough that the cumulative attrition imposed on the GAF contributed to its defeat early in 1944. Indeed, the reduced activity of the GAF after February of that year may be partly responsible for the improvement in AAF reporting. As a study of the Battle of Britain has revealed,<sup>112</sup> periods of furious combat tend also to be periods of frenzied claims. When interception is only occasional, the fighter pilots and bomber gunners seem to make more accurate assessments of their victories.

### *The Tactical Achievement*

The strategic bombing offensive at no time enjoyed official recognition in U.S. war plans except as a preliminary to the invasion of western Europe or as a program undertaken in support of that invasion. It followed that all air forces were subject from the spring of 1944 forward to an overriding dedication to the fulfilment of Eisenhower's mission, and that the diversion of bombing effort from strategic targets to tactical operations in behalf of the ground forces would be heavy. But if the strategic campaign was thus rendered less effective than it might have been, the final victory was no less complete.

The removal of the German air threat to Allied land operations on the continent, primarily an achievement of the heavy bomber commands, was decisive in permitting those operations to begin. There was no question that the diminution of such critical enemy supplies as fuel had proved of inestimable benefit to Allied ground forces. The participation of the strategic air forces in pre-invasion bombings and in the wrecking of transportation facilities had helped to make the victory on



## MISSION ACCOMPLISHED

the ground certain. More than that, there had been a superb coordination of effort between the advancing ground forces and the most powerful tactical air forces ever assembled. It is not intended to suggest that the air forces won the war, or even that they could have won single-handedly a war deliberately planned on the principle of interdependent land, sea, and air forces. Rather, the purpose is to emphasize that the final triumph owed much of its completeness to an extraordinarily effective coordination of the ground and air effort.

The beaten German ground commanders were almost unanimous in their testimony that their defeats had stemmed above all from their enemy's air power. Indeed, so extravagant was their praise, the suspicion sometimes arose they were attempting, unconsciously or otherwise, to explain away their own mistakes. Long before their final surrender, as in Field Marshal Model's reports to his superiors at the close of the disastrous summer of 1944,<sup>113</sup> they had dwelt repeatedly upon the especially depressing effect upon their troops of the Allied superiority in planes and tanks. Allied ground commanders mixed with their generous compliments a few criticisms regarding the machinery for securing air assistance and the value, in some instances, of mass bombing attacks on the battlefield,<sup>114</sup> but this last point merely confirmed the judgment of air commanders who more than once had objected to proposals from ground commanders for this employment of air power.\* As this is written, only one volume of the official U.S. Army history of the European war has been published, H. M. Cole's admirable study *The Lorraine Campaign*.<sup>115</sup> That study covers a period when the atrocious weather of late 1944 seriously limited the air effort, but the volume gives much credit to the supporting air arm for its work in tactical reconnaissance, in close collaboration with tank units, in the cover of ground troops, in the bombing of enemy concentrations and the strafing of enemy movement, in blasting a way through village barriers, and in the interdiction efforts. The author also emphasizes the enormous advantages enjoyed by the Allied ground forces as a result of the general air supremacy maintained by the Allied air forces. "Few of Patton's troops ever saw more than a single German plane at a time," we are told, "although they may have been subjected to a short night bombing or may have heard a few enemy reconnaissance planes chugging overhead in the darkness, making their rounds as 'bed check Charlies.'" The supremacy in the air achieved by the Allied air forces

\* See above, pp. 143-44, 199, 279, 366.

before the invasion of Normandy, and retained after D-day, allowed the Third Army a degree of tactical mobility and logistical freedom that was nearly absolute insofar as any threat from the Luftwaffe was concerned."<sup>116</sup>

Ironically enough, it had been the Germans themselves who demonstrated to a stunned world how easily land victories followed the attainment of air supremacy, the blocking of transportation, and the skilful use of airplanes in battles. The swift campaigns which brought most of continental Europe and much of northern Africa under Axis control were conspicuous for the effective employment of the Luftwaffe. And in the several critical instances where the Nazis failed—Dunkerque, Britain, Moscow, Stalingrad, and El Alamein—they had not been able to establish an air situation favorable to themselves.<sup>117</sup> Clear as these lessons were, the enemies of Germany seem to have learned more from them than did the Germans themselves, and they were eventually in a position to put them to highly effective use.

The British system of centralizing the control of available air forces under an air commander who was made equal in authority to the ground and naval commanders represented a distinct advance over the German doctrine and proved outstandingly successful in the African desert campaigns. Even when setbacks occurred, as in mid-1942, the RAF was chiefly responsible for preventing the defeat from being turned into a disaster. When the Eighth Army took the offensive at El Alamein the RAF, with some aid from AAF units, had won air supremacy and was able to strike concentrated blows at the enemy without having its strength dissipated on unsuitable targets which ground commanders might have designated. The great success which ensued, and the continued freedom which General Montgomery permitted the RAF to enjoy, re-emphasized the lesson that an air force functioned better in a tactical role if its commander had full power to direct it according to its capabilities in close cooperation with the ground forces but in no way subordinate to them.

Convinced as they were that the RAF principle was sound, AAF leaders were not able before 1943 to secure its adoption by the War Department. The United States had gone to war with an outmoded doctrine of air support which subordinated the air force to the ground force. In the area of battle not only did the air commander come under the army commander, but air units might be specifically allotted to the support of subordinate ground units. It was recognized that a contest

## MISSION ACCOMPLISHED

with an opposing air force for supremacy in the battle area might be necessary but, according to Field Manual 31-35 of 9 April 1942, "the most important target at a particular time will usually be that target which constitutes the most serious threat to the operations of the supported ground force." And in any case, the "final decision as to priority of targets" rested "with the commander of the supported unit." Such principles as these inevitably fostered distribution rather than concentration of force, encouraged an "umbrella" concept of defense which invited defeat in detail by the opposing air force, tended to commit the airplane to missions ill suited to its capacities, and robbed the air commander of full freedom to exploit the inherent flexibility of his weapon.

Tried and found wanting in the generally unsuccessful first months of the North African campaign, this doctrine was rewritten with the advice of men trained in the school of the Western Desert. The organization in February 1943 of the Northwest African Air Forces, a combined British and American command embracing all Allied air forces committed to that area, gave the control of air operations into the hands of commanders who were to cooperate with ground and naval commanders as equals and were subordinates only to the over-all command of Eisenhower.\* Thus, as the doctrine was finally made official in FM 100-20 of 21 July 1943, air power and land power became "co-equal and interdependent forces," neither of them "an auxiliary of the other." This principle represented a lesson taught by experience, and the men whose experience had taught it—Eisenhower, Montgomery, Bradley, and Patton, Spaatz, Tedder, Coningham, Brereton, Doolittle, Vandenberg, and Quesada—carried the new doctrine, after a further test of it in the invasions of Sicily and Italy, into western Europe as the guide to policy in one of the most effective collaborations known to military history.

It is hardly necessary to review in detail the varied achievements recorded in the preceding pages. Two great amphibious operations were staged virtually without opposition from a once powerful enemy air force. The GAF, moreover, was kept at a point of weakness that left it little military significance in the subsequent development of the ground campaigns. Indeed, the American infantryman became so accustomed to this state of affairs that he was likely to take the appearance of a single enemy plane as a special cause for grievance against the air force. Interdiction of the enemy's communications, if seldom absolute,

\* See Vol. II, 16-17, 27-29, 136-65.

## THE ARMY AIR FORCES IN WORLD WAR II

repeatedly was achieved on a scale sufficient to affect profoundly the balance of forces on the ground, and where interdiction failed, an alert reconnaissance gave notice of the enemy's movements. The employment of aviation in intimate teamwork with ground units improved as experience was acquired; in some areas of activity, notably in the collaboration of plane and tank crews, the record was a distinguished one. Aviation engineers and service organizations made certain that air support kept pace with the most rapid of the ground advances. Air transport services lacked the strength and equipment to meet larger emergencies, but day in and day out they delivered from rear areas critical items of supply which often meant the difference between a halt and a further advance. Airborne operations at times met with disappointment, but this new method of warfare in the end had been well mastered. Finally, the frequent summoning of the heavy bombers from their strategic war to render direct assistance to the ground forces revealed as never before the flexibility and versatility of air power.

Altogether, the Allied air forces, in tactical operations as in the fulfilment of their strategic mission, more than justified the faith placed in them by their peoples and their governments.

## NOTES



## NOTES

\* \* \* \* \*

### NOTES TO CHAPTER 1

1. War Cabinet, Chiefs of Staff Com. Operation OVERLORD, 20 July 1943, p. viii; Gen. Sir Alan Brooke at CCS 108th Mtg., 15 Aug. 1943. In his *Overture to Overlord* (New York, 1950) General Morgan recounts his experience as COSSAC.
2. OPD paper, Conduct of the European War, 10 Nov. 1943; JCS 124th Mtg., 17 Nov. 1943; Henry L. Stimson and McGeorge Bundy, *On Active Service in War and Peace* (New York, 1948), p. 439; Dwight D. Eisenhower, *Crusade in Europe* (New York, 1948), pp. 194, 198; Morgan, *Overture to Overlord*, p. 224.
3. SEXTANT Conference, minutes, 24 Nov. 1943.
4. CCS 409, memo of British Chiefs of Staff, 25 Nov. 1943; H. H. Arnold, *Global Mission* (New York, 1949), p. 464.
5. SEXTANT Conf., min. of plenary session between the USA, UK, and the USSR, 28 Nov. 1943, in EUREKA Conf.
6. CCS 426/1.
7. Stimson, *On Active Service*, p. 439; Robert E. Sherwood, *Roosevelt and Hopkins* (New York, 1948), p. 758.
8. SEXTANT Conf., as cited in n. 5.
9. Stimson, *On Active Service*, p. 442; Sherwood, *Roosevelt and Hopkins*, p. 803.
10. Eisenhower, *Crusade in Europe*, p. 207.
11. Interview, B. C. Hopper with Gen. Carl A. Spaatz, 20 May 1945; CPS 89th Mtg., 4 Nov. 1943, and memo from Leigh-Mallory attached to min.; COSSAC staff conf., 28 Aug. 1943. See also Morgan, *Overture to Overlord*, p. 205.
12. JCS 123d and 124th Mtgs., 15 and 17 Nov. 1943; Handy to Marshall, 5 Oct. 1943; Sherwood, *Roosevelt and Hopkins*, p. 764; Arnold, *Global Mission*, p. 455.
13. Eisenhower to Marshall, 17 Dec. 1943; CM-IN-19199, Eisenhower to Marshall, 31 Dec. 1943.
14. CCS/1/D, 21 Jan. 1943.
15. Ltr., Arnold to Doolittle and Twinning.
16. See especially USSBS, *The Effects of Strategic Bombing on the German War Economy*.
17. *Ibid.*, pp. 148-62.
18. 8th AF Hq., Eighth Air Force Tactical Development, Aug. 1942 to May 1945, p. 97.
19. Tactical Mission Report 119. This refers to both the Eighth Air Force report and the tactical mission folder compiled for Mission 119 in Hq. USSTAF in accordance with a regular practice. The two series of reports cover essentially the same ground, but occasionally information may be found in one which is not in the other. Hereafter the citation will be T/M Rpt. with the appropriate number to indicate the mission.
20. T/M Rpt. 130.
21. *Ibid.*; ltr., Kepner to Giles, n.d. (probably 2d week in Dec. 1943).
22. T/M Rpt. 145, among others.
23. Ltrs., Arnold to Portal, 25 Sept. and 31 Oct. 1943.
24. CM-OUT-10117 (11-25-43), AC/AS OC&R to SEXTANT, 1008, 24 Nov. 1943.
25. Ltr., Kepner to Giles, 27 Dec. 1943.
26. Ltr., Kepner to Giles, as cited in n. 21; ltr., Eaker to CG's VIII FC and Ninth Air Force, 31 Oct. 1943.
27. T/M Rpt. 149.
28. *Ibid.*, 154.
29. *Ibid.*, 159.
30. *Ibid.*, 169.
31. File 706, 24 Jan. 1944.
32. Eighth Air Force Stat. Summary; Ninth Air Force Stat. Sum.

33. Draft plan for such an attack of 2 Nov. 1943 in AFSHO files.
34. COPC/S 2071, 29 Nov. 1943.
35. Memo for Col. J. L. Loutzenheiser from Col. H. A. Berliner, AC/AS, Plans, 11 Oct. 1943; ltr., Berliner to Eaker, 26 Oct. 1943; ltr., Eaker to Hon. Artemus L. Gates, Asst. Sec. of Navy for Air, 16 Dec. 1943; *Radar, A Report on Science at War*, released by the Joint Board on Scientific Information Policy for Office of Scientific Research and Development (1945), p. 31.
36. On the subject of radar bombing see Hugh Odishaw (of the Radiation Laboratory), *Radar Bombing in the Eighth Air Force*, June 1946; *Radar, A Report*, especially chap. 9; Report by General Eaker on USAAF activities in the UK from 20 Feb. 1942 to 31 Dec. 1943; History, VIII AFSC, chap. 5; Eighth AF Tac. Dev., pp. 64 ff.
37. Eighth AF Tac. Dev., p. 85; *Radar Bombing in Eighth*, pp. 9 ff.
38. *Radar Bombing in Eighth*, chap. ii; *Radar, A Report*, pp. 30-32; History, VIII AFSC, chap. v, pp. 72 ff.
39. *Radar Bombing in Eighth*, p. 41.
40. *Ibid.*, chaps. ii-iii; *Radar, A Report*, pp. 30-32.
41. This is inferred from an apparent discrepancy in the reports of the mission; some apparently refer strictly to H<sub>2</sub>X and give nine as the number of pathfinders participating, but other reports presumably give over-all figures and say eleven. See also ltr., Eaker to Gen. McClelland, 13 Nov. 1943.
42. T/M Rpt. 119.
43. *Ibid.*
44. *Ibid.*
45. Hq. ETOUSA Immediate Release 8117, 4 Nov. 1943, in USSTAF T/M Rpt. 119.
46. See T/M Rpts. for period, *passim*.
47. Air Ministry War Room Monthly Summary of Bomber Command Operations, Dec. 1943, p. 21.
48. Statistical Summary of Eighth Air Force Operations, European Theater, 17 Aug. 1942 to 8 May 1945, p. 34.
49. *Radar Bombing in Eighth*, chap. v. See also T/M Rpts. 121, 124, 151, 159.
50. T/M Rpt. 124.
51. CM-IN-6387 (12-10-43), Eaker to Arnold, USAWW D1037, 10 Dec. 1943. Cf. ltrs., Eaker to Giles, 7 Dec., and Giles to Eaker, 17 Dec. 1943.
52. *Radar Bombing in Eighth*, p. 47.
53. Ltr., Spaatz to Arnold, 14 Jan. 1944.
54. *Radar Bombing in Eighth*, p. 47; CM-OUT-10322 (1-26-44), Arnold to Spaatz, A-5725.
55. T/M Rpts.; 8th AF Stat. Sum., p. 20.
56. Berliner correspondence cited in n. 35. Cf. USSBS, *Over-all Report, European War*.
57. Ltr., F. L. Anderson to Giles, 17 Nov. 1943.
58. See T/M Rpts. 130, 138, 140, 154, 156, 159.
59. See USSBS, Area Studies Div. Rpt.
60. Ltr., Eaker to Lovett, 15 Dec. 1943.
61. USSBS, Submarine Plant Rpt. 3, Deutsche Werke A.G., Kiel, p. 11; Ministry of Home Security report on raid, in USSTAF T/M Rpt. 154; ltr., Eaker to Col. G. A. Brownell, 22 Dec. 1943.
62. History, AAF Proving Ground Comd., Pt. XVI, App. A, Exh. 21.
63. *Ibid.*
64. USSTAF T/M Rpts.
65. T/M Rpts. 174 and 176.
66. T/M Rpt. 178.
67. USSBS, Ludwigshafen - Oppau Works, I. G. Farbenindustrie A.G., p. 29.
68. *Ibid.*; 8th AF Monthly Sum. of Opns., Jan.-Mar. 1944.
69. T/M Rpt. 182.
70. *Ibid.*; memo for Arnold from Gen. T. D. White, AC/AS Intel., 16 Jan. 1944.
71. History, 354th Ftr. Gp., Jan. 1944, p. 20.
72. T/M Rpt. 182.
73. CM-OUT-5052 (1-13-44), Arnold to Spaatz, A5425, 13 Jan. 1944.
74. USSTAF T/M Rpt. 182.
75. See T/M Rpts. for period in question.
76. CM-OUT-12222 (1-31-44), Arnold to Spaatz, F4, 31 Jan. 1944.
77. T/M Rpt. 220, 12 Feb. 1944; telephone conf., F. L. Anderson and O. Anderson, 10 Feb. 1944.
78. USSBS, Air Frames Plant Rpt. 9, Wiener Neustadter Flugzeugwerke, *passim*.
79. History, 15th AF, I, 255 ff. Cf. ltrs., Twining to Giles, 7 Feb. and 26 Mar. 1944;



CM-IN-12230 (4-17-44), Spaatz to Arnold V61033, 17 Apr. 1944.

80. Intops Summaries in History, 15th AF, Vol. II; 15th AF T/M Rpts.

81. File 706, 10 Apr. 1944; ltr., F. L. Anderson to Kuter, 3 Feb. 1944; ms. of H. C. Butcher Diary, 23 Nov. 1943.

82. For figures on strength, see 8th AF Stat. Sum.; Air Min. War Room Manual of Bomber Command Operations, 1939-45; 15th AF Stat. Sum., 1 Nov. 1943-1 Nov. 1944.

83. CCS 166/5, 8 Jan. 1944; CCS 166/7, 20 Jan. 1944; notes on CCS 166/7 by CCS and JCS Sec., AC/AS Plans, 21 Jan. 1944; msg., Air Min. to Britman Washington, 20 Jan. 1944.

84. CCS, 142d Mtg., 21 Jan. 1944. Cf. notes on CCS 166/7, as cited in n. 83.

85. CCS 166/11, 13 Feb. 1944.

86. Msg., Air Min. to Britman Washington, 20 Jan. 1944.

87. See T/M Rpts. for Jan. to Mar. 1944.

88. Memo, Spaatz to Eaker and others, 5 Jan. 1944, in History, MAAF, 10 Dec. 1943-1 Sept. 1944, Vol. II.

89. Interview with Eaker, 17 May 1947.

90. CM-IN-18714 (2-27-44), COS to AFHQ, COSMED 43. For the entire problem see History, MAAF, Vol. I, chaps. 3 and 8.

91. Notes on C's-in-C Conf. at AFHQ, 27 Feb. 1944, in File 706; ltr., Arnold to Eaker, n.d., in History, MAAF, Vol. II.

#### NOTES TO CHAPTER 2

1. COPC/S 2071, 29 Nov. 1943, and draft plan of 2 Nov., together with subsequent modifications.

2. Interview with Col. R. D. Hughes, Asst. Dir. Intel., USSTAF, 20 Mar. 1944.

3. Ltr., Anderson to Kuter, 11 Feb. 1944.

4. COPC Opnl. Plans file, *passim*; CM-IN-6221 (2-9-44), Spaatz to Arnold, K3578, 9 Feb. 1944; T/M Rpt. 223, 15 Feb. 1944.

5. Tel. conf., F. L. Anderson and O. A. Anderson, 8 Feb. 1944.

6. USSTAF Historical Sec., Meet the Weatherman; interview with Col. C. G. Williamson, Asst. DC/Opns., USSTAF, 14 June 1944; F. L. Anderson, Official Journal, 19 Feb. 1944.

7. Cable, Eaker to Spaatz, 19 Feb. 1944,

in USSTAF file, Directives; Williamson interview.

8. Memo for Record by Spaatz, 19 Feb. 1944, in USSTAF file, Directives. See also attached message, not sent.

9. F. L. Anderson, Official Journal, 19 Feb. 1944.

10. *Ibid.*

11. T/M Rpt. 226.

12. *Ibid.*

13. *Ibid.*; Monthly Sum. of Opns., Jan.-Mar. 1944.

14. USSBS, Air Frames Plant Rpt. 3, ATG Maschinenbau GmbH, Leipzig.

15. USSBS, Air Frames Plant Rpt. 2, Erla Maschinenwerke GmbH, Heiterblick.

16. T/M Rpt. 228.

17. 15th AF Intops Sum., 21 Feb. 1944; 9th AF Daily Sum. of Opns.

18. T/M Rpt. 228.

19. Tel. conf., F. L. Anderson and O. A. Anderson, 21 Feb. 1944; T/M Rpt. 230.

20. T/M Rpt. 230; 15th AF Intops Sum. 215; tel. conf., Anderson and Anderson, 22 Feb. 1944.

21. USSBS, Air Frames Plant Rpt. 1, Junkers Aircraft and Aero-Engine Works, Dessau; *ibid.*, 6, Messerschmitt A. G., Pt. B.

22. USSTAF T/M Rpt. 230.

23. 15th AF Intops Sum. 215.

24. Tel. conf., Anderson and Anderson, 22 Feb. 1944.

25. USSBS, The German Anti-Friction Bearings Industry, p. 35 and Fig. 5; 15th AF Intops Sum. 216.

26. USSTAF T/M Rpt. 233.

27. *Ibid.*; 15th AF Intops Sum. 217.

28. USSBS, Anti-Friction Bearings rpt., p. 30; USSTAF T/M Rpt. 233.

29. USSBS, Air Frames Plant Rpt. 4, Gothaer Waggonfabrik A. G., Gotha.

30. USSTAF T/M Rpt. 235; 15th AF monograph on Regensburg Mission of 25 Feb. 1944; MASAF Intops Sum. 218, 25 Feb. 1944.

31. MASAF Intops Sum. 218.

32. *Ibid.*

33. USSTAF T/M Rpt. 235.

34. USSBS, Air Frames Plant Rpt. 6, Messerschmitt A. G., Pt. A, p. 9; USSTAF T/M Rpt. 235.

35. USSBS, Messerschmitt A. G., Pt. A.

36. *Ibid.*, Pts. A and B; USSBS *Over-all Rpt.*

37. USSBS, *Over-all Rpt.*
38. Ltr., Spaatz to Arnold, n.d., in File 706; MAAF Air Intel. Weekly Sum. 68, 6 Mar. 1944; USSTAF Semimonthly Record of Results, 16-29 Feb. 1944; WD-TC-218 (2-27-44), conference, Vandenberg and Anderson, 26 Feb. 1944.
39. Ltr., Spaatz to Arnold, n.d., File 706.
40. Above information taken from USSBS Aircraft Div. Industry Rpt. and USSBS *Over-all Rpt.*, pp. 11-25. See also figures in USSAFE, *The Contribution of Air Power to the Defeat of Germany*, Vol. I and Apps. A and B.
41. *Ibid.*
42. USSBS, Aircraft Div. Industry Rpt., p. 74.
43. USSBS, Anti-Friction Bearings rpt., *passim*. Cf. AC/AS Intel., *Strategic Bombing of Axis Europe*, Jan. 1943 to Sept. 1944, dtd. 1 Dec. 1944, and *Contribution of Air Power to Defeat of Germany*, App. D.
44. USSBS, Aircraft Industry Rpt., pp. 7, 24 ff., 53.
45. See again sources cited in n. 38.
46. USSBS, *Defeat of the German Air Force*, p. 14; Eighth AF Tactical Development; History, 8th AF, April 1944.
47. See Plan for the Completion of the Combined Bomber Offensive, 5 Mar. 1944; F. L. Anderson, *Official Journal*, 7 Mar. 1944; ltr., Spaatz to Arnold, 6 Mar. 1944.
48. CM-IN-7876 (3-11-44), Spaatz to Arnold, K-4164, 11 Mar. 1944.
49. Eighth AF Tactical Development.
50. T/M Rpt. 247.
51. T/M Rpts., *passim*.
52. 8th AF Tac. Dev., p. 97.
53. T/M Rpt. 246.
54. *Ibid.*
55. Quoted in msg., Winant to Sec. of State, 6 Mar. 1944.
56. T/M Rpt. 250.
57. *Ibid.*
58. Information supplied by courtesy of RAF Hist. Sec.
59. USSBS, Anti-Friction Bearings rpt., p. 35 and Exh. B-1.
60. T/M Rpts. 250 and 252.
61. Quoted in USSTAF Semimonthly Record of Results, 16-31 Mar. 1944.
62. T/M Rpt. 278.
63. T/M Rpts., *passim*.
64. *Ibid.*
65. Ltr., Eaker to Arnold, 6 Mar. 1944, in History, MAAF, Vol. II; ltr., Twining to Giles, 26 Mar. 1944; msg., Eaker to Spaatz, 14 Mar. 1944, in History, MAAF, Vol. XXV. See also Intops Sums., *passim*; History, 15th AF, I, 30.
66. USSBS, *Defeat of GAF*, p. 8.
67. T/M Rpt. 264; 8th AF Operations Analysis Sec., *Air Evaluation of Defense Measures Taken to Protect Heavy Bombers from Loss and Damage*, Nov. 1944; History, 8th AF, Feb. 1944; interview with Maj. Gen. W. E. Kepner, 15 July 1944; USSBS, *Over-all Rpt.*, p. 17.
68. USSBS Interview 55, W. Keitel, 27 June 1945; History, USSTAF, Jan. 1944; History, 8th AF, Mar. 1944; MAAF Air Intel. Weekly Sum. 73, 10 Apr. 1944.
69. Air Eval. of Defense Measures, Table 15.
70. *Ibid.*, *passim*; ORS Rpt., 12 Feb. 1944; Eighth AF Tac. Dev., p. 25.
71. Portal to Spaatz, 13 Apr. 1944; CM-IN-8447, Eisenhower to Marshall, 12 Apr. 1944.
72. See USSBS, Area Studies Div. Rpt. For all over-all evaluations see conclusions in *Contribution of Air Power to the Defeat of Germany*.
73. USSBS, *Defeat of GAF*, p. 1.
74. USSBS, *Over-all Rpt.*, p. 22. Cf. USSBS Interview 56, Goering, 29 June 1945.
75. USSBS, *Defeat of GAF*, p. 1.
76. Air Min., Exercise THUNDERBOLT, Presentation and Report, Aug. 1947, Vol. II, p. 4.
77. USSBS, Aircraft Industry Rpt., pp. 73-74.
78. Some idea of Allied estimates of German fighter production and the effects of bombing attacks upon it may be gained from any of the contemporaneous intelligence reports, e.g., Air. Min., "Monthly German Aircraft Production," in Notes on MAAF Counter-Air Program, History, MAAF, Vol. V; Joint Intel. Com., Memos for Information 73 and 80, 18 May and 22 June 1944; USSAFE Dir. Intel., "Impact of American Air Power on German War Machine"; AC/AS Intel., *Strategic Bombing of Axis Europe*, Jan. 1943-Sept. 1944, dtd. 1 Dec. 1944, and Status of Air Prerequisites for Operation OVERLORD, 29 Mar. 1944.
79. For detailed discussion of the problem, together with a full statistical analysis

sis, see USSBS *Over-all Rpt.*, pp. 11-30; Contribution of Air Power to the Defeat of Germany, Vol. I and Apps. A and B.

80. USSBS, Aircraft Industry Rpt., chaps. 2 and 3.

81. *Ibid.*

82. USSBS, Defeat of GAF, p. 37, and *Over-all Rpt.*, p. 22.

83. USSBS, Defeat of GAF, pp. 3-6.

84. *Ibid.*

85. *Ibid.*, Fig. 16.

86. Cf. USSBS Inter., Goering.

87. USSBS interviews.

88. USSBS, Aircraft Industry Rpt., p. 71.

89. For the problem of coordination, see MAAF, Preliminary Study of Coordinated Attacks by U.S. Strategic Air Forces in Europe, Jan. 1944; ltr., Spaatz to Arnold, 1 Mar. 1944; ltr., Spaatz to Eaker, 3 Feb. 1944.

### NOTES TO CHAPTER 3

1. SCAEF conference, 21 Jan. 1944.

2. Despatch, Air Chief Marshal Sir Trafford Leigh-Mallory to SCAEF, Nov. 1944, p. 3.

3. Ninth Air Force Invasion Activities, pp. 2-23; 9th AF DC/S Plans, Notes on Planning Operation NEPTUNE.

4. Ltr., USSTAF to SCAEF (note states "Not sent but contents discussed").

5. Leigh-Mallory's despatch, p. 108.

6. Bernard Law Montgomery, *Normandy to the Baltic* (Boston, 1948), p. 49.

7. COSSAC Plan, OVERLORD, p. 4; Sir F.E. Morgan, *Overture to Overlord*, pp. 139-42.

8. COSSAC Plan, OVERLORD, p. 16 and App. K.

9. *Ibid.*, annex iv to App. K.

10. *Ibid.*, pp. vi and 25.

11. *Ibid.*, pp. 10, 21-22, and App. O.

12. *Ibid.*, p. 27.

13. *Ibid.*, p. 17.

14. *Ibid.*, p. 29.

15. *Ibid.*, pp. 20-21.

16. Dwight D. Eisenhower, *Crusade in Europe* (New York, 1948), p. 230.

17. Msg., Eisenhower to Marshall, W-10786, 8 Feb. 1944.

18. Montgomery, *Normandy to Baltic*, p. 5; SCAEF mtg., 21 Jan. 1944.

19. SCAEF mtg., 21 Jan. 1944.

20. Harry C. Butcher, *My Three Years with Eisenhower* (New York, 1946), p. 475; ltr., Leigh-Mallory to Eisenhower, 29 May 1944.

21. SCAEF mtg., 21 Jan. 1944.

22. Ltr., Marshall to Eisenhower, 10 Feb. 1944; H. H. Arnold, *Global Mission* (New York, 1949), p. 521.

23. Ltr., Eisenhower to Marshall, 19 Feb. 1944; SCAEF mtg., 18 Feb. 1944.

24. Report by the Supreme Commander to the Combined Chiefs of Staff on the Operations in Europe of the Allied Expeditionary Force, 6 June 1944 to 8 May 1945.

25. Msg., Eisenhower to Marshall, W-10786, 8 Feb. 1944; CCS 168th Mtg., 28 July 1944; Eisenhower, *Crusade in Europe*, p. 231.

26. Initial Joint Plan, NEPTUNE, 1 Feb. 1944, par. 41.

27. *Ibid.*, pars. 23 and 28.

28. *Ibid.*, par. 40.

29. *Ibid.*, par. 39.

30. COSSAC Plan, OVERLORD, p. 21; Leigh-Mallory's despatch, p. 13.

31. SCAEF mtg., 21 Jan. 1944.

32. Memo for B. C. Hopper from Col. A. R. Maxwell, 2 Nov. 1944.

33. Sir Arthur T. Harris, *Bomber Offensive* (London, 1947), p. 197.

34. Memo for DC/Opns. USSTAF from Col. R.D. Hughes, 25 Jan. 1944.

35. 6th Mtg. of the Bombing Com., 24 Jan. 1944.

36. *Ibid.*

37. AEAf, MS 22007/Air Opns., 12 Feb. 1944.

38. Mtg. of Leigh-Mallory, Spaatz, Harris, and Tedder, 15 Feb. 1944.

39. Interview, B. C. Hopper with Spaatz, 20 May 1945.

40. Harris to Portal, Montgomery, and Leigh-Mallory, 13 Jan. 1944; memo from Col. R. D. Hughes, 15 Feb. 1944, in File 706.

41. File 706, 3 Jan. 1944; Hughes memo, as cited in n. 40.

42. Ltr., Arnold to Spaatz, 20 Feb. 1944.

43. Memo by Spaatz, 19 Feb. 1944.

44. Translation of a French agent's report for E. D. Brant, Esq., 5 Mar. 1944.

45. Economic Warfare Div., American Embassy, 28 Feb. 1944.

NOTES TO PAGES 76-82

46. AAF Evaluation Board in ETO, Summary Report on the Effectiveness of Air Attack against Rail Transportation in the Battle of France, 1 June 1945, p. 35; USSAFE, The Contribution of Air Power to the Defeat of Germany, Vol. I, p. 48.
47. Unidentified paper of 4 Apr. 1944 in File 706.
48. Telecon, Spaatz and Arnold, 17 Mar. 1944.
49. Supplement No. 2.
50. Par. 4.
51. Supplement No. 10.
52. Par. 4.
53. Leigh-Mallory's despatch, Pt. III; AEF paper, Employment of Bomber Forces, 3 Mar. 1944.
54. Harris, *Bomber Offensive*, pp. 197-98.
55. *Ibid.*, p. 220.
56. Memo for Col. W.J. Paul from Brereton, 6 Aug. 1947.
57. A.W. Tedder, Employment of Allied Air Forces in Support of OVERLORD, 24 Mar. 1944.
58. Ltr., Spaatz to Arnold, 25 Mar. 1944.
59. Ltr., Eaker to Arnold, 8 Apr. 1944.
60. Ltr., Churchill to Roosevelt, 7 May 1944.
61. Ltr., Giles to Spaatz, 5 Mar. 1944.
62. Minutes of a meeting held on Saturday, 25 Mar. 1944, to discuss the bombing policy in the period before OVERLORD. Since the minutes omitted Spaatz's main points, he asked that they be included through a note to Portal dated 30 Mar. 1944.
63. Ltr., Eisenhower to Marshall, 29 Apr. 1944.
64. CM-IN-6585, Spaatz to Arnold, 26 Mar. 1944.
65. Ltr., Spaatz to Eisenhower, April 1944 (undated as to day).
66. Report by SAC to CCS on the Operations in Europe of the AEF, 6 June 1944 to 8 May 1945.
67. See source cited in n. 60.
68. Ltr., McNarney to Leahy, 10 May 1944.
69. AAF Eval. Board, Sum. Rpt. on Effectiveness of Air Attack against Rail Transportation in France, p. 35.
70. Ltr., Arnold to Eisenhower, Jan. 1944 (day not given).
71. Ltr., Eisenhower to Arnold, 23 Jan. 1944.
72. Butcher, *Three Years*, p. 455.
73. File 706, 24 Jan. 1944.
74. Harris, *Bomber Offensive*, pp. 214-15.
75. CM-IN-20222, Kuter to Arnold, 29 Feb. 1944; draft letter, Spaatz to Arnold, 1 Feb. 1944.
76. File 706, 15 Feb. 1944; Spaatz-Hopper interview, 20 May 1945. Spaatz told Eisenhower and Tedder that he had no confidence in Leigh-Mallory's ability to handle his job. Eisenhower was more tolerant of Leigh-Mallory and told Spaatz he thought proper credit had not been given the man's intelligence. (File 706, 17 Feb. 1944.) But Eisenhower soon realized that Leigh-Mallory's rating with the British, and especially with Churchill, by now was also low. (Eisenhower to Marshall, 3 Mar. 1944.)
77. Ltr., Eisenhower to Marshall, 3 Mar. 1944.
78. CM-IN-19221, Spaatz to Arnold, 26 Mar. 1944; ltr., Eaker to Arnold, 9 Apr. 1944.
79. Butcher, *Three Years*, p. 467.
80. *Ibid.*, pp. 498-99; memo by Brig. Gen. F.H. Smith on Eisenhower in the early days of OVERLORD.
81. Telecon, Lt. Gen. W.B. Smith and Maj. Gen. T.T. Handy, 17 Mar. 1944; CCS memo for RAF Chief of Air Staff and SCAEF, 27 Mar. 1944.
82. CCS memo for RAF Chief of Air Staff and SCAEF, 27 Mar. 1944, par. 4.
83. CM-IN-15312, Eisenhower to Marshall, 21 Mar. 1944.
84. CM-OUT-14952, Marshall to Eisenhower, 25 Mar. 1944.
85. CM-IN-8447, Eisenhower to Marshall, 12 Apr. 1944.
86. Ltr., Portal to Spaatz, 13 Apr. 1944.
87. Interview, B.C. Hopper with Spaatz, 27 June 1945.
88. Ltr., Spaatz to Tedder, 15 Apr. 1944; AEF file, Controversial Issues over Command, *passim*; AC/AS Plans folders: Air Situation in England and Items for Discussion in U.K., *passim*.
89. Interview, B.C. Hopper with Brig. Gen. E.P. Curtis, 19 May 1945.

90. Telecon, Spaatz and Arnold, 24 Mar. 1944; OPD Memo for Record, 25 Mar. 1944.
91. CCS Mtg., 19 Oct. 1943.
92. AC/AS Plans folders: Air Situation in England, Air Command in Europe, and Items for Discussion in U.K., *passim*.
93. As in undated letter, Arnold to Spaatz, in early 1944; Arnold, *Global Mission*, p. 511.
94. Memo by Spaatz, 20 Jan. 1944; ltr., Spaatz to Arnold, 1 Mar. 1944.
95. Ltr., Spaatz to Arnold, 22 Apr. 1944.
96. *Ibid*.
97. Notes on a conference of Spaatz and Vandenberg, 10 Apr. 1944, in File 706; Butcher, *Three Years*, p. 447.
98. Carl Spaatz, "If We Should Have to Fight Again," *Life*, 5 July 1948, p. 35; *Newsweek*, 11 Dec. 1950, p. 33.
99. Interview, Spaatz-Hopper, 20 May 1945.
100. Morgan, *Overture to Overlord*, p. 41.

NOTES TO CHAPTER 4

1. British Air Ministry (Air Hist. Br.) File 77 (Narratives); Hilary St. George Saunders, "The Flying Bomb," *Life*, XVII (20 Sept. 1944), p. 90.
2. SHAEF Air Defense Div., An Account of the Continental Crossbow Operations, 1944-45, p. 2.
3. USSBS (European War), V-Weapons [Crossbow] Campaign, p. 7.
4. *New York Times*, 6 Oct. 1945, p. 23; BAM (AHB) File 77 (Reports).
5. "German Robot Bomb," *Impact*, II (Aug. 1944), p. 43; BAM (AHB) File 77 (Investigations, Targets).
6. USSBS, V-Weapons Campaign, p. 1.
7. See, for example, "Retaliating Weapon-I," *The Aeroplane*, 6 Oct. 1944, p. 383; Lionel E. Charlton, *War from the Air: Past, Present, Future* (London, 1935), pp. 175-76; J.F.C. Fuller, *On Future Warfare* (London, 1928), *passim*; B.H. Liddell Hart, *Thoughts on War* (London, 1944), p. 173; and C.G. Philp, *Stratosphere and Rocket Flight (Astronautics)* (London, 1935), pp. 82-88.
8. Treaty of Peace with Germany, 28 June 1919, Chap. 4, Sec. 3, Arts. 198-202.
9. After the flying bomb attacks against England began OWI released a statement suggesting that Cooper Hewitt, C.F. Kettering, and L.A. Sperry had produced a pilotless aircraft for the U.S. Navy in 1917 ("OWI Refutes Claims That Robot Bombs Are New," *Product Engineering*, Aug. 1944, p. 521), but Air Corps Board Study No. 9, Radio Controlled Aircraft (25 Oct. 1935), and various letters of Arnold in Case History Controlled Missiles (AFSHO Archives) indicate that none of the trial flights of the naval torpedo were successful. The Signal Corps during World War I developed a small airplane carrying 187 pounds of explosives and capable of controlled flight up to 20 miles, but the war ended before a decision was reached on putting it into production. (See Item 2, Case History Guided Missiles, AFSHO Archives.)
10. For the U.S., see Case History Guided Missiles, AFSHO Archives; and for Britain, *Parliamentary Debates*, 5th Series, 402 (18 July to 3 Aug. 1944), Commons, pp. 496-97, and 5th Series, cxxxvi (19 Apr. to 15 June 1945), Lords, pp. 278-88.
11. Such is the evidence provided in interviews by the author with Prof. Werhner von Braun, former technical adviser to the Peenemünde experimental station, on 11 Feb. 1949, and on 12 July 1949 with Maj. Gen. Walter Dornberger, who as a member of the German Army Ordnance Division was responsible for the V-2 program. See also The German Long-Range Rocket Programme: 1930-45, 30 Oct. 1945, a detailed account, and The Story of Peenemünde, containing scores of reports and interviews on German rocket research.
12. Dornberger and von Braun interviews; BAM (AHB) File 77 (Interviews, Research); Hq. AAF Intelligence Summary, No. 45-13, 15 July 1946, p. 6.
13. Dornberger and von Braun interviews; BAM (AHB) File 77 (Research).
14. Interviews cited in n. 13; BAM (AHB) File 77 (Interviews, Research).
15. Interviews cited in n. 13; BAM (AHB) File 77 (Interviews).
16. Von Braun interview.
17. *Ibid.*; Dornberger interview.
18. Dornberger and von Braun interviews.
19. Combined Intelligence Objectives

Sub-Committee, Items Nos. 2, 4, 6, 25, 27, File No. XXX-71, Special Mission on Captured German Scientific Establishments, Braunschweig, 1 June 1945, p. 80; Dornberger interview.

20. Combined Intelligence Objectives Sub-Committee, Items Nos. 4, 6, File XXXII-71; BAM (AHB) File 77 (Research).

21. Dornberger interview; BAM (AHB) File 77 (Research).

22. Combined Intelligence Committee, Evaluation Report 53a, Interrogation of Albert Speer, 28 May 1945, 18 June 1945, p. 14, and 21 May 1945, pp. 2-3.

23. Information on V-Weapons Obtained from a German Field Marshal Captured on 4 May 1945, KO-15392. Also Hugh L. Dryden, AAF Advisory Group, Historical Notes on German Guided Missiles Development, n.d., KO-31512; Dornberger and von Braun interviews.

24. Dornberger and von Braun interviews; Dornberger's unpublished and unpagéd ms. on the V-2, made available through the courtesy of its author; BAM (AHB) File 77 (Research). Hitler's dream is referred to in various Speer interviews.

25. Dornberger and von Braun interviews; Dornberger, "V-2"; BAM (AHB), File 77 (Research).

26. The German Long-Range Rocket Programme: 1930-45, p. 17. The Dornberger and von Braun interviews corroborate this, and Chapter 4 of Dornberger's "V-2" contains a detailed account of the conversation with Hitler.

27. The German Long-Range Rocket Programme, pp. 31-32.

28. USSAFE A-2, The Contribution of Air Power to the Defeat of Germany, App. J, p. 167.

29. *Ibid.*

30. Interview with William Messerschmitt, 29 May 1945; USSBS, V-Weapons Campaign, p. 14. The Dornberger and von Braun interviews verify Messerschmitt's estimate.

31. Dornberger interview and his "V-2."

32. Interrogation reports of Goering, Speer, von Braun, Milch, von Rundstedt, and others.

33. Dornberger and von Braun are chary, in the interviews, of making state-

ments on the possible course of the war if the V-weapons program had been carried on according to its original timetable. Both, however, clearly indicate their supposition that the course of the war might have been different had the V-weapons been used at a much earlier date.

34. In BAM (AHB) File 77 (Reports); AC/AS, Plans file 8090-71.

35. AC/AS, Plans file 8090-71; Sir Arthur Harris, *Bomber Offensive* (London, 1947), p. 181.

36. BAM (AHB) File 77 (Operations). The effect of the Peenemünde raid of August 1943 can, in the opinion of the writer, never be satisfactorily estimated. The *Lagerbericht* of OKW/WFSt contains this entry for 18 Aug. 1943: "The development and production work [at Peenemünde] has been destroyed in great measure." Yet on the following day the *Lagerbericht* contains this entry: "Supplementary report of . . . Air attack on Peenemünde on the 17/18 of August. . . Development and production can recommence in about four weeks." Dornberger and von Braun, present at Peenemünde during the raid, consistently maintained in numerous interviews with Allied interrogators that the RAF raid had little effect on the V-2 program, chiefly because no serious damage was done to key facilities and because the decision to disperse V-2 production had been taken *before* the raid and was already in effect. Their statements are verified in the highly regarded Speer interrogation reports and elsewhere. Dornberger consistently sets the number of dead at 728 to 732, but both he and von Braun declare repeatedly that only one major V-2 technician was killed. They report, as do other sources, that most of the dead in the raid were Russian and Polish POW's whose near-by work camp was heavily bombed. (See also BAM [AHB] File 77 [Interrogations]; USSBS, V-Weapons Campaign; Harris, *Bomber Offensive*, pp. 184-85.) In assessing the raid of August 1943 one further element is to be considered. Dornberger told this writer that on his orders the Germans "faked" damage at Peenemünde immediately following the RAF raid by blowing up partially damaged buildings, firing

mines in the streets, setting additional fires, and by extensive camouflage. Dornberger reported this to no other Allied interrogator and he gives a somewhat different picture of the impact of the raid in a chapter of his unpublished "V-2." The stenographic record of his interview with the writer and a map of Peenemünde with his penciled indications of damage done by British and Germans are in AFSHO files.

37. AC/AS, Plans file 8090-71; Dornberger and von Braun interviews.

38. Dornberger and von Braun interviews.

39. See again n. 36.

40. VIII BC and VIII FC, Narratives of Opns., Mission 87, 27 Aug. 1943.

41. Lewis H. Brereton, *The Brereton Diaries* (New York, 1946), p. 296.

42. BAM (AHB) File 77 (Reports).

43. Long-Range Rockets, in Plans file 8090-71; 9th AF Hist. Sec., CROSSBOW Operations Against Ski Sites, 5 Dec. 1943-18 Mar. 1944 (hereinafter cited as 9th AF CB Opns.); AAF Operations Against CROSSBOW and Ski Site Installations, in AC/AS, Plans file 8090-69.

44. SHAEF V-Sec., Report on Flying Bomb and Rocket Storage Sites, Aug. 1943-Dec. 1944.

45. *Ibid.*

46. Long-Range Rockets, as in n. 43.

47. Ltr., Spaatz to Arnold, 1 Feb. 1944.

48. Harris, *Bomber Offensive*, p. 181; MID Rpts. 7945 and 8683, 17 Sept. and 30 Dec. 1943; OSS Rpt. RB-6966, 13 Dec. 1943.

49. WD incoming msg. No. 75, Madrid to MILID, 22 Feb. 1944, and series of reports in DDB, Rockets File, 1943, 1944.

50. SHAEF V-Sec. rpt. as cited in n. 44; Long-Range Rockets file.

51. Long-Range Rockets file.

52. Ltrs., Leigh-Mallory to Eaker, 1 Dec.; Eaker to Bottomley, 2 Dec.; Brig. Gen. G.D. Chauncey to Brereton, 3 Dec. 1943.

53. SHAEF V-Sec. rpt. on sites.

54. 9th AF CB Opns.

55. *Ibid.*

56. This organization is described in COS (43) 760 (O) Final, 17 Dec. 1943.

57. *Ibid.*; extract Minutes COS (44) 8th Meeting (O) Item 7, 11 Jan. 1944;

Bombing of German Secret Weapons, AC/AS Plans file 2924-8; Weekly CROSSBOW Countermeasures Rpts.

58. Varying estimates of operations necessary to destroy ski sites are contained in 8th and 9th AF historical files.

59. COS (43) 760 (O) Final, 17 Dec. 1943.

60. VIII BC Narrative of Opns., Mission 164, 24 Dec. 1943.

61. *New York Times*, 24 Dec. 1943.

62. JCS 625.

63. Msgs., Marshall to Devers, 22 Dec. 1943; Devers to Marshall, 23 Dec. 1943.

64. Memo for DC/S WDGS from AC/S, Directive, Committee for Countermeasures against German Secret Weapons.

65. Memo for DC/S WDGS from AC/S, Secret Weapons Committee, 13 Jan. 1944.

66. Minutes, 1st Mtg. of Com. on Countermeasures against German Secret Weapons, 6 Jan. 1944.

67. Note for Record, 14 Jan. 1944, in OPD File 380, CROSSBOW.

68. Ltr., C.R. Price, Offices of the War Cabinet, to Lt. Gen. F.E. Morgan, 16 Dec. 1943. General Morgan in *Overture to Overlord*, pp. 244-47, indicates that the question had thrust its way into the deliberations of his staff as early as the preceding summer.

69. Interim Report by COSSAC on the Effect of CROSSBOW on OVERLORD, 20 Dec. 1943.

70. Secret Weapons Countermeasures Estimate as of 10 Jan. 1944, AC/AS Plans file 8090-70.

71. Memo for CG AAF from AC/AS Intel., CROSSBOW, 3 Jan. 1944.

72. JCS 625/4.

73. That this possibility had been considered is indicated by a letter of Col. Luther S. Sweetser to Maj. Gen. S.G. Henry, 22 Feb. 1944, in Long-Range Rockets.

74. Memo for C/S from General Henry, 1 Feb. 1944; Note for Record, CROSSBOW Reconnaissance in France, 2 Feb. 1944, in OPD File 380, CROSSBOW; memo for C/S from AC/S, 16 Feb. 1944.

75. The CROSSBOW Countermeasures Progress Rpts.

NOTES TO PAGES 97-106

76. Secret Weapons Countermeasures Estimate as of 10 Jan. 1944.
77. R&R, Acting C/AS to AC/AS OC&R, German Secret Weapons Installations, 18 Jan. 1944.
78. Report by Col. A.A. Fickel to Countermeasures Subcom., CROSSBOW Committee, 17 Jan. 1944.
79. Record of telephone conversation CG AAF to CG AAF Proving Ground Command, 25 Jan. 1944, in Air Proving Ground historical files.
80. AAF Proving Ground Comd., Final Report on CROSSBOW Project, 1 Mar. 1944.
81. Memo for CG AAF Proving Ground Comd. from Col. Jack W. Hickman, Interim Report on Construction of CROSSBOW Targets.
82. Final Report on CROSSBOW Project, 1 Mar. 1944.
83. CM-OUT-149, Arnold to Eisenhower for Spaatz, 20 Feb. 1943.
84. Ltr. of Approval, Brig. Gen. E.L. Fubank, President AAF Board, Eglin Field CROSSBOW Project, 1 Mar. 1944; and AC/AS Plans files 8090-69, 8090-70, 8090-71, 8090-72, *passim*.
85. Col. J.W. Hickman, Report on CROSSBOW Mission to United Kingdom, n.d.; memo for Col. J.W. Hickman from Lt. Col. D.G. Hawes, Visit to UK Relative to CROSSBOW Mission, 12 June 1944; various reports by Col. Luther Sweetser to Maj. Gen. S.G. Henry, in AAG Sweetser file; narrative by Brig. Gen. Grandison Gardner, in Personal Narratives 1941-46, Air Proving Ground Comd. files.
86. *Ibid.*
87. Col. Hickman, Report on CROSSBOW Mission; Brereton to Arnold, 15 Feb. 1944; several ltrs., Spaatz to Arnold between 1 Jan. and 1 June 1944.
88. Ltr., Leigh-Mallory to Spaatz, 4 Mar. 1944.
89. The CROSSBOW Countermeasures Progress Reports, and a wide variety of studies of CROSSBOW operations by operations analysis units in the several air forces.
90. Ltr., Air Cdre. P. Warburton to Arnold, 21 Mar. 1944.
91. Ltrs. to Arnold from the several air commanders.
92. Ltr., Leigh-Mallory to Arnold, 29 Mar. 1944.
93. Ltr., Arnold to Welsh, 30 Mar. 1944.
94. Ltr., Arnold to Leigh-Mallory, 13 Apr. 1944.
95. Ltr., Col. J.B. Gordon, Asst. AG, USSTAF to CG 8th AF, 4 Mar. 1944.
96. Ltr., Spaatz to Arnold, 22 Apr. 1944.
97. Incl. to ltr., Spaatz to Arnold, 22 Apr. 1944.
98. SHAEF V-Sec. rpt. on sites; CROSSBOW Countermeasures Progress Rpts.
99. SHAEF V-Sec. rpt. on sites.
100. *Ibid.*
101. Ltr., Ismay to Eisenhower, 18 Apr. 1944.
102. Ltr., Tedder to Spaatz, 18 Apr. 1944.
103. Memo for CG AAF from OPD, CROSSBOW, 3 May 1944.
104. *Ibid.*
105. *Ibid.*
106. Memo for AC/AS Plans from OPD, 9 May 1944.
107. *Ibid.*
108. Ltr., Spaatz to Arnold, 6 May 1944; Col. Lance Hall, Factual Analysis of Experimental Attack on NOBALL Targets by 365th Fighter Group on 3 May 1944.
109. AC/AS Plans file 8090-71.
110. Ltr., Doolittle to Arnold, 27 May 1944.
111. BAM (AHB) File 77 (Reports).
112. Eighth Air Force Target Summary, 17 Aug. 1942 thru 8 May 1945.
113. BAM (AHB) File 77 (Reports).
114. *Ibid.*, VIII BC T/M Rpts. 87, 183.
115. CROSSBOW Countermeasures Progress Rpt. 38, 30 April-13 May 1944.
116. USSBS, V-Weapons Campaign; USSAFE A-2, Contribution of Air Power to the Defeat of Germany, App. J; Plans file 8090-71.
117. CROSSBOW Countermeasures Progress Rpt., 10 June 1944.
118. Ltr., Lt. Col. D.G. Hawes, to Dir. Proof Div., AAF Proving Ground Comd., Visit to the United Kingdom Relative to CROSSBOW Mission, 24 July 1944.
119. BAM (AHB) File 77 (Narratives: Flying Bomb and Rocket Campaign).



## NOTES TO CHAPTER 5

1. Memo for Eaker from Brig. Gen. Robert C. Candee, 21 Apr. 1943; ltr., Eaker to Arnold, 5 June 1943; ltr. with incl., Brig. Gen. H.S. Hansell to CG 8th AF, 12 July 1943.
2. Hq. 9th AF GO's 73, 74, 87, 22 Aug., 23 Aug., 13 Sept. 1943.
3. Ltr., Lt. Gen. J.L. Devers, CG ETO to C/S U.S. Army, 11 Sept. 1943; Lewis H. Brereton, *The Brereton Diaries* (New York, 1946), pp. 213-17.
4. Hq. USAFIME Movement Order to CG 9th AF, 21 Sept. 1943; 9th AF Station List, 17 Nov. 1943; History, IX BC, Dec. 1943, p. 3; memo by Lt. Col. Robert H. George, Hist. Off. 9th AF, Movement of the Ninth Air Force from the Middle East to the European Theater of Operations (July-Oct. 1943), n.d. but early in 1944.
5. See 8th AF and USAAFUK ltr. orders for the period. Memo by Maj. Robert C. Angell, historical officer, concerning Sources of Units of the Ninth Air Force, 24 Dec. 1943.
6. Ltr., Hq. 9th AF to CG IX BC and CG IX FC, 15 Dec. 1943.
7. Hq. USSTAF GO 6, 20 Jan. 1944.
8. Ltr., Gen. Spaatz to CG 9th AF, 24 Feb. 1944; interview with Spaatz by B.C. Hopper, 20 May 1945, pp. 6-8.
9. IX AFSC Staff Meeting Minutes, 25 Oct. and 3 Nov. 1943; memo for CG 9th AF from Gen. Miller, CG IX AFSC, 30 Nov. 1943; memos for Lt. Col. Jerome Preston, Chief, Plans and Statistics Sec., Hq., VIII AFSC from Maj. A. Lepawsky, 8 and 17 Dec. 1943.
10. IX AFSC Staff Mtg. Min., 26 Nov. 1943; ASC, USSTAF Staff Mtg. 12, 18 Jan. 1944; R&R, C/AS, Hq. AAF to AC/AS, MM&D, 8 Feb. 1944; historical memo by Maj. Robert C. Angell, The First Six Months of the Ninth Air Force in Britain, 15 Apr. 1944, pp. 10-11 (hereinafter cited as First Six Months in Britain); The Planning and Preparation of the Allied Expeditionary Air Force for the Invasion of North West France, pp. 30-31.
11. Memo for C/AS Hq. AAF from Operational Plans, n.s., 19 May 1944; memo for Gen. Timberlake, DC/AS Hq. AAF from Gen. Kuter, AC/AS Plans, 15 June 1944; Daily Diary of Liaison Off. ASC, USSTAF, at Washington, D.C., 15 June 1944; memo to Dir. of Maintenance, Hq. ASC, USSTAF from Gen. Knerr, 6 July 1944.
12. 9th AF Planning Journal, 25 Apr. 1944; Directive to Comdr. Advanced AEAf, AEAf/TS 378/AIR, 1 May 1944; ltr., Hq. AEAf to CG 9th AF, AEAf/TS 378/AIR, 9 May 1944; *The Brereton Diaries*, pp. 264, 295.
13. Hq. 9th AF GO's 101, 106, 16 and 23 Oct. 1943.
14. Hq. 9th AF GO's 101, 102, 16 Oct. 1943; History, IX BC, Dec. 1943, pp. 3, 7.
15. Hq. IX BC GO 67, 5 Dec. 1943; 9th AF Organization Chart, 12 May 1944; 26th SCU, Stat. Sum., 9th AF Opns., 16 Oct. 1943-8 May 1945, pp. 5, 6.
16. Hq. IX FC GO 15, 18 Oct. 1943; History, IX FC, 18 Oct.-31 Dec. 1943, p. 1.
17. Hq. 9th AF GO's 138 (4 Dec. 1943), 2 (4 Jan. 1944); 9th AF Orgn. Chart, 12 May 1944; The Ninth Air Force and Its Principal Commands in the E.T.O., in *The Ninth Air Force*, Vol. I, Pt. 1, pp. 92-94.
18. 9th AF Planning Journal, 21 Feb. 1944; IX ASC Mtg., 27 Feb. 1944.
19. IX AFSC Staff Mtg. Min., 27 Jan. 1944; ltr., Gen. Anderson, D/CG Opns., USSTAF to CG's 8th AF and 9th AF, 30 Jan. 1944; File 706, 24 Jan. 1944.
20. Hq. 9th AF GO 103, 18 Apr. 1944; 9th AF Orgn. Chart, 12 May 1944; Stat. Sum., 9th AF Opns., pp. 3, 5-6.
21. Hq. IX TCC GO's 3 and 4, 16 Oct. 1943; Hq. IX TCC SO 3, 24 Oct. 1943.
22. Hq. 9th AF GO's 38, 40, 82, 22, 25, 29 Mar. 1944; 9th AF Orgn. Chart, 12 May 1944; Stat. Sum., 9th AF Opns., p. 4.
23. Ltr., Arnold to Brereton, 11 May 1944; History, IX ADC, pp. 16-17; Stat. Sum., 9th AF Opns., pp. 4, 6.
24. History, IX ADC, pp. 16-30.
25. *Ibid.*, p. 17; Hq. 9th AF GO's 127, 16 Nov. 1943, and 83 and 84, 30 Mar. 1944.
26. Hq. 9th AF GO 101, 16 Oct. 1943; Hq. IX AFSC GO's 2, 23, 24, 16 Oct., 6, 7 Nov. 1943.
27. Hq. IX AFSC Memo 160-1, 18 Oct. 1943; Hq. IX AFSC GO 40, 6 Dec. 1943; Hq. IX AFSC, IX AFSC in Operation

OVERLORD, D minus 15 to D plus 90, pp. 2-3; memo for IX AFSC hq. staff officers and comdrs. of areas from CG, IX AFSC, 16 Oct. 1943.

28. IX AFSC in Opn. OVERLORD, pp. 4-6; IX AFSC Staff Mtg. Min., 27 Oct. 1943; Hq. 9th AF GO 117, 4 Nov. 1943; Hq. IX AFSC GO 43, 14 Dec. 1943.

29. Hq. IX AFSC Memos 20-8 and 20-12, 16 Feb., 3 Mar. 1944; Hq. IX AFSC, The Tactical Air Depots, 20 Apr. 1944; IX AFSC in Opn. OVERLORD, pp. 4-5.

30. Hq. 9th AF Memo 20-8, 3 Dec. 1943; Hq. IX AFSC Memo 20-11, 7 Jan. 1944. See histories, 1st and 2d Adv. Air Depot Areas.

31. Hq. 9th AF GO's 109, 130, 146, 28, 104, 111, 28 Oct., 21 Nov., 16 Dec. 1943, 4 Feb., 13 Apr., 22 Apr. 1944; History, IX AFSC, 16 Oct. 1943-9 May 1945, pp. 41-44.

32. IX AFSC Weekly Activity Rpt., 25 Nov. 1943; IX AFSC Staff Mtg. Min., 6 Jan. 1944; Stat. Sum., 9th AF Opns., p. 6; History, IX AFSC, June 1944, pp. 21-23.

33. Ltr., Hq. 9th AF to all units 9th AF, 27 Nov. 1943; 9th AF Engr. Hq. GO 1, 25 Jan. 1944; msg. 2750, Brereton to Arnold, 24 Jan. 1944; Hq. 9th AF GO 83, 30 Mar. 1944.

34. IX EC Orgn. Chart, 6 June 1944; History, IX EC, pp. 33-34.

35. First Six Months in Britain, pp. 7-8.

36. *Ibid.* See also histories of commands and AADA's.

37. History, IX AFSC, June 1944, p. 23; First Six Months in Britain, p. 7.

38. 9th AF Commanders Mtgs., 28 Apr., 18 May 1944; ltr., Col. R.C. Sanders, C/S IX BC to CG 9th AF, 1 May 1944; XIX TAC General and Special Staff Mtg. 2, 2 May 1944; IX AFSC Periodic Staff Rpt., 3 May 1944. For a discussion of the advanced landing grounds see History, IX FC and IX ASC, Mar. 1944, pp. 16-19.

39. Hq. 9th AF, Memo on Tactical Disposition of 9th AF, 13 Mar. 1944; 9th AF Station List, 5 May 1944; map, 9th AF Tactical Installations in Britain, 1 June 1944.

40. Ltr., Leigh-Mallory to Brereton, 3

Mar. 1944; ltr., Col. P.D. Berrigan, Office of Chief Engr. ETOUSA to CG Southern Base Sec. SOS, 5 Apr. 1944; 9th AF Station List, 5 May 1944; map, 9th AF Tac. Instls. in Britain, 1 June 1944.

41. Memo on Tactical Disposition of 9th AF, 13 Mar. 1944; 9th AF Station List, 5 May 1944; map, 9th AF Tac. Instls. in Britain, 1 June 1944.

42. See sources cited in n. 41.

43. Ltr., Hq. 8th AF to CG VIII ASC, 7 June 1943; Memo for Record by Col. S.E. Anderson, 1 July 1943; ltr., Anderson to CG VIII ASC, 30 Sept. 1943; ltr., Hq. VIII ASC to CG 3d Bomb. Wing (M), 18 Aug. 1943.

44. 9th AF Tactical Mission Rpt., Sum. of Mission 81, 9 Oct. 1943.

45. 9th AF T/M Rpt. 85, 22 Oct. 1943.

46. Ltrs., Col. S.E. Anderson to CG 9th AF, 23 Oct.; Anderson to A-3 IX BC, 3 Nov.; CG 9th AF to CG's IX BC and IX FC, 15 Dec. 1943.

47. Ltr., Brereton to Eaker, 10 Nov. 1943.

48. Ltr., Leigh-Mallory to Brereton, 19 Nov. 1943.

49. Ltr., CG 9th AF to CG IX BC, 25 Dec. 1943; T/M Rpts. 91 and 103, 3 Nov. and 1 Dec. 1943; Mission Sums. 107 and 136A, 13 Dec. 1943 and 7 Jan. 1944; Sums. of Opns. in History, IX BC, Dec. 1943, pp. 28-29, Jan. 1944, pp. 15-16.

50. Ltrs., Brig. Gen. A.C. Strickland, D/SASO AEAFF to CG 9th AF, 21 Dec. 1943; Anderson, D/CG Opns., USSTAF to AM Sir Douglas Evill, VCAS, 29 Jan. 1944; Evill to Leigh-Mallory, 2 and 16 Feb. 1944; Spaatz to Arnold, 5 Feb. 1944.

51. Ltr., Spaatz to Arnold, 1 Feb. 1944; ltr., Portal to Spaatz, 15 Feb. 1944.

52. See sources in nn. 50 and 51; also ltr., Evill to Anderson, 2 Feb. 1944; ltr., CG 9th AF to CG IX BC, 25 Dec. 1944; Minutes of a Meeting held at Hq. AEAFF on Friday, 4 Feb. 1944; ltr., Spaatz to Portal, 18 Feb. 1944; USSTAF Air Intel. Sum. 20, 31 Mar. 1944, p. 6; The Planning and Preparation of the AEAFF for the Invasion of North West France, p. 427.

53. VIII FC Narrative of Opns., 13 Dec. 1943; History, 354th Ftr. Gp., Nov.-Dec. 1943, p. 1; Brief Chronological Record of VIII Fighter Command from June

1942 to 10 Oct. 1944, p. 5.

54. IX FC Weekly Activity Rpts., 21 Jan. and 4 Feb. 1944; Stat. Sum., 9th AF Opns., p. 14.

55. Stat. Sum., 9th AF Opns., p. 5; History, IX BC, Apr. 1944, p. 7.

56. Ltr., CG IX BC to CO's all combat bomb. wings, 18 Mar. 1944; History, IX BC, Feb. 1944, pp. 8, 44.

57. Stat. Sum., 9th AF Opns., p. 14; History, IX BC, Feb. 1944, pp. 21, 27-28.

58. Memo by Maj. Angell, 2 June 1944.

59. History, IX BC, Mar. 1944, p. 42; Stat. Sum., 9th AF Opns., p. 14; History, IX FC and IX TAC, May 1944, p. 5.

60. Stat. Sum., 9th AF Opns., p. 14; Opnl. Mission Sum., in History, IX FC and IX ASC, Mar. 1944, pp. 7-8.

61. History, 67th Tac. Recon. Gp., Mar. 1944, pp. 1-5.

62. See especially IX AFSC Staff Mtg. Min., 28 Mar. 1944; Hq. 9th AF Memo 20-1C, 19 May 1944.

63. ASC USSTAF Staff Mtgs. 147, 154, 157, 21 Feb., 1 Mar., 6 Mar. 1944; ltr., Knerr to CG 9th AF, 1 Mar. 1944; USSTAF Reg. 20-1, 7 Mar. 1944; ltr. order, Hq. USSTAF to 9th AF, 15 May 1944; ltr., Hq. 9th AF to CO's 1st AADA, 2d AADA, BADA IX AFSC, 16 May 1944.

64. Hq. USAAFUK Policy 65-1, 17 Dec. 1943; USSTAF Regs. 65-1 and 65-10, 1 Mar. and 17 Apr. 1944; ltr. with incls., Hq. ASC, USSTAF to CG 9th AF, 22 Mar. 1944; ltr., CG 9th AF to CG USSTAF, 3 Apr. 1944.

65. IX AFSC Memo 65-1, 17 Nov. 1943 and 8 Jan. 1944; VIII AFSC Daily Staff Mtg., 1 Feb. 1944; Hq. ASC, USSTAF, G-4 Periodic Report for the Quarter Ending 31 Mar. 1944, dtd. 31 Mar. 1944; 1st Ind. (ltr., Hq. USSTAF to CG 9th AF, 29 May 1944), Hq. 9th AF to CG USSTAF, 7 June 1944; Hq. IX AFSC Memo 140-4, 11 June 1944.

66. IX AFSC Weekly Activity Rpt., 10 Feb. 1944; ltr., Gen. Miller to CO 31st AT Gp., 5 Apr. 1944; memo for Stat. Control Office, Hq. ASC, USSTAF from Ord. Off., 7 Apr. 1944; 9th AF Commanders' Mtg., 18 May 1944; memo for Brig. Gen. C.P. Kane, Hq. ASC USSTAF from Gen. Miller, 29 May 1944.

67. ASC. USSTAF Staff Mtgs., 124

and 186, 18 Jan. and 14 Apr. 1944; IX AFSC Staff Mtg. Min., 9 Mar. 1944; ltr., Gen. Miller to CG USSTAF, n.d. but April. Three depot repair squadrons had only 70 per cent of their equipment. See IX AFSC Per. Staff Rpt., 13 June 1944, p. 6.

68. IX AFSC Per. Staff Rpts., 5 Apr., 13 May, 23 May 1944; Stat. Sum., 9th AF Opns., p. 7; First Six Months in Britain, p. 12.

69. IX AFSC Per. Staff Rpts., 11 Nov., 9 Dec. 1943, 17 Feb., 28 Mar., 5 Apr., 13 Apr., 23 Apr., 23 May 1944; msg. U61850, Spaatz to Arnold, 8 May 1944; History, IX AFSC, p. 90.

70. IX AFSC Per. Staff Rpts., 16 Dec. 1943, 24 Jan., 3 Feb. 1944; IX AFSC Monthly Progress Rpts., Apr. 1944, p. 4, May 1944, p. 3; Hq. IX AFSC, Glider Assembly CG-4A, 1943-44 ETO, 16 Oct. 1944, p. 14.

71. IX AFSC Periodic Staff Rpts., 11 Nov. 1943, 24 Jan. 1944; IX AFSC Monthly Progress Rpts., Feb. 1944, pp. 22-26, Mar., pp. 22-26, Apr., May 1944; memo for CG BADA ASC, USSTAF from Dir. of Maintenance, Hq. ASC, USSTAF, 11 May 1944; History, IX FC and IX ASC, Feb. 1944, p. 9.

72. IX AFSC Memos 70-8 and 20-8, 11 and 16 Feb. 1944; Hq. IX AFSC, The Combat Group—The Service Team, 21 Feb. 1944; 9th AF Station List, 5 May 1944; History, 1st AADA, Initial Installation thru May 1944, Personnel Sec., p. 11.

73. IX AFSC Memos 20-11 and 70-10, 7 Jan. and 2 Mar. 1944; IX AFSC Monthly Progress Rpts., Feb.-May 1944; IX AFSC in Opn. OVERLORD, p. 6.

74. Hq. IX AFSC, Administrative Plan, OVERLORD, 8 May 1944; P&O Sec., Hq. IX AFSC, Notes on Planning Operation NEPTUNE, 9 Dec. 1944; Hq. IX AFSC, Support of Operation OVERLORD, Pt. 1, D minus 15 to D plus 24, p. 3; IX AFSC in Operation OVERLORD, pp. 11-12, 33; Hq. IX AFSC, Notes on Interview with Col. Vernon M. Babcock and Col. J.J. O'Hara, Apr. 1945.

75. Adm. Plan, OVERLORD, p. 2 and Annex 4, p. 1; Hist. Sec., 9th AF, Ninth Air Force Invasion Activities, April thru June 1944, pp. 35-36.

76. Adm. Plan, OVERLORD, p. 1; History, IX EC, pp. 53-54.
77. Adm. Plan, OVERLORD, p. 9; IX AFSC in Opn. OVERLORD, pp. 6-7.
78. Adm. Plan, OVERLORD, p. 3.
79. Adm. Plan, OVERLORD, pp. 2, 9, and Annex 1, pp. 1-3; IX AFSC in Opn. OVERLORD, p. 4.
80. Adm. Plan, OVERLORD, Annex 4, p. 2; IX AFSC in Opn. OVERLORD, pp. 16-17.
81. Adm. Plan, OVERLORD, Annex 4, pp. 1-2.
82. *Ibid.*, Annex 2, pp. 1-2.
83. Memo by Maj. R.C. Angell on Air Support Indoctrination Courses, 25 Feb. 1944; memo for CG 9th AF, n.s., 19 Apr. 1944.
84. IX FC Daily Staff Mtg., 4 Nov. 1943; memos by Maj. Angell on Training Schools and Fighter Leaders' School, 10 Jan. 1944 and 1 May 1944; IX ASC Daily Staff Mtgs., 2, 12, 19, 20, 25 Feb. 1944.
85. Hq. 9th AF Memos 50-2 and 50-6, 8 and 29 Nov. 1943; IX AFSC Per. Staff Rpt., 28 Mar. 1944; ltr., Hq. 9th AF to CG IX TAC, 28 Apr. 1944; IX TAC Daily Staff Mtg., 4 May 1944; ltr., Brig. Gen. D. M. Schlater, A-3 9th AF to CG 9th AF, n.d. but late May 1944.
86. Ltr., Brig. Gen. S. E. Anderson to CG 9th AF, 18 Apr. 1944.
87. IX BC Memo 50-12, 31 Dec. 1943; Hq. IX BC GO 28, 13 Feb. 1944; History, IX BC, Feb., p. 8, Apr. 1944, p. 39; memo by Maj. Angell on Pathfinder Schools, 13 Mar. 1944; ltr., Col. J. C. Kilborn, Opns. Off., IX BC to CG IX BC, 5 May 1944; ltr., Spaatz to Arnold, 10 May 1944.
88. Memo for CG IX BC from Brig. Gen. R. E. Nugent, DC/S Opns. 9th AF, 29 Mar. 1944; ltr., Hq. IX BC to CO's 98th and 99th Combat Wings (M), 23 Apr. 1944; ltr., Hq. IX BC to CG Adv. Hq. 9th AF, 29 May 1944; ltr., Spaatz to Arnold, 10 May; ORS Hq. IX BC Memo 18, Rpt. on Bombing in May 1944, 14 June 1944, pp. 1-2.
89. IX FC Memo 50-2, 29 Dec. 1943; IX ASC Daily Staff Mtg., 29 Feb. 1944; History, IX FC and IX ASC, Feb. 1944, p. 9; First Six Months in Britain, p. 12.
90. History, IX FC and IX ASC, Mar. 1944, pp. 11-12; IX ASC Daily Staff Mtg., 1 Apr. 1944; RAF Rpt. 4, Fighter

- Leaders' Course, Milfield, from Apr. 6th 1944 to Apr. 21st 1944; ltr., Gen. Schramm to CG IX ASC, 12 Feb. 1944.
91. Ltr., Col. J. E. Mallory, Air Insp. IX TAC to CG IX TAC, 25 Apr. 1944; History, IX FC and IX ASC, Mar., pp. 9, 13, Apr., p. 6, May 1944, p. 8.
92. Ltr., Brig. Gen. B. F. Giles to CG 9th AF, 26 Nov. 1943; Hq. IX TCC A-3 Per. Staff Rpts., 26 Mar., 12, 22 Apr., 2, 12, 22 May 1944.
93. IX AFSC Weekly Activity Rpts., 11, 18, 25 Nov., 23 Dec. 1943, 5 Apr. 1944; IX AFSC Per. Staff Rpts., 21 Mar., 3 May, 13 June 1944; memo by Maj. Angell on Exercise BOOMERANG, 22 Apr. 1944.
94. History, IX EC, pp. 33-39.
95. Ltr., Col. J. F. Early to CG ASC, USSTAF, 21 May 1944.

#### NOTES TO CHAPTER 6

1. Overall Air Plan, p. 18.
2. *Ibid.*, pp. 20-22.
3. *Ibid.*, pp. 26-27.
4. *Ibid.*, p. 11.
5. Statistical Control Div., Hq. AAF, Allied vs. Axis air strength report, in Eisenhower, *Crusade in Europe*, p. 484.
6. *Gesamtübersicht über die durchschnittliche Einsatzbereitschaft der flieg. Verbände, Mai 1944*, in AHB6, Air Ministry, London.
7. Despatch, ACM Leigh-Mallory to SCAEF, Nov. 1944, p. 3; Overall Air Plan, App. C; Brereton, *Brereton Diaries*, p. 259; memo, Brereton to Col. W. J. Paul, 6 Aug. 1947.
8. Air Signals Report on Operation NEPTUNE, 20 July 1944, Sec. iv; 11 Gp. and IX FC Joint Air Plan and Executive Order NEPTUNE, App. C; AAF Historical Study 36, Ninth Air Force Operations, April-November 1944, pp. 8, 23-29.
9. Tactical Air Plan, par. 91 and Annex 11.
10. *Ibid.*, pars. 89-90 and Annexes 9-10.
11. Memo, Brereton to Paul, 6 Aug. 1947.
12. 9th AF DC/S Plans, Notes on Planning Operation NEPTUNE; AAF-HS-36, p. 9.
13. *Brereton Diaries*, p. 270.

14. Memo, Brereton to Paul, 6 Aug. 1947.
15. Ltr., D/SCAEF to USSTAF and Bomber Command, 17 Apr. 1944.
16. 28 Apr. 1944. History of the Fifteenth Air Force, I, 410-11.
17. Hist. Study, Air Support by the Eighth Air Force in the Land Invasion of Continental Europe, pp. 9-16.
18. *Ibid.*; AEF to USSTAF, 1 June 1944.
19. Air Support by the Eighth Air Force in the Land Invasion of Continental Europe, p. 24.
20. *Ibid.*, pp. 30 and 57-59.
21. Eighth Air Force Operations in Support of OVERLORD, 10 Dec. 1944; AAF Evaluation Board in ETO, The Effectiveness of Third Phase Tactical Operations in the European Theater, Aug. 1945, Fig. 14.
22. Leigh-Mallory's despatch, Pt. v.
23. Air Support by the Eighth Air Force in the Land Invasion of Continental Europe, p. 62.
24. USSTAF Memo for Record, 15 Apr. 1944.
25. Leigh-Mallory at 29th SCAEF Mtg., 29 May 1944; Butcher, *Three Years*, p. 530; Effectiveness of Third Phase Tactical Operations in the European Theater, p. 45.
26. AEF to USSTAF, 1 June 1944; Air Support by the Eighth Air Force in the Land Invasion of Continental Europe, pp. 59-60.
27. *Ibid.*, p. 20; History, Opus. Research Sec., 8th AF, Jan. 1944-June 1945.
28. Ltr., Anderson to Leigh-Mallory, 5 June 1944, adding points omitted from the 3 June 1944 meeting of air commanders.
29. Min. of Air Commanders' Conference, 3 June 1944. In *Brereton Diaries*, pp. 270-71, Leigh-Mallory is described as losing his temper and being silenced by Tedder.
30. Air Support by the Eighth Air Force in the Land Invasion of Continental Europe, p. 20.
31. *Ibid.*, pp. 51-54.
32. Leigh-Mallory to Spaatz, 4 June 1944; 11 Gp. and IX FC Joint Air Plan and Executive Order, 1 June 1944, par. 20.
33. Air Support by the Eighth Air Force in the Land Invasion of Continental Europe, pp. 73-77; Leigh-Mallory to Spaatz, 4 June 1944; 11 Gp. and IX FC Joint Air Plan and Executive Order, 1 June 1944, par. 26; Effectiveness of Third Phase Tactical Operations in the European Theater, pp. 47-48.
34. SHAEF G-3 Memo for Chief of Staff, 26 May 1944.
35. AEF paper, American Airborne Operation, 31 May 1944; 9th AF Tactical Air Plan, Annex 12, 5 May 1944.
36. AEF paper, Day and Night Fighter Support for Airborne Operations, 1 June 1944; AAFHS-36, p. 64.
37. Leigh-Mallory to Eisenhower, 29 May 1944.
38. Eisenhower, *Crusade in Europe*, p. 247.
39. American Airborne Operation, 31 May 1944.
40. Effectiveness of Third Phase Tactical Operations in the European Theater, p. 45.
41. Air Support by the Eighth Air Force in the Land Invasion of Continental Europe, p. 46.
42. *Ibid.*, p. 65; AEF paper, Bombing Operations in Support of Operation OVERLORD, 1 June 1944.
43. Interview with Maj. Gen. W. E. Kepner by B. C. Hopper, 15 July 1944.
44. Allied Air Comdrs.' Conf., 23 May 1944.
45. CM-IN-5768, Spaatz to Arnold, 8 May 1944; CM-IN-22200, Eisenhower to CCS, 29 May 1944; memo, Maj. Gen. H. A. Craig to C/AS, 30 May 1944.
46. Spaatz to Eisenhower, 20 May 1944.
47. Ltr., Lt. Gen. Barton K. Yount to Arnold, 28 May 1944.
48. Eisenhower, *Crusade in Europe*, p. 250; Air Support by the Eighth Air Force in the Land Invasion of Continental Europe, p. 65; Butcher, *Three Years*, p. 566; *Brereton Diaries*, pp. 276-77.
49. Allied Air Comdrs.' Conf., 31 May 1944.
50. 10th Allied Air Comdrs.' Conf., 8 Mar. 1944; *Brereton Diaries*, p. 238; Leigh-Mallory's despatch, p. 2.
51. 13th Allied Air Comdrs.' Conf., 29 Mar. 1944.

52. SHAEF to USSTAF and RAF BC, 17 Apr. 1944.
53. 8th AF Rpt. on Tactical Operations in Support of Allied Landings in Normandy, attached to ltr., Spaatz to Arnold, 10 Dec. 1944.
54. SHAEF mtg., 15 Apr. 1944.
55. AEF MS 22007/Air Opns., 12 Feb. 1944.
56. Min. of 5th Bombing Com. Mtg., 24 Jan. 1944; Harris, *Bomber Offensive*, p. 197.
57. Historical study, Ninth Air Force Invasion Activities, p. 7.
58. Harris, *Bomber Offensive*, pp. 202-3; Air Min. Weekly Intel. Sum. 239; Leigh-Mallory's despatch, p. 15.
59. AEF Intel. Sums. covering the days mentioned.
60. Ltr., Brereton to Arnold, 20 May 1944, quoted in *Brereton Diaries*, p. 266; 15th Allied Air Comdrs.' Conf., 13 Apr. 1944.
61. Harris, *Bomber Offensive*, p. 203, says his forces were "rather more accurate" than American daylight bombers.
62. Ltr., SHAEF to USSTAF and RAF BC, 17 Apr. 1944; Leigh-Mallory's despatch, p. 14.
63. Leigh-Mallory's despatch, p. 14; AEF paper, 15 Apr. 1944.
64. AEF Intel. Sums.; Hq. USSAFE, The Contribution of Air Power to the Defeat of Germany, App. G, Pt. 2.
65. 8th AF T/M Rpt., 27 Apr. 1944.
66. AAF Eval. Board in ETO, Summary Report on Effectiveness of Air Attack against Rail Transportation in the Battle of France, 1 June 1945, Table A, p. 5; AEF paper, Bomber Operations, 30 Apr. 1944.
67. AAFEB Sum. Rpt. on . . . Rail Transportation, p. 14; MEW Intel. Weekly, 116, p. 6.
68. AEF/TS/22014, Preparatory Air Operations.
69. AEF Intel. Sums.; 8th AF T/M Rpt., 11 May 1944.
70. AEF, Review of Air Operations Preparatory to Operation OVERLORD, p. 11.
71. History, 15th AF, Vol. II, App. I; Leigh-Mallory's despatch, p. 15.
72. Leigh-Mallory's despatch, p. 15; AEF Review of Air Opns. . . . OVERLORD, p. 11; RAF BC Weekly Digest 112, 4 June 1944; Harris, *Bomber Offensive*, pp. 203-4; AAFEB Sum. Rpt. on . . . Rail Transportation, Table A, p. 5; SHAEF study, 16 May 1944.
73. Contribution of Air Power to the Defeat of Germany, App. G, Pt. 2; AAFEB Sum. Rpt. on . . . Rail Transportation, p. 14; SHAEF G-2 Report, 20 May 1944.
74. Leigh-Mallory's despatch, p. 16.
75. USSTAF Carrier Sheet, Dir./Intel. to D/O, 15 May 1944.
76. Ninth Air Force Invasion Activities, pp. 10-11.
77. Eighth AF Tactical Development, pp. 10-11; Ninth Air Force Invasion Activities, p. 44.
78. Kepner interview, 15 July 1944; AAFEB, Effectiveness of Strafing Attacks on Locomotives in Northern France, p. 8; AAFEB Sum. Rpt. on . . . Rail Transportation, p. 8; Review of Air Opns. . . . OVERLORD, pp. 15-16.
79. Memo, Brereton to Paul, 6 Aug. 1947; AAFEB in MTO, Strategic Target Selection System, Vol. II; ltr., Eaker to Spaatz, 24 Apr. 1944; History, IX BC, May 1944, p. 21.
80. AAFEB in MTO, Target Team on Railway Bridges, Mirville.
81. SHAEF mtg., 3 May 1944; Air C-in-C's Weekly Conf., 6 May 1944.
82. *Ibid.*
83. Ltr., Spaatz to Arnold, 10 May 1944.
84. Ninth Air Force Invasion Activities, p. 8.
85. AAFHS-36, p. 40.
86. Leigh-Mallory's despatch, p. 18.
87. AAFEB Sum. Rpt. on . . . Rail Transportation, p. 2.
88. AAFHS-36, p. 41.
89. AEF Intel. Sums.
90. Memo, Brereton to Paul, 8 Aug. 1947.
91. MEW Weekly Intel. Sum. 130, p. 6.
92. USSBS, Military Analysis Div., The Impact of Allied Air Effort on German Logistics.
93. Leigh-Mallory's despatch; Contribution of Air Power to the Defeat of Germany, II, 11; AAFEB Sum. Rpt. on

- . . . Rail Transportation, pp. 2, 5; Montgomery, *Normandy to the Baltic*, p. 32.
94. CM-IN-11861, Spaatz to Arnold, 14 June 1944.
95. AAFEB Sum. Rpt. on . . . Rail Transportation, pp. 3, 5, 14.
96. Contribution of Air Power to the Defeat of Germany, I, 9, and II.
97. USSBS, Effect of Air Power on Military Operations in Western Europe, Gen. Omar N. Bradley (ed.), Pt. iii; USSTAF Air Intel. Sum. 79, pp. 7-8; ADI (K) Rpt. 301/1945.
98. Leigh-Mallory's despatch, p. 100.
99. SHAEF Bombing Analysis Unit, Reports on 11 Aug. and 4 Nov. 1944. Spaatz said Zuckerman's study was faulty (ltr., Spaatz to Kuter, 14 Jan. 1945).
100. Memo, Brereton to Paul, 6 Aug. 1947; Harris, *Bomber Offensive*, p. 204; ltr., Tedder to Spaatz, October 1944.
101. Preliminary Study of the Attack Made on French Railway Centers in the Pre-D-day Period, 12 Nov. 1944.
102. Reports of 20 May and 7 June 1944.
103. Dated 22 July, one prepared by Ninth Air Force A-3 and the other, somewhat different in approach, appearing under a Ninth Air Force headquarters title.
104. Arnold, *Global Mission*, p. 518.
105. U.S. Embassy (London), Economic Warfare Div., Movement of German Division into the Lodgement Area, OVERLORD, 3 Oct. 1944; USSBS, Effect of Air Power on Mil. Opns., p. 13.
106. USSTAF Semimonthly Record of Results, 16-30 Apr. 1944, Transportation Sec.
107. AAFEB, Summary Rpt. on . . . Rail Transportation, p. 36.
108. Allied Air Comdrs.' Conf., 31 May 1944; Leigh-Mallory's despatch, Pt. iii.
109. 9th AF Air P/W Interrogation, Hermann Goering, 1 June 1945.
110. USSBS, Effect of Air Power on Mil. Opns., p. 20; Leigh-Mallory's despatch, p. 31; Contribution of Air Power to the Defeat of Germany, I, 24.
111. Goering interrogation, 1 June 1945.
112. Interrogation in 8th AF Daily Intel. Sum., 10-12 May 1945.
113. Interview with Albert Speer, No. 11-A, 13 June 1945; Adolf Galland, Birth, Life, and Death of the German Day Fighter Arm, ADI(K) Rpt. 373/1945.
114. Ninth Air Force Invasion Activities, pp. 3-5; AAFHS-36, pp. 30-31.
115. Review of Air Opns. . . . OVERLORD.
116. Notes of Meeting in Air C-in-C's Off., 6 May 1944.
117. Ninth Air Force Invasion Activities, pp. 4-5.
118. 8th AF T/M Rpts., 23 and 24 May 1944; USSTAF Air Intel. Sum. 47, pp. 20-21.
119. Leigh-Mallory's despatch, p. 28; Review of Air Opns. . . . OVERLORD, p. 8; Contribution of Air Power to the Defeat of Germany, II, 15, and App. C, Sec. 2; CM-IN-11861, Spaatz to Arnold, 14 June 1944; USSBS, Intr., Field Marshal Hugo von Sperrle, 30 May 1944.
120. Galland, ADI(K) Report No. 373/1945.
121. Allied Air Comdrs.' Confs., 26, 31 May 1944.
122. Montgomery, *Normandy to the Baltic*, p. 32; memo, Brereton to Paul, 6 Aug. 1947; Leigh-Mallory's despatch, p. 10.
123. Interview of Oct. 1945, quoted in Milton Shulman, *Defeat in the West* (New York, 1948), p. 91.
124. Montgomery, *Normandy to the Baltic*, p. 26.
125. Harris, *Bomber Offensive*, p. 195.
126. Air Support by the Eighth Air Force in the Land Invasion of Continental Europe, p. 24; Air Requirements as Viewed by the Army, 20 March 1944.
127. Air Support by the Eighth Air Force in the Land Invasion of Continental Europe, p. 18; Leigh-Mallory's despatch, pp. 19, 101.
128. 15th Weekly Air Comdrs.' Conf., 13 Apr. 1944; SHAEF mtgs., 10, 15 Apr. 1944.
129. Harris, *Bomber Offensive*, p. 205.
130. SHAEF mtg., 24 Apr. 1944.
131. Ninth Air Force Invasion Activities, pp. 10-11.
132. SHAEF mtg., 8 May 1944; Butcher, *Three Years*, p. 530.

NOTES TO PAGES 169-81

133. 17th Weekly Air Comdrs.' Conf., 2 May 1944.
134. AEF AF Intel. Sums.
135. Air Min. Weekly Intel. Sum. 249.
136. Harris, *Bomber Offensive*, p. 205; Leigh-Mallory's despatch, p. 20.
137. Leigh-Mallory's despatch, pp. 20, 21; Allied Air Comdrs.' Conf., 26 May 1944.
138. Leigh-Mallory's despatch, p. 106; Report by the Supreme Commander to the CCS on the Operations in Europe of the AEF, 6 June 1944 to 8 May 1945.
139. Review of Air Opns. . . OVERLORD, pp. 20, 21; Leigh-Mallory's despatch, p. 22.
140. Leigh-Mallory's despatch, p. 22.
141. Leigh-Mallory at Air Comdrs.' Weekly Conf., 2 May 1944.
142. Leigh-Mallory's despatch, pp. 22-23.
143. *Ibid.*, p. 24; Review of Air Opns. . . OVERLORD, pp. 21-22.
144. Contribution of Air Power to the Defeat of Germany, Vol. II, Sec. 1.
145. Report by the Supreme Comdr. to the CCS. . . 6 June 1944 to 8 May 1945.
146. USSBS, *Over-all Report (European War)*, pp. 39-41; Contribution of Air Power to the Defeat of Germany, App. E, Sec. 2.
147. Combined Strategic Targets Committee, A Review of the Air Offensive against Axis Oil Supplies, 21 June 1945; USSBS, Oil Div., German Oil, Chemical, Rubber, Explosives, and Propellants Industries, General Sum.
148. MAAF Air Intel. Weekly Sum. 79, 22 May 1944.
149. File 706; AC/AS, Plans, European Theater folder.
150. Memo for C/S from Operations Div., 24 Feb. 1944.
151. The Use of Heavy Bombers from March 1, 1944, Onward, 28 Feb. 1944.
152. Pt. 10 and par. 4.
153. Harris, *Bomber Offensive*, p. 220.
154. Ltr., Giles to Spaatz, 16 Mar. 1944.
155. Ltr., Arnold to Spaatz.
156. History, 15th AF, 1 Mar.-31 May 1944.
157. *Ibid.*, Vol. II, App. F; MAAF Air Intel. Weekly Sum. 76, 1 May 1944.
158. Fuehrer Conf., 18 May 1944.
159. History, 15th AF, Vol. II, App. F.
160. Interview with Spaatz by Hopper, 20 May 1945.
161. Memo for Eisenhower and Portal from Spaatz, 31 Mar. 1944.
162. Ltr., Giles to Spaatz, 5 Mar. 1944.
163. Msg., Spaatz to Arnold, 8 May 1944, U61850.
164. File 706, 19 Apr. 1944.
165. *Ibid.*, 20 Apr. 1944.
166. Msg., Spaatz to Doolittle, 20 Apr. 1944, U61161.
167. CM-IN-15683, Spaatz to Arnold, 21 Apr. 1944.
168. Interview with Albert Speer by Mil. Intel. Div., 25 July 1945.
169. 8th AF T/M Rpt., 12 May 1944; USSTAF Semimonthly Record of Results, 1-15 June 1944, Oil Sec.; USSTAF Air Intel. Sum. 28, p. 20.
170. USSBS, The Integration of the German Oil, Chemical, Rubber, and Explosives Industries.
171. Intr. of Albert Speer, quoted in 8th AF Daily Intel. Sum. 47, 18 June 1945.
172. Ltrs., Eaker to Spaatz, 6, 19 May 1944; Contribution of Air Power to the Defeat of Germany, App. E.
173. 8th AF T/M Rpt., 28 May 1944.
174. USSTAF Air Intel. Sum. 70, p. 24.
175. 8th AF T/M Rpt., 29 May 1944.
176. *Ibid.*, 28 and 29 May 1944.
177. British Air Ministry Translation, VII, conference of 15-16 May 1944.
178. Air Staff Posthostilities Intelligence Requirements of the GAF, Sec. IV (1), GAF Activity, Vol. III.
179. USSBS Interview, 19 May 1945.
180. Contribution of Air Power to the Defeat of Germany, App. E, Sec. 2.
181. Memo, War Cabinet Joint Intel. Subcom. to the Rt. Hon. Clement R. Attlee.
182. *Brereton Diaries*, pp. 253-54, 274.
183. AC/AS, Plans, OVERLORD Air Plans, 27 May 1944.
184. AAFHS-36, p. 47.
185. *Ibid.*, pp. 48-49; Leigh-Mallory's despatch, pp. 28-29.
186. 9th AF Reconnaissance Report, 15 May-5 June 1944; *Impact*, II, No. 5, p. 6.
187. CM-IN-9544-22, Spaatz to Giles, 28 June 1944.



## NOTES TO CHAPTER 7

1. Eisenhower, *Crusade in Europe*, p. 249; Despatch, ACM Leigh-Mallory to SCAEF, Nov. 1944, par. 185 ff.; War Dept. Historical Div., *Omaha Beachhead* (Washington, 1945), p. 37.

2. 8th and 9th AF's, Average Daily Summary of Planes, June 1944.

3. AEAF Minutes, 31 May; Brereton, *The Brereton Diaries*, p. 276; Leigh-Mallory's Despatch, par. 203; Eisenhower, *Crusade in Europe*, p. 252. Maj. Gen. Paul L. Williams, Report of IX Troop Carrier Command Operations (13 June 1944), together with War Department Special Observers Report (1 July 1944) and Dept. of the Army, Historical Div., *Utah Beach to Cherbourg* (Washington, 1947), constitute the basic sources for the account of airborne operations.

4. Extracts from RAF Wireless Intelligence Reports, 6 June, in 8th AF, Tactical Air Operations in Support of Allied Landings in Normandy.

5. Leigh-Mallory to Eisenhower, 7 June 1944.

6. Eisenhower, Report by the Supreme Commander to the CCS on the Operations in Europe of the AEF, p. 22; First U.S. Army, Report of Operations 20 Oct. 1943-1 Aug. 1944 (hereinafter cited as FUSA Opns.), p. 44; Montgomery, *Normandy to the Baltic*, p. 43.

7. The Ninth Air Force was created to serve tactical purposes, and its actions must bulk large in these pages. Since ready reference to the basic materials here used may be made by date and/or by unit involved, individual footnote citations of them have been largely omitted. The chief materials found in Air University Historical Division Archives are: (1) Mission Folders comprising the operational and field orders issued by Headquarters Ninth Air Force and its tactical elements; (2) "Opreps"—detailed daily reports on individual missions submitted by the groups concerned, which constitute our best source of information on missions actually flown; and (3) the monthly installments of command histories.

8. For 8th AF operations on D-day see 8th AF, Tactical Operations in Support

of Allied Landings, Survey of Effectiveness of Bombing of Invasion Coast Activities, and Development of Safety Aids; AAF Evaluation Board, The Effectiveness of Third Phase Tactical Operations in the European Theater, Aug. 1945; and AAF Historical Study draft, Tactical Operations of the Eighth Air Force.

9. 9th AF, Tactical Research Sec. (TRS) Reports 8, 10.

10. 9th AF, Operational Research Sec. (ORS), Report on Utah bombing.

11. Gen. Maj. Triepel, Cotentin Artillery, in Dept. of Army Hist. Div. files.

12. Answers to Questionnaires submitted by Air Effects Committee, 12th Army Group (hereinafter cited as Questionnaire).

13. 8th AF, Survey of Effectiveness of Bombing. See also C. P. Stacey, *The Canadian Army* (Ottawa, 1948), p. 179; FUSA Opns., pp. 41, 43, 46; Eisenhower, Report by Supreme Comdr., p. 21.

14. G. A. Harrison, The Cross Channel Attack (mimeographed first draft), chap. viii, p. 74; 8th AF, Tactical Opns., pp. 49-54.

15. AAF Historical Study 36, Ninth Air Force Operations, Apr.-Nov. 1944, p. 78.

16. 8th AF, Tactical Opns., p. 61.

17. AAFHS-36, p. 79.

18. IX TAC Combat Opns., Journal, 6 June 1944; memo, Fighter Direction, D-day, 24 Nov. 1944.

19. 8th AF, Tactical Opns., Recapitulation, p. 1; AAFHS-36, p. 81.

20. B. H. Liddell Hart, *The German Generals Talk* (New York, 1948), p. 238; Harrison, Cross Channel Attack, chap. iv, p. 32; OBW I, 49, and II, 13, in Dept. of Army Hist. Div. files.

21. A. Buelowius, Gen. der Flieger, and OBW I, 74, in Dept. of Army Hist. Div. files; Oberst Meltig, C/S Jagdkorps II, Some Aspects of the German Fighters' Effort during the Early Stages of the Invasion; intr. of H. Goering, 1 June 1945; GAF Hist. Branch, Survey of Anglo-American Air Operations.

22. Arnold, *Global Mission*, pp. 485, 490.

23. *Omaha Beachhead*, pp. 107, 116; interview with Quesada by author, 7 Feb. 1949.

24. Message 44, Hq. 9th AF, 6 June 1944.
25. 9th AF Opns. Records; AEAFF Minutes, 7 June; Quesada interview.
26. FUSA Opns., p. 52.
27. IX TAC Combat Opns. Journal.
28. Air Ministry Intel. Sum., 2 Sept. 1944; intr. of Genlt. Fritz Bayerlein, 29 May 1945.
29. 9th AF ORS Rpt. 49; 9th AF TRS Rpt. 31; ltr., Brereton to CG USSTAF, 12 July 1944; AEAFF Minutes, 14 June; 8th AF, Bomb Damage Survey of Road Interdiction 16 Aug. 1944.
30. 9th AF TRS Rpt. 112.
31. *Utah Beach*, pp. 87 ff.
32. *Ibid.*, pp. 108-9.
33. Hq. 9th AF Adv., A-2 Ltr., 4 July 1944.
34. Harrison, Cross Channel Attack, chap. ix, p. 31.
35. *Ibid.*, p. 10; *Utah Beach*, pp. 101, 128.
36. Ltr., Brereton to Arnold, 20 July 1944; Hq. 9th AF Adv., A-2 Rpt., 23 June 1944.
37. 7th German Army Telephone Log; *Utah Beach*, p. 148.
38. Lt. Col. Hoffman, Report to 7th Army on K. G. von Schlieben, in Dept. of Army HD files; AAFHS-36, pp. 84, 86.
39. *Omaha Beachhead*, p. 163; *Utah Beach*, p. 101.
40. 9th AF Historian's memorandum, 19 June 1944, DC/S Journal, and Air Operations in Support of Attack on Cherbourg (hereinafter cited as 9th AF, Cherbourg); AEAFF Minutes, 20, 22 June; *Brereton Diaries*, p. 289; Quesada interview, 7 Feb. 1949.
41. Hq. IX TAC to Hq. 9th AF, 20 June 1944; interview with Schlatter by author, 8 Apr. 1949; 9th AF, Cherbourg.
42. 9th AF Opns. Records; 9th AF, Cherbourg; 2d TAF Daily Log, 22 June 1944; AAFHS-36, p. 103.
43. *Utah Beach*, p. 172 ff.; Hq. 9th AF Adv. A-2 Rpt., 24 July; 9th AF TRS Rpt. 1, AEAFF Minutes, 23 June; Questionnaire (VII Corps); FUSA Opns., p. 63; *Brereton Diaries*, p. 290.
44. *Utah Beach*, pp. 179, 184-85; History, 368th F-B Gp., June 1944; 9th AF Adv. A-2 Rpt., 1 July 1944; Butcher, *My Three Years with Eisenhower*, p. 398.
45. *Utah Beach*, p. 203; FUSA Opns., p. 65; 9th AF Adv. A-2 Rpt., 3 July.
46. Questionnaire (9th Inf. Div.).
47. IX TAC Signal Sec. Journal; History, 70th F-B Wing, June 1944; 9th AF Historian's notes; 12th AG, Effects, p. 67; interview with Col. T. J. Cody by author, 6 Apr. 1949.
48. Eisenhower, *Crusade in Europe*, p. 262; AAFHS-36, p. 97.
49. Memo, Brereton to Col. W. J. Paul, 6 Aug. 1947; Quesada interview, 7 Feb. 1949; Leigh-Mallory's Despatch, par. 268; AEAFF Minutes, 29 June 1944; *Brereton Diaries*, pp. 152, 254, 265, 300.
50. FUSA Opns., p. 69; Eisenhower, *Crusade in Europe*, p. 164; B. L. Montgomery, Brief Notes for Senior Officers; Leigh-Mallory's Despatch, par. 329; Rommel to von Kluge, 15 July 1944; OBW I, p. 109.
51. History, IX EC, p. 70.
52. FUSA Opns., p. 56; History, IX EC, pp. 69-70, 73; interview with Col. H. W. Ehr Gott by author, 6 Apr. 1949.
53. Butcher, *Three Years*, p. 604; Quesada interview, 7 Feb. 1949.
54. 9th AF Adv., Sec. GS Journal, 6 July 1944.
55. War Dept. Hist. Div., *St.-Lô* (Washington, 1946), p. 8; ADI(K) 382/1944, 24 July.
56. *Brereton Diaries*, p. 305.
57. 7th German Army War Diary, 7 July 1944.
58. *St.-Lô*, p. 62.
59. 9th AF Weather Sec. Memo, n.d.
60. *St.-Lô*, pp. 33, 38; Bayerlein intr.; 9th AF TRS Rpts. Nos. 30, 56.
61. *St.-Lô*, p. 107; FUSA Opns., p. 90; CG XIX Corps to CG IX TAC, 20 July 1944, in History, 70th F-B Wing, July 1944.
62. 7th German Army War Diary, s.d. 17 July; Bayerlein intr.; 9th AF TRS Rpts. 82, 180.
63. Sir Arthur Tedder, *Air Power in War* (London, 1948), p. 89.
64. AEAFF Minutes, 14 June 1944.
65. Sir Arthur Harris, *Bomber Offensive*, p. 210. The attacks of IX BC were made on 5, 6, 7 July.
66. Montgomery, *Normandy to the*

*Baltic*, p. 73; Leigh-Mallory's Despatch, par. 273; Harris, *Bomber Offensive*, p. 211; 9th AF A-3 Memo, 10 July 1944.

67. AEAFF Minutes, 19 July 1944.

68. Butcher, *Three Years*, pp. 611, 613; Montgomery, *Normandy to the Baltic*, p. 81; Stacey, *The Canadian Army*, p. 188; Harris, *Bomber Offensive*, p. 212; Leigh-Mallory's Despatch, pars. 274 ff.; AEAFF Minutes, 16-18 July 1944; Air Staff Operational Sum., 19 July 1944; AAFHS draft, Tactical Opns. of Eighth Air Force, pp. 61 ff.; 8th AF, Development of Safety Aids.

69. Butcher, *Three Years*, p. 616; AEAFF Minutes, 21, 22 July 1944.

70. German Situation Rpts., von Kluge to Hitler, 21 July 1944; Liddell Hart, *The German Generals Talk*, p. 248.

71. The ramifications and resulting headaches of the interdiction program are clearly evident in SHAEF, Interdiction Handbook; AEAFF Orders, Cutting of Rail Lines, 9 June 1944; AEAFF Minutes, 12 June 1944; and AAFHS-36, pp. 87-89.

72. AAFEB, Effectiveness of Third Phase Tactical Air Operations, p. 339.

73. AEAFF Minutes, 19 June 1944.

74. AAFHS-36, pp. 87, 138.

75. AEAFF Minutes, 31 May, 3, 8-9, 11, 20-21 June, 11-12, 27 July, 10-11, 15 Aug. 1944; *Brereton Diaries*, p. 270.

76. AAFHS-36, pp. 78-79; 8th AF, Tactical Opns., p. 61; Leigh-Mallory's Despatch, par. 241.

77. 8th AF, Tactical Opns., p. 106; AEAFF Minutes, 31 June; AAFHS-36, p. 147.

78. 8th AF, Tactical Opns., p. 147; AEAFF Minutes, 17 June; 9th AF, Sec. GS Journal, 17 June.

79. Authorities for this and the following section are voluminous. Chief among them are AAF Evaluation Board, Effectiveness of Air Attack against Rail Transportation; 12th AG, Effects; Leigh-Mallory's Despatch, pars. 235 ff.; SHAEF Intelligence Notes, Evaluation of Rail Center Attacks, 6 July 1944; AEAFF, Target Status Rpts.; RAF Bombing Analysis Unit Rpt. 1, 4 Nov. 1944; intr. of Hans Hoeffner, Transport Commander in the West; AEAFF, Effects of Air Attacks against the French Railway Sys-

tem; General of (German) Railroad Troops Situation Rpts.; 8th AF, Tactical Opns.; 9th AF A-2 Bridge Target Photographs, TRS Rpts., and ORS Rpts.; AAFHS-36.

80. Harrison, Cross Channel Attack, chap. vi, p. 37.

81. Harris, *Bomber Offensive*, p. 114.

82. 9th AF TRS Rpt. 159. It is barely possible that two trains may have passed over the emergency structure.

83. General of German RR Troops Sit. Rpts., 8, 9, 30 June 1944; History, IX BC, June 1944; AAFEB, Effectiveness of Air Opns., p. 86.

84. AEAFF Minutes, 17 June 1944; AAFEB, Effectiveness of Air Opns., p. 86.

85. 9th AF TRS Rpt. 133; AEAFF Minutes, 21 July 1944; History, IX BC, July 1944; AEAFF, Target Status Rpt., 9 Aug. 1944.

86. AAFEB, Effectiveness of Air Opns., p. 86.

87. History, IX BC, July 1944; 9th AF, TRS Rpt. 127; General of German RR Troops, Sit. Rpt., 19 June 1944.

88. AAFEB, Effectiveness of Air Opns., p. 109.

89. Hoeffner, Effects of Air Attacks, 12, 18, 21 June 1944.

90. *Ibid.*, 18, 21, 29 June 1944.

91. 9th AF TRS Rpt. 174; 9th AF Invasion Activities, Annex VII; Hoeffner, Effects of Air Attacks, Annex 18.

92. Von Rundstedt, Effects of Air Operations.

93. 12th AG, Effects, p. 179.

94. Fuehrer Conference, 30 June 1944; Harrison, Cross Channel Attack, p. 24; Hoeffner, intr.; 12th AG, Effects, p. 165; Army Gp. B, Sit. Rpt., 7 July 1944.

95. General of RR Troops, Sit. Rpt., 6 June 1944; ADI (K) Rpt. 382/1944, 24 June; Shulman, *Defeat in the West*, p. 164.

96. AEAFF Minutes, 13 June 1944; AAFHS-36, p. 147.

97. Questionnaire (VII Corps); Quesada interview, 10 Feb. 1949.

98. Bayerlein intr.

99. OKW I, 89.

100. Interrogation of Genlt. Richard Schimpf, CG 3d Para. Div.; 7th Army, Phone Log, 15 June.

NOTES TO PAGES 220-34

101. General of RR Troops, Sit. Rpts., 9-16 June 1944.
102. AAFEB, Effectiveness of Air Opns., p. 122.
103. *Ibid.*, Annex 18; Shulman, *Defeat in the West*, p. 111.
104. General of RR Troops Sit. Rpts., 14-24 June 1944; Army Group B War Diary and situation maps.
105. AAF, Air Attack, p. 123; 12th AG, Effects, p. 59.
106. Von Rundstedt, Effects.
107. General of RR Troops, Sit. Rpt., 24 June 1944, and Recapitulation, June 1944; Army Group B, Sit. Rpt., 19 June 1944; 7th German Army Phone Log, 20, 21 June 1944, and Sit. Rpts., 19-26 June 1944.
108. General of RR Troops, Sit. Rpt., 24 June; AAFHS-36, pp. 111-12.
109. History, IX BC, June-July 1944; AAFHS-36, pp. 95, 114, 155; 9th AF TRS Rpts. 121, 138, 143-44, 146.
110. 7th Army Phone Log, 13, 29 June 1944.
111. OKW I, 32; ADI(K) Rpt. 333/1944, 6 July.
112. General of RR Troops, Sit. Rpt., 18 June 1944; 7th Army War Diary, 19 June 1944; Rommel, Analysis of Situation, 15 July 1944.
113. Hoeffner intr.
114. Hoeffner, Effects of Air Attacks, 14 June 1944.
115. 7th Army War Diary, 11 June 1944; OBW I, 89; General of RR Troops, Sit. Rpt., 14 June 1944; interrogation of von Rundstedt.
116. 7th Army Phone Log, 10, 15 June 1944, and War Diary, 6 July 1944; OBW I, 89; von Rundstedt intr.; *St.-Lô*, p. 102.
117. OBW I, 128.
118. General of RR Troops, Recapitulation, June 1944.
119. Eisenhower, *Crusade in Europe*, p. 257; cf. 7th Army Phone Log, 10 June 1944.
120. 7th Army, Sit. Rpts., 12-18 June through 24-30 July 1944; OBW II, 55; Fuehrer Conference, 12 June 1944.
121. Goering intr.
122. Liddell Hart, *The German Generals Talk*, p. 43; Shulman, *Defeat in the West*, p. 96.
123. OBW II, 37, 71; *ibid.*, I, 112, 115;

- Shulman, *Defeat in the West*, p. 114; Fuehrer Conference, 29 June 1944; 7th Army War Diary, 1, 18 July 1944.
124. Ltr., Morgan to Leigh-Mallory, 29 Nov. 1943.
125. AEAF Minutes, 10, 17 June.
126. Eisenhower, *Crusade in Europe*, p. 264 and his Report, p. 53. See also American Embassy (London), Economic Objectives Unit, Movement of German Divisions; FUSA Opns., p. 73.
127. Eisenhower, Report, p. 7; 12th AG, Effects, p. xii; Montgomery, *Normandy to the Baltic*, p. 112.
128. Some Aspects of Air Operations during the Initial Stages of Invasion, p. 1.
129. Von Rundstedt, Effects; interrogations by Weyland.
130. Shulman, *Defeat in the West*, p. 118, quoting a report by von Lüttwitz.

NOTES TO CHAPTER 8

1. Butcher, *My Three Years with Eisenhower*, p. 548; Brereton, *The Brereton Diaries*, p. 305; 8th AF, Special Report on Operations, 24 and 25 July 1944 (hereinafter cited as 8th AF, Spec. Rpt.).
2. AEAF Minutes, 19 July 1944; 9th AF, Sec. GS Journal, 21 July; *Brereton Diaries*, p. 313.
3. 8th AF, Spec. Rpt., which continues to be an authority for COBRA operations.
4. FUSA and IX TAC, Summary of Air Operations, 24 July 1944; msg., Quesada to 9th AF, 24 July 1944; 9th AF Opns. Journal; Quesada interview, 7 Feb. 1949.
5. 8th AF, 1st Air Div. Combat Wing Meeting, 24 July 1944; ltr., Lt. Col. Roseborough to 9th AF, 31 July 1944; 9th AF Historian's notes.
6. 9th AF Opns. Journal, 24 July 1944.
7. 8th AF, Development of Safety Aids; 8th AF, Spec. Rpt.; Orders for Operation COBRA.
8. 8th AF, Spec. Rpt.; 8th AF Tactical Opns.; AAFHS-36, pp. 122 ff.
9. 8th AF, Spec. Rpt. and appended docs.; History, IX BC, July 1944; ltr., Lt. Col. Roseborough to 9th AF, 31 July 1944; 9th AF Opns. Journal, 25 July 1944; interview with Dr. L. S. Taylor, chief, 9th AF ORS, by author, 5 Apr. 1949; in-

- interview with Dr. R. E. Gilman, 8th AF ORS, by author, June 1949.
10. 9th AF PW Intr. Unit Rpts., 26, 28 July 1944; 9th AF Adv. Rpt., 28 July 1944; 12th AG, Effects, p. 36; Eisenhower, Report of the Supreme Commander, p. 36; *Brereton Diaries*, p. 316; 9th AF Historian's notes; intr. of Genlt. Fritz Bayerlein, 29 May 1945; German Army Group B Sit. Rpts., 24-31 July 1944.
  11. Bayerlein interrogation.
  12. 12th AG, Effects, p. 27.
  13. See XIX Corps in Answers to Questionnaires submitted by Air Effects Com., 12th AG (hereinafter cited as Questionnaire with designation of unit concerned).
  14. Questionnaire (VII Corps, 2d Armd. Div.).
  15. Questionnaire (30th Inf. Div.); 12th AG Immediate Combat Rpt. 16; AAF Evaluation Board, The Effectiveness of Third Phase Tactical Operations . . . , Aug., 1945, p. 91; First U.S. Army, Report of Operations, 20 Oct. 1943-1 Aug. 1944, pp. 99, 120.
  16. Questionnaire (9th Inf. Div.).
  17. Questionnaire (VII Corps).
  18. Butcher, *Three Years*, p. 625.
  19. Von Rundstedt, Effects of Air Operations.
  20. FUSA Opns., pp. 99, 120.
  21. 9th AF ORS Rpt.; 8th AF, Development of Safety Aids.
  22. 2d TAF Daily Log, 25 July 1944.
  23. FUSA Opns., pp. 97, 121; Montgomery, *Normandy to the Baltic*, pp. 85 ff.; 12th AG, Report on Operations (hereafter cited as 12th AG Opns.), XI, 58; Questionnaire (2d Armd. Div.).
  24. Ltr., Brereton to Arnold, 20 July 1944; *Brereton Diaries*, p. 311; 12th AG, Effects, p. 41; Quesada interview, 7 Feb. 1949.
  25. IX TAC Opns. Order 90, 20 July 1944.
  26. Histories, IX TAC, IX FC, and 370th, 404th, and 406th F-B Gps.
  27. 12th AG Opns., III, 11; FUSA Opns., p. 106.
  28. History, 511th F-B Sq.; 9th AF Historian's Rpt., 29 July 1944; 9th AF Historian's notes; FUSA Opns., p. 106.
  29. IX TAC Sum. of Opns., July 1944.
  30. 7th German Army War Diary, 26 June 1944.
  31. 12th AG Opns., V, 64.
  32. History, IX TAC.
  33. XIX TAC, Report on Tactical Air Operations, p. 41; Maj. Gen. Otto P. Weyland, Diary, which was made available to the author through the courtesy of the general and is hereafter cited as Weyland Diary.
  34. Msgs., Smith to Arnold, 20 June; Eisenhower to Arnold, 13 July; Marshall to Eisenhower, 15 July; Eisenhower to Marshall, 17 July; and telecon, Giles and Spaatz, 24 June 1944.
  35. XIX TAC, Twelve Thousand Fighter-Bomber Sorties (hereinafter cited as XIX TAC, 12,000), p. 1; 9th AF Commanders' Meeting Minutes, 18 Aug. 1944; IX TAC Opns. Order 132, 9 Aug. 1944; Quesada interview, 29 Aug. 1944.
  36. 12th AG Opns., V, 35-36, 64-77.
  37. 7th German Army, Sit. Rpt., 7 Aug. 1944.
  38. XIX TAC, 12,000, pp. 2-4; Weyland Diary, 1-5 Aug. 1944.
  39. G. S. Patton, *War as I Knew It* (Boston, 1947), p. 101; 9th AF Air P/W Intr. Unit Rpt., 15 Aug. 1944; History, 25th Inf. Div.
  40. Luftwaffe Archives, Average of Flying Forces in State of Readiness for Action; Provision of Material; Daily Report of Damage by Enemy Action, July 1944, all from Luftwaffe files.
  41. Fuehrer Conference, 12 June 1944.
  42. Report of Luftflotte 3, 6-25 June 1944, circulated by the Military Governor of France, 1 July 1944; Rommel to C-in-C West, 1 July 1944; Weyland, von Rundstedt, and Leigh-Mallory (Despatch, par. 343) agree on the figure of 400 sorties.
  43. M. Shulman, *Defeat in the West*, pp. 145 ff.; OBW I, 132, and II, 55; Montgomery, *Normandy to the Baltic*, p. 96.
  44. FUSA, Report of Operations, 1 Aug. 1944-22 Feb. 1945 (hereinafter cited as FUSA, Aug.), I, 5; 12th AG Opns., V, 36; Leigh-Mallory, Despatch, par. 290; Weyland Diary, 6-7 Aug. 1944.
  45. Quoted in Shulman, *Defeat in the West*, p. 148.

NOTES TO PAGES 249-71

46. 7th German Army War Diary, 7 Aug. 1944.
47. Intr. of A. Hoeffner, in 12th AG, Effects, p. 175.
48. 7th German Army Phone Log, 7 Aug. 1944.
49. FUSA, Aug., Annex 4, p. 5; 2d TAF Intel. Digest, 17 Aug. 1944; 12th AG Opns., VI, 27-28; History, 35th Div.
50. 7th German Army Sit. Rpts., 10, 11, 13 Aug. 1944; von Kluge, Sit. Rpts., 10, 11, 13 Aug. 1944.
51. 8th AF, Special Report on Operation, 8 Aug. 1944; 8th AF, Development of Safety Aids; C. P. Stacey, *The Canadian Army*, pp. 197 ff.; Montgomery, *Normandy to the Baltic*, p. 97.
52. AEAFF Minutes, 9 Aug. 1944.
53. Leigh-Mallory, Despatch, par. 296; AEAFF Minutes, 17 Aug. 1944; 9th AF Historian's notes.
54. AEAFF Minutes, 11, 15 Aug. 1944; 9th AF Adv. Sec. GS Journal, 15 Aug. 1944; *Brereton Diaries*, p. 334.
55. IX TAC Combat Opns. Journal, 13 Aug. 1944; msg., Coningham to Vandenberg, 26 Aug. 1944.
56. XIX TAC, 12,000, p. 20; Patton, *War as I Knew It*, pp. 105, 108; msg., 9th AF Adv. to IX and XIX TAC's, 16 Aug. 1944.
57. AAFHS-36, pp. 186 ff., 194; TUSA Rpt., I, 29.
58. Von Kluge to OKW Opns. Staff, 13 June 1944.
59. 9th AF P/W Intr. Unit Rpts., 14, 18 Aug. 1944.
60. Bayerlein interrogation.
61. Shulman, *Defeat in the West*, pp. 158 ff.
62. Patton, *War as I Knew It*, p. 105; Stacey, *The Canadian Army*, p. 204, n. 9; IX BC Field Order 88, 13 Aug. 1944; Eisenhower, *Crusade in Europe*, p. 278; 12th AG Opns., V, 36.
63. Montgomery, *Normandy to the Baltic*, p. 85.
64. Leigh-Mallory, Despatch, par. 258b; 9th AF Historian's notes; Shulman, *Defeat in the West*, p. 164.
65. AAFHS-36, pp. 205, 207.
66. AAF, Air Effects, pp. 29-30; AAFHS draft, Tactical Opns. of 8th AF, pp. 106 ff.
67. History, IX BC.
68. Leigh-Mallory, Despatch, par. 253; AAF, Air Effects, p. 87.
69. History, IX BC; AAF, Air Effects, p. 29.
70. Msg., ANCXR to 9th AF, 20 Aug. 1944; AAFHS-36, pp. 174, 203, 220; 9th AF ORS Rpt., 26 Aug. 1944; 9th AF P/W Intr. Unit Rpt., 18 Aug. 1944; Questionnaire (83d Inf. Div.).
71. 12th AG Opns., V, p. 89; 12th AG, Effects, p. 128.
72. Questionnaire (VIII Corps); 9th AF ORS Rpt., p. 27; Weyland interview, 8 Feb. 1949; 12th AG, Effects, p. 129.
73. AAFEB, Third Phase Opns., pp. 113 ff.; 9th AF ORS Rpt., 28 Sept. 1944; 12th AG, Effects, pp. 129, 132; AAFHS draft, Tactical Opns. of 8th AF, pp. 70 ff.; 8th AF, Dev. of Safety Aids.
74. TUSA Rpt., I, Annex No. 3, p. xii; Weyland Diary, 2-3 Sept. 1944.
75. 12th AG, Effects, p. 131; AAFHS-36, pp. 222 ff.; 9th AF TRS Rpt. 147; Questionnaire (2d Inf. Div.).
76. 9th Army Rpt. II, Surrender of Foot March Group South; 7th Army G-2 History, Annex V; Weyland Diary, 20 Aug.-1 Oct. 1944; Weyland interview, 8 Feb. 1949; OBW I, pp. 156, 173, and II, p. 62; memo, A-2 to CG XIX TAC, 23 Aug. 1944; msg., Simpson to Weyland, 16 Sept. 1944; 9th AF Historian's notes; TUSA Rpt., I, pp. 64, 69.
77. 7th German Army Sit. Rpts., 15-21 Aug. 1944; TUSA Rpt., I, pp. 42-69; Montgomery, *Normandy to the Baltic*, p. 124.
78. FUSA Opns., Aug., p. 41; Patton, *War as I Knew It*, p. 124; Montgomery, *Normandy to the Baltic*, pp. 126 ff.; 12th AG Opns., V, 36-39.
79. TUSA Rpt., I, 35; 12th AG, Opns., XI, 136; 12th AG, Effects, p. 82; FUSA, Aug., I, 35; interview with Col. T. J. Cody by author, 6 Apr. 1949; XIX TAC, Tactical Air Opns., p. 17; 9th AF Commanders' Mtg. Minutes, 27 Aug. 1944.
80. History, IX EC, pp. 82-83, 87, 91, 96, 161; AAFHS-36, p. 234; XIX TAC, Report on Combat Opns., p. 27; Weyland interview, 8 Feb. 1949.
81. 9th AF, Director of Opns. Journal, 6 June 1944; Leigh-Mallory, Despatch, par. 209; FUSA Opns., pp. 19, 179; 12th

AG, Effects, pp. 47, 50; 9th AF Historian's notes; 12th AG, G-2 Air Rpt.; 7th German Army Sit. Rpt., 27 June-2 July 1944.

82. XIX TAC, Tactical Air Opns., p. 11; Bayerlein interrogation.

83. Questionnaire (VII Corps).

84. Msg., Patton to Weyland, 12 Aug. 1944; 9th AF incoming messages, 16 Aug. 1944; TUSA Rpt., I, p. 52; FUSA, Aug., Annex 5, p. 57.

85. Montgomery, *Normandy to the Baltic*, p. 110; AAFEB, *Crossing of the Seine*; Model to Hitler, 29 Aug. 1944.

86. 9th AF TRS Rpt. 155.

87. Model to Hitler, 29 Aug. 1944; 7th German Army Sit. Rpt., 7 Sept. 1944; AAFEB, *Third Phase Opns.*, p. 377.

88. 12th AG, Effects, pp. 113-14; msg., Patton to Weyland, 11 Sept. 1944; History, 373d F-B Gp.

89. 12th AG, Effects, pp. 138-40.

90. *General Marshall's Report, The Winning of the War in Europe and the Pacific* (New York, 1945), p. 38.

91. FUSA, Aug., I, 37; 12th AG Opns., XII, 193.

92. 12th AG Opns., XII, 193; FUSA, Aug., I, 28, 35, and Annex 2, p. 108; TUSA Rpt., I, 67; 12th AG, Effects, p. 96.

93. Questionnaire (VIII Corps, 10th Armd. Div.); FUSA, Aug., I, 46, Annex 10, and Annex 2, p. 108; TUSA Rpt., I, 40, 47, 64, 66, 69, and II, 13.

94. 12th AG Opns., VI, 13.

95. *Ibid.*; AEF Minutes, 26 June 1944; 12th AG, Effects, pp. 69-70.

96. 12th AG, Opns., VI, 27; TUSA, Aug., II, 23; msg., 9th AF to XIX TAC, 20 Aug. 1944.

97. AEF Minutes, 10 Aug. 1944; Report A/B Opns. in ETO, Tab. E; *Brereton Diaries*, pp. 324-40; 12th AG, Effects, p. 70.

98. 12th AG, Opns., XIII, 22; Leigh-Mallory, Despatch, par. 85.

99. 12th AG Opns., VI, 34.

100. TUSA Rpt., I, 62; FUSA, Aug., Annex 2, p. 108; 12th AG, Opns., V, 37, and VI, 34, 72.

101. FUSA, Aug., I, 36.

102. 12th AG, Opns., V, 38-39; FUSA, Aug., I, 31; TUSA Rpt., II, 3.

## NOTES TO CHAPTER 9

1. Memo by Spaatz on talk with Bradley, File 706, 20 July 1944.

2. File 706, 17 June 1944; Sir Francis de Guingand, *Operation Victory* (London, 1947), p. 401.

3. File 706, 15 and 23 June 1944; ltr., Lovett to Spaatz, 25 July 1944; Eisenhower, *Crusade in Europe*, p. 267.

4. File 706, 10 July and 25 June 1944.

5. Ltr., ACM Harris to Eisenhower, 18 July 1944.

6. File 706, 15 June 1944.

7. Ltr., Giles to Eaker, 13 June 1944; RAF BC Weekly Digest 120, 30 July 1944; memo, Brig. Gen. F. H. Smith to Vandenberg, 16 June 1944.

8. Plan for the Employment of the Strategic Air Forces.

9. USSBS, Aircraft Industry Div. Rpt., chap. 1.

10. *Ibid.*

11. Brig. Gen. T. D. White at Hq. AAF staff meeting, 17 July 1944.

12. USSBS, *The Effects of Strategic Bombing on the German War Economy*, p. 26.

13. See, for example, memo for Sec. of War from Franklin D'Olier, 11 June 1945.

14. Sir Arthur Harris, *Bomber Offensive*, pp. 224 and 229.

15. Msg., Spaatz to Doolittle and Twining, U-63552, 8 June 1944.

16. Combined Strategic Targets Com., Working Com. (Oil), *A Review of the Air Offensive against Axis Oil Supplies*, 21 June 1945.

17. MAAF Weekly Intelligence Summary (Isum), 83, p. 9.

18. USSTAF Air Isum 31, p. 21.

19. History, 15th AF, I, 383-84; MAAF Isum 83, p. 10; USSTAF Isum 31, p. 36.

20. MASAF folder, Ploesti Records Obtained in Rumania.

21. AAF Evaluation Board MTO Rpt., Ploesti, Vol. VI.

22. MAAF Isum 84, pp. 10-11; USSTAF Isum 32, p. 28. Throughout this chapter figures given for the number of German fighters shot down come from a study entitled "German Statistics on German Fighter Reaction to Anglo-American Bombing Attacks," which was

- prepared in 1947 by ADI(K)/USSAFE and was reissued as Science 2 Memo 151 by the Scientific Adviser to the Air Ministry, Mar. 1949.
23. OC&R Daily Activity Rpt., 1 Aug. 1944; CM-IN-26179, Spaatz to Arnold, 3 July 1944.
  24. MAAF Isum 85, pp. 8-9.
  25. MASAF folder, Ploesti Records Obtained in Rumania.
  26. MAAF Isum 85, pp. 10-11.
  27. USSTAF press release, 18 June 1944; 8th AF Tactical Mission Rpt., 18 June 1944; CM-IN-15952, Spaatz to Arnold, 19 June 1944.
  28. 8th AF T/M Rpt., 20 June 1944; USSTAF G-2, Contribution of Air Power to the Defeat of Germany, App. A, p. 26; USSTAF Semimonthly Record of Results, 16-30 June 1944, Oil Sec.; USSTAF Isum 37, p. 17.
  29. File 706, 17 June 1944.
  30. Bomber Command Operations Record Book, 21 June 1944; 20th meeting of Allied air commanders, 20 June 1944.
  31. 8th AF T/M Rpt., 21 June 1944; USSTAF Isum 33, p. 23; Doolittle at 21st mtg. of Allied air comdrs., 21 June 1944.
  32. 8th AF T/M Rpt., 24 June 1944.
  33. Doolittle at 30th mtg. of Allied air comdrs.; 8th AF T/M Rpt., 29 June 1944.
  34. Contribution of Air Power, App. E, pp. 12, 16; RAF BC Weekly Digests 114 and 115.
  35. CM-IN-18764, Portal to Arnold, 22 July 1944; AC/AS Intel. memo, 18 July 1944.
  36. CM-IN-18764, Portal to Arnold, 22 July 1944.
  37. A Review of the Air Offensive against Axis Oil Supplies.
  38. Harris, *Bomber Offensive*, pp. 225-30.
  39. History, 15th AF, I, 264-65, 394.
  40. A Review of the Air Offensive against Axis Oil Supplies; Joint Oil Targets Com. Weekly Bulletin 1, 5 July 1944.
  41. USSBS, interview with Albert Speer, 19 May 1945.
  42. USSBS, Underground and Dispersal Plants in Greater Germany; Harris, *Bomber Offensive*, p. 229.
  43. File 706, 10 July 1944; CM-IN-18613, Spaatz to Arnold, 21 July 1944.
  44. USSBS, Aircraft Industry Div. Rpt., chap. 1.
  45. Memos for Spaatz from Anderson, 13 and 17 July 1944; CM-IN-18613, Spaatz to Arnold, 21 July 1944.
  46. Ltrs., Arnold to Doolittle, 26 July, and Spaatz to Arnold, 22 July 1944.
  47. USSBS, Aircraft Industry Rpt., chap. 5.
  48. USSBS, Defeat of the German Air Force, p. 35.
  49. USSBS, interview with Hermann Goering, 29 June 1945; USSBS, Aircraft Industry Rpt., chap. 2; Dr. Rolf Wagenfuhr, Rise and Fall of the German War Economy, 1939-45.
  50. Harris, *Bomber Offensive*, pp. 217-18.
  51. File 706, 10 July 1944.
  52. USSBS, Statistical Appendix to *Over-all Report*, p. 28; RAF, The Battle of the Flying Bomb.
  53. USSBS, *Over-all Report*, pp. 88-89.
  54. 8th AF T/M Rpt., 7 July 1944; Brig. Gen. Sanford at 38th mtg. of Allied air comdrs., 8 July 1944.
  55. 8th AF T/M Rpts., 11, 12, 13 July 1944.
  56. USSTAF Isum 39, p. 11.
  57. OC&R Daily Activity Rpt., 1 Aug. 1944.
  58. MAAF Isums 86, pp. 8-12, and 87, p. 9; USSTAF Semimonthly Record of Results, 1-15 July 1944, Oil Sec.
  59. MAAF Isum 87, p. 9.
  60. History, 15th AF, I, chap. 7.
  61. *Ibid.*; USSTAF Semimonthly Record of Results, 1-15 July 1944, Oil Sec.; MASAF folder, Ploesti Records Obtained in Rumania.
  62. MAAF Isum 88, p. 9.
  63. *Ibid.*, p. 10.
  64. USSTAF Isum 39, pp. 11-12; USSBS Plant Rpt., Dornier Works.
  65. History, 15th AF, I, chap. 11.
  66. *Ibid.*; MAAF Isum 89, pp. 18-19; MASAF folder, Ploesti Records.
  67. USSTAF press release, 22 July 1944; RAF BC Weekly Digest 119, 23 July 1944.
  68. 8th AF T/M Rpt., 16 July 1944; ltr., Spaatz to Doolittle, 21 July 1944.
  69. 8th AF T/M Rpt., 18 July 1944; CM-IN-21216, Spaatz to Arnold, 25 July 1944; USSTAF Isum 39, p. 13; Spaatz to



- Doolittle, 20 July 1944; Arnold, *Global Mission*, p. 498.
70. Anderson at mtg. of Allied air comdrs., 20 July 1944; 8th AF T/M Rpt., 19 July 1944; USSTAF Isum 37, p. 22.
71. 8th AF T/M Rpt., 20 July 1944.
72. *Ibid.*, 21 July 1944; USSTAF press release, 22 July 1944; CM-IN-6695, Spaatz to Arnold, 7 Aug. 1944; USSBS, The German Anti-Friction Bearings Industry.
73. 8th AF T/M Rpt., 28 July 1944; USSTAF Isum 38, p. 9.
74. 8th AF T/M Rpt., 29 July 1944; USSTAF Isum 38, p. 10; CM-IN-24940, Spaatz to Arnold, 29 July 1944.
75. 8th AF T/M Rpt., 31 July 1944.
76. *Ibid.*, 4 and 5 Aug. 1944.
77. *Ibid.*, 6 Aug. 1944; Doolittle at mtg. of Allied air comdrs., 7 Aug. 1944; USSTAF press release, 7 Aug. 1944.
78. History, 15th AF, I, chap. 11, gives 1,100,000 tons, but a later British study raises the figure to 1,800,000 tons.
79. History, 15th AF, I, chap. 7; USSTAF Isum 41, p. 19; MAAF Isum 91, p. 7.
80. *Ibid.*; MASAF folder, Ploesti Records; USSTAF Isum 40, p. 28.
81. Ltrs., Eaker to Arnold, 31 Aug. and 17 Sept. 1944; Twining to Eaker, 25 Aug. 1944; Eaker to Giles, 17 Sept. 1944; AAFEB in MTO, Ploesti; OSS study, Bombardment of Ploesti Oil Refineries, 26 Sept. 1944; MASAF folder, Ploesti Records.
82. MAAF historical study, Operation REUNION; History, 15th AF, p. 480; History, MAAF, Sept. 1944-May 1945, IA; MAAF, Aircrew Recovery, 20 Oct. 1944.
83. 15th AF historical monograph, Operation FREEDOM; The Hall Mission to Bulgaria; MAAF, Aircrew Recovery, 20 Oct. 1944; History, MAAF, Sept. 1944-May 1945, IA.
84. MAAF Isum 93, p. 2; USSTAF Isum 41, p. 35.
85. USSTAF Isum 42, p. 31.
86. CM-IN-22496, Spaatz to Arnold, 24 Aug. 1944.
87. 8th AF INTOPS Sum., 9 Aug. 1944.
88. *Ibid.*, 14 Aug. 1944; History, 8th AF, Aug. 1944.
89. 8th AF INTOPS Sum., 16 Aug. 1944; USSTAF Isum 42, pp. 22-27.
90. 8th AF INTOPS Sum., 24 Aug. 1944; USSTAF Isum 42, pp. 22-27; USSTAF press release, 2 Sept. 1944; CM-IN-199, Spaatz to Arnold, 31 Aug. 1944.
91. 8th AF INTOPS Sums., 25, 26, 30 Aug. 1944; USSTAF Isums 43, pp. 17-22; 44, pp. 17-19; and 46, p. 11; CM-IN-25338, Spaatz to Arnold, 27 Aug. 1944.
92. 8th AF INTOPS Sums., 3, 5 Sept. 1944; History, 8th AF.
93. USSTAF press release, 15 Sept. 1944.
94. 8th AF INTOPS Sums., 8, 9 Sept. 1944; History, 8th AF; USSTAF Isum 45, p. 17.
95. 8th AF INTOPS Sum., 11 Sept. 1944; History, 8th AF; USSTAF Isums 45, pp. 22-23 and 46, p. 12.
96. 8th AF INTOPS Sum., 12 Sept. 1944; USSTAF Isums 45, p. 23 and 46, p. 12.
97. 8th AF INTOPS Sum., 13 Sept. 1944; USSTAF Isum 45, p. 24; USSTAF Semimonthly Record of Results, 1-15 Sept. 1944.
98. Contribution of Air Power to the Defeat of Germany, III, 96.
99. Statistical Summary of Eighth Air Force Operations, pp. 18-21, 29.
100. OC&R Daily Activity Rpt., 1 Aug. 1944; USSBS, Air Force Rate of Operation.
101. Round-up ltr., Eaker to Arnold, Aug. 1944; History, 15th AF, chap. 12, p. 12-b-15(41).
102. Harris at mtg. of Allied air comdrs., 30 June 1944; ltr., Winant to Hopkins, 1 Sept. 1944; in Robert E. Sherwood, *Roosevelt and Hopkins* (New York, 1948), p. 814.
103. USSTAF Semimonthly Record, 1-15 Sept. 1944.
104. A Review of the Air Offensive against Axis Oil Supplies.
105. Contribution of Air Power to the Defeat of Germany, App. E.
106. *Ibid.*
107. USSBS, Aircraft Industry Div. Rpt., chap. 5; AAFEB in MTO, The Strategic Target Selection System, Vol. II, Pt. 1.
108. German booklet of graphs and charts, 26FX-36a, Verluste der Fliegertruppe und Flugzeuge; British Air Ministry AHB 6 study 133.

109. From a large file named *Gesamtwverluste der fl. Verbände* which belonged to the Historical Section (6th Abteilung) of the German Air Force Quartermaster. Taken at Berchtesgaden by an Anglo-American team and now in AHB 6, British Air Ministry. The figures for killed and missing are accumulative from 6 June 1941 and do not include noncombat losses or wounded.
110. CM-IN-29130, Lt. Gen. W. Bedell Smith to Arnold, personal, 31 Aug. 1944; ltr., Spaatz to Arnold, 3 Sept. 1944.
111. USSTAF to 8th and 15th AF's, 1 Sept. 1944.
112. Tedder at mtgs. of Allied air comdrs., *passim*.
113. Ltr., Spaatz to Doolittle and Twining, 26 July 1944.
114. CM-IN-19443, Eisenhower to Marshall, personal, 23 July 1944; ltr., Eisenhower to Marshall, 29 July 1944.
115. CM-IN-18004, Spaatz to Arnold, 22 June 1944.
116. CM-IN-10287, Arnold to Spaatz, 11 Sept. 1944; ltr., Eisenhower to Marshall, 14 Aug. 1944; CM-IN-10912, Spaatz to Arnold, 12 Sept. 1944.
117. VIII FC rpt., Tactics and Technique of Long-Range Fighter Escort, 29 Aug. 1944.
118. History, 15th AF, I, chap. 7.
119. *Ibid.*, p. 257, graph 3; Stat. Sum. of 8th AF Opns., p. 31.
120. For appraisal of radar bombing, see sources cited in chap. 1, notes 35, 36.
121. AAF Redistribution Sta. 1 Air Intel. Contact Unit, Special Report on Morale of Outgoing Crews, 7 July 1944; ltr., Office of the Surgeon, USSTAF to Col. Harding, 22 Aug. 1944.
122. Ltrs., Arnold to Spaatz, personal, 14 Aug.; Col. B. K. Holloway to Arnold, 30 Aug.; Major J. C. A. Watson to Arnold, Aug. 1944.
123. Ltr., Giles to Spaatz, 22 June 1944.
124. CM-IN-26179, Spaatz to Arnold, 31 July 1944; OC&R Daily Activity Rpt., 5 Dec. 1944.
125. History, 8th AF, June and July 1944.
126. Ltr., Lt. Col. J. W. Wilson to Arnold, 15 Sept. 1944.
127. Msg., Spaatz to Arnold, U-65658, 30 July 1944.
128. *Ibid.*; CM-IN-10300, Spaatz to Arnold, 13 July 1944.
129. Ltr., Giles to Eaker, 16 Sept. 1944. General Eaker, who talked to many of the crews after their release, is convinced that there were no cases of unwarranted landing. (Interview with Gen. Eaker by Albert F. Simpson, 24-25 Jan. 1950.)
130. U.S. Military Attaché, Bern, to Arnold, 2 Aug. 1944.
131. Round-up ltr., Eaker to Arnold, Aug. 1944.
132. For a revealing and gripping account of a large American POW camp in Germany, see History of Center Compound, Stalag Inf. III, compiled by Robert R. Brum, Lyman B. Burbank, and Thomas E. Mulligan, 1 Oct. 1945.
133. AC/AS Plans, History of Negotiations and General Planning, FRANTIC.
134. John R. Deane, *The Strange Alliance* (New York, 1947), p. 20.
135. *Ibid.*, pp. 20-21; Deane to JCS, 22 Oct. 1944, in AC/AS, Plans folder, FRANTIC cables.
136. AC/AS, Plans, History of Negotiations and General Planning, FRANTIC.
137. *Ibid.*
138. CM-IN-16697, Spaatz to Arnold, 25 Jan. 1944.
139. Deane to Arnold, 2 Feb. 1944, in AC/AS, Plans folder, FRANTIC cables; CM-IN-1822, Deane to Marshall (eyes only), 2 May 1944.
140. AC/AS, Plans, History of Negotiations and General Planning, FRANTIC; History of Eastern Command, USSTAF, the AAF on the Russian Front, prepared by Lt. Col. Albert Lepawsky, Historian, Eastern Command.
141. History, Eastern Command; Deane to USSTAF, 16 Mar. 1944, in AC/AS Plans folder, FRANTIC cables.
142. History of Eastern Command.
143. Deane to Spaatz, 30 Apr. 1944, in AC/AS Plans folder, FRANTIC cables; ltrs., Anderson to Spaatz, 12 May and Spaatz to Arnold, 22 May 1944.
144. Deane, *Strange Alliance*, p. 112; History, Eastern Command.
145. Arnold to Deane, 30 May 1944, in AC/AS Plans folder, FRANTIC cables.
146. Deane, *Strange Alliance*, pp. 113-14.

NOTES TO PAGES 311-19

147. Ltr., Spaatz to Arnold, personal, 22 May 1944.
148. Ltr., Kuter to Deane, 10 May 1944; War Dept. radio orders, 16 May 1944.
149. Ltr., Spaatz to Arnold, personal, 22 May 1944; ltr., Eaker to Arnold, 22 May 1944; History, MAAF, 10 Dec. 1943-1 Sept. 1944, I.
150. CM-IN-19885, Spaatz to Arnold, 26 May 1944.
151. CM-IN-23961, Deane to Spaatz, 31 May 1944.
152. Deane, *Strange Alliance*, pp. 117-18.
153. Msg., Deane to Spaatz, Arnold, and Eaker, 31 May 1944, in AC/AS, Plans folder, FRANTIC.
154. Ltr., Eaker to Spaatz, 31 May 1944.
155. 15th AF plan for Operation FRANTIC JOE, 28 May 1944.
156. History, Eastern Command.
157. Deane, *Strange Alliance*, pp. 119-20.
158. Ltr., Eaker to Spaatz, 30 May 1944.
159. CM-IN-2359, Deane to Arnold, personal, 3 June 1944.
160. Ltr., Eaker to Arnold, 28 July 1944; Deane, *Strange Alliance*, p. 118; MAAF study, FRANTIC, p. 23.
161. USSTAF Isum 131, p. 5; History, 15th AF, p. 348.
162. Msg., Spaatz to Eaker, U-63203, 5 June 1944.
163. MAAF study, FRANTIC, p. 24.
164. *Ibid.*, pp. 25-26.
165. Ltr., Eaker to Lovett, 20 July 1944.
166. History, Eastern Command.
167. Interview with Hermann Goering by General Spaatz and others, 10 May 1945.
168. History, Eastern Command.
169. Deane, *Strange Alliance*, p. 122; Deane to Arnold, 24 June 1944 in FRANTIC cables.
170. History, Eastern Command.
171. Deane to Arnold, 28 June 1944, in FRANTIC cables.
172. General Walsh, quoted in History, Eastern Command.
173. Msg., Walsh to Spaatz, 2 Aug. 1944; memo, Kuter to Giles, n.d.;
- Spaatz to Deane and Walsh, 22 June 1944, in FRANTIC cables.
174. History, Eastern Command.
175. 15th AF study, FRANTIC JOE II.
176. 15th AF study, FRANTIC JOE III.
177. History, Eastern Command.
178. *Ibid.*
179. Arthur Bliss Lane (U.S. Ambassador to Poland, 1944-47), *I Saw Poland Betrayed* (New York, 1948), pp. 42-44.
180. Warsaw Dropping Operations, Tab A (folder of Maj. Gen. Fred L. Anderson).
181. Lane, *Poland Betrayed*, pp. 48-51, 53.
182. History, 15th AF, p. 479.
183. Warsaw Dropping Operations, Tab A.
184. *Ibid.*; Lane, *Poland Betrayed*, p. 49.
185. Deane to Marshall, 19 Sept. 1944, in FRANTIC cables; Warsaw Dropping Operations, Tab A; Extract from German doc. E-1715 in British Air Ministry (AHB6) study 261; ltr., Kuter to Anderson, 3 Oct. 1944.
186. Record of telephone conversation, Churchill and Anderson, in Warsaw Dropping Operations.
187. Kuter to Anderson, 3 Oct. 1944.
188. Msg., Deane and Walsh to Spaatz, U-68786, 2 Oct. 1944.
189. Deane to Arnold, 25 June 1944, in FRANTIC cables.
190. Ltr., Spaatz to Arnold, 27 Aug. 1944; Deane to Arnold, 25 Aug. 1944, in FRANTIC cables.
191. Arnold to Deane, 5 Sept. 1944, in FRANTIC cables; ltr., Spaatz to Arnold, 27 Aug. 1944.
192. Deane, *Strange Alliance*, pp. 123-24.
193. History, Eastern Command, conclusions; USSTAF memo, Brig. Gen. G. C. MacDonald to Maj. Gen. F. L. Anderson, 21 Aug. 1944. General Eaker in a postwar interview with Dr. Albert F. Simpson agreed that shuttle bombing had no material effect on the outcome of the war but he felt that it may have upset to some extent the enemy's logistics.
194. USSBS Interview 55, 27 June 1945; MID report, 15 June 1945.

NOTES TO PAGES 319-31

195. Ltr., Spaatz to Arnold, 27 Aug. 1944; ltr., Eaker to Arnold, eyes only, 26 Aug. 1944; Arnold to Deane and Harriman, 7 Sept. 1944, in FRANTIC cables.

196. Eisenhower, *Crusade in Europe*, p. 271; ltr., Eisenhower to Marshall, 25 Sept. 1944.

197. Memo, for Arnold from Brig. Gen. E. P. Curtis, 29 July 1944.

198. Ltr., Kuter to Anderson, 11 Aug. 1944.

199. CM-IN-20698, SCAEF to CCS, 22 Aug. 1944; ltr., Spaatz to Arnold, 27 Aug. 1944.

200. Ltr., Kuter to Anderson, 15 Aug. 1944.

201. Ltr., Spaatz to Arnold, 1 Sept. 1944.

202. CM-IN-1708, Eisenhower to Marshall, eyes only, 2 Sept. 1944; CM-IN-2717, Eisenhower to Arnold, personal, 3 Sept. 1944; ltr., Arnold to Eisenhower, 6 Sept. 1944; CCS 520/3, 12 Sept. 1944, memo by the British C/S; Minutes of CCS 172d Mtg., 12 Sept. 1944, OCTAGON.

203. Ltr., Arnold to Spaatz, 29 Sept. 1944.

204. Harris, *Bomber Offensive*, p. 214.

205. Ltr., Arnold to Spaatz, 29 Sept. 1944.

206. He renewed his proposal concerning this to Eisenhower in a letter of 18 Oct. 1944.

207. Eisenhower, *Crusade in Europe*, p. 307.

208. Ltr., Eisenhower to Marshall, 18 Sept. 1944.

209. Ltr., Eisenhower to Spaatz, 18 Sept. 1944.

210. Ltr., Spaatz to Eisenhower, 30 Sept. 1944; ltr., Harris to Eisenhower, quoted in Eisenhower, *Crusade in Europe*, p. 308.

211. Ltr., Eisenhower to Marshall, 25 Sept. 1944.

212. Harris, *Bomber Offensive*, p. 215.

NOTES TO CHAPTER 10

1. Ltr., Eaker to Brownell, 19 Feb. 1944; CM-IN-9073, Brit. C/S to AFHQ, 12 Jan. 1944; ltrs., Eaker to Arnold, 6, 21 Mar. 1944. Eaker assumed command

of MAAF on 15 January per Hq. MAAF GO 1, 15 Jan. 1944.

2. History, MAAF, I, 29; RAF Organization Memos 1-41, in History, MAAF, Vol. II.

3. CCS 387/3, 5 Dec. 1943; memo for Eaker *et al.* from Spaatz, 5 Jan. 1944; CCS 400/2, 4 Dec. 1943; JCS 602/3, 6 Dec. 1943.

4. CCS 400/2, 4 Dec. 1943; CCS 387/3, 5 Dec. 1943; AGWAR msg., AFHQ 9338, 9 Feb. 1944; ltr., Eaker to Giles, 23 Jan. 1944. See also Signal 02210, Air Min. to AFHQ *et al.*, 12 Jan. 1944, in History, MAAF, Vol. II.

5. USSAFE Directives of 11 Jan., 3, 22 Feb. 1944 (each in a ltr., Hq. USSAFE to CG 15th AF on above dates); conference between Spaatz and Eaker (London), Jan. 1944; History, MAAF, p. 22 and chap. vii; CM-IN-18067, MAAF to WAR, 25 Feb. 1944. See also ltr., Eaker to Giles, 6 Mar. 1944.

6. Msg., Eaker to Spaatz, 29, 19 Feb. 1944; msg., Spaatz to Eaker, IE 122CS, 19 Feb. 1944; File 706.

7. Ltr., Eaker to Giles, 23 Jan. 1944.

8. Ltr., A/M Slessor to Sir Charles Portal, C/AS, 20 Jan. 1944; History, MAAF, I, 7-8, II; Hq. MAAF, Minutes of Daily Staff Mtgs., 2 Feb. 1944; ltrs., Eaker to Timberlake, 8 Feb., and to Bissell, 23 Jan. 1944.

9. History, MAAF, I, 27-28; Hq. MAAF GO 14, 16 July 1944.

10. AG Ltr. 322, 10 Apr. 1944 (OB-I-AFRPG-M), authorized the allotment. See also ltrs., Eaker to Giles, 3 Feb., 6 Mar., and to Arnold, 21 Mar. 1944; History, MAAF, I, 30-32; telecon, Eaker and Giles, 6 May 1944.

11. History of the Original XII AFSC; History, AAFSC/MTO, 1 Jan.-30 June 1944, chaps. i-ii.

12. Ltr., Eaker to Giles, 23 Jan. 1944; History, AAFSC/MTO, 1 Jan.-30 June 1944, chaps. i-ii; Hq. AAF/MTO GO's 1, 6, 14-16 on 28 Jan., 21, 27 Mar., 5 Apr. 1944; ltr., Eaker to CG 12th AF *et al.*, 14 Mar. 1944.

13. History, AAFSC/MTO, 1 Jan.-30 June 1944, chap. i, pp. 65-67; ltr., Eaker to CG 12th AF *et al.*, 14 Mar. 1944; interview with Lt. Gen. I. C. Eaker by Albert F. Simpson, 24, 25 Jan. 1950.

14. Hq. AAF/MTO GO 8, 18 Feb. 1944; History, AAFSC/MTO, 1 Jan.-30 June 1944, chap. i, p. 65, chap. iii, pp. 327-36.

15. History, Original XII AFSC; History, AAFSC/MTO, 1 Jan.-30 June 1944, 1 July-31 Dec. 1944, 1 Jan. 1945-Inactivation; History, I ASAC; AAFSC/MTO, Aircraft and Glider Assembly in the MTO.

16. History, AAFSC/MTO, 1 Jan.-30 June 1944, chap. iii, pp. 364-73; History, Adriatic Depot Under AAF Control, 21 Dec. 1943-28 Feb. 1945, chap. i; History AAFSC/MTO, 1 July-31 Dec. 1944, chap. iii, pp. 436-52.

17. History, AAFSC/MTO, 1 Jan.-30 June 1944, chap. iii, pp. 337-51; 1 July-31 Dec. 1944, chap. iii, pp. 453-62; History, Allied Air Force Area Comd.

18. History, AAFSC/MTO, 1 Jan.-30 June 1944, chap. iii, p. 390; 1 July-31 Dec. 1944, chap. i, pp. 24-29; History, I ASAC.

19. History, AAFSC/MTO, 1 Jan.-30 June 1944, chap. iii, pp. 374-83; History, MAAF.

20. History, AAFSC/MTO, 1 Jan.-30 June 1944, pp. 91-92, 352-63; History, MATS, 25 May 1943-31 May 1944, Pt. I, pp. 1-4, Pt. III, pp. 2-57; Hq. AAFSC/MTO Adm. Memo 2, 26 Jan. 1944; History, MAAF, I, 32-34.

21. History, MAAF, pp. 34-35; 12th AF Adm. History, Pt. I; Hq. 12th AF, Medium Bomber Operations, 1 Jan.-28 Aug. 1944, pp. 1-3.

22. The order to disband TBF (GO 8) was "in accordance with verbal instructions from the Air Commander in Chief," which means that the decision was General Eaker's.

23. The order to disband TBF was issued on 29 April but was retroactive to 1 March. Apparently, the headquarters had disbanded even before 1 March, for Hq. MATAF Operations Record Book and Twelfth Air Force Administrative History both give 20 February as the date on which it ceased to exist; certainly, by 1 March all of its medium bombardment groups had been transferred to the MATAF wings which replaced TBF.

24. History, MAAF, pp. 34-35; RAF

Orgn. Memo 14, 21 Mar. 1944; Hq. MAAF GO 8, 29 Apr. 1944; 12th AF Adm. History, Pt. I; Hq. 12th AF, Medium Bomber Opns., pp. 1-3; MATAF Opns. Record Book, Feb. 1944, App. C, p. 11. See also, ltr., Coningham to Robb, 16 Nov. 1943, in files of Brit. Air Min. Air Historical Br. (BAM [AHB]).

25. 12th AF Adm. History, Pt. I, Pt. III; XII TAC Opnl. History, 1 Jan.-30 June 1944. See also CM-OUT-11689, CG NATO to CG ETO, 31 Dec. 1943; CM-IN-3545, Algiers to WAR, 6 Jan. 1944; CM-OUT-11753, OPD to Freedom Algiers *et al.*, 31 Dec. 1943; CM-IN-11701, JSM to Brit. C/S, 16 Mar. 1944.

26. 12th AF Adm. History, Pt. I, Pt. III; AAF/MTO GO 1, 16 Mar. 1944; incl. 3 to ltr., Eaker to Arnold, 1 June 1944; 12th AF, Troop Carrier Operations, 1944, pp. 1-2; Hq. 12th AF GO's 12, 14 Feb., and 72, 20 July 1944; redline msg., Williams to Eaker, IE3PW, 11 Feb. 1944.

27. History, 15th AF, Vol. I, chap. ii.

28. Ltr., Eaker to Arnold, 6 Mar. 1944; CM-IN-19854, Freedom to Brit. C/S, 28 Feb. 1944. See also ltrs., Eaker to Giles, 29 Feb., and to Arnold, 21 Mar. 1944; interview with Gen. Twining by Lt. C. B. O'Brien, cited in History, 15th AF, I, 73*n*. For the Eighth's effort to take three long-range fighter groups, see numerous IN msgs., Feb. and Mar. 1944; for example, 19180, Algiers to WAR, 27 Feb. 1944; 12237, JSM to AFHQ, 15 Mar. 1944; 11701, JSM to Brit. C/S, 16 Mar. 1944; 19221, Spaatz to Arnold, 26 Mar. 1944; 22609, CCS to Wilson, 31 Mar. 1944. See also telecon, Eaker, Craig *et al.*, 14 Mar. 1944; ltr., Eaker to Giles, 29 Feb. 1944.

29. Ltr., Eaker to Arnold, 1 June 1944. See also ltrs., Eaker to Giles, 29 Feb., 6 Mar., and Craig to Eaker, 22 Mar. 1944; 1st ind. (memo for CG 15th AF *et al.* from MAAF, 19 Apr. 1944), for CG MAAF from Twining, 30 Apr. 1944; telecon, Eaker, Craig *et al.*, 14 Mar. 1944.

30. For decisions at SEXTANT see CCS 379/7, 27 Nov. 1943; CCS 424, 5 Dec. 1943; CCS 136th Mtg., 5 Dec. 1943; SEXTANT, Minutes of Second Plenary Mtg., 23 Nov. 1943. For SHINGLE plans prior to SEXTANT and, more particularly, for discussions and plans

late in December, see C-in-C Med., Directive to the Naval Commander, Operation Shingle, 15 Nov. 1943; frozen cables 892 and 893, PM to D/PM and PM to President Roosevelt, 25 Dec. 1943; cable for Jacob from Hollis, 25 Dec. 1943; Report by SACMED to the CCS on the Italian Campaign, 8 Jan. to 10 May 1944 (cited hereinafter as Rpt. of SACMED, Jan.-May 1944); Hq. MAAF, Operations in Support of SHINGLE, pp. 2-8; History, MAAF, I, 151; TWX, MAAF Rear to MATAF, A297, 26 Dec. 1943; History, 12th AF (draft); FM H. R. L. Alexander, The Allied Armies in Italy; Brit. Hist. Sec., Central Med., British Forces at Anzio; Directives, TAF/60/AIR, 30 Dec. 1943, 14-15 Jan. 1944; CM-IN-17731, Algiers to WAR, 28 Dec. 1943; interview with Marshal Alexander by Sidney Matthews, 10-15 Jan. 1949; History, 5th Army, IV, 15-18; msg., Eisenhower to Wilson (to 15th AG, 5th Army, Troopers Personal), 1 Jan. 1944; msg., Eisenhower to CCS *et al.*, NAF 486, 25 Oct. 1943; msg., Alexander to Clark *et al.*, 1135, 25 Dec. 1943; AFHQ G-3, Amphibious Operations on the Coast of Italy, P/115 (Final), 1 Nov. 1943; 15th AG Operations Instruction 31, 8 Nov. 1943; Mark W. Clark, *Calculated Risk* (New York, 1950), pp. 283-86.

31. For the main features of the planning between 25 December and 12 January, see msg., Clark to Alexander, 2 Jan. 1944, quoted in History, 5th Army, IV, 10-25; JPS, 363/2/D, 10 Jan. 1944; ltr., Hq. 8th Amph. Force to C-in-C, U.S. Fleet, Action Report, Operation SHINGLE, 22 Feb. 1944. For the final plan, see Hq. 5th Army FO 5, 12 Jan. 1944; Hq. 15th AG Opns. Instrs. 12, 32, 34, 16 Dec. 1943, 2 and 12 Jan. 1944. See also IN msgs., Algiers to WAR: 1054, 2 Jan. 1944, 317, 1 Jan. 1944, 17731, 28 Dec. 1943, 1700, 3 Jan. 1944; msg., Eisenhower to CCS, NAF 577, 3 Jan. 1944; Report of SACMED, Jan.-May 1944.

32. The roles assigned to MAAF and its elements in SHINGLE are in Hq. 15th AG Opns. Instr. 34, 12 Jan. 1944. Certain commitments were canceled before SHINGLE was launched. These included sending an aviation engineer battalion ashore with the assault forces to

construct an airfield, the early basing on the field of the 31st Fighter Group, and the dropping of paratroops inland from the beach. For these canceled plans (and for many of the features of the air arm's responsibilities) see Hq. MATAF Intel. Appreciation 3, TAF/317/1, n.d.; Hq. MAAF, Opns. in Support of SHINGLE, p. 5; memo for CG MATAF, from Hq. XII ASC, 17 Jan. 1944; History, 12th AF, V, 13; Hq. MATAF, Opn. SHINGLE Opn. Instr. 1, 19 Jan. 1944; Hq. XII ASC Adm. Plan 1, 10 Jan. 1944; 8th Amph. Force Opn. Plan 147-43, SHINGLE, 12 Jan. 1944; History, 5th Army, IV, 18-24; ltr., House to Deane, 14 Sept. 1944; GSI Appreciation 15, n.d.; MATAF memo, Air Targets Presented by Operation SHINGLE, 1 Jan. 1944; TWX, MAAF Adv. to MATAF, A226, 15 Jan. 1944; TWX, MAAF Rear to MAAF Adv., A270, 15 Jan. 1944; msg., C-in-C to 15th AG, 19806, 27 Dec. 1943; msg., Rear to Troop Carrier Command *et al.*, A298, 26 Dec. 1943; msg., Eisenhower to Alexander, 20984, 29 Dec. 1943. The detailed plans for MAAF's operations are best found in Hq. NATAF Opnl. Directives for Opn. SHINGLE 1, 2, 3, on 30 Dec. 1943, and 4 on 4 Jan. 1944. See also 12th AF, Medium Bomber Opns., 1 Jan.-29 Aug. 1944; 12th AF in Central Italian Campaign, p. 12.

33. MAAF Cen. Med. Opns. Sums. 4-10, 26 Dec. 1943-1 Jan. 1944 (cited hereinafter as CMOS); MATAF Intel. Appre. 3, TAF/317/1/Int., n.d.; GSI Appre. 15, with App. A, B, n.d.; MATAF memo, Air Targets Presented by Operation SHINGLE; History, 5th Army, IV, 18-19.

34. History, MAAF, p. 153; Hq. MATAF, Minutes of Conference on Bombing Plan for Operation Shingle Held at TAF Hq., 5 Jan. 1944; MAAF, Opns. in Support of SHINGLE, p. 4; ltr., MAF to NASAF, 3 Jan. 1944; TWX, Norstad to Twining and Cannon, NTIO, JC91LN, 16 Jan. 1944; History, MAAF, p. 153.

35. MAAF, Opns. in support of SHINGLE, pp. 6-7; RAF Med. Review 6, p. 17; History, 12th AF (draft); Coffin Report, Annex G, Sec. 2, pp. 187-90; NASAF Intops Sum. 164 of 2-3 Jan.

1944; NATAF Int/Opsums 267-68 of 3-4 Jan. 1944; MAAF, Air Intel. Weekly Sums. (Isums) 58-59 of 27 Dec. 1943, 3 Jan. 1944; CMOS 11-12 of 2-3 Jan. 1944; MATAF ORB, 1944, p. 1.

36. RAF Med. Review 6, pp. 17-18; Minutes of a Conference Held at TAF Hq., 10 Jan. 1944, Relative to Bombing Schedule...; MASAF Intops Sum. 170, 8 Jan. 1944; MAAF Isum 61, 17 Jan. 1944; CMOS 13-21 of 4-13 Jan. 1944; MATAF Int/Opsums 269-79 of 4-14 Jan. 1944.

37. History, XII FC, Jan. 1944; MACAF Mare Nostrum 16-17.

38. Min. of Conf. Held at TAF Hq., 10 Jan. 1944, . . . Bombing; TWX, MATAF to TBF, A960, 11 Jan. 1944.

39. TWX, MAAF to MATAF, G287, 11 Jan. 1944; TWX, MATAF to MAAF Adv., A976, 13 Jan. 1944; msg., MAAF Adv. to MATAF *et al.*, A207, 14 Jan. 1944; msg., Cannon to Norstad, LN 78JC, 14 Jan. 1944; msg., Norstad to Cannon, JC 85 LN, 15 Jan. 1944; signal, MATAF to MAAF Adv. *et al.*, A994, 15 Jan. 1944; redline msg., CB 83 LN, 15 Jan. 1944.

40. TWX, MATAF to MAAF Adv. *et al.*, A994, 15 Jan. 1944; memo for MAAF Adv. from MATAF, Operation Shingle-Bombing Plan, 15 Jan. 1944; msg., Norstad to Twining and Cannon, 10, JC 91 LN, 16 Jan. 1944; msg., MATAF to TBF *et al.*, A988, 15 Jan. 1944; MATAF Opnl. Direc. for Opn. Shingle 4, 4 Jan. 1944, with amnd. in msg. A988; Hq. 12th AF, Medium Bomber Opns., 1 Jan.-28 Aug. 1944; USSTAF, The Contribution of Air Power to the Defeat of Germany (Coffin Rpt.), Annex G, Sec. 2, pp. 187-90.

41. Msg., Norstad to Twining and Cannon, 16 Jan. 1944; History, 15th AF, I, 311.

42. Msg., MATAF to TBF, A960, 11 Jan. 1944; History, 12th AF (draft); Hq. 12th AF, Medium Bomber Opns.; MATAF Int/Opsums 281-87, 17-23 Jan. 1944; MASAF Intops Sums. 178-84, 17-22 Jan. 1944; MAAF Isum 62, 24 Jan. 1944; CMOS 24-29 of 16-21 Jan. 1944; MAAF, Opns. in Support of SHINGLE, App. L; Coffin Rpt., Vol. III.

43. History, 15th AF, I, 424-26 and II, 244-45; MASAF Intops Sums. 163-84,

1-22 Jan. 1944; MAAF, Opns. in Support of SHINGLE, Annex O, Opnl. Stats.

44. MAAF, Opns. in Support of SHINGLE, App. L; 12th AF, Medium Bomber Opns.; Coffin Rpt., Annex G, Sec. 2, 187-90; History, 12th AF (draft); History, 15th AF (Rev.), I, 424-26 and II, 244-45; Fuehrer Conferences on Naval Affairs, Conference of 18 Jan. 1944; MATAF Int/Opsums 281-83, 17-19 Jan. 1944; Role of TBF in Interdiction of Rail Traffic in Support of Anzio Operation, n.d.

45. MATAF Int/Opsums 272-73, 277, 279, 285-86 of 8-9, 13, 15, 21-22 Jan. 1944; 12th AF, Medium Bomber Opns.

46. For the status of the GAF see History, 12th AF, V, 15; RAF Med. Review 6, p. 27; MAAF Isum 62, 24 Jan. 1944; NATAF Opnl. Direc. for Opn. SHINGLE, 30 Dec. 1943, App. C; MAAF, Opns. in Support of SHINGLE, Annex N; TAF/60/AIR, Opn. SHINGLE Opn. Instr. 1; Opnl. History, XII TAC, 1 Jan.-30 June 1944 (cited hereinafter as XII TAC Opnl. Hist.). For MAAFs counter-air operations up to 14 January, see History, 12th AF (draft); W. M. Gould, The Italian Campaign, Planning and Operations to June 1944 (draft), in files of BAM (AHB); MATAF Int/Opsums 272, 278, of 8, 14 Jan. 1944; MASAF Intops Sums. 169, 175 of 7, 13 Jan. 1944; MAAF Isum 61, 17 Jan. 1944; CMOS 13-22 of 4-14 Jan. 1944.

47. Msgs., MATAF to MAAF Adv. *et al.*, 17-18 Jan. 1944; History, 12th AF (draft); RAF Med. Review 6, pp. 23-24; MAAF Opns. in Support of SHINGLE, pp. 8, 15-16; 12th AF, Medium Bomber Opns.; MATAF Int/Opsum 284, 20 Jan. 1944; MASAF Intops Sums. 178-82, 16-20 Jan. 1944; MAAF Isum 62, 24 Jan. 1944; CMOS 24-29 of 16-21 Jan. 1944; redline msg., Twining from Eaker, 20 Jan. 1944; History, 15th AF, I, 341, 353.

48. RAF Med. Review 6, p. 29; MAAF Isum 62, p. 2; CMOS 27, 19 Jan. 1944; Hq. 47th Wing, Intel. Annex to Opns. Order for 19 Jan. 1944, dtd. 18 Jan. 1944; MASAF Intops Sum. 181, 19 Jan. 1944; MAAF, Opns. in Support of SHINGLE, pp. 8-9.

49. RAF Med. Review 6, p. 29; MAAF Isums 62-64 of 24, 31 Jan., 7 Feb. 1944.

50. RAF Med. Review 6, pp. 22-23, 26-27; MATAF Int/Opsums 267-68, 278-79, 284-85 of 3-4, 14-15, 20-21 Jan. 1944; CMOS 10-29 of 1-21 Jan. 1944; NATAF Opnl. Direc. for Opn. SHINGLE 3, 30 Dec. 1943, App. B; XII TAC Opnl. Hist.; XII ASC Daily Intel. Sums., 1-21 Jan. 1944; DAF Forward Hq., Daily Intel. Sums., 1-21 Jan. 1944.

51. RAF Med. Review 6, pp. 21-22; MAAF, Opns. in Support of SHINGLE, Annex N; Coffin Rpt., III, 18-19; History, 12th AF (draft); XII TAC Opnl. Hist.; XII ASC Isums 1-21 Jan. 1944; CMOS 10-29 of 1-21 Jan. 1944.

52. Msg., CG XII ASC Adv. to CG MATAF, EA 77 J, 14 Jan. 1944; History, 12th AF (draft); RAF Med. Review 6, p. 17; MAAF to Air Min., MAAF 61, 8 Feb. 1944, in files of BAM (AHB); History, Aviation Engineers in MTO, pp. 207-11; Notes on a Conference on SHINGLE Held at XII ASC Hq., 3 Jan. 1944; Disposition of Air Forces under Opnl. Control of MATAF for Opening Phase of Operation SHINGLE, TAF/185/ORG, 20 Jan. 1944; MAAF, Opns. in Support of SHINGLE, p. 6; redline msg., House to Cannon, 30 Dec. 1943.

53. History, 5th Army, IV, 24-48; 5th Army, Report on Cassino Operations, 5 June 1944; Clark, *Calculated Risk*, pp. 262-79.

54. Figures on the GAF are from MAAF Isum 62; RAF Med. Review 6, p. 27; 12th AF in Cen. Italian Campaign, p. 15; MAAF, Opns. in Support of SHINGLE, Annex N; NATAF Opnl. Direc. for Opn. Shingle 1, 30 Dec. 1943, App. C; XII TAC Opnl. Hist. Figures on MAAF are from TAF/185/ORG, 20 Jan. 1944; TAF/60/AIR, Opn. SHINGLE Opnl. Instr. 1, 19 Jan. 1944; MATAF Direcs. 1-4 (TAF/60/AIR), 30 Dec. 1943-4 Jan. 1944, in files of BAM (AHB); MAAF, Opns. in Support of SHINGLE, Annex O, Opnl. Stats.; MAAF Monthly Stat. Sum. 3, Jan. 1944; History, MAAF, I, 5; MATAF, Sum. of Opns. for 1944.

55. MAAF, Opns. in Support of SHINGLE, Annex P.

56. History, 5th Army, IV, 60-62; Eighth Amph. Force Opn. Plan Shin-

gle, 12 Jan. 1944; Hq. MACAF Opnl. Order 1, 19 Jan. 1944; Hq. XII ASC Opnl. Direc. SHINGLE to 64th FW *et al.*, 15 Jan. 1944; Hq. MATAF, Opn. SHINGLE Opnl. Instr. 1, 19 Jan. 1944; RAF Med. Review 6, p. 28; G-2 AFHQ Translation of Captured German Training Memo, Principles of Anglo-American Landing Operations, Feb. or Mar. 1944; statement by Mr. W. M. Gould, BAM (AHB); War Dept. Ger. Mil. Doc. Sec., German Operations at Anzio, p. 11.

57. For the landings and the matter of tactical surprise, see History, 5th Army, IV, 62-64, 67; cables, Wilson to Air Min. and U.S. JCS, MEDCOS 7 and 9, 22 Jan. 1944. For the absence of the GAF, see MAAF, Opns. in Support of SHINGLE, Annex N, Enemy Reaction to the Shingle Operation. On the matter of strategic surprise, see Questions Regarding the General Strategy During the Italian Campaign, by Field Marshal Kesselring, trans. by Ernest W. Matti (cited hereinafter as Kesselring Questions); WD GMDS, The German Opn. at Anzio, pp. 5, 7; memo. Kesselring to C/GS, Luftflotte 2, dated 12 Jan. 1944, in Trans. VII/16, BAM (AHB), 3 Jan. 1947.

58. XII ASC, Opn. Plan SHINGLE, 8 Jan. 1944; RAF Med. Review 6, p. 28; XII ASC Isum, 22-23 Jan. 1944; MATAF Int/Opsum 287, 23 Jan. 1944; MAAF, Opns. in Support of SHINGLE, p. 11 and Annex N; ltr., Eaker to Bissell, 23 Jan. 1944.

59. RAF Med. Review 6, pp. 16-17, 27-28; W. M. Gould, The Italian Campaign; XII TAC Opnl. Hist.; History, 64th FW, Jan. 1944; History, 5th Army, IV, 34, 64; MAAF, Opns. in Support of SHINGLE, pp. 12-14; MATAF, Rpt. on Air Opns. at Anzio, 2 Mar. 1944; History, MAAF, I, 160-64; CMOS 30-32 of 22-24 Jan. 1944; MATAF, Sum. of Opns. for 1944, p. 2; MATAF Int/Opsum 287, 23 Jan. 1944.

60. Kesselring Questions; History, 5th Army, IV, 64-68; ltr., Eaker to Bissell, 23 Jan. 1944. For other German opinion that the Allies should have driven inland, see WD GMDS, The German Opn. at Anzio, pp. 12-14, 120-21. See also Clark, *Calculated Risk*, pp. 286-87.

61. Ltr., Eaker to Arnold, 6 Mar. 1944;



Kesselring Questions; History, 5th Army, IV, 68, 85; *Washington Post*, 24 Jan. 1947; Clark, *Calculated Risk*, pp. 290, 295, 329-30.

62. History, 5th Army, IV, 73-84.

63. MAAF, Opns. in Support of SHINGLE; ltr., Eaker to Arnold, 6 Mar. 1944; Hq. ACMF Isum 32, App. B., 16 Feb. 1944; W. M. Gould, *The Italian Campaign*, chap. 7; Coffin Rpt., Annex G; Role of TBF in Interdiction of Rail Traffic in Support of Anzio Opns.

64. History, 5th Army, IV, 83-86.

65. MATAF Int/Opsums 287-95, 298 of 23-31 Jan., 3 Feb. 1944; CMOS 31-41 of 23 Jan.-2 Feb. 1944; XII ASC Isums 298-308 of 24 Jan.-3 Feb. 1944; XII TAC Opln. Hist.

66. 12th AF, Medium Bomber Opns.; MATAF Int/Opsums 287-300 of 23 Jan.-5 Feb. 1944.

67. CMOS 30-43 of 22 Jan.-4 Feb. 1944; MATAF Int/Opsums 287-300 of 23 Jan.-5 Feb. 1944; 12th AF, Medium Bomber Opns.; Coffin Rpt., Annex G, Sec. 2; History, 12th AF, Vol. V.

68. Draft Progress Rpt. for Opn. Pointblank, 1-31 Jan. 1944, in files of BAM (AHB); CMOS 33-43 of 25 Jan.-4 Feb. 1944; MASAF Intops Sums. 189-203 of 22 Jan.-5 Feb. 1944; MAAF, Opns. in Support of SHINGLE; Coffin Rpt., Annex W, Sec. 2; History, 15th AF (Rev.), I, 452-54.

69. BAM (AHB), Rise and Fall of the German Air Force; Brit. Hist. Sec., Cen. Med., British Forces at Anzio, Annex III to App. C-1, in files of BAM (AHB); History, 64th FW, Jan. 1944; MAAF, Opns. in Support of SHINGLE, pp. 16-17.

70. Ltr., Eaker to McNarney, 31 Jan. 1944; MAAF Isum 63, 31 Jan. 1944; CMOS 35, 27 Jan. 1944; MAAF, Opns. in Support of SHINGLE, Annex N; redline msg., MASAF from Air Command Post, 25 Jan. 1944.

71. MAAF, Opns. in Support of SHINGLE, Annex N; IN msg., Fairbanks to Brit. C/S: 19041, 28 Jan.; 18713, 27 Jan.; 17989, 26 Jan.; 16711, 25 Jan.; 16463, 24 Jan. 1944; MAAF Isums 63-64 of 31 Jan. and 7 Feb. 1944.

72. BAM (AHB), Rise and Fall of GAF; British Forces at Anzio, Annex III to App. C-1; 12th AF in Cen. It. Cam-

paign; MAAF, Opns. in Support of SHINGLE, pp. 16-17, and Annex N; MAAF Isums 63-64 of 31 Jan. and 7 Feb. 1944.

73. Ltr., Eaker to McNarney, 31 Jan. 1944; MAAF Isum 64, 7 Feb. 1944; CMOS 31, 38 of 23, 30 Jan. 1944; 15th AF monograph, Counter Air Force Operations; MASAF Isum 6, 12 Feb. 1945; 15th AF TMR, 30 Jan. 1944; History, 15th AF, I, 342-43, and II, 157; MASAF Intops Sum. 192, 30 Jan. 1944.

74. Draft Progress Rpt. for Opn. Pointblank, 1-31 Jan. 1944; MAAF Isum 64, 7 Feb. 1944; MAAF, Opns. in Support of SHINGLE, Annex N; 15th AF TMR, 31 Jan. 1944; 15th AF, Counter Air Force Opns.; MASAF Intops Sums. 192-93 of 30-31 Jan. 1944.

75. MAAF, Opns. in Support of SHINGLE, pp. 16-17 and Annex B; msg., CG XII ASC Adv. to Lt. Col. Mack, EA 150 J, 25 Jan. 1944; msg., Lt. Col. Mack to CG XII ASC Adv., 26 Jan. 1944; msg., CG XII ASC Adv. to Comdr. Amph. Task Force and Lt. Col. Mack, EA 153 J, 25 Jan. 1944; ltrs., Eaker to McNarney and Eaker to Giles, 31 Jan. 1944; Coffin Rpt., III, 18-25; History, 5th Army, IV, 72.

76. XII TAC Opln. Hist.; MAAF, Opns. in Support of SHINGLE, Annex N; History, 64th FW, Jan. 1944; MATAF Int/Opsums 288-97 of 24 Jan.-2 Feb. 1944; MAAF Isum 63, 31 Jan. 1944.

77. Ltr., Eaker to Giles, 31 Jan. 1944; History, 307th Ftr. Sq., Feb. 1944; History, 5th Army, IV, 72.

78. 5th Army, Rpt. on Cassino Opns.; 12th AF in Cen. It. Campaign, p. 31; CMOS 30-40 of 22 Jan.-1 Feb. 1944.

79. Coffin Rpt., I, 53, III, 4-5, and App. G; MAAF, Opns. in Support of SHINGLE; Hq. ACMF Isum 32, App. B, 16 Feb. 1944; MATAF, Sum. of Opns. 1944; W. M. Gould, *The Italian Campaign*, chap. 7; Role of TBF in Interdiction of Rail Traffic...; RAF Med. Review 6, pp. 43-46; WD GMDS, German Opns. at Anzio, p. 121.

80. History, 5th Army, IV, 101-23; German Opns. at Anzio, pp. 27-52.

81. XII TAC Opln. Hist.; History, 307th Ftr. Sq., Feb. 1944; History, 5th Army, IV, 110.

82. XII TAC Opln. Hist.; MATAF

- Int/Opsums 302, 305 of 7, 10 Feb. 1944; XII ASC Isums 312-21 of 7-16 Feb. 1944; History, 5th Army, IV, 123; MASAF Intops Sums. 200-205 of 7-12 Feb. 1944.
83. History, 5th Army, IV, 88-94.
84. Brit. Hist. Sec., Cen. Med., Opns. of British, Indian, and Dominion Forces in Italy, Pt. 1, Sec. A, p. 28; Hq. 15th AG Opns. Instr. 2, 2 Jan. 1944, both sources in BAM (AHB); History, 5th Army, IV, 4-5 and App. 5.
85. MATAF Int/Opsums 302-3 of 7-8 Feb. 1944; History, 5th Army, IV, 110-11; MAAF, Opns. in Support of SHINGLE, Annex N; XII ASC Isums 312-13 of 7-8 Feb. 1944; MAAF Isum 64, 7 Feb. 1944.
86. CMOS 47, 53, of 8, 14 Feb. 1944; AFHQ G-3 Rpt. 458, 10 Feb. 1944; MASAF Intops Sum. 201, 8 Feb. 1944.
87. 5th Army, Rpt. on Cassino Opns., 5 June 1944; XII TAC Opnl. Hist.; CMOS 52-54 of 13-15 Feb. 1944; MASAF Intops Sums. 206-8 of 13-15 Feb. 1944; MATAF Int/Opsums 308-10 of 14-16 Feb. 1944; XII ASC Isums 319/21 of 14-16 Feb. 1944. The figure of 1,700 sorties for 13-15 February is from MATAF Int/Opsums 308-10. Figures on sorties and bomb tonnage, 1 January-15 February, are from MAAF, Opns. in Support of SHINGLE, p. 17 and Annex O, Opnl. Stats.; History, MAAF, I, 166-67.
88. History, 5th Army, IV, 129-43; WD GMDS, German Opns. at Anzio, pp. 52-62; Clark, *Calculated Risk*, 306-10.
89. History, 5th Army, IV, 143-44; XII TAC Opnl. Hist.; MAAF Isum 67, 28 Feb. 1944; ACMF Isum 33, 23 Feb. 1944.
90. Summary of Interrogation of POW's Captured During Period Feb. 16 to Feb. 20, Anzio-Nettuno, by 5th Army, in files of BAM (AHB); memo for Hq. ACMF from 5th Army (Lt. Bombe), Influence of Allied Bombing Upon Operations in the Anzio Beachhead, 4 Mar. 1944; History, 15th AF, I, 452; XII TAC Opnl. Hist.; History, 12th AF (draft); ltr., AC/AS Intel. to CG 8th AF, 18 Mar. 1944; CMOS 55-58 of 16-19 Feb. 1944; MASAF Intops Sums. 209-13 of 16-20 Feb. 1944; MAAF Isum 67, 28 Feb. 1944; ACMF Isum 33, 23 Feb. 1944; MATAF Int/Opsums 310-14 of 16-20 Feb. 1944; XII ASC Isums 322-25 of 17-20 Feb. 1944; TWX, MAAF Algiers to Hq. MAAF, 5 Mar. 1944, quoting signal, 5th Army to AFHQ; ltr., Clark to Saville, 21 Feb. 1944.
91. Msg., Devers to AGWAR for Arnold, 10 Mar. 1944; W. M. Gould, *The Italian Campaign*; XII TAC Opnl. Hist.; Coffin Rpt., III, 25; MAAF, Opns. in Support of SHINGLE, Annex O; MAAF Isum 67, 28 Feb. 1944.
92. Msg., Devers to Arnold, NACOS W472, 17 Feb. 1944; msg., Devers to AGWAR for Arnold, 10 Mar. 1944.
93. CMOS 59-67 of 20-28 Jan. 1944; W. M. Gould, *The Italian Campaign*, chap. 7; MATAF, Int/Opsums 314-24 of 20-29 Feb. 1944; XII ASC Isums 325-34 of 20-29 Feb. 1944; MAAF Isum 67, 28 Feb. 1944; 42d BW Stinopsums 41-48 of 19-29 Feb. 1944.
94. MAAF Isums 59-66 of 3 Jan.-14 Feb. 1944. Ltr. of Spaatz to Arnold, 5 Feb. 1944, notes that only 4 per cent of the Fifteenth's efforts in January was on behalf of the CBO.
95. Cable, Eaker to Spaatz, 29, 19 Feb. 1944; cable, Spaatz to Eaker, IE 121 CS, 19 Feb. 1944.
96. History, MAAF, I, 142-47; canceled cable, 8th AF to Caserta, 19 Feb. 1944. See also ltrs., Spaatz to Arnold, 1, 5 Feb. 1944, and cables, Spaatz to Eaker, IE 122 CS and IE 15 CS, 19 and 20 Feb. 1944; Special File 706, entry of 19 Feb. 1944.
97. Cable, Eaker to Spaatz, 29, 19 Feb. 1944; cable, Spaatz to Eaker, IE 15 CS, 20 Feb. 1944; History, MAAF, I, 142-47.
98. AAF Reference History 22, *The Combined Bomber Offensive*, 1 Jan.-6 June 1944; MASAF Intops Sum. 213, 20 Feb. 1944; USSTAF, Opns. Intel. Sum. 605, 21 Feb. 1944; MAAF Isum 68, 6 Mar. 1944.
99. Good basic data on Big Week may be found in the following: History, MAAF, I, 142-47; Rpts. on Conferences between Generals Vandenberg and F. L. Anderson, 22, 24, 25 Feb. 1944; Giles and Anderson, 21 Feb. 1944, Kuter and Anderson, 20 Feb. 1944, in AAG cables; Rpt., A Record Week of Strategic Bombing, in History, MAAF, Vol. V; AAFRH-22; Intel. Rpts. of MASAF, MAAF, USSTAF for the period; nu-

merous cables from Eaker to Spaatz, Spaatz to Eaker, Twining to Eaker.

100. History, 5th Army, IV, 146-57; CMOS 68-69 of 29 Feb.-1 Mar. 1944; MASAF Intops Sum. 222, 29 Feb. 1944; MATAF Int/Opsum 324, 1 Mar. 1944; XII ASC Isum 335, 1 Mar. 1944.

101. MASAF Intops Sum. 224, 2 Mar. 1944; MATAF Int/Opsum 326, 3 Mar. 1944; CMOS 70, 2 Mar. 1944; ltr., Eaker to Lovett, 2 Mar. 1944; MAAF Isum 68, 6 Mar. 1944; XII ASC Isum 337, 3 Mar. 1944.

102. Memo for Hq. ACMF from 5th Army (Lt. Bombe), Influence of Allied Bombing...; 12th AF in Cen. It. Campaign, p. 35; History, 5th Army, IV, 155-61; CMOS 71, 3 Mar. 1944; XII TAC Opnl. Hist.; MAAF Isums 69-78 of 13 Mar.-15 May 1944.

103. *Washington Post*, 24 Jan. 1947.

104. Ltr., Eaker to Arnold, 6 Mar. 1944; memo for C/AS from AC/AS OC&R, Analysis of the SHINGLE Report, n.d.; memo for AC/S OPD *et al.* from Arnold, 27 Mar. 1944.

105. Ltr., Eaker to Bissell, 23 Jan. 1944; CM-IN-7690, Freedom to Brit. C/S, 10 Feb. 1944.

106. Memo for C/S *et al.* from Arnold, 27 Mar. 1944; memo for C/AS from W. F. McKee, AC/AS OC&R, n.d.

107. Msg., Devers to AGWAR from Arnold, 10 Mar. 1944; msg., ACMF to Freedom, sgd. Mainwaring, n.d., in files of BAM (AHB); ltr., MAAF to CG AAF, 28 Feb. 1944.

108. History, 5th Army, IV, 27-57, 87-100, 175-76; Hq. 15th AG Opns. Instr. 32, 2 Jan. 1944; Hq. 5th Army Opns. Instr. 13, 10 Jan. 1944; 5th Army, Rpt. on Cassino Opn. See also (among countless other documents) the following: Hq. 36th Inf. Div. FO 42, 18 Jan. 1944; Hq. 34th Inf. Div. FO 11, 21 Jan. 1944; Hq. 133d Inf. Regt. FO 7, 23 Jan. 1944; G-2 34th Div., Monthly Rpt. for Jan. 1944; The 133d Inf. Regt. in the Cassino-Rapido Operation.

109. XII TAC Opnl. Hist.; XII TAC Isums, Jan.-Mar. 1944; NATAF and MATAF Int/Opsums, Jan.-Mar. 1944.

110. MAAF, The Bombardment of Cassino, deals with the bombing of Cassino town on 15 March but it contains

several splendid photographs which show the tactical importance of the abbey's location overlooking the town.

111. Interview with General Eaker by Albert F. Simpson, 24, 25 Jan. 1950; Clark, *Calculated Risk*, pp. 314-23; CM-IN-7012, Wilson to Brit. C/S, MEDCOS 64, 9 Mar. 1944; History, 5th Army, IV, 98-99; msg., Eaker to Timberlake, PT 83 IE, 13 Feb. 1944; MAAF Isum 66, 21 Feb. 1944; AASC War Diary 7, 15 Feb. 1944; W. M. Gould, *The Italian Campaign*, chap. 8, citing interview with Slessor, 15 June 1948. On 20 July 1948, Mr. Hilary Saunders, librarian of the Houses of Parliament, who was then preparing a history of RAF operations in World War II, told the writer that a recent interview with Monte Cassino monks had convinced him that the Germans did not have a single man or gun in the monastery prior to the Allied bombing of 15 February. Mr. Saunders was equally sure, however, that the Allied leaders in Italy *believed* that the Germans were using the monastery. Sir D. Osborne, British representative to the Vatican in the winter of 1944, believed but could not prove that the Germans, through false information, deliberately led the Allies to believe that the abbey was being used for military purposes; their object was to induce the Allies to bomb the building, thereby giving the Germans a fine propaganda weapon. (CM-IN-3007, COS to AFHQ, 4 Mar. 1944; msg., Sir D. Osborne to Foreign Office, 362, 24 May 1944.) Osborne had warned the Vatican before the bombing that if the abbey or its environs were used for military purposes the Allies would have to take countermeasures; he had suggested to the Vatican that it ascertain from the Germans the truth of the situation, but had received no reply. (Msg., Sir D. Osborne to Foreign Office, 87, 11 Feb. 1944.)

112. Eaker interview by A. F. Simpson; History, 5th Army, IV, 98. For the plan of the ground attack, see 1 NZ Corps Opns. Instr. 4 of 9 Feb. 1944; 2 NZ Div. Opns. Instrs. 20, 21 of 13, 17 Feb. 1944; Clark, *Calculated Risk*, pp. 315-18.

113. History, 5th Army, IV, 98-99; MAAF Isum 66 of 21 Feb. 1944; AFHQ

G-3 Rpt. 465 of 16 Feb. 1944; MASAF Intops Sum. 208, 15 Feb. 1944.

114. 5th Army, Rpt. on Cassino Opn., 5 June 1944; msg., Wilson to Brit. C/S, MEDCOS 64, 9 Mar. 1944; History, 5th Army, IV, 99; MAAF Isum 66, 21 Feb. 1944; Clark, *Calculated Risk*, pp. 319-20.

115. Msgs., Wilson to Brit. C/S, 904, 20 Feb., and MEDCOS 41, 22 Feb. 1944; msg., Wilson to Air Min., MEDCOS 46, 28 Feb. 1944; MC-OUT-6961, Wilson to Alexander, 25 Feb. 1944, in files of BAM (AHB).

116. JCS 147th Mtg., 21 Feb. 1944; JCS 736, 28 Feb. 1944; ltr., Arnold to Eaker, 10 Feb. 1944.

117. JCS 149th Mtg., 29 Feb. 1944; CCS 502, 1 Mar. 1944; JSM to War Cabinet, JSM 1547, 29 Feb. 1944.

118. CCS 502/1, 5 Mar. 1944; CCS 502/2, 7 Mar. 1944; CCS 502/3, 8 Mar. 1944; MC-IN-5013, CCS to Wilson, FAN 342, 8 Mar. 1944; msg., Air Min. to Britman (Washington), COS (W) 1193, 4 Mar. 1944, in files of BAM (AHB).

119. 15th Army, MA 1109, in files of BAM (AHB); W. M. Gould, *The Italian Campaign*; History, 5th Army, IV, 177; CM-IN-6663, Wilson to CCS, NAF-645, 9 Mar. 1944; ltr., Eaker to Arnold, 6 Mar. 1944; cable, Eaker to Arnold, MAAF 887, 4 Mar. 1944; msg., Timberlake to Eaker, IE 155 PT, 8 Mar. 1944; ltr., XII ASC (Darcy) to CG MATAF, 22 Feb. 1944, and msg., MATAF to 42d BW *et al.*, 23 Feb. 1944, both in MATAF, Incoming and Outgoing Messages on Cassino; msg., Wilson to Alexander, 56453, 25 Feb. 1944; Eaker interview by A. F. Simpson.

120. Ltr., Eaker to Arnold, 6 Mar. 1944; History, MAAF, I, p. 175; MATAF, ORB 1944, p. 14; Eaker interview by A. F. Simpson.

121. History, 5th Army, IV, 176-77; ltr., CG XII ASC to CG MATAF, 22 Feb. 1944; TWX, MATAF to 42d BW *et al.*, A 170, 23 Feb. 1944; MATAF, Cassino Operation (Bombing Dir.), 11 Mar. 1944; memo for CG 57th BW *et al.* from MATAF, 23 Feb. 1944; TWX, MATAF to 42d BW *et al.*, AC 116, 24 Feb. 1944; memo for CG MAAF *et al.* from MATAF, 26 Feb. 1944; MATAF memo, Attack on Cassino, Italy, 15 Mar.

1944 (TAF/69/AIR), dtd. 11 July 1944; XII ASC, Detailed Plan for Operation LUDLUM, n.d. but forwarded to MATAF on 11 Mar. 1944. See also, 2 NZ Div. Opns. Order 41, 23 Feb., and Air Support Instr., 11 Mar.; 4 Indian Div. Opns. Instr. 4, 22 Feb.; 78 Div. Opns. Order 17, 28 Feb. 1944.

122. The following MATAF TWX's: A 170, 23 Feb.; AC 116, 24 Feb.; A 230, 4 Mar.; AC 234, 11 Mar.; A 267, 15 Mar. 1944. See also memo for CG MAAF *et al.* from MATAF, 26 Feb.; TWX, Eaker to Twining and MATAF, NT 89 IE, 11 Mar.; Hq. MATAF, Cassino Opn., 11 Mar. 1944.

123. History, MAAF, I, 177; RAF Med. Review 7, p. 10; History, 5th Army, IV, 178; History, 12th AF (draft); History, 15th AF (Rev.), p. 452; Daily Isums of MATAF, MASAF, XII ASC, 15 Mar. 1944; MATAF, Attack on Cassino, 11 July 1944; XII TAC Opnl. Hist.; MAAF Isum 70, 20 Mar. 1944. No two sources agree on the tonnage of bombs dropped. Figures range from 988 to 1,463 tons. Examination of all sources indicates that "slightly" more than 1,000 tons were dropped *on the town*. The same sort of problem—and the same lack of a positive answer—exists in regard to the number of sorties flown. In addition to the sources cited above and those cited in subsequent footnotes which deal with the bombing of Cassino, the author has consulted the following documents in the files of the British Air Ministry, Air Historical Branch: AFHQ G-2 Weekly Rpts.; 7/9 Army Air Support Control Report on Bombing of Cassino on 15 Mar. 1944, dtd. 23 Mar. 1944; Opns. of British, Indian, and Dominion Forces in Italy, Pt. I, Secs. A, C, E, F; War Room Monthly Sum. of MAAF Opns., Feb. and Mar. 1944; MAAF, Bombardment of Cassino, 25 June 1944.

124. Telecon, Eaker and Giles, n.d. but obviously 15 Mar. 1944; History, MAAF, I, 176-77, and II, transcript of msg., Eaker to Arnold, n.d.; MASAF Intops Sum. 237, 15 Mar. 1944; MATAF ORB 1944, p. 14; TWX, Eaker to Cannon for Webster, 16 Mar. 1944; memo for SASO, General Born's Views on the Cassino Show, 20 Mar. 1944; ltr., Air

Support Control Sec., Hq. 5th Army, 21 Mar. 1944, cited in History, 12th AF (draft); MATAF, Attack on Cassino, 11 July 1944; ltrs., Eaker to Arnold, 21 Mar., to Twining, 17 Mar., and to Devers, 6 Apr. 1944 (incl., Guenther to Eaker, 5 Apr.). For the bombing of our own troops, including the damaging of General Leese's headquarters, see, particularly, memo, Eaker to Edwards, 20 Mar.; MATAF ORB 1944, p. 14; ltr., Eaker to Leese, 16 Mar. 1944; ltr., Eaker to Edwards, 20 Mar. 1944; ltr., Edwards to Eaker, 27 Mar. 1944.

125. History, MAAF, I, 180; Attack on Cassino, 11 July 1944; MAAF, Bombardment of Cassino; Hq. 5th Army, Rpt. on Effect of Bombing and Shelling of Cassino, 27 Apr. 1944; Hq. MATAF, Report on Field Trip, 31 May 1944. See also ltr., Clark to Eaker, 5 Apr. 1944; interview with Alexander by Sidney Matthews, 10-15 Jan. 1949.

126. History, 5th Army, IV, 179; ltr., Eaker to Arnold, 21 Mar. 1944; MATAF memo, Bombing of Cassino; MATAF, Attack on Cassino; CM-IN-11267, MAAF to WD, 16 Mar. 1944; 5th Army, Rpt. on Cassino Opns., 5 June 1944, with Tab N, Operations against Cassino by NZ Corps; W. M. Gould, *The Italian Campaign*, chap. 8, citing interview with Slessor, 15 June 1948.

127. CM-IN-11267, MAAF to WD, 16 Mar. 1944. See also ltr., Giles to Eaker, 25 Apr. 1944; History, MAAF, I, 181.

128. Intrs. of POW's, cited in History, MAAF, I, 179-80; 5th Army, Rpt. on Effect of Bombing etc.; MATAF, Attack on Cassino; Eaker interview by A. F. Simpson.

129. History, 12th AF (draft); History, 5th Army, IV, 180; 5th Army, Rpt. on Effect of Bombing etc.; transcript of telecon, Eaker and Giles, 15 Mar. 1944; CM-OUT-6436, Arnold to Eaker, 15 Mar. 1944; 5th Army, Rpt. on Cassino Opns., 5 June 1944, with Tab N, Opns. against Cassino by NZ Corps; msg., Eaker to AGWAR for Arnold, MAAF 1557, 16 Mar. 1944; MATAF, Attack on Cassino; msg., MATAF to DAF *et al.*, A 267, 15 Mar. 1944; XII ASC, Detailed Plan for Opn. LUDLUM; ltr., Eaker to Arnold, 21 Mar. 1944; CM-IN-11267,

MAAF to WD, 16 Mar. 1944; XII TAC Opnl. Hist.

130. Opns. against Cassino by NZ Corps; MATAF, Attack on Cassino; History, 5th Army, IV, 180-82; Alexander interview; msg., Fairbanks to Freedom, B1230, 24 Mar. 1944; Clark, *Calculated Risk*, pp. 331-33.

131. Ltrs., Eaker to Arnold, 6 and 21 Mar. 1944; CM-IN-2185, Algiers to WAR, 3 Mar. 1944.

132. XII ASC Isums 349-58 of 16-23 Mar. 1944; MATAF Int/Opsums 340-48 of 16-23 Mar. 1944; XII TAC Opnl. Hist.; RAF Med. Review 7, pp. 15-16; History, 5th Army, IV, 182; Opns. against Cassino by NZ Corps, App. 20; MAAF Isum 71, 27 Mar. 1944.

133. MATAF Int/Opsums 339-47 of 16-23 Mar. 1944; XII ASC Isums 350-57 of 17-24 Mar. 1944.

134. 5th Army, Rpt. on Effect of Bombing etc.; MATAF, Attack on Cassino; AFHQ Training Memo 5, Lessons from Cassino Operation (15-25 Mar. 1944), 4 June 1944; ltr., Lt. Gen. Oliver Leese to Eaker, 18 Mar. 1944.

135. Ltr., Giles to Eaker, 25 Apr. 1944; AFHQ Tng. Memo 5, 4 June 1944; ltr., Eaker to SACMED, 12 Apr. 1944; MATAF ORB, 1944, pp. 14-15.

136. Ltr., Eaker to R. A. Lovett, 17 Apr. 1944; memo for Arnold from Eaker, n.d.; AFHQ Tng. Memo 5, 4 June 1944; 5th Army, Rpt. on Cassino Opn., with Tab N, App. 18, ltr., 5th Army to C-in-C AAI, 31 Mar. 1944; ltr., Eaker to SACMED, 12 Apr. 1944; MATAF, Attack on Cassino.

137. Ltrs., Eaker to R. A. Lovett, 17 Apr., to Arnold, 4 Apr., and to Devers, 6 Apr. 1944 (incl., Guenther to Eaker, 5 Apr.); MATAF ORB 1944, p. 14; W. M. Gould, *The Italian Campaign*, chap. 8, citing interview with Slessor.

138. See ltr., Eaker to SACMED, 12 Apr. 1944.

139. Ltr., Giles to Eaker, 25 Apr. 1944.

140. For the quotation, see ltr., Eaker to Arnold, 4 Apr. 1944.

#### NOTES TO CHAPTER 11

1. Report by the Supreme Allied Commander Mediterranean to the CCS on the Italian Campaign (London, 1948),

Pts. II, III (cited hereinafter as SAC-MED Rpt.); CCS 131st Mtg., SEXTANT, 26 Nov. 1943; msg., Wilson to Brit. C/S, MEDCOS 46, 28 Feb. 1944.

2. Msg., Spaatz sgd. Devers to Arnold, 25 Feb. 1944.

3. Ltrs., Eaker to Arnold, 6 and 21 Mar. 1944; see also, ltr., Eaker to Portal, 7 Mar. 1944.

4. General Conclusions of Report by Prof. S. Zuckerman, Scientific Adviser, MAAF, Air Attacks on Rail and Road Communications, 28 Dec. 1943 (cited hereinafter as Zuckerman Rpt.).

5. Zuckerman Rpt. On Zuckerman's recommendation, MAAF, on 24 Dec. 1943, issued an order limiting air attacks on rail communications to yards at seven Italian cities: Rimini, Foligno, Verona, Genoa, Turin, Vicenza, and Voghera. (See TWX, ACP MAAF to NASAF *et al.*, A213, 24 Dec. 1943, and memo for A-2 Target Sec. from Air Intel. ACP, 24 Dec. 1943; History, MAAF, I, 188-89. For Air Ministry's position see ltr., CS 19639, D.A.T., 2 Feb. 1944, sgd. Air Marshal Peck, in files of BAM [AHB]; for Tedder's support, see MAAF/ACP/S.63/AIR.)

6. Ltr., CG XII BC to CG 12th AF, 6 Oct. 1943; MAAF A-2 Sec. Sp. Intel. Rpt. 64, 24 Dec. 1943; ltr., AFHQ, GBI/OI/IIA-52, AC/S G-2, sgd. Col. Ford, 5 Jan. 1944; 12th AF A-2 Sec., Conclusions from a Suggested Plan for Making Impossible the Utilization of Italian Railways by the Enemy, 15 Jan. 1944; History, MAAF, I, 189-91; History, 15th AF (Rev.), II, 178-83; Brig. Gen. Lauris Norstad, Airlock in Italy, in Hq. MAAF, Air Power in the Mediterranean, Nov. 1942-Feb. 1945, dtd. 27 Feb. 1945; ltr., MAAF A-2 to A-3 (Ref. MAAF/S. 6653/INT), 29 Feb. 1944. For an interesting discussion, see Hq. 2677 Hq. Co. Exper., U.S. Army, Paper Prepared by OSS for Submission to the AAF: Air Attacks on Bridges and Marshalling Yards in Italy, 7 Mar. 1944. See also MAAF Weekly Intel. Sum. (Isum) 61, 17 Jan. 1944, pp. 21-24.

7. Hq. 2677 Hq. Co. Exper., Air Attacks on Bridges and M/Y; ltr., Arnold sgd. Giles to SACETO, 15 Apr. 1944.

8. History, 15th AF, II, 211; MATAF,

Report on Operation STRANGLE, p. 4; Coffin Rpt., App. G, Pt. 2; interview with Gen. Eaker by Albert F. Simpson, 24, 25 Jan. 1950.

9. Fifth Army History, V, pp. 2-4, 15-19; Minutes of Supreme Allied Commanders Conference, 27 Mar. 1944; ltr., Eaker to R. A. Lovett, 17 Apr. 1944; interviews with Gen. Eaker by Albert F. Simpson, 24, 25 Jan. 1950, and by Albert F. Simpson and R. T. Finney, 17 Apr. 1947; MAAF, Meeting Held to Discuss MAAF Policy, Spring 1944, 20 Feb. 1944, in files of BAM (AHB); MC-OUT-6961, Wilson to Alexander, 25 Feb. 1944; MATAF, Rpt. on Opn. STRANGLE, p. 1; msg., MATAF to XII ASC *et al.*, A308, 26 Mar. 1944. For discussions in mid-February of bombing policy, see memo for Dir. of Opns. from Slessor, 11 Feb. 1944; memo for Dep. Air C-in-C from Norstad, 13 Feb. 1944; The German Supply Situation in Italy; Minutes of Meeting (MAAF), 14 Feb. 1944.

10. MATAF Bombing Direc. 2, 19 Mar. 1944; MATAF memo to CG 42d BW *et al.*, 19 Mar. 1944. For the earlier directives, see MAAF Opns. Instr. 8, 18 Feb. 1944; MATAF Bombing Direc. 1, 25 Feb. 1944.

11. MATAF Bombing Direc. 2, 19 Mar. 1944; memo for CG XII ASC from MATAF, Employment of 57th Fighter Group, 26 Mar. 1944; Hq. MAAF Opns. Instr. 11, 4 Mar. 1944; XII TAC Opnl. History. For a discussion of the Italian rail system and for data on the capacity of the major lines, see MAAF Appreciation of Air Attacks against Enemy Communications and Supply in Italy, 28 Apr. 1944; MATAF, Rpt. on Opn. STRANGLE.

12. The phrase occurs in most documents which discuss the features and purposes of STRANGLE. See, for example, ltr., CG XII BC to CG 12th AF, 6 Oct. 1943; MAAF Isum, 22 Nov. 1943; MAAF A-2 Sec. Sp. Intel. Rpt. 64, 24 Dec. 1943.

13. Ltr., Eaker to Arnold, 18 Apr. 1944; MAAF Target Sec. Rpt., cited in History, MAAF, pp. 204-6.

14. Ltr., Eaker to Devers, 1 Apr. 1944; MAAF Target Sec., Assessment of Air

Operations against Enemy Communications in Italy, 16 June 1944.

15. AFHQ G-2 CMF, The German System of Supply in the Field, Italy, 1943-45, dtd. Feb. 1946, p. 76. This study is based entirely on enemy documents and interrogation of German POW's.

16. Coffin Rpt., Annex G, pp. 195-97.

17. 57th BW Opnl. and Intel. Sums., 19 Mar.-11 May 1944; 42d BW, Stinops-ums, 19 Mar.-11 May 1944; MATAF Int/Opsums 343-96, 19 Mar.-11 May 1944; 12th AF Target and Duty Sheets, Mar.-May 1944; 12th AF, Medium Bomber Operations, 1 Jan.-28 Aug. 1944; MATAF, Rpt. on Opn. STRANGLE; German System of Supply, etc. A good running account of air operations during STRANGLE is in MAAF Isums 71-78, 27 Mar.-May 1944. Heavies also tried a low-level (200-foot) attack on bridges but were quickly convinced that the effort was wasted and thereafter stayed at their proper altitude. (See memo for Eaker from Cannon, 13 Apr. 1944.)

18. MATAF, Rpt. on Opn. STRANGLE; 12th AF, Medium Bomber Opns. See also AFHQ G-3 Rpts. for the period.

19. Ltrs., Eaker to Devers, 1 Apr., and to R. A. Lovett, 17 Apr. 1944; memo for Marshall from Eaker, 15 Apr. 1944; ltrs., Eaker to Arnold, 18 Apr., 7 May 1944; Coffin Rpt., Annex G, pp. 197-99; MATAF, Rpt. on Opn. STRANGLE, p. 10; MAAF, Assess. of Air Opns. against En. Comm., 16 June 1944.

20. XII TAC Opnl. History; MATAF Int/Opsums 325-55, 1-31 Mar. 1944; XII ASC Isums 335-64, 1-31 Mar. 1944.

21. XII TAC Opnl. History; MATAF, Rpt. on Opn. STRANGLE; RAF Med. Review 7, pp. 11-15, 21-26, 38-39; History, 12th AF (draft); XII TAC Isums, 1 Apr.-12 May 1944.

22. XII TAC Opnl. History; MATAF, Rpt. on Opn. STRANGLE; History, 12th AF (draft); XII TAC Isums, 1 Apr.-12 May 1944. See also AFHQ G-3 Rpts. for the period.

23. XII TAC Opnl. History; MATAF, Rpt. on Opn. STRANGLE; RAF Med. Review 7.

24. MAAF, Operations in Support of DIADEM, VII, 23; MATAF, Rpt. on Opn. STRANGLE, p. 15; ltr., Eaker to

Giles, 12 July 1944; ltr., House to Deane, 14 Sept. 1944.

25. MAAF, Assessment of Air Opns. against En. Comm., 16 June 1944; ltr., Eaker to Arnold, 18 Apr. 1944; XII TAC Opnl. History; MATAF, Rpt. on Opn. STRANGLE, pp. 9, 13; Norstad, Airlock in Italy, in MAAF, Air Power in the Mediterranean; memo for Eaker from Cannon, 13 Apr. 1944; MAAF, Interdiction of Italian Railways, Weekly Status Report, 7-17 May 1944; AAFEB, MTO, Vol. I, Pt. VII.

26. MATAF, Rpt. on Opn. STRANGLE; 12th AF, Medium Bomber Opns., p. 42; Hq. RAF/MED/ME, Opnl. Research Sec., Bombing Survey Unit, A Study of the Bombing of the Central Italian Railway Lines During Operation STRANGLE, in files of BAM (AHB); memo for Air C-in-C MAAF, from G/C J. C. E. Luard, 19 Apr. 1944.

27. Italian Min. of Comm. Daily Status Rpt. of Italian Railways, quoted in MAAF, Assess. of Air Opns. against En. Comm., 16 June 1944; interview with Chief Engr., Rome Dist., Italian State Railways, by W. M. Gould, BAM (AHB); ltr., Eaker to Spaatz, 24 April 1944; History, IX BC, May 1944, p. 21. See also AAFEB, MTO, Vol. II, Strategic Target Selection.

28. 12th AF, Medium Bomber Opns.

29. Coffin Rpt., III, p. 31; OSS-AAI, Railroad Traffic Interdiction, Central It., Mar.-Apr. 1944, n.d.; MATAF, Rpt. on Opn. STRANGLE.

30. CMOS 89-140 of 19 Mar.-11 May 1944; MATAF, Rpt. on Opn. STRANGLE, p. 14; MATAF Int/Opsums 343-96, 19 Mar.-11 May 1944.

31. MATAF, Rpt. on Opn. STRANGLE, p. 13; MAAF Opns. Analysis Sec., Analysis of Tactical Attacks on Bridges and Viaducts, May 1944; MATAF, Rpt. on Bridge Busting, 16 Apr. 1944; memo for Eaker from Cannon, 13 Apr. 1944; ltr., Eaker to Arnold, 18 Apr. 1944.

32. History, 15th AF (Rev.), I, 343-45, and II, 158-59; MASAF Intops Sum. 240, 18 Mar. 1944; MAPRW, App. to PIR 673, 19 Mar. 1944; CMOS 86, 18 Mar. 1944.

33. CM-IN-14510, AFHQ to WD *et al.*, 19 May 1944.

34. Ltr., Eaker to Devers, 1 Apr. 1944; MASAF Monthly Stat. Sum., Mar. 1944; History, 15th AF (Rev.), I, 427, and II, 178-83, 246-50; RAF Med. Review 7, pp. 13-26, 32-41; MASAF Intops Sums. 244, 250-51 of 22, 28-29 Mar. 1944; memo for Eaker from Cannon, 13 Apr. 1944; CMOS 90, 96-97 of 22, 28-29 Mar. 1944.

35. MASAF Monthly Stat. Sum., Apr. 1944; History, 15th AF (Rev.), II, pp. 178-83, 246-50; RAF Med. Review 7, pp. 26, 32-41; MASAF Intops Sums. 254-83, 1-30 Apr. 1944, esp. 281-82 of 28-29 Apr.

36. MASAF Monthly Stat. Sum., May 1944; History, 15th AF (Rev.), II, 178-83, 246-50; RAF Med. Review 7, pp. 13-26, 32-41.

37. Coffin Rpt., pp. 201-2; History, 15th AF, II, 246-50, and I, 427; MAAF, Opns. in Support of DIADEM, VII, Tab CC.

38. MACAF, Mare Nostrum, A Review of MACAF Operations, Mar. 1943-Sept. 1944, dtd. 14 Sept. 1944; RAF Med. Review 7, *passim*; History, 12th AF (draft); MACAF, Attacks on Shipping ... During Operation STRANGLE, n.d.

39. Mare Nostrum, pp. 14-16; 242 Gp. Opns., Jan.-June 1944; CAF Opns., Western Med., Jan.-June 1944; History, 310th Bomb. Gp., Jan.-Mar. 1944; memo for Marshall from Arnold, 15 Apr. 1944; ltrs., Eaker to Arnold, 21 Mar., 7 May 1944; ltr., Eaker to Lovett, 8 Sept. (quoting a German admiral captured at Toulon).

40. Mare Nostrum, pp. 14-17; 242 Gp. Opns., Jan.-June 1944; CAF Opns., Western Med., Jan.-June 1944; History, 310th Bomb. Gp., Jan.-Mar. 1944.

41. Mare Nostrum, pp. 14-16; telecon, Eaker and Giles, 17 Apr. 1944.

42. Kesselring Questions.

43. Coffin Rpt., Annex G, pp. 197-201, 209-11; MAAF, Interdiction of It. RR, Weekly Status Rpt., 7-17 May 1944; MAAF Target Sec. Rpt., cited in History, MAAF, pp. 204-6; AAFEB, MTO, Vol. I, Pt. VII, pp. 24-26, 31 Jan. 1945; Klaus Stange, The Railroad Situation in Italy; AFHQ, German System of Supply, etc., p. 78; MAAF, Assess. of Air Opns. against En. Comm., 16 June 1944; It. Min. of Comm. Daily Status Rpts. of Italian RR.

44. XII TAC Opnl. History; MATAF, Rpt. on Opn. STRANGLE; ltrs., Eaker to Arnold, 21 Mar., 7 May 1944; AFHQ G-2, German System of Supply, etc., pp. 77-78; MATAF, Opn. DIADEM, pp. 25, 42; Stange, Railroad Sit. in Italy.

45. AFHQ Weekly Isum 94, 12 June 1944; MAAF, Assess. of Air Opns. against En. Comm.; MAAF Target Sec. Rpt., quoted in History, MAAF, pp. 204-6; AAFEB Rpt., Vol. I, Pt. VII, 31 Jan. 1945; Coffin Rpt., Vol. I.

46. MAAF, Assess. of Air Opns. against En. Comm.; MATAF, Opn. DIADEM, p. 41; Norstad, Airlock in Italy.

47. OSS-AAI P/W Intr. Rpts. on En. Comm. in Italy, 2 and 22 May, 1 and 6 June 1944; MAAF Target Sec. Rpt., 16 June 1944, cited in History, MAAF, pp. 204-6; Coffin Rpt., Annex G, pp. 199-201; MAAF Intel. Sec., Appre. of Air Attacks against En. Comm. and Supply; memo for Dep. Air C-in-C from Norstad, 13 Feb. 1944; CM-IN-2379, Freedom to CCS, 2 June 1944; Kesselring Questions; Stange, Railroad Sit. in Italy; Gen. Maj. Karl Koerner, chief of Transportation, Rail Transportation Problems in Italy, 8 Apr. 1947; MATAF, Operation DIADEM, p. 41; Eaker interview by Albert F. Simpson, 24-25 Jan. 1950.

48. Msg., Wilson to Brit. C/S, MEDCOS 41, 22 Feb. 1944; CCS 465/1, 24 Feb. 1944; CCS 147th Mtg., 25 Feb. 1944; msg., Air Min. to USSTAF *et al.*, AX440, 29 Feb., and Air Min. to AFHQ, COSMED 43, 26 Feb. 1944, in files of BAM (AHB).

49. CM-IN-15567, Wilson to WD *et al.*, MEDCOS 73, 21 Mar. 1944; msg., Eaker to Timberlake for Slessor, 19 Mar. 1944; Min. of C-in-C's Conf., 27 Feb. 1944; msg., Slessor to Air Min., Punch JCS 204, 24 Feb. 1944; msg., Wilson to CCS, NAF 645, 9 Mar. 1944; History, 5th Army, Vol. V.

50. CCS 465/12, 465/13, 465/15, 465/16, 465/17, 465/18, 465/19, 465/20, 465/21 of 23-24, 30 Mar., 3-4, 7-8, 8, 17 Apr. 1944; msg., Slessor to Timberlake for Eaker, 18 Mar. 1944; msg., Slessor to C/AS, Punch JCS 391, 18 Mar. 1944; msg., Slessor to Eaker, 17 Mar. 1944, last three msgs. in files of BAM (AHB).

51. CCS 465/21 and 465/22, 17-18 Apr.



1944; msg., Air Min. to AFHQ, COS-MED 90, 19 Apr. 1944.

52. MATAF Opnl. Instr. 1, 7 Mar. 1944; MATAF Opnl. Direc. 10, 10 May 1944; SACMED Rpt., Pts. II, III, pp. 4-5; Hq. ACMF Opnl. Instr. 46, 5 Mar. 1944; Min. of SAC Conf., 31 Mar. 1944; History, 5th Army, V, 21; CM-IN-4031, AFHQ to Brit. C/S, 5 Apr. 1944; MATAF ORB 1944, p. 12; XII TAC Opnl. History.; insg., Wilson to CCS, NAF 645, 9 Mar. 1944; CM-IN-15567, AFHQ to WD *et al.*, 21 Mar. 1944; AFHQ, Examination of Med. Strategy for the Summer of 1944 (P/154 Final), 16 Apr. 1944. For the detailed plans of the Fifth and Eighth Armies' offensive, see History, 5th Army, V, 22-29; Clark, *Calculated Risk*, pp. 337-46.

53. CM-IN-17913, Freedom to CCS, 23 Apr. 1944; XII TAC Opnl. History.

54. MAAF, Outline Plan for Air Participation in Operation DIADEM, 28 Apr. 1944; memo for Eaker from Cannon, 27 Apr. 1944; ltr., Eaker to Arnold, 7 May 1944; MAAF Opns. Order 35, 12 May 1944; MATAF Opnl. Instr. 1, 7 Mar. 1944; MATAF Opnl. Direc. 10-11 of 10 May 1944; MATAF, Opn. DIADEM, pp. 1, 2; Hq. AAI Opns. Order 1, 5 May 1944.

55. Coffin Rpt., I, 47-48; History, 5th Army, V, 33; MAAF, Opns. in Support of DIADEM, I, 7; Hq. AAI Opns. Order 1, 5 May 1944. The story of DIADEM is nicely summarized in SACMED Report, Pts. II-III, pp. 9-27, 37-48.

56. History, 5th Army, V, 37-99; MAAF Isums 78-80; RAF Med. Review 7; numerous cables, AFHQ to WD, 12-23 May 1944, esp. CM-IN-20698, Hq. AAI to AFHQ, 25 May 1944. For the story of the ground fighting to the capture of Rome, see Clark, *Calculated Risk*, pp. 346-64.

57. History, 5th Army, V, 101-14; MAAF Isums 79-81; RAF Med. Review 7. See also CM-IN-20698, Hq. AAI to AFHQ, 25 May 1944; War Dept. Ger. Mil. Doc. Sec., German Operations at Anzio, pp. 102-10.

58. History, 5th Army, V, 117-67; MAAF Isums 81-82; RAF Med. Review 7; numerous cables from AFHQ to the WD, 23 May-5 June 1944, especially

CM-IN-2379, Freedom to CCS, 2 June 1944; JCS (Slessor) 1794, The Effect of Air Power in a Land Offensive, 18 June 1944.

59. Ltrs., Eaker to Arnold, 7 and 22 May 1944; MATAF Opnl. Direcs. 10-11 of 10 May 1944; MAAF Isum 79, 22 May 1944; CM-IN-9080, MAAF to WD, 12 May 1944; ltr., Eaker to Giles, 13 May 1944; MATAF, Opn. DIADEM, pp. 10, 15; MAAF Opns. Order 35, 12 May 1944; MASAF Intops Sums. 295-97, 12-14 May 1944; MATAF Int/Opsums 397-400 of 12-15 May 1944; MATAF ORB 1944, p. 24; XII TAC Opnl. History; SACMED Rpt., Pts. II-III, p. 9; Clark, *Calculated Risk*, pp. 346-47.

60. Coffin Rpt., Annex G, pp. 203-11; MAAF, Opns. in Support of DIADEM; MATAF, Opn. DIADEM; MAAF, Interdiction of Italian Railways, Weekly Status Rpt., 7-17 May 1944.

61. Coffin Rpt., Annex G, pp. 203-5; MAAF, Interdiction of It. RR, Weekly Status Rpts., 10-25 May 1944; MATAF, Opn. DIADEM, pp. 16-17; Rpt. by Chief Engineer, State Railways, It. Min. of Comm., Status of Italian Railways, 16 Mar.-3 June 1944, in files of BAM (AHB); MATAF Int/Opsums 404-11, 19-26 May 1944; CM-IN-17009, AFHQ Command Post to WD, 22 May 1944; AAFEB MTO Rpt., Vol. I, Pt. II, Sec. III.

62. Coffin Rpt., Annex G, pp. 199-211; MAAF, Assess. of Air Opns. against Comm.; MAAF, Interdiction of It. RR, Weekly Status Rpts., 18 May-8 June 1944; MATAF, Opn. DIADEM, pp. 17-18, 35-38, and Annex F; It. Min. of Comm., Status of Italian RR; MATAF Int/Opsums 411-20, 26 May-4 June 1944; 42d BW Stinopsums 126-37, 20-31 May 1944; 57th BW Opnl. and Intel. Sums. of 20-31 May and 1-2 June 1944.

63. MAAF, Outline Plan for Air Participation in Opn. DIADEM, 28 Apr. 1944; History, 15th AF, II, 186, and I, 456-57; ltr., Eaker to Arnold, 7 May 1944; Coffin Rpt., Annex G, pp. 203-5; MAAF, Interdiction of It. RR, Weekly Status Rpts., 7-17 and 18-25 May 1944; MASAF Intops Sums. 297-318, 14 May-4 June 1944; MAAF Isum 80, 29 May

NOTES TO PAGES 390-93

1944; msg., 15th AF to All Wings and 205 Gp., 16-18 and 21 May 1944.

64. History, 15th AF, I, 456-57; MASAF Intops Sums. 305-9, 22-26 May 1944. See also msg., Eaker to Twining, NT189IE, 21 May 1944; msg., Twining to All Wings and 205 Gp., FAF-D-226, 21 May 1944.

65. Coffin Rpt., Annex G, pp. 205-7; MASAF Intops Sums. 308-10 and 318-21 of 25-27 May and 4-7 June 1944; CMOS 164-65, 167 of 4-5, 7 June 1944; MAAF Isums 80-81 of 29 May, 5 June 1944; msg., Spaatz to Twining thru Eaker, IE616CS, 24 May 1944; msg., Twining to All Wings and 205 Gp., 25-26 May 1944; ltr., USSTAF, Overall Direction for Support of Ground Operations by 15th AF, 16 May 1944; redline msg., USSTAF to MAAF and 15th AF, IE 642 CS, IE 650 CS, IE 661 CS, IE 165 CS, of 30-31 May, 2, 12 June 1944.

66. Numerous cables, esp. CM-IN-15431, Hq. AFHQ CP to WD, 20 May; CM-IN-11577, CG AFHQ to WD, 15 May; CM-IN-20376, CG AFHQ CP to WD, 26 May 1944; MATAF, Opn. DIADEM, pp. 10, 14; XII TAC Opnl. History.

67. Opns. of Brit., Indian, and Dominion Forces in Italy, Pt. II, Sec. F; CM-IN-23052, AFHQ Adv. to CCS, 29 May 1944, quoting Alexander; CM-IN-18613, AFHQ CP to WD, 25 May 1944; CM-IN-2379, Freedom to CCS, 2 June 1944; telecon, Eaker and Giles, 20 May 1944; MATAF, Opn. DIADEM, p. 14; XII TAC Opnl. History; Norstad, Airlock in Italy; ltr., Slessor to Arnold, 12 July 1944.

68. CM-IN-23052, AFHQ Adv. to CCS, 29 May 1944, quoting Alexander; CM-IN-18613, AFHQ CP to WD, 25 May 1944; memos for MAAF Historian from MAPRW A-2 Sec., 20 May, 1 and 8 June 1944.

69. MATAF, Opn. DIADEM, pp. 28, 31; CMOS 141-65, 12 May-5 June 1944; History, XII FC, May-June 1944; MACAF, Mare Nostrum 35-40, 18 May-22 June 1944; RAF Med. Reviews 7 and 9; MAAF Isums 79-84, 22 May-26 June 1944; Eaker interview by Albert F. Simpson, 24-25 Jan. 1950.

70. MATAF, Opn. DIADEM, p. 33; 12th AF, Troop Carrier Opns., 1944, pp.

51-52; MATAF ORB 1944, pp. 28-29.

71. Ltr., Eaker to Arnold, 22 May 1944; MATAF, Opn. DIADEM, pp. 2-3; MAAF Isum 79, 22 May 1944; MAAF, Opns. in Support of DIADEM.

72. RAF Med. Review 8, p. 47; MASAF Intops Sum. 297, 14 May 1944; MAAF A-2 Sec., GAF Operations in the First Week of the Offensive; 15th AF, Target Folders on Reggio Emilia and Piacenza.

73. RAF Med. Review 8, p. 47; MASAF Intops Sum. 310, 27 May 1944; MAAF Isum 81, 5 June 1944; msg., 15th AF to All Wings and 205 Gp., 24 and 26 May 1944; History, 15th AF, II, 170.

74. MAAF Isums 79-83; MATAF Int/Opsums 397-420, 12 May-4 June 1944; RAF Med. Review 7, pp. 50-60, *passim*; MAAF, Opns. in Support of DIADEM, Vol. I, Tab T, Vol. II, Tab K, Vol. VIII, Tab V.

75. RAF Med. Review 7, pp. 49-50, 57-60; MAAF Isums 79-83, 22 May-19 June 1944; MATAF Int/Opsums 397-420, 12 May-4 June 1944; MAAF, Opns. in Support of DIADEM, Vol. II and Vol. VII, Tab V; Technical Data Folder, file II J/90/904, in files of BAM (AHB); MATAF, Opn. DIADEM, pp. 43, 44, and Annex F; greenline msg., Darcy to Cannon, JC 11 TD, 13 May 1944; msg., Eaker to Twining, NT 177 IE, 13 May 1944; MAAF A-2 Sec., GAF Opns. in First Week of Offensive; Mare Nostrum 35, 18 May 1944; ltr., Eaker to Arnold, 31 Aug. 1944.

76. Coffin Rpt., III, p. 39; RAF Med. Review 7, pp. 59-60; MAAF Isums 79-83; MATAF Int/Opsums 397-420, 12 May-4 June 1944; MAAF, Opns. in Support of DIADEM, Vol. VII, Tab V; memo for Feldluft-Gaukommando XXVIII from GHQ Luftflotte 2, 4 June 1944 in Trans. VII/16, BAM (AHB), 3 Jan. 1947.

77. MATAF Int/Opsums 397-438; MAAF, Opns. in Support of DIADEM, Vol. VII, Tab V; MAAF Isums 79-83, 22 May-19 June 1944; RAF Med. Review 7, pp. 50-60.

78. Ltrs., Eaker to Arnold, 22 May and 1 June 1944; MAAF, Opns. in Support of DIADEM, Vol. IV, App. K, Efforts of MAAF, and Vol. VII, App. V.

79. MATAF, Opn. DIADEM, p. 4 and Annexes C-E; JCS (Slessor) 1794, The

Effect of Air Power in a Land Offensive; msg., Wilson to Brit. C/S, MEDCOS 118, 2 June 1944; MAAF Isum 80, 29 May 1944; 12th AF Adm. History, Pt. 1.

80. Hq. XII TAC, Rpt. on Forward Movement of Airfields; MATAF, Rpt. on Opn. DIADEM, pp. 3-4; ltr., MATAF to MAAF, 23 July 1944; XII TAC Opnl. History.

81. Msg., Air Min. for Brit. C/S from Wilson, MEDCOS 118, 2 June 1944; MATAF, Opn. DIADEM, p. 24; green-line msg., Darcy to Cannon, JC 28 TD, 2 June 1944; MAAF Isum 81, 5 June 1944; AAI Isums 46-47 of 24 May, 1 June 1944; MAAF, Assess. of Air Opns. against En. Comm.

82. MATAF Int/Opsum 421, 5 June 1944; MAAF, Assess. of Air Opns. against En. Comm.; MAAF Dir. of Opns., Air Force Participation in "Diadem," 31 July 1944; ltr., Eaker to Arnold, 22 May 1944; CM-IN-8000, Hq. AAI to AFHQ, 8 June 1944; AAI Isums 46-47, on 24 May, 1 June 1944; Norstad, Airlock in Italy; MAAF, Isum 82, 12 June 1944.

83. MATAF, Opn. DIADEM, p. 27; AFHQ Isum 94, 12 June 1944.

84. AAI Isum 49, 15 June 1944; AAF-EB, MTO, Vol. I, Pt. VII, pp. 24-26; Norstad, Airlock in Italy; MAAF, Assess. of Air Opns. against En. Comm.; MATAF, Opn. DIADEM, pp. 24-25 and App. B; MAAF Intel. Sec., TAF Attacks on Enemy Supply Lines (Central Italy); MAAF, Opns. in Support of DIADEM, VII, Annex V; XII TAC Opnl. History; MATAF Int/Opsums 420-31, 4-15 June 1944; MAAF Isum 83, 19 June 1944.

85. Memo for Marshall from Arnold, 15 Apr. 1944, quoting ltr., Eaker to Arnold. See also CM-IN-2379, Freedom to CCS, 2 June 1944.

86. Generals Devers, Clark, and Leese were outspoken in their praise. See ltr., Eaker to Arnold, 22 May 1944; Hq. MATAF, Opn. DIADEM, p. 28, and msg., Clark to Cannon; CM-IN-2379, Freedom to CCS, 2 June 1944. For Allied superiority on D-day of DIADEM see Coffin Rpt., III, Pt. 5, and MAAF, Opns. in Support of DIADEM.

87. MATAF, Opn. DIADEM, p. 42; Canadian Hist. Sec. (GS, Army Hq.)

Report 20; JCS (Slessor) 1794, 18 June 1944.

88. JCS (Slessor) 1794, The Effect of Air Power in a Land Offensive, 18 June 1944.

89. For good discussions of these points, see History, MAAF, I, 212-13, and JCS 1794, as cited above. See also, Hq. 5th Army Training Memo 1, Air Support of Ground Operations, 9 Mar. 1944; MAAF, Opns. in Support of DIADEM, VII, 22.

90. History, 5th Army, VI, 9-10; CM-IN-8000, Hq. AAI to AFHQ, 8 June 1944; MATAF, Opn. DIADEM, p. 5.

91. MATAF, Control and Disposition of TAF Units in Italy Immediately Before and After the Capture of Rome, 22 May and 28 May 1944; MATAF, Disposition and Order of Battle of TAF Units, etc., 27 May 1944; MATAF, Fighter Control Organization of TAF, etc., 30 May 1944; MATAF Opnl. Diracs. 12 and 13, 5 June 1944; MATAF, Opn. DIADEM, pp. 7-8; MATAF ORB 1944, pp. 28, 30; msg., MATAF to DAF Adv. et al., A703, 6 June 1944.

92. CM-IN-9820, MAAF to WD, 12 June 1944.

93. For air operations and the status of the interdiction program, 5-17 June, see AFHQ Isum 94, 12 June 1944; AAI Isum 49, 15 June 1944; MATAF Int/Opsums 421-34, 5-18 June 1944, esp. suppl. to 426, 10 June 1944; CMOS 165-78, 5-18 June 1944; MAAF Intel. Sec., TAF Attacks on Enemy Supply Lines (Central Italy); MAAF, Interdiction of It. RR, Weekly Status Rpt., 16 June 1944; 57th BW Opnl. and Intel. Sums. of 4-17 June 1944; 42d BW Stinopsums 141-54, 4-17 June 1944; CM-IN-14956, MAAF to WD, 18 June 1944. For details of ground advance, see History, 5th Army, VI, 19-46 and numerous cables from AFHQ to Washington, 5-16 June 1944.

94. MATAF Int/Opsums 433-44, 17-28 June 1944, especially 434 of 19 June; MAAF, Interdiction of It. RR, Weekly Status Rpts., 22, 29 June 1944; MATAF, Opn. DIADEM, p. 18. See also CM-IN-23018, Hq. AAI to AFHQ, 28 June 1944; AAI Isum 50, 21 June 1944; Coffin Rpt., Annex G.

95. The best accounts of MAAF's

shuttle missions to Russian bases during the summer of 1944 are in MAAF, The History of FRANTIC, 26 Oct. 1943-15 June 1944, and 15th AF, Operations FRANTIC I, III, IV. See also 15th AF Misc. Docs., Feb. 1943-July 1944 and Aug. 1944-Apr. 1945. For Strategic's operation over Italy on 22 June, see MASAF Intops Sum. 336, 22 June 1944; MAAF Isum 84, 26 June 1944. See also MAAF Isums 85-86 of 3, 10 July 1944. Figures on strength of the Fifteenth are from History, 15th AF, I, 63 ff. and 68 ff.

96. AAF Reference History 21, Special Operations, AAF Aid to European Resistance Movements, 1943-1945, pp. 28, 81-87, 223; RAF Med. Review 7, pp. 82-87.

97. AAFRH-21, pp. 88, 126; RAF Med. Review 8, p. 107.

98. MATAF files in AFSHO photostats; History, 57th BW to 15 Nov. 1944, p. 24; History, 87th FW, June 1944, and Periodical Opnl. Sums., 1 May-20 June 1944; RAF Med. Review 8, pp. 7-9. SACMED Rpt., Pts. II-III, pp. 24-25. For planning for BRASSARD during the spring, see, for example, CM-IN-20513, CG AFHQ to WD, 27 Apr. 1944; CM-IN-11539, AFHQ to WD, 15 May 1944; MATAF ORB 1944, *passim*, esp. p. 19, which notes that plans had been prepared by mid-April 1944.

99. MASAF Intops Sum. 331, 17 June 1944; MATAF ORB 1944, *passim*.

100. CM-IN-15631, AFHQ to AGWAR, 18 June 1944; greenline msg., Darcy to Cannon, JC 71 TD, 18 June 1944, Leese to Cannon, FL 60 TD, 17 June 1944; MATAF ORB 1944, p. 34; RAF Med. Review 8, pp. 8-9; MACAF, Mare Nostrum 41, 29 June 1944.

101. History, 5th Army, VI, 19-45, 107-8; numerous cables, AFHQ to Washington, 5-21 June 1944.

102. History, 5th Army, VI, 19-46, 49-51. See also cables, AFHQ to Washington, 16-25 June 1944; CM-IN-23018, Hq. AAI to AFHQ, 28 June 1944.

103. History, 5th Army, VI, 51-111; AFHQ Isums 95-101; RAF Med. Review 8, pp. 1-25. See also numerous cables, AFHQ to Washington, 25 June-15 Aug. 1944; MAAF Isums 84-91, 26 June-14 Aug. 1944.

104. MATAF ORB 1944, p. 32; XII TAC, Rpt.: Forward Movement of Airfields; History of Aviation Engineers in MTO; XII TAC Daily Isums 433-43, 20-30 June 1944; Adv. Hq. DAF Daily Isums 21-29, 20-30 June 1944; MAAF Isum 85, 3 July 1944; 87th FW Isums 55-65, 20-30 June 1944.

105. MATAF Int/Opsums 447-60, 1-14 July 1944; XII TAC Opnl. History; XII TAC Isums 444-57, 1-14 July 1944; 87th FW Isums 66-79, 1-14 July 1944; 57th BW Opnl. and Intel. Sums. 1-14, 1-14 July 1944; 42d BW Stinopsms 165-75, 2-14 July 1944; MAAF Isums 86-87 of 10, 17 July 1944; RAF Med. Review 8, pp. 12, 14.

106. History, 5th Army, VI, 51-111; AFHQ Isums 95-101; RAF Med. Review 8, pp. 1-25. See also numerous cables, AFHQ to Washington, 25 June-15 Aug. 1944, and MAAF Isums 84-91, 26 June-14 Aug. 1944.

107. MATAF Opnl. Instr. 2, 7 July 1944; Adm. History, 12th AF, Vol. I, Pt. 3; Adm. History, XII TAC, 1 July-15 Nov. 1944; MATAF ORB 1944, p. 39; RAF Med. Review 8, p. 17.

108. MATAF Opnl. Instr. 2, 7 July 1944; MATAF ORB 1944, p. 39.

109. 12th AF Adm. History, Pt. 2; RAF Med. Review 8, pp. 17-18.

110. MATAF Int/Opsums 464-81, 18 July-4 Aug. 1944; MAAF Isum 88, RAF Med. Review 8, p. 18; MATAF Opnl. Instr. 2, Annex A, 7 July 1944.

111. XII TAC, Rpt.: Forward Movement of Airfields; TWX, Eaker to CG MASAF *et al.*, 22 June 1944; History, 12th AF, Vol. V, Annex 11 (an unidentified and undated doc., Construction of Tactical Airfields in Italy, 29 May-17 July 1944); MATAF, Opn. DIADEM, P. 9.

112. CMOS 192-99, 1-8 July 1944; MATAF Int/Opsums 447-54, 1-8 July 1944.

113. Loose Minutes to SASO on Northern Belt of Interdiction, sgd. by Maj. W. H. Malloy, 15 June 1944; MATAF Opnl. Direc. 14, 17 June 1944; ltr., 12th AF to CIO MATAF, Communications Targets in Northern Italy, 21 June 1944; TWX, Cannon to CIO

NOTES TO PAGES 403-9

MATAF, n.d.; MATAF, Opn. MALLORY MAJOR, 15 Jan. 1945.

114. MATAF, Opn. DIADEM, p. 23; greenline msg., Darcy to Cannon, JC 65 TD, 18 June 1944, Cannon to Darcy, TD 21 JC, 23 June 1944; MATAF ORB 1944, pp. 33, 35; MATAF Opnl. Direc. 14, 17 June 1944; MATAF, Opn. MALLORY MAJOR; msg., MATAF to MAAF, A874, 22 June 1944; msg., MATAF to CG, 42d BW *et al.*, A907, 26 June 1944.

115. MATAF Opnl. Direc. 15, 11 July 1944; MATAF ORB 1944, pp. 35, 38; MATAF, Opn. MALLORY MAJOR.

116. MATAF Opnl. Direc. 15, 11 July 1944; MATAF, Opn. MALLORY MAJOR; MATAF, Monthly Air Intel. and Opns. Bull. 1, Nov. 1944, pp. 39-42.

117. Hq. 15th AF, memo for Maj. B. S. Magill from A-2 Analysis, 20 June 1944; ltr., MATAF to 57th BW *et al.*, 11 July 1944.

118. MAAF, Interdiction of It. RR, Weekly Status Rpt., 21 July 1944; CMOS 203-6, 12-15 July 1944; greenline msg., Cannon to Webster *et al.*, RW 28 JC, 15 July 1944; MATAF, Opn. MALLORY MAJOR; MATAF Int/Opsums 458-61, 12-15 July 1944.

119. MAAF, Interdiction of It. RR, Weekly Status Rpt., 21 July 1944; CMOS 207-11, 16-20 July 1944; MATAF, Opn. MALLORY MAJOR; MATAF Int/Opsums 462-66, 16-20 July; 57th BW, Opnl. and Intel. Sums. 16-20, 16-20 July 1944; 42d BW Stinopsums 177-81, 16-20 July 1944.

120. MAAF, Interdiction of It. RR, Weekly Status Rpt., 4 Aug. 1944; CMOS 212-26, 21 July-4 Aug. 1944; MATAF, Operation DIADEM, p. 23; MATAF, Opn. MALLORY MAJOR; MATAF Int/Opsums 466-80, 21 July-4 Aug. 1944; MAAF Isums 88-89 of 24, 31 July 1944.

121. MATAF, Opn. MALLORY MAJOR; MATAF Opnl. Direc. 15, 17 July 1944.

122. MATAF Opnl. Instr. 2, 7 July 1944; Adm. History, 12th AF, Vol. I, Pt. III; Adm. History, XII TAC, 1 July-15 Nov. 1944; MATAF Form 540, p. 39; RAF Med. Review 8, p. 17; MATAF, Opn. MALLORY MAJOR; MATAF Int/Opsums 458-80, 12 July-4 Aug. 1944; XII TAC Isums 559-70, 16-27 July 1944;

87th FW Isums 76-96, 11-31 July 1944.

123. MAAF Isums 85-86; Hq. 15th AF, Weekly Sum. of Opns.; RAF Med. Review 8; MASAF Intops Sum. 350, 6 July 1944; MAPRW/PIR 6229, 6 July 1944; MAAF, Interdiction of It. RR, Weekly Status Rpt., 13 July 1944; CMOS 197, 6 July 1944.

124. MASAF Intops Sum. 355, 11 July 1944; CMOS 202, 11 July 1944.

125. 15th AF, Weekly Sum. of Opns., 6 Aug. 1944; MAAF Isum 90; RAF Med. Review 8, p. 20; MASAF Intops Sum. 357, 377-78 of 13 July, 2-3 Aug. 1944; MAAF, Interdiction of It. and Southern France RR, Weekly Status Rpt., 10 Aug. 1944; CMOS 204, 13 July 1944.

126. MACAF, Mare Nostrum 41-46; XII FC monthly histories, March-Aug. 1944 (Annex 3, History, XII FC); MAAF Isums 84-90; MAAF, Monthly Stat. Sums. 5-10; MATAF ORB 1944, pp. 35, 38.

127. MAAF, Interdiction of It. RR, Weekly Status Rpts., 4, 11 Aug. 1944; AFHQ Isums 100-101; MATAF, Opn. DIADEM, p. 23.

128. MATAF, Opn. DIADEM; MATAF Monthly Air Intel. and Opns. Bull. 1, Nov. 1944; MAAF, Interdiction of It. RR, Weekly Status Rpts., 4, 11 Aug. 1944; AFHQ Isums 100-101; Koerner, Rail Transportation Problems in Italy.

129. History, 5th Army, VII, 3; SACMED Rpt., Southern France, p. 17.

NOTES TO CHAPTER 12

1. Report by the Supreme Allied Commander, Mediterranean, to the Combined Chiefs of Staff on the Operations of Southern France, Aug. 1944, p. 1 (cited hereinafter as SACMED Rpt., S. France); Hq. MAAF, Air Plans II, Planning for Operation ANVIL: Selected Papers Illustrating Air, 22 Aug. 1944.

2. CCS Memo for Information 165, 2 Dec. 1943; 5th Plenary Mtg., President and Prime Minister, SEXTANT: CCS 133d Mtg., 3 Dec. 1943; CCS 426/1, 6 Dec. 1943; CCS 424, 5 Dec. 1943.

3. CCS 424, App. B, 5 Dec. 1943; CM-IN-3950, AFHQ to AGWAR, 6 Jan. 1944; msg., CCS to Eisenhower, FAN 283, 6 Dec. 1943; ltr., AFHQ to C-in-C

Med., Air C-in-C Med., 29 Dec. 1944; History of MAAF, I, 123-25, VII, 3, 5; CM-IN-11741, AFHQ to AGWAR, 17 Jan. 1944; The Seventh United States Army, Report of Operations, France and Germany, 1944-1945, I, 3 (cited hereinafter as 7th Army History).

4. CCS 424, 5 Dec. 1943; CCS 136th Mtg., 5 Dec. 1943.

5. SACMED Rpt., Italian Campaign, Pts. II-III, p. 2; CCS 465/11, 24 Feb. 1944; CCS 147th Mtg., 25 Feb. 1944. For discussions in January and February (including Eisenhower's early recommendations) see CCS 465/1-465/7, 465/10 of 26, 31 Jan., 4, 4, 6, 8, 21 Feb. 1944; JPS 379/1-379/2, 379/4/D of 27, 29 Jan., 20 Feb. 1944; JCS 658/1-658/3 of 30 Jan., 5, 20 Feb.; CM-IN-16428, Brit. C/S to JSM, 23 Feb. 1944; CM-IN-16251, Freedom to Brit. C/S, 22 Feb. 1944; CM-IN-15721, ETOUSA to WAR, 22 Feb. 1944; CM-OUT-8837, JCS for Eisenhower, 21 Feb. 1944; CM-IN-14254, Brit. C/S to JSM, 19 Feb. 1944; CM-IN-18714, Brit. C/S to AFHQ, 26 Feb. 1944; CM-IN-4797, Algiers to WAR, 7 Mar. 1944; CM-IN-15567, AFHQ to WD *et al.*, 21 Mar. 1944. For some of the planning in the theater in winter of 1944, see ltr., Eaker to Arnold, 29 Feb. 1944; CM-IN-16314, 17889, and 6281 Algiers to WAR, 26, 29 Dec. 1943 and 10 Jan. 1944; CM-IN-20286, AFHQ to Brit. C/S, 29 Jan. 1944. For Force 163's difficulties with planning because of the lack of a firm decision by the CCS as to the strategic concept and the size of the force to be employed, see CM-IN-11741, AFHQ to AGWAR, 17 Jan. 1944; CM-IN-5520, Freedom to Brit. C/S, 8 Feb. 1944.

6. CCS 465/11, 24 Feb. 1944; CCS 147th Mtg., 25 Feb. 1944; CM-IN-16428, Brit. C/S to JSM, 23 Feb. 1944; CM-IN-18714, Brit. C/S to AFHQ, 26 Feb. 1944.

7. CM-IN-16251, Freedom to Brit. C/S, 22 Feb. 1944; CCS 465/12, 23 Mar. 1944; memo for Arnold from Hansell, n.d.; ltr., Eaker to Arnold, 6 Mar. 1944; CM-IN-20198, AFHQ to Brit. C/S, 28 Feb. 1944; ltr., Eaker to Wilson, 19 Mar. 1944; cables, Wilson to Brit. C/S, MEDCOS 904, 20 Feb. and MEDCOS 41, 22 Feb. 1944.

8. CCS 465/13-465/14 of 24, 28 Mar.

1944. See also CM-IN-20328, Brit. C/S to JSM, 28 Mar. 1944; CM-OUT-22575, Marshall to Eisenhower, 13 Apr. 1944.

9. CCS 152d Mtg., 31 Mar. 1944; CCS 465/12-465/15, 23, 24, 30, 30 Mar. 1944; CM-IN-15429, Marshall from Eisenhower, 21 Mar. 1944. See also, CM-OUT-6709, Marshall to Eisenhower, 16 Mar. 1944; CM-IN-10593, AFHQ to AGWAR, 15 Mar. 1944; CM-OUT-14078, Marshall to Eisenhower, 25 Mar. 1944; CM-IN-15567, AFHQ to WD *et al.*, 21 Mar. 1944. For a good summary of the status of preparations for ANVIL on 15 March, see CM-OUT-8861, CCS to Deane and Burrows, 21 Mar. 1944.

10. SACMED Rpt., It. Campaign, Pts. II-III, pp. 2-3; CCS 465/16-465/22 on 3, 4, 7, 8, 8, 17, 18 Apr. 1944; CM-IN-13977, JSM to AFHQ, 19 Apr. 1944; CM-OUT-22575, Marshall to Eisenhower, 13 Apr. 1944. When the U.S. chiefs accepted the British view (CCS 465/20, 8 Apr. 1944) they added that as a result of the decision to cancel ANVIL the United States would not divert any landing craft from the Pacific to the Mediterranean and would re-examine U.S. resources destined for the latter. (See, e.g., CM-IN-4879, Brit. C/S to JSM, 7 Apr. 1944.)

11. JCS 162d Mtg., 9 May 1944; CCS 158th Mtg., 28 Apr. 1944; SAC Conferences, 20, 23-24 Apr. 1944, in BAM (AHB); MC-IN-14752 and MC-OUT-3238, Wilson to Air Min. *et al.*, 23 Apr., 13 May 1944; CM-IN-17913, Freedom to CCS, 23 Apr. 1944; CM-IN-6593, AFHQ to AGWAR, 8 May 1944; CM-IN-1325, AFHQ to AGWAR for OPD, 1 May 1944; CM-IN-128, AFHQ to Brit. C/S, 29 Apr. 1944. For the continuing planning see, e.g., CM-IN-11908, AFHQ to WD *et al.*, 16 Apr. 1944; CM-IN-21180, AFHQ to AGWAR, 27 Apr. 1944; CM-IN-13590, AFHQ to Brit. C/S, 17 May 1944; CM-IN-17586, AFHQ to AGWAR, 23 May 1944; 7th Army History, I, 11-22; JCS 841/1, 1 May 1944.

12. CCS 163d Mtg., 11 June 1944; CM-IN-9167, SHAEF to WD, 11 June 1944.

13. CCS 164th Mtg., 13 June 1944; telecon, Gen. Handy and Gen. Hull, WD-TC-553, 12 June 1944.

14. CCS 164th Mtg., 13 June 1944; CM-

IN-11530, CCS to AFHQ and SHAEF, 14 June 1944.

15. SAC Confs., 53d and 54th Mtgs., 16-17 June 1944; CM-IN-16273, CG AFHQ to WD, 19 June 1944; SACMED Rpt., It. Campaign, Pts. II-III, p. 32; SACMED Rpt., S. France, p. 15. Wilson had long been interested in an amphibious operation against Istria or Genoa in connection with a continuing campaign in Italy. (See, e.g., CM-IN-15567, AFHQ to WD *et al.*, 21 Mar. 1944.)

16. SAC Confs., 53d and 54th Mtgs., 16-17 June 1944; msg., Alexander to Wilson, MA 1364, 8 June 1944; msg., Norstad to Slessor, A674, 9 June 1944, both in BAM (AHB); interview with Marshal Alexander by Sidney Matthews, 10-15 Jan. 1949; interview with Gen. Eaker by Albert F. Simpson, 24-25 Jan. 1950; SACMED Rpt., It. Campaign, Pts. II-III, p. 33; Clark, *Calculated Risk*, pp. 368-72.

17. SAC Conf., 54th Mtg., 17 June 1944. See also AFHQ, Implications of Alternative Operations in Support of OVERLORD, 15 June 1944, in BAM (AHB); CM-IN-16273, CG AFHQ to WD, 19 June 1944; SACMED Rpt., It. Campaign, Pts. II-III, p. 33.

18. SAC Conf., Special, 19 June 1944; CM-IN-11950, SHAEF to WD, 15 June 1944; SACMED Rpt., Pts. II-III, pp. 34-35; Clark, *Calculated Risk*, pp. 380-81.

19. CM-IN-16273, CG AFHQ ACP to WD *et al.*, 19 June 1944; MC-IN-9157, Wilson to CCS, 19 June 1944, and msg., Wilson to Eisenhower *et al.*, 19 June 1944, both in BAM (AHB); SAC Conf. 55, 19 June 1944; MC-OUT-5837A, Wilson to Gammell, 22 June 1944, in BAM (AHB); CM-IN-19511, Eisenhower to AGWAR for CCS and AFHQ for Wilson, S54425, 23 June 1944; TWX, Pankhurst to Slessor, DAP 683, 23 June 1944; Butcher, *My Three Years with Eisenhower*, p. 589. Eisenhower's position continued to be that if ANVIL could not be launched then several divisions should be sent from AAI to OVERLORD. (See e.g., CM-IN-19511, Eisenhower to AGWAR for CCS *et al.*, 23 June 1944.)

20. CCS 603-603/4 of 24, 27, 27, 28 June, 1 July 1944.

21. Butcher, *Three Years*, p. 601; Eisenhower, *Crusade in Europe*.

22. CCS 603/15-603/16, 603/18-603/19, 603/22, 5, 5, 10, 11, 22 Aug. 1944; Brit. C/S Mtgs. 262, 267 on 7, 10 Aug. 1944, in BAM (AHB); CM-IN-76552, JCS to Eisenhower *et al.*, 5 Aug. 1944; SACMED Rpt., S. France, p. 23; Butcher, *Three Years*, pp. 634-35.

23. MC-IN-1116, CCS to Wilson, 2 July 1944; SAC Confs., 60th Mtg., 3 July 1944; CM-IN-4622, AFHQ to SHAEF, 5 July 1944.

24. AFHQ memo for C-in-C Med. and Air C-in-C Med., 2 July 1944; ltr., SACMED to Air C-in-C Med. *et al.*, 7 July 1944; MAAF, Opns. in Support of DRAGON, Vol. II; SAC Conf. 7, 9 July 1944; CM-IN-06400, Hq. AAF Adv. to AFHQ, 6 July 1944; 5th Army History, VII, 3; 7th Army History, I, 45-57.

25. MATAF, Rpt. on Opn. DRAGON, p. 7; ltr., Eaker to Saville, 12 July 1944; CM-IN-4797, Algiers to WAR, 7 Mar. 1944. For the early assumption that the commander of XII TAC would be responsible for fighter cover and close support, see Hq. MATAF, Opn. ANVIL Opnl. Direcs. 1, 3 of 30-31 Jan. 1944 and ltr., MAAF to AOC NATAF, 28 Dec. 1943.

26. Ltr., SACMED to C-in-C Med. *et al.*, 7 July 1944; MAAF, Opns. in Support of DRAGON, Vol. II; 7th Army History, I, 57-63; Hq. 7th Army, ANVIL Outline Plan, 13 July 1944 and FO 1, ANVIL, 29 July 1944; SACMED Rpt., S. France, pp. 2-4. Western Task Force, Preliminary Report of Invasion of Southern France, has excellent maps of the invasion area.

27. WNTF, ANOR-1, 24 July 1944; Hq. MATAF, Outline Plan, Opn. ANVIL, 8 July 1944, and Annex B; Hq. XII TAC, Opn. ANVIL Opns. Order 1, 28 July 1944, and Annexes 2 and 3 and CTF 88, 1 Aug. 1944. Among the craft were twenty-four LCT's sent down by Eisenhower. (See MC-IN-17144, Eisenhower to AGWAR for CCS, 26 June 1944.)

28. For the earlier air plans see MATAF, Opn. ANVIL Opnl. Direcs. 1 of 30 Jan. 1944 (together with Amnd. 1 of 10 Feb.), 2-4 of 31 Jan. 1944, and 5-6 of 3 Mar. 1944; MAAF, Outline Air Plan for Operation ANVIL, MAAF/P-1 (Adv.), 17 Mar. 1944; plans data in His-

tory, MAAF, VII, 5; MATAF Form 540, 1944, p. 17; CM-IN-19807, MAAF to AGWAR, 28 Feb. 1944. For air plans after ANVIL became firm see Hq. MATAF, Outline Plan, Opn. ANVIL, 8 July 1944; MATAF Opnl. Instr. 3, 6-8 of 4, 7-8 Aug. 1944; MATAF, Outline Plan, NUTMEG, 27 July; MAAF, Outline Plan, Opn. ANVIL, MAAF/P-1 (final), 12 July 1944; MAAF Opns. Instr. 58, 13 July 1944; XII TAC, Outline Plan, Opn. NUTMEG, 24 July 1944; XII TAC Opn. ANVIL Opns. Order 1, 28 July 1944; ltr., Eaker to Arnold, 16 July 1944. See also MAAF, Progress of Air Planning for Operation ANVIL, 3 Mar. 1944, Annexes A-J; MATAF, Rpt. on Opn. DRAGOON, pp. 5-8.

29. Ltr., Eaker to Arnold, 16 July 1944; JCS 197, MAAF to AMSSO, 10 July 1944, in BAM (AHB).

30. MAAF, Outline Plan, Opn. ANVIL, MAAF/P-1 (final), 12 July 1944; History, MAAF, I, 123-25.

31. SAC Confs. of 12, 22, 26-28 July, 1 Aug.; MATAF, Report upon the Air Aspect of Cover Plan Operations in the Genoa Area, 18 Aug. 1944; msg., Wilson to Air Min. *et al.*, MEDCOS 155, 5 July 1944; Hq. A, F/44/64, Plan FERDINAND (approved version), 28 July 1944; CCS 603/6-603/7 of 5, 7 July 1944; JPS 485/1, 6 July 1944; CM-IN-7363, CCS to AFHQ, 8 July 1944; CM-IN-4623, AFHQ to CCS, 5 July 1944; incl. to ltr., Eaker to Arnold, 7 Aug. 1944; SACMED Rpt., S. France, pp. 20-21.

32. MATAF, Opnl. Instr. 3, Bombing Plan, Opn. DRAGOON, 4 Aug. 1944.

33. See, especially, ltr., Eaker to Arnold, 16 July 1944.

34. History, AAFSC/MTO, 1 Jan.-30 June 1944, chap. i, pp. 69-75, chap. v, pp. 432-39; Hq. AAFSC/MTO, AAFSC/MTO in the Invasion of Southern France; Hq. AAFEC/MTO, History of Aviation Engineers in MTO; Hq. AAFEC/MTO, Airfield Construction in Corsica, 10 Aug. 1944; Hq. 12th AF, XII AFSC in Opn. DRAGOON; Outline History, Corsica Air Sub-Area; ltrs., Hq. MAAF to AOC NATAF, 28 Dec. 1943, to AOC NACAF *et al.*, 29 Dec. 1943, and to CG AAFEC/MTO, 5 Jan. 1944; ltr., MAAF to CG NAASC, 29 Dec. 1943; MAAF, Outline

Plan for Opn. ANVIL, Pt. II, 12 July 1944; Hq. XII AFSC Opn. ANVIL Adm. Order 10, 23 or 25 July 1944; Hq. MAAF, A Preliminary Appreciation of MAAF to Support an Assault Against the South of France, 23 Dec. 1943; MACAF, Opns. in Support of Invasion of Southern France; CM-IN-17731, Algiers to WAR, 28 Dec. 1943; incl. 1 to ltr., Eaker to Arnold, 7 Apr. 1944; Report by Col. Eaton, A-4, MAAF, quoted in History, MAAF, I, 224-25; MATAF ORB 1944 (1 Jan.-15 July), *passim*.

35. MACAF, Opns. in Support of Invasion of S. France; MATAF, Rpt. on Opn. DRAGOON, pp. 8-10; MATAF ORB 1944 (1 Jan.-15 July), *passim*; Adm. History, 12th AF, Vol. I, Pt. III.

36. History, Avn. Engineers in MTO; Airfield Construction in Corsica. See also Hq. MAAF, A Preliminary Appreciation . . . , 23 Dec. 1943, and ltr., MAAF to CO AAFEC/MTO, 5 Jan. 1944; MACAF, Opns. in Support of Invasion of S. France; MAAF, Opns. in Support of DRAGOON, I, 3 and Annex H.

37. Ltrs., MATAF to AAI, 7, 20 July 1944; ltr., MATAF to MAAF, 5 July 1944; JCS 175, MAAF to AMSSO, 6 July 1944; MATAF Opnl. Instr. 2, 7 July 1944; MATAF ORB 1944, pp. 36-39; TWX, TAF (Italy) to MAAF *et al.*, A12, 19 July 1944; memo for All Concerned from Adv. Hq. AAI, 20 July 1944; MATAF Adm. Instr. 10, 16 July 1944; RAF Med. Review 8, p. 17; ltr., Eaker to Arnold, 16 July 1944.

38. Ltr., AFHQ, Report on Airborne Operations in DRAGOON; SAC Conf. (sp.), 17 June 1944; msg., Eisenhower to AGWAR for CCS and to AFHQ for Wilson, S54424, 23 June 1944; msg., Wilson to Air Min. for Brit. C/S and to Britman for U.S. JCS *et al.*, MEDCOS 131, 23 June 1944; CM-IN-21965, Wilson to SHAEF, 26 June 1944; msg., Norstad sgd. Spaatz to Eaker, IE 787 CS and IE 791 CS, 27 June 1944; MC-IN-3664, Eisenhower to AFHQ, 6 July 1944; CM-IN-4622, AFHQ to SHAEF, 5 July 1944. Troop Carrier forces available for DRAGOON finally totaled 415 aircraft and crews, 389 glider pilots, and 393 gliders. (MATAF, Rpt. on Opn. DRAGOON, p. 25. For paratroopers serving as infan-



try, see particularly CM-IN-246, Algiers to WAR, 31 Dec. 1943; CM-IN-7933, AFHQ to Brit. C/S, 11 Feb. 1944; AFHQ, Report on Airborne Operations in DRAGOON.)

39. Hq. PTCAD, Report of Opn. DRAGOON, 22 Aug. 1944, pp. 9-10, 36; MC-IN-3664, Eisenhower to AFHQ, 6 July 1944; Aircraft and Glider Assembly in MTO; History, AAFSC/MTO, 1 July-31 Dec. 1944; MATAF ORB 1944, pp. 38-39.

40. MC-IN-1116, CCS to Wilson, 2 July 1944; MC-OUT-1230, Wilson to Alexander, 5 July 1944.

41. MATAF Int/Opsums 448-81, 2 July-4 Aug. 1944; XII TAC Opnl. History.

42. History, 15th AF, I, 353, II, 188-89; CMOS 196, 202-3, 208, 215-16 of 5, 11-12, 17, 24-25 July 1944; MASAF, Operations in Support of the Landings in Southern France; MATAF, Rpt. on Opn. DRAGOON, p. 13; MASAF Intops Sums. 346-77, 2 July-2 Aug. 1944.

43. AAF Reference History 21, Special Operations: AAF Aid to European Resistance Movements, 1943-1945, pp. 67-75.

44. The record of these operations is found in MATAF, Rpt. on Opn. DRAGOON, pp. 13, 17; MATAF Int/Opsums 478-87, 1-10 Aug. 1944; MASAF Weekly Sum. of Opns., 31 July-6 Aug. 1944; AFHQ Isum 102; MASAF Intops Sums. 376-86, 1-11 Aug. 1944. See also MATAF Opnl. Instr. 3, 4 Aug. 1944; MASAF, DRAGOON Opns. Instr. 2, 9 Aug. 1944; MAAF, Interdiction of Railways in Southern France and Northern Italy, Weekly Status Rpt., 17 Aug. 1944; XII TAC Opnl. History; SACMED Rpt., S. France, p. 21.

45. MATAF, Rpt. on Opn. DRAGOON; AFHQ Isum 102; MATAF Int/Opsum 486, 9 Aug. 1944.

46. MASAF Weekly Sum. of Opns., 31 July-6 Aug. 1944.

47. MATAF Int/Opsums 478-87, 1-10 Aug. 1944; MASAF Intops Sums. 376-86, 1-11 Aug. 1944.

48. MATAF Opnl. Instr. 3, 4 Aug. 1944; XII TAC, Detailed Plan, Opn. NUTMEG, 5 Aug. 1944; XII TAC Opns. Order 4, 6 Aug. 1944; MASAF,

DRAGOON Opns. Instr. 2, 9 Aug. 1944.

49. The NUTMEG operations are from MATAF Int/Opsums 487-91, 10-14 Aug. 1944; XII TAC Isums 10-14 Aug. 1944; various unit histories; MAAF, Opns. in Support of DRAGOON, I, 14; CMOS 232-36, 10-14 Aug. 1944; MASAF Intops Sums. 385-90, 10-15 Aug. 1944; MASAF, Opns. in Support of Landings in S. France; 15th AF, Operation DRAGOON (which includes reports from each bomb. wing and group); XII TAC Opnl. History; History, 15th AF, I, 353; TWX, MAAF to MATAF *et al.*, n.d. but obviously 10 Aug. 1944; CM-IN-11214, CG MAAF to WD, 12 Aug. 1944; MAAF Intel. Sec., Operation "Dragoon," Attacks on Enemy Radar Stations, 25 Aug. 1944, which indicates that fewer than a third of the twenty-two radar sites attacked were knocked out.

50. MAAF, Signals Report on Opn. DRAGOON, Dec. 1944; MACAF, Opns. in Support of Invasion of S. France, 2 Oct. 1944, p. 31; Western Task Force, Invasion of S. France, pp. 45, 177.

51. MATAF Opnl. Instr. 8, 8 Aug. 1944; MATAF, Report on Airborne Diversion, MATAF/33/AIR; MAAF, Signals Rpt. on Opn. DRAGOON, pp. 12-13; Hq., 334th QM Depot Supply Co. (AB), Report on Airborne Diversion in Support of Operation DRAGOON, 16 Aug. 1944.

52. Report of Naval Comdr., WTF, Invasion of Southern France, p. 179; Statement of Generalmajor Bieringer, Feldkommandant of Var Dist., quoted in MATAF, Rpt. on DRAGOON; MAAF, Opns. in Support of DRAGOON, Vol. XI, Annex B (P/W Intrs.).

53. AFHQ Isums 96-103, 26 June-21 Aug. 1944; MAAF Intel. Sec., Mil. Liaison Br., The Germany Army, Southern France, 13 Aug. 1944; 7th Army History, 1944-45, I, 32-35; MATAF, Rpt. on Opn. DRAGOON, I, 4-5.

54. AAFEB rpt., MTO; 7th Army History, I, 37-44.

55. History, XII FC, Aug. 1944; MACAF, Mare Nostrum 51, 1 Sept. 1944; MACAF, Opns. in Support of Invasion of S. France.

56. PTCAD, Rpt. of Opn. DRAGOON; History, 437th TCG, Aug.

1944; AFHQ, Rpt. on Abn. Opns. in DRAGOON; TWX's 70, 71, 73, Cannon to Saville, 15 Aug. 1944; greenline msg., Williams to Cannon, JCo2PW, JC12PW, JC13PW, 10 and 15 Aug. 1944; MAAF, Signals Rpt. on Opn. DRAGOON, App. J; 12th AF, Troop Carrier Opns. 1944, pp. 53, 55, 58. For the planning see PTCAD, Tactical Air Plan for Opn. ANVIL, 29 July 1944; PTCAD FO 1, 7 Aug. 1944; Statistical Report of Operation DRAGOON in Hq. IX TC Comd. ltr., Operation DRAGOON, 13 Sept. 1944; Histories, 51st TCW and 62d TCG, Aug. 1944.

57. 7th Army History, I, 108-9.

58. MATAF Opnl. Instr. 3, 4 Aug. 1944; XII TAC, Detailed Plan, Opn. YOKUM, 1 Aug. 1944, and Opns. Order 4, 6 Aug. 1944; MASAF, DRAGOON Opns. Instr. 2, 9 Aug. 1944; Rpt. of Naval Comdr., WTF, pp. 252-56; MAAF, Opns. in Support of DRAGOON, I, 15-16, V, Annex H; CMOS 237, 15 Aug. 1944; MASAF Intops Sum. 390, 15 Aug. 1944; 15th AF, Opn. DRAGOON; CM-IN-15089, CG AFHQ Adv. to WD, 17 Aug. 1944; XII TAC Opnl. History. See also greenline msg., Saville to Cannon, JC16GS, JC19 thru 22GS, 15 Aug. 1944.

59. Rpt. of Naval Comdr., WTF, pp. 49-51; 7th Army History, I, 105.

60. AAFEB rpt., MTO, 18 Nov. 1944, Vol. I, Secs. III and V; MATAF, Rpt. on Opn. DRAGOON, Pt. IV. See also Hq. 42d BW, DRAGOON Opn., 16 Oct. 1944; History, 15th AF, I, 461-63; Rpt. of Naval Comdr., WTF, p. 190; AFHQ G-2 Field Rpt. for 15 Aug. 1944.

61. Rpt. of Naval Comdr., WTF, pp. 53, 184-90, 252-56; AFHQ G-2 Field Rpt. for 15 Aug. 1944; 7th Army History, I, 119-45; CM-IN-15089, CG AFHQ Adv. to WD, 17 Aug. 1944; ltr., Lt. Col. W. K. Wyant, 7th Army to Lt. Col. James Parson, MAAF, 11 Nov. 1944.

62. Ltr., Eaker to Arnold, 21 Aug. 1944; ltr., Eaker to Giles, 21 Aug. 1944. See also greenline msg., Cannon to Darcy, TD40JC, 15 Aug. 1944, quoting msg. from Patch.

63. MAAF, Opns. in Support of DRAGOON, Vol. XI, Annex B, Vol. XII, Annex C; MATAF, Rpt. on Opn. DRAGOON, p. 18; greenline msg., Saville to Cannon, JC22GS, 15 Aug. 1944.

64. XII TAC Isum 590, 16 Aug. 1944; MATAF, Rpt. on Opn. DRAGOON, p. 37; MATAF Int/Opsum 492, 15 Aug. 1944; 15th AF Weekly Sum. of Opns., 20/8/44, Tab B; msg., Saville to Cannon, JC20GS and JC24GS, 15 Aug., and JC-33GS, 17 Aug. 1944; ltr., Hq. 5th BW to CG 15th AF, DRAGOON Opn., 28 Sept. 1944; 55th Bombardment Wing Missions in Connection with Operation DRAGOON, n.d.; 42d BW Int/Opsum 201, 15 Aug. 1944; 42d BW, DRAGOON Opns., 16 Oct. 1944; 57th BW Int/Opsum 15, 15 Aug. 1944, and Rpt. on Bombings in Opn. DRAGOON, 16 Sept. 1944; 12th AF, Medium Bomber Opns., 1 Jan.-28 Aug. 1944, p. 87; MAAF, Opns. in Support of DRAGOON, I, 19-20; History, MAAF, I, 242; 7th Army History, I, 104-5.

65. History, 2d Air Combat Control Sq., 17 Nov. 1944; 64th FW, Rpt. on Opn. DRAGOON, 26 Sept. 1944; Rpt. of 2d AAC(S), Opn. DRAGOON, 1 Sept. 1944; MAAF, Signals Rpt. on Opn. DRAGOON, Dec. 1944, pp. 13-17.

66. PTCAD, Rpt. of Opn. DRAGOON; AFHQ, Rpt. on Abn. Opns. in DRAGOON; History, 437th TCG, Aug. 1944; 7th Army History, I, 119-49. A good summary of the landings and first ten days of advance is in CM-IN-25551, AFHQ to WD, 27 Aug. 1944; SACMED, S. France, p. 25.

67. 15th AF Weekly Sum. of Opns., 20 Aug. 1944, Tab B; 42d BW Int/Opsum 202, 16 Aug. 1944, and DRAGOON Opns., 16 Oct. 1944; 57th BW Int/Opsum 16, 16 Aug. 1944 and Rpt. on Bombings in DRAGOON, 16 Sept. 1944; Medium Bomber Opns., p. 89; MATAF Int/Opsum 493, 16 Aug. 1944; XII TAC Isum 591, 17 Aug. 1944; Rpt. of Naval Comdr., WTF, p. 55; MATAF, Rpt. on Opn. DRAGOON, p. 41.

68. MATAF Int/Opsums 493-94, 16-17 Aug. 1944; MATAF, Rpt. on Opn. DRAGOON, I, 44.

69. 7th Army History, I, 171-72, 179.

70. MAAF, Opns. in Support of DRAGOON, Vol. V, Annex H; TWX, MATAF to XII TAC Adv. *et al.*, A387, 20 Aug. 1944; CM-IN-19571, AFHQ to

WD, 21 Aug. 1944; ltr., Eaker to Arnold, 31 Aug. 1944; CM-IN-18219, CG AFHQ Adv. to WD, 19 Aug. 1944; MACAF, Opns. in Support of Invasion of S. France; XII TAC Opln. History; CM-IN-15958, AFHQ Adv. to WD, 17 Aug. 1944. For the details of the GAF's order of battle and for its weak offensive and defensive operations, see MAAF Isums 91-93 of 14, 21, 28 Aug. 1944; AFHQ Isum 103, 23 Aug. 1944; MATAF, Rpt. on Opn. DRAGOON, p. 46; msg., Saville to Cannon, JC30GS, 16 Aug. 1944; MATAF, Int/Opsums 492-97, 15-20 Aug. 1944; Rpt. of Naval Comdr., WTF, pp. 46-64; CM-IN-18219, CG AFHQ Adv. to WD, 19 Aug. 1944; CM-IN-17010, CG AFHQ Adv. to WD, 18 Aug. 1944; CM-IN-15958, AFHQ to WD, 17 Aug. 1944. For the German U-boat campaign see ltrs., Eaker to Arnold, 31 Aug. 1944, and Patch to Eaker, with attachment, 13 Oct. 1944.

71. XII TAC Isums 589, 592 of 15, 18 Aug. 1944; MATAF Int/Opsums 493, 497 of 16, 20 Aug. 1944; msg., Saville to Cannon, JC52GS, 21 Aug. 1944; MAAF Isum 93, 28 Aug. 1944; AFHQ Isum 104, 30 Aug. 1944; Rpt. of Naval Comdr., WTF, pp. 57, 73; MASAF Intops Sums. 390-95, 15-20 Aug. 1944.

72. Msgs., Cannon to Saville, GS97JC, GS98JC, GS103JC, GS121JC, GS31JC, 20-22, 25 Aug.-1 Sept. 1944; Rpt. of Naval Comdr., WTF, pp. 74-88; 7th Army G-2 Rpts. 3-4 on 19 Aug; XII TAC, Tactical Opns., a rpt. prepared by XII TAC for AAFEB; XII TAC Isums 590-96; XII TAC, Invasion of S. France, n.d.; TWX, XII TAC Adv. to 87th FW *et al.*, EA44, 17 Aug. 1944; msg., Eaker to Cannon, JC154IE, 20 Aug. 1944; msg., Cannon to Eaker, IE123JC, 21 Aug. 1944; msgs., Saville to Cannon, JC70GS, JC67GS, 25 Aug. 1944; ltrs., Eaker to Arnold, 31 Aug., 18 Sept. 1944; AFHQ Isum 103, 23 Aug. 1944; CM-IN-25585, CG AFHQ to WD, 27 Aug. 1944; MASAF Intops Sums. 392-403, 17-28 Aug. 1944; msgs., CG XII TAC to CG MATAF, 17, 20, 22 Aug. 1944; 7th Army History, 1944-45, I, 171, 185, 224-25; 7th Army G-2 Rpts. 3-14 of 18-29 Aug. 1944; 57th BW Int/Opsums 21-22, 25-28; 42d BW, DRAGOON Opns., 26 Oct. 1944; CM-IN-

19890, AFHQ Adv. to WD, 21 Aug. 1944; MATAF Int/Opsums 494-97, 17-20 Aug. 1944.

73. MAAF, Interdiction of RR in S. France and N. Italy Weekly Status Rpts., 17, 28 Aug. 1944; RAF Med. Review 8, pp. 24-25; MATAF Int/Opsums 498-99, 21-22 Aug. 1944.

74. MAAF, Interdiction of RR in S. France and N. Italy Weekly Status Rpts., 17, 28 Aug. 1944; 5th Army History, VII, 23-28; MASAF Intops Sums. 395-403, 20-28 Aug. 1944; MATAF Int/Opsums 500-505, 23-28 Aug. 1944.

75. Msgs., Cannon to Saville, GS97JC, GS98JC, GS103JC, GS121JC, GS31JC, 20-22, 25 Aug., 1 Sept. 1944; Rpt. of Naval Comdr., WTF, pp. 74-88; 7th Army G-2 Rpts. 3-14 of 18-29 Aug.; XII TAC, Tactical Opns., a rpt. prepared by XII TAC for the AAFEB; XII TAC Isums 590-96; XII TAC, Invasion of S. France, n.d.; TWX, XII TAC Adv. to 87th FW *et al.*, EA44, 17 Aug. 1944; msg., Eaker to Cannon, JC154IE, 20 Aug. 1944; msg., Cannon to Eaker, IE123JC, 21 Aug. 1944; msgs., Saville to Cannon, JC70GS, JC67GS of 25 Aug. 1944; ltr., Eaker to Arnold, 31 Aug. with incl., TWX from 7th Army; ltr., Eaker to Arnold, 18 Sept. 1944; AFHQ Isum 103, 23 Aug. 1944; CM-IN-25585, CG AFHQ to WD, 27 Aug. 1944; MASAF Intops Sums. 392-403, 17-28 Aug. 1944; msgs., CG XII TAC to CG MATAF, 17, 20, 22 Aug. 1944; 7th Army History, 1944-45, I, 171, 185, 224-25; 57th BW Int/Opsums 21-22, 25-28; 42d BW, DRAGOON Opns., 26 Oct. 1944; CM-IN-19890, AFHQ Adv. to WD, 21 Aug. 1944; MATAF Int/Opsums 494-97, 17-20 Aug. 1944.

76. Msgs., Saville to Cannon, n.n., 24 Aug., and JC51GS, JC47GS, JC60GS, JC69GS, 21, 20, 24-25 Aug. 1944; History, Avn. Engineers in MTO; Rpt. of Naval Comdr., WTF, pp. 64, 74-88; XII AFSC in Opn. DRAGOON, pp. 28-47; ltrs., Eaker to Arnold and Giles, both 21 Aug. 1944; CM-IN-25585, CG AFHQ to WD, 27 Aug. 1944; MATAF, Rpt. on Opn. DRAGOON, pp. 81-82.

77. Msg., Saville to Cannon *et al.*, JC67GS, 25 Aug. 1944; msgs., Saville to Cannon, JC77GS, JC81GS, 27 and 30 Aug. 1944; 7th Army History, I, 223.

NOTES TO PAGES 435-40

See also CM-IN-24519, CG AFHQ Adv. to WD, 26 Aug. 1944.

78. AFHQ Isums 104-5, 30 Aug., 6 Sept. 1944; msg., Cannon to Saville, GS-27JC, 30 Aug. 1944; MATAF, Rpt. on Opn. DRAGOON.

79. Rpt. of Naval Comdr., pp. 218-22, 259, 285, 60-83; msg., Cannon to Saville, GS86JC, GS42JC, GS91JC, GS94JC, 17, 18, 19 Aug. 1944; Saville to Cannon, JC34GS, 17 Aug. 1944; 42d BW, DRAGOON Opns.; msg., MATAF to 42d BW *et al.*, 17 Aug. 1944; Rpt. on Bombings by 57th BW in Opn. DRAGOON; MATAF, Rpt. on Opn. DRAGOON, Pt. IV, pp. 164-75; 42d BW Int/Opsums 204-6, 18-20 Aug. 1944; 7th Army History, I, 155-62; ltrs., Eaker to Arnold, 31 Aug., 2 Sept. 1944; ltr., Patch to Eaker, with incl., 13 Oct. 1944; XII TAC Opnl. History; MATAF Int/Opsums 494-97, 17-20 Aug. 1944.

80. Msgs., Cannon to Saville, GS110JC, GS113JC, GS114JC of 24 Aug., GS115-JC and GS120JC of 25 Aug., GS129JC, 26 Aug. 1944; CM-IN-25585, CG AFHQ to WD, 27 Aug. 1944; msg., Saville to Cannon, JC65GS, 24 Aug., JC6765, TD-28GS, 25 Aug., JC75GS and JC77GS, 27 Aug. 1944; Rpt. of Naval Comdr., pp. 75-87, 221; 42d BW, DRAGOON Opns., Rpt. on Bombings by 57th BW; 57th BW Int/Opsums 24-27; 42d BW Int/Opsums 210-13; XII TAC Isums, 20-25 Aug. 1944; msg., CG XII TAC to CG MATAF, E271A, 27 Aug. 1944; 7th Army History, I, 162-67; MATAF Int/Opsums 497-503, 20-26 Aug. 1944.

81. Various cables, 7th Army to WD, 1-12 Sept. 1944, especially CM-IN-2340 and CM-IN-7390, 1 and 7 Sept. 1944; CM-IN-2718, Freedom sgd. Wilson to Brit. C/S, 3 Sept. 1944; 7th Army History, I, 193-220, 250-72; XII TAC Opnl. History.

82. History, Avn. Engineers in MTO; msg., Saville to Cannon, n.n., 24 Aug. and 28 Aug., JC69GS, 25 Aug., JC69GS, 31 Aug. 1944; msg., Cannon to Eaker, IE133JC, 24 Aug., to Saville, GS119JC, 25 Aug., to XII TAC Adv. *et al.*, A76, 27 Aug. 1944; Histories, 79th, 324th, 57th, 86th Ftr. Gps., 415th Night Ftr. Sq., 111th T/R Sq., 47th Bomb. Gp. (L), Aug.-Sept. 1944; ltr., Eaker to Spaatz,

28 Sept. 1944; MAAF GO 17, 20 Sept. 1944; MATAF ORB, 1944, pp. 45-46; MAAF, RAF Orgn. Memo 43, 11 Sept. 1944.

83. Ltr., Eaker to Arnold, 18 Sept. 1944; CMOS 252-68, 30 Aug.-15 Sept. 1944; MATAF Int/Opsums 508-22, 1-15 Sept. 1944.

84. 7th Army History, I, 286; XII TAC Opnl. History. Concerning plans for Eisenhower to take over control of DRAGOON forces and Ninth Air Force to take over XII TAC, see CM-IN-8277, CG SHAEF to WD *et al.*, 9 Sept. 1944; CM-OUT-26119, Marshall to Eisenhower, 6 Sept. 1944; CM-IN-4369, AFHQ to Brit. C/S, 6 Sept. 1944; CM-IN-4490, SHAEF to WD *et al.*, 5 Sept. 1944; CM-IN-17110, SHAEF to WD *et al.*, 14 Sept. 1944; and CM-IN-10997, Octagon to WD *et al.*, 12 Sept. 1944.

NOTES TO CHAPTER 13

1. CM-OUT-23930, Marshall to Eisenhower and Devers, 1 Sept. 1944; CM-OUT-26119, Marshall to Eisenhower, 6 Sept. 1944; Mark Clark, *Calculated Risk*, pp. 394-437.

2. Ltr., CG MATAF to CG MAAF, TAF/156/1/Orgn., 5 July 1944; memo to All Concerned of Conference between Generals Eaker and Spaatz on 29-30 July 1944; interview with Gen. Eaker by Albert F. Simpson, 24-25 Jan. 1950.

3. Msgs., Cannon to Saville, GS119JC, 25 Aug., to Eaker, IE129JC, 25 Aug. 1944; to XII TAC, 87th FW, TWCAS A76, n.d.; msg., Darcy to Saville, GS44TD, 25 Aug. 1944.

4. SAC Conference, SAC (44) (Sp.), 20 Aug. 1944; ltr., Eaker to Arnold, 21 Aug. 1944.

5. 8th Army Intel. Sums. (Isums) 790-98, 26 Aug.-4 Sept. 1944; AFHQ Weekly Isums 104-5, 28 Aug., 4 Sept. 1944; AAI Weekly Isums 49, 60 of 31 Aug., 6 Sept. 1944; Hq. AAI, Operations Instruction 3, 16 Aug. 1944; msg., Wilson to Brit. C/S, JSM for U.S. C/S, MEDCOS 181, 2 Sept. 1944; Eaker interview by A. F. Simpson; Report by the SACMED to the CCS on the Italian Campaign, Pt. III, pp. 52-53, 56-60 (hereinafter cited as SACMED Rpt., It. Campaign).

6. Ltrs., Eaker to Devers, 30 Aug., and to Giles, 31 Aug. 1944; msg., Wilson to Brit. C/S, JSM for U.S. C/S, MEDCOS 181, 2 Sept. 1944.
7. Ltrs., Eaker to Devers, 30 Aug., and to Giles, 31 Aug. 1944; CM-OUT-26119, Marshall to Eisenhower, 6 Sept. 1944.
8. CM-IN-4490, personal from Marshall sgd. Eisenhower, 6 Sept. 1944; msg., SHAEF Fwd., sgd. Eisenhower for CCS, SACMED for Wilson, USSTAF for Spaatz, SHAEF Main for ETO, Brit. C/S, SCAF 77, 9 Sept. 1944.
9. Msg., CCS to SHAEF Main, SHAEF Fwd., AFHQ, FACS 76 for Eisenhower, FAN 413 for Wilson, 13 Sept. 1944; CCS 674, 11 Sept. 1944; CCS 674/1, 12 Sept. 1944.
10. CCS, 172d Mtg., OCTAGON Conf., 12 Sept. 1944; CCS 677, 12 Sept. 1944; CCS 677/1, 13 Sept. 1944.
11. CCS 677, 12 Sept. 1944; CCS 680/2, 16 Sept. 1944.
12. Hq. USSTAF DSM's 4 and 5 of 5 and 6 Oct. 1944; Minutes of Conference Held in Office of Gen. Spaatz, 7 Oct. 1944; ltr., Spaatz to Arnold, 16 Oct. 1944; ltr., Arnold to Spaatz, 2 Nov. 1944; telecon, Eaker and Giles, 13 Dec. 1944; ltr., Eaker to Giles, 21 Dec. 1944; ltr., Giles to Eaker, 28 Dec. 1944.
13. CCS 773, 31 Jan. 1945; CCS 773/1, 1 Feb. 1945; CCS 773/2, 1 Feb. 1945; CCS 773/3, 17 Feb. 1945; CCS, 185th Mtg., 2 Feb. 1945; msg., CCS to Eisenhower, FACS 151, and to Alexander, FAN 501, 2 Feb. 1945.
14. Hq. MATAF, Blockade, The Isolation of Italy from the Reich by Mediterranean Allied Tactical Air Force, 29 Aug. 1944-1 May 1945 (hereinafter cited as MATAF, Blockade), p. 23; Report by Field-Marshal the Viscount Alexander of Tunis on the Italian Campaign, 12th December 1944-2d May 1945 (draft) (hereinafter cited as Alexander, It. Campaign).
15. Msg., MATAF to DAF Adv., XII TAC Adv. and Rear, 242 Gp., 62d FW, 63d FW, MACAF, MAAF, *et al.*, A141, 12 July 1944; Hq. MATAF, Opnl. Direc. 16, 6 Aug. 1944.
16. Adv. Hq. DAF Daily Isums 65-85, 5-25 Aug. 1944; Hq. MATAF Int/Opsums 482-502, 4-25 Aug. 1944; RAF Mediterranean Review 8, pp. 23, 25.
17. The summary of DAF operations, 26 Aug.-8 Sept. 1944, is taken from Adv. Hq. DAF Isums 86-99; RAF Med. Review 8, p. 30.
18. Hq. MASAF Intops Sums. 402-4, 27-29 Aug. 1944; msg., Cannon to Eaker, IE130JC, 24 Aug. 1944.
19. Msg., Darcy to Saville, GS40TD, 23 Aug. 1944; Hq. 87th FW Isums 117 and 133, 21 Aug. and 6 Sept. 1944; MATAF Int/Opsums 498 and 508, 21 and 31 Aug. 1944.
20. Msgs., Saville to Cannon, JC70CS and JC67GS of 25 Aug., and to Darcy TD28CS, 25 Aug. 1944; msg., Cannon to Saville, GS121JC, 25 Aug. 1944.
21. The diversion of the 350th Fighter Group to offensive operations was part of a three-cornered switch. On 1 September it was decided to transfer the FAF 339th P-39 Squadron from CAF to XII TAC in France; 339th Squadron was replaced in CAF by RAF 251 Wing, and the 350th Group was transferred from Corsica to Italy for employment on Fifth Army front, under the operational control of DAF. (See Min. of Mtg. Held at Advance Hq. DAF on 29 Aug. 1944; Hq. MATAF Opns. Record Book, 1944, pp. 44-45; Hq. MAAF, RAF Orgn. Memo 43, 11 Sept. 1944; Histories, 345th, 346th, 347th Ftr. Sqs., Aug.-Sept. 1944.)
22. SAC Conf., SAC (44), 78th Mtg., 12 Aug. 1944; AAI Opns. Order 3, 16 Aug. 1944; msg., Wilson to Brit. C/S, MEDCOS 181, 2 Sept. 1944; 5th Army History, VII, 19-20.
23. History, 12th AF (draft), Pt. II, chap. x; 57th BW Int/Opsums 1-8, 1-8 Sept. 1944; 42d BW Stinopsums 218-24, 1-9 Sept. 1944; msg., Cannon to Eaker, IE121JC, 20 Aug. 1944; 15th AF Weekly Sum. of Opns., 4-10 Sept. 1944; Hq. MAAF, Interdiction of Communications Weekly Status Rpts., 5, 11, 18 Sept. 1944; MATAF, Blockade, p. 23.
24. 42d BW Stinopsums 224-25, 9-10 Sept. 1944.
25. MATAF Int/Opsums 516-27, 9-20 Sept. 1944; Adv. Hq. DAF Isums 100-111, 9-20 Sept. 1944; RAF Med. Review 8, pp. 39-40.
26. MATAF Opnl. Instr. 10, 8 Sept. 1944; msg., Hq. MATAF to 42d BW;

TWACT L733, L806, L837, L838, L878, L884, all of 9-10 Sept. 1944; 57th BW Int/Opsum 9, 9 Sept. 1944; 42d BW Stinopsum 226, 11 Sept. 1944.

27. Msgs., MATAF to 42d BW, 57th BW, and others, TWACT L715 and L927, 11 Sept. 1944.

28. 57th BW Int/Opsum 12, 12 Sept. 1944; 42d BW Stinopsum 227, 12 Sept. 1944; History, 42d BW, Sept. 1944; 5th Army History, VII, 83.

29. Msgs., MATAF to 42d BW, 57th BW, and others, TWACT L965, L974, L990, L1030, L1035, all of 12-13 Sept. 1944; 57th BW Int/Opsum 13, 13 Sept. 1944; 42d BW Stinopsums 229-30, 13-14 Sept. 1944.

30. Msgs., MATAF to 42d BW, 57th BW, and others, TWACT L1076, L1098, L1135, L1142, all of 14 Sept. 1944; 57th BW Int/Opsums 15-16, 15-16 Sept. 1944.

31. 8th Army Isums 797-810, 3-21 Sept. 1944; AAI Isums 60-62, 6, 13, 22 Sept. 1944; AFHQ Isums 106-8, 11, 18, 25 Sept. 1944; 5th Army History, VII, 119-51.

32. Sum. of DAF Opns., 9-21 Sept., taken from Adv. Hq. DAF Isums 100-113, 9-21 Sept. 1944; RAF Med. Review 8, pp. 35-36.

33. MATAF Opnl. Instr. 9, 25 Aug. 1944; History, 12th AF (draft), Pt. II, chap. x.

34. Msg., DAF Adv. to Hq. MATAF, n.n., 6 Sept. 1944; msg., MATAF to 57th BW, TWACT L635, 5 Sept. 1944; msg., Cannon to Knapp, RK64JC, 5 Sept. 1944; MATAF Opnl. Instrs. 9A and 9B, 5-6 Sept. 1944.

35. Msg., MATAF to TAF (Italy), personal for D'Albiac from Cannon, TWACT L679, 6 Sept. 1944; msgs. MATAF to 42d BW, 57th BW, DAF Adv., TAF (Italy), XII TAC Opns. A, XII TAC Adv., 63d FW, MASAF, 12th AF, MAAF, 87th FW, n.n., 6 Sept. 1944, TWACT L703, L745, L993, 7-9 Sept. 1944; msgs., MATAF to DAF Adv., TWACT L742, L643, L731, L746, 6-8 Sept. 1944; MATAF Opnl. Instrs. 9A and 9B, 5-6 Sept. 1944.

36. 42d BW Stinopsum 229, 14 Sept. 1944; 57th BW Int/Opsum 14, 14 Sept. 1944; Adv. Hq. DAF Isum 105, 14 Sept. 1944.

37. 57th BW Int/Opsums 15-21, 15-21

Sept. 1944; 42d BW Stinopsums 224-36, 9-21 Sept. 1944.

38. AAI Isum 62, 22 Sept. 1944; RAF Med. Review 8, p. 36; MATAF ORB, 1944, p. 47.

39. Msg., Wilson to Brit. C/S, JSM for U.S. C/S, MEDCOS 181, 2 Sept. 1944.

40. AFHQ Isum 108, 25 Sept. 1944. The same optimistic note is in MAAF Air Intelligence Weekly Summary 97, 25 Sept. 1944, and in AAI Intelligence Summary 62, 22 Sept. 1944.

41. Hq. MATAF, Recommended Interdiction of Enemy Communications Northern Italy, 20 Sept. 1944, and Intel. Appreciation 4, 30 Sept. 1944; MATAF, Blockade, pp. 23-24.

42. 42d BW Stinopsums 234, 240 of 22, 30 Sept. 1944; History, 12th AF (draft), Pt. II, chap. x; MAAF, Interdiction of Comms. Weekly Status Rpts., 26 Sept., 1 Oct. 1944; Coffin Rpt., Annex G, Pt. II.

43. History, 12th AF (draft), Pt. II, chap. xi; MAAF, Interdiction of Comms. Weekly Status Rpts. for Oct. 1944; 42d BW Stinopsums 234-40, 22-30 Sept. 1944; 57th BW Int/Opsums, Oct. 1944.

44. Organization of Coastal Air Force, Notes of Meeting Held 1st Sept. 1944; History of MAAF, IA, 257.

45. Msgs., Cannon to Saville, GS32JC, 1 Sept., to Morris, EM79JC, 2 Sept., and Cannon sgd. Spaatz to Chidlaw, IE7CS, 5 Sept. 1944; msg., Chidlaw to Cannon at SHAEF Rear, n.n., 5 Sept. 1944; Hq. XII FC GO 58, 12 Sept. 1944; Hq. MAAF GO 17, 20 Sept. 1944; Hq. MATAF Memo 1, 11 Sept. 1944; msgs., Cannon to Col. Monahan, JM93JC, and to Eaker, IE195JC, 11 Sept. 1944; 12th AF GO's 164, 174, of 11, 19 Sept. 1944.

46. Msg., Eaker to AAFSC/MTO, 12th AF, XII AFSC, MX30546, 7 Sept. 1944; msg., USSTAF sgd. Spaatz to AEA, personal for Royce, SHAEF Fwd. 366/17, 17 Sept. 1944; msg., Cannon sgd. Eaker to Cannon bounce to Vandenberg, JC266IE, 20 Sept. 1944; ltr., Lt. Col. Robert W. Green, Chief, Opns. Sec. and Col. John J. O'Hara, Jr. to CG IX AFSC, 20 Sept. 1944; memo for Gen. Vandenberg from Brig. Gen. R. E. Nugent, Dep. C/S Opns., 21 Sept. 1944; msg., Cannon to Saville, GS105JC, 24 Sept. 1944; msg.,

Eaker to Spaatz, CS238IE, n.d.; msggs., Spaatz to Cannon thru Eaker, IE27CS, JC1CS, 26 Sept. 1944; ltr., Royce to Cannon, 26 Sept. 1944.

47. Hq. AAF/MTO, Min. of Mtg. Held at Caserta, on 27-28 Sept. 1944; msg., Cannon to Eaker for Spaatz, CS1JC, 29 Sept. 1944; msg., Eaker to Spaatz, personal 15, 1 Oct. 1944.

48. Msg., 12th AF sgd. Cannon to CG XII FC, CG XII TAC, TWACT O722, 18 Oct. 1944; Hq. 12th AF GO 201, 19 Oct. 1944.

49. Msg., MATAF to "X" TAC, DAF, TAF (Italy), XII TAC Adv., MASAF, MAAF, AAI Adv., 5th Army, 8th Army, TWAS A431, 18 Sept. 1944.

50. MATAF Opnl. Direc. 17, 12 Sept. 1944; msg., MATAF to A/Cdre. Hudleston, AOCDAF, "X" TAC, TWAS A433, 18 Sept. 1944.

51. Msg. to Hudleston as cited in n. 50; msggs., MATAF to DAF Adv., XII FC, TAF (Italy), TWCAS A542 and A185, 24 Sept., 9 Oct. 1944; RAF Med. Review 9, p. 21; MATAF Opnl. Direc. 21, 3 Nov. 1944.

52. Histories, 47th Bomb. Gp., 27th, 57th, 79th, 86th, and 350th Ftr. Gps., 414th, 416th, and 417th Night Ftr. Sqs., Sept. 1944; XII FC Station List, 26 Sept. 1944.

53. The 57th Group moved to Italy from Corsica early in September but did not become operational until the 27th due to field maintenance. The 86th Group was in the process of moving from Corsica on the 20th, but completed the move quickly and flew its first mission under XII Fighter Command on 22 September. The flight echelon of the 47th Bombardment Group was in France on the 20th but the planes had returned to Italy by the 24th, joining the rear echelon which had moved from Corsica. The 414th Night Fighter Squadron began flying patrols on the 26th. (See Histories, 350th, 57th, and 86th Ftr. Gps., 414th, 416th Night Ftr. Sqs., 47th Bomb. Gp., Sept. and Oct. 1944; History, XXII TAC, 20 Sept.-31 Dec. 1944; Adv. Hq. DAF Isums 111-24, 20 Sept.-4 Oct. 1944; XXII TAC Sum. of Opns., Period 20-30 Sept. 1944.)

54. Hq. MATAF Monthly Air Intel. and Opns. Bull. 1, Nov. 1944.

55. Hq. MATAF Int/Opsums 429-537, 21 Sept.-1 Oct. 1944; Adv. Hq. DAF Isums 111-20, 21-30 Sept. 1944; RAF Med. Review 8, pp. 44-45.

56. MAAF Monthly Stat. Sums. 11-12, Sept.-Oct. 1944; Hq. MATAF, Operations for Months Sept. and Oct., Light and Medium Bomber Operations, and also Fighter and Fighter-Bomber Operations.

57. Adv. Hq. DAF Isums 121-48, 1-31 Oct. 1944; RAF Med. Review 9, p. 21.

58. XII FC Daily Isums 10-22, 1-18 Oct. 1944; XXII TAC Daily Isums 23-34, 19-31 Oct. 1944; RAF Med. Review 9, p. 21; MATAF, Blockade, p. 38.

59. RAF Med. Review 9, pp. 19-20; Adv. Hq. DAF Isums 121-24, 1-4 Oct. 1944.

60. Ltr., CG XXII TAC to CG MATAF, 20 Oct. 1944; ltr., Eaker to Clark, 3 Oct. 1944; extracts from press conference of Gen. Clark, 5th Army, 2 Oct. 1944.

61. History, 12th AF (draft), Pt. II, chap. x; MATAF Opnl. Instr. 13, 10 Oct. 1944; 57th BW Int/Opsums 12-13, 12-13 Oct. 1944; 15th AF Weekly Sum. of Opns., 9-15 Oct. 1944; History, 15th AF, Oct.-Dec. 1944; Hq. 15th AF, Army Cooperation-Bologna, 12 Oct. 1944; 42d BW Stinopsums 246-48, 11-13 Oct. 1944.

62. XII FC Isums 15-17, 11-13 Oct. 1944; History, 12th AF (draft), Pt. II, chap. x.

63. Hq. 5th Army G-2 Rpt. 424, Annex A, 3 Nov. 1944. See also Hq. 5th Army, PRU Report on Targets in Bologna Area Attacked on 12 Oct. 1944, and G-2 Sec., Interrogation Center Report 814, IPW, 19 Oct. 1944; RAF Med. Review 9, p. 19.

64. XII FC Isums 19-22, 14-18 Oct. 1944; XXII TAC Isums 23-25, 19-21 Oct. 1944; Hq. 5th Army G-2 Rpt 424, Annex A, 3 Nov. 1944.

65. SAC Conf., SAC (44) 112, 23 Oct. 1944; msg., SACMED to CCS, MEDCOS 205, 24 Oct. 1944; CM-IN-28407 and CM-IN-3954, Adv. Hq. AAI to AFHQ, personal for Wilson for approval prior to dispatch to Marshall and Brooke, 30 Oct. and 4 Nov. 1944; CM-IN-5691, AFHQ to War Cabinet Offices, JSM for U.S. JCS, 6 Nov. 1944; ltr., Hq. 5th Army to CG

II Corps, CG IV Corps, GOC XIII Corps, GOC 6SA Armored Div., 2 Nov. 1944; ltr., Adv. Hq. AAI to CG 5th Army, GOC 8th Army, CG MATAF, 20 Nov. 1944; AAI Opns. Order 4, 28 Nov. 1944; 5th Army Opns. Instr. 36, 29 Nov. 1944; SACMED Rpt., It. Campaign, Pt. III, pp. 82-84.

66. 57th BW Int/Opsums 14-31, 14-31 Oct. 1944, and 1-3, 1-3 Nov. 1944; 42d BW Stinopsums 249-60, 14 Oct.-3 Nov. 1944; XXII TAC Isums 26-34, 22 Oct.-1 Nov. 1944.

67. CM-IN-9804, Wilson to Brit. C/S, JSM for U.S. C/S, 9 Oct. 1944; msg., Wilson to Brit. C/S, JSM for U.S. C/S, MEDCOS 205, 24 Oct. 1944; SAC Conf., SAC (44) 112, 23 Oct. 1944, and 103d Mtg., 24 Oct. 1944; CM-IN-5601, AFHQ to War Cab., JSM for U.S. C/S, 4 Nov. 1944.

68. Msg., AFHQ to WD, MEDCOS 210, 22 Nov. 1944; SAC Conf., 113th Mtg., 21 Nov. 1944; CCS 677/2-677/5, 31 Oct., 17, 21, 24 Nov. 1944; SACMED Rpt., It. Campaign, Pt. III, pp. 84, 88.

69. AFHQ Isums 114-15, 6 and 13 Nov. 1944; Adv. Hq. DAF Isums 154-56, 7-9 Nov. 1944; 42d BW Stinopsum 264, 7 Nov. 1944; MATAF Int/Opsums Bull. 1, Nov. 1944; RAF Med. Review 9, p. 25.

70. 57th BW Int/Opsums 13-20, 13-20 Nov. 1944; 42d BW Stinopsum 269, 15 Nov. 1944; RAF Med. Review 9, p. 26; SACMED Rpt., It. Campaign, Pt. III, p. 84.

71. MATAF Opnl. Instr. 15, 19 Nov. 1944; 57th BW Int/Opsums 21-24, 21-24 Nov. 1944; MATAF Int/Opsum Bull. 1, Nov. 1944.

72. Adv. Hq. DAF Isums 166-69, 21-24 Nov. 1944; RAF Med. Review 9, p. 26; SACMED Rpt., It. Campaign, Pt. III, pp. 85-87.

73. RAF Med. Review 9, p. 26; AAI Isum 71, 28 Nov. 1944.

74. Hq. MATAF, Rec. Interdiction of Enemy Comm. N. Italy, 20 Sept. 1944, and Intel. Appre. 4-5, 30 Sept., 28 Oct. 1944.

75. Msg., MATAF to TAF (Italy), n.n., 29 Aug. 1944; msg., TAF (Italy) to MATAF, n.n., 30 Aug. 1944; Loose Minute, Maj. W. N. Mallory, MATAF Target Sec. to W/Cdre. D. I. Wiseman,

Chief Intel. Off., MATAF, 31 Aug. 1944, with note from W/Cdre. Wiseman to SASO.

76. MATAF, Blockade, pp. 22-23; MAAF Opns. Instr. 83, 13 Sept. 1944; msg., Pottenger to MAAF, TWACT A538, 24 Sept. 1944; msg., Cabell to Cannon, sgd. Eaker, 25 Sept. 1944.

77. MASAF Intops Sums. 401-4, 410, 26-29 Aug., 4 Sept. 1944; 15th AF Weekly Sum. of Opns., 21-27 Aug., 28 Aug.-3 Sept., 4-10 Sept. 1944; Coffin Rpt., Annex G, Pt. II; 57th BW Int/Opsums 29-31, 29-31 Aug. 1944 and 1, 1 Sept. 1944; 42d BW Stinopsums 215-17, 29-31 Aug. 1944; Hq. MAAF, Interdiction of Comm. Weekly Status Rpt., 5 Sept. 1944.

78. 57th BW Int/Opsums 22-30, 22-30 Sept. 1944; MATAF, Blockade, p. 25.

79. MASAF Intops Sum. 429, 23 Sept. 1944; 15th AF Weekly Sum. of Opns., 18-24 Sept. 1944; Coffin Rpt., Annex G, Pt. II; MAAF, Interdiction of Comm. Weekly Status Rpt., 26 Sept. 1944.

80. Hq. MATAF Intel. Appre. 4, 30 Sept. 1944; msg., MAAF to MASAF and MATAF, MX 32896, 1 Oct. 1944.

81. 42d BW Stinopsums 241-59, 1-31 Oct. 1944; History, 12th AF, Pt. II, chap. xi; MATAF, Blockade, p. 33; MASAF Intops Sums. 447, 459, 10 and 23 Oct. 1944; MATAF, Interdiction of Comm. Weekly Status Rpts., 9, 16, 23, 30 Oct. 1944; MATAF, Blockade, p. 33.

82. MATAF, Rec. Interdiction of Enemy Comm. N. Italy, 20 Sept. 1944, and Intel. Appre. 4, 30 Sept. 1944; MASAF Intops Sum. 440, 4 Oct. 1944; 15th AF Weekly Sum. of Opns., 2-8 Oct. 1944; 42d BW Stinopsums 242, 248-53, 3 and 13-20 Oct. 1944; MAAF, Interdiction of Comm. Weekly Status Rpts., 9, 16, 23 Oct. 1944.

83. MASAF Intops Sums. 446, 456, 10 and 20 Oct. 1944; 15th AF Weekly Sums. of Opns., 9-15, 16-22 Oct. 1944; msg., 15th AF to All Wings and XV FC, 15th AF D1976, 22 Oct. 1944; A-3 Planning Mtg., 22 Oct. 1944.

84. MATAF Intel. Appre. 5, 28 Oct. 1944.

85. For Allied contemporaneous intelligence see: AFHQ Isums 111-13, of 16, 23, 30 Oct. 1944; AAI Isums 59-62, 65-67 of 31 Aug.-22 Sept., 19 Oct.-1 Nov. 1944;



MAAF, Interdiction of Comm. Weekly Status Rpts., Sept. and Oct. 1944; MATAF Intel. Appre. 5, 28 Oct. 1944; MATAF Intops Bull. 1, Nov. 1944.

86. AAI Isum 63, 29 Sept. 1944; MATAF Intel. Appre. 5, 28 Oct. 1944; AFHQ Combined Weekly Isum 5, 6 Feb. 1945, which traces the removal of Italian industries from the time of the Italian armistice to date; Hq. MATAF Periodic Intel. Note 47, 28 Dec. 1944, which is a breakdown of rolling stock movement for the month of October through the Brenner and Tarvisio routes, the two most important supply routes in Italy.

87. MATAF Opnl. Direc. 21, 3 Nov. 1944.

88. MATAF Opnl. Instr. 14, 27 Oct. 1944; msg., Cannon to Eaker for Twinning, IE225JC, NT68JC, 5 Nov. 1944; Hq. MATAF, Operation BINGO, 20 Jan. 1945.

89. MATAF, Target Appre. 7, 23 Oct. 1944; Coffin Rpt., Annex G, Pt. II; MATAF Intops Bull. 1, Nov. 1944; msg., MATAF, Siena, sgd. Cannon to MAAF, Caserta, TWACT D587, 27 Oct. 1944; MATAF, Opn. BINGO, 20 Jan. 1945.

90. MATAF Target Appre. 7, 23 Oct. 1944; MATAF Opnl. Instr. 14, 27 Oct. 1944; msg., Cannon to Eaker for Twinning, IE225JC, NT68JC, 5 Nov. 1944.

91. 57th BW Int/Opsum, 6 Nov. 1944; XXII TAC Isum 38, 7 Nov. 1944; Adv. Hq. DAF Isum 153, 6 Nov. 1944; 42d BW Stinopsums 26-63, 4-6 Nov. 1944; MATAF, Opn. BINGO; MATAF Intops Bull. 1, Nov. 1944; MATAF, Blockade, p. 35; Coffin Rpt., Annex G, Pt. II.

92. See paper, Effects of Allied Air Attacks on German Transportation System, prepared by G/Capt. D. I. Wiseman, Chief Intel. Off., MATAF, 24 May 1945, based on intr. of Gen. von Vietinghoff, C-in-C, Army Gp. C, and Oberst Schnez, and docs. furnished by them; memo for Armament and Ord. Off., Hq. MATAF, from Capt. Raymond J. Lohr, Results of Interrogation of Chief of German Railroad Transport in Italy, 17 May 1945; Transformer Sub-Stations on the Lower Brenner Line, in MATAF Intops Bull. 7, May 1945.

93. MASAF Intops Sum. 473, 6 Nov. 1944; 15th AF Weekly Sum. of Opns., 6-

12 Nov. 1944; 336 PR Wing Interpretation Rpt. D.B. 254, 7 Nov. 1944; msg., 15th AF to All Wings and XV FC, D-2138, 10 Nov. 1944.

94. Ltr., Spaatz to CG 8th AF, CG 15th AF, 1 Sept. 1944; Directive agreed by DC/AS and Gen. Spaatz, 23 Sept. 1944; MAAF Opns. Instrs. 83, 87 of 13 Sept., 19 Oct. 1944.

95. Ltr., Spaatz to CG 8th AF, CG 15th AF, 1 Nov. 1944; USSTAF, Directive 2 for the Control of Strategic Air Forces in Europe, 1 Nov. 1944; msg., Spaatz to Eaker for Twinning, IE70CS, 1 Nov. 1944.

96. Msg., Eaker to CG MASAF, CG MATAF, MX 36832, 11 Nov. 1944.

97. MAAF Opns. Instr. 88, 16 Nov. 1944.

98. *Ibid.* In October MATAF was made responsible for the selection of MASAF's targets in Italy with the exception of the Brenner. (See MAAF Opns. Instr. 87, 19 Oct. 1944; msg., Pottenger to MAAF and MASAF, 24 Oct. 1944; msg., 12th AF sgd. Cannon to MASAF and MAAF, D2391, 5 Dec. 1944; msg., MAAF to CG MATAF, CG MASAF, MX 40839, 13 Dec. 1944; ltr., MATAF to C-in-C MAAF, 17 Dec. 1944.)

99. 42d BW Stinopsums 266, 268, 271-72, 10, 13, 17-18 Nov. 1944; Hq. 57th BW, Battle of the Brenner, pp. 20-21, 31; MATAF, Blockade, pp. 35-36, 39; MATAF Intops Bulls. 1-2, Nov.-Dec. 1944; MAAF, Interdiction of Comms. Weekly Status Rpts., Nov.-Dec. 1944; 57th BW Int/Opsums, 1-19 Nov., 2 and 10 Dec. 1944.

100. MAAF, Interdiction of Comms. Weekly Status Rpts., Dec. 1944; AAI Isums 72-73, 5 and 12 Dec. 1944; 15th Army Gp. Isums 74-75, 19 and 27 Dec. 1944.

101. MATAF, Blockade, p. 36; MAAF, Interdiction of Comms. Weekly Status Rpts., 13 Nov. 1944-3 Jan. 1945.

102. 42d BW Stinopsums 260-73, 3-19 Nov. 1944; 57th BW Int/Opsums, 1-17 Nov. 1944; MATAF, Blockade, pp. 36, 39; MAAF, Interdiction of Comms. Weekly Status Rpts., Nov. and 5 Dec. 1944; AAI Isums 69-71, 16, 22, 28 Nov. 1944; MATAF Intops Bull. 1, Nov. 1944.

103. MATAF Intops Bull. 2, Dec. 1944;

MAAF, Interdiction of Comms. Weekly Status Rpts., Dec. 1944; MATAF, Blockade, pp. 39-40; RAF Med. Review 9, p. 35; 57th BW Int/Opsums, 1-25 Dec. 1944.

104. USSTAF DSM's 4, 5, 5-6 Oct. 1944; Min. of Conf. Held in Office of Gen. Spaatz, 7 Oct. 1944; CCS 680/2, 16 Sept. 1944.

105. Hq. MAAF, Caserta, Notes on Conference, 13 Oct. 1944; ltr., Eaker to Maj. Gen. I. H. Edwards, 13 Oct. 1944; ltr., Spaatz to Arnold, 16 Oct. 1944; msg., Eaker to Spaatz, CS301E, 19 Oct. 1944; Hq. USSTAF, Min. of Mtg. Held at Caserta, 14 Oct. 1944 with Respect to Transfer of 42d Wing and Certain Service Units to France, 22 Oct. 1944.

106. Ltr., CG USSTAF to CG ETO, 2 Nov. 1944, msg., ETOUSA (Spaatz sgd. Eisenhower) to MTO, WD, 1st TAF (Prov.) for Royce, EX61466, 11 Nov. 1944; msg., Eaker to CG's 12th AF, XII AFSC, and 42d BW, MX37156, 15 Nov. 1944; msg., Eaker to CG's XII TAC, XII AFSC, MX37158, 15 Nov. 1944; Hq. 12th AF GO's 225, 240, 5 and 19 Nov. 1944.

107. CM-OUT-65175, Marshall to McNarney, 18 Nov. 1944; msg., Eaker to Cannon, JC3191E, 19 Nov. 1944.

108. Memo, Col. P. M. Spicer to CG MATAF, 19 Nov. 1944; ltr., Eaker to McNarney, 21 Nov. 1944; CM-IN-20805, McNarney to Marshall, 21 Nov. 1944; CM-IN-27792, Eaker sgd. McNarney to Arnold, 28 Nov. 1944; CM-OUT-68425, sgd. Marshall to CG's USAF and USAAF, POA, 25 Nov. 1944; 12th AF GO 6, 10 Jan. 1945; History, 319th Bomb. Gp., Dec. 1944-Aug. 1945.

109. MATAF, Blockade, p. 38; msg., Pottenger to DAF Adv. and XXII TAC, 22 Nov. 1944.

110. MATAF Intops Bulls. 1, 2, Nov.-Dec. 1944; MATAF, Blockade, pp. 38-40; RAF Med. Review 9, pp. 27, 35.

111. Msg., Pottenger to DAF Adv. and XXII TAC, 22 Nov. 1944; Adv. Hq. DAF Isums 167-91, 22 Nov.-31 Dec. 1944; MATAF, Blockade, pp. 38-39.

112. Msg., Pottenger to XXII TAC and DAF, 1 Dec. 1944; MATAF, Blockade, pp. 36-38.

113. History, XXII TAC, 20 Sept.-31 Dec. 1944, pp. 78-79; History, 47th Bomb.

Gp. (L), Nov.-Dec. 1944; MATAF Intops Bull. 2, Dec. 1944; XXII TAC Opns. Orders 4-5, 9 and 13 Nov. 1944.

114. Msg., Pottenger to XXII TAC and DAF, 1 Dec. 1944; MATAF, Blockade, pp. 36-38; Hq. XXII TAC Night Directives, 47th Bomb. Gp. (L), Dec. 1944; Min. of Conf. Held at Hq. BAF on 29 Oct. 1944; MATAF Opnl. Direcs. 21-21A, 3 and 9 Nov. 1944.

115. Hq. MATAF, Rec. Interdiction of Enemy Comms. N. Italy, 20 Sept. 1944; Hq. MATAF Intel. Appres. 4-5, 30 Sept. and 28 Oct. 1944.

116. MATAF Opnl. Direc. 21, 3 Nov. 1944; 57th BW Int/Opsums, 10-11 Nov. 1944; History, XXII TAC, 20 Sept.-31 Dec. 1944, I, 93-99; MATAF Intops Bull. 1, Nov. 1944; RAF Med. Review 9, p. 28.

117. MATAF Intops Bull. 2, Dec. 1944; RAF Med. Review 9, p. 36.

118. See sources in notes 43 and 44.

119. MAAF Monthly Stat. Sums. 11-18, Aug. 1944-Dec. 1945; MAAF Order of Battle, as of 30 Apr., 31 Aug., 31 Oct. 1944.

120. For MACAF's operations, 1 Sept. 1944-May 1945, see MAAF Central Med. Opnl. Sums. 254-497, 1 Sept. 1944-2 May 1945; MAAF Isums 94-129, 4 Sept. 1944-11 May 1945.

121. MASAF Intops Sum. 410, 4 Sept. 1944; 15th AF Weekly Sum. of Opns., 4-10 Sept. 1944; msg., Twining to Eaker, Spaatz, and Arnold, n.n., 5 Sept. 1944; msg., C-in-C Med. to MAAF, personal for Eaker, 6 Sept. 1944; Estimates of the Situation, 1-15 Sept. 1944, AHB 6, Trans. No. VII/82, in Air Min.; Coffin Rpt., Vol. VII, Pt. 7.

122. Ltr., Eaker to Arnold, 1 Oct. 1944; 57th BW Int/Opsum, 23 Sept. 1944.

123. Ltr., Eaker to Col. W. F. Chapman, CO 340th Bomb. Gp., 3 Oct. 1944.

124. MATAF Intops Bull. 1, Nov. 1944; RAF Med. Review 9, p. 30; 57th BW Int/Opsum, 28 Nov. 1944.

125. Msg., MATAF to CG's 42d BW, 57th BW, "X" TAC, DAF, TWACTION A454, 19 Sept. 1944.

126. German propaganda left no doubt but that this opposition was furnished by the IFRAF. (See 42d BW Stinopsums 252-54, 260, 19-21 Oct. and 3 Nov. 1944; AFHQ Isum 113, 1 Nov. 1944; MATAF

Int/Opsums 556-58, 19-21 Oct. 1944; Adv. Hq. DAF Isums 140, 148, 21 and 31 Oct. 1944.)

127. 42d BW Stinopsums 260-62, 266, of 3-5, 10 Nov. 1944; 57th BW Int/Opsums, 1-7 and 11 Nov. 1944; MATAF Int/Opsum 578, 10 Nov. 1944.

128. History, XXII TAC, 20 Sept.-31 Dec. 1944, I; History, 12th AF (draft), Pt. II; MATAF Intops Bull. 1; MATAF Opnl. Direc. 22, 14 Nov. 1944.

129. MASAF Intops Sums. 471, 483-84, 4 and 16-17 Nov. 1944.

130. MAAF Isum 105, 20 Nov. 1944; 15th AF A-3 Mtg. Notes, 17 Nov. 1944; msg., 15th AF to all wings and XV FC, D2205, 17 Nov. 1944; MASAF Intops Sum. 485, 18 Nov. 1944.

131. MAAF ORB, 1944, pp. 56-57, 59; SAC Conf., SAC (44) 118, 5 Nov. 1944; Hq. 12th AF, Troop Carrier Opns. 1944, 15 Mar. 1945; MATAF Intops Bulls. 1 and 2.

132. AFHQ Isums 104-13, 30 Aug.-30 Oct. 1944; Edgar McInnis, *The War: Fifth Year*, pp. 318-23; History of the Balkan Air Force, July 1945; RAF Med. Review 9, pp. 55-82; Coffin Rpt., Vol. III; CM-IN-28155, AFHQ to WD, 29 Oct. 1944; CM-IN-23276, CG AFHQ to WD, 26 Nov. 1944.

133. Coffin Rpt., Vol. III; MAAF Isums 93-94, 28 Aug. and 4 Sept. 1944; History, MAAF, Vol. 1A; MASAF Intops Sums. 396-406, 21-31 Aug. 1944; 15th AF Weekly Sums. of Opns., 21 Aug.-3 Sept. 1944.

134. 15th AF Weekly Sums. of Opns., 14 Aug.-3 Sept. 1944; MASAF Intops Sums. 405-7, 30 Aug.-1 Sept. 1944; Coffin Rpt., Vol. III; History, 15th AF, II, 173-74.

135. Ltr., Col. P. M. Barr, Deputy AC/S, A-2 15th AF to C/S, 25 Aug. 1944; 15th AF A-2 Mtg. Notes, 25 Aug. 1944; 15th AF Target and Duty Sheets, Sept.-Oct. 1944; MASAF Monthly Stat. Sum., Sept. 1944; MASAF Intops Sums. 407-36, 1-30 Sept. 1944; MAAF Isums 94-98, 4 Sept.-2 Oct. 1944; MAAF, Interdiction of Comms. Weekly Status Rpt., 26 Sept. 1944; History, 15th AF, II, 299.

136. Msg., Spaatz to Eaker for Twining, IE55CS, 19 Oct. 1944.

137. On 9 August, General Wilson and

Marshal Tito had agreed upon a coordinated effort to destroy all main rail lines in Yugoslavia. (See SAC Conf., Discussion with Marshal Tito, SAC [44], 74, 9 Aug. 1944; History of the Balkan Air Force, July 1945, pp. 10-11.)

138. 15th AF Target and Duty Sheets, Sept. 1944; MASAF Intops Sums. 407-14, 1-8 Sept. 1944; 15th AF Weekly Sums. of Opns., 28 Aug.-9 Sept. 1944; History, 15th AF, I, 465-66; BAF Weekly Sums. 9-10, 3 and 10 Sept. 1944; History of the Balkan Air Force, pp. 138-39; Coffin Rpt., Vol. III.

139. MASAF Intops Sums. 420-30, 14-24 Sept. 1944; MAAF Isums 96, 98 of 18 Sept., 2 Oct. 1944; 15th AF Weekly Sums. of Opns., 11-25 Sept. 1944.

140. MATAF Intops Sums. 450, 453-54 of 14, 17-18 Oct. 1944; History, 15th AF, II, 299; RAF Med. Review 9, pp. 55-82; History of the Balkan Air Force, pp. 23-28, 100-103; Hq. 12th AF Troop Carrier Opns. 1944; MATAF Intops Bulls. 1-2.

141. RAF Med. Review 9, pp. 61-63.

142. Min. of Conf. Held at Hq. BAF on 29 Oct. 1944; MATAF Opnl. Direcs. 21-21A, 3 and 9 Nov. 1944.

143. MATAF Intops Bull. 1; Adv. Hq. DAF Isums 149-72, 1 Nov.-1 Dec. 1944; 15th AF Target and Duty Sheets, Nov. 1944; RAF Med. Review 9, p. 67.

144. History, MAAF, Vol. 1A, chap. xvii; John R. Deane, *The Strange Alliance: The Story of Our Efforts at Wartime Co-operation with Russia* (New York, 1947), chap. viii; interview with Gen. Eaker by Albert F. Simpson, 24-25 Jan. 1950; interview with Col. John F. Batter by Robert T. Finney, 16 July 1951.

145. CM-IN-6817, Deane to JCS, 8 Sept. 1944; CM-IN-8275, Harriman and Deane to Arnold, 9 Sept. 1944; CM-IN-7853, Harriman, Walsh, Deane to Arnold personal, 9 Sept. 1944; CM-OUT-27434, Arnold to Deane and Walsh, 8 Sept. 1944; CM-IN-15794, Wilson to Arnold, 17 Sept. 1944; CM-IN-28813, Wilson to AGWAR, 30 Sept. 1944; CM-IN-15461, Eaker to Arnold, 16 Oct. 1944.

146. Investigation revealed that a startling similarity between the briefed target and the target actually attacked was responsible for the navigational error. (See CM-IN-12918, Eaker sgd. McNar-

ney to Marshall and Deane, 14 Nov. 1944; CM-IN-9840, Eaker to Arnold, Spaatz, Deane, Batjer, and Twining, 10 Nov. 1944.)

147. CM-IN-9448, Deane to JCS, 10 Nov. 1944; msg., CCS to Wilson, FAN 454, 20 Nov. 1944.

148. CM-OUT-65545, JCS to Deane, McNarney, and Eaker, 19 Nov. 1944; CM-IN-21828, Wilson to CCS, 22 Nov. 1944; msg., Eaker to Deane, n.n., 22 Nov. 1944; ltr., Eaker to C/S AFHQ, 22 Nov. 1944.

149. CM-OUT-60623, JCS to Deane, 10 Nov. 1944; CM-IN-9448, Deane to JCS, 10 Nov. 1944; CM-IN-27795, Deane to Wilson and CCS, 28 Nov. 1944; CM-OUT-69568, CCS to Deane, Archer, Eisenhower, and Wilson, 28 Nov. 1944; CM-IN-28017, Spaatz to Arnold personal, 29 Nov. 1944; CM-IN-29777, Deane to CCS, 30 Nov. 1944; CM-IN-4403, Deane to CCS, 5 Dec. 1944; CM-IN-10068, Wilson to CCS, 10 Dec. 1944; CM-IN-9026, Spaatz to Arnold, 9 Dec. 1944; CM-IN-28413, Archer and Deane to CCS, 29 Dec. 1944; CM-IN-8316, Archer and Hill sgd. Deane to Eaker, Spaatz, CCS, Brit. C/S, 10 Jan. 1945; CM-OUT-21167, CCS to Deane, Archer, Alexander, and Spaatz, 15 Jan. 1945; Deane, *Strange Alliance*, chap. viii; CM-IN-22187, Deane to CCS, 23 Nov. 1944; CM-OUT-67985, CCS to Deane and Archer, 24 Nov. 1944; CM-OUT-67986, CCS to Wilson, Eisenhower, and Spaatz, 24 Nov. 1944; CM-OUT-67900, JCS to Deane, 24 Nov. 1944.

150. CM-IN-26907, Wilson to CCS, 28 Nov. 1944; CM-IN-26659, Wilson to CCS, 30 Nov. 1944; CM-IN-29777, Deane and Archer to CCS, 30 Nov. 1944; CM-OUT-71154, CCS to Deane, Archer, and Wilson, 1 Dec. 1944; CM-OUT-21167, CCS to Deane, Archer, Alexander, and Spaatz, 15 Jan. 1945; History, MAAF, Vol. IA, chap. xvii.

151. SAC Confs., SAC (O) 132, 29 Dec. 1944, and SAC (O) (45) 1st Mtg., 8 Jan. 1945; msg., SACMED to CCS, MEDCOS 228, 8 Jan. 1945; ltr., AFHQ to CG 15th AG, Comdr. BAD, Comdr. L.F.M.L.G., C-in-C Med., C-in-C ME, Air C-in-C Med., 16 Jan. 1945; Alexander, *The Italian Campaign*, pp. 5, 13-15;

SACMED Rpt., It. Campaign, Pt. III, pp. 87-90.

152. MATAF, Opnl. Direc. 23, 9 Jan. 1945.

153. Msg., Spaatz to Eaker, IE132CS, 24 Dec. 1944; msg., Eaker to Twining and Cannon, JC340IE, 25 Dec. 1944.

154. Msg., MAAF to BAF, SAF, TAF, CAF, MX 41554, 21 Dec. 1944; msg., Rear MACMIS, BAF to MACMIS, 243, 26 Dec. 1944; MATAF, Blockade.

155. MASAF Intops Sums. 523-28, 532, 26-31 Dec. 1944, 4 Jan. 1945.

156. MATAF Intops Bull. 2; MATAF, Blockade, pp. 45-47; MAAF, Interdiction of Comms. Weekly Status Rpt., 3 Jan. 1945.

157. Adv. Hq. DAF Isums 184-91, 21-31 Dec. 1944; MATAF, Blockade, pp. 45-49.

158. 57th BW, Battle of the Brenner; 57th BW Int/Opsums, 1-31 Jan. 1945; MATAF Intops Bull. 3, Jan. 1945; MATAF, Blockade, p. 53; RAF Med. Review 10, p. 11.

159. 57th BW Int/Opsums, 1-31 Jan. 1945; ltr., CG XXII TAC to CG MATAF, 8 Jan. 1945; memo from CG XXII TAC for CG 5th Army, 8 Jan. 1945; XXII TAC Isums 89-113, 1-31 Jan. 1945; Adv. Hq. DAF Isums 192-211, 1-31 Jan. 1945; MATAF, Blockade, pp. 51-53; RAF Med. Review 10, p. 18.

160. RAF Med. Review 10, pp. 11, 18; 15th Army Gp. Isums 78-79, 23 Jan., 30 Jan. 1945; MATAF, Blockade, p. 49.

161. Msg., Eaker to CG MASAF, info. CG MATAF, MX 44684, 28 Jan. 1945; msg., Pottenger to XXII TAC, DAF, 57th BW, n.n., 27 Jan. 1945; msg., Pottenger to XXII TAC and DAF, D5232, 15 Feb. 1945; MATAF Intops Bull. 4, Feb. 1945; 15th Army Gp. Isums 78-83, 30 Jan., 6, 13, 20, 27 Feb. 1945; MATAF, Blockade, p. 53. In March, 715th Inf. Div. was also withdrawn from Italy, and as in the case of the other two divisions, from three weeks to a month was required to clear the frontier. (See MATAF, Blockade, p. 63; 15th Army Gp. Isums 84-87, 6, 13, 20, 27 Mar. 1945.)

162. MATAF, Blockade, p. 54; Alexander, *It. Campaign*, p. 16; 57th BW, Battle of the Brenner.

163. Msg., MATAF to MAAF, D4511,

27 Jan. 1945; msg., Eaker to Twining, MX44684, n.d.; msg., MATAF to MAAAF and MAAF, D4912, 7 Feb. 1945; msg., Cannon to Eaker, IE301JC, 8 Feb. 1945; msg., Eaker to Cannon, JC356IE, 9 Feb. 1945.

164. MASAF Intops Sums. 582-83, 587, 23-24 and 28 Feb. 1945.

165. MAAF, Interdiction of Comms. Weekly Status Rpt., 1 Mar. 1945; MATAF, Blockade, pp. 54, 59. See also, n. 161.

166. Msg., SACMED to CCS, MEDCOS 228, 8 Jan. 1945; msg., AFHQ, Malta to Hq. MAAF, Cabell for Eaker, A559, 30 Jan. 1945; ltr., Cabell to Eaker, 30 Jan. 1945; memo for CCS, Proposed Movement of Major Portion of 12th U.S. Air Force from Mediterranean to France, and paper, Transfer of Twelfth Air Force to Western Front, last two documents prepared by Brig. Gen. C. P. Cabell, MAAF representative at the Malta conference, the first for submission to the CCS and the latter for submission to the U.S. JCS, through Kuter, as presentation of the MTO point of view regarding the proposed move; msg., Alexander and Cabell to Eaker and Cannon, Cricket MX45003, 1 Feb. 1945; ltr., Cabell to Eaker, 2 Feb. 1945; msg., CCS to Alexander and Eisenhower, FAN 501 to Alexander and FACS 151 to Eisenhower (CM-IN-2583, CCS to AGWAR), 2 Feb. 1945; msg., Alexander to Eaker and McNarney, Cricket 63, 2 Feb. 1945. A complete file of documents dealing with the proposed move of units from MTO to ETO may be found in MAAF volume titled Operation GOLDFLAKE, the code name given the move, in AFSHO. See also, Alexander, It. Campaign, pp. 20-21.

167. An interesting difference in the understanding of General Eaker and General Spaatz regarding the move is noted in ltrs., Eaker to McNarney, 7 Feb. 1945 and Spaatz to Giles, 9 Feb. 1945.

168. Msg., Spaatz to Eaker, IE171CS, 3 Feb. 1945; msg., Eaker to Spaatz, personal 107, 4 Feb. 1945; msg., Spaatz to Eaker, IE172CS, 4 Feb. 1945; msg., Alexander to SHAEF, for action to AGWAR for CCS for info., AMSSO for Brit. C/S, NAF 851, 4 Feb. 1945; msg., Alexander to SHAEF, FX 21285, 5 Feb. 1945; msg.,

SHAEF Main sgd. Eisenhower to AFHQ, to AGWAR for CCS for info., S-77936, 5 Feb. 1945; msg., SHAEF Main, Gen. Noce sgd. Eisenhower to AFHQ for Gen. Harding, S78202, 7 Feb. 1945; ltr., Eaker to McNarney, 7 Feb. 1945; msg., Alexander to SHAEF Main AGWAR for CCS, Brit. C/S, FX 22925, NAF 855, 8 Feb. 1945; msg., Alexander to SHAEF, CCS, Brit. C/S, FX 22945, NAF 856, 8 Feb. 1945; msg., Eaker to Spaatz, CS627IE, 8 Feb. 1945; ltr., Eaker to A/M Slessor, Dep. Adm., Dir. of Opns., Dir. of Signals, Chief of Plans, and Maj. Gen. John K. Cannon, 9 Feb. 1945; msg., SHAEF Main sgd. Eisenhower to AGWAR for CCS and AMSSO for Brit. C/S, AFHQ for Alexander, S78349, 8 Feb. 1945; msg., Alexander to SHAEF Main, FX 23438, NAF 858, 9 Feb. 1945; msg., SACMED to MAAF, AAFSC/MTO, ETOUSA, SHAEF Main, AAF/MTO, FX 23890, 9 Feb. 1945.

169. Msg., Eaker to CG 12th AF, CG AAFSC/MTO, info. to CG ETOUSA, MX 45739, 9 Feb. 1945; msg., SACMED to PENBASE, FX 23986, 9 Feb. 1945; Hq. 12th AF GO 45, 6 Mar. 1945; Histories, 27th and 86th Ftr. Gps. and 319th Air Service Gp., Feb. 1945.

170. History, MAAF, Vol. IA; McInnis, *The War: Sixth Year*, pp. 154-58; William D. Leahy, *I Was There* (New York, 1950), pp. 329-35.

171. Hq. 5th Army, Outline Plan, Operation CRAFTSMAN, 10 Mar. 1945; 5th Army Opns. Instr. 7, 1 Apr. 1945; 5th Army History, IX, 23; Alexander, It. Campaign, p. 23.

172. History, MAAF, IA, 263; AAF/MTO GO 30, 24 Mar. 1945; Hq. MAAF GO 5, 24 Mar. 1945; CM-IN-56649, Marshall to McNarney, Eisenhower, and Spaatz, 21 Mar. 1945; CM-OUT-67633, sgd. Marshall to McNarney, 23 Mar. 1945; CM-OUT-57664, Marshall to McNarney, 23 Mar. 1945; Hq. XXII TAC GO 34, 6 Apr. 1945.

173. Hq. MAAF Opns. Instr. 112, 2 Apr. 1945.

174. Ltr., Hq. MATAF to AOC DAF and CG XXII TAC, 12 Mar. 1945; MATAF Opnl. Instr. 17A, 7 Apr. 1945.

175. MAAF, Interdiction of Comms.

Weekly Status Rpt., 12 Apr. 1945; 15th Army Gp. Isum 89, 9 Apr. 1945; MATAF, Blockade, pp. 61-70; MATAF Intops Bulls. 5-6, Mar.-Apr. 1945; RAF Med. Review 10, pp. 22, 24, 40; Hq. MATAF, Operation WOWSER.

176. Hq. USSTAF Direc. 3 for Strategic Air Forces in Europe, 12 Jan. 1945; MAAF, Opns. Instrs. 101, 109, 20 Jan. and 1 Mar. 1945.

177. Msg., Eaker to CG MASAF, MX 47940, 6 Mar. 1945; CM-IN-8139, Arnold to Giles, 9 Apr. 1945; msg., MATAF to CG's MASAF and MAAF, D7494, 6 Apr. 1945.

178. Hq. USSTAF Direc. 4 for Strategic Air Forces in Europe, 13 Apr. 1945; msg., Spaatz to Doolittle and Twining thru Cannon, NT18CS, 16 Apr. 1945; MAAF Opns. Instr. 115, 23 Apr. 1945.

179. MATAF Opnl. Instr. 17A, 7 Apr. 1945; MASAF Intops Sum. 627, 9 Apr. 1945; Adv. Hq. DAF Isum 263, 9 Apr. 1945.

180. Concerning the safety measures taken for the employment of heavy bombers in this close support role, see: Notes on Agreements Reached between Representatives of XXII TAC, MATAF, and 15th AF, n.d.; ltr., Hq. 5th Army to CG II Corps, 10 Apr. 1945; memo for G-3 from Hq. 5th Army, 31 Mar. 1945; MATAF, Opnl. Instr. 17A, 7 Apr. 1945; Agreement Reached at Conference between MATAF, 15th AF, and XXII TAC, 29 Mar. 1945; Adv. Hq. DAF Opns. Order 25, 6 Apr. 1945; Revised Plan for Operation BUCKLAND, Agenda for Conference of Wing A-2 and A-3 Personnel at Hq. 15th AF, 7 Apr. 1945.

181. MATAF Opnl. Instr. 17A, 7 Apr. 1945; 15th AF Weekly Sum. of Opns., 8-14 Apr. 1945; Hq. 15th AF, Opn. WOWSER, 31 May 1945; 57th BW Int/Opsums, 9-10 Apr. 1945; Adv. Hq. DAF Isums 263-64, 9-10 Apr. 1945; Alexander, It. Campaign, p. 29; Hq. MATAF, Opn. WOWSER; 15th AF FO 189, 8 Apr. 1945. For details see 15th AF Mission Rpts., 9-10 Apr. 1945, and Mission Sums. of the five wings under 15th AF.

182. Hq. MATAF, Opn. WOWSER. It was reported that New Zealand troops crossed the Senio early in the

operation without a single casualty-killed, wounded, or prisoner. (See RAF Med. Review 10, p. 3. For German reaction to the bombing, see Hq. 5th Army G-2 Rpt. 596, 24 Apr. 1945.)

183. 15th Army Gp. Isum 90, 17 Apr. 1945; RAF Med. Review 10, pp. 31-32.

184. Adv. Hq. DAF Isums 265-68, 11-14 Apr. 1945.

185. MASAF Intops Sums. 628-32, 10-14 Apr. 1945.

186. Hq. 5th AF Weekly Sum. of Opns., 8-14 Apr. 1945; 57th BW Int/Opsums, 11-14 Apr. 1945; Hq. MAAF, Interdiction of Comms. Weekly Status Rpts., 12 and 19 Apr. 1945.

187. History, XXII TAC, Jan.-May 1945; Hq. MATAF, Opn. WOWSER; Alexander, It. Campaign, p. 30.

188. Hq. 5th Army, Outline Plan, Opn. CRAFTSMAN, 10 Mar. 1945; Hq. 5th Army Opns. Instr. 7, 1 Apr. 1945; 5th Army History, IX, 23.

189. MATAF Opnl. Instr. 17A, 7 Apr. 1945; Hq. DAF Opns. Order 24, 6 Apr. 1945; msg., Twining to all units, 15th AF, D3772, D3782, 14-15 Apr. 1945; 15th AF Weekly Sum. of Opns., 15-21 Apr. 1945; Alexander, It. Campaign, p. 30; 15th AF Mission Rpts., 15-18 Apr. 1945.

190. Hq. XXII TAC Isums 184-88, 16-20 Apr. 1945; Hq. MATAF, Opn. WOWSER.

191. 57th BW Int/Opsums, 15-19 Apr. 1945.

192. 15th Army Gp. Isums 90-91, 17 and 24 Apr. 1945; 5th Army History, IX; Alexander, It. Campaign, p. 31.

193. Msg., Chidlaw to MAAF and MASAF, TWACT D8148, 19 Apr. 1945; msg., 15th AF to MATAF, MACAF, and others, E2364, D3857, 19-20 Apr. 1945; A-3 Mtg. Notes, 19 Apr. 1945; MATAF Opnl. Instr. 19, 17 Apr. 1945; MASAF Intops Sums. 638-44, 20-26 Apr. 1945; msg., Hq. 15th AF to all units, D3880, 22 Apr. 1945; A-3 Mtg., 22 Apr. 1945; 57th BW Int/Opsum, 24 Apr. 1945; RAF Med. Review 10, p. 39; Hq. MATAF, Opn. WOWSER.

194. Hq. MATAF, Opn. WOWSER; RAF Med. Review 10, pp. 37-38; 57th BW Int/Opsums, 21-24 Apr. 1945; XXII TAC Isums 189-92, 21-24 Apr. 1945; Adv. Hq. DAF Isums 275-78, 21-24 Apr. 1945.

195. Interrogation of General Armored Forces von Senger, CG XIV Corps, 14th Army Gp., 4 May 1945, in History, MAAF, Vol. XXXVIII.

196. 57th BW Int/Opsums, 26-30 Apr., 1-2 May 1945; MASAF Intops Sums. 644-50, 26 Apr.-2 May 1945; XXII TAC Isums 194-200, 26 Apr.-2 May 1945; Adv. Hq. DAF Isums 280-86, 26 Apr.-2 May 1945.

197. Hq. MATAF Int/Opsum 750, 2 May 1945.

NOTES TO CHAPTER 14

1. PWD SHAEF, Leaflet Operations, Western European Theatre, pp. 2-3 (hereinafter cited as Leaflet Opns).

2. PWD SHAEF, The Leaflet Propaganda Front, 15 Nov. 1944, in History, 1st Bomb. Div., Nov. 1944.

3. See copies in History, 1st Air Div., Jan. 1945.

4. Leaflet Propaganda Front, 15 Nov. 1944.

5. Leaflet Opns., pp. 1, 21-22; History, 8th AF, June 1944, pp. 26-27; Statistical Summary of Eighth Air Force Operations, European Theater, 17 Aug. 1942-8 May 1945, p. 10.

6. New York *Herald-Tribune*, 27 Oct. 1944.

7. Report of the 422d Bomb. Sq. on Night Operations, p. 12, in History, 406th Bomb. Sq., May 1945; Hq. 8th AF, "Leaflet Bomb," 12 Apr. 1944, in History, 8th AF; buckslip, 422d Bomb. Sq. War Diary, Jan. 1944.

8. Leaflet Opns., pp. 23-24; Let's Set Course, p. 15, in History, 406th Bomb. Sq., May 1945.

9. 1st Bomb. Div. War Diary, Oct.-Dec. 1943.

10. See 422d Bomb. Sq. War Diary, Jan.-Mar. 1944.

11. Cf. History, 8th AF, Feb. 1944, p. 7, and History, 422d Bomb. Sq., Feb. 1944.

12. 422d Bomb. Sq. War Diary, Apr. 1944; 8th AF, Narrative of Opns., Apr. 1944.

13. 422d Bomb. Sq. War Diary, May 1944; 8th AF, Narrative of Opns., May 1944.

14. 422d Bomb. Sq. War Diary, June 1944; Hq. ETOUSA Release 9680, 26 Oct. 1944.

15. Stat. Sum. of 8th AF Opns.

16. History, 8th AF, Nov. 1944, pp. 39-40; Stat. Sum. of 8th AF Opns., p. 70.

17. Leaflet Propaganda Front, 25 Jan. 1945; History, 8th AF, Dec. 1944, pp. 16-17.

18. 406th Bomb. Sq. War Diary, Jan., Mar. 1945; History, 406th Bomb. Sq., Feb. 1945; Leaflet Propaganda Front, 30 Apr. 1945.

19. Let's Set Course, p. 5.

20. CM-OUT-8231 (17-9-43), CCS to Devers, R3223, 17 Sept. 1943.

21. 492d Bomb. Gp., History of Carpetbagger Project, Vol. I (hereinafter cited as Carpetbagger History); History, 8th AF, Mar. 1944, p. 64.

22. History, 857th Bomb. Sq., May 1944, p. 12.

23. GO 473, 5 Aug. 1944, in History, 8th AF, Aug. 1944. The 788th Squadron was re-formed in the 2d Bombardment Division, and the 850th Squadron was re-formed in the 3d Bombardment Division.

24. Carpetbagger History, Vol. III; Special Operations (Air, MTO, pp. 109-10.

25. History, 857th Bomb. Sq., May 1944, pp. 8-9; Modification and Maintenance of B-24 Liberators for Carpetbagger Operations, in History, 859th Bomb. Sq., Sept. 1943-Sept. 1944; 3d Air Div., Report on Supply Missions; Carpetbagger History, Vol. I.

26. Operations Based on United Kingdom, App. A in ltr., Donovan to Arnold, 3 Mar. 1944.

27. Carpetbagger History, Vol. III; 3d Air Div., Rpt. on Supply Missions.

28. The totals probably were somewhat greater, since an equally reliable source gives 437 effective sorties, 100 "Joes," 5,103 containers, 1,594 leaflet packages, and 3,122 supply packages. (Stat. Sum. of 8th AF Opns., p. 68.)

29. History, 8th AF, July 1944, p. 27, Nov. 1944, p. 39; Carpetbagger History, Vol. III.

30. History, 859th Bomb. Sq., Sept. 1943-Sept. 1944.

31. History, 856th Bomb. Sq., Sept. 1944-Apr. 1945.
32. From 15 March to 30 April 1945, the 858th Bombardment Squadron completed at least thirty-one of forty-two sorties to Denmark and eleven of thirty to Norway. On the night of 23/24 March, thirteen sorties were attempted, but the records fail to give the mission's outcome. (History, 858th Bomb. Sq.)
33. *Ibid.*, Apr. 1945. This Squadron lost three aircraft over Norway and Denmark in April.
34. Stat. Sum. of 8th AF Opns., p. 58.
35. History, 859th Bomb. Sq., Sept. 1943-Sept. 1944; Carpetbagger History, Vol. I; History, 8th AF, Apr. 1944, pp. 15-16; History, 857th Bomb. Sq., May 1944.
36. Armament-Ordnance in CARPET-BAGGER Work, in History, 859th Bomb. Sq., Sept. 1943-Sept. 1944; History, 857th Bomb. Sq., May 1944; 3d Air Div., Rpt. on Supply Missions.
37. A Maquis Chief Visits the Carpetbaggers, in History, 859th Bomb. Sq., Sept. 1943-Sept. 1944.
38. 12th AF, Troop Carrier Operations, 1944, pp. 16, 35.
39. 3d Air Div., Rpt. on Supply Missions; CM-IN-11033 (14-6-44), SHAEF to WD, S53795, 13 June 1944.
40. 3d Air Div., Rpt. on Supply Missions.
41. *Ibid.*
42. *Ibid.*
43. *Ibid.*; Hq. 8th AF, Preliminary Report on GAF Reaction to CADILLAC Operation, 14 July 1944; History, 8th AF, July 1944, p. 60; memo, Bomber Attacks, in CADILLAC Plan, 14 July 1944, Mission 472.
44. CM-IN-1471 (2-8-44), SHAEF to WD, FWD12537, 2 Aug. 1944.
45. 3d Air Div., Rpt. on Supply Missions.
46. Special Opns. (Air), MTO, p. 41.
47. Special Opns. MTO, Sec. XVI, p. 1.
48. Special Opns. (Air), MTO, p. 12; 12th AF, TC Opns. 1944, p. 6.
49. History, 885th Bomb. Sq., Nov. 1943-May 1945, p. 1.
50. CM-IN-21017 (31-1-44), Eaker to Arnold, TSO143, 31 Jan. 1944.
51. Hq. 15th AF GO 153, 25 Mar. 1944; CM-IN-14443 (20-4-44), MAAF to WD, R19, 11 Apr. 1944.
52. History, 885th Bomb. Sq., Sept. 1944, p. 1.
53. 122d Bomb. Sq., War Diary, May 1944.
54. Special Opns. (Air), MTO, pp. 42-43.
55. History, 885th Bomb. Sq., Dec. 1944, p. 6; First Citation, 885th Bomb. Sq., pp. 1-3.
56. First Citation, 885th Bomb. Sq., p. 1; Special Opns. (Air), MTO, p. 45.
57. History, 885th Bomb. Sq., Oct. 1944, pp. 2-3; 12th AF, TC Opns., 1944, p. 5.
58. 60th TC Gp., Story of Resupply.
59. 12th AF, TC Opns., 1944, p. 18.
60. 60th TC Gp., Story of Resupply.
61. *Ibid.*; 12th AF, TC Opns., 1944, p. 19.
62. 7th TC Sq. War Diary, Mar. 1944; 12th AF, TC Opns., 1944, p. 10; 51st TC Sq. War Diary, Mar. 1944; History, 51st TC Sq., Feb. 1944, p. 2; Special Operations Sorties for February 1944, in History, MAAF, Vol. XII.
63. 7th TC Sq. War Diary, Mar. 1944.
64. Citation, 60th TC Gp., Tab 2; 12th AF, TC Opns., 1944, p. 33.
65. History, 10th TC Sq., Actv. to 31 May 1944.
66. History, 11th TC Sq., June 1944.
67. Special Opns. (Air), MTO, p. 87.
68. Citation, 60th TC Gp., Tab 2, p. 3.
69. Employment of Air Forces in Tactical Support of Partisan Operations, 18 July 1944; Special Opns. (Air), MTO, p. 12.
70. 60th TC Gp., Story of Resupply; 12th AF, TC Opns., 1944, p. 33.
71. CM-IN-9750 (13-5-44), AFHQ to WD, F44950, 13 May 1944.
72. Comparative figures were, in long tons: Yugoslavia, 571.42; Albania, 118.73; Greece, 48.44; Bulgaria, 15.74; Hungary, 1.39. (See Hq. MAAF Special Opns. during Aug. 1944, Monthly Rpt. 5, in History, MAAF, Vol. XXXV.)
73. 60th TC Gp., Report on Combat Operations for Aug. 1944, in History, 51st TC Wing, Aug. 1944.
74. Citation, 60th TC Gp., Tab 2, p. 6; 28th TC Sq. War Diary, Aug. 1944, p. 1.
75. BAF Weekly Summary 9, week



- ending 10 Sept. 1944; RAF Mediterranean Review 8, p. 117.
76. 12th AF, TC Opns., 1944, p. 33.
77. Hq. MAAF, Special Opns. during Oct. 1944, Monthly Rpt. 7, in History, MAAF, Vol. XXXV.
78. Special Opns. (Air), MTO, p. 30.
79. 12th AF, TC Opns., 1944, pp. 31, 33.
80. History, 16th TC Sq., Apr. 1945, p. 1.
81. Hq. MAAF, Special Opns. Monthly Rpts. 7-13.
82. 12th AF, TC Opns., 1944, p. 35; 7th TC Sq. War Diary, Oct.-Nov. 1944.
83. 7th TC Sq. War Diary, Nov. 1944; 51st TC Sq. War Diary, Nov.-Dec. 1944; History, 51st TC Wing, Dec. 1944, p. 3.
84. Hq. MAAF, Special Opns. during Oct. 1944, Monthly Rpt. 7; History, 885th Bomb. Sq., Nov. 1944.
85. Hq. MAAF Opns. Instr. 95, 4 Jan. 1945, Employment of Supply Dropping Units of MAAF, in History, MAAF, Vol. XXXVIII.
86. Hq. MAAF, Special Opns. Monthly Rpts. 10-13.
87. History, 16th TC Sq., May 1945.
88. Special Opns. (Air), MTO, pp. 13-16, 34, 36-37.
89. 12th AF, TC Opns., 1944, p. 31; History, 62d TC Gp., Nov. 1944; History, 885th Bomb. Sq., Nov.-Dec. 1944.
90. Special Opns. (Air), MTO, pp. 15-16.
91. *Ibid.*, p. 11.
92. Citation, 60th TC Gp., Tab 2, p. 5; 12th AF, TC Opns., 1944, Annex D; JICAME Rpt. 8160-44, 15 Aug. 1944.
93. Special Opns. (Air), MTO, p. 63.
94. *Ibid.*
95. 7th and 51st TC Sqs. War Diaries, Mar. 1944; History, 10th TC Sq., Actv. to 1 May 1944; 11th TC Sq. Mission Rpts., May 1944; 12th TC Sq. War Diary, May-June 1944; Histories, 10th, 11th, 28th TC Sqs., June 1944.
96. The Guerilla Situation in South France and Italy, in History, MAAF, XII.
97. History, 885th Bomb. Sq., Sept. 1944. Cf. Hq. MAAF, Special Opns. during September 1944, Monthly Rpt. 6.
98. History, 885th Bomb. Sq., Oct. 1944.
99. Hq. MAAF, Special Opns. Monthly Rpts. 5-13.
100. Special Account of Squadron Activities over Northern Italy, 22 November 1944-3 January 1945, in History, 4th TC Sq., Jan. 1945.
101. History, 885th Bomb. Sq., Nov.-Dec. 1944.
102. Histories, 51st TC Wing, Nov. 1944, p. 2; 4th, 7th, and 8th TC Sqs., Nov.-Dec. 1944; 62d TC Gp., Jan. 1945; 4th TC Sq., Jan. 1945; 7th TC Sq. War Diary, Dec. 1944 and Jan. 1945.
103. 7th TC Sq. War Diary, Dec. 1944.
104. Histories, 4th TC Sq., 62d TC Gp., and 51st TC Wing, Jan. 1945; 7th TC Sq. War Diary, Jan. 1945.
105. Hq. MAAF, Special Air Room Report on Partisan Activity in North Italy, 18 Jan. 1945, in History, MAAF, XXXVIII.
106. History, 51st TC Wing, Jan.-May 1945.
107. Histories, 15th and 2641st Special Gps., Jan., Mar.-Apr. 1945; AAF Reference History 21, Special Operations: AAF Aid to European Resistance Movements, 1943-1945.
108. 16th and 18th TC Sqs. War Diaries, Jan. 1945.
109. History, 51st TC Wing, Feb. 1945, p. 3.
110. History, 16th TC Sq., Feb. 1945.
111. History, 2641st Special Gp., Mar.-Apr. 1945.
112. Special Opns. (Air), MTO, p. 65.
113. History, 15th AF, II, 21; Citation, 60th TC Gp., Tab 2, p. 3.
114. Cf. Special Opns. (Air), MTO, p. 44 and Special Opns. MTO, Sec. XVI, App. A.
115. Incoming cables, Eisenhower to WD, 5722 (9-7-43), W4413/8749, 7 Aug. 1943; 12975 (18-7-43), W5167/1061, 18 July 1943; 22614 (30-8-43), W8634, 29 Aug. 1943; 1637 (3-8-43), W6406, 3 Aug. 1943.
116. History, 15th AF, II, 21.
117. Citation, 60th TC Gp., Tab 2, p. 3; 12th AF, TC Opns., 1944, pp. 10, 33, 37; History, 2641st Special Gp., Jan.-Mar. 1945.
118. History, Special Opns., ETOUSA, Pt. I, chap. ii, pp. 345-47.

119. Carpetbagger History, III; Special Opns. MTO, Sec. XVI, App. A.
120. History, 856th Bomb. Sq., Sept. 1944-Apr. 1945.
121. Special Opns. MTO, Sec. VIII, p. 2; Directive, Adv. Hq. Force 133 to Hq. TAF, 7 Jan. 1944; Directive, Hq. MATAF to A/C Forster, S.A.S., Hq. 133 Force, *et al.*, 12 Jan. 1944; Directive, Adv. Force 133 to TAF, 16 Jan. 1944, in AC/AS Plans, MANHOLE-BUNG-HOLE folder.
122. 249 Wing (RAF) to 267 Sq. (RAF), 4 Feb. 1944; msg., MATAF to Fwd. DAF, 249 Wing, *et al.*, 15 Feb. 1944, AC54; Manhole Operational Order 2, Hq. MATAF to Hq. DAF, *et al.*, 17 Feb. 1944; 12th AF, TC Opns., 1944, p. 8; History, 62d TC Gp., Feb. 1944.
123. History, 62d TC Gp., Feb. 1944; 7th TC Sq. War Diary, Feb. 1944.
124. Special Opns. (Air), MTO, pp. 64, 87.
125. Hq. MAAF, Special Opns. during May 1944, Monthly Rpt. 2.
126. CM-IN-21565 (30-3-44), Wilson to Brit. C/S, MEDCOS 77, 29 Mar. 1944; memo, Wilder to Allen, 23 Apr. 1944; Citation, 60th TC Gp., Tab 2, p. 3.
127. Hq. MAAF, Special Opns. during April 1944, Monthly Rpt. 1.
128. Hq. MAAF, Special Opns. during May 1944, Monthly Rpt. 2; 12th AF, TC Opns., 1944, p. 33.
129. Hq. MAAF, Special Opns. Monthly Rpts. 1-2, 5-13; 12th AF, TC Opns., 1944, p. 33.
130. Hq. MAAF, Special Opns. during Aug. and Sept. 1944, Monthly Rpts. 5-6.
131. History, 28th TC Sq., Sept. 1944.
132. History, 60th TC Gp., Tab 2, p. 4; Citation, 60th TC Gp., Tab 2, p. 6.
133. Ltr., Col. George Kraigher to Eaker, 3 June 1944, in History, MAAF, Vol. XII; CM-IN-22298 (29-5-44), SOM-TO to AFHQ, G/139, 27 May 1944, Daily Sitrep 42.
134. Ltr., Eaker to Arnold, 1 June 1944, in History, MAAF, Vol. II; RAF Med. Review 7, pp. 56-86.
135. Special Opns. (Air), MTO, p. 25; CM-IN-3678 (5-6-44), Force 266 to AFHQ, 4 June 1944.
136. History, 28th TC Sq., Aug. 1944; Special Opns. (Air), MTO, p. 26.

137. Special Opns. (Air), MTO, p. 27.
138. RAF Med. Review 10, p. 126.
139. History, MAAF, III, 319.
140. *Ibid.*, p. 320.
141. Citation, 60th TC Gp., Tab 2, p. 7; Histories, 10th TC Sq., 51st TC Wing, 60th TC Gp., Aug. 1944.
142. RAF Med. Review 10, pp. 95, 113.
143. CM-IN-647 (1-10-44), Eaker to Arnold, M32898, 1 Oct. 1944.
144. Hq. MAAF, Special Opns. Monthly Rpts. 10-13.

#### NOTES TO CHAPTER 15

- Despatch by Air Chief Marshal Sir Roderic Hill, Air Operations by Air Defence of Great Britain and Fighter Command in Connection with the German Flying Bomb and Rocket Offensives, 1944-45, *London Gazette*, No. 38437 (1948), p. 5591 (hereinafter cited as Hill, Despatch).
- Hill, Despatch, p. 5591.
- Ibid.*
- Msg., Conrad to Bissell for Henry, USSTAF EX32701, 12 June 1944.
- BAM (AHB), File 77 (narratives).
- Ibid.*, and The Battle of the Flying Bomb, p. 7. While there is no agreement on the actual number of V-1's launched during this period, German sources—in particular the Daily Dairy of LXV Army Corps (the organization that operated individual firing units in the field) and Dornberger's unpublished manuscript on the V-2—would indicate that as many as 300 rounds may have been fired on June 15/16.
- BAM (AHB), File 77 (nars.). The blast damage from V-1's was singularly high. (USSBS Physical Damage Div. Rpt. 20, "V" Weapons in London, England; USSBS, V Weapons [Crossbow] Campaign; memo for AC/AS Intel. Collection Div., from G/C R. B. Dowling, British Joint Staff Mission, 24 Jan. 1946; Min. of Home Security Research and Experiments Dept., The Damage Caused by the German Flying Bomb, n.d.)
- The Air Ministry, Hill states in his despatch, p. 5592, had expected to give a month's warning of any CROSSBOW attack by the Germans; actually, there was no warning whatever from the Air

Ministry preceding the attack of 12/13 June.

9. WP (44) 320, 13 June 1944. Marshall and Dill exchanged letters on the morning of 13 June 1944, following intelligence of the V-1 firings. (Ltr., Gen. Thomas Handy, WDGS to CG ETO, 13 June 1944.)

10. WP (44) 320, 13 June 1944.

11. 8th AF Target Sum., 17 Aug. 1942-8 May 1945.

12. COS (44) 197th Mtg. (O), 16 June 1944; Hill, Despatch, p. 5590 ff. The Air Defence of Great Britain was charged with neutralizing or destroying V-1's after they were launched; the Eighth, AEF, and the RAF Bomber Command with neutralizing or destroying the means of launching the missiles. The brilliant successes of ADGB in reducing the CROSSBOW danger do not fall within the scope of this narrative.

13. Msg., Conrad sgd. Eisenhower to Bissell for Henry, USSTAF EX33516, 17 June 1944; Brereton, *Diaries*, p. 288.

14. On the face of this memo is an inked note which reads: "Shown to PM at CROSSBOW mtg. 19th June." Brereton notes in his *Diaries* (p. 288, 18 June), "In view of...seriousness of the situation, the Supreme Commander has directed (I understand on the insistence of Churchill) that [CROSSBOW]...receive first priority." Two days later Brereton writes, "Prime Minister called on Ike Sunday afternoon [18 June] at our headquarters preliminary to a meeting of his cabinet to consider definitive measures. He has...directed...that [CROSSBOW] targets are to take first priority over everything except the urgent requirements of battle."

15. 8th AF Target Sum.

16. War Room Monthly Sum. of Bomber Command Opns., June 1944.

17. *Ibid.*

18. 8th AF Target Sum.

19. BAM (AHB), File 77 (nars.).

20. *Ibid.*; Hq. USSAFE, Contribution of Air Power to the Defeat of Germany (Coffin Rpt.), n.d., App. J, pp. 184-86.

21. War Room Monthly Sum. of BC Opns., June 1944.

22. BAM (AHB), File 77 (nars.).

23. AEF Commanders Conferences, various dates after 18 June 1944.

24. AEF/T.S. 13165/ Air/ Pt. IV/ Incl. 45A; ltr., Maj. Gen. F. L. Anderson to CG 8th AF, 1 July 1944, Tactical Bombing Operations in Occupied Territory.

25. AEF Comdrs. Conf., 16 June 1944.

26. *Ibid.*, 18 June 1944.

27. Report on Flying Bomb and Rocket Firing and Storage Sites, Aug. 1943-Sept. 1944, 23 Oct. 1944, App. M.

28. AEF Comdrs. Conf., 18 June 1944.

29. *Ibid.*

30. Loose Minute, Brig. Gen. F. H. Smith, Jr., D/SASO to C-in-C thru SASO, 20 June 1944.

31. Doolittle was strongly opposed to the use of GH sighting for modified site targets. (BAM [AHB], File 77 [nars.] and 8th AF Target Sum.)

32. AEF Comdrs. Conf., 18 June 1944.

33. *Ibid.*, 23 June 1944.

34. USSBS Interview 11, Reichsminister Albert Speer, May 1945, pp. 76, 79; Dornberger, V-2, n.n.; Brereton, *Diaries*, p. 289.

35. AEF Comdrs. Conf., 20 June 1944.

36. Brereton, *Diaries*, p. 289; Butcher, *My Three Years with Eisenhower*, p. 590; BAM (AHB), File 77 (nars.).

37. AEF Comdrs. Confs., 20 and 23 June 1944.

38. War Room Monthly Sum. of BC Opns., June 1944.

39. *Ibid.*

40. For the bombing of the Pas-de-Calais electrical system, see BAM (AHB), File 77 (nars.).

41. IN msgs., Spaatz to Arnold, U-63855 WAR, 20 June; U-63967, 22 June; U-63855, 25 June 1944.

42. The APHRODITE project was activated in the theater on 23 June 1944. (Ltr., Maj. Gen. F. L. Anderson, USSTAF to CG 8th AF, APHRODITE Directive; Col. Cass S. Hough, Daily Diary, Project "A," entry 23 June 1944. The complete files of the APHRODITE project [and under subsequent nomenclatures] are in AFSSHO files.) The AAF

Proving Ground began its related experiments (under the title WEARY WILLIE) informally in the summer of 1944, formally on 7 October 1944, and completed the first phases of its share of the project on 17 January and 9 April 1945. (AFPGC Index and List of Service Tests, E-44-48, Secs. 1-6.)

43. Air Min., CROSSBOW Counter Measures Progress and Intelligence Report for the period 25th June to 9th July, 1944, dtd. 11 July 1944.

44. AEF Comdrs. Conf., 30 June 1944.

45. 8th AF Target Sum.; War Room Monthly Sums. of BC Opns., June-Aug. 1944; AEF Comdrs. Confs., 20 June *et seq.*

46. Personal ltr., Spaatz to Eisenhower, 28 June 1944. A notation on this letter reads, "Carried by hand to Gen. E. by Gen. S. on 29 June 1944."

47. Butcher, *Three Years*, p. 595 (entry 29 June 1944). Since there were no written directives by Eisenhower on reaffirmation of the CROSSBOW bombing priority (BAM [AHB], File 77 [nars.]), this entry in Butcher's diary may be accepted as a record of Eisenhower's decision.

48. BAM (AHB), File 77 (nars.).

49. *Ibid.*

50. "CROSSBOW" Counter Measures Progress and Intel. Rpts. 42-43; BAM (AHB), File 77 (nars.); JP (44) 177 (Final), 5 July 1944; COS (44) 222d Mtg. (O), 5 July 1944.

51. Pers. ltr., Maj. Gen. F. L. Anderson to Brig. Gen. L. S. Kuter, 26 June 1944. Though written a few days before the V-1 bombardment increased, Anderson's letter is typical of many exchanged between air commanders at the time.

52. War Room Monthly Sum. of BC Opns., July 1944.

53. *Ibid.*, Aug. 1944.

54. 8th AF Target Sum.; Coffin Rpt., App. J, pp. 184-86; History, 15th AF, 1 June-30 Sept. 1944; 15th AF, Counter-Air Operations in Southwest Germany on 20 July 1944.

55. 8th AF Monthly Sums. of Opns., July-Aug. 1944; War Room Monthly Sums. of BC Opns., July-Aug. 1944.

56. BAM (AHB), File 77 (nars.); Joint

CROSSBOW Com. Review of Offensive Counter Measures and Future Policy 1, 5 Aug. 1944, p. 1. In the accounts cited, and in other documents of the period—in particular the voluminous comments of the air commanders in minutes, letters, and memos—there is evidence that attacks on even the most satisfactory targets (principally storage depots) were regarded as having at best a very small bearing on the rate of V-1 firings.

57. See n. 55.

58. BAM (AHB), File 77 (nars.). See also n. 55.

59. JP (44) 177 (Final), 5 July 1944; COS (44) 222d Mtg., 5 July 1944; 3d Rpt. by chairman CROSSBOW Com., 6 July 1944, item 6 and penciled note, Eisenhower to Tedder on copy; COS Brief and Action Rpt., 6 July 1944.

60. Rpt. by Gen. C. P. Cabell, Integrating Flying Bomb and Rocket Counter-Measures into the Final Offensive vs. Germany, bearing notation: ". . . forwarded to Lord Beaverbrook by Gen. Anderson, on 6 July 1944 (by pers. letter)."

61. *Ibid.*

62. Ltr., Anderson to Tedder, 8 July 1944.

63. The covering memo by Spaatz, which has not come to light, is mentioned in pers. letter, Spaatz to Tedder, 15 July 1944.

64. Pers. ltr., Spaatz to Eisenhower, 10 July 1944.

65. Pers. ltr., Spaatz to Tedder, 15 July 1944.

66. Pers. ltr., G. C. McDonald, Dir. of Intel., USSTAF to Air Vice Marshal Frank F. Inglis, AC/AS (I), Air Min., 15 July 1944.

67. Minutes of Joint CROSSBOW Com. 1st Mtg., Air Min., Whitehall, 21 July 1944; BAM (AHB), File 77 (nars.).

68. SHAEF did not favor establishment of a completely independent CROSSBOW Committee, as is seen in ltr., Lt. Gen. W. B. Smith, C/S SHAEF to Gen. Anderson, 21 July 1944.

69. BAM (AHB), File 77 (nars.).

70. Minutes of Joint CROSSBOW Com. 1st Mtg., 21 July 1944.

71. COPC/S, 2107, 8 July 1944, Preliminary Report on the Possibility of Re-

ducing the Flying Bomb Activity to an Acceptable Scale and on the Sterilization of the Large Rocket.

72. COPC/S, 2107, 23 July, Minutes of a Meeting Held at COPC, Pinetree, on 21 July 1944, to Discuss Operational Plans for the Attack of CROSSBOW and NOBALL Targets.

73. BAM (AHB), File 77 (nars.). The exhaustive analysis of CROSSBOW operations in the file here cited deals extensively with the conflict between Tedder and the air commanders and working members of the Joint Committee.

74. Joint CROSSBOW Com., Review of Offensive Counter Measures and Future Policy 1, 5 Aug. 1944; Joint CROSSBOW Com., Min. of Mtgs., 21 July, 28 July, 5 Aug. *et seq.*; memo, Col. A. R. Maxwell to Spaatz, 6 Aug. 1944; ltr., Air Min. to DSCA SHAEF, 15 Aug. 1944. Note on the Attack of Modified Launching Sites; BAM (AHB), File 77 (nars.). Following the fourth effort of the Joint Committee to suspend attacks on modified sites (5 Aug., first document cited above) Spaatz and Anderson were prepared to make one more strong attempt to obtain a new CROSSBOW policy from Eisenhower, by preparing letters and copies of the 5 Aug. report of the Joint Committee for forwarding to Eisenhower, Portal, and Arnold. (R&R, Anderson to D/O USSTAF, 7 Aug. 1944.) The author has found no evidence that the correspondence was forwarded.

75. BAM (AHB), File 77 (nars.).

76. 8th AF Monthly Sum. of Opns., Aug. 1944.

77. BAM (AHB), File 77 (nars.).

78. 8th AF Monthly Sum. of Opns., Aug. 1944.

79. BAM (AHB), File 77 (nars.).

80. War Room Monthly Sum. of BC Opns., Aug. 1944; 8th AF Monthly Sum. of Opns.

81. BAM (AHB), File 77 (nars.); CROSSBOW Counter Measures Progress and Intel. Rpt. 43, 10-23 July 1944. Gen. Dornberger, in conversation with the writer after the conclusion of the AFSHO interview (12 July 1949), indicated that the raid of 18 July 1944 had produced more serious damage and a

greater setback to operations at Peene-münde than the RAF raid of 17/18 Aug. 1943.

82. War Room Monthly Sums. of BC Opns., July-Aug. 1944; 8th AF Target Sum.

83. BAM (AHB), File 77 (nars.); Hill, Despatch.

84. In addition to receiving authentic intelligence on the V-2 from Polish sources early in July, the Allies were permitted to inspect (and later to transport to England) an essentially intact V-2 that had accidentally fallen in Sweden in June. (COS Brief and Action Report, 12 July 1944; CMS 307/DCAS, 3 Aug. 1944, Air Staff Memo on the Location and Attack of Rocket Firing Facilities; CROSSBOW Counter Measures Progress and Intel. Rpts. 42-43; BAM [AHB], File 77 [nars].)

85. IN msg., Spaatz to Arnold, U-63855 WAR, 20 June, U-63967 WAR, 22 June 1944; pers. ltr., Spaatz to Eisenhower, 28 June 1944.

86. R&R, Col. J. L. Travis to Col. A. R. Maxwell, Dir./Opns. USSTAF, 14 July 1944; memo for Sutterlin from F. L. Anderson, 27 July 1944, Transport of Committee to U.S. Bases in Russia. The Russians did not capture Blizna until late August; the committee entered the Polish site on 3 September 1944. (BAM [AHB], File 77 [nars.]; ltr., Anderson to Lt. Col. John A. O'Mara, 29 July 1944; ltr., Anderson to Duncan Sandys, chairman, War Cabinet CROSSBOW Com., 12 Aug. 1944; subsequent correspondence in AFSHO files.)

87. BAM (AHB), File 77 (nars.); War Room Monthly Sums. of BC Opns., June-Aug. 1944; CROSSBOW Counter Measures Progress and Intel. Rpts. 41-46, 11 June-3 Sept. 1944. In the latter reports more sanguine estimates were given of damage to large sites in consequence of Tallboy bombings than later examination perhaps justified. Report by the Sanders Mission to the Chairman of the CROSSBOW Committee, 21 Feb. 1945; Dornberger interview; AAFEB in ETO, Survey of Bomb Damage Sustained by the Large NOBALL Site at Watten, 31 Mar. 1945.

88. ADI (Science) (CBC) (44) 24, 27

- Aug. 1944; BAM (AHB), File 77 (nars.); CROSSBOW Counter Measures Progress and Intel. Rpt. 46, 20 Aug.-3 Sept. 1944.
89. Ltr., Air Vice Marshal J. M. Robb, D/CAS SHAEF, 25 Aug. 1944.
90. 8th AF Target Sum.; War Room Monthly Sum. of BC Opns., Aug. 1944.
91. 8th AF Target Sum.; 8th AF Monthly Sums. of Opns., July-Aug. 1944.
92. CROSSBOW Counter Measures Progress and Intel. Rpts. 41-46.
93. BAM (AHB), File 77 (nars.); 8th AF Target Sum.; War Room Monthly Sums. of BC Opns., June-Aug. 1944. It has been impossible to provide an exact listing of the number of times particular CROSSBOW targets were attacked by the Bomber Command.
94. CROSSBOW Counter Measures Progress and Intel. Rpt. 46.
95. BAM (AHB), File 77 (nars.). There is, in the chief documents on CROSSBOW, no agreement as to the number of V-1's successfully fired (passing the French coast) against England during this period. The total given in the text is drawn from presumably the most authoritative account and is conservative.
96. *Ibid.*; Rpt. on Flying Bomb and Rocket Firing and Storage Sites, Aug. 1943-Sept. 1944, App. M; CROSSBOW Counter Measures Progress and Intel. Rpt., 6-29 Aug. 1944.
97. BAM (AHB), File 77 (nars.).
98. Gen. F. L. Anderson at the COPC meeting of 21 August, when Col. A. R. Maxwell proposed using the Eglin Field technique against modified sites, succeeded in convincing the committee that "experience had proved this form of attack... expensive." (See n. 72.)
99. AFPGC, Summary of Activities, 1 July 1943-30 June 1945, for Inclusion in Rpt. to WD Chief of Staff, p. 14.
100. Listed in detail in BAM (AHB), File 77 (nars.); also, Hill, Despatch, *passim*; ltr., Anderson to Tedder, 8 July 1944, Joint CROSSBOW Com.; memo for Anderson from Brig. Gen. G. C. McDonald, Dir. Intel., USSTAF, 8 July 1944; pers. ltr., Spaatz to Tedder, 15 July 1944; pers. ltr., McDonald to F. F. Inglis, Air Min., 15 July 1944; Brief Report on CROSSBOW to Col. L. P. Weicker, n.s., in AFSHO files; Joint CROSSBOW Com., Min. 4th Mtg., 12 Aug. 1944.
101. BAM (AHB), File 77 (nars.); and docs. cited in n. 100, with exception of last item.
102. BAM (AHB), File 77 (nars.).
103. *Ibid.*
104. BIG BEN msgs. in AFSHO files.
105. BAM (AHB), File 77 (nars.).
106. *Ibid.*
107. USSBS, V Weapons [Crossbow] Campaign, pp. 15-16.
108. COS (44) 299th Mtg., 6 Sept. 1944; BAM (AHB), File 77 (nars.).
109. COS (44) 299th Mtg., 6 Sept. 1944; BAM (AHB), File 77 (nars.). For date of the campaign's end, see COS (45) 115th Mtg., 2 May 1945. At the CCS meeting of 26 September, Arnold proposed a "limited" secrecy policy but was voted down. (CCS 700, 26 Sept. 1944.)
110. War Room Monthly Sum. of BC Opns., Sept. 1944.
111. These totals listed under 8th AF Opns. in the Coffin Rpt., App. J, pp. 184-86, are unidentified as CROSSBOW operations in either 8th AF Target Sum., 17 Aug. 1942 thru 8 May 1945, or 8th AF Monthly Sum. of Opns., Sept.-Dec. 1944.
112. For detailed narrative of ADGB CROSSBOW opns., see BAM (AHB), File 77 (nars.) and Hill, Despatch. It may be noted here that beginning in September the ADGB operated continuously over continental Europe in carrying out its CROSSBOW "defensive" operations, thereby relieving heavy bomber forces of this responsibility.
113. Coffin Rpt., App. J, pp. 184-86; SHAEF Air Defense Div., An Account of the Continental CROSSBOW Operations, 1944-45, pp. 54-56.
114. An Account of the Continental CROSSBOW Opns., 1944-45, pp. 54-56.
115. BAM (AHB), File 77 (nars.).
116. *Ibid.*; COS (45) 115th Mtg., 2 May 1945.
117. 8th AF Target Sum.; War Room Monthly Sum. of BC Opns., Sept. 1944; Coffin Rpt., App. J, pp. 184-86; USSBS, V Weapons [Crossbow] Campaign, p. 18.
118. USSBS, V Weapons [Crossbow]

Campaign, p. 18; BAM (AHB), File 77 (nars.).

119. Ltr., Lt. Gen. F. E. Morgan to AC/S G-3, Weapons V-1 and V-2, 3 Oct. 1944.

120. Eisenhower to War Off. Air Ministry, S-61465, 9 Oct. 1944; Brit. C/S to Eisenhower, 6237, 24 Oct. 1944.

121. Ltr., SHAEF (Main), AG 370-3 ADD-AGM, 15 Dec. 1944, Functions of Continental CROSSBOW Collation and Intelligence Sections at Supreme Headquarters, AEF. For prior actions, see COS (44) 918 (O), 23 Oct. 1944, Annexes I and II; Min. of CROSSBOW Air Reconnaissance Mtg. Held at SHAEF, 28 Oct. 1944; Memoranda CICS/1 and CICS/2, 1 and 13 Nov. 1944.

122. Memoranda CICS/2, 13 Nov. 1944, App. B.

123. Memo for AC/S G-2 WDGS, n.n., Evaluation of Two Reports on New German Guided Missiles.

124. *Ibid.*; memo for Opns. Dep. A-2, 12 Dec. 1944, Evaluation of German Guided Missiles Reports Requested by G-2; ltr., Tedder to Portal, 19 Nov. 1944.

125. See memo cited in n. 123.

126. Ltr., Spaatz to Arnold, 7 Jan. 1945.

#### NOTES TO CHAPTER 16

1. Hq. USSTAF GO 59, 1 Sept. 1944; History, IX TCC, Sept. 1944; 26th SCU, Hq. 9th AF, Statistical Summary of Ninth Air Force Operations, 16 Oct. 1943-8 May 1945, p. 6; History, Det. A, 1st AADA Adv., IX AFSC, Aug. 1944.

2. Ninth Air Force Invasion Activities, Apr.-June 1944, p. 69.

3. IX AFSC in Operation OVERLORD, D-15 to D+90, pp. 24-25. See also monthly histories of 9th AF fighter and service groups, June-Aug. 1944.

4. History, 21st Weather Sq., 6 June 1944-1 Jan. 1945, II, 58; IX Engineer Command Periodic Staff Report, 1-10 June, Operations, p. 1; History, IX EC, pp. 62-63.

5. History, 21st Weather Sq., 6 June 1944-1 Jan. 1945, II, 5; History, IX AFSC, pp. 175-76.

6. Hq. IX AFSC GO 105, 17 July 1944; History, IX FC and IX TAC,

June 1944, p. 1; History, 70th FW, July 1944; 9th AF Invasion Activities, p. 69.

7. Movements Control Rpts., Arrivals on Far Shore, 6-10 June.

8. Build-Up Control Rpt. (BUCO), Statistics on 9th AF Far Shore Arrivals, 22 June 1944.

9. Histories, 66th, 9th, and 64th Airdrome Sqs. and 50th, 366th, 368th, and 395th Ftr. Gps., June 1944.

10. 9th AF Station List, 30 June 1944; Histories, 67th TR Gp. and 48th, 354th, 365th, 371st, 404th, 405th Ftr. Gps., June 1944.

11. 9th AF Station List, 31 July 1944 and Amend. 1, 10 Aug. 1944. See also histories of 10th PR Gp. and remaining fighter groups for July 1944 and 474th Ftr. Gp. for Aug. 1944.

12. Hq. XIX TAC GO's 15, 26, of 5 July, 20 Aug. 1944; History, XIX TAC, 1 July 1944-28 Feb. 1945, Pt. I, pp. 3-4.

13. History of 98th BW (M), July-Sept. 1944.

14. 9th AF Commanders Meeting, 20 Sept. 1944, pp. 2-3; Hq. 9th BD GO 124, 27 Oct. 1944; History, 97th BW, Sept.-Oct. 1944; History, 98th BW, Oct. 1944; History, 99th BW, Sept. 1944-May 1945, pp. 1-2.

15. 9th AF Station Lists, June-Aug. 1944.

16. Histories, 10th, 16th, 42d, 86th Air Depot Gps., July-Aug. 1944.

17. 9th AF Comdrs. Mtg., 14 July 1944, p. 21; History, IX AFSC, July 1944, p. 6.

18. History, 31st ATG, June-Aug. 1944.

19. IX AFSC Per. Staff Rpts., 3 Aug., p. 1, 3 Sept. 1944, p. 1; ASC-USSTAF Weekly Activity Rpt., 8 July 1944, p. 11; IX AFSC Monthly Progress Rpt., Sept. 1944, p. 3.

20. Hq. 9th AF GO 227, 18 Sept. 1944; Hq. IX AFSC GO 144, 14 Sept. 1944; Hq. IX BC GO 183, 17 Sept. 1944; History, 2d AADA, 1 Apr.-30 Sept. 1944, p. 2.

21. See monthly histories of 6th, 9th, 64th, 65th, 66th, 81st, 82d, 83d Airdrome Sqs., June 1944 thru Apr. 1945.

22. History, 2d AADA, Apr.-Sept. 1944, pp. 5, 11.

23. Hq. 9th AF GO 222, 13 Sept. 1944; msg., SHAEF Air to CG's 1st TAF and

9th AF Adv., A-234, 30 Oct. 1944; Ltr. of Instructions 1, Hq. 1st TAF to XII TAC and French TAC, 1 Nov. 1944.

24. IX AFSC Monthly Progress Rpt., Nov. 1944, p. 3; ltrs., USSTAF Main to CG 1st TAF, 28 Oct., 2 Nov. 1944. See also histories of IX, XIX, and XXIX TAC's for the period.

25. SOP SHAEF (M) AIR/S-35109/A-3, 24 Nov. 1944; ltr., A-3 SHAEF to SHAEF Mission (France), 20 Dec. 1944; 1st ind. (ltr., Knerr to CG U.S. Component AEF Main, 30 Sept. 1944), Brig. Gen. David M. Schlatter, Chief of Opns., AEF to D/CG Adm. USSTAF, 6 Oct. 1944; History, IX EC, pp. 146-48; The Ninth Air Force and its Principal Commands in the ETO, I, Pt. 3, 908-9.

26. 9th AF Station Lists, 30 June, 31 July 1944 and Sup. as of 10 Aug. 1944. See also histories of units previously mentioned as being in the beachhead.

27. History, IX FC and IX TAC, Sept. 1944, p. 4; maps opp. p. 146 in History, IX EC.

28. Memo for Dir. Special Studies, Hq. XIX TAC from Capt. John L. Brooks, Historian, XIX TAC, 22 May 1945; History, IX FC and IX TAC, Aug., p. 1, Sept. 1944, p. 1.

29. See maps opp. p. 146 in History, IX EC.

30. 1st TAF Station Lists, 19 Oct., 4 Nov., 28 Nov. 1944, 1 Jan. 1945; History, 1st TAF, map, p. 66.

31. History, 9th BD, Mar.-Apr. 1945, pp. 9-10; History, IX EC, maps opp. p. 146.

32. IX TCC Station Lists, 30 Sept., 17, 30 Nov. 1944, Feb., Mar. 1945; History, IX TCC, Jan.-Feb. 1945, pp. 63-66; History, IX EC, p. 166.

33. Memo for Col. James F. Early, Hq. IX AFSC, from Col. John M. Reynolds, Hq. IX AFSC Adv., 21 Aug. 1944.

34. T/O & E 1-137, 28 Mar. 1944; T/O & E 1-417, 2 Jan. 1944; IX AFSC in Opn. OVERLORD, D-15 to D+90, pp. 8-9.

35. Hq. IX AFSC GO 122, 11 Aug. 1944; ltr., Col. James D. Givens, Air Inspector, ASC-USSTAF to CG ASC-USSTAF, 24 Oct. 1944; IX AFSC in Opn. OVERLORD, pp. 8-9.

36. Memo for Col. J. F. Early from Col. J. M. Reynolds, 17 Aug. 1944; 9th

AF Comdrs. Mtg., 18 Aug. 1944; ltr., Spaatz to Arnold, 6 Nov. 1944; Hq. IX AFSC Memo 75-1, 20 Nov. 1944; History, 2d AADA, June-Sept. 1944, pp. 10-11; History, XIX TAC, 1 July 1944-28 Feb. 1945, Pt. 1, p. 120; History, A-4 Sec., Hq. 1st AADA, Sept. 1944, p. 1.

37. IX AFSC Monthly Progress Rpts., July, pp. 3-4, Sept. 1944, p. 4, Apr. 1945, p. 4.

38. See sources cited in n. 37.

39. History, 2d AADA, Apr.-Sept. 1944, pp. 11-12; History, XIX TAC, 1 July 1944-28 Feb. 1945, Pt. 1, p. 95. See also unit histories.

40. History, 2d AADA, pp. 11-12; History, IX AFSC, Sept. 1944, pp. 12-13; History, 2200th QM Trk. Co. (Avn.), Sept. 1944.

41. IX AFSC Monthly Progress Rpts., July, p. 3, Sept., p. 4, Oct. 1944, p. 4, Feb. 1945, p. 4.

42. IX TCC Monthly Stat. Sums., Jan.-Mar. 1945; Notes of 90th Allied Air Commanders Conference Held at Hq. AEF/SHAEF on 12 Sept. 1944 at 1130 Hours.

43. Memo for CG USSTAF from Gen. Knerr, 23 July 1944; 9th AF Comdrs. Mtg., 26 July 1944; Notes on Conf. Held at Hq. USSTAF, Friday, 11 Aug. 1944; ltr., Hq. ASC-USSTAF to Distribution, 30 Aug. 1944; ltr., Hq. ASC-USSTAF to CG 9th AF, 6 Sept. 1944; ltr., Col. J. D. Givens to CG ASC-USSTAF, 24 Oct. 1944.

44. Memo for CG ASC-USSTAF from Col. Leslie P. Arnold, CO 302d Trans. Wing, 10 Sept. 1944; Report of Investigation, Col. Milo C. McCune and Lt. Col. W. S. MacGill, Air Inspector's Sec., Hq. ASC-USSTAF, 9 Oct. 1944; Special Historical Rpt., Hq. 302d TW to Hist. Off., Hq. ASC-USSTAF, 16 Oct. 1944; History, 302d TW, p. 1.

45. Msg., Arnold to Spaatz, W8-4920, 22 Aug. 1944; memo for CG ASC-USSTAF from CO 302d TW, 24 Sept. 1944; History, 302d TW, Sept. 1944, p. 2.

46. 9th AF Comdrs. Mtg., 16 June 1944, p. 1; IX AFSC in Opn. OVERLORD, pp. 23-24; History, IX EC, p. 69; History, 31st ATG, June-July 1944.

47. IX AFSC Per. Staff Rpt., 13 Oct. 1944; SCO, Hq. USSTAF, Staff Refer-



ence Manual, Vol. III, Sums., Sec. IV.

48. SCO, Hq. USSTAF Staff Ref. Manual, Vol. III, Sums., Sec. IV; Off. of Surgeon, Hq. ASC-USSTAF Weekly Activity Rpt., 8 Sept. 1944; History, IX AFSC, Sept. 1944, p. 29; History, 302d TW, July-Aug. 1944; SCO, Hq. IX TCC Stat. Sum. 4, 31 July-30 Sept. 1944, dtd. 23 Oct. 1944.

49. Histories, 31st ATG, July-Aug. 1944 and 302d TW, Sept. 1944-Apr. 1945.

50. SCO, Hq. USSTAF Staff Ref. Manual, Vol. III, Sums., Sec. IV; History, IX AFSC, Sept. 1944, p. 29.

51. Ltr., Col. Arnold to Brig. Gen. C. P. Kane, D/CG ASC-USSTAF, 29 Sept. 1944; USSTAF Weekly Activity Rpt., 17 Mar. 1945, p. 5; History, 302d TW, Sept., Nov. 1944.

52. SHAEF Opns. Memo 29, 29 Apr. 1944; History, IX AFSC, June 1944, pp. 16-17.

53. 9th AF Comdrs. Mtg., 22 June 1944, p. 1; msg., Fwd. Ech. Communications Zone to SHAEF Main, E-46027, 8 Sept. 1944; ltr., Knerr to AC/S G-4, SHAEF, 30 Sept. 1944; ltr., Spaatz to Arnold, 30 Sept. 1944; 2d ind. (ltr., Maj. Gen. Paul L. Williams, CG IX TCC to CG 1st AAA and CG USSTAF, 20 Nov. 1944) Spaatz to CGAAF, 17 Jan. 1945.

54. Memo for Gen. Kane from Col. Arnold, 9 Sept. 1944; ltr., CO 302d TW to CG ASC-USSTAF, 4 Oct. 1944; ltrs., Spaatz to Arnold, 6, 20 Nov. 1944; ltr., Hq. USSTAF to CG 8th AF, 17 Jan. 1945, and 1st ind., Hq. 8th AF to CG USSTAF, Jan. 1945; Stat. Sum. of 8th AF Opns., 17 Aug. 1942-8 May 1945, p. 69; History, 302d TW, Sept. 1944.

55. IX TCC Monthly Stat. Rpt., Dec. 1944; History, 302d TW, Dec. 1944, p. 2.

56. AC/S A-3, SHAEF, Rpt. of Opns. of Allied Troop Carrier Aircraft, 1 May 1945; History, 302d TW, Mar.-Apr. 1945.

57. Ltr., Knerr to CG AAF, 10 May 1945.

58. History, IX EC, p. 146. This history is the chief source for the account of airfield construction which follows. Col. Herbert W. Ehr Gott furnished documents and verbal information which were of great assistance in the preparation of this section.

59. Stat. Sum. of 9th AF Opns., p. 6; Hq. IX EC, Aviation Engineer Operations on the European Continent, 6 June 1944-9 May 1945, p. 7; memo for CG-AAF from Col. George E. Mayo, Air Engr., Hq. AAF, 5 Apr. 1945, pp. 3-4; History, IX EC, pp. 186-87 and map opp. p. 186.

60. Hq. IX EC Ten Day Periodic Staff Rpt., 1-10 June 1944, Opns., p. 1; History, IX EC, pp. 62 ff.

61. See sources in n. 60.

62. See sources in n. 60.

63. Notes of the Eleventh Meeting of the Allied Air Commanders Held at Hq., AEAf on Sunday 11 June 1944.

64. History, IX EC, pp. 66-74 and App. 6.

65. Hq., IX EC Ten Day Per. Staff Rpt., 20-30 June 1944, Opns., p. 4; History, IX EC, pp. 66-67.

66. 9th AF Comdrs. Mtg., 23 June 1944, p. 3; History, IX EC, pp. 67, 150-54.

67. List of Airfields Operational and under Construction, D+14 to D+85, by Col. H. W. Ehr Gott, C/S IX EC, in History, IX EC, App. 5.

68. 9th AF Comdrs. Mtg., 30 June 1944, p. 2; History, IX EC, pp. 54, 70-71.

69. Air Operations Over the Invasion Front in June 1944, rpt. prepared by the German Air Hist. Br. (8th Abteilung), dated 27 Aug. 1944, p. 2, translated by British Air Min. AHB 6.

70. Memo for CGAAF from Col. Mayo, 5 Apr. 1945, p. 6; History, IX EC, pp. 70, 73-74, 169-72.

71. Ninth Air Force Plan for Operation NEPTUNE, 2 May 1944, Annex B, p. 1; Hq. IX EC GO 21, 7 Aug. 1944; 9th AF Comdrs. Mtg., 9 Aug. 1944, p. 4; History, IX EC and IX TAC, Aug. 1944, p. 2; History, IX EC, p. 77.

72. History, IX EC, pp. 82, 187-88.

73. Msg., Vandenberg to Spaatz, USSTAF IN-13482, 24 Aug. 1944; 9th AF Comdrs. Mtg., 20 Sept., pp. 2-3, 29 Oct. 1944, p. 2.

74. History, IX EC, pp. 82-84.

75. 9th AF Comdrs. Mtg., 18 Aug. 1944, p. 3; History, IX EC, pp. 84-87.

76. Hq. IX EC Ten Day Per. Staff Rpt., 20-30 June 1944, Opns., p. 1; ltr., Col. Karl B. Schilling, CO IX EC Adv.

to CG 9th AF, 11 Nov. 1944; History, IX EC, p. 154; IX AFSC in Opn. OVERLORD, pp. 31-32.

77. 9th AF Comdrs. Mtg., 27 Aug. 1944, pp. 1-2; History, IX EC, pp. 89-91.

78. History, IX EC, pp. 92-95.

79. *Ibid.*, p. 95.

80. Ltr., Maj. Gen. Ralph Royce, CG American Component, AEAFF to CG USSTAF, 29 Sept. 1944 and 1st ind., Gen. Knerr to CG ETOUSA, 30 Sept. 1944; History, IX EC, pp. 95-97, 155; Hq. ETOUSA Opns. Memo 30, 1 July 1944; IX AFSC in Opn. OVERLORD, pp. 31-32.

81. Hq. 9th AF Memo 55-25, 22 Sept. 1944; History, IX EC, pp. 97-98.

82. 9th AF Comdrs. Mtgs., 27 Sept., p. 4, 29 Oct. 1944, p. 2; History, 9th BD, Sept.-Oct. 1944, p. 2; History, IX EC, pp. 104-6.

83. History, IX EC, pp. 100-103.

84. Hq. USSTAF GO 81, 20 Oct. 1944; Changes in Aviation Engineer Organization Since 30 July 1944, by Col. H. W. Ehrigott, C/S IX EC, May 1945; memo for Col. Seaton Schroeder, CO USSTAF EC (Prov.) from CO 1st Engr. Regt. (Avn.) Prov., 9 Nov. 1944; ltr., Col. K. B. Schilling, CO IX EC Adv. to CG 9th AF, 9 Dec. 1944; msg., Hq. 9th AF Adv. to Hq. USSTAF, J512IE, 3 Jan. 1945; History, IX EC, pp. 96-97, 106-7.

85. Changes in Avn. Engineer Orgn.; USSTAF Daily Staff Mtg., 23 Dec. 1944; ltr., Hq. USSTAF, 13 Feb. 1945; Hq. USSTAF GO's 18, 32 of 17 Feb., 5 Apr.; History, IX EC, orgn. chart opp. p. 106.

86. USSTAF Weekly Activity Rpts., 3 Apr., p. 8, 17 Apr. 1945, pp. 8-9; ltr., Lt. Col. Arlon G. Hazen, CO 852d Engr. Avn. Bn. to CO IX EC Adv., 24 Apr.; History, IX EC, pp. 103-5, 112-13, 118, 167; ltr., Maj. Robert E. Miller, CO 23d Mobile Reclamation and Repair Sq., to CO 2d AADA, 27 Dec. 1944.

87. History, IX EC, pp. 123-30, 147.

88. 9th AF Comdrs. Mtg., 29 Oct. 1944, p. 3; History, IX EC, pp. 150-55, Annex 5.

89. Hq. IX EC, Memo, Airfields or Installations, n.s., 17 May 1945.

90. History, IX EC, pp. 153, 164-66.

91. Hq. IX EC, Avn. Engineer Opns. on the Continent, 6 June 1944 to 9 May 1945, p. 1.

92. Ltr., Hq. USSTAF to Distribution, 25 Sept. 1944.

93. Minutes, Air Force Comdrs. Mtg., Cannes, France, 25 Nov. 1944; Hq. USSTAF GO's 98, 100, 16 of 11, 15 Dec. 1944, 10 Feb. 1945; Hq. USSTAF Orgnl. Manual, 15 Dec. 1945; interview with Gen. Knerr by Capt. A. Goldberg, 12 May 1945.

94. History, IX AFSC, Oct. 1944, pp. 6-7; Minutes of Meeting on Supply of French Air Force, 22 Nov. 1944; interview with Maj. Gen. Robert M. Webster, CG 1st TAF, by Lt. H. Grattan, 28 May 1945; Hq. USSTAF Weekly Staff Mtg. 10, 21 Feb. 1945; Notes on Meeting Held 9 Nov. 1944 at A-42 (Villacoublay) 20 Nov. 1944; ASC-USSTAF Weekly Staff Mtg., 13 Jan. 1945; memo for All Staff Sections from Hq. 1st TAF, 10 Feb. 1945; ltr., Gen. Royce to CG 42d BW, 15 Jan. 1945; ltr., Hq. 1st TAF to CG USSTAF, 2 Jan. 1945 w/1 incl.

95. ASC-USSTAF Staff Mtg. 119, 5 Oct. 1944; Min. of Personnel Conf. at Hq. IX TCC, 7 Oct. 1944; ltr., Col. Givens to D/CG Adm. USSTAF, 4 Nov. 1944, pp. 1-4; ATSCE Weekly Activity Rpt., 10 Mar. 1945.

96. Ltr., Spaatz to Arnold, 5 Nov. 1944; ltr., Giles to Spaatz, 11 Dec. 1944; USSTAF Daily Staff Mtgs., 13 Nov., 30 Dec. 1944; Hq. 8th AF Ltr. Orders, 3, 10, 25, 30 Jan. 1945.

97. Ltr., Col. Philip B. Foote, CO VIII AFSC Sv. Ctr. to Brig. Gen. Joseph T. Morris, Dir/Maintenance, ASC-USSTAF, 23 Oct. 1944; Hq. VIII AFSC GO 30, 30 Dec. 1944; USSTAF Weekly Activity Rpt., 9 Jan. 1945, p. 4; 8th AF Station List, 6 Apr. 1945. For detailed accounts see histories of VIII AFSC Sv. Ctr. and 5th SAD.

98. ASC-USSTAF Mtg. 252, 18 July 1944; ltr., Hq. ASC-USSTAF to CG BADA, 3 Aug. 1944; ltr., Hq. BADA to CG ASC-USSTAF, 9 Aug. 1944; memo for Gen. Royce from Gen. Knerr, 2 Oct. 1944; memo for Brig. Gen. Myron R. Wood, CG IX AFSC from Gen. Knerr, 27 Oct. 1944; memo for CG

BADA from Gen. Knerr, 12 Nov. 1944; Min. of Mtg., 19 Dec. 1944, at IX AFSC; IX AFSC Per Staff Rpt., 23 Mar. 1945, p. 2; ATSC Weekly Activity Rpt., 24 Mar. 1945, p. 5.

99. Hq. IX AFSC Memos 20-18, 9 Oct., 55-25A, 12 Oct., 20-19, 10 Dec. 1944, 20-17, 20 Feb. 1945; ltr., Col. Givens to CG ASC-USSTAF, 24 Oct. 1944; History, XIX TAC, 1 July 1944-28 Feb. 1945, Pt. 1, p. 95; History, 1st AADA, Sept. 1944, p. 3.

100. Ltr., CG BADA to CG USSTAF, 11 Sept. 1944; Hq. IX AFSC G-4 Per. Rpt., quarter ending 15 Sept. 1944, dtd. 25 Sept. 1944.

101. 9th AF Comdrs. Mtg., 16 June 1944, p. 2; ltr., Lt. Col. Irving P. Turman, Exec. Dir/Supply to D/S Hq. ASC-USSTAF, 5 July 1944; USFET General Board Rpt. 130, pp. 16-17.

102. Hq. IX AFSC G-4 Per. Rpt., quarter ending 15 Sept. 1944, 25 Sept. 1944; Hq. IX AFSC Memo 20-20, 31 Oct. 1944; ltr., Col. Givens to D/CG Adm., 24 Oct. 1944; ltr., CG USSTAF to CG Comm. Zone, 10 Oct. 1944; IX AFSC Per. Staff Rpt., 13 Nov. 1944, p. 6; Historical Activities, Supply Div., Hq. CADA, p. 2.

103. Hq. USSTAF GO 96, 9 Dec. 1944; memo for CG BADA from Gen. Knerr, 27 Oct. 1944; CADA Weekly Activity Rpt., 21 Mar. 1945, p. 2.

104. Memo for Col. Early from Col. Reynolds, 17 Aug. 1944; msg., SHAEF to AGWAR, FWD-16181, 29 Sept. 1944, pp. 2-3; ltr., Gen. Knerr to CG Comm. Zone, 2 Nov. 1944.

105. 9th AF Comdrs. Mtg., 23 June 1944; memo for DC/AS, Hq. AAF, Brig. Gen. R. L. Owens from AC/AS Plans, 15 July 1944.

106. IX AFSC Per. Staff Rpts., 3 Jan., p. 6, 13 Jan. 1945, p. 1; USSTAF Weekly Activity Rpt., 13 Feb. 1945; 9th AF Stat. Sum., p. 8; 1st TAF Sum. of Opns., pp. 17-18.

107. 9th AF Stat. Sum., pp. 5, 8; 1st TAF Sum of Opns., pp. 17-18; USSTAF Weekly Activity Rpt., 1 May 1945, p. 6.

108. 9th AF Comdrs. Mtgs., 27 Aug., 27 Sept. 1944; USSTAF Weekly Activity Rpt., 3 Feb. 1945, p. 6; Hq. IX AFSC

Memo 65-37, 21 Jan. 1945; CADA Weekly Activity Rpt., 31 Jan. 1945, p. 1.

109. Memos for Col. Early from Lt. Garrison, Hq. IX AFSC, 5 and 23 Aug. 1944; IX AFSC Per. Staff Rpt., 3 Oct. 1944, p. 3; ASC-USSTAF Weekly Activity Rpt., 3 Feb. 1945, p. 1; USSTAF Weekly Activity Rpt., 27 Mar. 1945, p. 6; CADA Weekly Activity Rpt., 4 Apr. 1945, p. 2.

110. IX AFSC Monthly Progress Rpts., Sept., pp. 3-4, Oct., p. 4, Nov., p. 4, Dec. 1944, pp. 1, 3-4, Apr. 1945, p. 4; Journal of Communications between the Generals of Various Ninth Air Force Commands, 18 Dec. 1944; ATSC Weekly Activity Rpt., 28 Apr. 1945; History, XIX TAC, Pt. 1, p. 110a.

111. Hq. BADA Annual Stat. Sum., 1944, pp. 8-9; BADA Monthly Stat. Sums., Jan.-Apr. 1945.

112. IX AFSC Per. Staff Rpt., 4 July 1944, p. 5; memo for Eisenhower from Spaatz, 24 July 1944; msg., USSTAF Main to USSTAF, UA 502286, 20 Oct. 1944; msg., Eisenhower to Marshall, CM-IN-21143, 22 Oct. 1944; ATSC Weekly Activity Rpt., 7 Apr. 1945; BAM (AHB) Statement of Aircraft Unserviceable Through the Non-Availability of Spare Parts (Airframe or Engine).

113. Memo for Robert A. Lovett, A/SW for Air from Gen. Knerr, 13 June 1944; memo for Eisenhower from Spaatz, 24 July 1944; memo for Lt. Gen. Brehon B. Somervell, CG ASF from Gen. Knerr, 24 Jan. 1945; memo for CGAAF, from Gen. Knerr, 26 Mar. 1945.

114. Memo for CGAAF from Gen. Knerr, 26 Mar. 1945; CADA Weekly Activity Rpts., 31 Jan., p. 4, 21 Mar., pp. 3-4, 26 Mar. 1945, pp. 1-2.

115. IX AFSC Per. Staff Rpts., 13 Dec. 1944, p. 7, 13 Feb. 1945, p. 3; USSTAF Weekly Activity Rpts., 3 Feb., p. 5, 27 Mar. 1945, p. 6.

116. Memo for D/CG Opns., Hq. USSTAF from Lt. Col. George J. Fix, Jr., 8 July 1944; memo for Eisenhower from Spaatz, 24 July 1944; ltr., Spaatz to Giles, 26 Mar. 1945; USSTAF Weekly Activity Rpt., 27 Mar. 1945, p. 5; ATSC Weekly Activity Rpt., 31 Mar. 1945; IX AFSC Per. Staff Rpt., 3 Apr. 1945, p. 4; History,

BADA, Mar. 1945; AAF Stat. Digest, World War II, p. 243.

117. Ltr., Giles to Spaatz, 20 Apr. 1945; History, BADA, May 1945; Minutes, Meade Committee Hearings at Hq. USSTAF, 24 May 1945.

118. Msg., Eisenhower to Marshall, FWD 12434, 23 July 1944; ltr., Maj. Gen. Laurence S. Kuter, AC/AS Plans, Hq. AAF to Gen. Spaatz, 19 Aug. 1944; ASC-USSTAF Weekly Activity Rpt., 14 Oct. 1944; ATSCE Weekly Activity Rpts., 10 Mar., 7 Apr. 1945.

119. See Administration Plan, OVERLORD, Annex 4, p. 2. See also Vol. II, this series, pp. 617-18, 651-52 for a discussion of the gasoline distribution system in the United Kingdom.

120. Memo for CG ASC-USSTAF from Col. Bernerd F. Johnson, 24 June 1944; memo for Col. Johnson from Col. Reynolds, 9 July 1944, p. 2; IX AFSC in Opn. OVERLORD, pp. 16-19.

121. Memo for CG IX AFSC from Col. Reynolds, 26 June 1944, p. 2; memo for Col. Johnson from Col. Reynolds, 9 July 1944; ltr., CG IX AFSC to Dir. ATSC, Wright Field, 20 Dec. 1944.

122. Memo for CG IX AFSC from Col. Reynolds, 26 June 1944; memos for Col. Early from Col. Reynolds, 23, 28 July, 6 Aug. 1944; ltr., Gen. Wood to CG 9th AF, 7 Aug. 1944.

123. Ltr., Col. Reynolds to Col. Early, 8 Aug. 1944; memo for Col. Early from Col. Reynolds, 14 Aug. 1944, p. 2; ltrs., Lt. Garrison to Col. Early, 23 Aug., 7 Sept. 1944; memos for Col. Johnson from Lt. Col. William P. Boyd, 26 Aug., 6 Sept., 18 Sept. 1944; ltr., CG BADA to CG USSTAF, 11 Sept. 1944; ltr., Lt. Col. Boyd to D/S, Hq. ASC-USSTAF, 16 Sept. 1944; map, POL Distribution, prepared by Hq. Comm. Zone G-4 POL Sec., May 1945.

124. Memo for D/S, Hq. ASC-USSTAF from Lt. Col. Boyd, 16 Sept. 1944; memo for Gen. F. L. Anderson from Gen. Knerr, 15 Oct. 1944, pp. 1-2; msg., USSTAF Adv. to USSTAF Main, U-69214, 15 Oct. 1944.

125. SCO, Hq. ASC-USSTAF, Data on Aviation Fuel Delivery Routes and Storage Points as of 30 September 1944, 3 Oct. 1944; ltr., CG IX AFSC to CG

9th AF, 15 Feb. 1945; maps, POL Distribution, Feb., May 1945, by Comm. Zone G-4 POL Sec.

126. Memo for Col. Early from Col. Reynolds, 14 Aug. 1944, p. 2; Hq. 9th BD (M), Memo 65-42, 14 Nov. 1944; ltr., CG IX AFSC to all air depot groups of IX AFSC, 10 Feb. 1945, p. 2; IX AFSC Per. Staff Rpt., 13 Mar. 1945, pp. 3, 5; USFET Board Rpt. 130, pp. 76-78.

127. Memo for CG ASC-USSTAF from D/M, 4 July 1944; Hq. IX AFSC, Memo 65-27, 8 July and 27 Nov. 1944; IX AFSC Per. Staff Rpt., 23 July 1944, p. 9.

128. History, IX AFSC, July 1944, p. 8. See histories of 1st and 2d AADA's.

129. IX AFSC Per. Staff Rpt., 23 June 1944, pp. 7-8; IX AFSC in Opn. OVERLORD, pp. 20-21; History, IX AFSC, Dec. 1944, p. 45.

130. For a discussion of BADA's responsibilities, see Vol. II, this series, pp. 657-64. Ltr., CG ASC-USSTAF to CG BADA, 22 June 1944; SCO, ASC-USSTAF, Average Time Lapse of Partly Assembled Aircraft from Time Received at Docks to Time of Delivery to Combat Units for Months of July, Aug., Sept. 1944, dtd. 13 Oct. 1944; memo for Gen. F. L. Anderson from Col. Jerome Preston, SCO, Hq. ASC-USSTAF, 13 Oct. 1944; History, D/M, ASC-USSTAF, 1944, Pt. III, p. 1.

131. Ltr., CG ASC-USSTAF to CG BADA, 22 June 1944; msg., CG ATSCE to CG CADA, 27 Feb. 1945; IX AFSC Per. Staff Rpt., 3 Mar. 1945, p. 5.

132. Min. of Conf. between Maj. Gen. Paul L. Williams, CG IX TCC and Brig. Gen. C. P. Kane, D/CG ASC-USSTAF, 6 Feb. 1945; ltr., CG ASC-USSTAF to CG BADA, 9 Feb. 1945; ATSCE Weekly Activity Rpt., 24 Feb. 1945; History, IX AFSC, Aug. 1944, p. 11.

133. BADA Stat. Sums. for 1st Qtr. of 1944 and monthly thereafter through Apr. 1945.

134. Ltr., Col. Tooher to CG ASC-USSTAF, 20 Sept. 1944; ASC-USSTAF Mtg. 210, 18 May 1944; 1st wrapper ind. (ltr., Col. Tooher to CG ASC-USSTAF, 20 Sept. 1944), Hq. ASC-USSTAF to CG BADA, 25 Sept. 1944; History, D/M, ASC-USSTAF, Pt. III, p. 4.

135. D/M, ASC-USSTAF memo, Compilation of Complete Data on Operation of USAAF Heavy Bombers in the U.K., n.d. but probably Sept. 1944; IX AFSC Per. Staff Rpt., 23 Nov. 1944, p. 9.

136. IX AFSC Per. Staff Rpt., 13 July 1944, p. 6; History, IX AFSC, July, p. 9, Aug., p. 8, Oct. 1944, p. 8.

137. History, IX AFSC, July, pp. 9-10, Oct. 1944, p. 8; History, IX TAC, Pt. 1, p. 95.

138. IX AFSC in Opn. OVERLORD, pp. 20-21; History, D/M, ASC-USSTAF, 1944, Pt. III, p. 5.

139. History, IX AFSC, July, p. 8, Dec. 1944, pp. 16-17.

140. Ltr., CG ATSCE to CG 1st TAF, 28 Feb. 1945; msg., Col. J. D. Givens, D/M, ATSCE to CG 9th AF, 7 Mar. 1945; History, D/M, ATSCE, 1945, pp. 1-2; History, IX AFSC, Sept. 1944, p. 9, Apr. 1945, p. 11.

141. IX AFSC Monthly Progress Rpts., May 1944-Apr. 1945.

142. *Ibid.*; IX AFSC in Opn. OVERLORD, pp. 20-21.

143. History, D/M, ASC-USSTAF, 1944, Pt. III, pp. 7-8; D/M ATSCE Weekly Activity Rpt., 26 Apr. 1945.

144. Memo for CG ASC-USSTAF from D/M, 4 July 1944; 9th AF Comdrs. Mtg., 14 July 1944, p. 4.

145. 1st TAF Stat. Sum., p. 14; 9th AF Stat. Sum., p. 8; 8th AF Stat. Sum., pp. 14-15; History, 1st TAF Service Comd., p. 11.

146. 9th AF Comdrs. Mtg., 30 June 1944, p. 2; memo for CG ASC-USSTAF from D/M, 4 July 1944; Hq. IX AFSC Memo 65-16, 18 Dec. 1944; ltr., 2d TAF Rear Hq. to RAF 83 Gp. Rear Hq., 30 Nov. 1944; History, D/M ASC-USSTAF, 1944, Pt. D, pp. 1-5.

#### NOTES TO CHAPTER 17

1. On the enemy situation, see especially H. M. Cole, *The Lorraine Campaign* (U.S. Army in World War II: European Theater of Operations) (Washington, 1950), pp. 29-42.

2. GAF Order of Battle, 25 Sept. 1944. The average operational strength of Luftkommando West during September was 381, according to figures furnished

by British Air Ministry Air Historical Branch (BAM [AHB]) from German sources.

3. History, XXIX TAC, 14 Sept.-31 Oct. 1944.

4. History, 1st TAF (Prov.), I, 1-21. See also XII TAC greenline msg., Oct.-Nov. 1944.

5. Cole, *Lorraine Campaign*, p. 11. See also pp. 6-13 for an excellent condensation of the late summer discussions of strategy.

6. *Ibid.*, pp. 8-10.

7. AEAFF Planning Staff, Amendments to Third Draft: Post-NEPTUNE, Courses of Action after Capture of Lodgement Area, 25 Apr. 1944.

8. SHAEF, Post-NEPTUNE Operations, 12 Aug. 1944. See also Gen. Dwight D. Eisenhower, Report by the Supreme Commander to the CCS on the Operations in Europe of the Allied Expeditionary Force, 6 June 1944 to 8 May 1945, p. 62 (hereinafter cited as SAC Rpt.).

9. Cole, *Lorraine Campaign*, p. 10.

10. See especially Sir Bernard L. Montgomery, *Normandy to the Baltic*, pp. 192-99, and George S. Patton, Jr., *War as I Knew It*, p. 114.

11. Directive, SAC to Principal Subordinate Commanders, 29 Aug. 1944.

12. *Ibid.*, 4 Sept. 1944.

13. *Ibid.*, 13 Sept. 1944.

14. AAF Historical Study 36, The Ninth Air Force, Apr.-Nov. 1944, pp. 257-58.

15. 21 Army Gp., General Operational Situation and Directive, 14 Sept. 1944.

16. Montgomery, *Normandy to the Baltic*, p. 224.

17. 1st Allied Airborne Army, Operations in Holland, Sept.-Nov. 1944 (cited hereinafter as FAAA, Opn. MARKET).

18. 101st A/B Div., Opn. MARKET FO 1, 14 Sept. 1944; 82d A/B Div., Opn. MARKET FO 11, 13 Sept. 1944; Hq., Airborne Corps, Opn. MARKET Opn. Instr. 9, 13 Sept. 1944; 38 Gp., Opn. MARKET Opn. Order 526, 12 Sept. 1944.

19. History, IX Troop Carrier Comd., Sept. 1944, p. 4.

20. Msg., AEAFF Rear to USSTAF, RAF BC, 8th AF, 9th AF, 2d TAF, RAF

2 Gp., and FAAA, 11 Sept. 1944; Direc., AEF to Air Forces Concerned, Opn. MARKET, 16 Sept. 1944; ACM Sir Trafford Leigh-Mallory, Despatch to the Supreme Allied Commander Allied Expeditionary Forces, 1945, pp. 77-78 (hereinafter cited as Leigh-Mallory Despatch); 8th AF, Special Report of Operations in Support of First Allied Airborne Army, 17-26 Sept. 1944, pp. 2-3 (hereinafter cited as 8th AF, Opn. MARKET).

21. 8th AF, Opn. MARKET, pp. 4-5; FAAA, Opn. MARKET, pp. 11-12; 38 Gp. MARKET Opn. Order 526, and App. D, 12 Sept. 1944; AAFEB in ETO, The Effectiveness of Third Phase Tactical Air Operations in the European Theater, 5 May 1944-8 May 1945, p. 142 (hereinafter cited as Third Phase Tac. Air Opns.).

22. 8th AF, Opn. MARKET, pp. 7-12 and Annex 1, interpretation rpt. S.A. 2730, Attack on Tactical Targets in Holland on 17 Sept. 1944; FAAA, Opn. MARKET, pp. 15-18; History, 8th AF, Sept. 1944, p. 27; Notes of the 98th Allied Air Commanders Conference, 19 Sept. 1944, p. 3. The above and other sources consulted vary considerably in the figures of planes dispatched, successful sorties flown, losses sustained, etc. For the sake of consistency, the statistics given in 8th AF, Opn. MARKET have been used here.

23. 8th AF, Opn. MARKET; IX TCC, Opn. MARKET, Air Invasion of Holland, Annex J, pp. i-ii.

24. FAAA G-2, German Air Force Reaction to Airborne Landings in Holland, p. 1; SHAEF G-2 Weekly Intel. Sum. (Isum) 27, Pt. II, Air, 23 Sept. 1944.

25. Army Gp. B, Report on Experience Gained in the Battle with and Defeat of the First British Airborne Division in the Western Arnhem Sector, 1 Oct. 1944, reproduced in War Office Dir. of Air Monthly Liaison Ltr. 18, 23 Jan.-22 Feb. 1945.

26. BAM (AHB) Trans. VII/53, Extracts from Reports of Führer Conference Held on 17.9.44. See also Milton Shulman, *Defeat in the West*, pp. 184-85.

27. 8th AF, Opn. MARKET, pp. 13-19; FAAA, Opn. MARKET, pp. 18-20. See also rpt. by Capt. E. C. Thornton,

Observer, IX TCC A-3 Sec. to CG IX TCC, 1 Oct. 1944, pp. 2-3; Rpt., 50th TCW to CG IX TCC, 23 Oct. 1944; 38 and 46 Gps., Report on the British Airborne Effort in Operation MARKET, pp. 12-14 and Table III; IX TCC, Air Invasion of Holland, pp. 28-32.

28. Source as cited in n. 25 above, and SHAEF Intel. Notes 43, 6 Jan. 1945.

29. FAAA, Opn. MARKET, pp. 30-43; 8th AF, Opn. MARKET, pp. 20-43; IX TCC, Air Invasion of Holland, pp. 33-40 and Annex J, pp. iii-iv; Notes of 98th Allied Air Comdrs. Conf., 19 Sept. 1944; Notes of 99th Allied Air Comdrs. Conf., 22 Sept. 1944; 38 and 46 Gps., Rpt. on Brit. A/B Effort in Opn. MARKET, pp. 18-23 and Table IV; Montgomery, *Normandy to the Baltic*, pp. 230-39; Sir Francis de Guingand, *Operation Victory*, pp. 417-18; Lewis H. Brereton, *Brereton Diaries*, pp. 348-55; Leigh-Mallory Despatch, pp. 72, 77-79.

30. Cole, *Lorraine Campaign*, p. 256n.; FAAA, Opn. MARKET, pp. 45-47; Montgomery, *Normandy to the Baltic*, pp. 230-40; IX TCC, Air Invasion of Holland, Annex V, pp. v-vi; Dwight D. Eisenhower, *Crusade in Europe*, pp. 310-12; SAC Rpt., pp. 67-69; de Guingand, *Opn. Victory*, pp. 417-19.

31. Msg., AEF to ADGB, 2d TAF, 8th AF, 9th AF, 29 Sept. 1944.

32. Montgomery, *Normandy to the Baltic*, p. 243.

33. Memo for C/AS by Maj. Gen. L. S. Kuter, AC/AS Plans, 3 Nov. 1944, Brief of Attached Report on Airborne Operations in ETO (hereinafter cited as Kuter, Brief of Opn. MARKET).

34. Montgomery, *Normandy to the Baltic*, p. 242.

35. *Ibid.*

36. See BAM (AHB) Trans. VII/73, Situation Reports by German Army Commanders in Normandy, May 15-Oct. 11, 1944, p. 70; USSTAF Air Isum 49, 15 Oct. 1944.

37. Third Phase Tac. Air Opns., p. 155; 38 and 46 Gps., Rpt. on Brit. A/B Effort in Opn. MARKET, pp. 29-31.

38. IX TCC rpt., Troop Carrier Operational Activities, Sec. III, Opn. MARKET, p. 15; Leigh-Mallory Despatch, p. 79.

39. Kuter, Brief of Opn. MARKET; ltr., Spaatz to Arnold, 10 Dec. 1944; 8th AF, Opn. MARKET, p. 43; 8th AF Monthly Sum. of Opns., Sept. 1944, p. 1.

40. The table, slightly rearranged and mistakes in totals corrected, is taken from FAAA, Opn. MARKET, Annex 1, p. 1.

41. Ltr., Brig. Gen. H. B. Thatcher, AC/S A-3 SHAEF to Hq. 2d TAF, 29 Jan. 1945. Cf. Notes by A/C L. Darvall, AOC 46 Gp., on visit to Belgium and Holland 21-24 Sept., dtd. 26 Sept. 1944 (hereinafter cited as Darvall, Notes on Opn. MARKET).

42. 38 and 46 Gps., Rpt. on Brit. A/B Effort in Opn. MARKET, p. 29; Darvall, Notes on Opn. MARKET, par. 26.

43. Ltr., Brig. Gen. James M. Gavin, CG 82d A/B Div. to Maj. Gen. Paul L. Williams, CG IX TCC, 25 Sept. 1944.

44. 1st U.S. Army, Report of Operations, 1 Aug. 1944-22 Feb. 1945, pp. 47-56; 12th Army Gp., Destruction of the German Armies in Western Europe, June 6, 1944 to May 9, 1945, pp. 10-12; 12th Army Gp. G-3, Report of Operations, Final After Action Report, Pt. II, pp. 7-9.

45. Cole, *Lorraine Campaign*, pp. 209-59; Gen. Omar N. Bradley and Air Effects Com., 12th Army Gp., Effects of Air Power on Military Operations Western Europe (1945), pp. 134-35 (hereinafter cited as Bradley Rpt.); Patton, *War as I Knew It*, pp. 132-37.

46. The chief sources of information with regard to the operations of the tactical air forces under consideration are: Daily Opns. Rpts., Daily Isums (XIX TAC), and A-2 Periodic Rpts. (IX and XXIX TAC's); their monthly histories; 9th AF Monthly Sum. of Opns.; 9th AF Isums (Weekly); AEF Daily Air Isums; AEF Monthly Stat. Sum. of Opns.; Coffin Rpt., Vol. I (Pt. 1, Sec. E), Vol. II (Sec. D), Vol. III (p. 2). See also AAFHS-36, pp. 237-51; Bradley Rpt., pp. 125-27, 138-40; 12th Army Gp. G-2 Per. Rpt. (Daily) and G-3 Rpt. (Daily); 6th Army Gp. G-2 Weekly Isums; and similar daily and/or weekly G-2 and G-3 rpts.

47. Stat. data extracted from AEF Monthly Stat. Sum. of Opns., Sept. 1944, pp. 4, 24.

48. History, 9th Bomb. Div., Sept.-

Oct. 1944, pp. 104-36 and FO's and numerous other supporting docs.; 9th Bomb. Div. ORS Rpt. 58, 27 Sept. 1944; 9th AF ORS Rpt. 70, 13 Sept. 1944; Bradley Rpt., pp. 128-35; AAFHS-36, pp. 221-31.

49. See Patton, *War as I Knew It*, pp. 136-37 for a fine example of such an accomplishment on 24 Sept. by the 509th and 510th Sqs. of XIX TAC and Patton ltr. of commendation to Brig. Gen. O. P. Weyland.

50. AEF Daily Isums, 26-30 Sept. 1944; 9th AF Isums and USSTAF Isums (Weekly) for Sept. 1944.

51. SCAEF Special Mtg., 22 Sept. 1944; Harry C. Butcher, *My Three Years with Eisenhower*, pp. 675-76.

52. The staging of an airborne operation to assist the ground forces in seizing Beveland and Walcheren Islands was discussed at this meeting as well as at the Allied Air Commanders Conference held earlier on this day, but was turned down as not being feasible in this area. (Notes of 99th Allied Air Comdrs. Conf., 22 Sept. 1944.)

53. See ltr., Eisenhower to Montgomery, 24 Sept. 1944.

54. 9th AF Adv. Opnl. Orders 274 and 278, dtd. 21 and 25 Sept.; msg., 9th AF Adv. to IX, XII, and XIX TAC's, 29 Sept. 1944; msg., 9th AF Adv. to AEF, 29 Sept. 1944; AAFHS-36, pp. 251-61; Bradley Rpt., pp. 61-63.

55. Montgomery, *Normandy to the Baltic*, pp. 253-65; Edgar McInnis, *The War: Sixth Year*, pp. 16-20; SAC Rpt., pp. 68-69; SHAEF G-2 Weekly Isums 31-33, 22, 29 Oct., 5 Nov. 1944.

56. History, 9th Bomb. Div., Sept.-Oct. 1944, pp. 99-100, 140-41, 151, 156, 163-64.

57. 1st Army, Rpt. of Opns., pp. 54-56; Bradley Rpt., pp. 125-26, 140-41.

58. Rpt. by Field Marshal Model to C-in-C West, 1 Oct. 1944, in BAM (AHB) Trans. VII/73, p. 73.

59. History, 9th Bomb. Div., Sept.-Oct. 1944, pp. 135-40; 9th Bomb. Div. FO's, 24-26 Sept. 1944.

60. Msgs., CG 9th Bomb. Div. to CG 97th Combat Wing and to all gp. and wing comdrs., both of 6 Oct. 1944.

61. Bradley Rpt., pp. 126-27; History,

NOTES TO PAGES 616-26

9th Bomb. Div., Sept.-Oct. 1944, pp. 142-51.

62. History, IX TAC, Oct. 1944; 1st Army, Rpt. of Opns., pp. 59-62; Bradley Rpt., pp. 127, 141-42; Coffin Rpt., I, 39.

63. History, IX FC and IX TAC, Oct. 1944; IX TAC Daily Opns. Rpts. and A-2 Per. Rpts., Oct. 1944.

64. Sources cited in n. 63; 1st Army, Rpt. of Opns.; IX TAC Sum. of Opns. for Oct.; IX TAC Stat. Control Sec. Monthly Mission Sum., Oct. 1944.

65. 12th Army Gp. Ltr. of Instrs. 10, 21 Oct. 1944; XXIX TAC Daily Opns. Rpts. and A-2 Per. Rpts., Oct. 1944; History, XXIX TAC, Oct. 1944.

66. See Cole, *Lorraine Campaign*, pp. 256 ff.

67. XIX TAC Daily Opns. Rpts. and Daily Isums, Oct. 1944; rpt., XIX TAC to CG 9th AF, Use of Napalm Bombs, 3 Oct. 1944, with 5 incls.; History, XIX TAC, Oct. 1944; Brig. Gen. O. P. Weyland Diary, Oct. 1944 entries.

68. History, XIX TAC, Oct. 1944; 9th AF Ground Observers Rpt. TR-129, 6 Dec. 1944.

69. 7th Army, Report of Operations, France and Germany 1944-45, II, 359-69; 9th AF Monthly Sum. of Opns., Oct. 1944; 9th AF Isums 101-4, 9, 16, 23, 30 Oct.; XII TAC greenline msg., Oct.-Nov. 1944.

70. Msgs., 9th AF Adv. to IX and XIX TAC's, 5 Oct., and to IX, XII, XIX, and XXIX TAC's, 8 Oct. 1944.

71. Msgs., 9th AF Adv. to AEAf, 8 Oct., and to XII TAC, 17 Oct. 1944.

72. AAFHS-36, pp. 261-62; Bradley Rpt., pp. 61-62.

73. IX, XIX, and XXIX TAC's Daily Opns. Rpts. for Oct.; IX and XXIX TAC's A-2 Per. Rpts.; XIX TAC Daily Isums; monthly histories of the TAC's; 9th AF and AEAf Monthly Sums. of Opns., Oct. 1944; SHAEf Air Staff Target Sec. Bridge Status Rpts., Oct. 1944.

74. 9th AF Monthly Sums. of Opns., Sept.-Oct. 1944; XIX TAC, Reconnaissance in a Tactical Air Command, An Account of Operations of 10th Photo Group, Ren., Under XIX Tactical Air Command, of Ninth Air Force, in Conjunction with Third US Army's 1944 Campaigns in France, Germany, and

Luxembourg, pp. 32-39; 9th AF Stat. Sum. of Opns., 16 Oct. 1943-8 May 1945, p. 8.

75. Msg., Spaatz to Anderson, 27 Aug. 1944; memo for Brig. Gen. Clarence P. Kane from Brig. Gen. E. O. Langmead, Air Off. Adm. (U.S.), AEAf, 25 Aug. 1944. Cf. also draft of proposed msg., Eisenhower to CCS for Arnold, n.d. but probably 26 or 27 Aug. 1944.

76. Ltr., Spaatz to Arnold, 27 Aug. 1944. For further details see also msg., Spaatz to Anderson, 27 Aug., Anderson to Spaatz, 28 Aug., Anderson to Vandenberg, 28 Aug., and redline, Anderson to Spaatz, 28 Aug. 1944.

77. Msg., Vandenberg to Spaatz for Anderson, 29 Aug. 1944.

78. Redline msg., Tedder to Spaatz, 28 Aug. 1944.

79. Memo for senior U.S. officers, AEAf from Brig. Gen. E. O. Langmead, 26 Aug. 1944; Minutes of Meeting of Senior U.S. Officers, AEAf, 26 and 28 Aug. 1944; memo by Col. Peterson, Opns. Sec., 28 Aug. 1944; memo by Lt. Col. Morgan, Deputy CIO, 28 Aug. 1944; memo by Col. Stern, Signals Sec., 28 Aug. 1944; memo by Brig. Gen. Langmead, Questions for AVM Robb, 28 Aug. 1944; notes of meeting, Langmead and Breckenridge (USAAF) with Wigglesworth, Kingston-McLoughry, Edmunds, and Banks (RAF), 29 Aug. 1944.

80. Ltr., Arnold to Spaatz, 19 Sept. 1944.

81. Coffin Rpt., Vol. I, Pt. 1, chap. 2.

82. Directive, SHAEf to C-in-C, 21 Army Gp. and CG 12th Army Gp., 22 Oct. 1944, Decisions Reached at Supreme Commanders Conference, 18 Oct. 1944; 12th Army Gp. Ltr. of Instrs. 10, 21 Oct. 1944 (also Amend. 3 of 4 Nov.); Directive, SHAEf to ANCXF, 21, 6th, and 12th Army Gps., 2d TAF, 9th AF, and FAAA, 28 Oct. 1944; Montgomery, *Normandy to the Baltic*, pp. 268-69; Cole, *Lorraine Campaign*, pp. 296-300.

83. Msgs., 9th AF Adv. to IX and XIX TAC's, 21 Oct., to IX, XII, XIX, and XXIX TAC's, 22 Oct., to IX, XII, XIX, and XXIX TAC's and 9th Bomb. Div., 22 Oct., and to IX TAC, 23 Oct. 1944.

84. The discussion of these and sub-



sequent supporting operations is based upon the following: XIX TAC Daily Opns. Rpts. and Daily Isums, 1-9 Nov. 1944; History, XIX TAC, Nov. 1944; 9th Bomb. Div. FO's, 1-9 Nov. 1944; History, 9th Bomb. Div., Nov. 1944; History, 8th AF, Nov. 1944; Third Phase Tac. Air Opns., pp. 156-65; 8th AF Rpt., Close-in Air Cooperation by Heavy Bombers with Ground Forces, pp. 87-95; AAFEB, The Effect of Air Power in the Battle of Metz, pp. 4-17; XIX TAC, Opn. MADISON, Air Plan in Support of Third U.S. Army, with 5 Annexes, 3 Nov., and FO 100, with 2 Annexes, 8 Nov. 1944.

85. XIX TAC Daily Opns. Rpts. and Daily Isums, 9 Nov.-16 Dec. 1944; History, XIX TAC, Nov.-Dec. 1944; History, 9th Bomb. Div., Nov.-Dec. 1944; 3d Army After Action Rpts., Nov.-Dec. 1944; Bradley Rpt., pp. 136-37; Eisenhower, *Crusade in Europe*, pp. 329-30; Robert S. Allen, *Lucky Forward: The Story of Patton's Third U.S. Army* (New York, 1947), pp. 163-99; Patton, *War as I Knew It*, pp. 182-88; Weyland Diary, Nov.-Dec. entries; SAC Rpt., pp. 72-73; Coffin Rpt., II, 187-89, 197-99; 12th Army Gp. G-2 and G-3 Rpts. for Nov.-Dec. 1944; 3d Army G-2 and G-3 Rpts. for Nov.-Dec. 1944.

86. Cole, *Lorraine Campaign*, pp. 598-602.

87. History, The Seventh U.S. Army in France and Germany 1944-45, II, 377-482; 6th Army Gp. G-2 Weekly Isums 7-13, 4 Nov.-16 Dec. 1944.

88. 1st TAF (Prov.), Sum. of Opns. of American Units, 1 Nov. 1944 thru 8 May 1945, pp. 23-24; History, 1st TAF (Prov.) in ETO, 20 Oct. 1944-21 May 1945, pp. 41-60; 9th AF Monthly Sum. of Opns., Nov.-Dec. 1944; 9th AF Isums 107-12, 13 Nov.-18 Dec. 1944.

89. 1st Army, Rpt. of Opns., pp. 73-74; IX TAC Opns. Order Operation Q, 9 Nov. 1944; XXIX TAC, A Study of Operation Q, Nov. 1944; 9th AF Adv. Opn. Order 325, Operation Q, 11 Nov. 1944; 9th AF Adv., Air Plans A and B for Operation Q, 7 Nov. 1944; 1st Army Ltr. of Instrs. -AAA Marker Plan, 10 Nov. 1944; 9th Army Ltr. of Instrs. 7, 4 Nov. 1944; 8th

AF Rpt., Close-in Air Coop. by HB's with Ground Forces, pp. 75-81.

90. The operations reports and special studies prepared on the Q operation vary so widely in their statistical data with regard to planes dispatched, number of planes attacking and lost, tonnage of bombs dropped, etc., as to preclude reconciliation. For example, figures of bombs dropped by Bomber Command range from 5,437 to 6,370 tons. For the sake of uniformity the data used here are taken from IX TAC A-3, Report on Operation "Q" and Offensive, Feb. 1945.

91. 8th AF Rpt., Close-in Air Coop. by HB's with Ground Forces, pp. 81-84; 8th AF Rpt. to CG AAF, 27 Dec. 1944, Tactical Operations in Support of First and Ninth United States Armies-Eschweiler Area, 16 Nov. 1944; IX TAC, Opn. "Q" and Offensive; Report on Allied Air Operations, pp. 46-47; History, 8th AF, Nov. 1944; Third Phase Tac. Air Opns., pp. 166-75; IX and XXIX TAC's Daily Opns. Rpts. and A-2 Per. Rpts., 16 Nov. 1944.

92. 1st Army special rpt., Effects of Our Air Attacks of November 16, dtd. 20/21 Nov. 1944. Prisoners of war testified, however, to the nerve-shattering effect of the bombing.

93. 1st Army, Rpt. of Opns., pp. 74-98; 12th Army Gp. G-2 and G-3 Rpts., Nov.-Dec. 1944; SAC Rpt., p. 72; Eisenhower, *Crusade in Europe*, pp. 328-29; SHAEF G-2 Weekly Isums 34-39, 12 Nov.-17 Dec. 1944.

94. IX TAC, Opn. "Q" and Offensive, pp. 12-23 and stat. table; XXIX TAC Opn. Q; IX and XXIX TAC's Daily Opns. Rpts. and A-2 Per. Rpts., 15 Nov.-16 Dec. 1944; Coffin Rpt., II, 184, 186, 191, 195, 199; 9th AF Monthly Sums. of Opns., Nov.-Dec. 1944; 9th AF Isums 107-12, 13 Nov.-18 Dec. 1944; SHAEF Air Staff Monthly Stat. Sums. of Opns. and Daily Isums, Nov.-Dec. 1944; History, XXIX TAC, Nov.-Dec. 1944; History, IX FC and IX TAC, Nov.-Dec. 1944; Bradley Rpt., pp. 61-63, 78-81, 99-101, 105-8; Excerpts from Brig. Gen. R. E. Nugent's War Diary, entries for 20 Oct.-16 Dec. 1944. See also SHAEF G-2 Enemy Communications Sums. 14-16, 27 Nov.-11 Dec. 1944.

NOTES TO PAGES 635-45

95. History, 9th Bomb. Div., Nov.-Dec. 1944; 9th Bomb. Div. FO's, Nov.-Dec. 1944; Bradley Rpt., pp. 29-35.

NOTES TO CHAPTER 18

1. CCS 761/3, Development of Operations, 28 Oct. 1944-20 Jan. 1945, dtd. 29 Jan. 1945.
2. See, for example, CCS 660/1, Prospects of a German Collapse or Surrender (as of 8 Sept. 1944); memo for USSTAF from Enemy Objectives Unit, Economic Warfare Div. (EWD), U.S. Embassy (London), 11 Sept. 1944; CCS 761/3, 29 Jan. 1945; D. D. Eisenhower, *Eisenhower's Own Story of the War* (New York, 1946), p. 67; Special Report of Eighth Air Force Operations in Support of First Allied Airborne Army, 17-26 Sept. 1944, incl. to ltr., Spaatz to Arnold, 10 Dec. 1944; memo for Giles from Kuter, 3 Nov. 1944.
3. Memo for Giles from Kuter, 3 Nov. 1944; ltr., Arnold to Brereton, 13 Oct. 1944.
4. Ltrs., Arnold to Spaatz, 29 Sept., Spaatz to Arnold, 4 Oct. 1944.
5. Memo for Spaatz from Anderson, 26 Sept. 1944.
6. Talk to 8th AF hq. staff, 14 Nov. 1944, in History, 8th AF, Nov. 1944.
7. Ltr., Eaker to Spaatz, eyes only, 29 June 1944. Eaker had recently discussed this plan with General Arnold and was reporting Arnold's reaction.
8. Memo for Arnold from Kuter, 27 Aug. 1944; File 706, 21 July 1944.
9. Memo for Lt. Gen. W. B. Smith from Sec. of Gen. Staff, SHAEF, 14 Aug. 1944; ltr., Kuter to Anderson, 15 Aug. 1944; memo for Spaatz from Anderson, 17 Aug. 1944; memo for Eisenhower from Spaatz, 24 Aug. 1944; File 706, 9 Sept. 1944; Sir Arthur Harris, *Bomber Offensive*, pp. 245-46.
10. Memo for Col. A. R. Maxwell, USSTAF from Brig. Gen. R. A. McClure, Chief of Psychological Warfare Div., SHAEF, 16 Sept. 1944; JCS 176th Mtg., 14 Sept. 1944.
11. In a conversation with General Kuter and Col. C. G. Williamson reported in memo for Anderson from Williamson, 12 Sept. 1944.
12. Memo for Spaatz from Anderson, 1 Oct. 1944; ltr., Spaatz to Arnold, 4 Oct. 1944; msg., Spaatz to Doolittle, U-69186, 14 Oct. 1944; telecon, Maxwell (?) and Anderson, 14 Oct. 1944.
13. Minutes of first plenary mtg., 13 Sept. 1944, OCTAGON.
14. Ltr., Eaker to Arnold, eyes only, 21 Aug. 1944.
15. Directive agreed upon by General Spaatz and Dep. C/AS, RAF, 23 Sept. 1944.
16. USSTAF Semimonthly Record of Results, 16-30 Sept. 1944, Oil Sec.
17. Contribution of Air Power to the Defeat of Germany (Coffin Rpt.), App. E, p. 16; Target Priorities of the Eighth Air Force, p. 21; U.S. Embassy EWD, Notes on Effects of the Oil Offensive, 3 Nov. 1944.
18. Bradley Rpt., Pt. III.
19. Memo for Bormann from Speer, 16 Sept. 1944; History, 8th AF, Nov. 1944; A.D.I.(K) Rpt. 82/1945; USSTAF Air Intelligence Summary (Isum) 50, p. 23.
20. The figures in this section dealing with attacking aircraft and bomb tonnage are taken from the regular issues of USSTAF Isums and USSTAF Semimonthly Record of Results.
21. USSTAF Isum 48, p. 12.
22. *Ibid.*, 52, p. 15; Joint Oil Target Com. Bulletin 15.
23. USSTAF Isum 52, p. 15.
24. Joint Oil Target Com. Bull. 21.
25. Coffin Rpt., App. E, p. 12.
26. Combined Strategic Targets Com. (CSTC) Bull. 21.
27. Hq. 8th AF, Plan for Winter Operations.
28. 8th AF Intel. Memo, 11 Oct. 1944.
29. Report of Operations Analysts, in History, 8th AF, Nov. 1944.
30. 1st CSTC Mtg., 18 Oct. 1944.
31. Ltr., Eaker to Spaatz, 3 Nov. 1944.
32. USSBS Oil Div., Final Report: German Oil, Chemical, Rubber, Explosives, and Propellants Industries.
33. Coffin Rpt., App. E, p. 12.
34. See especially USSTAF Isums 54 (p. 24), 55 (pp. 14-15), 56 (p. 22), 57 (p. 15).
35. MAAF Air Intel. War Sum. 104, p. 2; 15th AF Weekly Sum. of Opns.

36. Memo for Spaatz from Anderson, 17 Nov. 1944.
37. RAF Bomber Command Weekly Digests 134 thru 138; Min. of CSTC Mtg., 22 Nov. 1944.
38. Spaatz Journal, 1 Dec. 1944.
39. Report 5, Speer to Hitler, 19 Jan. 1945.
40. USSBS Oil Div., Final Report.
41. CSTC Oil Bull. 1 (1945); CSTC Rpt. to Gen. Spaatz, 23 Nov. 1944.
42. CSTC Oil Bull. 24.
43. Hq. USSTAF, Notes on the Oil Offensive, Dec. 1944; U.S. Embassy EWD Study, 24 Nov. 1944.
44. CSTC Oil Bull. 19; CSTC 16th Mtg., 17 Jan. 1945.
45. Bradley Rpt., Pt. III.
46. Target Priorities of the 8th AF; History, 15th AF, p. 471; ltr., Spaatz to 8th and 15th AF's, 23 Sept. 1944.
47. USSBS Tank Industry Rpt., pp. 9-13.
48. Ltr., Spaatz to 8th and 15th AF's, 23 Sept. 1944; U.S. Embassy Study, 26 Aug. 1944.
49. Coffin Rpt., App. F, p. 109.
50. *Ibid.*, pp. 111-12.
51. USSTAF Semimonthly Record of Results, 1-16 Sept. 1944, AFV, TM, and Ord. Sec.
52. *Ibid.*, 16-30 Sept. 1944.
53. USSBS, Over-all Report (European War), p. 65.
54. Memo for Spaatz from Anderson, 27 Sept. 1944.
55. Coffin Rpt., App. F, p. 112.
56. Interview with Albert Speer, 19 May 1945.
57. USSBS, The German Anti-Friction Bearings Industry.
58. USSBS, Tank Industry Rpt., pp. 20-21.
59. USSBS, Impact of Allied Air Effort on German Logistics (2d ed.), p. 78.
60. USSBS, Motor Vehicles Industry Rpt.
61. USSBS, Tank Industry Rpt.; Bradley Rpt., p. 9. Coffin Rpt., App. F, Sec. 1 and USSBS, Impact of Allied Air Effort on German Logistics, pp. 89-92, give a more heartening picture of the air force achievements in this campaign.
62. Ltr., Arnold to Spaatz, 30 Dec. 1944.
63. Min. of a Mtg. Held in General Anderson's Office, 28 Oct. 1944; JPS Rpt., Operations in Europe, J.P. (44) 275 (Final), 29 Oct. 1944.
64. Tedder, Notes on Air Policy to be Adopted with a View to Rapid Defeat of Germany, 25 Oct. 1944; Min. of a Mtg. Held at the Air Ministry, 24 Oct. 1944; ltr., Spaatz to Arnold, 28 Oct. 1944.
65. Comment 2 (Arnold's R&R, 19 Oct. 1944), Kuter to Arnold, 20 Oct. 1944.
66. USSBS Transportation Div., The Effects of Strategic Bombing on German Transportation, p. 6.
67. *Ibid.*, pp. 12-13; USSTAF Semimonthly Record of Results, 16-30 Sept. 1944, Summary.
68. Effects of Strategic Bombing on German Transportation, p. 13.
69. USSTAF Semimonthly Record of Results, 16-31 Oct. 1944, Trans. Sec.
70. USSTAF Isum 53, p. 3.
71. Comments by 8th AF Dir. of Intel. 11 Oct. 1944; memo for Spaatz from Anderson, 1 Oct. 1944; SHAEF G-2, Air Attacks on Enemy Communications and Supplies, 11 Sept. 1944; ltr., Kuter to Arnold, 20 Oct. 1944.
72. Tedder, Notes on Air Policy to be Adopted with a View to Rapid Defeat of Germany.
73. Summary of Statements, Mtg. of Railway Experts and Intel. Officers, Air Ministry (Whitehall), 24 Oct. 1944.
74. *Ibid.*
75. Joint Planning Staff Rpt., Operations in Europe, 29 Oct. 1944.
76. Ltr., Spaatz to Arnold, 28 Oct. 1944.
77. *Ibid.*
78. Directive 2 for the Control of the Strategic Air Forces in Europe, 28 Oct. 1944.
79. Min. of CSTC, 27 Dec. 1944 (alluding to the decision of 28 Oct. 1944).
80. CSTC Working Com. (Transportation), Plan for Attack of German Transportation System, 7 Nov. 1944.
81. USSTAF Semimonthly Record of Results, 1-16 Nov. 1944, Trans. Sec.
82. *Ibid.*, 16-30 Nov. 1944.
83. SHAEF G-2, Present State of German Railways, 5 Dec. 1944.

NOTES TO PAGES 655-63

84. Ltrs., Doolittle to Spaatz, 15 Oct., Curtis to Spaatz, 18 Oct. 1944.
85. See, in addition to sources in n. 84, Bufton at Mtg. Held at Air Min., 17 Oct. 1944.
86. Memo for C/S SHAEF from SHAEF G-2, 29 Nov. 1944.
87. Bradley Rpt., p. 61, where Speer's statement is cited.
88. Notes of a Mtg. Held at SHAEF, 5 Dec. 1944; File 706, 5 Dec. 1944.
89. A.D.I.(K) Rpt. 375A/1945.
90. USSTAF Semimonthly Record of Results, 16-31 Dec. 1944, Sum.
91. A.D.I.(K) Rpt. 349/1945.
92. USSTAF Isum 60, p. 9.
93. CSTC, Current German Railway Situation and the Problems of Air Attack, 10 Jan. 1945.
94. USSTAF Isums 47 (p. 2), 52 (p. 1), 54 (p. 1) compared to monthly entries for the aircraft with Luftwaffe Kommando West and Luftwaffe Kommando Reich in the captured German documents, Durchschnittliche Einsatzbereitschaft der flieg. Verbände (Materiell).
95. Coffin Rpt., App. A.
96. History, 8th AF, Sept. 1944.
97. Interview with Hermann Goering, quoted in USSTAF Isum 82, p. 15; ltr., Spaatz to Arnold, 24 Sept. 1944.
98. Coffin Rpt., App. A, Table v-2.
99. USSBS, Aircraft Industry Div. Rpt., pp. 24-32. The German figures cited by USSBS agree, but for minor discrepancies, with the high command file, Auswertung der Einsatzbereitsch. der fliegenden Verb. vom 1 August 1943 bis November 1944.
100. Coffin Rpt., App. B, Annex A.
101. USSTAF Isum.
102. Memo for C/AS Hq. AAF from AC/AS Intel., 19 Oct. 1944.
103. Air Staff Post Hostilities Intelligence Requirements on GAF, Sec. IV, I, Vol. II. This is a valuable compilation of German Air Force losses and damage from Luftwaffe files.
104. Target Priorities of the 8th AF, p. 15.
105. USSTAF Isum 49, pp. 14-15; USSTAF Semimonthly Record of Results, 1-16 Sept. 1944, Sum.
106. USSBS, Aircraft Industry Rpt., p. 70.
107. Ltr., Spaatz to Eaker, 4 Oct. 1944.
108. A.D.I.(K) Rpt. 355/1945.
109. Memo for Giles from Air Marshal Welsh, 23 Jan. 1945.
110. USSBS Interview 56, Hermann Goering, 29 June 1945; USSBS Interview 7, Seiler, chairman of board of Messerschmitt Co., 16 May 1945.
111. Coffin Rpt., App. A, p. 30.
112. German Statistics on German Fighter Reaction to Anglo-American Bombing Attacks, A.D.I.(K)/USSAFE, App. I.
113. USSTAF Isum 52, p. 22.
114. Ltr., Spaatz to Arnold, 5 Nov. 1944.
115. Ltr., Doolittle to Spaatz, (?) Nov. 1944.
116. Talk to 8th AF hq. staff, 14 Nov. 1944, quoted in History, 8th AF, Nov. 1944.
117. Ltr., Spaatz to Arnold, 5 Nov. 1944.
118. Memo for Arnold from AC/AS Intel., 6(?) Nov. 1944; memo for Arnold from DC/AS, 21 Nov. 1944; ltr., Giles to Spaatz, 11 Dec. 1944.
119. USSBS, Aircraft Industry Div. Rpt., Tables v-2, v-3.
120. USSTAF Semimonthly Record of Results, 1-16 Oct. 1944, Luftwaffe Sec.; USSTAF Isums 50 (pp. 18-19), 60 (p. 23), 52 (p. 19), 54 (p. 21).
121. At 99th Air Cmdrs. Mtg.
122. USSTAF Isum 49, p. 15; memo for Anderson, USSTAF Hq. from MacDonald, 25 Oct. 1944; ltr., Air Min. to RAF BC and USSTAF, 26 Oct. 1944.
123. USSTAF Study, Review of Bombing Results, December 1944.
124. Air Staff Post Hostilities Intel. Requirements on GAF, Sec. IV, I, Vol. II.
125. Ltr., Spaatz to Giles, 13 Dec. 1944.
126. Statement of GAF Strength and Losses—Aircraft and Flying Personnel—Sept. 1939 to Jan. 1945, compiled from German records by Brit. Air Min. Air Hist. Br. According to this study, German strength was 6,313 aircraft for December 1944, the highest for the war. Of these aircraft, 1,688 were on the eastern front.
127. Ltr., Spaatz to Giles, 26 Dec. 1944.

128. Statements of Captured Luftwaffe Officers, in USSTAF Isum 67, pp. 8-11; A.D.I.(K) Rpt. 373/1945, Adolf Galland, Birth, Life and Death of the Fighter Arm.
129. USSTAF Isum 55, p. 4.
130. *Ibid.*, 56, p. 41.
131. USSBS, Air Force Rate of Operation, Exh. 29; USSTAF Isum 56, pp. 4, 25.
132. USSTAF Isum 56, p. 25.
133. *Ibid.*, 57, p. 4.
134. *Ibid.*, 59, p. 18.
135. *Ibid.*, 60, p. 4.
136. Coffin Rpt., App. A, p. 32.
137. A highly conservative German source now available shows the number of day fighters shot down after enemy contact as 353 in the west and 147 in the interior Reich zone for December 1944, when most of the aerial activity by the Germans was on the three days named. (See German statistics on German Fighter Reaction, Science 2, Memo 151.)
138. Galland, Birth, Life and Death.
139. Conversation of Hermann Goering with Spaatz, Vandenberg, Seversky, and others, 14 May 1945.
140. Coffin Rpt., App. A; memo for Lovett from AC/AS Intel., 30 Jan. 1945.
141. Ltr., Spaatz to Arnold, 7 Jan. 1945.
142. Galland, Birth, Life and Death.
143. USSTAF Semimonthly Records of Results, 1-15 Jan. 1945, Luftwaffe Sec.; memo for Lovett from AC/AS Intel., 30 Jan. 1945.
144. Ltr., Arnold to Spaatz, 30 Dec. 1944.
145. Memo for Spaatz from MacDonald, 3 Jan. 1945.
146. Ltr., Spaatz to Arnold, 7 Jan. 1945; Spaatz Journal, 9 Jan. 1945.
147. At Air Comdrs. Mtg., 11 Jan. 1945.
148. 8th AF Opns. Analysts Study, The Oxford Experiment in H<sub>2</sub>X Bombing, 30 Nov. 1944.
149. Ltrs., AAF to USSTAF, 9 Nov., Spaatz to Giles, 15 Dec. 1944.
150. Tactical Development of the 8th AF, p. 69; ltr., Gen. F. H. Smith to Gen. R. W. Douglass, 2 Oct. 1944.
151. History, 15th AF, pp. 270-71.
152. Harris, *Bomber Offensive*, p. 227.
153. Tactical Dev. of the 8th AF, p. 71.
154. History, 8th AF, Oct. 1944; History, 15th AF, p. 257.
155. History, 8th AF, Oct. 1944.
156. Stat. Sum. of 8th AF, p. 31; History, 15th AF, graph 3.
157. History, 8th AF, Nov. 1944; ltr., Spaatz to Giles, 26 Dec. 1944.
158. Ltrs., Spaatz to Doolittle, 18 Nov. and 11 Dec., Doolittle to Spaatz, 19 Dec. 1944.
159. History, 8th AF, Nov. and Dec. 1944.
160. *Ibid.*, Dec. 1944.
161. Memo for Gen. Anderson from Col. A. R. Maxwell, 25 Nov. 1944.
162. Ltr., Spaatz to Arnold, 27 Oct. 1944.
163. Stat. Sum. of 8th AF.
164. Fifteenth Air Force Plan for Winter Operations, 9 Oct. 1944.
165. Ltrs., Spaatz to Giles, 26 Dec., Eaker to Giles, 15 Dec. 1944; telecon, Eaker and Giles, 13 Dec. 1944.
166. Study by AC/AS Plans, Hq. AAF, 1 Dec. 1944.
167. CM-OUT-78434, Arnold to Spaatz, 16 Dec. 1944; ltr., Spaatz to Arnold, 30 Dec. 1944.
168. File 706, 6-9 Dec. 1944; George S. Patton, *War as I Knew It*, p. 183.
169. Robert E. Merriam, *Dark December* (New York, 1947), pp. 95-96; ltr., Spaatz to Arnold, eyes only, 13 Dec. 1944.
170. Ltr., Arnold to Spaatz, 30 Dec. 1944; Min. of Mtg. of Staff Sec. Heads, 8th AF Hq., 19 Dec. 1944, in History, 8th AF, Dec. 1944. W. B. Courtney, "Through Hell and High Brass," *Collier's*, 18 Dec. 1948, p. 93, describes Doolittle's hopes that the blitz would be a breakthrough to end all breakthroughs.
171. Ltr., Spaatz to Arnold, 7 Jan. 1945.
172. Spaatz at Air Comdrs. Mtg., 4 Jan. 1945.
173. 15th AF Weekly Sum. of Opns.; History, 15th AF, pp. 394-95; CSTC Oil Bull. 19 (1945).
174. Ltr., Tedder to Spaatz, 30 Dec. 1944.
175. Ltrs., Bottomley to Spaatz, 26 Dec. and 29 Dec. 1944.
176. Ltr., Spaatz to Arnold, 7 Jan. 1945.

NOTES TO CHAPTER 19

1. This account of German preparations for the Ardennes counterattack is based, in the main, upon Dr. Percy Ernst Schramm, *The Preparations for the German Offensive in the Ardennes*, Sept.-16 Dec. 1944 (hereinafter cited as Schramm, *Preparations for the Ardennes Offensive*). Dr. Schramm, professor of medieval and modern history at Göttingen University, was an officer in the reserve corps and in the fall of 1944 was in charge of keeping the war diary of the Wehrmacht operations staff. Other sources used were: Robert E. Merriam, *Dark December*, pp. 1-48, which, for the period in question, leans very heavily upon Dr. Schramm's book; B. H. Liddell Hart, *The German Generals Talk*, pp. 272-93; Milton Shulman, *Defeat in the West*, pp. 222-61. Cf. also Walter Bedell Smith, "Eisenhower's Six Great Decisions: 3, The Battle of the Bulge," *Saturday Evening Post*, June 22, 1946, pp. 39, 41, 43, 46.

2. Schramm, *Preparations for the Ardennes Offensive*, pp. 1-29, 65-68.

3. Colonel Wolter, *Die Luftwaffe im Zusammenwirken mit dem Westheer in der Zeit von Ende September 1944 bis Mai 1945* (hereinafter cited as Wolter, *Die Luftwaffe*), p. 34, App. 3 to G. von Rundstedt, *OB West, Bemerkungen zum II, Teil der Geschichte des "OB West."*

4. Cf., e.g., *The Kreipe Diary*, Situation Report by Chief, Luftwaffe Gen. Staff, for period 22 July to 2 Nov. 1944, pp. 7, 11, 13, 17, 23-25.

5. Wolter, *Die Luftwaffe*, pp. 34-35.

6. These figures were compiled from a table, entitled "Einsatz-(IST) Stärken der Fliegertruppe." The table forms Annexure 4 of Appendix 3 to *Geschichte des "OB West."*

7. Unless otherwise indicated, the following survey of aerial reconnaissance is based upon these sources: IX TAC, 67th Tac. Rcn. Gp. Opreps "A," 17 Nov.-15 Dec. 1944; IX TAC Daily Rcn. Rpt. Sums., 17 Nov.-15 Dec. 1944; 9th AF, 2d Phase Rpt., IX TAC G/132, 17 Nov.-15 Dec. 1944; IX TAC Opflash, 17 Nov.-15 Dec. 1944; IX TAC A-2 Per. Rpts., 17 Nov.-15 Dec. 1944; 12th AG

G-2 Per. Rpts., 17 Nov.-15 Dec. 1944; XIX TAC, Briefing Information for Group and Squadron S-2's, 17 Nov.-15 Dec. 1944; XIX TAC Opflash, 17 Nov.-15 Dec. 1944; XIX TAC Daily Intel. Sums., 17 Nov.-15 Dec. 1944; TUSA G-2 Per. Rpt., 17 Nov.-15 Dec. 1944; 12th AG Target Intel. G-2 (Air), Air Operations and Observations of Enemy Movements, Vol. I, 6 Sept.-31 Dec. 1944; TUSA After Action Rpts., Dec. 1944; FUSA and IX TAC, Sum. of Air Opns., 17 Nov.-15 Dec. 1944; 9th AF Adv., OUT redline msg., 24 Aug.-1 Dec. 1944.

8. These figures include all types of tactical reconnaissance missions flown, i.e., tactical reconnaissance itself, photo and weather reconnaissance, and artillery adjustment. The data were compiled from the daily Opflash's of the units concerned. The statistical data given in the respective command's daily intelligence summaries or reports are at considerable variance with the figures given here, since those sources cover a different hourly period.

9. See, for example, IX TAC F-B rpts., 5, 11 Dec.

10. History, IX TAC, Dec. 1944; Coffin Report, Vol. I, Pt. I, Sec. E, Campaign of Eastern France and the Siegfried Line (26 Aug.-15 Dec. 1944), n.p.

11. See n. 7 again and IX TAC PRO Story File, 1 Dec. 1944-28 Feb. 1945, notes Porter to Ehrenreich, 6 Dec., and Porter to Kelliher, 7 Dec. 1944.

12. SHAEF G-2 Weekly Isum; SHAEF G-2 Intel. Notes; 12th AG G-2 Per. Rpt., FUSA G-2 Per. Rpt., and TUSA G-2 Per. Rpt., all for 15 Nov. to time of breakthrough.

13. Ltr., Arnold to Spaatz, 30 Dec. 1944.

14. Ltr., Spaatz to Arnold, 7 Jan. 1945.

15. See opns. rpts. of forces concerned, 1-16 Dec. 1944.

16. Notes of the Allied Air Comdrs. Conf., 15 Dec. 1944.

17. 12th AG G-2 Per. Rpt., 16 Dec. 1944, Annex 3, pp. 1-2, which reproduces excerpts from a goodly number of documents captured during the first day's fighting.

18. Wolter, *Die Luftwaffe*, pp. 87-89. See also Excerpts from Brig. Gen. Richard E. Nugent's War Diary, entry for 17 Dec. 1944; memo for Col. M. McClenahan, AC/S A-2, IX TAC, from Richard B. Kramer (D.I.O.), Enemy Air Activity over FUSA Area 16-17 Dec. 1944, in IX TAC A-2 Journal (see also entries for 17 and 18 Dec.); Maj. Louis J. Sebille, Diary of a Six-Week Paddlefoot, 30 Nov. 1944-19 Jan. 1945, entries for 17 and 18 Dec.; 12th AG G-2 Per. Rpt., 23 Dec. 1944, pp. 3-4.

19. Dwight D. Eisenhower, *Crusade in Europe*, pp. 342-43. For a contrary point of view, i.e., that neither Eisenhower nor any other Allied commander realized on this day the true extent of the German attack, see Merriam, *Dark December*, p. 116.

20. FUSA, Rpt. of Opn., 1 Aug. 1944-22 Feb. 1945, II, 103-12; 12th AG G-3 Rpts. for 17-19 Dec.; 12th AG G-2 Per. Rpts. for 11-19 Dec.; Eisenhower, *Crusade in Europe*, pp. 344-50; Merriam, *Dark December*, pp. 116-19.

21. See Brig. Gen. O. P. Weyland, Weyland Diary, entries for 17, 19-20 Dec. 1944.

22. Msg., SHAEF to 6th AG and 12th AG, 19 Dec. 1944; 7th U.S. Army, Report of Operations in France and Germany 1944-45, II, 494-95; Eisenhower, *Crusade in Europe*, pp. 350-52; George S. Patton, Jr., *War as I Knew It*, pp. 188-92; TUSA After Action Rpts., 18 Dec. 1944.

23. Msgs., Eisenhower to AGWAR for CCS, SCAF 150, 20 Dec. 1944, and to CG's 6th, 12th, and 21 AG's, SCAF 151, 20 Dec. 1944; Eisenhower, *Crusade in Europe*, pp. 353-54; Montgomery, *Normandy to the Baltic*, p. 281; Omar N. Bradley, *A Soldier's Story* (New York, 1951), pp. 476-78.

24. Coffin Rpt., Vol. I, Pt. I, F, Campaign of the Ardennes; Nugent Diary, entry for 20 Dec. 1944; Weyland Diary, entries for 20, 22, 23 Dec. 1944; 2d TAF (RAF) Operational Order 265, 22 Dec. 1944; msg., 9th AF Adv. to USSTAF Main, 22 Dec. 1944; History, XXIX TAC, Dec. 1944; History, XIX TAC, Dec. 1944; History, IX TAC, Dec. 1944.

25. Unless otherwise indicated, the in-

formation about enemy air operations is taken from the daily operations, reconnaissance, and intelligence reports of the Ninth Air Force's three tactical air commands and their histories for December 1944 and January 1945. Consulted also were 9th AF Weekly Isums and Monthly Sum. of Opns.; Air Staff, SHAEF Monthly Stat. Sum. of Opns.; USSTAF, Allied Air Power and the Ardennes Offensive; 9th AF Opnl. History, Battle of the Ardennes; USSTAF Air Isum (Weekly); 12th AG G-2 Per. Rpt.; 12th AG G-3 Rpt. The only German account available, Colonel Wolter's story, based almost exclusively upon his own recollection and those of several former collaborators in the Luftwaffe, is very unsatisfactory for this period, with the exception of the 1 January 1945 attack upon Allied airfields.

26. All TAC's opns. rpts., 17 Dec., and their histories for Dec.

27. Sources cited in n. 26. See also 9th AF Opnl. Hist., Battle of the Ardennes, pp. 17-30; FUSA, Rpt. of Opns., 1 Aug. 1944-22 Feb. 1945, p. 108.

28. History, 9th BD, Dec. 1944.

29. History, 8th AF, Dec. 1944.

30. All TAC's opns. rpts., 19-22 Dec.

31. 67th TR Gp. and 10th PR Gp. opns. rpts., 19-22 Dec. 1944.

32. Air Staff, SHAEF, Report on Allied Air Force Operations from 17th to 27th Dec. 1944, pp. 3-4.

33. 12th AG G-2 Per. Rpts., 23-31 Dec.; 12th AG G-3 Rpts., 23-31 Dec.; FUSA Rpt. of Opns., 1 Aug. 1944-22 Feb. 1945, II, 117-29; Merriam, *Dark December*, pp. 184-98; Patton, *War as I Knew It*, pp. 198-208; Eisenhower, *Crusade in Europe*, pp. 358-62; Robert S. Allen, *Lucky Forward*, pp. 230-60; Montgomery, *Normandy to the Baltic*, pp. 282-84; Shulman, *Defeat in the West*, pp. 242-46; SHAEF G-2 Weekly Isum, 24-31 Dec. 1944; Maj. Gen. Richard Metz, The Use of Artillery in the Ardennes Offensive 1944 by the Fifth Panzer Army, pp. 24-33.

34. 12th AG, Recommendations and Air Requests for 18-19 Dec. 1944.

35. 9th BD FO's 679-80; msg., Gen. Anderson, CG 9th BD, to CO 391st BG, 23 Dec. 1944; msg., Gen. Anderson to

All Units, 9th BD, 24 Dec. 1944; 9th AF Adv. Daily Opns. Sum. to Air Staff, SHAEF, 24 Dec. 1944.

36. Msg., Gen. Anderson to All Units, 9th BD, 24 Dec. 1944.

37. History, 8th AF, Dec. 1944.

38. 9th AF Monthly Sum. of Opns., Dec. 1944; opnl. and intel. rpts. of components of the three TAC's, 23 Dec.; 12th AG G-2 Per. and G-3 Rpts., 23 Dec. 1944; FUSA G-2 Per. Rpt. and G-2 Estimate, 23 Dec. 1944; TUSA G-2 Per. Rpt., 23 Dec. 1944; 9th AF Adv. Daily Opns. Sum. to Air Staff, SHAEF, 23 Dec. 1944.

39. History, IX TCC, Dec. 1944; IX TCC SCO, Operation REPULSE, 22-29 Dec. 1944, p. 3.

40. History, 8th AF, Dec. 1944; USSTAF, Allied Air Power and Ardennes Offensive, pp. 69-71.

41. History, 9th BD, Dec. 1944; 373d and 474th F-B Gps. opns. rpts., 24 Dec. 1944.

42. Opns. rpts. of the 3 tactical air commands and their rcn. gps., 23-24 Dec. 1944. See also 12th AG G-2 Per. Rpt., 25 Dec. 1944.

43. IX TCC SCO, Opn. REPULSE, p. 3.

44. History, IX TAC, Dec. 1944; XXIX TAC A-2 Per. Rpt., 26 Dec. 1944; XIX TAC Isum, 26 Dec. 1944.

45. Histories, IX TCC and 8th AF, Dec. 1944.

46. Metz, The Use of Artillery in the Ardennes Offensive 1944 by the Fifth Panzer Army, p. 29.

47. History, 9th BD, Dec. 1944; Sum. of 9th AF Activities during the Battle of the Bulge, p. 3.

48. XXIX TAC managed to fly 38 uneventful sorties.

49. All TAC's opns. and intel. rpts., 26-31 Dec. 1944; 9th AF Monthly Sum. of Opns., Dec. 1944; 9th AF Adv. Daily Opns. Sums. to Air Staff, SHAEF, 26-31 Dec. 1944.

50. USSTAF, Allied Air Power and the Ardennes Offensive.

51. Rpts. of the rcn. gps. See also the sums. of tac. rcn. in 12th AG G-2 Per. Rpts.

52. IX TCC SCO, Opn. REPULSE, p. 3.

53. History, 8th AF, Dec. 1944.

54. 9th AF Monthly Sum. of Opns., Dec. 1944; 9th AF Opnl. Hist., Battle of the Ardennes, p. 60. See also Sum. of 9th AF Activities during Battle of the Bulge.

55. 7th Army, Rpt. of Opns., France and Germany 1944-45, II, 559-624; 6th AG G-2 Weekly Isums, 6 Jan.-3 Feb. 1945; Eisenhower, *Crusade in Europe*, pp. 362-63; Rpt. by the Supreme Comdr. to the CCS on the Opns. in Europe of the AEF, pp. 79-80; Harry C. Butcher, *My Three Years with Eisenhower*, pp. 737-38, 747-48; msg., Eisenhower to AGWAR for CCS, SCAF 163 (31 Dec. 1944), SCAF 168 (7 Jan. 1945), SCAF 179 (20 Jan. 1945); msg., Devers to SHAEF Main and to Eisenhower, 31 Dec. 1944; ltrs., de Gaulle to Eisenhower, 1 and 3 Jan. 1945; msg., Eisenhower to Devers (1 Jan.) and SCAF 167 (7 Jan. 1945); ltrs., Eisenhower to de Gaulle, 2 and 5 Jan. 1945.

56. FUSA, Rpt. of Opns., 1 Aug. 1944-22 Feb. 1945, II, 125-49; 12th AG G-2 Per. Rpt. and G-3 Rpt., 1-31 Jan. 1945; Eisenhower, *Crusade in Europe*, pp. 362-65; Patton, *War as I Knew It*, pp. 207-29; Allen, *Lucky Forward*, pp. 250-80; Shulman, *Defeat in the West*, pp. 253-61; Merriam, *Dark December*, pp. 194-207; Montgomery, *Normandy to the Baltic*, pp. 284-88.

57. 9th AF Opnl. Hist., Battle of the Ardennes, Sec. V, pp. 22-23.

58. USSBS, The Impact of the Allied Air Effort on German Logistics, Annex III to chap. ii, p. 56.

59. History, 9th BD, Jan. 1945; Sum. of 9th AF Activities during Battle of the Bulge; 9th AF Opnl. Hist., Battle of the Ardennes, Sec. IV, pp. 6-15, and Sec. V, pp. 17-24; 9th AF Adv. Daily Sums. of Opns. to Air Staff, SHAEF, Jan. 1945.

60. Notes of Allied Air Comdrs. Conf., 11 Jan. 1945, par. 9.

61. Notes of Allied Air Comdrs. Confs. for Jan. 1945. See also 21 AG Interpretation and/or Intel. Rpts. for 6, 13, 20, 27 Jan. and 3 Feb. 1945.

62. History, 8th AF, Jan. 1945.

63. XXIX TAC A-2 Per. Rpts., Opflash's and other rpts. for Jan.; Hist., XXIX TAC, Jan. 1945; Nugent Diary, entries for month of Jan. 1945; 9th AF



Adv. Daily Opsums to Air Staff, SHAEF, Jan. 1945; Air Staff, SHAEF A-2 Daily Air Isums, Jan. 1945.

64. IX TAC A-2 Per. Rpts., Op-flash's and other rpts. for Jan.; 67th TR Gp. Opreps for Jan.; History, IX TAC, Jan. 1945; 9th AF Adv., Daily Opsums to Air Staff, SHAEF, Jan. 1945; Notes of Allied Air Comdrs. Confs., Jan. 1945.

65. Figures based upon rpts. of 9th AF hq. and as reproduced in the A-2 Per. Rpts. of XIX and XXIX TAC's. The Jan. history of XIX TAC gives figures which are at variance with those given in its daily opsums.

66. Figures compiled from rpts. to 9th AF.

67. XIX TAC Daily Isums, Op-flash's and other rpts., Jan.; 10th PR Gp. Opreps, Jan.; History, XIX TAC, Jan. 1945; 9th AF Adv. Daily Opsums to Air Staff, SHAEF, Jan. 1945.

68. Gen. Omar N. Bradley and Air Effects Committee 12th AG, Effects of Air Power on Military Operations Western Europe (1945) (hereinafter cited as Bradley Rpt.), p. 185.

69. The AAFEB in ETO, The Effectiveness of Third Phase Tactical Air Operations in the European Theater, 5 May 1944-8 May 1945, pp. 188-89.

70. In addition to the histories of the respective air organizations, discussions and evaluation of the role of American air power during the period in question are to be found in the following references: USSTAF, Allied Air Power and the Ardennes Offensive, pp. 83-273; USSBS, The Impact of the Allied Air Effort on German Logistics, Annex III to chap. ii (particularly valuable for comments of German generals on the effectiveness of the air attacks); Metz, The Use of Artillery in the Ardennes Offensive 1944 by Fifth Panzer Army, pp. 47-48; General Stumpff, Aufgaben und Tätigkeit des Generals der Panzertruppen West in der Zeit vom September 1944 bis Mai 1945, pp. 3-4 (App. 8 to *Geschichte des "OB West"*); 2d TAF ORS and 21 AG ORS Joint Rpt. 1; Bradley Rpt., pp. 61, 73, 151-52, 155-57, 170-76, 180-82; 9th AF Opnl. Hist., Battle of the Ardennes; G-2 Weekly Isums of

SHAEF and 12th AG, Dec. 1944-Jan. 1945.

NOTES TO CHAPTER 20

1. Combined Intel. Com., Estimate of Enemy Situation as of 23 Jan. 1945; CSTC Min., 13th Mtg., 10 Jan. 1945; Memo for the Record by Gen. Giles, 5 Jan. 1945.

2. Personal memo for Arnold from Lovett, 9 Jan. 1945.

3. Memo for Bissell from Arnold, 8 Jan. 1945.

4. *Ibid.*

5. Ltr., Arnold to Spaatz, 14 Jan. 1945.

6. *Ibid.*

7. Allied Air Comdrs. Conf., 11 Jan. 1945.

8. Ltr., Spaatz to Arnold, 7 Jan. 1945.

9. Memo for Arnold from Kuter, 19 Jan. 1945; Hq. AAF AC/AS Plans Daily Activity Rpt., 20 Jan. 1945.

10. Memo for CG 8th AF from A-2 8th AF, 27 Jan. 1945; ltr., Giles to Spaatz, 31 Jan. 1945.

11. File 706, 8 Jan. 1945.

12. CSTC 13th Mtg., 10 Jan. 1945; CSTC study, Review of the Air Offensive against Axis Oil Supplies.

13. Contribution of Air Power to the Defeat of Germany (Coffin Rpt.), App. E.

14. Bufton at 14th CSTC Mtg., 17 Jan. 1945.

15. Fuehrer conf. extracts, "beginning of Jan. 1945."

16. Gen. Omar N. Bradley, Mil. Advisor, USSBS, and Air Effects Com., 12th Army Gp., Effects of Air Power on Military Operations in Western Europe, p. 61.

17. USSBS Transportation Div., The Effects of Strategic Bombing on German Transportation, p. 14.

18. USSBS, Over-all Report, p. 64.

19. Ltr., Spaatz to Arnold, 7 Jan. 1945.

20. File 706, Jan. 1945.

21. Ltr., Spaatz to Doolittle and Twinning, 9 Jan. 1945.

22. Fuehrer conf., 10 Jan. 1945.

23. Ltr., SHAEF Air Staff to CSTC, 12 Jan. 1945; History, 8th AF, Jan. 1945.

24. SHAEF C/S Mtg., 30 Dec. 1944.

25. World broadcast, 13 May 1945.

26. Ltr., Air Min. to Bomber Comd., USSTAF, and Coastal Comd., 27 Sept. 1944.
27. Memo for Gen. Anderson from Col. A. R. Maxwell, 29 Sept. 1944.
28. Ltr., Spaatz to Arnold, 19 Oct. 1944.
29. Ltr., Spaatz to Arnold, 11 Nov. 1944.
30. CM-IN-26012, Spaatz to Kuter, 26 Jan. 1945.
31. Addendum to JIC 246/2, 21 Jan. 1945.
32. Ltr., Anderson to Spaatz, eyes, 2 Feb. 1945; CCS 776/3.
33. Min. of 1st plenary mtg. between the U.S.A. and Great Britain, Malta, 2 Feb. 1945, in ARGONAUT Conf.
34. Directive 3 for the strategic air forces in Europe, 12 Jan. 1945.
35. Sir A. T. Harris, *Bomber Offensive*, p. 215.
36. Ltr., Spaatz to Arnold, 16 Jan. 1945.
37. AC/AS Plans Daily Activity Rpt., 24 Jan. 1945.
38. Ltr., Bottomley to Spaatz, 15 Jan. 1945.
39. USSTAF Air Intel. Sum. (Isum) 66, p. 17.
40. Col. Elliott Roosevelt at A-2 mtg., 23 Jan. 1945.
41. USSTAF Semimonthly Record of Results, 1-16 Jan. 1945, Sum.
42. USSTAF Isum 66, p. 21.
43. Bomber Command Weekly Digest 144; USSTAF Isum 70, p. 21.
44. Doolittle at Allied Air Comdrs. Conf., 18 Jan. 1945; USSTAF Isum 62, p. 21. No enemy record has been found to provide a check on this claim.
45. USSTAF Isum 64, pp. 15-16.
46. *Ibid.*, 67, p. 20.
47. Doolittle at Allied Air Comdrs. Conf., 18 Jan. 1945.
48. Ltr., Giles to Doolittle, 26 Jan. 1945.
49. *Ibid.*; ltr., Eaker to Giles, 4 Jan. 1945.
50. Hq. AAF AC/AS OC&R Diary, 2 Mar. 1945.
51. MAAF Air Intel. Weekly Sum. 115, p. 3.
52. USSTAF Semimonthly Record of Results, 16-28 Feb. 1945, Industry Sec.
53. CM-IN-13314, Kuter to Spaatz, 13 Feb. 1945.
54. Antonov at plenary mtg. between the U.S.A., Great Britain, and the U.S.S.R., 4 Feb. 1945, ARGONAUT Conf.
55. Ltr., Anderson to Spaatz, eyes, 2 Feb. 1945; Gen. Anderson's Journal, ARGONAUT.
56. CM-IN-259, SHAEF to War Dept. etc., 31 Jan. 1945.
57. 16th CSTC Mtg., 2 Feb. 1945.
58. CM-IN-18745 and 18562, Spaatz to Arnold, 18 Feb. 1945.
59. History, 8th AF, Feb. 1945, Résumé of Missions Flown; USSTAF Isums 66 (p. 19), 67 (p. 22); Spaatz at Allied Air Comdrs. Conf., 8 Feb. 1945; USSTAF Semimonthly Record of Results, 16-28 Feb. 1945, Industry Sec.
60. Msg., Kuter to Spaatz, U13314, 13 Feb. 1945.
61. CM-OUT-37181, Giles to Kuter, 14 Feb. 1945.
62. Msg., Spaatz to Kuter, U14466, 14 Feb. 1945.
63. Air Cdre. C. M. Grierson's press talk, SHAEF, 16 Feb. 1945.
64. CM-OUT-39730 and 39954, Arnold to Spaatz, 18, 19 Feb. 1945; CM-IN-18562 and 18745, Spaatz to Arnold, 19 Feb. 1945.
65. Ltr., Spaatz to Arnold, 20 Feb. 1945; CM-IN-19100, Anderson to Arnold, 19 Feb. 1945; AC/AS Plans Daily Activity Rpt., 19 Feb. 1945.
66. Ltrs., Arnold to Spaatz, 23 Nov. 1944, and Gardiner to Arnold, 20 Nov. 1944.
67. Report on APHRODITE Project, by Maj. Gen. E. E. Partridge, 20 Jan. 1945; AC/AS OC&R Diary, 7 Feb. 1945.
68. CCS 182d Mtg., 30 Jan. 1945.
69. Ltrs., Kuter to Arnold, 30 Mar. 1945, and Giles to Spaatz, 27 Apr. 1945.
70. Doolittle at Allied Air Comdrs. Conf., 1 Mar. 1945.
71. Coffin Rpt., App. E, p. 12.
72. Air Staff, SHAEF, Report on Allied Air Operations, 1st Oct. 1944-9th May 1945, p. 12.
73. History, 8th AF, Résumé of Missions Flown.
74. USSTAF Isum 67, pp. 21-22.
75. *Ibid.*, 69, p. 22; USSTAF Semimonthly Record of Results, 16-28 Feb. 1945, Oil Sec.

76. USSTAF Isum 66, pp. 4, 24.
77. *Ibid.*, 68, pp. 18-19.
78. USSTAF Semimonthly Record of Results, 1-15 Feb. 1945, Oil Sec.
79. USSTAF Isum 70, p. 17.
80. Ltr., Eaker to Spaatz, 15 Feb. 1945.
81. USSTAF Isum 68, p. 20; MAAF Isum 119, pp. 6-7.
82. USSTAF Isum 68, p. 4.
83. Doolittle at Allied Air Comdrs. Conf., 15 Feb. 1945.
84. Memo for Stimson from Marshall (drafted by Loutzenheiser), 6 Mar. 1945.
85. RAF BC Weekly Digest 148; USSTAF Isum 68, p. 15.
86. USSTAF Isum 69, p. 23.
87. Anderson at Allied Air Comdrs. Conf., 22 Feb. 1945.
88. History, 8th AF, Feb. 1945, Résumé of Opns.; USSTAF Isum 69, p. 18.
89. Eisenhower at press conference, 28 March 1945.
90. Ltr., Anderson to Spaatz, eyes, 2 Feb. 1945.
91. Ltr., Eaker to Spaatz, eyes, 1 Jan. 1945.
92. *Ibid.*; ltr., Bottomley to Spaatz, 26 Dec. 1944, personal.
93. Allied Air Comdrs. Conf., 1 Feb. 1945.
94. 8th AF Tactical Mission Rpt., 22 Feb. 1945; Harris at Allied Air Comdrs. Conf., 1 Mar. 1945; History, 15th AF, I, 273, 435.
95. 8th AF TMR, 23 Feb. 1945.
96. Doolittle at Allied Air Comdrs. Conf., 8 Mar. 1945; USSBS, The Effects of Strategic Bombing on German Transportation, p. 16.
97. USSTAF Isum 71, p. 22; Target Priorities of the 8th AF.
98. General Schlatter, 4 Feb. 1945.
99. USSBS, Effects...on Transportation, p. 16; Bradley, Effects of Air Power on Military Operations, p. 64.
100. Ltr., Air Min. to USSTAF, 6 Mar. 1945.
101. Allied Air Comdrs. Confs., 1 and 8 Mar. 1945.
102. Bradley Rpt., p. 64; USSBS, Effects...on Transportation, p. 16; USSBS, Impact of Allied Air Effort on German Logistics; Air Staff, SHAEF, Report on Allied Air Operations, 1st Oct. 1944-9th May 1945, pp. 22-23.
103. Swiss Claims for Alleged Bombings by AAF Units, in AFSHO files.
104. CM-OUT-43671, Marshall, personal, to Eisenhower and McNarney, 25 Feb. 1945.
105. Doolittle at Allied Air Comdrs. Conf., 8 Mar. 1945; 8th AF T/M Rpt., 4 Mar. 1945.
106. CM-OUT-47851, Marshall to Eisenhower, eyes, 5 Mar. 1945; CM-OUT-53409, Marshall to Spaatz, 15 Mar. 1945; Arnold to Spaatz, 28 Mar. 1945.
107. USSBS, Effects...on Transportation, p. 15; SHAEF to USSTAF and RAF BC, 3 Mar. 1945.
108. SHAEF G-2 review, 19 Feb. 1945.
109. Ltr., Vandenberg to Tedder, 14 Feb. 1945.
110. 8th AF T/M Rpt., 24 Feb. 1945; USSTAF Semimonthly Record of Results, 16-28 Feb. 1945, Oil Sec.
111. 8th AF T/M Rpt., 25 Feb. 1945; USSTAF Semimonthly Record of Results, 16-28 Feb. 1945, General Industry Sec.
112. 8th AF T/M Rpt., 26 Feb. 1945; USSTAF Isum 73, p. 21.
113. Fuehrer conf., 2 Mar. 1945.
114. 8th AF T/M Rpt., 27 Feb. 1945; USSTAF Isum 70, p. 22.
115. MAAF Isum 120, pp. 2-5; Anderson at Allied Air Comdrs. Conf., 1 Mar. 1945.
116. Eighth Air Force Tactical Development, pp. 28, 87.
117. CSTC Working Committee (Oil) Bulletin 11, 13 Mar. 1945.
118. USSTAF Isum 70, p. 4; 8th AF T/M Rpt., 2 Mar. 1945.
119. USSTAF Isum 70, pp. 4-5.
120. *Ibid.*, 71, pp. 17-21; 8th AF T/M Rpt., 3 Mar. 1945.
121. 8th AF T/M Rpt., 4 Mar. 1945.
122. 8th AF T/M Rpt., 5 Mar. 1945.
123. Doolittle at Allied Air Comdrs. Conf., 8 Mar. 1945.
124. 8th AF T/M Rpt., 7-9 Mar. 1945; USSTAF Semimonthly Record of Results, 1-15 Apr. 1945, AFV Sec.
125. Allied Air Comdrs. Conf., 15 Mar. 1945.
126. 8th AF T/M Rpt., 11 Mar. 1945; USSTAF Isum 72, p. 24; Allied Air Comdrs. Conf., 15 Mar. 1945.
127. Allied Air Comdrs. Conf., 15 Mar. 1945; 8th AF T/M Rpt., 12 Mar. 1945; John

NOTES TO PAGES 742-52

- R. Deane, *The Strange Alliance*, p. 140; USSTAF Semimonthly Record of Results, 1-15 Apr. 1945, Naval Sec.
128. RAF BC Weekly Digests 151-54.
129. Anderson at Allied Air Comdrs. Conf., 15 Mar. 1945.
130. *Ibid.*; MAAF Isum 122, pp. 4, 8-9; USSTAF Isum 73, p. 18.
131. USSTAF Isum 80, p. 3; 8th AF T/M Rpt., 14 Mar. 1945.
132. CCS 795/1, 13 Mar. 1945.
133. Deane, *Strange Alliance*, p. 140.
134. USSTAF Isum 72, pp. 5, 21; 8th AF T/M Rpt., 15 Mar. 1945.
135. 8th AF T/M Rpt., 17 Mar. 1945.
136. Doolittle at Allied Air Comdrs. Conf., 15 Mar. 1945.
137. *Ibid.*; 8th AF T/M Rpt., 18 Mar. 1945; USSTAF Isum 72, pp. 4-5, 16.
138. USSTAF Isum 73, p. 17; 8th AF T/M Rpt., 29 Mar. 1945.
139. USSTAF Isum 76; 8th AF T/M Rpt., 20 Mar. 1945.
140. Allied Air Comdrs. Conf., 21 Mar. 1945.
141. MAAF Isum 123, pp. 4-6; USSTAF Isum 77, p. 24; Anderson at Allied Air Comdrs. Conf., 29 Mar. 1945.
142. Coffin Rpt., App. A, Sec. 5.
143. MAAF Isum 124, pp. 5-7; USSTAF Isum 73, p. 5.
144. 8th AF Operations, 21-24 Mar. 1945, in Conjunction with . . . Rhine Crossing.
145. USSTAF Isum 75, p. 28; 8th AF T/M Rpts., 21-23 Mar. 1945; 8th AF Operations . . . in Conjunction . . . Rhine Crossing.
146. RAF BC Weekly Digest 153; Harris, *Bomber Offensive*, p. 255.
147. 8th AF T/M Rpt., 24 Mar. 1945; Operation VARSITY, Combat Evaluation Rpt., 31 Mar. 1945; Coffin Rpt., I, 8, 66.
148. 28 Mar. 1945.
149. Ltr., Spaatz to Arnold, 27 Nov. 1944.
150. Ltr., Eaker to Spaatz, 19 Jan. 1945; CM-IN-18775, McNarney to Arnold, 19 Jan. 1945; CM-OUT-24090, Arnold to Spaatz, 20 Jan. 1945.
151. CM-OUT-12018, Kuter to Deane, 12 Feb. 1945; William D. Leahy, *I Was There* (New York, 1950), p. 308.
152. CM-IN-20167, McNarney to Marshall, 19 Mar. 1945.
153. History, MAAF, 1 Sept. 1944-9 May 1945, IA, 377; ltr., Eaker to Arnold, 19 Mar. 1945.
154. History, MAAF, IA, 374.
155. CM-IN-70206, Marshall to Deane, 19 Apr. 1945.
156. CM-IN-10956, Wilson to Brit. C/S, MEDCOS 93, 14 Apr. 1944; msg., Marshall to Deane, WAR 24648, 18 Apr. 1944.
157. Deane, *Strange Alliance*, p. 127.
158. *Ibid.*, p. 131; CM-IN-14514, Deane to Marshall, 19 Apr. 1944.
159. Deane, *Strange Alliance*, pp. 136-37; History, MAAF, IA, 382.
160. Deane, *Strange Alliance*, p. 132; History, MAAF, IA, 383.
161. Deane, *Strange Alliance*, pp. 137-38; CM-IN-8316, USMilMisMos to WD, 9 Jan. 1945; CM-OUT-21167, CCS to Deane, 15 Jan. 1945.
162. CM-OUT-69568, CCS to Eisenhower, Wilson, Deane, 28 Nov. 1944.
163. CM-IN-3951, Deane to CCS, 3 Dec. 1944; Deane, *Strange Alliance*, p. 138.
164. Ltr., Anderson to Spaatz, personal, 6 Feb. 1945.
165. CCS 188th Mtg., 9 Feb. 1945.
166. Spaatz at Allied Air Comdrs. Conf., 12 Apr. 1945.
167. Deane, *Strange Alliance*, p. 139.
168. Ltrs., Spaatz to Hill and Deane, 17 Feb. 1945, and Air Min. to USSTAF, 6 Mar. 1945.
169. Deane, *Strange Alliance*, p. 141.
170. *Ibid.*
171. CM-OUT-55918, Arnold to Deane, 19 Mar. 1945. According to Leahy, *I Was There*, p. 308, certainly there was verbal approval.
172. USSTAF Semimonthly Record of Results, 16-31 Mar. 1945, AFV Sec.
173. *Ibid.*, 1-15 Apr. 1945, Production Sec.
174. Résumé of Opns., in History, 8th AF, Mar. 1945; USSTAF Isum 73, p. 23.
175. Allied Air Comdrs. Conf., 5 Apr. 1945.
176. Ltr., Arnold to Spaatz, 28 Mar. 1945.
177. Doolittle at Allied Air Comdrs. Conf., 12 Apr. 1945.
178. USSTAF Isum 74, p. 5.

179. *Ibid.*, p. 21; Coffin Rpt., App. A, p. 35.  
 180. USSTAF Isum 75, p. 10.  
 181. Doolittle at Allied Air Comdrs. Conf., 12 Apr. 1945.  
 182. Ltr., Portal to Arnold, 7 Apr. 1945.  
 183. Ltr., Tedder to Air Min. and USSTAF, 10 Apr. 1945.  
 184. Directive 4 for the strategic air forces in Europe, 13 Apr. 1945; ltr., Anderson to Arnold, 15 Apr. 1945.  
 185. Quoted in 15th AF History, App. G, 3 Apr. 1945.  
 186. USSTAF 161551B.  
 187. USSBS, Over-all Rpt., p. 38.

NOTES TO CHAPTER 21

1. Eisenhower, *Crusade in Europe*, pp. 366-75; msg., CCS to Eisenhower, FACS 123, 10 Jan., Eisenhower to AGWAR for CCS, SCAF 180, 20 Jan., Eisenhower to C-in-C EXFOR, CG's 12th AG, 6th AG, and FAAA, SCAF 176, 18 Jan. 1945; ltr., Lt. Gen. W. B. Smith, C/S SHAEF to CG Communications Zone, 5 Feb. 1945; ltr., Eisenhower to Bradley, 20 Feb. 1945; Report by the Supreme Commander to the CCS on the Operations in Europe of the AEF (SAC Rpt.), pp. 81-86.
2. Montgomery, *Normandy to the Baltic*, pp. 289-91; 21 AG, Directive for Operations VERITABLE and GRENADE, 21 Jan. 1945; rpt., Lt. Col. W. W. Stromberg, G-3 Future Plans, SHAEF, to Maj. Gen. J. F. M. Whiteley, G-3 Div., SHAEF, 24 Jan. 1945, Conference at Namur; 12th AG Letter of Instructions 15, 7 Feb. 1945; msg., Eisenhower to C-in-C EXFOR and CG 12th AG, SCAF 197, 1 Feb. 1945.
3. Montgomery, *Normandy to the Baltic*, pp. 298-308; Eisenhower, *Crusade in Europe*, pp. 375-76; SAC Rpt., pp. 88-90; Shulman, *Defeat in the West*, pp. 262-67; Coffin Rpt., II, Western Front Campaign, 229-30.
4. Total figures of air opns. compiled from SHAEF Air Staff Monthly Stat. Sum. of Opns., Feb.-Mar. See also SHAEF Air Staff Daily and Weekly Air Intel. Sums.; Report on Allied Air Operations, p. 55; Notes of Air Staff Meetings at Forward SHAEF for the period 1 Feb. to 11 Mar. 1945; 21 AG, Interdiction and "Q" Intel. Rpts., 3 and 10 Feb. 1945; 21 AG, Enemy Transportation and Supply Sums. for 3, 10, and 17 Mar. 1945.  
 5. Notes of Allied Air Comdrs. Confs., 8, 15, and 22 Feb. 1945.  
 6. See above, notes 4 and 5. In addition, see 9th BD FO's; History, 9th BD, Jan.-Feb. 1945; 9th AF Opnl. History, Book II, Roer to the Rhine, 1 Feb.-23 Mar. 1945 (hereinafter cited as 9th AF, Roer to the Rhine), pp. 33-35, 37-39, 41.  
 7. XXIX TAC, Opn. AIR GRENADE.  
 8. *Ibid.*; Nugent Diary, entries for 31 Jan.-22 Feb. 1945.  
 9. Nugent Diary, entry for 2 Feb. 1945.  
 10. XXIX TAC Opns. Orders, Opns. Rpts., and A-2 Per. Rpts., 1-22 Feb. 1945; 9th AF, Roer to the Rhine, pp. 43-51.  
 11. IX TAC Opns. Rpts. and A-2 Per. Rpts., 1-23 Feb. 1945; History, IX TAC, Feb. 1945.  
 12. XXIX TAC, Opn. AIR GRENADE.  
 13. FUSA, Report of Operations, 1 Aug. 1944-22 Feb. 1945 (pp. 150-62), 23 Feb.-8 May 1945 (pp. 3-24); Eisenhower, *Crusade in Europe*, pp. 376-78; XXIX TAC, Operation AIR GRENADE; FUSA, 9th Army and 12th AG G-2 Periodic Rpts. and G-3 Rpts.  
 14. XXIX TAC Opns. Rpts. and A-2 Per. Rpts., 1 Feb.-10 Mar. 1945; Notes of the Air Staff Mtgs. at Forward SHAEF, 1 Feb.-10 Mar. 1945; Notes of Allied Air Comdrs. Confs., Feb.-Mar. 1945; Nugent Diary, entries for 1 Feb.-10 Mar. 1945.  
 15. IX TAC Opns. Rpts. and A-2 Per. Rpts., 23-28 Feb. and 1-7 Mar. 1945; History, IX TAC, Feb.-Mar. 1945.  
 16. 9th BD FO's, 23 Feb.-7 Mar. 1945; History, 9th BD, Feb.-Mar. 1945; Notes of the Air Staff Mtgs. at Forward SHAEF, 1 Feb.-10 Mar. 1945; Notes of Allied Air Comdrs. Confs., Feb.-Mar. 1945.  
 17. 7th Army, Report of Operations, France and Germany 1944-45 (7th Army History), II, 625-52; 6th AG G-2 Weekly Isums, 13 Jan.-10 Feb. 1945; Eisenhower, *Crusade in Europe*, p. 374; SAC Rpt., p. 92.  
 18. History, 1st TAF (Prov.), I (79-

NOTES TO PAGES 765-74

108, 187-94), II (Tabs IV-A, IV-B, IV-C); History, 42d BW, Jan.-Feb. 1945.

19. 7th Army History, II, 665-92; 6th AG G-2 Weekly Isums, 17 Feb.-3 Mar. 1945; SAC Rpt., p. 92.

20. History, 1st TAF (Prov.), I, 109-17; 7th Army History, II, 672, 688; History, 42d BW, Feb.-Mar. 1945; 1st TAF COSUMS, 15 Feb.-14 Mar. 1945.

21. XIX TAC Opns. Rpts. and Daily Isums, Feb.-Mar. 1945; History, XIX TAC, Feb.-Mar. 1945; Weyland Diary, entries for 10, 25, 26 Feb. and 15, 18-22 Mar. 1945.

22. SHAEF Air Staff A-2 Weekly Isum 48, 18 Feb. 1945, Pt. II, pp. 1-2.

23. 7th Army History, III, 693-739, 946-49; 6th AG G-2 Isum, 17 Mar.-31 Mar. 1945; History, 1st TAF, I, 117-26; Eisenhower, *Crusade in Europe*, pp. 382-84; SAC Rpt., p. 93.

24. History, 1st TAF, I, 117-26; History, 42d BW, Mar. 1945; 6th AG Isum, 24 Mar. 1945; 1st TAF COSUMS, 15-24 Mar. 1945.

25. History, IX TAC, Mar. 1945.

26. Shulman, *Defeat in the West*, p. 274.

27. 9th BD FO's, 7-25 Mar. 1945; 9th AF, Roer to the Rhine, pp. 37-43.

28. IX TAC Opns. Rpts. and A-2 Per. Rpts., 7-25 Mar. 1945; History, IX TAC, Mar. 1945; 9th AF, Roer to the Rhine, pp. 60-78; FUSA, Rpt. of Opns., 23 Feb.-8 May 1945, pp. 27, 30; 12th AG G-2 Per. Rpts., 7-25 Mar. 1945; Bradley Rpt., pp. 123-24; Notes of the Air Staff Mtgs. at Forward SHAEF, 7-25 Mar. 1945.

29. FUSA, Rpt. of Opns., 23 Feb.-8 May 1945, pp. 24-42; 12th AG G-2 Per. Rpts. and G-3 Rpts., 7-25 Mar. 1945; Eisenhower, *Crusade in Europe*, pp. 378-81; SAC Rpt., pp. 90-91; Army Gp. B, Rpt. of the C/S, pp. 39-52; msg., Eisenhower to AGWAR for CCS, SCAF 223, 8 Mar. 1945.

30. XIX TAC Opns. Rpts. and Daily Isums, 22-25 Mar. 1945; History, XIX TAC, Mar. 1945; Patton, *War as I Knew It*, pp. 267-77; Allen, *Lucky Forward*, pp. 342-53; Coffin Rpt., II, 251-55.

31. Montgomery, *Normandy to the Baltic*, pp. 315-22; Eisenhower, *Crusade in Europe*, pp. 387-88; SAC Rpt., pp. 96-98; *The Brereton Diaries*, entries for

1, 15, 19, 20, 27 Feb., 12, 22, 23 Mar. 1945; Notes of Allied Air Comdrs. Conf., 21 Mar. 1945.

32. *The Brereton Diaries*, entries for 24-29 Mar. 1945; Bradley Rpt., pp. 145-46; Notes of Allied Air Comdrs. Confs., 8, 15, 22, 28 Feb., 1, 8, 15 Mar. 1945; Notes of the Air Staff Mtgs. at Forward SHAEF, 27 Feb.-20 Mar. 1945; directive, SHAEF Air Staff to 9th AF, 2d TAF, and 1st TAF, 17 Feb. 1945, Isolation of the Ruhr; msg., SHAEF Air Staff to USSTAF, RAF BC, 9th AF, 2d TAF, and 1st TAF, 3 Mar. 1945, Allocation of Areas for Interdiction of the Ruhr; 9th BD FO's, 16 Feb.-20 Mar. 1945; History, 8th AF, Feb.-Mar. 1945; XXIX TAC Opns. Rpts. and A-2 Per. Rpts., 10-20 Mar. 1945; Rpt. on Allied Air Opns., pp. 19-20; SHAEF Air Staff Report of Allied Air Operations in Preparation for, and in Connection with, Operations "PLUNDER" and "VARSITY" (hereinafter cited as Opns. PLUNDER and VARSITY), pp. 2-4 and Apps. A and B; memo for 2d TAF from SHAEF Air Staff, 12 Mar. 1945.

33. 8th AF Monthly Sum. of Opns., Mar. 1945, pp. 19-56; Opns. PLUNDER and VARSITY, p. 5.

34. 9th BD FO's, 21-23 Mar. 1945.

35. XXIX TAC Opns. Rpts. and A-2 Per. Rpts., 21-23 Mar. 1945.

36. Data for RAF BC, 2d TAF, and FC were compiled from XXIX TAC, A-2 Per. Rpts., 21-23 Mar. 1945. See also Opns. PLUNDER and VARSITY, pp. 4-5, and SHAEF Air Staff Monthly Stat. Sum. of Opns., Mar. 1945.

37. Montgomery, *Normandy to the Baltic*, pp. 322-27; 9th Army G-2 Per. Rpts. and G-3 Rpts., 24-25 Mar. 1945; Eisenhower, *Crusade in Europe*, pp. 389-91; XXIX TAC, Operation FLASH-POINT; FAAA, Operation VARSITY; Opns. PLUNDER and VARSITY, pp. 5-7 and App. D; Rpt. on Allied Air Opns., pp. 60, 65-67; RAF 38 Gp., Report on Operation VARSITY; IX TCC, Tactical and Non-Tactical Operations During the Final Phase of the War in Europe, pp. 75-84; Coffin Rpt., II, 257-65.

38. 8th AF 2d Air Div., Report on Operation VARSITY.

39. 9th AF mission file for 24 Mar.

1945, which contains opns. orders and mission rpts. for all subordinate units and participating air orgns.; Opns. PLUNDER and VARSITY, pp. 7-9; XXIX TAC, Opn. FLASHPOINT; 8th AF Monthly Sum. of Opns., Mar. 1945; 9th BD FO, 24 Mar. 1945; Notes of the Daily Air Staff Mtgs. at Forward SHAEF, 24-25 Mar. 1945; Notes of Allied Air Comdrs. Conf., 29 Mar. 1945.

40. XXIX TAC, Opn. FLASHPOINT; 9th and 12th AG G-2 Per. Rpts. and G-3 Rpts., 24 Mar.-20 Apr. 1945; 12th AG Ltr. of Instrs. 20, 4 Apr. 1945; Coffin Rpt., II, 265-67.

41. FUSA, Rpt. of Opns., 23 Feb.-8 May 1945, pp. 43-87; 12th AG and FUSA G-2 Per. Rpts. and G-3 Rpts., Apr. 1945; SAC Rpt., pp. 105-10; Coffin Rpt., II, 267-69.

42. TUSA G-2 Per. Rpts. and G-3 Rpts., Apr. 1945; Patton, *War as I Knew It*, pp. 309-31; Allen, *Lucky Forward*, pp. 343-93; Coffin Rpt., II, 269-71.

43. 7th Army History, III, 763-89; 6th AG G-2 Isums, 31 Mar.-14 Apr. 1945; SAC Rpt., pp. 104-11; Eisenhower, *Crusade in Europe*, p. 412.

44. 7th Army History, III, 789-865; 6th AG G-2 Isums, 21 Apr.-8 May 1945; SAC Rpt., pp. 111, 115-16; Eisenhower, *Crusade in Europe*, pp. 412, 418.

45. Opns. and intel. rpts. of the three TAC's for 25 Mar.-8 May 1945; 9th AF Opnl. History, Bk. III, Across the Rhine, pp. 31-54 in Sec. I and pp. 38-86 in Sec. II; Notes of the Air Staff Mtgs. at Forward SHAEF, 25 Mar.-3 May 1945; Notes of Allied Air Comdrs. Confs., 29 Mar., 5, 12, 19, 26 Apr., 4 May 1945; SHAEF Air Staff, Air Analysis, 24 Mar.-7 May 1945; SHAEF Air Staff Weekly Isums, Mar.-Apr. 1945; Weyland Diary, entries for 23-25, 27-28, 31 Mar., 2, 8, 10-11, 16-17, 26, 29 Apr. 1945; Coffin Rpt., II, 274-83.

46. 9th BD FO's, 24 Mar.-3 May 1945; History, 9th BD, Mar.-Apr. 1945; 9th AF Opnl. History, III, pp. 19-31 in Sec. I and pp. 19-37 in Sec. II.

47. Figs. on rcn. sorties flown compiled from data in SHAEF Air Staff Monthly Stat. Sum. of Opns., Apr.-May 1945. Detailed rcn. accounts are in opns. rpts. of tac. and P/R gps. of the TAC's.

See also 12th AG G-2 Per. Rpts.; 9th AF Opnl. History, Bk. III, pp. 54-58 in Sec. I and pp. 86-95 in Sec. II; Coffin Rpt., App. M, Sec. III, pp. 116-18.

48. History, 1st TAF, I (127-29), II (Tab VI-A); History, 42d BW, Mar. 1945; 1st TAF COSUMS, 23 Mar.-1 Apr. 1945.

49. History, 1st TAF, I (144-49), II (Tab VI-B); History, 42d BW, Mar.-Apr. 1945.

50. History, 1st TAF, I, 144-49; History, 42d BW, Mar.-Apr. 1945.

51. History, 1st TAF, I (129-35, 149-51), II (Tab VI-B); 1st TAF COSUMS, 28 Mar.-8 May 1945.

52. History, 1st TAF, I, 135-44; History, 42d BW, Apr. 1945; 1st TAF COSUMS, 26 Mar.-8 May 1945.

53. History, 1st TAF, I, 135-44; History, 42d BW, Apr.-May 1945; 1st TAF COSUMS, 23 Mar.-8 May 1945.

#### NOTES TO CHAPTER 22

1. USSTAF Semimonthly Record of Results, 1-15 Apr. 1945, Tactical Targets Sec.

2. Doolittle at Allied Air Comdrs. Conf., 26 Apr. 1945.

3. USSTAF PRO releases, May 1945.

4. *Ibid.*

5. USSTAF Semimonthly Record of Results, 1-15 Apr. 1945, Tactical Targets Sec.

6. History, 15th AF, I, 273-74; MAAF Air Intel. War Sum. (Isum) 126, pp. 1-3.

7. MASAF Weekly Isum 17, p. 16.

8. USSTAF Isum 79, p. 3.

9. 9th AF Opnl. History, Bk. III, Sec. 2, pp. 11-19.

10. Sir Arthur Harris, *Bomber Offensive*, p. 72.

11. MAAF Air Surrender docs., Pt. II, IA, Effect of Air Operations (Strategic).

12. Interview with Reichsmarshal Hermann Goering at Ritter Schule, Augsburg, 10 May 1945.

13. *Ibid.*

14. Interviews with Hermann Goering, 29 May and 29 June 1945.

15. USSBS Inter. 59, Grand Adm. Karl Doenitz, 27 June 1945.

16. 12th AG P/W Bulls. 26 and 28, on the effects of U.S. strategic and tactical air power.

NOTES TO PAGES 786-95

17. USSBS Inter. 62, Col. Gen. Alfred Jodl, 29 June 1945.
18. USSBS Inter. 55, FM Wilhelm Keitel, 27 June 1945.
19. MAAF P/W Intel. Sec. Rpt., 14 June 1945.
20. USSBS Inter. 11-A, Albert Speer, 22 May 1945.
21. USSBS, Over-all Report (European War), p. 71.
22. USSBS Over-all Economic Effects Div., The Effects of Strategic Bombing on the German War Economy, pp. 8-9, 45.
23. *Ibid.*, p. 8.
24. *Ibid.*
25. *Ibid.*, pp. 9, 13.
26. *Ibid.*, pp. 10-11.
27. *Ibid.*, pp. 130-31.
28. *Ibid.*, p. 133.
29. *Ibid.*, p. 6.
30. *Ibid.*, pp. 6, 141.
31. *Ibid.*, p. 7.
32. Draft memo for AC/AS Intel. from Maj. R. A. Colbert, 27 Mar. 1944.
33. Memo for Maj. Gen. F. L. Anderson from Lt. Col. James B. Ames, 28 Mar. 1944; memo for Spaatz from Anderson, 3 Apr. 1944.
34. Ltr., Spaatz to Arnold, 5 Apr. 1944.
35. Ltr., Arnold to Spaatz, 21 Apr. 1944.
36. Ltrs., Spaatz to Arnold, 12 May, Arnold to Spaatz, 5 June, Anderson to Kuter, 27 May, Kuter to C/AS, 28 Apr. 1944.
37. Min. of a Mtg. Held in the Air Council Room, Whitehall, 26 May 1944; History of the U.S. Strategic Bombing Survey (European), I, 23.
38. Harris, *Bomber Offensive*, p. 259.
39. Ltr., Marshall to King, 3 Nov. 1944 (referring to 6 June 1944 decision).
40. CM-IN-12790, Spaatz to Arnold, 15 July 44; ltr., Anderson to Kuter, 24 July 1944.
41. Ltrs., Spaatz to Arnold, 22 July, and Arnold to Fickel, 3 Nov. 1944.
42. Memo for S/W from the President, 9 Sept. 1944.
43. Ltr., Stimson to D'Olier, 2 Nov. 1944.
44. Ltr., Arnold to D'Olier, 18 Oct. 1944.
45. USSBS, Over-all Rpt., p. 9.
46. CM-OUT-55918, Arnold to Deane, 19 Mar. 1945; William D. Leahy, *I Was There*, p. 308.
47. Harris, *Bomber Offensive*, chap. 12, *passim*.
48. USSBS, Over-all Rpt., p. 107.
49. USSBS, Effects of Strategic Bombing... Economy, p. 156.
50. Stat. Sum. of 8th AF Opns., p. 52.
51. The Statistical Story of the Fifteenth Air Force, p. 16.
52. USSBS, Effects of Strategic Bombing... Economy, p. 48.
53. USSBS Aircraft Div. Industry Rpt., The German Aircraft Industry, table v-1.
54. *Ibid.*, pp. 13-14.
55. *Ibid.*, chap. 4.
56. *Ibid.*, chap. 5.
57. *Ibid.*, chap. 2.
58. *Ibid.*, chap. 5.
59. CSTC Bull. 1945-19, A Review of the Air Offensive against Axis Oil Supplies.
60. USSTAF, Plan for the Completion of the Combined Bomber Offensive, 5 Mar. 1944; War Cabinet Joint Intel. Subcommittee to Clement R. Attlee, 27 May 1944.
61. Memo for S/W from F. D'Olier, 11 June 1945; USSBS Oil Div. Final Rpt., German Oil, Chemical, Rubber, Explosives, and Propellants Industries.
62. USSBS, Over-all Rpt., p. 45.
63. USSBS, Effects of Strategic Bombing... Economy, p. 82.
64. *Ibid.*
65. USSBS Oil Div. Final Rpt.
66. *Ibid.*
67. *Ibid.*
68. *Ibid.*
69. *Ibid.*
70. Interview with Albert Speer, 19 May 1945.
71. USSBS Oil Div. Final Rpt.
72. Gen. Omar N. Bradley, mil. advisor, USSBS, and Air Effects Com., The Effects of Air Power on Military Operations in Western Europe (Bradley Rpt.), p. 13.
73. USSBS, Over-all Rpt., p. 61.
74. Bradley Rpt., pp. 14-15.
75. USSBS, Statistical App. to Over-all Rpt., Chart 1.
76. USSBS Transportation Division,



The Effects of Strategic Bombing on German Transportation, p. 4.

77. *Ibid.*, p. 5.
78. USSBS, Summary Rpt., p. 12.
79. Bradley Rpt., p. 6.
80. Contribution of Air Power to the Defeat of Germany (Coffin Rpt.), App. F.
81. USSBS Munitions Div., Tank Industry Rpt.
82. USSBS, Over-all Rpt., p. 68; Coffin Rpt., App. F.
83. Coffin Rpt., App. H.
84. Bradley Rpt., p. 7.
85. Coffin Rpt., App. K, p. 7; USSBS, Over-all Rpt., pp. 78-81.
86. Memo for S/W from D'Olier, 11 June 1945.
87. Memorandum for Arnold from the COA, 8 Mar. 1943.
88. USSBS, Over-all Rpt., p. 70.
89. *Ibid.*
90. Memorandum for Arnold from the COA, 8 Mar. 1943; Plan for Combined Bomber Offensive from the United Kingdom, 14 May 1943.
91. USSBS, Over-all Rpt., p. 26.
92. *Ibid.*, p. 29; Target Priorities of the Eighth Air Force; USSTAF, Plan for the Employment of the Strategic Air Forces, 10 June 1944.
93. USSBS, Over-all Rpt., p. 29; Coffin Rpt., I, Pt. iv.
94. Bradley Rpt., p. 165.
95. USSBS Inter. 56, Hermann Goering, 29 June 1945.
96. Interview with Albert Speer, 25 July 1945.
97. Memo for S/W from D'Olier, 11 June 1945.
98. App. K, p. 8.
99. Target Priorities of the 8th AF.
100. Bradley Rpts., p. 9; USSBS, Over-all Rpt., p. 58.
101. Bradley Rpt., p. 167.
102. USSBS, Over-all Rpt., p. 52.
103. *Ibid.*, p. 50.
104. *Ibid.*, p. 49.
105. Harris, *Bomber Offensive*, p. 268; Bradley Rpt., p. 16; Coffin Rpt., App. L, p. 72.
106. USSBS, Over-all Rpt., p. 101; USSBS Morale Div. Rpt.
107. Harris, *Bomber Offensive*, p. 176.
108. USSBS, Over-all Rpt., p. 95.
109. Flugzeugunfalle und Verluste bei den fl. Verbänden, in BAM (AHB).
110. Gesamtverluste der fl. Verbände, ADI(K) Docs. Sec., 26 FD 27; Auswertung der Einsatzbereitsch. der fliegenden Verb. vom 1 August 1943 bis November 1944; Verluste der Fliegertruppe und Flugzeuge in booklet 26FX 36a; German Statistics on German Fighter Reaction to Anglo-American Bombing Attacks, App. I, ADI(K), USSAFE, 1947; Air Staff Post-Hostilities Intelligence Requirements on GAF Tactical Employment, GAF Activity, Sec. IV (I), Vol. II, and Vol. I, App. V, consolidation of monthly reports from Kontrollberichte of the 6th Abteilung, Generalquartiermeister, BAM (AHB) 6 Study 132.
111. ADI(K) Report No. 351/1945, GAF Operations, Claims and Losses, 1944-Feb. 1945, App. IX.
112. Hansard Extract, 14 May 1947, Announcement in the House of Commons of Losses of German Aircraft in the Battle of Britain According to Contemporary RAF Estimates and Official German Records.
113. H. M. Cole, *The Lorraine Campaign* (The U.S. Army in World War II: European Theater of Operations) (Washington, 1950), pp. 4, 39.
114. Bradley Rpt., Annex I, Extracts from Opinions of Key Commanders.
115. See n. 113.
116. *Ibid.*, especially pp. 598-602.
117. Coffin Rpt., Vol. I, Pt. 1.



## GLOSSARY



## GLOSSARY\*

\* \* \* \* \*

|           |                                                       |
|-----------|-------------------------------------------------------|
| AADA      | Advanced Air Depot Area                               |
| AAFAC     | Allied Air Force Area Command                         |
| AAFEB     | Army Air Forces Evaluation Board                      |
| AAFPGC    | Army Air Forces Proving Ground Command                |
| AAFSC/MTO | Army Air Forces Service Command, MTO                  |
| ACC       | Armored Column Cover                                  |
| ACRU      | Aircrew Rescue Unit                                   |
| ADGB      | Air Defence of Great Britain                          |
| AOG       | Aircraft on ground for parts                          |
| ASP       | Air support party                                     |
| BAF       | Balkan Air Force                                      |
| BATS      | Balkan Air Terminal Service                           |
| CADA      | Continental (Central) Air Depot Area                  |
| CATOR     | Combined Air Transport Operations Room                |
| CSTC      | Combined Strategic Targets Committee                  |
| FAAA      | First Allied Airborne Army                            |
| FFI       | French Forces of the Interior                         |
| FUSA      | First United States Army                              |
| MAPRW     | Mediterranean Allied Photographic Reconnaissance Wing |
| MR&R      | Mobile reclamation and repair                         |
| OKL       | Commander of the Luftwaffe                            |
| OKW       | Commander of the Wehrmacht                            |
| POL       | Petrol-oil-lubricants                                 |
| PTCAD     | Provisional Troop Carrier Air Division                |
| PWD       | Psychological Warfare Division                        |
| SACMED    | Supreme Allied Commander, Mediterranean               |

\* This glossary includes only terms not listed in preceding volumes, and it omits code words for which the index provides a ready guide to definition.

THE ARMY AIR FORCES IN WORLD WAR II

|       |                                                   |
|-------|---------------------------------------------------|
| SCAEF | Supreme Commander, Allied Expeditionary Forces    |
| SFHQ  | Special Force Headquarters                        |
| SHAEF | Supreme Headquarters, Allied Expeditionary Forces |
| SOE   | Special Operations Executive                      |
| SPOC  | Special Projects Operations Center                |
| TUSA  | Third United States Army                          |

# INDEX





# INDEX

\* \* \* \* \*

## A

- Aachen, 267, 595-96, 611, 614-16, 634, 636, 688; Allied air bases, 568
- Aber, Lt. Col. Earle, 497-98
- Adige R., 451, 456, 462-63, 487-89; Valley, 517
- Adriatic Base Depot, 331-32
- Adriatic Sea, 351, 379, 400-401, 404, 406, 440, 445, 449, 451-53, 484-85; patrolled by MACAF, 382, 391, 399, 468; planned Allied amph. opn., 411, 455*n*
- Advanced Air Depot Areas, 1st and 2d, 115-16, 130, 132, 549, 551, 557, 575-77, 586, 590
- Aegean Is., 468; Sea, 342, 475
- Ahrdorf, 616, 618, 676, 690, 694
- Ahrweiler, 618, 690, 692-94, 696, 704-5, 761
- Air base construction: clutches, 567; on continent, 562-73; difficulties, 269-70; maps, 120, 564; supply and evac. strips, 567-69; surfacing, 119, 565-69, 571-72; total number, 572; in U.K., 118-21. *See also* Air Forces; Aviation engineers.
- Airborne operations: ANVIL-DRA-GOON, 414, 419-20, 426-31; Arnhem-Nijmegen drop (MARKET), 598-612; Normandy, 70-71, 138, 145-46, 185, 188-89; Rhine crossing (VARSITY), 746, 774; Rome campaign, 391; vs. supply opns., 276-77. *See also* numbered units.
- Aircraft Carrier Force, 415, 431
- Aircraft types (U.S.):
- A-20, charac., 352, 378, 470-71
  - A-26, first use, 263
  - A-36, charac., 369
  - B-17, mod., 16, 18, 727-28
  - B-24, mod., 277, 421, 499, 637
  - B-25, charac., 341*n*, 435, 480-81
  - B-26, charac., 121-22, 367; mod., 341*n*
  - B-29, possible use in ETO, 669, 719, 727
  - C-47, charac., 250, 426
  - L-4, charac., 269-70
  - P-38, charac., 10-11; mod., 589; range, 9-10, 22, 336, 351
  - P-40, charac., 344, 364; range, 336
  - P-47, charac., 113, 119, 240, 250, 271, 588-89; mod., 744; range, 9-10, 336
  - P-51, charac., 11-12, 113, 124, 264, 348, 356, 364, 579, 740; as F-6, 589; range, 49, 336
  - P-61, charac., 247
  - Piper Cub, charac., 356, 362-63
- Aircrew Rescue Unit No. 1, 523
- Air Defence of Great Britain: CROSS-BOW, 527, 533, 535, 542, 544-45; MARKET, 601, 604, 606-7, 609-10; OVERLORD comd., 81
- Air Forces (numbered):
- First AF (Fr.), 597, 764, 781
  - First Tactical AF: air bases, 554, 570-71; Battle of Bulge, 699, 702; Engr. Comd., 570; estbd., 597; Rhine campaign, 629, 764-65, 768, 780-82; Service Comd., 574, 578, 591; strength, 481, 579, 582
  - Second Tactical AF (RAF): AEAFF control, 110, 113; air bases, 565; air-ground coop., 238, 597, 614, 760; Atlantic Wall, 168, 171; Battle of Bulge, 686, 688, 693, 695; comd., 5, 81, 139, 530, 544; coord. with 9th AF, 130, 180, 203, 208, 249, 254-56; CROSSBOW, 91, 95, 105*n*; interdiction program, 613, 623, 699, 772-73; MARKET, 601, 604, 606-11; Normandy, 186, 194, 199-200, 207, 211-12, 218; strength, 596; trans. campaign, 151-53; VARSITY, 774-75; VERITABLE, 758-59
  - Eighth AF: accidental bomb. (friendly troops) 230, 234, 251, 670, (Switz.) 735; air drop Netherlands, 784; airlift, 561; ARGUMENT, 30-32, 36-43; Atlantic Wall, 169, 171; Battle of Bulge, 681-82, 686, 688, 690, 692, 695-96, 700, 702-9, 711,

THE ARMY AIR FORCES IN WORLD WAR II

- 717; Battle of France, 228, 231, 233, 237-38, 250, 260, 263, 270; Berlin (first bombing), 48, 53; CARPET-BAGGER, 498, 500-503, 505; CBO, 5, 7, 196, (plan to complete) 77; comd. question, 6, 80-82, 319; coord. with 15th AF, 28, 65, 294, 299-300, 314, 327, 357-59; CROSS-BOW, 28, 48, 90-91, 95, 103-5, 122, 176, 289, 292, 528-30, 533-39, 543-44; engr. topographic bns., 277; eval., 24, 43-44, 51-54, 155, 166, 287, 302-4; FRANTIC, 313-17; leaflet drops, 495-96; logistics, 305, 574, 586, 588, 591-92; losses, 660, 668, 800, (to jets) 745; low morale, 306-8; MADISON, 624, 626; MARKET, 601-10; morale bomb., 639-40; 9th AF aid by, 108, 112-16, 125, 134; Normandy, 186, 189-90, 193-94, 208, 212-14; OVERLORD, 11, 72, 142-48, 167, 278; priority, 109-10, 113, 121, 124, 128, 579-80; proposed move to France, 574, 668-69; QUEEN, 631-32; radar, 13, 15, 18, 21-25, 286, 296, 666-67, 723, 737; rate of opns., 17-18, 21, 24-25; strat. offensive opns., 294-96, 299-302, (a/c) 23, 164-65, 295, 662-63, 693, 719, 746-47, 772-73, 793, 802-4, (final) 752-53, (oil) 172, 174, 176, 178, 280-85, 295, 299, 641-46, 664, 670, 718, 723-24, 728, 736, 739-40, 743, 751, 794, (ord. and vehicle) 647-48, 783, (trans.) 73, 149, 152-56, 292, 652-56, 665, 722, 725-34, 738, 744, 797, (U-boats) 720, 741; strat. vs. tac. bomb., 279, 289, 293, 296, 299; strength, 8, 12, 18, 26, 65, 113, 280, 575, 596, 661; tactics, 56, 305-6
- Ninth AF: ACC, 239, 784; Adv. Hq., 139, 199, 202-3, 244, 268, 552-53; aid to XII Ftr. Comd., 451; airfield campaign, 164-65; ARGUMENT, 31-36, 43; Atlantic Wall, 168-69, 171; bases, 118-21, 548-73; Battle of Bulge, 686-93, 703, 711; Battle of France, 232, 238, 254, 273; charts and maps, 111, 120, 564; CHEERFUL, 764; comd. question, 5-6, 81-82, 244-45, 427n; coord. (with 8th AF) 51, (with 2d TAF) 203, 214, 621; CROSSBOW, 93, 95, 104-6, 121-25, 528, 538, 540, 544; eval., 52, 161, 166, 620; ground support, 207, 239-44, 261, 631-32, 681-82, 760, 777-78, 785; interdiction program, 613, 617-20, 623-24, 694, 701, 704; jettisonable tanks, 128-29, 135, 580; leaflet drops, 496; logistics, 126-34, 547-92; maint., 129-30, 133, 566, 585-92; MARKET, 601, 604, 607, 609-10; mission, 107, 122, 125; move to continent, 547-53; Normandy, 158-59, 189-94, 196, 200-201, 211-14, 218, 223; oil campaign, 176; orgn., 107-21, 126, 571; OVERLORD, 11, 68, 141-43, 145, 147, 149, 153, (Adm. Plan) 130-34; rate of (opns.) 611, 620, (serviceability) 591-92; rcn., 180, 681; shortages, 128, 136, 559, 580-84; signal units, 202, 268-69; strength, 12, 107-8, 113, 124, 128, 596-97; supply system, 127-28, 131-33, 555-62, 577-85, 590; training, 134-37; trans. campaign, 77, 150-51, 154, 156; transport system, 127, 133, 555-62; VARSITY, 774
- Twelfth AF: ANVIL, 417; 9th AF aid by, 135-36; orgn. and comd., 32, 327, 329-31, 335, 419, 482; proposed move to France, 439-41, 450, 464, 481-82; strength, 333
- Fifteenth AF: AA defense, 56; air rescue, 298-99, 520-23; ANVIL, 425; Anzio (opns.) 26, 29, 320-21, 340-41, 351, 354, (plans) 339; ARGUMENT, 13, 30-32, 36-43, 46; Balkans, 474, 640, 747, (strafe Russians) 476, 749; CBO, 7, 173, 325, 358, 385, 441-42; comd. question, 6, 81-82; coord. (with 8th AF) 28, 65, 290, 299-300, 327, 357, 359, (with XII TAC) 432; CROSSBOW, 533, 540; DIADEM, 381, 390-93, 406, 784; eval., 55, 298, 304-5; first (Berlin attack) 745, (1,000-ton raid) 380; FRANTIC, 311-15; orgn., 326-33, 336; OVERLORD, 142; P-51 need, 49; radar, 286, 666-67, 723; range of planes, 640, 668, 719; rate of opns., 25-26, 54-55; special opns., 506, 519; strat. offensive opns., 290-92, 305-6, (a/c) 164-65, 662-63, 793, 804, (completed) 746, 752, (oil) 172, 174, 177-78, 280-83, 287, 296-98, 302, 642-46, 660, 670, 724, 728, 739, 743, 745, 794, (ord. and vehicle) 647-49, (trans.) 152-55, 652-56, 665, 722, 730-34, 738, 742, 797; strength,

- 26, 280, 335-36, 434, 506, 653; VAR-SITY, 774. *See also* MASAF.
- Air-ground cooperation: AAF coop. (with RAF) 203, 207-8, (with Russ. army) 380; Battle of Bulge, 669-70, chap. 19 *passim*; Battle of France, 207, 244-45, 247, 249, 251-58, 263-65; doctrine, 202-3, 243, 430; eval., 360-61, 370, 762, 805-8; GRENADE, 759-63; Italy (climax) 445-47, 453, 483, (invasion) 348-49, (Rome) 387-90; MADISON, 626, 628-29; Normandy, 134, 194, 196-201, 205; QUEEN, 631-35; Rhine campaign, 107, chap. 17 *passim*; S. France, 430-37; use of (GLO's) 245-46, (L-4's) 270, (Rover Joes and Davids) 388, 447, 486; VERITABLE, 758-59. *See also* Airtank coop.
- Air Ministry (Brit.): airfield constr., 118; CBO, 27, 46-47, 61; comd. question, 320; CROSSBOW, 93, 95, 101, 123, 525, 529-30, 532, 535-36, 545; Norwegian bomb., 720; OVERLORD, 73, 77, 80; strat. vs. tac. bomb., 279; trans. bomb., 650
- Air Service Command, USSTAF: adm., 126-30, 551, 573, 588; air transport, 557-58, 561; base depot, 575-78; trucking, 557
- Air support party, 239n
- Air-tank cooperation, 239-42, 246, 271-72, 784, 805, 808
- Air Technical Service Command in Europe, 573-74
- Ala, 461, 463, 466, 486
- Albania, 408, 509, 511-14, 518, 520, 523
- Albano, 350, 356
- Albert Canal, 158, 596
- Albes, 462, 486
- Alconbury, 498
- Aldenhoven, 631, 633
- Alessandria, 380, 421
- Alexander, FM Sir Harold, 354; on ANVIL, 412; on BRASSARD plans, 399; Cassino (battle) 368, (bomb.) 363, 366; on It. campaign, 387, 420, 482, 489; MAL-LORY, 403; SACMED, 478, 481
- Algiers, 328, 392, 409, 414n, 421, 505, 515
- Allied Air Force Area Comd., 331-32
- Allied Expeditionary Air Force: a/c campaign, 213; air ren., 179; Atlantic Wall, 169-71; attacks on airfields, 164; bridge destruction, 158-59; comd. question, 245, 621; CROSSBOW, 93, 103n, 104-5, 530, 540; disbandment, 620-22; eval., 155, 161, 611-12; interdiction program, 223, 260, 613; MARKET, 602; Normandy, 199; orgn., 5, 108-12, 122-23, 140, 552; OVERLORD, 28, 68, 81-82, 145, 179; plans, 141, 147-48, 228; strategy, 598; strat. vs. tac. bomb., 279; strength, 59, 596; supply, 561; training, 136; trans. plan, 73-77, 80, 149-50, 152, 156, 173
- Allied Force Headquarters, 327-28, 372, 400, 409, 413, 441, 448, 505
- Alps, 374, 456, 516; enemy (escape routes) 448, 455, (supply routes) 390, 432, 480; Partisans, 505; weather conditions, 55, 66, 359, 644, 654, 668, 723, 730, 738, 748.
- Alsace, 260, 702-3, 706, 764-65; plain, 629, 701
- Alsace-Lorraine, 756
- Amberg Kummertsbrück, 779
- Amiens, 12, 123, 151, 154, 268, 496, 550, 555
- Amsterdam, 122
- Ancon, 194, 202
- Ancona, 339, 341, 350, 374, 380, 400-401, 408
- Andernach, 700, 705
- Anderson, Maj. Gen. Frederick, 31-32, 35, 75, 123, 135, 157, 311, 379, 534-35, 666, 717, 789-90
- Anderson, Maj. Gen. Orvil, 790
- Anderson, Maj. Gen. S.E., 110, 190-92, 550
- Angers, 215, 221, 224, 246
- Annecy, 500
- Antwerp, 608, 672; capture, 268, 599, 623, 636; port, 69, 585, 612, 614, 635; V-weapon attacks, 542, 544-45
- ANVIL: final plan, 414-17; indecision over, 71, 408, 410-13; prep. for, 4, 8, 325, 401, 405, 407, 418-20; redsgd. DRAGON, 402; relation (to DIADEM) 384, 391, (to OVERLORD) 391, 409-10. *See also* DRAGOON.
- Anzio: Allied failure, 371, 409; amph. opns., 26, 32, 328, 336-70 *passim*, 408, 410; breakout, 384-90; demand on air forces, 373, 376; GAF, 793; lessons, 415, 430, 437-38. *See also* SHINGLE.
- Apeldoorn, 600
- Apennines, 352, 389, 403, 405, 420, 439
- APHRODITE, 531, 536, 538
- Aprilia, 353-54
- Arezzo, 339-41, 350, 374, 388, 396, 401-2
- Argenta, 485-86; Gap, 482, 485
- Argentan, 219, 246, 249-58, 266-67. *See also* Falaise.
- ARGUMENT. *See* "Big Week."
- Arlon, 692, 698
- Armies (numbered):  
First Allied Airborne Army: MAR-

## THE ARMY AIR FORCES IN WORLD WAR II

- KET, 600-601, 604, 606; orgn., 245, 554<sup>n</sup>, 574, 596, 599; plans, 277; VARSITY, 746-47, 771
- First Army: air support, 547, 567, (judgment of) 201; Battle of Bulge, 656, 672-73, 678, 681-82, 686-87, 697, 703, 707-8; Battle of France, 228, 237-38, 241, 243, 248, 255, 273, 276-77, 294-95; Normandy, 199, 202-5; orgn., 243-46; Rhine campaign, 595, 597, 599, 611, 614, 616-19, 623, 631-34; Rhine crossing, 756-57, 759, 762-63, 766, 769-70, 775-79; supply, 556, 561, 567-68
- First Army (Can.), 613, 756-57
- First Army (Fr.), 574, 597, 629, 702, 756, 764-65, 777, 780
- First Army (Ger.), 767
- Second Army (Brit.): Battle of Bulge, 702-3; Rhine campaign, 599-600, 607, 612, 614, 623; Rhine crossing, 756-57, 762, 771, 773, 775
- Third Army: air support, 547, 550, 567, (eval.) 806; Battle of Bulge, 672, 686, 692, 696; Battle of France, 246-47, 256-60, 265-68, 274-77, 408, 426, 434, 436; orgn., 243; OVERLORD, 141; Rhine campaign, 597, 599, 611, 616-19, 623, 628-29, 635; Rhine crossing, 756, 763, 765-68, 776, 778-80, 785; supply, 556, 561-62, 567-68
- Third Army (Ukrainian), 476
- Fifth Army: air support, 352, 417-18, 420, 442, 464, (eval.) 357, 454, (need for) 358-59, 366, 373; Italy (Cassino) 360-63, 366, 376, (Gustav Line) 336-37, 342, 344-49, 354-55, 361-62, 364, 371, 408, (northern) 399-402, 426, 433, 445-56, 468, 477-78, 482, 486-89, 777, (Rome) 385-87, 394, 396, 410-11; proposed move to France, 440-41; troops to ANVIL, 407, 413-14, 419
- Fifth Panzer Army, 248, 267, 676, 680, 683, 685, 694-95, 697, 702
- Sixth Panzer Army, 676, 678, 680, 682-83, 694, 697, 702, 725
- Seventh Army: ANVIL (build-up), 401, 413-14, (opns.) 267, 431-34, 436, 439-40, 443, (plans) 415; Battle of Bulge, 685-86, 699, 701-2; Battle of France, 503, 505-6; redsgd., 437; Rhine campaign, 597, 629, 635; Rhine crossing, 756, 765, 767-68, 776-77, 780
- Seventh Army (Ger.): on Allied (close support) 205, 249, (interdiction) 222, 250; Battle of Bulge, 683, 689, 694; Battle of France, 2347<sup>n</sup>, 243, 247, 267, 426; CG captured, 267-68; Normandy, 198, 216, 219, 223, 225-26
- Eighth Army (Brit.): air support, 352, 402, 418, 420, 442, 464, 467; El Alamein, 806; Italy (Arno) 399-401, 407, 419, 426, 433, 440, 443, (diversion for Anzio) 337, (northern) 445-50, 452-56, 475, 477-78, 482, 485-87, (Rome) 371, 385-87, 396, 408, (stalled) 344, 349, 354
- Ninth Army: Battle of Bulge, 656, 672, 682, 686, 701, 703; Battle of France, 266; dsgn., 263; Rhine campaign, 597, 616, 623-24, 631-35; Rhine crossing, 756-62, 771-75, 778, 785
- Tenth Army (Ger.), 346, 387, 488
- Eleventh Army (Ger.), 776
- Fourteenth Army (Ger.), 488
- Fifteenth Army (Ger.), 159, 226, 258
- Nineteenth Army (Ger.), 434, 764-65
- Armored column cover. *See* Air-tank cooperation.
- Army Air Forces Air Service Comd., 127
- Army Air Forces Air Transport Comd., 299, 331, 557, 559
- Army Air Forces Antisubmarine Comd., 498
- Army Air Forces Board, 99
- Army Air Forces Headquarters: AC/AS (Intel.) 716, (Plans) 110, 717; a/c repl., 579; bomb. doctrine, 279, 284, 305, 537, 638, 722, 725, 727; CBO, 17; comd. question, 81-83, 320; CROSSBOW, 99, 103, 526, 546; Engr. Comd., 118; logistics, 582; oil campaign, 174-75; OVERLORD, 71, 139; radar bomb., 723; trans. campaign, 78, 653; USSBS, 789
- Army Air Forces, Mediterranean Theater of Operations, 327, 329, 332-33
- Army Air Forces Proving Ground Comd., 98-99, 531, 727
- Army Air Forces Service Comd., Mediterranean Theater of Operations, 330-35, 417, 420
- Army Engineer Beach Brigade, 577
- Army Ground Forces, 98, 790. *See also* Air-ground coop. and numbered units.
- Army Groups (numbered):  
1st Army Gp., 81

- 6th Army Gp.: Battle of Bulge, 685, 701; orgn., 437, 440-41, 464; Rhine campaign, 597, 617; Rhine crossing, 764, 775-76, 781-82; supply, 554, 590
- 12th Army Gp.: Battle of Bulge, 681-82, 690, 704; Battle of France, 263; coop. with 9th AF, 244, 268-69; on interdiction, 260; orgn., 243-44, 268; Rhine campaign, 597, 599, 601, 612, 616; Rhine crossing, 759-60, 766; supply, 275, 277, 560, 569
- 15th Army Gp., 442, 483, 513
- 21 Army Gp.: Battle of Bulge, 672, 686; Battle of France, 254, 267; orgn., 140; OVERLORD, 179; Rhine campaign, 597, 599-600, 622, 635; Rhine crossing, 760, 778
- Army Service Forces, 173, 790
- Arnheim, 598; Allied offensive, 600-601, 604, 606-8, 611-14, 652; communications, 610; paratroop drop, 276, 609, 771
- Arnold, Gen. of the Army H.H.: Allied airborne force, 245; ANVIL, 412-15; Anzio, 361, 365-66, 371; Battle of Bulge, 710; CG AAF, 18, 25, 160, 660-61, 715-16, 752; comd. question, 79, 81-83, 320-21, 327-28, 621-22; coop. with Russians, 319; CROSSBOW, 97-101, 103-4, 123; 8th AF move to France, 668-69; FRANTIC, 309-11, 317-18; GAF, 8, 196, 288, 666; ground (offensive) 207, 637, (support) 29; intel. failure, 681; logistics, 305; long-range escort, 11; MARKET-GARDEN, 608; morale, 306, (bomb.) 639, 650, 727; 9th AF, 107, 110, 114; oil campaign, 174, 286; special opns., 506; Swiss bomb., 736; trans. campaign, 75, 79, 161; 12th AF move to France, 440; USSBS, 789-90
- Arno R., 396, 400-402, 406, 408, 426, 433, 439, 478
- Arnsberg, 742
- Asch, 570
- Aschaffenburg, 690, 700, 706, 724, 737, 776, 781
- Aschersleben, 36-37
- Ascot, 268, 551
- Athens, 302, 474, 475*n*
- Atlantic Wall, 159, 166-72
- Atomic energy: bomb, 85, 542-43, 546, 638; German experimentation, 97
- Au Gay, 202-3, 205, 549
- Augsburg, 31, 41-42, 44, 290, 738, 782
- Aulnoye, 151, 154
- Aure R., 197
- Austria, 25, 403, 406, 408, 412, 456, 462, 660; a/c factories, 297, 358-59, 399; airfields, 351-52, 472, 572; GAF in, 663, 778; oil targets, 177, 643, 670, 728, 730; ord. campaign, 647; Russ. advance thru, 747, 749; Tirol, 777; trans. campaign, 483, 654, 656, 722, 730-31, 738, 742, 745, 784
- Avezzano, 341, 344-45, 377, 387, 391
- Aviano, 351-52, 471
- Aviation engineers: airfield constr. (Corsica) 418, (Italy) 345, 393-94, 401, (S. France) 432, 434, 436; Battle of France, 269, 277; eval., 808; Rhine campaign, 601; UTAH beach, 203-4. *See also* IX and XII Engr. Comds.
- Aviation fuel supply, 128-29, 131, 582-85
- Avignon, 155, 420-23, 431, 433
- Avisio R., 405-6, 463
- Avord, 164-65
- Avranches, 241, 246-48, 251
- AWPD-1, 186; AWPD-42, 801

## B

- Baal, 617, 762
- Babcock, Col. Vernon, 130
- Babington-Smith, F/O Constance, 84, 89
- Bad Berka, 779
- Bad Dürkheim, 768
- Baden-Baden, 777
- Bad Godesberg, 705-6
- Bad Kreuznach, 676, 680
- Bad Münster, 619, 696, 704-5
- Balkan Air Force, 399, 406, 467, 473-75, 510-11
- Balkan Air Terminal Service, 510, 520-21
- Balkans, 28, 82, 150, 290, 302, 436*n*, 458, 467, 640; GAF strength, 342, 657; leaflet drops, 509, 517-18; oil, 390, 403; Partisans, 326, 494, 507, 509-11, 513; proposed offensive into, 385, 408, 411, 441, 455*n*; rail targets, 155, 380, 399, 473, 652, 796; Russ. offensive, 439, 472, 748-49; special opns., 507, 520-24; supply missions to, 507-15
- Baltic Sea, 84, 89, 741
- Bamberg, 779
- Barcus, Brig. Gen. Glenn, 430
- Barfleur, 141, 577
- Bari, 332, 521-22
- Base Air Depot Area, 109, 115, 126-29, 557, 575-78, 580, 586-90
- Basle, 623, 735, 777
- Bastia, 417, 485
- Bastogne, 685, 689, 692-95, 697-701, 709, 711

THE ARMY AIR FORCES IN WORLD WAR II

- Batjer, Col. John, 476  
 Battalions (numbered):  
     5th Ranger Bn., 264  
     816th Engr. Avn. Bn., 563  
     819th Engr. Avn. Bn., 548, 563-65  
     820th Engr. Avn. Bn., 563  
     834th Engr. Avn. Bn., 548, 563-65  
 Battle of Britain, 138, 804, 806  
 Battle of the Bulge, 624, 636, 669-70, 715, 717; Allied (battle order) 685-86, (resistance) 683-89, 694-95, 701-11; eval. of air role, 681, 695-96, 704-5, 708, 710-11, 718, 797; German (opns.) 656, 682-83, 701-3, 793, (order of battle) 675, (plans) 672-73, (retreat) 705, 709; intel., 673-82; interdiction, 690-93, 696-701, 704-9, 769  
 BATTY, 531  
 Bavaria, 654, 737, 781-82  
 Baverstock, 126, 577  
 Bayerlein, Maj. Gen. Fritz, 235-36, 257  
 Bayeux, 68, 197, 222  
 Bayreuth, 753, 776  
 Beaugency, 260, 266  
 Beaumont-le-Roger, 164-65  
 Beaumont-sur-Oise, 165  
 Beauvais, 165, 273  
 Beaverbrook, Lord, 534  
 Belfort, 154-55, 165, 219, 436, 505; Gap, 597, 629  
 Belgium, 258, 615, 708; advance thru, 277, 562, 595; Allied bases, 553-54, 562, 568, 570-72, 574, 585, 652, 665, 669, 703; Atlantic Wall, 166; bridge targets, 157-58, 650; CROSSBOW, 525, 539; GAF bases, 213, 657; labor, 569, 571; leaflet drops, 495-98; line of battle, 596; occupation, 499; rail targets, 74, 150-52, 156, 260, 653, 692; V-weapon sites, 288  
 Belgrade, 290, 302, 399, 472, 474-75, 511, 513, 523, 748  
 Bénerville, 141, 144, 168  
 Benson, Capt. Karl, 520  
 Berchtesgaden, 61, 638  
 Berg, 678, 770  
 Bergamo, 405, 423  
 Bergen, 720  
 Bergius hydrogenation process, 172, 286  
 Berlin, 23, 28, 178, 301, 650, 660, 740, 743, 749, 785, 795; a/c industry, 22, 662; attack on, 12, 48-56, 125, 664, 725-26, 729, 734, 737, 742, 744-45, 774, (eval.) 50-52, 738, (GAF opposition) 51, 53, 746, 752; ball-bearing target, 36; CROSSBOW, 86, 530; morale bomb., 638-39, 727, (controversy) 284-85; ord. target, 647-48, 720, 751, 753; Russ. advance on, 746  
*Berliner Boersen-Zeitung*, 53  
 Bernburg, 31, 34, 36-37  
 Besançon, 505, 554  
 Bethune, 93, 153-54  
 Bielefeld, 647-48, 654, 736, 742  
 Bierset, 568  
 "Big Week": eval., 34-35, 37, 43-48; GAF, 63, 66, 666; opns., 13, 31-43, 328, 359  
 Bingen, 600, 654, 664, 676-77, 680, 682  
 BINGO, 461-63, 466  
 Biological warfare, 97  
 Birnn, Col. Roland, 332  
 Bitburg, 614, 676, 678, 683, 693-94, 700, 705  
 Bitche, 701  
 Bitterfeld, 723, 738  
 Black Forest, 777  
 Blatzheim, 677-78  
 Blechhammer, North and South, 281, 291, 297, 299, 302, 642-46, 670  
 Blida, 420, 505-6, 515  
 Blizna, 538  
 Böhlen, 176-77, 285, 289, 300-301, 642, 644, 740  
 Bologna, 387-90, 397, 401-5, 443, 445-46, 468, 640; capture, 514; 5th Army offensive toward, 440, 448, 451, 453-56, 478, 482, 485, 487-88, 784; rail center, 350, 380, 391, 452  
 Bolzano, 380, 406, 461, 480  
 Bombsights, 341*n*  
 Bomb types: Azon-controlled, 728; German controlled glide, 351; leaflet, 496; napalm, 233, 262, 531*n*, 783; Tallboy (*see* RAF BC)  
 Bonn: Battle of Bulge, 675-77, 688, 692, 698, 706, 708; GRENADE, 760-61; Rhine campaign, 600, 612, 614, 631, 769-70  
 Bonn-Hangelar, 692, 694  
 Boppard, 706, 771  
 Bordeaux, 412, 427, 783  
 Bór-Komorowski, Gen. Tadeusz, 316  
 Bottomley, AM Sir Norman: CROSSBOW, 93, 99, 101; Direc. (No. 3) 724, (No. 4) 753; oil campaign, 640, 645, 653, 670, 721, 733; USSTAF, 59  
 Bottrop, 644-45  
 Bournemouth, 550  
 Boxmeer, 756  
 Bradley, Gen. Omar: Battle of Bulge, 685-86, 703; COBRA, 228, 239; CG 1st Army, 199, 203, 230, 708; CG 12th Army Gp., 243, 254, 597, 611-12, 621, 656, 775; comd.

- question, 620; Eisenhower's 4 Sept. 1944 direc., 599; MARKET, 601; plans, 623, 756; Rhine campaign, 655, 769; trans. campaign, 161, 656; USSBS, 790; UTAH, 71
- Brant, E.D., 73, 157, 653
- BRASSARD, 399-400
- Brautisch, FM Walter von, 86, 88
- Braun, Werhner von, 88, 102*n*
- Brazil, 330, 450*n*
- Bremen: a/c campaign, 9-10, 12, 662; oil campaign, 281, 284-85, 295-96, 642, 645; ord. target, 647; radar bomb., 20, 58; shipbuilding, 19; sub pens, 737, 741, 751; trans. campaign, 736, 771, 773
- Brenner Pass: enemy supply route, 390, 403*n*, 461; GAF activity, 470; Ger. rate of repair, 460; Partisans, 517; priority target, 468, 478-80, 484; rail target, 297, 350, 406, 456-59, 462-63, 466-67, 481, 486-87, 652, 738, 784; U.S. troops join, 777
- Brenta R., 456, 458, 460, 464, 467, 478, 487-88
- Breton, Lt. Gen. Lewis: AEAf, 140; airlift to Normandy, 188; ARGUMENT, 32; bridge destruction, 157-58; CG FAAA, 245, 596, 600-601, 607*n*; CG 9th AF, 5, 107-10, 113, 122, 134, 142, 148-49, 151, 186, 199, 245, 268; CROSSBOW, 90, 93, 100; Engr. Comd., 117-18; trans. campaign, 77, 151, 161; UTAH, 71
- Brescia, 404, 406, 448, 453, 468
- Breskens Pocket, 613
- Brest, 164, 220, 246, 262-65, 268, 270, 597, 599, 611-12
- Brezna, 522
- Brigades (numbered):
- 1st Engr. Avn. Brig., 567-68, 570
  - 1st Independent Parachute Brig. (Pol.), 596, 600-601, 608
  - 2<sup>e</sup> Brigade de Bombardement, 764
  - 2d Engr. Avn. Brig., 567-68, 570
  - 3d Engr. Avn. Brig., 571
- Brindisi, 506-7, 509, 511-12, 515, 520, 522
- British: airfield constr. units, 565; bomb. survey unit, 371; Imperial Staff, 527; Min. of Economic Warfare, 75, 286; Min. of Home Security, 16; morale, 543, 546; petroleum supply, 583-85; proposed Balkan invasion, 408, 441; Special Opns. Exec., 493; troops in (ANVIL) 414, (Battle of France) 207-8, 246, (Greece) 474, 475*n*, (Normandy) 186, 190; War Cabinet ("Battle of the Atlantic" Com.) 529*n*, (CROSSBOW) 89, 93, 102, 526-27, 529*n*, 533-34, 536, 542, (Night Air Defence Com.) 529*n*, (trans. campaign) 79, 151. *See also* units.
- British Airborne Troops Command, 596
- British Chiefs of Staff: ANVIL, 385, 410-11, 413; CROSSBOW, 95, 102, 529*n*, 534, 542, 545; It. stalemate, 363-65; proposals for all-out attacks, 638-39; 12th AF move to France, 440
- British Guards Armoured Division, 600, 607
- British Joint Staff Mission, 96, 101
- Brittany, 597; airfield campaign, 165; Allied base, 270; OVERLORD, 68; rail targets, 217, 249; suggested invasion, 413; supply problem, 275; 3d Army drive, 246, 260-67
- Brno, 749
- Broadhurst, AVM Harry, 203
- Brod, 399, 474-75
- Brooke, Sir Alan, 75, 527
- Brooks, Maj. Gen. Edward, 616
- Browning, Lt. Gen. F.A.M., 601
- Brühl, 700, 705
- Brux, 176-77, 281, 292, 300-301, 642, 646, 648, 670, 723
- Brunswick, 176, 178; a/c industry, 22-25, 33-36, 48, 54, 296, 300; Allied bases, 554; captured, 775; ord. target, 647-48, 740
- Brussels, 154-55, 165, 268, 554, 574
- Bucharest, 283, 290, 298, 315, 472, 476, 748-49
- Budapest, 281, 290, 473, 462, 642, 747-48
- Budrio, 443, 446
- Buer, 286, 642
- BUICK, 505
- Buir, 678, 760
- Bulgaria, 472, 474, 477, 509-11, 518, 523
- Bullay, 700, 704-5, 766
- BUNGHOLE, 519-20
- Burtonwood, 127, 130
- Bushey Heath, 67*n*
- Bushy Park, 67*n*
- Busigny, 153-54
- Butler, Maj. Gen. William, 5
- Byrd, Rear Adm. Richard, 790

## C

- Cabell, Brig. Gen. Charles, 329, 535
- CADILLAC, 504
- Caen: airfield campaign, 163-64; bridge targets, 197, 207; Brit. occupation, 246, 250; Canal, 71; carpet bomb., 208, 293; friendly troops bombed, 251; Ger. de-

THE ARMY AIR FORCES IN WORLD WAR II

- fense, 209, 222, 278, 303, 426; OVERLORD plans, 68-71, 138, 141, 144-45, 147; rail target, 190-93
- Cairo, 299, 326; Conference, 3, 371, 409
- Calais, 150, 154, 158-59, 168, 206
- Cambrai, 122, 153-54, 165, 550
- Campoleone, 349, 353, 355-56, 360
- Canada, 207-8, 251, 258, 267, 386
- Canale d'Isongo, 479
- Cannes, 426, 429, 481, 748
- Cannon, Lt. Gen. John: ANVIL, 412, (tac. air comdr.) 414, 433, 435-36; CG MAAF, 482; CG MATAF, 326, 469-70, 478; CG 12th AF, 32, 327; 15th AF aid, 358; 12th AF move to France, 464
- Cantal, 503-4
- Cap Nègre, 414, 424
- Cardonville, 549
- Carentan, 144, 193-94, 198, 231
- "Carpet," 56
- CARPETBAGGER, 498-502, 507, 510, 518
- Carroceto, 353-54, 356, 360, 387
- Carrouges, 255-56
- Carsoli, 341-42, 345
- Casablanca, 326; Conference, 3, 57
- Casalecchio, 446, 487
- Casale Monferrato, 445, 449
- Casarsa, 390, 405, 467
- Caserta, 328, 345, 350, 393, 464
- Cassino, 345, 408, 410; campaign, 337, 342, 349, 354, 361-70, 373, 376-77, 384-86; mass bombing, 367-68, (eval.) 369-70. *See also* Monte Cassino.
- Castelfranco, 467, 479
- Castle Hill, 366, 368
- CASTOR, 531
- Castrop, 644-45, 740
- Catoctin*, USS, 430
- Cecina, 342, 382, 401
- Centocelle, 343, 387
- Cesena, 380, 390, 443, 452-53
- Châlons, 275, 585
- Châlons-sur-Marne, 153
- Chalon-sur-Saône, 504-5
- Channel Is., 146, 171, 494
- Chantilly, 268, 552
- Charleroi, 151, 154-55, 574
- CHARWOOD, 208
- Chartres, 165, 212, 216-17, 252, 260, 550-54, 568, 585
- Châteauroux, 265-66, 503
- CHATTANOOGA CHOO-CHOO, 156
- Chaumont, 154-55
- Cheddington, 495<sup>11</sup>, 498, 501.
- CHEERFUL, 764-65, 768
- Chelveston, 495<sup>11</sup>
- Chemical warfare, 97, 534
- Chemnitz, 301, 315, 725, 727, 729, 731, 740
- Cherbourg, 68-70, 146, 170-71, 188, 269, 275, 637; air assault, 186, 192, 200-203; airdrop, 189; airfield campaign, 122; assault plans, 198-200; CROSSBOW, 90, 93, 100, 525; friendly units bombed, 200; occupation, 204, 550, 568, 584-85
- Chetniks, 52; 53
- Chidlaw, Maj. Gen. B.W., 449, 453, 482
- Chief of Staff, Supreme Allied Commander (COSSAC), 68-73
- Chièvres, 165, 574
- Chiswick, 542
- Chiusi, 374, 377, 389, 400
- Chivasso, 397, 445
- Churchill, Prime Minister Winston: ANVIL, 385, 409-10, 411<sup>11</sup>, 413; Anzio, 337; ARGUMENT, 32, (vs. SHINGLE) 358; Balkans, 82; CROSSBOW, 85<sup>11</sup>, 527, 529<sup>11</sup>; It. campaign, 640; OVERLORD, 3-4, 80; radar, 140; robot B-17's, 728; supplies to Warsaw, 316-17; trans. plan, 75, 78-79, 152; U-boats, 720-21; UTAH, 70; Yalta, 724
- Ciampino, 343, 427
- Ciotat, 426-27
- Cisterna, 349, 354, 360, 386
- Civitavecchia, 339-41, 345, 387, 396, 400
- CLARION, 639, 732-35, 761-62
- Clark, Gen. Mark, 32, 358, 363, 366, 401<sup>11</sup>, 412, 453, 486
- Clay, Lt. Gen. Lucius, 790
- Clerf, 697, 705, 708
- Cleve, 757-58
- Cloyes, 212, 260
- Coblenz: Battle of Bulge, 675-77, 682, 686, 688, 690, 692, 694, 699-700, 704, 706, 708; GRENADE, 761; Rhine campaign, 600; trans. campaign, 618, 654, 657, 736, 780
- Coblenz-Engers, 706
- Coblenz-Güls, 705
- Coblenz-Lützel, 688, 704, 706
- COBRA: air opns., 232-34; air-tank coop., 239-42; artillery spotting, 270; bomb. results, 234-37; friendly forces bombed, 230, 234, 236; plans, 228, 231-32; weather problem, 228-30, 232
- Cole, H.M., 805
- Colleville, 559
- Colli Laziali, 337, 348, 350
- Collins, Lt. Gen. J.L., 198-99, 205



- Colmar, 505, 701, 764; Canal, 764; Pocket, 629, 764-65
- Cologne: a/c campaign, 663; Battle of Bulge, 675-80, 688, 699, 704, 706, 708; GRENADE, 760-61, 763; motor vehicle target, 647-48; QUEEN, 631, 633-34; Rhine campaign, 600, 612, 769; trans. campaign, 618, 623, 652, 654, 657, 719, 725
- Cologne-Kalk, 688
- Combined Air Transport Operations Room, 561-62
- Combined Bomber Offensive: air superiority, 58-59, 63; area bomb., 58; comd. question, 5-6, 28; coord. (8th and 15th AF's) 6, 28, 41, 55, 66, 325-27, 397, 433; (RAF and AAF) 7, 27, 30; vs. CROSSBOW, 95, 97, 101-2, 529; direc. of 13 Feb. 1944, 27-28; end, 56-57, 484; eval., 21-22, 56-66, 196, 658; ftr. escort, 9-11, 16, 22; opns., 8-9, 25-26, 63; plans, 7-8, 12-13, 30-31, 57, 67, 76-77, 173; vs. SHINGLE, 358; strength, 26-27; target priority, 15, 27, 40. *See also* Strategic bombing offensive.
- Combined Chiefs of Staff: Balkan bomb line, 477, 749; CARPETBAGGER, 498; CBO, 7, 57, 121, 327; comd. question, 6, 56, 81-82, 320-21; CROSSBOW, 101-2; ground support, 29, 724; mass air attacks, 365-66; oil campaign, 174-75; OVERLORD, 3, 26-28, 68, 70; S. France invasion, 409-13, 420; shuttle bombing, 309; strategy in MTO, 478; target priority, 640, 653, 666, 721-22; 12th AF move to France, 48, 440-42, 449, 464
- Combined Operational Planning Committee, 30, 68, 536-37
- Combined Operations Section, 244
- Combined Strategic Targets Committee, 642-43, 654, 657, 718-19, 733, 753
- Commands (numbered):
- I Air Service Area Comd., 331-33
  - II Air Service Area Comd., 331
  - III Air Service Area Comd., 331
  - VIII Air Force Composite Comd., 498
  - VIII Air Force Service Comd., 115-16, 574, 592
  - VIII Air Support Comd., 107-8, 110, 112, 121
  - VIII Bomber Comd., 12, 18, 103*n*, 105, 122, 190, 211
  - VIII Ftr. Comd.: Battle of France, 232, 254-55, 260; functions, 16, 33, 145; Hq., 574; losses, 303; MARKET, 601; IX FC control by, 123, 125; Normandy opns., 190, 194, 196, 211-14; orgn., 11; strength, 10
- VIII Tactical Air Service Area Comd., 108
- IX Air Defense Comd., 114-15, 247
- IX Air Force Service Comd.: air depot gps., 550-52, 575-77, 586, 590; air-drome sqs., 549; assembly, 129, 586-87; bases, 572; battle-damage repair, 590-91; CG, 115, 558; chart, 576; functions, 126-34, 141, 239, 548, 574-75; Hq., 549, 551, 586; modification, 129, 586, 588-89; MR&R sqs., 130, 134, 550, 587, 590-92; orgn., 115-21, 575-77; POL, 133, 583-85; QM Truck gps., 556; repl. control depots, 117; salvage, 134, 592; service teams, 116-17, 127-33, 550-52, 556, 580, 590; strength, 116-17, 126, 131, 551; tac. air depots, 115-16, 121, 127, 129-30, 575; training, 136-37; transport system, 127, 133, 555-62, 568-69, 584-85. *See also* AADA; BADA; Ninth AF.
- IX Air Support Comd., 112-13
- IX Bomber Comd.: bases, 119-20, 548, 550; Battle of France, 230, 234, 238, 261-64, 271, 274; coop. with RAF BC, 207-8; CROSSBOW, 104; Normandy, 190, 193, 197-200, 206, 208, 212-13, 216-17, 223; orgn., 110-12, 550; OVERLORD, 141; strength, 112, 124; targets, 121-25, 257, 261; training, 135. *See also* 9th Bomb. Div.
- IX Engineer Comd.: air base constr., 131, 141-42, 203, 240, 548-49, 562-73, 584; CG, 118, 570; orgn., 117-19, 552, 569-71; strength, 563; training, 137, 566
- IX Fighter Comd.: bases, 119-20; Battle of France, 238; ftr.-bomber dsgn., 125*n*; Normandy, 190, 192, 194, 200, 212-13; orgn. and functions, 11, 112-13, 123-25, 134-35, 140; OVERLORD, 141
- IX Tactical Air Comd.: ACC, 239-40; bases, 119-20, 547, 549-50, 553-54; Battle of Bulge, 675-77, 682, 686-88, 692, 697-98, 703, 707-8; Battle of France, 228, 231, 238, 242-44, 249, 255-56, 272-75; mission, 547, 552; Normandy, 205, 208, 212, 254; orgn., 113, 125, 141, 202-3, 597; Rhine campaign, 600, 613-23, 631-33; Rhine

## THE ARMY AIR FORCES IN WORLD WAR II

- crossing, 760-63, 769-70, 774, 778;  
supply, 131
- IX Troop Carrier Comd.: bases, 119-21, 548, 554-55, 570, 587; Battle of Bulge, 692-94, 700; CG, 114, 4277; FAAA orgn., 596; functions, 554, 557-62, 574, 578; MARKET, 601, 609-10; Normandy, 188; OVERLORD, 145-48; Rhine campaign, 774; strength, 113-14, 558, 579; training, 136
- XII Air Force Engineer Comd., 333, 416-17
- XII Air Force Service Comd., 330-33, 417, 441
- XII Air Force Training and Replacement Comd., 331, 333, 335
- XII Air Support Comd.: opns. (Anzio) 339, 344-49, 352-55, (N. Italy) 362, 374, 377-78; orgn., 333; redsgd. XII TAC, 335, 385
- XII Bomber Comd., 333, 335, 372
- XII Fighter Comd., 335, 449-51, 468
- XII Tactical Air Comd.; ANVIL-DRAGOON, 420-21, 425, 428, 430-37; bases, 554, 570; control of Navy planes, 415; move to Corsica, 418, 442; opns. (Italy) 385-86, 388, 390, 396, 402-3, 443-45, 449, 453, (Rhine campaign) 617-19, 623, (Rhine crossing) 764-65, 781; orgn., 335, 393, 450; USSTAF control, 437, 440-41
- XII Troop Carrier Comd., 114, 333, 335, 419
- XV Air Force Service Comd., 331, 333
- XIX Air Support Comd., 112-13
- XIX Tactical Air Comd.: ACC, 262; bases, 119-20, 547, 549-50, 553-54, 567; Battle of Bulge, 673-80, 686-88, 692, 698-99, 703, 705, 709-10; Battle of France, 243, 247, 249-52, 255-57, 265-66, 275; mission, 547, 552; orgn., 113, 244, 597; Rhine campaign, 600, 613, 616-19, 623-24; Rhine crossing, 766, 768, 771, 778; supply, 131
- XXII Tactical Air Comd.: opns., 452-55, 466-68, 471, 478-80, 483-87; orgn., 450, 482; proposed move to France, 481
- XXIX Tactical Air Comd.: bases, 554; Battle of Bulge, 673, 682, 686, 688, 692-99, 703, 707; orgn., 552, 597; Rhine campaign, 616-18, 623, 629-33; Rhine crossing, 758-63, 772-74, 778
- Committee of Operations Analysts, 799-801
- Communications Zone, 133, 555-56, 561, 568-69, 571, 578, 583-85
- Compiègne, 195, 274, 574-75, 578, 586
- Conflans-Ste.-Honorine, 215, 261
- Coningham, AM Sir Arthur: AEAFA Adv., 203; coop. with Vandenberg, 254, 622; CROSSBOW, 530; interdiction, 213, 218; 2d TAF, 110, 139-40; VERITABLE, 758
- Constanza, 748
- Continental (Central) Air Depot Area, 575, 587
- Cook, Lt. Robert, 521
- Corlett, Maj. Gen. Charles, 207
- Cormailles-en-Vexin, 164-65
- CORNCOB, 487
- Corps (numbered):
- I Corps (Fr.), 764
  - II Corps, 345-46, 354, 386, 454, 486-87
  - II Corps (Fr.), 764
  - II Corps (Pol.), 484
  - III Corps, 698, 701-2
  - IV Corps, 486-87
  - V Corps, 192, 196, 198, 239, 614, 616, 631, 633, 682, 687, 702, 759
  - 5 Corps, 396, 456, 484
  - VI Corps, 348-49, 353, 386, 390, 767-68, 777
  - VII Corps, 198, 201, 204-6, 219, 231, 237, 239, 241, 271-73, 611, 614-15, 631-33, 701-2, 760, 763, 775
  - VIII Corps, 204-6, 239, 241, 260, 262-64, 633, 682-83, 686, 698, 701-2, 766
  - 10 Corps, 345-46
  - XI Corps, 777
  - XII Corps, 611, 624, 626, 698, 701-2, 766-67, 771
  - XIII Corps, 762, 775
  - XIV Corps (Ger.), 488
  - XV Corps, 256, 267, 765, 768, 776-77, 781
  - XVI Corps, 762-63, 775
  - XVIII Airborne Corps, 701-2
  - XVIII Corps, 596
  - XIX Corps, 204-7, 236, 239, 273, 611, 614-15, 631, 762, 775
  - XX Corps, 274, 611, 617, 624, 626, 768
  - XXI Corps, 764-65, 768, 777
  - 30 Corps, 624, 701-2
  - LXXXIV Corps (Ger.), 205

- Corsica: Allied base, 374, 387*n*, 391, 402-3, 405, 414, 417, 434-36, 443, 445, 449-51, 471, (for ANVIL) 416-18; bombed by GAF, 392; conquest, 325-26, 408
- Cosina R., 455-56
- Cotentin Peninsula, 69-70, 138, 143, 145-46, 148, 222, 262, 270. *See also* Cherbourg.
- Cottbus, 725, 727, 731
- Coulommiers, 568
- Coutances, 193, 238, 241-42
- Creil, 151-52, 154, 165, 551, 556
- Cremona, 402, 404-5, 452
- Crete, 342, 346, 351
- Cricqueville, 549
- Crookham Common, 587
- CROSSBOW: aerial rcn., 84, 93, 102, 126, 529-30; American mission, 99-100; controversy, 21, 24-25, 28, 48, 54, 100-104, 123, 173-76, 278-79, 284-85, 288-89, 297, 304, 528-37, 544-46; Eglin Fld. tests, 97-104, 106, 531, 536, 541; eval., 106, 540-41, 546; intel., 84, 91-93, 525, 529*n*, 531, 534, 538, 541, 545-46; Joint CROSSBOW Com., 535-38, 543; opns., 89-91, 95, 104-6, 121-25, 527-34, 537-44; orgn., 93, 95, 535, 541, 544-45; plans, 85, 89, 93, 95-97, 526-27, 530-39, 543; War Dept. Com., 96-97, 99
- CRUMPET I, 447; II, 447-48
- Cunningham, Fleet Adm. Sir A.B., 416, 469
- Czechoslovakia, 297, 299-300, 472, 572, 660, 668, 745, 776, 783, 785, 798
- D
- Dahlem, 676, 679, 688, 692, 695, 697
- Dahn, 768
- Dalmatia, 382, 399, 455*n*, 469, 475
- Danube R., 412, 777, 784; mined, 177, 281, 297, 654, 797; Plain, 462; Russ. offensive, 472-73; ships bombed, 399; Valley, 776
- Darcy, Brig. Gen. Thomas, 482
- Darmstadt, 624, 626, 677, 680, 682, 776
- Dasburg, 702, 705, 708-10
- Daun, 617, 690, 693
- D'Aurelio, Gen., 372
- Deane, Maj. Gen. John, 309-12, 319, 476-77, 748-49
- Debrecen, 312, 472-73, 748
- Dempsey, Lt. Gen. Sir Miles, 757
- Denmark, 33, 36, 86, 500
- Depots (numbered):
- 4th Base Air Depot, 577
  - 5th Strategic Air Depot, 574
  - 20th Repl. Control Depot, 551
- Desert Air Force: Balkans, 475; coop. (with XII TAC) 385-88, 390, (with XXII TAC) 453; Italy (BINGO) 461, 466, (invasion) 344, 356, 360, (northern) 467, 478-80, 483, (STRANGLE) 374, 377-78, (support 8th Army) 352, 354, 396, 402, 449-56, 485, 488, (support 5th & 8th Armies) 415, 418, 433, 442-43, 446-48, 451; MANHOLE, 519; strength, 402, 419; units to BAF, 399
- Devers, Gen. Jacob: ANVIL, 410, 412, (bombing) 428; Anzio air assault, 357; Battle of Bulge, 685, 701; CG NATOUSA, 327; CG 6th Army Gp., 440, 597, 612, 620, 623, 669, 776, 780; CROSSBOW, 96; Monte Cassino bombing, 362-63, 368; Rhine crossing, 756
- DIADDEM, 384; eval., 395-96, 412; GAF, 392-93, (losses) 394; MAAF losses, 393; merger with STRANGLE, 377, 383; opns., 388-91, 411, 439; plan, 386; relation to BRASSARD, 399-400
- "Dicing missions," 180-81
- Dietrich, Col. Gen. Joseph, 248
- Dieuze, 617, 627
- Dijon, 164, 265, 273, 435, 500, 504, 519, 554
- Dill, FM Sir John, 96
- Dives R., 138
- Divisions (numbered):
- 1st Air Div., 734, 736-37, 741
  - 1 Airborne Div., 596, 600-601, 604, 606
  - 1st Bomb. Div., 15-16, 23, 37, 233. *See also* 1st Air Div.
  - 1st Ftr. Div., 112
  - 1st SS Panzer Div., 249, 256
  - 2d Air Div., 734, 737, 741
  - 2d Armored Div., 236, 240, 242, 256, 775
  - 2d Armored Div. (Fr.), 629
  - 2d Bomb. Div., 16, 23, 37, 230, 686, 690. *See also* 2d Air Div.
  - 2 Div. (N.Z.), 363*n*, 367
  - 2d Inf. Div., 265, 683
  - 2d SS Panzer Div., 205, 221, 223-24, 249, 257, 696
  - 3d Air Div., 502-5, 734, 737, 740-41
  - 3d Armored Div., 240, 242, 245, 256, 692, 775
  - 3d Bomb. Div., 15-16, 23, 37, 233, 667. *See also* 3d Air Div.
  - 3d Inf. Div., 409, 765
  - 3d Parachute Div. (Ger.), 220
  - 4th Armored Div., 252, 689, 776
  - 4 Div. (Indian), 363*n*, 366
  - 4th Inf. Div., 236, 683

THE ARMY AIR FORCES IN WORLD WAR II

- 5th Inf. Div., 274, 628  
 6 Airborne Div., 596  
 6th Armored Div., 768, 776  
 7th Armored Div., 255, 272, 692, 702  
 8 Div. (Indian), 478  
 9th Armored Div., 689, 769  
 9th Bomb. Div., 550-51, 554, 579, 614-15, 618, 623-24, 627-30, 633-34, 682, 690-92, 699, 703-4, 758, 760, 763, 769, 773-74  
 9th Inf. Div., 202, 237, 616  
 9th SS Panzer Div., 220, 224, 604  
 10th Armored Div., 689  
 10th Mountain Div., 486-87  
 10th SS Panzer Div., 220, 224, 604  
 11th Armored Div., 776  
 16th SS Panzer Grenadier Div., 480  
 17th Airborne Div., 562, 596  
 17th SS Panzer Grenadier Div., 221  
 21st Panzer Div., 193  
 28th Inf. Div., 683  
 29th Inf. Div., 265  
 30th Inf. Div., 230, 234, 236, 248, 615  
 36th Inf. Div., 362  
 43 Inf. Div., 600  
 45th Inf. Div., 409, 430  
 50 Inf. Div., 600  
 63d Inf. Div., 768  
 69th Inf. Div., 776  
 77th Div. (Ger.), 198  
 78 Div., 363*n*  
 79th Inf. Div., 252, 267  
 82d Airborne Div., 145-46, 186, 189, 548, 596, 600-601, 604, 606-8  
 83d Inf. Div., 266  
 84th Inf. Div., 762  
 84th Inf. Div. (Ger.), 258  
 90th Inf. Div., 628  
 96th Inf. Div., 628  
 99th Inf. Div., 683  
 101st Airborne Div., 145-46, 186, 188-89, 548, 596, 600-601, 604, 606-7, 689  
 104th Inf. Div., 613  
 106th Inf. Div., 683  
 116th Panzer Div., 249  
 117th Inf. Div., 248  
 254th Inf. Div., 768  
 265th Inf. Div. (Ger.), 220  
 275th Inf. Div. (Ger.), 225  
 331st Inf. Div. (Ger.), 258  
 344th Inf. Div. (Ger.), 258  
 352d Inf. Div. (Ger.), 207  
 356th Inf. Div. (Ger.), 480  
 Doenitz, Grand Adm. Karl, 738, 786, 799  
 D'Olier, Franklin, 790  
 Dollbergen, 723, 740  
 Donohue, Lt. Harold, 521  
 Doolittle, Maj. Gen. James: ARGUMENT, 31-32, 38; Atlantic Wall, 169; Battle of France, 254, 637; CG 8th AF, 6, 573, 753; CLARION, 735; CROSS-BOW, 104, 285, 305, 529, 536-37; 8th AF bombing accuracy, 741-42; GAF, 288, 661, 666, 744; interdiction, 213, 706; MARKET, 609; morale bombing, 639; oil campaign, 176; ord. campaign, 720; OVERLORD, 144-45, 147-48; relations with Eisenhower, 319; Rhine mass bombing, 655, 669; Special Services, 306; strat. air, 279, 717, 754; trans. campaign, 75; USSTAF air discipline, 668  
 Dornberger, Maj. Gen. Walter, 86-88, 102*n*  
 Dortmund, 645, 654, 732, 740, 742  
 Douve R., 189  
 DOVE, 430-31  
 DRAGOON: airborne opn., 428, 431; air opns., 423-25, 433-36, 443; comd., 415-16; eval., 437-38; Ger. (retreat) 435, (strength) 427; landings, 429-30, 432; naval and air diversion, 426-27; prep. for, 407; redsgn. of ANVIL, 402, 408; SHAEF control, 437, 440-41  
 Drava R., 474  
 Dreiborn, 678, 682, 688  
 Dresden, 725, 727, 731-32, 740, 749  
 Dreux, 214, 253, 260  
 Drvar, 510-11, 521, 523  
 Dülmen, 729, 773  
 Düren: Battle of Bulge, 675-77, 679, 695, 697, 703; GRENADE, 759-60, 763; Rhine campaign, 614, 631-33, 756; trans. target, 615-19  
 Düsseldorf: Battle of Bulge, 673, 678, 706-7; GRENADE, 757; oil campaign, 642; ord. targets, 301, 648; Rhine campaign, 600, 756; trans. campaign, 623  
 Duisburg, 644, 654, 706, 760  
 Dulce, 459, 461  
 Dumpelfeld, 618, 761  
 Dunkerque, 168, 672, 806  
 DUNN, 522  
 Dunn, Maj. Bruce, 522  
*Dunquerque*, 291  
 Durance R., 431

E

- Eaker, Lt. Gen. Ira: ANVIL, 385, 410, 412-13, 415; Anzio, 360-61; ARGUMENT, 32, 358; bridge destruction,

- 157; Cassino bomb., 362-63, 368; CG AAF/MTO, 327; CG 8th AF, 108, 498; CG MAAF, 6, 29, 326, 328-29, 462, 466, 482; CG USAAFUK, 108; comd. question, 320, 621; counter-air opns., 358 (vs. jets) 730; CROSSBOW, 93; 15th AF (combat losses) 303, (strength) 336; Fr. air bases, 668; FRANTIC, 311-13; H2X, 18; Italy (interdiction) 371, 376, 378, 394, 478, (stalemate) 640; mass bomb., 366-67, 733; morale, 307; MTO special opns., 506, 523; oil campaign, 643; Ploesti bomb., 298; trans. campaign, 78; 12th AF move to France, 440, 464; USSR liaison problem, 319, 476, 748-50
- Eastern Command, 311, 314-15, 317-19
- East Prussia, 426, 672, 702
- Echternach, 672, 680, 683, 694, 698
- Edwards, Maj. Gen. Idwal, 327, 367
- Eglin Fld., Fla., 98-100, 104
- Ehrang, 154, 688, 690, 692, 696
- Ehrgott, Col. H.W., 131, 572
- Eindhoven, 600-601, 604, 607
- Eisenach, 776
- Eisenhower, Gen. of the Army Dwight: airlift, 188-89; Allied airborne force, 244-45; ANVIL, 385, 409-11, 413-14, 419; area bomb., 284, 638-39, 727; Atlantic Wall, 169; Battle of Bulge, 685-86, 701, 703; comd. question, 79-83, 142, 319, 321, 327, 596, 620, 622; CROSSBOW, 99, 102-3, 526-27, 531-35, 540, 545; Direc., 321, 599-600; FRANTIC, 310, 316; interdiction, 371; logistics, 305; Normandy invasion, 190, 205, 226, 228; oil campaign, 174-75, 179, 718; OVERLORD, 7, 58, 67, 70-71, 73, 144, 146, 148, 173; Rhine (campaign) 598, 612-13, 623, 649-50, 656, (crossing) 747, 756; SHAEF (comd.) 4-6, 207-8, 279, 426, 436-37, 721, 807, (mission) 804; St.-Lô bomb., 237; Swiss bomb., 735; trans. campaign, 72, 75-76, 78-79, 149-51, 161; 12th AF move to France, 440-41; USSR liaison problem, 749
- Elba, 390, 399-400, 437
- Elbe R., 776, 778
- Eller, 690, 693, 696, 705, 763, 766
- Elliot, AVM W., 399
- Elsenborn, 678, 683, 702-3
- Elster, Maj. Gen. Eric, 265-66
- Emmerich, 757-58, 775
- Empoli, 340, 377, 397
- English Channel, 69, 72, 140-41, 143, 146, 160, 166, 585, 598
- Ensdorf, 628
- Épinal, 154-55
- Erfurt R., 763
- Erfurt, 776
- Erkner, 36, 48-49, 51-52
- Escout Canal, 596
- Eschweiler, 615, 631-33
- Essen, 652, 734, 742
- Étang-de-Lindre dam, 617
- Étaples, 168, 260
- Ettinghausen, 693, 770
- European Advisory Committee, 535
- European Theater of Operations, U.S. Army, 96, 99, 573
- Euskirchen: Battle of Bulge, 676-77, 679, 682, 688, 690, 692-700, 705, 708; bridge targets, 618, 623, 634; Rhine campaign, 615, 635; trans. target, 617, 761
- Evacuation and infiltration, 518-24. *See also* Rescue.
- Évreux, 122, 165, 214, 219

## F

- Fabriziano, 339, 350, 374
- Faenza, 390, 403, 452-53, 455-56, 464, 467-68
- Falaise: campaign, 193, 208, 246, 251; Falaise-Argentan (gap) 266, 269, 705, (pocket) 253-58; Ger. defense, 248, 250. *See also* Argentan.
- Fano, 377, 380, 382, 389, 396, 401
- Fécamp, 168-69
- Ferrara, 397, 445, 448, 452, 482, 485-86
- Ferry Pilot (Transport) Service, 331-33
- Field Manual (31-35) 807; (100-20) 186, 196, 209, 227, 807
- Filton, 126, 129
- Fischer-Tropsch hydrogenation process, 172
- Fiume, 39, 41, 358, 455<sup>n</sup>, 468-69, 522, 724, 730-31
- Flers, 250, 254
- Florence: Allied drive toward, 396, 400; captured, 401, 408; rail lines, 339-41, 348, 350, 374, 377-80, 387<sup>n</sup>, 388-89, 395, 397, 402-3, 433
- Florennes, 165, 568
- Floridsdorf, 283, 644, 646, 742, 745
- Foggia, 26, 41, 281, 325-26, 332, 366, 371-72, 441
- Foglia R., 433
- Foligno, 339-41, 350, 389, 396, 399
- Force 163, 409, 414<sup>n</sup>

THE ARMY AIR FORCES IN WORLD WAR II

- Forêt d'Andaine, 223; de Conches, 223; d'Ecouves, 223; de la Haye, 274; de Parroy, 617, 629; de Senonches, 223
- Forlì, 391, 394, 443, 453, 455
- Formia, 345, 386
- Fort Driant, 617
- Fort du Roule, 201
- France: Air Service Comd., 574; Army B, 435, 437; Battle of, 228-77; crisis, 701; GAF strength, 342, 346, 351, 392, 657; labor, 569, 571; leaflet drops, 495-98; liberated, 499, 645, 658; Normandy invasion (opns.) 185-227, (plans) 67, 70, 83, 138; oil campaign, 283, 292; railways, 73, 150, 156, 160-61, 214-18, 291, 637, 798 (*see also* trans. campaign); resistance movement (*see* Maquis); southern invasion (opns.) 408-38, (plans) 290; sub pens, 799; troops in (ANVIL) 414, 428, 435-37, (BRASSARD) 399-400, (Rome campaign) 386, 400-401; units in MAAF, 326, 330-32. *See also* units.
- Frankfurt, 25, 48, 54, 58, 176; a/c campaign, 275; Allied air base, 585; Battle of Bulge, 677-78, 680, 682, 700; Rhine campaign, 599, 611, 624; trans. campaign, 652, 654, 657, 732, 741, 770; USSBS Hq., 790
- FRANTIC: bases, 310-11; 8th AF, 313-16; eval., 318-19; JOE, 311-12; OVERLORD, relation to, 311, 313; plans, 308-9; Russ. attitude, 309-11; supplies to Warsaw, 316-17; targets, 311-12
- Frascati, 350, 353, 356, 393
- Fraulautern, 628
- FREEDOM. *See* Rescue of AAF P/W's.
- Freiburg, 618, 735
- French Air Force, 331-32, 391, 418, 432. *See also* units.
- French Expeditionary Corps, 345
- French Forces of the Interior, 217, 266, 427, 503-6. *See also* Maquis.
- Freyberg, Gen. Bernard, 363, 366
- Friedrichshafen, 178, 292, 294, 648, 735, 737
- Fritsch, FM Werner von, 86
- Frosinone, 345, 352, 387
- Fürth, 41-42
- Fulda, 676-78, 700, 706
- FULL HOUSE, 145, 190
- G
- Gaggenau, 301, 647-48
- Galland, Adolf, 166, 663, 786
- GARDEN, 600, 606-11
- Gardner, Brig. Gen. Grandison, 98-99, 531
- Garigliano R., 345, 362, 386
- Garrod, AM Sir Guy, 482-83
- Geilenberg, Edmund, 287, 641, 718, 728
- Geilenkirchen, 611, 624, 703
- Geldern, 757-59
- Gelsenkirchen, 17, 286, 644, 732, 734, 741
- Gemünd, 676, 679, 687, 693-94, 697, 705-8
- Gemünden, 705, 776
- Genck, 615
- Geneva, 504-5
- Genoa: bridges, 377, 391, 403-6; capture, 489; coastal defenses, 416, 424; Gulf of, 468-69; harbor targets, 380, 425; trans. campaign, 421, 443, 452
- German Air Force: a/c characteristics (Ar-234) 659, (FW-190) 10, 661, (He-111) 542*n*, (Ju-87) 392, (Ju-88) 10, 273, 343, 392, (Me-109) 10, 661, (Me-163) 659, 740, (Me-262) 659-60, 729, 740, (Me-410) 343; on Allied air at Normandy, 227; attack on Patton's Hq., 247; combat losses, 46-47, 63, 177, 665, 793, 803-4; controlled glide bombs, 351; eval., 806; fr. tactics, 10, 23, 37-39, 176, 744; General QM Dept., 802, 803*n*; jet a/c, 279, 659-60, 666, 715-16, 728, 739-40, 743, 793; opns. (Anzio) 346, 350-51, 354-55, 357, 369, 793, (Battle of Bulge) 687, 689, 701, 703, (interception) 122, 284, 289, 292, 301, 595, 604, 606, 608, 612, 759, 775, 778, (Normandy) 185, 190, 195, 793, (Poltava attack) 313-14, (Rhine crossing) 770; OVERLORD challenge, 8-13, 27; POINTBLANK, 57, 69, 162-64; strength, 9, 13, 55-56, 58-64, 66, 77, 139, (France) 138, 162, 166, 195-96, 247, 423, 432, (Germany) 287, 657-58, 660-61, 663-64, 666, 671, 719, 754, 781-82, 792, 807, (Italy) 387, 392, 470-71, (MTO) 342, 346, 379; units (Air Force Comd. West) 595, 673, (Fliegerkorps II) 195, (Jagdkorps II) 195, (Luftflotte 3) 195, 247, 595, (Luftflotte Reich) 62
- Germany: a/c production, 9, 45, 59-62, 69, 195, 288, 658-60, 792-93; Army Gp. B, 218-19, 225, 235, 673; Army Gp. G, 765-68; Balkan retreat, 513; defenses, 56, 170-71, 281-83, 495, 595, 604, 606-7, 757-59; F-boats, 381; leaflet drops to, 495-96, 498, 518; morale (civilian) 7, 13, 178, 638, 672, 746, 802, (troop) 193, 198, 201-2, 209, 227, 235, 237, 246, 264, 266, 356-57, 368, 429, 454; National Redoubt, 779, 781-82; *Oberkommando der Wehrmacht*, 221, 672, 743; oil resources, 172,

- 280, 286-87, 641-43, 645, 670, 717-18, 724, 728, 730, 754, 794-95; panzer production, 647-49, 798; propaganda, 52-53; railway system, 650-53, 655, 657, 722, 729, 734, 739, 746, 796 (*see also* Trans. campaign); repair skill, 407, 459-60, 462, 646, 652, 657; strategy, 598; strength, 226, 246, 258, 272, 355, 394, 426-27, 437, 715; surrender (Germany) 785, (Italy) 482, 489, 784; Yugoslav offensive, 521-22. *See also* Chaps. 17, 19, 21; numbered units.
- Germersheim, 600, 768
- Gernsheim, 780
- Gerolstein, 676, 678, 690, 693, 700, 706
- Gerow, Lt. Gen. Leonard, 196
- Ghornley, Vice Adm. Robert, 790
- Giessen, 675, 678, 682, 693, 732
- Giles, Lt. Gen. Barney, 113-14, 174, 205, 726
- Gironde R., 781
- Gjinokastër, 513
- Gladbach, 673, 688, 760, 762, 770
- Goch, 623, 757-58
- Goebbels, Reichsminister Joseph, 178, 530
- Goering, Reichsmarschall Hermann: Allied air war, 786, 793, 800; Berlin bomb., 12, 53; GAF (ftr. comdrs.) 664-65, (losses) 63, 178, (Poltava) 314; German counteroffensive, 673; Hitler, 226; OVERLORD, 162; scapegoat, 785; Albert Speer, 44, 288; V weapons, 87
- GOLD, 143
- Golzheim, 676, 763
- GOODWOOD, 208-9
- Gotha, 31, 36-40, 359, 624, 776
- Gothic Line, 396, 401, 403, 406, 433, 439, 443, 445, 448
- Grandcamp les Bains, 244, 549, 577
- Grave, 600, 604
- Graz, 41, 473, 649, 662, 731
- Greece: BAF, 399; Brit. occupation, 511; evac. (Allied crews) 523, (Ger.) 468, 472-75; GAF, 342, 351, 663; infiltration, 520; leaflet drops, 518; supply drops, 509, 511-12
- GRENADE, 757-63
- Grenoble, 155, 423, 427, 431, 496
- Grevenbroich, 618, 635, 679, 760
- Gros Réderching, 765
- Grosseto, 339, 343, 399-400
- Groups (numbered):
- 1st Ftr. Gp., 351
  - 1st Intransit Depot Gp., 577
  - 1st Transport Gp., 558, 560
  - 2d Bomb. Gp., 339, 380
  - 2d Gruppo (It.), 470
  - 4th Ftr. Gp., 49
  - 4th Ftr. Gp. (Fr.), 432, 443
  - VIII Air Force Intransit Depot Gp., 132, 548, 577
  - 10th Air Depot Gp., 551
  - 10th P/R Gp., 180-81, 264, 270, 550, 673, 675-76, 678, 693, 710
  - 11 Gp., 113, 122, 125, 140
  - 12th Bomb. Gp., 335*n*, 343
  - 14th Ftr. Gp., 351, 432
  - 15th Special Gp., 513
  - 16th Air Depot Gp., 551
  - 17th Bomb. Gp., 367, 423, 466
  - 27th Air Transport Gp., 128, 557-60
  - 27th Ftr.-Bomber Gp., 354, 405, 432, 450, 481
  - 31st Air Transport Gp., 127, 133, 551, 557-60
  - 31st Ftr. Gp., 335*n*, 336, 345, 352, 392
  - 33d Ftr. Gp., 335*n*, 345, 352
  - 36th Ftr.-Bomber Gp., 124*n*, 265-66, 694, 769
  - 38 Gp., 562, 596, 609-10, 758, 774
  - 42d Air Depot Gp., 551
  - 46 Gp., 562, 596, 609-11, 774
  - 47th Bomb. Gp., 354, 378, 405, 418, 425, 443, 449, 451, 467, 471
  - 48th Ftr.-Bomber Gp., 124*n*, 256, 692, 694
  - 50th Ftr.-Bomber Gp., 124*n*, 256, 549
  - 52d Ftr. Gp., 335*n*, 336, 421
  - 55th Ftr. Gp., 9, 123
  - 57th Ftr. Gp., 335*n*, 374, 378, 423, 443, 449, 451, 461
  - 60th TC Gp., 509-11, 518, 520-22
  - 61st TC Gp., 114*n*
  - 62d TC Gp., 501, 516
  - 64th TC Gp., 512, 516-17
  - 67th T/R Gp., 119, 126, 270, 550, 673, 675, 678, 693, 709-10
  - 68th Rcn. Gp., 506
  - 79th Ftr.-Bomber Gp., 335*n*, 344, 352, 402, 405, 450
  - 81st Ftr. Gp., 335*n*
  - 82d Ftr. Gp., 351, 425
  - 83 Gp., 203, 254, 695
  - 86th Air Depot Gp., 551
  - 86th Ftr.-Bomber Gp., 354, 405, 423, 432, 443, 449, 451*n*, 481
  - 97th Bomb. Gp., 339, 351, 380
  - 98th Bomb. Gp., 380, 390
  - 99th Bomb. Gp., 339, 351, 380, 392
  - 205 Gp., 177, 281, 316, 340-41, 380, 406, 425, 443, 486, 516, 518

THE ARMY AIR FORCES IN WORLD WAR II

- 242 Gp., 382, 391, 399  
 301st Bomb. Gp., 339, 351, 380  
 305th Bomb. Gp., 495  
 310th Air Serv. Gp., 466  
 310th Bomb. Gp., 335*n*, 377, 381, 388, 470  
 313th TC Gp., 114*n*  
 314th TC Gp., 114*n*  
 315th TC Gp., 114  
 316th TC Gp., 114*n*  
 319th Air Serv. Gp., 481  
 319th Bomb. Gp., 367, 423, 464-66  
 320th Bomb. Gp., 367, 423, 466  
 321st Bomb. Gp., 343, 388, 435  
 322d Bomb. Gp., 112, 124  
 323d Bomb. Gp., 112  
 324th Ftr. Gp., 352, 423, 450  
 325th Ftr. Gp., 351  
 328th Air Serv. Gp., 498  
 332d Ftr. Gp., 335*n*, 336, 421  
 340th Bomb. Gp., 388, 392, 456, 469-70  
 350th Ftr. Gp., 335, 382, 418, 443-45, 449, 451  
 352d Ftr. Gp., 574, 694, 698  
 354th Ftr.-Bomber Gp., 11-12, 24, 123-24, 252, 266, 273, 275, 698  
 355th Ftr. Gp., 49  
 357th Ftr. Gp., 49  
 358th Ftr. Gp., 124*n*  
 361st Ftr. Gp., 574, 698  
 362d Ftr.-Bomber Gp., 124*n*, 252-53, 272, 617, 698  
 363d Ftr.-Bomber Gp., 124*n*, 252  
 363d T/R Gp., 673, 693  
 365th Ftr.-Bomber Gp., 104, 124*n*, 197, 273, 275, 686-87, 698  
 366th Ftr.-Bomber Gp., 124*n*, 125, 197, 206, 256, 549  
 367th Ftr.-Bomber Gp., 124*n*, 125, 205, 273, 686, 698  
 368th Ftr.-Bomber Gp., 124*n*, 197, 201, 240, 245, 273, 275, 549, 686, 698  
 370th Ftr.-Bomber Gp., 124*n*, 262, 273, 615  
 371st Ftr.-Bomber Gp., 124*n*, 253  
 373d Ftr.-Bomber Gp., 124*n*, 252, 615, 692-94, 762  
 376th Bomb. Gp., 355, 380, 390  
 386th Bomb. Gp., 112  
 387th Bomb. Gp., 112  
 391st Bomb. Gp., 217, 690  
 404th Ftr.-Bomber Gp., 124*n*, 207, 256, 694  
 405th Ftr.-Bomber Gp., 124*n*, 242, 252, 255, 265-66, 275, 617, 698, 762  
 406th Ftr.-Bomber Gp., 124*n*, 238, 252-53, 274-75, 617, 698  
 410th Bomb. Gp., 201  
 434th TC Gp., 114  
 435th TC Gp., 114*n*  
 436th TC Gp., 114*n*  
 437th TC Gp., 114*n*  
 438th TC Gp., 114*n*  
 439th TC Gp., 114*n*  
 440th TC Gp., 114*n*  
 441st TC Gp., 114*n*  
 442d TC Gp., 114*n*  
 449th Bomb. Gp., 343, 351, 380  
 450th Bomb. Gp., 351, 355, 380, 390  
 451st Bomb. Gp., 380, 390  
 454th Bomb. Gp., 355, 380  
 455th Bomb. Gp., 380  
 456th Bomb. Gp., 380, 393  
 459th Bomb. Gp., 54, 380, 393  
 460th Bomb. Gp., 54, 390  
 461st Bomb. Gp., 390  
 463d Bomb. Gp., 54, 392  
 464th Bomb. Gp., 390  
 465th Bomb. Gp., 390  
 474th Ftr.-Bomber Gp., 205, 273, 275, 619, 693  
 478th Ftr. Gp., 615  
 479th Antisub. Gp., 498  
 482d Bomb. Gp., 14, 498  
 483d Bomb. Gp., 390  
 484th Bomb. Gp., 390  
 485th Bomb. Gp., 390  
 492d Bomb. Gp., 497-98, 500, 519  
 801st Bomb. Gp., 498-99  
 2641st Special Gp., 513-14, 517-18  
 Guingand, Gen. Sir Francis de, 612  
 Gunn, Lt. Col. James III, 298  
 Gustav Line, 336-37, 342, 345-48, 354, 360-64, 368, 371, 377, 386-87, 396  
 Győr, 473, 662

H

- Haguenau, 571, 624  
 Haine-St. Pierre, 152, 154  
 Halberstadt, 22-24, 31, 36-37  
 Hall, Brig. Gen. William, 299  
 Halle, 300, 738, 753, 776  
 Hamburg: a/c plants, 662; Battle of Bulge, 677; oil campaign, 281, 284, 296, 642, 644-45, 670, 723, 737, 740; trans. campaign, 654; U-boats, 741, 744, 751-52  
 Hamm, 654, 676, 732



- Hanau, 663, 677-78, 680, 682, 690  
 Handorf, 662-63, 773  
 Handy, Gen. Thomas, 412  
 Hannover, 664-65; AA, 176; a/c plants, 300-301; Battle of Bulge, 682; captured, 775; oil campaign, 178, 281, 296, 644, 737, 743, 751; ord. target, 647-48  
 Hansell, Brig. Gen. H.S., Jr., 107  
 Harburg, 284, 296, 644, 723  
 Harperscheid, 678, 682, 688  
 Harriman, Amb. Averill, 309-11, 314, 319  
 Harrington, 495*n*, 498-500  
 Harris, Marshal of the RAF Sir Arthur: Atlantic Wall, 168; Big Week, 35; comd. question, 140, 321-22; coop. with Eisenhower, 319, 321; CROSSBOW, 89, 529, 537; interdiction, 213; morale bomb., 639, 671; RAF (Bomber Comd.) 752, (combat losses) 303; strat. bomb., 174, 254, 279, 285, 785; trans. campaign, 74-75, 77-78, 161; USSBS, 791  
 HARRY, 456  
 Hasselt, 151-52, 154, 158  
 HASTY, 391  
 Hausser, Gen. Paul, 248-50  
 Haute-Savoie, 504-5  
 Hébécrévon, 235-36  
 Hébert, 563-65  
 Heflin, Lt. Col. Clifford, 498  
 Heide, 727, 744  
 Heidelberg, 768, 777, 780  
 Heilbronn, 777, 780  
 Heinsberg, 632, 635  
 Helgoland, 727  
 Hellenthal, 678, 682, 688  
 HELLHOUND, 638  
 Hemmingstedt, 301-2, 723, 744  
 Henry, Maj. Gen. Stephen, 96  
 Hergarten, 676-77  
 Hermeskeil, 618-19  
 Hewitt, Vice Adm. Henry, 414  
 Hildesheim, 743, 773  
 Hillbringen, 628  
 Hillesheim, 694, 700, 708  
 Hinman, Brig. Gen. Dale, 115  
 Hitler, Adolf: AA, 56; a/c production, 60; Allied air offensive, 645, 793; on B-29, 719; "Baby Blitz," 162; Battle of Bulge, 636-37, 669, 672-73; Battle of France, 248, 250, 258; diplomacy, 787; GAF (jets) 660, 728, (strategy) 668; gas warfare, 148; Ger. repair skill, 718; Hq., 638; It. campaign, 353; MARKET, 604; Normandy, 198, 209, 226; oil campaign, 174, 287; Albert Speer, 788; V weapons, 86-88, 102*n*  
 Hitler Line, 377, 386  
 Hoarding aircraft reporting stations, 171  
 Hobbs, Maj. Gen. Leland, 236  
 Hodges, Gen. Courtney: CG 1st Army (Battle of Bulge) 673, 683, 685, 702-3, (Battle of France) 246, 268, (Rhine campaign) 597, 611, 623, (Rhine crossing) 776  
 Hodges, Maj. Gen. James, 16  
 Hohe Rhön R., 776-77  
 Holland. *See* Netherlands.  
 Hollerath, 678, 699  
 Homburg, 680, 686, 690, 692, 700, 706, 768  
 Hopkins, Harry, 319  
 Horrem, 679, 760  
 Houffalize, 694, 696-98, 702-3, 705, 707-8  
 Houlgate, 144, 168, 186  
 Hülzweiler, 628  
 Hürtgen, 633, 635, 678; Forest, 616, 633, 759  
 Hungary, 311; AAF air bases, 748; a/c plants, 297, 662; oil campaign, 172, 177, 281, 286, 739; Russ. (air bases) 668, 747, (offensive thru) 472, 702, 749; steel, 315; trans. campaign, 283, 312, 473, 654, 722, 730, 742  
 HURRICANE I, 639-40, 733
- I
- Idice R., 485  
 IJssel R., 600, 614, 623  
 Île de Cézembre, 262; de Pomegues, 435-36; de Porquerolles, 414, 424, 435; de Ratonneau, 435-36  
 Il Giogo Pass, 445-46, 448  
 Imola, 403, 451, 468, 485  
 Indian troops, 387. *See also* units.  
 Inglis, AM Frank, 99, 101, 535  
 Initial Joint Plan (NEPTUNE), 71-72, 170, 186  
 Innsbruck, 462, 479, 777  
 Isarco R., 462, 486  
 Isigny, 194, 197, 577  
 Ismay, Sir Hastings, 102  
 Istres, 343, 351  
 Italian Air Force, 399  
 Italian Fascist Republic Air Force, 470  
 Italy: Allied campaign, 28-29, 32, 55, 65, 290, 325-489; base for spec. opns., 494, 507; defeat, 325; labor in Ger. army, 407; leaflet drops, 517-18; min. of comm. on STRANGLE, 378-79; Partisans, 389*n*, 406, 472, 489, 494, 514, 516-17; railway system, 155, 339, 372-73, 376, 389, 652,

THE ARMY AIR FORCES IN WORLD WAR II

722, 730, 738, 796; sabotage, 178; shuttle bomb. inaug., 148; supply drops to, 509, 514, 784; troops with Allies, 401; units in MAAF, 330-32. *See also* units.

J

"Janes" and "Joes," 494, 499, 501-2, 507, 518

Jena, 776, 779

Jet aircraft: attacks on, 730; GAF potential, 659-60, 666, 715-16, 728, 739-40, 743, 793; manufacture, 717, 789; opns., 729, 744-46, 751-52, 783; priority target, 721, 736

JOCKEY, 753-54

Jodl, Col. Gen. Alfred, 786

Johnson, Col. B.F., 583

Joint Chiefs of Staff: ability of MAAF, 412; ANVIL, 385, 410-11, 413; vs. Balkan offensive, 441; comd. question, 79; CROSSBOW, 96-97; direc. to coord. 8th and 15th AF's, 327; mass air at Anzio, Cassino, 365; morale bomb. question, 639; USSBS, 790

Joint Intelligence Committee, 75, 173, 720, 735

Joint Planning Staff, 653

Jülich, 614-15, 617, 619, 631-32, 634, 675-76, 756, 759, 762

Junck, Lt. Gen. Werner, 58, 786

Junkerath, 692, 695

JUNO, 143

Jutland Peninsula, 50, 285, 293

K

Kaiserslautern, 618, 624, 680, 690, 692, 700, 705, 768

Kall, 677, 693, 695-96, 705, 761

Kane, Brig. Gen. C.P., 574

"Kangaroos," 250

Karlsruhe, 155, 600, 652, 654, 680, 706, 777, 803

Kassel, 647-49, 654, 662, 682, 720, 724-25, 738, 741, 776

Keitel, FM Wilhelm, 56, 318, 786

Kempen, 758, 760

Kenny, Gen. George, 71

Kepner, Maj. Gen. William, 11, 32, 147

Kesselring, FM Albert: Anzio, 346, 349, 353, 359-60, 369; final It. stand, 455-56, 459, 468, 478; Gustav Line, 337, 348, 372, 383, 515, (retreat) 386-87, 389, 394-95, 400-401, 433, 442-46, 448, 453; Hq. bombed, 387; on (interdiction) 397, 406, (STRANGLE) 382

Keuchingen, 694, 696

Kiel, 12, 123; jet factory, 296, 659; leaflet drops, 495; naval dockyard, 752; oil campaign, 293; ord. target, 648; U-boats, 19-21, 301, 741

Klagenfurt, 26, 352, 358, 522, 662, 731

Klein Machnow, 49-50

Kluge, FM Günther von, 209, 248-50

Knerr, Maj. Gen. H.J.: air bases, 570; air transport, 558, 561-62; CG ASC, USSTAF and D/A, CG USSSTAF, 573; modification, 588; 9th AF control, 109-10, 126-27, 586; shortages, 581

Koerner, Genmaj. Karl, 403*n*

Koller, Gen. Karl, 786

Konz-Karthaus, 154-55, 624, 693-94, 696, 704

Korneuberg, 644, 745

Krefeld, 758, 760

Kreising, 38-39

Krewinkel, 682

Kupresko Valley, 521

Kuter, Maj. Gen. Laurence, 639, 726, 789

L

La Futa Pass, 445-48, 451

Lahnstein, 680, 771

Lake Bolsena, 357, 393

Lake Maggiore, 445, 451

Lamone R., 455-56, 477

Lampedusa, 408

Landau, 275, 618, 627, 677, 706, 768

Langerwehe, 631-32, 635

Langmead, Brig. Gen. E.C., 574

Laon, 151, 165, 273, 550

La Pernelle, 144, 168

La Roche, 696-97, 705, 708

La Spezia, 455*n*, 516-17; oil target, 390; ord. target, 468; port, 380, 387, 470; rail targets, 374, 388, 402-4; U-boats, 469

La Trésorerie, 420, 432

Lattre de Tassigny, Gen. Jean de, 597, 764-65

Laval, 217, 246, 255

Lavezzola, 485-86

Lavis, 463, 486

Leaflet propaganda, 494-98, 779

Leahy, Fleet Adm. William, 639

Le Bourget, 152

Lech R., 784

Leese, Gen. Sir Oliver, 354, 448

Leeuwarden, 124, 602

Leghorn, 340-41, 377, 380, 391, 396, 401-2, 478

Le Havre, 69, 93, 168, 206, 258, 585

- Leigh-Mallory, ACM Sir Trafford: airfield attacks, 164, 166; Atlantic Wall, 168-71; COBRA, 228, 230; cmd. AEAF, 5-7, 108-10, 122-23, 139-40, 155, 320, 620; CROSSBOW, 93, 100-101, 289; death, 622; Eisenhower, 189; Hq., 67-68; interdiction, 157-58, 213; MARKET, 607; oil campaign, 174; OVERLORD, 70, 72, 80-82, 144-46, 149-50, 157; tac. bomb., 279; trans. campaign, 73-78, 152, 154, 156
- Leipheim, 659, 744
- Leipzig, 536, 659, 664; a/c campaign, 30, 33-34, 43, 285, 289; air base, 572; captured, 776; oil campaign, 744; trans. campaign, 654, 725, 738, 753
- Le Manoir, 158, 215
- Le Mans, 151, 154, 212, 219, 221, 246, 249, 252, 276, 553-54, 567
- LeMay, Maj. Gen. Curtis, 16, 37
- Le Muy, 414, 428, 430
- Leopold Canal, 596, 613
- Lessay, 204, 207, 241
- Le Tubé, 343, 351
- Leuna, 176-78, 281, 294-95, 300-301, 642-46, 660-61, 723
- Levant, 414, 428
- Liblar, 679, 761
- Liège, 154-55, 158, 267, 568
- LIÈGE (Ger. opn.), 248
- LIFTON, 516
- Ligurian Sea, 381, 391, 408, 417
- Lille, 122, 164, 496, 803*n*
- Limburg, 275, 554, 676-78, 680, 771
- Limoges, 221, 423, 503-4
- Linnell, AM Sir John, 327
- Linnich, 614-15, 631, 633, 757, 762
- Linz, 473, 644, 646, 648-49, 705, 731, 738
- Lippe, 760, 770; Canal, 775
- Lippstadt, 618, 662, 775
- Liri Valley, 337, 340, 342, 346-54, 366, 386, 388
- Lisieux, 193, 238
- Livenza R., 456, 464, 467, 478
- Livron, 421, 431
- Ljubljana Gap, 412-13, 474-75
- Lloyd, AVM Sir Hugh, 326
- Löbau, 283, 302, 644
- Loire R., 145, 158, 160, 210, 213-16, 221, 223, 246-47, 260-61, 265-66, 499
- London: attempted robot-bomber attacks, 728; "Baby Blitz," 162; Montgomery's Hq., 68; Special Force Hq., 501; USSBS Hq., 790; V-weapon attacks, 84, 90-93, 288, 526, 530, 532, 542*n*, 544
- Lovett, AS/W (Air) Robert, 715-16, 733
- Lucca, 339-40, 516
- Ludendorff Bridge, 769
- Ludwigshafen, 12, 296; area bomb., 58; Battle of Bulge, 680; I.G. Farbenindustrie, 20-22; oil campaign, 296, 300-302, 642, 644; trans. campaign, 155, 600, 654, 729
- Lüttwitz, Gen. Freiherr Heinrich von, 227, 249, 257
- Lützkendorf, 176, 178, 289, 294, 301-2, 642, 644, 729, 753
- Luftwaffe. *See* German Air Force.
- Lugo, 403, 485
- Lunbach, 690, 700
- Lure, 597
- Luxembourg: air bases, 562-63, 568, 570, 572; battle area, 596, 686, 708-9; liberated, 267, 595; radar installations, 661; rail targets, 154
- Lwów, 220, 311
- Lyon, 503; airfields, 432, (Allied) 437, 519, 554, (bombed) 164; ANVIL, 414; Ger. (defense) 427, (retreat) 434, 436; rail target, 155, 390-91, 420, 423

## M

- Maas R., 604, 607, 624, 703, 757
- Maastricht, 267, 585, 595
- Maas-Waal Canal, 604
- MacCloskey, Col. Monro, 506
- McDonald, Brig. Gen. George, 535
- MacGregor, AC H.D., 329
- Maclean, Brig. F.H., 519-20
- McNair, Lt. Gen. Lesley, 234
- McNarney, Gen. J.T., 735
- Macon, Maj. Gen. Robert, 266
- MADISON, 624-29
- Magdeburg: a/c factory, 300, 662; captured, 775; panzer factory, 647, 720; petroleum plants, 178, 281, 284, 296, 301, 642, 723, 725, 732, 740; trans. campaign, 654, 727, 729, 731
- Maginot Line, 619
- Main R., 776-77
- Maintenon, 217, 253, 260
- Mainz, 301, 600, 624, 652, 676, 682, 688
- Maisons-Lafitte, 158, 214
- Maisy, 141, 168, 192, 194, 198
- Malignano, 516
- MALLORY, 403-4, (MAJOR) 404, 406, 442, 445
- Malmédy, 670, 693, 697
- Malta conference, 481, 724-25, 728, 732-33
- MANHOLE, 519
- MANNA, 475, 511-12

THE ARMY AIR FORCES IN WORLD WAR II

- Mannheim, 155, 300, 647-48, 654, 700, 706, 729, 768, 771, 775, 780  
 Mantes, 152-54, 158, 210, 224, 260, 267  
 Mantova, 404, 406, 452, 489  
 Maquis, 221, 413, 415, 421-23, 493-94, 500, 502-6  
 Marche, 692, 697, 702  
 Marecchio R., 448  
 Maribor, 26, 358, 474, 749  
 Marienburg, 9, 22  
 Marigny, 231, 238, 241  
 Marina di Pisa, 516  
 MARKET, 600-611, 637, 640  
 Marne R., 267  
 Marseille, 377, 391; air assault, 421-25, 433; airlift, 562; capture, 435-36; plan to capture, 412, 414-15; rail target, 155  
 Marshall, Gen. of the Army George: Allied airborne force, 244; ANVIL, 411-13; Berlin bomb., 725 CBO, 27; CLARION, 732; comd. question, 4, 80, 320-21; CROSSBOW, 96, 98; C/S USA, 78, 305; OVERLORD, 71; strat. bomb., 649; Swiss bomb., 735-36; 12th AF move to France, 440  
 Martinvast, 90-91  
 Martinville Ridge, 206  
 Massa, 516  
 Mayen, 617-18, 676, 690, 692-93, 696, 698-99, 705  
 Mayenne, 246, 252  
 Medeno Polje, 519-20  
 Mediterranean Air Transport Service, 331, 333  
 Mediterranean Allied Air Forces: aid (to Balkans) 510, (to Maquis) 421; air evac. Balkans, 520-22; antisub., 391, 469; ANVIL, 413-34, (eval.) 434*n*, 436*n*; CBO, 28; control of foreign air units, 330, 332, 399; infiltration opns., 519; Italy, 150, 174, 337-407, 442-89; liaison problem with USSR, 476, 748-49; orgn., 326-29, 335-36, 449; OVERLORD, 148; sortie rate, 355, 357, 360, 384*n*, 388, (effect on morale) 356-57; strength, 346, 365, 372, 387, 392, 413, 418, 478  
 Mediterranean Allied Coastal Air Force: antisub., 381-82; ANVIL, 415, 418, 427, 431; BRASSARD, 400; Italy (DIADÉM) 386, 391, 406, 417, (invasion) 340, 346, 356-57, (relieved from opns.) 463, 468-69, (STRANGLE) 374, 381-84; orgn., 326, 329, 331, 335, 449; strength, 469; support Tito, 399; units to DAF, 419  
 Mediterranean Allied Photographic Reconnaissance Wing, 329*n*, 333, 346, 390  
 Mediterranean Allied Strategic Air Force: ANVIL (losses) 436*n*, (opns.) 420-25, 428-31, (plans) 415, 418; Balkan opns., 472-76; CBO, 357-58, 379-80, 390, 397, 403, 433; Italy (Cassino) 362-63, 366-67, 370, (DIADÉM) 386-93, 405-6, (invasion) 339-41, 343, 350-51, 353-56, 360, (northern) 443, 453, 456, 458-62, 469, 471, 479, 481, 483-84, 486-88, (relieved) 463, (STRANGLE) 374, 380-81, 384; leaflet drop, 518; orgn., 326-27, 329, 513; strength, 397  
 Mediterranean Allied Tactical Air Force: aid to (It. Partisans) 472, (Tito) 399; ANVIL (losses) 436, (opns.) 423-25, 428-37, 443, (plans) 413, 415-19; vs. Balkans, 475; Elba, 400; 15th AF aid to, 340-41, 358; 5th and 8th Army joint control, 396, 401; Italy (Cassino) 362-63, 366-67, 369-70, (DIADÉM) 386-93, 395, 397, (invasion) 337, 339, 342-45, 349-56, 360, (northern) 442, 445-49, 452-56, 458-62, 470-71, 479-81, 483-84, 488-89, (STRANGLE) 373-84; mission, 463, 467-69, 478; orgn., 326-27, 329, 335, 482, 513, 517; strat. opns., 403-4, 406; strength, 466  
 Melun, 267, 568  
 Menningen, 292, 753  
 Merderet R., 188-89  
 Merseburg: oil targets, 176-78, 281, 289, 294-95, 300-302, 642, 644-46, 660-61  
 Merville, 574  
 Merzig, 628, 676, 678, 680, 698  
 Messerschmitt, Willy, 88  
 Mestre, 380, 406, 467-68  
 Metz: airfield campaign, 164; Allied air base, 710; Ger. (counteroffensive) 672, (defense) 220, 267, 274; MADISON, 624, 626-28; Rhine campaign, 599, 611, 616; trans. campaign, 154-55  
 Metz, Maj. Gen. Richard, 695  
 Meurthe R., 629  
 Meuse-Escaut Canal, 600, 607  
 Meuse R., 158, 267, 596, 623, 672, 685, 689, 694, 696, 701  
 Middle Wallop, 112, 202, 549  
 Mielec, 311-13, 315  
 Mikołajczyk, Premier Stanislaus, 317  
 Milan, 380-81, 404-6, 445, 452, 649  
 Milch, Generalfeldmarschall Erhard, 786  
 Miller, Maj. Gen. H.J.F., 109, 115-16  
 MIMOSA (Ger. opn.), 221  
 Mimoyecques, 90-91, 531*n*

## INDEX

- Minden, 654, 737  
 Miramas, 420-21  
 Mirgorod, 310, 312, 314  
 Misburg, 284, 300-301, 644, 670, 740  
 Mitrovica, 474-75  
 Model, FM Walter, 595, 767, 805  
 Modena, 397, 516  
 Moder R., 767  
 Modrath, 616, 618  
 Möckau, 30, 35  
 Moerdijk bridge, 602  
 Molotov, Foreign Minister V.M., 309, 317  
 Monastery Hill, 362, 364, 366, 368  
 Monroe, Capt. James, 496  
 Mons, 154, 273  
 Monschau, 672, 679, 682, 694, 703; Forest, 759  
 Montalto di Castro, 341-42, 374  
 Montbéliard, 436, 597  
 Monte Cassino Abbey, 355, 362-64, 366, 368, 386  
 Montelimar, 425, 434, 436  
 Montenegro, 511, 522  
 Montgomery, FM Sir Bernard: Arnhem, 611, 672; Atlantic Wall, 167; Battle of Bulge, 686, 703; Battle of France, 250; bridge destr., 157; CG 21 Army Gp., 597, 620-21, 760; Ger. reinforcements, 258; MARKET-GARDEN, 599-601, 607-8; IX BC, 197; Normandy, 208; OVERLORD, 68, 140, 143, 147; plans, 612, 623, 756, 771; RAF BC, 747; Rhine campaign, 614, 624, 764, 766; Rhine crossing, 773; Rommel, 225; tac. bomb., 279, (in Africa) 806-7; UTAH, 71  
 Montignies-sur-Sambre, 152, 154  
 Montpellier, 351, 392, 420  
 Moore, Lt. H.H., 548  
 Moore, Capt. Homer, 521  
 Moosbierbaum, 283, 302, 644, 646, 724, 730, 745  
 Morgan, Lt. Gen. Sir Frederick, 3, 67, 71, 83, 97, 226, 545  
 Morscheid, 624, 696, 705  
 Mortain, 247-50, 252, 254, 256, 258  
 Moscow, 309, 311, 476, 748-49, 806  
 Moselle R.: Battle of Bulge, 672-73, 675-76, 680, 700, 704, 709; battle line, 277, 439, 619, 623-24; bridgehead, 616, 627; crossed, 274, 766-67, 771; Rhine campaign, 596-97, 599-600, 611  
 Mostar, 399, 474  
 Mount (Beni) 446, (Oggiolo) 446, (Trochchio), 388  
 München-Gladbach, 673, 688, 760, 762  
 Münster, 751, 771; Battle of Bulge, 676, 678, 682; radar bomb., 17, 21, 54; Rhine crossing, 773; trans. campaign, 652, 654, 732  
 Münstereifel, 677, 679, 682, 692, 694, 699, 708  
 Mulde R., 776  
 Mulhouse, 154-55, 613, 629, 764, 776  
 Munich, 296, 659; a/c industry, 290, 292-93, 662; Allied air base, 572; captured, 777; Ger. retreat, 781; ord. target, 647; trans. campaign, 652, 654, 737, 753
- ### N
- Namur, 151-53, 667  
 Nancy, 152, 164-65, 267, 274, 554, 568, 570, 616  
 Nantes, 210, 215-16, 246, 260, 435  
 Naples, 371-72, 414*n*; airfields, 345, 352-53, 356, 366, 374; Allied port, 346-48, 427; GAF attacks, 350, 392; seized, 325  
 Naval Forces, Allied, 81, 167, 270, 430-31, 434, 442*n*; ANVIL (bomb.) 416, 429, 435-36, (diversion) 426, (task force) 414-15, 427; bomb. of land targets (Anzio) 348, (Brittany) 262, (Normandy) 208, 226; losses at Anzio, 352  
 Navy, U.S., 130, 430, 557, 572, 720-21, 790  
 Neckar R., 777, 780  
 Neder Rijn R., 604, 607  
 Venning, 628  
 NEPTUNE. *See* Initial Joint Plan.  
 Nervesa, 464, 467, 480  
 Netherlands: Allied bases, 554, 562, 570, 572, 585, 665; CARPETBAGGER, 500; CROSSBOW, 539, 542*n*, 543; food drops, 784; GAF bases, 52, 164-66, 213; leaflet drops, 495-98; liberation, 595; OVERLORD, 68; resistance movement, 493; Rhine campaign, 612, 619, 702-3; tac. rcn., 179  
 Nettuno, 352-53, 356  
 Neuburg, 730, 737, 744-46, 753  
 Neuerburg, 690, 694  
 Neunkirchen, 155, 654, 680, 700, 706  
 Neuss, 677, 758, 760, 762  
 Neustadt, 618, 677, 770  
 Neuwied, 700, 705-7, 770, 772  
 Newman, Brig. Gen. J.B., 118, 570  
 New Zealand troops, 363, 366, 370, 387, 485  
 Nice, 155, 339, 391, 421, 426, 429  
 "Nickels," 494. *See also* Leaflet propaganda.  
 Nideggen, 678-79, 682, 693  
 Nijmegen, 598, 600-601, 604, 607, 612, 756-57

THE ARMY AIR FORCES IN WORLD WAR II

- Nîmes, 155, 420  
 Nis, 474-76  
 NOBALL, 123-24. *See also* V weapons.  
 Nörvenich, 616-18  
 Nohfelden, 680, 693  
 Nonnweiler, 618, 694, 705, 766  
 Normandy: airfield campaign, 163-64; Allied bases, 240, 269, 547-69; Atlantic Wall, 168, 170; CADILLAC, 504; OVERLORD, 150; trans. campaign, 154, 156-62  
 Normandy invasion: air (doctrine) 185-86, 189, (superiority) 227, 793, 806; airfield constr., 203-4; air opns. (close support) 194-99, (eval.) 192-93, 219-27, 278, (interdiction) 209-19, 262, (pre-invasion) 190-92, 210, 214; eval. (of bridge-head) 637, (of landings) 228, 411, 413; Ger. (build-up) 195, 226, 427, (retreat) 248, 267  
 Norstad, Maj. Gen. Lauris, 329  
 North African Theater of Operations, U.S. Army, 327  
 North Sea, 15, 33, 50, 285, 734, 756, 797  
 Northwest African Air Forces, 329*n*, 333, 807  
 Norway, 17, 57, 170, 494, 496, 500, 720  
 Novi Sad, 474-75  
 Nürnberg, 301, 554, 572, 648, 720, 732, 753, 777, 781  
 Nugent, Brig. Gen. Richard, 200, 597, 699, 707, 760  
 NUTMEG, 416, 424-26. *See also* DRAGON.  
 O
- Oberlahnstein, 654, 682  
 Ober Raderach, 533, 540  
 Obertraubling, 31, 37, 42  
 Oberwürzbach, 768  
 Oberzier, 678, 682, 763  
 OCTAGON conference, 441, 464  
 Odertal, 281, 291, 299, 642-43, 646, 670  
 Offenburg, 654, 664  
 Office of Strategic Services, 372, 493-94, 500-501, 505, 509, 514; sp. opns., 502  
 Oil campaign: bomb-type question, 643; delay, 172-73; direcs., 280-81, 640, 718; eval., 177-79, 285-87, 746, 794-96; Joint Oil Targets Com., 286; opns., 176-78, 281-85, 292, 299, 302, 641-45, 670, 723-24, 728, 731-32, 739-45, 751  
 Oise R., 260-61  
 Oissel, 158, 213, 215, 273  
 Oldenburg, 727
- Olzheim, 679, 683  
 OMAHA beach: air assault, 190-92, 194; air-ground coop., 196-97, 202; assault plans, 143, 186; landings, 548-49; landing strips, 131, 204, 563-65; supply, 577  
 Operational Research Section, 233, 237, 389*n*, 790  
 Oppenheim, 771  
 Ora, 406, 459, 461-63  
 Oranienburg, 53, 743  
 ORATION, 519  
 Orbetello, 381, 393  
 Orcia R., 400  
 Ordnance campaign, 647-49, 721, 798-99  
 Orléans, 145, 165, 210, 214-16, 261, 266, 276, 496, 550, 555, 568  
 Orne R., 71, 138, 193  
 ORPHAN, 531  
 Orte, 341, 353, 356, 374, 377, 388, 397  
 Orvieto, 339, 341, 355-56, 374, 379, 389  
 Oschersleben, 22-24, 31, 36-37  
 Osnabrück, 654, 732, 737, 751  
 Ossenigo, 459, 461  
 Ossola Valley, 515  
 Ostend, 93, 170-71, 585  
 Ostiglia, 404-5, 449, 488  
 Oswiecim, 281, 642, 670  
 Ott, Brig. Gen. Isaac, 575  
 Ouistreham, 70, 141, 168  
 Our R., 702, 705, 709  
 Ourthe R., 596, 702  
 OVERLORD: airfield campaign, 162-66; air ren., 179-81; ANVIL, 385, 409-12; Anzio, 337, 364-65; CBO, 8, 11, 26-28, 65; comd. structure, 79-81; comm. system, 140; vs. CROSSBOW, 92-93, 96-97, 103; D-day, 77, 79, 83, 146, 158-61, 165-71, 178-79, 181; GAF weakness, 195-96, 287; lessons, 424; LST shortage, 71; oil campaign, 173, 176, 178-79, 284; plans, 3-7, 67-71, 138-39, 141-43, 162-63, 167, 170, 391-92; shuttle bomb., 309; trans. campaign, 72-79, 157, 161; USSTAF in, 68
- P
- Paderborn, 662, 751, 771, 775  
 Padua, 380, 448, 453, 464, 467, 480  
 Palatinate, 767-68, 771  
 Palestrina, 345, 350  
 PANCAKE, 453-54  
 Pantelleria, 170, 325, 408, 437  
 Panzer Lehr Division, 197, 206-7, 235-36, 257

- Paris, 12, 210, 214, 216, 260-61, 273, 504;  
Allied bases, 269, 550-55, 557, 567-69,  
573, 584-85; GAF airfields, 164-65, 252-  
54; Ger. in, 220-22, 224; leaflet drops,  
496; liberated, 267; OVERLORD, 68,  
71, 145; rail center, 152, 155, 212; 3d  
Army drive to, 158-59, 426; V-weapon  
attacks, 84, 542
- Parma, 388, 397, 402-3, 452
- Parndon Wood, 542
- Pas-de-Calais: CROSSBOW, 21, 527, 531,  
533, 539; German defense, 226, 258;  
OVERLORD, 69, 143, 158, 180-81;  
V-weapon launching, 84, 90-91, 93, 100,  
525-26, 598
- Patch, Lt. Gen. Alexander: ANVIL (CG  
ground forces) 414, 434, 437, (naval  
bomb.) 416; Battle of Bulge, 685; CG  
7th Army, 267, 597, 765; DRAGOON,  
429; UNDERTONE, 767
- Pathfinder operations. *See* Radar and  
radio.
- Patton, Gen. George: air support, 272,  
628-29, 805, 807; CG 3d Army (Battle  
of Bulge) 685, 689, 692, 699, 701-3, 709,  
(Battle of France) 243-44, 246-47, 250,  
255, 257, 260, 265-70, 278, 408, 426, 637,  
(Rhine campaign) 597, 599-600, 609,  
611, 616, 623, 669, (Rhine crossing) 770-  
71, 776, 778; MADISON, 624, 626
- Peenemünde, 84, 86-87, 89-90, 92, 293-94,  
296, 300, 537-38, 540
- Peltz, Genmaj. Dietrich, 719
- Périers, 204-5, 207, 221, 231, 236, 241
- Péronne, 154, 260, 269
- Persian Gulf Command, 310
- Perugia, 341, 343, 346, 374, 377, 388, 393,  
396, 400-401, 408
- Pesaro, 443, 447
- Pfalzel, 693, 696
- Pforzheim, 618, 706
- Piacenza, 390, 392, 403-6, 445, 451, 453,  
467, 516-17
- Piave R., 456, 458, 460, 463-64, 467, 478, 517
- Piedicolle, 456, 478-80
- Pilsen, 648, 783
- Piombino, 341, 377, 380-81, 387, 390, 401,  
406
- Pirmasens, 618, 675
- Piryatin, 310, 312, 314
- Pisa: battle line, 411, 426, 468; capture, 400-  
403, 408-9; rail lines, 337, 339-41, 365,  
371, 374, 377, 380, 383, 388, 394, 396; sup-  
ply drops to Partisans, 516
- Pistoia, 339, 341, 393, 397, 401, 403, 405, 516
- Piteccio, 403, 405
- Ploesti: a/c campaign, 315; bomb line, 748;  
eval., 298, 643; German defense, 287;  
occupation, 641; oil campaign, 66, 173-  
74, 177-78, 280-81, 291-92, 296-97, 399
- PLUNDER, 746, 751
- Podgorica, 513
- Pölitz, 178, 281, 284, 287, 300, 642, 645, 670,  
723
- Poggibonsi, 341, 350
- POINTBLANK: CROSSBOW, 92, 99,  
102; diversion (to SHINGLE) 361, (to  
STRANGLE) 380; eval., 288; 15th AF  
in, 327, 336, 339, 358, 374, 380, 390; re-  
lation (to oil campaign) 173, 175, (to  
OVERLORD) 69, 75, 162. *See also* CBO.
- Pointe du Hoc, 141, 168, 192
- POL (petrol-oil-lubricants). *See* Oil cam-  
paign.
- Pola, 41, 468-69, 731
- Poland: a/c factories, 33, 38, 311, 315;  
armored force, 267, 613; FRANTIC,  
316-18; Ger. defense, 660, 665; oil cam-  
paign, 281, 286, 297, 299, 314; Partisans,  
749; Russ. offensive, 702; spec. opns.,  
505-6, 520; trans. campaign, 156; troops  
in It. campaign, 386, 401, 484-85; units in  
(BAF) 399, (MAAF) 330. *See also* units.
- Poltava, 310, 312-13
- Pont-à-Mousson, 267, 274, 624
- Pontassieve, 341, 374, 388
- Pontaubault, 217, 241, 247
- Pontecorvo, 342, 345, 350
- Pontedera, 339, 341, 350, 377, 401
- Pontorson, 217, 247
- Ponziane I., 346
- Popoli, 344, 352
- Po R. and Valley: bridges bombed, 403-7,  
442, 445, 449, 468; German (air bases)  
55, (defense) 446, 460, 487, (retreat) 488;  
ground offensive, 412, 420, 448, 489; in-  
terdiction campaign, 402, 416, 421-23,  
443, 451-53, 456-59, 467, (eval.) 480, 483;  
supply drops to Partisans, 514-15, 517
- Portal, C/AS Sir Charles: ARGUMENT,  
32; CBO, 28; CCS, 6; CLARION, 735;  
comd. question, 56, 80, 320-21; CROSS-  
BOW, 530, 542; 8th AF losses, 645; end  
strat. bomb. offensive, 753; long-range  
escort, 11; oil campaign, 670, 722, 733;  
robot B-17, 728; trans. campaign, 75, 77-  
78; USSR liaison problem, 477
- Port Cros, 414, 428
- Port-en-Bessin, 197, 583-84
- Porto Civitanova, 341, 350

THE ARMY AIR FORCES IN WORLD WAR II

Porto Ferrario, 390, 400  
 Posen, 33, 38-39  
 Postumia, 456, 478-79  
 Prague, 746  
 Prato, 340-41, 377, 397, 401, 403, 405, 443  
 Prekaja Mountains, 521  
 Pronsfeld, 690, 694, 696  
 Provisional Troop Carrier Air Division,  
 427-28, 431  
 Prüfening, 31, 41  
 Prüm, 614, 679, 686, 690, 694-95, 698, 706,  
 708  
 Psychological Warfare Division, SHAAF,  
 495, 501, 518, 639

Q

QUADRANT conference, 409  
 Quebec conference (I) 3, (II) 320, 640  
 QUEEN, 631-33  
 Quesada, Maj. Gen. Elwood, 716, 807; air-  
 tank coop., 239; comd. question, 621;  
 CG IX FC, 112-13, 140, 190, 196, 199;  
 CG IX TAC, 134, 203, 205, 272, 550, 699

R

Radar and radio, 85, 104, 124, 135-36, 530;  
 AA, 529; ANVIL, 420, 427*n*, 428; Atlan-  
 tic Wall, 169; "Big Week," 36; CBO,  
 10, 12, 14-17, 21, 25, 48; enemy installa-  
 tions, 529; eval., 18-22, 286, 306, 671; 15th  
 AF, 26, 406; Gee-H, 286, 539, 627, 667;  
 H<sub>2</sub>S, 14; H<sub>2</sub>X, 14-18, 32, 190, 285, 290-  
 91, 293, 627, 666-67, 736, 741, 744; Micro-  
 H, 667, 750; need for, 18, 54, 666; Nor-  
 mandy, 188, 190; Oboe type, 17-18, 147;  
 oil campaign, 284, 296, 642, 667; OVER-  
 LORD, 147; radio countermeasure a/c,  
 602; in supply drops, 499, 502, 506; target  
 priorities, 13-14; WEARY-WILLIE, 531  
 Ramsay, Adm. Sir Bertram, 168  
 Rangers, 197, 264-65  
 Rapido R., 346, 349, 362, 364, 366, 386  
 Ravenna, 443, 452-53, 455*n*  
 Recco, 391, 403-4  
 Reconnaissance: armed (France) 205, 212,  
 218, 238-39, 242, 255, 265, 271, (Italy)  
 389, 402, (S. France invasion) 429, 432;  
 photo (France) 211-12, 240, 265, (Italy)  
 360, 389*n*, 390, (Rhine campaign) 270-  
 71, 619-20, 722, 779; tactical (Battle of  
 Bulge) 673-82, 699-700, (eval.) 805,  
 (France) 240, 253, 265, 430, (Italy) 388,  
 (jet interference) 643, 659  
 Red Ball express highways, 275  
 "Red Stocking," 519

Rees, 758-59, 770  
 Regensburg: a/c factories, 9, 31, 41-42, 55;  
 ball-bearing factories, 294, 308, 358-59;  
 captured, 776; German defense, 23; oil  
 campaign, 724, 730; trans. campaign, 743  
 Reggio Emilia, 340, 358, 392, 451  
 Regiments (numbered):  
 1st Airfield Maint. Regt., 566, 570*n*  
 2d Airfield Maint. Regt., 570  
 38th Inf. Regt., 265  
 923d Engr. Avn. Regt., 570  
 Reichswald, 604, 757, 759  
 Reims: Allied base, 269, 276, 550, 554, 562,  
 568; GAF base, 273; German surrender,  
 785; leaflet drops, 496; Spaatz's Hq., 754;  
 trans. campaign, 154-55  
 Remagen, 600, 616, 618, 706, 708, 769-71  
 Rennes, 220, 223, 246, 496  
 Rescue of AAF P/W's: FREEDOM (Bul-  
 garia), 298-99; REUNION (Rumania),  
 298, 523  
 Rheinbach, 676-78, 682, 687, 700, 761  
 Rheinberg, 757, 762  
 Rheine, 654, 732, 771  
 Rheydt, 675, 677, 758, 760  
 Rhine R.: Battle of Bulge, 673, 675-80, 682,  
 685, 688, 701, 704-9, 711; CHEERFUL,  
 764-65; crossing, 612, 652, 769-75, 780-  
 81; German (retreat) 708, (supply) 797;  
 GRENADE, 760-63; interdiction line,  
 72, 616-19; offensive (Allied) 599-600,  
 608, 623, 629, 636-37, 656, 666, 669, 724,  
 732, 736, 746-47, 756-57, 765-68, 796;  
 photo rcn., 270  
 Rhone R.: Allied offensive, 267, 408, 439,  
 570; bridges (bombed) 423, 431, (spared)  
 434, 443; GAF (bases in delta) 425,  
 (withdrawal) 432; Maquis activity, 503-  
 4, 506  
 Richardson, Brig. Gen. W.L., 115  
 Rieti, 343, 351, 397  
 Riga, 311-12  
 Rimini: battle line, 403, 409, 411, 426, 443,  
 446-47; capture, 448, 452; harbor, 401;  
 rail lines, 337, 340-41, 350, 365, 371, 380,  
 383, 388-89, 394, 396*n*, 397, 402, 445  
 Risle R., 261  
 Robb, AM James, 622  
 Roccasecca, 342, 345  
 Rochefort, 693, 697  
 Rodenkirchen bridge, 706  
 Roermond, 756, 762  
 Roer R., 596, 633, 703, 707, 732, 756-63  
 Rötgen Forest, 616



- Rome, 337-69 *passim*, 397, 400, 408, 413; Allied base, 419; bombed, 348, 352, 358; campaign, 371-84; capture, 384-96, 411; GAF weakness, 342-43; Hq. XII TAC, 393; leaflet drop, 518; occupation, 326
- Rommel, FM Erwin, 166-67, 219-20, 222-23, 225-26
- Roosevelt, Brig. Gen. Elliott, 309, 311
- Roosevelt, President F.D.: ANVIL, 385, 409-10, 413; OVERLORD, 3-4; supplies to Warsaw, 316-17; trans. plan, 79; U-boat campaign, 721; USSBS, 790; Yalta, 724, 748, 750
- Rosignano, 516-17
- Rostock, 39, 296, 300
- Rotterdam, 599, 784
- Rouen, 158, 210, 214-15, 258, 260, 271, 496, 587
- Rouffach, 764
- Roulement system, 132, 270, 549
- Rovereto, 463, 470, 486
- Royal Air Force, 163, 285, 305; aid to (9th AF) 127, 134-36, 584, (Pol. Partisans) 749; air base constr., 569; aircraft types (Baltimore) 378, (Beaufighter) 381, (Boston) 378, (Halifax) 406, 420, (Mosquito) 104, (Spitfire) 336, 348, 402, (Stirling) 188, (Typhoon) 200, 249, (Wellington) 355, 421, 426, 539; ARGUMENT, 30, 33, 35, 43; in BAF, 399; Battle of Bulge, 688; bridge destruction, 157, 159; C/AS (*see* Portal); CROSSBOW, 89, 546; FRANTIC, 309; GAF defeat, 59; leaflet drops, 495, 497, 518; Maclean mission, 519; Normandy, 190, 193-94, 208; orgn., 139, 806; OVERLORD, 143; radar, 14; RAF-AAF comd., 81, 203, 207, 326-29, 385, 388, 430, 453, 592, 621, 807; special opns., 493, 505, 507, 518-22; strength, 139; supply, 417*n*, 418, (missions) 511; units under AAF, 391, 402, 415, 450*n*. *See also* units.
- Royal Air Force Bomber Comd., 19; airfield campaign, 164-65, 793; Atlantic Wall, 169-71; Battle of Bulge, 693, 717; Battle of France, 250, 263; bomb. doctrine, 7, 284, 639; CBO, 7, 28, 196; comd. question, 6, 79-82, 319, 321, 529; CROSSBOW, 89, 103*n*, 105*n*, 289, 292, 527-30, 533-34, 537-39, 543; daylight bombing, 208, 639, 645, 729, 742, 747; eval., 155, 166, 302-4, 790-91, 795, 797; interdiction, 700, 773; MARKET, 601-2, 610; mission, 640, 721-22, 787, 802; Normandy, 186, 211-14; oil campaign, 173, 176, 281, 286, 296, 642, 645, 670, 718, 723-24, 728, 742, 753, 794; ord. and vehicle campaign, 648, 799; OVERLORD, 72, 142, 145-46, 148, 167, 278; QUEEN, 631-32; Rhine campaign, 613; strat. bomber offensive, 279, (end) 754, (rate of opns.) 293, 751-52; strength, 26, 596; Tallboy use, 216, 263-64, 521, 538-39, 742; trans. campaign, 74, 77-78, 149, 151-52, 154, 175, 292, 652, 654, 656, 726-27, 731-34, 737, 742, 747, 772; U-boats, 720; VERITABLE, 758
- Royal Air Force Coastal Command, 538, 601
- Royal Air Force Fighter Command, 773-74
- Royal Air Force Middle East, 326
- Royal Australian Air Force, 391
- ROYAL FLUSH, 145, 194
- Royal Navy, 400, 430*n*
- Royce, Maj. Gen. Ralph, 245, 597, 765*n*
- Rüsselsheim, 294, 537-38
- Ruhland, 178, 281, 285, 300-301, 313, 642, 723, 740, 743, 745, 749
- Ruhr: encircled, 751, 775-76, 797; leaflet drops, 779; MARKET-GARDEN, 607; mass bomb. proposed, 636, 638-40; offensive, 635, 650; oil targets, 173, 175-76, 281, 642, 645, 718, 723-24, 728, 732-34, 742; power station, 801; trans. campaign, 653-54, 656, 719, 721, 725, 733, 736, 738, 740-41, 743, 746-47, 770-73
- Rumania: a/c factories, 297; airfields, 313, 315; change to Allied side, 298, 511; leaflet drops, 292; oil campaign, 76, 172, 174, 281, 283, 286, 291; REUNION, 298, 523; Russ. (base) 318, (offensive) 472
- Rundstedt, FM General Gerd von: Allied (air power) 784, (interdiction campaign) 218, 222, 224, 227, 705; Atlantic Wall, 166; C-in-C West, 595-96; CG (Ger. 15th Army) 159-60, (Ger. 7th Army) 219, 226; Ger. counteroffensive, 656, 670-73, 732; OVERLORD, 162; replaced, 209; St.-Lô bomb., 236-37; trans. campaign, 160

## S

- Saar: Basin, 599, 765, 767-68, 771; River, 619, 624, 628, 701, 709, 765
- Saarbrücken: Battle of Bulge, 676, 698-700; trans. campaign, 154-55, 219, 290, 293, 618, 627, 652, 654, 657; UNDERTONE, 768
- Saarburg, 680, 690, 696
- Saarlautern, 626, 628, 677, 680

THE ARMY AIR FORCES IN WORLD WAR II

- Sachsenheim, 624, 626  
 St.-Dizier, 165, 554, 568  
 Ste.-Mère-Église, 146, 189  
 St.-Germain, 573  
 St. Ghislain, 152, 154  
 St.-Gilles, 238-39, 241  
 St.-Laurent-sur-Mer, 548, 563  
 St.-Lô, 227-28, 426, 653, 669; Allied (air base) 584, (drive toward) 193, 204, 206, 502, 504; captured, 207, 220; carpet bomb., 231-37, 243, 278, 294-95  
 St.-Malo, 246, 262  
 St.-Mandrier peninsula, 435  
 St. Oedenrode, 601, 604  
 St. Paul's School, London, 68  
 St.-Pierre du Mont, 565  
 St.-Quentin, 273, 597  
 St.-Sauveur-Lendelin, 243-44  
 St. Valentin, 647-48, 745  
 St.-Valéry, 125, 169  
 St.-Vith: Allied counterattack, 702, 705-6, 708; American retreat, 683, 685, 687; Battle of, 692-94, 697-99, 711  
 St. Wendel, 627, 676-77, 680  
 Salerno, 342, 356, 414-15, 430, 438, 514, 517-18  
 Salon, 343, 351, 392  
 Salonika, 474, 475*n*  
 Salzbergen, 602, 732  
 Sandys, Duncan, 89, 542  
 Sangro R., 326  
 San Michele, 463, 466, 486  
 San Stefano, 377, 380-81, 387, 390  
 Sant'Ambrogio, 362, 461, 466  
 Santerno R. and Valley, 448, 477, 482, 484-86  
 Saône-et-Loire, 505  
 Saône Valley, 504  
 Sarajevo, 399, 474-75, 477, 513  
 Sardinia, 325, 366, 387*n*, 408, 418, 435  
 Sarreguemines, 154-55, 614  
 Sarthe R., 246  
 Saumur, 215, 221  
 Sava R., 475  
 Saverne Gap, 629  
 Saville, Brig. Gen. Gordon, 366, 414, 432, 434-35, 453, 597, 765  
 Savio R., 452-53  
 Savoie, 505  
 Savona, 424, 468  
 Saxony, 294  
 SCAEF. *See* Eisenhower (Supreme Commander, Allied Expeditionary Forces).  
 Schacht, Dr. Hjalmar, 785  
 Schaffhausen, 735  
 Schelde: Estuary, 599, 612-13, 623-24; River, 271  
 Schilling, Col. Karl, 118, 567  
 Schlatter, Maj. Gen. David, 200, 622  
 Schleiden, 677-78, 682, 687-88, 693, 697, 705-6, 708  
 Schmidt, 635, 679, 759  
 Schnee Eifel, 628, 672  
 Scholven, 642, 645, 670  
 Schouwen I., 602  
 Schramm, Brig. Gen. N.L., 135-36  
 Schwabisch Hall, 624  
 Schwalbe, Gen. Eugen-Felix, 258  
 Schweinfurt: a/c factories, 37; ball-bearing campaign, 8, 38-40, 45, 294, 359, 648, 800; captured, 777; German defense, 23, 34, 781  
 Seine R.: bridges bombed, 157-59, 210, 213, 261; crossings, 258, 267; interdiction line, 214-15; OVERLORD, 68; trans. campaign, 160, 222-23, 260  
 Senio R., 477, 482, 484-85, 784  
 Serbia, 511  
 Serchio Valley, 468  
 Services of Supply, ETO, 118, 127, 133*n*, 137  
 SESAME, 446  
 Sesto Imolese, 485  
 Sète, 416, 424  
 SEXTANT conference, 409  
 SHINGLE, 336; Allied strength, 355, 364; vs. ARGUMENT, 358-59; failure, 360-61, 371, (dangers) 346, 364-65, 384-85, 409; German (build-up) 350-51, 353, (counterattack) 355, 359; interdiction, 349-50, 355; invasion, 346-48; Navy losses, 352; plans for, 336-39, 361; prelim. air opns., 339-45, 371. *See also* Anzio.  
 Shuttle bombing, 148, 397. *See also* FRANTIC.  
 Siberia, 309-10, 318  
 Sicily: Allied base, 325-26; campaign eval., 333, 342, 351, 415, 431, 437-38, 807  
 Siegburg, 676, 678, 770  
 Siegen, 678, 770  
 Siegfried Line, 166, 596, 646; Battle of France, 239, 266, 277; bombed, 271, 611, 628; breached, 267, 595, 766-68; photo rcn., 270, 619; Rhine campaign, 599-600, 623, 635; UNDERTONE, 767-68  
 Siena, 339-40, 343, 350, 377, 393, 396-97, 401  
 Sienna R., 238  
 Silesia, 173, 281, 289, 297, 736  
 Sillaro R., 485

- Simmern, 618, 704-5  
 Simpson, Lt. Gen. William, 266, 597, 616, 623, 757  
 Sinzig, 678, 690, 700, 705-6, 761  
 Siracourt, 90, 531<sup>m</sup>  
 Skopje, 399, 474, 513  
 Slapton Sands, 135  
 Slessor, AM Sir John: Allied interdiction, 389-90, 395; ANVIL, 385, 410, 412-13, 415; DAF, 419; DC/MAAF, 327, 482-83  
 Slovenia, 511  
 Smith, Brig. Gen. Frederic, Jr., 530  
 Smith, Lt. Gen. W.B., 96-97, 168, 245, 719  
 Smyser, Col. Rudolph, 567  
 Soest, 618, 682  
 Sofia, 299, 358, 399, 522  
 Soissons, 226, 267, 275  
 Somain, 153-54  
 Somervell, Gen. Brehon, 173  
 Somme R., 267, 538  
 Sora, 345, 387, 391  
 South African Air Force, 391, 450<sup>m</sup>, 451<sup>m</sup>, 484  
 Spaatz, Gen. Carl: air (ren.) 681, (support) 299, (transport) 558-61; Allied airborne force, 245; ARGUMENT, 31-33; Battle of Bulge, 685, 710; bridge destruction, 157; CLARION, 735; comd. question, 7, 80-83, 140, 320-21, 620-22; comd. USSTAF, 6, 21, 108-10, 199, 327, 358, 573, 586, 716, 752, 786, (declares CBO over) 484, 754-55; coop. with Eisenhower, 319, 322; coord. attack, 299; CROSSBOW, 92, 100-101, 103, 123, 289, 530-32, 535, 537-38, 546; direcs., 722, 724, 753; fighter cover, 660; FRANTIC, 310-11, 313, 318; French bases, 668-69; GAF, 287, 314, 661-63, 665, 717; German surrender, 785; H2X, 18; interdiction, 213, 371, (Italy) 478-79; jet campaign, 659, 666, 719; logistics, 305, 582; MARKET, 637; morale, 307; morale bomb., 284, 305, 638-39, 726, 733; Norwegian bomb., 720; oil campaign, 173-75, 280-81, 640, 650, 653, 656, 670, 721, 794; ord. campaign, 647; OVERLORD, 68, 144-45, 147-48, (vs. POINTBLANK) 26; poison gas, 148; pre-invasion opns., 181; radar bomb., 14, 667; Swiss bomb., 735-36; trans. campaign, 74-75, 78-79, 160-61, (counterproposal to) 76-77, 173; 12th AF move to France, 440, 464; USSR liaison problem, 319, 748, 750; USSBS, 789-90  
 Special Force Headquarters, 493, 501, 503  
 Special Leaflet Squadron, 495-98. *See also* 422d Bomb. Sq.  
 Special Operations Executive, 493, 501, 505, 509, 511, 514  
 Special Projects Operations Center, 506  
 Special Service Forces, 306, 414  
 Speer, Reichsminister Albert: Allied failure to bomb Rhine, 655, (electric power stations) 800; Allied strat. bomb., 179, 287, 645, 648, 786; appointment, 788; Ardennes offensive, 656; dispersal of industry, 789, 792; Ger. production (a/c) 44, 60, 288, 658, 793, (oil) 641, 646, (tank) 649, 799; morale, 178; V weapons, 87  
 Sperrle, Gen. Hugo, 786  
 Spessart Mountains, 777  
 Speyer, 600, 623, 675, 677  
 SPOC. *See* Special Projects Operations Center.  
 Squadrons (numbered):  
   1st Ftr. Sq. (Braz.), 450<sup>m</sup>  
   2d Air Combat Control Sq. (Amph.), 430  
   3d Radio Sq. Mobile, 273  
   4th Antisubmarine Sq., 498  
   4th TC Sq., 516  
   7th TC Sq., 507, 509, 512, 516, 520  
   8th TC Sq., 516  
   10th TC Sq., 510-11, 521  
   16th TC Sq., 512-13, 517  
   21st Weather Sq., 548  
   22d Antisubmarine Sq., 498  
   28th TC Sq., 521  
   36 Sq., 421  
   36th Bomb. Sq., 498  
   40th Mobile Comm. Sq., 548  
   51st TC Sq., 507, 509, 512-13, 519, 522  
   99th Ftr. Sq., 335<sup>m</sup>  
   109th T/R Sq., 673  
   111th T/R Sq., 450  
   122d Bomb. Sq., 421, 506  
   122d Liaison Sq., 506  
   148 Sq., 516  
   208 T/R Sq., 450<sup>m</sup>  
   216 Sq., 426  
   225 T/R Sq., 450<sup>m</sup>  
   301st Sq. (Pol.), 516  
   307th Ftr. Sq., 352  
   310th T/R Sq., 550  
   378th Ftr. Sq., 617  
   395th Ftr.-Bomber Sq., 549  
   406th Bomb. Sq., 495<sup>m</sup>, 496-98  
   414th Night Ftr. Sq., 418, 451<sup>m</sup>  
   416th Night Ftr. Sq., 451<sup>m</sup>  
   417th Night Ftr. Sq., 450<sup>m</sup>

THE ARMY AIR FORCES IN WORLD WAR II

422d Bomb. Sq., 495  
 422d Night Ftr. Sq., 675, 679, 687, 709  
 425th Night Ftr. Sq., 675, 680, 710  
 442d Night Ftr. Sq., 616  
 624 Sq., 421, 505-6, 514  
 788th Bomb. Sq., 498-99  
 850th Bomb. Sq., 498-99  
 856th Bomb. Sq., 498, 500, 519  
 857th Bomb. Sq., 498  
 858th Bomb. Sq., 495, 498, 500, 519  
 859th Bomb. Sq., 498, 500, 512-13, 516, 518  
 885th Bomb. Sq., 421, 506-7, 509, 512-13, 515, 518  
 Stadtkyll, 694, 705  
 Stalin, Marshal Joseph: **FRANTIC**, 309-10, 314; **OVERLORD** and **ANVIL**, 409; supplies to Warsaw, 317; Tehran conf., 4; Yalta conf., 724, 748, 750  
 Stalingrad, 647, 806  
 Stanmore, 5, 68, 80, 140, 228  
 Stavelot, 687, 694-95  
 Sterkrade, 644-45, 724  
 Stettin, 175, 477, 738, 749  
 Steyr, 38-39, 44, 55, 359, 648  
 Stimson, Sec. of War H.L., 96, 731, 790-91  
 Stockheim, 677, 763  
 Stolberg, 611  
 Strahm, Brig. Gen. V.H., 108, 113  
**STRANGLE**: direc., 373-76; lack of night bombers, 378, 381; merger with **DIADEM**, 377, 383, 388; opns., 377-81, (eval.) 157, 382-84, 386, 395, (total) 393  
 Strasbourg, 155, 613, 618, 629, 701  
*Strasbourg*, 435  
 Strategic bombing offensive: air-raid toll, 801; claims, 802-4; command of, 56-57, 79-83, 279, 319-21; completed (by 8th AF) 752-53, (by 15th AF) 745-46; vs. **CROSSBOW**, 288-89; directives, 27-28, 174-76, 279-81, 640, 653, 718-19, 721, 725, 753; eval., 298, 302-4, 715-17, 739, 754, 787, 792-802 (*see* **USSBS**); plan for completion of **CBO**, 76-77. *See also* Combined Bomber Offensive; Oil campaign; Ordnance campaign; Transportation campaign.  
**STUD**, 145, 194  
 Stuttgart: a/c factories, 35, 300-302, 659; airfields (Allied) 554, (**GAF**) 782; ball-bearing campaign, 41, 44; Battle of Bulge, 675, 682; captured, 777; trans. target, 652, 654, 719, 770, 781  
 Sudetenland, 281, 292  
 Sulmona, 341-42, 344, 352

Sunninghill, 110, 115, 552  
 Supreme Allied Commander, Mediterranean, 437, 477-78, 481, 519  
 Supreme Commander, Allied Expeditionary Forces. *See* Eisenhower.  
 Supreme Headquarters, Allied Expeditionary Forces: Air Staff, 622; Battle of Bulge, 685; Battle of France, 263, 455*n*, 637; bridge destruction, 158; **CARPET-BAGGER**, 503; comd. question, 5-7, 81, 319-20, 561, 573, 621-22, 783; **CROSSBOW**, 99, 538-39, 545; direc. of 14 Sept. 1944, 321; **DRAGOON**, 437, 440-41; eval. air, 716; G-3, 682; Ger. jet planes, 304, 659, 719; intel. of Ger. counteroffensive, 681; interdiction, 623; It. campaign, 448; location, 67; morale bomb., 639, 727; ord. campaign, 720; **OVERLORD**, 58, 77, 142, 144-45, 147-48, 179; plans, 763-64, (St.-Lô) 227; strat. vs. tac. bomb., 280, 669; supply, 598; **TAC's**, 597; trans. campaign, 73, 75, 156, 161, 653, 655, 732-33, 753  
 Sweden, 307, 726, 742  
 Swinemünde, 738, 741-42  
 Switzerland, 86, 307, 437, 456, 735-36, 777, 784  
**SWORD**, 143

T

Taben, 694, 696  
 Tactical Air Depot Area, 115  
 Tactical air liaison officers, 239*n*  
 Tactical Bomber Force, 333-35, 339-40, 345, 354  
 Tagliamento R., 405, 456, 460, 462, 464, 478  
**TALOS**. *See* Tactical air liaison officers.  
*Taranto*, 469-70  
 Tarascon, 420-21, 431  
 Target priorities and selection: **ARGUMENT**, 30-31; **CARPETBAGGER**, 501; **CBO**, 15, 22, 27-29, 64-65; **FRANTIC**, 311-12; Goering's appraisal, 786; interdiction (Balkans) 467, (France) 260, (Ger.) 617-18, 623-24, (Italy) 460-61, 484; jet a/c, 659, 662, 666, 719; **MADISON**, 626-27; **MARKET**, 601-2; morale bomb., 725; oil, 175, 281, 468, 640, 647-48, 653, 656, 661, 721, 751; ord. and motor vehicles, 646-47, 798; **OVERLORD**, 138, 142, 149; power stations, 801; strat. bomb., 279, 304-5; supplies to Balkans, 507, 513; trans. campaign, 150,

- 158, 462, 650, 653, 736, 796; U-boats, 720.  
See also CROSSBOW controversy.
- Tarquina, 355, 516
- Tarvisio, 390, 406, 456, 460, 478-80
- Tedder, ACM Sir Arthur: airfield campaign, 166; Atlantic Wall, 168; Battle of France, 254; COBRA, 228; comd. question, 6-7, 80-81, 140, 319-21, 621-22; CROSSBOW, 103, 304, 527, 529*n*, 530, 532, 535-37, 540; GAF, 744-45; interdiction, 213, 650, 653, 735, 753; oil campaign, 175-76, 670; orgn. MAAF, 328; OVERLORD, 144; Rhine mass bomb., 655-56, 669; trans. campaign, 73, 76-78, 149, 152, 161, 174; Zuckerman thesis, 372
- Tehran, 309, 311; conference, 4
- Tempsford, 499
- Tergnier, 124, 154
- Terni, 339-42, 350, 374, 377, 396
- Thann, 764
- The Hague, 784
- Thionville, 154-55, 165, 585, 624, 626-27
- THUNDERCLAP, 639
- Ticevo, 520
- Ticino R., 445, 449
- Tisza R., 473
- Tito, Marshal, 391, 399, 472, 510-11, 515, 519*n*, 521-22, 748
- Todt organization, 102*n*, 166
- TORCH, 333, 408, 437
- Torgau, 776
- Torreberetti, 404-6, 445
- TOTALIZE, 251
- Toul, 568, 570
- Toulon: Allied (capture) 435, (invasion) 414-15, 426, 429, 433; harbor bombed, 291, 358, 381, 420, 423, 425; rail lines, 390
- Toulouse, 221, 496
- Touques R., 261
- Tours, 215, 217, 223
- Traben, 680
- Transportation campaign: bridge destruction, 156-59; CLARION, 732-33, (eval.) 734-35; debate, 73-78, 650-56, 718; direc., 719, 721, 736; eval., 153-56, 159-62, 657, 671, 727, 729, 739, 746, 754, 788, 796-98; opns., 150-59, 654, 722, 725-26, 730-32, 738, 740-45; vs. other objectives, 72-73
- Trebbia R., 403-4
- Trento, 387, 459, 461-63, 466-67, 486
- Trier: Allied base, 571; Battle of Bulge, 675, 680, 686, 688, 692-94, 698; bridge destruction, 693, 696, 700; rail lines, 618, 657; Siegfried Line, 596
- Trieste, 413, 455*n*, 468-69, 730-31
- Tripoli, 326
- Trondheim, 720
- Troop carrier operations. See Airborne operations.
- Troyes, 154-55, 267
- Truman, President Harry, 728
- Truscott, Lt. Gen. Lucian, 429
- Tunis, 5, 328, 337
- Tunisia, 331, 333, 371, 408
- Turin, 339, 380, 391, 397, 405-6, 445, 449, 516
- Turner, Capt. Floyd, 520
- Tutow, 33, 38-39
- Twining, Lt. Gen. Nathan, 32, 305, 326-27, 336, 471, 478, 754
- Tyrrhenian Sea, 381, 385-86, 391, 417

## U

- U-boats: bombed, 741, 744, 751; new types, 715, 717, 720, 789, 799
- Udenbreth, 616
- Udine, 351-52, 358, 379-80, 423, 464, 467, 471, 479, 515, 517
- Ulm, 302, 647-48, 720, 737, 739-40, 777, 779, 781
- UNDERTONE, 767-69
- Union of Soviet Socialist Republics: AAF air support for, 380, 726, 729; air bases (for shuttle bombers) 290, 397, (in Hungary) 668; Balkan offensive, 455*n*, 472-73, 475, 479, 511; CROSSBOW, 538; eastern front, 638, 702, 706, 724-25, 728, 730-31, 736, 738-39, 741-46, 783-85, (juncture with West), 754, 756, 776, 778; FRANTIC, 148, 308-9, 311-12, 315; liaison problem, 476-77, 747-51; occupation zone, 789, 791; OVERLORD, 71; Rumania offensive, 174; summer offensive, 410-11, 426, 439, 788; supplies to Warsaw, 316; units under (MAAF) 330, (RAF) 522; V weapons, 86
- United States Army Air Forces in the United Kingdom, 93, 108
- United States Embassy (London), 76, 161, 163
- United States Strategic Air Forces: a/c production campaign, 288; air (rcn.) 179, (transport) 558-59, 561; ARGUMENT, 31, 35, 41, 43, 46; Balkan bomb line, 477; "Big Week," 35; British aid, 583; comd. question, 56-57, 80-82, 319-22; control (of FAF) 332, (of 9th AF) 108-10, 123, 126, 133, 136, 554*n*, 573, 575, (of XII TAC) 437; coop. with MAAF, 326; coord. 8th AF and 15th AF, 32, 327-

THE ARMY AIR FORCES IN WORLD WAR II

- 28; counter-air campaign, 358-59; CROSSBOW, 101, 305, 526, 538; Engr. Comd., 570-71; estbd., 6; eval. of opns., 59, 161, 172, 295, 303, 318, 644, 668, 735-36; flak losses, 668; FRANTIC, 310, 315; ftr. alloc., 113, 579; GAF, 280, (build-up) 657-59, 661-62, 666, 719, (jet planes) 287-88, 295, 304; ground support, 29; H2X need, 18, 666; Hq. moved to France, 319; Joint Oil Targets Com., 286; mission, 484, 640, 669, 721-22, 787; morale bomb., 638, 727, 799; oil campaign, 77, 179, 281, 728, 794-95; ord. campaign, 647-48; OVERLORD, 68, 142, 148-49; plans, 49, 279; rate of opns., 293; strength, 578-80, 588; supplies to Warsaw, 316-17; target priorities, 175; trans. campaign, 74, 77, 154-56, 653, 726; 12th AF move to France, 481-82; U-boat campaign, 720; USSBS, 789
- United States Strategic Bombing Survey: a/c campaign, 794; ARGUMENT, 44-46; CROSSBOW, 106; eval. strat. bomb. campaign, 791-92; GAF (a/c acceptance rate) 61-62, (defeat) 59; Gotha attack, 40; oil campaign, 795; ord. and vehicle campaign, 799; orgn., 789-90; target systems missed, 800-801; trans. campaign, 161, 797-98
- Upper Silesia, 654
- UTAH: air assault, 141, 143, 170, 192; airborne assault (opn.) 188, (plans) 70, 146; D-day opns., 186, 188-89, 198, 548; landing strips on, 563, 565; supplies, 577
- Uxbridge, 113, 138, 140, 145, 194, 199, 202, 211, 244
- V
- Valence, 420, 432-34, 436-37
- Valenciennes, 154, 273
- Vandenberg, Lt. Gen. Hoyt: AEAFCOM structure, 82; Battle of Bulge, 685, 710; CG 9th AF, 245, 573, 669, 708, 786; comd. question, 621; coop. with Coningham, 254, 622; CROSSBOW, 100; Moscow mission, 309; trans. campaign, 149, 655-56, 736
- Var R., 391, 420-21
- Varreville, 70-71
- VARSITY, 746, 751, 771, 774
- Veghel, 600-601, 604
- Velletri, 345, 360, 387
- Venice, 405, 468, 489; Venetian plain, 453, 455-59, 463, 467, 480
- Venlo, 124, 757, 762
- Venraij, 614, 623
- Ventimiglia, 339, 374, 397, 421-23
- Vercors, 503-4
- Verdun, 267, 568, 570, 667
- VERTIBLE, 756-57, 772
- Vermand, 597
- Verona: airfields, 350; battle line, 448, 451; captured, 489; power station, 461-62; rail lines, 350, 380, 404-6, 445, 453, 459, 466-68, 479, 481
- Versailles, 268, 573, 649, 685, 717
- Vianden, 683, 694, 705, 709
- Vicenza, 463, 467, 471, 480
- Vichy, 414; fleet, 358
- Vielsalm, 702, 705, 708
- Vienna: a/c factories, 390; bomb line, 749; Ger. defense, 287; oil targets, 644-45, 724, 742, 745; ord. targets, 178, 281, 283, 291, 299, 647, 649, 720; Russ. (advance to) 746, (bases) 747-48; trans. campaign, 473-74, 652, 654, 730-31, 784
- Villach, 517
- Villafranca, 403, 471
- Villaorba, 343, 379
- Villa Perosa, 26, 339, 358
- Vipiteno, 481, 777
- Vire, 197, 207, 246
- Vis, 382, 399, 521
- Viterbo, 340-43, 355, 358, 374, 396-97, 400
- Vittel, 554
- Vittorio Veneto, 517
- Völklingen, 154, 680
- Volturno R., 325-26
- Vosges Mountains, 595
- V weapons: attacks on plants, 285, 294, 296, 799-800; experimentation, 85-87, 280; intel., 84, 91-93, 525; opns., 84, 86-88, 917, 106, 284, 288, 526-45, 598, 638; plans, 88-89, 92-93; production plants, 86-87, 532-37, 788-89; sites (constr.) 84, 538, (large) 90, 102, 105-6, 529, 538-40, 546, (modified) 525-29, 531, 539-41, (ski) 98-100, 536; target priority, 279
- W
- Waal R., 604, 607
- Wahn, 677, 692
- Walcheren I., 602, 613-14
- Walsh, Maj. Gen. Robert, 311
- War Department: CROSSBOW Com., 96-97, 99; on Engr. Comd., 118; General Staff, 103; New Developments Div., 96
- Warsaw, 316-18, 426
- Warton, 130, 587
- Watton, 84, 90-91, 498, 5317

- WEARY-WILLIE, 531  
 Webster, Maj. Gen. Robert, 765*n*  
 Weimar, 729, 776  
 Welferding, 765  
 Welsh, AM Sir William, 101  
 Wengerohr, 635, 690, 694  
 Wenzendorf, 662-63  
 Wesel, 678, 706, 747, 757-58, 771  
 Weser R., 15, 729, 732, 736, 775, 793  
 Wesseling, 642, 645  
 Western Naval Task Force, 415, 435  
 Wetzlar, 680, 770  
 Weyland, Maj. Gen. Otto: air-ground coop., 629; Battle of Bulge, 685; CG IX FC, 247; CG XIX ASC, 112, 550; CG XIX TAC, 243-44, 247, 264, 676, 760; comd. question, 621; surrender of Gen. Elster, 266  
 WIDEWING, 78  
 Wiener Neustadt, 25  
 Wiesbaden, 626, 663, 770, 803  
 Wilhelmina Canal, 604  
 Wilhelmshaven, 10, 15, 17, 19-20, 25, 50, 54, 751  
 Williams, Maj. Gen. Paul, 114, 427*n*, 574, 601  
 Williams, Maj. Gen. Robert, 15  
 Wilson, FM Sir Henry: ANVIL, 364, 385, 410-14, 419-20; Anzio, 365-66, 371; C in C AFHQ, 327; It. offensive, 448, 455*n*; Monte Cassino bomb., 362-63; SACMED, 29, 32, 82, 328, 339, 358, 477-78, 519; 12th AF move to France, 440, 464; USSR liaison, 476-77  
 Winant, Amb. John, 303  
 "Window," 56, 146, 188, 426, 620  
 Wings (numbered):  
     3d Bomb. Wing, 110-12  
     3 Wing (SAAF), 484  
     4th Bomb. Wing, 312  
     5th Bomb. Wing, 335  
     7 Wing (SAAF), 451*n*  
     8 Wing (SAAF), 450*n*  
 IX TC Service Wing, 574, 587  
     42d Bomb. Wing, 333-35, 339, 403, 418, 446-47, 454, 464-66, 579, 764, 780  
     47th Bomb. Wing, 336  
     49th Bomb. Wing, 336  
     50th TC Wing, 114, 427*n*, 554-55  
     51st TC Wing, 335, 382, 391, 399, 401, 418-19, 427, 471-72, 475, 513-15, 518  
     52d TC Wing, 114, 335, 554  
     53d TC Wing, 114, 427*n*, 554-55  
     55th Bomb. Wing, 336  
     57th Bomb. Wing, 333-35, 339, 400, 403, 418, 433, 447, 456, 461, 464, 478, 484  
     63d Ftr. Wing, 391, 400, 464-66  
     64th Ftr. Wing, 348, 450  
     70th Ftr.-Bomber Wing, 113, 125, 202, 549  
     71st Ftr. Wing, 113, 135-36  
     84th Ftr. Wing, 113  
     87th Ftr. Wing, 335, 387*n*, 396*n*, 400, 405  
     97th Bomb. Wing, 112, 550, 554  
     98th Bomb. Wing, 112, 550, 554, 567  
     99th Bomb. Wing, 112, 550, 554  
     100th Ftr. Wing, 113  
     232 Wing, 451  
     244 Wing, 335*n*, 344, 352  
     302d Transport Wing, 558-62, 570, 579-80  
     303d Ftr. Wing, 113  
     304th Bomb. Wing, 336  
     305th Bomb. Wing, 336  
     306th Bomb. Wing, 336  
     306th Ftr. Wing, 312, 336  
     307th Bomb. Wing, 336  
     324 Wing, 345, 450*n*  
     334 Wing, 505, 507, 509-11, 513, 521-22  
 Winter Line, 336  
 Wizernes, 90, 531*n*  
 Wollseifen, 678-79, 682  
 Wood, Brig. Gen. Myron, 115*n*, 558  
 Worms, 600, 676, 775, 780  
 WOWSER, 483-84, 784  
 Würzburg, 770, 777
- X
- Xanten, 757-59
- Y
- Yalta conference, 724-26, 748-50, 791  
 YOKUM, 428  
 Yonne R., 267  
 Yugoslavia: a/c campaign, 358; Ger. (evac.) 349, 467, 472, 474-75, (strength in) 455*n*; infiltration, 520; leaflet drops, 494, 518; Maclean mission, 519-20; oil campaign, 177, 281, 291, 297; Partisans, 382, 390-91, 472, 475, (evac.) 399, 511, 520-23, (supplied by Allies) 509-16; Russ. offensive, 749; trans. campaign, 283, 483, 722, 730, 742; units in (BAF) 399, (MAAF) 330  
 Yvrench-Bois-Carré, 91

THE ARMY AIR FORCES IN WORLD WAR II

Z

Zagreb, 399, 474-75, 477, 513, 749

Zara, 41, 522

ZEBRA, 503-4

Zeitz, 177-78, 281, 300, 644, 723

Zemun, 513

Zinnowitz, 293-94

Zon, 601, 604

Zossen, 743

Zuckerman, Prof. Solly, 73, 161, 170, 371-73, 376, 395

Zülpich, 677, 679, 682, 688, 693, 703, 705, 761

Zuid Beveland, 271

Zuider Zee, 600, 604

Zurich, 735

Zweibrücken, 628, 676, 706, 768

Zwickau, 176, 662