

DOE/EA-2128

**Final Environmental Assessment
Large Pilot Testing – Advanced
Post Combustion CO₂ Capture Technology**

June 2020



U.S. Department of Energy



National Energy Technology Laboratory

Responsible Agency: U.S. Department of Energy

Title: Large Pilot Testing – Advanced Post Combustion CO₂ Capture Technology, Environmental Assessment (DOE/EA- 2128)

Location: City Water, Light, and Power, 300 S. 7th St., Ste. 100, Springfield, IL 62701

For further information about this Environmental Assessment, contact: Pierina N. Fayish NEPA Compliance Officer National Energy Technology Laboratory P.O. Box 10940 Pittsburgh, PA 15236 412-386-5428	For general information on the Department of Energy’s process for implementing the National Environmental Policy Act, contact: Brian Costner, Director Office of NEPA Policy and Compliance (GC-20) U.S. Department of Energy 1000 Independence Avenue, SW Washington, DC 20585-0103 (202) 586-4600, or leave a message at (800) 472-2756
--	--

Abstract: The United States (U.S.) Department of Energy (DOE) National Energy Technology Laboratory (NETL) prepared this Environmental Assessment (EA) to analyze the potential environmental, cultural, and socioeconomic impacts of partially funding a proposed Project to design, construct, and operate a 10-megawatt-electric (MWe) carbon capture system based on the Linde-BASF advanced amine-based post-combustion carbon dioxide (CO₂) capture technology at a coal-fired power plant. DOE proposes to provide cost-shared funding to a project team led by the University of Illinois at Urbana–Champaign (UIUC), for the proposed Large-Pilot Testing Facility Project at the City Water, Light and Power (CWLP) Facility, an existing power plant in Springfield, Illinois. The proposed Project would involve the construction and two-year operation of a Large Pilot Testing Facility to demonstrate the scalability and commercial potential of the Linde-BASF post-combustion CO₂ capture technology using U.S. domestic coal, resulting in mitigation of the risks associated with adopting this technology at full scale and creating a pathway for commercial deployment in the U.S.

Under the Proposed Action, DOE proposes to provide approximately \$3 million of the project’s \$3.7 million total cost via cost-shared financial assistance to the Trustees of the University of Illinois (UIUC). The project partners are required to obtain funding for the remaining 20 percent of the project cost.

Availability: This EA was released for public review and comment after publication of the Notice of Availability in the Springfield Review-Journal on April 6, 2020. The public was invited to provide written or e-mail comments to DOE on the Draft EA during the comment period, which occurred from April 6, 2020 to May 5, 2020. Copies of the Draft EA were distributed to cognizant agencies, Native American Tribes, public libraries and interested

parties. The Draft EA was also made available for review at the Lincoln Library, 326 S. 7th Street, Springfield, IL 62701, and the Illinois State Library, Gwendolyn Brooks Building, 300 S. Second Street, Springfield, IL 62701. Since much of the country was experiencing office shut-downs due to the COVID-19 pandemic, all copies of the document were disseminated electronically, with the exception of hardcopies mailed to the libraries and Native American Tribes. Additionally, DOE waited two weeks after the close of the comment period to ensure that any letters mailed had been received and to allow for any late comments to arrive.

The Draft and Final EA are available to the public on DOE's NETL website at <https://netl.doe.gov/node/6939> and DOE's National Environmental Policy Act (NEPA) website at <https://energy.gov/nepa/nepa-documents>.

Responses were received from the Environmental Protection Agency and from the Illinois Department of Natural Resources, State Historic Preservation Office. The Environmental Protection Agency letter stated that the agency had "no comments on the Draft EA." The Illinois Department of Natural Resources, State Historic Preservation Office letter stated that based on the information provided [the Draft EA], they had "no objection to the undertaking proceeding as planned."

No comments were provided by other agencies, tribes, non-governmental organizations, or the public.

The agency letters are included in the Final EA, and appropriate changes were made in the corresponding sections of the document. Other changes include minor edits to correct typos or improve clarity. All changes are shown in bold text to allow readers to quickly identify altered material.

TABLE OF CONTENTS

CHAPTER 1. INTRODUCTION	1-1
1.1 Document Structure	1-1
1.2 Background	1-1
1.3 DOE’s Proposed Action	1-2
1.4 Purpose and Need	1-2
1.5 National Environmental Policy Act and Related Procedures	1-3
1.6 Laws, Regulations, and Executive Orders	1-3
1.7 Public Involvement, Agency Coordination and Tribal Consultation	1-4
CHAPTER 2. PROPOSED ACTION AND ALTERNATIVES	2-1
2.1 Introduction	2-1
2.2 Proposed Action	2-1
2.3 No-Action Alternative	2-1
2.4 Alternatives Considered but Dismissed	2-1
2.5 Large Pilot Testing Facility Project Description	2-2
2.5.1 Location and Setting	2-2
2.5.2 Large Pilot Testing Facility Project Configuration and Process Design	2-4
2.5.3 Large Pilot Testing Facility Construction	2-6
2.5.4 Large Pilot Testing Facility Operations	2-7
2.5.5 Post-Test Use of the Large Pilot Testing Facility	2-8
CHAPTER 3. AFFECTED ENVIRONMENT AND ENVIRONMENTAL CONSEQUENCES	3-1
3.1 Introduction	3-1
3.1.1 Resource Areas Screened from Detailed Analysis	3-1
3.2 Air Quality and Climate	3-2
3.2.1 Affected Environment	3-2
3.2.2 No-Action – Environmental Consequences	3-3
3.2.3 Proposed Action – Environmental Consequences	3-3
3.3 Water Resources	3-5
3.3.1 Affected Environment	3-6
3.3.2 No-Action – Environmental Consequences	3-9
3.3.3 Proposed Action – Environmental Consequences	3-9
3.4 Biological Resources	3-10
3.4.1 Affected Environment	3-10
3.4.2 No-Action – Environmental Consequences	3-15
3.4.3 Proposed Action – Environmental Consequences	3-16
3.5 Health and Safety	3-19
3.5.1 Affected Environment	3-19
3.5.2 No-Action – Environmental Consequences	3-19
3.5.3 Proposed Action – Environmental Consequences	3-19
3.6 Solid and Hazardous Waste	3-22
3.6.1 Affected Environment	3-22
3.6.2 No-Action – Environmental Consequences	3-22

3.6.3	Proposed Action – Environmental Consequences.....	3-22
3.7	Infrastructure and Utilities	3-24
3.7.1	Affected Environment.....	3-24
3.7.2	No-Action – Environmental Consequences.....	3-24
3.7.3	Proposed Action – Environmental Consequences.....	3-24
3.8	Visual Resources.....	3-27
3.8.1	Affected Environment	3-27
3.8.2	No-Action – Environmental Consequences.....	3-27
3.8.3	Proposed Action – Environmental Consequences.....	3-27
3.9	Socioeconomic Conditions.....	3-29
3.9.1	Affected Environment	3-29
3.9.2	No-Action – Environmental Consequences.....	3-30
3.9.3	Proposed Action – Environmental Consequences.....	3-30
3.10	Resource Areas Dismissed from Further Review	3-30
3.10.1	Geology and Soils	3-30
3.10.2	Land Use.....	3-31
3.10.3	Cultural and Paleontological Resources.....	3-31
3.10.4	Environmental Justice.....	3-32
3.10.5	Noise	3-32
3.11	Cumulative Impacts.....	3-33
3.11.1	No Action – Environmental Consequences.....	3-33
3.11.2	Proposed Action – Environmental Consequences.....	3-34
CHAPTER 4. LIST OF PREPARERS.....		4-1
CHAPTER 5. LITERATURE CITATIONS.....		5-1
CHAPTER 6. DISTRIBUTION LIST		6-5
APPENDIX A. PREVIOUS NEPA ACTIONS.....		A-1
APPENDIX B. AGENCY AND TRIBAL CORRESPONDENCE.....		B-1

LIST OF TABLES

Table 3.1.	State or Federally Listed Species Potentially Occurring within the Project Area....	3-12
Table 3.2.	Migratory Bird Species Potentially Occurring in the Project Area	3-13
Table 3.3.	Demographic and Economic Information 2018.....	3-29

LIST OF FIGURES

Figure 2.1.	Proposed Project Location – CWLP Vicinity Map.....	2-3
Figure 2.2.	Proposed Project Plan – Testing Facility Adjacent to Dallman Unit No. 4	2-4
Figure 2.3.	Proposed Project Plan – Testing Facility Plot Area	2-5
Figure 2.4.	Carbon Capture Pilot Plant Process.....	2-6
Figure 2.5.	Large Pilot Testing Facility Project Timeline	2-8
Figure 3.1.	Direct Approach from Highway – Lincoln Graphic	3-28
Figure 3.2.	Side View from Highway– Lincoln Graphic.....	3-28

ACRONYMS AND ABBREVIATIONS

° F	Degrees Fahrenheit
BGEPA	Bald and Golden Eagle Protection Act
CAA	Clean Air Act
CEMS	Continuous Emission Monitoring System
CEQ	Council on Environmental Quality
CERCLA	Comprehensive Environmental Response, Compensation and Liability Act
CFR	Code of Federal Regulations
CO ₂	Carbon Dioxide
CO ₂ -eq	CO ₂ -equivalent
CWA	Clean Water Act
CWLP	City Water, Light and Power
DOE	U.S. Department of Energy
DOI	U.S. Department of the Interior
EA	Environmental Assessment
EcoCAT	Ecological Compliance Assessment Tool
EIV	Environmental Information Volume
EO	Executive Order
ESA	Endangered Species Act
FEMA	Federal Emergency Management Agency
GHG	Greenhouse Gases
GJ	Gigajoules
gpd	gallons per day
gpm	gallons per minute
IDNR	Illinois Department of Natural Resources
IEPA	Illinois Environmental Protection Agency
ISTC	Illinois Sustainable Technology Center
lb/hr	pound(s) per hour
m ³	cubic meter
MBTA	Migratory Bird Treaty Act
MWe	Megawatt-Electric
NEPA	National Environmental Policy Act
NETL	National Energy Technology Laboratory
NPDES	National Pollutant Discharge Elimination System
NRHP	National Register of Historic Places
PM _{2.5} / PM ₁₀	Particulate Matter (2.5-micron / 10-micron)

Project	Large Pilot Testing – Advanced Post Combustion CO ₂ Capture Technology Project
PSD	Prevention of Significant Deterioration
psig	pounds per square inch gauge
RCRA	Resource Conservation and Recovery Act
SCSWCD	Sangamon County Soil and Water Conservation District
SCWRD	Sangamon County Water Reclamation District
SSCRPC	Springfield-Sangamon County Regional Planning Commission
SWPPP	Stormwater Pollution Prevention Plan
TMDL	Total Maximum Daily Load
U.S.	United States
U.S.C.	United States Code
UIUC	University of Illinois, Urbana–Champaign
USEPA	U.S. Environmental Protection Agency
USFWS	U.S. Fish and Wildlife Service
USGS	U.S. Geological Survey
VOM	Volatile Organic Matter

CHAPTER 1. INTRODUCTION

The United States (U.S.) Department of Energy (DOE) National Energy Technology Laboratory (NETL) prepared this Environmental Assessment (EA) to analyze the potential environmental and social impacts of partially funding a proposed Project to design, construct, and operate a 10-megawatt-electric (MWe) carbon capture system at a coal-fired power plant using the Linde-BASF advanced amine-based post-combustion carbon capture technology. The proposed Project is referred to as the Large Pilot Testing – Advanced Post Combustion CO₂ Capture Technology Project (Project), and would be located at the existing City Water, Light and Power (CWLP) facility in Springfield, Illinois.

1.1 Document Structure

The DOE has prepared this EA in compliance with the National Environmental Policy Act (NEPA) and other relevant federal and state laws and regulations. This EA discloses the direct, indirect, and cumulative environmental effects that would result from the Proposed Action and alternatives. The document is organized into four parts:

- Chapter 1: Introduction—This chapter includes information on the Project proposal, the purpose of and need for the Project, and the agency’s proposal for achieving that purpose and need.
- Chapter 2: Proposed Action and Alternatives—This chapter provides a more detailed description of the agency’s Proposed Action as well as alternative methods for achieving the stated purpose. Alternatives considered but not analyzed in detail also are discussed in this chapter.
- Chapter 3: Affected Environment and Environment Consequences—This chapter contains a description of current resource conditions in the Project Area and the environmental effects of the No Action Alternative and implementing the Proposed Action.
- Chapter 4: List of Preparers—This chapter provides a list of preparers for the EA.
- Chapter 5: Literature Citations—This chapter provides references for literature and data cited throughout the document.
- Appendices—The appendices provide information on previous NEPA actions, consultation efforts, and other information to support the analyses presented in the EA.

1.2 Background

In 2017, Congress directed the DOE’s Office of Fossil Energy to develop large-pilot scale projects for potentially transformational coal technologies aimed at enabling step change improvements in coal powered system performance, efficiency, and cost of electricity. These technologies include post-combustion CO₂ capture systems that could significantly reduce the

greenhouse gas emissions of a coal-fueled system. While the technologies are at various stages of development, some are ready to proceed to the large pilot scale. Large-scale pilots are necessary to reduce the technical and financial risk associated with the adoption of a new technology in the marketplace. This is the final stage of research and development prior to commercial demonstration; thus, the projects should have already demonstrated technical success of the integrated components at the small-pilot scale.

In order to implement the Fossil Fuel Large-Scale Pilot program, DOE issued Funding Opportunity Announcement DE-FOA-0001788 on September 28, 2017 to request proposals for the large-scale pilot projects. DOE conducted a competitive merit review of the proposals and selected projects for the planning phase of project development in January 2018.

The Fossil Fuel Large-Scale Pilot program consists of three phases: I. Feasibility, II. Design, and III. Construction/Operation. In order to select the optimal projects for implementation, the proposed Projects undergo competitive down-selections at critical points in the project. In Phase I, Feasibility, the objective was to demonstrate the team's full commitment and capability to implement Phase II and Phase III, update the budget and schedule, and complete an Environmental Information Volume (EIV). Phase I was completed by all selected projects in April 2019, and DOE competitively assessed each project location for technical merits and potential environmental impacts prior to selecting six projects to proceed to Phase II, Design. During Phase II, the selected project participants would complete a Front-End Engineering Design study, secure funding for Phase III, and complete the NEPA process.

The "Large Pilot Testing of Linde-BASF Advanced Post-Combustion CO₂ Capture Technology at a Coal-Fired Power Plant" Project was selected under Phase II and must complete the NEPA process. DOE assessed this Project as required by NEPA implementing procedures and regulations and issued a Categorical Exclusion to the Project prior to Phase I and again prior to Phase II of the Project for work conducted in those phases. Copies of all categorical exclusions for the previous phases of the proposed Project are included in Appendix A.

1.3 DOE's Proposed Action

DOE's proposed action is to provide cost-shared financial assistance to the Trustees of the University of Illinois (UIUC). DOE proposes to provide approximately \$3 million of the Project's \$3.7 million total cost. UIUC and the Project partners are required to obtain funding for the remaining 20 percent of the Project cost.

1.4 Purpose and Need

The purpose and need for DOE action is to advance the commercial readiness development of potentially transformative coal technologies that can improve system performance, efficiency, and the cost of electricity. **Congress directed DOE to complete pilots of this size, in order to enable step change improvements in coal-powered system performance, efficiency, and cost**

of electricity. A large-scale pilot is the final step in the research and development process and would demonstrate the scalability and commercial potential of the Linde-BASF post-combustion CO₂ capture technology using U.S. domestic coal. As a result, the risks associated with adopting this technology at full scale would be mitigated, creating a pathway for commercial deployment in the U.S. **UIUC proposed this project at the CWLP facility because it is a preexisting facility with the space, coal type and configuration needed to complete the project, located in close proximity to the project research team at UIUC.**

1.5 National Environmental Policy Act and Related Procedures

DOE prepared this EA in accordance with the NEPA, as amended (42 United States Code [U.S.C.] 4321), the President's Council on Environmental Quality (CEQ) regulations for implementing NEPA (40 Code of Federal Regulations [CFR] 1500-1508), and DOE's implementing procedures for compliance with NEPA (10 CFR 1021). This statute and the implementing regulations require that DOE, as a federal agency:

- assess the environmental impacts of its proposed action;
- identify any adverse environmental effects that cannot be avoided, should the proposed action be implemented;
- evaluate alternatives to the proposed action, including a no action alternative; and
- describe the cumulative impacts of the proposed action together with other past, present, and reasonably foreseeable future actions.

These provisions must be addressed before a final decision is made to proceed with any proposed federal action that has the potential to cause impacts to the natural or human environment, including providing federal funding to a project. This EA is intended to meet DOE's regulatory requirements under NEPA and provide DOE with the information needed to make an informed decision about providing financial assistance. In accordance with the above regulations, this EA allows for public input into the federal decision-making process; provides federal decision-makers with an understanding of potential environmental effects of their decisions before making these decisions; and documents the NEPA process.

1.6 Laws, Regulations, and Executive Orders

- Clean Air Act (CAA)
- Clean Water Act (CWA)
- Protection of Wetlands (Executive Order [EO] 11990)
- Floodplain Management (EO 11988)
- Endangered Species Act (ESA)
- Migratory Bird Treaty Act (MBTA)

- Bald and Golden Eagle Protection Act (BGEPA)
- The Noise Control Act of 1972, as amended
- Federal Actions to Address Environmental Justice in Minority Populations and Low-Income Populations (EO 12898)
- Pollution Prevention Act of 1990
- Resource Conservation and Recovery Act (RCRA)
- Comprehensive Environmental Response, Compensation and Liability Act (CERCLA)

1.7 Public Involvement, Agency Coordination and Tribal Consultation

DOE coordinated with the following agencies, tribes, and non-governmental agencies through agency consultation letters and/or notification of the availability of the EA.

Federal, State and Local Agencies

- Bureau of Indian Affairs
- U.S. Department of the Interior (DOI) Regional Environmental Officer
- Fish and Wildlife Service
- Environmental Protection Agency, Region 5
- Illinois Department of Natural Resources
- Illinois Environmental Protection Agency (IEPA)
- National Association of State Energy Officials
- National Association of Tribal Historic Preservation Officers
- State and Tribal Government Working Group
- U.S. Forest Service (Local Office)
- U.S. Army Corps of Engineers

Tribal Governments

- Kickapoo Tribe of Indians of the Kickapoo Reservation in Kansas
- Kickapoo Tribe of Oklahoma
- Menominee Indian Tribe of Wisconsin
- Miami Tribe of Oklahoma
- Osage Nation
- Peoria Tribe of Indians of Oklahoma

Non-governmental Organizations

- Center for Biological Diversity
- Clean Water Action
- Ducks Unlimited, Inc.
- Earthjustice
- Electric Power Research Institute
- Environmental Defense Fund
- Environmental Defense Institute
- Friends of the Earth
- Greenaction for Health and Environmental Justice
- Institute for Energy and Environmental Research
- National Audubon Society
- The Nature Conservancy
- Sierra Club
- Trout Unlimited
- Utilities Technology Council
- The Wilderness Society
- Western Resource Advocates

Correspondence from the U.S. EPA and the Illinois Department of Natural Resources, State Historic Preservation Office contained no comments to be addressed in the EA. The EPA correspondence stated that the agency had “no comments on the Draft EA.” The SHPO correspondence stated that based on the information provided [the Draft EA], they had “no objection to the undertaking proceeding as planned.”

Copies of agency correspondence are included in Appendix B of this EA.

This page intentionally left blank.

CHAPTER 2. PROPOSED ACTION AND ALTERNATIVES

2.1 Introduction

This chapter describes the Proposed Action and No-Action Alternative analyzed in this EA, as well as those alternatives dismissed from further consideration. As described in Chapter 1, CEQ's regulations direct all federal agencies to use the NEPA process to identify and assess the reasonable alternatives to proposed actions that would avoid or minimize adverse effects of these actions upon the quality of the human environment (40 CFR 1500.2[e]).

2.2 Proposed Action

DOE's proposed action is to provide cost-shared financial assistance to the Trustees of the University of Illinois (UIUC). DOE proposes to provide approximately \$3 million of the Project's \$3.7 million total cost. UIUC and the Project partners are required to obtain funding for the remaining 20 percent of the Project cost.

2.3 No-Action Alternative

Under the No Action Alternative, DOE would not provide cost-shared funding to the proposed Project. The Project may be delayed if the University opts to search for other funding sources. More likely, the Large Pilot Testing Facility would not be constructed. DOE assumes, for the purposes of NEPA, that under the No Action Alternative the recipient would not pursue the Project. Consequently, the Linde/BASF technology would not be tested at large-pilot scale using domestic U.S. coal, and the level of commercial readiness for this technology would not be advanced.

2.4 Alternatives Considered but Dismissed

NEPA requires DOE to assess the range of reasonable alternatives to the proposed action. Because DOE's proposed action is limited to providing financial assistance in cost-sharing arrangements to selected applicants in response to a competitive funding opportunity, DOE's decision is limited to either accepting or rejecting the Project as proposed by the proponent, including its proposed technology and selected sites. Six projects have proceeded through the multi-step selection process to this phase of work, and those are the only projects available to be selected for construction and operation. Those projects will be analyzed for potential impacts separately and will not be discussed further in this EA. DOE will use the completed NEPA documents for the selected projects to provide environmental information when deciding whether to fund UIUC's proposed Project. The NEPA documentation for other potential projects will include two additional Environmental Assessments: DOE/EA-2127 "Flameless Pressurized Oxy-Combustion Large Pilot" and DOE/EA-2134 "Making Coal Relevant for Small Scale Applications: Modular Gasification for Syngas/Engine CHP Applications in Challenging

Environments.” The DOE’s consideration of reasonable alternatives to this project under NEPA is therefore limited to the No-Action Alternative.

2.5 Large Pilot Testing Facility Project Description

2.5.1 Location and Setting

The proposed Project would be located on the southwest end of CWLP Dallman Power Plant facility in Springfield, Illinois adjacent to Dallman Unit No. 4 (Unit No. 4). The Large Pilot Testing Facility would be located within the larger industrial area that is bounded on three sides by Springfield Reservoir, the water supply for the City of Springfield. Routes 36/72/55 travel along the northwest side of CWLP and Adlai Stevenson Drive passes to the north of the site (Figure 2.1).

Figure 2.1. Proposed Project Location – CWLP Vicinity Map



2.5.2 Large Pilot Testing Facility Project Configuration and Process Design

The testing facility would be constructed as a stand-alone facility with a footprint that falls within an area of approximately 120 feet by 425 feet on the west side of Unit No. 4 (Figure 2.2). The current land use for this area is equipment and materials storage. Ducting would be installed from the coal-fired power plant flue to the testing facility and back.

Figure 2.2. Proposed Project Plan – Testing Facility Adjacent to Dallman Unit No. 4



The capture process would take a slipstream from the Unit No. 4 flue gas stream and would capture post-combustion carbon dioxide (CO₂) from the coal-fired power plant flue gases using the Linde-BASF patented amine solvent-based technology. The slipstream would be removed upstream of the Continuous Emission Monitoring System (CEMS) installed in the Unit No. 4 stack and the captured CO₂ stream and treated exhaust gases from the capture process would be returned to the Unit No. 4 stack upstream of the CEMS. The captured CO₂ and treated exhaust gas from the capture process would be mixed with the Unit No. 4 flue gas and would be emitted to the atmosphere through the Unit No. 4 stack (Figure 2.3).

The Large Pilot Testing Facility would consist of the following process components:

- Flue Gas Ductwork connections from the Unit No. 4 stack to the capture process
- Flue Gas Pre-Treating (Direct Contact Cooling) Process
- CO₂ Absorption Process
- Regeneration of the amine solvent
- Ancillary equipment including storage tanks and truck loading/unloading station
- Utility (including electricity, cooling water, potable water, steam) connections to CWLP

Figure 2.3. Proposed Project Plan – Testing Facility Plot Area

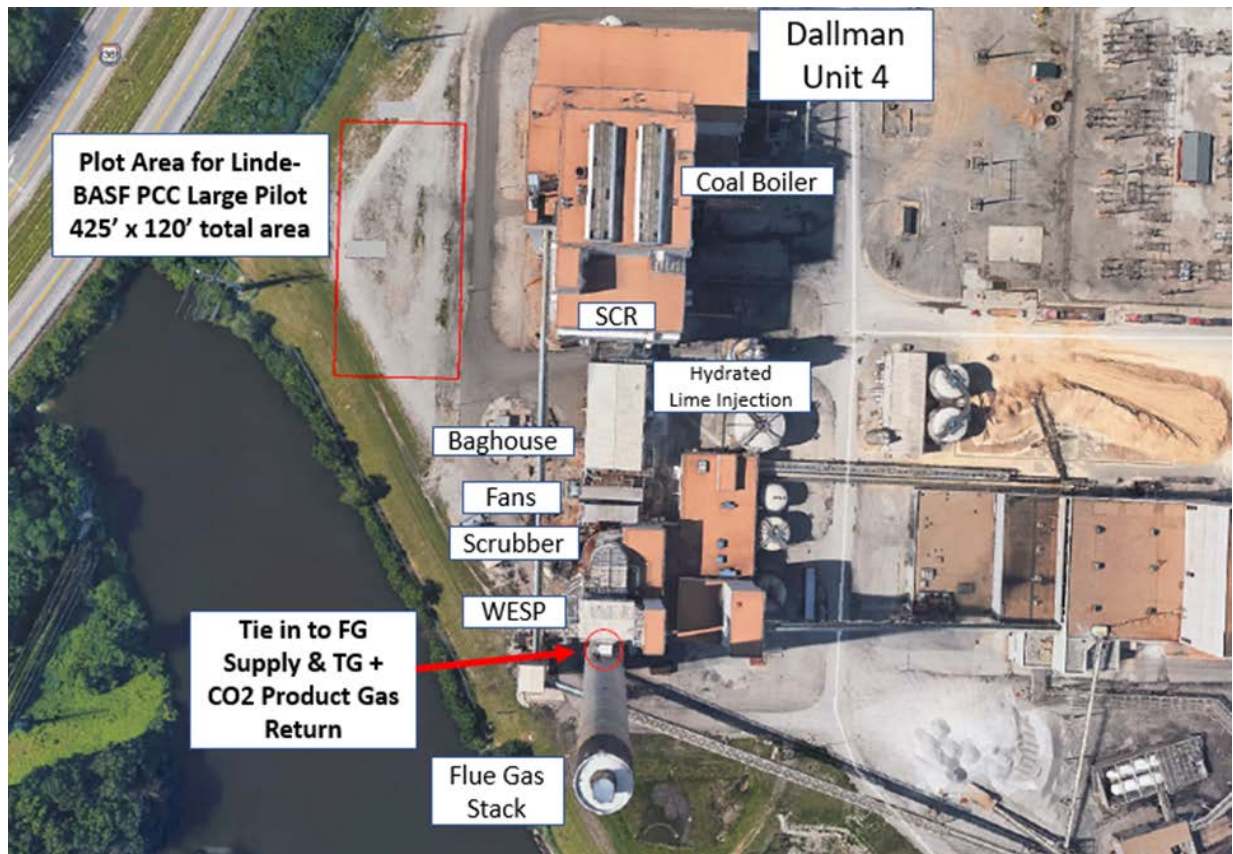

The capture process is illustrated in Figure 2.4.

Figure 2.4. Carbon Capture Pilot Plant Process

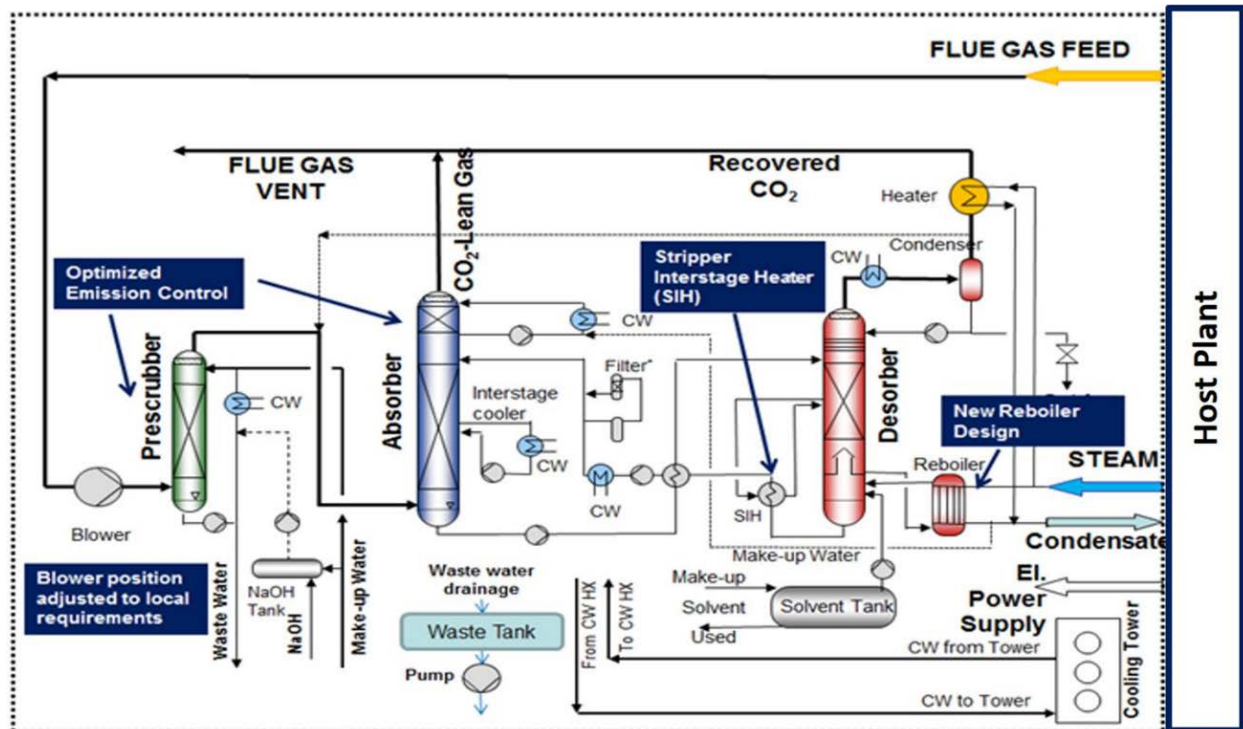

2.5.3 Large Pilot Testing Facility Construction

The final engineering, procurement and construction activities of the testing facility would occur in an approximately two-year timeframe. Appropriate agreements for the site construction would be implemented with the host site prior to any work being performed. The Project would have a full-time site Superintendent whose role is to make sure all work is performed according to the design documents and in accordance with the approved safety plan.

The foundation design would be developed based on the final pilot plant layout, soil testing, and other factors including the weights of the modular assemblies. The process modules would be fabricated and assembled with the equipment in a fabrication shop. After completing a Factory Acceptance Test, the modules would be shipped to the host site for installation. The site construction contractor would prepare the site, receive the modules and lift them into place for integration with the power plant. Based on the construction strategy, the columns would either be shop fabricated or field erected to minimize the overall construction cost. Once the modules and columns are placed, they would be anchored to the concrete foundation. Tie-ins of all electrical wiring, control devices, host site flue gas and utilities, and the return lines for the CO₂ product and treated flue gas would be designed and installed. A final system check would be performed on the complete installation and the connectivity to the control and data acquisition systems. All possible device calibrations would be performed, and the lines cleared of any particles, moisture

and air, where needed. The test solvent and other process chemicals would be delivered to the site and loaded into storage tanks. Upon completion of construction, temporary fencing, barricades and all construction materials and debris would be removed.

The equipment and supplies originally stored on the proposed test plan site would be relocated to another available area within the power plant facility to allow for construction activities including leveling the existing ground surface and pouring a concrete pad. Subsurface activities may involve the construction of pilings to accommodate equipment weight at the site. The depth of the pilings is estimated to be 25-30 feet below ground level however the depth would be determined based on geological samples and subsequent design requirements. Solvent storage tanks would be built as part of the pilot plant design. The testing facility would include three column structures and modular steel skids mounted with auxiliary equipment such as heat exchangers, filters and pumps. Ducting between the power plant stack and the testing facility would be constructed and piping, electrical and instrumentation for the testing unit would be tied into the existing power plant. No additional outdoor land areas would be disturbed by this Project and no plans to reclaim land areas are necessary.

Groundwater and surface water protection measures would be installed as part of the proposed Project design to minimize temporary impacts from runoff, sedimentation, and erosion during construction activities.

The site location and design accounts for the local surface utilities in the immediate vicinity. A 138-kV power line directly west of the site, and a 69-kV power line approximately 300 feet to the north of the site would not interfere with the location of, or construction activities for the site.

Spill-control curbing would be designed and constructed to further contain post-construction spills and runoff and the completed testing facility would have multiple spill containment barriers, including a secondary containment system surrounding the tank farm. Final design of the secondary containment system would be adequately sized at a height to contain 110 percent of the largest volume liquid storage tank within the secondary containment area and also to account for the anticipated rainfall volume. It is anticipated that the testing facility design would include roofing or other design elements to direct a majority of the rainfall outside of the secondary containment system.

2.5.4 Large Pilot Testing Facility Operations

Setup and initial operation of the Large Pilot Testing Facility and maintenance and troubleshooting to address ongoing operation needs (i.e., load changes or variable feed gas conditions) would be performed by at least one engineer and 1-2 operators, located either in the central power plant control room or a dedicated Linde-BASF control room. Ongoing operations would be continuously supervised from the control room, however under stable feed and load conditions the facility would be designed for automatic operation and minimal intervention from

a control room is anticipated. The facility would experience variable operating conditions based on test objectives.

A field operator would address routine inspections and maintenance activities and perform any required batch sampling. For these activities, it would be typical for a single field operator to be on-site per shift.

Periodic delivery of process chemicals and offsite transport of wastes would occur, as needed, over the duration of the planned two-year operation period.

Figure 2.5 shows the historical and projected timeline of the testing facility Project.

Figure 2.5. Large Pilot Testing Facility Project Timeline

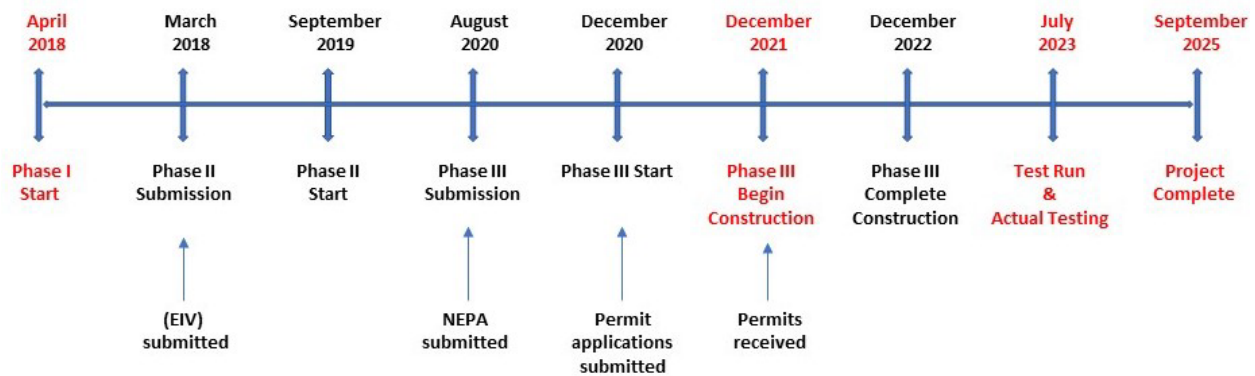

2.5.5 Post-Test Use of the Large Pilot Testing Facility

Upon completion of testing, and before the end of the Project, the capture system would be dismantled and removed from the site. Decommissioning would include removal of all equipment from the site. The site would then be returned to its previous condition. Demolition, dismantling, removal, and site restoration would be included in the Project plan and budget.

CHAPTER 3. AFFECTED ENVIRONMENT AND ENVIRONMENTAL CONSEQUENCES

3.1 Introduction

This section provides relevant environmental, cultural, and socioeconomic baseline information, and identifies and evaluates the individual or cumulative environmental and socioeconomic changes likely to result from constructing and operating the proposed testing facility at CWLP. The region of influence for this EA includes CWLP and the immediately surrounding areas.

CEQ regulations encourage NEPA analyses to be as concise and focused as possible, consistent with 40 CFR Part 1500.1(b) and 1500.4(b): "...NEPA documents must concentrate on the issues that are truly significant to the action in question, rather than amassing needless detail ... prepare analytic rather than encyclopedic analyses." Consistent with the NEPA and CEQ Regulations, this EA focuses on those resources and conditions potentially subject to effects.

The methodology used to identify the existing conditions and to evaluate potential impacts on the physical and human environment involved the following: review of documentation and Project information provided by UIUC and their consultants, searches of various environmental and agency databases, agency consultations, and a site visit conducted on September 27, 2019. All references are cited, where appropriate, throughout this EA.

Wherever possible, the analyses presented in this chapter quantify the potential impacts associated with the Proposed Action and the No-Action Alternative. Where it is not possible to quantify impacts, the analyses present a qualitative assessment of the potential impacts. The subsections presented throughout the remainder of this chapter provide a concise summary of the current affected environment within the region of influence, and an analysis of the potential effects to each resource area considered from implementation of the No-Action Alternative and the Proposed Action.

3.1.1 Resource Areas Screened from Detailed Analysis

Sections 3.10 to 3.14 describe the resources that DOE has determined would not be affected or would sustain negligible impacts from the Proposed Action and would not require further evaluation. The resource areas dismissed from further analysis are Geology and Soils, Land Use, Cultural and Paleontological Resources, Environmental Justice, and Noise.

3.2 Air Quality and Climate

3.2.1 Affected Environment

3.2.1.1 Air Quality

CWLP currently operates Units 31, 32, and 33 in addition to operating Unit No. 4. Unit No. 4 and combustion turbines currently are providing approximately 99.5 percent of the load throughout the year. The current discussions surrounding the continuation of operations for Units 31, 32, 33 include recommendations for retiring Units 31 and 32 by December 31, 2020 and retiring Unit 33 no later than October 1, 2023 (CWLP 2019a).

The power generation units at CWLP operate under a Clean Air Act Title V Operating Permit issued by the IEPA. The IEPA issued a revised Clean Air Act Permit Program permit to the City of Springfield for CWLP Dallman Station on September 11, 2017.

3.2.1.2 Air Quality Monitoring Network

Sangamon County is located in an air quality attainment area for the six criteria air pollutants; Ground-level ozone (1 hour and 8 hour), particulate matter (PM_{2.5} and PM₁₀), carbon monoxide, lead, sulfur oxides and nitrogen dioxide. Ambient ozone and PM_{2.5} pollutant levels are monitored in Springfield, with data reported by IEPA. In 2018 air quality in the Springfield area was categorized as “good” 69.7 percent of the time and categorized as “moderate” 30 percent of the time (IEPA 2018).

3.2.1.3 Climate

The proposed Project would be located at CWLP site in Springfield, Sangamon County, Illinois. The climate in the Springfield area is typical of the Midwest with hot summers and cold, moderately snowy winters. The average low temperature for January is 16° F with an average of 2.05 inches of precipitation. The average high temperature for July is 86° F with an average of 3.94 inches of precipitation (U.S. Climate Data, no date). Between 2009 and 2018, the average annual precipitation total was 39 inches and the average annual snowfall was 23 inches (NOAA 2019).

3.2.1.4 Class I Areas

There are no Class I areas in the vicinity of the proposed Project site. The closest Class I area to the proposed Project site is the Mingo National Wildlife Refuge in southeastern Missouri (USFWS 2013; USEPA 2016).

3.2.2 No-Action – Environmental Consequences

Under the No Action Alternative, the proposed Project would not be implemented. There would be no air emissions associated with proposed Project construction and no effect on the air emissions from Unit No. 4 or other units at CWLP. CWLP would continue to operate Unit No. 4 in accordance with CWLP's Title V Operating Permit.

Under the No Action Alternative, no research findings related to potential utility of the capture process technology in capturing CO₂ from coal-fired power plant operations and addressing global climate change would be realized.

3.2.3 Proposed Action – Environmental Consequences

Construction of the proposed Project would result in direct criteria air pollutant emissions from fuel combustion for operation of construction equipment and indirect criteria air pollutant emissions from consumption of electricity during the construction period. Construction of the proposed Project also would result in fugitive particulate emissions (PM₁₀, PM_{2.5}) from site clearing and excavation, installation of pilings and concrete, and other construction activities. Proposed project construction activities are not expected to exceed air quality monitoring thresholds or ambient air quality standards in offsite areas. Impacts to air quality during proposed Project construction would be minor and temporary. The impacts would be minimized by using best practices during construction activities, including, but not limited to the use of water sprays for dust suppression and the use of construction equipment with appropriate emission controls.

The proposed Project would take approximately 30,000 standard cubic feet per minute flue gas from the exhaust stack of Unit No. 4 coal-fired power plant at CWLP as input to the capture process. The capture process would be designed with a recycle stream back to the inlet of the absorber, so that the CO₂ content of the flue gas entering the absorber can be varied for research purposes up to 20 mole percent. The captured CO₂ would be combined with the treated flue gas from the capture process, and the combined exhaust gases would be returned from the testing facility to the Unit No. 4 stack. The combined treated gases and captured CO₂ from the testing facility capture process would be returned to the Unit No. 4 stack upstream of the Unit No. 4 stack CEMS, and therefore both the air emissions from Unit No. 4 and air emissions from the testing facility would be monitored by the Unit No. 4 CEMS. The exhaust gases from the testing facility would be emitted to the atmosphere from the Unit No. 4 stack along with the exhaust gases from the Unit No. 4 electric power generation.

IEPA has indicated to the Illinois Sustainable Technology Center (ISTC) that a construction and operating permit would be required for the testing facility as a "Modification to the Facility" and indicated that CWLP would need to amend its Title V Operating Permit within one year of commencement of capture process operations (University of Illinois 2019a). The proposed Project would be considered a single source within CWLP's operations, but the proposed Project would have its own air emission limits separate from the air emissions limits already established

for Unit No. 4 and the other units at CWLP in existing permits. If the decision is made to implement the proposed Project after Phase II, a permit application for the Modification to the Facility would be submitted to IEPA as part of Phase III. IEPA has indicated to the ISTC that a separate permit would not be required for the amine solvent storage tank (University of Illinois 2019a).

Linde-BASF has estimated the effect of operation of the proposed test facility on air emissions from the Unit No. 4 stack. Flue gas from Unit No. 4 would be taken from the stack and fed into the proposed testing facility. Emissions of nitrogen oxides would not increase as a result of the operation of the proposed testing facility. Soluble nitrogen oxides components would be removed in the direct contact cooler. Nitrogen oxides in the exhaust gas offtake would pass through the proposed testing facility and return to the Unit No. 4 stack in the treated exhaust gas without being affected. The amount of nitrogen oxides and nitrogen dioxide in the treated gas is estimated to be less than 4.6 pounds per hour (lb/hr). A substantial decrease in sulfur dioxide emissions (up to 90 percent) from operation of the proposed testing facility would occur in the capture process due to the process step where sulfur dioxide is reacted with sodium hydroxide in the direct contact cooler, resulting in sodium salts that are removed in the condensate purge. The sulfur dioxide content of the treated exhaust gas from the proposed testing facility would be less than 0.1 lb/hr.

Operation of the proposed testing facility would add volatile organic material (VOM) emissions to the Unit No. 4 stack gas and increase the VOM emissions from Unit No. 4. Any added emissions would need to be validated and would not be permitted to exceed existing air emissions permit limits for Unit No. 4. The IEPA has established air emissions limits for CWLP that are included in the Prevention of Significant Deterioration (PSD) permit for the facility. Based on the most recent testing of Unit No. 4 (2011), the actual VOM emissions measured in the PSD test was 0.78 pounds VOM per hour.

Linde-BASF has estimated that the increase in VOM emissions resulting from operation of the proposed test facility would be in the range of 1.2 to 1.8 lb/hr. The increase in VOM emissions would result from amine and amine-degradation products contained in the treated exhaust gas from the proposed test facility that would be returned to the Unit No. 4 stack. The increase in VOM emissions resulting from amine carryover into the treated exhaust gas would represent an approximate factor of 1.5 increase in VOM emissions from the 0.78 pounds per hour emissions measured for Unit No. 4. The VOM emissions from Unit No. 4 including the VOM content of the treated exhaust gas would remain below the PSD permit limit of 8.8 pounds per hour for Unit No. 4. The proposed test facility operating conditions (e.g., lean solution return temperature, water wash control temperature, and absorber inter-stage cooling temperature) design has been optimized to result in minimum amine carry-over and hence can be used to control the pilot plant operations well below the VOM emission limits for Unit No. 4. The increase in VOM emissions resulting from operation of the proposed test facility would be temporary; the proposed test facility would be decommissioned at the end of its two-year operation.

Ammonia would be produced as a degradation product of the amine solvent. The capture process would be designed to minimize amine solvent losses to the treated exhaust gas from the capture process and the ammonia content of the treated exhaust gas would be less than 0.5 lb/hr. The point of amine carryover into the treated exhaust gas is mainly around the absorber. There are two water wash sections included in the proposed testing facility design; these sections wash the amine back and thereby reduce the amount of carryover into the treated gas stream at the top of the absorber. There is also a dry bed system included in proposed testing facility design. Based on Linde-BASF experimental (small pilot testing) data, this system produces a lower carryover than other designs. Small particles (aerosols) that may be contained in the flue gas offtake also could increase the amount of amine carryover. Depending on the number of small particles (aerosols) in the flue gas offtake, a system design component also could be added that would remove aerosols from the incoming flue gas. Because the existing Unit No. 4 flue gas treatment system design includes a baghouse for aerosol emissions control, Linde-BASF estimates that aerosols in the flue gas offtake would not contribute to an increase in amine carryover. In the event that aerosols represent a potential concern, system design elements can be included to remove aerosols from the incoming flue gas if needed. The treated exhaust gas containing the residual amine would be emitted to the atmosphere through the Unit No. 4 stack.

Upon commencement of operation, air emissions from the test facility would be determined either by directly measuring the concentration of pollutants in the exhaust gas from the testing facility (before the exhaust gas is returned to the Unit No. 4 stack) or by measuring the concentration of pollutants in the Unit No. 4 stack gas (after the exhaust gas is returned to the Unit No. 4 stack). Measured air emissions would be compared to permit conditions included in the IEPA air emissions permit (modification to the facility) that would be issued for the proposed test facility as part of Phase III.

3.3 Water Resources

This section describes water resources – surface waters, water quality, wetlands, floodplains, and groundwater – in the Project area. Water resources typically are defined in terms of watersheds, which are areas of land that drain all the streams and rainfall to a common outlet (e.g., river, lake, ocean); the watershed also includes the underlying groundwater (U.S. Geological Survey (USGS), no date). Surface waters, wetlands, floodplains, and groundwater are distinct resources, but they function as a single, integrated natural system in the watershed. As such, disruption of any part of these resources may affect the functioning of the entire system (FEMA 2007).

The Project falls within the Lake Springfield-Sugar Creek watershed (Hydrologic Unit Code 12: 071300070707), which is a sub-watershed of the larger Sugar Creek watershed (Hydrologic Unit Code 10: 0713000707).

Federal regulatory requirements for water resources may include:

- Executive Order 11990, *Protection of Wetlands*, requires Federal agencies to “avoid to the extent possible the long and short term adverse impacts associated with the destruction or modification of wetlands and to avoid direct or indirect support of new construction in wetlands wherever there is practicable alternative.” This EO does not apply to the issuance of Federal agencies of permits, licenses, or allocations to private parties for activities involving wetlands on non-Federal property.
- Executive Order 11988 requires federal agencies to reduce the risk of flood loss, to minimize impact of floods on human safety, health and welfare, and to restore and preserve the natural and beneficial values served by floodplains. To meet these objectives, each agency has the responsibility to evaluate the potential effects of its actions on floodplains. This Executive Order applies to management of federal lands and facilities; federally undertaken, financed, or assisted construction and improvements; and federal activities and programs affecting land use.
- The National Flood Insurance Act established the National Flood Insurance Program, a voluntary floodplain management program for communities (cities, towns, or counties) implemented by the Federal Emergency Management Agency (FEMA). Any action within a FEMA-mapped floodplain in a participating community must follow the community’s FEMA-approved floodplain management regulations (FEMA 2007a).
- The Clean Water Act (CWA) establishes the basic structure for regulating the discharge of pollutants into waters of the United States. ¹ The sections of the CWA most applicable to the effects of ground disturbance activities include Section 303(d), Section 404, Section 401, and Section 402, which establishes the National Pollutant Discharge Elimination System (NPDES) permit program.

3.3.1 Affected Environment

3.3.1.1 Surface Waters, Surface Water Quality, and Floodplains

Surface Waters

Surface waters include rivers, streams, creeks, lakes, ponds, and reservoirs. Surface water is maintained by precipitation and can be lost through evaporation, seepage into the ground, or use by plants and animals. Typical beneficial surface water uses include drinking water, public supply, irrigation, agriculture, thermoelectric generation, mining, and other industrial uses.

The Lake Springfield-Sugar Creek watershed contains 35,821 feet of streams and 3,965 acres of other surface waters (e.g., ponds, lakes), the latter of which is Lake Springfield. Lake Springfield

¹ See 40 CFR 230.3 and 33 CFR 328 for definition of waters of the United States.

makes up nearly 20 percent of the watershed and is the nearest surface water to the Project (~75 feet to the southwest). Lake Springfield is a 3,965-acre, 12-mile long impoundment created between 1931 and 1933 by damming Sugar Creek and Lick Creek, the two main tributaries that flow into the lake. Little Panther and Panther Creeks flow into Sugar Creek, and Polecat Creek and several small tributaries flow directly into the lake. The lake is maintained at 560 feet mean sea level at Spaulding Dam, averages 13.4 feet in depth and has a storage capacity of 17 billion gallons. The shoreline is approximately 57 miles long, with 21.6 miles leased to private homeowners and lakes clubs, with the remaining consisting of natural areas, public parks, and City of Springfield administrative property. The lake is owned and maintained by the City of Springfield, and primarily functions to: 1) serve as the drinking water source for the City of Springfield, nearby communities and rural customers, 2) provide condenser cooling water for the municipal power plant complex, and 3) be a source of beauty and recreation for the citizens of the area (Sangamon County Soil and Water Conservation District [SCSWCD] 2017)

Water Quality

Clean Water Act (CWA) Section 303(d) requires states, territories, and authorized tribes (as delegated by the U.S. EPA) to develop lists of impaired surface waters, which are those that do not meet water quality standards established by these jurisdictions. The CWA requires that these jurisdictions establish priority rankings for surface waters on the list and develop total maximum daily loads (TMDLs) of pollutants for these surface waters. A TMDL is a calculation of the maximum amount of pollutant that a surface water can receive and still meet established water quality standards. The IEPA has been delegated the authority by the U.S. EPA (USEPA) to assess water quality of Illinois surface waters and develop the state's Section 303(d) list of impaired surface waters. Surface waters are assigned priority rankings of 1 through 5, with Category 5 considered impaired under Section 303(d) and requiring a TMDL. The 2018 IEPA list of Section 303(d) impaired surface waters is the most current published list (IEPA 2019). Lake Springfield is listed as a Category 5 impaired water for aquatic life and aesthetic quality uses. The impairments are caused by water quality standard exceedances for dissolved oxygen, phosphorus (total), total suspended solids, and aquatic algae. The sources for these exceedances include golf courses, internal nutrient cycling, agriculture, runoff from forest/grassland/parkland, littoral/shore area modifications, other recreational pollution sources, and unknown. A TMDL for phosphorous (total) was approved in 2017; TMDLs have not yet been developed or approved for dissolved oxygen, total suspended solids, or aquatic algae.

Floodplains

Floodplains are defined as any land area susceptible to being inundated by waters from any source (44 CFR 59.1) and are often associated with surface waters and wetlands. Floodplains are valued for their natural flood and erosion control, enhancement of biological productivity, and socioeconomic benefits and functions. For human communities, however, floodplains can be considered a hazard area because buildings, structures, and properties located in floodplains can

be inundated and damaged during floods. FEMA develops Flood Insurance Rate Maps (FIRMs), the official maps on which FEMA delineates special flood hazard areas for regulatory purposes under the National Flood Insurance Program. Special flood hazard areas are also known as 100-year floodplains, or areas that have a 1 percent annual chance of flooding. FEMA also maps 500-year floodplains, or areas that have a 0.2 percent annual chance of flooding.

The Project is not located within any FEMA-mapped floodplains (FEMA, 2007). The nearest mapped floodplain is a 100-year floodplain associated with Lake Springfield that is located approximately 47 feet southwest of the Project.

3.3.1.2 Groundwater

There are no major regional aquifers present in the Lake Springfield-Sugar Creek watershed, and groundwater in the watershed itself is very limited (SCSWCD 2017; Bergstrom et al. 1976). The watershed is not within an area designated by the U.S. EPA as a Sole Source Aquifer.

Groundwater in the watershed typically occurs beneath unconsolidated deposits greater than 300 feet deep, and in the watershed these deposits are less than 50 feet deep in nearly all areas (SCSWCD 2017). The impermeable nature of the surface geology in the watershed acts to protect the limited groundwater resources from contamination, and it is believed that groundwater plays a minor role in the health and function of the watershed and is a small component of the water balance (SCSWCD 2017). Seepage from the Lake Springfield into aquifers or groundwater is considered to be negligible given the low hydrologic conductivity of the area (Makowski, et al. 1986); and there is no groundwater entry into Lake Springfield, as it is entirely surface fed (SCSWCD 2017). The Project site has been previously disturbed and is compacted and would not support any water infiltration into the ground.

3.3.1.3 Wetlands

Wetlands are important features in the landscape that provide numerous beneficial services for people and for fish and wildlife. Some of these services, or functions, include protecting and improving water quality, providing fish and wildlife habitats, storing floodwaters, producing aesthetic value, ensuring biological productivity, filtering pollutant loads, and maintaining surface water flow during dry periods. Functions are the result of the inherent and unique natural characteristics of wetlands.

Wetland functions also can reflect a measurable value to society. For example, a value can be determined by the revenue generated from the sale of fish that depend on the wetland, by the tourist dollars associated with the wetland, or by public support for protecting fish and wildlife. Although large-scale benefits of functions can be valued, determining the value of an individual wetland is difficult because wetlands differ widely and do not all perform the same functions or perform functions equally well (USEPA, 2002).

The Project is not located within any wetlands based on the most current National Wetland Inventory (USFWS 2019). The nearest wetland is approximately 800 feet west of the Project on

the west side of Interstate 55 and is classified as a freshwater emergent wetland. The National Wetland Inventory also shows Lake Springfield as a lacustrine deep-water aquatic habitat system (See Section 3.3.1.1 for discussion of Lake Springfield).

3.3.2 No-Action – Environmental Consequences

Under the No Action Alternative, the Proposed Action would not occur, and the Linde/BASF technology would not be tested at large pilot scale at CWLP. Implementation of the No Action Alternative would result in no changes to the project site or nearby surface waters, floodplains, or wetlands.

3.3.3 Proposed Action – Environmental Consequences

3.3.3.1 Surface Water, Surface Water Quality, and Floodplains

Surface waters and floodplains do not occur in the Project's construction footprint, and therefore, no filling, excavating, or clearing would occur in these resources. The erosion and transport of sediment due to construction (e.g., clearing, excavating, filling) could result in localized water quality degradation of Lake Springfield due to its proximity to the Project (~75 feet away). Sediment deposition into surface waters can increase turbidity and adversely affect aquatic species and habitats by increasing water temperatures and decreasing dissolved oxygen levels (USEPA 2007). Sediment deposition into surface waters also can increase pollutant and nutrient levels which can adversely affect water quality conditions. For example, excess phosphorous may enhance algal growth in a surface water, which can affect the availability of oxygen in water. The use of construction equipment also could result in accidental spills or leaks of petrochemicals (e.g., gasoline, hydraulic fluids) that could reach surface waters if not contained and cleaned up. Any accidental spill that would reach Lake Springfield could degrade surface water quality, which could adversely affect aquatic habitat or limit the beneficial use of the lake (e.g., recreation, public water supply). Project construction would require the development of a Stormwater Pollution Prevention Plan (SWPPP) which would contain site-specific measures to avoid and minimize erosion and sediment transport to surface waters, as well as measures to contain and clean up accidental petrochemical spills. The potential impacts to Lake Springfield would be mitigated through the use of site-specific measures and best practices identified in the SWPPP and associated NPDES permit (CWA Section 402), designed for water quality protection and to ensure water quality standards of nearby surface waters are not exceeded.

Surface water and floodplain impacts are not anticipated during operations. The proposed Project would operate under CWLP's existing NPDES permit [#IL00224767] for facility operations to ensure discharge to Lake Springfield would not violate water quality standards. No modifications to the existing NPDES permit would be required with the addition of the testing facility, and any surface water runoff (e.g., rainfall) would be captured and discharged per CWLP's existing NPDES permit. In addition, testing facility design elements would help control runoff, including

storm covers (over pumps, piping, etc.) to divert rainwater away from the testing facility equipment, runoff collection gutters, and multiple spill containment barriers. Spill containment would include a secondary containment system surrounding liquid storage tanks adequately sized to contain 110 percent of the volume of the largest volume liquid storage tank within the secondary containment area, and to account for the anticipated rainfall volume. Wastewater generated from the testing facility would be handled through the CWLP Water Treatment Plant or through the Sangamon County Water Reclamation District at its Sugar Creek Plant. Therefore, potential impacts would be minor and temporary and would result in minimal impacts to surface water during the operation of the project.

3.3.3.2 Groundwater

The impermeable nature of the surface geology in the watershed and the disturbed and compacted nature of the Project site would limit groundwater contamination during construction and operations. Subsurface activities could include the construction of pilings for the testing facility. The required SWPPP and NPDES construction permit and CWLP's existing NPDES permit described in Section 3.3.2.1 would provide additional protections to groundwater through required containment and treatment of runoff and wastewater, and cleanup of accidental spills. Therefore, no impacts on groundwater are anticipated.

3.3.3.3 Wetlands

Wetlands do not occur in the Project's construction footprint, and therefore, no filling, excavating, or clearing would occur in this resource. It is unlikely that any construction or operations activity would impact wetlands in the vicinity of the Project site, as the nearest wetland is 800 feet away, is upgradient from the Project site, and occurs on the other side of Interstate-55. Therefore, there would be no impacts on wetlands.

3.4 Biological Resources

3.4.1 Affected Environment

Information regarding wildlife species and habitat within the Project area was obtained from a review of existing published sources, site-specific wildlife and habitat information from the EIV (University of Illinois 2019), U.S. Fish and Wildlife Service (USFWS), and Illinois Department of Natural Resources (IDNR) file information.

The proposed Project site would be located within the existing CWLP facility in an area currently developed and used for equipment and materials storage. No sensitive habitats or ecologically sensitive terrain is present at the proposed Project site, and no new surface disturbance would be required for construction or operation of the Project (University of Illinois 2019).

General wildlife likely to occur in the Project area is typical of developed urban areas in Sangamon County and includes species such as squirrels, rabbits, fox, mourning doves, songbirds, and white-tailed deer (USFWS, 2019). Given the active power plant and the major roadways adjacent to the proposed Project site, species likely to occur in the proposed Project area would be those acclimated to urban environments.

3.4.1.1 Aquatic Resources

Lake Springfield is located adjacent to the Project site (see Section 3.3.1.1). Lake Springfield supports various fish species, including blue catfish, bluegill, channel catfish, black crappie, flathead catfish, largemouth bass, white bass, bullhead, carp, green sunfish, muskellunge, northern pike, rainbow trout, striped bass, longear sunfish, redear sunfish, saugeye, smallmouth bass, walleye, white crappie, yellow perch, blackspotted topminnow, bowfin, golden shiner, and warmouth (SCSWCD 2017; Austen et. al. 1993). Several aquatic mussels have also been documented in Lake Springfield, including cylindrical papershell, rock-pocketbook, pink papershell, three horned wartyback, Wabash pigtoe, white heelsplitter, pondmussel, giant floater, mapleleaf, lilliput, and paper pondshell (Illinois State Museum 2006). Nonindigenous aquatic species identified in Lake Springfield include water flea (*Daphnia lumholtzi*) and Asian clam (*Corbicula fluminea*) (USGS 2020). The shoreline of Lake Springfield located adjacent to the Project site consists of rock boulder rip-rap with low amounts of woody debris within a narrow band (~25 feet) of shrubs and trees (Austen et. al. 1993).

3.4.1.2 Special Status Species

The Endangered Species Act (ESA), 16 U.S.C. 1531 et seq., establishes a national program for the conservation of threatened and endangered species of fish, wildlife, and plants, as well as the preservation of the ecosystems on which they depend. ESA Section 7 requires any federal agency authorizing, funding, or carrying out any action to ensure that the action is not likely to jeopardize the continued existence of any endangered species or threatened species, or result in the destruction or adverse modification of critical habitat of such species. Regulations implementing the ESA interagency consultation process are found in 50 CFR Part 402. Illinois endangered species protection authority is found in 520 ILCS § 10/1 et seq.

Special status species are those that state or federal agencies afford an additional level of protection by law, regulation, or policy. Species identified in this section are federally listed species protected under the ESA, the Bald and Golden Eagle Protection Act (BGEPA), or those designated as state sensitive by the IDNR. Six state or federally threatened or endangered species were reported to have the potential to occur within the Project area based on known range and distribution. However, based on habitat requirements, the proposed Project site does not support suitable habitat for any of these species. Table 3.1 summarizes these species, their habitat requirements, and their potential to occur in the Project area (USFWS IPaC 2020; EcoCAT 2018).

Table 3.1. State or Federally Listed Species Potentially Occurring within the Project Area

Common Name	Scientific Name	Status	Habitat ¹	Potential for Occurrence
Birds				
Bald Eagle	<i>Haliaeetus leucocephalus</i>	BGEPA	Breeding habitat most commonly includes areas close to (within 4 kilometers) coastal areas, bays, rivers, lakes, reservoirs, or other bodies of water that reflect the general availability of primary food sources including fish, waterfowl, or seabirds. Nests usually are in tall trees or on pinnacles or cliffs near water. Wintering areas are commonly associated with open water though in some regions (e.g., Great Basin) some bald eagles use habitats with little or no open water (e.g., montane areas) if upland food resources (e.g., rabbit or deer carrion, livestock afterbirths) are readily available. Wintering eagles tend to avoid areas with high levels of nearby human activity (boat traffic, pedestrians) and development (buildings).	Low – no known nests or territories are within 1-mile of the Project area.
Barn Owl		ST	Woodlands, groves, farms, barns, towns, cliffs. Typically occur in open or semi-open country in lowlands. May nest in forest or city if nearby area has good open foraging territory, such as farmland, marsh, prairie, desert.	Low – Limited suitable habitat exists in the Project area, and no recent occurrences have been documented.
Mammals				
Indiana Bat	<i>Myotis sodalis</i>	FE	Summer habitat includes small to medium river and stream corridors with well-developed riparian woods; woodlots within 1 to 3 miles of small to medium rivers and streams; and upland forests. Caves and mines as hibernacula.	Low – No suitable habitat exists within the Project area.
Northern Long-eared bat	<i>Myotis septentrionalis</i>	FT	Old growth trees of over 100 years old and away from edges are the preferred habitat of the northern long-eared bat. Hibernates in caves and mines – swarming in surrounding wooded areas in autumn. During late spring and summer roosts and forages in upland forests.	Low – No suitable habitat exists within the Project area.
Reptiles				
Kirtland's Snake	<i>Clonophis kirtlandi</i>	ST	Prairie wetlands, wet meadows, and grassy edges of creeks, ditches, and ponds, usually in association with crayfish burrows. Has been found in damp habitat remnants in vacant lots of urban settings.	Low – Limited suitable habitat exists in the Project area, and no current occurrences have been documented.

Common Name	Scientific Name	Status	Habitat ¹	Potential for Occurrence
Plants				
Eastern Prairie Fringed Orchid	<i>Platanthera leucophaea</i>	FT	Occurs most often in mesic to wet unplowed tallgrass prairies and meadows but has been found in old fields and roadside ditches. The eastern prairie fringed orchid also occurs in bogs, fens, and sedge meadows.	None

¹ Sources: <https://www.fws.gov/midwest/Endangered/listing/index.html>; <https://www.dnr.illinois.gov/Pages/default.aspx>.

ST = State Threatened, FT = Federally Threatened, FE = Federally Endangered, BGEPA = Bald and Golden Eagle Protection Act

3.4.1.3 Migratory Birds

The USFWS has statutory authority and responsibility for enforcing the Migratory Bird Treaty Act (MBTA) (16 U.S.C. 703-712). Most native bird species (birds naturally occurring in the United States) are protected under the MBTA, and the list of protected species is identified in 50 CFR 10.13, which is reviewed and updated regularly. MBTA species having the potential to occur in the Project Area are listed in Table 3.2 (USFWS IPaC 2020). There is a low occurrence potential for all of the reported migratory bird species in the Project area, given the current conditions and lack of vegetation communities and other habitat components at the site and the occurrences would be isolated to individuals briefly passing through the area.

Table 3.2. Migratory Bird Species Potentially Occurring in the Project Area

Common Name	Scientific Name	Status	Habitat ¹
American Golden-plover	<i>Pluvialis dominica</i>	MBTA, BCC	Nonbreeding habitat includes short grasslands, pastures, golf courses, mudflats, sandy beaches, and flooded field. Nests on grassy tundra; prefers dry upland areas.
Black-billed Cuckoo	<i>Coccyzus erythrophthalmus</i>	MBTA, BCC	This species breeds in forest edge and open woodland, both deciduous and coniferous, with dense deciduous thickets. Found in extensive tracts of dry upland woods where it uses the midstory canopy and the overstory canopy for most activities. In northern plains also utilizes prairie shrub thickets and shelterbelts at lower elevations.
Bobolink	<i>Dolichonyx oryzivorus</i>	MBTA, BCC	This species generally selects habitat with moderate to tall vegetation, moderate to dense vegetation, and moderately deep litter, lacking woody vegetation. It is found in native and tame grasslands, haylands, lightly to moderately grazed pastures, no-till cropland, small-grain fields, oldfields, wet meadows, and planted cover.
Cerulean Warbler	<i>Dendroica cerulean</i>	MBTA, BCC	Habitat is frequently described as mature deciduous forest, particularly in floodplains or other mesic conditions.
Dunlin	<i>Calidris alpine arcticola</i>	MBTA, BCC	Nonbreeding habitat consists of mudflats, estuaries, marshes, flooded fields, sandy or gravelly beaches, and shores of lakes, ponds, and slough). Nests on the ground, usually in drier sites such as sand dunes or tundra.

Common Name	Scientific Name	Status	Habitat ¹
Henslow's Sparrow	<i>Ammodramus henslowii</i>	MBTA, BCC	Breeding habitat includes open fields and meadows with grass interspersed with weeds or shrubby vegetation, especially in damp or low-lying areas, adjacent to salt marsh in some areas. Uses unmowed hayfields (abandoned if cut). Found in a variety of habitats that contain tall, dense grass and herbaceous vegetation.
Kentucky Warbler	<i>Oporornis formosus</i>	MBTA, BCC	Breeding: Humid deciduous forest (Hamel 1992), dense second growth, swamps. Occurs in stands of various ages but is most common in medium-aged forests (Shugart et al. 1978). Prefers forests with a slightly open canopy, dense understory, and well-developed ground cover (Bushman and Therres 1988). Seldom found in conifers.
Lesser Yellowlegs	<i>Tringa flavipes</i>	MBTA, BCC	Nonbreeding: marshes, ponds, wet meadows, lakes and mudflats (AOU 1983), coastal salinas. Nests in muskeg country, to edge of tundra, in marshes and bogs, clearings or burned-over sections of black spruce forest. The nest is a depression in the ground. It may be located on a slope, far from water (Terres 1980).
Prothonotary Warbler	<i>Protonotaria citrea</i>	MBTA, BCC	Breeding: Mature deciduous floodplain, river, and swamp forests; wet lowland forest. Primary habitats are almost always near standing water; swamps that are somewhat open with scattered dead stumps are preferred. Bottomland forests and extensive willow thickets near lakes or ponds are also quite suitable. Requires dense underbrush along streambanks (Bushman and Therres 1988). Nests in cavity (natural, old woodpecker hole, bird box, etc.), in snag or living tree, often or always near or over water, at a average height of 1.5-3 m (range 0.9-9.8 m).
Red-headed Woodpecker	<i>Melanerpes erythrocephalus</i>	MBTA, BCC	Open woodland, especially with beech or oak, open situations with scattered trees, parks, cultivated areas and gardens (AOU 1983). Nests in hole excavated 2-25 meters above ground by both sexes in live tree, dead stub, utility pole, or fencepost. Sometimes uses existing holes in poles or posts. Individuals typically nest in the same tree or cavity in successive years (Ingold 1991).
Rusty Blackbird	<i>Euphagus carolinus</i>	MBTA, BCC	Breeding habitat includes moist woodland (primarily coniferous), bushy bogs and fens, and wooded edges of water courses and beaver ponds. Nests are in trees or shrubs, usually in or near water, frequently in a conifer to about 6 meters above ground. During migration and winter, habitat is primarily wooded wetlands and riparian areas but also includes various open woodlands, scrub, pastures, and cultivated lands (AOU 1983).
Semipalmated Sandpiper	<i>Calidris pusilla</i>	MBTA, BCC	Nonbreeding: mudflats, sandy beaches, shores of lakes and ponds, and wet meadows (AOU 1983). In northern Alaska, postbreeding habitat was mainly coastal mudflats and slough edges (Smith and Connors 1993). Breeds on grassy or dry shrubby tundra, usually near water. In northern Alaska, favored areas with well-drained ridges for nesting and adjacent wet tundra for feeding (see Johnson and Herter 1989). Often returns to nest in natal area or area of previous nesting (Gratto et al. 1985). The nest is a shallow depression, lined with grasses, moss, and leaves.

Common Name	Scientific Name	Status	Habitat ¹
Short-billed Dowitcher	<i>Limnodromus griseus</i>	MBTA, BCC	Mudflats, tidal marshes, pond edges. Migrants and wintering birds favor coastal habitats, especially tidal flats on protected estuaries and bays, also lagoons, salt marshes, sometimes sandy beaches. Migrants also stop inland on freshwater ponds with muddy margins. Breeds in far north, mostly in open bogs, marshes, and edges of lakes within coniferous forest zone.
Wood Thrush	<i>Hylocichla mustelina</i>	MBTA, BCC	Breeding habitat includes deciduous or mixed forests with a dense tree canopy and a fairly well-developed deciduous understory, especially where moist. Bottomlands and other rich hardwood forests are prime habitats. Also frequents pine forests with a deciduous understory and well-wooded residential areas. Thickets and early successional woodland generally do not provide suitable habitat.

¹ Habitat descriptions compiled from NatureServe 2020. Accessed online at: <http://explorer.natureserve.org/index.htm>.

3.4.1.4 Vegetation

Springfield is part of the Illinois prairies ecoregion. Current land use in the region consists largely of agricultural production, with most native prairies being converted to crops such as corn, soybeans and livestock (USEPA 2019a).

The proposed Project site consists of previously disturbed land currently used for general storage of materials. Vegetation in the areas adjacent to the Project site consist of asphalt or grasses and gravel; open grassy areas and small wooded riparian areas occur between the Project site and State Highway 36/72/55 and Lake Springfield (University of Illinois 2019; USGS 2018; MRLC, no date).

3.4.2 No-Action – Environmental Consequences

3.4.2.1 Aquatic

Under the No Action Alternative, the Proposed Action would not occur, and the Linde-BASF technology would not be tested at large pilot scale at CWLP. Implementation of the No Action Alternative would result in no changes to the project site or nearby aquatic resources.

3.4.2.2 Wildlife

Under the No Action Alternative, the Proposed Action would not occur, and the Linde-BASF technology would not be tested at large pilot scale at CWLP. Implementation of the No Action Alternative would result in no changes to the present wildlife habitat, noises, or emissions from the existing plant.

3.4.2.3 Vegetation

Under the No Action Alternative, the Proposed Action would not occur, and the Linde-BASF technology would not be tested at large pilot scale at CWLP. Implementation of the No Action Alternative would result in no changes to the project site and surrounding vegetation.

3.4.3 Proposed Action – Environmental Consequences

3.4.3.1 Aquatic

The erosion and transport of sediment due to construction (e.g., clearing, excavating, filling) could result in localized water quality degradation of Lake Springfield due to its proximity to the Project (~75 feet away). Sediment deposition into surface waters can increase turbidity that can adversely affect aquatic species. For example, high turbidity levels can affect fish gill function, blood sugar levels, and behavior (e.g., altered response to predation risk). Sediment deposition into surface waters also can increase pollutant and nutrient levels, which can result in excess phosphorous loading that can enhance algal growth and the availability of oxygen for aquatic organisms. The use of construction equipment also could result in accidental spills or leaks of petrochemicals (e.g., gasoline, hydraulic fluids) that could reach surface waters if not contained and cleaned up. These petrochemicals can be toxic to aquatic organisms and can affect the health and survival of these organisms and their habitats. However, direct and indirect impacts to aquatic species and their habitats are not expected during construction or operation of the proposed Project. While there would be a potential for accidental spills or sediment to reach Lake Springfield, the use of engineering controls and best practices would limit the likelihood of such an accident. All surface runoff and wastewater generated during construction and operations would be controlled, contained, and treated prior to any discharge to Lake Springfield per the SWPPP and NPDES permits. These discharges to Lake Springfield would be in compliance with water quality standards and would not affect aquatic habitat conditions. Refer to Section 3.3.3.1, *Surface Water, Surface Water Quality, and Floodplains*, for additional details regarding potential impacts to water resources. Because there would be no direct or indirect impacts to aquatic species and their habitats, there would be no impacts to aquatic resources.

3.4.3.2 Special Status Species

SSS – Bats

Direct impacts to Indiana bat and northern long-eared bat are not anticipated. No potential roosting or foraging habitat exists within the Project site or would be disturbed during construction or operation of the proposed Project. Bats are a highly mobile species and mortality due to vehicular collisions with project-related vehicles or construction equipment would not be likely. All hazardous materials and wastes would be stored and disposed of in accordance with CWLP's Environmental Health and Safety program requirements and the project's hazardous

materials handling and waste disposal plan, so the potential for exposure to hazardous chemicals in the event of an accidental release would be unlikely.

Indirect impacts associated with the proposed Project include increased construction-related noise, human presence, and the use of artificial lighting. These impacts already occur at the proposed Project site in association with operation of the current CWLP facility and would increase slightly under the Proposed Action. Bats may use roosting or foraging habitat in the wooded areas surrounding the proposed Project site and increased construction-related disturbance may cause temporary habitat displacement or aversion to use of adjacent habitats. However, due to current levels of human presence and noise in the vicinity, individuals are likely to be acclimated to human presence and noise. Given the lack of suitable roosting and foraging habitat within the proposed Project site, and the temporary nature of the proposed Project, impacts to special status bat species would likely be minor and short term in duration and would not result in population-level impacts to the bat population.

SSS – Bald Eagle

Publicly available historical nest occurrence data indicate that no bald eagle nest sites or territories are located within 1-mile of the Project area (EcoCAT 2018). No direct or indirect impacts to bald eagles or eagle nesting or foraging habitat would occur from construction or operation of the Project. The proposed Project site currently consists of a gravel industrial storage area devoid of any vegetation; therefore, the Project would not result in any changes to habitat quality or vegetation community composition or result in reduced prey availability for bald eagles. Mortality from exposure to hazardous chemicals would be unlikely, as described above. The Project would have no impact on bald eagles.

SSS – Barn Owl

An online review using the IDNR Ecological Compliance Assessment Tool (EcoCAT) reported that a known occurrence of barn owl was recorded at the Project site. Further consultation with IDNR determined the online information was from a September 2011 record of a barn owl nest (with two juveniles) on CWLP property in an unused fan housing. Both juveniles left the location and no additional occurrences of barn owls have been recorded at the site. Therefore, no current nests are known to be present in the area, and IDNR determined that it was unlikely that activities (construction, operation) such as those associated with the Proposed Action would have any impact on barn owl, or other state listed species (University of Illinois 2019).

SSS – Kirtland's Snake

IDNR reported that Kirtland's snake had the potential to occur in the Project area based on historical distribution; however, this species is not currently known to inhabit Sangamon County. The Project would not impact any wetlands and the Project site does not contain suitable habitat for this species. No impacts to this species are expected to occur.

SSS – Eastern Prairie Fringed Orchid

All surface disturbance associated with the Proposed Action would be located on the west side of the existing CWLP facility in an area that is currently used for general storage of materials. No eastern prairie fringed orchids are known to occur at the Project site, and no suitable habitat for the species exists within the Project area; therefore, no impacts to this species are expected to occur.

3.4.3.3 Migratory Birds

As identified in Table 3.1, a variety of migratory bird species have the potential to occur in the Project area. However, due to the lack of suitable nesting and foraging habitat within the Project area, no direct impacts to migratory birds would be expected to occur from the Proposed Action. Mortality due to vehicular collisions with project-related vehicles or construction equipment would not be likely, and all hazardous materials and wastes would be stored and disposed of in accordance with the City Water, Light and Power Safety Manual (2015).

Indirect impacts could occur to migratory bird species residing in habitats adjacent to the Project site due to increased noise, fugitive dust, and human presence associated with construction activities. This could result in habitat loss as a result of an avoidance response to an area greater than the disturbance footprint. However, human presence and noise currently exist in the Project area and would increase only slightly under the Proposed Action. Impacts to migratory birds would be short term and minor and would not result in population-level impacts.

3.4.3.4 Vegetation

The proposed Project area currently consists of a gravel industrial storage yard and does not contain any sensitive plant communities or sensitive habitats; therefore, no impacts to vegetation communities or special status plant species are expected from the Proposed Action.

3.4.3.5 Impacts Summary

DOE has contacted U.S. Fish and Wildlife Service to confirm the proposed Project would contribute no impacts to protected species. The U.S. Fish and Wildlife Service has not identified any issues associated with the proposed Project. Given the lack of impacts identified by both the Federal and state wildlife agencies as well as the temporary nature of the proposed Project, impacts to special status species are expected to be less than significant.

3.5 Health and Safety

3.5.1 Affected Environment

The affected environment for health and safety includes proposed Project construction and operations personnel, CWLP employees at CWLP, and members of the public that could be potentially exposed to health and safety impacts of the proposed Project.

Approximately 10 construction workers would be on site for 8 months for proposed Project construction, including construction of pilings and concrete pads, installation of structures and process equipment, and fabrication of ductwork to connect the testing facility to Unit No. 4. Construction workers on site could be exposed to workplace hazards and health and safety impacts during proposed Project construction and during project decommissioning after the end of proposed Project operations.

Linde-BASF has designed the testing facility to be fully automated, however, Linde-BASF has indicated that there would be operations personnel on site 24-hours per day for the duration of testing facility operation. Operations workers also would be involved in overseeing deliveries of process chemicals and materials at the truck loading/unloading station for the proposed Project and involved in other operations, materials management, and waste management activities, and could potentially be exposed to workplace hazards and health and safety impacts during project operations.

3.5.2 No-Action – Environmental Consequences

Under the No Action Alternative, the Proposed Action would not occur, and the Linde/BASF technology would not be tested at large pilot scale at CWLP. Implementation of the No Action Alternative would result in no increased potential for adverse impacts to public or employee health and safety from proposed Project construction, operation, or decommissioning. CWLP would continue to operate under existing conditions and would continue to adhere to CWLP's existing safety practices and procedures, and applicable standards.

3.5.3 Proposed Action – Environmental Consequences

Construction and operation of the proposed Project would result in the potential for health and safety impacts to proposed Project construction, operations, and decommissioning personnel, CWLP employees, and members of the public. Potential health and safety impacts to project construction and operations personnel would include workplace (occupational) injuries during construction, operation, and decommissioning including those related to operation of mechanical and electrical equipment, fall hazards, vehicle accidents, and potential occupational exposure to hazardous materials from transport, storage, and use of process chemicals including amine solvent, sodium hydroxide, and other corrosive, flammable, or toxic chemicals.

Linde-BASF would conduct construction and operation activities for the proposed Project in accordance with applicable health and safety regulations and guidelines, including applicable OSHA regulations and applicable CWLP and operator standards and guidelines. A project-specific worker health and safety program would be developed based on the existing CWLP health and safety protocols and procedures that apply to CWLP personnel and BASF and Linde-BASF protocols and procedures. The draft site safety plan would be provided to CWLP for alignment with existing site safety requirements and protocols including the CWLP Safety Manual (CWLP 2015). Implementation of a final site safety plan for the testing facility would be done in coordination with CWLP. The project-specific health and safety program would be incorporated into project training materials. Linde-BASF and CWLP would provide training for all testing facility operations personnel and all site visitors.

The City Water, Light and Power Safety Manual (2015) includes policies and procedures for general safety, including employee roles and responsibilities, incident reporting, hazardous conditions reporting, vehicle accidents, machine guarding, hazardous energy control (lockout/tagout), and confined space entry. The Safety Manual also includes policies and procedures for mandatory use of personal protective equipment based on employees' job activities and hazard potential, and policies and procedures for chemical and toxic substance safety including organic solvents and corrosives. Policies and procedures in CWLP Safety Manual would be applied to construction, operation, and decommissioning of the proposed Project. These policies and procedures would be supplemented for the proposed Project by project-specific policies and procedures developed by Linde-BASF that are specific to the capture process, (e.g., management of amine solvent).

Linde-BASF's comprehensive *Safety by Design* guidelines would be applied in designing the proposed Project and Linde-BASF would develop corporate-wide Standard Requirements, project-specific Standard Operating Procedures, and project-specific training materials would promote plant construction and operation safety and address potential construction and operational hazards. Linde-BASF would conduct a comprehensive Hazard and Operability study of the proposed Project design and proposed operation to identify potential hazards and apply mitigation measures to identified hazards. Elements of the HAZOP Study would include process subsystems of the Direct Contact Cooler, Absorber and Regenerator, as well as the supply of utilities such as flue gas, cooling water, steam, potable water, process water and instrument air.

Safety elements of the proposed test facility design include:

Flue gas supply and return valves would be constructed of corrosion-resistant material and would be of automatic fail-close design. The cooling water system would be designed to prevent amine solvent from entering the cooling water system, and the skid containment system design of the proposed facility would include a manually operated pump system to allow sampling of contaminated liquid before any transfer to the wastewater line. Process equipment and piping would be designed to maintain acceptable surface temperatures in accordance with established

CWLP Safe Operating Standards, and equipment would be designed and installed to maintain the maximum feasible distance from underground power lines.

Linde-BASF would conduct Process Safety Reviews of proposed Project systems at five distinct stages to identify and mitigate potential hazards. The five stages are (1) project initiation and definition, (2) project award/start, (3) design, (4) construction, and, (5) plant operations. Each Process Safety Review would review a series of checklists including safety and environment, technology/design, and plant controls and shut down. CWLP relies on the City of Springfield Fire Department to respond to all but minor fires at the facility. It is anticipated that the proposed Project would follow the same fire response plan as is in place for CWLP.

Operation of the proposed Project would involve use of hazardous materials including amine solvent, sodium hydroxide (caustic), and VOM. Operation of the proposed Project would use 24,000 gallons of amine solvent as a process fluid to capture the CO₂ from the power plant flue gas. Up to 34,830 gallons of fresh (unused) amine solvent would be delivered to the site once by truck prior to commencement of operation; the fresh amine solvent would be stored in an above-ground storage tank and spent (used) solvent would be stored in an above-ground storage tank within the limits of the testing facility. The spent solvent would be stored on site for the duration of the proposed testing facility operation and would be transported off site for disposal after the end of proposed Project operation. Transport, storage, and handling of fresh and spent amine solvent would be conducted in accordance with solvent handling guidance developed by BASF.

Both fresh and spent amine solvent storage tanks would be located within a secondary containment system to contain any potential releases, and amine piping would be welded, rather than flanged, to reduce the potential for leakage from the piping system. Operation of the proposed Project would use caustic to remove sulfur dioxide from the power plant flue gas prior to processing in the CO₂ capture process. Caustic would be delivered to the site periodically by truck, to a truck unloading station. Caustic would be stored in a storage tank within the boundaries of the testing facility. The storage tank would be located within a secondary containment of sufficient volume to contain 110 percent of the volume of the storage tank, to control any potential releases. Operation of the proposed Project also would involve use of low-pressure and high-pressure steam and capture of CO₂; releases of which to the workplace environment also could result in potential occupational health and safety hazards.

The capture process including storage tanks would be equipped with safety relief valves that would open in the event of pressure excursions in the process equipment. These relief valves would reduce the potential for unplanned releases from process equipment and storage tanks. Safety relief valves would be designed in accordance with applicable standards for storage vessels and equipment. Safety relief valves would only operate in the event of process vessel mechanical failure and would not open during routine operation of the testing facility. Process instrumentation design would include safety-instrumented systems, flow restriction and safety interlocks, automatic safe-shutdown capability, and emergency power supply to maintain process safety reduce the potential for unplanned incidents.

All Project-related construction personnel and operations personnel would receive training in areas relevant to construction and operational safety and their job requirements including Hazard Communication/Right-to-Know, Hazardous Materials Management/Chemical Hygiene, Job Safety Assessment, and Hazardous and Solid Waste Management. Construction and operations personnel would use personal protective equipment appropriate for their work activities in accordance with CWLP safety plan and applicable requirements. The testing facility would be equipped with eye wash stations and emergency showers for response to chemical exposure from amine solvent and from handling of other hazardous materials.

3.6 Solid and Hazardous Waste

3.6.1 Affected Environment

The affected environment for solid and hazardous waste management includes on-site areas within CWLP in which solid and hazardous wastes would be generated and stored and off-site locations in which solid and hazardous wastes generated from testing facility construction, operation, and decommissioning would be transported and disposed. The CWLP generates solid and hazardous wastes from its existing power plant operations, including coal combustion solids, spent solvents, waste oil, municipal solid waste, and other solid and hazardous wastes, which are managed in accordance with CWLP's solid and hazardous management procedures and in accordance with applicable local government and state standards for solid and hazardous waste management including RCRA requirements. Municipal solid waste from CWLP is transported off site to local municipal solid waste landfills for disposal. Waste oil, spent solvents, and other solid and hazardous wastes are transported off site for disposal to licensed treatment and disposal facilities.

3.6.2 No-Action – Environmental Consequences

Under the No Action Alternative, the Proposed Action would not occur, and the Linde-BASF technology would not be tested at large pilot scale at CWLP. Implementation of the No Action Alternative would result in no increase to the generation of solid waste or hazardous waste from the CWLP site. CWLP would continue to operate under existing conditions and would continue to adhere to CWLP's existing solid and hazardous waste practices and procedures, and applicable standards.

3.6.3 Proposed Action – Environmental Consequences

Construction of the proposed Project would generate solid and hazardous wastes including construction and demolition debris from site clearing, excavation, and construction, and potentially waste oils, spent solvents, and other solid waste (e.g., scrap metal) from construction activities. Solid and hazardous wastes generated from construction activities would be managed by the construction contractor and transported off site for disposal at licensed facilities.

Stormwater generated from the construction site would be managed in accordance with the construction permit and site-specific stormwater pollution prevention plan and erosion and sedimentation control plan for the construction site.

Operation of the proposed Project would generate solid and hazardous wastes. It is anticipated that the proposed Project would obtain a separate RCRA hazardous waste generator number from the IEPA and would not operate under CWLP's hazardous waste generator number. It is anticipated that the proposed Project would be categorized as a Resource Conservation and Recovery Act (RCRA) hazardous waste large-quantity generator based on the types and quantities of hazardous wastes anticipated to be generated by proposed Project operations. RCRA large-quantity generator are required to remove hazardous waste from the site within 90 days of the date of waste generation. The IEPA has indicated that the planned one-time removal of spent solvent and activated carbon at the end of the capture process operations may be categorized by the IEPA as an episodic event under RCRA regulation 40 CFR 262 subpart L and indicated that the proposed Project may then be categorized as a small quantity generator rather than as a large-quantity generator.

The proposed Project operation would involve use of amine solvent for the CO₂ capture process and also would involve use of other process materials, the use of which would result in generation of solid waste and hazardous waste. Up to 34,830 gallons of amine solvent would be delivered to the proposed Project site prior to commencement of operation. Spent solvent would be stored in an on-site above-around storage tank for the duration of proposed Project operation. The volume of solvent utilized in the 10 MWe testing facility is expected to be approximately 24,000 gallons. At the end of proposed Project operations, a one-time removal of the full spent solvent inventory is expected, along with any remaining fresh (unused) solvent.

The proposed Project operation also would involve use of activated carbon to remove surface-active contaminants and dissolved or emulsified high molecular organic compounds. Spent activated carbon also would be stored on site for the duration of proposed Project operations and there would be a one-time removal of the spent carbon from the proposed Project site at the end of the proposed Project operation. Spent activated carbon would be returned to the activated carbon supplier for regeneration and reuse elsewhere. The amount of solid waste generated from the activated carbon bed would be approximately 1.2 cubic meters (m³) or 1.7 metric tons of spent carbon.

Filter cartridges would be used in the mechanical filter process to remove particulate matter from the amine solvent. The frequency of replacement of the filter cartridges would be minimized through the design and size of the filter, with an estimated duration of one filter cartridge per six months. Off-site transport and disposal of the spent filter cartridges would be conducted by a vendor, to a licensed off-site hazardous waste treatment and disposal facility. Approximately 0.14 m³ of spent filter cartridges would be generated annually from proposed Project operations.

The spent solvent would be collected and stored in an above-ground storage tank within the limits of the testing facility until the completion of proposed Project operation. Off-site transport

and disposal of the spent solvent would be conducted by a vendor, to a licensed off-site hazardous waste treatment and disposal facility.

Off-site disposal locations and vendors for offsite transport and disposal of solid and hazardous wastes generated from proposed Project operations would be coordinated with direct oversight from CWLP and in accordance with CWLP's site-specific waste management processes and procedures, therefore there would be no impacts from solid and hazardous wastes.

3.7 Infrastructure and Utilities

3.7.1 Affected Environment

The affected environment for infrastructure and utilities includes the existing utility infrastructure at CWLP and the existing production of electricity, water, and steam at the CWLP. CWLP includes four coal-fired steam turbine electric generators (with a total rating of 578 MW), one dual-fuel natural gas and oil-fired combustion turbine (with a total rating of 115 MW), and two oil-fired combustion turbines (with a total rating of 31 MW). CWLP produces electricity and water as a public utility and consumes electric and water in operating its electric power generation equipment. CWLP generates wastewater that is treated in CWLP wastewater treatment plant and subsequently discharged under an NPDES permit. CWLP power plant flue gas desulfurization system effluent is indirectly discharged to the Sangamon County Water Reclamation District under a separate discharge permit.

3.7.2 No-Action – Environmental Consequences

Under the No Action Alternative, the Proposed Action would not occur, and the Linde-BASF technology would not be tested at large pilot scale at CWLP. Implementation of the No Action Alternative would result in no construction of utility infrastructure and would not result in any increase in consumption of water, electricity, or natural gas at the CWLP site. The No Action Alternative would result in no increase in generation of wastewater or stormwater from the CWLP site. CWLP would continue to operate under existing conditions and would continue to consume electricity and water for its electric power generating operations and would continue to generate wastewater from its electric power generating operations. CWLP would continue to adhere to CWLP's wastewater and stormwater management practices and procedures, and applicable standards.

3.7.3 Proposed Action – Environmental Consequences

3.7.3.1 Water and Wastewater

High-pressure steam, low-pressure steam, cooling water, and potable water would be provided to the testing facility by CWLP through direct connections to CWLP electrical, steam, process

water, and potable water systems. All utilities provided to the testing facility by CWLP would be directly metered by CWLP.

Approximately 5,130 gpm (1,170 m³/h) of cooling water at an average temperature of 84° F would be required for testing facility operation. Cooling water would be returned from the testing facility to CWLP at an average temperature of 100° F.

Potable water would be used for eyewash stations and safety showers at the capture pilot plant. Potable water consumption (non-continuous) would be approximately 22 gpm (5.0 m³/h), but not continuously needed. Amine solvent would be supplied to the testing facility already premixed with water and therefore a large volume of fill water would not be needed for the amine solvent storage tank.

High-pressure steam at an average operating pressure of 253 pounds per square inch gauge (psig) (838° F) would be supplied by CWLP and expanded to 75 psig for use in the capture process. Steam condensate would be returned from the testing facility to CWLP.

During normal operation of the capture process the specific thermal energy consumption of the testing facility including the supply of high-pressure and low-pressure steam is expected to range between 2.3-3.0 Gigajoules (GJ)/metric ton captured CO₂, corresponding to approximately 600 GJ per day for capture of approximately 200 metric tons CO₂ per day.

Demineralized water would be needed for the capture process; potable or process water cannot be used for this purpose because the chlorine in the potable/process water would accumulate in the capture process. The operator and CWLP would develop a source of demineralized water for the capture process.

The following wastewater/stormwater streams would occur from operation of the testing facility:

Continuous flow:

- Process condensate from the Direct Contact Cooler flue gas treatment process

Discontinuous (intermittent) flow:

- Process condensate from the stripper condenser to maintain the stripper water balance
- Liquid waste from process (process water containing trace solvent concentrations)
- Liquids from cleaning/flushing process equipment during maintenance activities
- Stormwater runoff from the site

Several waste streams generated from the testing facility operation are being assessed for treatment options. The Direct Contact Cooler would generate approximately 1,400 gallons per hour (~34,000 gallons per day [gpd]) of process condensate during capture process operation (University of Illinois 2019a). The local municipality initially had concerns about sulfate compounds from the proposed Project Direct Contact Cooler wastewater but after further investigation, sulfates are no longer a major area of concern. Once final Direct Contact Cooler

wastewater concentration values are determined after detailed engineering, the proposed Project would proceed with choosing a wastewater design. The three main options are (1) Direct Contact Cooler wastewater would have its own treatment/sampling and discharge permit, (2) Direct Contact Cooler wastewater would have its own treatment/sampling but combine with CWLP discharge permit, and (3) Direct Contact Cooler wastewater would go through CWLP treatment/sampling and discharge permit. The engineering group CMT has been hired to work with the Sangamon County Water Reclamation District (SCWRD) in regard to development of a treatment/disposal method for this wastewater stream.

Operation of the capture process also would generate process water discharge containing 1-2 weight percent amine (University of Illinois 2019a); this discharge would be generated intermittently in the event that purging water from the capture process is needed to control the process water balance, or in the event that a solvent leak results in process water contamination. This wastewater stream also could not be managed by CWLP's on-site wastewater treatment plant. This wastewater, if generated, could be stored on site in CWLP's existing contaminated water storage tank prior to discharge to SCWRD, or may require disposal off site at a licensed hazardous waste treatment and disposal facility if wastewater is categorized as hazardous or special waste and the SCWRD cannot accept it for treatment.

Liquids that would intermittently be generated from maintenance activities also are not expected to be acceptable for treatment in CWLP's wastewater treatment plant. Any liquids generated would be monitored, and liquids that are not acceptable for treatment in CWLP's wastewater treatment plant would be either treated on site or disposed of offsite in licensed treatment and disposal facilities. Stormwater from the testing facility site that is not found to be uncontaminated also would be either treated on site or disposed of offsite in licensed facilities.

Upgrades to utility and waste management infrastructure are anticipated to occur at CWLP during the planning and construction of the testing facility. These may include:

- Addition of a filter press to the flue gas desulfurization (FGD) wastewater treatment plant
- Lime sludge ponds relocation
- CWLP wastewater treatment plant upgrades (such as rerouting piping or waste streams)
- Ash pond closure preparation

3.7.3.2 Stormwater

Captured and diverted uncontaminated stormwater from the testing facility site would be handled, treated and discharged by CWLP under its existing NPDES permit. No modification to the CWLP NPDES permit would be needed for management of uncontaminated stormwater from the testing facility. All stormwater generated from the testing facility would be monitored; any stormwater that is determined to be contaminated would be stored on site in CWLP storage tanks prior to treatment or offsite disposal or would be reused as process water within the capture process.

3.7.3.3 Electricity

Electricity needed to operate the testing facility would be supplied by CWLP through a direct connection to CWLP electrical system. Approximately 310 kW/day of electricity would be needed to operate the testing facility.

3.7.3.4 Natural Gas

The proposed testing facility would not be supplied with or consume natural gas.

3.8 Visual Resources

3.8.1 Affected Environment

The affected environment for visual resources includes the current view of the proposed Project site, an existing power plant along an interstate highway and the immediate surrounding area. The testing facility would be an addition to the power plant site and therefore is in character with the existing viewshed. Based on consultation with the Illinois State Historic Preservation Officer and the EIV for the proposed Project, no tribal-sensitive or other scenic vistas have been identified in the proposed Project area (University of Illinois 2019). The only identified visual resource at the proposed Project site is the graphic on the side of Unit No. 4, indicating that Springfield is the hometown of President Lincoln. A vegetative buffer consisting of grasses, shrubs, and trees occupies the area between the interstate highway (Routes 36/72/55) and the existing CWLP facility.

3.8.2 No-Action – Environmental Consequences

Under the No Action Alternative, the Proposed Action would not occur, and the Linde-BASF technology would not be tested at large pilot scale at CWLP. Implementation of the No Action alternative would result in no construction of utility infrastructure associated with the testing facility and no changes in the existing view of the power plant including the Lincoln graphic on Unit No. 4.

3.8.3 Proposed Action – Environmental Consequences

Under the Proposed Action, the testing facility would be constructed on the southwest side of the existing CWLP facility. The installation would include three columnar structures consisting of a direct contact cooler, absorber, and stripper; all approximately 8.5 feet in diameter and 90, 190, and 120 feet in height, respectively. The main viewpoint of the Lincoln graphic on Unit No. 4 for residents and visitors to Springfield occurs while traveling on Routes 36/72/55, an interstate highway with speeds of 55 mph or greater. Visual modeling indicates the proposed Project's columnar structures intersect, but do not block this graphic as viewed on the direct approach to the power plant from Routes 36/72/55 (Figure 3.1).

Figure 3.1. Direct Approach from Highway – Lincoln Graphic

From angles of view on the highway other than the direct approach, the columnar structures do not interfere with the view of the graphic (Figure 3.2). Because the proposed Project is intended to be a temporary installation, the entire view of the graphic would be restored after Project completion.

Figure 3.2. Side View from Highway– Lincoln Graphic

The proposed Project does not include removal of surrounding vegetation; further minimizing visual impacts. As the view of the Lincoln graphic is only partially blocked on the direct approach when traveling on Routes 36/72/55, and is fully viewable from other aspects when travelling on the highway, the impacts to visual resources are minimal and temporary and do not affect the purpose of the graphic installation.

3.9 Socioeconomic Conditions

3.9.1 Affected Environment

The proposed Project site is in Springfield, Illinois, which is in Sangamon County. Table 3.3 below illustrates the demographic information in Springfield, Sangamon County, Illinois, and the United States (USCB, no date(a)); (USCB, no date(b)).

Table 3.3. Demographic and Economic Information 2018

	Springfield City	Sangamon County	Illinois	United States
Total Population	116,459	197,661	12,821,497	322,903,030
Percent of population under 18 years of age	22.0	22.6	22.8	22.8
Percent of population over 65 years of age	16.9	16.7	14.8	15.2
Percent of population identifying as Caucasian, non-Hispanic	71.3	80.5	61.6	61.1
Percent of population identifying as African American	19.7	12.6	14.0	12.3
Percent of population unemployed	7.5	5.2	5.5	4.9
Percent of population in poverty	18.2	13.4	12.1	13.1

As depicted in Table 3.3, the City of Springfield has similar demographic characteristics to Sangamon County with slightly higher unemployment and people in poverty as well as larger percent of people identifying as African American. Besides the larger percent of population being Caucasian, Sangamon County has minimal differences in these demographics to the state of Illinois. There are negligible differences between state of Illinois and the United States with the demographic and economic characteristics (USCB, no date(a)); (USCB, no date (b)).

The healthcare and social assistance industry employees the largest percentage of people in the city of Springfield (17.9 percent), followed by public administration (14.3 percent), retail (10.9 percent), and accommodation and food service (7.6 percent). Finance and insurance (5.8 percent) and professional, scientific, and technical services (5.6 percent) employed higher percentages of the working population than other services except public administration

(4.5 percent), construction (3.5 percent), and transportation, wholesale trade, and information, all less than 3 percent (University of Illinois 2019).

3.9.2 No-Action – Environmental Consequences

Under the No Action Alternative, the Proposed Action would not occur, and the Linde-BASF technology would not be tested at large pilot scale at CWLP. Implementation of the No Action alternative would result in no change to purchases of materials, construction jobs, and no operations and maintenance jobs. No change would occur in the employment and demographics for the area and therefore there would be no impacts to Socioeconomic conditions.

3.9.3 Proposed Action – Environmental Consequences

As proposed, the temporary construction workers would spend money in the local area, such as meals and possibly hotels. These expenditures would be short-term and localized, so they are unlikely to have measurable impact to Springfield’s economy as Springfield has diverse industries employing residents.

During operation, the proposed Project would first offer employment to current employees impacted by the retirement of existing power plant units, and no additional employment positions are planned for operation activities, thereby decreasing the impact of the proposed Project to the community employment or changing the demographics of the area (University of Illinois 2019b). Even if all eight expected full-time equivalent staff (one person working full time for one year) were new hires, the impact would be negligible on the city’s population of over **116,000** people (University of Illinois 2019).

The budget for the proposed Project is \$3.7 million. While the proposed Project proponents would attempt to utilize local contractors for the proposed Project, it is not suspected that all of the expenditures would be local. Therefore, the proposed Project would be expected to have a minor, short-term, and beneficial impact on the economy.

3.10 Resource Areas Dismissed from Further Review

3.10.1 Geology and Soils

The soils in the proposed Project area are mostly Osco silt loam with some Elco silty clay loam (USDA, no date(a)). These soils are moderately erodible (USDA, no date(a)); USDA, no date(b)). The proposed Project site’s soils were historically disturbed and include both permeable and impervious surface. Subsurface activities for construction of the proposed facility would be limited to construction of pilings to accommodate equipment weight at the site. The construction would disturb soils down to an estimated maximum of 25 to 35 feet for installation of pilings. Standard soil erosion prevention measures (e.g., sediment fencing or construction berms or barriers) would be used to minimize construction impacts (University of Illinois 2019). The

proposed Project's operation would not disturb soils or geology. Consequently, with erosion control measures in place, negligible impacts to soils and geology would be anticipated and this topic was dismissed from further analysis.

3.10.2 Land Use

A current power and water treatment plant is the planned location for the proposed Project. The current land use of the proposed Project site is general materials storage for the power plant and water treatment plant. The proposed Project would not expand the footprint of the existing power and water treatment plant (University of Illinois 2019). Since the proposed Project also is utilities-related and would not change the existing facility's boundaries, the proposed Project does not represent a change in land use, and this topic has been dismissed from further analysis.

3.10.3 Cultural and Paleontological Resources

The planned proposed Project location is a previously disturbed area of an industrial site, and there are no known cultural resources on or adjacent to the site. Consultation with the Illinois State Historic Preservation Officer has occurred (see Appendix B) and no cultural resources have been identified based on that consultation. The proposed Project would not be located on or adjacent to tribal lands, lands considered to be sacred or lands used for traditional purposes. There are no known tribal sensitivities for the proposed Project site (University of Illinois 2019). The closest site on the National Register of Historic Places (NRHP) is 2.4 miles away (National Park Service 2014). Given the distance to the closest NRHP site and the proposed Project site's current industrial character, the proposed Project is not anticipated to impact any NRHP site.

Paleontological resources (fossils) most commonly occur in sedimentary rocks. In the proposed Project area, sedimentary rocks are found near streams, and the proposed Project site is not located on or near a stream (University of Illinois 2019). Thus, the proposed Project is unlikely to disturb paleontological resources.

During construction, an appropriately trained person would supervise the construction activities to monitor for cultural and paleontological resources. If cultural or paleontological resources were to be discovered, the proposed Project work would stop, and appropriate authorities would be notified.

Six Federally Recognized Tribes have expressed interest in activities in Sangamon County. They include the Kickapoo Tribe of Indians of the Kickapoo Reservation in Kansas, Kickapoo Tribe of Oklahoma, Menominee Indian Tribe of Wisconsin, Miami Tribe of Oklahoma, Osage Nation, and Peoria Tribe of Indians of Oklahoma (Housing and Urban Development, no date). DOE has contacted these Tribes to confirm the proposed Project would contribute no impacts to Tribal interests. Because the Tribes have not identified any tribal issues associated with the proposed Project and because monitoring during any soil disturbance deeper than the historical disturbance

depth would occur, the proposed Project is not expected to have any impacts on cultural resources, and this topic has been dismissed from further analysis.

3.10.4 Environmental Justice

Executive Order 12898, *Federal Actions to Address Environmental Justice in Minority Populations and Low Income Populations*, requires all Federal agencies to identify and address disproportionately high and adverse human health or environmental effects of their programs and policies on minorities and low-income populations and communities. The population of Springfield, Illinois does include some levels of minority and low-income populations. However, neither minority nor low-income populations live adjacent or in close proximity to the proposed Project site, as the CWLP site, and therefore the proposed testing facility site, are separated from any residential area by Springfield Reservoir, vegetation including trees, and roadways including Routes 36/72/55 and Adlai Stevenson Drive (USEPA 2019b). As described in the other resource area analysis, the proposed Project is not expected to have significant adverse impacts. Consequently, given the proximity of the proposed Project location to the environmental justice populations and the low to negligible level of adverse impacts from construction and operation of the proposed Project, no disproportional adverse impacts on low-income or minority populations are anticipated, and this topic has been dismissed from further analysis.

3.10.5 Noise

The Noise Control Act of 1972, 42 U.S.C. § 4901 et seq., directs federal agencies to carry out programs in their jurisdictions to the fullest extent within their authority and in a manner that furthers a national policy of promoting an environment free from noise that jeopardizes health and welfare. This would involve complying with applicable municipal noise ordinances to the maximum extent practicable. Illinois regulates noise at the state level with authority found in 415 ILCS 5/23 et seq.

The proposed Project site on-site and adjacent to an active power plant and is separated from sensitive receptors (e.g., residents or schools) by Springfield Reservoir, vegetation including trees and shrubs, and roadways including Routes 36/72/55 and Adlai Stevenson Drive. The nearest schools are Concordia Lutheran School – Preschool and Laketown Elementary 0.77 miles and 1.1 miles respectively; the nearest hospital, West Lake Center Hospital is 0.47 miles; and the nearest residences are 0.35 to the east in a dense neighborhood, and a strip of lakeshore houses 0.33 miles to the south (USEPA 2019b).

No special construction equipment is anticipated to be used and while multiple construction equipment is likely to be used simultaneously, construction is planned for day-time hours when noise is likely to be masked by other existing noise sources. The proposed Project may have weekend or night construction activities if required to react to weather events or material deliveries (University of Illinois 2019b). Perceived impacts from night or weekend noise may be greater as less ambient noise from traffic and other human activities would occur concurrently,

however night construction is not planned and therefore would be an infrequent occurrence that would be minimized to the extent possible. In addition, the proposed Project would not remove any natural or artificial noise barriers (University of Illinois 2019).

The proposed Project would be engineered and conducted such that its activities would not exceed any local, state, or Federal regulations, including those established to protect worker and community hearing. Due to planned decommissioning of some older units on site, the net change in operation noise in the proposed Project area would likely be minimal. If subsequent noise modeling indicates the construction or operational noise would be greater than allowed by any regulation, noise abatement measures, such as hearing protection or screening, would be implemented (University of Illinois, 2019). Consequently, the proposed Project is expected to have minimal changes to the current noise environment, and this topic has been dismissed from further analysis.

3.11 Cumulative Impacts

As defined by CEQ, cumulative effects are those that “result from the incremental impact of the Proposed Action when added to other past, present, and reasonably foreseeable future actions, without regard to the agency (federal or non-federal) or individual who undertakes such other actions” (40 CFR 1508.7). Cumulative effects analysis captures the effects that result from the Proposed Action in combination with the effects of other actions taken during the duration of the Proposed Action at the same time and place. Cumulative effects may be accrued over time and/or in conjunction with other pre-existing effects from other activities in the area (40 CFR 1508.25); therefore, pre-existing impacts and multiple smaller impacts should also be considered. Overall, assessing cumulative effects involves defining the scope of the other actions and their interrelationship with the Proposed Action to determine if they overlap in space and time.

The NEPA and CEQ regulations require the analysis of cumulative environmental effects of a Proposed Action on resources that may often manifest only at the cumulative level. Cumulative effects can result from individually minor, but collectively significant actions taking place at the same time, over time. As noted above, cumulative effects are most likely to arise when a Proposed Action is related to other actions that could occur in the same location and at a similar time.

3.11.1 No Action – Environmental Consequences

Implementation of the No-Action Alternative would result in no increased potential for adverse cumulative impacts. Construction of the Proposed Action would not occur, the Large Pilot Testing Facility would not be constructed and ultimately operated at the CWLP facility, the proposed Project disturbance area and construction laydown area would not be cleared and prepped for construction activities, and the proposed utility lines would not be constructed to support the proposed Project. As such, the No-Action Alternative would not contribute to cumulative effects within the CWLP facility or the City of Springfield.

3.11.2 Proposed Action – Environmental Consequences

This section identifies reasonably foreseeable proposed Projects that may have cumulative, incremental impacts in conjunction with the Proposed Action.

3.11.2.1 Future Planned Operation of the Large Pilot Testing Facility

There currently is no plan for continued operation of the testing facility past the proposed testing timeframe of two years. As proposed, when testing is completed, the facility would be decommissioned and removed from CWLP grounds. Decommissioning activities would result in temporary and minor adverse cumulative impacts to air quality, noise, materials and wastes, and health and safety. CWLP plans to retire Dallman Units 31 and 32 by December 31, 2020 and Unit 33 no later than October 1, 2023 (CWLP 2019a).

3.11.2.2 Future Planned Projects at CWLP

CWLP completes infrastructure maintenance and upgrades to maintain the existing infrastructure and support potential future growth opportunities. The following are planned to be performed in the same timeframe as the construction of the Large Pilot Testing Facility:

- Addition of a filter press to the flue gas desulfurization wastewater treatment plant
- Preparation for ash pond closure
- Wastewater treatment plant upgrades (such as rerouting piping or waste streams)
- Relocation of lime sludge ponds

The infrastructure modifications would result in temporary minor adverse cumulative impacts to air quality, noise, materials and wastes, and health and safety.

3.11.2.3 City of Springfield Road and Bridge Projects

According to the Comprehensive Plan – City of Springfield, Illinois (SSCRPC 2018), capital proposed Projects with committed funding that are planned for the City of Springfield from 2015-2019 include:

- The extension of 11th Street, East Knox to Lincolnshire Boulevard
- Archer Elevator Road – YMCA driveway to Concordia Village driveway and Iles Avenue – Meadowbrook Road to Rotary Park
- Stanford Avenue – 11th Street to Fox Bridge Road entrance
- Stanford Avenue Extension – Fox Bridge to Taylor

Planned illustrative Road and Bridger projects for 2020-2030 would total approximately \$159 million; as of the publication of the Comprehensive Plan in 2017, funding was not yet committed (SSCRPC 2018). In addition, an expansion of Business I-55 Sixth Street is in the

planning phase; however, construction is not anticipated to overlap with construction of the Large Pilot Testing Facility (IDOT 2020).

The transportation improvements would not impact use of the main routes for transportation of construction equipment and supplies to CWLP, and cumulative impacts with the proposed testing facility would be negligible (IDOT 2020; SSCRPC 2018).

3.11.2.4 Greenhouse Gases and Climate Change

Climate change is an inherently cumulative effect caused by releases of greenhouse gases from human activities and natural processes around the world. Greenhouse gases (GHG) are compounds in the atmosphere that absorb and emit radiation, effectively trapping heat (longwave radiation) and causing what is known as the greenhouse effect. The greenhouse effect causes the Earth's atmosphere to warm and thereby create changes in the planet's climate systems. The primary GHG in the Earth's atmosphere are water vapor, CO₂, methane, nitrous oxide, and ozone. Scientists quantify and analyze GHG using the common unit of CO₂-equivalents (CO₂-eq), which is based on the global warming potential of each greenhouse gas. CO₂-eq signifies the functionally equivalent amount or concentration of CO₂ that would have the equivalent global warming impact.

During the construction phase, GHG emissions would result from construction of the Large Pilot Testing Facility components. Direct GHG emissions including CO₂, methane, and nitrogen dioxide would result from diesel fuel and gasoline consumption for operation of construction equipment and vehicles. Indirect GHG emissions would result from electricity consumption (e.g., lighting) for proposed testing facility construction.

During operations, the Large Pilot Testing Facility would result in indirect GHG emissions including CO₂, methane, and nitrogen dioxide from electricity consumption (e.g., lighting, electric-powered process equipment) and steam (e.g., process heat) for proposed testing facility operation. Direct fuel consumption for the proposed testing facility would be limited to emergency power generation. DOE has estimated that operation of the proposed testing facility would require 310 kw of electricity and 600 gigajoules per day of thermal (steam) energy. In 2018 CWLP power plant units generated 2.4 million net megawatt-hours of electricity and emitted 2.4 million metric tons of CO₂ (USEPA 2019c). Approximately 45 percent of the net electricity generation from the Dallman power plant units in 2018 was from Dallman Unit No. 4 (CWLP 2019). The estimated 310 kw electricity consumption and 600 gigajoules per day of thermal (steam) energy consumption for operation of the proposed testing facility would therefore result in a minimal cumulative increase in GHG emissions from CWLP.

The Large Pilot Testing Facility is designed to test a technology for capturing CO₂ from the power plant's Dallman Unit No. 4, however, the CO₂ captured by the Large Pilot Testing Facility operation would be captured solely for the purposes of technology demonstration, and the captured CO₂ would subsequently be reintroduced into the Unit No. 4 power plant stack and would be emitted to the atmosphere. The amount of CO₂ emitted by the power plant's Dallman

Unit No. 4 during Large Pilot Testing Facility Operation would therefore be approximately the same as if the Large Pilot Testing Facility were not operating. Minor amounts of GHGs would be emitted indirectly through the consumption of steam and electricity for operation of the Large Pilot Testing Facility. In total, therefore, the proposed Project would result in minor release of GHGs to the atmosphere.

Because climate change is considered a cumulative global phenomenon, it is generally accepted that any successful strategy to address climate change must rest on a global approach to controlling GHG emissions. As discussed in Chapters 1 and 2, part of the purpose and need of the research proposed in this proposed Project is geared toward development and testing of a technology that reduces the amount of CO₂ released into the atmosphere from combustion of fossil fuels, thereby reducing GHG emissions. Advancement of this technology would be beneficial in reducing plant emission including GHGs, and ultimately would reduce the rate and magnitude of climate change.

This page intentionally left blank.

CHAPTER 4. LIST OF PREPARERS

U.S. Department of Energy – National Energy Technical Laboratory

Pierina N. Fayish – DOE NEPA Document Manager

B.S. Marine Science; M. Environmental Science and Management

16 years of experience

ICF Jones & Stokes

Neil Sullivan – Managing Director, Environmental Planning

B.S., Human and Physical Geography, M. Sc., Integrated Environmental Management,

21 years of experience

Debra Sehi – Project Manager/Senior Environmental Planner

B.S., Environmental Health

26 years of experience

Robert Lanza, P.E. – Chemical Engineer Principal

B.S., Chemical Engineering; M. Eng., Chemical Engineering

39 years of experience

David Johnson – Senior Biologist

B.S., Biology

35 years of experience

Meghan Edwards, PMP and ACP – Senior Environmental Planner

B.A., Environmental Studies; M. Natural Resources,

14 years of experience

Sara Stribley, Biologist

B.S., Biology

9 years of experience

Lissa Johnson – Senior GIS Analyst

B.A., Digital Media Studies; B.A., Anthropology

14 years of experience

This page intentionally left blank.

CHAPTER 5. LITERATURE CITATIONS

- Austen, D.J., J.T. Peterson, B. Newman, S.T. Sobaski, and P.B. Bayley. 1993. Illinois Natural History Survey – Compendium of 143 Illinois Lakes: Bathymetry, physico-chemical features, and habitats. Prepared for the Illinois Department of Conservation Division of Fisheries. Technical Report 93/9. June. Accessed January 15, 2020.
https://www.ideals.illinois.edu/bitstream/handle/2142/10252/inhscae01993i009_2_opt.pdf?sequence=2&isAllowed=y.
- Bergstrom, R.E., K. Piskin, and L.R. Follmer. 1976. Geology for Planning in the Springfield-Decatur Region, Illinois. Illinois State Geological Survey Circular 497.
- CWLP (City Water, Light and Power). 2019. Springfield City Water, Light, and Power – Electricity Generation, 2018. Accessed January 23, 2020.
<https://www.cwlp.com/Departments/ElectricDeptHome/ElectricInformation/Generation.aspx>.
- CWLP. 2019a. Integrated Resource Plan Update, Generation Unit Retirements, Public Forum Meeting. January 29, 2020.
<https://www.cwlp.com/Documents/CWLP%20Public%20Forum%20Generation%20Retirements%201-29-20%20.pdf>.
- CWLP. 2015. City Water, Light, and Power Safety Manual. Springfield City Water, Power, and Light Environmental Health and Safety Office, November, 2015.
- FEMA (Federal Emergency Management Agency). 2007. Floodplain Management: Principles and Current Practices. Chapter 8: Floodplain Natural Resources and Functions. FEMA Emergency Management Institute. Accessed January 13, 2020.
<https://training.fema.gov/hiedu/aemrc/courses/coursetreat/fm.aspx>.
- FEMA. 2007a. Flood Insurance Rate Map (FIRM) for Sangamon County, Illinois, and incorporated areas. Panel 265 of 575; Map Number 17167C0265F.
- Housing and Urban Development. No date. Tribal Directory Assessment Tool (TDAT). Accessed December 11, 2019. <https://egis.hud.gov/TDAT/>.
- IDOT (Illinois Department of Transportation). 2020. Sangamon County – I-55/South Sixth Street Expansion Project. Accessed January 8, 2020. <http://www.idot.illinois.gov/Projects/I-55-Sixth-Street-Project>.
- IEPA (Illinois Environmental Protection Agency). 2019. Illinois Integrated Water Quality Report and Section 303(d) List, 2018. Accessed January 13, 2020.
<https://www2.illinois.gov/epa/topics/water-quality/watershed-management/tmdls/Pages/303d-list.aspx>.

- IEPA. 2018. Illinois Annual Air Quality Report: 2018 Illinois Environmental Protection Agency, Bureau of Air 1021 North Grand Avenue, East Springfield, IL 62794-9276: Figure 9: 2018 Air Quality Index Summaries by Sector. Accessed January 16, 2020. <https://www2.illinois.gov/epa/topics/air-quality/air-quality-reports/Documents/2018%20Annual%20Air%20Quality%20Report%20Final.pdf>.
- IEPA. 2017. Responsiveness Summary for the Revised Clean Air Act Permit Program (CAAPP) Permit Issued to: City of Springfield for the City Water Light and Power Dallman Station, Springfield, Illinois September 11, 2017: Source I.D. No.: 167120AAO; Permit No.: 95090091. Accessed January 16, 2020. <https://www2.illinois.gov/epa/Documents/iepa/public-notices/2016/cwlp-dallman/95090091-issued-revised-caapp-rs.pdf>.
- Illinois State Museum. 2006. Mussels of Illinois: Mussel Database. Accessed January 15, 2020. <http://www.museum.state.il.us/ismdepts/zoology/mussels/database.html>.
- Makowski, P.B., W.P. Fitzpatrick, and N.G. Bhowmik. 1986. Reservoir Yield Analysis of Lake Makowski, P.B., W.P. Fitzpatrick, and N.G. Bhowmik. 1986. *Reservoir Yield Analysis of Lake Springfield, Springfield, Illinois*. Illinois State Water Survey Contract Report 393. Accessed January 13, 2020. <https://www.isws.illinois.edu/pubdoc/CR/ISWSCR-393.pdf>.
- MRLC. No date. Multi-Resolution Land Characteristics. National Land Cover Database 2016 (NLCD2016) Legend. Accessed January 10, 2020. <https://www.mrlc.gov/data/legends/national-land-cover-database-2016-nlcd2016-legend>.
- NatureServe. 2019a. NatureServe Explorer: *Myotis sodalis*. Accessed January 10, 2020. <http://explorer.natureserve.org/servlet/NatureServe?searchName=Myotis%20sodalis>.
- NatureServe. 2019b. NatureServe Explorer: *Myotis septentrionalis*. Accessed January 10, 2020. <http://explorer.natureserve.org/servlet/NatureServe?searchName=Myotis%20septentrionalis>.
- NOAA (National Oceanic and Atmospheric Administration). 2019. Global Summary of the Year – Sangamon County, Illinois, 2018. National Oceanic and Atmospheric Administration. Accessed January 16, 2020. <https://www.ncdc.noaa.gov/cdo-web/datasets/GSOY/locations/FIPS:17167/detail>.
- National Park Service. 2014. National Register of Historic Places. Accessed January 10, 2020. <https://www.nps.gov/maps/full.html?mapId=7ad17cc9-b808-4ff8-a2f9-a99909164466>.
- SSCRPC (Springfield-Sangamon County Regional Planning Commission). 2018. Comprehensive Plan—City of Springfield, Illinois: 2017-2037. Accessed January 10, 2020. <https://www.springfield.il.us/Businesses/2037CompPlan.aspx>.
- U.S. Climate Data. No date. Climate Springfield – Illinois. Accessed September 8, 2018. <https://www.usclimatedata.com/climate/springfield/illinois/united-states/usil1114>.

- USCB (United States Census Bureau). No date(a). American Community Survey Demographic and Housing Estimates, 2018. Accessed January 17, 2020.
https://data.census.gov/cedsci/table?q=62703&g=0100000US_0500000US17167_0400000US17160000US1772000&table=S0101&tid=ACSST1Y2018.S0101&hidePreview=false&vintage=2018&layer=place&cid=DP05_0001E&lastDisplayedRow=26&moe=false&y=2018&t=.
- USCB. No date(b). American Community Survey: Selected Economic Characteristics (DP03). Accessed January 17, 2020.
https://data.census.gov/cedsci/table?q=unemployment&g=0100000US_0400000US17_0500000US17167_1600000US1772000&lastDisplayedRow=144&table=DP03&tid=ACSDP1Y2018.DP03&vintage=2018&mode=&hidePreview=true.
- USDA (United States Department of Agriculture). No date(a). Web Soil Survey. Accessed January 9, 2020. <https://websoilsurvey.sc.egov.usda.gov/App/WebSoilSurvey.aspx>.
- USDA. No date(b). Highly Erodible Land Definitions. Accessed January 9, 2020.
https://www.nrcs.usda.gov/wps/portal/nrcs/detailfull/pr/soils/?cid=nrcs141p2_037282.
- USEPA (U.S. Environmental Protection Agency). 2019a. Ecoregion Download Files by State – Region 5. Accessed January 10, 2020. <https://www.epa.gov/eco-research/ecoregion-download-files-state-region-5>.
- USEPA. 2019b. USEPA's Environmental Justice Screening and Mapping Tool. Accessed November 27, 2019. <https://ejscreen.epa.gov/mapper/>.
- USEPA. 2019c. USEPA Greenhouse Gas Reporting Program (GHGRP). Facility Information – Dallman 2018. Accessed January 23, 2020.
https://ghgdata.epa.gov/ghgp/service/facilityDetail/2018?id=1001529&ds=E&et=FC_CL&popup=true.
- USEPA. 2016. Mandatory Class I Areas – Map, Accessed January 16, 2020.
https://www.epa.gov/sites/production/files/2016-02/npsmap_basemap_classi_11x17.jpg.
- USEPA. 2002. USEPA Office of Water. Office of Wetlands, Oceans, and Watersheds. Functions and Values of Wetlands Factsheet EPA 843-F-01-002c. September. Accessed January 13, 2020.
<https://nepis.epa.gov/Exe/ZyPDF.cgi/200053Q1.PDF?Dockey=200053Q1.PDF>.
- USFWS (U.S. Fish and Wildlife Service). 2019. National Wetland Inventory: Illinois. Accessed January 13, 2020. <https://www.fws.gov/wetlands/Data/State-Downloads.html>.
- USFWS. 2013. USFWS, National Wildlife Refuge System, Mingo National Wildlife Refuge last updated March 4, 2013. Accessed January 16, 2020.
<https://www.fws.gov/refuges/AirQuality/ARIS/MING/>.
- USFWS. No date. Information for Planning and Consultation. Accessed January 10, 2020.
<https://ecos.fws.gov/ipac/location/KZ32M2ZBGBA4PPFSWEDWEHFXGM/resources#endangered-species>.

- USGS (U.S. Geological Survey). No date. Watersheds and Drainage Basins. Accessed January 13, 2020. https://www.usgs.gov/special-topic/water-science-school/science/watersheds-and-drainage-basins?qt-science_center_objects=0#qt-science_center_objects.
- USGS. 2020. NAS – Nonindigenous Aquatic Species databased. Accessed January 20, 2020. <https://nas.er.usgs.gov/viewer/omap.aspx/>.
- USGS. 2018. The National Map. Accessed January 10, 2020. <https://viewer.nationalmap.gov/advanced-viewer/>.
- University of Illinois. 2019. Large Pilot Testing of Linde/BASF Advanced Post-Combustion CO₂ Capture Technology at a Coal-Fired Power Plant Phase I Topical Report, Appendix 5, Environmental Information Volume for Selected Host Site – CWLP. Prepared for the Department of Energy National Energy Technology Laboratory. March 30, 2019.
- University of Illinois. 2019a. IEPA Meeting with UIUIC and CWLP July 30, 2019 (*City Water, Light, and Power (CWLP) Large Scale Pilot Project (Phase II) – Linde-BASF 7/30/2019 Notes and Meeting Summary*).
- University of Illinois. 1986. Illinois State Water Survey Contract Report 393. Prepared by Illinois State Water Survey Division, Surface Water Section at the University of Illinois. Prepared for City Springfield, Illinois. Accessed January 13, 2020. <https://www.isws.illinois.edu/pubdoc/CR/ISWSCR-393.pdf>.

CHAPTER 6. DISTRIBUTION LIST

Federal Agencies (via email)

Bureau of Indian Affairs	National Association of State Energy Officials
Department of the Interior, Office of Environmental Policy and Compliance	National Association of Tribal Historic Preservation Officers
Environmental Protection Agency, Region 5	U. S. Army Corps of Engineers
General Services Administration	U.S. Forest Service, Eastern Region

State/Local Agencies (via email)

Fish and Wildlife Department, Illinois-Iowa Field Office	Illinois Department of Natural Resources
Illinois Environmental Protection Agency	State and Tribal Government Working Group (STGWG)

Tribes

Kent Collier NAGPRA Kickapoo Tribe of Oklahoma PO Box 70 McLoud, OK 74851	Geoffery Standing Bear Principle Chief Osage Nation PO Box 779 Pa whuska, OK 74057
Joan Delabreau Chairwoman Menominee Indian Tribe of Wisconsin PO Box 910 Keshena, WI 54135	Lester Randall, Chairman Kickapoo Tribe of Indians of the Kickapoo Reservation in Kansas 1107 Goldfinch Road Horton, KS 66439
Diane Hunter Tribal Historic Preservation Officer Miami Tribe of Oklahoma PO Box 1326 Miami, OK 74355	

Libraries

Lincoln Library Circulation Desk - Public Reading Room 326 S. 7th Street Springfield, IL 62701	Illinois State Library Kathryn Dauksza Associate Director Gwendolyn Brooks Building, 300 S. Second Street Springfield, IL 62701
---	---

Non-governmental Organizations (via email)

Center for Biological Diversity	Institute for Energy and Environmental Research
Champaign County Audubon Society	Sierra Club Illinois Chapter
Ducks Unlimited, Inc., Great Lakes/Atlantic Regional Office	The Nature Conservancy
Earthjustice	The Wilderness Society, Maine Headquarters
Electric Power Research Institute	Trout Unlimited
	Western Resource Advocates

APPENDIX A. PREVIOUS NEPA ACTIONS

NETL F 451.1-1/1
Revised: 11/24/2014
Reviewed: 11/24/2014
(Previous Editions Obsolete)

U.S. DEPARTMENT OF ENERGY - NETL

CATEGORICAL EXCLUSION (CX) DESIGNATION FORM

Project No.: DE-FE0031591 Recipient Name: University of Illinois Project Location: Champaign, IL
Sub-recipient(s) and Locations:
Prairie State Generating Company - Marissa, IL

NETL Sponsoring Org.: FE/TDIC/Coal/Carbon Capture Team NETL Contact: Andrew Jones
Brief Title of Proposed Action: Large Pilot Testing of Linde/BASF Advanced Post-Combustion CO2 Capture Tech...

Brief Description of Activities:
Establishing the feasibility of installing a 10 MWe capture facility at one of three potential host sites, completing an Environmental Information Volume, updating costs and schedules for Phases II/III.

THE PROPOSED ACTION FALLS WITHIN THE FOLLOWING CATEGORICAL EXCLUSION(S) FROM APPENDICES A AND B TO SUBPART D OF DOE NEPA IMPLEMENTING PROCEDURES (10 CFR 1021):

General Administration/Management

- A1 - Routine business actions
 A9 - Info gathering, analysis, documentation, dissemination, and training
 A11 - Technical advice and planning assistance

Facility Operations

- B1.3 - Routine maintenance and custodial services
 B1.7 - Communication system and data processing equipment acquisition, installation, operation, removal
 B1.15 - Support building or structure, non-waste storage, construction/operation

Safety and Health

- B2.1 - Modifications to enhance workplace habitability
 B2.2 - Installation/improvement of building/equipment instrumentation
 B2.3 - Installation of equipment for personnel safety and health

General Research

- B3.1 - Site characterization/environmental monitoring
 B3.6 - R&D or pilot facility construction/operation/decommissioning
 B3.7 - New infill exploratory, experimental oil/gas/geothermal well construction and/or operation
 B3.9 - Certain CCT demonstration activities, emissions unchanged
 B3.11 - Outdoor tests, experiments on materials and equipment components

Electrical Power and Transmission

- B4.4 - Power management activities (storage, load shaping, and balancing)
 B4.6 - Transmission support addition/modifications at developed facility site
 B4.11 - Construction of power substations and interconnection facilities
 B4.13 - Upgrading and rebuilding existing power lines (< 20 miles)

Conservation, Fossil, and Renewable Energy Activities

- B5.1 - Actions to conserve energy, no indoor air quality degradation
 B5.3 - Modification/abandonment of wells
 B5.5 - Short crude oil/gas/steam/geothermal carbon dioxide pipeline const/oper within an existing right-of-way (< 20 miles) between existing facilities
 B5.13 - Experimental wells for injection of small quantities of carbon dioxide (< 500,000 tons)
 B5.15 - Small scale renewable energy research/development/pilot projects
 B5.22 - Alternative fuel vehicle fueling stations
 B5.23 - Electric vehicle charging stations

Other

- Specify category:
 Specify category:
 Specify category:

This action (1) would not present any extraordinary circumstances such that the action might have a significant impact upon the human environment; (2) is not connected to other actions with potentially significant impacts; (3) is not related to other actions with cumulatively significant impacts; and (4) is not inconsistent with 10 CFR 1021.211 - Interim Actions or 40 CFR 1506.1 - Limitations during the NEPA process.

SELECT ONE OF THE FOLLOWING:

- This Categorical Exclusion includes all tasks and phases in the Statement of Work or Statement of Project Objectives for this project.
 This Categorical Exclusion is only valid for the following tasks/phases . The DOE initiator acknowledges the responsibility to obtain a NEPA determination prior to initiating any activities outside the scope of this Categorical Exclusion.

SELECT ONE OF THE FOLLOWING:

- This Categorical Exclusion includes all locations and activities for this project.
 Additional sites, sub-recipients, or activities cannot be identified at this time. The DOE initiator acknowledges the responsibility to obtain a NEPA determination prior to initiating any activities outside the scope of this Categorical Exclusion.

NOTE: ANY CHANGE(S) TO THE PROJECT SCOPE OR LOCATIONS MAY REQUIRE A NEW NEPA DETERMINATION.

DOE Initiator Signature: ANDREW JONES Digitally signed by ANDREW JONES
Date: 2018.10.01 11:30:58 -0500

Date: 10 / 01 / 2018

NEPA Compliance Officer: Mark W Lusk Digitally signed by Mark W Lusk
Date: 2018.10.05 12:00:00 -0500

Date: 10 / 5 / 2018

month day year

The following special condition is provided for the consideration of the Contracting Officer:

NEPA's comment: This CX covers Phase I activities only. Additional NEPA review will be required prior to proceeding to additional Phases.

NETL F 451.1-1/1
Revised: 11/24/2014
Reviewed: 11/24/2014
(Previous Editions Obsolete)

U.S. DEPARTMENT OF ENERGY - NETL

CATEGORICAL EXCLUSION (CX) DESIGNATION FORM

Project No.: DE-FE0031581 Recipient Name: University of Illinois Project Location: Champaign, IL

Sub-recipient(s) and Locations:

Linde LLC - Murray Hill, NJ; Affiliated Engineers - Multiple, IL, WI, MD; Affiliated Construction Services - Middleton, WI; CWLP Power Plant - Springfield, IL; Abbott Power Plant - Champaign, IL; LENA & BASF - Houston, TX

NETL Sponsoring Org.: FE/TDIC/Coal/Carbon Capture Team NETL Contact: Andrew Jones

Brief Title of Proposed Action: Large Pilot Testing of Linde/BASF Advanced Post-Combustion CO2 Capture Tech...

Brief Description of Activities:

Establishing the feasibility of installing a 10 MWe capture facility at one of two potential host sites, completing an Environmental Information Volume, updating costs and schedules for Phases II/III.

THE PROPOSED ACTION FALLS WITHIN THE FOLLOWING CATEGORICAL EXCLUSION(S) FROM APPENDICES A AND B TO SUBPART D OF DOE NEPA IMPLEMENTING PROCEDURES (10 CFR 1021):

General Administration/Management

- A1 - Routine business actions
 A9 - Info gathering, analysis, documentation, dissemination, and training
 A11 - Technical advice and planning assistance

Facility Operations

- B1.3 - Routine maintenance and custodial services
 B1.7 - Communication system and data processing equipment acquisition, installation, operation, removal
 B1.15 - Support building or structure, non-waste storage, construction/operation

Safety and Health

- B2.1 - Modifications to enhance workplace habitability
 B2.2 - Installation/improvement of building/equipment instrumentation
 B2.3 - Installation of equipment for personnel safety and health

General Research

- B3.1 - Site characterization/environmental monitoring
 B3.6 - R&D or pilot facility construction/operation/decommissioning
 B3.7 - New infill exploratory, experimental oil/gas/geothermal well construction and/or operation
 B3.9 - Certain CCT demonstration activities, emissions unchanged
 B3.11 - Outdoor tests, experiments on materials and equipment components

Electrical Power and Transmission

- B4.4 - Power management activities (storage, load shaping, and balancing)
 B4.6 - Transmission support addition/modifications at developed facility site
 B4.11 - Construction of power substans and interconnection facilities
 B4.13 - Upgrading and rebuilding existing power lines (< 20 miles)

Conservation, Fossil, and Renewable Energy Activities

- B5.1 - Actions to conserve energy, no indoor air quality degradation
 B5.3 - Modification/abandonment of wells
 B5.5 - Short crude oil/gas/steam/geothermal/carbon dioxide pipeline const/oper within an existing right-of-way (< 20 miles) between existing facilities
 B5.13 - Experimental wells for injection of small quantities of carbon dioxide (< 500,000 tons)
 B5.15 - Small scale renewable energy research/development/pilot projects
 B5.22 - Alternative fuel vehicle fueling stations
 B5.23 - Electric vehicle charging stations

Other

- Specify category: _____
 Specify category: _____
 Specify category: _____

This action (1) would not present any extraordinary circumstances such that the action might have a significant impact upon the human environment; (2) is not connected to other actions with potentially significant impacts; (3) is not related to other actions with cumulatively significant impacts; and (4) is not inconsistent with 10 CFR 1021.211 - Interim Actions or 40 CFR 1506.1 - Limitations during the NEPA process.

SELECT ONE OF THE FOLLOWING:

- This Categorical Exclusion includes all tasks and phases in the Statement of Work or Statement of Project Objectives for this project.
 This Categorical Exclusion is only valid for the following tasks/phases _____. The DOE initiator acknowledges the responsibility to obtain a NEPA determination prior to initiating any activities outside the scope of this Categorical Exclusion.

SELECT ONE OF THE FOLLOWING:

- This Categorical Exclusion includes all locations and activities for this project.
 Additional sites, sub-recipients, or activities cannot be identified at this time. The DOE initiator acknowledges the responsibility to obtain a NEPA determination prior to initiating any activities outside the scope of this Categorical Exclusion.

NOTE: ANY CHANGE(S) TO THE PROJECT SCOPE OR LOCATIONS MAY REQUIRE A NEW NEPA DETERMINATION.

DOE Initiator Signature: ANDREW JONES Digitally signed by ANDREW JONES
Date: 2018.08.08 11:01:00 -0500

Date: 02 / 08 / 2018

month day year

NEPA Compliance Officer: Mark W Lusk Digitally signed by Mark W Lusk
Date: 2018.02.09 14:42:44 -0500

Date: 02 / 09 / 2018

month day year

The following special condition is provided for the consideration of the Contracting Officer:

NCO's comment: This CX covers Phase I activities only. Additional NEPA review will be required prior to proceeding to additional Phases.

NETL F 451.1-1/1
Revised: 11/24/2014
Reviewed: 11/24/2014
(Previous Editions Obsolete)

U.S. DEPARTMENT OF ENERGY - NETL

CATEGORICAL EXCLUSION (CX) DESIGNATION FORM

Project No.: DE-FE0031581 Recipient Name: Univ of IL (ISGS,ISTC) Project Location: Champaign, IL
Sub-recipient(s) and Locations:
Linde LLC-Murray Hill,NJ;Affiliated Engineers-Champaign,IL,Hunt Valley,MD,Chicago,IL;Affiliated Construction Svcs-Middleton,WI;CWLP Power Plant-Springfield,IL;LEDD-Dresden,Germany;LENA&BASP-Houston,TX,ICP Jones&Stokes-Fairfax,VA
NETL Sponsoring Org: FE/TDIC/Coal/Carbon Capture Team NETL Contact: Andrew Jones
Brief Title of Proposed Action: Large Pilot Testing of Linde/BASF Advanced Post-Combustion CO2 Capture Technology
Brief Description of Activities:
Completion of PERD study, NEPA, and permitting for 10 MWe CO2 absorption pilot at CWLP host site, TEA update, and updating costs and schedules for Phase III.

THE PROPOSED ACTION FALLS WITHIN THE FOLLOWING CATEGORICAL EXCLUSION(S) FROM APPENDICES A AND B TO SUBPART D OF DOE NEPA IMPLEMENTING PROCEDURES (10 CFR 1021):

General Administration/Management

- A1 - Routine business actions
 A9 - Info gathering, analysis, documentation, dissemination, and training
 A11 - Technical advice and planning assistance

Facility Operations

- B1.3 - Routine maintenance and custodial services
 B1.7 - Communication system and data processing equipment acquisition, installation, operation, removal
 B1.15 - Support building or structure, non-waste storage, construction/operation

Safety and Health

- B2.1 - Modifications to enhance workplace habitability
 B2.2 - Installation/improvement of building/equipment instrumentation
 B2.3 - Installation of equipment for personnel safety and health

General Research

- B3.1 - Site characterization/environmental monitoring
 B3.6 - R&D or pilot facility construction/operation/decommissioning
 B3.7 - New infill exploratory, experimental oil/gas/geothermal well construction and/or operation
 B3.9 - Certain CCT demonstration activities, emissions unchanged
 B3.11 - Outdoor tests, experiments on materials and equipment components

Electrical Power and Transmission

- B4.4 - Power management activities (storage, load shaping, and balancing)
 B4.6 - Transmission support addition/modifications at developed facility site
 B4.11 - Construction of power substations and interconnection facilities
 B4.13 - Upgrading and rebuilding existing power lines (< 20 miles)

Conservation, Fossil, and Renewable Energy Activities

- B5.1 - Actions to conserve energy, no indoor air quality degradation
 B5.3 - Modification/abandonment of wells
 B5.5 - Short crude oil/gas/steam/geothermal/carbon dioxide pipeline const/oper within an existing right-of-way (< 20 miles) between existing facilities
 B5.13 - Experimental wells for injection of small quantities of carbon dioxide (< 500,000 tons)
 B5.15 - Small scale renewable energy research/development/pilot projects
 B5.22 - Alternative fuel vehicle fueling stations
 B5.23 - Electric vehicle charging stations

Other

Specify category:

Specify category:

Specify category:

This action (1) would not present any extraordinary circumstances such that the action might have a significant impact upon the human environment; (2) is not connected to other actions with potentially significant impacts; (3) is not related to other actions with cumulatively significant impacts; and (4) is not inconsistent with 10 CFR 1021.211 - Interim Actions or 40 CFR 1506.1 - Limitations during the NEPA process.

SELECT ONE OF THE FOLLOWING:

- This Categorical Exclusion includes all tasks and phases in the Statement of Work or Statement of Project Objectives for this project.
 This Categorical Exclusion is only valid for the following tasks/phases: . The DOE initiator acknowledges the responsibility to obtain a NEPA determination prior to initiating any activities outside the scope of this Categorical Exclusion.

SELECT ONE OF THE FOLLOWING:

- This Categorical Exclusion includes all locations and activities for this project.
 Additional sites, sub-recipients, or activities cannot be identified at this time. The DOE initiator acknowledges the responsibility to obtain a NEPA determination prior to initiating any activities outside the scope of this Categorical Exclusion.

NOTE: ANY CHANGE(S) TO THE PROJECT SCOPE OR LOCATIONS MAY REQUIRE A NEW NEPA DETERMINATION.

DOE Initiator Signature: ANDREW JONES Digitally signed by ANDREW JONES Date: 2019.06.24 13:03:58 -0500

Date: 06 / 24 / 2019

month day year

NEPA Compliance Officer: MARK LUSK Digitally signed by MARK LUSK Date: 2019.07.01 10:05:04 -0500

Date: 07 / 01 / 2019

month day year

The following special condition is provided for the consideration of the Contracting Officer:

This CX covers the additional NEPA review required prior to possible selection and initiation of this project for Phase III, as well as the other scope listed above.

NETL F 451.1-1/1
Revised: 11/24/2014
Reviewed: 11/24/2014
(Previous Editions Obsolete)

U.S. DEPARTMENT OF ENERGY - NETL

CATEGORICAL EXCLUSION (CX) DESIGNATION FORM

Project No.: DE-FE0031581 Recipient Name: University of Illinois Project Location: Champaign, IL

Sub-recipient(s) and Locations:

Approved: Linde LLC-Murray Hill, NJ; Affiliated Engineers-Champaign, IL; Affiliated Construction Svcs- Middleton, WI; CWLP Power Plant-Springfield, IL; LEED-Dresden, Germany; LENA & BASF-Houston, TX. New sub: LEA - Tonawanda, NY

NETL Sponsoring Org.: FE/TDIC/Coal/Carbon Capture Team NETL Contact: Andrew Jones

Brief Title of Proposed Action: Large Pilot Testing of Linde/BASF Advanced Post-Combustion CO2 Capture Technology

Brief Description of Activities:

Completion of FEED study, NEPA, and permitting for 10 MWe CO2 absorption pilot at CWLP host site, TEA update, and updating costs and schedules for Phase III.

THE PROPOSED ACTION FALLS WITHIN THE FOLLOWING CATEGORICAL EXCLUSION(S) FROM APPENDICES A AND B TO SUBPART D OF DOE NEPA IMPLEMENTING PROCEDURES (10 CFR 1021):

General Administration/Management

- A1 - Routine business actions
 A9 - Info gathering, analysis, documentation, dissemination, and training
 A11 - Technical advice and planning assistance

Facility Operations

- B1.3 - Routine maintenance and custodial services
 B1.7 - Communication system and data processing equipment acquisition, installation, operation, removal
 B1.15 - Support building or structure, non-waste storage, construction/operation

Safety and Health

- B2.1 - Modifications to enhance workplace habitability
 B2.2 - Installation/improvement of building/equipment instrumentation
 B2.3 - Installation of equipment for personnel safety and health

General Research

- B3.1 - Site characterization/environmental monitoring
 B3.6 - R&D or pilot facility construction/operation/decommissioning
 B3.7 - New infill exploratory, experimental oil/gas/geothermal well construction and/or operation
 B3.9 - Certain CCT demonstration activities, emissions unchanged
 B3.11 - Outdoor tests, experiments on materials and equipment components

Electrical Power and Transmission

- B4.4 - Power management activities (storage, load shaping, and balancing)
 B4.6 - Transmission support addition/modifications at developed facility site
 B4.11 - Construction of power substations and interconnection facilities
 B4.13 - Upgrading and rebuilding existing power lines (< 20 miles)

Conservation, Fossil and Renewable Energy Activities

- B5.1 - Actions to conserve energy, no indoor air quality degradation
 B5.3 - Modification/abandonment of wells
 B5.5 - Short crude oil/gas/steam/geothermal/carbon dioxide pipeline construction within an existing right-of-way (< 20 miles) between existing facilities
 B5.13 - Experimental wells for injection of small quantities of carbon dioxide (< 500,000 tons)
 B5.15 - Small scale renewable energy research/development/pilot projects
 B5.22 - Alternative fuel vehicle fueling stations
 B5.23 - Electric vehicle charging stations

Other

- Specify category:
 Specify category:
 Specify category:

This action (1) would not present any extraordinary circumstances such that the action might have a significant impact upon the human environment; (2) is not connected to other actions with potentially significant impacts; (3) is not related to other actions with cumulatively significant impacts; and (4) is not inconsistent with 10 CFR 1021.211 - Interim Actions or 40 CFR 1506.1 - Limitations during the NEPA process.

SELECT ONE OF THE FOLLOWING:

- This Categorical Exclusion includes all tasks and phases in the Statement of Work or Statement of Project Objectives for this project.
 This Categorical Exclusion is only valid for the following tasks/phases. The DOE initiator acknowledges the responsibility to obtain a NEPA determination prior to initiating any activities outside the scope of this Categorical Exclusion.

SELECT ONE OF THE FOLLOWING:

- This Categorical Exclusion includes all locations and activities for this project.
 Additional sites, sub-recipients, or activities cannot be identified at this time. The DOE initiator acknowledges the responsibility to obtain a NEPA determination prior to initiating any activities outside the scope of this Categorical Exclusion.

NOTE: ANY CHANGE(S) TO THE PROJECT SCOPE OR LOCATIONS MAY REQUIRE A NEW NEPA DETERMINATION.

DOE Initiator Signature: ANDREW JONES

Date: 10 / 24 / 2019

NEPA Compliance Officer: Mark Lusk

Date: 10 / 31 / 2019

The following special condition is provided for the consideration of the Contracting Officer:

CX approval is for the addition of a new sub-recipient, Linde Engineering America (LEA), in Tonawanda, NY. CXs have been previously approved for all other recipients.

APPENDIX B. AGENCY AND TRIBAL CORRESPONDENCE

B.1 Introduction

During preparation of the Environmental Assessment (EA), the United States (U.S.) Department of Energy (DOE) actively maintained communication with government agencies and Native American Tribes. This appendix summarizes the records of formal consultation between the DOE and these government agencies and Native American Tribes.

B.2 Agency Correspondence

This appendix contains copies of correspondence with the following state and federal agencies:

- Illinois Department of Natural Resources
- U.S. Fish and Wildlife Service

No response was received from the U.S. Fish and Wildlife Service.



NATIONAL ENERGY TECHNOLOGY LABORATORY
Albany, OR • Morgantown, WV • Pittsburgh, PA



February 5, 2020

Illinois Department of Natural Resources
Illinois State Historic Preservation Office
Attn: Review and Compliance
1 Old State Capitol Plaza
Springfield, Illinois 62701

Re: Consultation Under NHPA Section 106 for a project in Sangamon County, Illinois

Dear Sir or Ma'am:

The U.S. Department of Energy (DOE) is preparing an Environmental Assessment (EA) for DOE's proposed action of providing cost-shared financial assistance to the Trustees of the University of Illinois (UIUC) for the "Large Pilot Testing of Linde/BASF Advanced Post-Combustion CO₂ Capture Technology at a Coal-Fired Power Plant" project. The EA is being prepared to fulfill DOE's obligations under the National Environmental Policy Act (NEPA), the Council on Environmental Quality's NEPA regulations, and DOE's NEPA implementing procedures. The EA will evaluate the potential effects of construction and subsequent 2-year operation of the facility for research purposes.

This undertaking and its effects are also being considered under Section 106 of the National Historic Preservation Act (NHPA) of 1966, as amended, and implementing regulations at 36 CFR Part 800. As part of compliance with Section 106, DOE is writing to seek your comments on any issues or concerns for traditional cultural properties, sacred sites, or site of traditional religious or cultural importance in the area that might be affected by the proposed project and would like to know if you wish to receive a copy of the draft EA. We respectfully ask that you provide any information or comments within 30 days to enable us to complete this phase of the project within the scheduled timeframe.

The DOE's proposed action is to provide cost-shared financial assistance to UIUC. DOE proposes to provide approximately \$3 million of the project's \$3.7 million total cost.

UIUC's project would include construction of a 10-MWe CO₂ capture unit pilot plant adjacent to the existing Dallman #4 Unit at the coal-fired City Water, Light, and Power (CWLP) plant located at 3100 Stevenson Drive, Springfield, Illinois. The proposed pilot plant would be constructed on the southwest side of the existing CWLP facility on land currently used for equipment and materials storage. The pilot plant would be constructed in an area of approximately 120 feet by 425 feet (51,000 square feet, 1.2 acres), see **Figure 1** and **Figure 2**. **Figure 3** shows the pilot plant location and the associated CWLP components.

626 Cochran Mill Road, P.O. Box 10940, Pittsburgh, PA 15236

pierina.fayish@netl.doe.gov@netl.doe.gov

Voice (412) 386-5428

Fax (412) 386-4775

www.netl.doe.gov



NATIONAL ENERGY TECHNOLOGY LABORATORY
Albany, OR • Morgantown, WV • Pittsburgh, PA



Figure 1 - Proposed Pilot Plant Site Location West of Dallman #4 Unit

626 Cochran's Mill Road, P.O. Box 10940, Pittsburgh, PA 15236
pierina.fayish@netl.doe.gov@netl.doe.gov • Voice (412) 386-5428 • Fax (412) 386-4775 • www.netl.doe.gov



NATIONAL ENERGY TECHNOLOGY LABORATORY
Abony, OR • Morgantown, WV • Pittsburgh, PA



Figure 2 – Proposed Pilot Plant Site Ground-level View West of Dallman #4 Unit

626 Cochrans Mill Road, P.O. Box 10940, Pittsburgh, PA 15236
plerina.fayish@netl.doe.gov@netl.doe.gov • Voice (412) 386-5428 • Fax (412) 386-4775 • www.netl.doe.gov



NATIONAL ENERGY TECHNOLOGY LABORATORY
Albany, OR • Morgantown, WV • Pittsburgh, PA

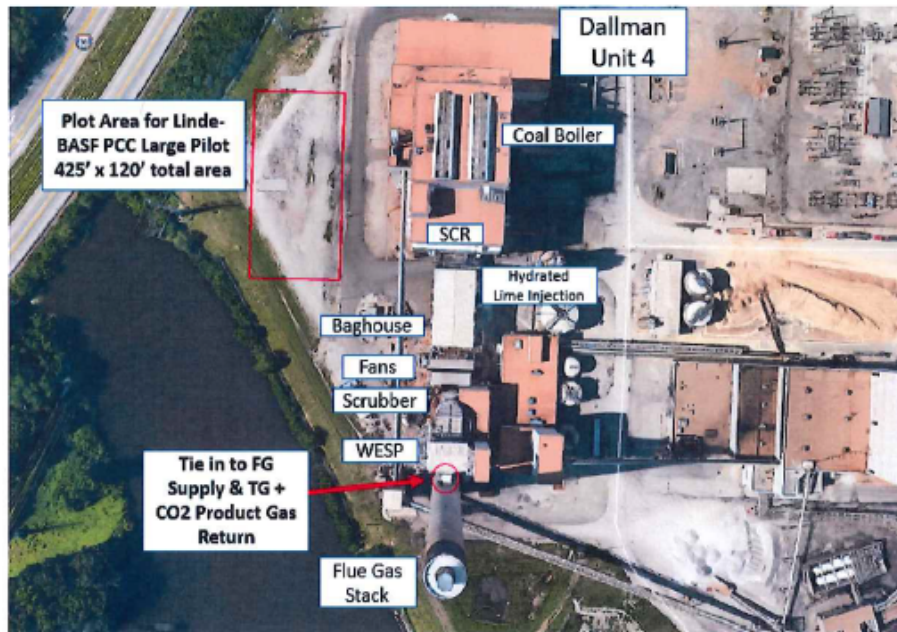

Figure 3 – Location of Pilot Plant on CWLP Facility

This project would use 24,000 gallons of amine compounds which would be stored on-site. The pilot would receive a slipstream from the CWLP plant and return captured CO₂ to the stack for venting, see Figure 4. CWLP is located on a peninsula and the proposed location for the pilot unit is within 200 feet of Lake Springfield, a freshwater reservoir that is used as a potable water source for the City of Springfield. Operation is planned to occur for two years following a one-year period of construction, see Figure 5.

Surface disturbance at the proposed project site would consist of the installation of pilings extending 10-15 feet below ground level and leveling and preparing for a concrete pad on which the pilot capture plant would be constructed. As shown in Figure 1 and Figure 2, the site has been historically disturbed and is currently used for equipment and materials storage. With the exception of the piling installation, the leveling and surface preparation activities would not disturb the soil to a depth lower than has historically been disturbed for power plant construction and operation activities.

626 Cochrans Mill Road, P.O. Box 10940, Pittsburgh, PA 15236

pierina.fayish@netl.doe.gov@netl.doe.gov

Voice (412) 386-5428

Fax (412) 386-4775

www.netl.doe.gov



NATIONAL ENERGY TECHNOLOGY LABORATORY
Albany, OR • Morgantown, WV • Pittsburgh, PA

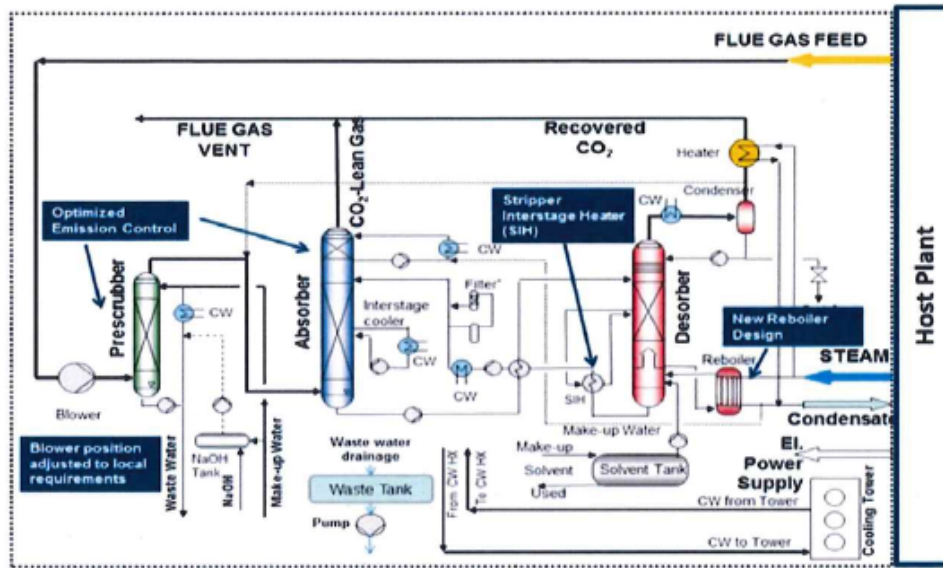

Figure 4 – Proposed Pilot Plant Carbon Capture Process

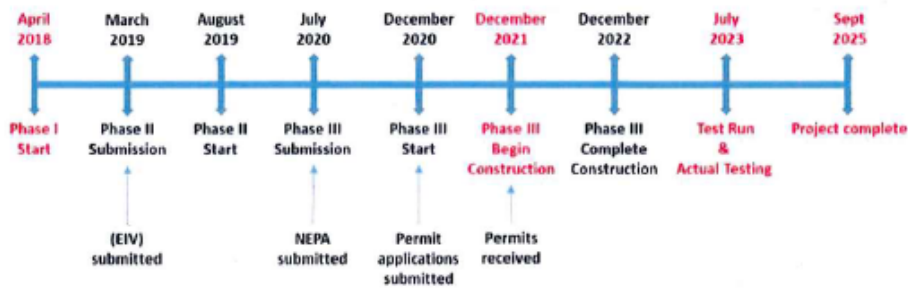

Figure 5 – Project Timeline



NATIONAL ENERGY TECHNOLOGY LABORATORY
 Albany, OR • Morgantown, WV • Pittsburgh, PA



Dallman #4 Unit has been on-line at the CWLP since 2009 and a graphic depicting President Abraham Lincoln and identifying Springfield as President Lincoln's hometown is painted on the southwest side. The proposed pilot plant installation would include three columnar structures consisting of a direct contact cooler, absorber, and stripper; all approximately 8.5 feet in diameter and 90, 190, and 120 feet in height, respectively. The main viewpoint of the Lincoln graphic on Dallman #4 Unit for residents and visitors to Springfield occurs while traveling on Routes 36/72/55, an interstate highway with speeds of 55 mph or greater. Visual modeling indicates the proposed project's columnar structures intersect, but do not block this graphic as viewed on the direct approach to the power plant from Routes 36/72/55, see **Figure 6**. From angles of view on the highway other than the direct approach, the columnar structures do not interfere with the view of the graphic, see **Figure 7**.



Figure 6 – Lincoln Graphic -Direct Approach from Routes 36/72/55

626 Cochran's Mill Road, P.O. Box 10940, Pittsburgh, PA 15236

• pierina.fayish@netl.doe.gov@netl.doe.gov

• Voice (412) 386-5428

• Fax (412) 386-4775

• www.netl.doe.gov



NATIONAL ENERGY TECHNOLOGY LABORATORY
Albany, OR • Morgantown, WV • Pittsburgh, PA



Figure 7 - Lincoln Graphic – Alternate View from Routes 36/72/55

Figure 8 identifies the project location and the surrounding area and Figure 9 identifies the NRHP listed location that is closest to the proposed pilot plant.

If you have any questions or comments, please contact Ms. Pierina Fayish at

National Energy Technology Laboratory M/S:922-1W13
P.O. Box 10940
Pittsburgh, PA 15236-0940
Attention: Pierina Fayish
Pierina.Fayish@netl.doe.gov
(412) 386-5428

Thank you for your assistance in this matter.

Sincerely,

Pierina N. Fayish

626 Cochrans Mill Road, P.O. Box 10940, Pittsburgh, PA 15236
pierina.fayish@netl.doe.gov@netl.doe.gov • Voice (412) 386-5428 • Fax (412) 386-4775 • www.netl.doe.gov



Figure 8 – Project Location and Surrounding Area

626 Cochran Mill Road, P.O. Box 10940, Pittsburgh, PA 15236			
piefna.fayish@netl.doe.gov@netl.doe.gov	• Voice (412) 386-6428	• Fax (412) 386-4775	• www.netl.doe.gov



NATIONAL ENERGY TECHNOLOGY LABORATORY
Albany, OR • Morgantown, WV • Pittsburgh, PA

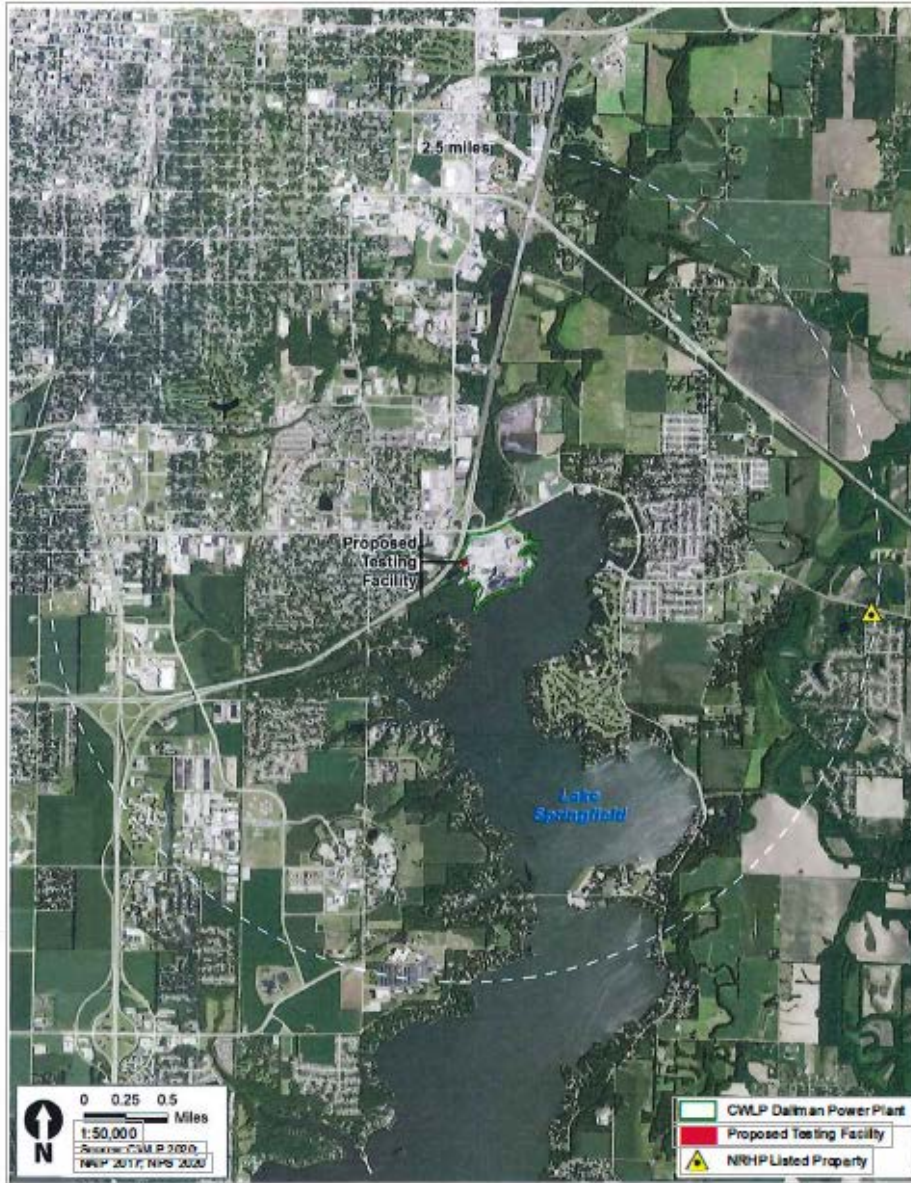

Figure 9 – Area View with Closest NRHP Facility Location

626 Cochran Mill Road, P.O. Box 10940, Pittsburgh, PA 15236
pierina.fayish@netl.doe.gov@netl.doe.gov • Voice (412) 386-5428 • Fax (412) 386-4775 • www.netl.doe.gov



NATIONAL ENERGY TECHNOLOGY LABORATORY
Albany, OR • Morgantown, WV • Pittsburgh, PA



February 3, 2020

U.S. Fish and Wildlife Service
NEPA Compliance Officer
Illinois-Iowa Field Office
1511 47th Avenue
Moline, IL 61265

Re: Consultation Under NEPA for a project in Sangamon County, Illinois

Dear Sir or Ma'am:

The U.S. Department of Energy (DOE) is preparing an Environmental Assessment (EA) for DOE's proposed action of providing cost-shared financial assistance to the Trustees of the University of Illinois (UIUC) for the "Large Pilot Testing of Linde/BASF Advanced Post-Combustion CO₂ Capture Technology at a Coal-Fired Power Plant" project (Project). The EA is being prepared to fulfill DOE's obligations under the National Environmental Policy Act (NEPA), the Council on Environmental Quality's NEPA regulations, and DOE's NEPA implementing procedures. The EA will evaluate the potential effects of construction and subsequent 2-year operation of the facility for research purposes. The purpose of this letter is to initiate consultation with the U.S. Fish and Wildlife Service, Illinois-Iowa Field Office and to request information on any federal- or state-listed threatened, endangered, or candidate species, or critical habitat within the vicinity of the Project.

The DOE's proposed action is to provide cost-shared financial assistance to UIUC. DOE proposes to provide approximately \$3 million of the project's \$3.7 million total cost.

UIUC's Project would include construction of a 10-MWe CO₂ capture unit pilot plant adjacent to the existing Dallman #4 Unit at the coal-fired City Water, Light, and Power plant in Springfield Illinois. The proposed pilot plant would be constructed on the west side of the existing CWLP facility on land currently used for equipment and materials storage. The pilot plant would be constructed in an area of approximately 120 feet by 425 feet (51,000 square feet). This project would use 24,000 gallons of amine compounds which would be stored on-site. The pilot plant would receive a slipstream from the CWLP plant and return captured CO₂ to the stack for venting. CWLP is located on a peninsula and the proposed location for the pilot unit is within 200 feet of Lake Springfield, a freshwater reservoir that is used as a potable water source for the City of Springfield.

Surface disturbance at the proposed project site would consist of the installation of pilings extending 10-15 feet below ground level and leveling and preparing for a concrete pad on which the pilot capture plant would be constructed. With the exception of the piling installation, the leveling and surface preparation activities would not disturb the soil to a depth lower than has historically been disturbed for power plant construction and operation activities.

626 Cochran's Mill Road, P.O. Box 10940, Pittsburgh, PA 15236

• pierina.fayish@netl.doe.gov@netl.doe.gov

• Voice (412) 386-5428

• Fax (412) 386-4775

• www.netl.doe.gov



DOE reviewed the Rare, Threatened, and Endangered Species list for Sangamon County as published on the U.S. Fish and Wildlife Service Midwest Region Endangered Species list and the Illinois Department of Natural Resources search engine for potential threatened and endangered species within Sangamon County, Illinois in January 2020. Refer to Table 1 attached to this letter for federal and state-listed species noted within your database as known or believed to occur within Sangamon County, Illinois and their preferred habitat.

DOE does not anticipate any adverse effects on federal- or state-listed wildlife species based on the proposed construction and operation of the Large Pilot Testing CO₂ Capture project. As part of the NEPA process, we are seeking your input on any environmental issues or concerns your agency may have on the Proposed Action and the potentially affected areas as described above. We respectfully ask that you provide any information or comments within 30 days to enable us to complete this phase of the project within the scheduled timeframe.

If you have any questions or comments, please contact Ms. Pierina Fayish at

National Energy Technology Laboratory M/S:922-1W13
P.O. Box 10940
Pittsburgh, PA 15236-0940
Attention: Pierina Fayish
Pierina.Fayish@netl.doe.gov
(412) 386-5428

Thank you for your assistance in this matter.

Sincerely,

Pierina N. Fayish



Table 1 Federal and State-listed Species Known or Believed to Occur within Sangamon County, Illinois

Common Name	Scientific Name	Status	Habitat ¹	Potential for Occurrence
Birds				
Bald Eagle	<i>Haliaeetus leucocephalus</i>	BGEPA	Breeding habitat most commonly includes areas close to (within 4 km) coastal areas, bays, rivers, lakes, reservoirs, or other bodies of water that reflect the general availability of primary food sources including fish, waterfowl, or seabirds. Nests usually are in tall trees or on pinnacles or cliffs near water. Wintering areas are commonly associated with open water though in some regions (e.g., Great Basin) some bald eagles use habitats with little or no open water (e.g., montane areas) if upland food resources (e.g. rabbit or deer carrion, livestock afterbirths) are readily available. Wintering eagles tend to avoid areas with high levels of nearby human activity (boat traffic, pedestrians) and development (buildings).	Low – no known nests or territories are within 1-mile of the Project area.
Barn Owl		ST	Woodlands, groves, farms, barns, towns, cliffs. Typically occur in open or semi-open country in lowlands. May nest in forest or city if nearby area has good open foraging territory, such as farmland, marsh, prairie, desert	Low – Limited suitable habitat exists in the Project area, and no recent occurrences have been documented.

626 Cochrans Mill Road, P.O. Box 10940, Pittsburgh, PA 15236
 pierina.fayish@netl.doe.gov@netl.doe.gov • Voice (412) 386-5428 • Fax (412) 386-4775 • www.netl.doe.gov



NATIONAL ENERGY TECHNOLOGY LABORATORY
 Albany, OR • Morgantown, WV • Pittsburgh, PA



Mammals				
Indiana Bat	<i>Myotis sodalis</i>	FE	Summer habitat includes small to medium river and stream corridors with well-developed riparian woods; woodlots within 1 to 3 miles of small to medium rivers and streams; and upland forests. Caves and mines as hibernacula.	Low – No suitable habitat exists within the Project area.
Northern Long-eared bat	<i>Myotis septentrionalis</i>	FT	Old growth trees of over 100 years old and away from edges are the preferred habitat of the northern long-eared bat. Hibernates in caves and mines - swarming in surrounding wooded areas in autumn. During late spring and summer roosts and forages in upland forests.	Low – No suitable habitat exists within the Project area.
Plants				
Eastern Prairie Fringed Orchid	<i>Platanthera leucophaea</i>	FT	Occurs most often in mesic to wet unplowed tallgrass prairies and meadows but has been found in old fields and roadside ditches. The eastern prairie fringed orchid also occurs in bogs, fens, and sedge meadows.	None

¹ Sources:

<https://www.fws.gov/midwest/Endangered/listing/index.html>

<https://www.dnr.illinois.gov/Pages/default.aspx>

626 Cochran Mill Road, P.O. Box 10940, Pittsburgh, PA 15236

pierina.fayish@netl.doe.gov@netl.doe.gov

Voice (412) 386-5428

Fax (412) 386-4775

www.netl.doe.gov



Scoping Comments from Illinois Department of Natural Resources



Illinois Department of Natural Resources

One Natural Resources Way Springfield, Illinois 62702-1271
www.dnr.illinois.gov

JB Pritzker, Governor
Colleen Callahan, Director

March 3, 2020

Ms. Pierina Fayish
National Energy Technology Laboratory
P.O. Box 10940
Pittsburgh, PA 15236-0940

Re: NEPA Scoping - Large Pilot Testing of the Linde/BASF Method for Advanced Post-Combustion CO₂ Capture Technology at a Coal-Fired Power Plant

Dear Ms. Fayish:

The Illinois Department of Natural Resources (Department) has reviewed the above-mentioned project as part of the NEPA scoping process. The project is a joint partnership between the U.S. Dept. of Energy, University of Illinois, and City Water Light and Power (CWLP). The project will construct a 10-MWe CO₂ capture unit pilot plant adjacent to the Dallman #4 Unit at the CWLP facility in Springfield, IL. Further details are provided in the notice. The Department offers the following comments for your consideration:

The project proponent should be aware of a 2011 record for the state-threatened Barn Owl (*Tyto alba*) at the CWLP industrial complex. There are also records for the state-threatened Kirtland's Snake (*Clonophis kirtlandi*) in the general area. The Department has reviewed this information, along with the project scope, and determined adverse impacts to these species, and other wildlife, are unlikely. If any conflicts with these species, or other fish and wildlife develop, please consult with the Department immediately.

Thank you for the opportunity to comment. Please contact Mr. Brian Willard of this office at 217-557-0480 or brian.c.willard@illinois.gov for additional information, or if providing a response to this correspondence.

Sincerely,

A handwritten signature in black ink that reads "Nathan Grider".

Nathan Grider
Manager, Impact Assessment Section
Office of Realty & Capital Planning
Illinois Dept. of Natural Resources
One Natural Resources Way
Springfield, IL 62702-1271
nathan.grider@illinois.gov
Phone: (217) 557-0483

cc: IDNR, Office of Resource Conservation
IDNR, Director's Office

Correspondence Received During the Public Comment Period on the Draft EA

UNITED STATES ENVIRONMENTAL PROTECTION AGENCY
REGION 5
77 WEST JACKSON BOULEVARD
CHICAGO, IL 60604-3590

April 14, 2020

REPLY TO THE ATTENTION OF:
Mail Code RM-19J

Pierina Fayish
National Energy Technology Laboratory
Department of Energy
P.O. Box 10940
Pittsburgh, Pennsylvania 15236

Re: Draft Environmental Assessment for Large-Scale Carbon Dioxide Capture Pilot Testing, Springfield, Sangamon County, Illinois

Dear Ms. Fayish:

The U.S. Environmental Protection Agency (EPA) has reviewed the referenced draft environmental assessment (EA), which was prepared by the National Energy Technology Laboratory (NETL). We are providing comments pursuant to our authorities under the National Environmental Policy Act (NEPA), Council on Environmental Quality regulations (40 CFR Parts 1500-1508), and Section 309 of the Clean Air Act.

NETL proposes to provide cost-share funding to the University of Illinois at Urbana-Champaign's Illinois Sustainable Technology Center (ISTC) and The Linde Group/BASF Corporation (Linde/BASF) to evaluate and demonstrate the scalability and commercial potential of post-combustion carbon dioxide (CO₂) capture technology at the City, Water, Light, and Power coal power plant (CWLP) in Springfield, Illinois. The proposed project would consist of construction, operation, and subsequent demolition of facilities necessary to carry out the proposed scaling operation, which is expected to operate for a period of two years.

Two alternatives have been provided:

- *Alternative 1 (Preferred Alternative)*. NETL would provide \$3 million in cost-shared funding to ISTC and Linde/BASF to construct, operate, and demolish a post-combustion CO₂ capture facility at CWLP.
- *Alternative 2 (No Action Alternative)*. NETL would not provide \$3 million in cost-shared funding to ISTC and Linde/BASF to construct, operate, and demolish a post-combustion CO₂ capture facility at CWLP.

Recycled/Recyclable • Printed with Vegetable Oil Based Inks on 100% Recycled Paper (100% Post Consumer)

Based on our review of the EA, we have no comments. We are available to discuss the contents of this letter at your convenience. Please feel free to contact Mike Sedlacek of my staff at 312-886-1765, or by email at sedlacek.michael@epa.gov.

Sincerely,

KENNETH
WESTLAKE

Digitally signed by KENNETH
WESTLAKE
Date: 2020.04.14 15:01:20 -05'00'

Kenneth A. Westlake
Deputy Director, Tribal and Multimedia Programs Office
Office of the Regional Administrator



Illinois Department of Natural Resources

One Natural Resources Way Springfield, Illinois 62702-1271
www.dnr.illinois.gov

JB Pritzker, Governor
Colleen Callahan, Director

Mailing address: State Historic Preservation Office, 1 Old State Capitol Plaza, Springfield, IL 62701

Sangamon County
Springfield
3100 Stevenson Drive
DOE

PLEASE REFER TO: SHPO LOG #024021020

New construction, Large pilot testing plant/Advanced Post-Combustion CO₂ Capture - UIUC

April 8, 2020

Pierina Fayish
U.S. Department of Energy
National Energy Technology Laboratory
P.O. Box 10940
Mailstop B922/ M217
Pittsburgh, PA 15236

Dear Ms. Fayish:

We have reviewed the documentation submitted for the referenced project(s) in accordance with 36 CFR Part 800.4. Based upon the information provided, no historic properties are affected. We, therefore, have no objection to the undertaking proceeding as planned.

Please retain this letter in your files as evidence of compliance with section 106 of the National Historic Preservation Act of 1966, as amended. This clearance remains in effect for two (2) years from date of issuance. It does not pertain to any discovery during construction, nor is it a clearance for purposes of the Illinois Human Skeletal Remains Protection Act (20 ILCS 3440).

If you are an applicant, please submit a copy of this letter to the state or federal agency from which you obtain any permit, license, grant, or other assistance. If further assistance is needed contact Jeff Kruchten, Chief Archaeologist at 217/785-1279 or Jeffery.kruchten@illinois.gov.

Sincerely,

Robert F. Appleman
Deputy State Historic
Preservation Officer

B.3 Tribal Correspondence

This appendix contains the letter sent to the Bureau of Indian Affairs and a representative letter used for tribal correspondence with the following Native American Tribes. This appendix also contains correspondence from Tribes that responded to DOE's consultation letter.

- Bureau of Indian Affairs
- Kickapoo Tribe of Indians of the Kickapoo Reservation in Kansas
- Kickapoo Tribe of Oklahoma
- Menominee Indian Tribe of Wisconsin
- Miami Tribe of Oklahoma
- Osage Nation
- Peoria Tribe of Indians of Oklahoma



NATIONAL ENERGY TECHNOLOGY LABORATORY
Albany, OR • Morgantown, WV • Pittsburgh, PA



February 3, 2020

Bureau of Indian Affairs
545 Marriott Drive, Suite 700
Nashville, TN 37214

Re: Consultation Under NHPA Section 106 for a project in Sangamon County, Illinois

The U.S. Department of Energy (DOE) is preparing an Environmental Assessment (EA) for DOE's proposed action of providing cost-shared financial assistance to the Trustees of the University of Illinois (UIUC) for the "Large Pilot Testing of Linde/BASF Advanced Post-Combustion CO₂ Capture Technology at a Coal-Fired Power Plant" project. The EA is being prepared to fulfill DOE's obligations under the National Environmental Policy Act (NEPA), the Council on Environmental Quality's NEPA regulations, and DOE's NEPA implementing procedures. The EA will evaluate the potential effects of construction and subsequent 2-year operation of the facility for research purposes.

This undertaking and its effects are also being considered under Section 106 of the National Historic Preservation Act (NHPA) of 1966, as amended, and implementing regulations at 36 CFR Part 800. As part of compliance with Section 106, DOE is writing to seek your comments on any issues or concerns for traditional cultural properties, sacred sites, or site of traditional religious or cultural importance in the area that might be affected by the proposed project and would like to know if you wish to receive a copy of the draft EA. We respectfully ask that you provide any information or comments within 30 days to enable us to complete this phase of the project within the scheduled timeframe.

The DOE's proposed action is to provide cost-shared financial assistance to UIUC. DOE proposes to provide approximately \$3 million of the project's \$3.7 million total cost.

UIUC's project would include construction of a 10-MWe CO₂ capture unit pilot plant adjacent to the existing Dallman #4 Unit at the coal-fired City Water, Light, and Power plant in Springfield Illinois. The proposed pilot plant would be constructed on the west side of the existing CWLP facility on land currently used for equipment and materials storage. The pilot plant would be constructed in an area of approximately 120 feet by 425 feet (51,000 square feet). This project would use 24,000 gallons of amine compounds which would be stored on-site. The pilot would receive a slipstream from the CWLP plant and return captured CO₂ to the stack for venting. CWLP is located on a peninsula and the proposed location for the pilot unit is within 200 feet of Lake Springfield, a freshwater reservoir that is used as a potable water source for the City of Springfield.

626 Cochran Mill Road, P.O. Box 10940, Pittsburgh, PA 15236

• pierina.fayish@netl.doe.gov • netl.doe.gov

• Voice (412) 386-5428 •

• Fax (412) 386-4775 •

• www.netl.doe.gov



NATIONAL ENERGY TECHNOLOGY LABORATORY
Albany, OR • Morgantown, WV • Pittsburgh, PA



Surface disturbance at the proposed project site would consist of the installation of pilings extending 10-15 feet below ground level and leveling and preparing for a concrete pad on which the pilot capture plant would be constructed. With the exception of the piling installation, the leveling and surface preparation activities would not disturb the soil to a depth lower than has historically been disturbed for power plant construction and operation activities.

If you have any questions or comments, please contact Ms. Pierina Fayish at

National Energy Technology Laboratory M/S:922-1W13
P.O. Box 10940
Pittsburgh, PA 15236-0940
Attention: Pierina Fayish
Pierina.Fayish@netl.doe.gov
(412) 386-5428

Thank you for your assistance in this matter.

Sincerely,

Pierina N. Fayish





NATIONAL ENERGY TECHNOLOGY LABORATORY
Albany, OR • Morgantown, WV • Pittsburgh, PA

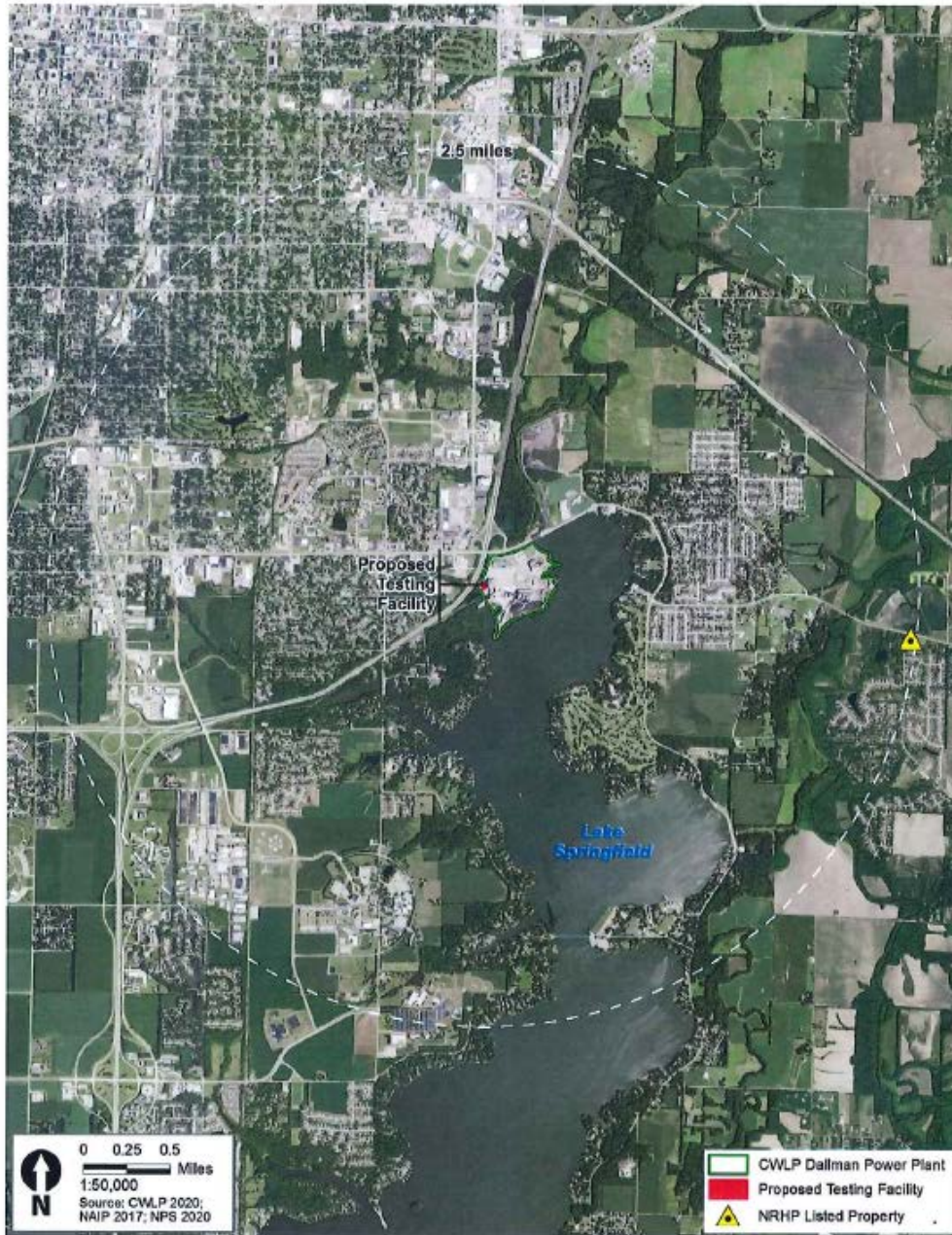

626 Cochrans Mill Road, P.O. Box 10940, Pittsburgh, PA 15236
pierina.fayish@netl.doe.gov@netl.doe.gov • Voice (412) 386-5428 • Fax (412) 386-4775 • www.netl.doe.gov



February 3, 2020

Tribe
Tribe Point of Contact
Tribe Point of Contact Title
Tribe Address

Re: Consultation Under NHPA Section 106 for a project in Sangamon County, Illinois

Dear Tribe Point of Contact Title:

The U.S. Department of Energy (DOE) is preparing an Environmental Assessment (EA) for DOE's proposed action of providing cost-shared financial assistance to the Trustees of the University of Illinois (UIUC) for the "Large Pilot Testing of Linde/BASF Advanced Post-Combustion CO₂ Capture Technology at a Coal-Fired Power Plant" project. The EA is being prepared to fulfill DOE's obligations under the National Environmental Policy Act (NEPA), the Council on Environmental Quality's NEPA regulations, and DOE's NEPA implementing procedures. The EA will evaluate the potential effects of construction and subsequent 2-year operation of the facility for research purposes.

This undertaking and its effects are also being considered under Section 106 of the National Historic Preservation Act (NHPA) of 1966, as amended, and implementing regulations at 36 CFR Part 800. As part of compliance with Section 106, DOE is writing to seek your comments on any issues or concerns for traditional cultural properties, sacred sites, or site of traditional religious or cultural importance in the area that might be affected by the proposed project and would like to know if you wish to receive a copy of the draft EA. We respectfully ask that you provide any information or comments within 30 days to enable us to complete this phase of the project within the scheduled timeframe.

The DOE's proposed action is to provide cost-shared financial assistance to UIUC. DOE proposes to provide approximately \$3 million of the project's \$3.7 million total cost.

UIUC's project would include construction of a 10-MWe CO₂ capture unit pilot plant adjacent to the existing Dallman #4 Unit at the coal-fired City Water, Light, and Power plant in Springfield Illinois. The proposed pilot plant would be constructed on the west side of the existing CWLP facility on land currently used for equipment and materials storage. The pilot plant would be constructed in an area of approximately 120 feet by 425 feet (51,000 square feet). This project would use 24,000 gallons of amine compounds which would be stored on-site. The pilot would receive a slipstream from the CWLP plant and return captured CO₂ to the stack for venting. CWLP is located on a peninsula and the proposed location for the pilot unit is within 200 feet of Lake Springfield, a freshwater reservoir that is used as a potable water source for the City of Springfield.

628 Cochran's Mill Road, P.O. Box 10940, Pittsburgh, PA 15236
 pierina.fayish@netl.doe.gov@netl.doe.gov • Voice (412) 386-5428 • Fax (412) 386-4775 • www.netl.doe.gov



Surface disturbance at the proposed project site would consist of the installation of pilings extending 10-15 feet below ground level and leveling and preparing for a concrete pad on which the pilot capture plant would be constructed. With the exception of the piling installation, the leveling and surface preparation activities would not disturb the soil to a depth lower than has historically been disturbed for power plant construction and operation activities.

If you have any questions or comments, please contact Ms. Pierina Fayish at

National Energy Technology Laboratory M/S:922-1W13
P.O. Box 10940
Pittsburgh, PA 15236-0940
Attention: Pierina Fayish
Pierina.Fayish@netl.doe.gov
(412) 386-5428

Thank you for your assistance in this matter.

Sincerely,

Pierina N. Fayish



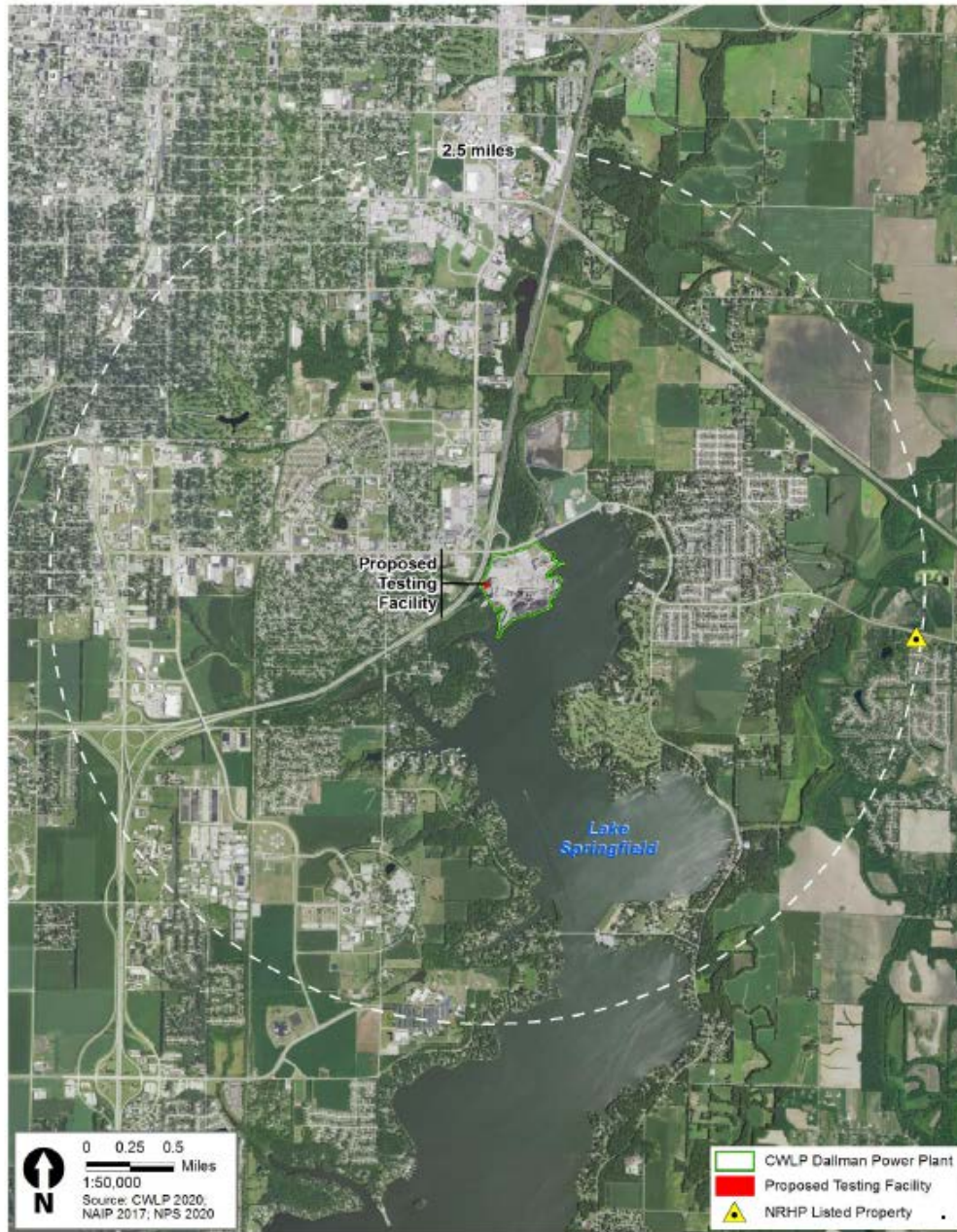

626 Cochrans Mill Road, P.O. Box 10940, Pittsburgh, PA 15236
pierna.fayish@netl.doe.gov@netl.doe.gov • Voice (412) 386-6428 • Fax (412) 386-4775 • www.netl.doe.gov

Scoping Comments from Miami Tribe of Oklahoma



Miami Tribe of Oklahoma

3410 P St. NW, Miami, OK 74354 • P.O. Box 1326, Miami, OK 74355
Ph: (918) 541-1300 • Fax: (918) 542-7260
www.miamination.com



Via email: Pierina.Fayish@netl.doe.gov

March 10, 2020

National Energy Technology Laboratory M/S:922-1W13
P.O. Box 10940
Pittsburgh, PA 15236-0940
Attn: Pierina Fayish

Re: Large Pilot-Testing of Linde/BASF Advanced Post-Combustion CO₂ Capture Technology at a Coal-Fired Power Plant Project – Comments of the Miami Tribe of Oklahoma

Dear Ms. Fayish:

Aya, kikwehsitoole – I show you respect. My name is Diane Hunter, and I am the Tribal Historic Preservation Officer for the Federally Recognized Miami Tribe of Oklahoma. In this capacity, I am the Miami Tribe's point of contact for all Section 106 issues.

The Miami Tribe offers no objection to the above-referenced project at this time, as we are not currently aware of existing documentation directly linking a specific Miami cultural or historic site to the project site. However, as this project is within the aboriginal homelands of the Miami Tribe, if any human remains or Native American cultural items falling under the Native American Graves Protection and Repatriation Act (NAGPRA) or archaeological evidence is discovered during any phase of this project, the Miami Tribe requests immediate consultation with the entity of jurisdiction for the location of discovery. In such a case, please contact me at 918-541-8966 or by email at dhunter@miamination.com to initiate consultation.

The Miami Tribe accepts the invitation to serve as a consulting party to the proposed project. In my capacity as Tribal Historic Preservation Officer I am the point of contact for consultation.

Respectfully,

Diane Hunter
Tribal Historic Preservation Officer

This page intentionally left blank.