

Pennsylvania State Energy Program's Conergy Navy Yard Solar Project

Philadelphia,
Philadelphia County, Pennsylvania



FINAL
ENVIRONMENTAL ASSESSMENT

ENVIRONMENTAL ASSESSMENT

For The
 PENNSYLVANIA STATE ENERGY PROGRAM'S
 CONERGY NAVY YARD SOLAR PROJECT
 PHILADELPHIA, PENNSYLVANIA
 U.S. Department of Energy
 National Energy Technology Laboratory

TABLE OF CONTENTS

CONTENTS	
1.0 SUMMARY	5
1.1 INTRODUCTION AND BACKGROUND	5
1.2 PURPOSE AND NEED	7
1.3 SCOPE OF THIS ENVIRONMENTAL ASSESSMENT	7
2.0 PROPOSED ACTION AND ALTERNATIVES	8
2.1 PROPOSED ACTION	8
2.2 PENNSYLVANIA'S PROPOSED ACTION	8
2.3 NO ACTION ALTERNATIVE	11
2.4 ALTERNATIVES CONSIDERED BUT DISMISSED	11
3.0 AFFECTED ENVIRONMENT	11
3.1 NATURAL RESOURCES	13
3.1.1 WATER RESOURCES	13
3.1.2 GEOLOGY, TOPOGRAPHY AND SOILS	16
3.1.3 VEGETATION AND WILDLIFE	17
3.1.4 AIR QUALITY AND CLIMATE CHANGE	18
3.1.5 NOISE	19
3.2 CULTURAL RESOURCES	19
3.2.1 VISUAL RESOURCES	19
3.2.2 ARCHEOLOGICAL AND HISTORIC RESOURCES	21
3.3 SOCIOECONOMIC RESOURCES	21
3.3.1 LAND USE	21
3.3.2 PLANNING POLICIES AND CONTROLS	22
3.3.3 DEMOGRAPHICS AND ENVIRONMENTAL JUSTICE	22
3.4 INFRASTRUCTURE	23
3.4.1 ROADWAYS AND TRAFFIC	23
3.4.2 POTABLE WATER	23
3.4.3 STORMWATER MANAGEMENT	23
3.4.4 SANITARY SEWER	24
3.4.5 ENERGY SYSTEM	24
3.4.6 SOLID WASTE	25
3.4.7 HAZARDOUS MATERIALS	25
4.0 ENVIRONMENTAL CONSEQUENCES	26
4.1 NATURAL RESOURCES	26
4.1.1 WATER RESOURCES	26
4.1.2 GEOLOGY, TOPOGRAPHY AND SOILS	27
4.1.3 VEGETATION AND WILDLIFE	27
4.1.4 AIR QUALITY	28
4.1.5 NOISE	32
4.2 CULTURAL RESOURCES	32

4.2.1 VISUAL RESOURCES	32
4.2.2 ARCHEOLOGICAL AND HISTORIC RESOURCES	33
4.3 SOCIOECONOMIC RESOURCES	33
4.3.1 LAND USE	33
4.3.2 PLANNING POLICIES AND CONTROLS	34
4.3.3 DEMOGRAPHICS AND ENVIRONMENTAL JUSTICE	34
4.4 INFRASTRUCTURE	34
4.4.1 ROADWAYS AND TRAFFIC	34
4.4.2 POTABLE WATER	35
4.4.3 STORMWATER MANAGEMENT	35
4.4.4 SANITARY SEWER	36
4.4.5 ENERGY SYSTEM	36
4.4.6 SOLID WASTE	36
4.4.7 HAZARDOUS MATERIALS	37
5.0 CUMMULATIVE IMPACTS	37
6.0 PUBLIC COMMENT	39
7.0 LIST OF PREPARERS	39
8.0 AGENCIES AND PERSONS CONSULTED	40
9.0 REFERENCES	41

APPENDICES

APPENDIX 1: SITE MAPS
APPENDIX 2: SITE PHOTOGRAPHS
APPENDIX 3: PA SHPO RESPONSE LETTER
APPENDIX 4: SHPO SUBMISSION
APPENDIX 5: HISTORICAL BUILDING DEMOLITION PLAN
APPENDIX 6: CONSTRUCTION EQUIPMENT
APPENDIX 7: PERMIT APPLICATIONS
APPENDIX 8: AGENCIES RETURN CORRESPONDENCE ABOUT PERMITS
APPENDIX 9: WETLANDS REPORT
APPENDIX 10: SWALE DETAIL
APPENDIX 11: FLOOD PLAIN MAP
APPENDIX 12: GROUNDWATER TABLE MAP
APPENDIX 13: USGS MAP
APPENDIX 14: TOPOGRAPHIC MAP
APPENDIX 15: AERIAL PHOTOGRAPHY PHOTOGRAPH FROM 1944
APPENDIX 16: SOIL MAP
APPENDIX 17: PGC LETTER
APPENDIX 18: FALCON LOCATION
APPENDIX 19: ARCHEOLOGICAL LETTER
APPENDIX 20: NAVY YARD PRELIM PHASE 1 EA
APPENDIX 21: FLOODPLAIN MAP WITH ARRAY LAYOUT
APPENDIX 22: ELEVATIONS ABOVE 4.2 FLOODPLAIN
APPENDIX 23: TEMPORARY ELECTRIC/TRAILER LOCATION
APPENDIX 24: FEMA FIRMETTE MAP
APPENDIX 25: NPDES PERMIT APPROVAL LETTER

LIST OF ACRONYMS

BRAC	Base Realignment and Closure
CAA	Clean Air Act
CEQ	Council on Environmental Quality
CFR	Code of Federal Regulations
cy	Cubic Yards
dB	Decibels
dBA	A-Weighted Decibels
dBA LEQ	Decibel Equivalent
DCNR	Pennsylvania Department of Conservation and Natural Resources
DEP	Pennsylvania Department of Environmental Protection
DOE	Department of Energy
DOT	Department of Transportation
EA	Environmental Assessment
EIS	Environmental Impact Statement
E&S	Erosion and Sedimentation
FEMA	Federal Emergency Management Agency
FIRM	Flood Insurance Rate Map
FONSI	Finding of No Significant Impact
GHG	Greenhouse Gasses
GPIC	Greater Philadelphia Innovation Cluster
HAPs	Hazardous Air Pollutants
HAZMAT	Hazardous Materials
IBA	Important Bird Area
MW	Megawatt
NAAQS	National Ambient Air Quality Standards
NEPA	National Environmental Policy Act
OC	On-Center
PADEP	Pennsylvania Department of Environmental Protection
PADOT	Pennsylvania Department of Transportation
PEDA	Pennsylvania Energy Development Authority
PCBs	Polychlorinated Biphenyls
PGC	Pennsylvania Game Commission
PHMC	Pennsylvania Historical and Museum Commission
PIDC	Philadelphia Industrial Development Corporation
PNDI	Pennsylvania National Diversity Inventory
PWD	Philadelphia Water Department
SEP	State Energy Program
SHPO	State Historic Preservation Officer
SWPPP	Stormwater Pollution Prevention Plan
USDA	United States Department of Agriculture
USEPA	United States Environmental Protection Agency
USFWS	United States Fish and Wildlife Services
USGS	United States Geological Survey
VOCs	Volatile Organic Compounds

1 SUMMARY

1.1 Introduction and Background

Conergy Projects, Inc. (Conergy) proposes to construct and operate a 1.251 megawatt (MW) solar photovoltaic (PV) facility at the former Navy Yard site in south Philadelphia in Pennsylvania's Philadelphia County to provide up to 1,596 MW hours of electricity per year, feeding directly into the distribution grid. After considering a number of alternative PV configurations and acquiring land via a lease to install the facility, the project proponents have identified a final proposed layout that meets the production criteria and minimizes the footprint of the system. The PV panels would be installed on an unused portion of the Navy Yard, which is a capped landfill area that overlooks the Schuylkill River and is immediately south of the Girard Point Bridge. The entire facility would be visible from airplanes landing at Philadelphia International Airport.

The Commonwealth of Pennsylvania selected this project for a \$1,279,000 grant from the Pennsylvania Department of Environmental Protection (PADEP) via the Pennsylvania Energy Development Authority (PEDA). Of this, \$512,441 is proposed to come from a formula grant pursuant to U. S. Department of Energy's (DOE's) State Energy Program (SEP). The purpose of the SEP is to promote the conservation of energy and reduce dependence on imported oil by helping states develop comprehensive energy programs and by providing them with technical and financial assistance. States can use their SEP funds for a wide variety of activities related to energy efficiency and renewable energy. See *generally* 42 United States Code (U.S.C.) § 6321 *et seq.* and 10 Code of Federal Regulations (CFR) Part 420. In the *American Recovery and Reinvestment Act of 2009* (Public Law 111-5, 123 Statute 115; Recovery Act), Congress appropriated \$3.1 billion to DOE for the SEP, and Pennsylvania received approximately \$99 million pursuant to a statutory formula for distributing these funds.

In accordance with the National Environmental Policy Act (NEPA), DOE must complete a review of potential environmental impacts of proposals under SEP before making a decision whether to allow states to use the funds for the projects identified by the states. Conergy prepared this environmental assessment (EA), with Pennsylvania's assistance, to analyze the potential environmental impacts of the proposed Photovoltaic Facility. This EA analyzes the following areas of potential environmental impacts: natural resources including water resources, geology, topography and soils, vegetation and wildlife, air quality, and noise; cultural resources including visual, archeological and historical resources; infrastructure including roadways and traffic, potable water, storm water management, sanitary sewer, energy systems, solid waste, and hazardous material; socioeconomic resources including land use, planning policies and control, demographics and environmental justice, and human health and safety.

The proposed solar PV facility would generate emissions-free energy that would not degrade air quality. The use of solar power would offset greenhouse gases and other emissions from fossil fuels used to generate electricity, thereby providing an environmental benefit. The project would also create green construction and green energy maintenance jobs, re-develop a parcel of the Philadelphia Navy Yard that has limited development potential due to the nature of the physical site, and afford the Philadelphia Industrial Development Corporation (PIDC) and the City of Philadelphia with economic development value on a closed landfill.

The proposed project came about after analysis of a variety of options including different sites and different configurations on the selected site. The considered sites included other brownfields, closed and active landfills, large corporate buildings and a local school district's buildings. The other options for the selected site at the Philadelphia Navy Yard included a

1.8 MW design and a 1.5 MW design. Not constructing the project was considered, but would negate the advantages of: creating a wide variety of jobs during construction, creating long-term part-time maintenance positions, assisting the City of Philadelphia in achieving its goal to be a substantial solar energy producer within the next several years.

For this proposed project, the areas of concern with the greatest potential for impact include wildlife, water and storm water management, and historic preservation. This document examines those areas in closer detail.

Wildlife resources were reviewed because of presence of a species important to Pennsylvania. The Pennsylvania Game Commission (PGC) determined that a Pennsylvania Endangered Species, *Falco peregrinus* (Peregrine Falcon) is nesting within 1000 feet of the site. This requires a modified work schedule to minimize impacts, but should have no deleterious impact on wildlife.

The proposed location of the project is within the 100-year floodplain of the Schuylkill River (FEMA 2009). Thus, pursuant to Executive Order 11988, *Floodplain Management*, each Federal agency is required, when conducting activities in a floodplain, to take actions to reduce the risk of flood damage; minimize the impacts of floods on human safety, health, and welfare; and restore and preserve the natural and beneficial values served by floodplains. Regulations issued by DOE that implement this Executive Order are contained in 10 CFR Part 1022, "Compliance with Floodplain and Wetland Environmental Review Requirements." This regulation requires DOE to prepare a floodplain assessment for any proposed action in the base floodplain, which is the 100-year floodplain (that is, a floodplain with a 1.0 percent chance of flooding in any given year). At 10 CFR 1022.2(b), the regulation also states that whenever possible, DOE shall accommodate requirements of the Executive Order through the applicable NEPA procedures. Accordingly, it is the intent that this EA meet the requirements for a floodplain assessment as described in Section 3.1.1 of the regulation, as well as fulfilling requirements under NEPA.

The Philadelphia Naval Ship Yard Historic District, as listed on the National Register, includes the proposed site. The Pennsylvania Historical and Museum Commission's (PHMC) Bureau for Historic Preservation (the State Historic Preservation Office (SHPO)), according to Section 106 of the National Historic Preservation Act of 1966, as amended in 1980 and 1992, and the regulations (36 CFR Part 80) of the Advisory Council on Historic Preservation as revised in 1999 and 1003, was required to consider the project's potential effect upon both historic and archaeological resources. The PHMC has determined that the effect of demolition of two buildings, deemed as contributing in the Historic District, requires mitigation – recordation of the structures - be taken to reduce the effect the proposed project will have on historic resources. PHMC has also determined that there is no adaptive reuse option available and indicated that stipulating recordation in a Memorandum of Agreement, if entered into by all parties, would be sufficient to satisfy these requirements.

1.2 Purpose and Need

DOE's Purpose and Need

DOE's purpose and need is to ensure that SEP funds are used for activities that meet Congress's statutory aims to improve energy efficiency, reduce dependence on imported oil, decrease energy consumption, or promote renewable energy. However, it is not DOE's role to dictate to Pennsylvania how to allocate its funds among these objectives or to prescribe the projects it should pursue.

Pennsylvania's & Conergy's Purpose and Need

PEDA's purpose and need is to take action to help fulfill its mission to finance clean, advanced energy projects in Pennsylvania, including solar energy projects. Applications are evaluated using criteria including but not limited to technical and financial feasibility of the project, number and quality of jobs created or preserved, and other economic benefits for the Commonwealth of Pennsylvania. Projects must show financial commitment from at least one source other than PEDA and demonstrate a net environmental benefit to Pennsylvania. Conergy's purpose and need is to facilitate green job creation, economic development and growth and improve and drive the solar market place in Pennsylvania.

1.3 Scope of This Environmental Assessment

This EA presents information on the potential impacts associated with the distribution of a grant to Conergy for the construction of a solar facility in Philadelphia. This EA was prepared in compliance with the National Environmental Policy Act of 1969 (NEPA; 42 U.S.C. 4321 et seq.); the National Environmental Policy Act, Council on Environmental Quality (CEQ) regulations 40 CFR Parts 1500-1508; and DOE NEPA Implementation Procedures 10 CFR 1021.

This EA analyzes the following resource areas:

- Natural Resources – including water resources, geology, topography and soils, vegetation and wildlife, air quality, and noise;
- Historic Resources – including visual, and historical resources;
- Infrastructure – including roadways and traffic, potable water, stormwater management, sanitary sewer, energy systems, solid waste, and hazardous material;
- Socioeconomic Resources – including land use, planning policies, demographics and environmental justice, and human health and safety.

The following resource areas were not carried forward for further analysis:

- Geology, Topography and Soils - the proposed project is not underlain by, or located within an area of, significant geology;
- Vegetation – the proposed project is not located within or adjacent to a wilderness area nor is the area surrounding the proposed project populated by threatened or endangered plant species;
- Noise – the proposed project generates no noise above accepted zoning levels, even during construction;
- Visual Resources – the proposed project does not fall in the sight line of any valued visual resources, such as scenic rivers or parks;
- Archeological Resources – as the area is comprised of landfill material and previously disturbed land, the proposed project contains no archeological resources that are required to be investigated in accordance with the Pennsylvania SHPO;
- Roadways and Traffic – the proposed project should have no impact on roadways and traffic;

- Land Use – the current zoning of the site and surrounding area coincides with the required zoning of the proposed project;
- Planning Policies – the proposed project is synchronous with the intended use stipulated by the Navy Yard Master Plan;
- Demographics and Environmental Justice – implementation of the proposed project would not result in disproportionately high and adverse effects on the health and/or environment of minority and/or low income populations;
- Human Health and Safety – the proposed project would not result in increased risks to human health and safety.

As a result of this EA, if no significant impacts are identified, a Finding of No Significant Impact (FONSI) may be issued by DOE. If potential impacts are identified, an Environmental Impact Statement (EIS) may be required.

2.0 PROPOSED ACTION AND ALTERNATIVES

2.1 DOE's Proposed Action

DOE's proposed action is to allow Pennsylvania to use its SEP funds for a grant to assist in the financing of the Conergy solar project in order to facilitate Pennsylvania's achievement of the objectives of SEP.

2.2 Pennsylvania's Proposed Project

PEDA selected the Exelon-Conergy Solar Energy Center II for a \$1.279 million grant based on its location on otherwise unusable brownfield site, ideal public viewing access, ability to provide emissions-free energy, creation of jobs during project construction, and generate electricity for the local utility grid. A criterion of the PEDA grant program is that the project must be completed and fully operational by December 31, 2011. The proposed project is the construction of solar facility within the City of Philadelphia that would generate electricity to be sold to the PJM grid as an alternative energy source. The facility would generate approximately 1,596 MW hours of electricity.

The proposed project offers benefits to several parties. The PIDC would receive a nominal lease payment from Conergy or the financing company for hosting the solar PV project on its property. Exelon will receive the electricity in to the grid and receive the Renewable Energy Credits, thereby fulfilling its obligations for the alternative energy sources under the Pennsylvania Alternative Energy Portfolio Standards Act of 2004. (http://www.puc.state.pa.us/electric/electric_alt_energy.aspx)

The Philadelphia Navy Yard is now hosting the Greater Philadelphia Innovation Cluster (GPIC) for Energy Efficient Buildings. The GPIC is described as "a consortium of academic institutions, federal laboratories, global industry partners, regional economic development agencies and other stakeholders that joined forces to secure up to \$130 million in federal grants from DOE. The funding will foster national energy independence and create quality jobs for the region. The GPIC's efforts are intended to establish The Navy Yard, Philadelphia and the region as the national center for energy efficient research, education, policy and commercialization. (<http://www.sep.benfranklin.org/programs-services/industries-sectors/energy/greater-philadelphia-innovation-cluster/>) Key personnel of the GPIC will be headquartered at The Navy Yard in a retrofitted building that will become a living laboratory for energy efficient building design." Having a solar facility such as the proposed project complements these efforts and also offers the opportunity to teach the public through scheduled tours held at the facility. The

GPIC is an entirely separate project that has no relation to the implementation to the proposed solar PV project. However, the projects lie in close proximity to each other.

Proposed Site

The proposed site is an approximately 8.1 acre parcel which is currently an undeveloped, capped landfill located within the Philadelphia Navy Yard. The Philadelphia Navy Yard is an industrial and commercial former US Navy facility that was transferred out of military ownership in March 2000. As such, the property is presently zoned and permitted for both commercial and industrial operations. The site is currently unused property with overgrown weed vegetation and is solely used for temporary storage by other local facility owners. The Schuylkill River is located west of the property and extends to the Delaware River south of the project site. The proposed project would include demolition of three dilapidated buildings, two of which are eligible for the National Register of Historic Places and which will undergo recordation prior to demolition. A Memorandum of Agreement (MOA) was developed between DOE, Pennsylvania DEP, Philadelphia Industrial Development Corporation, Conergy, and the Pennsylvania Historical and Museum Commission, which is Pennsylvania's SHPO. During the construction phase, a one story office trailer would be connected to electrical services onsite, as well as temporary portable sanitation units. A detailed site map illustrating the current property conditions and planned solar PV facility is included in Appendix 1. Site photographs are additionally included as Appendix 2.

The proposed site was capped in order to remediate a waste management area that was previously used for the treatment, storage and disposal of solid waste generated by the U.S. Navy at the Philadelphia Naval Base (US Navy Remedial Action Contract, Contract No N62472-94-D-0398, Delivery Order No. 0029, July 1999 prepared by Foster Wheeler Environmental Corporation). One of the historic buildings referenced was an incinerator building where the waste was burned prior to placement in the landfill. In 1999, the landfill was closed and capped by the US Navy. The top of the cap seal currently exists approximately 18 inches below the existing grade of the site. The construction of the proposed solar facility will not disturb the existing cap. Clean fill material will be added on top of the existing cap, with the solar equipment then placed on top of the clean fill material.

Construction

Construction would include installation of 5,586 solar modules, racking, electrical systems, distribution line, foundation systems for the inverter cabinets, and fencing around the proposed site. This would be performed in accordance with an approved erosion and sedimentation control plan, a National Pollutant Discharge Elimination System (NPDES) permit, and in compliance with all other applicable requirements. Solar installation, including site preparation, PV erection, final commissioning, interconnection line installation, and overall systems tie-in and start-up is planned to be completed by December 31, 2011, to meet the deadlines of the current awarded grant, which proposes to use funding from both the DOE SEP Recovery Act stimulus program and the Commonwealth of Pennsylvania's Growing Greener II Bond Initiative.

In order to ensure the integrity of the cap and to ensure its seal, no penetrations would be made to the existing grade during the construction sequence. Construction also would entail clearing and grubbing portions of the current property for appropriate clean fill to be laid down and leveled. Before construction, the entire 8.1 acres would be mowed with a standard lawn mower. After the mowing is complete approximately 45 trees would be removed from the site in order to prevent shading of the modules on the completed system. The stumps of the trees would be left in the ground as to not disturb the cap and they would be cut to be flush with the existing grade. In addition, the existing man-made swale present on the site would have perforated pipe

placed on the bottom and covered with sand and a layer of clean fill on the top. The alterations to the man-made swale were approved during the NPDES application and approval process. The construction equipment planned for use onsite is described in Appendix 6.

In addition, the three current buildings located on the property would be demolished. Two of these buildings are eligible for listing on the National Register of Historic Places. Conergy has approval, in the form of a letter from the PA SHPO found in Appendix 3, for demolition of these buildings as there is no current or planned use of any of the structures. Documentation regarding the historical buildings is located in Appendix 4, including the application to PA SHPO. A MOA regarding the recordation of the historical structures was negotiated and signed by all parties. The third building has no historical significance and has been approved for demolition. Conergy would remove the buildings with a demolition company that would first test for any asbestos within the buildings then would demolish the buildings according to the plan located in Appendix 5 and in accordance with the MOA with the PA SHPO. If asbestos is found in the buildings, prior remediation of the asbestos will occur.

There would be two inverters located on the facility, each 500 kilowatt. A distribution line would be routed across the Tasty Baking Company, via an easement to a pole for distribution to the grid. This distribution line would be built up with fill on top of the existing cap. The fill will create a pathway across the northwest portion of the site, a pathway that would be wide enough for vehicles to drive on top. Within this fill would be a concrete duct bank with conduit for the distribution line created as per the National Electric Code (NEC) requirements. This pathway would be at approximately a 1:3 slope, so that vehicles could drive over it, to a surface that would be eight (8') feet wide and one foot six inches (1'-6") deep. This would be a typical run for the detail and extend six hundred forty four (644') foot long across the northwest part of the property. At this point an easement would be established through the Tasty Baking Facility to continue a trenched run to the interconnection point.

Operation

The equipment associated with the proposed project would consist of construction equipment, and electrical equipment after the installation is completed.

The construction equipment will be used onsite during construction only. After the installation is completed, inverters, combiners, medium voltage switchgear, and monitoring equipment will be running for the daily operations of the facility.

Conergy and its project partners would operate and maintain the solar energy project according to standard industry procedures and applicable requirements. Routine maintenance of the inverter equipment would be necessary to maximize performance and identify potential problems or maintenance issues. Each inverter would be remotely monitored to ensure operations are proceeding efficiently. Any problems would be reported to operations and maintenance personnel, who would perform both routine maintenance and arrange major repairs. In addition, all roads, pads, and trenched areas would be regularly inspected and maintained to minimize erosion. The road loop portion of the road surrounding the historical buildings will have fill material on top, with solar equipment in the area. The northern part of the access road will be a dirt road leading to the access fences of the facility. (See maps, Appendix 1)

During the Operations and Maintenance term of the facility (approximately 20 years after installation), there will be occasional module washing required, where a water truck would bring potable water in from offsite to wash and rinse off the modules. Approximately 3,300 gallons of

water is expected to be used to wash the entire facility. A low pressure, pressure washer is used to spray the modules, followed by a light scrubbing by either a soft bristled brush or a squeegee. Only fresh water would be used. No chemicals are permitted for cleaning. This process would be completed over approximately a four day period, with half the day actually spraying water, and the other half setting up equipment and scrubbing. Any remaining unused water will leave the site in the water truck. This operation does not require any state or local permits.

2.3 No Action Alternative

Under the No Action Alternative, DOE would not allow Pennsylvania to use its SEP funds for this project. For purposes of this EA, it is assumed that the project would not proceed without SEP funding. This assumption could be incorrect, but it allows for a comparison between the potential impacts of the project as proposed and the impacts of not proceeding with the project. Without the proposed project, Conergy operations would continue as otherwise planned but without the proposed solar project being installed. Additional power would not be supplied to the utility grid. This means that the additional power that the utility is expecting and planning for would not be supplied. Concurrently, the No Action Alternative would deprive the Philadelphia area of a supplier of an efficient, alternative fuel source to local businesses that would serve to reduce regional greenhouse gas emissions. Further, Pennsylvania's ability to use its SEP funds for energy efficiency and renewable energy activities would be impaired, as would its ability to create jobs and invest in the nation's infrastructure in furtherance of the goals of the Recovery Act.

2.4 Alternatives Considered but Dismissed

Based on the current zoning and permitting of the primary site being synchronous with its proposed future use, alternative locations were not deeply explored by Conergy. Additionally, the anticipated success of the facility is largely based on its location.

Alternate locations within the Philadelphia Area of the Exelon Utility region were discussed and evaluated before applying for the PEDA grant round in April of 2009. These options included both roof-mounted and ground-mounted systems.

From a financial feasibility standpoint, public school buildings, government buildings, landfills and brownfield sites were the options reviewed. Roofs of the local public school buildings were dismissed as an option due to the concerns over the varying structural requirements of the buildings, the lack of one facility able to handle the size of solar array being considered and the limited installation timeline available with the school year. Government buildings were dismissed due mostly to the size limitation and the need for long lead times for lease agreements and approvals. Alternate landfills considered throughout the Southeastern region of Pennsylvania were discounted for several reasons, including lease pricing for the land, feasibility of the cap on the facility for a solar installation without additional pricing for added fill, and on one of the sites the cap on the facility had not been settled for the required time period before construction could begin on the facility. Finally, for other brownfield sites, many of them required remediation prior to re-use or came with liability issues which made financing impossible.

3.0 AFFECTED ENVIRONMENT

To determine if the actions of constructing the project could have environmental impacts, Conergy applied for permits to the relevant governmental agencies and conducted site

reconnaissance. Copies of the permit applications and the corresponding agencies' return correspondence are included as Appendix 7 and Appendix 8, respectively.

Table 1 provides a summary of socioeconomic, environmental, and cultural impacts of the No-Action Alternative and the proposed project.

Table 1. Summary of Socioeconomic, Environmental, and Cultural Impacts

Area of Potential Impact	No-Action Alternative		Proposed Project	
	Construction	Operations	Construction	Operations
Wetlands	Negligible	Negligible	Negligible	Negligible
Water Quality/Streams	Negligible	Negligible	Negligible	Negligible
Stormwater	Negligible	Negligible	Minimal (regulated through NPDES permit)	Negligible
Floodplains	Negligible	Negligible	Minimal	Minimal
Groundwater	Negligible	Negligible	Negligible	Negligible
Topography	Negligible	Negligible	Negligible	Negligible
Soil	Negligible	Negligible	Negligible	Negligible
Vegetation	Negligible	Negligible	Negligible	Negligible
Wildlife	Negligible	Negligible	Negligible	Negligible
Threatened & Endangered Species	Negligible	Negligible	Minimal (modified schedule)	Negligible
Parks & Recreation	Negligible	Negligible	Negligible	Negligible
Air Quality	Negligible	Negligible	Minor	Minor (Beneficial)
Noise	Negligible	Negligible	Negligible	Negligible
Visual Resources	Negligible	Negligible	Negligible	Negligible
Archeological Resources	Negligible	Negligible	Negligible	Negligible
Historic Resources	Negligible	Negligible	Minor (Mitigation)	Negligible
Land Use	Negligible	Negligible	Negligible	Negligible
Planning	Negligible	Negligible	Negligible	Negligible
Demographics	Negligible	Negligible	Negligible	Negligible
Environmental Justice	Negligible	Negligible	Negligible	Negligible
Roadways & Traffic	Negligible	Negligible	Negligible	Negligible
Potable Water	Negligible	Negligible	Negligible	Negligible
Sanitary Wastewater	Negligible	Negligible	Negligible	Negligible
Energy	Negligible	Negligible	Negligible	Minor (Beneficial)
Solid Waste	Negligible	Negligible	Minor	Negligible
Hazardous Materials	Negligible	Negligible	Negligible	Negligible

3.1 Natural Resources

3.1.1 Water Resources

Surface Water (Wetlands)

Field inspection reveals an absence of perennial surface water on the site of the proposed project. However, maps of the Project Area prepared by Pennoni Associates dated October 7, 2008, have shown small wetland areas in the vicinity of the Project. Ed Bonner of the Army Corps of Engineers conducted a field view on March 4, 2009. Bonner found "0 linear feet" of non-wetland waters and "0 acres" of wetlands on the site as stated in his report dated June 24, 2009 (Appendix 9). Therefore, there are no surface waters on the site under the jurisdiction of the Army Corps of Engineers or the PADEP.

Stormwater

A NPDES Individual Permit Modification and Plan Revision for NPDES Permit Number PAS10-5312-R was issued on May 6, 2011, from the PADEP to the PIDC. This approved the Erosion and Sedimentation Control Plan for discharge of stormwater from the construction activities of the proposed project on what the original permit refers to as Parcels 2 and 10 of the Philadelphia Navy Yard. A man made swale is present on the site. The swale will be addressed in construction by installing a perforated pipe along the bottom of the swale and covering the swale with sand to act as a filter. The clean fill that will be brought to the site will then be placed on top of the sand. The design of the proposed project was such that no reduction in the swale's function will result. (Appendix 10).

The total area of disturbance would be less than 10 acres. Ground-disturbing activity requires compliance with the PADEP Chapter 102 erosion control regulations, including the preparation and implementation of an Erosion and Sediment Pollution Control Plan. PADEP in consultation with the PWD is responsible for administering the Erosion Control Program in Philadelphia County. In addition to the required Erosion and Sediment Pollution Control Plan, earthmoving projects that disturb more than 1 acre may require an NPDES Permit. Pursuant to the Chapter 102/NPDES delegation, the PADEP and/or PWD staff reviews the submitted plans, issues NPDES Permits, and performs site inspections. After an Erosion and Sediment Pollution Control Plan is reviewed and determined to be adequate, a determination of adequacy letter is issued. If an NPDES permit is needed, the PADEP (with PWD acceptance) would issue the NPDES permit concurrently with or shortly after the Erosion and Sediment Pollution Control Plan adequacy determination. The letter approving the proposed project's plan can be found in Appendix 25.

An approved Erosion and Sediment Pollution Control Plan, in compliance with the NPDES permit, would be implemented before, during, and following construction activities. As per the PADEP, plans are required to be available at the construction site.

On-site quality assurance inspectors would ensure that the erosion and sediment pollution control measures are implemented and properly installed and maintained. These measures include filter socks, sediment fence, and inlet protection. The filter socks and/or sediment fence would be installed around the entire perimeter of the project site, with additional socks/fence installed around any fill stock piles, concrete pads, and along the perimeter of the swales. The appropriate type of filter sock would be used and maintained according to the erosion and sediment control details located on the approved civil engineering plans for the project. These

would be installed and maintained throughout construction of the project until final approval is obtained from the PADEP/PWD for removal of the sock/fence.

Inlet protection would include temporary filter bags installed in all necessary inlets which require erosion and sediment filtering. These bags will be installed by lifting the inlet grate and installing a one inch rebar around the bag for easy removal and maintenance during construction and upon final approval. Inlet protection is not required for an inlet tributary to a sediment basin or trap.

Floodplains

The Flood Insurance Rate Map (FIRM) #4207570189G, with an effective date of January 17, 2007, published by the Federal Emergency Management Agency (FEMA) for Philadelphia, Pennsylvania, was used to determine if the subject property is located within a floodplain. According to the FIRM document, the proposed facility is located within Zone AE and Zone X which corresponds to areas of base flood elevation determined to be 10 feet NAD 83 (North American Datum of 1983) and areas of 0.2% annual chance flood (500 year flood), respectively. Zone X2 is also present which corresponds to areas outside the 0.2% annual chance flood. The subject FIRM information is included in Appendix 11.

No construction would occur in the Federal Emergency Management Agency (FEMA)-designated floodway of the Schuylkill River (Appendix 21), but as per PADEP policy under 25 PA Code Chapter 105, Dam Safety and Waterway Management; the floodway is defined as extending from the stream to 50 feet from the top of the bank of the stream in tidal areas. Thus, a Chapter 105 permit is required and was submitted on June 24, 2011, to PADEP. Under 25 PA Code, Chapter 106, Floodplain Management, the proposed project does not require a permit as solar installations are not public utilities nor is the project being constructed by a government entity. Exclusion from Chapter 106 permitting was confirmed with PADEP.

As seen in Appendix 11, approximately six acres of the project site would be located within the designated floodplains. Currently the stormwater from this site flows into one of two drainage swales and into the tidal portion of the Schuylkill River and the Reserve Basin. The current design of the project will be adding six (6) to twelve (12) inches of fill to some portions of the site, raising the level to above the 100-year floodplain (Appendix 22). This fill will add to the stability of the cap on the landfill portion of this site. As this area is in a tidal segment of the Schuylkill River, elevating this small area will not contribute to any upstream or downstream flooding during a flood event, as the flood elevations are based on tidal forces and not the volume capacity of the floodplain. This was confirmed with FEMA Region III Regional Environmental Manager by PADEP during a phone call on June 28, 2011.

The PV system will be placed on this filled and leveled area on ballasts, as pilings or other soil penetrations would interfere with the capping of the landfill on the site. These ballasts will be constructed of concrete and a portion of the total physical area of some ballasts will be located in the floodplain. There are two different sizes of ballasts being installed. (Table 2 and 3 below). There would be a total of 236 - 7' ballasts and 238 - 9' ballasts, this will equal 15,043 cu.ft. (557 cy) and 18,963 cu.ft. (702 cy) respectively of ballast material that would be located in the floodplain. As indicated in the Chapter 105 permit application, 67,500 cu. ft. (2,500 cy) of clean fill will be added to the PADEP defined floodway.

The maximum volume of fill material that would be brought to the site is 2,500 cy. Cumulatively, the fill and ballasted material total a maximum of 3,759 cy of additional volume that would be brought into the site. The watershed for the Delaware River and the Schuylkill River is

approximately 13,500 and 1,916 square miles, respectively. Therefore, given the enormous size of these watersheds, the total volume of ballast and relatively small amount of fill material to be placed within the floodplain at the proposed project site, the proposed project will have a minimal effect on the flood characteristics of these two watersheds, as confirmed by FEMA. Reducing the volume of the flood plain on this property will not affect the elevation of the flood levels on adjacent properties. Also, the demolition of the three current structures could potentially create a de minimis impact related to the floodplains.

Table 2. Ballast/Racking view from side of system

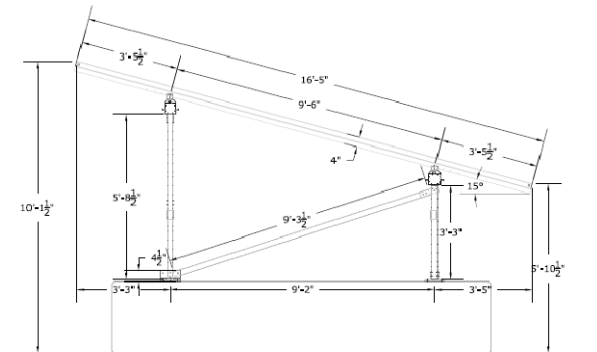
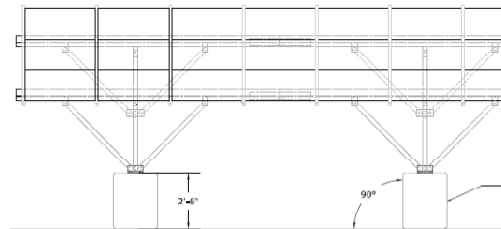

Table 3. Ballast/Racking view from front of system



As part of the design, there are large portions of open space. As can be seen in Table 3 and Table 4, the majority of the ground area would be exposed. This would be the fill material as described in Section 3.1.1 Stormwater. The significant items that are located on the ground will be the ballasts and the inverter equipment pads, which total 2,477 SF in plan area.

Table 4. Solar PV Row design



The PA DEP and PWD approved a Modification and Plan Revision to the Navy Yard NPDES Permit (NPDES Permit No. PAS10-5312-R) for parcels 2 and 10 for the development in the designated floodplain. Conditions of this permit require that all equipment within the flood zone would be water (flood) resistant (as the panel support structures are) or elevated one foot above the base elevation of the designated 100-year floodplain. In addition, the Chapter 105 permit requires frequent inspections of encroachment materials (ballast and fill) for continued safe operations.

Groundwater

As reflected by the water table map of Philadelphia, the water table elevation for the project site is 0 feet. The project site ranges in elevation between sea level and fifteen (15) feet (Appendix 12) with most of the development activity occurring on ground between elevations five (5) feet and fifteen (15) feet.

3.1.2 Geology, Topography and Soils

Geology

As reflected by the Geologic Map of Pennsylvania (1990, revised 2007), located at: <http://www.dcnr.state.pa.us/topogeo/maps/map7.pdf>, the site of the proposed PV facility is underlain by a combination of sand, gravel and silt.

Topography

The subject property is located within United States Geological Survey (USGS), 7½ minute Philadelphia Quadrangle. As indicated by the corresponding 1994 USGS topographic quadrangle map, the proposed site is located at an approximate range elevation of sea level to 15 feet above mean sea level and slopes gently towards two drainage swales that bisect the property and discharge to the Reserve Basin or the Schuylkill River (Appendix 14). The natural topographic gradient is unknown as the area has been disturbed by human activity since sometime prior to 1944. This can be referenced by aerial photographic site analysis indicating human activity at the facility, (Appendix 15).

Soils

The following United States Department of Agriculture (USDA) website was reviewed for data on soils beneath the subject property: <http://websoilsurvey.nrcs.usda.gov/app/WebSoilSurvey.aspx>. The subject property is underlain by Trenton Gravel and the soils are classified by the USDA as Urban Soil. The proposed project will be mostly located on a man-made landfill which has been, in some places, capped with an asphalt cap and clean fill soil. Appendix 16 has the soils map for the proposed installation location.

Site preparation and project construction would result in earth disturbance, which is subject to PADEP Chapter 102 requirements. See section 3.1.1 above, Water Resources/Stormwater for additional information on soil erosion controls. The soils beneath the site have not been classified by the USDA as prime or unique farmland.

The total area of disturbance would be less than 10 acres. Ground-disturbing activity requires compliance with the PADEP Chapter 102 erosion control regulations, including the preparation and implementation of an Erosion and Sediment Pollution Control Plan. PADEP, in consultation with the PWD, is responsible for administering the Erosion Control Program in Philadelphia County. In addition to the required Erosion and Sediment Pollution Control Plan, earthmoving projects that disturb more than 1 acre might require an NPDES Permit. Pursuant to the Chapter 102/NPDES delegation, the PADEP and/or PWD staff reviews plans, issues NPDES Permits, and performs site inspections. After an Erosion and Sediment Pollution Control Plan is reviewed and approved, a determination of adequacy letter is issued. If a NPDES permit is needed, the PADEP would issue the NPDES permit concurrently with or shortly after the Erosion and Sediment Pollution Control Plan adequacy determination.

An approved Erosion and Sediment Pollution Control Plan, in compliance with the NPDES permit, would be implemented before, during, and following construction activities. On-site quality assurance inspectors would ensure that the erosion and sediment pollution control measures are implemented and properly installed and maintained.

3.1.3 Vegetation and Wildlife

The US Fish and Wildlife Service (USFWS), PGC, PA Department of Conservation and Natural Resources (DCNR), and Pennsylvania Fish and Boat Commission (PFBC) are responsible for protecting various plant and animal species and associated habitat in the proposed project area. A primary emphasis of these agencies is to ensure that appropriate actions are taken to reduce or mitigate potential harm to protected species and habitat. To identify potentially affected species and habitat, the project proponents first used the Pennsylvania Natural Diversity Inventory (PNDI), which is found on the DCNR Pennsylvania Affected Environment and Environmental Impacts Natural Heritage Program website (<http://www.naturalheritage.state.pa.us/>). This was followed by direct contact with the DCNR and PGC. PNDI search results did not indicate any reason to coordinate with the PFBC. A letter was written by DOE to the USFWS dated March 23, 2011, requesting comments on the proposed project. A response from this letter has not yet been received to date.

Vegetation

The subject property is located within an urban-industrial area where the land has been previously disturbed and developed. The majority of the site is absent of quality vegetation as the site was previously used for waste processing by the Navy. Most remaining vegetation onsite and in the vicinity consists of grasses, shrubs, and some young trees. As the area has been disturbed for decades, the vegetative species found onsite consist mostly of alien and opportunistic species in primary succession post-disturbance. The PNDI review reported no species of concern onsite. According to the Five Year Operation and Maintenance Contract and user manual, and the Remedial Action Plan Document, current maintenance of the site is completed by the Department of the Navy, which consists of ensuring that the vegetation is mown and that any large trees or shrubs which may disturb the cap of the landfill are removed. (Contract Number N62472-03-D-0802)

Wildlife

The existing wildlife onsite and in the vicinity of the property consists of species commonly found in urban settings, such as small birds, rats and squirrels.

Threatened and Endangered Species

The PNDI review reported one species under PGC jurisdiction within the proposed project area, peregrine falcon (*Falco peregrines*), a Pennsylvania endangered species.

Conergy and its consultants have contacted organizations below to establish if any endangered or threatened species were located on or near the site.

- U.S. Fish and Wildlife Service (<http://ecos.fws.gov>)
- The Pennsylvania Natural Heritage Review (<http://www.gis.dcnr.state.pa.us/hgis-er/default.aspx>)

As described above, a PNDI review reported one species present. Following review of the PNDI report and other project information, PGC instructs no construction be completed February 15 through July 31 within 1000 feet of the nesting site as per state regulations (see Appendix 17). Construction noise and activities are known to disturb the nesting and foraging behaviors of peregrine falcons and other bird species. This site would not be under construction during these timelines. Please reference Appendix 18 for the location of nest belonging to the Pennsylvania endangered peregrine falcon.

The nearest IBA (Important Bird Area) for Pennsylvania is located at John Heinz National Wildlife Refuge, approximately two and a half miles away. This area is separated from the site

of the proposed project by I-95, the Philadelphia International Airport, the PWD Southwest Water Pollution Control Plant, various industries and the Penrose Industrial Park, a portion of the Sunoco Refinery and some residences. <http://iba.audubon.org/iba/viewState.do?state=US-PA>

Wildlife Preserves

A project summary has been sent to USFWS in a letter dated March 23, 2011. A response from this letter has not yet been received to date. The following resources were reviewed:

- U.S. Fish and Wildlife Service National Wildlife Refuge Service (<http://www.fws.gov/refuges/whm/wilderness.html>)
- Pennsylvania Department of Conservation and Natural Resources (<http://www.dcnr.state.pa.us>)

The reviewed resources indicate that the subject property is not located within the vicinity of a wildlife preserve.

Wilderness Areas

A project summary has been sent to USFWS in a letter dated March 23, 2011. A response from this letter has not yet been received as of May 2011. The following resources were reviewed:

- National Wilderness Preservation System (<http://www.wilderness.net>),
- National Park Service (<http://www.nps.gov/parks.html>).
- Pennsylvania Department of Conservation and Natural Resources (<http://www.dcnr.state.pa.us>)

These resources indicate that the subject property is not located within a wilderness area.

3.1.4 Air Quality and Climate Change

Air quality is defined by the concentrations of various air pollutants in the atmosphere. The significance of a pollutant concentration is determined by comparing the concentrations in the atmosphere to the applicable state or national ambient air quality standards, which represent the maximum allowable atmospheric concentrations that may occur and still protect public health and welfare with a reasonable margin of safety.

In response to the Clean Air Act (CAA) of 1970 and its subsequent amendments, the U.S. Environmental Protection Agency (USEPA) established the National Ambient Air Quality Standards (NAAQS) which establish the safe levels of exposure to seven (7) criteria air pollutants which include: ozone (O₃); carbon monoxide (CO); nitrogen dioxide (NO₂); sulfur dioxide (SO₂); lead (Pb); particulate matter, 10 microns or less (PM₁₀); and particulate matter, 2.5 microns or less (PM_{2.5}). In addition to the criteria pollutants, the USEPA is also concerned with, and regulates, hazardous air pollutants (HAPs) and toxic air pollutants including: metals, nitrogen oxides (NO_x), and volatile organic compounds (VOCs) in accordance with CAA policies.

According to the Environmental Protection Agency Mid-Atlantic Air Protection website (<http://www.epa.gov/reg3artd/airquality/airquality.htm>), Philadelphia County, Pennsylvania, is in non-attainment for PM_{2.5} and ozone (listed as “moderate”). Philadelphia County is in attainment for carbon monoxide, sulfur dioxide, PM₁₀, nitrogen dioxide, and lead. The Philadelphia Health Department (<http://www.phila.gov/health/AirManagement/>) administers air quality programs in the City. The proposed project does not require any air quality permits.

Construction would be the greatest potential source of emissions associated with the proposed project. The primary sources of air pollutant emissions would be exhaust emissions generated by construction equipment, commuter vehicles, and delivery trucks, as well as fugitive dust from

clearing and site grading. Construction activities would occur over the course of less than six months. Operation of the proposed project would result in no emissions of criteria air pollutants or greenhouse gases from operation of the solar generating equipment itself, including the PV modules, inverters, switchgear, transformers, and conductors. Operation of the facility would result in minor emissions from personal and maintenance vehicles, limited delivery trucks, and limited equipment exhaust. However, there would be minor positive impacts to air quality from the proposed facility, since the energy it produces would presumably replace electricity produced by a fossil fuel power plant.

The burning of fossil fuels such as natural gas and coal emits carbon dioxide, which is a greenhouse gas. Greenhouse gases can trap heat in the atmosphere and have been associated with global climate change. The Intergovernmental Panel on Climate Change stated that warming of the earth's climate system is clear, and that most of the observed increase in globally averaged temperatures since the mid-20th century is very likely due to the observed increase in concentrations of greenhouse gases caused by human activities (IPCC 2007).

3.1.5 Noise

Noise is generally defined as an unwanted or objectionable sound resulting from volume and/or pitch. Noise levels are measured and expressed in decibels (dB) that are weighted to sounds perceivable by the human ear, known as A-weighted sound level (dBA). Decibels range from zero (0) to 180 and are measured on a logarithmic scale; thus, increasing the number of noise sources does not increase the volume in the same proportion. Over a specific time period, noise levels are averaged and expressed as the noise level equivalent for that period (dBA_{Leq}).

Sensitive noise receptors are generally defined as those locations or areas where dwelling units or other fixed, developed sites of frequent human use occur; however, sensitive noise receptors may also relate to wildlife environments. Resource data including statistics from the US Census (www.census.gov) and aerial photographs indicate that there are no potentially sensitive noise receptors located within the area of the proposed facility.

Currently, the dominant noise source within the vicinity of the proposed project is vehicular traffic and associated noise from the surrounding roadways, especially Interstate 95, which is located immediately north and bridges the proposed project site. Once implemented, the dominant noise originating from the proposed project would be associated with construction activity; however, once completed, there will be no noise generated beyond occasional vehicles there to maintain the site. The Philadelphia Code, Title 10. Regulation of Individual Conduct and Activity, Subsection 10-403 would apply to any noise created during construction.

Reference:

([http://www.amlegal.com/nxt/gateway.dll/Pennsylvania/philadelphia_pa/thephiladelphiacode?f=templates\\$fn=default.htm\\$3.0\\$vid=amlegal:philadelphia_pa](http://www.amlegal.com/nxt/gateway.dll/Pennsylvania/philadelphia_pa/thephiladelphiacode?f=templates$fn=default.htm$3.0$vid=amlegal:philadelphia_pa))

3.2 Cultural Resources

3.2.1 Visual Resources

The visual character of the area was evaluated for potential visual impacts relative to existing and proposed land use in the immediate vicinity of the Proposed Action. The area of visual influence is determined by estimating the visibility of the proposed facility to viewers from public spaces, with special consideration given to visually sensitive features located in the immediate area.



The site of the Proposed Action is located along the western margin of Philadelphia Navy Yard. The subject property offers views of the surrounding roadways including Basin Bridge Road, S. 26th Street, the Girard Point Bridge, and Langley Avenue (Appendix 1).

Basin Bridge Road is a two (2) lane public road located within Philadelphia Navy Yard that runs north and south and is east of the project site. The road terminates at the intersection of Langley Road and turns into S 26th Street. The proposed facility would be visible from this intersection.

S. 26th Street is a two (2) lane public road that extends along the northeastern boundary of the project site and serves as access to the Philadelphia Navy Yard. The proposed facility would be visible from the intersection of S 26th Street and Langley Avenue.

The Girard Point Bridge is a four (4) lane public bridge that is part of I-95 and is located above the northwestern portion of the project. The proposed facility would be visible from the northern bound side of the Girard Point Bridge. The project site is not directly accessible from this road as it is a bridge over the Schuylkill River.

Langley Avenue is a two (2) lane public road that intersects Basin Bridge Road and S. 26th Street and borders the project site to the north. This road is the access point to the project and access for municipal activity. The proposed facility would be visible from Langley Avenue.

The area surrounding the proposed facility is industrial. Instead of a property used for storage, the area will be a clean, maintained facility with no scrub landscaping.

Vehicular traffic will increase during construction on S. 26th Street, and on a short portion of Langley Avenue into the proposed facility. The vehicles will be for green energy jobs created by the proposed project, as well as delivery vehicles during standard business hours. In addition, there will be construction equipment that is used during the installation that will be on location.

Overall, there are no anticipated visual impacts that would significantly affect nearby residents and users of the project area and surrounding areas as a result of the development of this project.

3.2.2 Archeological and Historic Resources

For the purpose of this EA, the term “archeological resources” refers to cemeteries and prehistoric or historic subsurface sites including buildings and structures that no longer exist. “Historic resources” refers to existing buildings, structures or objects, including historic districts.

Archeological Resources

Based on site research, as confirmed by a project review completed by the Bureau for Historic Preservation, no archeological resources are located onsite or within the immediate vicinity of the proposed project (Appendix 19); therefore, no adverse effect would be anticipated in the implementation of the proposed project. No mitigation of archeological resources would be necessary in conjunction with implementing the proposed project. The Archeological review of this site was originally done for entire vacant 19.1 acres of the property; therefore, the interconnection run across the northwest portion of the property will also have no anticipated adverse effect. Research also indicates that the connection line via the easement on the Tasty Baking property also extends through a highly disturbed area once used for container storage by the Navy (Appendix 15).

Historical Resources

There are three buildings currently located on the property and under the proposed project, all three would be demolished. Two of these buildings are eligible for the National Register of Historical Places. Conergy has approval, in the form of a letter from the PA SHPO (Appendix 3), for demolition of these buildings as there is no current or planned use of any of the structures, with appropriate mitigation through recordation of the buildings. In addition the documentation regarding the historical buildings is located in Appendix 4, within the application to PA SHPO. The third building has no historical reference and is approved to be demolished. Conergy would remove the buildings with a demolition company that would first test for any asbestos within the buildings then would demolish the buildings according to the plan located in Appendix 5. Any asbestos found would be remediated prior to demolition.

3.3 Socioeconomic Resources

3.3.1 Land Use

The proposed project is located in the Philadelphia Naval Business District within the former Philadelphia Navy Yard complex, south of the City of Philadelphia, Pennsylvania. The site of the proposed action is located along the western margin of Philadelphia Navy Yard. The subject property offers views of the surrounding roadways including Basin Bridge Road, S. 26th Street, the Girard Point Bridge, and Langley Avenue, as well as being immediately east of the Schuylkill river.

The land use pattern beyond the boundaries and surrounding the proposed solar energy project site is primarily commercial/industrial. The proposed solar energy project is in the immediate vicinity of the Schuylkill River. The section of river nearest the project area is not an Audubon

Pennsylvania-designated IBA, (see Section 3.1.3 for more discussion on IBA)
<http://iba.audubon.org/iba/viewState.do?state=US-PA>.

3.3.2 Planning Policies and Controls

The former Navy Base facility is in an area recommended in the September 2010 “An Industrial Land & Market Strategy for the City of Philadelphia” for designation as an Industrial Protection Area. These areas are explained as “vibrant, employment-rich industrial districts and corridors. Such areas should be protected and receive regulatory support and market certainty that land use policy will remain industrial”. This information was obtained from the City of Philadelphia Planning Commission Website: <http://www.philaplanning.org/>. Although the former Navy Yard is currently attracting new employers and business, the project site itself is a former military landfill, that is capped and therefore useable only for certain very limited purposes. A photovoltaic facility such as the proposed project, which does not disturb the cap, is a use of the site consistent with its limited development potential.

As previously discussed, both the Master Plan for the Navy Yard, and the Philadelphia City Planning Commission details the proposed protection and further industrial development of industrial use properties in existing industrial areas. As such, the development of the property will not result in the displacement of residents.

<http://citymaps.phila.gov/portal/>

3.3.3 Demographics and Environmental Justice

The 2000 U.S. Census provides the basis for analyzing the demographic composition of the area around the project site. Executive Order 12898 requires federal agencies to: 1) identify any disproportionately high and adverse effects on human health or human environment of minority and/or low income populations resulting from federal programs, policies, and activities, and 2) identify alternatives that may mitigate these impacts.

In the Census, persons are self-identified as belonging to one or more racial subgroups: White; Black or African-American; American Indian and Alaska Native; Asian; Native Hawaiian or Other Pacific Islander; or Other Race. The Census also enumerates persons of Hispanic or Latino origin who may be of any race. While race does not imply specific behavioral patterns, this information is useful in understanding the demographic setting and identifying environmental justice communities of concern.

Characterization of a group of persons as a potentially “affected community” requires the fulfillment of one of the three following criteria: 1) a minority population of the affected area that exceeds 50 percent 2) a low-income population based on the Bureau of Census Current Population reports; or 3) a minority population significantly greater than the minority population percentage in the general population, or other appropriate unit of geographic analysis.

Certain cultural, social, occupational, historical, or economic characteristics of an affected community may amplify the environmental effects of an action; a population may be more sensitive and less resilient in adapting to the effects of an action than other communities. The distribution of the effects within a study area is important. Affected communities would be considered to experience high adverse impacts related to the action.

In addition, Executive Order 13045, Protection of Children from Environmental Health Risks and Safety Risks (Executive Order 13045, 62 Federal Register 19885), states that each federal agency shall make it a high priority to identify and assess environmental health risks and safety risks that may disproportionately affect children and ensure that its policies, programs, activities,

and standards address disproportionate risks to children that result from environmental health risks or safety risks. Environmental health risks and safety risks mean risks to health or safety that are attributable to products or substances that children are likely to come into contact with or to ingest.

The 2000 US Census indicates that the City of Philadelphia population is 1,517,550, 25.3% of the population are children, 55% of the total population is classified as not white, 18.4% and 22.9% of families and individuals, respectively, are under the poverty level, and the city has a median household income of \$30,749 and the proposed project is located in US Census tract 005000, which has a recorded population of zero (0). The two Census tracts located nearest the proposed project are tract 005200, with a reported population of 1 white person, over the age of 18, over 100% of the poverty level and tract 0051000 with a reported population of 611 persons, 65% black or African American, 24.7% white, 5% Asian, 4.6% Other Race, 1.8% Latino. Of this, 12% are under the age of 18 and 14% are 100% below the poverty level.

The two adjacent Census tracts are not within sight of the proposed project, resulting in no visual impact or impact to property values, either positive or negative. No pathways or uses of resources that are unique to a minority or low-income community have been identified, nor have any disproportionately high adverse impacts on low-income and minority populations been identified. The project site would be fenced; preventing access to the site by the public, and operation of the site would not involve the use or release of harmful substances or create a public health and safety risk to these populations. Construction impacts from air emissions and noise would be minimized through compliance with the City of Philadelphia regulations resulting in no impact on minority or low-income populations in the areas adjacent to the project area. Lack of public access to the site, in addition to lack of hazardous substances during the operation of the proposed project would prevent disproportionate environmental risks and health risks to children. Both the US Census Bureau and the City of Philadelphia Planning Commission websites were consulted to verify this information: www.census.gov and www.philaplanning.org

3.4 Infrastructure

3.4.1 Roadways and Traffic

During the project construction phase, there would be a temporary increase in vehicular traffic on the local roads as described in section 3.2.1. This modest traffic increase would occur for a period of approximately six (6) months. No long-term or permanent impacts to the local transportation systems would occur as a result of this project, as this project requires only a short construction time.

3.4.2 Potable Water

The proposed facility would be located near a 12 inch water main serviced by of the City of Philadelphia municipal service pipeline that supplies Philadelphia Navy Yard. The City of Philadelphia draws its municipal water supply from the Schuylkill River. This service will be used in case of an emergency for fire extinguishing and any other municipal uses. In accordance with local building codes, the municipal water supply is available for fire suppression.

3.4.3 Stormwater Management

Currently, the stormwater from this site runs into two manmade swales that were created during the initial BRAC plan implementation when the landfill portion of the site was capped. The

construction of this proposed project would encompass one of those swales. The plan for the stormwater would be to keep the swale functioning the same way as it was prior to the proposed construction. A perforated pipe will be placed within the length of the swale, so that water can filter into it and drain fluently. A sand material will be put on top of the perforated pipe to filter the stormwater. The sand will be layered up to the top of the swale. On top of that sand would be an approved clean fill material that will be imported to build up the total of the site approximately six (6) to twelve (12) inches so as not disturb the existing cap.

The remaining portions of the construction area will be covered with the approved clean fill material, leaving the existing grade as an impervious surface, to maintain or improve upon the current site hydrology. The fill has been approved by Pennoni Associates (Civil Engineers) and also meets the clean fill requirements of PIDC. The gradation of the fill will allow the stormwater to flow across the property as it does pre-development.

As currently designed, the stormwater from the proposed project flows into one of two manmade drainage swales, which discharge to the tidal portion of the Schuylkill River and the Reserve Basin. The landfill cap was designed to direct drainage to these swales. The proposed project includes placement of six (6) to twelve (12) inches of clean fill to create a buffer to the cap and proper foundation support for the ballasts. The resulting grades will be similar to those existing and will maintain the site drainage patterns.

3.4.4 Sanitary Sewer

There is currently no sanitary sewer service to the site. During the construction phase portable restroom facilities would be provided for the workers and managed in accordance with applicable disposal requirements. After completion, during the operations phase, there is no need for sanitary sewer service.

3.4.5 Energy System

Natural Gas

A municipal natural gas service line extends from the south east corner of the site, runs across Basin Bridge Road, and extends along the road heading north. However, the proposed facility would not utilize natural gas and construction will not disturb the southeast corner of the property by the road, or the Basin Bridge Road surface.

Electricity

Currently there is no active electric service on the site. The closest active electric line is at the utility pole next to 26th Street just south of the entrance to the project site. This would be used to pull temporary electric service during the construction phase for use in the office trailer and for any electrical equipment necessary for the proposed installation (Appendix 23).

Four (4) electrical receptacles would be installed on the inverter pad of the proposed project. The electrical equipment that will be installed during construction of the solar facility will have a life span of approximately 20 years after the installation is completed. Operation and Maintenance activities of the electrical system will be conducted for the duration of its life to maintain a safe and efficient system.

The interconnection point from the proposed PV installation to the Utility grid is northwest of the project site. A 13,200 Volt Medium Voltage electrical line would be run on top of the existing grade in conduit in a concrete duct bank and covered with the same fill as proposed for the

capped portion of the installation. The electric line would run to the existing PECO electrical pole located on the Tasty Baking Company property and would be accessed via a property easement. This is where the photovoltaic plant will be interconnected to the PECO utility grid for distribution. The line in the easement will be approximately 664 ft in length and installed in a trench at a depth of 3 feet below grade, concrete encased and backfilled with topsoil.

3.4.6 Solid Waste

Conergy has classified three types of waste that would be generated during the demolition of the buildings and installation of the proposed PV system.

Demolition waste from the three current structures will be first tested for asbestos, polychlorinated biphenyls (PCBs) and hazardous waste. All items that are determined to be hazardous will be disposed of according to the current regulations. The concrete from the current buildings, if determined safe, will be broken up and placed into the sub levels of the current structures as described in Section 2.2 Construction and in Appendix 5.

The second type of waste would be recyclable components such as cardboard, wooden pallets, and excess installation supplies. These items would either be recycled via local commercial recycling services or, in the case of excess supplies, would be returned to the appropriate warehousing facility. Conergy is also investigating the opportunity to recycle parts of the buildings to local builders, if the components are found to not contain any hazardous or residual materials from past uses.

The third type of waste will consist of limited trash waste. This will consist of items similar to pallet straps, packing foam used for protection during shipping, and other shipping supplies. These types of items will be disposed of using a local trash hauling carrier, according to the local regulations.

All types of waste will be sorted onsite during the construction process and placed in separate containers for disposal according to the local city and state regulations.

3.4.7 Hazardous Materials

Limited volumes of hazardous materials may be used onsite in conjunction with facility construction. During construction all materials will be handled per the appropriate safety regulations and will be stored in approved containers. All materials on site will have manufacturer's instructions and cut sheets, as well as Material Safety and Data Sheets to go along with the material if it is considered potentially hazardous. Additionally, minimal volumes of hazardous materials are expected to be used onsite following construction in association with facility operation and maintenance. The proposed project does not include the storage, management, and/or treatment of hazardous materials.

It is not expected to find any forms of asbestos on the project site. However, if asbestos or any other hazardous material is found on the project site, in all situations it will be removed in such a manner to comply with the applicable federal, state, and local regulations.

Prior to demolition, the existing building will be checked for hazardous materials. If they are located, the items will be removed and contained by a licensed HAZMAT contractor and/or trained personnel in a manner that is consistent with applicable regulations. The items would then be transported by that licensed contractor in a manner that is consistent with applicable DOT regulations. And the contractor will proceed to dispose of the hazardous materials at an appropriate facility in accordance with applicable regulations.

4.0 ENVIRONMENTAL CONSEQUENCES

4.1 Natural Resources

4.1.1 Water Resources

This section addresses surface water, floodplains and wetlands, and groundwater resources. It provides the information necessary to meet DOE's obligations under 10 C.F.R. Part 1022, "Compliance with Floodplain and Wetland Environmental Review Requirements."

Alternative #1 – The Proposed Project

The NPDES application was reviewed by the City of Philadelphia and the PADEP and an NPDES Individual Permit Modification and Plan Revision for NPDES Permit Number PAS10-5312-R was issued on May 6, 2011 to PIDC. A man made swale is present on the site. The swale will be addressed in construction by placing a perforated pipe along the bottom of the swale and covering the swale with sand to act as a filter. The clean fill that will be brought to the site will then be placed on top of the sand. The design of the swale was such that there will be no alteration to the swales function (Appendix 10).

Wetlands, Surface Water, and Groundwater

In compliance with both the Clean Water Act and Pennsylvania's Clean Streams Law, there are no wetlands or streams within the proposed project site. Overall, the implementation of the proposed project, as designed, would not present a significant risk to the local surface or ground water resources.

Floodplains and Stormwater

Flood Insurance Rate Map (FIRM) #4207570189G, with an effective date of January 17, 2007, published by the FEMA for Philadelphia, Pennsylvania, was used to determine if the subject property is located within a floodplain. According to the FIRM document, the proposed facility is located within Zone AE and Zone X which corresponds to areas of base flood elevation determined to be 10 feet NAD 83 and areas of 0.2% annual chance flood (500 year flood), respectively. Zone X2 is also present which corresponds to areas outside the 0.2% annual chance flood. The inverters are not planned for installation in the 500 year flood area. The subject FIRM information is included in Appendix 11.

In compliance with both the Clean Water Act and Pennsylvania's Clean Streams Law, Conergy has determined that there are no wetlands or streams within the proposed project site (Appendix 9, 20). Although the subject property is largely vacant as a result of previous site activity, grading and general land disturbance associated with facility construction would increase the potential for soil loading into man-made drainage swales onsite with resulting impact to the Schuylkill River. Additionally, the operation of construction equipment onsite, with the associated need for fueling and maintenance, would provide a mechanism for potentially exposing peripheral water resources to petroleum and other chemical contaminants if released accidentally. Based on the anticipated schedule, construction of the facility would require six (6) months for completion. Potential negative impacts to water resources associated with the implementation of the proposed project would be addressed through the application of the Pennsylvania Erosion and Sediment Control Handbook (1992) minimum standards, including the implementation of a site specific Erosion and Sediment Control (E&S) Plan and a Stormwater Pollution Prevention Plan (SWPPP). Potential impacts to groundwater resulting from surface spills would likewise be addressed by the SWPPP during construction.

PADEP has jurisdiction over stormwater permitting at the proposed site. PADEP requires that Conergy's proposed project be covered under the (general) NPDES permit following approval of a SWPPP by the PWD review. Conergy would conduct all construction activities following the practices detailed in the approved plan. Aside from the ballasting and inverter footprint of the proposed project, the majority of the site would remain surfaced with the existing combination of pervious and impervious material, thus having little impact on stormwater runoff. Because Conergy would create and implement the approved stormwater management and sediment control plan and SWPPP, the proposed project should have no impact on stormwater quantity or quality.

Because the proposed project would be located within the base floodplain, the proposed project location must be evaluated to determine if it is practical in light of its exposure to flood hazards, the extent to which it will aggravate the hazards of others, and the potential to disrupt floodplain values. Past coverage of the property by impermeable surfaces and the existing buildings has irretrievably disrupted the beneficial floodplain values. The project will not create additional increase of flooding for nearby properties, as those properties have been impacted by previous development of the property and development in the tidal flood plain does not impact flood elevations. In addition, a PADEP Chapter 105 permit application has been submitted which covers the work that will encroach on what the PADEP considers the floodway by policy. The FEMA Firmette Map is shown in Appendix 24.

Alternative #2 – No Action Alternative

Under the No Action Alternative, the proposed project would not be completed and the property would remain in its current condition with minimal improvements being implemented to effectively manage stormwater runoff and protect local water resources. Under this alternative, there would be no increased risk to water resources during the construction phase of the project. However, if the project were not implemented, in a major flood event there would not be additional fill protecting the landfill material from exposure to the river. In addition, the objectives of the SEP and Recovery Act would also not be advanced.

4.1.2 Geology, Topography and Soils

Alternative #1 – The Proposed Project

The proposed project, being implemented on top of the existing site within clean fill brought onto the site, would not affect the geology or soils on the site. The addition of clean fill, and its grading, would affect the topography of the site to allow for proper stormwater management. In the lease agreement with PIDC, Conergy is required to ensure that the existing cap will remain undisturbed. Thus, no grading will be done of existing fill, only the fill brought onsite to allow for better drainage of stormwater and proper leveling of panel ballasts.

Alternative #2 – No Action Alternative

Under the No Action Alternative, the proposed project would not be undertaken resulting in no effects to the geology, topography or soil currently occupying the subject property. Also, the objectives of the SEP and Recovery Act would not be advanced.

4.1.3 Vegetation and Wildlife

Alternative #1 – The Proposed Project

The implementation of the proposed project could result in temporary impacts to existing low-quality vegetation during grading and/or construction activity; however, any loss would be

insignificant since the proposed project would include full restoration of any damaged areas. Following construction, the operation of the facility would result in no significant change to the existing conditions.

The proposed project would not adversely impact terrestrial wildlife and/or migratory birds, as construction would occur in a currently developed area that offers no critical habitat. No adverse impacts to terrestrial wildlife and/or migratory birds are anticipated from the operation of the facility based on proximity to existing roadways and the current/existing development within the surrounding area. Conergy is proposing using a crushed fill for the top portion of the ground installation. This will mean that no vegetation is planned on being planted. However, if planting does occur, it will only be native varieties to the area.

The proposed project's proximity to the PA endangered species Peregrine Falcon would be mitigated by Conergy following the requirements set forth by PGC for no construction to occur during the critical nesting season of February 15 through July 31. (Appendix 17)

The proposed project is neither: located in proximity to any wildlife preserves nor wilderness areas, thereby no impact to those resources would occur.

Alternative #2 – No Action Alternative

Under the No Action Alternative, the current vegetation and wildlife features of the property would remain unchanged and the solar facility would not be constructed. Also, the objectives of the SEP and Recovery Act would not be advanced.

4.1.4 Air Quality

Alternative #1 – The Proposed Project

Construction would be the greatest potential source of emissions under the proposed project. The primary sources of air pollutant emissions would be exhaust emissions generated by construction equipment, exhaust emissions associated with commute vehicles and delivery trucks, as well as fugitive dust emissions from vegetation clearing and site grading. Construction activities would occur over the course of less than six months. In order to mitigate these impacts, appropriate measures would be implemented during construction activity, including proper engine tuning and the avoidance of unnecessary idling.

Short-term impacts to air quality would occur during construction of the project from construction equipment emissions, increases in local traffic, and the potential increase of fugitive dust when the site is disturbed. Use of construction equipment (i.e., diesel powered construction equipment, as well as delivery vehicles, employee vehicles, etc.) would emit particulate matter (PM10 and PM2.5) carbon monoxide (CO), volatile organic compounds (VOC), sulfur oxides (SOx), and nitrogen oxides (NOx). Use of mobile equipment and earthwork activities would result in fugitive dust emissions.

The project covers 8.1 acres and is scheduled to be built out over a <6-month period. Construction of the proposed project would involve removal of existing vegetation, grading, earthmoving, assembly, and erection of equipment and switchyard facilities. These activities would be staggered, such that different activities are occurring on different areas of the site at any given time. It is expected that the construction activities would result in periodic peak and lull periods of emissions based on the staggering of activities and associated equipment use over time. The source categories contributing to construction emissions include non-road

engine exhaust (i.e., on-site construction equipment), construction-related fugitive dust, and mobile sources both on-site and off-site.

On-Site Construction Equipment Emissions

The tables below provide the expected emissions from use of construction equipment on-site. Emission factors were developed from EPA's NONROAD2008a model for construction emissions and conservatively assumed all diesel emission sources are Tier 0 engines. See *Exhaust and Crankcase Emission Factors for Nonroad Engine Modeling --Compression-Ignition, NR-009d* (EPA-420-R-10-018, July 2010) tables 4 through 7.

<http://www.epa.gov/oms/models/nonrdmdl/nonrdmdl2010/420r10018.pdf>

Construction emission factors are multiplied by expected hours of operation for each piece of equipment during the <6-month construction period. The hours of operation for construction equipment are conservatively based on a four week operational window at 5 fivedays per week and 12-hours per day. Total hours of operation used in the emission calculations are 240-hours per piece of equipment.

Emission Factors Construction Equipment									
Equipment	Description	HP	VOC lb/hr/unit	CO lb/hr/unit	NOx lb/hr/unit	PM-10 lb/hr/unit	PM-2.5 lb/hr/unit	SO2 lb/hr/unit	CO2 lb/hr/unit
Dump Truck	Diesel	450	0.67	2.67	8.31	0.40	0.39	0.037	524.21
Excavator (scrap shear, pneumatic hammer, bucket)	Diesel	275	0.41	1.64	5.08	0.24	0.23	0.023	320.35
Bulldozer	Diesel	400	0.60	2.4	7.38	0.35	0.34	0.033	465.96
Skid Steer	Diesel	50	0.20	0.55	0.80	0.10	0.09	0.005	64.38
Skid Loader	Diesel	50	0.20	0.55	0.80	0.10	0.09	0.005	64.38
Mini Excavator	Diesel	50	0.20	0.55	0.80	0.10	0.09	0.005	64.38
Backhoe	Diesel	75	0.16	0.58	1.37	0.12	0.11	0.007	97.00

Estimated Project Construction Equipment Emissions									
Equipment	Number of Units	Hours of Operation per unit	VOC tons	CO tons	NOx tons	PM-10 tons	PM-2.5 tons	SO2 tons	CO2 tons
Dump Truck	2	240	0.16	0.64	1.99	0.10	0.09	0.009	125.82
Excavator (scrap shear, pneumatic hammer, bucket)	2	240	0.09	0.39	1.22	0.06	0.06	0.006	76.88
Bulldozer	2	240	0.14	0.58	1.77	0.08	0.08	0.008	111.83
Skid Steer	2	240	0.05	0.13	0.19	0.02	0.02	0.001	15.45
Skid Loader	2	240	0.05	0.13	0.19	0.02	0.02	0.001	15.45
Mini Excavator	2	240	0.05	0.13	0.19	0.02	0.02	0.001	15.45
Backhoe	2	240	0.04	0.14	0.33	0.03	0.03	0.002	23.28
<i>Construction Equipment Emissions</i>			<i>0.58</i>	<i>2.14</i>	<i>5.88</i>	<i>0.33</i>	<i>0.32</i>	<i>0.03</i>	<i>384.16</i>

Construction-Related Fugitive Dust

Fugitive dust would be generated from site disturbance associated with construction and grading activities. Fugitive dust emissions would be lessened by the application of erosion and sedimentation control measures which would be utilized by the project and otherwise required by the NPDES permit including a rock construction entrance. Using an 8.1-acre construction area, a total suspended particulate (TSP) construction emission factor of 1.2 ton/acre (AP-42 Chapter 13.2.3 Heavy Construction Operations) and a PM10/TSP ratio of 0.306 (developed from data in AP-42 Chapter 13.2.2 Unpaved Roads), emissions of PM10 from fugitive dust generated by construction activities such as grading are estimated to be 2.97 tons for the project. The construction activity would be distributed throughout the project site over several months which would limit concentrations and durations of emissions at any localized point in the vicinity of the Project.

Mobile Sources

Air emissions from mobile sources would be generated from workers and delivery vehicles commuting to and from the Project during construction. Commuter and delivery vehicles would generate tailpipe emissions of VOC, NOx, PM, CO, SO₂, and CO₂ in similar quantities to other vehicles in the area travelling local roads. EPA's Motor Vehicle Emission Simulator (MOVES2010) vehicle emissions model was used to generate emission factors for various types of on-road motor vehicles (in pounds per vehicle mile traveled (lb/VMT)). Output data from the model for light-duty gasoline vehicle (passenger cars) and heavy-duty diesel truck (material/equipment delivery trucks) data were used to calculate the emissions. The longest round-trip distance that delivery trucks or commuter vehicles traveled was estimated to be 65 miles (32.5 miles one way). Also, to be further conservative and to cover both deliveries and workers, it was assumed that 250 round trips were generated for material/equipment delivery vehicles and 2,400 round trips (120 days * 20 vehicles) for Project worker commuter vehicles. The MOVES2010 emission factors for employee commuter and delivery truck traffic were applied to the estimated VMT to quantify the CO₂ and criteria pollutant emissions from on-road mobile sources. A summary of the emissions from on-road mobile sources is provided below.

Estimated Project Mobile Emissions	
Vehicle Type	Vehicle Miles Traveled (VMT)
Light Duty Vehicles	156,000 (2,400 trips * 65 miles/trip)
Heavy Duty Vehicles	16,250 (250 trips * 65 miles/trip)
Pollutant	Tons
VOC	0.11
CO	0.97
NOx	0.47
PM-10	0.64
SO2	0.03
CO2	120.10

Total Construction Emissions

Based on the calculations outlined above, the total emissions that are expected to result from the construction of the Project are summarized in the table below.

Total Project Construction Emissions	
Pollutant	Tons
VOC	0.69
CO	3.11
NOx	6.35
PM-10	3.94
SO2	0.06
CO2	504.26

Operation of the proposed project would result in no emissions of criteria air pollutants or greenhouse gases from operation of the solar generating equipment itself, including the PV modules, inverters, switchgear, transformers, substation, and conductors. Operation of the facility would result in minor emissions from occasional personal and maintenance vehicles, limited delivery trucks, and limited equipment exhaust.

The generation of electricity through the use of emission-free PV arrays is expected to have a net beneficial impact on the emission of combustion-related pollutants. The proposed project would generate approximately 1,596 megawatt hours per year, which would offset greenhouse gases as follows: approximately 1.6 million pounds of CO₂, 2,361 pounds of NO_x and 12,385 pounds of SO_x and other emissions from the use of fossil fuels to generate electricity. This information is generated using PVSyst, the USEPA Power Profiler, and several environmental calculators, including American Clean Energy Environmental benefits calculator: <http://amcleanenergy.com/about-solar/solar-myths-facts>

Alternative #2 – No Action Alternative

Under the No Action Alternative, the proposed project would not be implemented and the corresponding potential air impacts would not occur. However, failure to construct a solar manufacturing facility within Metropolitan Philadelphia, Pennsylvania could result in a minimal negative effect on regional air quality. The No Action Alternative would promote the continued use of coal for electricity generation. On March 16, 2011, the EPA stated that power plants are

the single largest emitters of mercury to the air. In its notice, the EPA stated in its fact sheet “Proposed Mercury and Air Toxics Standards” (<http://www.epa.gov/airquality/powerplanttoxics/actions.html>) Its desire to reduce HAPs from power plants, specifically those fueled by coal. The proposed project would help achieve that objective. Also, the objectives of the SEP and Recovery Act would not be advanced.

4.1.5 Noise

Alternative #1 – The Proposed Project

As discussed in Section 3.1.5, the implementation of the proposed project would initially result in noise associated with construction. According to the Laborers Health and Safety Fund of North America, most pieces of heavy earth moving equipment operate at 90 dB or below. Given that no more than three pieces of heavy equipment are expected to be operating at any time during construction, the cumulative level of construction site noise onsite should range between 90 dB and 100 dB and rapidly diminish with increasing distance from the limits of disturbance. Upon completion, the operation generates no noise. Compliance with the Philadelphia Code by Conergy and its contractor and lack of sensitive noise receptors should ensure no negative impacts from noise.

Alternative #2 – No Action Alternative

Under the No Action Alternative, the proposed project would not be implemented and no corresponding potential noise impacts would occur. Also, the objectives of the SEP and Recovery Act would not be advanced.

4.2 Cultural Resources

4.2.1 Visual Resources

Alternative #1 – The Proposed Project

Visual impacts are determined by analyzing the existing quality of a view, the sensitivity of a view (as related to important historic and/or cultural sites), and the relationship of the mass and scale of the proposed facility to the existing visual environment. As related to the proposed project, visual impacts can be characterized as follows:

- No visual Impact – occurs when the proposed alterations would not be visible;
- Minor visual impact – occurs when the proposed alterations would be visible but would not interfere with views and would not change the character of the existing views;
- Moderate visual impact – occurs when the proposed alterations would be visible and would interfere with existing views but would not change the character of the existing views;
- Major visual impact – occurs when the proposed alterations would be visible as a contrasting or dominant element that interferes with views and substantially changes the character of the existing views;
- Positive visual impact – occurs when the proposed alterations would improve a view or visual appearance of an area.

As per the inquiry requested of the PHMC site research indicates that overall, there are no anticipated visual impacts from the proposed project that would affect any remaining buildings determined eligible for the National Register of Historic Places, nor are there any nearby residents to affect as a result of the development of this project. The buildings on site that were deemed historic by the PHMC will be permitted to be demolished as long as a proper recordation sequence is executed.

Therefore, based on current property usage, implementation of the proposed project would present an overall positive visual impact to the surrounding area. The current property contains unkempt plants, trees and buildings, whereas the proposed facility would be maintained properly. Each part of the project was selected with the intent for the project to be aesthetically pleasing and to improve the visual perspective of this area. The mitigation of visual resources in conjunction with project implementation would not be necessary.

Alternative #2 – No Action Alternative

Under the No Action Alternative, the proposed facility would not be constructed and the visual character of the site and surrounding area would remain in its current state. Also, the objectives of the SEP and Recovery Act would not be advanced.

4.2.2 Archeological and Historic Resources

Alternative #1 – The Proposed Project

Based on site research, as confirmed by a project review completed by the Bureau for Historic Preservation, no archeological resources are located onsite or within the immediate vicinity of the proposed project (Appendix 19); therefore, no adverse effect would be anticipated in the implementation of the proposed project. No mitigation of archeological resources would be necessary in conjunction with implementing the proposed project.

The review by the PA SHPO allows for Conergy to remove the two buildings deemed “contributing” to the Philadelphia Naval Ship Yard Historic District, with appropriate mitigation through recordation of the buildings. The involved parties are developing a Memorandum of Agreement to document the requirement of recordation. The recordation of the buildings allows for documentation, which would not occur if the structures were allowed to continue to deteriorate because of the weather and natural conditions.

Alternative #2 – No Action Alternative

Based on the absence of archeological resources within the immediate vicinity of the project site, the No Action Alternative does not have an effect that differs from that of the proposed project. However, the objectives of the SEP and Recovery Act would not be advanced.

Under the No Action Alternative, the existing historic buildings would remain in place and continue to deteriorate due to weather conditions until such time that they would become a safety hazard and need to be demolished. The PHMC has agreed that there is no adaptive reuse possible for these buildings. In addition, the past use of the buildings would not lend easily to alternative uses, especially for the incinerator building located at the southern end of the property.

4.3 Socioeconomic Resources

4.3.1 Land Use

Alternative #1 – The Proposed Project

Implementing the proposed project would not introduce a use of the subject property that deviates from its current zoning classification.

Alternative #2 – No Action Alternative

The No Action Alternative would not have an effect that differs from that of the proposed project. However, the objectives of the SEP and Recovery Act would not be advanced.

4.3.2 Planning Policies and Controls**Alternative #1 - The Proposed Project**

Implementing the proposed project would neither result in property development that is contrary to the planning policies and controls detailed by the most recent Navy Yard Master Plan nor plans outlined by the Philadelphia City Planning Commission.

Alternative #2 – No Action Alternative

The No Action Alternative would not have an effect that differs from that of the proposed project. However, the objectives of the SEP and Recovery Act would not be advanced.

4.3.3 Demographics and Environmental Justice**Alternative #1 - The Proposed Project**

The proposed project is isolated from residential properties and/or areas of proposed residential development. Furthermore, the site is currently zoned/used for light industrial purposes, which is consistent with the proposed project. Therefore implementation of the proposed project would not result in disproportionately high and adverse effects on human health or human environment of minority and/or low income populations.

Alternative #2 – No Action Alternative

Based on the current zoning and use of the subject property, the No Action Alternative would not have an effect that differs from the results of implementing the proposed project. However, the objectives of the SEP and Recovery Act would not be advanced.

4.4 Infrastructure**4.4.1 Roadways and Traffic****Alternative #1 – The Proposed Project**

Minimal roadway and traffic impacts are expected to occur during facility construction since the Navy Yard is adjacent to I-95 and the entire Navy Yard site is zoned industrial. The volume of truck traffic would only increase during the construction phase of the project; any increases in traffic volume are anticipated to have a minimal overall effect. Equipment deliveries include approximately 10 deliveries of modules, five deliveries of racking, one delivery of inverters, one delivery of transformers, and four separate deliveries of the electrical switchgear and equipment. The fill material will be delivered on an as needed basis and will be approximately a total of 75 deliveries. There will be approximately 100 deliveries of the concrete ballast blocks due to the size and weight of that equipment. Approximately two deliveries of electrical wiring will be delivered per week during the middle two months of construction. Any equipment that will not be immediately used will be stored in a safe and protected area on site.

As the upgrading and/or extension of the utility service connections will occur through an easement on an adjacent property there are no anticipated disruptions of local traffic patterns.

Alternative #2 – No Action Alternative

Under the No Action Alternative, the current roadway and traffic conditions in the vicinity of the proposed facility would remain unchanged. However, the objectives of the SEP and Recovery Act would not be advanced.

4.4.2 Potable Water**Alternative #1 – The Proposed Project**

The proposed project does not require potable water for operations. Therefore there will be no impact on potable water utilities.

Alternative #2 – No Action Alternative

The No Action Alternative would not have an effect that differs from that of the proposed project. However, the objectives of the SEP and Recovery Act would not be advanced.

4.4.3 Stormwater Management**Alternative #1 - The Proposed Project**

A NPDES Individual Permit Modification and Plan Revision for NPDES Permit Number PAS10-5312-R was issued on May 6, 2011, from the PADEP to the PIDC. This approved the Erosion and Sedimentation Control Plan for discharge of stormwater from the construction activities of the proposed project on what the original permit refers to as Parcels 2 and 10 of the Philadelphia Navy Yard. A man made swale is present on the site. The swale will be addressed in construction by placing a perforated pipe along the bottom of the swale and covering the swale with sand to act as a filter. The clean fill that will be brought to the site will then be placed on top of the sand. The design of the swale was such that there will be no alteration to the swale's function (Appendix 10). For additional information about the stormwater management plans, please see Section 3.1.1 Stormwater.

An approved Erosion and Sediment Pollution Control Plan, in compliance with NPDES, would be implemented before, during, and following construction activities. On-site quality assurance inspectors would ensure that the erosion and sediment pollution control measures are implemented and properly installed and maintained.

During construction, the following measures will be used to manage the stormwater: filter socks, sediment fence, and inlet protection. The filter socks and or sediment fence would be installed around the entire perimeter of the project site, with additional socks/fence installed around any fill stock piles, concrete pads, and along the perimeter of the swales. The appropriate type of filter sock would be used and maintained according to the erosion and sediment control details located on the approved civil engineering plans for the project. These would be installed and maintained throughout construction of the project until final approval is obtained from the City of Philadelphia/PADEP for removal of the sock/fence.

Inlet protection would include temporary filter bags installed in all inlets which require erosion and sediment filtering. These bags will be installed by lifting the inlet grate and installing a one inch rebar around the bag for easy removal and maintenance during construction and upon final approval. Inlet protection is not required for an inlet tributary to a sediment basin or trap.

Alternative #2 – No Action Alternative

Under the No Action Alternative, the proposed project would not be completed and the property would remain in its current condition with minimal improvements being implemented to effectively manage stormwater runoff and protect local water resources.

4.4.4 Sanitary Sewer**Alternative #1 – The Proposed Project**

There is no sanitary sewer service to the site, and portable restroom facilities would be managed in accordance with applicable laws. Therefore there would be no negative impact to sanitary sewer from the proposed project.

Alternative #2 – No Action Alternative

The No Action Alternative would not have an effect that differs from that of the proposed project. However, the objectives of the SEP and Recovery Act would not be advanced.

4.4.5 Energy System**Alternative #1 – The Proposed Project**

The proposed project would install an electrical service to the site. Currently there is no active service installed. The new electrical service would interconnect at an existing electrical line at a PECO pole located on the Tasty Baking property. This electrical line will then be trenched through the Tasty Baking property and extend in conduit 644 feet on grade with fill over to the point where it will be integrated with the medium voltage run from the project inverter and switchgear.

Alternative #2 – No Action Alternative

Under the No Action Alternative, there would continue to be no electric service to the site would remain in its current configuration. However, the objectives of the SEP and Recovery Act would not be advanced.

4.4.6 Solid Waste**Alternative #1 – The Proposed Project**

During implementation of the proposed project, the generation of solid waste, as demolition debris and predominately recyclable materials, could present potential negative environmental effects as a result of exposure to precipitation events and the subsequent generation of impacted stormwater runoff. Once operational, the facility would generate no waste. During facility construction, solid waste debris would be segregated and appropriately staged, pending removal from the site for disposal, with appropriate measures implemented, as necessary, to prevent exposure to precipitation events and/or the generation of runoff. Following construction, facility operations would not require solid waste mitigation procedures as all imported solid waste material would be processed within a contained environment.

Alternative #2 – No Action Alternative

Under the No Action Alternative, the site of the proposed project would remain unchanged. However, the objectives of the SEP and Recovery Act would not be advanced.

4.4.7 Hazardous Materials

Alternative #1 – The Proposed Project

Limited volumes of hazardous materials such as including lubricants and fuel for construction vehicles may be used onsite in conjunction with facility construction. The proposed project does not include the storage, management, and/or treatment of hazardous materials. However, during the demolition phase of the project, asbestos materials or PCB containing light ballasts may be encountered, which would be removed prior to demolition.

Accordingly, the construction site would be required to accommodate the temporary storage of hazardous material(s), in accordance with USEPA, PADEP and City of Philadelphia regulations.

The storage of all hazardous materials during construction must be compliant with applicable local state and/or federal regulations. Furthermore, the accumulation, handling, containment, transport, treatment and/or disposal of hazardous wastes (if any) generated during construction would be: 1) segregated to reduce hazardous waste volumes to be managed; 2) contained by a licensed HAZMAT contractor and/or trained personnel in a manner that is consistent with applicable regulations; 3) transported by a licensed HAZMAT contractor in a manner that is consistent with applicable DOT regulations; and 4) disposed of at an appropriate facility in accordance with applicable regulations.

Once the project would be completed, there is no use, storage or generation of hazardous materials or wastes during the operation of the project.

Alternative #2 – No Action Alternative

Under the No Action Alternative, the site would remain in its current state which includes potential for environmental interaction with hazardous materials and/or waste only if the landfill cap and or cover materials are disturbed. However, the objectives of the SEP and Recovery Act would not be advanced.

5.0 CUMULATIVE IMPACTS

Per CEQ Regulations (40 CFR 1508.7):

"Cumulative impact" is the impact on the environment which results from the incremental impact of the action when added to other past, present, and reasonably foreseeable future actions regardless of what agency (Federal or non-Federal) or person undertakes such other actions. Cumulative impacts can result from individually minor but collectively significant actions taking place over a period of time.

The proposed project poses the greatest potential to impact stormwater/floodplains, threatened and endangered species, air quality, historic resources, energy and waste. Cumulative impacts of each of these are examined here.

Stormwater impacts during and following construction are subject to an NPDES permit to be issued by PADEP. In issuing a NPDES permit for the proposed project, PADEP will ensure that the discharge of stormwater from the project site will not impact the receiving waters.

With respect to floodplain issues, Executive Order (EO) 11988 (Floodplain Management) requires Federal agencies to minimize occupancy or modification to the floodplain. As indicated on the FIRM map, the project area is located within the zone designated as a special flood

hazard area inundated by the 100-year flood; base flood elevations have been determined. In addition, PADEP regulations, including those under Chapter 105 and Chapter 106 are currently in place to prevent unacceptable impacts from developments to floodplains. As set forth in Section 3.1, the impact from the project is negligible. Adding approximately 200 cy of fill to the PADEP defined floodway, and less than 2,500 cy of total fill to the floodplain will have a very minor impact on the Schuylkill River's total tidal floodplain capacity in this area. Construction activities occurring in the 100-year floodplain would be temporary, and will result in a minor alteration of the existing grade and contours within the affected area. The proposed project's design was selected to minimize the amount of fill needed to bring portions of the site to level, thus minimizing potential harm to and within the floodplain. Additional fill on the existing cap of the onsite landfill will help to protect the watershed from the results of cap erosion, and PADEP requirements under the NPDES and Chapter 105 permits will ensure future monitoring, maintenance, and repair of any damage to the property that may expose landfilled materials. Existing PADEP floodplain regulations should ensure that impacts to unrelated future projects will also be insignificant. No projects currently proposed in the area will add to cumulative impacts to the floodplain.

As stated above, the tidal floodplain is not affected by filling and development, so this Project and others at the Navy Yard would have no impact on the floodplain. Past development at the Navy Yard has generally included increases in impervious surface and resulting runoff quantity and quality. The proposed development, which would maintain or possibly improve the site hydrology, would not add to the cumulative effects.

The identified PA Endangered Species, under state regulations, is required to be protected during nesting season for construction occurring in all but emergency circumstances. In the past, this species had been displaced by human development but has been adapting to urban settings. Presently the Girard Point Bridge, immediately north and bridging the site, has been undergoing preservation since 2009 through Recovery Act funding through the PA DOT. That project also had to address avoidance of the falcon whose nest has continued to be located on pier 26. The work on the proposed project outside the critical nesting season should have little to no impact on the falcon.

As for air quality and energy impacts, regionally, implementing the proposed project would incrementally and cumulatively result in a positive environmental impact to the Metropolitan Philadelphia area primarily by providing an alternative energy source that would produce less Green House Gas (GHG) emissions.

Historic resources at the Navy Yard have been undergoing remodeling and restoration for a number of years. The removal of the two "contributing" structures actually allows for the full recordation of the buildings and the elimination of continued deterioration of structures whose proximity, size, and configuration do not lend themselves to any other options.

The waste impacts would only occur during the construction phase and are very minimal, as much of the materials would actually be recycled.

Overall, implementing the proposed project would offer beneficial impacts to the subject property and the immediate area within the vicinity of Philadelphia Navy Yard visually by property cleanup. A blighted property would detract from the overall appearance of the Navy Yard to potential redevelopers of adjacent sites. The solar panels will be a visual boost to what is now a former industrial site with decaying buildings. All of the material that will be brought in

as fill will be neatly graded and all solar panels will be lined neatly as to make the site aesthetically pleasing.

Furthermore, the construction of a solar photovoltaic facility would benefit the Philadelphia economy by creating green jobs, and assisting in electricity production, to reduce grid parity in the Philadelphia area.

6.0 PUBLIC COMMENT

DOE issued the draft EA on July 20, 2011, and advertised its release in the *Philadelphia Inquirer* on July 24 through July 26. In addition, DOE sent a copy of the EA to the Thomas F. Donatucci, Sr., Philadelphia Free Library Branch and the Whitman Library Branch of the Philadelphia Free Library. The EA is also on file in the Government Publications Department of the Philadelphia Free Library. DOE established a 15-day public comment period that began July 27 and ended on August 10, 2011.

In conjunction with the public comment period, copies of the Draft EA were forwarded to the DEP, PHMC, and USFWS.

No comments were received.

7.0 LIST OF PREPARERS

Conergy Projects, Inc.

101 Lindenwood Drive, Suite 130

Malvern, PA 19355

Peter Hartenstine Project Manager, East Coast. BS Civil Engineering, 4 years professional experience

Lynette Ottinger Executive Assistant and Grant Administrator. BS Business Operations and Information Systems Management, 5 years professional experience

Pennonni

3001 Market Street

2nd Floor, Philadelphia, PA 19104

(215) 222-3000

Patrick Foley PE, Project Engineer. BS Civil Engineering

Tom Friese PE, Senior Engineer and Manager. BAE Architectural Engineering, MS Civil Engineering, 26 years professional experience

Manko, Gold, Katcher and Fox, L.L.C.

401 City Avenue, Suite 500

BalaCynwyd, PA 19004

Jonathan Rinde BA, SUNY Binghamton, 1979, Masters of Regional Planning, University of Michigan, 1981, JD, Temple University, 1989, 7 year's experience as an environmental consultant, 20 year's experience as a lawyer

Michael Nines BS Civil Engineering 12 years professional experience

Pennsylvania Department of Environmental Protection (PADEP)
Department of Environmental Protection
Southeast Regional Office
2 East Main Street
Norristown, PA 19401-4915

Heather Cowley, Regional Energy Manager. BS Environmental Science, 17 years professional experience

8.0 AGENCIES AND PERSONS CONSULTED

Pennsylvania Historic and Museum Commission (PHMC)
Commonwealth Keystone Building, 2nd Floor
400 North Street
Harrisburg, PA 17120-0093

Philadelphia Industrial Development Corporation (PIDC)
2600 Centre Square West
1500 Market Street
Philadelphia PA 19102

Pennsylvania Game Commission
Bureau of Wildlife Habitat Management
Division of Environmental Planning and Habitat Protection
2001 Elmerton Ave
Harrisburg, PA 17110-9797

Pennsylvania Fish and Boat Commission
1601 Elmerton Ave
Harrisburg, PA 17110-9797

U.S. Fish and Wildlife Service
Pennsylvania Field Office
315 South Allen Street, Suite 322
State College, PA 16801

PA Historical and Museum Commission
State Museum Building
300 North Street
Harrisburg, PA 17120

Pennsylvania Department of Conservation and Natural Resources
 Bureau of Forestry
 Ecological Services Section
 400 Market St.
 PO Box 8552
 Harrisburg, PA 17105-8552

FEMA Region III – DC, DE, MD, PA, VA, WV

Ms. Catharine McManus
 Regional Environmental Officer
 DHS/FEMA Region III
 615 Chestnut Street
 One Independence Mall, 6th Floor
 Philadelphia, PA 19106-4404
 Phone: 215-931-5510
 Fax: 215-931-5501
 Email: kate.mcmanus@dhs.gov
 Website: www.fema.gov/about/regions/regioniii

Delaware River Basin Commission

www.drbc.net

The Commission is interested in projects affecting water quantity, water quality, aquatic communities, or habitat within the Delaware River Basin.

Ms. Carol R. Collier
 Executive Director
 Delaware River Basin Commission
 PO Box 7360
 25 State Police Drive
 West Trenton, NJ 08628-0360
 Phone: 609-883-9500 (ext. 200)
 Fax: 609-883-9522
 Email: carol.collier@drbc.state.nj.us

Environmental Protection Agency (cont.)

EPA Region 3 – DC, DE, MD, PA, VA, WV

Ms. Barbara Rudnick
 NEPA Program Team Leader
 Environmental Protection Agency
 1650 Arch Street, 3EA30
 Philadelphia, PA 19103
 Phone: 215-814-3322
 Fax: 215-814-2783
 Email: rudnick.barbara@epa.gov
 Website: www.epa.gov/region3

9.0 REFERENCES

Berg, T. M., Edmunds, W.E., Geyer, A. R. and others, *Geologic map of Pennsylvania*, 2nd ed., 1980. Scale 1:250,000 Accessed additionally online via PA Department of Conservation and Natural Resources <http://www.dcnr.state.pa.us/topogeo/pub/map.aspx>

Census (U.S. Census Bureau) 2000. *American FactFinder, Decennial Census, Summary File 1 & Summary File 3*, accessed through <http://factfinder.census.gov>

2000. US Census Bureau American FactFinder. Demographic Profile Highlights. Geographic areas: Census tracts 50, 51, and 52, Philadelphia County, Pennsylvania. Internet Web site: http://factfinder.census.gov/servlet/SAFFacts?_event=&geo_id=05000

EIA (Energy Information Administration) 2008. "U.S. Greenhouse Gas Emissions Increased by 1.4 Percent in 2007," accessed through <http://www.eia.doe.gov/neic/press/press310.html>, December 3.

FEMA (Federal Emergency Management Agency) 2008. Flood Insurance Rate Map for Philadelphia County and Incorporated Areas Panel 189 of 230, Map Number #4207570189G, National Flood Insurance Program, effective date [January 17, 2007]

IPCC (Intergovernmental Panel on Climate Change) 2007. *Climate Change 2007: The Physical Science Basis. Contribution of Working Group I to the Fourth Assessment Report of the Intergovernmental Panel on Climate Change* [Solomon, S., D. Qin, M. Manning, Z. Chen, M. Marquis, K.B. Averyt, M. Tignor and H.L. Miller (eds.)]. Cambridge University Press, Cambridge, United Kingdom and New York, NY, USA, 996 pp. <http://www.ipcc.ch/ipccreports/ar4-wg1.htm>

NRCS (Natural Resources Conservation Service) 2010. *U.S. Department of Agriculture, Natural Resources Conservation Service. National Soil Survey Handbook, Title 430-VI*. Available online at: <http://soils.usda.gov/technical/handbook/>

United States Department of Agriculture, 2010. Natural Resources Conservation Service, Web Soil Survey 2.2, National Cooperative Soil Survey, Philadelphia Pennsylvania <http://websoilsurvey.nrcs.usda.gov/app/WebSoilSurvey.aspx>

US Department of Energy (DOE). 2004. Recommendations for the Preparation of Environmental Assessment and Environmental Impact Statements, Second Edition. December 2004. Web site: http://nepa.energy.gov/documents/green_book2004_12_30_final.pdf.

2008. Environmental Justice Strategy. May 2008. Internet Web site: http://nepa.energy.gov/documents/EJ_Strategy_05_08.pdf.

2010. *Environmental Assessment for DOE's Proposed Financial Assistance to Pennsylvania for Frey Farm Landfill Wind Energy Project, Manor Township, Lancaster, PA*. EA-1737. Available online: <http://nepa.energy.gov/1289.htm>

USEPA (U.S. Environmental Protection Agency) 2010. *National Ambient Air Quality Standards (NAAQS)*, accessed through <http://www.epa.gov/air/criteria.html>

2010. *Currently Designated Nonattainment Areas for All Criteria Pollutants*, accessed through <http://www.epa.gov/air/oaqps/greenbk/ancl.html>

2009. Mid-Atlantic 8-Hour Ozone Non-Attainment and Maintenance Areas, http://epa.gov/reg3artd/airquality/ozone8hrmaintareas_2.htm

2011. Reducing Toxic Air Emissions from Power Plants, Accessed online
<http://www.epa.gov/airquality/powerplanttoxics/actions.html>

USFWS (U.S. Fish and Wildlife Service) 2009. *View Wetlands Data with Google Earth*,
accessed through <http://www.fws.gov/wetlands/Data/GoogleEarth.html>

1990, revised 2007. Geologic Map of Pennsylvania, accessed through
<http://www.dcnr.state.pa.us/topogeo/maps/map7.pdf>

PV Watts, Accessed online
<http://rredc.nrel.gov/solar/calculators/PVWATTS/version1/US/Pennsylvania/Philadelphia.html>

Power Profiler. United States Environmental Protection Agency, Accessed online
<http://www.epa.gov/cleanenergy/energy-and-you/how-clean.html>

All reference material was accessed between March 9, 2011 and April 21, 2011.

Appendix 1

ENGINEERS STAMP:

PREHISTORIC AREA
ARCHAEOLOGICAL PARCEL 1
GIRARD POINT, PARCEL 1

AREA	AREA NO.	AREA NAME	AREA TYPE	AREA STATUS
1	101	ARCHAEOLOGICAL PARCEL 1	ARCHAEOLOGICAL	EXISTING
2	102	ARCHAEOLOGICAL PARCEL 2	ARCHAEOLOGICAL	EXISTING
3	103	ARCHAEOLOGICAL PARCEL 3	ARCHAEOLOGICAL	EXISTING
4	104	ARCHAEOLOGICAL PARCEL 4	ARCHAEOLOGICAL	EXISTING
5	105	ARCHAEOLOGICAL PARCEL 5	ARCHAEOLOGICAL	EXISTING
6	106	ARCHAEOLOGICAL PARCEL 6	ARCHAEOLOGICAL	EXISTING
7	107	ARCHAEOLOGICAL PARCEL 7	ARCHAEOLOGICAL	EXISTING
8	108	ARCHAEOLOGICAL PARCEL 8	ARCHAEOLOGICAL	EXISTING
9	109	ARCHAEOLOGICAL PARCEL 9	ARCHAEOLOGICAL	EXISTING
10	110	ARCHAEOLOGICAL PARCEL 10	ARCHAEOLOGICAL	EXISTING
11	111	ARCHAEOLOGICAL PARCEL 11	ARCHAEOLOGICAL	EXISTING
12	112	ARCHAEOLOGICAL PARCEL 12	ARCHAEOLOGICAL	EXISTING
13	113	ARCHAEOLOGICAL PARCEL 13	ARCHAEOLOGICAL	EXISTING
14	114	ARCHAEOLOGICAL PARCEL 14	ARCHAEOLOGICAL	EXISTING
15	115	ARCHAEOLOGICAL PARCEL 15	ARCHAEOLOGICAL	EXISTING
16	116	ARCHAEOLOGICAL PARCEL 16	ARCHAEOLOGICAL	EXISTING
17	117	ARCHAEOLOGICAL PARCEL 17	ARCHAEOLOGICAL	EXISTING
18	118	ARCHAEOLOGICAL PARCEL 18	ARCHAEOLOGICAL	EXISTING
19	119	ARCHAEOLOGICAL PARCEL 19	ARCHAEOLOGICAL	EXISTING
20	120	ARCHAEOLOGICAL PARCEL 20	ARCHAEOLOGICAL	EXISTING
21	121	ARCHAEOLOGICAL PARCEL 21	ARCHAEOLOGICAL	EXISTING
22	122	ARCHAEOLOGICAL PARCEL 22	ARCHAEOLOGICAL	EXISTING
23	123	ARCHAEOLOGICAL PARCEL 23	ARCHAEOLOGICAL	EXISTING
24	124	ARCHAEOLOGICAL PARCEL 24	ARCHAEOLOGICAL	EXISTING
25	125	ARCHAEOLOGICAL PARCEL 25	ARCHAEOLOGICAL	EXISTING
26	126	ARCHAEOLOGICAL PARCEL 26	ARCHAEOLOGICAL	EXISTING
27	127	ARCHAEOLOGICAL PARCEL 27	ARCHAEOLOGICAL	EXISTING
28	128	ARCHAEOLOGICAL PARCEL 28	ARCHAEOLOGICAL	EXISTING
29	129	ARCHAEOLOGICAL PARCEL 29	ARCHAEOLOGICAL	EXISTING
30	130	ARCHAEOLOGICAL PARCEL 30	ARCHAEOLOGICAL	EXISTING
31	131	ARCHAEOLOGICAL PARCEL 31	ARCHAEOLOGICAL	EXISTING
32	132	ARCHAEOLOGICAL PARCEL 32	ARCHAEOLOGICAL	EXISTING
33	133	ARCHAEOLOGICAL PARCEL 33	ARCHAEOLOGICAL	EXISTING
34	134	ARCHAEOLOGICAL PARCEL 34	ARCHAEOLOGICAL	EXISTING
35	135	ARCHAEOLOGICAL PARCEL 35	ARCHAEOLOGICAL	EXISTING
36	136	ARCHAEOLOGICAL PARCEL 36	ARCHAEOLOGICAL	EXISTING
37	137	ARCHAEOLOGICAL PARCEL 37	ARCHAEOLOGICAL	EXISTING
38	138	ARCHAEOLOGICAL PARCEL 38	ARCHAEOLOGICAL	EXISTING
39	139	ARCHAEOLOGICAL PARCEL 39	ARCHAEOLOGICAL	EXISTING
40	140	ARCHAEOLOGICAL PARCEL 40	ARCHAEOLOGICAL	EXISTING
41	141	ARCHAEOLOGICAL PARCEL 41	ARCHAEOLOGICAL	EXISTING
42	142	ARCHAEOLOGICAL PARCEL 42	ARCHAEOLOGICAL	EXISTING
43	143	ARCHAEOLOGICAL PARCEL 43	ARCHAEOLOGICAL	EXISTING
44	144	ARCHAEOLOGICAL PARCEL 44	ARCHAEOLOGICAL	EXISTING
45	145	ARCHAEOLOGICAL PARCEL 45	ARCHAEOLOGICAL	EXISTING
46	146	ARCHAEOLOGICAL PARCEL 46	ARCHAEOLOGICAL	EXISTING
47	147	ARCHAEOLOGICAL PARCEL 47	ARCHAEOLOGICAL	EXISTING
48	148	ARCHAEOLOGICAL PARCEL 48	ARCHAEOLOGICAL	EXISTING
49	149	ARCHAEOLOGICAL PARCEL 49	ARCHAEOLOGICAL	EXISTING
50	150	ARCHAEOLOGICAL PARCEL 50	ARCHAEOLOGICAL	EXISTING

PREVIOUS CAP AREA
MANAGE REFERENCE
NOTES

INTERVIOUS CAP AREA
MANAGE REFERENCE
NOTES

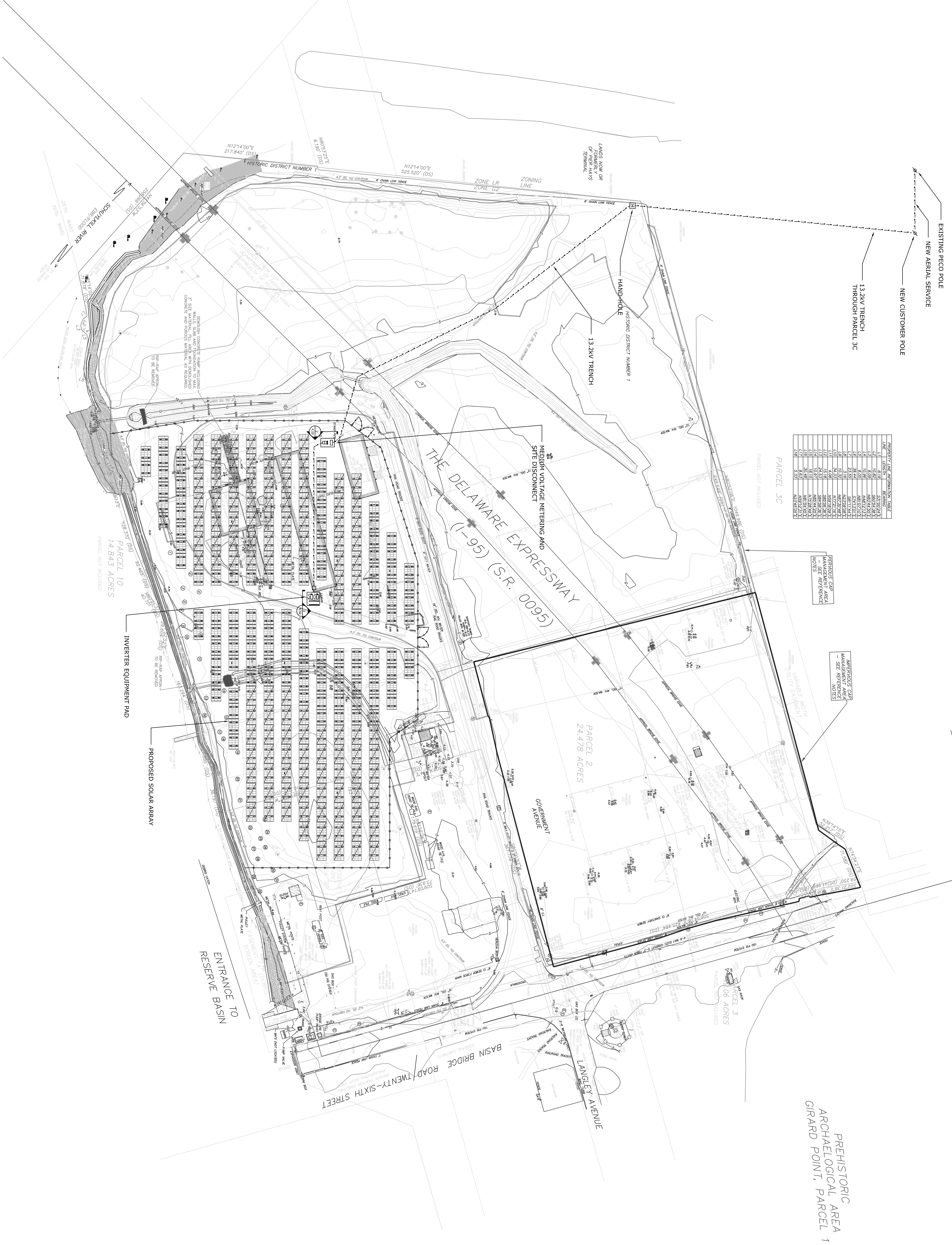

GENERAL NOTES:

COPYRIGHT © 2011 BY CONERGY PROJECTS, INC.
ALL RIGHTS RESERVED. THIS DRAWING OR SPECIFICATION IS PROTECTED BY U.S. COPYRIGHT LAW AND INTERNATIONAL TREATIES. IT HAS BEEN PREPARED EXPRESSLY FOR THE CLIENT NAMED IN THE PROJECT INFORMATION BOX HEREIN. TO BE USED ONLY IN CONNECTION WITH THE CONERGY PROJECTS, INC. PROJECTS. NO REPRODUCTION, USE, DISSEMINATION, OR DUPLICATION SHALL BE MADE WITHOUT THE PRIOR WRITTEN CONSENT OF CONERGY PROJECTS, INC.

NO.	DATE	DESCRIPTION	BY	CHK
1	01/02/2011	CREATED	CKC	CKC
2	01/02/2011	REVISIONS	CKC	CKC

CONERGY PROJECTS GROUP
101 UNDERWOOD DRIVE, SUITE 130
MALVERN, PA, 19355
TEL: (610) 251-3800
FAX: (660) 436-6114

4890 BASIN BRIDGE ROAD
PHILADELPHIA, PA, 19153-0697

CONFIDENTIAL
CONERGY PROJECTS, INC. THE INFORMATION CONTAINED HEREIN MAY NOT BE USED OR REPRODUCED IN ANY MANNER WITHOUT WRITTEN PERMISSION BY OWNER.
PHILADELPHIA NAVAL YARD
PHILADELPHIA, PA

OVERALL SITE PLAN
SCALE: 1" = 75'-0"
SHEET 3 OF 17

Appendix 2

Site Photographs



1. "Birds Eye View" of the Project Site.



2. Ground View of the Project Site from the Southwest looking to the Northeast



3. Vegetation currently on Project Site, looking South



4. Ground View of the Project Site from the Northeast looking to the Southwest



5. Southwestern part of the Project Site



6. Southeastern part of the Project Site



7. Northwestern part of the Project Site



8. Northern part of the Project Site



9. Existing inlet at man made swale

Appendix 3



Commonwealth of Pennsylvania
Pennsylvania Historical and Museum Commission
Bureau for Historic Preservation
Commonwealth Keystone Building, 2nd Floor
400 North Street
Harrisburg, PA 17120-0093
www.phmc.state.pa.us

23 August 2010

Andy Welsh
Conergy
101 Lindenwood Drive
Suite 130
Malvern, PA 19355

TO EXPEDITE REVIEW USE
BHP REFERENCE NUMBER

RE: ER# 10-1539-101-C
DOE: Exelon-Conergy Solar Center II Project, Philadelphia Naval Ship Yard,
Philadelphia

Dear Mr. Welsh:

The Bureau for Historic Preservation (the State Historic Preservation Office) has reviewed the above named project in accordance with Section 106 of the National Historic Preservation Act of 1966, as amended in 1980 and 1992, and the regulations (36 CFR Part 800) of the Advisory Council on Historic Preservation as revised in 1999 and 2004. These regulations require consideration of the project's potential effect upon both historic and archaeological resources.

Thank you for providing the additional information on the above referenced project. It is our understanding that there is no adaptive reuse possible for the two buildings on the project site that contribute to the significance of the National Register listed **Philadelphia Naval Ship Yard Historic District**. Therefore your intention is to demolish these buildings prior to developing the solar panel installations.

In our opinion this project will have an effect on the Philadelphia Naval Ship Yard Historic District. Furthermore, it is our opinion that the demolition of Buildings 668 and 548, contributing buildings in the Historic District, will adversely affect the historic and architectural qualities that make the property eligible. To comply with the regulations of the Advisory Council on Historic Preservation, the follow the procedures outlined in 36 CFR 800.6, must be followed when the effect is adverse. The Department of Environmental Protection will need to notify the Advisory Council of the effect finding and continue to consult with the Bureau for Historic Preservation to seek ways to avoid or reduce the effects on historic properties.

The next step in the process is the development of a Memorandum of Agreement. We agree that recordation of Buildings 548 and 668 is appropriate mitigation for these buildings and should be stipulated in the Memorandum of Agreement.

If you need further assistance in this matter, contact Ann Safley at (717) 787-9121.

Sincerely

A handwritten signature in black ink, appearing to read 'Douglas C. McLearen', with a long horizontal flourish extending to the right.

Douglas C. McLearen, Chief
Division of Archaeology & Protection

cc: Andrew Place, DEP, P.O. Box 2063, Harrisburg, PA 17105-2063

DMcL/ras



Commonwealth of Pennsylvania
Pennsylvania Historical and Museum Commission
Bureau for Historic Preservation
Commonwealth Keystone Building, 2nd Floor
400 North Street
Harrisburg, PA 17120-0093
www.phmc.state.pa.us

22 July 2011

Cliff Whyte
National Energy Technology Laboratory
P.O. Box 880
Morgantown, WV 26507

TO EXPEDITE REVIEW USE
BHP REFERENCE NUMBER

RE: ER# 10-1539-101-E
DOE: Memorandum of Agreement for Conergy Navy Yard Solar Project, Philadelphia

Dear Mr. Whyte:

The Bureau for Historic Preservation (the State Historic Preservation Office) has reviewed the above named project in accordance with Section 106 of the National Historic Preservation Act of 1966, as amended in 1980 and 1992, and the regulations (36 CFR Part 800) of the Advisory Council on Historic Preservation as revised in 1999 and 2004. These regulations require consideration of the project's potential effect upon both historic and archaeological resources.

The Bureau for Historic Preservation has executed the enclosed Memorandum of Agreement for the project referenced above. Please forward the Agreement, along with supporting documentation, to the Advisory Council on Historic Preservation for acceptance.

If you need further assistance in this matter, contact Ann Safley at (717) 787-9121.

Sincerely

A handwritten signature in cursive script that reads "Jean H. Cutler".

Jean H. Cutler
Director

JHC/ras

MEMORANDUM OF AGREEMENT

A MEMORANDUM OF AGREEMENT AMONG THE UNITED STATES DEPARTMENT OF ENERGY, **CONERGY PROJECTS, INC.**, THE PENNSYLVANIA STATE HISTORIC PRESERVATION OFFICE, THE PENNSYLVANIA DEPARTMENT OF ENVIRONMENTAL PROTECTION, AND **PHILADELPHIA INDUSTRIAL DEVELOPMENT CORPORATION.**]

REGARDING THE **CONERGY NAVY YARD SOLAR PROJECT, PHILADELPHIA, PENNSYLVANIA**

WHEREAS, the United States Department of Energy (DOE) administers the following financial assistance programs: *the Energy Efficiency and Conservation Block Grant Program* under the Energy Independence and Securities Act of 2007 (EECBG); *the State Energy Plan* under the Energy Policy and Conservation Act of 1975 and the State Energy Efficiency Programs Improvement Act of 1990 (SEP); and *the Weatherization Assistance Program* (WAP) for Low-Income Persons under Title IV of the Energy Conservation and Production Act, the Energy Policy Act of 2005, the Energy Independence and Security Act of 2007, and the American Recovery and Reinvestment Act of 2009 (ARRA); collectively referred to as the “Programs”; and

WHEREAS, the DOE has determined that projects funded by the Programs are undertakings subject to review under Section 106 of the National Historic Preservation Act, 16 U.S.C 470f (NHPA) and its implementing regulations at 36 CFR part 800 (undertakings); and

WHEREAS, a Programmatic Agreement (PA) was executed on **October 28, 2010** among the DOE, the PENNSYLVANIA DEPARTMENT OF ENVIRONMENTAL PROTECTION, THE PENNSYLVANIA DEPARTMENT OF COMMUNITY AND ECONOMIC DEVELOPMENT, and the **PENNSYLVANIA** State Historic Preservation Office (SHPO) pursuant to 36 CFR 800.14 (b) in order to meet more efficiently and effectively DOE’s responsibilities under Section 106; and

WHEREAS, PENNSYLVANIA DEPARTMENT OF ENVIRONMENTAL PROTECTION is receiving financial assistance from DOE to carry out **the State Energy Program** and is authorized, according to the August 28, 2009 memorandum, **Pages 18 and 19 of the PA**, to initiate Section 106 compliance in accordance with 36 CFR 800.2 (c)(4); and

WHEREAS, CONERGY PROJECTS, INC. proposes to **install a 1.251 MW photovoltaic energy system located at 4590 Basin Bridge Road in the Navy Yard Complex of Philadelphia, PA**; and

WHEREAS, CONERGY PROJECTS, INC., in consultation with the SHPO, has determined that the Area of Potential Effects (APE) for this undertaking is the center of the proposed property, as shown on the attached map (Attachment 2), and

WHEREAS, two (2) of the three (3) buildings (buildings 668 and 548) **are contributing buildings in the National Register listed Philadelphia Naval Shipyard Historic District**; and

WHEREAS, CONERGY PROJECTS, INC. in consultation with the SHPO has determined that the undertaking will have an adverse effect on buildings 668 and 548 and has notified DOE of the adverse effect pursuant to **Stipulation VIII.A. of the PA**; and

WHEREAS, in accordance with Stipulation **VIII.C.**of the PA, the DOE does not have to invite the Advisory Council on Historic Preservation (ACHP) to participate in consultation to resolve the adverse effects unless the consultation extends beyond forty-five days; and

WHEREAS, the DOE has invited CONERGY PROJECTS, INC. to participate in this consultation and to sign this Agreement as an invited signatory and CONERGY PROJECTS, INC. has elected to participate; and

WHEREAS, the DOE has invited the PHILADELPHIA INDUSTRIAL DEVELOPMENT CORPORATION to participate in this consultation and to sign this Agreement as an invited signatory and the **PHILADELPHIA INDUSTRIAL DEVELOPMENT CORPORATION** has elected to participate; and

NOW THEREFORE, in order to satisfy the DOE's Section 106 responsibilities to take into account the effects of the undertaking on historic properties, the DOE and the SHPO agree that the undertaking shall be implemented in accordance with the following stipulations:

STIPULATIONS

The Department of Energy in cooperation with **CONERGY PROJECTS, INC.**, shall ensure that the following stipulations are met:

I. PROCESS

- A. Conduct an appropriate recordation process of the buildings being demolished and submit the recordation documents and photographs to the Department of Energy and the Pennsylvania State Historic Preservation Office.
- B. Recordation and all reporting of the building demolition is to be reported as per Attachment 1 of this Agreement by no later than September 30, 2011.

II. DURATION OF AGREEMENT

- A. This Agreement will continue in full force and effect until building demolition and construction of the proposed project is completed by December 31, 2011. At any time in the three-month period prior to such date, any party to this Agreement may request the other signatory parties to consider an extension or modification of this Agreement. No extension or modification will be effective unless all parties to the Agreement have agreed with it in writing.

III. POST-REVIEW DISCOVERIES

- A. If potential historic properties are discovered or unanticipated effects on historic properties found, CONERGY PROJECTS, INC. shall implement the discovery plan included as Attachment 1 of this Agreement.

IV. MONITORING AND REPORTING

- A. Following completion of the work, **CONERGY PROJECTS, INC.** shall provide all parties to this Agreement and the ACHP a summary report detailing work undertaken pursuant to its terms. Such report shall include any scheduling changes proposed, any problems encountered, and any disputes and objections received in **CONERGY PROJECTS, INC.'S** efforts to carry out the terms of this Agreement.

V. DISPUTE RESOLUTION

- A. Should any party to this Agreement object in writing to the DOE regarding any action carried out or proposed with respect to this Agreement or to implementation of this Agreement, the DOE will consult with the objecting party to resolve the objection.
- B. If after initiating such consultation, the DOE determines that the objection cannot be resolved through consultation, the DOE shall
 - 1. Forward all documentation relevant to the dispute, including the DOE's proposed resolution, to the ACHP. The ACHP shall provide DOE with its advice on the resolution of the objection within thirty (30) days of receiving adequate documentation. Prior to reaching a final decision on the dispute, DOE shall prepare a written response that takes into account any timely advice or comments regarding the dispute from the ACHP and Signatories, and provide them a copy of this written response. DOE will then proceed according to its final decision.
- C. Should the ACHP not provide its advice regarding the dispute within the thirty (30) day time period, the DOE may make a final decision on the dispute and proceed accordingly. Prior to reaching such a final decision, DOE shall prepare a written

response that takes into account any timely comments regarding the dispute from the signatories to the MOA, and provide them and the ACHP with a copy of such written response.

- D. At any time during implementation of the measures stipulated in this Agreement, should an objection pertaining to this Agreement be raised by a member of the public, the DOE shall notify the parties to this Agreement and take the objection into account, consulting with the objector and, should the objector so request, with any of the parties to this Agreement to resolve the objection.
- E. DOE's responsibility to carry out all other actions to the terms of this MOA that are not subject of the dispute remain unchanged.

IV. AMENDMENTS

- A. This MOA may be amended when such an amendment is agreed to in writing by all signatories. The amendment will be effective on the date a copy signed by all of the signatories is filed with the ACHP.

V. TERMINATION

- A. If any signatory to this MOA determines that its terms will not or cannot be carried out, that party shall immediately consult with the other parties to attempt to develop an amendment per Stipulation IV, above. If within thirty (30) days an amendment cannot be reached, any signatory may terminate the MOA upon written notification to the other signatories.
- B. Termination shall include the submission of a technical report or other documentation by CONERGY PROJECTS, INC. on any work done up to and including the date of termination.
- C. Once the MOA is terminated, and prior to work continuing on the undertaking, DOE must either (a) execute an MOA pursuant to 36 CFR 800.6 or (b) request, take into account, and respond to the comments of the ACHP under 36 CFR 800.7. DOE shall notify the signatories as to the course of action it will pursue.

V. EXECUTION OF AGREEMENT

This Agreement may be executed in counterparts, with a separate page for each signatory. The DOE will ensure that each party is provided with a copy of the fully executed Agreement.

Execution of this Memorandum of Agreement by the DOE and the SHPO and its submission to the ACHP in accordance with 36 CFR 800.6(b)(1)(iv), shall, pursuant to 36 CFR 800.6(c), be considered to be an agreement pursuant to the regulations issued by the ACHP for the purposes of Section 110(l) of the NHPA. Execution, submission, and implementation of the terms of this Agreement, demonstrates that the DOE has afforded the ACHP an opportunity to comment on the proposed undertaking and its effect on historic properties, and that the DOE has taken into account the effect of the undertaking on historic properties.

VI. Anti-Deficiency Act Assurance.

This MOA is neither a fiscal nor a funds obligation document. Any endeavor involving reimbursement or contribution of funds among or between parties to this MOA will be handled in accordance with applicable laws, regulations, and procedures, and will be subject to separate agreements that shall be effected in writing.

SIGNATORIES:

UNITED STATES DEPARTMENT OF ENERGY
OFFICE OF WEATHERIZATION AND INTERGOVERNMENTAL PROGRAMS

By: 
LeANN OLIVER, PROGRAM MANAGER

Date: 7/13/11

CONERGY PROJECTS, INC.

By: 
KURT ZWERKO, VICE PRESIDENT

Date: 7/6/11

PENNSYLVANIA STATE HISTORIC PRESERVATION OFFICER

By: 
Jean Cutler, Deputy State Historic Preservation Officer

Date: 7/21/11

**PENNSYLVANIA DEPARTMENT OF ENVIRONMENTAL PROTECTION
BUREAU OF ENERGY INNOVATIONS AND TECHNOLOGY DEPLOYMENT**

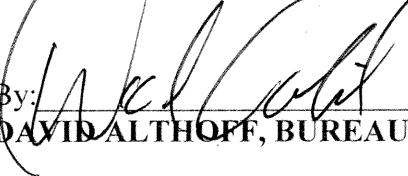
By: 
DAVID ALTHOFF, BUREAU DIRECTOR

Date: 6/29/2011

PHILADELPHIA INDUSTRIAL DEVELOPMENT CORPORATION

By: 
MARK SELTZER, DIRECTOR, LEASING AND DEVELOPMENT
Williams J. Agate, Jr., Vice President, Navy Yard Management and Development

Date: July 7, 2011

ATTACHMENT 1

STATE LEVEL RECORDATION

A. Building Description and History:

The applicant must submit a completed Pennsylvania Historic Resource Form including a description and history of the building. The date of construction and historic uses of the building should be documented by reference to historic maps, deeds or other appropriate sources listed in the Bureau for Historic Preservation Biographical References.

B. Photography:

Photographs must show all exterior elevations of the buildings as well as any significant interior features. Photographs should be labeled in pencil with the name and address (including county) of the property, date and view shown in the photograph (i.e. east elevation). Photographs must be taken with 35mm or larger format cameras with black and white film printed on black and white paper or follow the National Register photograph policy (see our website www.phmc.state.pa.us/bhp). Prints may be 3 1/2" X 5" or larger. Negatives must be housed in polypropylene sleeves, labeled with the same information as the photographs, and submitted to PHMC/Bureau for Historic Preservation.

C. Map Location:

Submit a U.S.G.S. quadrangle, 7.5 minute map showing the outline of the property associated with the buildings. A site map must also be submitted with includes the property boundaries and the location of the buildings outlining the walls at ground level (building's footprint), noting the dimensions and indicating porches with dashed lines.

D. Digital Copy:

Submit an additional copy of above items in digital format. Contact the Bureau for Historic Preservation's National Register section for guidelines.

Attachment 2

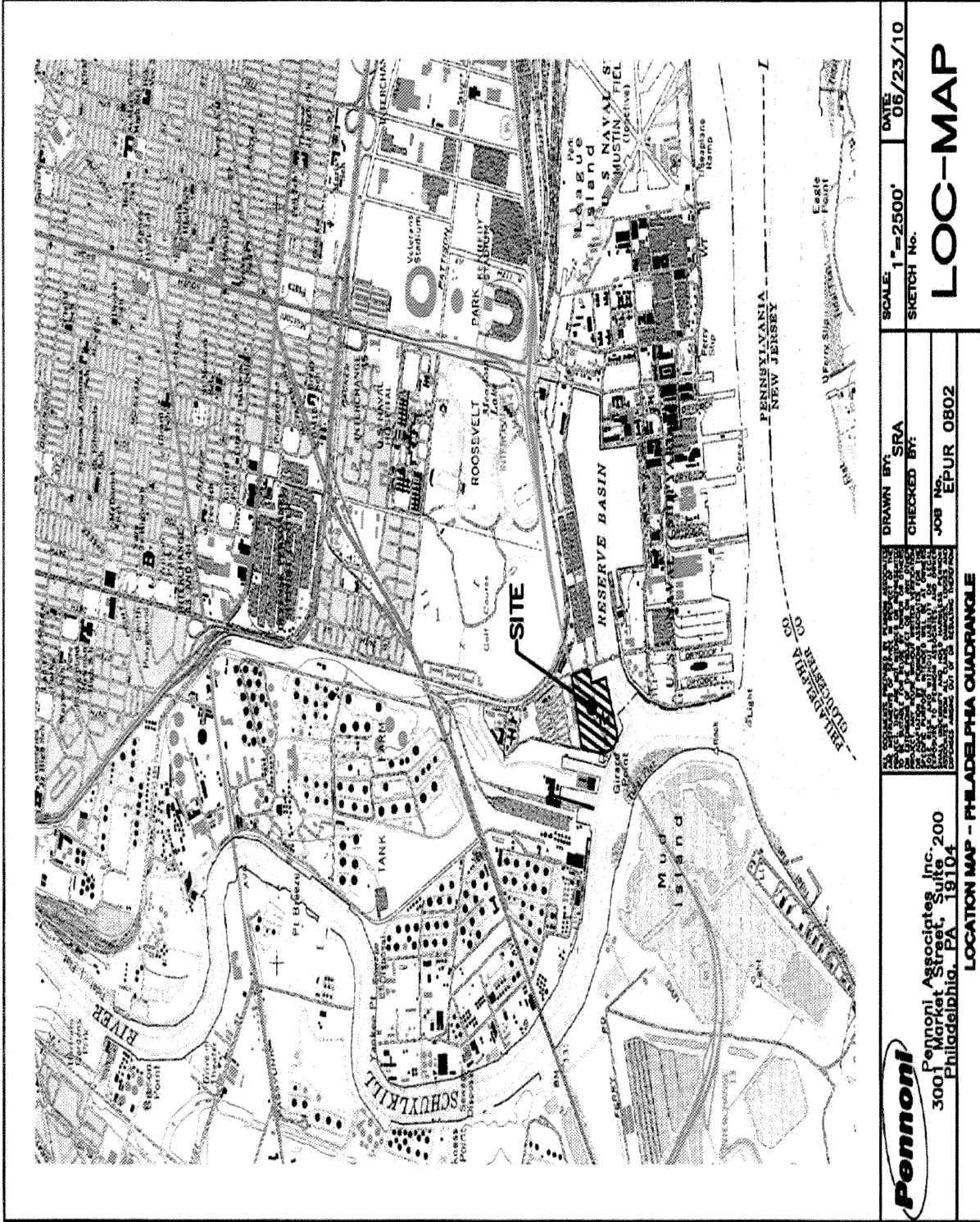

 <p>Pennoni Associates, Inc. 300 Market Street, Suite 200 Philadelphia, PA 19104</p>	<p>DATE: 06/23/10</p>
<p>DRAWN BY: SRA</p>	<p>SKETCH NO.</p>
<p>CHECKED BY:</p>	<p>LOC-MAP</p>
<p>JOB No. EPUR 0802</p>	<p>PENNSYLVANIA NEW JERSEY</p>
<p>LOCATION MAP - PHILADELPHIA QUADRANGLE</p>	

Appendix 4

BHP Use Only
ER #

**Request to Initiate Consultation in Compliance with the State History Code and
Section 106 of the National Historic Preservation Act**

Applicant Information (print neatly, this will be used in the return envelope)

Applicant Name	CONERGY PROJECTS INC.		
Street Address	222 W. LANCASTER AVE., STE 200		
City	PAOLI	Phone Number	610-251-3829
State/ZIP	PA 19301		

Contact Person to Receive Response (if applicable) (print neatly, this will be used in the return envelope)

Name/Company	ATTN: ANDREW WELSH CONERGY PROJECTS		
Street Address	222 W. LANCASTER AVE STE 200		
City	PAOLI	Phone Number	610-251-3829
State/ZIP	PA 19342		

Project Information

Project Title	The Exelon-Conergy Solar Center II		
Project Location and/address	Basin Bridge Road and Langley Avenue		
Municipality	Philadelphia, PA	County Name	Philadelphia
If this project was ever reviewed before, include previous ER #			

Project Type (Check all that apply)

Government Funded/Sponsored or On Government Land?
 Yes No **Specify Agency and/or Program Name Below**

State Agency:	DEP - PEDA GRANT	Local:	
Federal Agency:		Other:	

Permits or Approvals Required

Yes No **Specify Agency and/or Program Name Below**

Anticipated Permits:	Building Permit		
State Agency:	PEDA	Program:	
Federal Agency:		Program:	

Agency Office to Receive Response (Check all that apply)

Army Corps of Engineers: Philadelphia Baltimore Pittsburgh

DEP Office: Central Office Regional Office: _____

District Mining Office: _____ Oil & Gas Office: _____

Other: (provide address) _____

BHP Use Only
ER #

Required Project Information for BHP/SHPO Review

Total Acres in the property under review: 19.3 acres

Total acres of earth disturbance for this proposed activity: 6.5 acres

Are there any buildings or structures within the project area? Yes No

Approximate age of buildings:

Project located in or adjacent to a historic district? Yes No Unsure

Name of Historic District Philadelphia Naval Yard

Submissions Must Also Include:

MAP LOCATION: A 7.5 USGS Map showing the project boundary and the Area of Potential Effect (APE). The APE should include indirect effects, such as visual and audible impacts. Federal Projects must provide an explanation of how the APE was determined.

PHOTOS: Photos of all buildings or structures in the APE over 50 years old. If the property is over 50 years old submit a Historic Resource Form with this initial request. The forms are available at <http://www.phmc.state.pa.us/bhp/inventories>.

PROJECT DESCRIPTION NARRATIVE: Provide a detailed project description describing the project, any ground disturbance, any previous land use, and age of all effected buildings in the project area. Attach a site map showing the location of all buildings in the project area.

The Exelon-Conergy Solar Center II is a project that will be on the Philadelphia Naval Base east of the intersection of Langley Avenue and Basin Bridge Road in Philadelphia, PA. The project is planned to be a 1.5 megawatt photovoltaic system. The site is to be graded down flat and existing buildings that are within the project's plan are to be demolished and all the material to be removed off site to a designated location. The site will then be restored to a state that is agreed upon and that will appear in the contract documents and drawings.

I have reviewed all DEP Permit Exemptions listed on the DEP website www.dep.state.pa.us.

In addition, federal agencies must provide:

Measures that will be taken to identify consulting parties including Native Americans.

Measures that will be taken to notify and involve the public.

The information on this form is needed to determine whether potential historic or archaeological resources are present. Additional historic information or investigation may be requested to determine the significance of the resources or the effects of the project on those resources. Form and attachments must be submitted by mail. Submissions via e-mail will not be accepted.

Signature Block

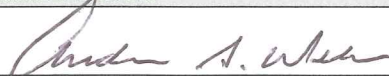

Applicant's Signature

6.1.10

Date

Pennsylvania Historical & Museum Commission
Bureau for Historic Preservation

Please Print and Mail Completed Form and Required Information to:

**PA Historical & Museum Commission
Bureau for Historic Preservation
400 North Street
Commonwealth Keystone Building 2nd Floor
Harrisburg, PA 17120-0093**

Site Plan and Photo Attachments
Conergy
The Exelon-Conergy Solar Center II

Solar Center Site Overview



Project Layout – Site Plan

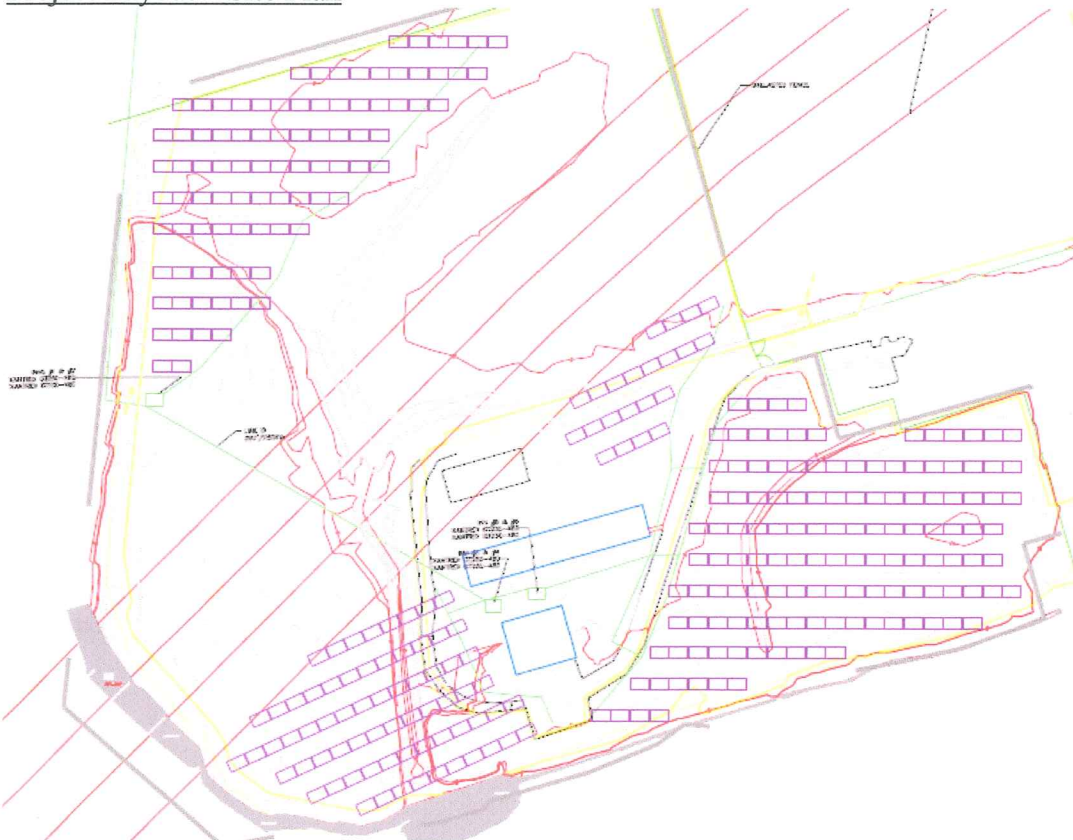

Structures to be Demolished

Ground View



Structure 1



Structure 2



Structure 3



Structure 4



Appendix 5



ALLIANCE ENVIRONMENTAL SYSTEMS, INC.

550 East Union St • West Chester, PA 19382 • Phone: (610) 701-9000 • Fax: (610) 701-9990

Work Plan Building Demolition Philadelphia Naval Yard Philadelphia, PA

The following is a description of the work practices for the demolition work at the Philadelphia Naval Yard in Philadelphia, PA:

In accordance with Pennsylvania Law, an asbestos survey will be taken before any demolition work can begin. **Conergy** will arrange for this survey with a third party firm to complete this prior to demolition. Alliance is fully insured and licensed to handle any asbestos containing materials that may be found during the survey.

Alliance will make the required ten (10) day notification to the DEP and EPA and will also make the PA One Call.

All of Alliance's workers will be given an overview of the project along with any concerns or hazards that may exist before beginning the work. Alliance workers will be equipped with hard hats, safety glasses, gloves and proper work shoes at all times during the project.

Two Story Concrete Structure

A track mounted excavator equipped with a pneumatic hammer will begin by breaking the concrete walls into smaller pieces starting from the top of the structure moving around the structure in order to maintain the building's integrity and continuing down in a systematic fashion. A Second machine will clear out the rubble as the work progresses. Workers will plan and review each day's tasks prior to the start of work.

The buildings elevated floor slabs will be demolished using the same method of wrecking as the concrete walls, starting at the roof elevation and completing the uppermost level first and continuing down in a systematic fashion. No work will begin that can not be safely completed by end of the work day in order to ensure that a collapse of any part of the structure will not occur prematurely.

Below grade slabs will be broken to allow for drainage prior to filling void areas, pits and basements with processed rubble from the building. The concrete and masonry will be processed down to a one (1) foot minus product.

The roofing material, insulation and all other C&D materials will be separated from the recyclable concrete and loaded into debris containers and disposed at legal facility.

Metal components as well as piping, conduit, and other metals generated by our operations will be placed in metal containers for off-site recycling.





ALLIANCE ENVIRONMENTAL SYSTEMS, INC.

550 East Union St • West Chester, PA 19382 • Phone: (610) 701-9000 • Fax: (610) 701-9990

One Story Block and Wood Structure

A track mounted excavator equipped with a grapple will demolish this structure by inducing the roof to the ground in a controlled manner. The masonry walls will be demolished from the top down using the excavator with the grapple and continuing through the structure systematically. No work will begin that can not be safely completed by end of the work day in order to ensure that a collapse of any part of the structure will not occur prematurely. Ceilings, partitions and all other C&D materials that are not integral to the structure will be removed prior to building demolition and legally disposed of at a licensed facility. Masonry will be segregated from C&D materials and processed to a one (1) foot minus product for re-use at the site.

Steel Building with Metal Siding

A track mounted excavator equipped with a shear will demolish this structure by cutting through the steel roof members and lowering them to the ground in a controlled manner. The steel will be demolished from the top down using the excavator with the shear and continuing through the structure systematically. No work will begin that can not be safely completed by end of the work day in order to ensure that a collapse of any part of the structure will not occur prematurely.



Appendix 6



Construction Equipment Expected Onsite

The following list of construction equipment is expected onsite during the construction of the Conergy-Exelon Solar Energy Center II. The equipment will not all be used at the same time, but will vary usage throughout the different phases of the installation.

Equipment Type	Size
Dump Truck	Large
Excavator Attachments: Scrap Shear, Pneumatic Hammer, Bucket	Medium
Bulldozer	Medium
Skid Steer	Small
Skid Loader	Small
Mini Excavator	Small
Backhoe	Small

Appendix 7



**PERMIT APPLICATION
NOTICE OF INTENT FOR COVERAGE
UNDER THE GENERAL (PAG-02) NPDES PERMIT
OR
APPLICATION FOR AN INDIVIDUAL NPDES
PERMIT FOR STORMWATER DISCHARGES
ASSOCIATED WITH CONSTRUCTION ACTIVITIES**

PLEASE READ THE PERMIT SUMMARY SHEET AND INSTRUCTIONS PROVIDED IN THIS PERMIT APPLICATION PACKAGE BEFORE COMPLETING THIS FORM. COMPLETE THE ATTACHED CHECKLIST AND WORKSHEETS 1 THROUGH 5 REFERENCED AFTER APPENDIX C OF THIS PERMIT APPLICATION. COMPLETE ALL OTHER APPLICABLE WORKSHEETS REFERENCED IN THE APPLICATION CHECKLIST.

1 acre to less than 5 acres of disturbance with a point source discharge 5 acres or larger disturbance

PLEASE PRINT OR TYPE INFORMATION IN BLACK OR BLUE INK.

CHECK APPROPRIATE BOX		GENERAL <input checked="" type="checkbox"/>	INDIVIDUAL <input type="checkbox"/>
APPLICATION TYPE	NEW <input type="checkbox"/>	RENEWAL <input type="checkbox"/>	MAJOR MODIFICATION <input checked="" type="checkbox"/>
SECTION A. APPLICANT INFORMATION			
Applicant's Last Name	First Name	MI	Phone (610) 251-3829
Welsh	Andrew		FAX (866) 436-6114
Email Address	a.welsh@conergy.us		
Organization Name or Registered Fictitious Name	Phone	(610) 251-3823	
Conergy Projects Inc	FAX	(866) 436-6114	
Mailing Address	City	State	ZIP + 4
101 Lindenwood Drive	Malvern	PA	19355
Suite 130			
Co-Applicant's Last Name (if applicable)	First Name	MI	Phone (215)218-2848
Zappile	Carmen	G	FAX
Email Address			
Organization Name or Registered Fictitious Name	Phone	(215)218-2848	
Philadelphia Authority for Industrial Development c/o Philadelphia Indisutral Development Corporation	FAX	(215)551-1014	
Mailing Address	City	State	ZIP + 4
Quarters A - 1413 Langley Avenue	Philadelphia	PA	19112
SECTION B. PROJECT INFORMATION AND SITE ANALYSIS			
1. Project Name: Photovoltaic Facility - Philadelphia Navy Yard			

2. Project Description

The developer, Conergy, proposed to construct a photovoltaic facility on portions of parcels 2 and 10 at former Philadelphia Navy Yard. This new development is to produce renewable solar energy with the installation of photovoltaic appurturance arrays on portions of the permeable cap from the Girard Point Management Area with the installation of photovoltaic arrays. The project consists of installing a graded material above the existing surface at areas of the photovoltaics and appurtenances. The material will assist with leveling the foundations and photovoltaic arrays to desired elevations. The arrays will be connected to sheltered inverters with non penetrating concrete foundations. Utility (electric) connections will be run on the existing surface and concrete encased. Fill material will installed on the existing surface to allow vehicular/pedestrian crossings. A new fence will be installed to secure the facility and be installed on a precast concrete "Jersey" barrier.

- | | | |
|-----------------------------------------------------------|------------------------------------------------|--------------------------------------------------|
| <input type="checkbox"/> Residential Subdivision | <input type="checkbox"/> Sewerage/Water System | <input type="checkbox"/> Private Road/Residence |
| <input checked="" type="checkbox"/> Commercial/Industrial | <input type="checkbox"/> Public Road | <input type="checkbox"/> Government Facility |
| <input type="checkbox"/> Utility Facility/Transmission | <input type="checkbox"/> Recreational | <input type="checkbox"/> Remediation/Restoration |

3. Total Project Area (Acres): 13.7 8.05

4. Project Location or Physical Address (if available):

4590 Basin Bridge Road
4621 Basin Bridge Road

5. County	Municipality	City	Boro	Twp
Philadelphia	City of Philadelphia	<input checked="" type="checkbox"/>	<input type="checkbox"/>	<input type="checkbox"/>
		<input type="checkbox"/>	<input type="checkbox"/>	<input type="checkbox"/>

6. Latitude: N 39 ° / 53 ' / 38.25 " Longitude: W 75 ° / 11 ' / 38.75 "

Collection Method: EMAP HGIS GISDR ITPMP GPS WAAS LORAN

Check the horizontal reference datum (or projection datum) employed in the collection method. EMAP and HGIS (PNDI) have known datum and do not require checking here. NAD27 NAD83 WGS84 (GEO84)

Enter the date of collection if the lat and long coordinates were derived from GPS, WAAS or LORAN. ____ mm ____ dd ____ yyyy

7. U.S.G.S. Quad Map Name Philadelphia, PA-NJ

8. Existing and Previous Uses of the Land Proposed for Construction (use separate sheet if necessary):

Existing Land Uses: Agriculture Forest/Woodland Barren Urban Brownfield Other

Description: Landfill

Previous Land Uses: Agriculture Forest/Woodland Barren Urban Brownfield Other

Description: Incinerator Plant for Navy Yard

9. Site Analysis

a. Describe how Natural Resources features on the site (Worksheets 2 and 3 referenced in the Pa. Stormwater BMP Manual) were considered in: Location and Design of the project, E & S Plan Design, PCSM Plan Design. (attach additional sheet if necessary)

There are three drainage swales on the property, ^{one swale} ~~that~~ will be filled in with a ^{pervious} ~~perious~~ clean fill material and perforated pipe to convey stormwater in its original manner away from the property. ~~The drainage swale north of the I-95 Bridge will receive check dams.~~

b. Identify naturally occurring geologic formations or soil conditions that may have the potential to cause pollution during earth disturbance activities and include BMPs to avoid or minimize potential pollution and its impacts from the formation.

There will be limited earth disturbance associate with this project. The landfill has a permeable membrane that is covered with roughly 2' of fill. A minimum of 6" of a pervious clean fill material will be placed and the photovoltaic arrays will be mounted on concrete foundations on top of the stone.

10. Potential Toxic or Hazardous Pollutants: (Submit the following data if soil contaminant, geology or past or present land use provides a potential for contaminated runoff from the project site) N/A Use additional sheets if necessary.

Pollutant	Concentration w/Units	Source	Sample Type	Date(s) / Number of Samples

11. Fill Material

Based on a cut/fill analysis of the project site, will the site need to import fill, export fill or will the site balance? Be sure to read the instructions before completing this section. Clean Fill can not be placed in or on waters of the Commonwealth.

Check the appropriate box

- Import fill – the Operator will, in most situations, be responsible to perform environmental due diligence and determine that all fill imported to the site meets the department's definition of clean fill. The plan designer must include a note on the drawings to identify the operator(s) responsibility and provide the definition of Clean Fill and Environmental Due Diligence.
- Export fill – the Applicant is responsible for performing environmental due diligence at the time this application was submitted to determine that any fill exported from the site will be certified as clean fill.
- Balance all cuts and fills with the amount of rock and soil available on the site.

12. Total Disturbed Area (Acres) to be permitted: ~~13.7~~ **8.05** ~~4-4-11~~ ~~09-02-11~~

13. Estimated Timeframe for completion of project: Project Start Date 09-01-10 Project End Date 06-01-11

14. Estimated Timetable for Phased Projects Build Out (Complete for phased projects only)

Phase No. or Name	Proposed Type of Activity	Total Area	Disturbed Area	Start Date	End Date
1	Installation of PV Arrays & Inverter Stations	13.72 8.05	13.72 8.05	<u>09-01-10</u>	<u>12-31-10</u>
				4-4-11	09-02-11

15. Stormwater Discharges to (during construction): Impaired Waters According to Chapter 303(d) List
 Waters of the Commonwealth Municipal Separate Storm Sewer Private Storm Sewer Non Surface Waters

Receiving Water/Watershed Name: Schuylkill River	Chapter 93 Receiving Water Classification: (Designated use) WWF, MF	Existing Use (if different from the Designated use)
Name of Municipal Storm Sewer Operator: City of Philadelphia	Name of Private Storm Sewer Operator: N/A	Other: (including off-site discharges) N/A

SECTION C. E & S AND POST CONSTRUCTION STORMWATER MANAGEMENT (PCSM) PLAN

Note: For projects involving multiple watershed boundaries, please submit a complete, separate Section C for each additional watershed.

1. Provide a brief summary of proposed BMPs and their performance to manage E & S for the project. If E & S BMPs and their application do not follow the guidelines referenced in the Pa. Erosion and Sediment Pollution Control Program Manual, provide documentation to demonstrate performance equivalent to, or better than, the BMPs in the Manual.

E & S BMPs

During construction on the project the contractor will install ~~silt fence~~ ^{filter sock} along all downslope areas to prevent runoff from entering the river. ~~Within the existing drainage swales check dams will be installed every fifty feet to reduce the speed of flow.~~ In the areas where the arrays are to be installed within the swale areas ~~24"~~ ^{24"} perforated HDPE pipe will be installed wrapped in geo-textile fabric and then a pervious clean fill material will be used to fill in the swale and bring it to grade. The amount of flow through the swales will be equivalent to the existing flows. A rock construction entrance will be used at the main point of egress into the site.

PCSM Plan Information - The PCSM Plan should be designed to maximize volume reduction technologies, eliminate (where possible) or minimize point source discharges to surface waters, preserve the integrity of stream channels, and protect the physical, biological and chemical qualities of the receiving surface water. **The DEP recommends the use of Control Guideline 1 (CG1) referenced in the Pa. Stormwater BMP Manual to achieve this goal.**

Design standards applied to develop the PCSM Plan. Check those that apply.

- Act 167 Plan - The attached PCSM plan is consistent with an applicable approved Act 167 Plan. **A letter of consistency from the Municipal or County Engineer should be provided with the application.** Complete and submit all applicable worksheets referenced in the application checklist as part of the permit application for each approved Act 167 Plan.

Complete the following table for all applicable approved Act 167 Stormwater Management Plans. (use additional sheets if necessary)

ACT 167 Plan Name	Date Adopted	Consistency Letter Included
_____	_____	<input type="checkbox"/>

- The attached PCSM plan is consistent with all applicable local stormwater management ordinances, including MS4 (NPDES Permit to Discharge Stormwater Through a Municipal Separate Storm Sewer System) ordinances. **A letter of consistency from the Municipal or County Engineer must be provided with the application.** Complete and submit all applicable worksheets referenced in the application checklist as part of the permit application.

Complete the following table for all applicable Municipalities. (use additional sheets if necessary)

Municipality Name	Ordinance Number	Consistency Letter Included
_____	_____	<input type="checkbox"/>

The PCSM Plan must satisfy either subparagraph a or b below. Check those that apply.

- A. Act 167 Plan approved on or after January 2005 – The attached PCSM Plan, in its entirety, is consistent with all requirements pertaining to rate, volume, and water quality from an Act 167 Stormwater Management Plan approved by DEP on or after January 2005.

OR

- B. The PCSM Plan must satisfy one or both of the following requirements:

- PA Stormwater BMP Manual - The attached PCSM plan is consistent with water quality design features and BMPs as presented in the Pennsylvania Stormwater BMP Manual. CG 1 has been met.
- Other Design Standard – The attached PCSM plan was developed using partial compliance with the above standards or other standard. Demonstrate/explain in the space provided how this standard meets the criteria described in the PA Comprehensive Stormwater Management Policy Document 392-0300-002.

This should remain the same - - - -
Are the Ch. Buildings counted?

2. SUMMARY TABLE FOR SUPPORTING CALCULATION AND MEASUREMENT DATA			
Please reference the Stormwater Methodology used (i.e. SCS Method)			
	Pre-construction	Post Construction	Net Change
Design storm frequency <u>2-yr</u> _____ inches Rainfall amount <u>3.20</u> _____ inches			
Impervious area (acres) <i>1.70</i>	1 <u>0.86</u>	2 <u>0.86</u> <i>1.31</i>	3 0.00 <i>0.03</i>
Volume of stormwater runoff <input type="checkbox"/> acre-feet or <input checked="" type="checkbox"/> cubic feet without planned stormwater BMPs (check appropriate box)	4 112,470 <i>24326</i>	5 112,470 <i>27355</i>	6 0.00 <i>3029</i>
Volume of stormwater runoff <input type="checkbox"/> acre-feet or <input checked="" type="checkbox"/> cubic feet with planned stormwater BMPs (check appropriate box)		7 112,470 <i>27355</i>	8 0.00 <i>3029</i>
Stormwater peak discharge rate for the design frequency storm (cubic feet per second)	9 48.09 <i>5.48</i>	10 48.09 <i>5.73</i>	11 0.00 <i>0.25</i>

- Box 1. Pre-construction impervious area:** The total acres of impervious area on the project site before construction activities begin, based on land use for five years preceding the planned project.
- Box 2. Post construction impervious area:** The total acres of impervious area on the project site after construction activities have been completed.
- Box 3. Net change of impervious area:** The difference between the acres of impervious area listed in Box 1 and Box 2. Zero or negative values are acceptable.
- Box 4. Pre-construction stormwater runoff volume without planned BMPs:** The amount of stormwater runoff volume from the project site that would result from the design storm occurrence before construction activities begin, based on land use for five years preceding the project.
- Box 5. Post construction stormwater runoff volume without planned BMPs:** The amount of stormwater runoff volume from the project site that would result from the design storm occurrence after construction activities have finished assuming that no stormwater infiltration or retention BMPs have been installed.
- Box 6. Net change in stormwater volume without planned BMPs:** The difference between the amounts of stormwater runoff volume listed in Box 4 and Box 5.
- Box 7. Post construction stormwater runoff volume with planned BMPs:** The amount of stormwater runoff volume from the project site that would result from the design storm occurrence after construction activities have finished and the planned stormwater infiltration or retention BMPs have been installed.
- Box 8. Net change in stormwater runoff volume with planned BMPs:** The difference between the amounts of stormwater runoff volume listed in Box 4 and Box 7.
- Box 9. Pre-construction stormwater discharge rate:** The stormwater runoff discharge rate for the design frequency storm as determined by the land use for the past five years.
- Box 10. Post construction stormwater discharge rate:** The stormwater runoff discharge rate for the design frequency storm event after all planned stormwater BMPs are installed.
- Box 11. Net change stormwater discharge rate:** The difference between the stormwater runoff discharge rates listed in Box 9 and Box 10.

3. SUMMARY DESCRIPTION OF POST CONSTRUCTION STORMWATER BMPs (consistent with Worksheets 3 and 5 referenced in the Pa. Stormwater BMP Manual)

Key: RC = Rate Control VC = Volume Control WQ = Water Quality

In the lists below, check the BMPs identified in the PCSM Plan, and their function(s) using the above Key. More than one function may be checked for a BMP. List the stormwater volume and area of runoff to be treated by each BMP type. If any BMP in the PCSM Plan is not listed below, describe it in the space provided after "Other".

BMP	Function(s)	Volume of stormwater treated	Acres treated
<input type="checkbox"/> Wet ponds	<input type="checkbox"/> VC <input type="checkbox"/> RC <input type="checkbox"/> WQ		
<input type="checkbox"/> Constructed wetlands	<input type="checkbox"/> VC <input type="checkbox"/> RC <input type="checkbox"/> WQ		
<input type="checkbox"/> Retention basins	<input type="checkbox"/> VC <input type="checkbox"/> RC <input type="checkbox"/> WQ		
<input type="checkbox"/> Detention basin	<input type="checkbox"/> VC <input type="checkbox"/> RC <input type="checkbox"/> WQ		
<input type="checkbox"/> Underground detention	<input type="checkbox"/> VC <input type="checkbox"/> RC <input type="checkbox"/> WQ		
<input type="checkbox"/> Dry Extended detention basin	<input type="checkbox"/> VC <input type="checkbox"/> RC <input type="checkbox"/> WQ		
<input type="checkbox"/> Sediment fore bay	<input type="checkbox"/> VC <input type="checkbox"/> RC <input type="checkbox"/> WQ		
<input type="checkbox"/> Infiltration trench	<input type="checkbox"/> VC <input type="checkbox"/> RC <input type="checkbox"/> WQ		
<input type="checkbox"/> Infiltration Berm/Retentive Grading	<input type="checkbox"/> VC <input type="checkbox"/> RC <input type="checkbox"/> WQ		
<input type="checkbox"/> Subsurface Infiltration bed	<input type="checkbox"/> VC <input type="checkbox"/> RC <input type="checkbox"/> WQ		
<input type="checkbox"/> Infiltration basin	<input type="checkbox"/> VC <input type="checkbox"/> RC <input type="checkbox"/> WQ		
<input type="checkbox"/> Pervious pavement	<input type="checkbox"/> VC <input type="checkbox"/> RC <input type="checkbox"/> WQ		
<input type="checkbox"/> Dry well/Seepage pit	<input type="checkbox"/> VC <input type="checkbox"/> RC <input type="checkbox"/> WQ		
<input type="checkbox"/> Bio-infiltration areas	<input type="checkbox"/> VC <input type="checkbox"/> RC <input type="checkbox"/> WQ		
<input type="checkbox"/> Rain gardens/Bio-retention	<input type="checkbox"/> VC <input type="checkbox"/> RC <input type="checkbox"/> WQ		
<input checked="" type="checkbox"/> Vegetated swales	<input type="checkbox"/> VC <input type="checkbox"/> RC <input checked="" type="checkbox"/> WQ	49,200	5.82
<input type="checkbox"/> Constructed filters	<input type="checkbox"/> VC <input type="checkbox"/> RC <input type="checkbox"/> WQ		
<input type="checkbox"/> Protect Sensitive & Special Value Features	<input type="checkbox"/> VC <input type="checkbox"/> RC <input type="checkbox"/> WQ		
<input type="checkbox"/> Protect/Conserve/Enhance Riparian areas	<input type="checkbox"/> VC <input type="checkbox"/> RC <input type="checkbox"/> WQ		
<input type="checkbox"/> Restoration: Buffers/ Landscape/Floodplain	<input type="checkbox"/> VC <input type="checkbox"/> RC <input type="checkbox"/> WQ		
<input type="checkbox"/> Disconnection from storm sewers	<input type="checkbox"/> VC <input type="checkbox"/> RC <input type="checkbox"/> WQ		
<input type="checkbox"/> Rooftop disconnection	<input type="checkbox"/> VC <input type="checkbox"/> RC <input type="checkbox"/> WQ		
<input type="checkbox"/> Vegetated roofs	<input type="checkbox"/> VC <input type="checkbox"/> RC <input type="checkbox"/> WQ		
<input type="checkbox"/> Runoff capture/Reuse	<input type="checkbox"/> VC <input type="checkbox"/> RC <input type="checkbox"/> WQ		
<input type="checkbox"/> Oil/grit separators	<input type="checkbox"/> VC <input type="checkbox"/> RC <input type="checkbox"/> WQ		
<input type="checkbox"/> Water quality inserts/inlets	<input type="checkbox"/> VC <input type="checkbox"/> RC <input type="checkbox"/> WQ		
<input type="checkbox"/> Street sweeping	<input type="checkbox"/> VC <input type="checkbox"/> RC <input type="checkbox"/> WQ		
<input checked="" type="checkbox"/> Other Check Dam	<input type="checkbox"/> VC <input type="checkbox"/> RC <input checked="" type="checkbox"/> WQ	49,200	5.82
<input checked="" type="checkbox"/> Other Sand Filter Underdrain	<input type="checkbox"/> VC <input type="checkbox"/> RC <input checked="" type="checkbox"/> WQ	46,918 7,201 SF	5.55 0.978

4. OFF SITE DISCHARGE ANALYSIS

Does the project propose any off-site discharges to areas other than surface waters? Yes No

If yes, has the applicant obtained the type of easement that provides the legal authority for this discharge?
 Yes No

Applicant must provide a demonstration that the discharge will not cause erosion, damage, or nuisance to off-site properties.

5. THERMAL IMPACTS ANALYSIS

Please explain how thermal impacts associated with this project were avoided. Thermal impacts will be avoided by routing the existing stormwater through perforated pipe through the existing swales. The amount of proposed discharge will be equal or less than the existing discharge.

If thermal impacts cannot be avoided, describe how impacts were minimized and the BMPs that will mitigate such impacts in a manner that will protect and maintain water quality in receiving surface waters in accordance with 25 Pa. Code Chapter 93.

SECTION D. ANTIDegradation ANALYSIS MODULE

This Section is to be completed for Special Protection Watershed Only. (HQ/EV and EV Wetlands)

PART 1 NON-DISCHARGE ALTERNATIVES EVALUATION

The applicant must consider and describe any and all non-discharge alternatives for the entire project area which are environmentally sound and will:

- Minimize accelerated erosion and sedimentation during the earth disturbance activity
- Achieve no net change from pre-development to post-development volume, rate and concentration of pollutants in water quality

E & S Plan	Official Use Only	PCSM Plan	Official Use Only
<p>Check off the environmentally sound non-discharge Best Management Practices (BMPs) listed below to be used prior to, during, and after earth disturbance activities that have been incorporated into your E & S Plan based on your site analysis. For BMPs not checked, provide an explanation of why they were not utilized. (attach additional sheets if necessary)</p>		<p>Check off the environmentally sound non-discharge Best Management Practices (BMPs) listed below to be used after construction that have been incorporated into your PCSM Plan based on your site analysis. For BMPs not checked, provide an explanation of why they were not utilized. (attach additional sheets if necessary)</p>	
<p>Non-discharge BMPs</p> <p><input type="checkbox"/> Alternative Siting</p> <p style="padding-left: 20px;"><input type="checkbox"/> Alternative location</p> <p style="padding-left: 20px;"><input type="checkbox"/> Alternative configuration</p> <p style="padding-left: 20px;"><input type="checkbox"/> Alternative location of discharge</p> <p><input type="checkbox"/> Limited Disturbed Area</p> <p><input type="checkbox"/> Limiting Extent & Duration of Disturbance (Phasing, Sequencing)</p> <p><input type="checkbox"/> Vegetated Riparian Buffers (100 ft min)</p> <p><input type="checkbox"/> Other _____</p>		<p>Non-discharge BMPs</p> <p><input type="checkbox"/> Alternative Siting</p> <p style="padding-left: 20px;"><input type="checkbox"/> Alternative location</p> <p style="padding-left: 20px;"><input type="checkbox"/> Alternative configuration</p> <p style="padding-left: 20px;"><input type="checkbox"/> Alternative location of discharge</p> <p><input type="checkbox"/> Low Impact Development (LID / BSD)</p> <p><input type="checkbox"/> Vegetated Riparian Buffers (100 ft min)</p> <p><input type="checkbox"/> Infiltration</p> <p><input type="checkbox"/> Water Reuse</p> <p><input type="checkbox"/> Other _____</p>	

Part 2 Antidegradation Best Available Combination of Technologies (ABACT)

If the net change in stormwater discharge from or after construction is not fully managed by non-discharge BMPs, the applicant must utilize ABACT BMPs to manage the difference. The Applicant must specify whether the discharge will occur during construction, post-construction or both, and identify the technologies that will be used to ensure that the discharge will be a non-degrading discharge. ABACT BMPs include but are not limited to:

E & S Plan	Official Use Only	PCSM Plan	Official Use Only
<input type="checkbox"/> Treatment BMPs: <input type="checkbox"/> Sediment basin with skimmer <input type="checkbox"/> Sediment basin ratio of 4:1 or greater (flow length to basin width) <input type="checkbox"/> Sediment basin with 4-7 day detention <input type="checkbox"/> Flocculants <input type="checkbox"/> Land disposal: <input type="checkbox"/> Vegetated filters <input type="checkbox"/> Vegetated Riparian buffers <100ft. <input type="checkbox"/> Immediate stabilization <input type="checkbox"/> Pollution prevention: <input type="checkbox"/> PPC Plans <input type="checkbox"/> Street sweeping <input type="checkbox"/> Channels, collectors and diversions lined with permanent vegetation, rock, geotextile or other non-erosive materials <input type="checkbox"/> Stormwater reuse technologies: <input type="checkbox"/> Sediment basin water for dust control <input type="checkbox"/> Sediment basin water for irrigation <input type="checkbox"/> Other _____		<input type="checkbox"/> Treatment BMPs: <input type="checkbox"/> Infiltration Practices <input type="checkbox"/> Wet ponds <input type="checkbox"/> Created wetland treatment systems <input type="checkbox"/> Vegetated swales <input type="checkbox"/> Manufactured devices <input type="checkbox"/> Bio-retention/infiltration <input type="checkbox"/> Green Roofs <input type="checkbox"/> Land disposal: <input type="checkbox"/> Vegetated filters <input type="checkbox"/> Vegetated Riparian Buffers <100ft. <input type="checkbox"/> Disconnection of roof drainage <input type="checkbox"/> Bio-retention/bio-infiltration <input type="checkbox"/> Pollution prevention: <input type="checkbox"/> Street sweeping <input type="checkbox"/> Nutrient, pesticide, herbicide or other chemical application plan alternatives <input type="checkbox"/> PPC Plans <input type="checkbox"/> Non-structural Practices <input type="checkbox"/> Land Preservation <input type="checkbox"/> Restoration BMPs <input type="checkbox"/> Stormwater reuse technologies: <input type="checkbox"/> Cisterns <input type="checkbox"/> Rain barrels <input type="checkbox"/> Dry hydrant with underground storage <input type="checkbox"/> Spray/Drip Irrigation <input type="checkbox"/> Other _____	
Are the ABACT BMPs selected sufficient to minimize E & S discharges to the extent that existing or designated surface water uses are protected? <input type="checkbox"/> Yes <input type="checkbox"/> No. If no, and the project is located in a HQ water, proceed to Part 3.		Are the ABACT BMPs selected sufficient to achieve no net change to the extent that existing or designated surface water uses are protected? <input type="checkbox"/> Yes <input type="checkbox"/> No. If no, and the project is located in a HQ water, proceed to Part 3.	

Part 3 Social or Economic Justification (SEJ) (for projects in high quality waters only)

If the applicant cannot demonstrate that the net change in discharge will protect the existing quality of the receiving surface waters, for projects in HQ waters, the applicant may pursue the SEJ process for demonstrating that lowering water quality is necessary to accommodate important economic or social development in the area in which the waters are located, in accordance with Chapter 10 of the Water Quality Antidegradation Implementation Guidance Manual, DEP Document ID No. 391-0300-002.

SECTION E. CONSULTANT FOR THIS PROJECT

Last Name	First Name	MI
Foley	Patrick	M
Title	Consulting Firm	
Project Engineer	Pennonni Associates Inc.	
Mailing Address		
3001 Market Street, Suite 200		
City	State	ZIP+4
Philadelphia	PA	19104-2897
Email	Phone	Ext
pfoley@pennonni.com	2152223000	3518
	FAX	
	2152220598	

SECTION F. COMPLIANCE HISTORY REVIEW

Is/was the applicant(s) in violation of any permits issued by DEP or any regulated activities within the past five years?
 Yes No

If yes, list each permit or project that is/was in violation and provide compliance status of the activity (use additional sheets to provide information on all permits).

Permit Program or Activity: _____ Permit Number (if applicable): _____

Brief description of non-compliance: _____

Steps taken to achieve compliance	Date(s) Compliance Achieved

Current Compliance Status: In-Compliance In Non-Compliance

If the applicant is not in compliance with any permit requirement of DEP Regulations or regulated activity, provide a narrative description of how the applicant will achieve compliance with the permit requirement or activity, including the schedule for achieving compliance with appropriate milestones.

SECTION G. PERMIT COORDINATION

Does the applicant (owner and/or operator) have, have pending, or require any other environmental permits for this project and any additional planning requirements?

Yes No If yes, list each permit or approval, permit number, and description.

Coordination Questions

1. Does the project involve any of the following: Placement of fill, excavation within or a placement of a structure located in, along, across, or projecting into a water course, floodway or body of water (including wetlands)?

Yes No If yes, identify which authorization under Chapter 105 is applicable.

Joint Permit General Permit Waiver

2. What is your 537 Plan status? Please note that 537 Plan approval is required prior to permit issuance. The Act 537 has been submitted. The project is an unmanned facility and no sanitary sewers are proposed.

3. Is your project associated with a Brownfield's Remediation? Yes No If yes, please indicate any coordination to date with the Environmental Cleanup Program (Act 2 or Superfund). The existing site is a part of the SIA Agreement with Girard Point Management Area.

4. Are there any additional permits or approvals that may be required for this project? Yes No If yes, please list them. City of Philadelphia Building and Zoning Permits.

SECTION H. CERTIFICATION

Applicant Certification

I certify under penalty of law that this application and all related attachments were prepared by me or under my direction or supervision by qualified personnel to properly gather and evaluate the information submitted. Based on my own knowledge and on inquiry of the person or persons directly responsible for gathering the information, the information submitted is, to the best of my knowledge and belief, true, accurate and complete. The responsible official's signature also verifies that the activity is eligible to participate in the NPDES permit, and that BMP's, E&S Plan, PPC Plan, PCSM Plan, and other controls are being or will be, implemented to ensure that water quality standards and effluent limits are attained. I am aware that there are significant penalties for submitting false information, including the possibility of fine and imprisonment or both for knowing violations pursuant to Section 309(c)(4) of the Clean Water Act and, 18 Pa. C.S. §§4903-4904.

Applicant

Co-Applicant (if applicable)

Andrew Welsh

Carmen Zappile Zappile, VICE President

Print Name and Title of Person Signing

Print Name and Title of Person Signing

(610) 251-3829

(215) 231-8020 215-2048

Telephone Number of Person Signing

Telephone Number of Person Signing

Andrew D. Welsh

Carmen Zappile

Signature of Applicant

Signature of Co-Applicant

7/29/10

7/29/10

Date Signed

Date Signed

Please note below the name, address and telephone number of the individual that should be contacted in the event additional information is required.

Name: Patrick Foley

Address: 3001 Market Street, Suite 200, Philadelphia, PA 19104-2897

Telephone: (215) 222-3000 ext. 3518 FAX: (215) 222-0598

Notarization: Andrew Welsh

Commonwealth of Pennsylvania

County of Philadelphia

Sworn to and Subscribed to Before Me This

NOTARY

SEAL

29th Day of July, 2010

Jaime Spingler

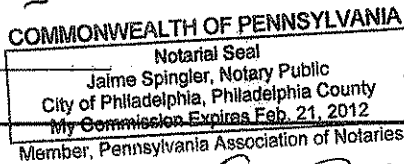

My Commission Expires: Feb 21, 2012

Notarization: ~~Carmen Zappile~~ GINA D. MORGAN

Commonwealth of Pennsylvania

County of Philadelphia

Sworn to and Scribed to Before Me this

NOTARY

SEAL

29th Day of July, 2010,

Gina D. Morgan

Notary Public

My Commission Expires:

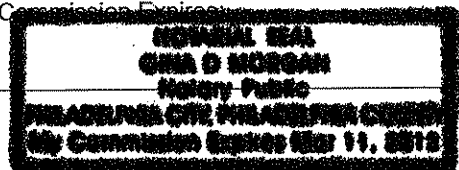



**APPLICATION CHECKLIST
GENERAL NPDES PERMIT FOR STORMWATER DISCHARGES
ASSOCIATED WITH CONSTRUCTION ACTIVITIES**

Please check the following list to make sure that you have included all the required information. Place a check mark in the column provided for all items completed and/or provided. Failure to provide all of the requested information will delay the processing of the application and may result in the application being placed ON HOLD with NO ACTION, or being considered withdrawn and the application file closed.

THIS CHECKLIST MUST BE COMPLETED AND ENCLOSED WITH YOUR GENERAL PERMIT APPLICATION FORM

✓CHECKLIST FOR <u>NEW</u> GENERAL NPDES PERMIT APPLICATION			Applicant Check ✓ If Included	Official Use Only	
1.	Fully completed, properly signed and notarized Notice of Intent Form (1 original and 2 copies).		<input type="checkbox"/>	<input type="checkbox"/>	
2.	Complete Erosion and Sediment Control Plans. (3 copies) Location: Drawings (D), Narrative (N).		<input type="checkbox"/>	<input type="checkbox"/>	
a.	Written Narrative (<i>Must be labeled "E&S Plan" or "Erosion & Sediment Control Plan", be complete & legible, and be the final plan for construction</i>) Written Narrative Includes the following:	Location <u>N</u>	Page <u>See All</u>	<input checked="" type="checkbox"/>	<input type="checkbox"/>
i.	8.5" X 11" USGS map with outline of project area	Location <u>N</u>	Page <u>85</u>	<input checked="" type="checkbox"/>	<input type="checkbox"/>
ii.	Soils information (including hydric soils) Types, depth, slope and locations of soils	Location <u>N</u>	Page <u>3</u>	<input checked="" type="checkbox"/>	<input type="checkbox"/>
iii.	Physical characteristics and limitations of soils	Location <u>N</u>	Page <u>3</u>	<input checked="" type="checkbox"/>	<input type="checkbox"/>
iv.	Supporting calculations to show anticipated peak flows for the design storms	Location <u>N</u>	Page <u>67</u>	<input checked="" type="checkbox"/>	<input type="checkbox"/>
v.	Analysis of the impact that runoff from the project site will have on existing downstream watercourses resistance to erosion	Location <u>N</u>	Page <u>4</u>	<input checked="" type="checkbox"/>	<input type="checkbox"/>
vi.	Provide supporting calculations, standard worksheet, and narrative description of the location for all proposed E&S Control BMPs used before, during and after earth disturbance including but not limited to the following:				
	A. Channels	Location <u>N</u>	Page <u>na</u>	<input type="checkbox"/>	<input type="checkbox"/>
	B. Sediment Basins	Location <u>N</u>	Page <u>na</u>	<input type="checkbox"/>	<input type="checkbox"/>
	C. Sediment Traps	Location <u>N</u>	Page <u>na</u>	<input type="checkbox"/>	<input type="checkbox"/>
	D. Filter Fabric Fencing	Location <u>N</u>	Page <u>C8001</u>	<input checked="" type="checkbox"/>	<input type="checkbox"/>
	E. Outlet Protection	Location <u>N</u>	Page _____	<input type="checkbox"/>	<input type="checkbox"/>
	F. Other BMPs (Specify) <u>Construction Entrance</u>	Location <u>N</u>	Page <u>C8001</u>	<input checked="" type="checkbox"/>	<input type="checkbox"/>

Checklist

				Applicant Check <input checked="" type="checkbox"/> If Included	Official Use Only
	G. Other BMPs (Specify)	Location <u>N</u>	Page <u>na</u>	<input type="checkbox"/>	<input type="checkbox"/>
b.	Plan Drawings (<i>Must be labeled "E&S Plan" or "Erosion & Sediment Control Plan", be complete & legible, and be the final plan for construction</i>) Drawings include the following:	Location <u>D</u>	Page <u>See All</u>	<input type="checkbox"/> FORMCH <input type="checkbox"/> ECKBOX	<input type="checkbox"/>
	i. Legend for any symbols that may be used on the drawing	Location <u>D</u>	Page <u>C8001</u>	<input checked="" type="checkbox"/>	<input type="checkbox"/>
	ii. Topographic Features including existing contours, improvements, streams, wetlands, watercourses, etc. and sufficient surrounding area	Location <u>D</u>	Page <u>C8001</u>	<input checked="" type="checkbox"/>	<input type="checkbox"/>
	iii. Soil types and locations	Location <u>D</u>	Page <u>C8001</u>	<input checked="" type="checkbox"/>	<input type="checkbox"/>
	iv. Construction techniques or special considerations to address soil limitations	Location <u>D</u>	Page <u>C8001</u>	<input checked="" type="checkbox"/>	<input type="checkbox"/>
	v. Limits of project area, NPDES boundary	Location <u>D</u>	Page <u>C8001</u>	<input checked="" type="checkbox"/>	<input type="checkbox"/>
	vi. Limits of earth disturbance	Location <u>D</u>	Page <u>C8001</u>	<input checked="" type="checkbox"/>	<input type="checkbox"/>
	vii. Proposed alteration including proposed contours and proposed improvements	Location <u>D</u>	Page <u>C8001</u>	<input checked="" type="checkbox"/>	<input type="checkbox"/>
	viii. Maximum during construction drainage areas to hydraulic BMPs	Location <u>D</u>	Page <u>C8001</u>	<input checked="" type="checkbox"/>	<input type="checkbox"/>
	ix. Location of water which may receive runoff and receiving water classification pursuant to Chapter 93 and the "statewide existing use listing"	Location <u>D</u>	Page <u>C8001</u>	<input checked="" type="checkbox"/>	<input type="checkbox"/>
	x. Standard Construction Details for all proposed E&S Control BMPs used before, during and after earth disturbance	Location <u>D</u>	Page <u>C8501</u>	<input checked="" type="checkbox"/>	<input type="checkbox"/>
	xi. Location of BMPs showing final contours are identified	Location <u>D</u>	Page <u>C8001</u>	<input checked="" type="checkbox"/>	<input type="checkbox"/>
	xii. Complete and site specific sequence of BMP installation and removal including activities planned to limit exposed areas	Location <u>D</u>	Page <u>C8001</u>	<input checked="" type="checkbox"/>	<input type="checkbox"/>
	xiii. Procedures or Note requiring the proper recycling or disposal of waste materials associated with the project site	Location <u>D</u>	Page <u>C8501</u>	<input checked="" type="checkbox"/>	<input type="checkbox"/>
	xiv. Maintenance Program including inspection schedule, sediment cleanout levels, repair parameters and time frames, and directions for sediment removal	Location <u>D</u>	Page <u>C8501</u>	<input checked="" type="checkbox"/>	<input type="checkbox"/>
	xv. Note explaining responsibilities for fill materials including definition of environmental due diligence and clean fill	Location <u>D</u>	Page <u>na</u>	<input type="checkbox"/>	<input type="checkbox"/>

Checklist

			Applicant Check <input checked="" type="checkbox"/> If Included	Official Use Only <input type="checkbox"/>	
3.	Permit filing fee of \$500 payable to the appropriate Clean Water Fund.		<input checked="" type="checkbox"/>	<input type="checkbox"/>	
4.	Notifications to the local municipality and county governments that specify Acts 67 and 68 Coordination, and that the application is for a general NPDES stormwater permit authorizing the discharge of stormwater during construction activities. A "sample" notification letter is provided in Appendices B and C.		<input checked="" type="checkbox"/>	<input type="checkbox"/>	
5.	Proof of receipt of municipal notifications; copies of certified mail receipts or acknowledgment letters from the local municipality and county government. (3 copies)		<input checked="" type="checkbox"/>	<input type="checkbox"/>	
6.	The PNDI Review receipt for the project area. Include impact clearance letters if proof of agency coordination is required. (3 copies)		<input checked="" type="checkbox"/>	<input type="checkbox"/>	
7.	Complete Post Construction Stormwater Management Plan. (3 copies) Location: Drawings (D), Narrative (N).		<input checked="" type="checkbox"/>	<input type="checkbox"/>	
	a. Written Narrative (<i>Must be separate from E&S Plan and labeled "PCSM" or Post-Construction Stormwater Management"</i> and be the final plan for construction) Written Narrative Includes the following:	Location N	Page <u>See All</u>	<input checked="" type="checkbox"/>	<input type="checkbox"/>
	i. Site Description & Analysis	Location N	Page <u>2-4</u>	<input checked="" type="checkbox"/>	<input type="checkbox"/>
	ii. Soil types and descriptions (including hydric soils)	Location N	Page <u>3</u>	<input checked="" type="checkbox"/>	<input type="checkbox"/>
	iii. Pre-development and post-development drainage area runoff calculations for each drainage area	Location N	Page <u>78</u>	<input checked="" type="checkbox"/>	<input type="checkbox"/>
	iv. Routing Analysis to demonstrate peak control for the 1-year through 100-year storm events (<i>Routing should consider the benefits of BMPs</i>)	Location N	Page <u>78</u>	<input checked="" type="checkbox"/>	<input type="checkbox"/>
	v. Calculations for permanent stormwater BMPs (<i>including volume of water treated through BMPs</i>)	Location N	Page <u>95</u>	<input checked="" type="checkbox"/>	<input type="checkbox"/>
	vi. Curve Numbers and/or land use coefficients	Location N	Page <u>79</u>	<input checked="" type="checkbox"/>	<input type="checkbox"/>
	vii. Infiltration/Geotechnical report and soil infiltration test pit results	Location N	Page <u>na</u>	<input type="checkbox"/>	<input type="checkbox"/>

Checklist

				Applicant Check <input checked="" type="checkbox"/> If Included	Official Use Only
b. Additional Worksheets					
Note: Required Worksheets 1 through 5 are attached after Appendix B. Complete the following worksheets as applicable.					
i.	Worksheet 6 – Small Site/Small Impervious Area Exception for peak rate Mitigation Calculations <i>(If worksheet 6 is not applicable, rate control is required)</i>	Location <u>N</u>	Page <u>97A</u>	<input checked="" type="checkbox"/>	<input type="checkbox"/>
ii.	Worksheet 10 – Water Quality Compliance for Nitrate <i>(Required if using CG 1)</i>	Location <u>N</u>	Page <u>97B</u>	<input checked="" type="checkbox"/>	<input type="checkbox"/>
iii.	Worksheet 11 – BMPs for Pollution Prevention <i>(Required if not using CG1 or if applicant is not meeting Nitrate requirements)</i>	Location <u>N</u>	Page <u>97C</u>	<input checked="" type="checkbox"/>	<input type="checkbox"/>
iv.	Worksheet 12 – Water Quality Analysis of Pollutant Loading from all Disturbed Areas <i>(Required if not using CG1 or if applicant is not meeting Nitrate requirements)</i>	Location <u>N</u>	Page <u>97D</u>	<input checked="" type="checkbox"/>	<input type="checkbox"/>
v.	Worksheet 13 – Pollutant Reduction Through BMP Applications <i>(Required if not using CG 1 or if applicant is not meeting Nitrate requirements)</i>	Location <u>N</u>	Page <u>97E</u>	<input checked="" type="checkbox"/>	<input type="checkbox"/>
c. Plans/Drawings <i>(Must be a stand alone separate plan from the E&S Plan and labeled "PCSM" or Post-Construction Stormwater Management" and be the final plan for construction)</i>		Location <u>D</u>	Page <u>C9001</u>	<input checked="" type="checkbox"/>	<input type="checkbox"/>
i.	Construction Details for permanent stormwater BMPs including permanent stabilization	Location <u>D</u>	Page <u>C9001</u>	<input checked="" type="checkbox"/>	<input type="checkbox"/>
ii.	Location of BMPs showing final contours are identified	Location <u>D</u>	Page <u>C9001</u>	<input checked="" type="checkbox"/>	<input type="checkbox"/>
iii.	Location of soil types are identified (including hydric soils)	Location <u>D</u>	Page <u>C9001</u>	<input checked="" type="checkbox"/>	<input type="checkbox"/>
iv.	Location and depths of test pits / infiltration testing sites are identified	Location <u>D</u>	Page <u>na</u>	<input type="checkbox"/>	<input type="checkbox"/>
d. Ownership, Operations, and Maintenance Procedures <i>(Must be included on drawings)</i>		Location <u>D</u>	Page <u>C9001</u>	<input checked="" type="checkbox"/>	<input type="checkbox"/>
i.	Applicant or entity (association, company, agency, etc.) listed as responsible party	Location <u>D</u>	Page <u>C9001</u>	<input checked="" type="checkbox"/>	<input type="checkbox"/>

Checklist

8.	Consistency letter from Municipal or County Engineer (where applicable)		<input checked="" type="checkbox"/>	<input type="checkbox"/>
9.	Appendix A Land Use Questions		<input checked="" type="checkbox"/>	<input type="checkbox"/>
10.	Complete Required Worksheets 1 – 5 (see worksheets at the end of the NPDES Individual Permit Application Checklist)		<input checked="" type="checkbox"/>	<input type="checkbox"/>
11.	Checklist for Subsequent Phases (of permitted projects)			
	a	Estimated time frame for phased project build-out (update as necessary)	<input checked="" type="checkbox"/>	<input type="checkbox"/>
	b	Complete E & S Plans for specific phase (3 copies)	<input checked="" type="checkbox"/>	<input type="checkbox"/>
	c	New Section C and complete PCSM Plan for specific phase (3 copies)	<input checked="" type="checkbox"/>	<input type="checkbox"/>
	d	Consistency letter from municipal or county engineer (where applicable)	<input checked="" type="checkbox"/>	<input type="checkbox"/>
	CHECKLIST FOR GENERAL NPDES PERMIT <u>RENEWALS</u> ONLY			Applicant Check <input checked="" type="checkbox"/> If Included
				Official Use Only
1.	Administratively complete, signed, and notarized Notice of Intent Form, including items 1-7. (1 signed original and 2 copies of the NOI/application)		<input type="checkbox"/>	<input type="checkbox"/>

Worksheet 1. General Site Information

INSTRUCTIONS: Fill out Worksheet 1 for each watershed

Date: ~~7-21-10~~ 2-17-11

Project Name: Naval Yard Photovoltaic Site

Municipality: Philadelphia

County: Philadelphia

Total Area (acres): ~~13.72~~ 8.05

Major River Basin: Delaware

<http://www.dep.state.pa.us/river/Maps/PAbasins.htm>

Watershed: Delaware

Sub-Basin: Schuylkill

Nearest Surface Water(s) to Receive Runoff: Schuylkill

Chapter 93 – Designated Water Use: WWF, MF

<http://www.pacode.com/secure/data/025/chapter93/chap93toc.html>

Impaired according to Chapter 303(d) List? Yes No

<http://www.depweb.state.pa.us/watersupply/cwp/view.asp?a=1261&q=480056>

List Causes of Impairment:

Is there an established TMDL that applies: Yes No

Total Maximum Daily Loads (TMDLS)

http://www.dep.state.pa.us/watermanagement_apps/tmdl/

http://www.epa.gov/reg3wapd/tmdl/pa_tmdl/index.htm

Is project subject to, or part of:

Municipal Separate Storm Sewer System (MS4) Requirements? Yes No

<http://www.depweb.state.pa.us/watershedmgmt/cwp/view.asp?a=1437&q=519543&watershedmgmtNav=>

Existing or planned drinking water supply? Yes No

If yes, distance from proposed discharge (miles):

Approved Act 167 Plan? Yes No

<http://www.depweb.state.pa.us/watershedmgmt/cwp/view.asp?a=1437&q=519879>

Existing River Conservation Plan? Yes No

<http://www.dcnr.state.pa.us/brc/rivers/riversconservation/registry/>

Worksheet 2. Sensitive Natural Resources

INSTRUCTIONS

1. Provide Sensitive Resources Map according to non-structural BMP 5.4.1 in Chapter 5. This map should identify wetlands, woodlands, natural drainage ways, steep slopes, and other sensitive natural areas.

2. Summarize the existing extent of each sensitive resource in the Existing Sensitive Resources Table (below, using Acres). If none present, insert 0.

3. Summarize Total Protected Area as defined under BMPs in Chapter 5.

4. Do not count any area twice. For example, an area that is both a floodplain and a wetland may only be considered once.

EXISTING NATURAL SENSITIVE RESOURCE	MAPPED? Yes/no/n/a	TOTAL AREA (Ac.)	PROTECTED AREA (Ac.)
Waterbodies	na		
Floodplains	na		
Riparian Areas	na		
Wetlands	na		
Woodlands	na		
Natural Drainage Ways	na		
Steep Slopes, 15% - 25%	na		
Steep Slopes, over 25%	na		
Other:			
Other:			
TOTAL EXISTING:			

Worksheet 3. Nonstructural BMP Credits

PROTECTED AREA

1.1 Area of Protected Sensitive/Special Value Features (see WS 2)	0.00 Ac.
1.2 Area of Riparian Forest Buffer Protection	0.00 Ac.
3.1 Area of Minimum Disturbance/Reduced Grading	0.00 Ac
TOTAL	0.00 Ac

Site Area	Minus	Protected Area	=	Stormwater Management Area
13.72 8.05	-	0.00	=	13.72 8.05
This is the area that requires stormwater management				

VOLUME CREDITS

3.1 Minimum Soil Compaction (See Chapter 8, page 22 – SW BMP Manual)

Lawn _____ ft² x 1/4" x 1/12 = _____ ft³

Meadow _____ ft² x 1/3" x 1/12 = _____ ft³

3.3 Protect Existing Trees (See Chapter 8, page 23 – SW BMP Manual)

For Trees within 100 feet of impervious area:

Tree Canopy _____ ft² x 1/2" x 1/12 = _____ ft³

5.1 Disconnect Roof Leaders to Vegetated Areas (See Chapter 8 page 25 – SW BMP Manual)

For runoff directed to areas protected under 5.8.1 and 5.8.2

Roof Area _____ ft² x 1/3" x 1/12 = _____ ft³

For all other disconnected roof areas

Roof Area _____ ft² x 1/4" x 1/12 = _____ ft³

5.2 Disconnect Non-Roof impervious to Vegetated Areas (See Chapter 8, page 26 – SW BMP Manual)

For Runoff directed to areas protected under 5.8.1 and 5.8.2

Impervious Area _____ ft² x 1/3" x 1/12 = _____ ft³

For all other disconnected roof areas

Impervious Area 12,712 ft² x 1/4" x 1/12 = 265 ft³

TOTAL NON-STRUCTURAL VOLUME CREDIT* 265 ft

**For use on Worksheet 5*

Worksheet 4. Change in Runoff Volume for 2-YR Storm Event

PROJECT: Naval Yard Photovoltaic Site
 Drainage Area: 8.05
 2-Year Rainfall: 3.20 in

Total Site Area: 8.05 acres
 Protected Site Area: 8.05 acres
 Managed Area: 8.05 acres

All changed From previous.

Existing Conditions:

Cover Type/Condition	Soil Type	Area (sf)	Area (ac)	CN	S	la (0.2*S)	Q Runoff ¹ (in)	Runoff Volume ² (ft ³)
Woodland								
Meadow	Ub	294,646	6.76	58	7.24	1.45	0.34	8,364
Impervious	Ub	55,840	1.28	98	0.20	0.04	2.97	13,829
TOTAL:		350,486	8.05					22,193

**20% OF EXISTING IMPERVIOUS AREA IS CALCULATED AS MEADOW.*

Developed Conditions

Cover Type/Condition	Soil Type	Area (sf)	Area (ac)	CN	S	la (0.2*S)	Q Runoff ¹ (in)	Runoff Volume ² (ft ³)
Grass	Ub	293,234	6.73	61	6.39	1.28	0.44	10,840
Impervious	Ub	57,252	1.31	98	0.20	0.04	2.97	14,179
TOTAL:		350,486	8.05					25,019

2-Year Volume Increase (ft³):

2-Year Volume Increase = Developed Conditions Runoff Volume – Existing Conditions Runoff Volume

- Runoff (in) = $Q = (P - 0.2S)^2 / (P + 0.8S)$ where
 P = 2-Year Rainfall (in)
 S = $(1000 / CN) - 10$
- Runoff Volume (CF) = $Q \times \text{Area} \times 1/12$
 Q = Runoff (in)
 Area = Land use area (sq. ft)

Note: Runoff Volume must be calculated for EACH land use type/condition and HSGI. The use of a weighted CN value for volume calculations is not acceptable.

Worksheet 5. Structural BMP Volume Credits

PROJECT: NAVAL YARD PHOTOVOLTAIC SITE
SUB-BASIN: NPDES BOUNDARY

Required Control Volume (ft³) – from Worksheet 4: 0.00
Non-structural Volume Credit (ft³) – from Worksheet 3: 0.00
 (maximum is 25% of required volume)
Structural Volume Reqmt (ft³) 0.00
(Required Control Volume minus Non-structural Credit)

	Proposed BMP	Area (ft ²)	Volume Reduction Permanently Removed (ft ³)
6.4.1	Porous Pavement		
6.4.2	Infiltration Basin		
6.4.3	Infiltration Bed		
6.4.4	Infiltration Trench		
6.4.5	Rain Garden/Bioretention		
6.4.6	Dry Well / Seepage Pit		
6.4.7	Constructed Filter		
6.4.8	Vegetated Swale		
6.4.9	Vegetated Filter Strip		
6.4.10	Berm		
6.5.1	Vegetated Roof		
6.5.2	Capture and Re-use		
6.6.1	Constructed Wetlands		
6.6.2	Wet Pond / Retention Basin		
6.7.1	Riparian Buffer Restoration		
6.7.2	Landscape Restoration / Reforestation		
6.7.3	Soil Amendment		
6.8.1	Level Spreader		
6.8.2	Special Storage Areas		
	Other		

Total Structural Volume (ft³): 0.00
Structural Volume Requirement (ft³): 0.00
DIFFERENCE 0.00

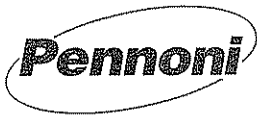

PENNONI ASSOCIATES INC.
CONSULTING ENGINEERS

EPUR 0801

June 23, 2010

VIA UPS

Bureau of Land Management
Pennsylvania Game Commission
Division of Environmental Planning and Habitat Protection
2001 Elmerton Avenue
Harrisburg, PA, 17110-9797
Fax Number: (717) 787-6957

**Re: PNDI Search (20100610247874)
Conergy Photovoltaic Site at the Navy Yard, Philadelphia
North 26th Street
Philadelphia, PA 19112**

To Whom It May Concern:

We are writing on behalf of the developer, Conergy, for review and comment on the enclosed PNDI search. Three (3) potential impacts have been found notifying us to send the entire PNDI Search Review Receipt.

The project is located at The Philadelphia Naval Yard on South 26th Street within the City of Philadelphia, Philadelphia County. As part of the land transfer of the Philadelphia Navy Yard to Philadelphia Authority for Industrial Development (PAID) the Navy capped the existing landfill. The site is currently not in use; however the developer proposes to construct a photovoltaic site with associated site improvements on the pervious cap. Conergy leases the 19.23 acre project site within the 1,200 acre Navy Yard. This leased area is included in the 29.0 acre project area used for the PNDI search. The site is bounded by the Reserve Basin to the south, the Tastybaking Facility to the north, the Schuylkill River to the west and 26th Street to the east.

This new development is to produce renewable solar energy on portions of the permeable cap from the Girard Point Management Area with the installation of photovoltaic arrays. A graded material will be placed above the existing surface at areas of the photovoltaics and appurtenances. The material will assist with leveling the foundations and photovoltaic arrays to desired elevations. The arrays will be connected to sheltered electric inverters with non penetrating concrete foundations. Utility (electric) connections will be run on the existing surface and concrete encased. A new fence will be installed to secure the facility and be installed on a precast concrete "Jersey" barrier. All work is to be done beyond the top of the existing Schuylkill River/Reserve Basin Banks.

Due to the nature of the project, the installation of a renewable energy source and the lack of overall development, it is our belief that project will not cause any adverse impacts to the three (3) potential impact species. We are therefore requesting a letter from your agency clearing the site of any potential impacts.

We have enclosed; a USGS quadrangle map depicting the project site, a Preliminary Site Plan Exhibit, Sheet C1001 and a photo of an example array installation. Please do not hesitate to contact me if you have any questions or require additional information.

Very truly yours,

PENNONI ASSOCIATES INC.



Patrick M. Foley, P.E.
Project Engineer

cc: Andy Welsh., Conergy
Mark Seltzer, PAID

Enclosures

1. PROJECT INFORMATION

Project Name: **James Inabinet**

Date of review: **6/10/2010 1:39:24 PM**

Project Category: **Development, New commercial/industrial development (store, gas station, factory)**

Project Area: **29.0 acres**

County: **Philadelphia Township/Municipality: Philadelphia**

Quadrangle Name: **PHILADELPHIA ~ ZIP Code: 19145, 19112**

Decimal Degrees: **39.894559 N, -75.194292 W**

Degrees Minutes Seconds: **39° 53' 40.4" N, -75° 11' 39.5" W**

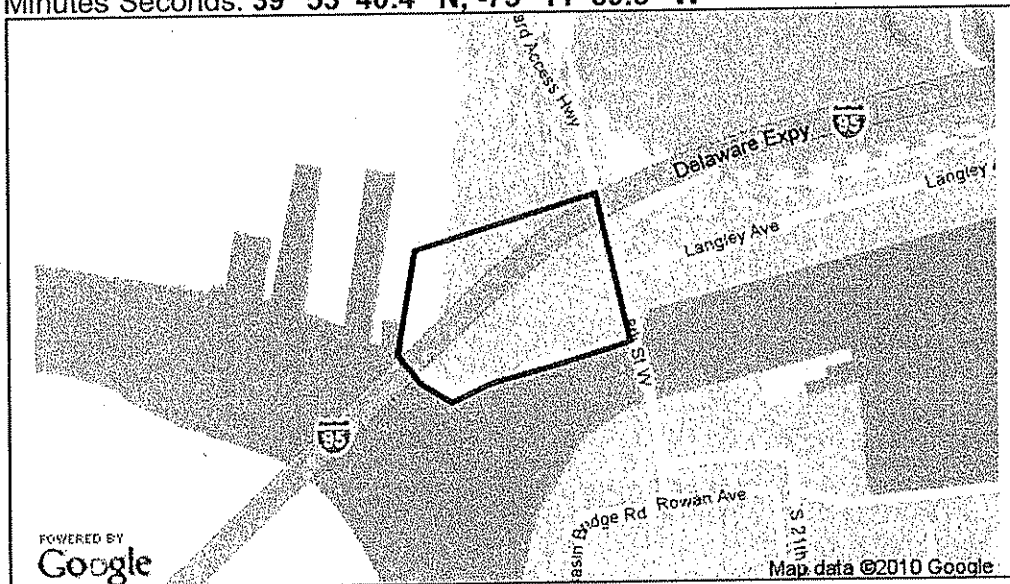

2. SEARCH RESULTS

Agency	Results	Response
PA Game Commission	Potential Impact	FURTHER REVIEW IS REQUIRED, See Agency Response
PA Department of Conservation and Natural Resources	Potential Impact	FURTHER REVIEW IS REQUIRED, See Agency Response
PA Fish and Boat Commission	Potential Impact	FURTHER REVIEW IS REQUIRED, See Agency Response
U.S. Fish and Wildlife Service	No Known Impact	No Further Review Required

As summarized above, Pennsylvania Natural Diversity Inventory (PNDI) records indicate there may be potential impacts to threatened and endangered and/or special concern species and resources within the project area. If the response above indicates "No Further Review Required" no additional communication with the respective agency is required. If the response is "Further Review Required" or "See Agency Response," refer to the appropriate agency comments below. Please see the DEP Information Section of this receipt if a PA Department of Environmental Protection Permit is required.

RESPONSE TO QUESTION(S) ASKED

Q1: Accurately describe what is known about wetland presence in the project area or on the land parcel. "Project" includes all features of the project (including buildings, roads, utility lines, outfall and intake structures, wells, stormwater retention/detention basins, parking lots, driveways, lawns, etc.), as well as all associated impacts (e.g., temporary staging areas, work areas, temporary road crossings, areas subject to grading or clearing, etc.). Include all areas that will be permanently or temporarily affected -- either directly or indirectly -- by any type of disturbance (e.g., land clearing, grading, tree removal, flooding, etc.). Land parcel = the lot(s) on which some type of project(s) or activity(s) are proposed to occur .

Your answer is: **2. The project area (or land parcel) has not been investigated by someone qualified to identify and delineate wetlands, or it is currently unknown if the project or project activities will affect wetlands.**

Q2: Aquatic habitat (stream, river, lake, pond, etc.) is located on or adjacent to the subject property and project activities (including discharge) may occur within 300 feet of these habitats

Your answer is: **1. Yes**

3. AGENCY COMMENTS

Regardless of whether a DEP permit is necessary for this proposed project, any potential impacts to threatened and endangered species and/or special concern species and resources must be resolved with the appropriate jurisdictional agency. In some cases, a permit or authorization from the jurisdictional agency may be needed if adverse impacts to these species and habitats cannot be avoided.

These agency determinations and responses are **valid for one year** (from the date of the review), and are based on the project information that was provided, including the exact project location; the project type, description, and features; and any responses to questions that were generated during this search. If any of the following change: 1) project location, 2) project size or configuration, 3) project type, or 4) responses to the questions that were asked during the online review, the results of this review are not valid, and the review must be searched again via the PNDI Environmental Review Tool and resubmitted to the jurisdictional agencies. The PNDI tool is a primary screening tool, and a desktop review may reveal more or fewer impacts than what is listed on this PNDI receipt.

PA Game Commission

PGC Species:

Scientific Name: Casmerodius albus

Common Name: Great Egret

Current Status: Endangered

Proposed Status: Endangered

Scientific Name: Falco peregrinus

Common Name: Peregrine Falcon

Current Status: Endangered

Proposed Status: Endangered

Scientific Name: Pandion haliaetus

Common Name: Osprey

Current Status: Threatened

Proposed Status: Threatened

RESPONSE: Further review of this project is necessary to resolve the potential impacts(s). Please send project information to this agency for review (see WHAT TO SEND).

PA Department of Conservation and Natural Resources

DCNR Species:

Scientific Name: Echinochloa walteri

Common Name: Walter's Barnyard-grass

Current Status: Endangered

Proposed Status: Endangered

RESPONSE: Further review of this project is necessary to resolve the potential impacts(s). Please send project information to this agency for review (see WHAT TO SEND).

PA Fish and Boat Commission

PFBC Species:

Scientific Name: Sensitive Species**

Common Name:

Current Status: Threatened

Proposed Status: Special Concern Species*

RESPONSE: Further review of this project is necessary to resolve the potential impacts(s). Please send project information to this agency for review (see WHAT TO SEND).

U.S. Fish and Wildlife Service

RESPONSE: No impacts to federally listed or proposed species are anticipated. Therefore, no further consultation/coordination under the Endangered Species Act (87 Stat. 884, as amended; 16 U.S.C. 1531 *et seq.*) is required. Because no take of federally listed species is anticipated, none is authorized. This response does not reflect potential Fish and Wildlife Service concerns under the Fish and Wildlife Coordination Act or other authorities.

* Special Concern Species or Resource - Plant or animal species classified as rare, tentatively undetermined or candidate as well as other taxa of conservation concern, significant natural communities, special concern populations (plants or animals) and unique geologic features.

** Sensitive Species - Species identified by the jurisdictional agency as collectible, having economic value, or being susceptible to decline as a result of visitation.

WHAT TO SEND TO JURISDICTIONAL AGENCIES

If project information was requested by one or more of the agencies above, send the following information to the agency(s) seeking this information (see AGENCY CONTACT INFORMATION).

Check-list of Minimum Materials to be submitted:

- SIGNED** copy of this Project Environmental Review Receipt
- Project narrative with a description of the overall project, the work to be performed, current physical characteristics of the site and acreage to be impacted.
- Project location information (name of USGS Quadrangle, Township/Municipality, and County)
- USGS 7.5-minute Quadrangle with project boundary clearly indicated, and quad name on the map

The inclusion of the following information may expedite the review process.

- A **basic** site plan (particularly showing the relationship of the project to the physical features such as wetlands, streams, ponds, rock outcrops, etc.)
- Color photos keyed to the basic site plan (i.e. showing on the site plan where and in what direction each photo was taken and the date of the photos)
- N/A** Information about the presence and location of wetlands in the project area, and how this was determined (e.g., by a qualified wetlands biologist), if wetlands are present in the project area, provide project plans showing the location of all project features, as well as wetlands and streams
- N/A** The DEP permit(s) required for this project

4. DEP INFORMATION

The Pa Department of Environmental Protection (DEP) requires that a signed copy of this receipt, along with any required documentation from jurisdictional agencies concerning resolution of potential impacts, be submitted with applications for permits requiring PNDI review. For cases where a "Potential Impact" to threatened and endangered species has been identified before the application has been submitted to DEP, the application should not be submitted until the impact has been resolved. For cases where "Potential Impact" to special concern species and resources has been identified before the application has been submitted, the application should be submitted to DEP along with the PNDI receipt, a completed PNDI form and a USGS 7.5 minute quadrangle map with the project boundaries delineated on the map. The PNDI Receipt should also be submitted to the appropriate agency according to directions on the PNDI Receipt. DEP and the jurisdictional agency will work together to resolve the potential impact(s). See the DEP PNDI policy at <http://www.naturalheritage.state.pa.us>.

5. ADDITIONAL INFORMATION

The PNDI environmental review website is a **preliminary** screening tool. There are often delays in updating species status classifications. Because the proposed status represents the best available information regarding the conservation status of the species, state jurisdictional agency staff give the proposed statuses at least the same consideration as the current legal status. If surveys or further information reveal that a threatened and endangered and/or special concern species and resources exist in your project area, contact the appropriate jurisdictional agency/agencies immediately to identify and resolve any impacts.

For a list of species known to occur in the county where your project is located, please see the species lists by county found on the PA Natural Heritage Program (PNHP) home page (www.naturalheritage.state.pa.us). Also note that the PNDI Environmental Review Tool only contains information about species occurrences that have actually been reported to the PNHP.

6. AGENCY CONTACT INFORMATION

PA Department of Conservation and Natural Resources

Bureau of Forestry, Ecological Services Section
400 Market Street, PO Box 8552, Harrisburg, PA.
17105-8552
Fax:(717) 772-0271

U.S. Fish and Wildlife Service

Endangered Species Section
315 South Allen Street, Suite 322, State College, PA.
16801-4851
NO Faxes Please.

PA Fish and Boat Commission

Division of Environmental Services
450 Robinson Lane, Bellefonte, PA. 16823-7437
NO Faxes Please

PA Game Commission

Bureau of Wildlife Habitat Management
Division of Environmental Planning and Habitat Protection
2001 Elmerton Avenue, Harrisburg, PA. 17110-9797
Fax:(717) 787-6957

7. PROJECT CONTACT INFORMATION

Name: JAMES INABINET
Company/Business Name: PENNONI ASSOCIATES INC.
Address: 3001 MARKET STREET, SUITE 200
City, State, Zip: PHILADELPHIA, PA 19104
Phone: (215) 222-3000 EXT. 3503 Fax: (215) 222-0598
Email: JINABINET@PENNONI.COM

8. CERTIFICATION

I certify that ALL of the project information contained in this receipt (including project location, project size/configuration, project type, answers to questions) is true, accurate and complete. In addition, if the project type, location, size or configuration changes, or if the answers to any questions that were asked during this online review change, I agree to re-do the online environmental review.

James K. Inabnet

applicant/project proponent signature

06-19-10

date

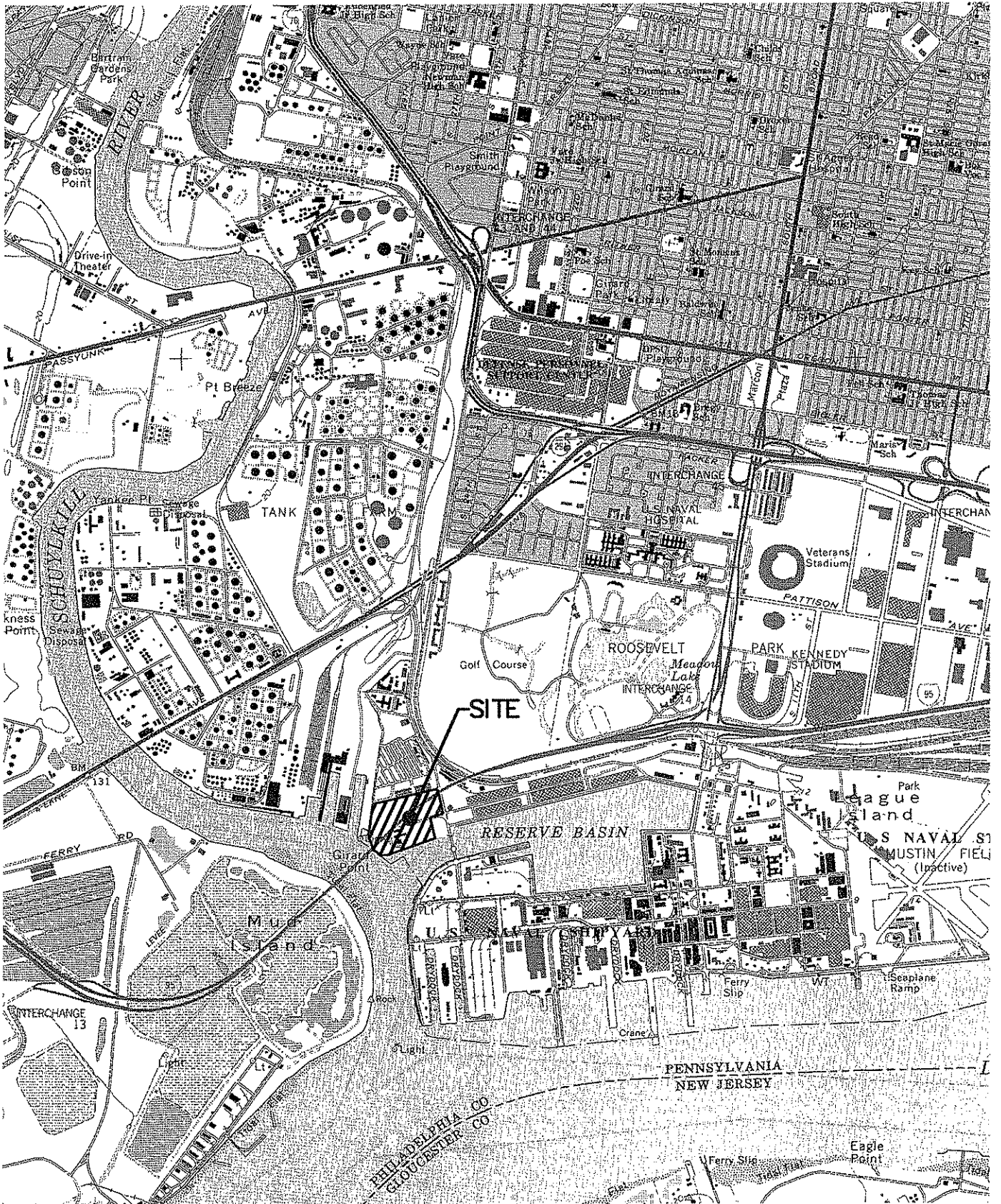

Pennoni

Pennoni Associates Inc.
3001 Market Street, Suite 200
Philadelphia, PA 19104

ALL DOCUMENTS PREPARED BY PENNONI ASSOCIATES ARE INSTRUMENTS OF SERVICE IN RESPECT OF THE PROJECT. THEY ARE NOT INTENDED OR REPRESENTED TO BE SUITABLE FOR REUSE BY OWNER OR OTHERS ON EXTENSIONS OF THE PROJECT OR ON ANY OTHER PROJECT. ANY REUSE WITHOUT WRITTEN VERIFICATION OR ADAPTATION BY PENNONI ASSOCIATES FOR THE SPECIFIC PURPOSE INTENDED WILL BE AT OWNERS SOLE RISK AND WITHOUT LIABILITY OR LEGAL EXPOSURE TO PENNONI ASSOCIATES; AND OWNER SHALL INDEMNIFY AND HOLD HARMLESS PENNONI ASSOCIATES FROM ALL CLAIMS, DAMAGES, LOSSES AND EXPENSES ARISING OUT OF OR RESULTING THEREFROM.

DRAWN BY:
SRA

CHECKED BY:

JOB No.
EPUR 0802

SCALE:
1"=2500'

SKETCH No.

DATE:
06/23/10

LOC-MAP

LOCATION MAP - PHILADELPHIA QUADRANGLE

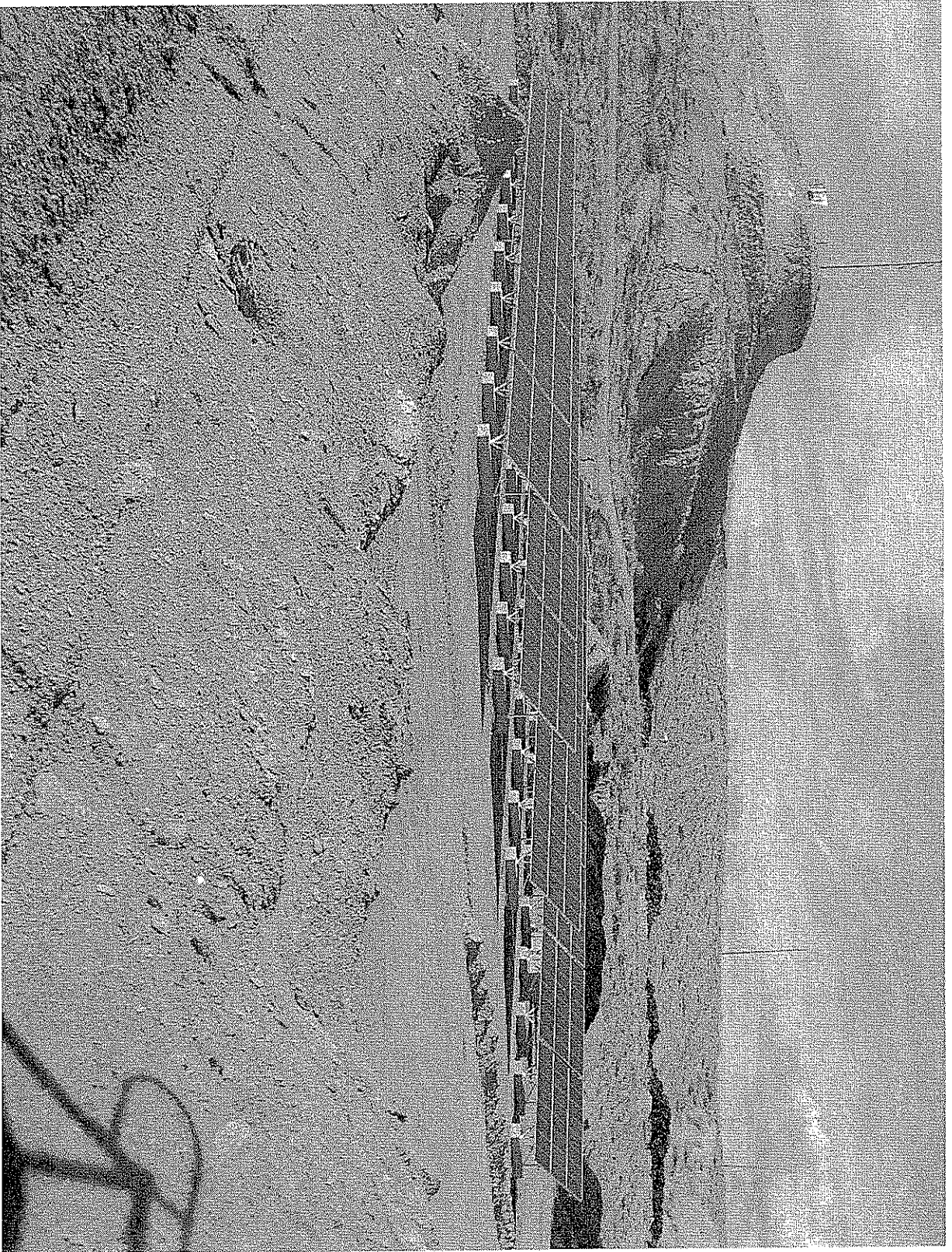

EXAMPLE PHOTOVOLTAIC ARRAY
NOR PROJECT SITE

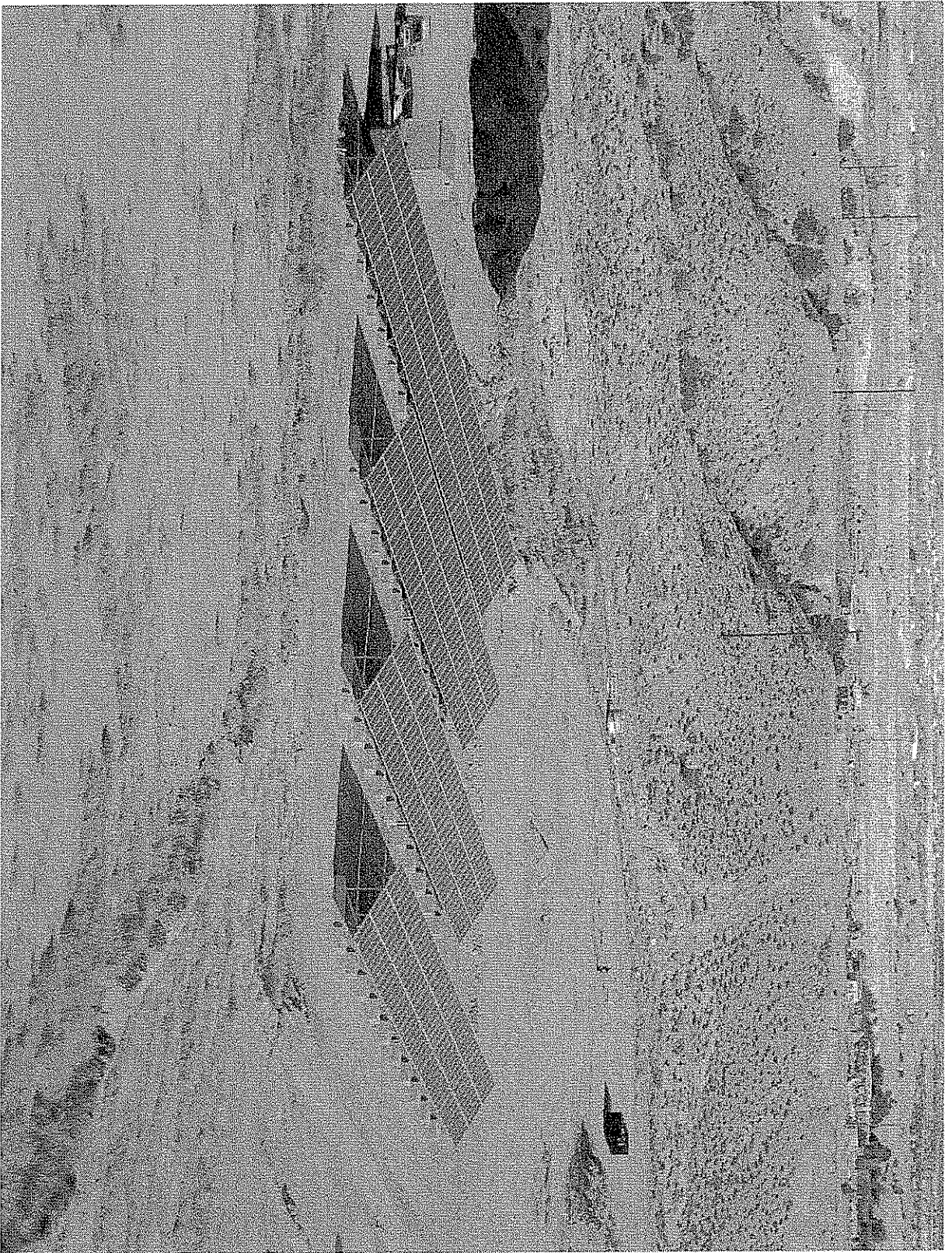

EXAMPLE PHOTOVOLTAIC ARRAY
NOT PROJECT SITE

Appendix 8

**pennsylvania**DEPARTMENT OF CONSERVATION
AND NATURAL RESOURCES

BUREAU OF FORESTRY

July 14, 2010

PNDI Number: 20100610247874**Patrick M. Foley****Pennoni**

One Drexel Plaza

3001 Market Street, 2nd Floor

Philadelphia, PA 19104

Fax: 215-222-0384 (hard copy will not follow)

Re: Conergy Photovoltaic Site at the Navy Yard
Philadelphia, Philadelphia County

Dear Mr. Foley,

Thank you for your submission of the Pennsylvania Natural Diversity Inventory (PNDI) Environmental Review Receipt Number **20100610247874** for review. PA Department of Conservation and Natural Resources screened this project for potential impacts to species and resources of concern under DCNR's responsibility, which includes plants, terrestrial invertebrates, natural communities, and geologic features only.

No Impact Anticipated

PNDI records indicate species or resources of concern are located in the vicinity of the project. However, based on the information you submitted concerning the nature of the project, the immediate location, and our detailed resource information, DCNR has determined that no impact is likely. No further coordination with our agency is needed for this project.

This response represents the most up-to-date summary of the PNDI data files and is valid for one (1) year from the date of this letter. An absence of recorded information does not necessarily imply actual conditions on-site. Should project plans change or additional information on listed or proposed species become available, this determination may be reconsidered. Should the proposed work continue beyond the period covered by this letter, please resubmit the project to this agency as an "Update" (including an updated PNDI receipt, project narrative and accurate map).

This finding applies to impacts to DCNR only. To complete your review of state and federally-listed threatened and endangered species and species of special concern, please be sure the U.S. Fish and Wildlife Service, PA Game Commission, and the Pennsylvania Fish and Boat Commission have been contacted regarding this project as directed by the online PNDI ER Tool found at www.naturalheritage.state.pa.us.

Sincerely,

Rebecca H. Bowen, Environmental Review Manager FOR Chris Firestone, Wild Plant Program Mgr.
Ph: 717-772-0258 ~ c-rbowen@state.pa.us

conserve**sustain****enjoy**

P.O. Box 8552, Harrisburg, PA 17015-8552 717-787-3444 (fax) 717-772-0271

TOTAL P.01



established 1866

Pennsylvania Fish & Boat Commission

Division of Environmental Services
Natural Diversity Section
450 Robinson Lane
Bellefonte, PA 16823-9620
(814) 359-5237 Fax: (814) 359-5175

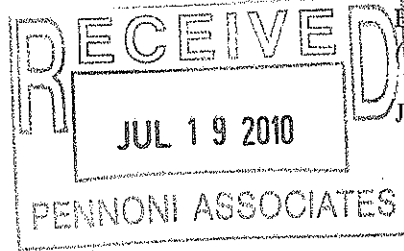

July 15, 2010

IN REPLY REFER TO
SIR # 34517

PATRICK FOLEY
PENNONI
One Drexel Plaza
3001 MARKET ST, 2ND FLOOR
PHILADELPHIA, PA 19104

RE: Species Impact Review (SIR) - Rare, Candidate, Threatened and Endangered Species
CONERGY PHOTOVOLTAIC FACILITY
PNDI Search Number (if available): 20100610247874
City of PHILADELPHIA, PHILADELPHIA County, Pennsylvania

This responds to your inquiry about a Pennsylvania Natural Diversity Inventory (PNDI) Internet Database search "potential conflict" or a threatened and endangered species impact review. These projects are screened for potential conflicts with rare, candidate, threatened or endangered species under Pennsylvania Fish & Boat Commission jurisdiction (fish, reptiles, amphibians, aquatic invertebrates only) using the Pennsylvania Natural Diversity Inventory (PNDI) database and our own files. These species of special concern are listed under the Endangered Species Act of 1973, the Wild Resource Conservation Act, and the Pennsylvania Fish & Boat Code (Chapter 75), or the Wildlife Code. The absence of recorded information from our files does not necessarily imply actual conditions on site. Future field investigations could alter this determination. The information contained in our files is routinely updated. A Species Impact Review is valid for one year only.

X **NO ADVERSE IMPACTS EXPECTED FROM THE PROPOSED PROJECT**

____ Except for occasional transient species, rare, candidate, threatened or endangered species under our jurisdiction are not known to exist in the vicinity of the project area. Therefore, no biological assessment or further consultation regarding rare species is needed with the Commission. Should project plans change, or if additional information on listed or proposed species becomes available, this determination may be reconsidered.

X An element occurrence of a rare, candidate, threatened, or endangered species under our jurisdiction is known from the vicinity of the proposed project. However, given the nature of the proposed project, the immediate location, or the current status of the nearby element occurrence(s), no adverse impacts are expected to the species of special concern.

If you have any questions regarding this review, please contact the biologist indicated below:

____	Chris Urban	814-359-5113	<u>X</u>	Kathy Gipe	814-359-5186
____	Nevin Welte	814-359-5234	____	Bob Morgan	814-359-5129

Thank you in advance for your cooperation and attention to this important matter of species conservation and habitat protection.

SIGNATURE: Christopher A. Urban DATE: July 15, 2010
Christopher A. Urban
Chief, Natural Diversity Section

Our Mission:

www.fish.state.pa.us

To protect, conserve and enhance the Commonwealth's aquatic resources and provide fishing and boating opportunities.



COMMONWEALTH OF PENNSYLVANIA
PENNSYLVANIA GAME COMMISSION

2001 ELMERTON AVENUE, HARRISBURG, PA 17110

"TO MANAGE ALL WILD BIRDS, MAMMALS AND THEIR HABITATS
FOR CURRENT AND FUTURE GENERATIONS."

August 18, 2010

PNDI Number: 20100610247874

James Inabinet
Pennoni Associates Inc.
3001 Market Street Suite 200
Philadelphia, PA 19104

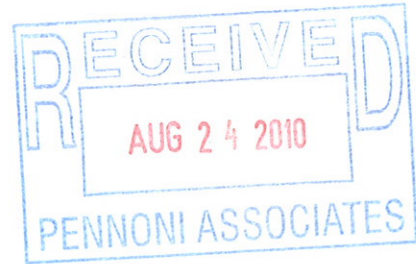

PNDI Number: 20100610247874
Re: Conergy Photovoltaic Site at the Navy Yard
City of Philadelphia, Philadelphia County, PA

Dear Mr. Inabinet,

Thank you for submitting the Pennsylvania Natural Diversity Inventory (PNDI) Environmental Review Receipt Number 20100610247874 for review. The Pennsylvania Game Commission (PGC) screened this project for potential impacts to species and resources of concern under PGC responsibility, which includes birds and mammals only.

Potential Impact Anticipated

PNDI records indicate species or resources of concern are located in the vicinity of the project. The PGC has received and thoroughly reviewed the information that you provided to this office as well as PNDI data, and has determined that potential impacts to threatened, endangered, and species of special concern birds and mammals may be associated with your project. Therefore, additional measures are necessary to avoid potential impacts to the species listed below.

Scientific Name	Common Name	PA Status
<i>Falco peregrinus</i>	Peregrine Falcon	ENDANGERED

Next Steps

The following Conservation Measure should be performed to minimize impacts to nesting peregrine falcons located on the Girard Point Bridge:

- *No construction/installation activities associated with the above reference project should occur within 1000 feet of the peregrine falcon nest located on the Girard Point Bridge during nesting season, March 1 – June 30.*

This response represents the most up-to-date summary of the PNDI data files and is valid for one (1) year from the date of this letter. An absence of recorded information does not necessarily imply actual conditions on site. Should project plans change or additional information on listed or proposed species become available, this determination may be reconsidered.

Should the proposed work continue beyond the period covered by this letter, please resubmit the project to this agency as an "Update" (including an updated PNDI receipt, project narrative and accurate map). If the proposed work has not changed and no additional information concerning listed species is found, the project will be cleared for PNDI requirements under this agency for an additional year.

This finding applies to impacts to birds and mammals only. To complete your review of state and federally-listed threatened and endangered species and species of special concern, please be sure that the U.S. Fish and Wildlife Service, the PA Department of Conservation and Natural Resources, and/or the PA Fish and Boat Commission have been contacted regarding this project as directed by the online PNDI ER Tool found at www.naturalheritage.state.pa.us.

Sincerely,



Tracey Librandi Mumma
Division of Environmental Planning & Habitat Protection
Bureau of Wildlife Habitat Management
Phone: 717-787-4250, Extension 3614
Fax: 717-787-6957
E-mail: tlibrandi@state.pa.us

A PNHP Partner



Pennsylvania Natural Heritage Program

TLM/tlm

cc: DuBrock
Brauning
McMorris



Division of Environmental
Planning and Habitat
Protection
717-783-5957

COMMONWEALTH OF PENNSYLVANIA
Pennsylvania Game Commission

2001 ELMERTON AVENUE
HARRISBURG, PA 17110-9797

*"To manage all wild birds, mammals and their habitats
for current and future generations."*

ADMINISTRATIVE BUREAUS:

ADMINISTRATION.....717-787-5670
HUMAN RESOURCES.....717-787-7836
FISCAL MANAGEMENT.....717-787-7314
CONTRACTS AND
PROCUREMENT.....717-787-6594
LICENSING.....717-787-2084
OFFICE SERVICES.....717-787-2116
WILDLIFE MANAGEMENT.....717-787-5529
INFORMATION & EDUCATION.....717-787-6286
WILDLIFE PROTECTION.....717-783-6526
WILDLIFE HABITAT
MANAGEMENT.....717-787-6818
REAL ESTATE DIVISION.....717-787-6568
AUTOMATED TECHNOLOGY
SERVICES.....717-787-4076

www.pgc.state.pa.us

August 10, 2011

Mr. Cliff Whyte
U.S. Department of Energy
National Energy Technology Laboratory
P.O. Box 880
Morgantown, West Virginia 26507-0880

Re: Draft Environmental Assessment for the Conergy Navy Yard Solar Project
Philadelphia, Pennsylvania
DOE/EA-1876D

Dear Mr. Whyte,

Thank you for the opportunity to review the Draft Environmental Assessment for the Conergy Navy Yard Solar Project located in Philadelphia, Pennsylvania (DOE/EA-1876D). The Pennsylvania Game Commission (PGC) has screened this project for potential impacts to species and resources of concern under PGC responsibility, which includes birds and mammals only.

In the PGC's August 18, 2010 letter, potential impacts to the state listed endangered peregrine falcon (*Falco peregrinus*) were identified. At that time, the PGC requested that no activities associated with this project occur within 1,000 feet of the nest during the nesting season, March 1 through June 30. However, since that time additional information regarding peregrine falcons has become available. Therefore, in effort to better protect peregrine falcons and to ensure that adverse impacts to all facets the nesting season are avoided, the nesting season has been determined to be February 15 through July 31.

Please be aware that the PGC's most recent review of this project was completed on August 10, 2011. This response letter identified potential impacts to nesting peregrine falcons and requests that no activities associated with this project shall occur within 1,000 feet of nesting peregrine falcons during the nesting season, February 15 through July 31 (attached).

The PGC requests that the August 10, 2011 letter be included in the final environmental assessment and that the associated conservation measure be implemented to minimize impacts to nesting peregrine falcons.

If you have any questions or concerns, please contact me at (717) 783-5957.

Sincerely,



Olivia A. Braun
Environmental Planner
Division of Environmental Planning & Habitat Protection
Bureau of Wildlife Habitat Management
Phone: 717-787-4250, Extension 3128
Fax: 717-787-6957
e-Mail: OBraun@state.pa.us

A PNHP Partner



OAB/oab

Enclosure

cc: Librandi Mumma, PGC
File



COMMONWEALTH OF PENNSYLVANIA
Pennsylvania Game Commission

2001 ELMERTON AVENUE
HARRISBURG, PA 17110-9797

*"To manage all wild birds, mammals and their habitats
for current and future generations."*

ADMINISTRATIVE BUREAUS:

ADMINISTRATION.....	717-787-5670
HUMAN RESOURCES.....	717-787-7836
FISCAL MANAGEMENT.....	717-787-7314
CONTRACTS AND PROCUREMENT.....	717-787-6594
LICENSING.....	717-787-2084
OFFICE SERVICES.....	717-787-2116
WILDLIFE MANAGEMENT.....	717-787-5529
INFORMATION & EDUCATION.....	717-787-6286
WILDLIFE PROTECTION.....	717-783-6526
WILDLIFE HABITAT MANAGEMENT.....	717-787-6818
REAL ESTATE DIVISION.....	717-787-6568
AUTOMATED TECHNOLOGY SERVICES.....	717-787-4076

www.pgc.state.pa.us

Division of Environmental
Planning and Habitat
Protection
717-783-5957

August 10, 2011

PNDI Number(s): 20110621303231

Mr. James Inabinet
Pennoni Associates, Inc.
One Drexel Plaza
3001 Market Street, 2nd Floor
Philadelphia, Pennsylvania 19104

Re: Conergy Site – Photovoltaic Site at the Navy Yard
City of Philadelphia, Philadelphia County, Pennsylvania

Dear Mr. Inabinet,

Thank you for submitting the Pennsylvania Natural Diversity Inventory (PNDI) Environmental Review Receipt Number 20110621303231 for review. The Pennsylvania Game Commission (PGC) screened this project for potential impacts to species and resources of concern under PGC responsibility, which includes birds and mammals only.

Potential Impact Anticipated

PNDI records indicate species or resources of concern are located in the vicinity of the project. The PGC has received and thoroughly reviewed the information that you provided to this office as well as PNDI data, and has determined that potential impacts to threatened, endangered, and species of special concern birds and mammals may be associated with your project. Therefore, additional measures are necessary to avoid potential impacts to the species listed below.

Scientific Name	Common Name	PA Status
<i>Falco peregrines</i>	Peregrine falcon	ENDANGERED

Next Steps

The following Conservation Measure should be performed to minimize impacts to nesting peregrine falcons located on the Girard Point Bridge:

- No demolition, construction, or installation activities associated with the above referenced project should occur within 1,000 feet of the peregrine falcon nest located on the Girard Point Bridge during nesting season, February 15 though July 31.

This response represents the most up-to-date summary of the PNDI data files and is valid for one (1) year from the date of this letter. An absence of recorded information does not necessarily imply actual conditions on site. Should project plans change or additional information on listed or proposed species become available, this determination may be reconsidered.

Should the proposed work continue beyond the period covered by this letter, please resubmit the project to this agency as an "Update" (including an updated PNDI receipt, project narrative and accurate map). If the proposed work has not changed and no additional information concerning listed species is found, the project will be cleared for PNDI requirements under this agency for an additional year.

This finding applies to impacts to birds and mammals only. To complete your review of state and federally-listed threatened and endangered species and species of special concern, please be sure that the U.S. Fish and Wildlife Service, the PA Department of Conservation and Natural Resources, and/or the PA Fish and Boat Commission have been contacted regarding this project as directed by the online PNDI ER Tool found at www.naturalheritage.state.pa.us.

Sincerely,



Olivia A. Braun
Environmental Planner
Division of Environmental Planning & Habitat Protection
Bureau of Wildlife Habitat Management
Phone: 717-787-4250, Extension 3128
Fax: 717-787-6957
e-Mail: OBraun@state.pa.us

A PNHP Partner



OAB/oab

cc: Librandi Mumma, PGC
DuBrock, PGC
Brauning, PGC
Gross, PGC
Barber, PGC
File

Appendix 9

PRELIMINARY JURISDICTIONAL DETERMINATION FORM

BACKGROUND INFORMATION

A. REPORT COMPLETION DATE FOR PRELIMINARY JURISDICTIONAL DETERMINATION (JD): JUN 24 2009

B. NAME AND ADDRESS OF PERSON REQUESTING PRELIMINARY JD:
Douglas McLaughlin, Conergy Projects Group, 222 W. Lancaster Avenue Suite 200, Paoli, Pennsylvania 19301

C. DISTRICT OFFICE, FILE NAME, AND NUMBER: CENAP-OP-R-2009-0052

D. PROJECT LOCATION(S) AND BACKGROUND INFORMATION: Tax parcel #45-5-24-0002 in the City and County of Philadelphia, PA. The property is located along the shoreline of the Schuylkill River at the entrance to the Reserve Basin of the former Philadelphia Naval Shipyard.

(USE THE ATTACHED TABLE TO DOCUMENT MULTIPLE WATERBODIES AT DIFFERENT SITES)

State: Pennsylvania County: Philadelphia City: Philadelphia

Center coordinates of site (lat/long in degree decimal format):

Lat. 39.8939781° N, Long. 75.1949704° W

Universal Transverse Mercator: Easting (x) Northing (y)

Name of nearest waterbody: Schuylkill River

Identify (estimate) amount of waters in the review area:

Non-wetland waters: 0 linear feet: 0 width (ft) and/or 0 acres.

Cowardin Class: Riverine

Stream Flow: Perennial

Wetlands: 0 acres.

Cowardin Class:

Name of any water bodies on the site that have been identified as Section 10 waters:

Tidal: Schuylkill River and Nval Reserve Basin

Non-Tidal: None

E. REVIEW PERFORMED FOR SITE EVALUATION (CHECK ALL THAT APPLY):

Office (Desk) Determination.

Date:

Field Determination.

Date(s): 4 March 2009

1. The Corps of Engineers believes that there may be jurisdictional waters of the United States on the subject site, and the permit applicant or other affected party who requested this preliminary JD is hereby advised of his or her option to request and obtain an approved jurisdictional determination (JD) for that site. Nevertheless, the permit applicant or other person who requested this preliminary JD has declined to exercise the option to obtain an approved JD in this instance and at this time.

2. In any circumstance where a permit applicant obtains an individual permit, or a Nationwide General Permit (NWP) or other general permit verification requiring "pre-construction notification" (PCN), or requests verification for a non-reporting NWP or other general permit, and the permit applicant has not requested an approved JD for the activity, the permit applicant is hereby made aware of the following: (1) the permit applicant has elected to seek a permit authorization based on a preliminary JD, which does not make an official determination of jurisdictional waters; (2) that the applicant has the option to request an approved JD before accepting the terms and conditions of the permit authorization, and that basing a permit authorization on an approved JD could possibly result in less compensatory mitigation being required or different special conditions; (3) that the applicant has the right to request an individual permit rather than accepting the terms and conditions of the NWP or other general permit authorization; (4) that the applicant can accept a permit authorization and thereby agree to comply with all the terms and conditions of that permit, including whatever mitigation requirements the Corps has determined to be necessary; (5) that undertaking any activity in reliance upon the subject permit authorization without requesting an approved JD constitutes the applicant's acceptance of the use of the preliminary JD, but that either form of JD will be processed as soon as is practicable; (6) accepting a permit authorization (e.g., signing a proffered individual permit) or undertaking any activity in reliance on any form of Corps permit authorization based on a preliminary JD constitutes agreement that all wetlands and other water bodies on the site affected in any way by that activity are jurisdictional waters of the United States, and precludes any challenge to such jurisdiction in any administrative or judicial compliance or enforcement action, or in any administrative appeal or in any Federal court; and (7) whether the applicant elects to use either an approved JD or a preliminary JD, that JD will be processed as soon as is practicable. Further, an approved JD, a proffered individual permit (and all terms and conditions contained therein), or individual permit denial can be administratively appealed pursuant to 33 C.F.R. Part 331, and that in any administrative appeal, jurisdictional issues can be raised (see 33 C.F.R. 331.5(a)(2)). If, during that administrative appeal, it becomes necessary to make an official determination whether CWA jurisdiction exists over a site, or to provide an official delineation of jurisdictional waters on the site, the Corps will provide an approved JD to accomplish that result, as soon as is practicable.

This preliminary JD finds that there "may be" waters of the United States on the subject project site, and identifies all aquatic features on the site that could be affected by the proposed activity, based on the following information:

SUPPORTING DATA: Data reviewed for preliminary JD (check all that apply - checked items should be included in case file and, where checked and requested, appropriately reference sources below):

- Maps, plans, plots or plat submitted by or on behalf of the applicant/consultant:
- Data sheets prepared/submitted by or on behalf of the applicant/consultant.
 - Office concurs with data sheets/delineation report.
 - Office does not concur with data sheets/delineation report.
- Data sheets prepared by the Corps:
- Corps navigable waters' study:
- U.S. Geological Survey Hydrologic Atlas:
 - USGS NHD data.
 - USGS 8 and 12 digit HUC maps.
- U.S. Geological Survey map(s). Cite scale & quad name: Phila quad, 7.5 min.
- USDA Natural Resources Conservation Service Soil Survey. Citation:
- National wetlands inventory map(s). Cite name:
- State/Local wetland inventory map(s):
- FEMA/FIRM maps:
- 100-year Floodplain Elevation is: (National Geodetic Vertical Datum of 1929)
- Photographs:
 - Aerial (Name & Date): Google Earth.
 - Other (Name & Date): site photographs 4 March 2009.
- Previous determination(s). File no. and date of response letter: CENAP-OP-R-1995-0868-1(JD), CENAP-OP-R-1996-2669-1 (NWP38).
- Other information (please specify): Frshwater Wetlands Absence/Presence Determination by Pennoni Associates, dated October 7, 2008.

IMPORTANT NOTE: The information recorded on this form has not necessarily been verified by the Corps and should not be relied upon for later jurisdictional determinations.



Signature and date of
Regulatory Project Manager
(REQUIRED)

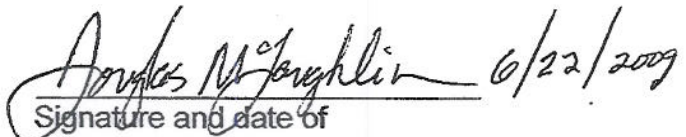

Signature and date of
person requesting preliminary JD
(REQUIRED, unless obtaining the
signature is impracticable)

TABLE 1

Site number	Latitude	Longitude	Cowardin Class	Estimated amount of aquatic resource in review area	Class of aquatic resource
1	39.89397	-75.19497	N/A	none	N/A
2					
3					
4					
5					
6					
7					
8					
9					
10					

**NOTIFICATION OF ADMINISTRATIVE APPEAL OPTIONS AND PROCESS AND
REQUEST FOR APPEAL**

Applicant: Conergy Projects Group

File Number: CENAP-OP-R-2009-0052

Date: JUN 24 2009

Attached is:

See Section below

<input type="checkbox"/>	INITIAL PROFFERED PERMIT (Standard Permit or Letter of permission)	A
<input type="checkbox"/>	PROFFERED PERMIT (Standard Permit or Letter of permission)	B
<input type="checkbox"/>	PERMIT DENIAL	C
<input type="checkbox"/>	APPROVED JURISDICTIONAL DETERMINATION	D
<input checked="" type="checkbox"/>	PRELIMINARY JURISDICTIONAL DETERMINATION	E

SECTION I - The following identifies your rights and options regarding an administrative appeal of the above decision. Additional information may be found at <http://usace.army.mil/inet/functions/cw/cecwo/reg> or Corps regulations at 33 CFR Part 331.

A: INITIAL PROFFERED PERMIT: You may accept or object to the permit.

- **ACCEPT:** If you received a Standard Permit, you may sign the permit document and return it to the Philadelphia District Engineer for final authorization. If you received a Letter of Permission (LOP), you may accept the LOP and your work is authorized. Your signature on the Standard Permit or acceptance of the LOP means that you accept the permit in its entirety, and waive all rights to appeal the permit, including its terms and conditions, and approved jurisdictional determinations (JD) associated with the permit.
- **OBJECT:** If you object to the permit (Standard or LOP) because of certain terms and conditions therein, you may request that the permit be modified accordingly. You must complete Section II of this form and return the form to the Philadelphia District Engineer. Your objections must be received by the Philadelphia District Engineer within 60 days of the date of this notice, or you will forfeit your right to appeal the permit in the future. Upon receipt of your letter, the Philadelphia District Engineer will evaluate your objections and may: (a) modify the permit to address all of your concerns, (b) modify the permit to address some of your objections, or (c) not modify the permit having determined that the permit should be issued as previously written. After evaluating your objections, the Philadelphia District Engineer will send you a proffered permit for your reconsideration, as indicated in Section B below.

B: PROFFERED PERMIT: You may accept or appeal the permit

- **ACCEPT:** If you received a Standard Permit, you may sign the permit document and return it to the Philadelphia District Engineer for final authorization. If you received a Letter of Permission (LOP), you may accept the LOP and your work is authorized. Your signature on the Standard Permit or acceptance of the LOP means that you accept the permit in its entirety, and waive all rights to appeal the permit, including its terms and conditions, and approved jurisdictional determinations associated with the permit.
- **APPEAL:** If you choose to decline the proffered permit (Standard or LOP) because of certain terms and conditions therein, you may appeal the declined permit under the Corps of Engineers Administrative Appeal Process by completing Section II of this form and sending the form to the North Atlantic Division Engineer, ATTN: CENAD-PD-PSD-O, Fort Hamilton Military Community, Building 301, General Lee Avenue, Brooklyn, NY 11252-6700. This form must be received by the North Atlantic Division Engineer within 60 days of the date of this notice with a copy furnished to the Philadelphia District Engineer.

C: PERMIT DENIAL: You may appeal the denial of a permit under the Corps of Engineers Administrative Appeal Process by completing Section II of this form and sending the form to the North Atlantic Division Engineer, ATTN: CENAD-PD-PSD-O, Fort Hamilton Military Community, Building 301, General Lee Avenue, Brooklyn, NY 11252-6700. This form must be received by the North Atlantic Division Engineer within 60 days of the date of this notice with a copy furnished to the Philadelphia District Engineer.

D: APPROVED JURISDICTIONAL DETERMINATION: You may accept or appeal the approved JD or provide new information.

- **ACCEPT:** You do not need to notify the Corps to accept an approved JD. Failure to notify the Corps within 60 days of the date of this notice, means that you accept the approved JD in its entirety, and waive all rights to appeal the approved JD.
- **APPEAL:** If you disagree with the approved JD, you may appeal the approved JD under the Corps of Engineers Administrative Appeal Process by completing Section II of this form and sending the form to the North Atlantic Division Engineer, ATTN: CENAD-PD-PSD-O, Fort Hamilton Military Community, Building 301, General Lee Avenue, Brooklyn, NY 11252-6700. This form must be received by the North Atlantic Division Engineer within 60 days of the date of this notice with a copy furnished to the Philadelphia District Engineer.

E: PRELIMINARY JURISDICTIONAL DETERMINATION: You do not need to respond to the Corps regarding the preliminary JD. The Preliminary JD is not appealable. If you wish, you may request an approved JD (which may be appealed), by contacting the Corps district for further instruction. Also you may provide new information for further consideration by the Corps to reevaluate the JD.

SECTION II - REQUEST FOR APPEAL or OBJECTIONS TO AN INITIAL PROFFERED PERMIT

REASONS FOR APPEAL OR OBJECTIONS: (Describe your reasons for appealing the decision or your objections to an initial proffered permit in clear concise statements. You may attach additional information to this form to clarify where your reasons or objections are addressed in the administrative record.)

ADDITIONAL INFORMATION: The appeal is limited to a review of the administrative record, the Corps memorandum for the record of the appeal conference or meeting, and any supplemental information that the review officer has determined is needed to clarify the administrative record. Neither the appellant nor the Corps may add new information or analyses to the record. However, you may provide additional information to clarify the location of information that is already in the administrative record.

POINT OF CONTACT FOR QUESTIONS OR INFORMATION:

If you have questions regarding this decision and/or the appeal process you may contact:

U.S. Army Corps of Engineers, Philadelphia District
ATTN: CENAP-OP-R
Wanamaker Building, 100 Penn Square East
Philadelphia, PA 19107-3390
Telephone:

If you only have questions regarding the appeal process you may also contact:

Mr. Michael G. Vissichelli
Administrative Appeals Review Officer
North Atlantic Division, Corps of Engineers Fort Hamilton
Military Community Bldg. 301, General Lee Avenue Brooklyn,
NY 11252-6700
Telephone: (718) 765-7163
Email: Michael.G.Vissichelli@usace.army.mil

RIGHT OF ENTRY: Your signature below grants the right of entry to Corps of Engineers personnel, and any government consultants, to conduct investigations of the project site during the course of the appeal process. You will be provided a 15 day notice of any site investigation, and will have the opportunity to participate in all site investigations.

_____ Signature of appellant or agent.	Date:	Telephone number:
-------------------------------------------	-------	-------------------

Appendix 10

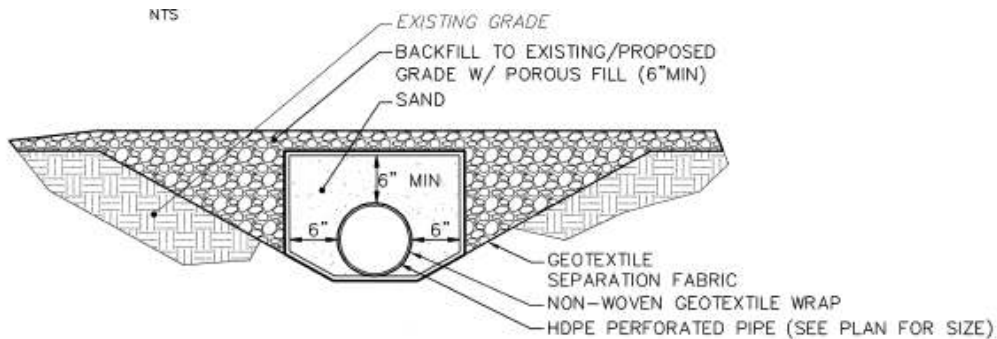

NOTE: SATISFACTORY FILL: ASTM D 2487 SOIL CLASSIFICATION GROUPS GP, GC, GM, SP, SC, AND SM, OR A COMBINATION OF THESE GROUPS; WITH A PLASTICITY INDEX LESS THAN 8 PERCENT (PER ASTM D 4318) AND FREE OF ROCK OR GRAVEL LARGER THAN 3 INCHES IN ANY DIMENSION, DEBRIS, WASTE, FROZEN MATERIALS, VEGETATION, AND OTHER DELETERIOUS MATTER, INCLUDING RECYCLED CONCRETE. SOIL SHALL HAVE NO MORE THAN 20% PASS THE # 200 SIEVE. MOISTURE CONTENTS ABOVE THE LABORATORY DETERMINED OPTIMUM MOISTURE CONTENTS DO NOT CONSTITUTE SOILS BEING CLASSIFIED AS UNSATISFACTORY.

NOTE: SAND SHALL BE ASTM-C-33 (OR TO FINE SAND, NO ORGANIC MATERIAL AASHTO M-6) SIZE (0.02" - 0.04"), CONCRETE SAND, CLEAN, MEDIUM

NOTE: GEOTEXTILE SHALL CONSIST OF NEEDED NON-WOVEN POLYPROPYLENE FIBERS AND MEET THE FOLLOWING PROPERTIES:

- a. GRAB TENSILE STRENGTH (ASTM-D4632) \geq 120 LBS
- b. MULLEN BURST STRENGTH (ASTM-D3786) \geq 225 PSI
- c. FLOW RATE (ASTM-D4491) \geq 95 GAL/MIN/FT²
- d. UV RESISTANCE AFTER 500 HRS (ASTM-D4355) \geq 70%
- e. HEAT-SET OR HEAT-CALENDARED FABRICS ARE NOT PERMITTED

UNDERDRAIN SECTION

NTS

Appendix 11

Appendix 12

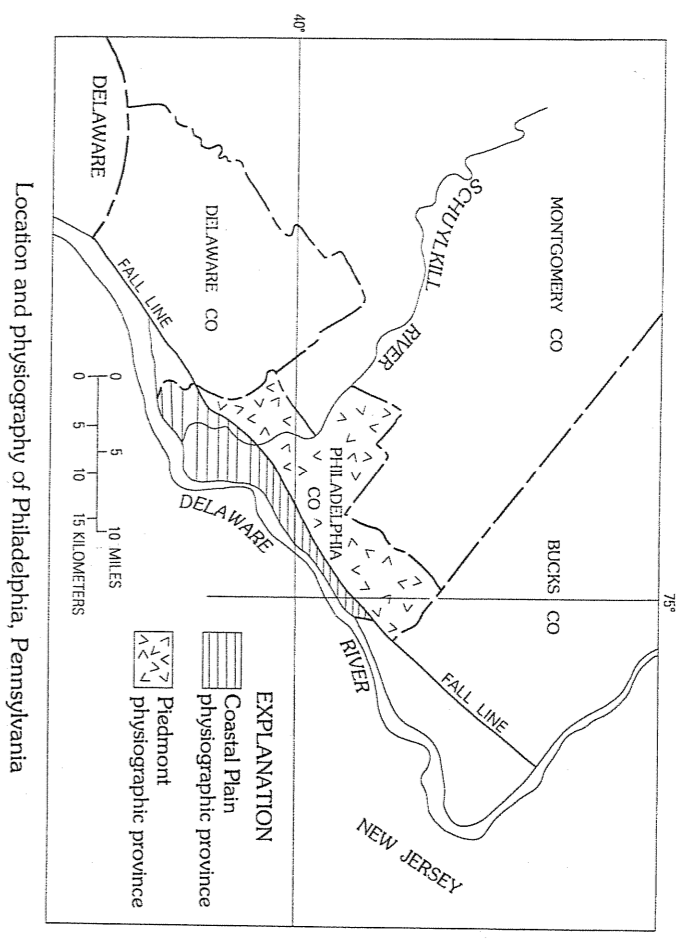
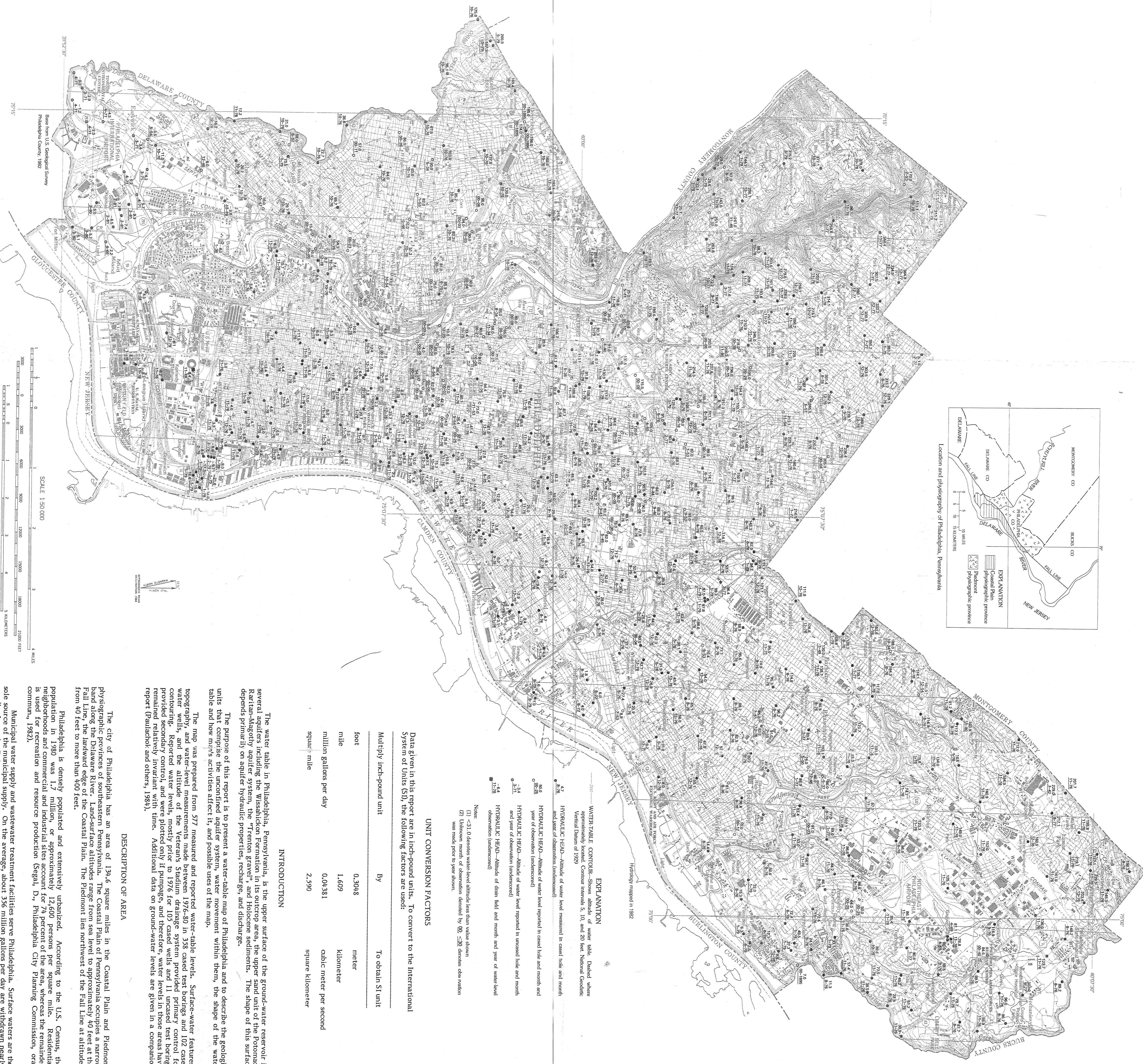

EXPLANATION

- WATER-TABLE CONTOUR—Shows altitude of water table. Dashed where vertically located. Contour interval is 51 and 20 feet. National Geologic Vertical Datum of 1929.
 - HYDRAULIC HEAD—Altitude of water level measured in canal hole and mouth and year of observation (underground).
 - HYDRAULIC HEAD—Altitude of water level measured in unlined hole and mouth and year of observation (underground).
 - HYDRAULIC HEAD—Altitude of dam field and mouth and year of water-level observation (underground).
- Note:*
(1) < 31.0 indicates water level altitude less than value shown.
(2) Unknown amount of observation denoted by 00. < 50.0 denotes observation was made prior to year shown.

UNIT CONVERSION FACTORS

Data given in this report are in inch-pound units. To convert to the International System of Units (SI), the following factors are used:	
Multiply inch-pound unit	To obtain SI unit
foot	0.3048 meter
mile	1.609 kilometer
million gallons per day	0.00381 cubic meter per second
square mile	2.590 square kilometer

INTRODUCTION

The water table in Philadelphia, Pennsylvania, is the upper surface of the ground-water reservoir in several aquifers including the Wissahickon Formation in its outcrop area, the upper sand unit of the Potomac-Raritan-Magothy aquifer system, the "Trenton gravel", and Holocene sediments. The shape of this surface depends primarily on aquifer hydraulic properties, recharge, and discharge.

The purpose of this report is to present a water-table map of Philadelphia and to describe the geologic units that comprise the unconfined aquifer system, water movement within them, the shape of the water table and how man's activities affect it, and possible uses of the map.

The map was prepared from 577 measured and reported water-table levels. Surface-water features, topography, and water-level measurements were obtained from the City of Philadelphia, the Pennsylvania Department of Environmental Protection, the U.S. Geological Survey, and the U.S. Army Corps of Engineers. Reported water levels, mostly prior to 1976 for 105 cased wells and 11 uncased test borings remained relatively invariant with time. Additional data on ground-water levels are given in a companion report (Faulstich and others, 1983).

DESCRIPTION OF AREA

The City of Philadelphia has an area of 134.6 square miles in the Coastal Plain and Piedmont physiographic provinces of southeastern Pennsylvania. The City of Philadelphia extends across a narrow band along the Delaware River. Land-surface altitudes range from sea level to 300 feet above sea level along Fall Line, the landward edge of the Coastal Plain. The Piedmont lies northwest of the Fall Line at altitudes from 40 feet to more than 400 feet.

Philadelphia is densely populated and extensively urbanized. According to the U.S. Census, the population in 1980 was 1.7 million, or approximately 12,600 persons per square mile. The residential and commercial and industrial sites account for 74 percent of the area, whereas the rest is used for recreation and resource production (Segall, D., Philadelphia City Planning Commission, oral communication, 1982).

Municipal water supply and wastewater treatment facilities serve Philadelphia. Surface waters are the sole source of the municipal supply. On the average, about 356 million gallons and 102 cased wells, equally from the Delaware and Schuylkill Rivers, principally for industrial and domestic uses. Nearly 8 million gallons of ground water are withdrawn daily by municipal and private concerns, mainly for site de-watering and industrial uses. A 3,000-mile network of sewers transports water surface and ground waters to three treatment plants. Ultimately, treated wastewater is discharged to the Delaware River.

Philadelphia is underlain by crystalline rocks and by the younger unconsolidated sediments of the Coastal Plain aquifer system. The aquifer system in the City, chiefly of the Wissahickon Formation of Late Proterozoic and early Paleozoic age, crops out in the City. The aquifer system is underlain by the Potomac-Raritan-Magothy aquifer system. The deep Coastal Plain sediments, the Potomac-Raritan-Magothy aquifer system, the Potomac-Raritan-Magothy aquifer system has been subdivided into the following units: over sand, lower clay, middle sand, middle clay, upper sand, and upper clay. Generally, the Cretaceous over sand, middle sand, middle clay, upper sand, and upper clay, which are the most permeable units, are overlain by the Trenton gravel, which in turn may be overlain by the Trenton gravel. The Trenton gravel is the stratigraphic equivalent of the Raritan Formation, and the Trenton gravel is the equivalent of Pleistocene sediments of Wisconsin age described by Greenman and others (1961) in their report on the ground-water resources of the Philadelphia area.

The water table occurs within the geologic units that comprise the unconfined aquifer system. This system has two principal components: (1) The Wissahickon Formation in its outcrop areas and (2) Trenton gravel, and Holocene sediments. Water levels presented in this report represent conditions specifically in these geologic units.

The Wissahickon Formation consists chiefly of schist that is believed to represent a thick accumulation of arkosic and argillaceous sediments that were metamorphosed into dense hard foliated rock. These rocks typically exhibit well-developed cleavage and jointing.

The upper sand unit of the Potomac-Raritan-Magothy aquifer system is composed of medium to coarse sand and minor amounts of very fine to fine sand. In parts of south Philadelphia, the upper sand unit typically exhibit well-developed cleavage and jointing.

The Trenton gravel consists of sand and gravel and minor amounts of clay. The water-bearing properties of the sediments vary greatly, ranging from thin thickness and physical character. The Trenton gravel attains a maximum thickness of about 80 feet; the typical thickness, however, is about 40 feet (Greenman and others, 1961, p.46).

The Holocene sediments are composed of mud, silt, and fine sand. These sediments are near 80 feet thick in parts of Philadelphia, and are usually less than 10 feet (Greenman and others, 1961, p.45).

In the outcrop area of the Wissahickon Formation, ground water commonly occurs under unconfined conditions in openings along bedding and schistosity planes, and fractures.

In Philadelphia, the upper clay unit of the Potomac-Raritan-Magothy aquifer system has limited areal extent. Consequently, the upper sand unit commonly forms a hydraulically continuous single aquifer. The Holocene sediments are generally much less permeable than the underlying sediments and locally may constitute a leaky confining bed.

RECHARGE AND DISCHARGE

The unconfined aquifers are recharged by precipitation, surface-water sources, and leakage from sewer lines. Fifty-two percent of the collector system consists of brick sewers which commonly have deteriorated joints. The water table is below the sewers, leakage from sewers adds to million gallons per day (Roman, R., City of Philadelphia Water Department, oral communication, 1982) and provides some additional recharge, although most of this leakage is thought to infiltrate directly into sewers that lie beneath the water pipes.

Water from the unconfined aquifers discharges to the atmosphere and to surface-water bodies and deeper aquifers. Local infiltration to sewers and withdrawals for site remediation are also important factors. Infiltration to sewers averages about 135 million gallons per day during periods of high water table (City of Philadelphia Water Department, 1973, sec.13). Continuous dewatering of tunnels for three subway stations and foundation dewatering in central and south Philadelphia removes about 3.6 million gallons daily and controls water-table levels within the area of dewatering influence.

THE WATER TABLE

The water table in Philadelphia is represented by the contour map. The map shows the water table as of 1974-83, and is based principally on measurements made during that period.

The accuracy of the water-table contours is such that 80 percent of all water-table levels can be expected to fall within one-half of the contour interval except in areas of very high topographic relief.

In unstratified ground-water systems, the water-table profile generally resembles the land-surface profile. In Philadelphia, however, the water table is generally higher than the land surface, especially in hillslopes and ridges, and is lowest in valleys where it is in contact with the land surface. In Philadelphia, however, the altitude and shape of the water table has been altered significantly by human activities. Water-table levels throughout much of the area are influenced more by dewatering and leakage from sewers and water pipes than by topography; consequently, short-term and seasonal fluctuations are dampened to a narrow range in areas affected by dewatering and leakage.

Although pumping and water-table levels were fairly stable during 1976-80, any significant change in the location or intensity of pumping can cause a commensurate change in the altitude and shape of the water table. The altitude of the water table can also change when leaky brick sewers are replaced by relatively watertight sewers constructed of other materials.

Several prominent hydrologic features in south Philadelphia are shown on the map. The widespread area of negative head results from pumping, principally in New Jersey, from the lower sand unit of the Potomac-Raritan-Magothy aquifer system. This sustained withdrawal has produced significant vertical differences in head between aquifers. Due to these head differences, water flows downward from the lower sand unit through the intervening clay units to the lower sand unit, causing head to decline locally below sea level in the Philadelphia area. These ground-water levels are lower than surface-water levels, and are dampened to a narrow range in areas affected by dewatering and leakage.

Two localized cones of depression are also shown. The cone near Greenwicht results from intensive pumping of the Coastal Plain aquifers by local industries; consequently, heads in observation wells have declined significantly. The cone near Center City is caused by dewatering for construction factors including ground-water flow to sewers and pumping of ground water for construction. In the latter case, the water level in Mingo Creek, which is continually maintained by pumping at about 6 feet below sea level, in an earthen dam at the mouth of Mingo Creek hydraulically separates the Creek from the Schuylkill River. In which water levels average about 1 foot above sea level.

The elongated mound north of the U.S. Naval Base is about 10 feet above the regional water table and may be due to hydraulic effects produced by underlying low-permeability layers, or caused by leakage from sewers and water pipes.

Based on the area of negative head, ground-water levels are typically at or above water-surface levels in adjoining systems. In the Philadelphia area, tidal streams receive ground-water flows to aquifers, however, and is retained as bank storage during high tide when stream levels are higher than ambient ground-water levels.

POSSIBLE USES OF THIS REPORT

This map provides information on water-table levels useful in identifying the source of seepage to structures and for delineating areas of high water table that may cause excessive infiltration to sewers. The map may be used to estimate the depth of the water table at an excavation site by subtracting the local water-table elevation from the surface altitude. The map also provides information useful for determining flow direction (and therefore, recharge and discharge) and for estimating hydraulic properties and the quantity of ground-water flow, and for locating recharge and discharge areas.

REFERENCES

- City of Philadelphia Water Department, Water Pollution Control Division, 1975, Infiltration/Inflow analysis of the Philadelphia sewer system.
- Greenman, D. W., Rima, D. R., Lockwood, W. N., and Heister, Harold 1961, Ground-water resources of the Coastal Plain area of southeastern Pennsylvania. Pennsylvania Geol. Survey, 4th ser., Water Resources Report 11, 375 p.
- Owens, J. P., and Minard, J. P., 1979, Upper Potomac sediments of the lower Delaware Valley and the northern Delaware Piedmont, New Jersey, Pennsylvania, Delaware, and Maryland. U.S. Geological Survey Professional Paper 106-52, 47 p.
- Paulstich, G. N., Wood, C. R., and Neeson, L. J., 1984, Hydrologic data for aquifers in Philadelphia, Pennsylvania: U.S. Geological Survey Open-File report 83-149. In press.

WATER-TABLE MAP OF PHILADELPHIA, PENNSYLVANIA, 1976-1980

By
Gary N. Paulstich and Charles R. Wood
1984

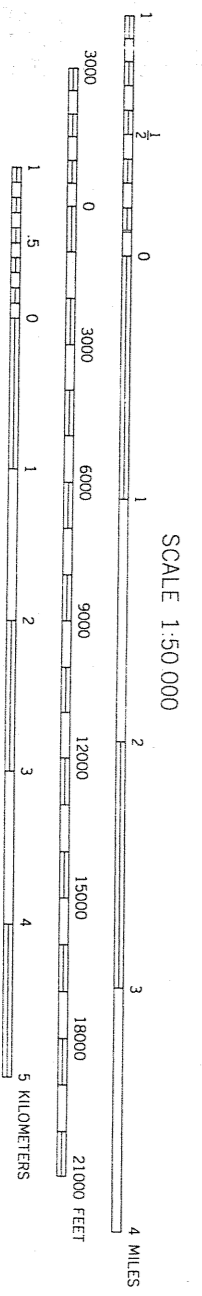

Appendix 13

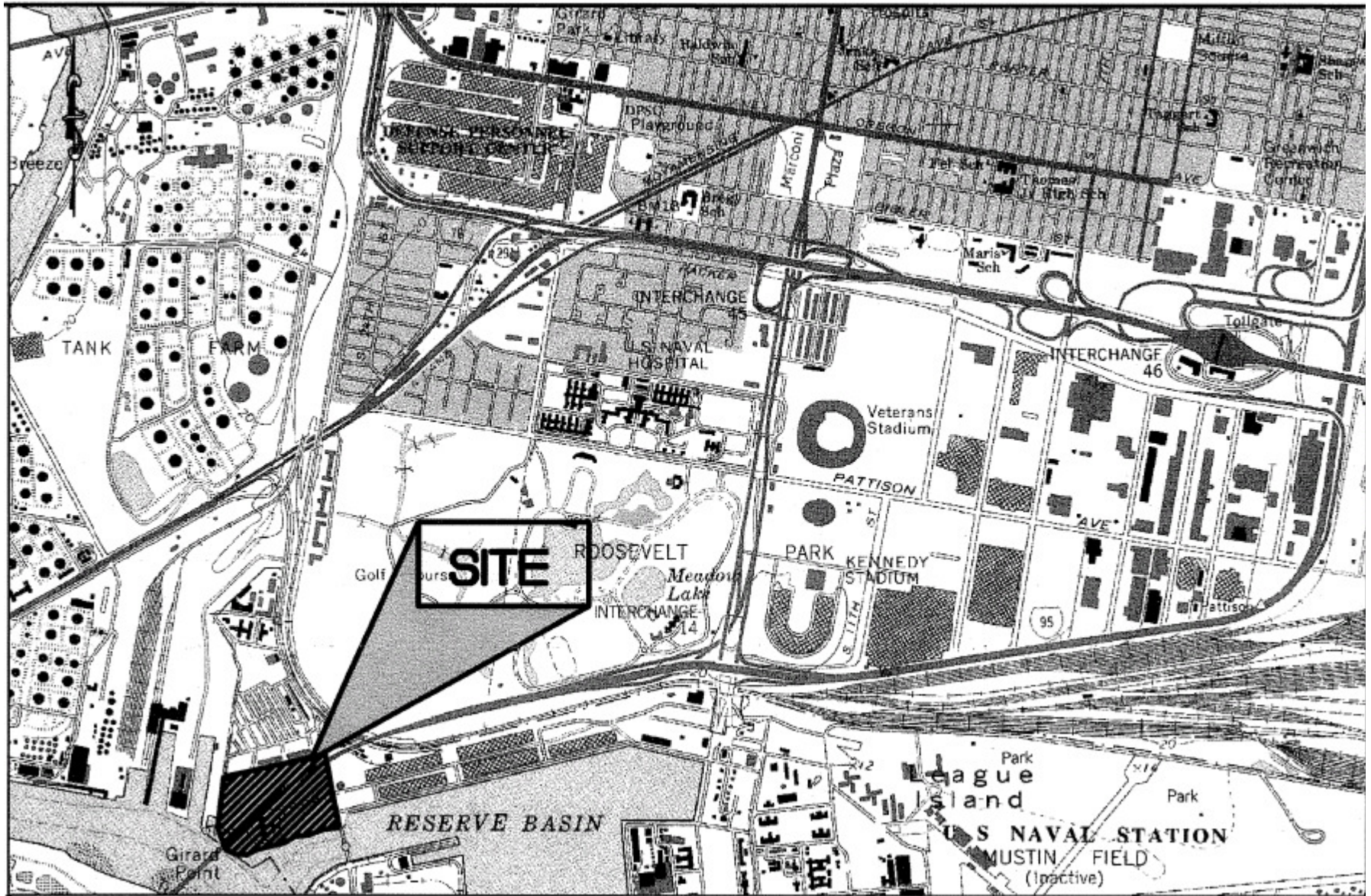

LOCATION MAP

PORTION OF U.S.G.S. QUADRANGLE
PHILADELPHIA, PA—NJ

Appendix 14

Appendix 15

United States
Environmental Protection
Agency

Environmental Monitoring
Systems Laboratory
P.O. Box 93478
Las Vegas NV 89193-3478

TS-PIC-94134
May 1994

Research and Development

EPA Aerial Photographic Site Analysis Philadelphia Naval Complex Philadelphia, Pennsylvania

EPA Region 3
and O&R

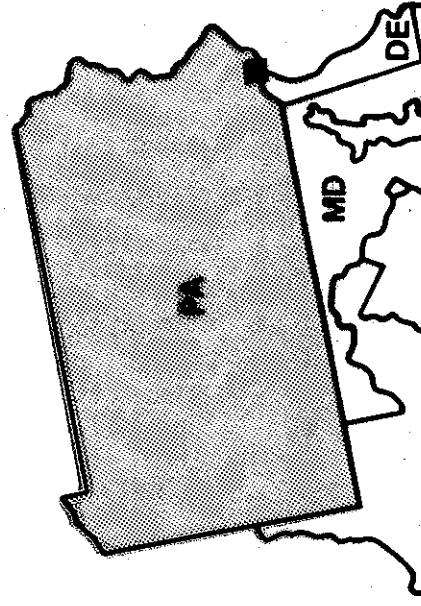

7
TS-PIC-94134
May 1994

Aerial Photographic Site Analysis
Philadelphia Naval Complex
Philadelphia, Pennsylvania

by
Nancy R. Bronson, Imagery Analyst
Hughes STX Corporation
Warrenton, Virginia 22186

Contract No. 68-C3-0367

Work Assignment Manager
E. Terrence Slonecker
Environmental Photographic Interpretation Center
Environmental Monitoring Systems Laboratory
Warrenton, Virginia 22186

ENVIRONMENTAL MONITORING SYSTEMS LABORATORY
OFFICE OF RESEARCH AND DEVELOPMENT
U.S. ENVIRONMENTAL PROTECTION AGENCY
LAS VEGAS, NEVADA 89193-3478

INTRODUCTION

An analysis of aerial photography was performed on the Philadelphia Naval Complex, located in Philadelphia, Pennsylvania. The site was analyzed to support the Environmental Protection Agency's (EPA) Region 3 in its remedial investigation by documenting past waste disposal practices and other activities of environmental significance.

The facility was constructed in the early 1800's and underwent periods of rapid expansion during the Civil War and in 1939. During its history, the Naval Complex has functioned as a shipyard, airfield, aircraft factory, catapult design and test facility, and a research and development facility. Collateral data supplied by EPA Region 3 categorizes the facility by zones (Zones I-IV). The shipyard was analyzed in addition to all four Zones.

Figure 1 shows the site location, the four Zones, and the shipyard, keyed to a copy of a U.S. Geological Survey (USGS) 1:24,000-scale topographic map. The site, excluding the Reserve Basin, covers 450 hectares (1,113 acres). Surface runoff from the site flows into the Reserve Basin, the Schuylkill River, and the Delaware River, which flows south into Delaware Bay. Site boundaries or areas used in this analysis were determined from collateral data supplied by EPA Region 3 and do not necessarily denote legal property lines or ownership.

The analysis of ten years of aerial photography for the time period 1944 to 1992¹ revealed frequent staining and/or spills; drum storage with associated staining; and landfilling in Zone I. Stains and spills were observed from 1953 to 1979 in Zone II and from 1953 to 1992 in both the shipyard and Zone III. The aircraft engine test facility in Zone III and the aircraft overhaul and assembly building in Zone IV were locations of persistent staining. Extensive filling in Zone IV was observed from 1944 through 1979. Waste disposal in Zone IV appears to have occurred during the 1970's.

The EPA's Environmental Photographic Interpretation Center in Warrenton, Virginia, a branch of the Advanced Monitoring Systems

¹A complete listings of maps and photography used in this report is provided in the References section.

Division of the Environmental Monitoring Systems Laboratory in Las Vegas, Nevada, performed this analysis at the request of the Superfund Support Section of EPA Region 3 in Philadelphia, Pennsylvania, and the Office of Emergency and Remedial Response in Washington, D.C.

METHODOLOGY

A search of government and commercial sources was undertaken to obtain large scale aerial photography of the site spanning the desired time frame. The photography and other sources of information used in this report are listed in the References section.

The analysis was performed by viewing backlit transparencies of aerial photography through stereoscopes. Stereoscopic viewing creates a perceived three-dimensional effect which, when combined with viewing at various magnifications, enables the analyst to identify signatures associated with different features and environmental conditions. The term "signature" refers to a combination of visible characteristics (such as color, tone, shadow, texture, size, shape, pattern, and association) which permit a specific object or condition to be recognized on aerial photography.

The terms "possible" and "probable" are used to indicate the degree of certainty of signature identification. "Possible" is used when only a few characteristics are discernible or these characteristics are not unique to a signature. "Probable" is used when incrementally more characteristics are discernible. No qualifying terms are used when the characteristics of a signature allow for a definite feature identification.

Photographic prints were made from those years of aerial photographic coverage that reveal significant information about the site. Overlays to the prints and/or base maps serve to locate significant features; additional observations and analysis are discussed in the text.

Site boundaries or areas used in this analysis were determined from collateral data supplied by EPA Region 3 and do not necessarily denote legal property lines or ownership.

Due to factors inherent in the photographic printing process, prints do not exhibit the level of detail that is visible in the original aerial photography. Therefore, some features identified from the aerial photography may not be clearly discernible, or even visible, on the photographic prints presented in this report.

AERIAL PHOTO SITE ANALYSIS

ZONE I

Zone I comprises 32 hectares (80 acres) and is located north of the Reserve Basin, along the west side of Bridge Street. According to collateral data provided by Region 3, this portion of the Naval Complex includes the damage control training center, the heating plant, hazardous waste storage buildings, a scrap yard, an incinerator, and an industrial waste treatment plant.¹

MAY 6, 1960 (FIGURE 2)

Photography from 1944 and 1953 was analyzed but not reproduced for this report due to few significant findings. Features noted during those years are included in the analysis for 1960.

Buildings in the north part of Zone I, the damage control training center, were under construction in 1944. Coverage of the northern portion was not available for 1953; spills, stains (ST), and standing liquid (SL) are visible there in 1960.

A scrap yard and open storage area (OS) occupy the central portion of Zone I. Scrap yard fencing is shown to differentiate its contents from items in the open storage area. Stains are consistently seen on the ground of the open storage area and have not been annotated unless associated with drum storage (DS). A large area of standing liquid is visible near a possible drum storage area in 1960. A possible pit is located along the west boundary.

Filling (FA) of the south part of Zone I was visible in 1944. The incinerator (INC)* was also present; fill materials include light- and dark-toned mounded material (possibly incinerator waste). Material not used as fill appears to have been removed by barge and rail. Disposal appeared to be taking place along the water's edge between 1944 and 1953 when probable waste materials (WM) were observed. By 1960, probable crates or containers (C) and probable debris had been deposited west of the incinerator. Mounded material, a stain or standing liquid, and disturbed ground (DG) or a possible pit are noted in the southeast portion of the Zone.

¹Information provided by EPA Region 3 is referenced throughout this report and denoted with an asterisk (*).

MARCH 23, 1979 (FIGURE 3)

Photography from 1965, 1973, and 1975 was analyzed but not reproduced due to few significant findings. Those findings are discussed with the analysis for 1979.

Spills were observed in the north portion of Zone I between 1965 and 1979. Light-toned (LT) material (M) and disturbed ground were also noted during this period. Drum storage areas with associated stains and standing liquid are present in the northwest part of the open storage area. Stains surrounding crates or containers, a spill, and light-toned material are noted in 1979 south of the open storage area.

Light- and dark-toned mounded materials were observed in the southern portion of Zone I during this period and were used as fill material in the southwest portion. Interstate 95 was built between 1965 and 1973. A small building, identified as the treatment plant,* was added before 1965. An addition on its east side was noted between 1975 and 1979. Coarse-textured mounded materials, possible drum storage with standing liquid, crates or containers, and debris were all noted during the 1970's.



FIGURE 2
PHILADELPHIA NAVAL COMPLEX

ZONE 1
MAY 6, 1960

APPROX. SCALE

APPROX. SCALE 1:4,900

MAY 6, 1960
ZONE I

VAL COMPLEX

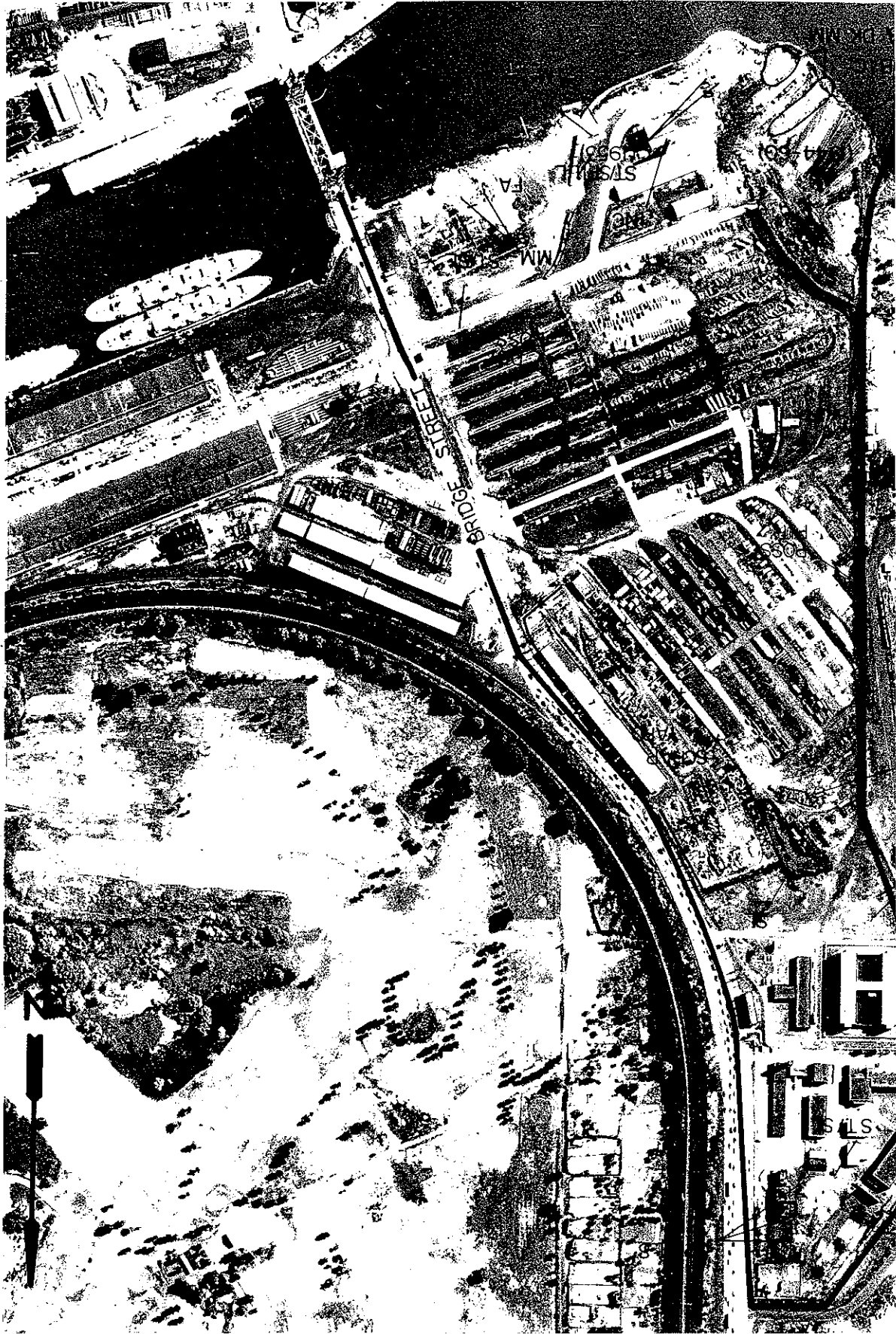

- LEGEND**
- B - Building
 - BR - Breach
 - C - Crates/Containers
 - DB - Debris
 - DG - Disturbed Ground
 - DK - Dark-Toned
 - DS - Drum Storage
 - EX - Excavation
 - FA - Fill Area
 - HT - Horizontal Tank
 - IM - Impoundment
 - INC - Incinerator
 - LT - Light-Toned
 - M - Material
 - MM - Mounded Material
 - OS - Open Storage
 - SL - Standing Liquid
 - ST - Stain
 - VT - Vertical Tank
 - WM - Waste Materials
 - Access Road
 - Berm
 - Channelized Drainage
 - Edge of Slope
 - Feature Boundary
 - x-x- Fence
 - - - Historical Boundary
 - - - Natural Drainage
 - - - Site/Zone Boundary
 - Vertical Tank



FIGURE 3 PHILADELPHIA NAVAL COMPLEX ZONE I MARCH 23, 1979

APPROX. SCALE 1



LEGEND

- B - Building
- BR - Breach
- C - Crates/Containers
- DB - Debris
- DG - Disturbed Ground
- DK - Dark-Toned
- DS - Drum Storage
- EX - Excavation
- FA - Fill Area
- HT - Horizontal Tank
- IM - Impoundment
- INC - Incinerator
- LT - Light-Toned
- M - Material
- MM - Mounded Material
- OS - Open Storage
- SL - Standing Liquid
- ST - Stain
- VT - Vertical Tank
- WM - Waste Materials

- - Access Road
- ~~~~~ - Berm
- - Channelized Drainage
- ~~~~~ - Edge of Slope
- - Feature Boundary
- x-x- - Fence
- - - - - Historical Boundary
- - Natural Drainage
- - Site/Zone Boundary
- - Vertical Tank

ZONE I
 COMPLEX MARCH 23, 1979 APPROX. SCALE 1:4700

Appendix 16

Appendix 17



COMMONWEALTH OF PENNSYLVANIA
PENNSYLVANIA GAME COMMISSION

2001 ELMERTON AVENUE, HARRISBURG, PA 17110

"TO MANAGE ALL WILD BIRDS, MAMMALS AND THEIR HABITATS
FOR CURRENT AND FUTURE GENERATIONS."

August 18, 2010

PNDI Number: 20100610247874

James Inabinet
Pennoni Associates Inc.
3001 Market Street Suite 200
Philadelphia, PA 19104

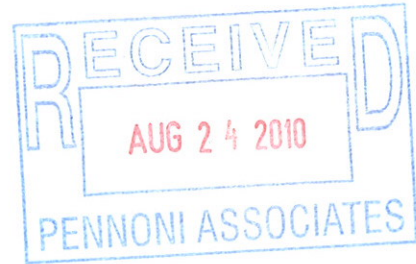

PNDI Number: 20100610247874
Re: Conergy Photovoltaic Site at the Navy Yard
City of Philadelphia, Philadelphia County, PA

Dear Mr. Inabinet,

Thank you for submitting the Pennsylvania Natural Diversity Inventory (PNDI) Environmental Review Receipt Number 20100610247874 for review. The Pennsylvania Game Commission (PGC) screened this project for potential impacts to species and resources of concern under PGC responsibility, which includes birds and mammals only.

Potential Impact Anticipated

PNDI records indicate species or resources of concern are located in the vicinity of the project. The PGC has received and thoroughly reviewed the information that you provided to this office as well as PNDI data, and has determined that potential impacts to threatened, endangered, and species of special concern birds and mammals may be associated with your project. Therefore, additional measures are necessary to avoid potential impacts to the species listed below.

Scientific Name	Common Name	PA Status
<i>Falco peregrinus</i>	Peregrine Falcon	ENDANGERED

Next Steps

The following Conservation Measure should be performed to minimize impacts to nesting peregrine falcons located on the Girard Point Bridge:

- *No construction/installation activities associated with the above reference project should occur within 1000 feet of the peregrine falcon nest located on the Girard Point Bridge during nesting season, March 1 – June 30.*

This response represents the most up-to-date summary of the PNDI data files and is valid for one (1) year from the date of this letter. An absence of recorded information does not necessarily imply actual conditions on site. Should project plans change or additional information on listed or proposed species become available, this determination may be reconsidered.

Should the proposed work continue beyond the period covered by this letter, please resubmit the project to this agency as an "Update" (including an updated PNDI receipt, project narrative and accurate map). If the proposed work has not changed and no additional information concerning listed species is found, the project will be cleared for PNDI requirements under this agency for an additional year.

This finding applies to impacts to birds and mammals only. To complete your review of state and federally-listed threatened and endangered species and species of special concern, please be sure that the U.S. Fish and Wildlife Service, the PA Department of Conservation and Natural Resources, and/or the PA Fish and Boat Commission have been contacted regarding this project as directed by the online PNDI ER Tool found at www.naturalheritage.state.pa.us.

Sincerely,



Tracey Librandi Mumma
Division of Environmental Planning & Habitat Protection
Bureau of Wildlife Habitat Management
Phone: 717-787-4250, Extension 3614
Fax: 717-787-6957
E-mail: tlibrandi@state.pa.us

A PNHP Partner



Pennsylvania Natural Heritage Program

TLM/tlm

cc: DuBrock
Brauning
McMorris



Division of Environmental
Planning and Habitat
Protection
717-783-5957

COMMONWEALTH OF PENNSYLVANIA
Pennsylvania Game Commission

2001 ELMERTON AVENUE
HARRISBURG, PA 17110-9797

*"To manage all wild birds, mammals and their habitats
for current and future generations."*

ADMINISTRATIVE BUREAUS:

ADMINISTRATION.....717-787-5670
HUMAN RESOURCES.....717-787-7836
FISCAL MANAGEMENT.....717-787-7314
CONTRACTS AND
PROCUREMENT.....717-787-6594
LICENSING.....717-787-2084
OFFICE SERVICES.....717-787-2116
WILDLIFE MANAGEMENT.....717-787-5529
INFORMATION & EDUCATION.....717-787-6286
WILDLIFE PROTECTION.....717-783-6526
WILDLIFE HABITAT
MANAGEMENT.....717-787-6818
REAL ESTATE DIVISION.....717-787-6568
AUTOMATED TECHNOLOGY
SERVICES.....717-787-4076

www.pgc.state.pa.us

August 10, 2011

Mr. Cliff Whyte
U.S. Department of Energy
National Energy Technology Laboratory
P.O. Box 880
Morgantown, West Virginia 26507-0880

Re: Draft Environmental Assessment for the Conergy Navy Yard Solar Project
Philadelphia, Pennsylvania
DOE/EA-1876D

Dear Mr. Whyte,

Thank you for the opportunity to review the Draft Environmental Assessment for the Conergy Navy Yard Solar Project located in Philadelphia, Pennsylvania (DOE/EA-1876D). The Pennsylvania Game Commission (PGC) has screened this project for potential impacts to species and resources of concern under PGC responsibility, which includes birds and mammals only.

In the PGC's August 18, 2010 letter, potential impacts to the state listed endangered peregrine falcon (*Falco peregrinus*) were identified. At that time, the PGC requested that no activities associated with this project occur within 1,000 feet of the nest during the nesting season, March 1 through June 30. However, since that time additional information regarding peregrine falcons has become available. Therefore, in effort to better protect peregrine falcons and to ensure that adverse impacts to all facets the nesting season are avoided, the nesting season has been determined to be February 15 through July 31.

Please be aware that the PGC's most recent review of this project was completed on August 10, 2011. This response letter identified potential impacts to nesting peregrine falcons and requests that no activities associated with this project shall occur within 1,000 feet of nesting peregrine falcons during the nesting season, February 15 through July 31 (attached).

The PGC requests that the August 10, 2011 letter be included in the final environmental assessment and that the associated conservation measure be implemented to minimize impacts to nesting peregrine falcons.

If you have any questions or concerns, please contact me at (717) 783-5957.

Sincerely,



Olivia A. Braun
Environmental Planner
Division of Environmental Planning & Habitat Protection
Bureau of Wildlife Habitat Management
Phone: 717-787-4250, Extension 3128
Fax: 717-787-6957
e-Mail: OBraun@state.pa.us

A PNHP Partner



OAB/oab

Enclosure

cc: Librandi Mumma, PGC
File



COMMONWEALTH OF PENNSYLVANIA
Pennsylvania Game Commission

2001 ELMERTON AVENUE
HARRISBURG, PA 17110-9797

*"To manage all wild birds, mammals and their habitats
for current and future generations."*

ADMINISTRATIVE BUREAUS:

ADMINISTRATION.....	717-787-5670
HUMAN RESOURCES.....	717-787-7836
FISCAL MANAGEMENT.....	717-787-7314
CONTRACTS AND PROCUREMENT.....	717-787-6594
LICENSING.....	717-787-2084
OFFICE SERVICES.....	717-787-2116
WILDLIFE MANAGEMENT.....	717-787-5529
INFORMATION & EDUCATION.....	717-787-6286
WILDLIFE PROTECTION.....	717-783-6526
WILDLIFE HABITAT MANAGEMENT.....	717-787-6818
REAL ESTATE DIVISION.....	717-787-6568
AUTOMATED TECHNOLOGY SERVICES.....	717-787-4076

www.pgc.state.pa.us

Division of Environmental
Planning and Habitat
Protection
717-783-5957

August 10, 2011

PNDI Number(s): 20110621303231

Mr. James Inabinet
Pennoni Associates, Inc.
One Drexel Plaza
3001 Market Street, 2nd Floor
Philadelphia, Pennsylvania 19104

Re: Conergy Site – Photovoltaic Site at the Navy Yard
City of Philadelphia, Philadelphia County, Pennsylvania

Dear Mr. Inabinet,

Thank you for submitting the Pennsylvania Natural Diversity Inventory (PNDI) Environmental Review Receipt Number 20110621303231 for review. The Pennsylvania Game Commission (PGC) screened this project for potential impacts to species and resources of concern under PGC responsibility, which includes birds and mammals only.

Potential Impact Anticipated

PNDI records indicate species or resources of concern are located in the vicinity of the project. The PGC has received and thoroughly reviewed the information that you provided to this office as well as PNDI data, and has determined that potential impacts to threatened, endangered, and species of special concern birds and mammals may be associated with your project. Therefore, additional measures are necessary to avoid potential impacts to the species listed below.

Scientific Name	Common Name	PA Status
<i>Falco peregrines</i>	Peregrine falcon	ENDANGERED

Next Steps

The following Conservation Measure should be performed to minimize impacts to nesting peregrine falcons located on the Girard Point Bridge:

- No demolition, construction, or installation activities associated with the above referenced project should occur within 1,000 feet of the peregrine falcon nest located on the Girard Point Bridge during nesting season, February 15 though July 31.

This response represents the most up-to-date summary of the PNDI data files and is valid for one (1) year from the date of this letter. An absence of recorded information does not necessarily imply actual conditions on site. Should project plans change or additional information on listed or proposed species become available, this determination may be reconsidered.

Should the proposed work continue beyond the period covered by this letter, please resubmit the project to this agency as an "Update" (including an updated PNDI receipt, project narrative and accurate map). If the proposed work has not changed and no additional information concerning listed species is found, the project will be cleared for PNDI requirements under this agency for an additional year.

This finding applies to impacts to birds and mammals only. To complete your review of state and federally-listed threatened and endangered species and species of special concern, please be sure that the U.S. Fish and Wildlife Service, the PA Department of Conservation and Natural Resources, and/or the PA Fish and Boat Commission have been contacted regarding this project as directed by the online PNDI ER Tool found at www.naturalheritage.state.pa.us.

Sincerely,



Olivia A. Braun
Environmental Planner
Division of Environmental Planning & Habitat Protection
Bureau of Wildlife Habitat Management
Phone: 717-787-4250, Extension 3128
Fax: 717-787-6957
e-Mail: OBraun@state.pa.us

A PNHP Partner



OAB/oab

cc: Librandi Mumma, PGC
DuBrock, PGC
Brauning, PGC
Gross, PGC
Barber, PGC
File

Appendix 18

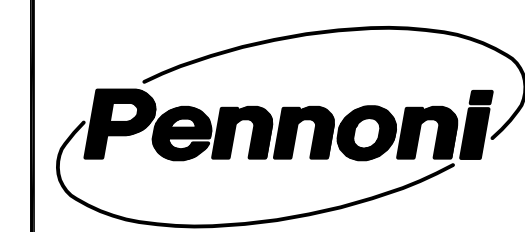

Pennoni Associates Inc. Engineers • Surveyors • Planners • Landscape Architects

One Drexel Plaza, 3001 Market Street Philadelphia, PA 19104

Pennoni Associates Inc.

PHOTOVOLTAIC FACILITY - PHILADELPHIA NAVAL YARD PARCELS 2 & 10
4500 BASIN BRIDGE ROAD AND 4621 BASIN BRIDGE ROAD
PHILADELPHIA NAVAL YARD - PHILADELPHIA, PA 19112
PNDI - FALCON NEST LOCATION AND CONSTRUCTION RESTRICTION LIMITS
CONERGY PROJECTS, INC.
101 LINDENWOOD DRIVE, SUITE 130
MALVERN, PA 19355

ALL DOCUMENTS PREPARED BY PENNONI ASSOCIATES ARE INSTRUMENTS OF SERVICE IN RESPECT OF THE PROJECT. THEY ARE NOT INTENDED OR REPRESENTED TO BE SUITABLE FOR REUSE BY OWNER OR OTHERS ON EXTENSIONS OF THE PROJECT OR ON ANY OTHER PROJECT. ANY REUSE WITHOUT WRITTEN NOTIFICATION OR ADAPTATION BY PENNONI ASSOCIATES FOR THE SPECIFIC PURPOSE INTENDED WILL BE AT OWNERS RISK AND WITHOUT LIABILITY OR LEGAL CONSEQUENCE TO PENNONI ASSOCIATES. AND OWNER SHALL HOLD PENNONI ASSOCIATES HARMLESS FROM ALL CLAIMS, DAMAGES, LOSSES AND EXPENSES ARISING OUT OF OR RESULTING THEREFROM.

EPUR 0801
SHEET 1 OF 1

SCALE 1"=60'
DRAWN BY LEL
DATE 03/03/11
APPROVED PMF
DRAWING NO. CS-9804

GENERAL NOTES:

- THE VERTICAL DATUM IS CITY OF PHILADELPHIA VERTICAL DATUM.
- THE PURPOSE OF THIS PLAN IS TO DEPICT THE CONSTRUCTION OF A 1.5MW PHOTOVOLTAIC ARRAY SYSTEM. REFER TO "T" SERIES DRAWINGS FOR ELECTRICAL IMPROVEMENTS. REFER TO "S" SERIES DRAWINGS FOR STRUCTURAL IMPROVEMENTS.
- UTILITY NOTES
 - THE LOCATION OF THE EXISTING ON AND OFF SITE UNDERGROUND UTILITIES SHOWN ON THIS PLAN HAVE BEEN TAKEN FROM EXISTING UTILITY RECORDS AVAILABLE AT THE TIME THESE PLANS WERE PREPARED AND FROM SURFACE OBSERVATION OF THE SITE.
 - COMPLETENESS OR ACCURACY OF LOCATION AND DEPTH OF UNDERGROUND UTILITIES AND STRUCTURES IS NOT GUARANTEED.
 - IN ACCORDANCE WITH PA ACT 187, THE CONTRACTOR SHALL NOTIFY ALL UTILITIES WITHIN THE WORK AREA VIA THE PENNSYLVANIA ONE CALL SYSTEM, INC. (800-242-1776) A MINIMUM OF 3 WORKING DAYS BEFORE THE START OF EXCAVATION. THE CONTRACTOR SHALL VERIFY LOCATIONS AND DEPTHS OF ALL UNDERGROUND UTILITIES AND STRUCTURES BEFORE THE START OF WORK. THE NATURE AND EXISTING LOCATIONS OF EXISTING UTILITIES SHOULD BE VERIFIED PRIOR TO INITIATING ANY ACTIVITY THAT MAY AFFECT THEIR USE OR LOCATION.
 - IF CONFLICTS ARE FOUND THE CONTRACTOR SHALL IMMEDIATELY NOTIFY THE OWNER AND DESIGN ENGINEER FOR INSTRUCTION BEFORE PROCEEDING WITH WORK.
- ALL DIMENSIONS ARE IN UNITED STATES MEASUREMENT UNLESS OTHERWISE INDICATED AS PHILADELPHIA DISTRICT STANDARD (DS) MEASUREMENTS.
- ACCORDING TO THE SOIL SURVEY OF PHILADELPHIA COUNTY, PENNSYLVANIA ALL LANDS LOCAL AREA WITHIN THE BOUNDARY OF THIS PROJECT ARE CLASSIFIED AS URBAN LAND (UB).

SITE NOTES:

- WHERE NOT OTHERWISE SPECIFIED IN THE PLANS OR IN THE ACCOMPANYING DETAILS, THE REFERENCED MATERIALS AND CONSTRUCTION METHODS SHALL BE IN ACCORDANCE WITH THE APPLICABLE SPECIFICATIONS OF P.A. D.O.T. PUBLICATION 408 OR CITY SPECIFICATIONS, WHICHEVER IS MORE STRINGENT.
- NO SEWER OR WATER PROPOSED FOR THIS PROJECT.
- THE VERTICAL DATUM IS CITY VERTICAL DATUM.
- ALL WORK SHALL COMPLY WITH APPLICABLE STATE, FEDERAL AND LOCAL CODES AND ALL NECESSARY LICENSES AND PERMITS SHALL BE OBTAINED BY THE CONTRACTOR AT HIS EXPENSE UNLESS PREVIOUSLY OBTAINED BY THE OWNER/DEVELOPER.
- THE CONTRACTOR SHALL IMMEDIATELY INFORM THE ENGINEER OF ANY DISCREPANCIES OR ERRORS HE DISCOVERS IN THE PLAN.
- DEVIATION FROM THESE PLANS AND NOTES WITHOUT THE PRIOR CONSENT OF THE OWNER OR HIS REPRESENTATIVE OR THE ENGINEER MAY BE CAUSE FOR THE WORK TO BE UNACCEPTABLE.
- ALL MATERIALS SHALL BE NEW UNLESS USED OR SALVAGED MATERIALS ARE AUTHORIZED BY THE OWNER AND TENANT.
- NECESSARY BARRICADES, SUFFICIENT LIGHTS, SIGNS AND OTHER TRAFFIC CONTROL METHODS AS MAY BE NECESSARY FOR THE PROTECTION AND SAFETY OF THE PUBLIC, SHALL BE PROVIDED AND MAINTAINED THROUGHOUT THE CONSTRUCTION.
- HIGH INTENSITY LIGHTING FACILITIES SHALL BE SO ARRANGED THAT THE SOURCE OF ANY LIGHT IS CONCEALED FROM PUBLIC VIEW AND FROM ADJACENT RESIDENTIAL PROPERTY AND DOES NOT INTERFERE WITH TRAFFIC.
- THE CONTRACTOR SHALL MAINTAIN ACCESS FOR EMERGENCY VEHICLES AROUND AND TO ALL BUILDINGS NEAR CONSTRUCTION. I.E. IN TIMES OF RAIN OR MUD, ROADS SHALL BE ABLE TO CARRY A TRUCK BY BEING PAVED OR HAVING A CRUSHED STONE BASE, ETC. WITH A MINIMUM WIDTH OF 20 FEET. ACCESS TO BUILDINGS THAT HAVE SPRINKLER OR STANDPIPE SYSTEMS SHALL BE WITHIN 40 FEET OF THE FIRE DEPARTMENT CONNECTOR. (NFPA 1141 3-1).

SITE INFORMATION:

ADDRESS: PARCEL 2 (BRT # 78-8-0010-01) 4590 BASIN BRIDGE ROAD AND PARCEL 10 (BRT # 78-8-0055-01) 4621 BASIN BRIDGE ROAD PHILADELPHIA, PA 19112

OWNER: PHILADELPHIA AUTHORITY FOR INDUSTRIAL DEVELOPMENT (PAID) CENTER SQUARE WEST 1500 MARKET STREET PHILADELPHIA, PA 19102-2000

DEVELOPER: CONERGY PROJECTS, INC. 101 LINDENWOOD DRIVE, SUITE 130 MALVERN, PA 19355

REFERENCE:

- SURVEY INFORMATION TAKEN FROM A PLAN PREPARED BY PENNONI ASSOCIATES INC., ENTITLED, "EXISTING CONDITIONS/TOPOGRAPHIC SURVEY PLAN", LAST REVISED 08/26/08.
- LOCATIONS OF ON-SITE AND OFF-SITE UTILITIES AS SHOWN ARE APPROXIMATE AND MAY OR MAY NOT BE COMPLETE. THE NATURE AND EXACT LOCATION OF EXISTING UTILITIES SHOULD BE VERIFIED PRIOR TO INITIATING ANY ACTIVITY THAT MAY AFFECT THEIR USE OR LOCATION.
- PROPOSED DEVELOPMENT INFORMATION PROVIDED BY CONERGY PROJECTS, INC.
- EXISTING MONITORING WELL INFORMATION PROVIDED BY STONE AND WESTER ENVIRONMENTAL TECHNOLOGY AND SERVICES, CHERRY HILL, NJ. PLAN: FIGURE 11-2, GRAB POINT MANAGEMENT AREA, REVISED OCTOBER 2, 1996.
- PARCEL INFORMATION OBTAINED FROM PLANS ENTITLED, "PHILADELPHIA NAVAL BASE FINAL PLAT FOR TRANSFER FROM UNITED STATES NAVY TO PHILADELPHIA AUTHORITY FOR INDUSTRIAL DEVELOPMENT STAGE 1 PARCELS 2, 3 & 10" SHEET 2 OF 11 DATED 11/14/01, SHEET 3 OF 11 DATED 11/20/00, AND SHEET 4 OF 11 DATED 11/20/00, PREPARED BY VANDEMARK & LYNCH, INC.

LEGEND

- BOUNDARY LINE
- EXISTING BUILDINGS
- EXISTING EDGE OF PAVEMENT
- EXISTING RAILROAD TRACKS
- EXISTING MANHOLE
- EXISTING FIRE HYDRANT
- EXISTING FENCE LINE
- 3X9 PHOTOVOLTAIC ARRAYS WITH FOUNDATION
- 3X7 PHOTOVOLTAIC ARRAYS WITH FOUNDATION
- MONITORING WELL
- PROPOSED FENCE LINE

PHILADELPHIA NAVAL BUSINESS CENTER
DATUM COMPARISON

DATUM	CITY	NGVD 29	NAVD 88	PNSY
500 YEAR FLOOD	8.49	14.01	13.03	16.72
100 YEAR FLOOD	4.19	9.71	8.73	12.42
HIGH TIDE 1933	2.84	8.56	7.58	11.27
HIGH TIDE 1950	2.84	8.36	7.38	11.07
	0.00	5.50	4.54	8.21

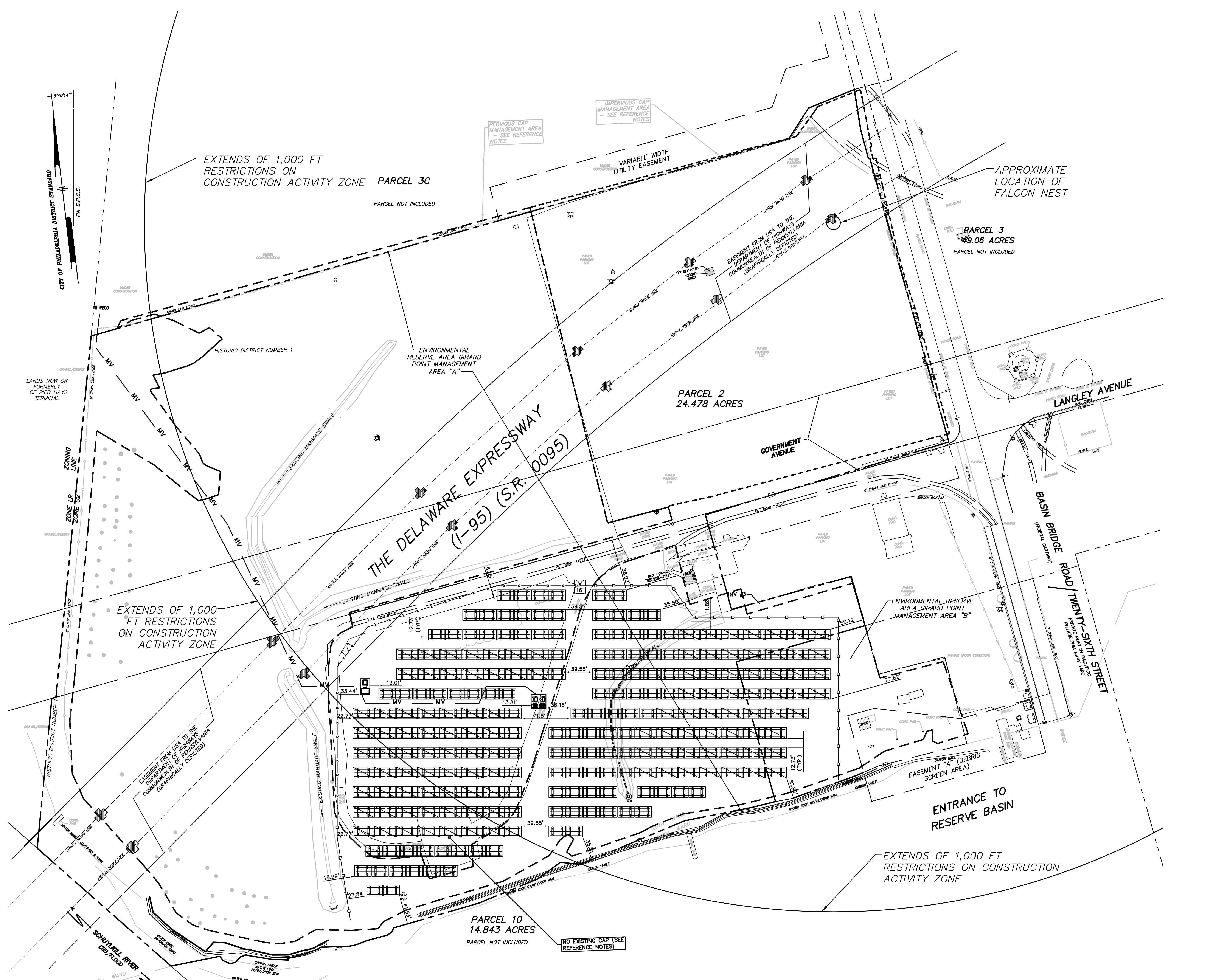
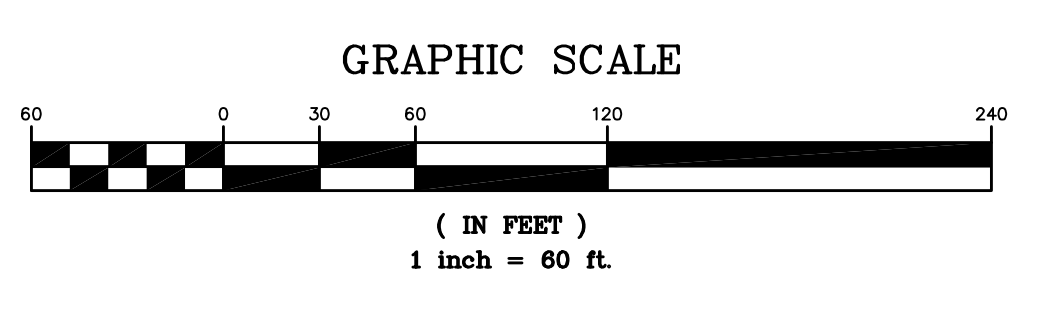

FLOOD ZONE INFORMATION:

BASED UPON THE JANUARY 17, 2007 FLOOD INSURANCE RATE MAP 42075701890, PANEL 189 OF 230, THE SUBJECT AREA IS LOCATED IN THE FOLLOWING AREAS:

ZONE AE - BASE FLOOD ELEVATION DETERMINED-10 FT NAD 83

ZONE X(SHADED) - AREAS OF 0.2% ANNUAL CHANCE FLOOD (500 YR FLOOD) (INDICATED AS X1 WITHIN THE DRAWING SET)

ZONE X - AREAS DETERMINED TO BE OUTSIDE THE 0.2% ANNUAL CHANCE FLOOD (INDICATED AS X2 WITHIN THE DRAWING SET)

NO FIELD SURVEYING WAS PERFORMED TO DETERMINE THIS ZONE AND AN ELEVATION CERTIFICATE MAY BE NEEDED TO VERIFY THIS DETERMINATION OR APPLY FOR A VARIANCE FROM THE FEDERAL EMERGENCY MANAGEMENT AGENCY.

- NOTES:**
- PA ONE-CALL NOTIFICATION: IN ACCORDANCE WITH PA ACT 287 OF 1974 AS AMENDED BY PA ACT 187, OF 1996, THE CONTRACTOR SHALL NOTIFY ALL UTILITIES WITHIN THE WORK AREA VIA THE PENNSYLVANIA ONE CALL SYSTEM, INC. (800-242-1776)
 - DEVELOPER IS IN THE PROCESS OF OBTAINING DEMOLITION PERMITS FOR BUILDING WITHIN PROPOSED LEASE AREA FOR ALTERNATE PHOTOVOLTAIC ARRAY LOCATIONS.

EXTENDS OF 1,000 FT RESTRICTIONS ON CONSTRUCTION ACTIVITY ZONE

PARCEL 3C
PARCEL NOT INCLUDED

PARCEL 3
9.06 ACRES
PARCEL NOT INCLUDED

PARCEL 2
24.478 ACRES

PARCEL 10
14.843 ACRES
PARCEL NOT INCLUDED

NO EXISTING CAP (SEE REFERENCE NOTES)

Appendix 19



Pennsylvania
Historical & Museum
Commission



Bureau for Historic Preservation
Commonwealth Keystone Building
400 North Street, 2nd Floor
Harrisburg, PA 17120-0093

FAX TRANSMITTAL SHEET

DATE: 7/23/10

ORGANIZATION: Corergy

ATTENTION: Andrew Welsh

FAX NUMBER: (866) 436-6114

From: Ann Sply Telephone Number: _____

Fax Number: 717/772-0920

NUMBER OF PAGES (including Cover Sheet): 2

COMMENTS: ER# 10-1539-101-B



Commonwealth of Pennsylvania
Pennsylvania Historical and Museum Commission
Bureau for Historic Preservation
Commonwealth Keystone Building, 2nd Floor
400 North Street
Harrisburg, PA 17120-0093
www.phmc.state.pa.us

23 July 2010

Andrew Welsh
Conergy Projects
101 Lindenwood Drive
Suite 130
Malvern, PA 19355

TO EXPEDITE REVIEW USE
BHP REFERENCE NUMBER

RE: ER# 10-1539-101-B
DOE: Exelon-Conergy Solar Center II Project, Naval Shipyard, Philadelphia

Dear Mr. Welsh:

The Bureau for Historic Preservation (the State Historic Preservation Office) has reviewed the above named project in accordance with Section 106 of the National Historic Preservation Act of 1966, as amended in 1980 and 1992, and the regulations (36 CFR Part 800) of the Advisory Council on Historic Preservation as revised in 1999 and 2004. These regulations require consideration of the project's potential effect upon both historic and archaeological resources.

In our opinion no archaeological resources will be affected by this project.

The above referenced project is located in the National Register listed **Philadelphia Naval Shipyard Historic District**. In our opinion the placement of a photovoltaic system in the proposed area should have no adverse effect upon this historic resource. However, this finding is conditional upon retention of the existing buildings in the project area, which contribute to the significance of the historic property. We look forward to discussing the feasibility of developing the proposed project while retaining these buildings.

If you need further assistance in this matter, contact Ann Safley at (717) 787-9121.

Sincerely

A handwritten signature in cursive script, appearing to read 'Ann Safley'.

Douglas C. McLearen, Chief
Division of Archaeology & Protection

DMcL/ras

Appendix 20

PHASE I ENVIRONMENTAL SITE ASSESSMENT

**1413 Langley Avenue, Parcels 2 and 10 (portion of)
Philadelphia Naval Business Center
Philadelphia, Philadelphia County, Pennsylvania 19112**

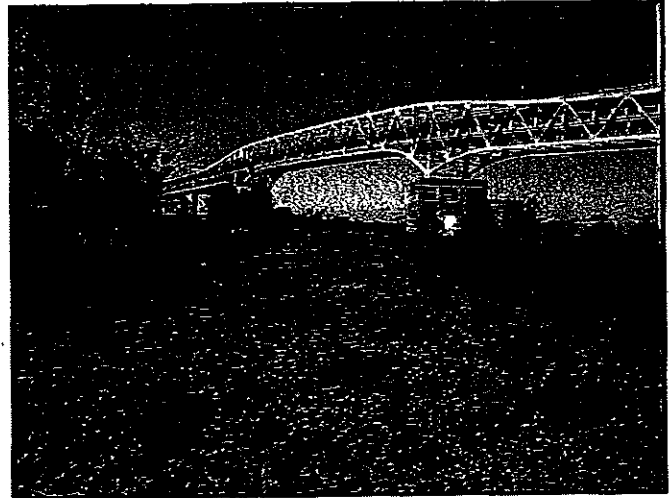

Submitted To:

Mr. Peter Alyanakian
EPURON
1500 Walnut Street, Suite 1501
Philadelphia, Pennsylvania 19102

Submitted By:

Pennoni Associates Inc.
One Drexel Plaza
3001 Market Street
Philadelphia, Pennsylvania 19104

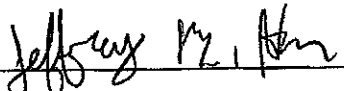

Jeffrey M. Ham
Associate Environmental Scientist



William F. Schmidt, P.E.
Associate Vice President

Proj. No. EPUR 0801

October 28, 2008

TABLE OF CONTENTS

	<u>Page</u>
EXECUTIVE SUMMARY	iii
Findings and Opinion.....	iv
Conclusions.....	iv
1.0 INTRODUCTION.....	1
1.1 Purpose.....	1
1.2 Scope of Work	2
1.3 Limitations, Exceptions, Special Terms and Conditions	2
1.4 User Reliance	2
2.0 SUBJECT PROPERTY DESCRIPTION.....	3
2.1 Subject Property Location and Legal Description	3
2.2 Subject Property Characteristics	4
2.2.1 Current Use of the Subject Property	4
2.2.2 Site Structures	4
2.2.3 Site Utilities	4
2.3 Current Uses of Adjoining Properties and Properties in the Surrounding Area	4
3.0 USER PROVIDED INFORMATION.....	5
4.0 PHYSICAL SETTING	7
4.1 Topography/Regional Drainage.....	7
4.2 Soils	7
4.3 Underlying Formation.....	7
4.4 Groundwater	8
4.5 Water Migratory Pathways	8
5.0 HISTORICAL RECORDS	9
5.1 Aerial Photographs	10
5.2 Historical Maps.....	101
5.3 Property Tax Files.....	101
5.4 Recorded Land Title Records	122
5.5 Historical Topographical Maps	13
5.6 Local Street Directories	13
5.7 Building Department Records	13
5.8 Zoning/Land Use Records	13
5.9 Previous Environmental Reports	14
6.0 REGULATORY AGENCY RECORDS REVIEW	17
6.1 Standard Environmental Record Sources, Federal and State	17
6.1.1 Subject Property.....	18
6.1.2 Adjacent and Surrounding Properties -- Facilities of Potential Concern	18
6.1.3 Orphan Sites.....	20
6.2 Additional Environmental Records Sources -- State and Federal	20
6.2.1 Pennsylvania Department of Environmental Protection.....	20

6.2.2	United States Environmental Protection Agency	21
6.3	Additional Environmental Records Sources – Regional and Local	21
6.3.1	City of Philadelphia, Department of Licenses and Inspections	21
6.3.2	City of Philadelphia, Water Department.....	21
7.0	SITE RECONNAISSANCE.....	212
7.1	General Observations – Exterior Areas	22
7.2	General Observations – Interior Areas	22
7.3	Hazardous Substances in Connection with Identified Uses.....	22
7.4	Storage Tanks	23
7.5	Floor Drains and/or Sumps	23
7.6	Other Observations	23
7.7	Polychlorinated Biphenyls (“PCBs”).....	23
7.7.1	Transformers and Capacitors	24
7.7.2	Fluorescent Light Ballasts	24
7.7.3	Elevators and Hydraulic Equipment	24
7.8	Non-Scope Considerations	24
7.8.1	Asbestos-Containing Material (“ACM”)	24
7.8.2	Lead-Based Paint	26
7.8.3	Lead in Drinking Water	27
7.8.4	Wetlands	27
7.8.5	Radon Gas.....	27
7.8.6	Mold.....	27
8.0	INTERVIEWS.....	29
8.1	Present Owners, Operators and Occupants.....	29
8.2	Past Owners, Operators and Occupants	29
8.3	State and/or Local Government Officials	29
9.0	DATA GAPS.....	30
10.0	FINDINGS.....	31
11.0	OPINION AND CONCLUSIONS.....	32
12.0	NON-SCOPE CONSIDERATIONS.....	34
13.0	ENVIRONMENTAL PROFESSIONAL STATEMENT AND SIGNATURE.....	35
14.0	REFERENCES.....	36

APPENDICES

- A Figures
- B Environmental Database Report
- C Supporting Documentation
- D Photographs

EXECUTIVE SUMMARY

On behalf of EPURON ("Client"), Pennoni Associates, Inc. ("Pennoni") has performed a Phase I Environmental Site Assessment ("ESA") of the property at 1413 Langley Avenue which includes a portion of Parcels 2 and 10, in the Philadelphia Naval Business Center at Girard Point, Philadelphia County, Philadelphia, Pennsylvania, 19112 ("subject property"). The subject property is located in an area referred to as "Environmental Reserve Area." Parcel 2 is designated as Management Area "A." The area of Parcel 2 previously capped with approximately two (2) to three (3) feet of fill is the portion of Parcel 2 that comprises the subject property; the area containing Buildings 825, 548, and 668 and the land immediately surrounding those buildings, within the limits of Parcel 2, is not part of the subject property. The portion of Parcel 10 that comprises the subject property includes the areas designated as Management Area "B" and Easement "A" (Debris Screen Area). With the exception of a right-of-way for an elevated section of Interstate 95, which traverses the subject property, and a shed within Easement "A," the subject property consists of undeveloped, vegetated land adjacent to the Schuylkill River and Reserve Basin.

Pennoni conducted the ESA in general conformance with the scope and limitations the American Society for Testing and Materials ("ASTM") Standard Practice for Environmental Site Assessments: Phase I Environmental Site Assessment Process, Designation E 1527-05. ASTM E 1527-05 is a voluntary consensus standard that constitutes "all appropriate inquiry into the previous ownership and uses of the property consistent with good commercial or customary practice." The procedures included in the ASTM E1527-05 standard comply with the United States Environmental Protection Agency ("USEPA") 40 CFR Part 312, Standards and Practices for All Appropriate Inquiries; Final Rule.

The primary objective of the Phase I ESA was to identify recognized environmental conditions ("RECs") in connection with the subject property. A REC is defined as the presence or likely presence of any hazardous substance or petroleum products on a property under conditions that indicate an existing release, a past release, or a material threat of release of any hazardous substances or petroleum products into structures on the property or into the ground, groundwater, or surface water of the property.

To identify RECs in connection with the subject property, Pennoni's Phase I ESA included a records review; a site reconnaissance; interviews with current and past owners, operators, and occupants of the subject property; interviews with local, state, and federal government officials; a review of information provided by the User (i.e., the party seeking to complete an environmental site assessment of the subject property); and preparation of a report presenting Pennoni's findings, opinions, conclusions and supporting documentation. The Phase I ESA for the subject property did not include any testing or sampling of materials (e.g., soil, water, air, building materials).

Our findings, opinions, and conclusions regarding RECs in connection with the subject property are summarized below. Results of our evaluation of non-scope considerations including suspect asbestos-containing building materials ("ACM"), suspect lead-based paint, lead in drinking water, wetlands, flood zones, radon, and mold are also summarized below.

FINDINGS

The key findings of Pennoni's Phase I ESA for the subject property, including non-scope considerations, are discussed below and are summarized in the Findings Summary Table. Our findings include known or suspect RECs, historical RECs, and de minimus conditions in connection with the subject property, if any.

FINDINGS SUMMARY TABLE

Environmental Conditions	Not Identified/No Significant Finding	Identified/Deemed De minimus /Not a REC	REC	Further Inv. Rec'd./Action Needed
Historical Review			X	None
On-Site Industrial Operations			X	None
User Provided Information			X	None
Adjoining Properties of Concern			X	None
Regulatory Agency Review	X			
Hazardous Substances	X			
Storage Tanks	X			
Floor Drains/Sumps	X			
Other Issues – stains and corrosion, drains, sumps, stressed vegetation, solid waste, septic systems, etc.	X			
PCBs	X			
Asbestos-Containing Materials*	X			
Lead-based Paint*	X			
Lead in Drinking Water*	X			
Wetlands	X			
Radon*	X			
Mold	X			

*Collection and analysis of samples from the subject property is necessary to determine whether or not these environmental conditions are a concern at the subject property.

OPINION AND CONCLUSIONS

Pennoni has performed a Phase I ESA of the subject property in general conformance with the scope and limitations of the ASTM Standard Practice for Environmental Site Assessments: Phase I Environmental Site Assessment Process, Designation E 1527-05. This assessment has revealed the following RECs in connection with the subject property:

- The subject property consisted of areas formerly associated with the Philadelphia Naval Base ("PNB") which were utilized as the Girard Point Incinerator, landfills and a parking lot that was also utilized as a storage area for hazardous and non-hazardous wastes by the United States ("US") Navy.
- The current land use documentation for the subject property identifies deed restrictions with respect to groundwater drawn from wells shall not be used or made available for human consumption; no permanent residences shall be constructed or otherwise developed and no portion shall be used as a permanent residence; construction or development of an outdoor childcare playground must include two (2) feet of clean fill material, or other cover, as approved by the Pennsylvania Department of Environmental Protection ("PADEP"), between the underlying soil and the surface of the playground prior to commencement of its use.
- Previous reports provided for review and inclusion in this report identified sources and locations of contamination within the current boundaries of the subject property. The Girard Point Management Area ("GPMA") of the Philadelphia Naval Base (which includes the subject property) was divided into two (2) work areas, Zone A and Zone B. Zone A covers approximately twenty (20) acres and consists of Installation Restoration Program ("IR") Site 3, IR Site 4, IR Site 5, and Building 993 (Industrial Wastewater Treatment Building). Zone B covers approximately five (5) acres and consists of the Northwest Parking Lot ("NWPL"). The subject property consists of the IR Site 4, IR Site 5, and the NWPL parcels. The IR Site 4 parcel is a 6 acre landfill area used for the disposal of ash and debris generated by the Girard Point Incinerator (Building 668) as well as solid wastes that could not be incinerated. The IR Site 5 parcel is a 5 acre landfill area containing spent blasting grit, construction debris, and incinerator ash from the Girard Point Incinerator and solid waste that could not be incinerated. The NWPL parcel is a 4 acre area used prior to 1950 as a parking lot and in the early 1980's as a storage area for hazardous and non-hazardous wastes by the US Navy.

The remediation activities reported for the Zone A and Zone B portions of the subject property consisted of the construction of a permeable cover cap in Zone A and the construction of an asphalt cap in Zone B.

Based upon the site inspection conducted by Pennoni, the engineering controls proposed for the subject property have been constructed and are adequately serving their intended purpose. If the engineering and institutional controls are properly maintained, no additional adverse impact to the subject property is anticipated. Therefore, no further investigation is required with respect to the soil and groundwater impacts previously identified on the subject property.

1.0 INTRODUCTION

On behalf of EPURON (“Client”), Pennoni Associates, Inc. (“Pennoni”) has performed a Phase I Environmental Site Assessment (“ESA”) of the property at 1413 Langley Avenue which includes a portion of Parcels 2 and 10, in the Philadelphia Naval Business Center at Girard Point, Philadelphia County, Philadelphia, Pennsylvania, 19112 (“subject property”). The subject property is located in an area referred to as “Environmental Reserve Area.” Parcel 2 is designated as Management Area “A.” The area of Parcel 2 previously capped with approximately two (2) to three (3) feet of fill is the portion of Parcel 2 that comprises the subject property; the area containing Buildings 825, 548, and 668 and the land immediately surrounding those buildings, within the limits of Parcel 2, is not part of the subject property. The portion of Parcel 10 that comprises the subject property includes the areas designated as Management Area “B” and Easement “A” (Debris Screen Area). With the exception of a right-of-way for an elevated section of Interstate 95, which traverses the subject property, and a shed within Easement “A,” the subject property consists of undeveloped, vegetated land adjacent to the Schuylkill River and Reserve Basin.

Pennoni conducted the Phase I ESA in general conformance with the scope and limitations of the American Society for Testing and Materials (“ASTM”) Standard Practice for Environmental Site Assessments: Phase I Environmental Site Assessment Process, Designation E 1527-05. The procedures included in the ASTM E1527-05 standard comply with the United States Environmental Protection Agency (“USEPA”) 40 CFR Part 312, Standards and Practices for All Appropriate Inquiries; Final Rule.

ASTM E 1527-05 is a voluntary consensus standard that constitutes “all appropriate inquiry into the previous ownership and uses of the property consistent with good commercial or customary practice.” The ASTM practice is intended to permit a User (i.e., the party seeking to complete an environmental site assessment of the subject property, in this case, EPURON) to satisfy one of the requirements to qualify for the innocent landowner, contiguous property owner, or bona fide prospective purchaser limitations on Comprehensive Environmental Response, Compensation and Liability Act (“CERCLA”) liability (i.e., landowner liability protections or LLPs). The practice does not address whether requirements in addition to all appropriate inquiry have been met in order to qualify for LLPs (e.g., continuing obligations not to impede the integrity and effectiveness of AULs, the duty to take reasonable steps to prevent releases, or the duty to comply with legally required release reporting obligations).

ASTM E 1527-05 does not include any testing or sampling of materials (e.g., soil, water, air, building materials).

This report presents the findings, opinions, and conclusions, and supporting documentation for the Phase I ESA of the subject property, completed by Pennoni as of the date of this report. Information made available to Pennoni after this date, which would change the conclusions of this report, will be forwarded upon receipt.

1.1 Purpose

The purpose of the assessment was to identify recognized environmental conditions (“RECs”) in connection with the subject property. A REC is defined as the presence or likely presence of any hazardous substance or petroleum products on a property under conditions that indicate an existing release, a past release, or a material threat of release of any hazardous substances or petroleum

products into structures on the property or into the ground, groundwater, or surface water of the property.

1.2 Scope of Work

Pennoni's Phase I ESA for the subject property included a records review; site reconnaissance; interviews with past and present owners, operators, and occupants of the subject property; interviews with local, state, and federal government officials; review of information provided by the User; and preparation of this report presenting Pennoni's findings, opinions, conclusions and supporting documentation, as referenced in our Proposal # ZZZ08-9330 (2) dated May 8, 2008, revised May 17, 2008.

The Environmental Professional responsible for preparation of this report has the specific qualifications, based on education, training, and experience to assess a property of the nature, history, and setting of the subject property. Mr. William F. Schmidt meets the definition of an "Environmental Professional" as defined in the ASTM standard and AAI regulation. The Environmental Professional Statement and Signature are presented in Section 11.0 of this report. The report was reviewed by Mr. William F. Schmidt, P.E., Associate Vice President of Pennoni Associates, Inc. Mr. Schmidt was supported by Ms. Cynthia D. Shaw, LEED AP, Senior Environmental Consultant, and Mr. Jeff Ham, Associate Environmental Scientist.

1.3 Limitations, Exceptions, Special Terms and Conditions

Pennoni conducted a Phase I ESA of the subject property in general conformance with the scope and limitations of ASTM Standard E 1527-05. The Phase I ESA for the subject property did not deviate from this standard. Data gaps that would affect the ability of the environmental professional to identify RECs are identified in Section 9.0 of this report. This Phase I ESA is valid provided that it has been completed within 180 days prior to the acquisition of the subject property or the date of the intended transaction.

1.4 User Reliance

This report and findings, conclusions, and recommendations contained herein, are furnished for the sole use and benefit of the Client to aid in understanding the environmental condition and potential liabilities of the subject property. This report may not be assigned, quoted, reproduced, relied upon, or otherwise used without the express prior written consent of Pennoni.

All documents prepared by Pennoni Associates Inc. are the instruments of service in respect of the project. They are not intended or represented to be suitable for reuse by owner or others on extensions of the project or on any other project.

Any reuse without the written verification or adaptation by Pennoni Associates Inc. for the specific purpose intended will be at owner's sole risk and without liability or legal exposure to Pennoni Associates and owner shall indemnify and hold harmless Pennoni Associates Inc. from all claims, damages, losses, and expenses arising out of or resulting there from.

2.0 SUBJECT PROPERTY DESCRIPTION

The following paragraphs provide a description of the subject property including its location, general characteristics, and current use. Current uses of adjoining properties and properties in the surrounding area are also described below.

2.1 Subject Property Location

The subject property is located west of the intersection of Langley Avenue and Basin Bridge Road in Philadelphia, Pennsylvania. The subject property is shown on the United States Geological Survey ("USGS") 7.5- minute topographic quadrangle for Philadelphia, Pennsylvania-New Jersey, and the center of the subject property is located at the following map coordinates: 39.894197 degrees North latitude, 75.194982 degrees West longitude. A copy of the topographic quadrangle map, showing the location of the subject property, is provided in Appendix A and titled "Property Location Map."

The subject property consists of an irregularly-shaped tract of land approximately 16 acres in size, generally bounded by a Tasty Baking Company development site to the north, Basin Bridge Road to the east, the Schuylkill River to the south and southwest, and a pier to the west. The subject property includes a portion of Parcels 2 and 10 in the Philadelphia Naval Business Center at Girard Point, Philadelphia, Pennsylvania, 19112. The subject property is located in an area referred to as "Environmental Reserve Area." Parcel 2 is designated as Management Area "A." The area of Parcel 2 previously capped, with approximately two (2) to three (3) feet of fill, is the portion of Parcel 2 that comprises the subject property; the area containing Buildings 825, 548, and 668 and the land immediately surrounding those buildings, within the limits of Parcel 2, is not part of the subject property. The portion of Parcel 10 that comprises the subject property includes the areas designated as Management Area "B" and Easement "A" (Debris Screen Area) within the Environmental Reserve Area. The boundaries and general features of the subject property are depicted in the Site Plan, which is included in Appendix A.

The subject property is located within a 25-acre area of the northwest portion of the former Philadelphia Naval Base ("PNB") referred to as the Girard Point Management Area and designated as Zone 1C in the Base Realignment and Closure Act ("BRAC") Cleanup Plan, dated April 1999. The United States Navy ("Navy") had previously utilized the Girard Point Management Area, which encompasses the subject property, for the treatment, storage, and disposal of solid wastes generated at the PNB.

In 1995, a substantial portion of the PNB was closed and made available to Philadelphia Authority for Industrial Development ("PAID") for non-military use. On March 30, 2000, the United States, acting through the Navy, transferred approximately 1200 acres of the former PNB to PAID. PAID subsequently redesignated this property as the "Philadelphia Naval Business Center" ("PNBC") and it is now commonly known as The Navy Yard.

On September 18, 2008, Pennoni visited the City of Philadelphia, Department of Records to obtain tax parcel numbers for the subject property. The tax parcel numbers corresponding to Parcels 2 and 10 are 45-S-24-0002 and 45-S-24-0011, respectively. Parcels 2 and 10 are designated as Lots 2 and 11 on the tax parcel maps contained in the Department of Record files. Pennoni was unable to obtain a copy of these maps.

2.2 Subject Property Characteristics

The following paragraphs describe the general characteristics of the subject property, including its current use and a description of structures, roads, and other improvements (i.e., heating/cooling system, sewage disposal, source of potable water, etc.) on the subject property.

2.2.1 Current Use of the Subject Property

With the exception of a right-of-way for an elevated section of Interstate 95, which traverses the subject property, and a shed within Easement "A," the subject property consists of undeveloped, vegetated land adjacent to the Schuylkill River and Reserve Basin.

2.2.2 Site Structures

Other than support structures for an elevated section of Interstate 95, and a shed on the portion of Parcel 10 designated as Easement "A," there are no structures on the subject property.

2.2.3 Site Utilities

Water and sewer service are provided by City of Philadelphia. Electric service is provided by Duke Energy through PIDC, and natural gas service is provided by Philadelphia Gas Works.

2.3 Current Uses of Adjoining Properties and Properties in the Surrounding Area

Adjoining properties, and properties and roads in the area surrounding the subject property, are identified below.

- North – Land being developed by Tasty Baking Company is north of the subject property beyond which is the land proposed for development as the Commerce Center at Girard Point.
- South – The Schuylkill River and Reserve Basin are south of the subject property, beyond which is the Delaware River.
- East – Other properties within the Philadelphia Naval Business Center, where the subject property is located, are east of the subject property.
- West – The Schuylkill River is west of the subject property.

3.0 USER PROVIDED INFORMATION

As defined by ASTM E1527-05, in order to qualify for one of the LLPs, the User must provide the following information, if available, to the Environmental Professional:

- environmental cleanup liens that are filed or recorded against the subject property;
- activity and use limitations that are in place on the subject property or that have been filed or recorded in a registry;
- specialized knowledge or experience of the person seeking to qualify for the LLP;
- the relationship of the purchase price to the fair market value of the subject property if it were not contaminated;
- commonly known or reasonably ascertainable information about the property; and
- the degree of obviousness of the presence or likely presence of contamination at the subject property, and the ability to detect the contamination by appropriate investigation.

3.1 Environmental Liens and/or Activity and Use Limitations

The Client is aware that the subject property was previously utilized as a landfill, and that soil and groundwater beneath the subject property have been impacted with regulated compounds. Furthermore, the Client understands that engineering controls—specifically a combination of a permeable cover cap and an asphalt cap—have been constructed on the subject property in order to eliminate exposure to impacted soil and groundwater. The Client is also aware that activity and use limitations (“AULs”) have been imposed on the subject property due to the presence of the impacted soil and groundwater and the placement of the cap on the property. Pennoni reviewed the current deed for the subject property as part of this Phase I ESA; based upon this review, Pennoni has identified institutional and engineering controls in connection with the subject property. This will be discussed in detail in Sections 5.4 – Recorded Land Title Records and 5.9 – Previous Environmental Reports.

3.2 Specialized Knowledge

The Client does not have any specialized knowledge or experience related to the subject property or nearby properties.

3.3 Commonly Known or Reasonably Ascertainable Information

The Client is aware that the subject property was previously utilized as a landfill, and that soil and groundwater beneath the subject property have been impacted with regulated compounds. The Client instructed Pennoni to consult with Mr. Tom Detito, an archivist with Cushman and Wakefield, in order to obtain additional information relating to the environmental history of the subject property.

3.4 Valuation Reduction for Environmental Issues

The Client did not disclose the prospective purchase price for the subject property; therefore, Pennoni is unable to comment on whether the purchase price being paid for subject property reasonably reflects the fair market value of the subject property.

3.5 Presence or Likely Presence of Contamination at the Subject Property

The Client is aware that the subject property was previously utilized as a landfill, and that soil and groundwater beneath the subject property have been impacted with regulated compounds. Furthermore, the Client understands that engineering controls—specifically a combination of a permeable cover cap and an asphalt cap—have been constructed on the subject property in order to eliminate exposure to impacted soil and groundwater.

4.0 PHYSICAL SETTING

Pennoni reviewed a current United States Geologic Survey ("USGS") 7.5 Minute Topographic Map for the Philadelphia, Pennsylvania-N.J. Quadrangle showing the subject property and surrounding areas.

Pennoni also reviewed additional discretionary and non-standard physical setting sources, including the United States Department of Agriculture ("USDA"), Natural Resource Conservation Service ("NRCS"), Web Soil Survey, and the Atlas of Preliminary Geologic Quadrangle Maps of Pennsylvania.

Information gathered from these sources is presented below.

4.1 Topography/Regional Drainage

According to the United States Geological Survey ("USGS") 7.5- minute topographic quadrangle for Philadelphia, Pennsylvania-N.J., the subject property is at an elevation of approximately 18 feet above mean sea level. A review of the topographic map showing the subject property and observations of local topography made during the site reconnaissance, indicate that the subject property slopes to the south toward the Schuylkill River and Reserve Basin.

Surface water on the subject property is expected to drain to the south toward the Schuylkill River. Regionally, the area is drained by the Delaware River, located approximately ½-mile south of the subject property.

4.2 Soils

According to the USDA-NRCS Web Soil Survey, the soils on the subject property are classified as Urban Land (Ub).

According to the United States Department of Agriculture's publication *Soil Survey for Philadelphia and Bucks Counties, Pennsylvania*, the soils on the subject property consist of Urban Land (Ub). This land type consists of cut and fill areas, most of which have been developed for residential, commercial, or industrial use or for multilane highways. During development, the original soil horizon was destroyed in at least 70 percent of the area. Areas of both cut and fill are moderately or rapidly permeable. Where the original soil was removed and the substratum exposed, the material remaining is rapidly permeable and extremely low in organic-matter content and fertility.

4.3 Underlying Formation

According to the 1981 Atlas of Preliminary Geologic Quadrangle Maps of Pennsylvania, the underlying formation at the subject property is the Trenton Gravel (Q_T).

According to DCNR's *Engineering Characteristics of the Rocks of Pennsylvania* (Environmental Geology Report 1), 2nd edition, 1982, the Trenton Gravel is approximately 30 feet thick and consists of gray to pale-reddish-brown, very gravelly sand, inter-bedded with cross-bedded sand and silt layers. The Trenton Gravel occurs at between 0 and 20 feet amsl in the Delaware River Valley and was deposited by the alluvial processes of the Delaware River. Porosity and permeability are high and wells may have yields in excess of 1,000 gallons per minute.

4.4 Groundwater

Groundwater is expected to flow to the south, parallel to the surface gradient. Groundwater would be expected to be located in the joints and fractures of the underlying formation. In order to further determine groundwater conditions on the subject property, however, a property-specific hydrogeologic investigation would be necessary.

4.5 Water Migratory Pathways

Potential migratory pathways for surface water and groundwater entering and exiting the subject property are important in establishing the potential for surrounding areas to impact the subject property or for the subject property to impact neighboring properties that are downgradient. Local topography slopes to the south toward the Schuylkill River. Therefore, surface water and groundwater are expected to migrate from the properties located north of the subject property.

5.0 HISTORICAL RECORDS

The purpose of consulting historical records is to develop a history of the previous uses of the subject property and surrounding area in order to help identify the likelihood of past uses having led to RECs in connection with the subject property.

ASTM E 1527-05 requires identification of all obvious uses of the subject property from the present, back to the subject property's first developed use (including agricultural uses and placement of fill dirt), or back to 1940, whichever is earlier. As such, Pennoni reviewed as many of the standard historical sources (i.e., aerial photographs, fire insurance maps, property tax files, recorded land title records, USGS topographic maps, local street directories, building department records, zoning/land use records, etc.) as were necessary and both reasonably ascertainable and practically reviewable (i.e., publicly available, obtainable from its source within reasonable time and cost constraints), and sufficiently useful by the Environmental Professional.

5.1 Aerial Photographs

Available aerial photographs were reviewed to determine past uses and conditions of the subject property. An aerial photograph published by the Aero Service Corps for the year 1944 with a scale of one (1) inch equal to 500 feet were reviewed at the Free Library of Philadelphia. Delaware Valley Regional Planning Commission ("DVRPC") aerial photographs were reviewed for the years 1965, 1970, 1975, 1980, 1985, 1990, and 1995 with a scale of one (1) inch equal to 400 feet. Additional DVRPC aerial photographs from 2000 and 2005 with a scale of one (1) inch equal to 200 feet were also reviewed. The following is a brief narrative of the aerial photographic review:

- 1944 – The subject property is not improved with any structures. Buildings 825, 548 and 668 located adjacent to the subject property are visible in the aerial photograph. The area of the subject property to the east and west of these buildings appears to be disturbed, most likely as a result of landfilling activities conducted by the US Navy. The northern portion of the subject property and the area directly adjacent to the west of Basin Bridge Road appears to be used for the storage of materials and vehicles.
- 1965 – No significant changes to the subject property or surrounding area from the 1944 aerial photograph are apparent.
- 1970 – The photograph shows parked trucks and other vehicles on the portion of the subject property adjacent to the west of Basin Bridge Road. Construction of Interstate 95 is underway. The area of the subject property to the east of buildings 825, 548 and 668 is still disturbed, most likely due to its use as a landfill.
- 1975 – The landfilling operations in the area between buildings 825, 548 and 668 and Basin Bridge Road on the subject property have expanded. The northeast portion of the subject property consists of an asphalt-paved vehicle/material storage area. Interstate 95 has been constructed; the land beneath and on either side of it is vacant.
- 1980 – Landfilling activity in the southern portion of the subject property appears to have ceased, and vegetation covers the area. No vehicles/materials are stored in the northeast

portion of the subject property. No other significant changes to the subject property or surrounding area from the 1975 aerial photograph are apparent.

- 1985 – There is much less activity on all areas of the subject property near Basin Bridge Road compared to earlier photographs; most of the area is vacant with the exception of what appear to be some small storage buildings.
- 1990 – The aerial photograph shows a parking lot with many vehicles in the southeast portion of the subject property adjacent to the west of Basin Bridge Road. There also appear to be either rectangular-shaped storage sheds or trailer-type trucks on the subject property. There is significant activity on the area of the subject property adjacent to the Reserve Basin compared to earlier photographs. The northernmost portion of the subject property is mostly vacant with the exception of what appears to be several small storage buildings/sheds. There is a disturbed area on Parcel 2, north of where Interstate 95 traverses the subject property. The remainder of the subject property is vacant.
- 1995 – Some of the parking lot shown in the 1990 photograph appears to have been removed. This area of the subject property appears to contain many trailer-size storage containers. There is significantly less activity on the subject property compared to 1990. The area of the subject property between the property where Buildings 825, 548 and 668 are located and Basin Bridge Road is mostly cleared/vacant except for what appears to be several vehicles or storage containers. The northernmost portion of the subject property is cleared/vacant. The remainder of the subject property is vacant.
- 2000 – With the exception of what appears to be a small building on the eastern portion of the subject property, the subject property is vacant.
- 2005 – No significant changes to the subject property from the 2000 aerial photograph are apparent. An asphalt paved area has been constructed north of Parcel 2, adjacent to Basin Bridge Road.

5.2 Historical Maps

Available historical maps, including property atlases and street maps, were reviewed to determine past uses and conditions of the subject property. Historic property atlases and insurance maps obtained from the Greater Philadelphia GeoHistory Network website (<http://www.philageohistory.org/geohistory/index.cfm>) were reviewed for the years 1843, 1855, 1860, 1888, 1895, 1903, and 1910. In addition, Pennoni reviewed historic land use maps for the years 1942, 1962, and 1967. The following is a brief narrative of the historical map review:

- 1843 Philadelphia County, Charles Ellet, Jr. – the map shows the subject property as undeveloped land; the map shows Providence Island and Mud Island southwest of Girard's Point, and League Island to the southeast of Girard's Point
- 1855, Philadelphia City, R.L. Barnes – the map shows the subject property as undeveloped land; the map also shows Mud Island to the southwest, and the Back Channel and League Island to the southeast of the subject property
- 1860, Atlas of the City of Philadelphia, Samuel L. Smedley – the map shows the subject

property as undeveloped land; the map shows Girard's Point, League Island to the southeast across the Back Channel, and Mud Island to the southwest across the Schuylkill River

- 1888, Baist's Property Atlas of the City of Philadelphia, Penn – the map shows Girard Point; and several basins along the Schuylkill River, with railroad lines adjacent/parallel to them; Mud Island is shown southwest of Girard Point across the Schuylkill River; an area labeled "League Island, US Navy Yard" is shown southeast of Girard Point across the Back Channel.
- 1895, Atlas of the City of Philadelphia, George W. and Walter S. Bromley – the map shows Girard Point and several basins along the Schuylkill River, with railroad lines adjacent/parallel to them; Government Avenue is shown on the southern portion of Girard Point along the Back Channel; an area labeled "League Island, US Navy Yard" is shown southeast of Girard Point across the Back Channel; Mud Island is shown on the map, southwest of Girard Point, across the Schuylkill River.
- 1903, Philadelphia Streets, Dodd, Mead & Co. – the map shows Girard Point, although not labeled as such, and Government Avenue on the southern portion of Girard Point along the Back Channel; four basins are shown to the west of Girard Point along the Schuylkill River; an area labeled "League Island, US Navy Yard" is southeast of Girard Point, across the Back Channel
- 1910, Atlas of the City of Philadelphia, Geo W. and Walter S. Bromley – the map shows Girard Point; several basins are shown along the Schuylkill River, with railroad lines adjacent/parallel to them; Mud Island, Back Channel, Government Ave are labeled on the map; the area labeled "League Island" on earlier maps is labeled "Phila Navy Yard"
- 1942, Land Use Map – the map shows Girard Point and Government Avenue; the area west of Basin Bridge Road is labeled "V;" the area adjacent to the Schuylkill River is labeled "Boat Houses"
- 1962, Land Use Map – the subject property is labeled as "United States of America (US Navy Yard);" land west and adjacent to the subject property is labeled "Girard Point;" the Reserve Basin is labeled on the map; property north of the subject property is labeled "Franklin Delano Roosevelt Park" and "Golf Club."
- 1967, US Naval Base, Philadelphia – the subject property is identified as containing Public Works Storage Areas. A lumber yard and scrap yard are shown on the land north and adjacent to the subject property. Buildings 825, 548, and 668 are shown on the map.

5.3 Property Tax Files

Property tax files include records of past ownership, appraisals, maps, sketches, photos, or other information pertaining to the property. Pennoni reviewed property tax records at the City of Philadelphia, Department of Records. Philadelphia Authority for Industrial Development is listed as the current owner of the subject property; they have owned the property since March 30, 2000. No other historical property tax files were reviewed for the subject property as part of this Phase I ESA.

5.4 Recorded Land Title Records

Recorded land title records include records of historical fee ownership, including leases, land contracts and AULs on or of the subject property.

As indicated in Section 2.1, the subject property includes a portion of Parcels 2 and 10, in the Philadelphia Naval Business Center at Girard Point, Philadelphia County, Philadelphia, Pennsylvania, 19112. The subject property is located in an area referred to as "Environmental Reserve Area." Parcel 2 is designated as Management Area "A." The area of Parcel 2 previously capped, with approximately two (2) to three (3) feet of fill, is the portion of Parcel 2 that comprises the subject property; the area containing Buildings 825, 548, and 668 and the land immediately surrounding those buildings, within the limits of Parcel 2, is not part of the subject property. The portion of Parcel 10 that comprises the subject property includes the areas designated as Management Area "B" and Easement "A" (Debris Screen Area) within the Environmental Reserve Area.

Pennoni obtained a copy of the current deeds for the subject property from the City of Philadelphia, Recorder of Deeds. According to the current deeds for Parcels 2 and 10, the subject property was purchased by Philadelphia Authority for Industrial Development on March 30, 2000 from the United States of America ("USA"). The current deeds for both parcels are referenced by an address of 4501 South Broad Street rather than 1413 Langley Avenue. A copy of the current deeds is included in Appendix C of this report.

The current deed for Parcel 2 contains a "Special Sections" that presents a "Reservation re Groundwater Monitoring Wells" that provides USA with an easement for periodic sampling of existing groundwater monitoring wells and maintenance of groundwater monitoring wells. "Special Sections" of the deed for Parcel 2 also includes an indemnification that includes covenants and restrictions regarding use of groundwater, development for permanent residential use, outdoor childcare playgrounds, and excavation of Subparcel 2(a). Specifically, the deed for Parcel 2 indicates that groundwater drawn from wells situated within Parcel 2 shall not be used or made available for human consumption; no permanent residences shall be constructed or otherwise developed on Parcel 2 and no portion of Parcel 2 shall be used as a permanent residence; construction or development of an outdoor childcare playground within Parcel 2 must include two (2) feet of clean fill material, or other cover, as approved by the Pennsylvania Department of Environmental Protection ("PADEP"), between the underlying soil and the surface of the playground prior to commencement of its use; and that neither the soil or asphalt covers placed within Subparcel 2(a) nor the soil beneath these covers, will be excavated or disturbed without the prior written approval of PADEP.

The current deed for Parcel 10 contains a "Special Sections" that presents a "Notice re Hazardous Substances" which indicates that hazardous substances were disposed of on the property and a "Reservation re Groundwater Monitoring Wells" that provides USA with an easement for periodic sampling of existing groundwater monitoring wells and maintenance of groundwater monitoring wells. "Special Sections" of the deed for Parcel 10 also includes an indemnification that includes covenants and restrictions regarding use of groundwater, development for permanent residential use, and outdoor childcare playgrounds. Specifically, the deed for Parcel 10 indicates that groundwater drawn from wells situated within Parcel 10 shall not be used or made available for human consumption; no permanent residences shall be constructed or otherwise developed on Parcel 2 and no portion of Parcel 10 shall be used as a permanent residence; construction or development of an outdoor childcare playground within Parcel 10 must include two (2) feet of clean fill material, or

other cover, as approved by the Pennsylvania Department of Environmental Protection (“PADEP”), between the underlying soil and the surface of the playground prior to commencement of its use.

Chain of title information was not provided by Client for review and inclusion in this report.

5.5 Historical Topographical Maps

Pennoni reviewed an historical topographical map for the subject property dated 1890-1910 on www.philageohistory.com. A summary of the information gathered based on Pennoni’s review of this map is presented below.

- 1890-1910, Historical Topographic Map – the map shows Girard Point; several basins are shown west of Girard Point, along the Schuylkill River; a few structures are located adjacent to the basins, and railroad lines lead to the basins.

5.6 Local Street Directories

Since local street directories were not reasonably ascertainable, Pennoni did not review them as part of the Phase I ESA for the subject property.

5.7 Building Department Records

Building department records include documents pertaining to permission of the local government to construct, alter, or demolish improvements on property.

Pennoni personnel visited the City of Philadelphia Department of Licenses and Inspections (“L&I”) on September 18, 2008 to review available files for the subject property.

Files for the subject property contained a December 12, 2000 Application for Zoning Permit and/or Use Registration Permit for property located at “Bldg 763-2001 Langley Ave – Parcel 2 & 3 – Phila Naval Business Ctr.” The owner of the property is listed as “Phila Author for Industrial Development,” and the applicant is listed as “Prime Plate Industries/Peter Lazer.” Although the permit references Parcel 2, it appears that the permit application was submitted for addition of parking and loading for properties east of Parcel 2, referred to as “Lease Lot A, B, and C and Bldg 763,” and shown on a plan attached to the application.

Files for the subject property also contained a November 26, 2001 Application for Zoning Permit and/or Use Registration Permit for “Parcel #2” to “establish Parcel #2 as turned over by the Federal Government and establish uses as existing at time of turnover with easements as shown.” No plan was attached to the application showing easements. The owner is listed as “Phila. Authority for Industrial Development (PAID).”

Copies of documentation obtained from L&I are included in Appendix C.

5.8 Zoning/Land Use Records

Zoning/land use records for the subject property indicate the uses permitted by local government in particular zones within its jurisdiction. According to information gathered from www.citymaps.phila.gov, the subject property is zoned as a G2, General Industrial District.

5.9 Previous Environmental Reports

Pennoni obtained copies of previous environmental reports prepared for the subject property from Mr. Tom Detitto, an archivist with Cushman and Wakefield. A brief summary of these reports is presented below. Copies of these reports are included on a compact disc in Appendix C.

- *Girard Point Management Area Zone A and Zone B Cap*, dated January 1998, prepared by Foster Wheeler Environmental Corporation

Foster Wheeler Environmental Corporation ("Foster Wheeler") prepared this report to design and develop construction plans and specifications for the remediation and restoration of the Girard Point Management Area ("GPMA") of the Philadelphia Naval Base. The GPMA was divided into two (2) work areas, Zone A and Zone B. The remediation activities consisted of the construction of a permeable cover cap in Zone A, the construction of an asphalt cap in Zone B, the removal and disposal of contaminated soil located near the former Girard Point Incinerator, and the removal of a 6,000-gallon underground storage tank ("UST") in the vicinity of the former Industrial Wastewater Treatment Building.

According to the Foster Wheeler report, the work conducted at Zone A was to be completed in accordance with the Girard Point Management Plan, and the work in Zone B was to be completed as part of the Early Removal Action to eliminate the sources of unacceptable risk in Zone B. Zone A covers approximately twenty (20) acres and consists of Installation Restoration Program ("IR") Site 3, IR Site 4, IR Site 5, and Building 993 (Industrial Wastewater Treatment Building). Zone B covers approximately five (5) acres and consists of the Northwest Parking Lot ("NWPL"). The IR Site 3 is a 1.25 acre site which was used extensively in the past for the storage of out-of-service transformers. The IR Site 4 is a 6 acre landfill area used for the disposal of ash and debris generated by the Girard Point Incinerator (Building 668) as well as solid wastes that could not be incinerated. The IR Site 5 is a 5 acre landfill area containing spent blasting grit, construction debris, and incinerator ash from the Girard Point Incinerator and solid waste that could not be incinerated. The Industrial Wastewater Treatment Building (Building 993) treated wastewater generated on-site and had an UST for acid storage located at the site. The NWPL site is a 4 acre area used prior to 1950 as a parking lot and in the early 1980's as a storage area for hazardous and non-hazardous wastes by the US Navy.

- *Environmental Baseline Survey (EBS) for Zone I of the Philadelphia Naval Complex*, dated October 1999, prepared by EA Engineering, Science, and Technology, Inc.

EA Engineering, Science, and Technology, Inc. ("EA Engineering") prepared their report to document the environmental conditions of the parcel of land identified as Zone I of the PNB, which encompasses the subject property. The subject property includes a portion of the 25-acre area of the northwest portion of the former PNB referred to as the Girard Point Management Area and designated as Zone 1C in the BRAC Cleanup Plan, dated April 1999. The Navy had previously utilized the Girard Point Management Area, which encompasses the subject property, for the treatment, storage, and disposal of solid wastes generated at the PNB.

Based upon a review of previous reports available for the Girard Point Management Area, EA Engineering identified three (3) IR sites and nine (9) Resource Conservation and Recovery Act ("RCRA") Solid Waste Management Units ("SWMUs") at Zone I. Of these sites, two (2) IR sites and three (3) SWMU sites were identified on the subject property.

The EA Engineering report stated that Building 668 Incinerator was associated with IR Program Site 4 (RCRA SWMU L-1) and IR Program Site 5 (RCRA SWMU L-2). According to the report the IR Program Site 4 (L-1), the Girard Point Landfill Area, was a 4-acre landfill in operation from the 1940's to the 1970's. The area was used to dispose of waste blasting grit, ash from the incinerator, and construction debris (concrete, wood, metal, and glass). Soil samples were collected and analyzed for heavy metals, which were detected. The IR Program Site 5 (L-2), the Girard Point Blasting Grit Disposal Area, was in operation from the 1940's to the 1970's. The area was land filled with yellow-white ash generated from the incinerator, waste blasting grit, and some construction materials (metal, concrete, wood, brick, scrap metal, and asbestos piping insulation). Soil samples collected from this area were collected and analyzed for heavy metals, which were detected. Remedial Investigations of both areas were completed in 1997, with remedial actions including a combination of vegetative cover, asphalt cover, and riverbank stabilization performed. Long term monitoring of groundwater in these areas was reported to be ongoing.

Also included in the Building 668 section of the EA Engineering report was the SWMU WP-2, the Girard Point Blasting Grit Waste Piles ("WP") area. This area was in operation from 1990 to 1995, and consisted of a one-acre site with several piles of waste blasting grit that was reportedly recycled and sent offsite to a recycling facility.

The SWMU M-7 location began operations between 1942 and 1951 through 1980. From 1980 to 1983 the location was used as a waste accumulation area and was included in the evaluation and remediation of the Girard Point Management Area. The waste was removed and remedial actions were conducted as necessary. According to the EA Engineering report, the waste was managed and that Phase I and Phase II investigations were performed. The area was paved and groundwater monitoring is ongoing at this site.

The SWMU WP-1 location was a 30 foot by 100 foot area where three waste piles of petroleum-containing soil were stockpiled. Soil from UST removals was stored south of Building 668 from October 1990 to September 1991. This area was included in the evaluation and remediation of the Girard Point Management Area. Waste piles were removed for off-site disposal. Remedial actions were reported to have been completed and groundwater monitoring is ongoing on the site.

As a result of the environmental conditions of Zone I, usage restrictions were established for this area of the PNB. The usage restrictions include a prohibition of the use of groundwater drawn from Zone I for human consumption or potable use; a prohibition on residential development of the area; and a requirement that at least two (2) feet of clean fill material be placed over any area within Zone I to be used as an outdoor childcare playground.

- *2003 Annual Report—Long Term Groundwater Monitoring Program for Girard Point Management Area at Philadelphia Naval Business Center*, dated November 2003, prepared by EA Engineering, Science, and Technology, Inc.

This report prepared by EA Engineering includes tables indicating that monitoring wells located at the site were sampled on July 7 and 8, 2003, and analyzed for metals including arsenic, cadmium, chromium, copper, zinc, nickel, lead, selenium, and mercury. Limited analytical data was included in this report; however, arsenic, chromium, lead, nickel, and zinc were reported to

have been detected at concentrations exceeding the regulatory levels.

6.0 ENVIRONMENTAL RECORDS REVIEW

As part of the Phase I ESA for the subject property, Pennoni reviewed both standard and additional environmental record sources for the subject property and surrounding area. Our environmental records review consisted of a review of the following:

- the Environmental FirstSearch Report for the subject property provided by InfoMap Technologies, Inc. of West Chester, Pennsylvania;
- information requested from the United States Environmental Protection Agency (“USEPA”), Region III;
- information requested from the Pennsylvania Department of Environmental Protection (“PADEP”); and,
- information requested from regional and local sources including, the City of Philadelphia, Department of Licenses and Inspections and the City of Philadelphia, Water Department.

Results of our environmental records review are presented below.

6.1 Standard Environmental Record Sources, Federal and State Databases

On behalf of Pennoni, InfoMap Technologies, Inc. (“InfoMap”) searched state and federal environmental databases for the subject site and surrounding area. The Environmental FirstSearch (“FirstSearch”) Report provided listings, accompanied by a map, of facilities and operations with reported environmental concerns within the ASTM E 1527-05 specified search radius around the subject property.

InfoMap Technologies, Inc. searched the following federal databases:

- Federal National Priorities List (“NPL”) site list
- Federal Delisted NPL site list
- Federal Comprehensive Environmental Response, Compensation, and Liability Information System (“CERCLIS”) list
- Federal CERCLIS No Further Remedial Action Planned (“NFRAP”) site list
- Federal Resource Conservation and Recovery Act (“RCRA”) Corrective Action (“CORRACTS”) facilities list
- Federal Treatment, Storage, and Disposal (“RCRA TSD”) facilities list
- Federal RCRA (“RCRA GEN”) generators list
- Federal Institutional Control/Engineering Control (“IC/EC”) registries
- Federal Emergency Response Notification System (“ERNS”) list

InfoMap Technologies, Inc. also searched the following state databases:

- State Hazardous Waste Sites (“SHWS”) list
- State Solid Waste Facility/Landfill (“SWF/LF”) site list
- State Leaking Underground Storage Tank (“LUST”) site list
- State Registered Underground and Aboveground Storage Tank (“REG UST/AST”) site list
- State Institutional Control/Engineering Control (“IC/EC”) registries
- State Voluntary Cleanup Program (“VCP”) sites list
- State Brownfields sites list

The FirstSearch Report is presented in Appendix B. Complete listings and descriptions of each of the databases searched are included in the FirstSearch Report.

6.1.1 Subject Property

Thirty-one (31) sites are listed as ERNS sites in the FirstSearch Report with a portion of their Site Name/ID/Status or Address in the Site Summary Report referenced to Girard Point. Most of the incidents at these ERNS sites include sheens observed on the river or accidental releases of small quantities of fuel into the Schuylkill River by vessels. Based on the information contained in the FirstSearch Report, none of these incidents are likely to have impacted the subject property.

One (1) site, Girard Point Transfer Station at 3600 South 26th Street, Philadelphia, PA, referenced as 0.32 miles southwest of the subject property, is listed as an SWL site. No other information is contained in the FirstSearch Report.

6.1.2 Adjacent and Surrounding Properties -- Facilities of Potential Concern

The FirstSearch Report identified the following facilities located adjacent to or in close proximity to the subject property:

- **PECO Energy Co Penrose Ave Site**
Penrose and Lanier Ave
Philadelphia, PA 19145
0.64 miles northwest of the subject property

The site is listed as in the FirstSearch Report as a RCRA COR ACT site, a RCRA facility with reported violations subject to corrective action. The site is listed as a small quantity generator. The Corrective Action Event is listed as “CA Prioritization – Medium CA Priority,” dated October 1, 1991. Based on the location of this site relative to the subject property, impacts to the subject property are unlikely.

- **Philadelphia Naval Business Center**
5001 S Broad Street
Philadelphia, PA 19112
0.85 miles northeast of the subject property

The site is listed as a RCRA COR ACT site in the FirstSearch Report. The report lists

numerous violations between 1988 and 2005 including "TSD-Other Requirements (Oversight)," "TSD-Manifest Requirements," "Generator-Manifest Requirements." The FirstSearch Report also indicates that corrective action was taken on six (6) occasions between September 1988 and February 1999; corrective measures listed in the report include:

- Referred to a non-RCRA Authority – Referred to CERCLA (9/30/88)
- Stabilization Measures Evaluation – Further Investigation Necessary (10/8/93)
- Stabilization Measures Implemented – Primary Measure is Exposure Control (8/8/95)
- Release to Groundwater Controlled (4/8/96)
- Human Exposures Controlled (4/8/96)
- Stabilization Construction Completed (2/1/99)

Since more detailed information regarding this site is not provided in the FirstSearch Report, its location within the Philadelphia Naval Business Center, relative to the subject property, could not be determined, and potential impacts to the subject property cannot be evaluated.

- **SPC**
2600 Penrose Avenue
Philadelphia, PA 19145
0.45 miles northwest of the subject property

The site is listed as a LUST site in the FirstSearch Report. According to the report, a release from an underground storage system containing petroleum occurred on November 2, 1999. The status is listed as "Interim or Remedial Actions Initiated." Based on the location of this site relative to the subject property, impacts to the subject property are unlikely.

- **Unknown**
On Schuylkill River between Girard Point and Platt Bridge
Philadelphia, PA 19112
0.14 miles southeast of the subject property

The site is listed as an ERNS site on the FirstSearch Report. According to the report, a sheen, from an unknown oil, was reported on the river on June 15, 1992. No other information is contained in the FirstSearch Report.

- **Tidewater Grain Pier**
26th and Penrose Avenue
Philadelphia, PA 19145
0.57 miles northwest of the subject property

The Tidewater Grain Pier site is listed as a CERCLIS NFRAP site in the FirstSearch Report. The report indicates that a Removal Assessment was completed on May 22, 1992 and that as of October 14, 1992, no further remedial action was planned for the site. Based on the location of this site relative to the subject property, impacts to the subject property are unlikely.

- **Mid-Atlantic (Contractor)
Tide Water Grain Co Pier 1
Philadelphia, PA 19145
0.57 miles northwest of the subject property**

The site is listed as an ERNS site in the FirstSearch Report. According to the report, a spill of 12,000 tons of salt onto land occurred on September 29, 1993. The remaining salt was moved. No waterway was impacted.

6.1.3 Orphan Sites

The unfiltered FirstSearch Report identified 211 orphan sites, or sites which could not be mapped due to inadequate address information. Based on a review of the “site name/ID/status” and “address” information for these sites, provided in the Sites Summary Report contained in the FirstSearch Report, two (2) of the sites, listed on the ERNS database, appear to be located on or adjacent to the subject property. Incidents at these locations are unlikely to have impacted the subject property, as described below.

- **Gerards Point
Philadelphia, PA**

The FirstSearch Report indicates that approximately one (1) gallon of No. 6 fuel oil was spilled into a drip pan on a vessel while Penn Maritime was unloading material from another barge and the release was “secured.” No other information regarding the incident is provided in the report.

- **Philadelphia Shipyard at Pier 2
Philadelphia, PA**

The FirstSearch Report indicates that a hydraulic power unit on a pier leaked approximately one (1) gallon of hydraulic oil onto the pier due to equipment problems, the “area was contained, cleanup is underway,” and the release was “secured.”

6.2 Additional Environmental Records Sources – State and Federal Regulatory Agencies

6.2.1 Pennsylvania Department of Environmental Protection, Southeast Regional Office

Pennoni submitted a written request, in a letter dated September 15, 2008, to the PADEP, Southeast Regional Office for information regarding environmental concerns at the subject property. A copy of the letter is contained in Appendix C. PADEP responded to our request on September 17, 2008 indicating that they have information in their files for the subject property. Pennoni reviewed these files at the Southeast Regional Office on October 1, 2008. A summary of the information gathered is presented below.

- A RCRA Subtitle C Site Identification Form for the Philadelphia Naval Business Center which commented on the types of hazardous wastes typically generated as a result of redevelopment and construction activities.
- A PADEP Acknowledgement of Notification of Regulated Waste Activity (Verification) letter.

- A letter from the Philadelphia Industrial Development Corporation (“PIDC”) to the PADEP referencing the Discharge Monitoring Report (“DMR”) for the power plant at the Philadelphia Business Center for the period of November 1, 2007 through November 30, 2007.
- A PADEP letter referencing PIDC’s NPDES permit and discharge limitations and monitoring requirements.
- A letter from Manko, Gold, Katcher, Fox, LLP referencing a revision to the NPDES permit made addressing deficiencies with the prior permit submittal by the Philadelphia Authority for Industrial Development (“PAID”).

No REC’s were identified in connection with the subject property as a result of the PADEP file review.

6.2.2 United States Environmental Protection Agency – Region III

Pennoni submitted a written request, in a letter dated September 15, 2008, to USEPA, Region III for information regarding environmental concerns at the subject property. A copy of the letter is contained in Appendix C. The USEPA responded stating that no files existed for the subject property at the 1413 Langely Avenue address. A CERCLIS file; however, was included for the USN Philadelphia Naval Shipyard, Building 993 Broad Street site. This site was designated as having a Non-NPL Status with a removal only designation and no site assessment work needed.

6.3 Additional Environmental Records Sources – Regional and Local Government

6.3.1 City of Philadelphia Department of Licenses and Inspections (“L&I”)

Pennoni reviewed available records for the subject property at L&I. The results of this review are presented in Section 5.7 of this report.

6.3.2 City of Philadelphia, Water Department

Pennoni submitted a written request, in a letter dated September 15, 2008, to the City of Philadelphia Water Department for information regarding environmental concerns at the subject property. A copy of the letter is contained in Appendix C. The Philadelphia Water Department responded to this request via a September 22, 2008 letter indicating that their files do not contain any records for the subject property; a copy of this letter is also included in Appendix C.

7.0 SITE RECONNAISSANCE

Pennoni personnel completed an inspection of the subject property on September 15, 2008 in order to visually inspect the property for evidence of RECs. During the site visit, Ms. Cynthia Shaw of Pennoni was unescorted. Photographs of the significant features observed during the site visit are provided in Appendix D.

Methodology

Ms. Shaw walked both perimeter and interior areas of the subject property, where accessible. Ms. Shaw walked from the asphalt paved area, east of Basin Bridge Road, toward the Reserve Basin, along the subject property's eastern property boundary. She walked along the subject property's southern and western property boundaries adjacent to the Reserve Basin and Schuylkill River and walked in a northerly and/or easterly direction to observe interior areas of the subject property, where possible. Drainage swales on the subject property were dry at the time of the site reconnaissance. From the northwestern corner of the subject property, Ms. Shaw walked in an easterly direction through interior sections of the subject property, back to the asphalt paved area, east/northeast of the subject property, between the subject property and Basin Bridge Road.

Limitations

Limitations on our ability to make observations during the site reconnaissance included dense vegetation within interior sections of the subject property. Pennoni viewed interior areas of the subject property, where possible (e.g., by following drainage swales and walking through less densely vegetated areas).

Ms. Shaw was unescorted during the site reconnaissance; therefore, she was unable to observe the interior of the shed located within Easement "A."

7.1 General Observations – Exterior Areas

With the exception of a right-of-way for an elevated section of Interstate 95, which traverses the subject property, and a shed within Easement "A," the subject property consists of undeveloped, vegetated land adjacent to the Schuylkill River and Reserve Basin. The subject property is generally level.

7.2 General Observations – Interior Areas

With the exception of the shed on Easement "A," there are no buildings on the subject property. Since Pennoni was unescorted during the site reconnaissance, we were unable to observe the interior of the shed.

7.3 Hazardous Substances in Connection with Identified Uses

The subject property currently consists of vacant, vegetated land; there are no hazardous substances used at the subject property in connection with this use.

7.4 Storage Tanks

No storage tanks were observed on the subject property.

7.5 Floor Drains and/or Sumps

With the exception of a shed on Easement "A," there are no buildings on the subject property. Since Pennoni was unescorted during the site reconnaissance, we did not observe the interior of the shed. No floor drains and/or sumps were observed on the subject property.

7.6 Other Observations

Results of other interior and exterior observations made during Pennoni's site reconnaissance are summarized in the table presented below.

Stains or Corrosion	Not Observed
Pits, Ponds or Lagoons	Not Observed
Stained Soil or Pavement	Not Observed
Stressed Vegetation	Not Observed
Fill Material	Present, based on a review of historical information
Municipal Solid Waste	Municipal solid waste is not currently generated on the subject property
Regulated Waste Disposal	Not Observed
Biomedical Waste Disposal	Not Observed
Waste Water	Not Observed
Wells	Not Observed
Septic Systems	Not Observed
Current/Past Agricultural Activity	Not Observed
Odors	No strong, pungent, or noxious odors were observed
Pools of Liquid	Not Observed
Drums/Containers	Not Observed
Unidentified Chemicals	Not Observed

7.7 Polychlorinated Biphenyls ("PCBs")

PCBs are a class of compounds that were developed in the 1930s and became widely used in industry from the mid-1900s to the late 1970s. The flame resistance of PCBs made them ideal for use in electrical equipment and they did not break down or react with other chemicals, even under extreme conditions of high temperature and pressure. PCBs were commonly used, therefore, in hydraulic fluids, lubricating oils, and transformers, electric motors, switches, and capacitors (including fluorescent lighting ballasts), as well as in paints, plastics, and other household items.

Because PCBs persist in the environment and, because they are fat-soluble, they bio-accumulate in

the food chain, the elimination of PCBs from distribution in commerce was mandated in federal legislation in the late 1970s. For economic reasons, however, the use of PCBs in existing equipment was allowed to continue for the useful or normal life of the equipment, as long as specific conditions were met. At present, many industrial facilities continue to rely upon PCB-containing equipment and transformers, while many commercial and residential structures continue to use lighting fixtures, switches, and other articles that contain some level of PCBs.

7.7.1 Transformers and Capacitors

Pennoni observed one (1) transformer located on a concrete pad within a fenced area adjacent to the shed located within Easement "A.". The unit was not labeled. No evidence of staining or leaks was observed beneath or surrounding the transformer.

7.7.2 Fluorescent Light Ballasts

Fluorescent light ballasts contain capacitors that may be filled with PCB-containing dielectric fluid. With the exception of the shed within Easement "A,," there are no buildings on the subject property. Since Pennoni was unescorted during the site reconnaissance, we did not observe the interior of the shed.

7.7.3 Elevators and Hydraulic Equipment

With the exception of the shed within Easement "A,," there are no buildings on the subject property. Elevators and hydraulic equipment are not present on the subject property.

7.8 Non-Scope Considerations

7.8.1 Asbestos-Containing Material ("ACM")

Asbestos is a naturally occurring mineral that has been used for centuries for variety of applications. Asbestos is a very stable crystalline mineral that forms fibers and withstands high temperature extremely well. Because of this physical and chemical property, commercial and industrial applications and usage of asbestos increased dramatically during the early 1900s. Asbestos was commonly known as a type of insulation, but it was also as a stabilizer and strengthening material in plaster, cement, and other composite materials. As such, asbestos was commonly used in building materials such as insulation, plaster, vinyl surfacing materials, and roofing and roof flashings, as well as in brake linings, caulking, and gaskets for ovens and furnaces. Because asbestos is a mineral, it can also be found in the soils of some areas around the world.

Once commercially milled, asbestos fibers are typically found at sizes that are measured in microscopic, micron particle sizes. Uncontrolled releases of asbestos fibers can remain airborne for an extended time and the particles tend to by-pass most of the defense mechanisms of the respiratory tract. As such, asbestos fibers have the ability to reach the inner portions of the lungs where they can become lodged and cause significant scarring and damage on a cellular level. Diseases attributable to asbestos exposure include asbestosis, mesothelioma, and lung cancer. Occupational exposure to asbestos is, therefore, highly regulated in the workplace.

The mere presence of ACM in a building is not necessarily cause for significant concern. So long as asbestos is not disturbed or accessible to damage or contact and does not become airborne, it poses little health risk and management of ACM in-place is considered a safe and acceptable practice. The U.S. EPA and OSHA have issued substantial guidance regarding proper procedures for the operations and maintenance of asbestos in the workplace. The U.S. EPA has also issued guidelines for home and building owners who have ACM insulation and surfacing materials such as flooring and roofing in their houses. Consequently, while most commercial production and use of asbestos was discontinued in the late 1970s and early 1980s, ACM remain in-place and in use in many commercial, industrial, and residential structures.

Asbestos regulations govern issues such as asbestos exposure and materials handling, transportation, and disposal and they place obligations upon building owners and operators to make notification to building occupants, tenants, visitors, contractors, and employees who may come in contact with the ACM.

Building owners, in particular, are responsible to make notifications regarding the presence and location of ACM. Additionally, all suspect materials are required by law to be "presumed to be asbestos containing materials" (PACM). PACM must be handled and treated as ACM until proven otherwise to be non-ACM.

Policies and procedures relating to the on-going management of PACM and ACM in occupied buildings are typically presented in written asbestos Operations and Maintenance (O&M) Plans. O&M Plans outline the various building owner responsibilities and procedures relating to the asbestos and serve as a tool to ensure consistent and proper management practices.

If a building containing ACM is to be demolished, the asbestos is typically removed prior to the demolition activities. Pursuant to the federal EPA National Emissions Standards for Hazardous Air Pollutants (NESHAP) regulations in 40 CFR 61, subpart M, ACM and asbestos-containing wastes must be removed, handled, and disposed in a manner that does not allow visible and/or uncontrolled emissions of asbestos to the environment.

Also, pursuant to the OSHA General Industry Standards 29 CFR 1910.1001 and the Construction Standards in 29 CFR 1926.1101, employers of employees who may encounter ACM are responsible to ensure that the employees are not exposed to airborne concentrations in excess of permissible exposure limits (PELs) that are based upon a time-weighted average exposure. Additionally, the employees must be properly trained so that they can recognize hazards and avoid unacceptable exposure.

With the exception of the shed within Easement "A," there are no structures on the property. Access was not granted to the small building on the subject property during the site reconnaissance; therefore, potential suspect ACM located within this building was not evaluated as part of this assessment. There is also a potential that asbestos-containing materials were buried in the landfill areas of the subject property that are now covered by the cap installed on the property.

7.8.2 Lead-Based Paint

Lead is commonly added to paints because of its characteristic to resist corrosion. LBP was used substantially for industrial applications; it is also commonly encountered in older commercial and residential properties.

Oral ingestion may represent a major route of exposure in contaminated workplaces and houses. Lead poisoning can cause permanent damage to the brain and many other organs and causes reduced intelligence and behavioral problems. Lead can also cause abnormal fetal development in pregnant women.

The U.S. EPA estimates that approximately three quarters of the nation's housing (i.e., roughly 64 million dwellings) contain some LBP. When properly maintained and managed, this paint poses little risk. However, 1.7 million children have blood-lead levels above safe limits, mostly due to exposure to LBP hazards.

According to the Housing and Urban Development ("HUD") Authority, lead-based paint LBP is defined as paint on surfaces with lead in excess of 1.0-milligrams per square centimeter ("mg/cm²"), as measured by an x-ray fluorescence ("XRF") detector of 0.5 percent by weight.

Use of LBP in construction was banned in 1978 and Congress passed legislation in 1992 requiring the disclosure of known information on LBP and LBP hazards before the sale or lease of most housing built before 1978. Consequently, LBP was generally phased out in commercial buildings, as well.

Similar to asbestos, OSHA has also established worker protection standards for exposure to lead. Unlike the case with asbestos, however, LBP does not need to be removed from a structure prior to demolition so as the issue of worker exposure and adequate protection can be addressed.

If waste materials from the demolition contain sufficient quantities of LBP, it may meet the definition of a hazardous waste under the U.S. EPA's Resources Conservation and Recovery Act ("RCRA") found in 40 CFR 260 - 279. Therefore, the need for pre-demolition abatement of LBP must be evaluated on a case-by-case basis to determine if the abatement is warranted.

Pursuant to applicable OSHA regulations, the party that is contracting for services to perform work in the structure is required to provide notice to the contractor or employer that LBP is likely present. Most contractors will likely need to know specific locations of the paint such that many owners and managers of buildings containing LBP opt to have a survey performed so that information that is more specific is available and the matter does not delay renovation and construction projects.

With the exception of the shed within Easement "A," there are no structures on the property. Since Pennoni was unescorted during the site reconnaissance, we did not observe interior portions of the small building on the western portion of the subject property.

7.8.3 Lead in Drinking Water

The City of Philadelphia Water Department currently provides water to the subject property.

Public water suppliers are required to monitor lead levels in the water supply and maintain corrosion control programs to minimize the leaching of lead from plumbing, solder joints, and fixtures. Although water which may be supplied to the subject property is unlikely to contain lead, drinking water at the tap may contain lead if a building's water supply system consists of lead pipes, solder joints, and/or fixtures. Collection and analysis of a water sample would be necessary to determine if concentrations of lead in drinking water are a concern at the subject property.

7.8.4 Wetlands

Pennoni gathered wetlands data for the subject property and surrounding area from the NWI On-line Wetlands Mapper at <http://www.fws.gov/nwi>. According to the Wetlands Mapper, there are no wetlands on the subject property. Wetlands are shown southwest of the subject property, across the Schuylkill River on an area referred to as "Mud Island;" these wetlands are classified as PEM/UB (Palustrine, Emergent, Unconsolidated Bottom), PUB (Palustrine, Unconsolidated Bottom), LIUB (Lacustrine, Limnetic, Unconsolidated Bottom), PFO1 (Palustrine, Forested, Broad-Leaved Deciduous), and PEM (Palustrine, Emergent). Pennoni did not observe any wetlands during our site reconnaissance.

7.8.5 Radon Gas

Radon gas is a naturally occurring radioactive gas found in soils and rocks. It is generated by the decay of naturally occurring uranium as a colorless and odorless gas. Radon gas can accumulate once inside an enclosed space such as an office building or home. There is an increased risk of developing lung cancer when exposed to elevated levels of radon gas. In general, the risk increases as the concentration of radon gas and the length of exposure increases. The EPA has established 4 picoCuries per liter ("pCi/L") of radon gas in indoor air as a guidance level for residences, while readings above 20 pCi/L are considered an actionable level.

According to PADEP, the average radon level for the 19112 zip code is 2.1 pCi/L. Actual radon concentrations at the subject property can only be determined by on-site measurement.

With the exception of an elevated section of Interstate 95 and the shed on Easement "A," the subject property currently consists of vacant, vegetated land. The concentrations of radon at and near the subject property are below the USEPA guidance level of 4 pCi/L. Therefore, health risks due to radon are currently not a concern on the subject property. Plans for future use of the subject property include installation of a photovoltaic electricity generating facility.

7.8.6 Mold

With the exception of the shed on Easement "A," there are no buildings on the subject property; therefore, an assessment for mold was not completed as part of the Phase I ESA for the subject property.

8.0 INTERVIEWS

To obtain information regarding RECs in connection with the subject property, Pennoni conducted interviews with past and present owners and occupants, and state and/or local government officials. Information gathered from interviews conducted as part of Pennoni's Phase I ESA for the subject property is presented below.

8.1 Present Owners, Operators and Occupants

The current and previous property owners were not interviewed as part of this Phase I ESA. Mr. Tom Dettito, an archivist with Cushman and Wakefield, provided Pennoni with a compact disc containing previous environmental reports prepared for the subject property and the Philadelphia Navy Yard. The previous environmental reports pertaining to the subject property are summarized in Section 5.9 of this Report.

8.2 Past Owners, Operators and Occupants

Pennoni did not identify or conduct interviews with past owners, operators, or occupants of the subject property. Since past uses of the subject property are documented in various historical records reviewed by Pennoni as part of this Phase I ESA, the absence of this information does not represent a significant data gap that affects our ability to identify RECs in connection with the subject property.

8.3 State and/or Local Government Officials

In accordance with ASTM E 1527-05, Pennoni made a reasonable attempt to interview at least one staff member of any one of the following types of state and/or local government agencies:

- local fire department that serves the subject property;
- state and/or local health agency or local/regional office of state health agency serving the area in which the subject property is located;
- state and/or local agency or local/regional office of state agency having jurisdiction over hazardous waste disposal or other environmental matters in the area in which the property is located; or
- local agencies responsible for the issuance of building permits or groundwater use permits that document the presence of AULs which may identify a REC in the area in which the property is located.

Refer to Section 6.3 for information gathered from local, regional, and state government officials.

9.0 DATA GAPS

As required by ASTM E1527-05, significant data gaps that affect the ability of the Environmental Professional to identify RECs in connection with the subject property shall be identified and commented on, and the sources of information that were consulted to address the data gaps must also be identified. A data gap is only significant if other information and/or professional experience raises reasonable concerns involving the data gap.

Pennoni identified the following significant data gaps which affected the ability of the EP to identify RECs in connection with the subject property:

1. No property valuation was provided for review; therefore, Pennoni is unable to comment on whether the purchase price being paid for subject property reasonably reflects the fair market value of the subject property. Pennoni does not consider this data gap to be a significant constraint on our ability to provide an opinion regarding RECs on the subject property.
2. Historic property tax files were not reviewed by Pennoni as part of this ESA. Pennoni determined that these standard historical resources were not reasonably ascertainable, practically reviewable, and/or sufficiently useful. Therefore, Pennoni does not consider this data gap to be a significant constraint on our ability to provide an opinion regarding RECs on the subject property.
3. Pennoni was unable to interview the current or former owners of the subject property; however, the previous uses of the subject property are documented in the historical sources reviewed by Pennoni. Therefore, Pennoni does not consider this data gap to be a significant constraint on our ability to provide an opinion regarding RECs on the subject property.

10.0 FINDINGS

The key findings of Pennoni's Phase I ESA for the subject property are discussed below. Our findings include known or suspect RECs, historical RECs, and de minimus conditions in connection with the subject property, if any. Results of our evaluation of non-scope considerations are presented in Section 12.0.

- The subject property consisted of areas formerly associated with the Philadelphia Naval Base ("PNB") which were utilized as the Girard Point Incinerator, landfills and a parking lot that was also utilized as a storage area for hazardous and non-hazardous wastes by the US Navy.
- The current land use documentation for the subject property identifies deed restrictions with respect to groundwater not for human consumption; no permanent residences; construction or development of an outdoor childcare playground must include two (2) feet of approved fill.
- Previous reports identified sources and locations of contamination within the current boundaries of the subject property which consists of the IR Site 4, IR Site 5, and the NWPL parcels. The IR Site 4 parcel is a 6 acre landfill area used for the disposal of ash and debris generated by the Girard Point Incinerator (Building 668) as well as solid wastes that could not be incinerated. The IR Site 5 parcel is a 5 acre landfill area containing spent blasting grit, construction debris, and incinerator ash from the Girard Point Incinerator and solid waste that could not be incinerated. The NWPL parcel is a 4 acre area used prior to 1950 as a parking lot and in the early 1980's as a storage area for hazardous and non-hazardous wastes by the US Navy.
- The remediation activities reported for the Zone A and Zone B portions of the subject property consisted of the construction of a permeable cover cap in Zone A and the construction of an asphalt cap in Zone B.

11.0 OPINION AND CONCLUSIONS

Based on the conditions described in our findings, Pennoni's opinion regarding the impact of these conditions on the subject property, if any, is presented below. Conclusions summarizing all RECs connected with the subject property are also presented below.

Pennoni has performed a Phase I ESA of the subject property in general conformance with the scope and limitations of the ASTM Standard Practice for Environmental Site Assessments: Phase I Environmental Site Assessment Process, Designation E 1527-05. This assessment has revealed the following RECs in connection with the subject property:

- The subject property consisted of areas formerly associated with the Philadelphia Naval Base ("PNB") which were utilized as the Girard Point Incinerator, landfills and a parking lot that was also utilized as a storage area for hazardous and non-hazardous wastes by the US Navy.
- The current land use documentation for the subject property identifies deed restrictions with respect to groundwater drawn from wells shall not be used or made available for human consumption; no permanent residences shall be constructed or otherwise developed and no portion shall be used as a permanent residence; construction or development of an outdoor childcare playground must include two (2) feet of clean fill material, or other cover, as approved by the Pennsylvania Department of Environmental Protection ("PADEP"), between the underlying soil and the surface of the playground prior to commencement of its use.
- Previous reports provided for review and inclusion in this report identified sources and locations of contamination within the current boundaries of the subject property. The Girard Point Management Area ("GPMA") of the Philadelphia Naval Base (which includes the subject property) was divided into two (2) work areas, Zone A and Zone B. Zone A covers approximately twenty (20) acres and consists of Installation Restoration Program ("IR") Site 3, IR Site 4, IR Site 5, and Building 993 (Industrial Wastewater Treatment Building). Zone B covers approximately five (5) acres and consists of the Northwest Parking Lot ("NWPL"). The subject property consists of the IR Site 4, IR Site 5, and the NWPL parcels. The IR Site 4 parcel is a 6 acre landfill area used for the disposal of ash and debris generated by the Girard Point Incinerator (Building 668) as well as solid wastes that could not be incinerated. The IR Site 5 parcel is a 5 acre landfill area containing spent blasting grit, construction debris, and incinerator ash from the Girard Point Incinerator and solid waste that could not be incinerated. The NWPL parcel is a 4 acre area used prior to 1950 as a parking lot and in the early 1980's as a storage area for hazardous and non-hazardous wastes by the US Navy.

The remediation activities reported for the Zone A and Zone B portions of the subject property consisted of the construction of a permeable cover cap in Zone A and the construction of an asphalt cap in Zone B.

Based upon the site inspection conducted by Pennoni, the engineering controls proposed for the subject property have been constructed and are adequately serving their intended purpose. If the engineering and institutional controls are properly maintained, no additional adverse impact to the subject property is anticipated. Therefore, no further investigation is required with respect to the soil

and groundwater impacts previously identified on the subject property.

12.0 NON-SCOPE CONSIDERATIONS

Pennoni's evaluation of non-scope considerations does not indicate environmental issues or conditions of concern with regard to suspected asbestos-containing materials, lead-based paint, lead in drinking water, wetlands, radon, or mold on the subject property.

13.0 ENVIRONMENTAL PROFESSIONAL STATEMENT AND SIGNATURE

I declare that, to the best of my professional knowledge and belief, I meet the definition of an "environmental professional" as defined at 40 C.F.R. §312.10. I have the specific qualifications based on education, training, and experience to assess a property of the nature, history and setting of the subject property. I have developed and performed the all appropriate inquiries in conformance with the standards and practices set forth in 40 C.F.R. Part 312.

William F. Schmidt

William F. Schmidt, P.E.

Associate Vice President

14.0 REFERENCES

The following documents, publications, maps, etc. were used as source materials for this Phase I Environmental Site Assessment:

- ASTM Standard Practice for Environmental Site Assessments: Phase I Environmental Site Assessment Process, 2005.
- Atlas of Preliminary Geologic Quadrangle Maps of Pennsylvania, 1981
- City of Philadelphia, Department of Records
- City of Philadelphia, Department of Licenses and Inspections (L&I)
- City of Philadelphia, Recorder of Deeds
- City of Philadelphia, Water Department
- Delaware Valley Regional Planning Commission, Pennsylvania Orthotiles, aerial photographs dated 2000 and 2005.
- InfoMap Technologies, Inc. of West Chester, PA, Environmental FirstSearch Report dated September 16, 2008.
- Pennsylvania Department of Environmental Protection (PADEP), Southeast Regional Office
- The Free Library of Philadelphia, aerial photographs dated 1944, 1965, 1970, 1975, 1980, 1985, 1990, and 1995
- U.S. Department of Agriculture, National Resources Conservation Service (USDA-NRCS) Web Soil Survey
- USEPA 40 CFR Part 312 Standards and Practices for All Appropriate Inquiries; Final Rule, November 1, 2005.
- USEPA, Region III
- U.S. Fish and Wildlife Service, National Wetlands Inventory, On-line Wetlands Mapper
- United States Geological Survey (USGS), 7.5 minute topographic map for the Philadelphia, Pennsylvania-N.J. Quadrangle.
- *Girard Point Management Area Zone A and Zone B Cap*, dated January 1998, prepared by Foster Wheeler Environmental Corporation

Appendix 21

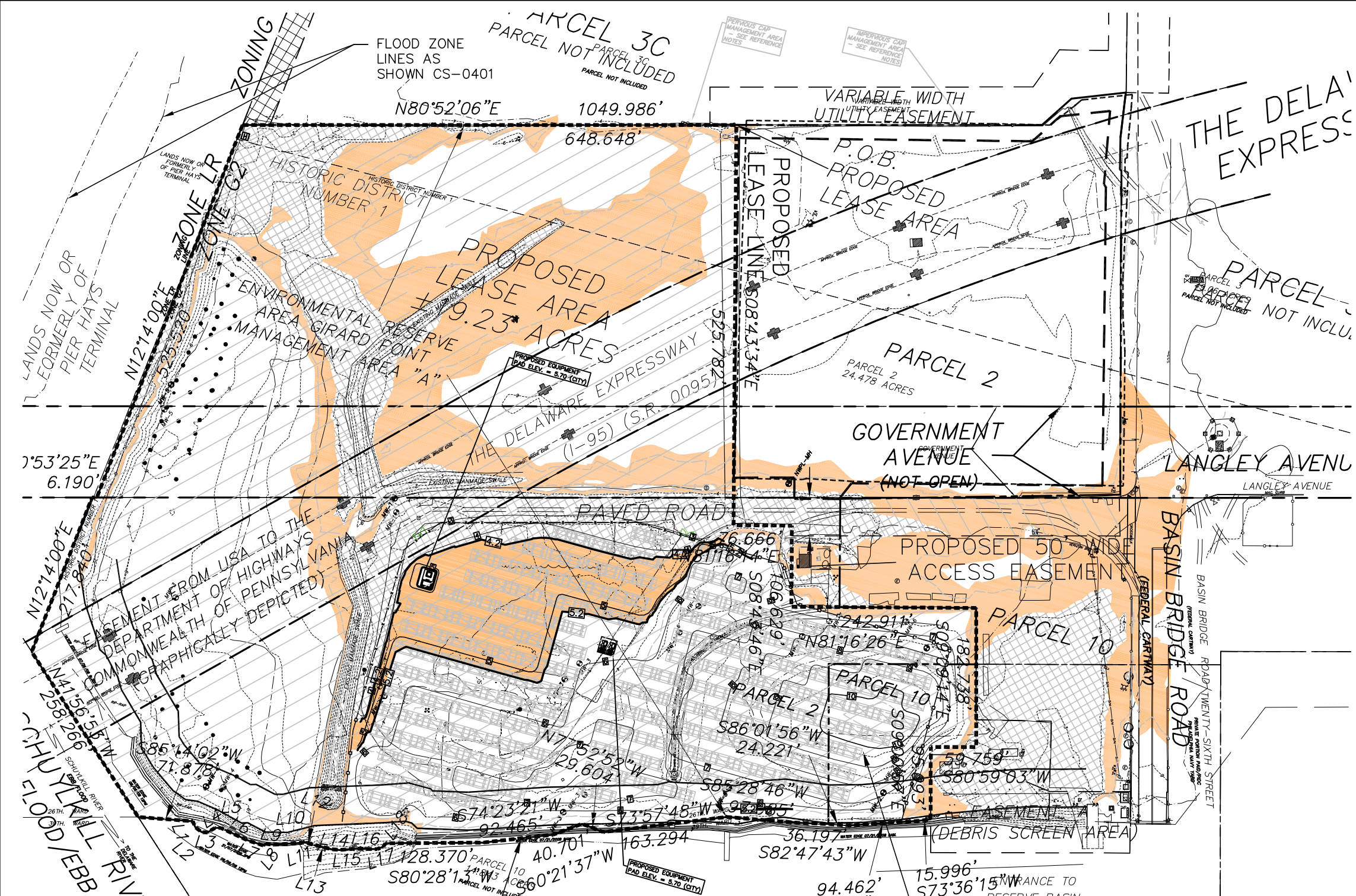

SITE INFORMATION:

ADDRESS: PARCEL 2 (BRT # 78-8-0010-01)
4590 BASIN BRIDGE ROAD AND
PARCEL 10 (BRT # 78-8-0055-01)
4621 BASIN BRIDGE ROAD
PHILADELPHIA NAVY YARD
PHILADELPHIA, PA 19112

OWNER: PHILADELPHIA AUTHORITY FOR
INDUSTRIAL DEVELOPMENT (PAID)
CENTER SQUARE WEST
1500 MARKET STREET
PHILADELPHIA, PA 19102-2000

DEVELOPER: CONERGY PROJECTS, INC.
101 LINDENWOOD DRIVE, SUITE 130
MALVERN, PA 19355

FLOOD ZONE INFORMATION:
BASED UPON THE JANUARY 17, 2007 FLOOD INSURANCE RATE MAP 4207570189G, PANEL 189 OF 230, THE SUBJECT AREA IS LOCATED IN THE FOLLOWING AREAS,
ZONE AE- BASE FLOOD ELEVATION DETERMINED-10 FT NAD 83
ZONE X SHADED - AREAS OF 0.2% ANNUAL CHANCE FLOOD (500 YR FLOOD) (INDICATED AS X1 WITHIN THE DRAWING SET)
ZONE X - AREAS DETERMINED TO BE OUTSIDE THE 0.2% ANNUAL CHANCE FLOOD (INDICATED AS X2 WITHIN THE DRAWING SET)

FLOOD ZONES ON THIS PLAN AREA DEPICTED BY INTERPOLATING THE 4.2 AND 5.2 CONTOUR ELEVATIONS FROM THE FIELD SURVEY. ELEVATION CERTIFICATE MAY BE NEEDED TO VERIFY THIS DETERMINATION OR APPLY FOR A VARIANCE FROM THE FEDERAL EMERGENCY MANAGEMENT AGENCY.

LEGEND

	BOUNDARY LINE
	EXISTING BUILDINGS
	EXISTING EDGE OF PAVEMENT
	INTERPOLATED AREA ABOVE ELEV 4.2 AND BELOW ELEV 5.2 (ZONE X SHADED)
	INTERPOLATED AREA BELOW ELEVATION 4.2 (ZONE AE)
	EXISTING RAILROAD TRACKS
	FLOOD PLAIN (FEMA MAP BASED)
	EXISTING MINOR CONTOURS
	EXISTING MAJOR CONTOURS
	EXISTING UTILITY MANHOLES
	EXISTING FIRE HYDRANT
	EXISTING FENCE LINE
	EXISTING TREE
	EXISTING MONITORING WELL
	PROPOSED 4.20 EL AND 5.20 EL CONTOUR
	PROPOSED MINOR CONTOURS
	PROPOSED MAJOR CONTOURS
	3X9 AND 3X7 PHOTOVOLTAIC ARRAYS WITH FOUNDATION
	PROPOSED FENCE LINE

- REFERENCE:**
1. THE PURPOSE OF THIS PLAN IS TO DEPICT THE FLOOD ZONE INFORMATION UTILIZING THE FIELD SURVEYED TOPOGRAPHIC INFORMATION WITH THE FEMA FLOOD INFORMATION. THE FEMA FLOOD ELEVATION 10 FT NAVD 1983 (4.2 CITY DATUM). THE PROPOSED LOCATION OF THE ZONE AE, ZONE X SHADED, AND ZONE X WITH THE PROPOSED GRADING.
 2. SURVEY INFORMATION TAKEN FROM A PLAN PREPARED BY PENNONI ASSOCIATES INC., ENTITLED, "EXISTING CONDITIONS/TOPOGRAPHIC SURVEY PLAN", LAST REVISED 08/26/08.
 3. PROPOSED DEVELOPMENT INFORMATION PROVIDED BY CONERGY PROJECTS, INC.
 4. PARCEL INFORMATION OBTAINED FROM PLANS ENTITLED, "PHILADELPHIA NAVAL BASE FINAL PLAT FOR TRANSFER FROM UNITED STATES NAVY TO PHILADELPHIA AUTHORITY FOR INDUSTRIAL DEVELOPMENT STAGE 1 PARCELS 2, 3 & 10" SHEET 2 OF 11 DATED 11/14/01, SHEET 3 OF 11 DATED 11/20/00, AND SHEET 4 OF 11 DATED 11/20/00, PREPARED BY VANDEMARK & LYNCH, INC.
 5. THE INDICATED MANMADE SWALES WERE CONSTRUCTED AT THE TIME OF THE ENVIRONMENTAL CAPPING IN 1998 AND SIZED TO CONVEY THE 10-YEAR RUNOFF FROM THE CAPPED AREAS.

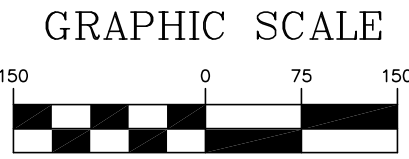

 PENNONI ASSOCIATES INC. 3001 Market Street, Suite 200 Philadelphia, PA 19104	ALL DOCUMENTS PREPARED BY PENNONI ASSOCIATES ARE INSTRUMENTS OF SERVICE IN RESPECT OF THE PROJECT. THEY ARE NOT INTENDED OR REPRESENTED TO BE SUITABLE FOR REUSE BY OWNER OR OTHERS ON EXTENSIONS OF THE PROJECT OR ON ANY OTHER PROJECT. ANY REUSE WITHOUT WRITTEN VERIFICATION OR ADAPTATION BY PENNONI ASSOCIATES FOR THE SPECIFIC PURPOSE INTENDED WILL BE AT OWNERS SOLE RISK AND WITHOUT LIABILITY OR LEGAL EXPOSURE TO PENNONI ASSOCIATES. AND OWNER SHALL INDEMNIFY AND HOLD HARMLESS PENNONI ASSOCIATES FROM ALL CLAIMS, DAMAGES, LOSSES AND EXPENSES ARISING OUT OF OR RESULTING THEREFROM.	DRAWN BY: J.M.D. CHECKED BY: PMF JOB No. EPUR 0801	SCALE: 1"=150' DATE: 06/28/11 SKETCH No. CS-0403
	FIGURE C - ANTICIPATED FLOOD ZONE WITH PROPOSED SITE/GRADING		

Appendix 22



SITE INFORMATION:

ADDRESS: PARCEL 2 (BRT # 78-8-0010-01)
 4590 BASIN BRIDGE ROAD AND
 PARCEL 10 (BRT # 78-8-0055-01)
 4621 BASIN BRIDGE ROAD
 PHILADELPHIA NAVY YARD
 PHILADELPHIA, PA 19112

OWNER: PHILADELPHIA AUTHORITY FOR
 INDUSTRIAL DEVELOPMENT (PAID)
 CENTER SQUARE WEST
 1500 MARKET STREET
 PHILADELPHIA, PA 19102-2000

DEVELOPER: CONERGY PROJECTS, INC.
 101 LINDENWOOD DRIVE, SUITE 130
 MALVERN, PA 19355

FLOOD ZONE INFORMATION:

BASED UPON THE JANUARY 17, 2007 FLOOD INSURANCE RATE MAP 4207570189G, PANEL 189 OF 230, THE SUBJECT AREA IS LOCATED IN THE FOLLOWING AREAS,
 ZONE AE- BASE FLOOD ELEVATION DETERMINED-10 FT NAD 83
 ZONE X SHADED - AREAS OF 0.2% ANNUAL CHANCE FLOOD (500 YR FLOOD) (INDICATED AS X1 WITHIN THE DRAWING SET)
 ZONE X - AREAS DETERMINED TO BE OUTSIDE THE 0.2% ANNUAL CHANCE FLOOD (INDICATED AS X2 WITHIN THE DRAWING SET)

FLOOD ZONES ON THIS PLAN AREA DEPICTED BY INTERPOLATING THE 4.2 AND 5.2 CONTOUR ELEVATIONS FROM THE FIELD SURVEY. ELEVATION CERTIFICATE MAY BE NEEDED TO VERIFY THIS DETERMINATION OR APPLY FOR A VARIANCE FROM THE FEDERAL EMERGENCY MANAGEMENT AGENCY.

LEGEND

	BOUNDARY LINE
	EXISTING BUILDINGS
	EXISTING EDGE OF PAVEMENT
	EXISTING RAILROAD TRACKS
	INTERPOLATED AREA ABOVE ELEVATION 4.2
	INTERPOLATED AREA BELOW ELEVATION 4.2
	FLOOD PLAIN (SURVEY BASED)
	FLOOD PLAIN (FEMA MAP BASED)
	EXISTING MINOR CONTOURS
	EXISTING MAJOR CONTOURS
	EXISTING UTILITY MANHOLES
	EXISTING FIRE HYDRANT
	EXISTING FENCE LINE
	EXISTING TREE
	EXISTING MONITORING WELL

REFERENCE:

1. THE PURPOSE OF THIS PLAN IS TO DEPICT THE FLOOD ZONE INFORMATION UTILIZING THE FIELD SURVEYED TOPOGRAPHIC INFORMATION WITH THE FEMA BASE FLOOD ELEVATION 10 FT NAVD 1983. SURVEY TOPOGRAPHIC INFORMATION IN CITY DATUM (4.2 FT).
2. SURVEY INFORMATION TAKEN FROM A PLAN PREPARED BY PENNONI ASSOCIATES INC., ENTITLED, "EXISTING CONDITIONS/TOPOGRAPHIC SURVEY PLAN", LAST REVISED 08/26/08.
3. PARCEL INFORMATION OBTAINED FROM PLANS ENTITLED, "PHILADELPHIA NAVAL BASE FINAL PLAT FOR TRANSFER FROM UNITED STATES NAVY TO PHILADELPHIA AUTHORITY FOR INDUSTRIAL DEVELOPMENT STAGE 1 PARCELS 2, 3 & 10" SHEET 2 OF 11 DATED 11/14/01, SHEET 3 OF 11 DATED 11/20/00, AND SHEET 4 OF 11 DATED 11/20/00, PREPARED BY VANDEMARK & LYNCH, INC.
4. THE INDICATED MANMADE SWALES WERE CONSTRUCTED AT THE TIME OF THE ENVIRONMENTAL CAPPING IN 1998 AND SIZED TO CONVEY THE 10-YEAR RUNOFF FROM THE CAPPED AREAS.

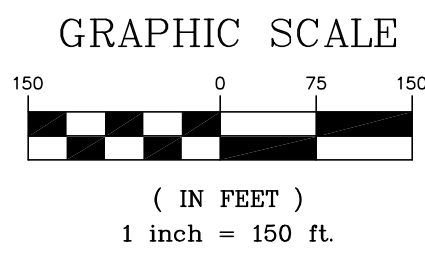

Pennoni
 PENNONI ASSOCIATES INC.
 3001 Market Street, Suite 200
 Philadelphia, PA 19104

ALL DOCUMENTS PREPARED BY PENNONI ASSOCIATES ARE INSTRUMENTS OF SERVICE IN RESPECT OF THE PROJECT. THEY ARE NOT INTENDED OR REPRESENTED TO BE SUITABLE FOR REUSE BY OWNER OR OTHERS ON EXTENSIONS OF THE PROJECT OR ON ANY OTHER PROJECT. ANY REUSE WITHOUT WRITTEN VERIFICATION OR ADAPTATION BY PENNONI ASSOCIATES FOR THE SPECIFIC PURPOSE INTENDED WILL BE AT OWNERS SOLE RISK AND WITHOUT LIABILITY OR LEGAL EXPOSURE TO PENNONI ASSOCIATES. AND OWNER SHALL INDEMNIFY AND HOLD HARMLESS PENNONI ASSOCIATES FROM ALL CLAIMS, DAMAGES, LOSSES AND EXPENSES ARISING OUT OF OR RESULTING THEREFROM.

DRAWN BY: J.M.D.
 CHECKED BY: PMF
 JOB No. EPUR 0801

SCALE: 1"=150'
 DATE: 06/28/11
 SKETCH No. **CS-0402**

FIGURE B - EXISTING CONDITIONS WITH SURVEY CONTOUR FLOODPLAIN OVERLAY

Appendix 23

Appendix 24

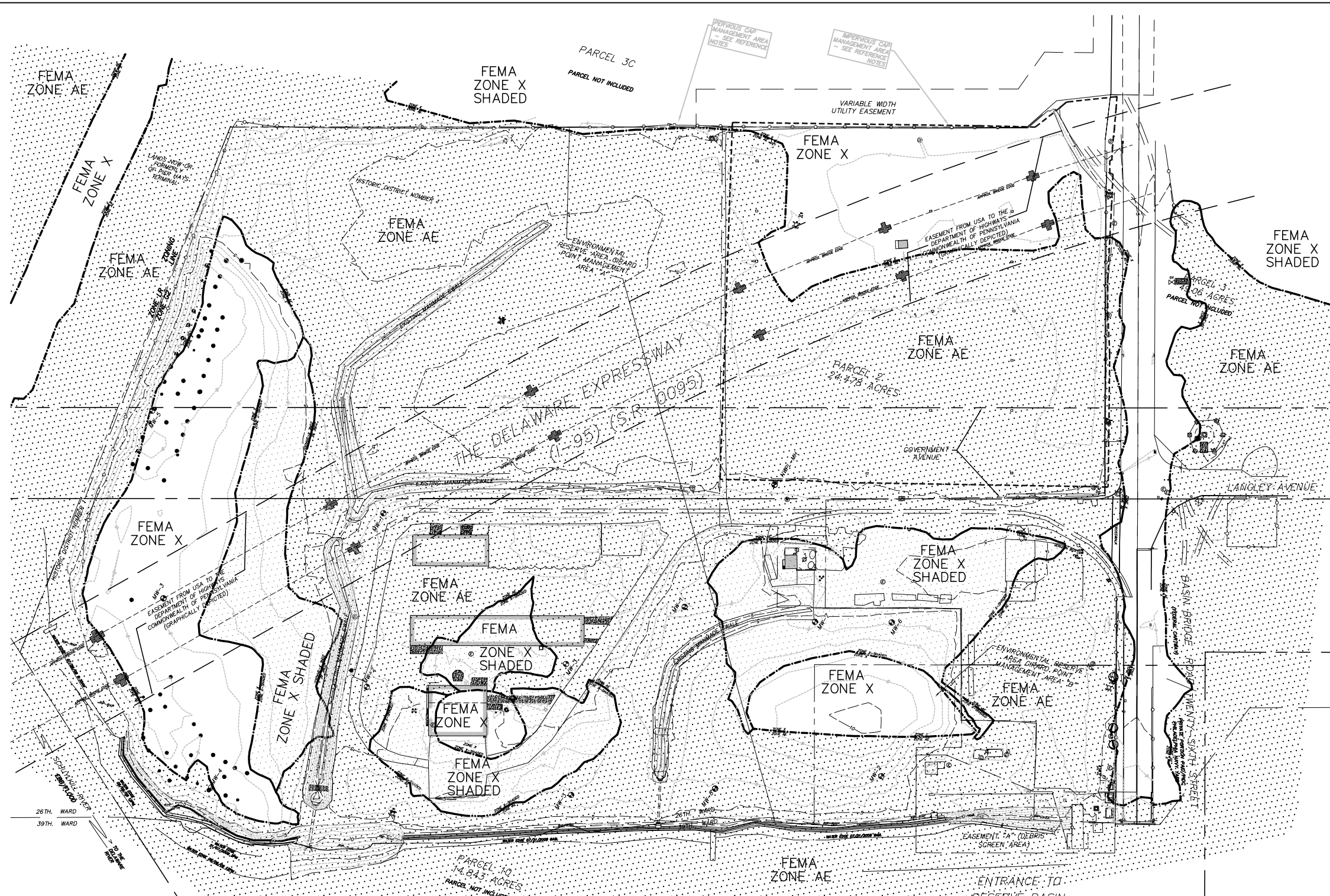

SITE INFORMATION:

ADDRESS: PARCEL 2 (BRT # 78-8-0010-01)
 4590 BASIN BRIDGE ROAD AND
 PARCEL 10 (BRT # 78-8-0055-01)
 4621 BASIN BRIDGE ROAD
 PHILADELPHIA NAVY YARD
 PHILADELPHIA, PA 19112

OWNER: PHILADELPHIA AUTHORITY FOR
 INDUSTRIAL DEVELOPMENT (PAID)
 CENTER SQUARE WEST
 1500 MARKET STREET
 PHILADELPHIA, PA 19102-2000

DEVELOPER: CONERGY PROJECTS, INC.
 101 LINDENWOOD DRIVE, SUITE 130
 MALVERN, PA 19355

FLOOD ZONE INFORMATION:

BASED UPON THE JANUARY 17, 2007 FLOOD INSURANCE RATE MAP 4207570189G, PANEL 189 OF 230, THE SUBJECT AREA IS LOCATED IN THE FOLLOWING AREAS,
 ZONE AE- BASE FLOOD ELEVATION DETERMINED-10 FT NAD 83
 ZONE X SHADED - AREAS OF 0.2% ANNUAL CHANCE FLOOD (500 YR FLOOD) (INDICATED AS X1 WITHIN THE DRAWING SET)
 ZONE X - AREAS DETERMINED TO BE OUTSIDE THE 0.2% ANNUAL CHANCE FLOOD (INDICATED AS X2 WITHIN THE DRAWING SET)

NO FIELD SURVEYING WAS PERFORMED TO DETERMINE THIS ZONE AND AN ELEVATION CERTIFICATE MAY BE NEEDED TO VERIFY THIS DETERMINATION OR APPLY FOR A VARIANCE FROM THE FEDERAL EMERGENCY MANAGEMENT AGENCY.

LEGEND

	BOUNDARY LINE
	EXISTING BUILDINGS
	EXISTING EDGE OF PAVEMENT
	EXISTING RAILROAD TRACKS
	FLOOD ZONE X SHADED
	FLOOD ZONE AE SHADED
	FLOOD PLAIN (FEMA MAP BASED)
	EXISTING MINOR CONTOURS
	EXISTING MAJOR CONTOURS
	EXISTING UTILITY MANHOLES
	EXISTING FIRE HYDRANT
	EXISTING FENCE LINE
	EXISTING TREE
	EXISTING MONITORING WELL

REFERENCE:

1. THE PURPOSE OF THIS PLAN IS TO DEPICT THE FLOOD ZONE INFORMATION UTILIZING THE FLOOD INSURANCE RATE MAP 4207570189G, WITH FIELD SURVEYED TOPOGRAPHIC INFORMATION.
2. SURVEY INFORMATION TAKEN FROM A PLAN PREPARED BY PENNONI ASSOCIATES INC., ENTITLED, "EXISTING CONDITIONS/TOPOGRAPHIC SURVEY PLAN", LAST REVISED 08/26/08.
3. PARCEL INFORMATION OBTAINED FROM PLANS ENTITLED, "PHILADELPHIA NAVAL BASE FINAL PLAT FOR TRANSFER FROM UNITED STATES NAVY TO PHILADELPHIA AUTHORITY FOR INDUSTRIAL DEVELOPMENT STAGE 1 PARCELS 2, 3 & 10" SHEET 2 OF 11 DATED 11/14/01, SHEET 3 OF 11 DATED 11/20/00, AND SHEET 4 OF 11 DATED 11/20/00, PREPARED BY VANDEMARK & LYNCH, INC.
4. THE INDICATED MANMADE SWALES WERE CONSTRUCTED AT THE TIME OF THE ENVIRONMENTAL CAPPING IN 1998 AND SIZED TO CONVEY THE 10-YEAR RUNOFF FROM THE CAPPED AREAS.

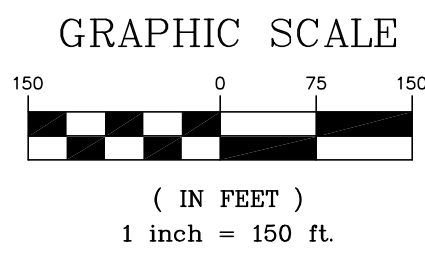

Pennoni
 PENNONI ASSOCIATES INC.
 3001 Market Street, Suite 200
 Philadelphia, PA 19104

ALL DOCUMENTS PREPARED BY PENNONI ASSOCIATES ARE INSTRUMENTS OF SERVICE IN RESPECT OF THE PROJECT. THEY ARE NOT INTENDED OR REPRESENTED TO BE SUITABLE FOR REUSE BY OWNER OR OTHERS ON EXTENSIONS OF THE PROJECT OR ON ANY OTHER PROJECT. ANY REUSE WITHOUT WRITTEN VERIFICATION OR ADAPTATION BY PENNONI ASSOCIATES FOR THE SPECIFIC PURPOSE INTENDED WILL BE AT OWNERS SOLE RISK AND WITHOUT LIABILITY OR LEGAL EXPOSURE TO PENNONI ASSOCIATES. AND OWNER SHALL INDEMNIFY AND HOLD HARMLESS PENNONI ASSOCIATES FROM ALL CLAIMS, DAMAGES, LOSSES AND EXPENSES ARISING OUT OF OR RESULTING THEREFROM.

DRAWN BY: J.M.D.
 CHECKED BY: PMF
 JOB No. EPUR 0801

SCALE: 1"=150'
 DATE: 06/28/11
 SKETCH No. **CS-0401**

FIGURE A - EXISTING CONDITIONS WITH FEMA FLOODPLAIN OVERLAY

Appendix 25



pennsylvania

DEPARTMENT OF ENVIRONMENTAL PROTECTION

SOUTHEAST REGIONAL OFFICE

RECEIVED

MAY 12 2011

PENNONI ASSOCIATES

May 6, 2011

Mr. Carmen Zappile
Philadelphia Industrial Development Corporation
Quarters A – 1413 Langley Avenue
Navy Yard
Philadelphia, PA 19112

Re: NPDES Individual Permit Modification and
Plan Revision
NPDES Permit No. PAS10-5312-R
Photovoltaic Facility Parcels 2 and 10
City and County of Philadelphia

Dear Mr. Zappile:

This letter is in reference to the request received by your consultant on February 22, 2011, regarding revisions to the subject permit, including Erosion and Sedimentation (E&S) Control Plan, which authorized the discharge of stormwater for the construction activities at this site. These changes include the proposed construction of a photovoltaic facility on portions of Parcels 2 and 10 at the former Philadelphia Navy Yard.

The requested E&S Control Plan revisions are approved and added to NPDES Individual Permit No. PAS10-5312-R. Please add the enclosed drawings describing the revision to the E&S Control Plan at the project site. A copy of the stamped plans is attached for your records.

All conditions specified in the original permit remain in effect and are to be complied with as part of this plan revision. Please ensure that the plans are fully implemented and available at the construction site.

Mr. Carmen Zappile

- 2 -

If you have any questions, please contact Ms. Ranjana Chopra Sharp at 484.250.5166.

Sincerely,

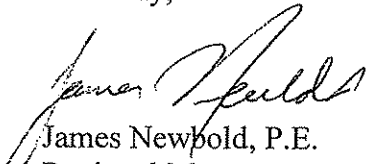

James Newbold, P.E.
Regional Manager
Watershed Management

Enclosure

cc: Ms. Marjoram – Philadelphia Water Department
Philadelphia City Planning Commission
Mr. Foley, P.E. – Pennoni Associates
Mr. Welsh – Conergy Projects
Ms. Sharp
Mr. Rocco
Ms. Moore
Re 30 (GJS11WTSD)63-6