

Nuclear Thermal Propulsion Ground Test History

The Rover/NERVA Program

***Harold P. Gerrish Jr
NASA Marshall Space Flight Center
February 25, 2014***

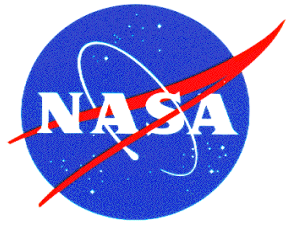

Agenda

- Rover/NERVA Program
- Nuclear Rocket Development Station
- Rover/NERVA Engine Ground Tests
- Final Rover/NERVA Engine Designs

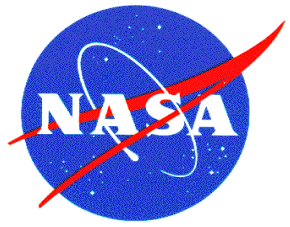

How Did Nuclear Propulsion Start?

- Many nuclear programs were under way in the early 1950's
- The Atomic Energy Commission (AEC) was before Department Of Energy (DOE)
- 1955 AEC assigned Lawrence Livermore labs Project Pluto (code name Tory) for nuclear ramjets and Los Alamos Project Rover for nuclear rockets
- Project Orion (external thermonuclear blast push propulsion) was developed in parallel
- The Nevada test site was selected in 1956 since it was close to both LLNL and LANL. Facility Construction began in 1957. [1]



Rover

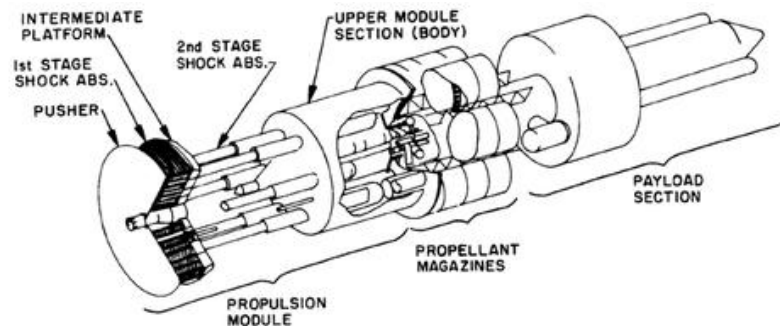

Orion



Pluto-Tory IIC

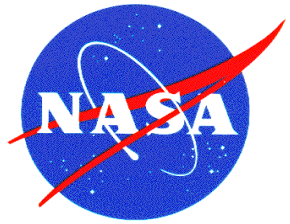

Nuclear Rocket Program Organization

[2]

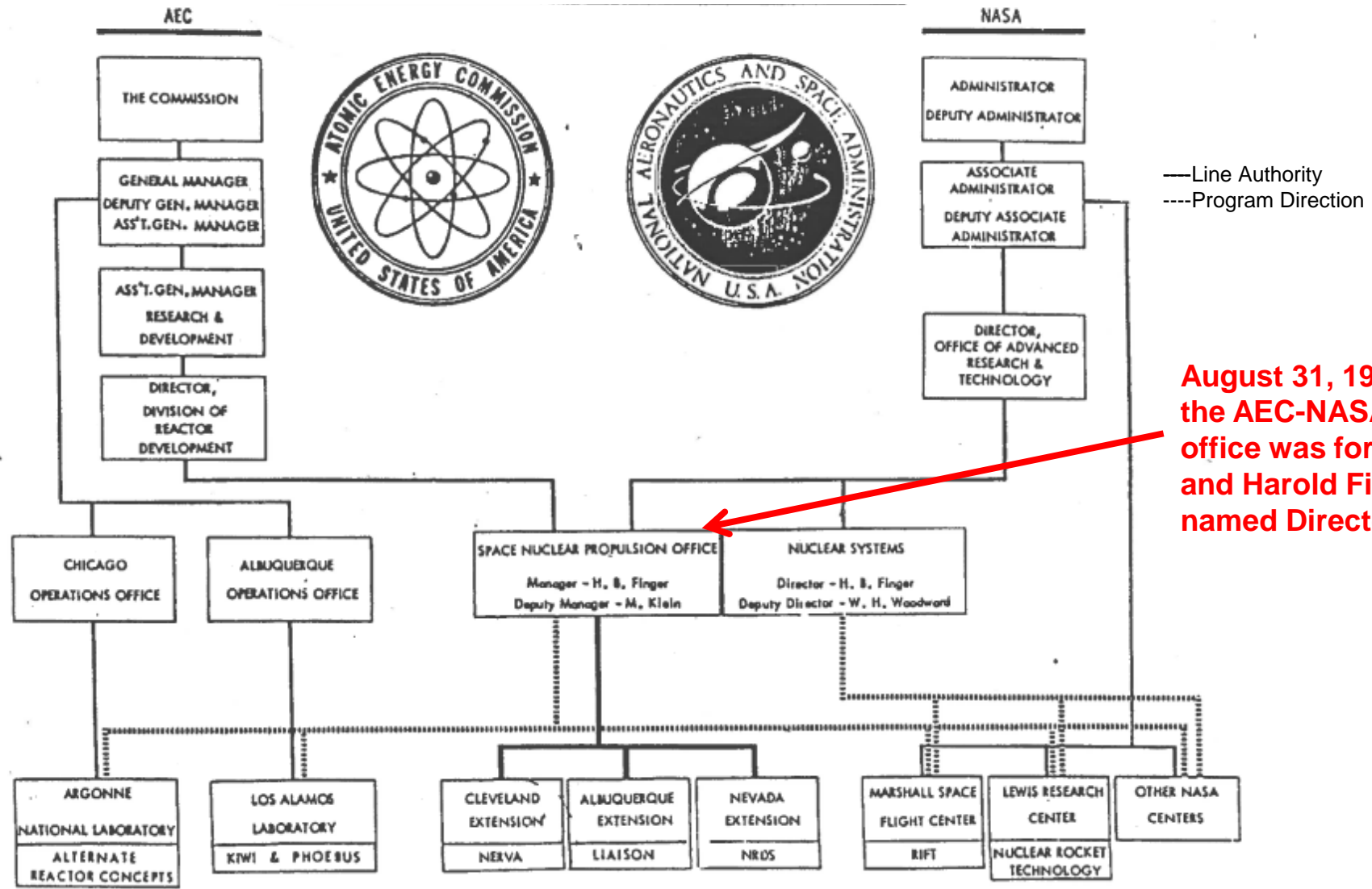

**August 31, 1960
the AEC-NASA
office was formed
and Harold Finger
named Director**

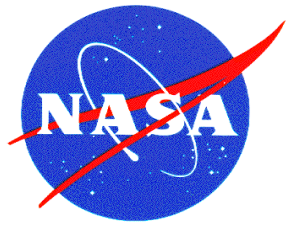

Early Program Actions Rover/NERVA

[2]

- 1. August 31, 1960: AEC-NASA Space Nuclear Propulsion Office established.**
- 2. September, 1960: Contracts with Convair, Douglas, Lockheed, Martin on flight testing nuclear rockets (RIFT).**
- 3. December, 1960: Contract with Parsons team on master plan for required Nuclear Rocket Engine Development Facilities.**
- 4. February, 1961: Issued RFP for NERVA contractor. Proposals due April 3.**
- 5. June 7, 1961: Aerojet General- Westinghouse Team selected for NERVA contract.
July 10, 1961: NERVA contract signed.**
- 6. July, 1961: RIFT studies extended.**
- 7. August, 1961: Contract with Vitro to design Engine MAD Building. Construction started in 1962.**
- 8. July 11, 1962: RIFT development contract awarded to Lockheed.**

NERVA-Nuclear Engine for Rocket Vehicle Application

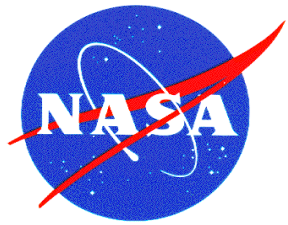

Project Rover/NERVA Funding

[1]

Dollars in Millions

AEC Operating Costs	
KIWI	136.9
NERVA	334.4
Advanced Research and Technology	200.7
NRDS Operations	75.3
Equipment Obligations	43.4
Facility Obligations (NOA)	82.8
TOTAL	873.5
NASA	
NERVA	346.5
Supporting Research and Technology	138.7
NRDS Operations	19.9
KIWI	21.6
RIFT	19.1
Facilities	30.9
TOTAL	567.7
TOTAL: AEC and NASA	1,450.2

Fiscal Year-Dollars in Millions

	1955	1956	1957	1958	1959	1960	1961	1962	1963	1964
AF		0.68	2.73	3.7	0.53	0.4 ¹				
AEC		4.6	17.4	13.2	23	25.8 ²	37.4 ³	40.9	76.8	96.4
NASA							17.6 cum.	36.9	81.4	84.7
Total		5.28	20.13	16.9	23.53	26.2	37.4	77.8	158.2	181.1

	1965	1966	1967	1968	1969	1970	1971	1972	1973	Total
AF										8.04
AEC	98.4	92.7	84.9	72.9	58	51.9	46.8	15	5	861.1
NASA	57.6	58.1	55.4	54.3	33.1	36.3	38	15	8.5	576.9
Total	156	150.8	140.3	127.2	91.1	88.2	84.8	30 ⁴	13.5 ⁵	1,446.04

The total would be \$7.6B in FY13

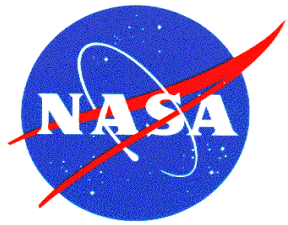

Kennedy Strongly Supports NTP

President John F. Kennedy

Special Address to Congress On The Importance of Space, 25 May 1961

“... I therefore ask the Congress, above and beyond the increases I have earlier requested for space activities, to provide the funds which are needed to meet the following national goals:



“First, I believe that this nation should commit itself to achieving the goal, before this decade is out, of landing a man on the Moon and returning him safely to the Earth...

“Secondly ... accelerate development of the Rover nuclear rocket. This gives promise of some day providing a means for even more exciting and ambitious exploration of space, perhaps beyond the Moon, perhaps to the very end of the solar system itself.

“Third ... accelerating the use of space satellites for world-wide communications.

**Fifty two years later, it's the only goal mentioned that remains unfulfilled-
three down, one to go!**

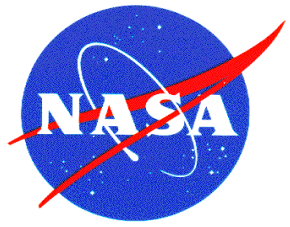

Kennedy at the Nuclear Rocket Development Station 12/8/62

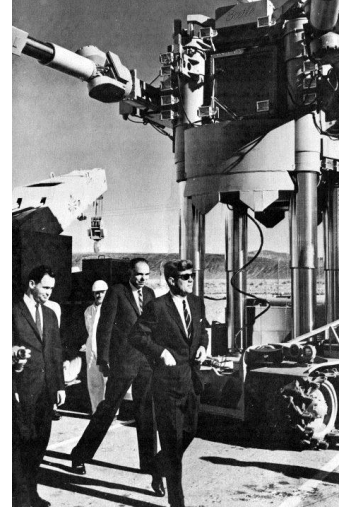

↑
**Harold
Finger**

Kennedy visited NTS one week after KIWI-B4A failed. Kennedy shown the engine in MAD before it was disassembled [2]



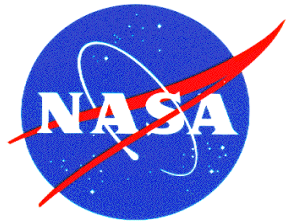

Nuclear Rocket Evolution

[3]

Flight Systems

Engineering Development

Experimental Development

Exploratory Development

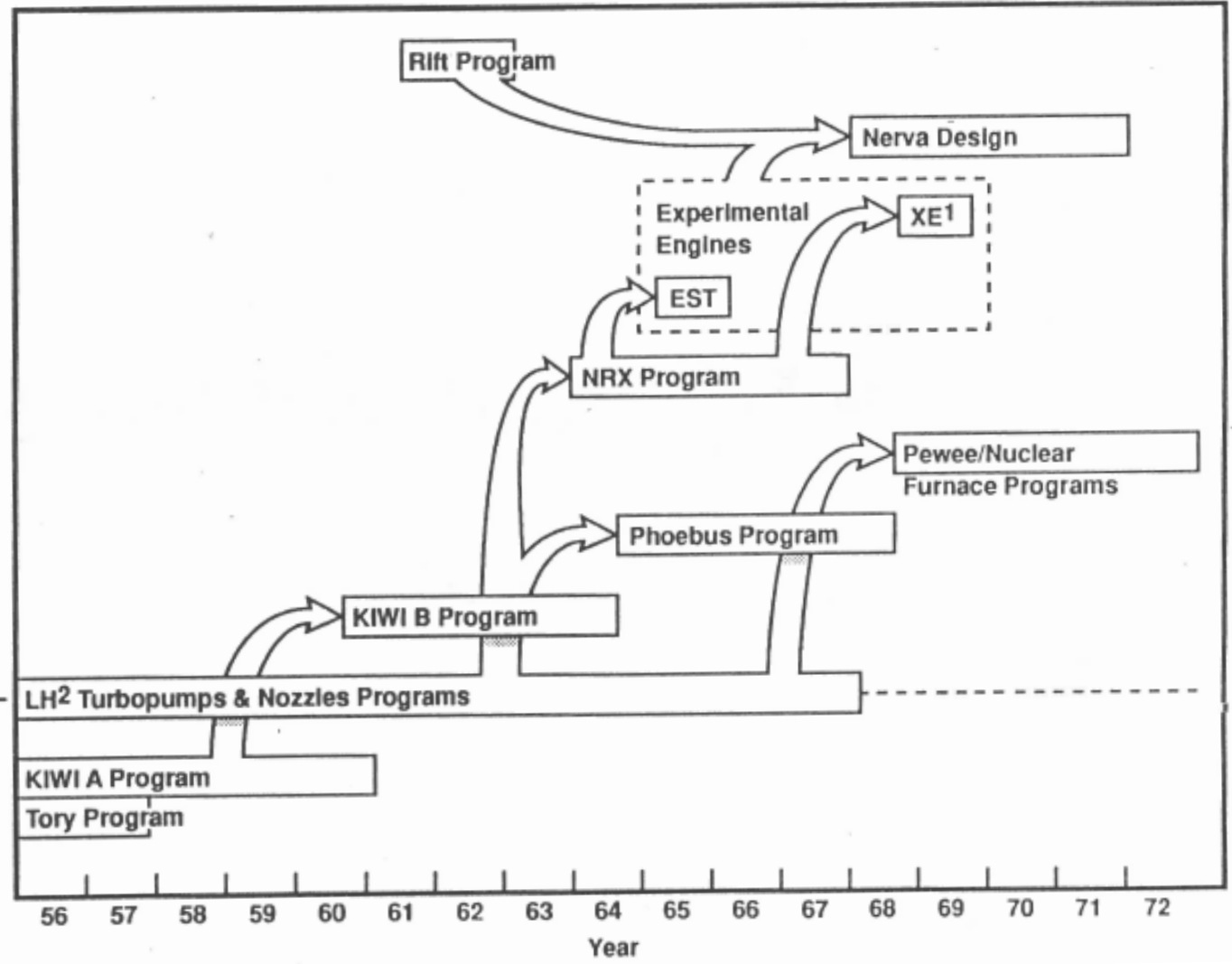

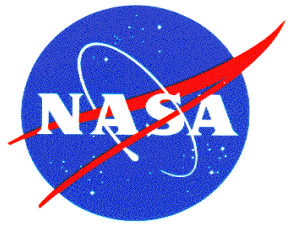

Reactor In Flight Test (RIFT)

- Started 1960 and ended 1963
- Managed by MSFC
- Purpose- furnish the vehicles for the first flight tests of nuclear rocket engines and demonstrate the practicality of nuclear rocket propulsion for space vehicle applications
- Scope-
 - Design nuclear stage
 - R&D to qualify materials and components to withstand radiation
 - Fabrication and assembly of stages including NERVA engine
 - Static testing and flight demonstration

INBOARD PROFILE OF RIFT [4]

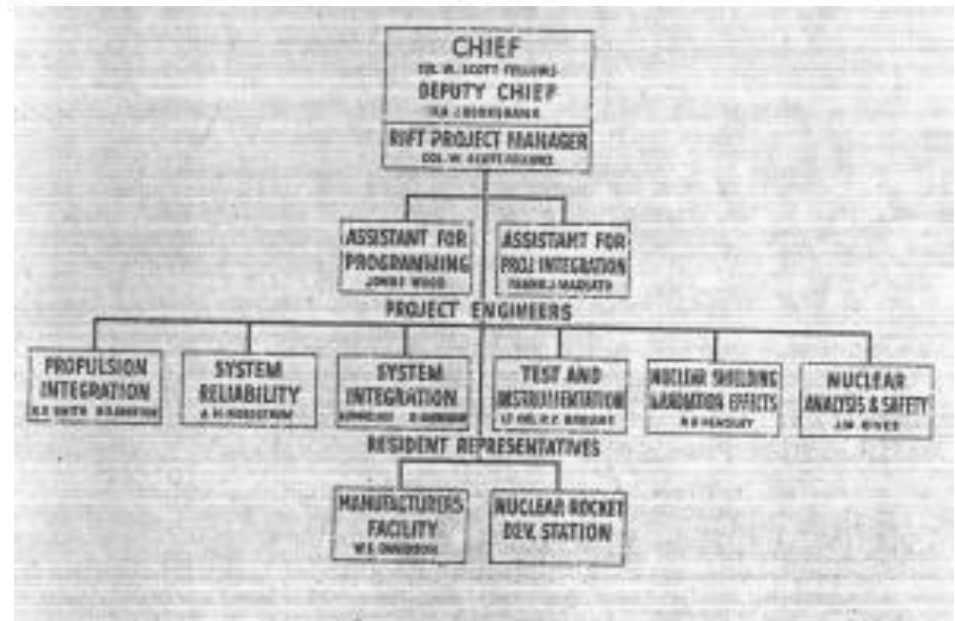
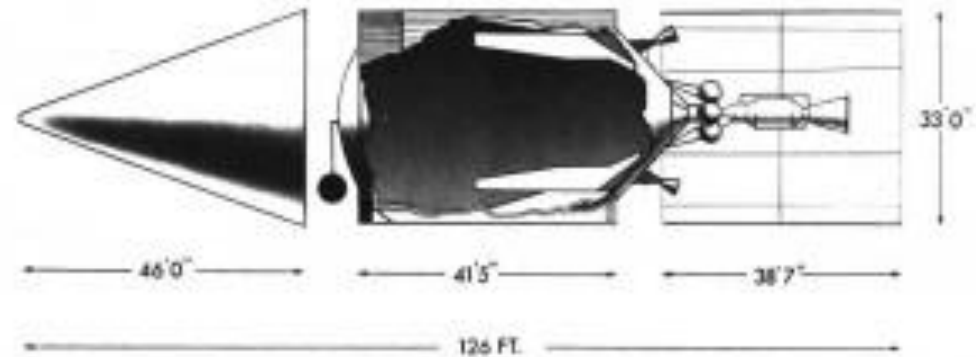

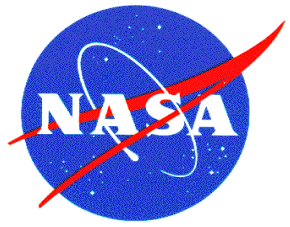

Nuclear Rocket Development Station (NRDS)

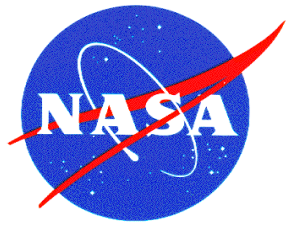

Nuclear Rocket Development Station (NRDS)- Nevada Test Site

Nevada National Security Site used to be called Nevada Test Site (NTS) during Rover/NERVA

NRDS

[5]



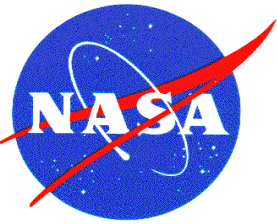

Nuclear Rocket Development Station-NRDS

[2]

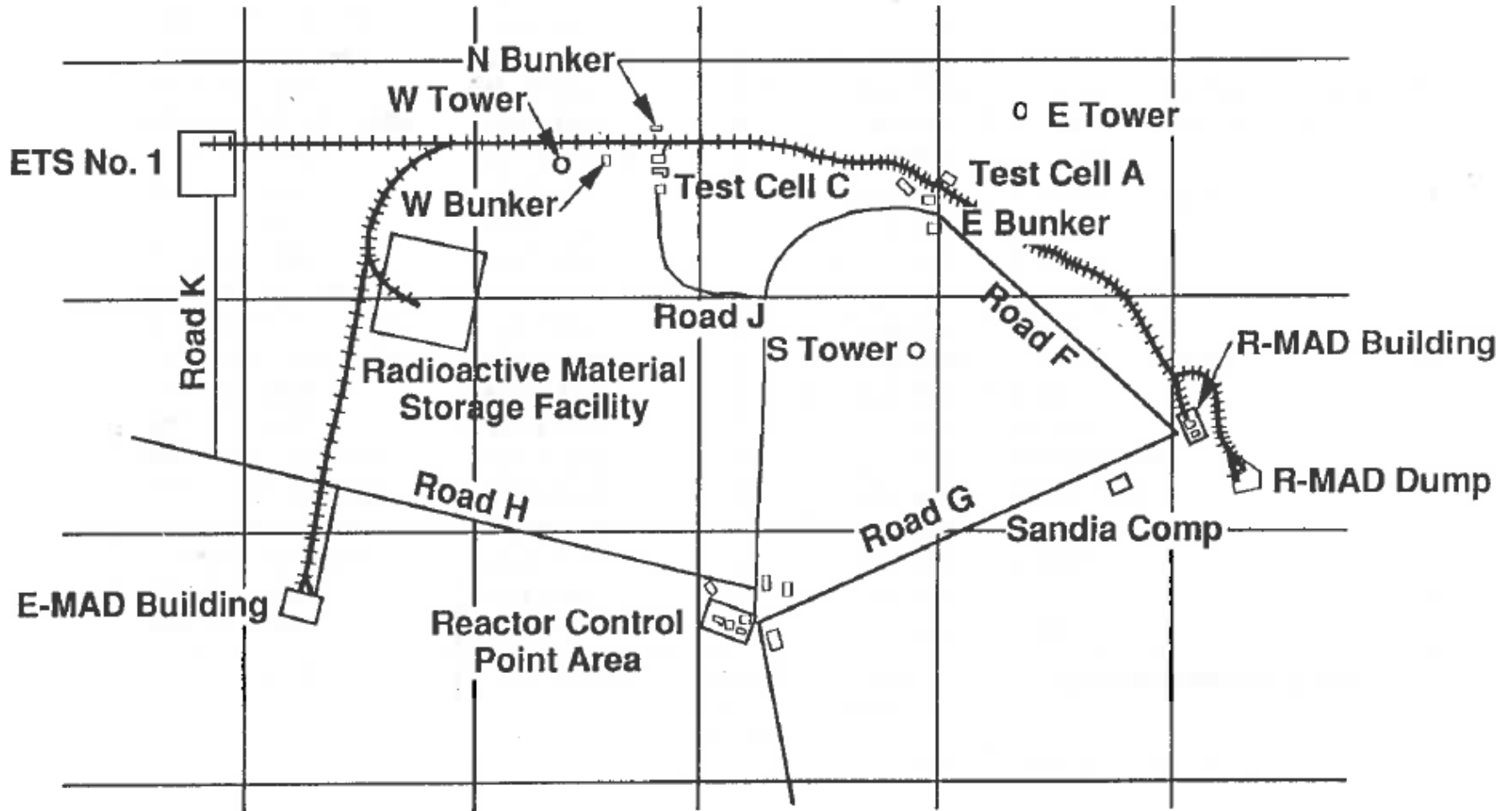

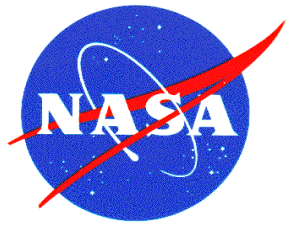

Engine Maintenance Assembly and Disassembly (E-MAD)



E-MAD, was used to assemble nuclear rocket engines for testing and to disassemble and inspect radioactive engines after testing. [1]

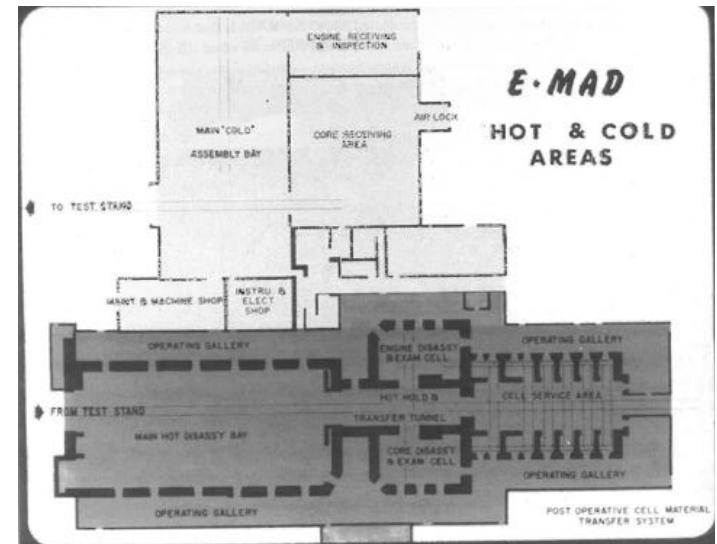

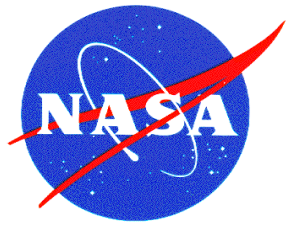

Nuclear Rocket Development Station Test Cells



Test Cell "A"



Test Cell "C"

With two 500,000 gallon dewars of LH2

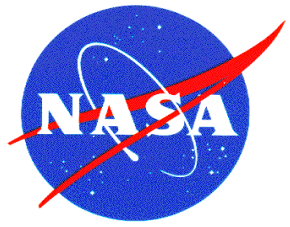

Engine Test Stand-1



- 77,000 gallon LH2 run tank
- Structure made of aluminum
- Engine surrounded by clamshell to provide high altitude simulation and reduce radiation effects on facility

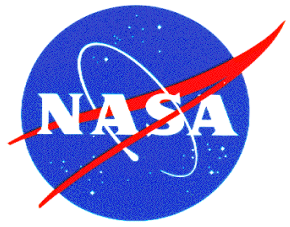

Ground Transportation



NERVA nuclear reactor and controls were assembled at the Large, PA, Westinghouse Astronuclear Lab, made safe for travel and possible accidents with poison wires, and shipped as one unit to the Jackass Flats, Nevada Test Site (Aerospace America, June 1989).



Transportation of Spent Fuel at EMAD

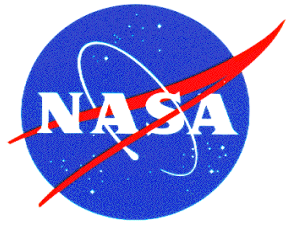

Rover/NERVA Engine Ground Tests

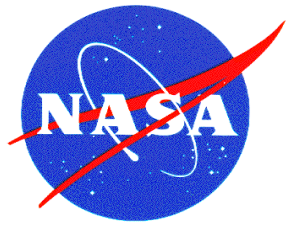

Chronology of Engine Tests

[3]

Note: Does not include TNT Test

Date	Test Article	NRDS Test Facility	Maximum Power	Time at Maximum Power
July 1, 1959	KIWI-A	A	70 MW	5 min
July 8, 1960	KIWI-A1	A	85 MW	6 min
October 10, 1960	KIWI-A3	A	100 MW	5 min
December 7, 1961	KIWI-B1A	A	300 MW	30 sec
September 1, 1962	KIWI-B1B	A	900 MW	Several sec
November 30, 1962	KIWI-B4A	A	500 MW	Several sec
May 13, 1964	KIWI-B4D	C	1,000 MW	40 sec
July 28, 1964	KIWI-B4E	C	900 MW	8 min
September 10, 1964	KIWI-B4E	C	900 MW	2.5 min – restart
September 24, 1964	NRX-A2	A	1,100 MW	40 sec
October 15, 1964	NRX-A2	A	Restart	(mapping)
April 23, 1965	NRX-A3	A	1,165 MW	3.5 min
May 20, 1965	NRX-A3	A	1,122 MW	13 min
May 28, 1965	NRX-A3	A	≤500 MW	1.5 min (-28.5 min)
June 25, 1965	Phoebus 1A	C	1,090 MW	10.5 min
March 3, 16, 23, 1966	NRX-EST	A	1,100 MW	1.5 min – 14.5 min – 8 min
June 23, 1966	NRX-A5	A	1,140 MW	15.5 min – restart – 14.5 min
February 23, 1967	Phoebus 1B	C	1,500 MW	30 min
December 13, 1967	NRX-A6	C	1,100 MW	62 min
June 26, 1968	Phoebus 2A	C	4,200 MW	12 min
December 3–4, 1968	Pewee	C	514 MW	40 min
June 11, 1969	XE-Prime	ETF-1	1,100 MW	11 min
June 29–July 27, 1972	Nuclear Furnace	C	44 MW	109 min (4 tests)

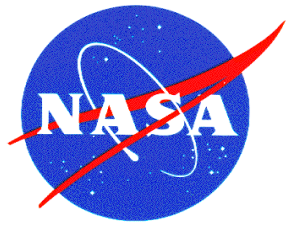

Rover/NERVA Engines

[6]

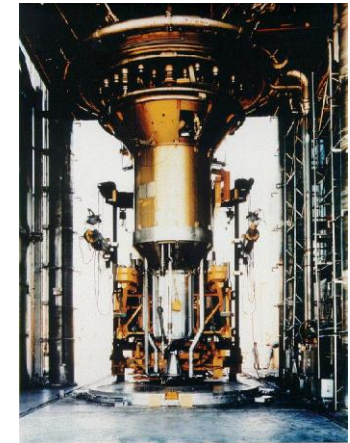
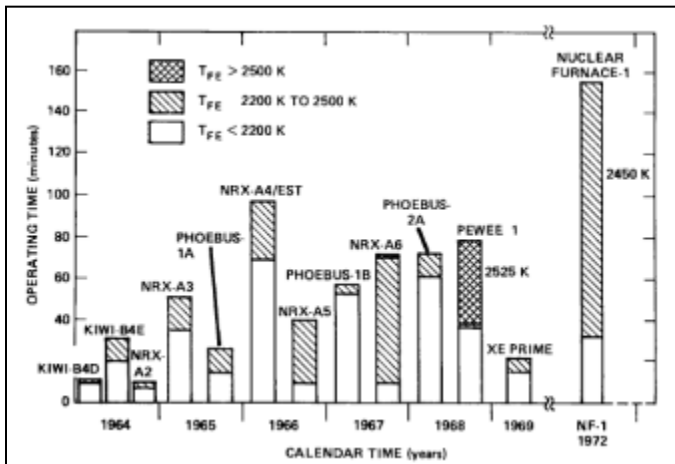
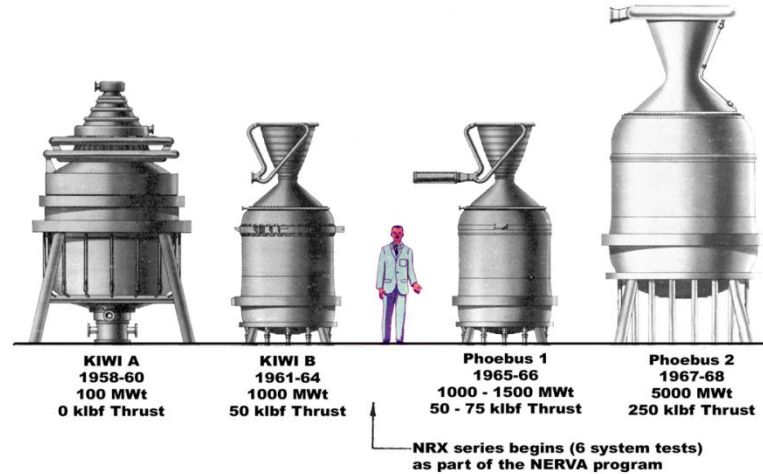
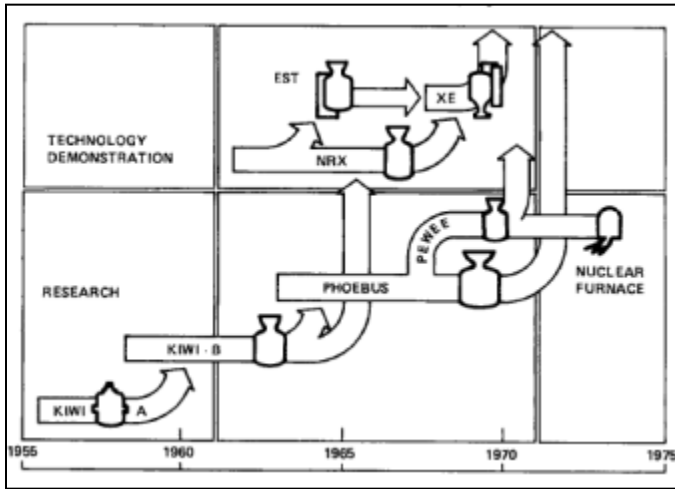

20 NTP engines designed built and tested during Rover/NERVA

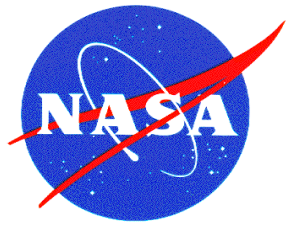

Rover/NERVA Reactor System Test Sequence

[6]

NERVA

	'59	'60	'61	'62	'63	'64	'65	'66	'67	'68	'69	'70	'71	'72
NRX Reactor Test				NRX-A1 ●			● NRX-A3			NRX-A6				
Engine Tests				NRX-A2 ●			NRX/EST ●		XECF ●		XE ●			

ROVER

KIWI	● KIWI A ● KIWI A	KIWI A3 ●		KIWI B1 B ●		● KIWI B4 D								
		KIWI B4 A ●		● KIWI B1 A		● KIWI TNT		● KIWI B4 E						
Phoebus				Phoebus 1A ●					● Phoebus 1B					
										● Phoebus 2A				
Pewee										● Pewee				
Nuclear Furnace													NF-1 ●	

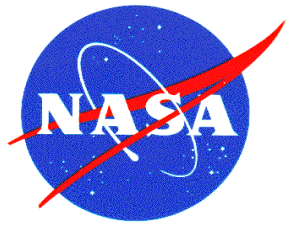

KIWI A, A', and A3

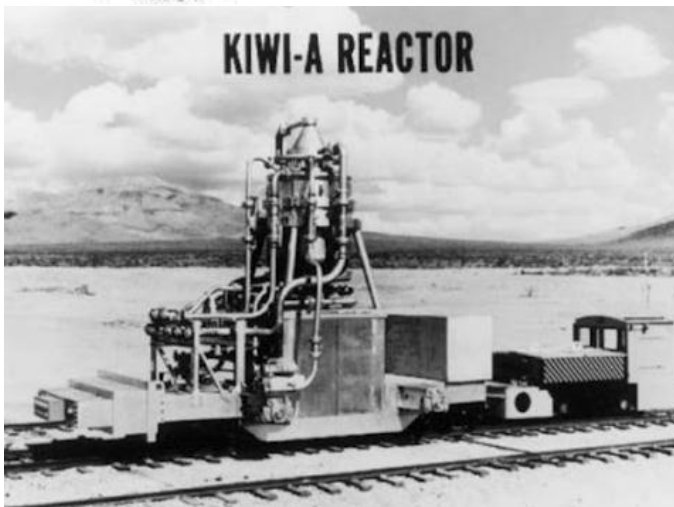
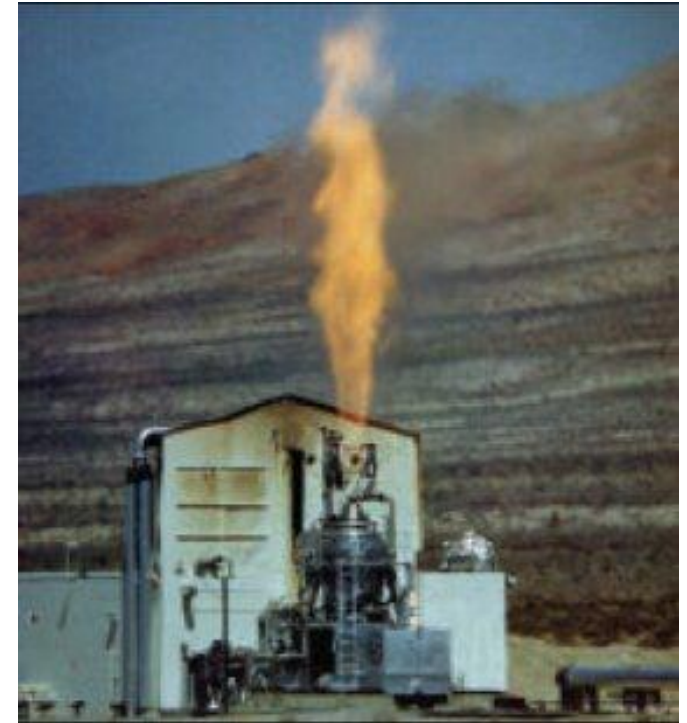
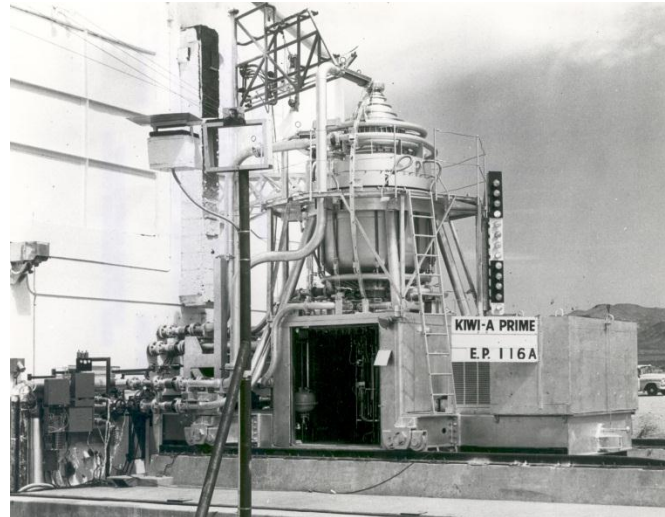
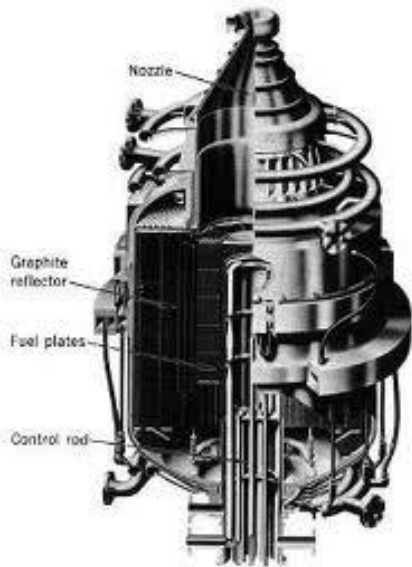

The KIWI A reactors demonstrated the following technologies: instrumentation and control, fuel element design and fabrication, structural design and testing techniques [7]

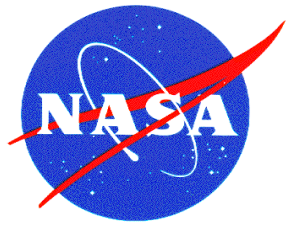

KIWI B1 A

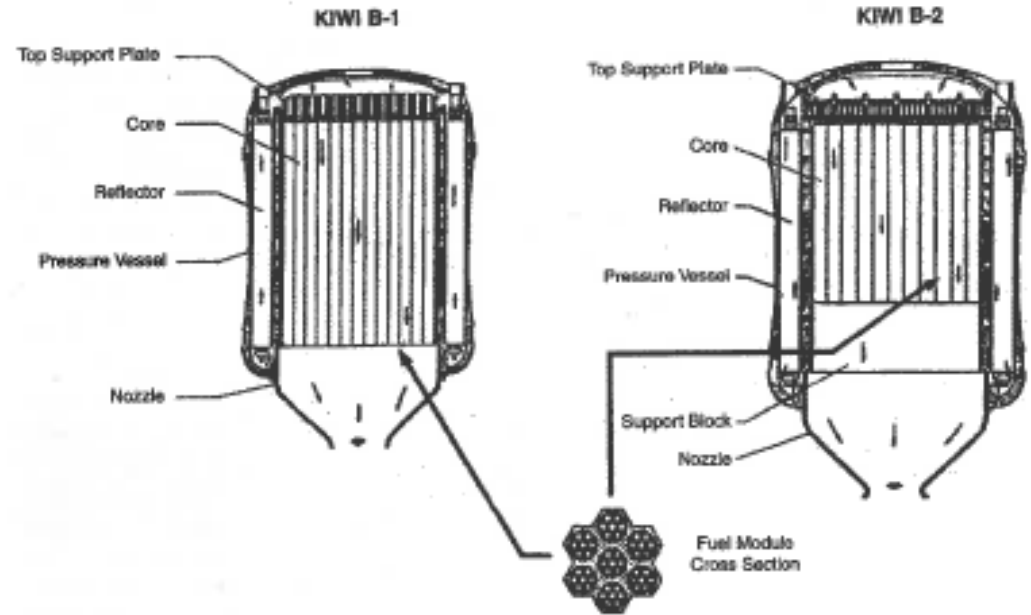

- The KIWI-B series was designed to achieve a 10-fold increase in power (1000MW) over the KIWI-A series while holding size constant [7]
- Regeneratively cooled nozzle
- Only operate for 36 seconds before stopping due to hydrogen fires near the nozzle flange area [8]

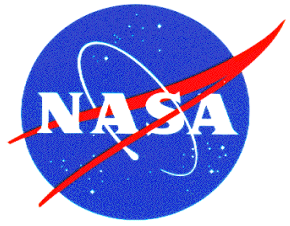

KIWI B4 A

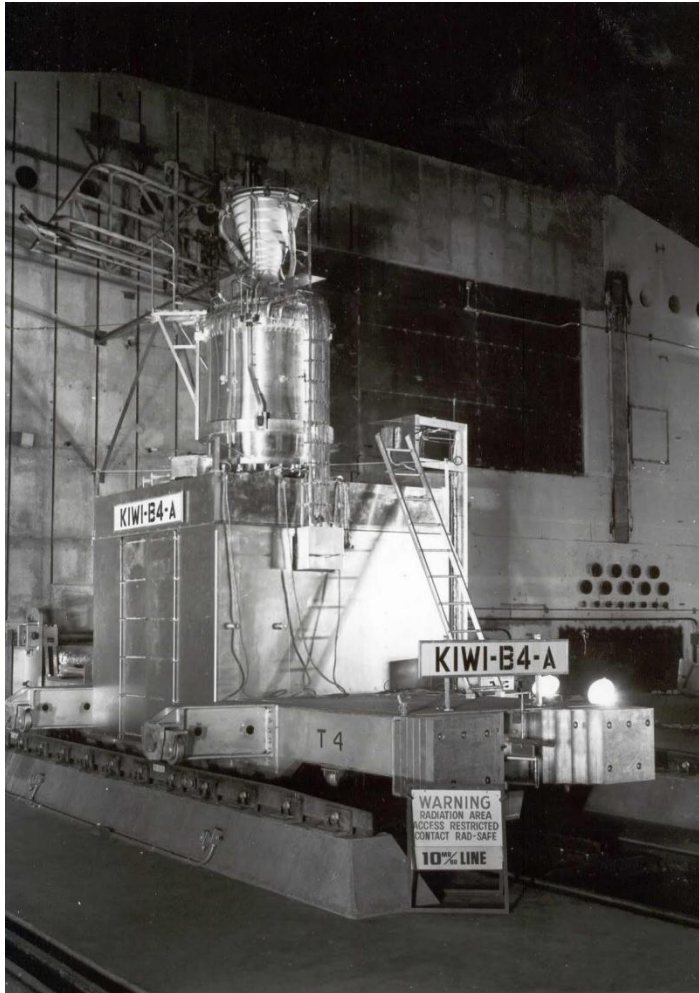

Tests were quickly turned off when the test started and flashes of light in the exhaust indicated core damage as power risen to ~ 450 MW. Fuel elements broke down due to severe vibrations [8]

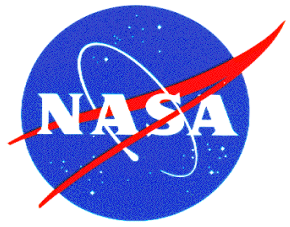

KIWI B4 A Cold Flow Test



- Harold Finger halted further hot fire testing until vibration problem resolved. Dr Norris Bradbury (LANL Director) said stopping hot fire testing would kill the program. [2]
- Cold Flow test run with nitrogen and non-fissioning reactor and well instrumented. Vibration caused by interstitial flow. Problem resolved with better bundling of the core and seals. Final cold flow tests showed no vibration[2]
- Dr. Norris Bradbury wrote Harold Finger and said **“insistence on a repeat KIWI B-4A cold flow test resulted in a damned interesting experiment! Perhaps we have all learned something!”**[2]

Non nuclear flow induced problem!

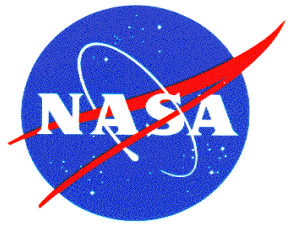

KIWI B4 D

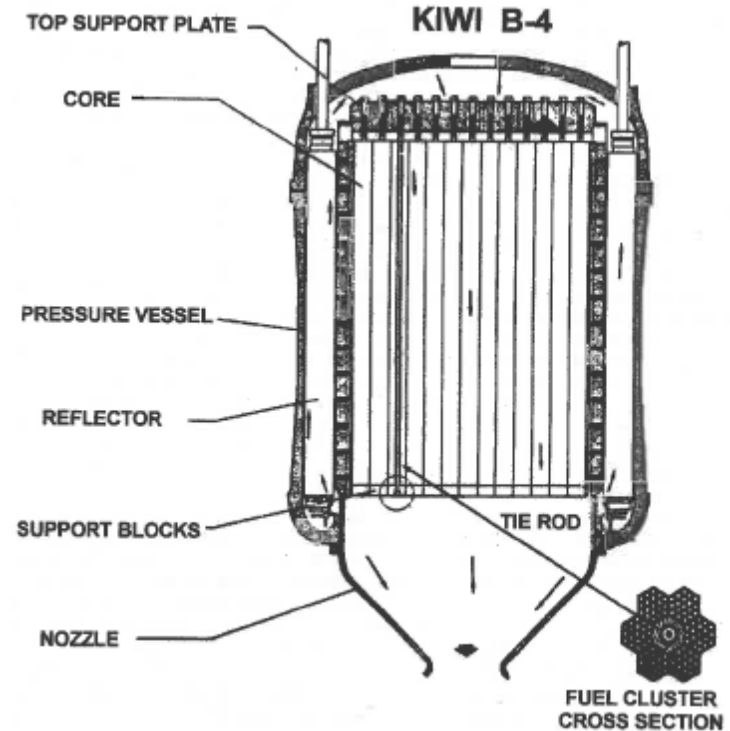
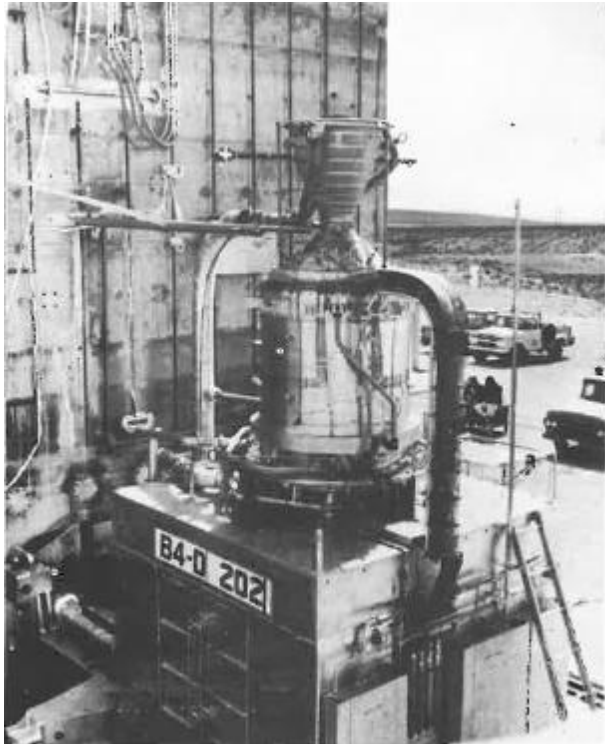

Cold flow test in early 1964. Hot fire test run was curtailed during the test after 40 seconds due to leak in the nozzle which led to a failure. No evidence of any core vibration or fuel element ejection. [8]

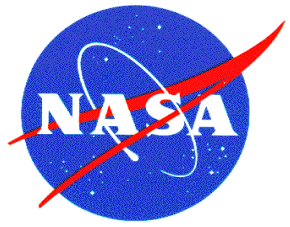

KIWI B4 E



Tested a few months after KIWI B4-D. The engine was the first redesign tested after the intense investigation of KIWI B4-A. No significant problems noticed during disassembly. The design jumped up into the NERVA NRX

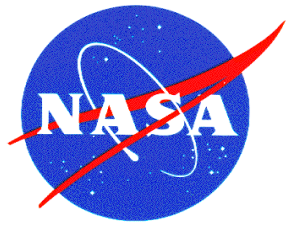

KIWI TNT (Transient Nuclear Test)

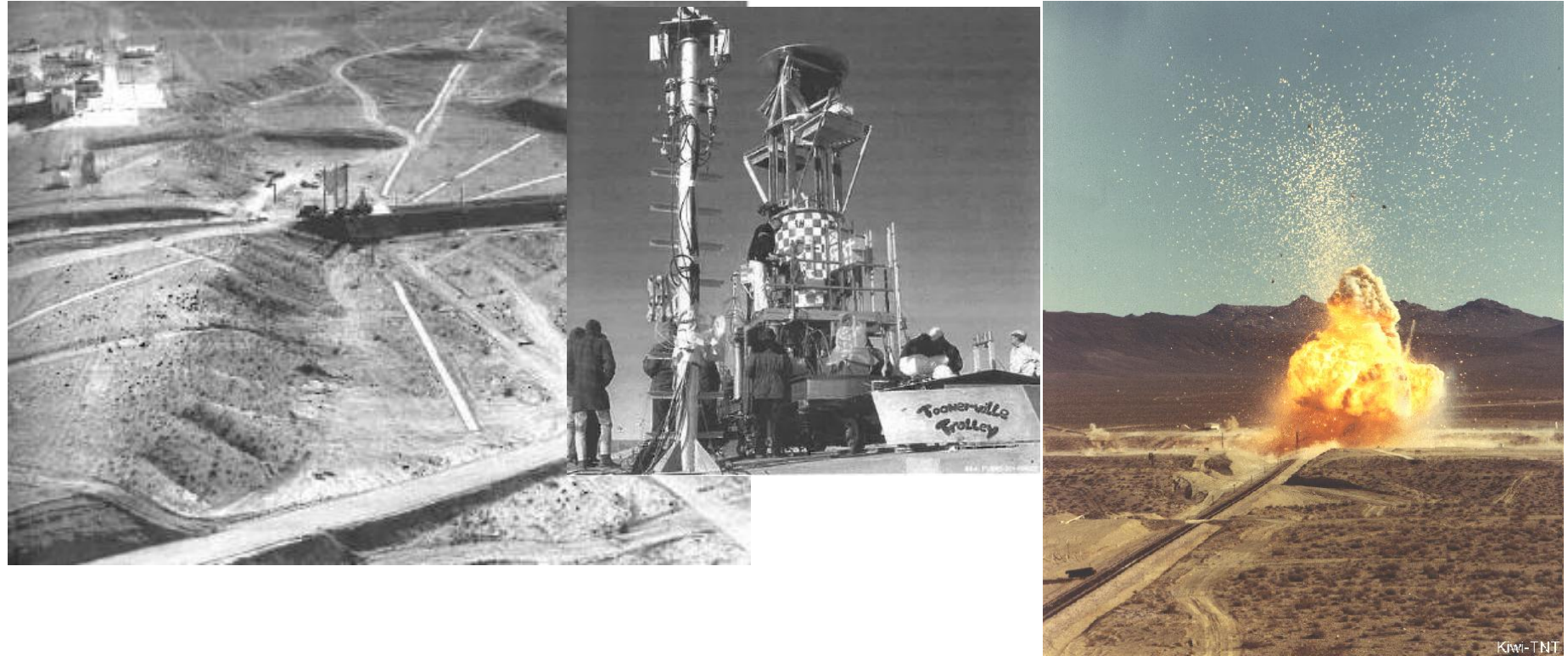

- Intentional (control drum speed 4000 deg/sec) reactor destruction to partly examine engine disposal in space[8]
- Can't happen with slow control drum actuators (45 deg/sec)!
- ~200-300 lbs gunpowder equivalent. Explosion mechanical not nuclear[1]
- Done 700' from test cell C

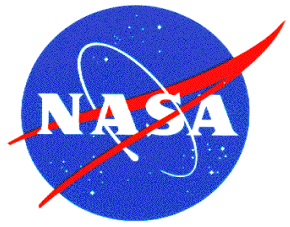

NRX-A1 to A3



- NRX reactor series was developed to prove that the KIWI-B4 series reactor structure could withstand vibration and shock environments, and that reactor controls could handle rapid exhaust temperature variations (100R per sec)[7]

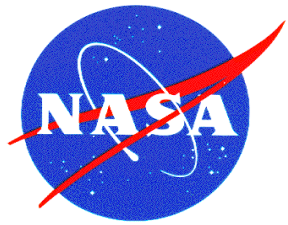

NRX/EST (Engine System Test)

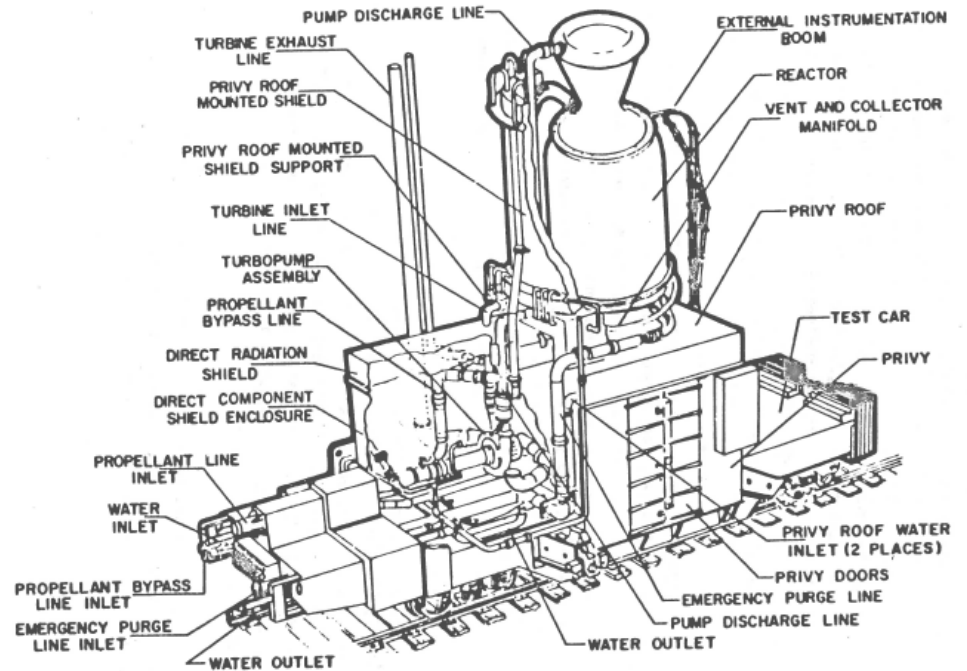

- First rocket engine “breadboard” using flight functional relationship.
- Hot bleed bootstrap principle was demonstrated.
- Operated with 11 start-ups and final run for 13.7 minutes. [8]

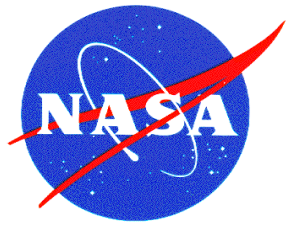

NRX-A6

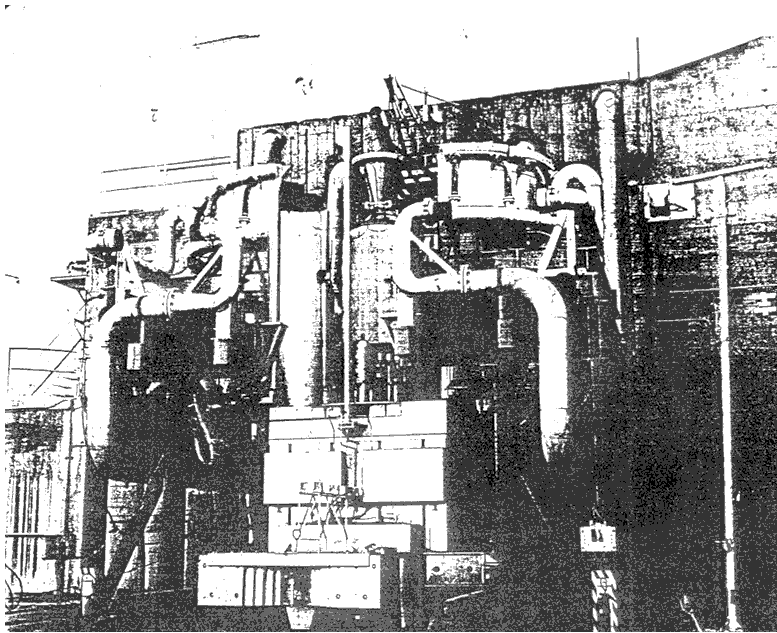

- Engine run continuously for 62 minutes and 2220K at test cell C
- LN₂ pulse cooling was completed after 75.3 hours[8]
- Reduction of 75-80% fuel element time rate of corrosion compared to NRX/EST and NRX-A5[8]

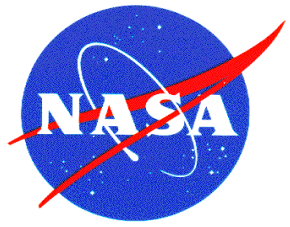

Phoebus-1A



- Prototype of new class of reactors to increase specific impulse, power density and power level. [8]
- Run for 10.5 minutes before running out of propellant.
- Intense radiation environment caused capacitance gauges to produce erroneous LH₂ tank measurements and supply was became empty. [8]
- Double 500,000 gallon LH₂ dewars were not yet installed.

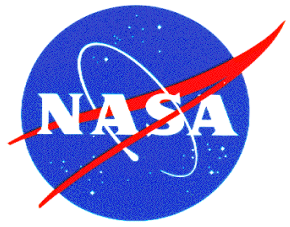

Phoebus-1B



[8]

- Phoebus-1B is rated at 1500 MW with total test duration of 46 minutes.
- External coatings of NbC reduce corrosion to .7g/element compared to uncoated.
- Mid range erosion noticeable.

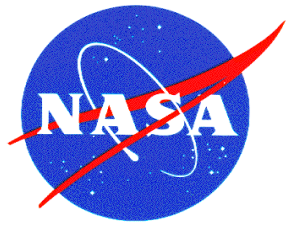

Phoebus-2A

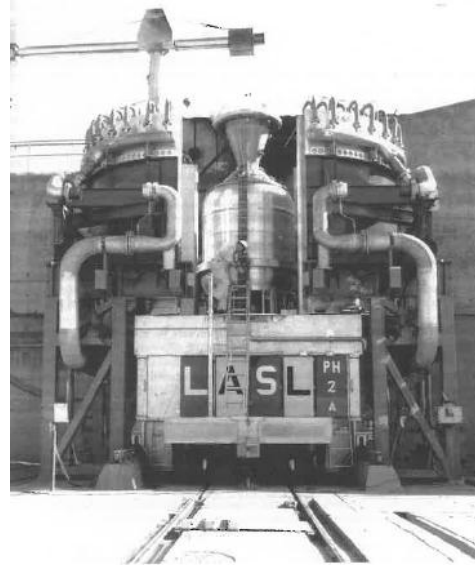

- 5 GW Reactor Core
- 805 seconds Isp space Equiv.
- 250,000 lbf Thrust
- Ran for 32 minutes with 12 min above 4 GW
- Excellent mechanical and thermal performance

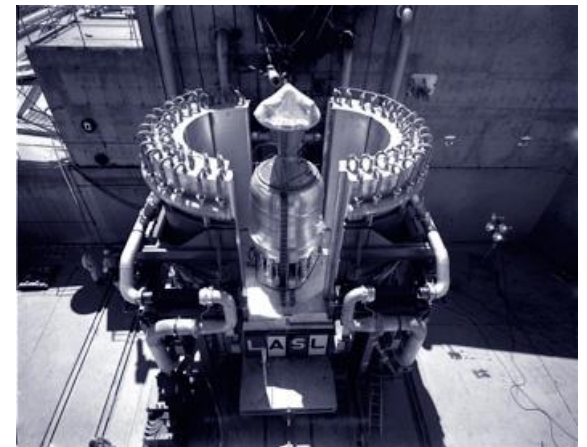

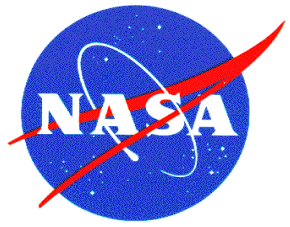

XE' Experimental Engine

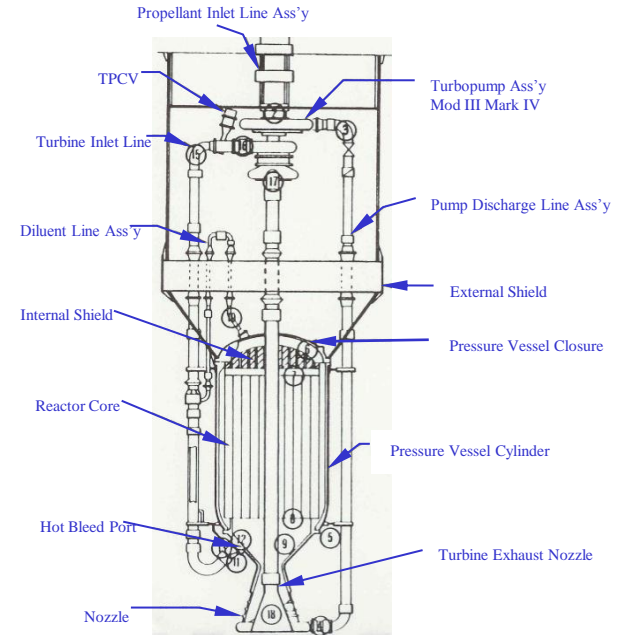

- 55430 lbs thrust
- 1140 MW power using NRX-A5 type fuel
- Hot-bleed-cycle in flight type configuration
- 28 restarts in 1969
- 11 minutes at full power
- Optimum startup and shutdown sequence demonstrated [8]



XE'' at MSFC

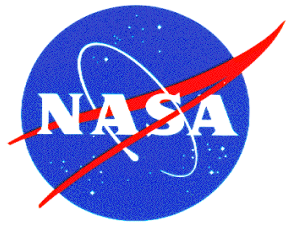

Pewee

[8]



- Pewee set records in power density and temperature. Operated at 503 MW for 40 minutes at 2550K with a peak to 2750K
- ~25k lbf of thrust
- Tested both NbC and ZrC coated fuel elements. ZrC out performed NbC in reducing corrosion.

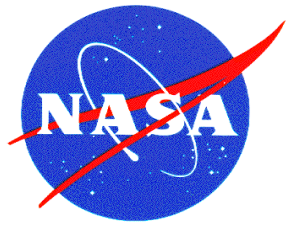

Nuclear Furnace NF-1

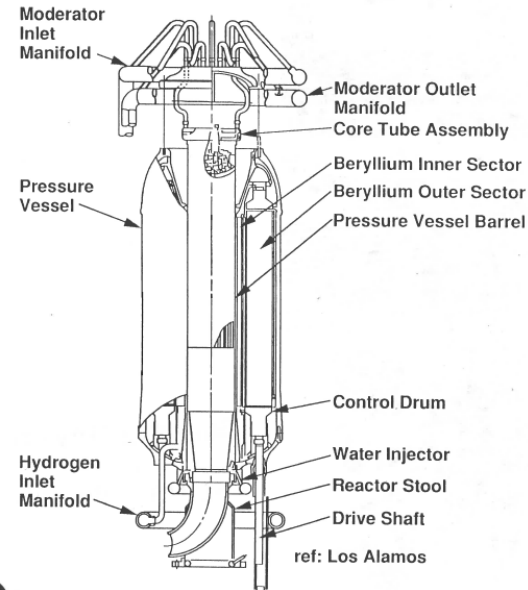
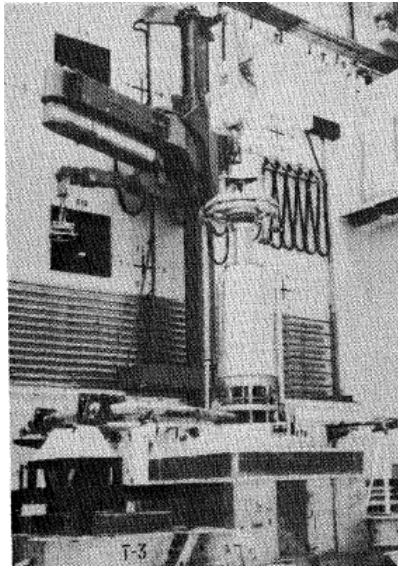

[11]

- 44 MW in size and ran on GH_2 . 4500-5000 MW/m^3 power density
- NF-1 test started in Summer 1972 and last reactor test done before program canceled
- Six runs were made. Final two runs completed without incident
- Exit gas temperature above 4000R for 121 minutes and above 4400R for 109 minutes total
- Only Rover/NERVA reactor test with filtered exhaust before burning hydrogen in flare stack
- Composite fuel achieved better corrosion performance, while carbide fuel had cracked extensively near center of reactor

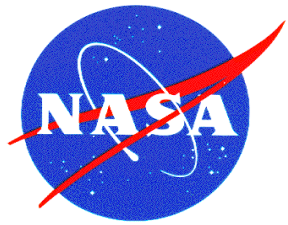

Mid-band Corrosion in NERVA Fuel Elements

Fuel element Axial Profile

[6,11]

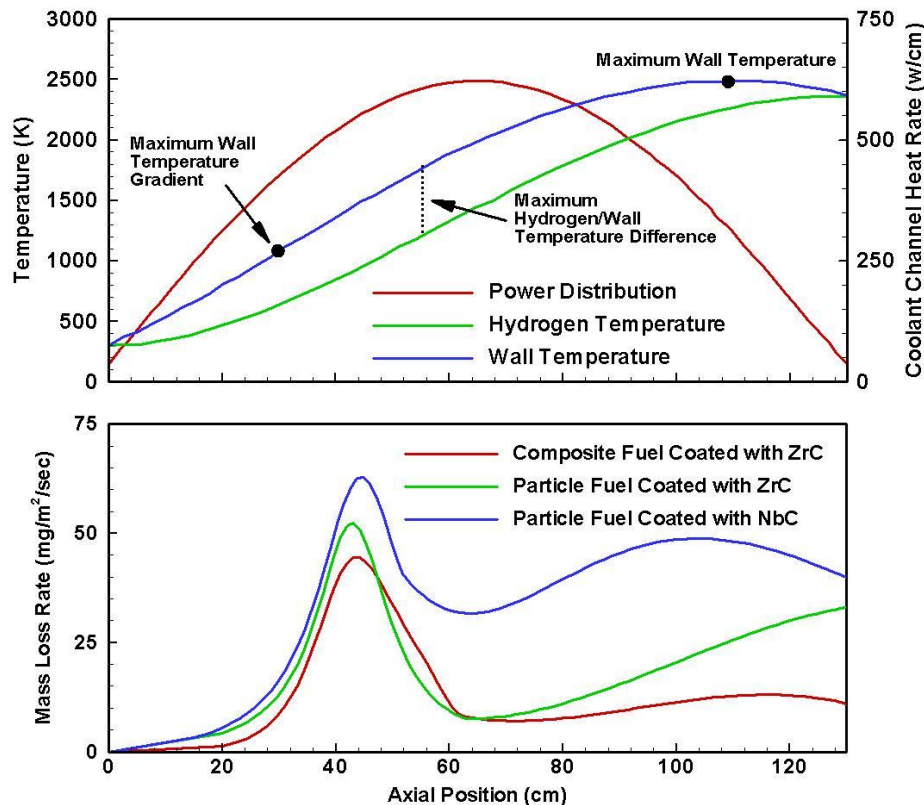

- Mass loss is greatest where fuel temperatures are only half of the maximum
- NF-1 had 8-50 grams mass loss per fuel element from ~90 minute run

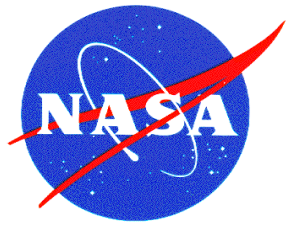

Feasibility of Engine Clustering



[1]

- Two reactors. One was KIWI B4, the other was PARKA zero power reactor
- One reactor stationary, while the other moved to distances of 16', 9', and 6'
- Data showed neutron coupling had marginal effects, which were negligible

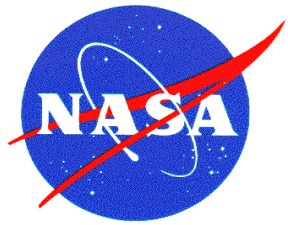

Other Test Rigs

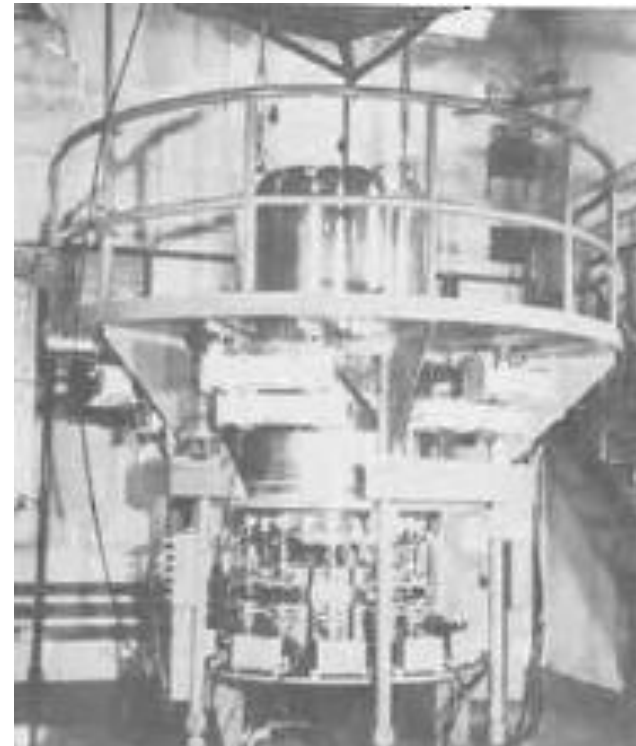
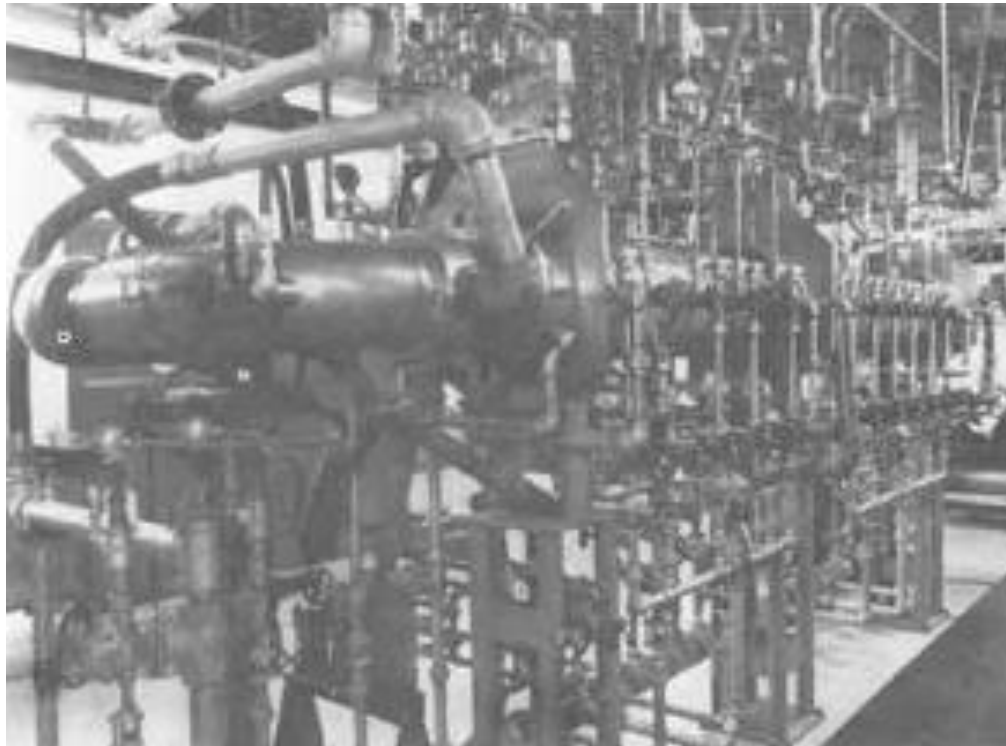

[10]

Hot Gas Test Rig

- Fuel Elements Resistively heated with DC current
- Changes in fuel element composition during a test affected electrical conductivity

Reactor Critical Assembly

- Nuclear data obtained at low neutron flux levels or essentially zero power

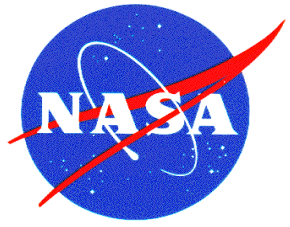

Final Rover/NERVA Engine Designs

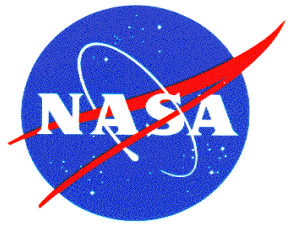

“Small Engine” Nuclear Rocket Design

[6]

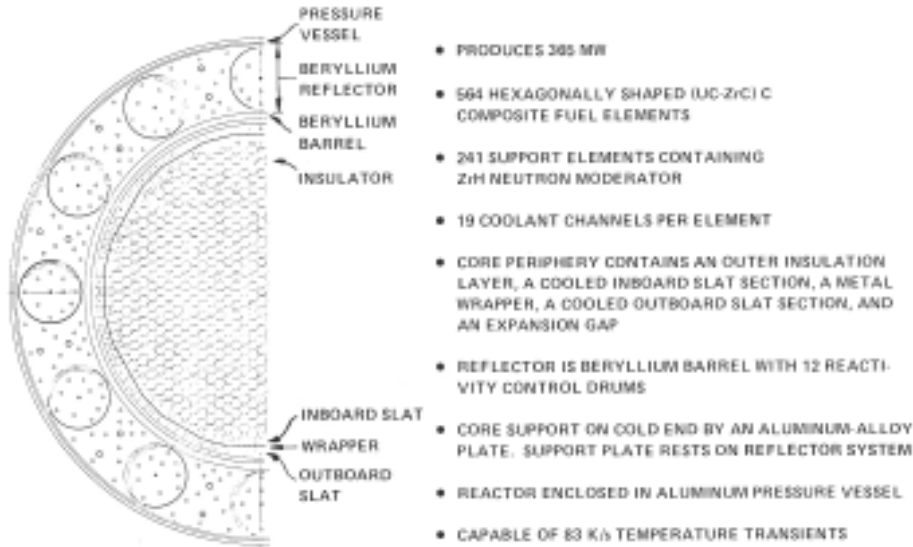

16,125 lbf
367 MW

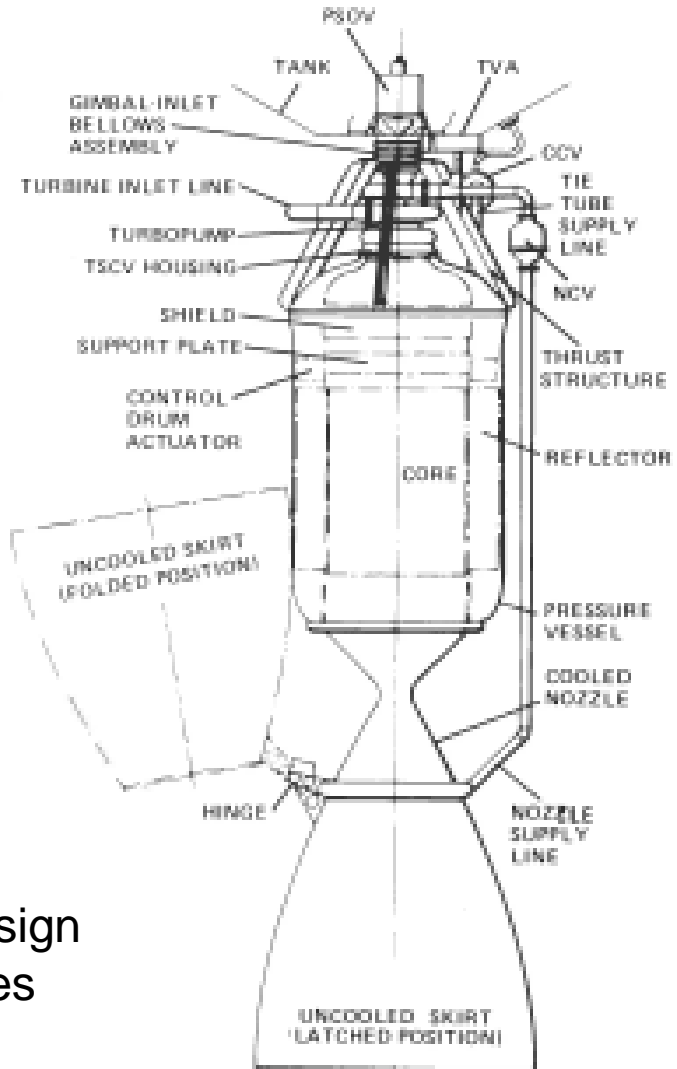

This engine design was the last reactor design based on lessons learned from past engines

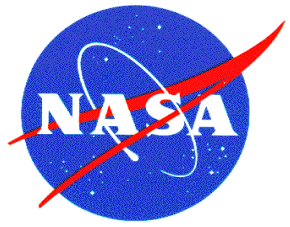

NERVA Flight Engine

[9]

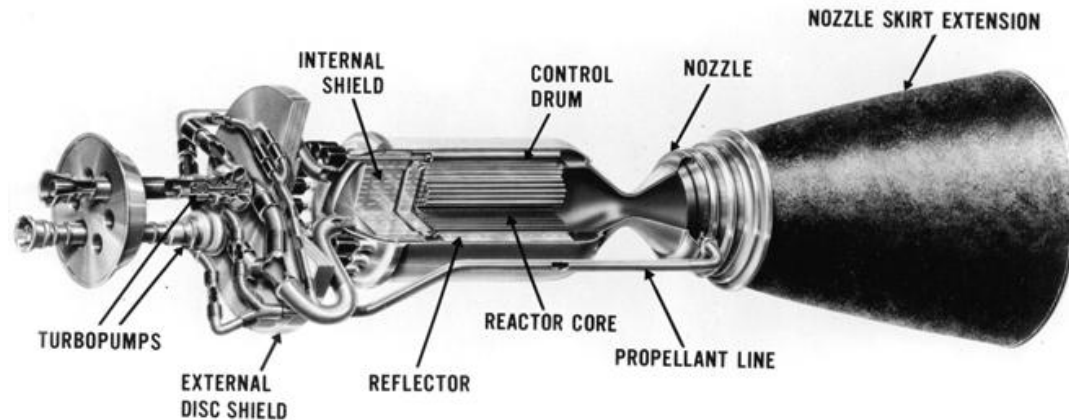
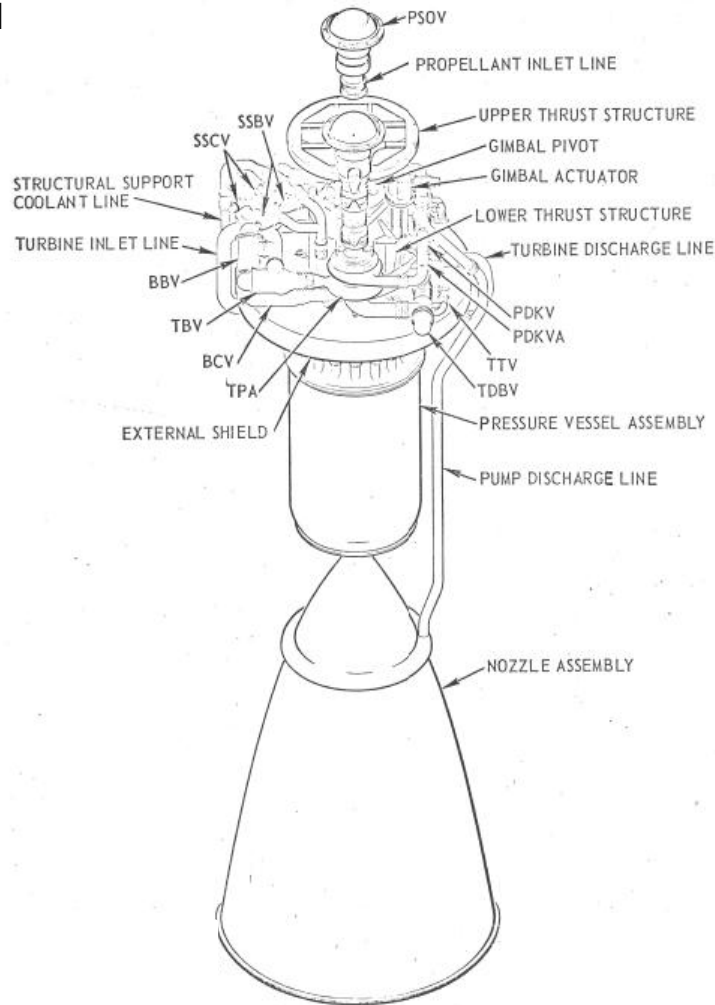

- Thrust 75,000 lbf
- Isp 825sec
- Chamber Pressure 450 psi
- 60 startups
- Minimum 10hr at rated temperature
- Design specs ready to go before program canceled

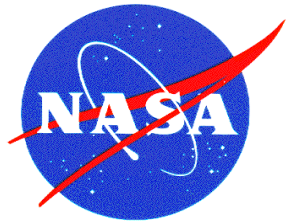

NERVA Start-up and Shut-down

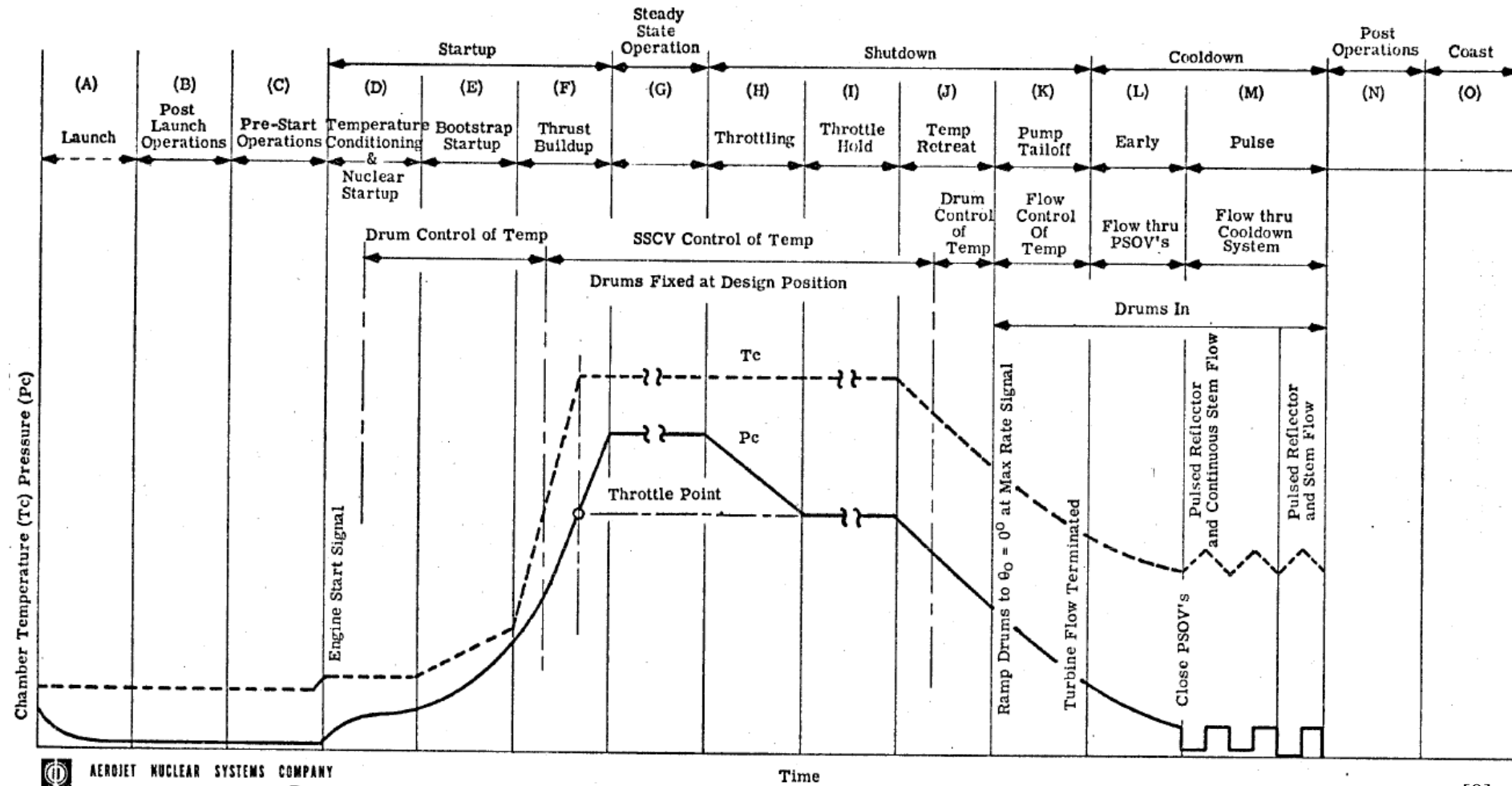

AEROJET NUCLEAR SYSTEMS COMPANY
A DIVISION OF AEROJET-GENERAL

[9]

Based on NERVA Flight Design

- Startup to steady state can take ~1-2 minutes for conditioning, 30 sec for thrust buildup
- Shut down time depends on steady state duration. 5 min run, I=.5min, M=16.5 hours. 20 minute run time, I=3 minutes, M=49 hours

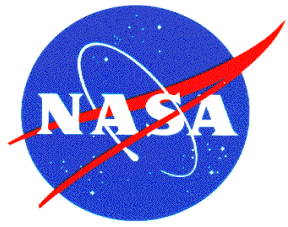

Conclusion

- The Rover/NERVA program was canceled before a prototype flight was achieved, but achieved a TRL 6 for the design requirements set in the 1960's and 1970's.
- Many lessons learned from the entire Rover/NERVA program will help the current NTP program develop faster and at a lower cost back up to TRL 6.

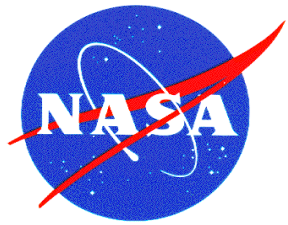

References

1. Dewar, J.A., "To the End of the Solar System- The Story of the Nuclear Rocket", Second Edition, Apogee Books 2007, p19, 56, 74, 83, 84,182, 207,
2. Finger, H. B., "Managing the Rover/NERVA Program", ANS/ENS International Meeting, 2000, slide 2, 8, 9,10 page 6, 7
3. Gunn, S. V., "Development of Nuclear Rocket Engine Technology" MSFC NTP short course, 1992, section 14 page 4, 6, 27
4. Fellows, W. S., "RIFT", Astronautics, December 1962, p38-42.
5. Nevada Test Site Public Information Brief, 2012 <http://www.h-o-m-e.org/nts-vision-project/nts-briefing-paper.html>
6. Angelo, J. A., Buden, D., "Space Nuclear Power", OrbitBook Company 1985, p179-181, 184, 187, 188
7. Walton, J. T., "An Overview of Tested and Analyzed NTP Concepts", AIAA-91-3503, p4, 6
8. Finseth, J. L., "Overview of Rover Engine Tests- Final Report", NAS 8-37814, 1991, p29, 40, 47, 51, 60, 63, 67, 68, 88, 98, 100, 111, 112
9. NERVA Engine Reference Data, S130-CP-090290AF1, Aerojet, September 1970.
10. Willaume, R. A., Jaumotte, A., Bussard, R. W., "Nuclear Thermal and Electric Rocket Propulsion", Gordon and Breach Science Publishers, 1967, pp 292-293.
11. Kirk, W. L., "Nuclear Furnace-1 Test Report", LA-5189-MS, 1973, pp 3, 6