

GAMEPRO

THE #1 VIDEO GAME MAGAZINE

Mortal Kombat III



Bigger and Badder!
New Character Info Inside!

First Look
at the New
SUB-ZERO!

FREE! Genesis ProStrategy Guide
Phantasy Star IV!
16 Pages of Tips, Maps,
and Strategies!

ProReviews!

- Road Rash 3
- X-Men 2
- True Lies
- Return Fire (3DO)
- Flashback (Jaguar)
- Mortal Kombat II (32X)
- Earthworm Jim (Sega CD)

Previews!

- Mega Man 7
- Primal Rage is coming home!



Banned in Boston!



Neo-Geo CD

Sega Saturn and Sony PlayStation Games!

April 1995

\$4.95 Canada \$5.95



0 74470 65945 7

**ALL
NEW**

NBA ACTION '95
STARRING DAVID ROBINSON



Reggie Miller will be raining 3's!



Robinson takes his slams to a new level!



Rookie sensation Grant Hill explodes to the hole!

RISE ABOVE THE REST!

Real NBA stars including Patrick Ewing, Hakeem Olajuwon, Tim Hardaway, Jason Kidd, Shawn Kemp and Larry Johnson take flight with our "All-New Fast Breaking View." Choose from 27 NBA Teams, to battle through League, Playoffs and the NBA Finals. Trade players to build a dynasty, then immortalize the glory with your own personalized cart! Create your own players, put yourself in the game, and see how you measure up to NBA stars or play with 30 Hall of Famers. Large Battery tracks stats in 19 different categories. Marv Albert calls all the action. NBA Action '95 starring David Robinson is fan-tastic!



Game Gear™ features may vary from Genesis™.



Sega, Genesis, Game Gear, Sega Sports and Team Player are trademarks of SEGA. NBA Action is a trademark of NBA Entertainment, Inc. The NBA and individual NBA member Team identifications used on or in this product are trademarks, copyrighted designs and other forms of intellectual property of NBA Properties, Inc. and the respective member Teams and may not be used, in whole or in part, without the prior written consent of NBA Properties, Inc. ©1995 NBA Properties, Inc. All rights reserved. The Videogame Rating Council, its Rating System, symbols and indicia are trademarks of Sega of America, Inc. ©1995 SEGA. All rights reserved.

SO REAL YOU'LL FORGET IT'S A GAME

NHL[®]

ALL-STAR

HOCKEY

95

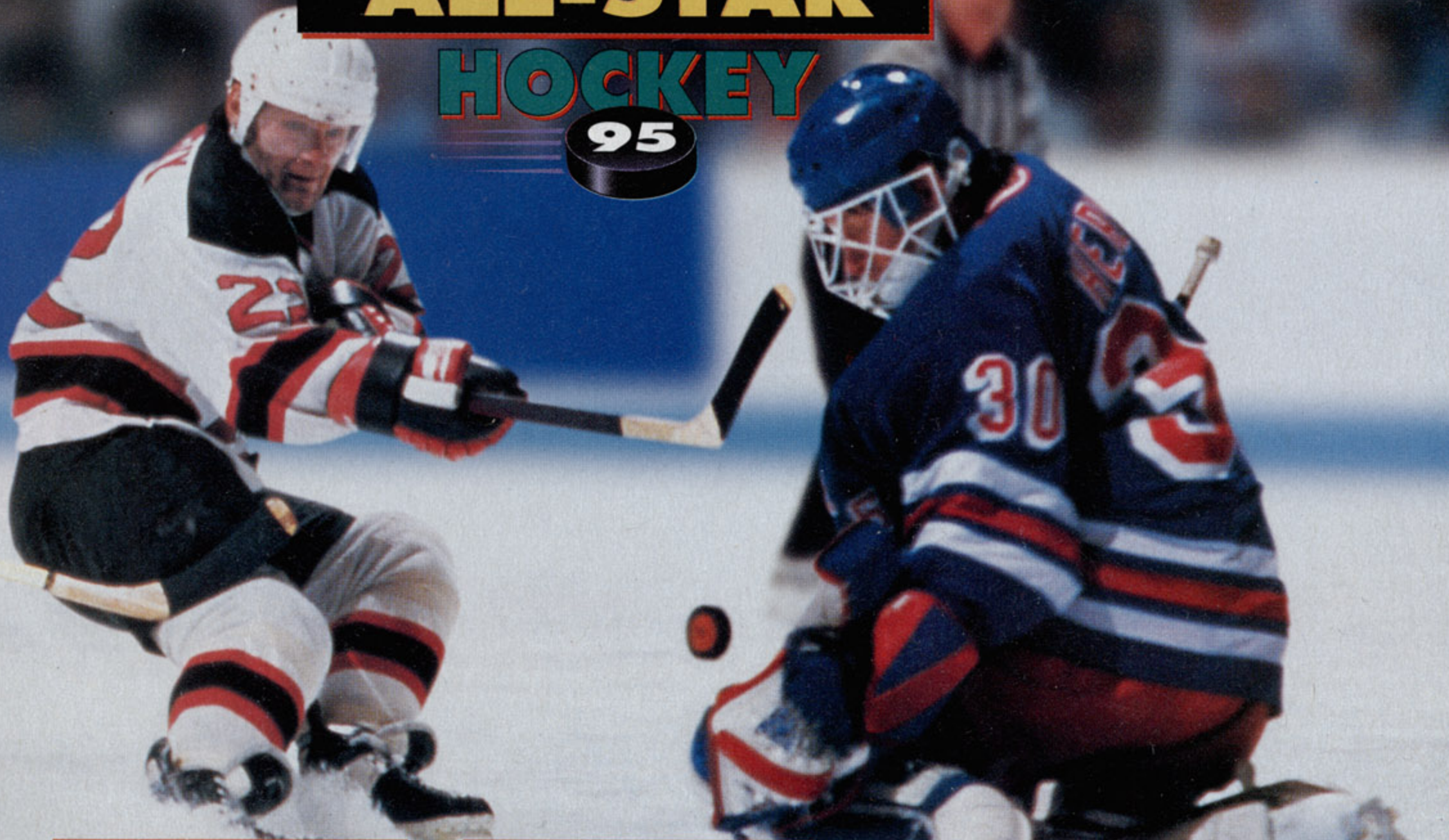

Crushing check! Over 1,000 animated frames including slap shots, wrist shots and 14 different goalie animations!



Fedorov unloads against the Rangers! All 650 NHL players are here - and you select automatic or manual goalie control!



Game Gear™ gives you all 26 NHL teams - and all real NHL players for playoff action straight through the Stanley Cup Finals!

THE ULTIMATE POWER PLAY.

Skate your way to Stanley Cup[®] glory with all-new All-Star Hockey! Play with all 26 NHL[®] teams and all 650 NHL Players including Bure, Messier, Yzerman, Jagr, Lindros, Hull, Irbe, Chelios and more! Real ice-action is here too with line changes, "speed bursts", instant replays, one timers - with a battery that tracks season standings & stats, sampled sound effects and color commentary from Marv Albert, voice of the NY Rangers. It's as real as it gets - and it's only from Sega Sports!



Game Gear™ features may vary from Genesis™.

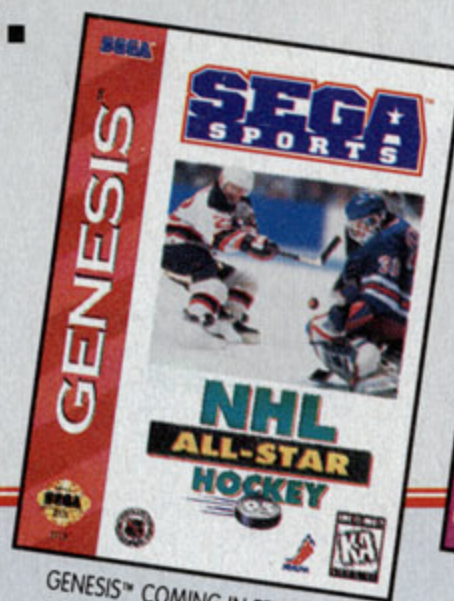

GENESIS™ COMING IN FEBRUARY

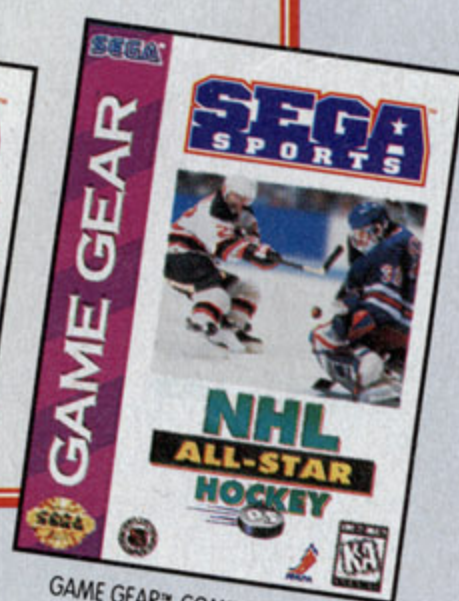

GAME GEAR™ COMING IN MARCH



Sega, Genesis, Game Gear and Sega Sports are trademarks of SEGA. NHL is a registered trademark of the National Hockey League. Stanley Cup is a registered trademark of the National Hockey League. Team names and logos depicted are officially Licensed Trademarks of the National Hockey League. ©NHL 1995. NHLPA, National Hockey League Players' Association and the logo of the NHLPA are registered trademarks of the NHLPA and are used under license by SEGA. ©1995 SEGA. All rights reserved.

SO REAL YOU'LL FORGET IT'S A GAME



SECRET OF EVERMORE™ UNLEASHED JUNE '95.

SUPER NINTENDO
ENTERTAINMENT SYSTEM

Mintendo, Super Nintendo Entertainment System and the official seals are registered trademarks of Nintendo of America Inc. © 1991 Nintendo of America Inc. All Rights Reserved.



Place nose here and
pull back slowly to
see the hidden image.

YOU'RE LOOKING INTO THE EYES OF ONE SICK PUPPY.

Hey Subscriber! Are You Moving?



Give us advanced notice
and you're sure to get
your next issue on
time...as usual.

Write to:
GamePro Subscriptions
P.O. Box 55527
Boulder, CO 80322

(Be sure to include both your old and new address)



GAMEPRO

Publisher **John F. Rousseau**

Editor-in-Chief **LeeAnne McDermott**
Director of Creative Services **Francis Mao**

Executive Editor **Wes Nihei**
Managing Editor **Janice Crotty**
Assistant Managing Editor **Kathy Skaggs**
Senior Editors **Andy Eddy**
Chris Strodder

Senior Associate Editor **Lawrence Neves**
Associate Editors **Chris Nicolella**
Tom Russo

Copy Editor **Paul Curthoys**
Editorial Intern **Allan McGraw**

Associate Art Director **Janette Harms**
Senior Designer **Teresa Hill**
Designer **Carey Perez**
Design Associate **Charmaine Conui**
Art Intern **Manny Barredo**

Production Manager **Patricia Ferguson**
Assistant Production Manager **Susanna Johnson**
Production Coordinators **Vincent F. Burns**
Cathie Burgyan
Courtney O'Connell

Ad Production Coordinator **Debra Vernon**
Director of Marketing **Valerie Hennigan**
Marketing Manager **Julie Marple**
Tradeshow/Events Manager **Cindy Penrose**
New Media Manager **Cara Martyak**
Marketing Specialist **Rebecca Patton**
Marketing Coordinator

Director of Manufacturing **Fran Fox**
Manufacturing Manager **Cathy Theroux**
Manufacturing Specialist **Jill McWilliams**
Manufacturing Coordinator **Lynn Luis**

Circulation Director **Holly Klingel**
Circulation Manager **Marcia Newlin**
Fulfillment Specialist **Randy Randolph**
Subscription Coordinator **Amy Nibbi**



President and Founder **Patrick Ferrell**
Executive Vice President **John F. Rousseau**
COO/Senior Vice President **Bruce W. Gray**
Human Resources Director **Christine Y. Yam**
Executive Assistant to the President **Diana Cruz**
Executive Assistant to the E.V.P. **Lonnie M. Forbes**
Human Resources Representative **Kelly Lynch**

Controller **Carmen Mangion**
Senior Financial Analyst **Laura Ashe**
Senior Accountant **Laura Rosenga**
Accounting Coordinator **Terry Gering**

Operations Manager **Jeannine C. Harvey**
Office Services Supervisor **Lesieli Friesen**
System Specialist **Salvatore Conigliaro**
Receptionist **Pamela Raass**
Warehouse Supervisor **Sam Grimaldo**

Entire contents copyright 1995 by Infotainment World, Inc. All rights reserved. Reproduction in whole or part without prior written permission by the publisher is prohibited. All submissions including, but not limited to, artwork, text, photographs and videotapes become the property of the publisher. Submissions cannot be returned; senders should retain a copy. The GAMEPRO® name and logo are registered trademarks of Infotainment World, Inc. Ultra 64, Super Nintendo, Nintendo, and Game Boy are Registered Trademarks of Nintendo of America, Inc. Sega Saturn, 32X, Genesis, Sega CD, and Game Gear are Registered Trademarks of Sega of America, Inc. Sony PlayStation is a Registered Trademark of Sony Computer Entertainment of America. 3DO is a Registered Trademark of The 3DO Company. CD-i is a Registered Trademark of Philips Consumer Electronics Company. Atari Jaguar is a Registered Trademark of Atari Corp. Neo-Geo is a Registered Trademark of SNK Home Entertainment, Inc. Printed in the U.S.A.

For subscription problems only, please write: P.O. Box 55527, Boulder, CO 80322-5527

Member **BPA**
INTERNATIONAL®

Volume 7, #4; April Issue; GAMEPRO® (ISSN 1042-8658) is published monthly for \$24.95 per year by Infotainment World, Inc., 951 Mariner's Island Blvd., Ste. 700, San Mateo, CA 94404; An IDG Company; The World's Leader In Information Services On Information Technology. Second class postage paid at San Mateo, CA, and at additional mailing offices. **POSTMASTER:** Send address changes to GAMEPRO, P.O. Box 55527, Boulder, CO 80322-5527. **Change of Address:** Please send old label and new address to GAMEPRO, P.O. Box 55527, Boulder, CO 80322-5527. **Foreign and Canadian orders** must be prepaid in U.S. dollars on a U.S. bank and must include \$30/year additional postage. Canadian GST# 131 304 347.



1-900-860-TIPS

OPTION 1

CLUES

OPTION 2

TIPS

OPTION 3

CLASSIC TIPS

OPTION 4

16 BIT

OPTION 5

HOT SHOTS

CALLS AVERAGE THREE MINUTES IN
LENGTH AND COST \$1.29 A MINUTE.
TOUCH-TONE PHONE REQUIRED.

Be sure to get your parents' permission to use the Hotline if you are under 18 years of age.
Messages subject to change without notice. A service of Infotainment World in San Mateo, CA

RISE GAME GENIE CODES

GET
GAME GENIE
CODES!
CompuServe®
GO "GAMEGENIE"
LIBRARY 8

THE LATEST CODES FOR THE HOTTEST GAMES!

HOT
GAME GENIE
PRICES!
FOR
Genesis™
Super NES™
Game Gear™ \$34.99
Game Boy®
NES® \$29.99
Manufacturer's suggested retail prices.
Actual prices may vary.

SUPER NES™

**ROBOTREK™
Game** CB34-3D47 + D734-3D17 *Start at level 3*
BDE6-1DC2 *First robot starts out stronger*

**THE REN AND STIMPY SHOW:
TIME WARP™
Game** 3CB1-14AC *Infinite lives*
CBBE-4468 + 6DBE-47D8 + DDBE-4768 + 62BE-47A8 *Don't have to charge special attack*

82ED-4DD6 *Infinite energy*
CBEF-440B + 17EF-446B + 3CEF-47DB + 3CEF-470B *Get 1 kitty gritty get 99*
CODES ONLY WORK FOR PLAYER ONE

**MORTAL KOMBAT II™
Game** C2C4-47AA / C2C7-47AA *Infinite continues*
C2B1-14F7 / C2B1-17F7 *Player 1 invincible*

C2B5-14F7 / C2B5-17F7 *Player 2 invincible*

DDB1-1FF7 / DDB1-14F7 *Player 1 killed by one hit*

622B-C7AC / 622B-C70C *Disable throws in two player mode*

6DC7-1DAA / 6DC0-1DAA *Infinite time*

CBC6-3D6E + D3C6-3DAE / CBCB-3D6E + D3CB-3DAE *Always fight Smoke*

CBC6-3D6E + DEC6-3DAE / CBCB-3D6E + DECB-3DAE *Always fight Noob Saibot*

THERE ARE 2 VERSIONS OF THIS GAME. IF THE FIRST CODE DOESN'T WORK ON YOUR GAME, THEN TRY THE SECOND CODE

CBC6-3D6E + FDC6-3DAE / CBCB-3D6E + FDCB-3DAE *Always fight Jade*

GENESIS*

**URBAN STRIKE™
Game** R12B-860Y *MASTER CODE — MUST BE ENTERED*
D3RA-AA9G *Infinite lives*
CKPT-AA4L *Infinite fuel*
AM4A-AA4G *Infinite ammo*
AKYT-AA2R *Timer never runs out*

GAME GEAR*

**FATAL FURY SPECIAL™
Game** 00C 38B E6E *Infinite time*
003 814 D5A *Terry's throw does very little damage*
775 61D C4A *Terry's standing kick kills*

**SAMURAI SHODOWN™
Game** 00C B3D 3BE *Infinite time*
01B F4D EB9 *Infinite energy*
20B 4BC F77 + 06B 4AC E68 *All hits do massive damage*

GAME BOY®

**JURASSIC PARK PART 2:
THE CHAOS CONTINUES™
Game** 00C-46E-19E *Infinite hearts*
00C-11E-E6E *Infinite lives*
AF3-C9B-7F6 *Only need 1 card to open the gate*
003-DCB-19A *Can't collect any energy*
AFC-46E-19E *1 hit and you die*

**MEGA MAN 5™
Game** 01B-75F-915 *Infinite lives*
004-1D9-3B7 *Infinite energy*
4B9-44F-808 *Start with about 1/2 energy*
212-269-E61 *Almost invincible*

NES® ON VACATION



FEATURES

26 **WeaponLord, Part 3**

Namco's game designers bring the artists' vision to the screen.



22 **Cover Feature: Mortal Kombat III**

MK III's coming to the arcades, but that's not the only place it's trying to make an impact.



33 **LamePro**

WARNING: The Surgeon General has determined that reading LamePro could be hazardous to your mental health.



Judge Ito to replace Sly Stallone as Judge Dredd! Page 33.



Sub-Zero or robot clone? Page 22.



PROSTRATEGY

69 **ProStrategy Guide: Phantasy Star IV (Genesis)**

This walk-through gets your Phantasy Star IV journey under way. To continue your trek, look for more PS IV strategies in the May issue of SWATPro.

107 **Role-Player's Realm: Final Fantasy III**

The finale of No Fantasy Too Final!



Go one-on-one with the X-Men! Page 120.

114 **SWATPro**

Secret weapons and tactics for your favorite games.

120 **The Fighter's Edge**

Master X-Men at the arcade.

BLOB OUT! Make short order of bilious blobs and evil trolls with Prince Ali's weapons, punches and kicks — or dig deeper to discover *HIDDEN SECRET MOVES* — a SEGA™ first!



ROCK ON! You'll need more than sticks and stones to battle the Rock Boss. Count on the four Wild Spirits to back you up — especially the superhot Efreet the Fire Spirit!



FIRE UP! Wrap your brain around mind-boggling puzzles that lead to close encounters of the fire-breathing kind — then save up to 4 games with battery back-up!



BEYOND OASIS



SEGA™

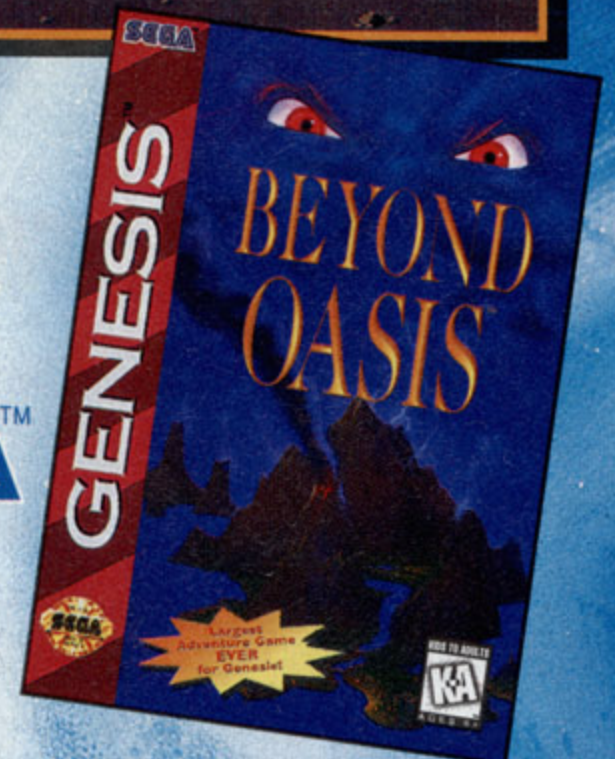

Sega, Genesis and Beyond Oasis are trademarks of SEGA. ©1995 SEGA. All rights reserved.

THE ULTIMATE ADVENTURE AWAITS!

PROREVIEWS

38 Genesis

- 38 X-Men 2: Clone Wars
- 40 Road Rash 3
- 42 Desert Demolition Starring Road Runner & Wile E. Coyote
- 44 Warlock
- 46 Izzy's Quest for the Olympic Rings
- 46 Minnesota Fats The Pool Master
- 47 Lemmings 2: The Tribes
- 47 The Punisher

48 Sega CD

- 48 Earthworm Jim Special Edition
- 49 Supreme Warrior
- 49 RDF: Global Conflict
- 50 Lords of Thunder
- 51 Midnight Raiders
- 51 Ultraverse Prime
- 52 BC Racers
- 52 Jeopardy!
- 54 Battle Frenzy
- 54 The Lawnmower Man
- 56 Keio Flying Squadron
- 56 Crime Patrol

58 32X

- 58 Space Harrier
- 58 Mortal Kombat II
- 60 Metal Head
- 60 Night Trap



Motorcycle madness! Page 40.

62 Super NES

- 62 True Lies
- 64 Warlock
- 66 Pac-In-Time
- 67 Micro Machines
- 67 GP-1 Part II
- 68 BreakThru!
- 68 Bust-A-Move
- 86 Tetris & Dr. Mario
- 86 Pieces
- 86 Wario's Woods
- 86 Pinball Fantasies

88 3DO

- 88 Return Fire
- 90 Starblade
- 90 Novastorm
- 91 Crime Patrol
- 91 Iron Angel of the Apocalypse

92 Jaguar

- 92 Flashback
- 94 Cannon Fodder

96 The Sports Page

- 96 Coach K College Basketball (Genesis)
- 97 NHL All-Star Hockey '95 (Genesis)

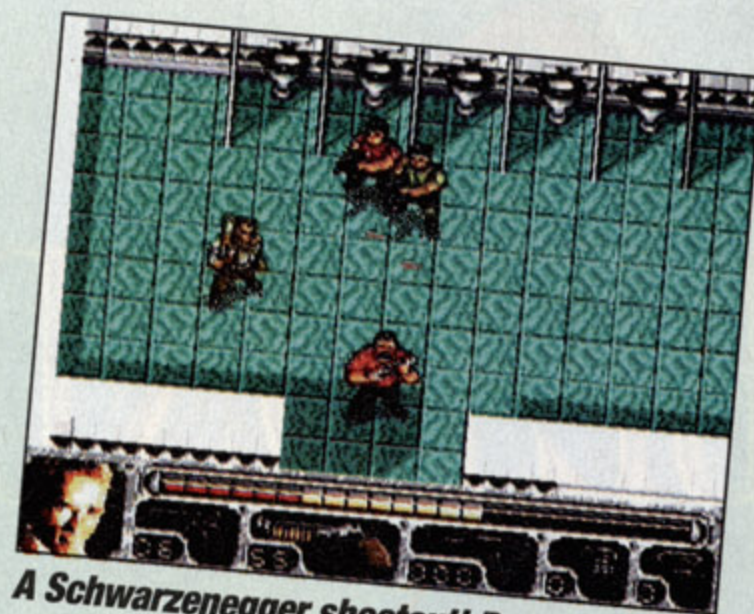

A Schwarzenegger shootout! Page 62.

- 100 International SuperStar Soccer (SNES)
- 101 ATP Tour Championship Tennis (Genesis)
- 101 Links (Sega CD)
- 102 Super Bases Loaded 3: License to Steal (SNES)
- 102 Super RBI Baseball (SNES)
- 103 Madden NFL '95 (Game Gear)

104 Role-Player's Realm

- 104 Ultima VII: The Black Gate (SNES)
- 105 Crusader of Centy (Genesis)
- 106 Popful Mail (Sega CD)
- 107 No Fantasy Too Final, Part IV: Final Fantasy III Strategy Guide

110 Game Gear

- 110 Bonkers: Wax Up
- 110 Stargate

DEPARTMENTS

12 Letter from the GamePros

12 The Mail

14 GamePro Gallery

16 The Cutting Edge
The Neo•Geo CD brings arcade games to your home.

18 Hot at the Arcades
Sega Rally Championship!

128 GamePro Labs
The Mad Catz System Selector, the Sega Power Strip, and the HT-2 Home Theater System

130 Buyers Beware
Information for savvy consumers

132 Short ProShots
Primal Rage, Mega Man 7, Real Monsters, and more!

141 Index of Advertisers

142 Overseas ProSpects
Toh Shin Den (PlayStation), Clockwork Knight (Saturn), and previews!



Take your Rage home! Page 133.

146 ProNews
Nintendo cracks down on counterfeit games.

THIS YEAR, SHAWN KEMP WILL PLAY FOR YOU.

crash



Your Crash card. If your player performs, you win.

the 15 top rebounders in the game. When your



A silver signature insert in every pack. Shawn Kemp card from Series One depicted for demonstration purposes only.

The Upper Deck Company introduces "You Crash The Game"™ by Collector's Choice™. Inside packs of Collector's Choice Series 2 Basketball you'll

find **Crash** cards featuring

boards during the season, you snag a prize.

BUT DON'T LET IT GO TO YOUR HEAD.

The prize? A complete set of **Crash** cards you can't get anywhere else.

You'll also find **Crash** cards for the top "Rookie Scorers." If your

Crash Rookie scores 1,250 points, you score too.

Hey, this year the best players in

the NBA aren't just playing for a title.

They're playing for you.



A 210 card set that delivers the best players, inserts and subsets in the game.

Hey Shawn, grab some boards or grab some bench.



Are You Playing The Game?



Upper Deck and the card/hologram combination are trademarks of The Upper Deck Company. ©1994 The Upper Deck Company. All Rights Reserved. Printed in the U.S.A. Product depicted for demonstration purposes only and subject to change without further notice. Odds of finding a pack containing a "You Crash The Game" insert card are 1:8. All NBA and Team insignias depicted on this product are the property of NBA Properties, Inc. and the respective NBA teams and may not be reproduced without the written consent of NBA Properties, Inc. Copr. © 1994 NBA Properties, Inc. No purchase necessary to enter. Game open to US and Canada residents. Void where prohibited or restricted. All claims must be received by 6/30/95. 1250 Rookie Points 15 card set and 1000 Rebounds 15 card set each have an estimated retail value of \$10.00(U.S.)/\$13.80(CND). Odds of winning and number of prizes depend on performance of players and number of entrants. Card winners must submit \$3.00 postage and handling fee. CA, MD, GA, OH & VT residents may omit handling fee. For a free game card, send a self-addressed, stamped envelope with your name, address, and telephone number printed legibly on a 3" x 5" card to NBA Crash Series Two Card Request, PO Box 28772, St. Louis MO 63146 by 6/1/95. Crash card recipients will be randomly selected from eligible entries at a ratio of 1:8. Subject to official rules - for a copy send a stamped, self-addressed envelope to NBA Crash Series Two Rules, PO Box 460611, St. Louis MO 63146. WA & VT residents may omit return postage.



Wired For Speed

There are over 100 killer 3DO[®] titles out there, with dozens more coming soon.



You don't need a lot of **BRAINS** to see why the **GoldStar 3DO[™]** Interactive Multiplayer[®] is the



game system that can't be beat. Its



FULL-MOTION Video, full-blown **3D-GRAPHICS**

and **16 MILLION COLORS** make everything else look like

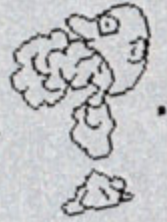

Its special audio processor blasts you with **CD-QUALITY SOUND.**

And for the total head trip, its **32-BIT RISC Chip**

moves so fast, other game systems look like they're standing still. Heard enough?

Then it's time to face the future. Check out

GoldStar 3DO[™], if you've got the nerve.



The **GoldStar 3DO[®]** system is jammed full of space-age technology and comes with lots of **FREE** stuff.



FREE

\$130 TOTAL VALUE

SHOCK WAVE



FIFA INTERNATIONAL SOCCER



GoldStar

Play The Future Today

3DO, the 3DO logo and Interactive Multiplayer are trademarks of the 3DO Company. All other trademarks are the property of their respective owners.

Plug in the optional digital video module and pump out movie-quality pictures or play feature-length films on video CDs.

Five in '95

The Winter Consumer Electronics Show (CES) in Las Vegas was an odd event this year. Usually, vendors exhibit all kinds of new software, but this one was notably light on that front. Instead, the next generation of gaming hardware stole the spotlight. Nintendo's Ultra 64, Sega's Saturn, and Sony Computer Entertainment's PlayStation will soon join Atari's Jaguar and the 3DO console. That's five major new game platforms with more than 32 bits of processing punch in each.

Although the systems didn't officially debut at CES, the competition among them was fierce. For example, the Sony folks stayed at the same hotel as the Sega folks. When Sega's group arrived at the hotel, it was greeted by a banner in the lobby and balloons around the hotel pool emblazoned with "Sony Computer Entertainment™ ♥ Sega." On following nights, the word "Sony" was expanded to say "Sega Owns Next Year." And word has it that Sega's inflatable Sonic mascot was later found slashed at the bottom of the pool. Whoa, these guys takes their games seriously!

Furthermore, most of the press conferences on the upcoming systems discussed the capabilities of their competitors' hardware as well. Nintendo showed videos of how superior its Ultra 64 would be in the realm of 3D graphics, thanks to the influence and experience of Silicon Graphics. Meanwhile, everyone seemed to have an opinion about whether Nintendo would be able to bring out the Ultra 64 at the targeted \$250 price tag – or if it would even be released this year.

No, this is one show that wasn't fought in official displays on the show floor, but in the trenches of hotel suites and press parties, with hype raids and gossip bombs. Hopefully, the murky promises of hardware-to-be will be clearer when the systems fight it out in May on the floor of the Electronic Entertainment Expo in Los Angeles. Sega, Sony, and Nintendo have all promised to put American versions of their wares on display for all to see and judge.

Until those consoles are released, you have an advantage. Check out this issue's "Overseas ProSpects," which looks at Japanese software for the Sony PlayStation and Sega Saturn. For the time being, put your wallet someplace safe, because you'll need it later this year.

The GamePros
San Mateo, CA



Future Watch

Future Watch

I'm writing in regard to James Wright's letter last October. He suggested that Nintendo's Ultra 64 will be the same as Atari's Jaguar. Just because the two systems will have similar technology and similar prices, they won't necessarily be the same. After all, look at the difference between the SNES and the Genesis – two 16-bit systems that have very different capabilities. Don't think that the Ultra 64 will just be a remake of the Jag: Nintendo could be saving the best for last.

Eddie Holman
Antioch, CA



Watch out for Damien Burt, a 16-year-old gamer from Ravenna, Ohio. Damien wonders what classes would help him become a game reviewer. Journalism courses are excellent preparation.

Has any company ever thought of making a three-player fighting game? You'd have lots of multidirectional attacks, such as Dragon's two-way jump kick in Way of the Warrior. Perhaps the characters would be viewed from an angled-overhead view so you could see them retreat into the background as well as move left and right.

Scott Davis
Columbus, OH

GamePro Readers Speak Out!

The Magazine Biz



Samurai Shodown rated high on the Game Boy...



...and on the SNES.

In December, you gave Samurai Shodown for the Game Boy slightly higher ratings than Samurai Shodown for the SNES. Are you saying that a Game Boy game is better than a SNES game?

Joshua Kendall
Hephzibah, GA

Andromeda replies:

No. Given the choice, we'd rather play the SNES version. What those ratings tell you is how Samurai Shodown for the Game Boy compares to other Game Boy games, and how the SNES version compares to other SNES games. It wouldn't be fair to directly compare a 4-meg handheld game with its 32-meg SNES sibling.

One of your SF II strategy guides shows memorabilia available from Capcom (SF II coins and cards, for instance). How do you order these items?

Aaron Krygier
Buffalo, NY

Bacon replies:

Action figures and a few of the other products should be available at major toy stores. If you can't find something, or if it's a somewhat obscure product (such as the SF II underwear), contact each manufacturer individually.

Here are a couple of the main numbers: Hasbro (toys and games): 800/242-7276; Innovative Time Corp. (watches and clocks): 800/765-0595; Infotainment World (strategy guides): 415/349-4300; Era Industries (backpacks and gym bags): 800/323-5999; Capboy America (baseball caps): 310/632-9033.

I really like the original Samurai Shodown. Do you have any strategy guides for it?

Brian J. Funk
Seattle, WA

Toxic Tommy replies:

Fans of the Neo-Geo arcade game will like the Samurai Shodown Survival Guide in our October '93 issue.

Cart Queries



Tecmo's Pro Bowl feature

Do any recent football games allow you to choose the players you want for a Pro Bowl matchup?

Ramon Salceda
Los Angeles, CA

Ben D. Rules replies:

In Tecmo Super Bowl II for the SNES, you can choose from different groups of stars for your Pro Bowl team, but you can't select every single NFL player.



Get goofy with the Goofster.

There are all kinds of Mickey Mouse games, but what about a SNES game where you can play as Goofy? He often appears in Capcom's Disney games, but not as a main character.

Joel Bennett
Beckley, WV

Bonehead replies:

You must've missed Capcom's Goof Troop, reviewed in our August '93 issue. Here's how it scored with us:

| Graphics | Sound | Control | FunFactor | Challenge |
|----------|-------|---------|-----------|---------------------------|
| 4.0 | 4.0 | 4.0 | 4.5 | ADJ. Adjustable |

Has Sega changed Sonic's look in Sonic & Knuckles?

C.M. Wells
Adelphi, MD

Bro' Buzz replies:

A top Sega spokesperson says that Sonic has undergone slight variations by accident. In the past, when Sega licensed its famous hedgehog for use on other products like hats and shirts, the companies developing those products would make subtle changes in his appearance.

When Sonic 3 came out last year, Sega started monitoring Sonic more carefully to ensure a consistent appearance. Sonic's only change in video games over the years is in his plume, which is now more spread out and moves across his back to suggest a rear view when he turns.

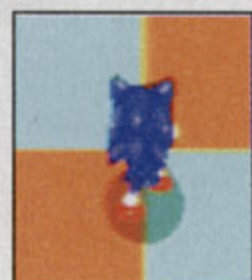

Sonic turns his back.



Knuckles in real life.

I've been playing and reading about Sonic & Knuckles. One question: What's an echidna?

Sean Stanford
Fairbanks, AL

The Unknown Gamer replies:

Echidna is the name for the kind of animal that Knuckles is. These long-nosed, egg-laying mammals are native to Australia and are also called spiny anteaters.

Will all 3DO games play on all 3DO systems, whether the system is made by Goldstar or Panasonic?

Anonymous
Houston, TX

Tommy Glide replies:

That's the theory, though we've had a few loading delays when putting older 3DO games into the new Goldstar system. But all 3DO games are supposed to work in all 3DO systems.



Han storms past uniformed troopers on Bespin.

In Super Empire Strikes Back for the SNES, why are there snowtroopers in Bespin? They weren't in the movie.

Daniel Taylor

Lawrence of Arcadia replies:

Maybe snowtroopers weren't in the Cloud City, but stormtroopers certainly were. Stormtroopers in various uniforms appear throughout Bespin in both the game and the movie.

Let's Get Technical



Four Gs: Game Gear Game Genie

I know there's a Game Genie for the Game Boy, but is there one for the Game Gear?

Matt Cooley
Jackson, MI

The Lab Rat replies:

Yes. We reviewed it in our January '94 "GamePro Labs." The unit is available at most major toy stores for less than \$40.

What does the Aura Interactor really do? Does it let you feel everything that's going on in a game? For instance, if I'm playing MK II while wearing the Interactor, would I feel it when I get uppercuts?

Yan Vayner
Brooklyn, NY

Sarah Nade replies:

When you wear the Interactor (\$99), you're basically wearing a powerful audio speaker strapped to your back. It vibrates with bass sounds that pound along your spine. You won't feel an uppercut snap your head back.

Whaddaya Think?

This is your magazine, so tell us what you'd like to see in it. Send your suggestions to:

GAMEPRO Magazine

Dear Editor
P.O. Box 5828
San Mateo, CA 94402

You also can contact GamePro via the Internet with this address:
the-mail.gamepro@iftw.com

We cannot publish all letters, and we cannot send personal replies to your letters or e-mails.

GAMEPRO GALLERY

PRIZE

This month's winning artist will receive a **GAMEPRO** T-shirt!



Christian Valle, Glendale, NY



Michael Madison, Laurel, MD



Ahmet Adzemovic, Staten Island, NY

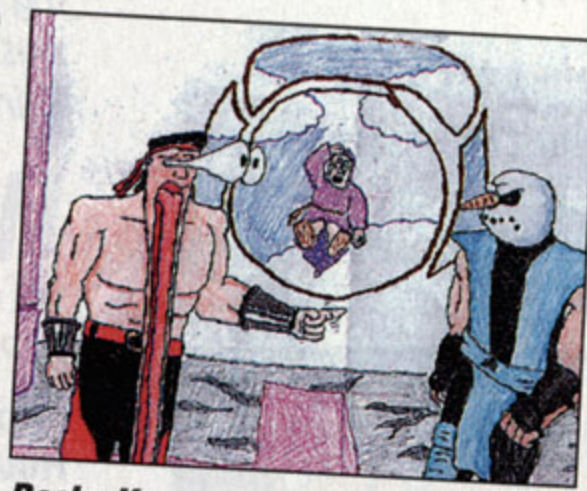

Becky Kramer, Elmwood Park, IL



Danielle Perrone, Deer Park, NY

Advertisement

MEET IZZY

GREEK VILLAGE 1

At the very beginning of the level, go back to the left and jump straight up. An egg will fall from the sky and open up into a 1-UP after jumping on top of it.

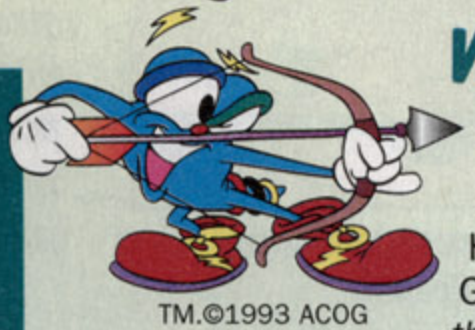

TM.©1993 ACOG

WHO IS IZZY?!?

IZZY is the official character of the 1996 Atlanta Olympic Summer Games. He is also the star of U.S. GOLD's IZZY'S Quest for the Olympic Rings

video game for the Genesis and Super Nintendo. IZZY exists in the Torch World where he is capable of morphing himself into any sports equipment to help him gather gold, silver, and bronze medals hidden throughout his world.



GREEK VILLAGE 2

After sliding down the first vine in the game, jump back up it. Above the middle platform and at the top right of the vine there will be 1-UPs. Judges will also pop up and give you a special bonus.



IZZY'S OLYMPIC GAMES TRIVIA

- The estimated cost of the 1996 Olympic Games in Atlanta: **\$1.9 billion**
- Number of Sports to be featured at the Games: **26**
- New Sporting events: **Softball, Mountain Biking, and Beach Volleyball**
- Number of Events: **271**
- Medals to be awarded: **1,933**
- Number of Athletes: **10,000**
- Number of coaches and officials: **5,500**
- Estimated number of spectators: **2 million**
- Estimated number of television viewers: **35 billion**
- Number of tickets to the games: **11 million**
- Seating at the Olympic Games Stadium: **85,000**
- Combined hours of television coverage: **3,000**

STAY TUNED TO THE NEXT ISSUE OF GAMEPRO FOR MORE EXCLUSIVE, TOP-SECRET, IZZY GAMING TIPS!!



Arturo Velasquez and Freddie Sanchez, East Boston, MA



Dena Natali, Sacramento, CA



Rafael Dualle
New York, NY



Edmond Flores, Canoga Park, CA



Calvin Armstrong, New York, NY

Send Your Art To:

GAMEPRO Magazine

GamePro Gallery

P.O. Box 5828

San Mateo, CA 94402

Sorry, but no art can be returned.

Advertisement

WIN BIG WITH 'IZZY



- (5) FIRST PRIZES**
- Panasonic 3DO system
 - Starter Jacket
 - IZZY Hat
 - IZZY plush character
- (10) SECOND PRIZES**
- Starter Jacket
 - Atlanta carrying bag
 - IZZY baseball cap

- (20) THIRD PRIZES**
- Atlanta carrying bag
 - IZZY plush character
 - IZZY cloisonné pin
- (30) FOURTH PRIZES**
- IZZY baseball cap
 - IZZY plush character
 - IZZY cloisonné pin
 - 1 year GAMEPRO subscription

- (30) FIFTH PRIZES**
- IZZY plush character
 - GAMEPRO baseball cap
 - GAMEPRO T-shirt
- (40) SIXTH PRIZES**
- IZZY cloisonné pin
 - GAMEPRO T-shirt

Official licensed product of the Atlanta Committee for the Olympic Games, Inc. TM, © '92, '93 ACOG



(1) GRAND PRIZE

- Panasonic Entertainment Center
- 26" TV
- VCR
- Speakers
- Panasonic 3DO system
- IZZY plush doll

CLIP ALL 5 IZZY'S TO WIN!

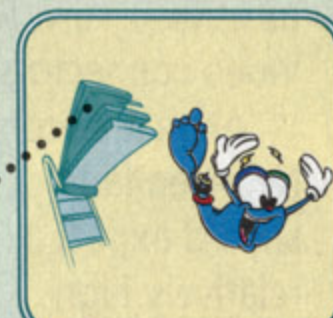

(1 OF 5)

A different ring will be featured in each GamePro Magazine from April '95 through the August '95 issues.

Name _____

Address _____

City, _____

State, _____

Zip _____

Clip all FIVE IZZY's, paste onto an index card, enclose in an envelope and mail entry to:

IZZY Sweepstakes, PO Box 5960, San Mateo, CA 94402



CONTEST RULES AND REGULATIONS

OFFICIAL RULES No purchase necessary. To enter the sweepstakes, please print your name, address and phone number on a 3x5 index card and mail it directly to: IZZY Sweepstakes, PO Box 5960, San Mateo, CA 94402 San Mateo, CA 94402. Or, fill out the attached entry form and mail that in to the above address. One entry per person. All duplicate entries of violator will be voided. Infotainment World, Inc. and U. S. Gold assume no responsibility of late, misdirected, incomplete, or illegible entries. All mail in entries must be post-marked by August 31, 1995. Void where prohibited.

AWARDING OF PRIZES Winners will

be determined on September 5, 1995 in a random drawing by GamePro magazine. Odds of winning depend upon the number of all eligible entries received. Winners will be notified by phone. Winners entry and acceptance of prize constitutes permission to use their names, photographs, and likeness for purposes of advertising and promotion on behalf of GamePro and/or U. S. Gold without further compensation. Winner is responsible for any and all federal, state, and local taxes if necessary. A complete list of prize winners will appear in a future issue of GamePro magazine.

ELIGIBILITY Employees of Infotainment World, Inc., U. S. Gold and all participating vendors, their subsidiaries,

affiliates, advertising agencies, and their immediate families are not eligible. **LIABILITIES** This promotion is operated by Infotainment World, Inc., and U. S. Gold which is solely responsible for its conduct, completion and awarding of prizes. All decisions of Infotainment World, Inc., and U. S. Gold on all matters relating to this promotion are final. Infotainment World, Inc., and U. S. Gold and participating sponsors assume no liabilities resulting from the use of this prize. **PRIZE RESTRICTIONS** Alternative prizes or cash will not be offered in lieu of prizes described above. Prize may not be substituted, transferred, or exchanged. All prizes will be awarded by October 15, 1995. Eligible to residents of the contiguous United States only.



The NEO•GEO CD: An Arcade in Your Home

SNK takes the lead in the race to bring arcades into your living room.

By The Whizz

SNK's disc-covered a new way to deliver its cartridge-based arcade games to home systems. Last September it released the Neo•Geo CD in Japan with a plan to reproduce its existing Neo•Geo library on CD, along with all future arcade games.

The Neo•Geo CD's scheduled for a U.S. debut sometime in late '95. According to SNK, the CD-based systems will be produced in addition to the company's Neo•Geo cartridge systems, which, frankly, are very expensive and difficult to find in the U.S.

The Same, Only Different

The CD features the identical CPU set-up as the cart system and the arcade unit: a 68000 processor supported by a Z80 chip. Hefty memory is needed, however, to help drive the CD's display – and this system's memory is massive: 56 megabytes of main memory with 512 kilobytes (K) of video RAM and 64K of sound RAM (SRAM). The CD unit also features RGB, A/V, RF, and S-Video connectors.

All that silicon means that Neo•Geo fans should expect a relatively high price tag on the new unit. The Japanese Neo•Geo CD costs about ¥49,800 (\$530). SNK of America hopes to bring its

version in at \$399. CD game prices will range from \$49 to \$69.

Arcade in Your Home

Additionally, all Neo•Geo games created for the arcades will be ported directly to the CD and cartridge formats approximately one month after their arcade debut, and 25 games from the existing Neo•Geo library are being converted to CD format. You can also expect bundled CD deals when the unit arrives in the U.S.

CD versions of the games will duplicate gameplay and graphics from the arcades. The audio, however, will be remastered for the discs (remember all the SRAM mentioned above?). You're likely

to hear completely different tunes, but the voices, albeit CD crystal clear, will articulate the same dialogue as the arcade version.

One-One Thousand, Two-One Thousand...

Neo•Geo-phytes will probably want to hold their horses until the American CD unit arrives. As with most CD players, access time is a major hassle for Japanese gamers, with more than 30 seconds of initial load time reported in some instances.

Recognizing the need for CD speed in America, SNK plans to outfit the U.S. units with double-speed CD drives to shave precious seconds off the access time. Of course, this modification could open up the possibility of compatibility problems between U.S. and Japanese CDs.

Disc Continued

All next-generation game systems will try to bring arcade action home. SNK's ready and waiting. **G**



Neo•Geo CD Games

According to SNK, every game currently playable in the arcades will make its way to compact disc. Like a blast from the past, these Neo•Geo CDs are currently available in Japan.

- Aero Fighters 2
- Aggressors of Dark Combat
- Alpha Mission II
- Art of Fighting
- Art of Fighting 2
- Baseball Stars 2
- Blue's Journey
- Burning Fight
- Fatal Fury 2
- Football Frenzy
- King of Fighters '94
- King of the Monsters 2
- Last Resort
- League Bowling
- Magician Lord
- Nam 1975
- Ninja Commando
- Puzzled
- Samurai Shodown
- Samurai Shodown II
- Super Sidekicks 2
- The Super Spy
- Thrash Rally
- Top Hunter
- Top Player's Golf
- World Heroes 2 Jet



The control pad features the Neo•Geo's standard four buttons with a minijoystick thumb pad for directionals.



The Neo•Geo CD package will include two controls pads and possibly several bundled games.



The American version of the top-loading Neo•Geo CD will house a new double-speed drive.

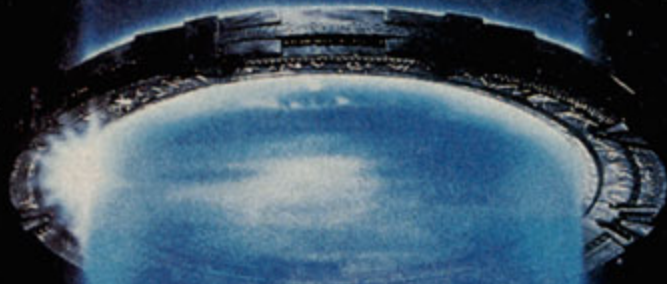

IT WILL TAKE
YOU
A MILLION
LIGHT YEARS
FROM HOME.

STARGATE™

BUT WILL
IT BRING
YOU BACK?



BATTLE RA'S
MORPHING
HENCHMEN!



DESERT DOGFIGHT
IN A STOLEN
GLIDER!



O'NEIL HEATS UP
THE PALACE
GUARDS!



FIREFIGHT IN
THE STREETS
OF NAGADA!



LOOK FOR STARGATE™
ON HOME VIDEO
FROM LIVE® ENTERTAINMENT



SUPER NINTENDO
ENTERTAINMENT SYSTEM

GENESIS™

GAME GEAR™

GAME BOY

Acclaim
entertainment inc.

HOT AT THE ARCADES



By Bruised Lee

Sega's becoming a major arcade road hog. It made its mark in realistic driving simulations with Virtua Racing, then Daytona USA roared into the arcades and blew everyone's doors off. Now it's time to rally with Sega Rally Championship, which could be Sega's hottest driving game yet.

Start 'Er Up

Sega Rally Championship promises to be the most realistic car-racing game to date. You can burn rubber in the new Toyota Celica GT-Four WRC or the Lancia Delta Integrale '92 WRC, the machines that careened through the courses in the

World Rally Cars



Toyota Celica GT-Four WRC

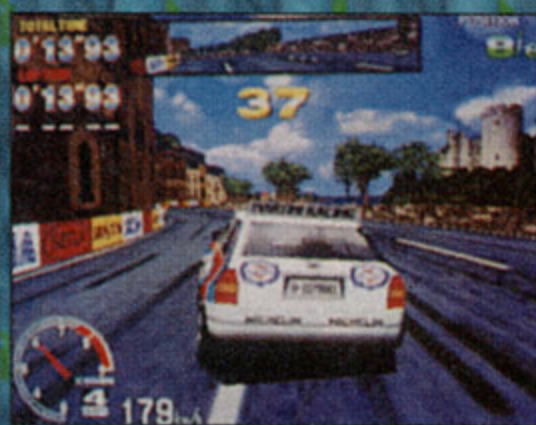

Lancia Delta Integrale '92 WRC



PRO TIP: Watch for road signs to see where the course takes you.

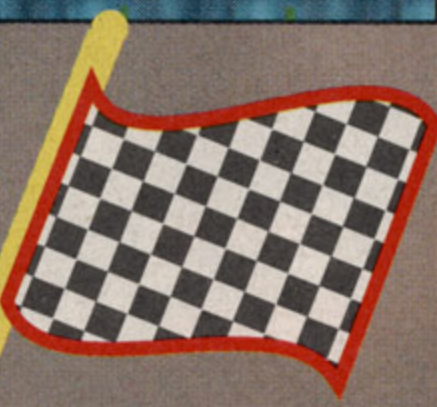

Choose between automatic or four-speed transmission.



World Rally Championship. Both come in manual and automatic transmissions.

Gameplay perspectives alternate from first-person to behind-the-car views. The gorgeous graphics are texture-mapped polygons à la Daytona.

In sit-down units, innovative hardware reproduces the feel of a real race. A twin-clutch steering-reaction mechanism produces a sensation of cornering and different surfaces, and a shock generator transmits the vibration and



PRO TIP: To ensure your safety, take the turns on the outside.

Zoom with a View



Check out the road from the driver's seat...



...or drive from behind the car.

impact from the screen to the seat. Up to four Sega Rally units can be interconnected.

Radical Rally

Rally features three selectable stages. The Easy course takes you on a cruise through a desolate desert. In the Medium course, the action picks up as you race in a forest. If you're feeling gutsy, try the Expert track, which slams you into a wild ride through the mountains.

Sega Rally's ready to race through your local arcades. Try to hitch a ride. **G**

By Sega
Available April

Set the Stage

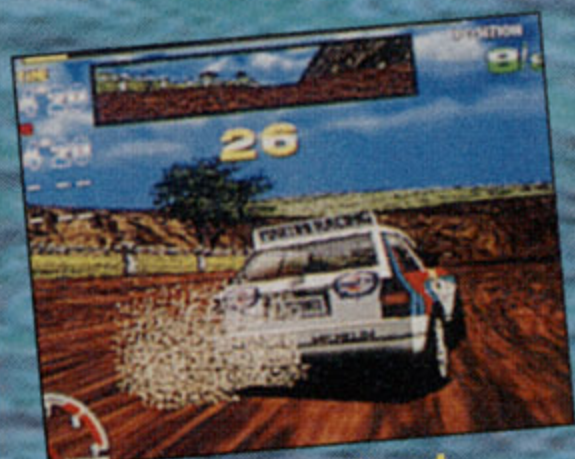

Take it easy in the Desert.

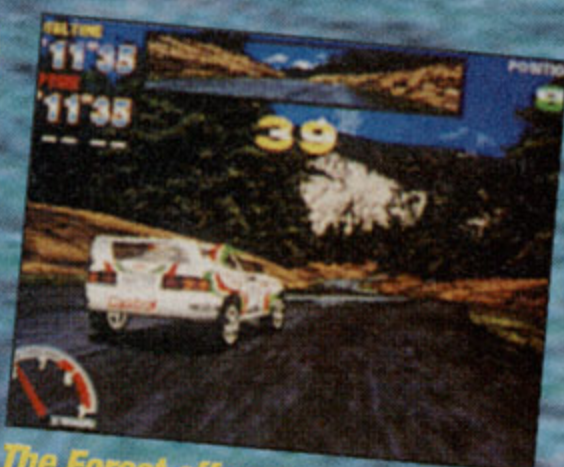

The Forest offers up a medium challenge.



Face an expert-level course in the Mountains.

BEWARE
THE ULTIMATE
EVIL OF

WARLOCK™

COMING APRIL 13

The evil unfolds... (516) 624-9300



Please get permission from whoever pays the phone bill before calling the above number.

Warlock™. Developed by Realtime Associates for Trimark Interactive © 1994 Trimark Interactive. Nintendo, Super Nintendo Entertainment System and the Official Seals are registered trademarks of Nintendo of America Inc. © 1991 Nintendo of America, Inc. Sega and Genesis are trademarks of Sega Enterprises, Ltd. All rights reserved. Acclaim is a division of Acclaim Entertainment, Inc. © & © 1995 Acclaim Entertainment, Inc. All rights reserved.

THE BEAT IS BACK

Donkey Kong Country
Super NES Set
40 Banana Bucks

Super Game Boy
25 Banana Bucks

Donkey Kong
for Game Boy
10 Banana Bucks

Donkey Kong Country
15 Banana Bucks

Game Boy
20 Banana Bucks

With
Banana Bucks

Collect 'em when you buy
select Nintendo products!

Spend your Banana Bucks on bunches of cool stuff!

Here's an offer that's sure to appeal to your sense of greed. First, buy any (or all!) of the Nintendo products shown on the opposite page between March 21

and April 30. Then mail us your proofs-of-purchase and your Banana Bucks order form. We'll exchange your proofs for the cool stuff shown below.



DKC Jacket
Price: 45 Banana Bucks

DKC T-Shirt
Price: 18 Banana Bucks

Collectible Donkey Kong
Price: 9 Banana Bucks

Diddy Kong Cap
Price: 12 Banana Bucks

Donkey Kong Country Soundtrack CD
Price: 14 Banana Bucks

DKC Sweatshirt
Price: 28 Banana Bucks

Make your move FAST!

These items are authentic, top-quality, can't-get-it-in-the-stores stuff. To get yours, just follow the steps on this order form. Start grabbin' your Banana Bucks fast and cash'em in before May 31, 1995! See order form for details.

Play It Loud



Banana Bucks Order Form

Please fill out all information below, printing clearly. Orders must be postmarked by 5/31/95.

Name _____

Address _____

City _____ State _____ Zip _____

Telephone (____) _____

I have earned _____ Banana Bucks. I have written in the UPC number for each item purchased and I am enclosing my cash register receipts (no photocopies allowed) that are dated no earlier than 3/21/95 and no later than 4/30/95. (Please circle the Nintendo items purchased on the receipts.)

| Item | UPC# (Last 6 Digits from Bar Code) | Qty. | What each is worth | Total Banana Bucks |
|-----------------------------------|------------------------------------|------|--------------------|--------------------|
| Donkey Kong Country Super NES Set | | | | |
| Super Game Boy | | X 40 | Banana Bucks= | |
| Game Boy | | X 25 | Banana Bucks= | |
| Donkey Kong Country | | X 20 | Banana Bucks= | |
| Donkey Kong for Game Boy | | X 15 | Banana Bucks= | |
| | | X 10 | Banana Bucks= | |

TOTAL BANANA BUCKS: _____

Please follow instructions below:

- List correct UPC number for each product.
- Include original cash register receipt(s), along with order form.
- Enclose check or money order for shipping & handling charges (payable to Nintendo).
- Mail by 5/31/95.

Nintendo Banana Bucks Stuff
P.O. Box 2977
Redmond, WA 98073-2977.

Allow 4-6 weeks for delivery. Offer valid only in U.S. through 5/31/95. Offer valid only on purchases made from retailers on or between 3/21/95 through 4/30/95 or while supplies last. You may order as many items as your total Banana Bucks value allows; however, no credit or return will be given for Banana Buck(s) over the amount "spent" on merchandise ordered. Nintendo is not responsible for lost, late, misdirected, mutilated, illegal or postage-due mail. Offer available to customers of retailers only.

I WISH TO SPEND MY BANANA BUCKS ON THE FOLLOWING:

| Description | Item# | Size (Circle) | Qty. | Banana Bucks Each | Total Banana Bucks |
|-----------------------------------|-------|---------------|------|-------------------|--------------------|
| Collectible Donkey Kong | 101 | | | | |
| Diddy Kong Cap | 102 | | X | 9 | = |
| Donkey Kong Country Soundtrack CD | 103 | | X | 12 | = |
| DKC T-Shirt | 104 | S M L XL | X | 14 | = |
| DKC Sweatshirt | 105 | S M L XL | X | 18 | = |
| DKC Jacket | 106 | S M L XL | X | 45 | = |

Total # Banana Bucks Needed _____
Total Shipping & Handling (See chart below) \$ _____

| Total # Banana Bucks Submitted | Shipping & Handling Required |
|--------------------------------|------------------------------|
| 1 - 20 | \$4.00 |
| 21 or more | \$6.00 |

Banana Bucks cannot be used to help pay for shipping and handling.

COVER
FEATURE

MORTAL KOMBAT III

Leads A Kombat Krossover

Mortal Kombat III will muscle its way into the arcades at the same time the MK saga is crossing over to film, television, animated videos, and a horde of other products.

They say it's all in the story. With each new version of the game, Mortal Kombat's two principals, Lead Programmer Ed Boon and Lead Artist John Tobias, have taken great care to develop and embellish the story underlying Mortal Kombat. The new game Mortal Kombat III, slated for an April release to arcades, takes the MK saga to new extremes that extend to visual design and gameplay.

Basic Kombat

"The basic Mortal Kombat story is always there," says Tobias, "but it evolves as we create the game and get into the characters. Over the course of the 11 to 12 months it took to make the game, characters grew and changed."

MK III will feature 14 selectable characters, two fresh bosses including Shao Kahn (who's now selectable), and two hidden characters. Kung Lao, Sub-Zero, Jax, Liu Kang, and Rayden are in for sure from MK II, and Sonya returns from MK I. Johnny Cage, Baraka, Reptile, Scorpion, Mileena, and Kitana will not make it out of the Outworld.

Mortal Kombat: The Legend Continues

The Mortal Kombat III story line takes a major twist: Shao Kahn takes over the Earth! The cursed martial artist has opened a por-

tal to present-day Earth and plans to slowly transform Earth into the Outworld.

The story line will have a major influence on the game's visuals as well as the makeup of the new Kombat Krew. Since the setting is contemporary, many of the game's backgrounds will feature an urban environment. The city scenes, however, will be completely barren but not desolate.

Says Tobias, "The world is beginning to warp into the Out-

By Eye Spy



Jax gets new bionic arms that enable him to fire missiles and other projectiles.

Kano returns from the Outworld.

Kung Lao sports the new streamlined high-tech look that will characterize MK III.

world and Shao Kahn has taken over the souls of every living human, but the world has not been devastated." Of course, the gods are protecting the Mortal Kombat fighters, so they aren't affected.

A couple of substories within the game center on some of the returning Kombatants. For example; Sonya (who was absent in MK II), Jax (from MK II), and Kano (who was unplayable in MK II) play out their own little drama. Following MK I, Sonya captured the villainous Kano, but they were trapped in the Outworld. In MK III, they've managed to escape back to Earth, where Sonya and Jax are now special-forces teammates who are after Kano.

Is MK III a lead-in to MK IV? Not intentionally, say the head



Shao Kahn's queen will be the first Mortal Kombat character with controllable aerial moves.

Kombat creators. "As far as the story goes, MK III's story will have a definite ending," Boon says. "We're not so cocky that we've created material for a Mortal Kombat IV, but we might tease people with a few potential elements."



Sub-Zero will be unmasked for MK III. Here actor John Turk strikes a pose.



Brian Glynn reprises his role as the Outworld villain, Shao Kahn.

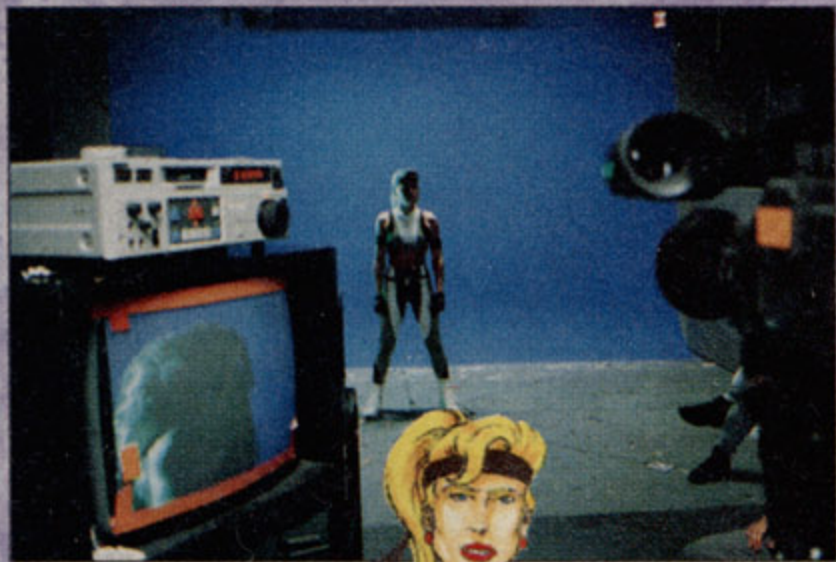

Sonya gets a new look to go along with a new bicycle kick, thanks to Kerri Hoskins.



New Kombat Kharacters

With nine new characters to play, Mortal Kombat fans should have their hands full. The names of

the new guys weren't finalized at press time, but Boon and Tobias were open to sharing some info about some of them.

One fighter is a mean swordsman, a warrior who survived Shao Kahn's takeover in the Outworld. After his triumph, Shao Kahn sent out warriors to flush out the survivors. Seriously crippled during the ensuing fight with Shao Kahn's forces, this character now fights with two hook swords on each arm. Unlike Baraka,



New faces will play new and old MK characters.

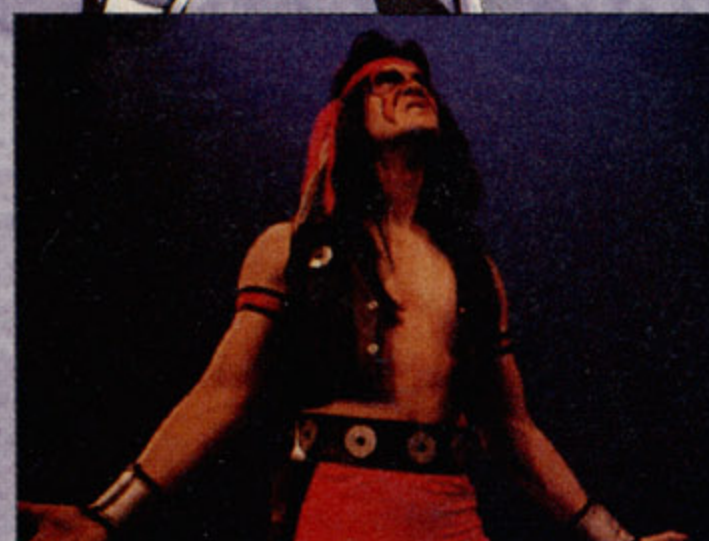

MK III's 14 playable fighters will include nine new Kombatants.

MORTAL KOMBAT III

Leads A Kombat Krossover

he swings his blades more like traditional swords. His combos will have a long reach.

Sub-Zero loses his palette-swapped soulmate, Scorpion, but he's picked up by two new twins, who are cybernetic ninjas. In MK III, Sub-Zero has quit the Lin Kuei Chinese ninja clan. In retaliation, the Kuei sends out two robot ninjas to assassinate him. They have their own MK III agenda because Shao Kahn can't control robots, but you'll be able to play either one. The two robo-Kombat clones will have different moves, including unique specials, but they'll both use missiles, flame throwers, and energy nets as standard weapons.

Like Sub-Zero and Scorpion, they'll look exactly alike, but according to Tobias "their design is somewhat influenced by Boba Fett [the space bounty hunter of *Star Wars*] and the *Predator*."

Two new female characters will join Sonya in the cast. One will be Shao Kahn's queen, who will be selectable. She'll be the first MK character who can pull aerial attacks. Although she doesn't exactly fly so much as float, you'll be able to control her airborne movement. She'll have long, flowing white hair that you can also use like a weapon.

Boon and Tobias are keeping the lid on hidden characters, but Tobias reveals that "there will be one Goro-type character, although we don't want to say too much about her [emphasis ours] yet." They do deny, however, that there will be "people" in the game (not even themselves) à la NBA

Jam. They also deny the rumor that Killer Instinct characters will cross over into Kombat.

Kombat Is Koming!

Mortal Kombat III is scheduled to begin coin-operated duty some time in April. Mortal Kombatants ought to keep an eye out for test units in arcades around late March. Take time now to appreciate the depth of MK's expanding story...you won't have time when your token's on the line! **G**

Mortal Kombat Live!

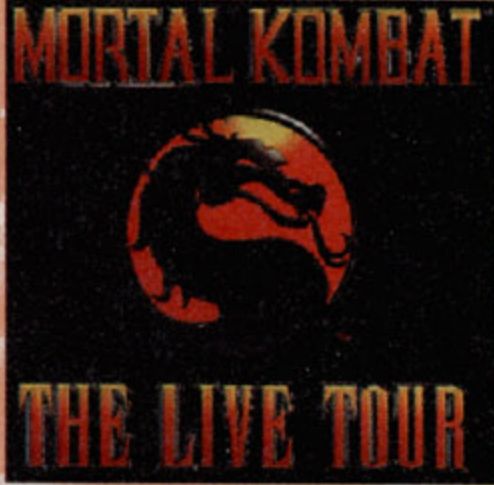

This summer, Mortal Kombat: The Live Tour will go on the road with a live-action, interactive show that's planned to continue through May 1996. The tour is scheduled to hit 150 cities. Ticket prices will start at \$10.

The Tour is expected to start with Shang Tsung opening the Mortal Kombat competition, followed by a mix of music, magic, gymnastics, and more than 20 martial artists. To make the show interactive, audience members will be invited to participate: MK III displayed on a video wall will become a battle arena, and exclusive codes will be revealed.

For more information, call 212/501-8607. Information will also be available soon on various online services.

Mortal Kombat on Video

Mortal Kombat covers all the entertainment fronts this summer with the April 11 release of *Mortal Kombat – The Animated Video: The Journey Begins*, an animated feature with 3D computer animation and special effects galore.

The movie revolves around the human threesome of Johnny Cage, Sonya Blade, and Liu Kang as they head into competition against Goro, Sub-Zero, and Scorpion. Much of the film uses motion-capture technology, where sensors are attached to live actors whose movements are then recorded from various angles.

The people behind the project brought in some heavy hit-

ters. The motion-capture process was a partnership between Acclaim Studios and award-winning R/Greenberg Associates West, which is well known for its work on such films as *Demolition Man*. Other animation was created by Motionworks (*The Pagemaster*), which merged 2D images with computer-generated 3D backgrounds. Special effects were done by Alison Savitch (*Terminator 2*), who is also in charge of special effects for the live-action feature, *Mortal Kombat – The Movie*.

The \$14.98 video will come with a discount booklet that offers up to \$75 off various MK licensed products, such as T-shirts, POGs, game gloves, and admission to Mortal Kombat – The Live Tour.

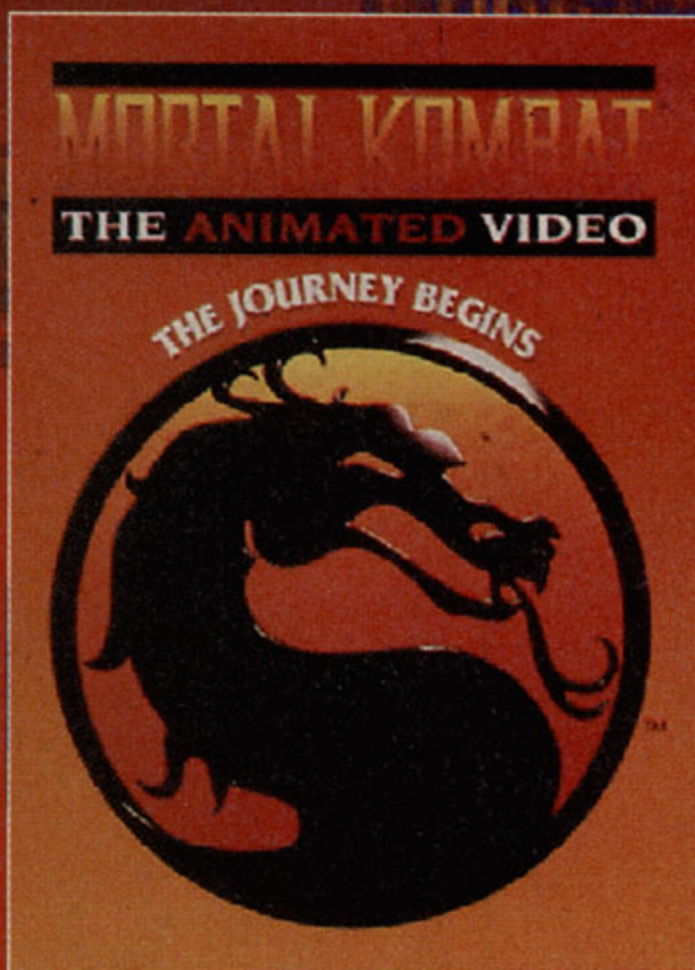

Mortal Kombat – The Animated Video includes action with Sonya, Liu Kang, and Goro.



Izzy needs help gettin' back some stolen rings.

And **YOU** just volunteered.



Official licensed product of the Atlanta Committee for the Olympic Games, Inc. TM, © '92, '93 ACOG

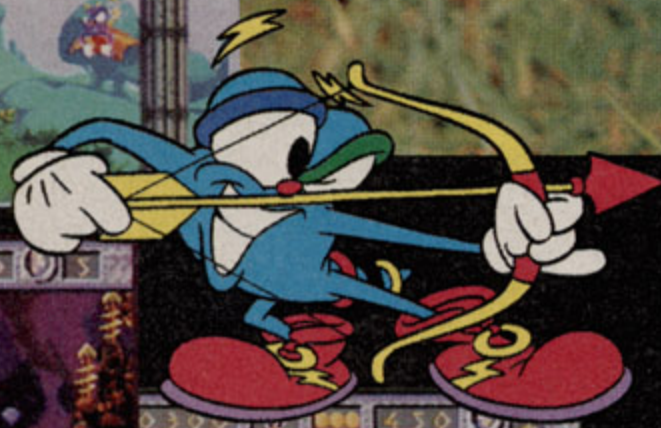
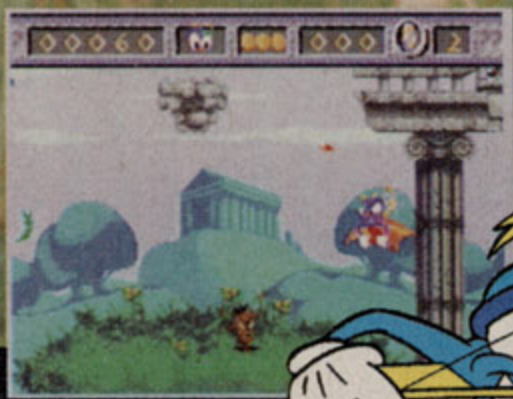

The hounds are tuckered out and we can't go any further. But those darn Slimers and their pesky, no-good friends made off with the Olympic rings. And because of those idiots, the Olympics Games are as good as over. Now it's up to you and that morphing maniac IZZY to get the rings back. Stick with IZZY and you'll fence like a fiend and fly like a javelin.

Now, I know you're thinking, "Who cares?" Well... Think of the Athletes. Think of the fans. But don't even think about coming back without those rings. Now get goin'.



Available for SEGA™ GENESIS™ and SUPER NINTENDO ENTERTAINMENT SYSTEM®

ON LOCATION

WeaponLord

GRAPHICS ON THE CUTTING EDGE

Namco and Visual Concepts' new weapons-fighting game shows that the artist's brush is as mighty as the sword.

By Slasher Quan

Remember the final scene in *Conan the Barbarian*? With no fear in his face, Arnold Schwarzenegger swings his broadsword and decapitates James Earl Jones. Scenes like this gave WeaponLord's developers and artists the vision to create a vicious-looking barbarian fighting game. The challenge, however, was realizing that vision within the limitations of the SNES and Genesis systems.



The DemonLord

All color character illustrations by Omar Velasco and Ray Wong



The DemonLord's Web Takedown puts Jen-Tai flat on her back.

Shoot for the Moon

WeaponLord's graphical yardstick was set high, possibly higher than for any previous 16-bit game. Lead Artist Alvin Cardona and the art team



Korr uses his Flaming 360, but Divada's poised and ready with a High Thrust Block.

insisted on achieving these graphical landmarks: the biggest sprites, most detailed characters, most intense parallax backgrounds, and most animation in a fighting game.

Visual Concepts' WeaponLord art team – Alvin Cardona, Omar Velasco, Ray Wong, Fred

Wong, and Ken Shibata – took up the challenge. This is the team's first video game project, and their influences include Japanese anime and comic-book artists such as Simon Bisley (the original Lobo), Whilce Portacio (*Wetworks*), and Jim Lee (*Wildcats*, *X-Men*).

Pixel-by-Pixel Perfection

WeaponLord's art follows the tradition of *Street Fighter II*: It is being hand drawn pixel-by-pixel on a computer – unlike



Divada retaliates against Korr with a vicious multihitting Frenzy.

the digitized video sprites in *Mortal Kombat*, the polygons in *Virtua Fighter*, or the rendered graphics of *Killer Instinct*. Hand-drawn art has allowed for more expression but is requiring an excruciating amount of time



The War Queen Jen-Tai uses her Mid-Deflect to stop Bane's oncoming attack.

and refinement with the PC program, D-Paint.

The result is a look unlike any other fighting game's. Imagine a super-muscular character like Zangief...except on *WeightGainer 2000* and growth hormones! Check out the 6'8", 397 lb. Bane or the

7'1", 435 lb. DemonLord, and you'll see the art team's definition of "buffed"!

Paintings or Backgrounds?

Unlike the character animation, which is hand drawn on a computer, these backgrounds are created with a new technique. Using acrylics, freelance artist Glenn Kim painted backdrops that were then scanned into a computer and retouched in Adobe PhotoShop.



Bane proves the extent of his power with this midair swing of his Stone Warhammer.



Divada



Painted Backgrounds
 Artist Glenn Kim's incredible hand-painted backgrounds are scanned into the computer in rough form, then cleaned up in Adobe PhotoShop to achieve their final look.



Bane

This technique provides more rich, colorful scenery than is possible in D-Paint. Layers upon layers of parallax scrolling are added for a 3D effect that should rival (and surpass) Street Fighter II's.

Fatal Gore

WeaponLord won't cringe when it comes to violence. The game has what Lead Designer James Goddard bills as a "totally original finishing-move" system that's based on combos.

The violence will be depicted realistically, and there will be plenty of gore, though the game bears the Teen rating. Despite the hand-drawn animation, don't expect any cartoony, balloony blood.

Gallery of Graphics

A picture speaks a thousand words, so scope out the full-color renderings, pencil sketches, and D-Paint animation sequences in this article. Judge for yourself whether WeaponLord's graphics are on the 16-bit cutting edge. **G**

(Look for continued coverage of WeaponLord and its development in GamePro.)

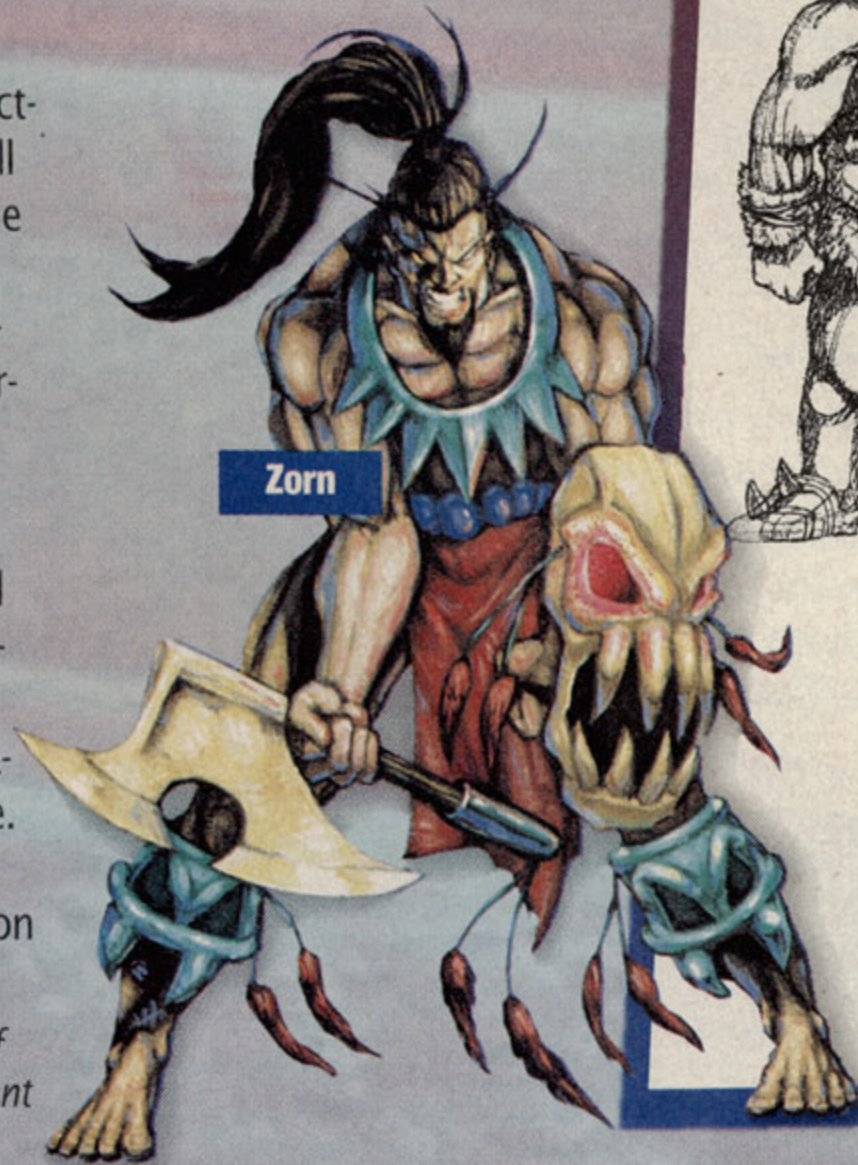

Zorn

Work In Progress

All the fighters in the DemonLord's tournament were born under the Warrior's Moon, which plays a key part in the story.



Another character created by Alvin Cardona, this orc warrior never made it to WeaponLord's final rounds.

Jen-Tai underwent many revisions. This sketch was one of her earlier conceptions.



The Art of Weapon Fighting



The WeaponLord art team, including (back row, left to right) Aki Rimpilainen, Ken Shibata, Ray Wong, and Steve Chiang. Seated (left to right) are Fred Wong, Alvin Cardona, and Omar "Omz" Velasco.

WeaponLord's art team gave GamePro an inside look at the creative engine at Namco and Visual Concepts.

GamePro: What's unique about WeaponLord's art?

Alvin Cardona: We wanted each frame to be dynamic — we wanted drama! A lot of games fudge on anatomy. In WeaponLord, there's much attention to detail — the musculature and anatomy are blasted out and huge, but it's all correct and realistic.

GP: What was the specific inspiration for the characters?

Ray Wong: With Bane, James [Goddard, lead designer] wanted this guy with horns, sabretooth teeth, and a wolf's head, so I tried to imagine this hulking figure of a man and go crazy. Bane came out.

Omar Velasco: Well, the axe guy, Zorn, looks very similar to our lead artist (laughs)...

GP: What was the biggest challenge?

AC: Getting the artists' styles to look consistent and fit the genre.

OV: Making the characters swing their weapons with convincing force within the limitations of the hardware.

GP: How hard was it to design the characters?

James Goddard: It would have been the easiest thing in the world to say, "Okay, we have this cyborg guy with an eye dangling, and he has this big fist, and when you do a Dragon Punch motion, he goes, 'Baboken!' and jumps in the air five times spinning with flames."

That's easy, that's just mental. A weapons game is a real pain in the ass, and that's why we're doing it.

AC: It was hard to conceive original characters who didn't look like anything else. It was a painstaking process from start to finish...all these guys on the team have been sleeping on the floor at one point or another!

GP: How did the art evolve?

JG: At first we thought the characters should be 70–80 pixels tall, but Korr was looking pretty scrawny. We decided to try to push the limits, and now they're about 88 pixels tall. There's an

amazing difference between the two sizes. Increasing their size meant it would take a long time to do the art, and we'd have less characters, but we chose quality over quantity.

GP: How much better could WeaponLord's graphics be on 32-bit hardware?

AC: Significantly better. In a 32-bit version, we could go crazy on special moves.

In this version, we were limited in the size of the special moves and the amount of graphics on the screen. Also, higher resolution and more colors would mean more detail — even more ripped characters.



A caricature of Lead Artist Alvin Cardona with WeaponLord's hero, the barbarian Korr

Art Evolution



The first character developed was the barbarian Korr. As you can see, he underwent a radical beefing up from the original concept (top) to the final look (bottom).

D-Paint Animations

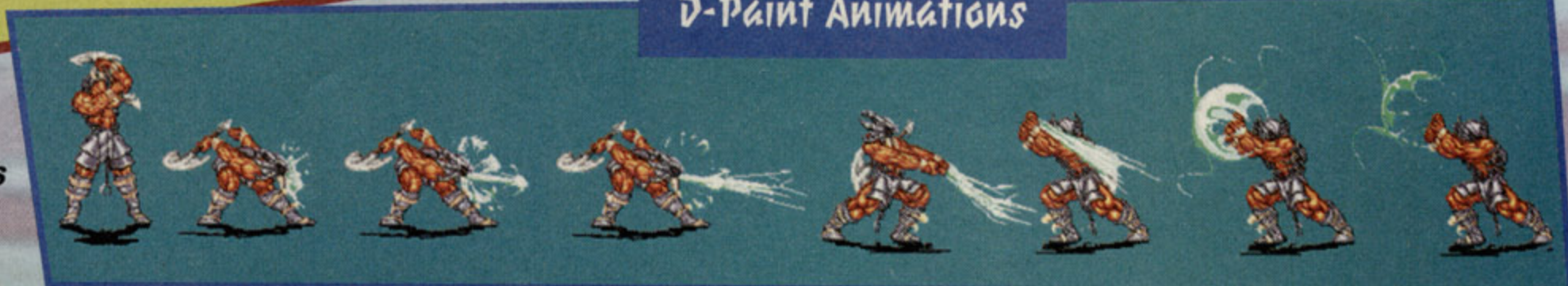

The DemonLord Zarak uses his spider's powers in this vicious Takedown.



DAWN OF THE METAL AGE!



Original Artwork

Engraved, 3-D,
Prismatic Foil
Stamped and laminated on
every card in every pack!



Computer
Special Effects



3-D Prismatic Engraving



Print & Laminate

THE METAL PROCESS

From Start to Finish
FLEER's Marvel Metal™
Collectable card set stands
alone as a one of a kind
technological masterpiece.

Computer Generated Imagery

Marvel Metal comes alive with high-tech CGI colorization. The trading card industry's most talented computer artists:

- Jung Choi
- Tractor
- Regie Milburn



Original Artwork

Marvel Metal features art from Marvel's best pencillers:

- **George Perez** (*Hulk: Future Imperfect*)
- **Ron Lim** (*X-Men 2099*)
- **Darick Robertson** (*Spider-Man: Power of Terror*)
- **Ken Lashley** (*Excalibur, X-Calibre*)

Venom possesses the Punisher

Alternate M takes your favorite Marvel characters and explores alternate possibilities.



All-New Power Grids!
Rate the power of your favorite Marvel characters!

MARVEL METAL 1995 CHECKLIST

Alternate X

- 1 Beast
- 2 Bishop
- 3 Cyclops
- 4 Gambit
- 5 Holocaust
- 6 Jean Grey
- 7 Nightcrawler
- 8 Sunfire
- 9 Weapon X

Avengers

- 10 Black Widow
- 11 Captain America
- 12 Giant Man
- 13 Thor
- 14 Thunderstrike
- 15 Vision

Cosmic Powers

- 16 Galactus
- 17 Nebula
- 18 Silver Surfer
- 19 Thanos
- 20 Tyrant
- 21 Warlock

Force Works

- 22 Hawkeye
- 23 Iron Man
- 24 Mandarin
- 25 Scarlet Witch
- 26 Spider-Woman
- 27 War Machine

Marvel Universe

- 28 Daredevil
- 29 Deathlok
- 30 Elektra
- 31 Hulk
- 32 Human Torch
- 33 Invisible Woman
- 34 Mephisto
- 35 Modok
- 36 Mr. Fantastic
- 37 Namor
- 38 Puppet Master
- 39 She-Hulk
- 40 Silver Sable
- 41 Super Skrull
- 42 Thing

Marvel 2099

- 43 Bloodhawk
- 44 Brimstone Love
- 45 Doom 2099
- 46 Ghost Rider 2099
- 47 Hulk 2099
- 48 Junkpile
- 49 Meanstreak
- 50 Punisher 2099
- 51 Ravage 2099
- 52 Skullfire
- 53 Spider-Man 2099
- 54 Vendetta
- 55 Xi'an

Midnight Sons

- 56 Blade
- 57 Blaze
- 58 Dr. Strange

- 59 Ghost Rider
- 60 Morbius
- 61 Strange
- 62 Vengeance

New Warriors

- 63 Firestar
- 64 Justice
- 65 Kymaera
- 66 Night Thrasher
- 67 Nova
- 68 Rage

Punisher

- 69 Punisher

Spider-Man

- 70 Black Cat
- 71 Carnage
- 72 Dr. Octopus
- 73 Judas Traveller
- 74 Rhino
- 75 Scarlet Spider
- 76 Scorpion
- 77 Shocker
- 78 Spider-Man
- 79 Stunner
- 80 Venom
- 81 Vulture

X-Men

- 82 Apocalypse
- 83 Archangel
- 84 Banshee
- 85 Beast

- 86 Bishop
- 87 Boomer
- 88 Cable
- 89 Chamber
- 90 Colossus
- 91 Cyclops
- 92 Deadpool
- 93 Domino
- 94 Gambit
- 95 Husk
- 96 Iceman
- 97 Jean Grey
- 98 Jubilee
- 99 Juggernaut
- 100 Lady Deathstrike
- 101 Legion
- 102 Longshot
- 103 M
- 104 Magneto
- 105 Mondo
- 106 Mr. Sinister
- 107 Mystique
- 108 Nightcrawler
- 109 Penance
- 110 Phoenix
- 111 Professor X
- 112 Psylocke
- 113 Random
- 114 Rogue
- 115 Sabretooth
- 116 Sauron
- 117 Shadowcat
- 118 Skin
- 119 Storm
- 120 Strong Guy
- 121 Stryfe
- 122 Synch
- 123 Warpath
- 124 White Queen
- 125 Wolverine

Alternate M

- 126 Beast
- 127 Cable
- 128 Dr. Doom
- 129 Fantastic Four
- 130 Iron Man
- 131 Kraven
- 132 Rogue
- 133 Silver Surfer
- 134 Spider-Man
- 135 Storm
- 136 Venom
- 137 Wolverine
- 138 Checklist

Blasters

| Metal | Character | Gold |
|-------|-----------------|------|
| MB1 | Cable | GB1 |
| MB2 | Captain America | GB2 |
| MB3 | Cyclops | GB3 |
| MB4 | Gambit | GB4 |
| MB5 | Hulk | GB5 |
| MB6 | Human Torch | GB6 |
| MB7 | Iron Man | GB7 |
| MB8 | Jean Grey | GB8 |
| MB9 | Punisher | GB9 |
| MB10 | Rogue | GB10 |
| MB11 | Silver Surfer | GB11 |
| MB12 | Spider-Man | GB12 |
| MB13 | Storm | GB13 |
| MB14 | Thing | GB14 |
| MB15 | Thor | GB15 |
| MB16 | Venom | GB16 |
| MB17 | War Machine | GB17 |
| MB18 | Wolverine | GB18 |

**Three All-New
Limited Edition Subsets
New Technology!**

Silver Flashers™ [One in every pack]
137 characters silhouetted against a silver etched foil background.

Metal Blasters™ [One in every 2 packs]
18 of Marvel's top characters blast off of every card!

Gold Blasters™ [One in every 3 packs]
A chase card of a chase card!
The Metal Blaster characters framed in gold foil.

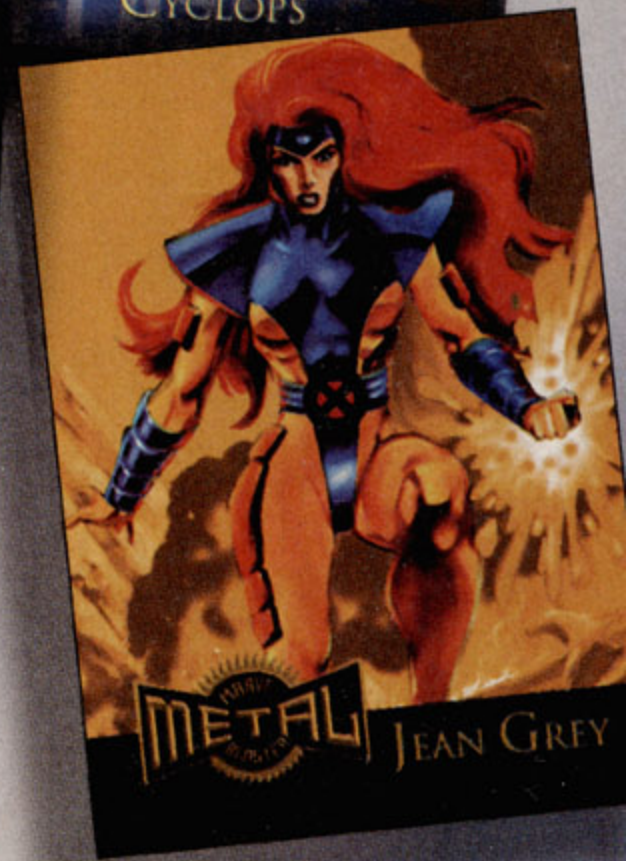

**DISTRIBUTED BY
FLEERCORP**

**Heroes World
Top Products**

- #1 Jan 1994
'94 Fleer Ultra X-Men
- #1 Apr 1994 T/C
Amazing Spider-Man
- #1 May 1994
Beavis & Butt-Head
- #1 Jun 1994
Flair Marvel Universe
- #1 Aug 1994 T/C
Marvel Cards Universe
- #1 Oct 1994
Marvel Masterpieces 1994
- #1 Dec 1994
'95 Fleer Ultra X-Men

**Diamond Distributors
Top Trading Cards**

- #1 1993 OVERALL
'94 Fleer Ultra X-Men
- #1 Jan 1994
'94 Fleer Ultra X-Men
- #1 Apr 1994 N/S
Amazing Spider-Man
- #1 May 1994 N/S
Beavis & Butt-Head
- #1 Jun 1994
Flair Marvel Universe
- #1 Aug 1994
Marvel Cards Universe
- #1 Oct 1994
Marvel Masterpieces 1994
- #1 Dec 1994
'95 Fleer Ultra X-Men

**Capital City
Top Trading Cards**

- #1 Jan 1994
'94 Fleer Ultra X-Men
- #1 Apr 1994
Amazing Spider-Man
- #1 May 1994
Beavis & Butt-Head
- #1 Jun 1994
Flair Marvel Universe
- #1 Jul 1994
Flair Marvel Universe
- #1 Aug 1994
Marvel Cards Universe
- #1 Oct 1994
Marvel Masterpieces 1994
- #1 Dec 1994
'95 Fleer Ultra X-Men

Thanks Again For A Great 1994!

LAMEPRO[®]

#1 Video Game and Pet Care Magazine

Earthworm Gym

It Will Make You Feel
Worm All Over!!

FREE!

SUPER DUPER TETRIS

160-page NoStrategy Guide
for the best Tetris ever!
New Shapes Revealed!

NoReviews!

- **Killer Stink**
- **Doom and Doomer**
- **Forrest Gump:
The Video Game**
- **Samurai Slodown**
- **Boogerman II:
Snot Funny**
- **The Lying King**
- **Marcia Clark in
Legal Enforcers**
- **Super Killer Street
Kombat Mortal
Fighter Rage VI:
The New Guys**



April 1995
\$249.99 + tax





By Conan the Librarian

Head for California, enjoy the bright lights, beautiful beaches, snowy mountains...and a few other surprises in store for you out on the Golden Coast.



PROTIP: Watch out for the Fire and Flood icons. They both appear in Los Angeles...at the same time.



anyway. And if that isn't enough, Mother Nature lends some much-needed help in the form of earthquakes, floods, and fires. Riots, low



PROTIP: Sun icon? No way! California has enough of that. These are UV Warning icons. Too much sun, and you're a goner!

Sim California



PROTIP: Prison icons appear everywhere in California, but watch out for the NIMBY (Not In My Back Yard) icons.

Going Back to Cali

The story follows most of the sim games out there. You have to arrange cities to make the state great, but you can't be a cheapskate about it. Spend millions on factories and watch smog worsen.

Build more jails – just to see the crime statistics soar

stock options (Orange County only), and more round out the Danger list.

I Left My Heart

The graphics are sunny and cheerful, though every background has a palm tree in it. Sun-bleached blondes, muscle-bound hunks, and gun-toting lunatics also make appearances.

The music is Beach Boyesque, except in some cities, where it's Boy George-esque. Finger-snapping, middle-of-the-road pop music fills the rest of the soundtrack. There's also some voice added, but the only speech you'll hear is variations of "Let's do lunch."

All in all, Sim California is great fun – unless you're the governor, in which case it's great fun and very lucrative. So enough of surf, sun, and sand...nobody lives like that in California anyway! **L**

| Sim California By Accountants R Us | | | | |
|---------------------------------------|-------|-------------------------------|-----------|-----------|
| Graphics | Sound | Control | FunFactor | Challenge |
| ☺ | ☺ | ☺ | ☺ | NOPE |
| 1.0 | 2.0 | 3.0 | 4.0 | |
| \$129.99 | | 1 state | | |
| 1 meg | | Way-overhead view | | |
| Available yesterday | | Multipolling | | |
| Simulation | | ERRP rating: Infants to Grave | | |
| 3 players | | | | |



By Scarier Larry

Gamers who haven't had enough Ranger action should check out this kinder, gentler action game. The Flower Arrangers know love when they see it, and they spread it on as thickly as possible...the love, that is.

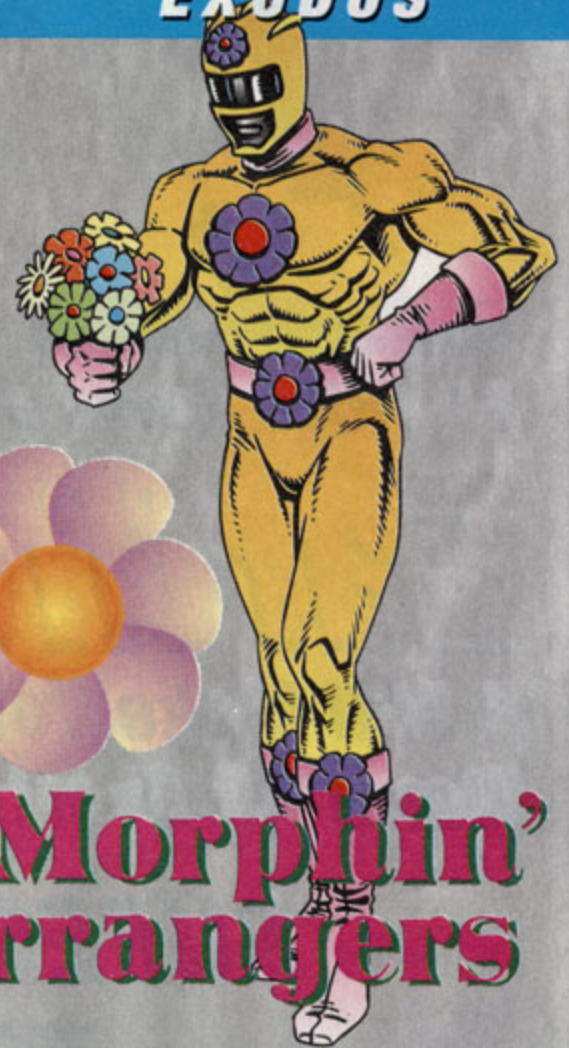

Mighty Morphin' Flower Arrangers

Flower Power

First off, there's a new batch of Rangers in town. Meet Kris, the Mauve Ranger, Ricki the Teal Ranger, Molly the Turquoise Ranger, and Kim the Off-White But Not Quite Beige Ranger. Each has their own special Flower Power move, such as Kris's Dozen Roses On Your Birthday or Molly's Cheap Dandelions Because It's A First Date.

The Power moves aren't meant to be mean, and they're not. No bloodshed, no arm ripping, but maybe just a little shoving and name calling. Nothing serious.

Go, Go, Flower Arrangers

The graphics are scrumptious, with just the right touch of pathos and angst. Lovely hues highlight a gorgeous background, and the cast is buffed and beautiful.

The music is, of course, disco. Pulse-pounding, house-driven tunes that make you want to spin and spin and... sorry. It's good.

Control is a problem. Although you want your Rangers to go one way, they always surprise you. But if you want a game that lets you be you and lets the love shower down, check out the Flower Arrangers. **L**

Power Moves!



The Mother's Day Gardenias



The Cheap Dandelions Because It's A First Date



The Dozen Roses For Your Birthday

| Mighty Morphin' Flower Arrangers By Programmers College | | | | |
|--|-------|---|-----------|-----------|
| Graphics | Sound | Control | FunFactor | Challenge |
| ☺ | ☺ | ☺ | ☺ | NOPE |
| 5.0 | 4.0 | 3.0 | 2.0 | |
| Rental only | | 1 level | | |
| 975 megs | | Just-left-of-center view | | |
| Available 1998 | | Multistrolling | | |
| Action/adventure/romance | | ERRP rating: MAPO (Middle-Aged People Only) | | |
| 157 players | | | | |



JAGGED WIRE



By Howard NoSell

Baseball players never saw the end of the season last year, but that minor hitch didn't deter Programmers College from developing its first-ever sports title. In Strike Edition, you won't see any rosters, lineups, and stats...but you will meet Gus the Groundskeeper, Manny the Hot Dog Vendor, and others who still head to the stadium every day.

RBI RPG

Strike Edition features beautiful views of the field, some nice views of the parking lot, and a journey through the empty halls of the greatest stadiums in the world.

Because of the strike, you have to talk to groundskeepers, security guards, and the end boss, the team owner. Abandoned locker rooms and empty sportscasting booths also need to be inspected.

Super SBPA RBI ERA Bases Loaded Hardball III '95: Strike Edition



PROTIP: Throw one low and inside. Actually, throw them all low and inside if you want. There are no umpires.



PROTIP: Steal home. Who's going to stop you?

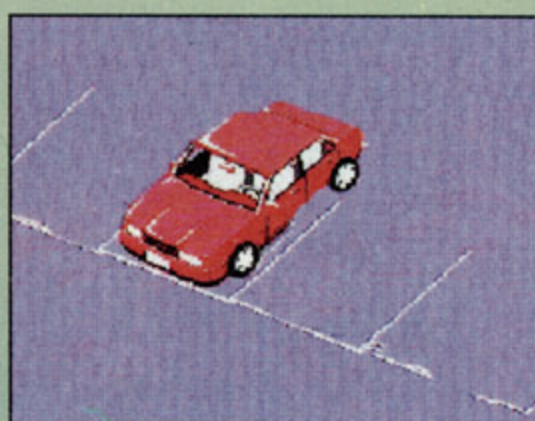
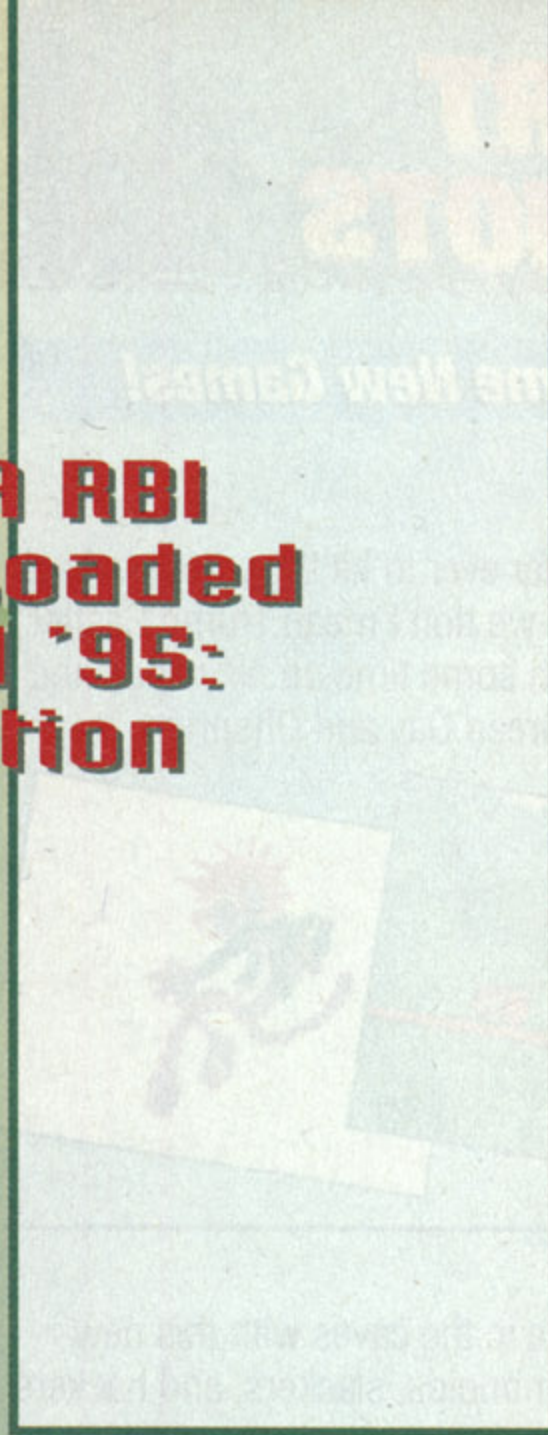

Parking lot looks good, doesn't it?

Strike Three

The graphics are beautiful. The grass never looked greener, and the cobwebs in the dugout never looked grayer or more detailed. Empty stadium seats and vacated parking-lot stalls also add to the atmosphere.

The sounds are sparse. No bats cracking, gloves thumping, or players huffing as they round the bases. Listen instead for the wind whistling through the overhead lights or the pigeons cooing near the water fountain.

Strike Edition is a great addition to any baseball player's repertoire. If you don't like the burden of stats, rosters, and lineups, you'll love this game. Besides, why look for the players anyway? They sure didn't look for you. **L**

Super SBPA RBI ERA Bases Loaded Hardball III '95: Strike Edition
By Programmers College

| Graphics | Sound | Control | FunFactor | Challenge |
|----------|-------|---------|-----------|-----------|
| ☺ | ☺ | ☺ | ☺ | NOPE |
| 5.0 | 4.0 | 1.0 | 5.0 | |

\$39.99
4.5 megs
Available very, very soon
Sports
No players

1 level
From-the-bench view
Multiscrolling
ERRP rating: IM (Immature)

Every mag's doin' it – that's a lot of rags doin' it!

Why not... **LAMEPRO TOO**

The **CUTTING**-edge magazine for a **new** generation of **LamePros**

Twice as much attitude

Twice as many Lame Reviews

Twice as much news you can't use

Twice as many tips and tactics that don't work

Twice as much info about overseas games you'll never play



LAMEPRO TOO

It's the same 'Pro...just twice as Lame!

(Not only that, but we hit you up for twice the cover price!)

SHORT POT SHOTS

A Quick Look at Lame New Games!

Punk Panther

The first nose-pierced feline character ever to hit the screen is back from a stint in the Big House...and we don't mean Trump Castle! Punk Panther is a hip, sleek cat with some time on his hands and a soundtrack featuring bands like Green Day and Offspring.

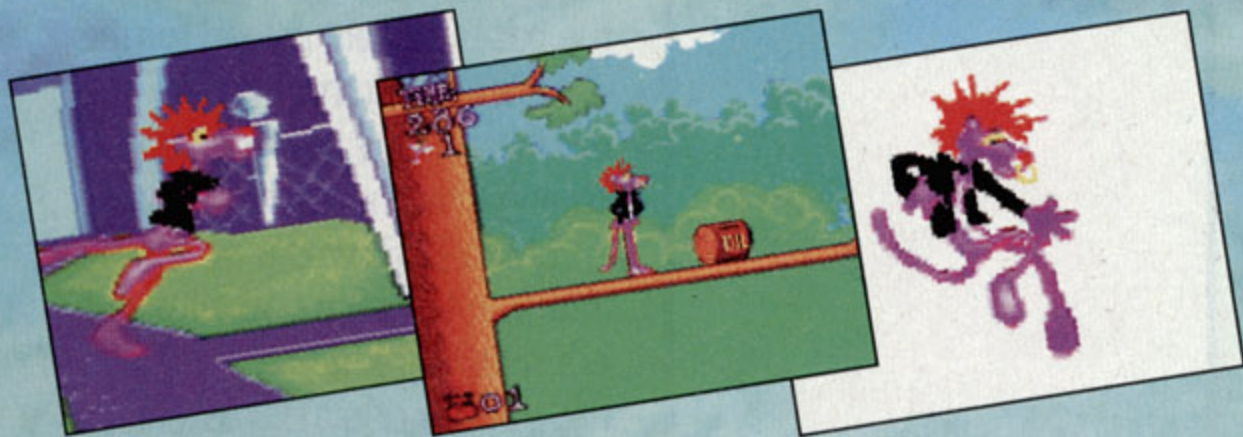

Primal Rave

Prehistoric partying at its best. Rave in the caves with this new fighting party game. Wheezers, numbnoids, slackers, and hackers battle it out to be the top raver.



Moron Kombat VII: Jim Carey vs. Forrest Gump

If you could only get one of these two numbskulls to turn around, you might have a fairly good fighting game. Trying to do a finishing move may try your patience, so get a good joystick. Stupid is as stupid fights.



Make Your Own Country Rap Video Starring Dairy Queen Latifah

Country rap, where the homeboys meet the cowboys, is sweeping the nation. Now you can put some twang in your thang. Six stages of hip-hop-n-bop action take you and your Chevy pickup convertible from Hollywood to Dollywood, stopping along the way to out-jam killer country-rap stars like Iced Tea, Snoop Garthy Garth, and the Good Ol' Beastie Boys.



NOT AT THE ARCADES

ALIEN vs. Editor

Be afraid, be very afraid...especially if you're an editor. This Doom-ed game looks like a winner. Fly down the halls and trap your favorite *LamePro* editor...then plant some eggs in that empty head!

There are more than 15 million moves, all of them done with two buttons and the joystick. Do the math. Play a game for only 12 tokens a shot.

Face Huggers will try their best to attach themselves to the editors, but once they get a good look, they'll try to detach themselves in a hurry. You must keep the Face Huggers motivated.

If you play as the editor, you can hunt down the Alien, but you must first turn your stories in on time. Missing a deadline is an automatic loss of life. As for weapons, you get a pen, some paper...but no help from a hostile printer. Oh, well. That's publishing. And this is Alien vs. Editor. **L**

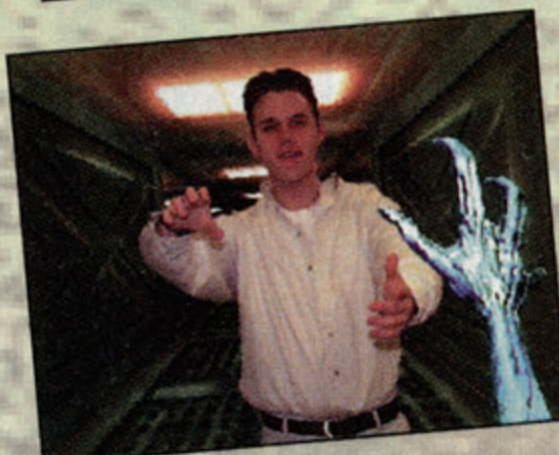



METAL WARRIORS



MAKE NO MISTAKE, OPERATING THIS SKULL STOMPING, JET PROPELLED, 50 FOOT METALLIC BEAST IS NOT FOR PEOPLE WHO LIKE THEIR MILK WARM. SO, IF YOU'VE GOT HAIR ON YOUR CHEST, STRAP YOURSELF INTO METAL WARRIORS™ FOR YOUR SUPER NES® AND PILOT ONE OF SIX HEAVILY ARMED BATTLEDROIDS. DESTROY THE ENEMY ACROSS NINE CARNAGE-FILLED LEVELS WITH AN ARSENAL OF FLAME THROWERS, BEAM SABRES AND PLASMA CANNONS. IF YOUR UNIT'S TAKING TOO MUCH DAMAGE, EJECT AND NAB A FULLY FUNCTIONAL ONE. BUT WATCH YOUR TAIL. WHEN YOU'RE OUT IN THE OPEN, YOU'RE EASY MEAT. THERE'S ALSO THE 2 PLAYER BATTLE-MODE, WHERE YOU AND A FRIEND CAN MELT EACH OTHER INTO BEDPANS. IT'S KONAMI'S METAL WARRIORS™. PICK IT UP AND YOU'LL STAND TALLER. EVEN IF YOU ARE SPINELESS.

WARNING 
DO NOT ATTEMPT TO OPERATE THIS MACHINERY IF YOU'RE A SPINELESS WUSS



COMING SOON! METAL WARRIORS. CALL 1-900-896-HINT FOR FREE PREVIEW INFORMATION.*



Metal Warriors™ and ©1994 LucasArts Entertainment Company. LucasArts is a trademark of LucasArts Entertainment Company. All Rights Reserved. Used under authorization. ©1995 Konami (America) Inc. Super NES™ and the official seals are registered trademarks of Nintendo of America Inc. ©1991 Nintendo of America Inc. *Konami Hintline's normal rates are \$0.85 per min. for pre-recorded hints and \$1.15 for live assistance, but the Metal Warriors option is free until May 31, 1995. You must be 18 years of age or have parental permission to call, and have a Touch-Tone phone. You may be asked for information on this ad.

Genesis



By Tommy Glide

Drag your adamantium claws out of the closet one more time! A large X-Men cast returns to the Genesis in this good-looking platform game.

More Mutants, Less Filling

It doesn't take X-trasensory mutant powers to notice the cool enhancements in this latest X-Men game. This platform hopper adds Beast, Psylocke, and Magneto to the



PROTIP: To beat this Sentinel boss, crouch and blast the revolving squares below the yellow beam, then jump over his projectiles.

original Genesis lineup of Gambit, Cyclops, Nightcrawler, and Wolverine.

With these seven heroes, you battle the Phalanx, an alien virus that wants to rule the world by cloning the X-Men. The traditional gameplay features six jump-and-attack



PROTIP: When battling Exodus, stay to the right and jump to hit him. When he surges power into the walls, make sure you jump, or you'll be harmed.

levels that resemble previous X-Men games.

Each hero brings their own special moves and powers to the fight, adding needed variety to the familiar action. Control freaks will have a field day climbing walls with Wolverine and teleporting with Nightcrawler. The combinations of special movements and attacks



PROTIP: As Nightcrawler, you can't attack or be harmed by some enemies while crawling on the ceiling. Use this opportunity to get into position and drop for teleport attacks.

will keep gamers busy mastering the many survival skills.

Standing tall, the large, detailed X-Men sprites should make Marvel Comics proud. While the sprites and background graphics are first rate, the animation isn't quite as smooth. A few more frames of animation for each character would've been X-quisite.

The sound doesn't match the graphical intensity. Some effects, like the laser sounds, are high quality. Others are mediocre, like the crackling explosions in the escape from the Sentinels. The same is true with the music: Some levels groove, others don't.

Solve for "X"

While the simultaneous two-player action is a nice feature, don't expect an arcade-quality



PROTIP: When this mini boss confronts you, stay on the platform and hit him as he rises.

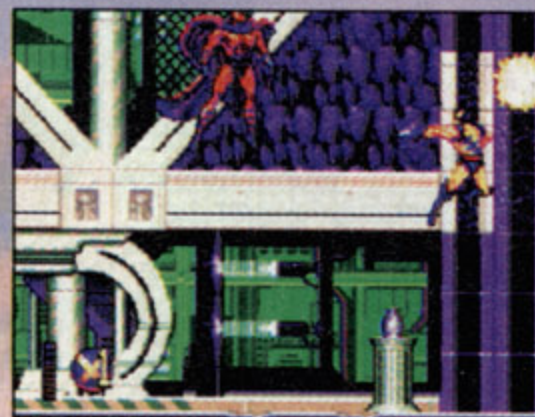

PROTIP: Against Magneto, break through the walls to the right. When his bolts noticeably damage a wall, break the rest yourself and enter the next room.

two-player game. The side-view screen scrolls so tightly that two players have to stay virtually on top of each other to progress.

Still, fans of the X-Men will really enjoy the capabilities of their heroes, though tough boss characters like Apocalypse will challenge intermediate and advanced gamers. If platform punchers are your type of game, then join this team. "X" again marks the spot. **G**

X-MEN CLONE WARS 2

The X-Posse



Beast



Gambit



Psylocke



Cyclops



Nightcrawler



Wolverine

| Genesis Game Profile | | | | |
|----------------------------|---|-------------------------|---------------------------|-----------------------------|
| X-Men 2: Clone Wars | | | | |
| (By Sega) | | | | |
| | While not totally X-hilarating, X-Men 2: Clone Wars is chock full of heroic adventure that will leave you X-hausted. | | | |
| | Graphics 4.5 | Sound 3.5 | Control 4.0 | FunFactor 4.0 |
| \$59.99 | 16 megs | Available now | 2 players | 6 levels |
| Action/adventure | | Multiscrolling | | |

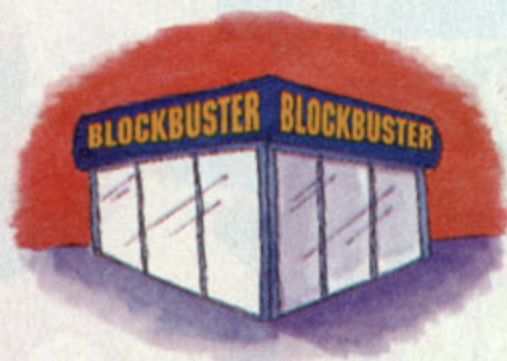

GO TO BLOCKBUSTER
AND RENT THE
HOTTEST NEW GAME.



BORED WITH IT.



ATTEMPT IT.



CONQUER IT.



WHERE THE CHALLENGE NEVER ENDS.



CURSE IT.



MASTER IT.



GO WITH IT.



BEAT IT.

THE CHALLENGE NEVER ENDS, BUT THIS OFFER WILL.

RENT ONE VIDEO GAME,
GET ONE FREE.

Rent one game, get second game rental of equal or lesser value FREE! (Excludes video equipment.) Limit one per account. Not valid with any other offers. All taxes are the responsibility of the recipient. Offer good for members only at participating Blockbuster Video locations. Membership rules and regulations apply. OFFER EXPIRES MAY 1, 1995.



56101300008



PROREVIEW

Genesis



By Bacon

Road Rash 3 revisits EA's venerable blend of racing and thrashing, packing in enough visual and gameplay variety to dazzle veteran rashers. With new feature-packed tracks and five deadly new weapons, your pulse will pound for months.

World Party

In the latest version of Road Rash, you strike out to conquer the world, racing on seven tracks in such countries as Brazil, Japan, and Kenya to rake in bucks and buy new bikes. Yes, that's seven tracks – each level still consists of five races, but you now face new courses on higher levels!

Also, instead of saving to buy a new bike, you can now upgrade its suspension, perfor-



PROTIP: Kick opponents in turns to clear them off the course.

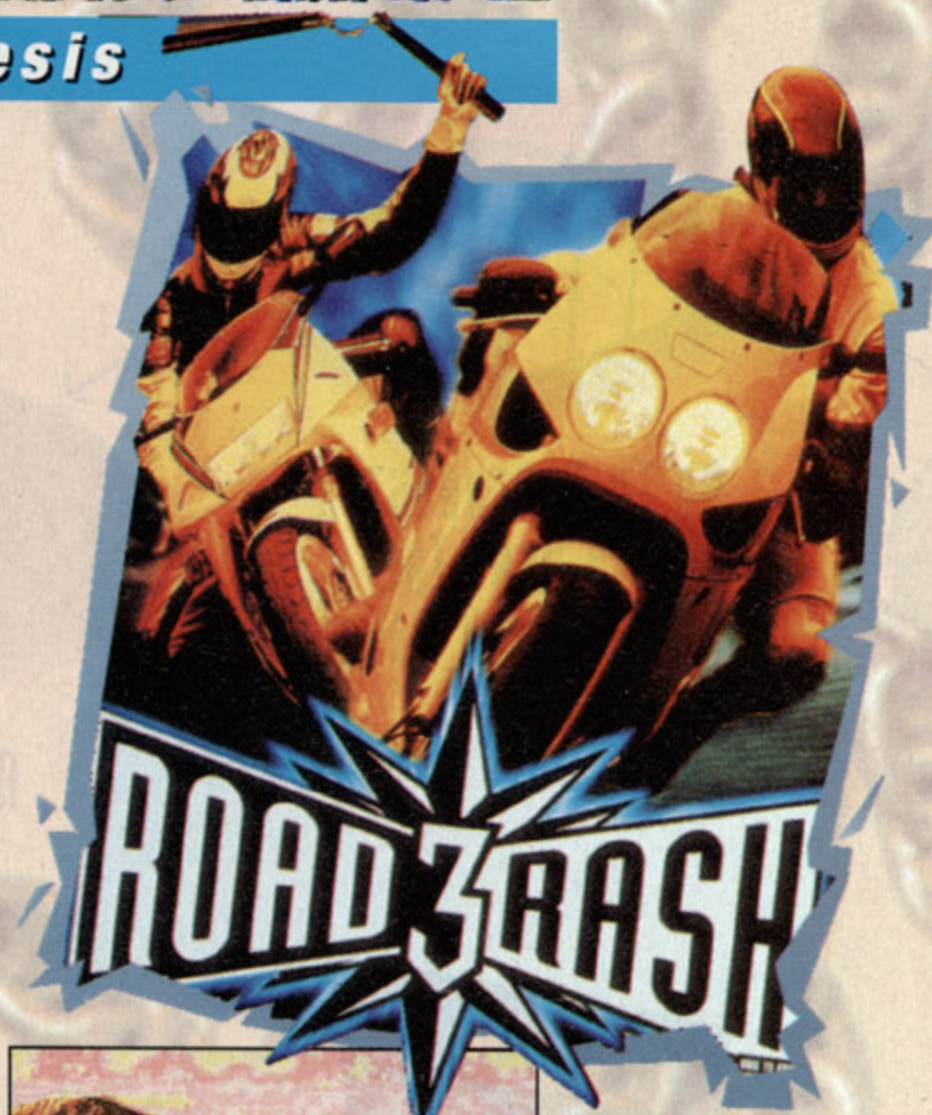

PROTIP: Use the backhand punch or backhand weapon strike to prevent someone from passing.

mance, protection, and tires for a much lower price. The tight controls create unique handling for each bike; you'll instantly feel the difference as you buy better equipment.

Rashers can carry as many weapons as they can collect, though switching between weapons requires unwieldy button presses. But with new weapons like mace, cattle prods, nunchuks, and crowbars at your fingertips, you'll want 'em all.



PROTIP: Listen for honks – they warn you of oncoming traffic.



PROTIP: In the U.K., Australia, and Japan, cars drive on the left side of the road.



PROTIP: Always save one nitro burst for the finish-line sprint.

Cops chase you in helicopters and cars, but roadside ramps provide quick escapes. The same two-player modes – Take Turns, Split



PROTIP: Experienced riders should upgrade suspension and performance as soon as possible, while novices should upgrade protection and tires first.

Screen, Mano a Mano – return to the Rash. Although they have more speed and fluidity than RR 2's jerky two-player racing, they still feel twitchier and less responsive than the one-player racing.

Gentlemen, Start Your Clubs

This cart emphasizes fighting over riding, which cranks the excitement into high gear. You won't slide out or crash into road signs as often, but to win, you have to pound half the pack off its bikes.

Graphically, the backgrounds feature much more realistic details and scenery, such as Germany's snow-lined track. The foregrounds are enhanced with snazzy oncoming traffic, roadside obstacles like Japanese pedestrians, and slick sprites and bikes.

The music suits the locale of each level, but it remains



PROTIP: Brawl with the racers at the start to snatch a weapon early on.

annoyingly peppy. The sound effects, though often silly, intensify the combat.

Rough Rash

With its greatly expanded features, RR 3 has enough depth to keep your pedal to the metal. Experienced rashers will delight in mastering these bikes and battling on the challenging new tracks. If you've never rashed before, grab a crowbar and toe the line! **G**

Genesis Game Profile

Road Rash 3

(By Electronic Arts)



Road Rash 3's impressive array of killer features makes for thrilling thrashing. Five new weapons, seven new tracks, and vicious fighting – what more could you ask for?

Graphics Sound Control FunFactor Challenge



\$59.95
16 megs
Available now
Racing/fighting
2 players

7 tracks
5 levels
Forward scrolling
Behind-the-biker view
Passwords

U R Lance



U go to the

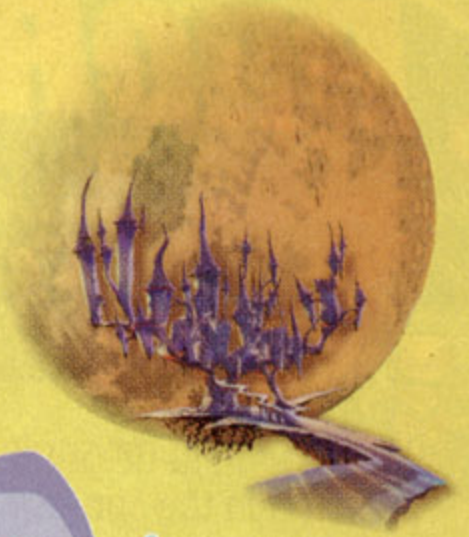

2 fix a



U find that the



is going 2



U run from Fritz

destroy the



and b-come the



get

BRAIN DEAD 13

by



on

| MAY | | | | | | |
|------|------|------|------|-------|------|-------|
| Sun. | Mon. | Tue. | Wed. | Thur. | Fri. | Sat. |
| | 1 | 2 | 3 | 4 | 5 | 6 |
| | | | | | 11 | 12 13 |

Get your demo CD NOW!

Available from leading retailers for \$5.00

PC CD-ROM • Sega CD • 3DO • Mac CD-ROM • MPEG

Brain Dead 13 is a trademark of ReadySoft Incorporated. ©1995 ReadySoft Incorporated. ALL RIGHTS RESERVED.

Genesis



By Captain Squideo

Looking for some fun in the sun? Hit the desert highway with the Road Runner and his nutty nemesis, Wile E. Coyote. Clever animations and dual-sided gameplay make Desert Demolition a lightweight frolic.

Double Your Fun

Desert Demolition is really two games in one. You play through the six levels as either the dinner (Road Runner) or the diner (Wile E.), with the gameplay



PROTIP: Before you slide down this first rope, grab the extra coyote life off-screen to the upper left.

changing depending on which character you control.

Naturally, Road Runner is pure speed and can dodge, bounce, and sprint past the coyote's traps. Conversely, as the slower Wile E., you com-

mand an array of wacky Acme gadgets, including rockets, spring shoes, and wings.

Desert Duo

Although there's double the gameplay, there's not exactly double the fun. As in the cartoons, Road Runner is pretty one dimensional - the coyote's the comedy star.

Road Runner's basic running and jumping gets pretty routine, and he can usually



PROTIP: To exit Choo Choo Terrain, throw this switch before you reach the smokestack.

The controls are easy, especially for the simple Road Runner. He charges along, stops quickly, and bounces accurately.

Once you know what each new Acme gadget can do, Coyote is pretty easy, too. Al-

though his spring shoes are awkward, flying with the wings and racing with the skates offer fast fun.

Acme Animation

The graphics and sounds are true to the classic cartoons. The backgrounds are flat and colorful, and the two protagonists are large, fluid sprites.

Best of all are the humorous animations when the frantic Wile E. flounders with his springs or skates. The sounds



PROTIP: Beat the Acme truck in the Grand Finale by dodging its bombs and pulling the switches to drop explosives onto it.

are cartoon quality, punctuating the action with lots of boings, bams, and beep-beeps.

Fans of the cartoons will welcome these crazy critters into their homes like family. Serious gamers hoping for a challenge won't find it here, however. With only one simple boss to beat at the end, Desert Demolition is easy fun that's entertaining one afternoon but forgotten the next. **G**

DESERT DEMOLITION

Starring Road Runner and Wile E. Coyote



Win as the Road Runner, and you're named Acme President; win as Wile E., and you're Acme Customer of the Year.

race right out of danger to the exits. The real fun comes when Wile E. uncovers his latest goofy gadget and uses it to catch his prey.



PROTIP: These cannons look like they hurt you, but they actually help you reach elevated areas.



Genesis Game Profile
Desert Demolition
Starring Road Runner & Wile E. Coyote
 (By Sega)

K-A The dynamic duo duels in the desert in this fun frolic. Play as either the rocketing Runner or the crafty Coyote with his arsenal of wacky Acme gadgets.

| Graphics | Sound | Control | FunFactor | Challenge |
|----------|-------|---------|-----------|-------------|
| | | | | ADJ. |
| 4.0 | 4.0 | 3.5 | 3.5 | Adjustable |

\$49.99
 16 megs
 Available now
 Action/adventure

1 player
 6 levels
 Side view
 Multiscrolling

IT'S WHAT TV WAS INVENTED FOR...BUST A MOVE!

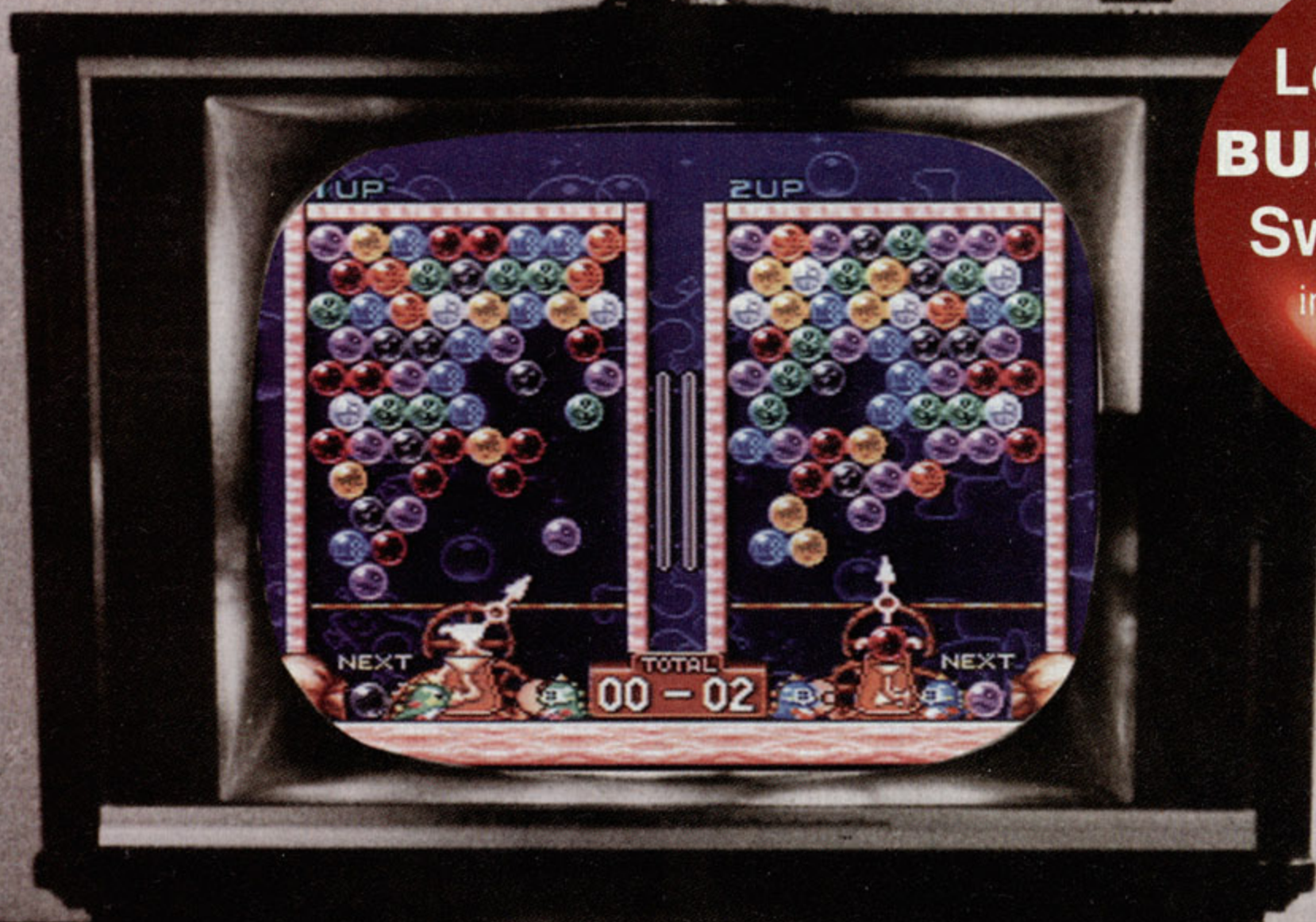

Look for the
BUST-A-MOVE
Sweepstakes

in the June issue
of GAMEPRO



Bust-A-Move is the new puzzle solving game that will have you busting for hours. Line up three of the same color balloons and bust them before they come towering down.

You can play alone or split the screen to bust a friend. There's even a handicapping option so the whole family can play. Find out what TV was invented for and Bust-A-Move!

TaitoTM
Taito America Corporation

Genesis



By Captain Squideo

Too little, too late – that's Warlock for the Genesis. Its standard walk-n-shoot action might've seemed thrilling back when the *Warlock* movie was in theaters, but now it plays like a dozen similar carts.

Bram Stoker's Warlock

This game bears a strong resemblance to last year's average game Bram Stoker's



PROTIP: After you nail a demon wolf attacking from the right, turn left and fire at another one about to attack from offscreen.



PROTIP: When fighting the zombies, try to line up two on the same side so you can take 'em both out with one Magic Blast.



Dracula. You're a lone mortal searching for an evil monster who has the home-castle advantage. You walk; he materializes and vanishes. You have two main weapons; he has an army of undead cronies. You



PROTIP: Ride this Levitation Crystal across the chasm to spells and potions. Then ride back and walk to the waterfall's hidden exit.



PROTIP: At the beginning of the Grim Garden, use the Levitation Crystal to snag the goodies hidden atop the cliff to the left.

through spells without having to refer to a separate menu screen. You can't fire your weapons while on the move, however, and there's a deadly delay between shots. Also, finding health power-ups doesn't automatically restore health – you tediously select health power-ups from your spells to claim them.

Warlock

Not only does the plot seem familiar, but you'll also swear you've experienced these graphics and sound effects before. The graphics do convey an eerie mood with sinister background details and moving shadows.

But the beasts you en-

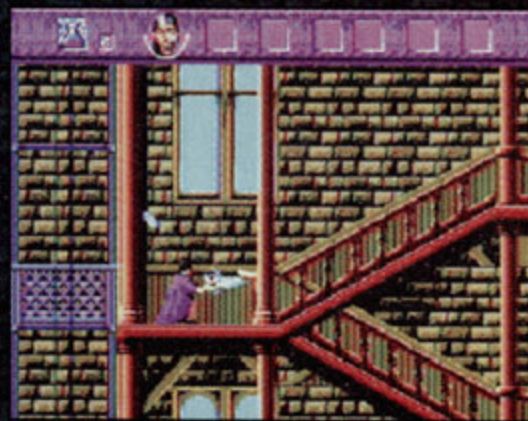

PROTIP: Hit this easy-to-overlook switch outside the elevator to take the elevator up to the Level One exit. Don't forget the blue Protection spell behind you.

CREATURES OF the Night



counter, which include morphing monsters, are too small to generate genuine thrills. Same with the sounds: The droning music, subtle howls, and the Warlock's laugh convey an ambient scariness, but no overwhelming roars or musical crescendos stay with you.

Fans of horror games might war to the final fight. But if you're looking for a chilling challenge, look elsewhere. Warlock the game is like Warlock the movie: a decent rental on a stormy night. But worth buying? Now *that's* scary. **G**

WARLOCK

Genesis Game Profile

Warlock

(By Acclaim)

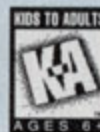

The undead, spiders, haunted castles – is Drac back? Well, sort of. Warlock's a decent horror show that borrows themes and effects from other creepy carts.

Graphics Sound Control FunFactor Challenge



\$59.95
Available now
Action/adventure
1 player

Side view
Multiscrolling
Passwords

have better things to do; he's stuck in this game.

The lack of speed and the sameness of the levels are problems. You plod through haunted gardens and castles, stopping to fire at creepy critters ahead. That's it.

Dull Fangs

While the settings change, the action doesn't. You find helpful spells and crystals, but they lack innovation and eventually become routine.

The controls are also ordinary. Thankfully, you scroll

Kawasaki® SUPER BIKE

Challenge



SEGA
GENESIS



STRADDLE THE HOTTEST THING ON TWO WHEELS...

...for the adrenaline rush of a lifetime!!! Kawasaki SuperBike Challenge saddles you on real, high-powered Kawasaki motorcycles that scream around a multitude of SuperBike circuits, including the Suzuka 8 Hour Endurance race. With superior graphics and sound, you'll experience lightning fast, realistic motorcycle performance with pit stops, tire wear and ever-changing weather conditions. Blow past the competition and earn points toward your ultimate goal, the SuperBike championship. Kawasaki SuperBike Challenge is motorcycle racing at its fastest!!!



TIME WARNER
INTERACTIVE

Available at your local retailer for the Sega™ Genesis™, Sega Game Gear™ and Super NES™ game platforms.

*Kawasaki™ is a trademark licensed by Kawasaki Motors Corp., U.S.A. All rights reserved. TM and © 1995 Time Warner Interactive, Inc. All rights reserved. Sega™, Genesis™ and Game Gear™ are trademarks of Sega Enterprises Ltd. All rights reserved. Nintendo, Super Nintendo Entertainment System and the official seal are registered trademarks of Nintendo of America Inc. ©1991 Nintendo of America Inc. Game Pak (SNS-GP).

ENTER TO WIN BIG PRIZES!

Just fill out and cut off the card below and return to: Kawasaki SuperBike Challenge, Time Warner Interactive at P.O. Box 360782, Milpitas, CA 95036-0782, and you could be a winner of one of the following prizes:

- (1) GRAND PRIZE: Kawasaki Ninja 250 Motorcycle
- (2) FIRST PRIZES: Kawasaki World Assault Leather Varsity Jacket
- (5) SECOND PRIZES: Two Time Warner Interactive Video Games
- (25) THIRD PRIZES: Kawasaki Water Bottle and Key Chain

NAME _____

ADDRESS _____

CITY _____

STATE _____

ZIP _____

AGE _____

PHONE _____

No purchase required. One entry per person. To enter, fill in the above information or print your name, address, city, state, zip code, phone number, and age on a 3" x 5" piece of paper and mail to the address below. Sweepstakes runs from March 15, 1995 through June 15, 1995. Entries must be postmarked no later than June 15, 1995. Void where prohibited. Not responsible for late, lost, mutilated, or misdirected mail. This sweepstakes is sponsored by Time Warner Interactive, Inc. and is open to U.S. residents excluding employees (and their immediate families) of Time Warner Interactive, Inc., their parent companies, subsidiaries, affiliates and agencies. Prizes and approximate retail values are: Grand Prize: (1) Kawasaki Ninja 250 motorcycle (\$3,499.00); (2) First Prizes: Kawasaki World Assault leather varsity jackets (\$350.00 ea.); (5) Second Prizes: Sets of two Time Warner Interactive video games of the winners' choice (\$120.00 each set); (25) Third Prizes: Kawasaki water bottle and key chain (\$3.00 ea.). Total retail value of all prizes is \$4,874.00. Chances of winning are determined by total number of valid entries received. Winners will be randomly drawn on or about June 16, 1995 and will be notified by mail. All prizes will be awarded. Judges' decisions are final. Cash equivalents or merchandise will be awarded for grand prize if entrant is under the age of 18. Taxes, if any, are the responsibility of the winners. For a list of winners, send a self-addressed stamped envelope to Kawasaki SuperBike Challenge Sweepstakes, P.O. Box 360782, Milpitas, CA 95036-0782. Requests must be received before June 30, 1995. Void where prohibited. Void in Quebec, Canada. All federal, state, and local laws and regulations apply. Acceptance of prize constitutes permission to use winners' names and likeness for publicity purposes without additional compensation or permission.



By Tommy Glide

Although "Olympic" appears in the title, "Sonic" would be a better fit; this game plays more like the hedgehog's platform hopper than a sports sim. As a fun action/adventure game, Izzy earns a bronze medal.

Take It Izzy

The 1996 Summer Games seem far off, but not for Izzy. As the Olympic mascot, he must search the Torch World to collect the five Olympic rings that keep the torch lit. In this ten-level quest, Izzy morphs into eight sporting characters, collecting power-ups and loads of bonuses.

Nice backgrounds bring colorful detail to Izzy's world, but it's Izzy himself who stimulates the game visually. His numerous and determined expressions make him an easy-to-like character.

The sound effects are enjoyable with great splats, smashes, and blasting trumpets. His smurfy soundtrack,



PROTIP: As "the javelin" Izzy, you may look sharp, but you're still vulnerable. Avoid as many dangers as you can and aim for medals to restore your energy.

| Izzy's Quest for the Olympic Rings By U.S. Gold | | | | |
|--|-----------|----------------|-----------------------------|-------------|
| Graphics | Sound | Control | FunFactor | Challenge |
| | | | | ADJ. |
| 4.0 | 3.5 | 3.5 | 3.5 | Adjustable |
| \$59.95 | 16 megs | Available now | Action/adventure | 1 player |
| 10 levels | Side view | Multiscrolling | ESRB rating: Kids to Adults | |



Genesis

however, would have been better left in the '80s.

Izzy Come, Izzy Go

With a long jump and an attack jump, Izzy's clean, sim-



PROTIP: Be sure to morph into "the fencing" Izzy before tackling these Izzy-eating plants.



PROTIP: Repeatedly tap Button B as the "hammer-throwing" Izzy to rise to higher platforms.

ple controls are perfect for younger gamers. But even at the harder of the two difficulty settings, the game won't challenge veteran adventurers.

The morphing segments add interest, but they feel like an afterthought. They aren't as long or as important as you would expect.

The quantity of hidden objects really livens up this game. Easter eggs (really, they're painted eggs) are hidden on every screen.

Izzy might not be a keeper, but it's a guaranteed good rental, especially for novices. **G**



By Tommy Glide

Chalk up – it's your turn to shoot stick with the legendary bad boy of billiards, Minnesota Fats. Unfortunately, the variety of pool games included on this cart doesn't make up for the same old overhead gameplay.

Rack 'Em

Offering Story, Tournament, and Versus modes, Minnesota Fats tests pool sharks in eight table games, including standards like

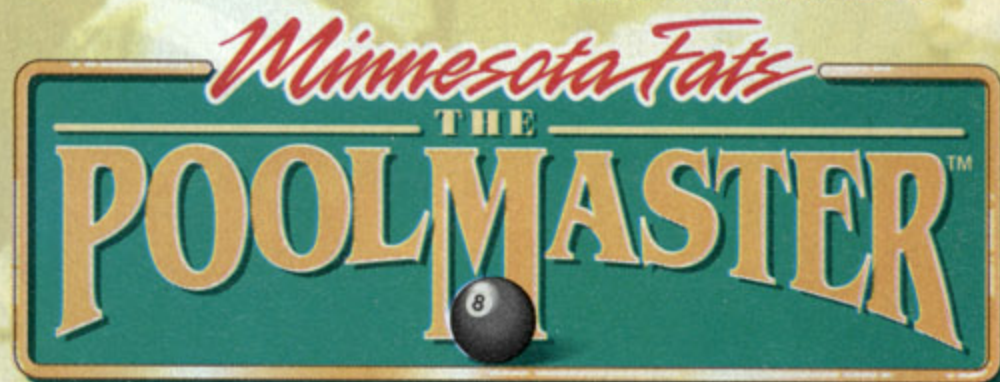

eight ball, nine ball, and cut-throat. For fancy shooters, there's a Trick mode with 16 increasingly difficult trick shots.

The graphics don't help pump up the action on the tables. Viewed from above, the balls look small and flat. The character animations and Fats' appearance in the Story mode add visual flair, but more should have been done to enhance the graphics for the gameplay.

As mediocre as the graphics are, the music is even worse. While the game offers you a jukebox, the selection of tunes comes straight out of an eleva-



PROTIP: Practice your English; you'll need to put subtle spin on the cue ball to make difficult cut shots like this one.



The ball guide helps you set up accurate bank shots.



PROTIP: To shoot well on the lag, hit the ball when the power meter crosses back over the third of the four lines.

tor. Fortunately, the sound effects give you the authentic crack of colliding balls and the muted thud of the felt rail.

Now Leaving Minnesota

Controlwise, the game doesn't offer the precision a pool player wants. The ball guide, cue-ball window, and power meter add to the realism of the control – but you're never confident of your shot accuracy.

While the trick shots, tournaments, and Story mode breathe life into the game, waiting for the computer player to think of his next shot is a snooze. Unless you're a pool fanatic, this joystick is no substitute for a real stick. **G**

| Minnesota Fats The Pool Master By Data East | | | | |
|--|-----------|-----------------------------|-----------|--------------|
| Graphics | Sound | Control | FunFactor | Challenge |
| | | | | INT. |
| 2.5 | 2.0 | 2.5 | 2.5 | Intermediate |
| \$59.95 | 8 megs | Available May | Pool | 2 players |
| Overhead view | Passwords | ESRB rating: Kids to Adults | | |

PROREVIEW

Genesis



PROTIP: Pouring glue enables the lemmings to easily make bridges.



PROTIP: Lemmings can't fall too far. One of the easiest ways to accidentally do yourself in is creating a situation where they splatter. Plan ahead.

layouts and the moves the lemmings perform. The rodents themselves, however, are so tiny that it's tough to point and click with precision.

Lemming Entertain You
A rockin' soundtrack is entertaining enough, though it's easy to do without. The lemmings are as charming as ever, and their famous exclamations add to the game's personality. The increasing difficulty makes the later puzzles extremely challenging, so there's enough variety for all levels of gamers. If you like this style of play, by all means follow Lemmings 2 to your nearest Genesis. **G**

PROTIP: The Practice mode is a worthwhile place to spend some time and become acquainted with the abilities of each tribe.



By The Unknown Gamer

A sequel to one of the biggest puzzlers ever, Lemmings 2 includes 12 tribes of mindless lemmings and 120 levels of mind-bending play. If you liked the original game, you'll like this sequel.

Follow the Leader

The gameplay will be familiar to fans of the original: You must lead a certain percentage of the mindless rodents to safety through a maze of

Lemmings 2: The Tribes



dangerous obstacles. In this version, each tribe of lemmings has different skills, and you have to figure out how to use them to navigate safely.

As in the original game, the controls utilize an easy point-and-click interface. Although the controls are straightforward, the graphics sometimes impair your ability to precisely control the lemmings.

There's a nice variety and much creativity in the level

| Lemmings 2: The Tribes by Psygnosis | | | | |
|-------------------------------------|---------|---------------|-----------|--|
| Graphics | Sound | Control | FunFactor | Challenge |
| | | | | ADJ. |
| 3.5 | 3.5 | 4.0 | 3.5 | Adjustable |
| \$59.99 | 16 megs | Available now | Puzzler | 1 player 120 levels Multiscrolling ESRB rating: Not rated |



By Scary Larry

The Punisher is back on the streets, doling out his particular brand of justice. Unfortunately, he must be cruising on the Streets of Rage because this game is almost identical to that classic series.

They Must Be Punished

It seems that The Punisher is married to the mob. He tracked them down by investigating their money-laundering scheme in the Cayman Islands, and



PROTIP: Almost anything can be used as a weapon.

this cart is based on. You've seen the enemies in Streets of Rage, so don't expect anything spectacular. Even the bosses seem puny.

The music and sounds aren't any better than the graphics. Weak enemy groans and minimal auxiliary sound effects just add to the Punisher's misery.

Capcom's The Punisher is limited in creativity, which makes it limited in appeal.

THE PUNISHER



PROTIP: The gun's targeting device is automatic, so fire away.

now their trail leads him back to the city for average beat-em-up action.

Besides standard punching and jumping, there is a series of special moves, such as the Power Dive and Head Slam. But getting these moves to work requires a lot of frustrating button pressing. Throwing a grenade is easier in real life. You can also invite a friend to play as Nick Fury, the S.H.I.E.L.D. agent, in a two-player simultaneous mode.

Comic-Book Look

The graphics never come close to the coin-op game that



PROTIP: Break barrels instead of throwing them to reveal power-ups.

Fans of the skull-on-the-leotards hero will definitely groan when they see what's been done to their vigilante. The only satisfied gamers might be Streets of Rage fans who haven't had enough. **G**

| The Punisher by Capcom | | | | |
|------------------------|---------|---------------|------------------|---|
| Graphics | Sound | Control | FunFactor | Challenge |
| | | | | ADJ. |
| 3.0 | 2.5 | 2.0 | 3.0 | Adjustable |
| Price not available | 16 megs | Available now | Action/adventure | 2 players Side view Multiscrolling ESRB rating: Teen |

Sega CD



By Manny LaMancha

Earthworm Jim, one of 1994's best carts, gets new life on the Sega CD with many enhancements and additions. While it's not an entirely new game, there's enough freshness – much of it based on players' suggestions – to warrant a look.

The Early Worm Gets The Bird

If you don't know EWJ's background, you've surely been living in a worm hole. A space suit drops from the sky, landing on Jim, a hapless earthworm.

When he crawls inside it, he's transformed into a super being. The suit's intelligence and invincibility transform Jim into a formidable foe to the



PROTIP: If you don't beat Psy-Crow in the *Andy Asteroids* level, you'll face him on the planet's surface. Shoot him to stun him, then sling your whip as he floats.

Sega CD Game Profile

Earthworm Jim Special Edition

(By Interplay)



Earthworm Jim was already a hot cartridge game, but the move to Sega CD reheats it with new levels, sounds, and more.

| Graphics | Sound | Control | FunFactor | Challenge |
|----------|-------|---------|-----------|------------|
| | | | | |
| 5.0 | 4.5 | 5.0 | 5.0 | Adjustable |

Price not available
CD
Available April
Action/adventure
1 player

10 levels
Side view
Multiscrolling
Passwords

alien bird Psy-Crow and his cronies who are trying to retrieve it.

Happiness Is a Worm Gun

In the EWJ carts, Jim sports a gun and whipping ability; the CD version adds a new weapon, the homing missile. Beyond that, this game poses a similar contest, filled with

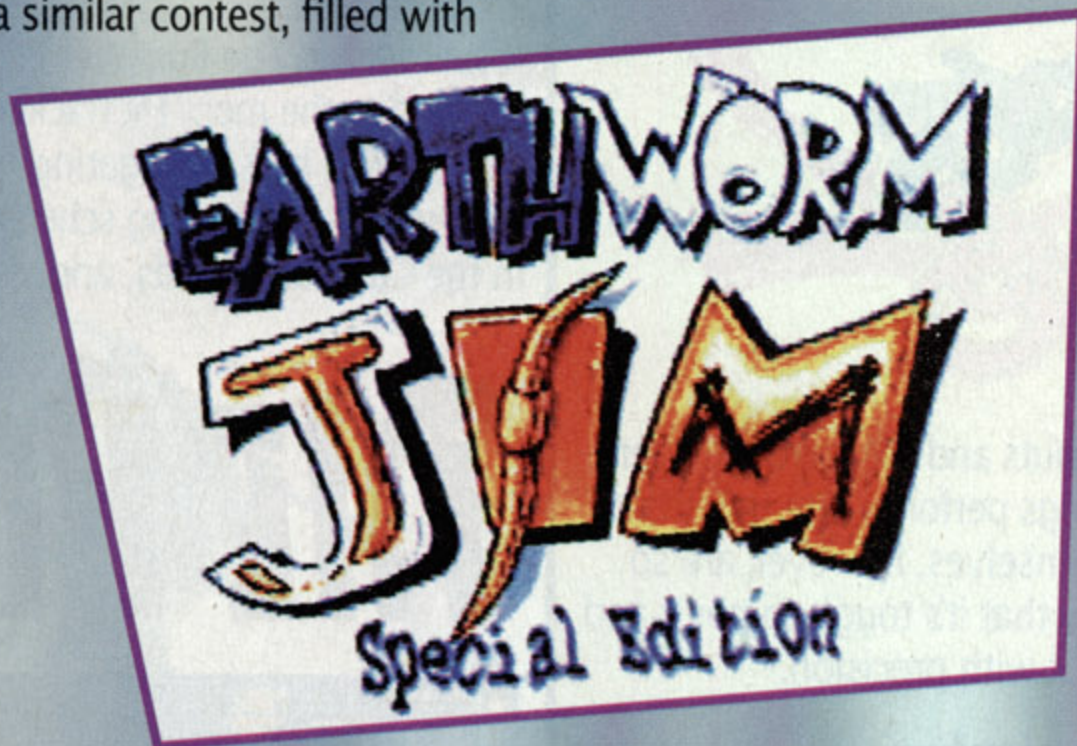

jump-n-shoot-n-whip side-scrolling action, plus the Mucus bungee-jump and other races.

The Sega CD version adds lots of fresh components: new levels, power-on graphics, and opening screens for levels; plus a new soundtrack by Tommy Tallarico and comical sound bites. The graphics and



PROTIP: If you miss hitting a Butler Worm after jumping toward it, hold Down to hang low on the basketball so he doesn't chomp you in half.

PROTIP: Before battling the Queen's butt, leap off the third ball and hook the little spot above you. Head to the left to a platform with a 1-up.



PROTIP: Hit the Queen at four spots – above, below, left, and right – as you rotate around her.

PROTIP: In the *What the Heck* level, watch for what comes out of Evil's gun. Jump if it's a fireball; duck your head if it's a rock.



swing is a bit tricky, but it's simply timing.

No Worms for The Wear

Most CD games based on cartridges are the same game with a little extra, like digital music. Earthworm Jim Special Edition goes much farther by not only putting in jammin' music – not that the cart versions' music needed improving – but also more gameplay and passwords.

If you already have EWJ on cart, you might want to check out the CD to determine if the additions are worth your time and money. The new features might just be enough bait for this new worm to hook you. **G**



PROTIP: In *Big Bruty*, lure the creature to the left and hoist yourself up on the rope. When he's clear, run past where he was, then lure him to the right. Stand on the right side of the teeter-totter, and when he walks on it, you'll sail up into new territory.

animation are great, but occasional minor audio flaws, such as a missing sound effect or raspiness, bring the Sound grade down a notch. Most players, however, won't notice the few audio blemishes.

Controlling Jim is smooth going. The control will be second nature if you've played before, and new Jimsters will pick it up in a snap. The whip

The Many Faces of Jim

Hidden codes will unmask these different looks for your favorite worm. Can you find them?



Groucho Jim



Goofy Ear Jim



Big Red Hair Jim



Nearsighted Jim



By Slo Mo

If you're a kung fu theater buff, here's your chance to be a star. Supreme Warrior is a fighting-game homage to Chinese martial arts movies, but you'll go nuts trying to reach the closing credits.

Fang Tu Very Much

In order to retrieve a magical mask from an evil mystic named Fang Tu, you must fight three warlords and their six bodyguards. Beating them



PRO TIP: A palm strike or punch will block an attack.

one-on-one earns you special fighting skills, which you need to beat the mighty Tu.

Warrior's live-action visuals are jumping with weird Asian magical effects, sets modeled after ancient China, and fighters flying through the air on wires. Grainy Sega CD video notwithstanding, it's a good show.

The sounds are great, thanks to the melodramatic



PRO TIP: A good block absorbs your opponent's Chi power into yours. A Super block fires his energy back at him.



Sega CD

SUPREME WARRIOR

dialogue. Bad guys dis you big time. For a real kung fu movie effect, you can even make actors speak Cantonese (yes, their English-speaking lips are out of synch with the audio).

Supreme fighting takes time to figure out. It's a little frustrating because you can jam buttons like a maniac, but you can only score a hit during certain moments of the live-action video.

Moreover, directional and button combinations must orchestrate five punches, five kicks, three blocks, three spe-



PRO TIP: The Earth Warlord is your strongest opponent. Don't begin your quest with him.



cial attacks, and nine special skills. Use a six-button controller – if you don't have one, good luck!

Play the Fu

Beat Supreme Warrior, and you'll acquire the supreme patience of a video kung fu master. This game's for fu fans who don't mind getting their butts kicked while they watch a cool show. **G**



By Tommy Glide

Want to spend time behind the controls of a tough rolling cannon? Look to RDF Global Conflict. This top-gun tank sim is no simple shooter.

Rapid Enjoyment

As a member of the Rapid Deployment Force (RDF), you step inside the M1-A2 battle



PRO TIP: Use your guided missiles against enemy helicopters.

tank for a tour of duty throughout Eastern Europe, the Middle East, and Alaska. As you command your tank, you must destroy enemy targets and fend off squirrely tanks and speedy helicopters.

Full-motion video from your commanding general outlines each mission. But beware of the General's acting – it's bad enough to make David Hasselhoff's performances look like Oscar winners.

The good graphics are polar opposites of the bad acting. The enemy vehicles, scaling, and backgrounds are all



PRO TIP: Drive fast in reverse to keep these charging vehicles in front of you for better shots.

executed well. Neatly rendered cinemas set up each location, though the full-motion video isn't as clean as it could be.

The sounds score. The music is excellent, and good effects, such as tread sounds, add to the authenticity.

He Who Blasts Last...

Controlling your tank gets complicated. Even the best dri-



PRO TIP: Travel the roads to conserve fuel. Destroy supply trucks and leave the power-ups where they're easy to find.

vers will have to work at maneuvering and quickly firing. Your weapons (including missiles and a smoke screen) are all accurate, but they require practice to perfect.

Devising the different battle strategies keeps RDF interesting, but the control complications make the game less accessible to civilians. As a true tank simulation, this game is tough, but it's also tread and turrets above the rest. **G**

| Supreme Warrior by Digital Pictures | | | | |
|-------------------------------------|---------------------|---------|-----------|-------------|
| Graphics | Sound | Control | FunFactor | Challenge |
| | | | | ADJ. |
| 3.5 | 5.0 | 3.5 | 4.0 | Adjustable |
| Price not available | 1 player | | | |
| CD | First-person view | | | |
| Available now | 2 CDs | | | |
| Fighting | ESRB rating: Mature | | | |



| RDF Global Conflict by Absolute | | | | |
|---------------------------------|-----------------------------|---------|-----------|-------------|
| Graphics | Sound | Control | FunFactor | Challenge |
| | | | | ADV. |
| 4.0 | 4.0 | 3.5 | 3.5 | Advanced |
| \$54.95 | Cockpit view | | | |
| CD | Multiscrolling | | | |
| Available now | 10 save slots | | | |
| Tank sim | ESRB rating: Kids to Adults | | | |
| 1 player | | | | |
| 15 levels | | | | |

Sega CD



By The Unknown Gamer

Lords of Thunder is a fairly close port of a popular Duo shooter. Because traditional shooting games are rare for the Sega CD, this game's a welcome addition to its library.

Lords of Wonder

Long ago, the Dark One was imprisoned in the center of



PROTIP: To defeat the Auzal boss, dodge his homing shots and repeatedly fire at his chest and neck.

the six lands of Mistral. All was well until the six bosses that guarded the prison were overcome by the Dark One's minions. As the warrior Landis, you shoot your way past the Dark One's guardians and then battle the Dark One himself.

This shooter's action is pretty traditional. Originally a Hudson Soft game, the side-



PROTIP: The bubbles are harmless, but when you're inside them, they block your shots.

view, multiscrolling shootin' is a familiar and welcome sight to purists.

You can choose to begin your journey in any of the six Lands of Mistral. Each region has unique enemies and ter-

LORDS OF THUNDER

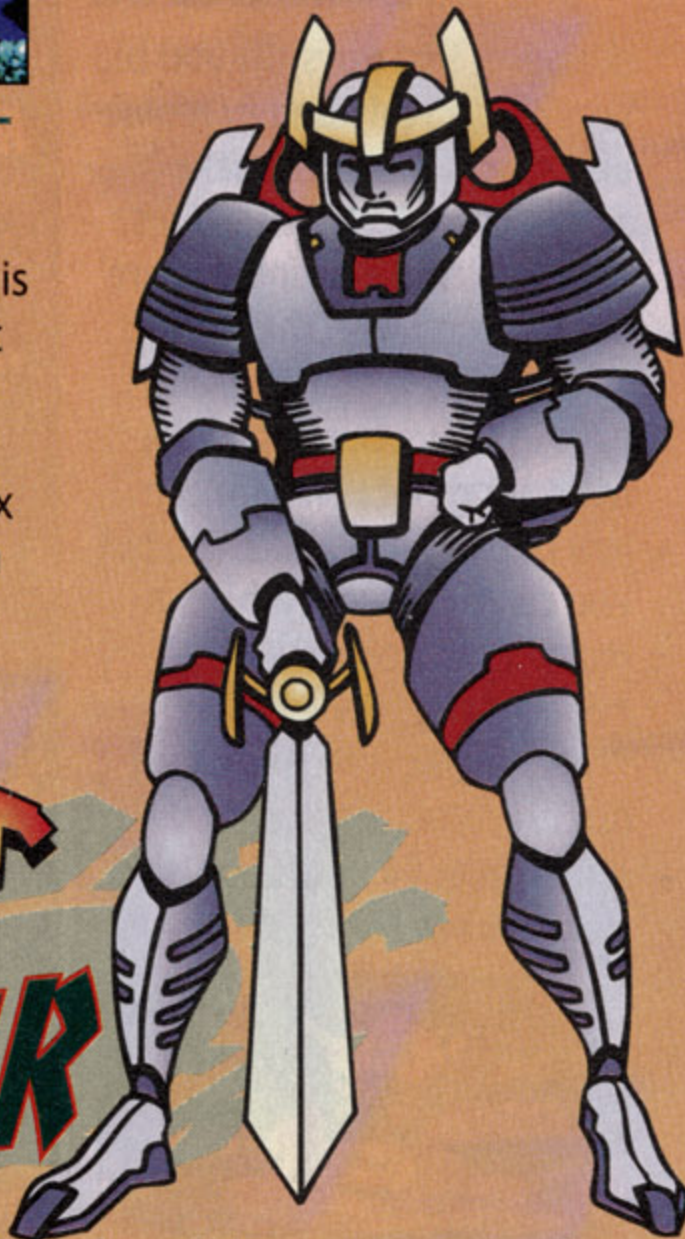

PROTIP: In Cieldom, the red snakes are hard to dodge. Use bombs to quickly destroy them.

rain, including deserts, volcanoes, and oceans.

You're armed with one of four elemental types of armor, each with different weaponry and bombs. Defeating enemies earns you crystals and power-ups.

The more power-ups you grab or buy with your crystals, the stronger your weapons. Figuring out which armor to use and which power-ups to



PROTIP: When there are lots of power-ups onscreen, focus on grabbing the red crystals and the power-up orbs.



PROTIP: The Cieldom boss dives unpredictably at you. Shoot him continually but be ready to dodge.

Although somewhat two-dimensional in comparison to newer shooters like Star Wars Arcade, Lords boasts large bosses, a horde of interesting enemies, and a traditional array of explosive effects.

The colors aren't quite as sharp and bright as the original Duo version, but the backgrounds are interesting and



PROTIP: The old Rapid Fire trick works well. Turn on Rapid Fire and concentrate on dodging.

buy adds strategy to an otherwise shoot-shoot-and-shoot-again game.

In Control

Controlling Landis is straightforward – one button for shooting and one for bombs. Precise maneuvering is key in shooters, and Landis hits the mark.

include a wide range of obstacles and scenery. A slew of pulse-pounding rock tunes hype the action.

Thunderous Applause

Lords of Thunder won't reign as the top shooter this year –

its traditional side-scrolling action may seem dated in comparison to some of the newer shooters. Its classic gameplay, though, is welcome thumb candy for Sega CD jet jockeys starved for traditional shoot-em-ups. **G**



PROTIP: The Descant boss is easy to destroy. Dodge up and down to avoid his shots and nail him repeatedly in the blue light on his chest.

Sega CD Game Profile Lords of Thunder (By Sega)



A strong version of the popular Duo shooter, Lords of Thunder provides some much-needed shootin' fun on the Sega CD.

| Graphics | Sound | Control | FunFactor | Challenge |
|----------|-------|---------|-----------|--------------|
| | | | | |
| 4.0 | 4.0 | 4.0 | 4.0 | Intermediate |

\$49.99
CD
Available now
Shooter

1 player
7 levels
Side view
Multiscrolling



By Greasy Gus

Like Tomcat Alley, Midnight Raiders is a full-motion-video air-combat game for the Sega CD. But be prepared – you're trading in the F-14 for a slower chopper.

Joker's Wild

In Midnight Raiders, you play as Joker, the point gunner in a chopper squadron. You must first destroy opposing tanks and helicopters to get behind enemy lines, then you enter a



Sega CD



PROTIP: When you have two targets onscreen, shoot at the enemy that appeared first.

genuine war-machine footage that enhances the feel of your mission. The sound shines with clear voices and roaring explosions.

Alley Allies Only

MR offers good cursor control, but it should've been compatible with a game gun. The difficulty varies; some targets are nearly impossible to hit, while



PROTIP: When you see this group of trees, an enemy is going to rise straight up and quickly fire. You can learn the enemy-movement patterns by studying the backgrounds.

others are sitting ducks. Being forced to align your cross hair on a tiny enemy chopper while your pilot nags you is enough to make you air sick.

The gameplay isn't as fast as Tomcat Alley's. It stalls with the cut-and-paste video sequencing of attacks, and the repetitive dialogue between team members quickly gets old. Unless you really loved Tomcat Alley, you may only want to go for a test run. **G**

MIDNIGHT RAIDERS



PROTIP: In the easy mode, you have plenty of ammo. Shoot rapidly to be sure that you hit the enemy. Always hit tanks dead center.

chemical-weapons plant on foot to rescue a scientist.

The full-motion-video gameplay is like Tomcat Alley's: Lock on to the enemy and launch your missile. When you later leave the cockpit, the gameplay remains the same – move the cursor and shoot.

The video of the landscape, weaponry, and explosions is all grade-A Hollywood. The game even incorporates some

| Midnight Raiders by Sega | | | | |
|--------------------------|-------------------|---------|-----------|--------------|
| Graphics | Sound | Control | FunFactor | Challenge |
| | | | | |
| 4.5 | 4.0 | 3.5 | 3.5 | Intermediate |
| \$59.99 | 1 player | | | |
| CD | Multiple views | | | |
| Available now | ESRB rating: Teen | | | |
| Shooter | | | | |



By Scary Larry

Translations of small-press comic books have not fared well this season (Cadillacs & Dinosaurs and Time Cop are two notable disappointments). Ultraverse Prime is another title that fails as a video game.

Prime Ribbed

Ultraverse Prime is one of the worst CD games you'll ever see. This one-dimensional action title comes "bundled" as part of a two-CD set. That's one CD too many, unfortu-



PROTIP: Combine kicks and punches to pound crowds.

The sound isn't any better than the graphics. Thumpin', bass-rich music doesn't rescue a poor lineup of sound effects, which includes girlish squeals when the hero dies.

Comic Relief

The only saving factor of this CD is its storage capacity; in it are 12 issues of Prime, page by page, in a neat comic-book

ULTRVERSE PRIME



PROTIP: The best way to get a handle on enemies is coming in at them from an angle.

nately, because Prime never comes close to what Microcosm achieves.

It's a simple, poorly illustrated Double Dragon clone, with Prime battling some of the most ridiculous-looking enemies since the new Republican Congress convened. Below-average controls translate into below-average action.

The sounds and graphics are a waste of CD technology. The backgrounds harken to an earlier period in video game history – back before there were 8-bit systems.

section. You can read any issue, check out the great art, or see two recorded interviews with the creators of Prime.

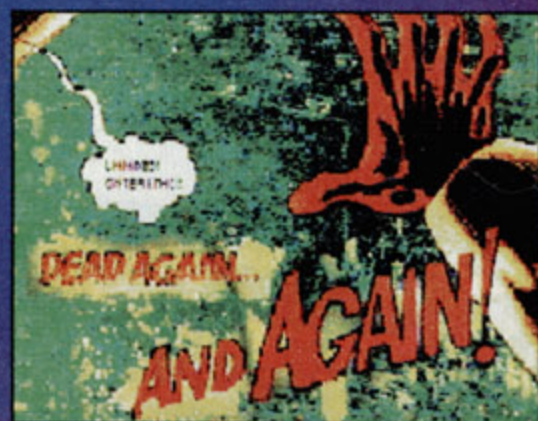

If you have the eyes for it, you can read back issues of Prime.

We can only hope that those people had nothing to do with the programming of the actual video game – this is one title past its Prime. **G**

| Ultraverse Prime by Sony Imagesoft | | | | |
|------------------------------------|-------------------|---------|-----------|------------|
| Graphics | Sound | Control | FunFactor | Challenge |
| | | | | |
| 1.5 | 2.0 | 2.0 | 2.0 | Adjustable |
| \$19.99 | 1 player | | | |
| CD | Side view | | | |
| Available now | Multiscrolling | | | |
| Action/adventure | ESRB rating: Teen | | | |



By Captain Squideo

Super Mario Kart goes Road Rashin' in this charming racer. It's not intense, but BC Racers is good-natured fun.

Blast to the Past

Joe 'n' Mac would recognize this cartoonlike racing. Competing on 32 prehistoric courses, your Neanderthal racers are paired up on stony motorcycles with sidecars.



PRO TIP: Look for shortcuts that help you get around the crowd.

Snagging power-ups as they go, the cave dudes bash their competitors. Without serious timers or gauges to complicate the races, and with word balloons punctuating punches, BC Racers emphasizes lightweight action.

The graphics could be straight from *The Flintstones*. Comical characters with goofy



PRO TIP: Match the BC Racers' strengths with your style of racing. Granite and Tina are the fastest team.

| BC Racers by Core Design | | | | |
|--------------------------|-----------------------------|---------|-----------|-----------|
| Graphics | Sound | Control | FunFactor | Challenge |
| | | | | |
| 3.5 | 3.5 | 3.0 | 3.5 | ADJ. |
| \$49.95 | 32 tracks | | | |
| CD | Multiple views | | | |
| Available now | Multiscrolling | | | |
| Driving | ESRB rating: Kids to Adults | | | |
| 2 players | | | | |



Sega CD

hair ramble past volcanoes and rock houses, making this ride a lark in

the Jurassic Park. Unfortunately, pixelated landscapes sometimes make it hard to spot the power-ups on the track.

The sounds aren't as colorful as they should've been. Peppy music drives the action, but the minimal voices and sound effects don't really convey the exuberant spirit of the graphics.

Yabba Dabba Doo

The only complications are with the controls. Get a six-



PRO TIP: Simultaneously press Buttons A, B, and C at the start of the race to thrash your way to the head of the pack.

button pad, or you'll fumble with the three-button setup as you try to simultaneously accelerate, steer, punch, and hit Nitro. One good control feature is the ability to switch your view from behind the racer to an aerial shot.

While it probably isn't for sophisticated gamers, BC Racers still has plenty of youth appeal. Until they're ready for Road Rash, novices can get good mileage from these cave clowns. **G**



By Tommy Glide

The answer is: Jeopardy! So the question must be: Where is knowledge exploited to win quick cash? In the fine Sega CD version of this popular game show, you crunch your cranium attempting to answer host Alex Trebek's questions – but don't expect any real greenbacks if you win.

Trek Trek

Wager your wits by answering trivia questions in the Jeopardy, Double Jeopardy, and Final Jeopardy rounds of play. Just like in the show, there are Daily Doubles hidden under the monitors in one of the six categories of questions.



PRO TIP: The CPU opponents are tough, so make things easier with a dummy human opponent.

Jeopardy CD's graphics blow away the cart versions, with full-motion video of the real

| SCIENCE | POP CULTURE | SPORTS | ARTS & ENTERTAINMENT | GENERAL KNOWLEDGE | JEOPARDY! |
|---------|-------------|--------|----------------------|-------------------|-----------|
| \$200 | \$200 | \$200 | \$200 | \$200 | \$200 |
| \$400 | \$400 | \$400 | \$400 | \$400 | \$400 |
| \$600 | \$600 | \$600 | \$600 | \$600 | \$600 |
| \$800 | \$800 | \$800 | \$800 | \$800 | \$800 |
| \$1000 | \$1000 | \$1000 | \$1000 | \$1000 | \$1000 |

PRO TIP: If you're not knowledgeable about a category, start with the easiest questions (these are worth the lowest dollar amounts).



PRO TIP: If you feel you know the category well, buzz in as soon as the question appears. The entry timer gives you a minute, so you have time to read the question.

TV studio and footage of Alex Trebek. But the overacting contestants and Alex's scripted appearances remind you that you're not experiencing the show.

With the show's music, background sounds, and Alex's clear voice, the sound



rates high. Unfortunately, Alex doesn't read the questions or announce each category as he does on the show.

Controls for \$200

The controls can get tiresome. You must spell out your answers using a cursor, which slows the gameplay. Also, unless you own a multiplayer adapter and have an extra controller, two players must share a controller in a three-player game.

With categories like French Literature and Archaeology, the questions are guaranteed to be as tough and as varied as the show's. Brainy whiz kids looking for the true Jeopardy challenge will enjoy this one. **G**

| Jeopardy! by Sony Imagesoft | | | | |
|-----------------------------|-----------------------------|---------|-----------|-----------|
| Graphics | Sound | Control | FunFactor | Challenge |
| | | | | |
| 4.0 | 4.0 | 3.0 | 3.5 | ADV. |
| \$59.95 | Multiple views | | | |
| CD | 3 save slots | | | |
| Available now | ESRB rating: Kids to Adults | | | |
| TV game show | | | | |
| 3 players | | | | |

Answer these questions correctly and you're one step closer to winning a Super prize

Here's the deal.

Courtesy of the GamePro Editor.

In the March, April and May issues of GamePro, you'll find questions about Super Game Boy. Ten questions total.

Answer all the questions correctly and you could win one of the Super prizes shown here. Nothing to it, right? After all, you've got a copy of last month's GamePro. You know, the one that includes the monster Super Game Boy ad with all the answers. WHAT? YOU GAVE IT TO A FRIEND AFTER CUTTING OUT THE FIRST QUIZ. You're through. Finished!! Just throw the second quiz away!!! (Don't worry! When the editor wasn't looking, the rest of us planted a few facts about Super Game Boy in this ad. Use a magnifying glass to find them. Then, mark the questions correctly.) What's happening to our youth today? Oh, what a shame. Because if you did have the facts to answer the questions, I'd say:

1. Write in the correct answers.
2. Cut out a completed quiz form from each issue.
3. Staple them together and drop them in the mail to:

Super Game Boy Contest
c/o GamePro Magazine
P.O. Box 5828
San Mateo, CA 94402

Super Game Boy Fact:

If you really want to go crazy with your borders, hook up the Super NES® Mouse to port II on your Super NES. It will work like Mario Paint™.

Super Game Boy Fact:

SLIDE THE SUPER GAME BOY INTO YOUR SUPER NES AND THEN POP ANY GAME BOY GAMES INTO THE SUPER GAME BOY. YOU'LL GET INSTANT COLOR!

Form:

4. If you pause your Super Game Boy game and let it set long enough, the border image changes. T__F__
5. Super Game Boy can transform your favorite Game Boy games into full-screen, multi-colored masterpieces. T__F__
6. Hook up the Super NES Mouse to port II on you Super NES and it will work like _____ Paint™.

Super Game Boy® Fact:
Super Game Boy is a high-impact unit that transforms your favorite Game Boy games into full-screen, multi-colored masterpieces.



Super Game Boy Fact:

IF YOU PAUSE YOUR GAME AND LET IT SET LONG ENOUGH, THE BORDER IMAGE CHANGES AND/OR SETS ITSELF IN MOTION. IT'S LIKE A SUPER NES SCREEN SAVER.

1 Grand Prize winner of a 27" Stereo TV, Super NES® Control Set, Super Game Boy and the NEW game Donkey Kong Land.

4 First Place winners of a Super NES® Control Set, Super Game Boy and the NEW game Donkey Kong Land.



Here's what you can win.

30 Second Place winners of the NEW game Donkey Kong Land and Super Game Boy.

30 Third Place winners of a Super Game Boy.

30 Fourth Place winners of a 1 year subscription to GamePro.

Your entry must be postmarked by June 1, 1995.

Good Luck. And have a Super time.

Contest Rules and Regulations

Official Rules

No purchase necessary. One entry per person. All duplicate entries of violator will be voided. Infotainment World, Inc. and Nintendo assume no responsibility of late, misdirected, incomplete, or illegible entries. All mail in entries must be post-marked by June 1, 1995. Void where prohibited.

Awarding of Prizes

Winners will be determined on June 15, 1995 in a random drawing by GamePro magazine. Odds of winning depend upon the number of all eligible entries received. Winners will be

notified by phone. Winners entry and acceptance of prize constitutes permission to use their names, photographs, and likeness for purposes of advertising and promotion on behalf of GamePro and/or Nintendo without further compensation. Winner is responsible for any and all federal, state, and local taxes if necessary. A complete list of prize winners will appear in a future issue of GamePro magazine.

Eligibility

Employees of Infotainment World, Inc., Nintendo and all participating

vendors, their subsidiaries, affiliates, advertising agencies, and their immediate families are not eligible.

Liabilities

This promotion is operated by Infotainment World, Inc., and Nintendo which is solely responsible for its conduct, completion and awarding of prizes. All decisions of Infotainment World, Inc., and Nintendo on all matters relating to this promotion are final. Infotainment World, Inc., and Nintendo and participating sponsors assume no liabilities resulting from the use of this prize.

Prize Restrictions

Alternative prizes or cash will not be offered in lieu of prizes described above. Prize may not be substituted, transferred, or exchanged. All prizes will be awarded by August 31, 1995. Eligible to residents of the contiguous United States only.

©1995 Nintendo of America Inc. Super NES, Super Game Boy, Game Boy, Donkey Kong Land, Metroid II, Super Mario Land are trademarks of Nintendo of America Inc.

Nintendo®
GAMEPRO



By Captain Squideo

Battle Frenzy recycles the first-person action that sent gamers to their



Sega CD

BATTLE FRENZY

Doom. But this new thriller has enough excitement to stand on its own.

Doom Revolution

Battle Frenzy has much of what made Doom and Wolfenstein 3-D succeed: You stalk through corridors, gather weapons, unlock doors, and blast charging enemies.

Reach the end of a level, and you must return through the maze with the clock ticking down. The formula isn't new, but it's still intense.

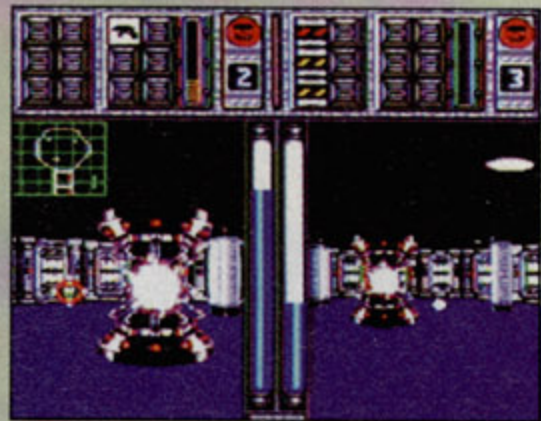

PROTIP: Aim slightly to the side of the main core, and defenders will turn right into your shots.

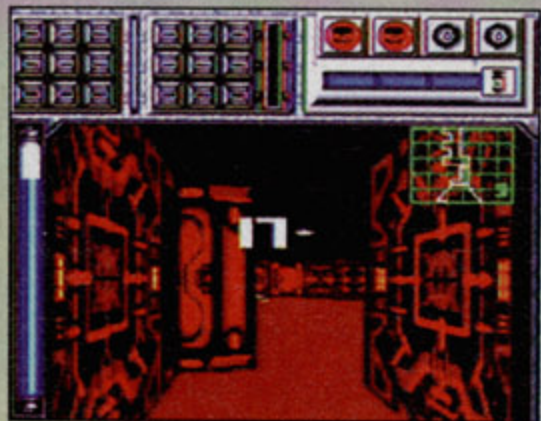

PROTIP: As you sprint out of a level, hit Button A to open doors before you reach them.

| Battle Frenzy by Domark | | | | |
|-------------------------|-------|-------------------|-----------|--------------|
| Graphics | Sound | Control | FunFactor | Challenge |
| | | | | INT. |
| 4.0 | 3.0 | 3.5 | 4.0 | Intermediate |
| \$59.95 | | 16 levels | | |
| CD | | First-person view | | |
| Available now | | Multiscrolling | | |
| Action/adventure | | ESRB rating: Teen | | |
| 2 players | | | | |

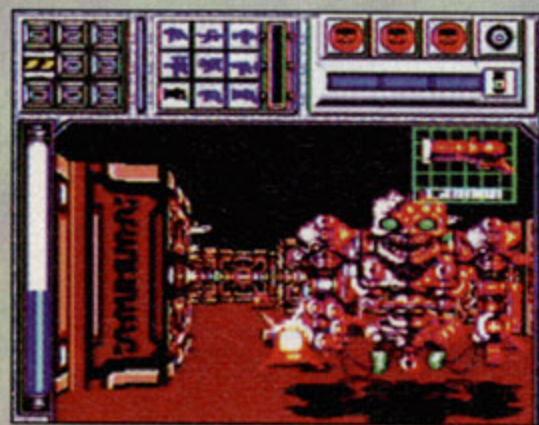

PROTIP: Use your Spray, Rapid Pulse, or Tribolt on quick enemies and save your powerful Cannon or Piercer for big robots.

Battle Frenzy adds excitement with a two-player cooperative mode that splits the screen as you explore with your partner (though extricating both players in time is tricky). Even better is the Vs. Battle, which pits you against a pal in three sealed arenas. Tag, you're dead!

Feeding Frenzy

The graphics and sounds will be familiar to anyone who's Doomed: moody corridors, big stiff characters, and pixelization when you hit walls. Unfortunately, the robotic enemies aren't as visually interesting as Doom's monsters. The sinister music builds atmosphere, but roars or voices would've generated real thrills.

The controls rank only above average. Once you find new weapons, you can't return to your basic gun. And there's no running in these halls – a frustrating restraint when you're racing the clock.

Despite these limitations, Battle Frenzy is still a thrill-a-minute game. Sega CD owners finally have a Doom disc, and it's dynamite. **G**



By Captain Squideo

Unlike many Sega CD games with 16-bit brethren, Lawnmower Man CD is entirely different from its cartridge predecessors. Utilizing the CD's sound and graphics potential, this game initially seems appealing, but it lacks the fun of the carts.

Yawnmower Man

If you saw the movie, you'll recognize this game's characters; if you played the 16-bit games, however, you won't recognize the slow strategy. You play as Dr. Angelo, a scientist pulled into a virtual-reality universe by the maniacal Cyberjobe.

To escape, you must pull some serious skull sessions to solve timed puzzles. Unlike

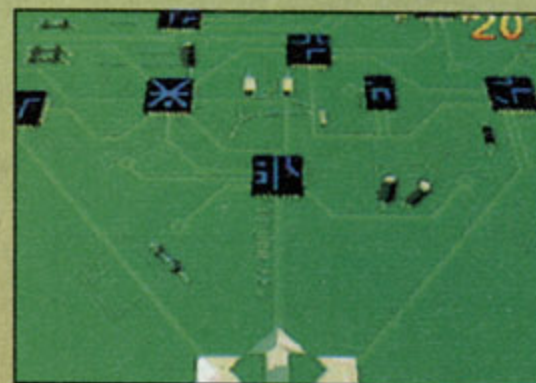

PROTIP: Read the highlighted squares like a map to follow Path to Freedom's safe circuit.

quences are interesting.

The sounds – highlighted by Steve Hillage's pulsing soundtrack – create the appropriate mood. Echoing voices and futuristic sound effects put you into a sci-fi frame of mind.

VR: Very Redundant

The controls almost do the job. The lone Fire button is used differently on each level, giving you lots to do. Unfortunately, slight delays between your button press and onscreen movement make everything tougher as the clock ticks down.

Strategy fans might like the



the SNES and Genesis carts, there are no action/adventure levels. To its detriment, Lawnmower Man strains your brain, not your thumbs.

This game looks good – from across the room. Movie footage is interspersed with the various VR gameplay settings, but everything gets pixelated up close or when there's a lot of onscreen movement. Thankfully, the morphing se-



PROTIP: In this puzzle, highlight "6," the square, "Y," and "2."

challenge, but action lovers won't. They'll wish this Lawnmower Man had used more brawn and less brain. **G**



PROTIP: When flying, hit the directionals as soon as you see the onscreen arrows.

| The Lawnmower Man By Time Warner Interactive | | | | |
|---|-------|------------------------|-----------|-------------|
| Graphics | Sound | Control | FunFactor | Challenge |
| | | | | ADJ. |
| 4.0 | 4.0 | 3.0 | 3.0 | Adjustable |
| \$49.95 | | 12 levels | | |
| CD | | Multiple views | | |
| Available now | | Multiscrolling | | |
| Strategy | | ESRB rating: Not rated | | |
| 1 player | | | | |

NOTHING, NOTHING CAN PREPARE YOUR 32X.



UNLEASH JOHNNY CAGE'S™
SHADOW KICK!



SHANG TSUNG'S NEW PLAN IS TO LURE HIS ENEMIES
TO COMPLETE IN THE OUTWORLD WHERE THEY WILL
MEET CERTAIN DEATH BY SHANG HONOR HIMSELF.

ALL THE ACTION OF THE
ARCADE SMASH!



FRIENDSHIP?



FLAMING SKULLS SCREAM
PAST YOU IN STEREO!

MORTAL KOMBAT® II

Rip into the *real* arcade action that 32 megs of high-speed, 32 bit processing can deliver! Trade-up to faster game play, realistic character animation, state-of-the-art graphics and the bone-crunching music and sound f/x of the arcade smash—from "Finish Him" to "Flawless Victory." You might have played it before but... Nothing, NOTHING can prepare you for MKII on 32X!



MIDWAY

NOW ON

GENESIS™
32X

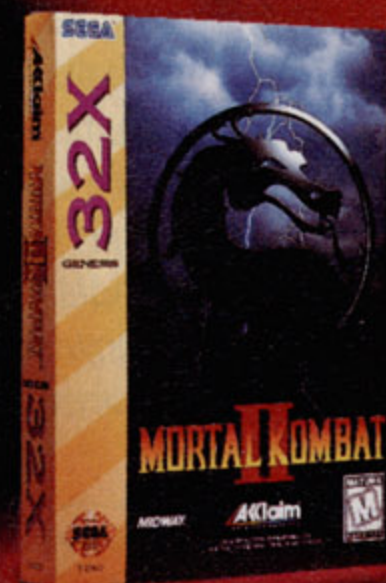

Acclaim®
entertainment inc.



By Scary Larry

It's been a while since we've seen a Sega CD title that's so heavily influenced by Japanese games. Fast and funny, Keio is a refreshing reminder of why we love shooters.

You're in the Bunny

Keio offers lots of shootin' thrills - once you get past the Playboy bunny attire of the pilot, that is. You play as Rami, who is cute, sexy...and out to destroy the armies of Russia and the U.S. on the way to a showdown with the nefarious



Sega CD

anything that moves with an array of effective weapons and power-ups.



PROTIP: Dip into the water to get away from enemies.



PROTIP: At the beginning of the second stage, watch out for the flock of birds. Weave in and out of traffic.

Dr. Pon, an ethnocentric raccoon with an IQ of 1400.

The tried-and-true controls effect simple but fun gameplay. You ride on your pet dragon, Spot, bellowing flames, bombs, spiked armor balls, and more as you fight to the end.

You also face a deadly army of furry raccoons who blindly follow their leader. You bomb houses, take down obnoxious fat kids, and generally shoot at

KO for Keio

The graphics have a definite Japanese edge to them. The cinematics showcase some great anime sequences, and the sprites show strong definition. The backgrounds and



PROTIP: This cow-cart boss has lots of weak points, but knock out the middle gun turret first.

enemies are humorous and reminiscent of the classic Japanese shooter Parodius.

The impressive sound features rich music and funny effects when enemies are hit, making for a great sonic picnic. The cinematics also feature full dialogue.

Keio moves as smoothly as it sounds, so novice players and serious shooters alike will enjoy Keio. If you're tired of complicated flight sims and shooters, Keio may be the break you're looking for. **G**



By Scary Larry

Since Lethal Enforcers hit the home market last year, digitized shooters have sprung up faster than crime statistics. Crime Patrol has something else to offer beyond the standard shooting action: really bad acting!

America's Least Wanted

Crime Patrol puts you in four scenarios: Rookie, Sergeant, SWAT, and Delta (a unit like the Navy SEALs). As you blast away at bad guys, you progress through the rankings and see

Is It a Crime?

You'll hear a lot of background noise (like sirens and gunshots) and some voice. But how much you hear isn't as important as what you hear - Crime Patrol's graced with some of the corniest lines ever spoken in a game.

As usual with these shooters, the inaccurate control leaves a lot to be desired. But even with a gun (sold separ-



PROTIP: In the Gang Fight, immediately shoot above and to the left of the officer.

CRIME PATROL



PROTIP: You can shoot at the introductory screens to speed things up, but be careful. You may end up immediately facing an attacker.

the best that sleaze has to offer, like drug busts, machine-gunnin' mechanics, and strippers. The scenarios justify the game's ESRB rating.

Actually, you don't see much sleaze because of the poor-quality graphics. If American Laser Games were serious about this port-over of the awesome 3DO version, it should've made it for the 32X. The color bleed is so bad that you're temporarily blinded by explosions.

ately), the game is too basic, following the standard pattern of "shoot the criminals, avoid the innocent bystanders." With



PROTIP: When you round the corner in the airport, the first person (the chauffeur) is a bad guy, but the next person is your contact, an undercover cop.

nothing added to pad the mediocrity of yet another shooting title, it's a crime that this one made it through the line. **G**

Keio Flying Squadron by JVC

| Graphics | Sound | Control | FunFactor | Challenge |
|----------|-------|---------|-----------|-------------|
| | | | | ADJ. |
| 4.0 | 4.0 | 4.0 | 4.0 | Adjustable |

\$49.99
CD
Available now
Shooter
1 player

7 levels
Side view
Multiscrolling
ESRB rating: Kids to Adults

Crime Patrol by American Laser Games

| Graphics | Sound | Control | FunFactor | Challenge |
|----------|-------|---------|-----------|-------------|
| | | | | ADJ. |
| 3.0 | 3.0 | 2.5 | 3.0 | Adjustable |

\$54.99
CD
Available now
Shooter
2 players

First-person view
Compatible with Game Gun and Menacer
ESRB rating: Mature

Operators Are Standing By.

This is only for those who want to tap into the very latest in video gaming—everyone else turn the page. Here's the deal: you call and Digital Pictures sends you a 20 minute Behind the Scenes video tape absolutely free. Got it? It'll show you how we use Hollywood techniques, directors and stars to make interactive movies that put you in the game. We're talking about hits like Slam City with Scottie Pippen, Supreme Warrior and Corpse Killer. No cartoons but real live 100% full-motion video games, wall-to-wall, with no lags or delays. So call and get a glimpse of what the future of gaming's going to be. And if you're the kind who thinks you need mommy's permission, then don't bother. Just go ask

her for a lollipop...maybe she'll let you stay up late tonight.

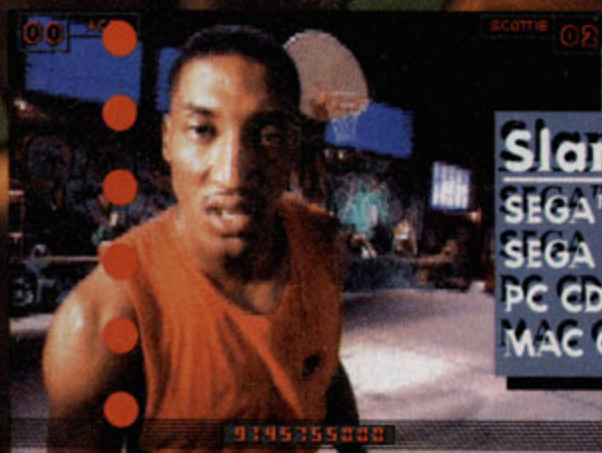

Slam City
SEGA™ CD
SEGA CD 32X™
PC CD ROM
MAC CD ROM*



Supreme Warrior
SEGA™ CD
SEGA CD 32X™
PC CD ROM*
MAC CD ROM*
3DO™



Corpse Killer
SEGA™ CD
SEGA CD 32X™
PC CD ROM*
MAC CD ROM
3DO™

*COMING SOON

Yeah, these are what the games look like. But these pictures don't tell you squat. That's why we're trying to give you the tape, Einstein.

Digital Pictures



1
4
5
4
2
9
2
8
0
0
0
4



By **Andromeda**

Space Harrier is old news to most players, but this 32X version is one of the best home versions of the game to date.

Don't Get Harried

As the last of the Sentinels of Dragonland, Harri must shoot his way through more than 15 stages of arcade-style action. Space Harrier was one of the first shooters to use a first-person perspective, and the familiar view's back in this version.

No surprises in the game-play - just dodge obstacles

Space Harrier

and shoot everything before it shoots or hits you. As in the original, each hit you take counts as a "Try." Depending on the difficulty setting, you get different numbers of lives and Tries.

Harrier's controls are straightforward and simple: one button to shoot and the control pad to maneuver. In comparison with 16-bit ver-

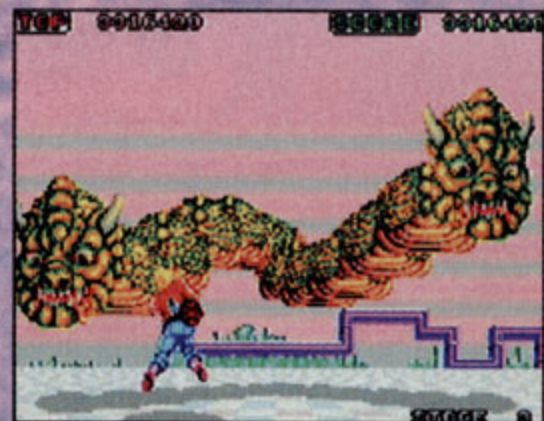

PROTIP: Use the stone to defeat many of the bosses. Shoot this two-headed dragon in both heads until it explodes.

| Space Harrier by Sega | | | | |
|-----------------------|-----------------------------|---------|-----------|-------------|
| Graphics | Sound | Control | FunFactor | Challenge |
| | | | | ADJ. |
| 4.0 | 3.5 | 4.0 | 4.0 | Adjustable |
| 49.99 | 15+ stages | | | |
| 24 megs | First-person view | | | |
| Available now | ESRB rating: Kids to Adults | | | |
| Shooter | | | | |
| 1 player | | | | |

PROVIEW

32X



PROTIP: To battle the dragon at the end of Stage 1, shoot him in the head while you dodge the fire he spits. After he turns red, it takes just one more hit to destroy him.



PROTIP: Keep moving constantly so you're harder to hit.

sions of the game, there's no slowdown or sprite flicker, and the action is quick and precise.

Space Ace

Space Harrier's graphics and sounds are both solid. The graphics are closer to the original arcade game than prior versions. Bright, fluorescent colors and crisp sprites create vivid action. The tunes are unremarkable, but they're a good backdrop for the action.

Space Harrier's an old game, but this latest version is close enough to the arcade classic to make it a nice trip down memory lane for players who love the game. If you've never seen the game before, by all means take this Harrier for a test flight. **G**



By **Bruised Lee**

Last year Acclaim released the CD version of Mortal Kombat. Players were expecting it to be a carbon copy of the arcade, but most fans felt it failed miserably. Once again, history repeats itself with the disappointing MK II for the 32X.

Be Prepared

MK's fighting format and look are familiar to everyone by now. This game is virtually identical to previous versions of MK II, with a few slight graphical improvements.

You'll notice the fighters and backgrounds have more colors, but key details and animations from the coin-op game are still missing. Considering that the 32X system should be able to do so much more than is shown here, one can only think that MK II 32X was a rush job.

Some good news: There are more sounds and voices in the game than you heard on



PROTIP: Perform your favorite combos in the corners.



All the arcade intro scenes were added to the 32X version.



PROTIP: Use the low sweep to avoid projectiles.

the Genesis, but many are still missing compared to the original. Unfortunately, the voices on the 32X are just as muffled and scratchy as they were in the 16-bit version.

The control is also like the control on the Genesis - imperfect. For instance, some of the two-in-one combos don't come off as easily as they do in



MORTAL KOMBAT II

the arcades. At least all the moves and combos are here.

32 Why?

The 32X version of MK II has souped-up colors and more voices. That's about the extent of the improvements you'll find here. If you own the 16-bit version, you don't need this one unless you're a glutton for punishment. **G**

| Mortal Kombat II by Acclaim | | | | |
|-----------------------------|---------------------------|---------|-----------|-------------|
| Graphics | Sound | Control | FunFactor | Challenge |
| | | | | ADJ. |
| 3.5 | 2.5 | 3.0 | 2.5 | Adjustable |
| \$69.99 | Side view | | | |
| Available now | Multiscrolling | | | |
| Fighting | Not yet rated by the ESRB | | | |
| 2 players | Sega rating: MA-13 | | | |
| 14 levels | | | | |

HEY CHARLES, NO ONE'S DOPPER THAN ME. I'M SWATTIN' DOTS. I'M DROPPIN' HOOKS. I'M SWEEPIN' BOARDS. I'M THREADING THE NEEDLE FROM EVERYWHERE. CHARLES: "GETTIN' TIRED OF MAKING YOU LOOK SO BAD. I'LL TURN YOU INTO A PEST. FASTER THAN YOU CAN SAY 'HEY WHERE YOU GOIN'?" MARK: "EY YOU FOR BREAKFAST. WINNER YOU BUCKETHEAD. YOU COULD BE A BACKSTRAP IN A SUITCASE. I'LL FREEZE YOUR DEFENSE. COME ON, GIVE UP THAT ROCK. OR DO I HAVE TO PICK YOUR POCKET AND REVERSE SLAM THAT BALL ON YOU? YOU CALL THAT DEFENSE? A 92-YEAR-OLD WITH A PLASTIC HIP AND FAKE TEETH CAN'T STOP ME. GET IN THAT. YOU WISH YOU WERE ME. NOT IF YOU WERE CHUCK, YOU THROW ENOUGH ELBOWS TO BUILD A FIVE-STORY MANSION WITH A DETACHED TV ROOM. YOU'RE ALRIGHT. SO WHAT IF YOU GOT THE PIKE? WHERE YA GOIN'?" CHARLES: "I'LL SHOOT YOU WITHIN' THE PAINT AND THE BACK PASS. 'GAS. YOU GOT TO GO."

"JUST SHUT UP AND JAM"



Shut Up and Jam 2 is all the trash talkin', elbow-throwin' streetball you could ever want. The animations are dope and the combination moves are deadly. You've got twenty-five ways to slam. Behind-the-back passes. Double-clutches. Alley-oops. 10 players to pick from and zero refs. And it's the only video game in the world with Sir Charles himself. Enough talk. Get Shut Up and Jam 2. Then take some chump off the dribble and drive it to the hole.

Charles Barkley's name and likeness are used under license by, and Barkley Shut Up and Jam 2 and Sport Accolade are trademarks of, Accolade, Inc. Licensed by Sega Enterprises Ltd. for play on the Sega Genesis System. Sega and Genesis are trademarks of Sega Enterprises Ltd.

SPORT ACCOLADE

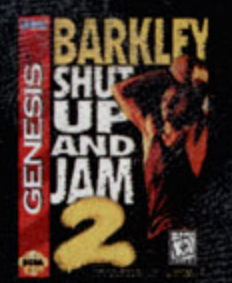



By Manny LaMancha

Metal Head represents Sega's effort to enter the BattleMech genre of robotic combat. It offers some nice variety, but it ultimately falls victim to horrible sound and erratic graphics.

Well-Fed Robots

Years in the future, the Federation has constructed Metal Head robots to keep an unruly public in line. Anti-Federation terrorists have unleashed their own series of mechs, so Metal Head troopers are sent to

regain control of the capitol.

Your mech's controls are intricate, but practice brings it under your command. A six-button controller makes fast work of such moves as commanding your robot to run.

AV Meltdown

The 3D graphics aren't bad – the changeable views are especially nice – but it's hard to precisely target mechs because of

METAL HEAD



PRO TIP: Using the overhead view and radar together gives you a nice lock on the enemy.



PRO TIP: Press Button A to side-step around corners. This move enables you to alternately shoot and quickly take cover.

| Metal Head by Sega | | | | |
|--------------------|----------------|-----------------|----------------------------|-------------|
| Graphics | Sound | Control | FunFactor | Challenge |
| | | | | ADJ. |
| 3.0 | 2.0 | 4.0 | 3.0 | Adjustable |
| \$69.99 | 24 megs | Available March | Robot shooter | 1 player |
| 20+ missions | Multiple views | Multiscrolling | ESRB rating: Kids to Adult | |

inconsistent onscreen movements. The talking-head clips are laughable.

The similarly weak sound is hardly proof of so-called advanced hardware. The music



PRO TIP: Take every opportunity to increase your armaments.

is repetitive, and the remaining audio is filled with pops and an annoying raspy quality.

If Metal Head has a plus, it's the variety of the missions, which range from battling mechs in the street to blasting a power generator and escaping in limited time. Even these actions, however, eventually become redundant.

In the end, Metal Head looks like a promising programming experiment not taken to fruition. It's a clunker. **G**

PROREVIEW

32X

32X CD



By Bruised Lee

Look out, Congress, the evil Night Trap is back to haunt us again. This rerun presents the same old Sega CD game with enhanced colors and a larger viewing screen.

It's Back

The stream of games for the new 32X system has consisted mainly of rehashed versions of old games, such as the tedious MK II CD. Night Trap joins this less-than-stellar list.

As in the Sega CD original from two years ago, your mission is to protect five teenagers from vampires by setting traps in the Lakeshore Winery house.

The only improvements lie in the graphics: You get a better-looking game, a wider use of colors, and a much larger



Night Trap undergoes a face lift with more colors and a cleaner look. And, as the box states, these are real actors, not computer-generated cartoons.

game screen. But that's it – no extra scenes color the action, and all the trap patterns for catching the vampires remain the same.

If you fear change, you're sure to love the 32X version's sounds and controls; they're carbon copies of those in the original. You'll hear the same voices and sounds without any improvements.

NIGHT TRAP



PRO TIP: Break out your old time and room log because the layouts haven't changed.



PRO TIP: Wait for the trap meter to go into the red before hitting the trap button.

The control is also identical, giving you the limited game interaction that requires you to perform basic point-and-click maneuvers.

Don't Be Trapped

If you already own the Sega CD original, there's no reason to play this version. Night Trap for the 32X seems more like a marketing ploy than a game designed to show off a superior new system. Don't fall into this Trap. **G**

| Night Trap by Digital Pictures | | | | |
|--------------------------------|-------|---------------|------------------|---------------------|
| Graphics | Sound | Control | FunFactor | Challenge |
| | | | | INT. |
| 3.5 | 3.0 | 2.5 | 2.5 | Intermediate |
| Price not available | CD | Available now | Action/adventure | 1 player |
| | | | | Side view |
| | | | | ESRB rating: Mature |

Brandish™

While Some Fantasy Games Just Scratch the Surface, Brandish Unlocks the Underworld!

NOW that you've mastered games like *Breath of Fire™* and *Brain Lord™*, we think you're ready for a role-playing game where the sun doesn't shine and the monsters grow big, really big!

In *Brandish*, you stand accused of murder, being pursued by a fearless bounty hunter looking to collect the reward. About to be captured, you fall into a deep underworld maze filled with dangerous traps and deadly monsters including: giant crabs, headless fist-pounding warriors and fire-spitting gargoyles. With the bounty hunter still hot on your trail, you must navigate your way out of the mazes and back to the surface ASAP. Our only advice: stay alert, well armed and always moving upwards!



Headless warriors are out to ruin your day



Narrow corridors & rolling boulders are a deadly combo



Some underworld characters give helpful advice for a price



NAVIGATE YOUR WAY THROUGH FIVE TREACHEROUS LEVELS AS YOU FIGHT TO RETURN TO THE SURFACE

DEFEND YOURSELF AGAINST 55 DIFFERENT MONSTERS FROM THE UNDERWORLD

KEEP A LOOKOUT FOR TRAPS THAT WILL SEND YOU BACK LEVELS OR TIME WARP YOU TO A NEW LOCATION

SEEK OUT MORE THAN 50 DIFFERENT ITEMS THAT WILL HELP YOU IN YOUR QUEST

VISIT THE MAGIC, WEAPONS & ITEM SHOPS FOR USEFUL MERCHANDISE & ADVICE

SAVE UP TO TWO GAMES AT ANY ONE TIME!

KOEI

KOEI Corporation, 1350 Bayshore Highway, Suite 540
Burlingame, CA 94010

Official Nintendo Seal of Quality
SUPER NINTENDO ENTERTAINMENT SYSTEM

Brandish is a trademark of KOEI Corporation. Nintendo, Nintendo Entertainment System, and the official seals are trademarks of Nintendo of America. Breath of Fire is a trademark of CAPCOM Co. Ltd. Brain Lord is a trademark of ENIX America Corporation.

PC
Compatible

KIDS TO ADULTS
K-A
AGES 6+



By Scary Larry

Although this game isn't going to set any players on fire with its basic gameplay and mediocre graphics, True Lies is kind of fun. Play it for ten minutes, and you'll be hooked. Play it for an hour, unfortunately, and you'll finish this easy adventure.

True Grit

In this movie-based game, you play as Harry Tasker, a quiet, unassuming computer salesman who lives a double life as a spy. Thankfully, you don't have to play as the computer salesman. You fight through ten overhead-view levels,



PROTIP: Check in out-of-the-way places for power-ups.

some as exotic as the Forbidden City of China and some as mundane as a shopping-mall bathroom.

Armed with a semiautomatic 9-mm pistol, Harry finds a cache of other weapons to

True Lies

supplement his adventures. Uzis, grenades, flamethrowers, and antipersonnel mines round out the arsenal. Health and extra-life icons are also scattered around the levels.

You'll need all this help because the controls can be tricky at times. In many situations, you have to shoot

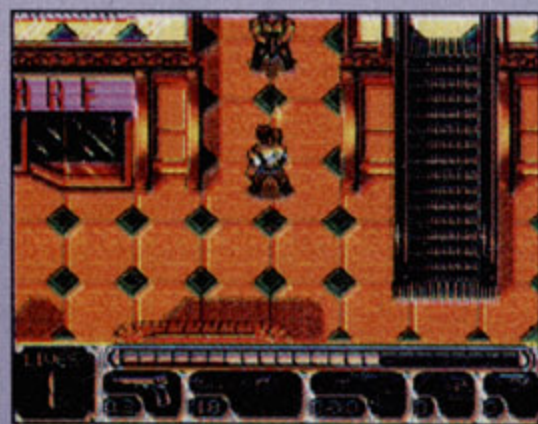

PROTIP: Fire ahead of yourself when walking into a blind alley. There's usually an enemy ahead.

around corners or at unseen enemies. You find yourself spraying gunfire wildly across an area just to register a couple of hits on an enemy.

Little Lies

The graphics are tame by today's standards. A mix of Zombies Ate My Neighbors

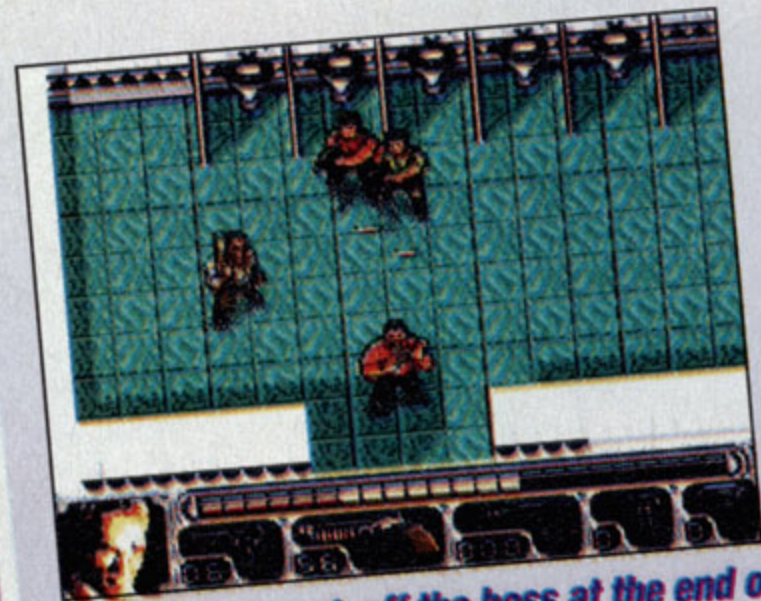

PROTIP: To knock off the boss at the end of the mall level, first shoot out the stall doors on each toilet, which stops the flood of his cronies. Then go after the boss, hitting him from the side while avoiding his bullets.

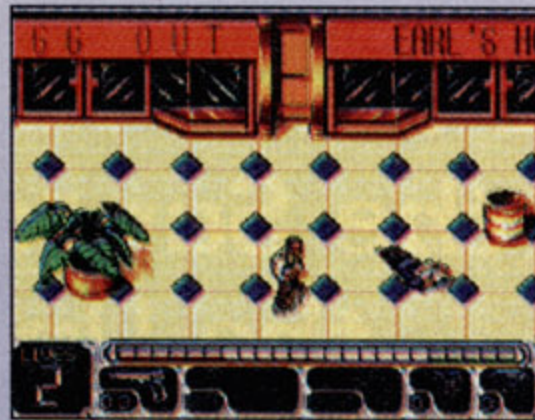

PROTIP: Your pistol has unlimited bullets, but you must reload every 15 shots. If you're down to one or two shots, fire until you reload.

and Soldiers of Fortune, the game does sport bloody take-downs of its small sprites. Gunning for the bad guys is made extra difficult by their close resemblance to the bystanders.

The sounds are also basic. Stripped-down, monotonous music replays through each level. The death groans of enemies are weak and subdued, and there are no voiceovers or speech samples (unlike another game based on an Arnold Schwarzenegger movie, T2: Judgment Day, which had Arnie saying "terminated").

True Blues

Because the action gets frantic but never unbearable, the game works for both novice and intermediate gamers. Maybe this game is so appealing because there aren't many good overhead-view action/



PROTIP: If you don't shoot in the first level, you can walk through without getting hit!

adventures of this type any more. If you couldn't bear for Zombies or Soldiers to end, True Lies picks up the slack. **G**

WEAPONS 'R' US

Uzi



PROTIP: The Uzi shoots in a straight line, but you can spray from left to right. It's most useful in the park, where there are few bystanders.

Grenades



PROTIP: Be careful using grenades. They tend to bounce back, and they do massive damage.

Shotgun



PROTIP: The shotgun has a large, effective range. Stand behind barriers and shoot.

Super NES Game Profile

True Lies

(By Acclaim)



True Lies is a throw-back to an older type of adventure game: It's *Zombies Ate My Neighbors* with real guns. True Lies plays better than it looks.

| Graphics | Sound | Control | FunFactor | Challenge |
|----------|-------|---------|-----------|------------|
| | | | | |
| 3.5 | 3.0 | 3.5 | 4.0 | Adjustable |

Price not available
16 megs
Action/adventure
1 player

10 levels
Overhead view
ESRB rating: Teen



By Bro' Buzz

Warlock is loosely based on a schlocky horror movie about a time-traveling evil wizard from the past. This cart is also a throwback to the good old days of side-view action/adventure carts. The blast-to-the-last action follows the best traditions of platform gaming, but it could have used a little more magic.

On the Warpath

You play a druid hero who must find six sacred stones before the evil Warlock uses them to put reality's lights

PROTIP: To outrace the rising magic fire at the end of the Castle area, don't fight slime creatures. Always grab the 1-up at the beginning of the stairs.



PROTIP: During the third part of the quest for the fifth Stone, load up on Tremor spells. When you find a Tremor Staff in the water, grab it with the Orb. When you jump up, the staff reappears.



out. As "The Hero," you cast powerful, semi-rapid-fire magical blasts and command an all-purpose Orb, which continuously hovers around you.

You can shoot the Orb like a boomerang in four directions to grab items or sting your foes. This weapon is the highlight of an otherwise mundane control show.

Unfortunately, slightly imprecise directionals put a tad too much adventure into two critical Warlock-whopping skills, the duck-and-roll and the run-and-jump. You often fall into bottomless gaps or inadvertently roll into enemies



PROTIP: During the quest for the fifth Stone, save the Strong Smart Bomb you find in the Graveyard. Later in the mausoleum, you must use it on a tough slime creature.



PROTIP: The Orb sails through some obstructions to hit targets or grab items.



PROTIP: Practice the duck-and-roll move (press Down and hit Button B). It helps you past some traps, such as the furnaces in the Wizard's Castle.

because Down and the Jump button occasionally don't fire on cue.

B Movie

Warlock's challenge won't burn your thumbs as much as fry your brain cells. Until you reach the final level, Warlock warriors, such as skeletons and demons, attack in easily analyzed patterns and readily succumb to multiple magical blasts. Most boss creatures took the day off, but the few that are on the job, especially the Warlock, are tough.

Maintaining the challenge curve is left up to devastating end- and mid-level obstacles, such as trying to race up danger-infested stairways ahead of a rapidly rising firestorm. Moreover, the quest for each stone gets successively longer and more difficult.

Warlock's visuals need some pizzazz. The backgrounds are dark, deep, and dangerous looking, but the character sprites

appear flat and indistinct.

The sounds are sinister, as organ-based music jams ominously. The audio effects are few but fierce.

Warlock Worries

Warlock won't set your system on fire, but despite the sometimes-frustrating controls, it's a good intermediate adventure with some truly challenging puzzles. However, Warlock is definitely no lock. **G**



A holdover from the movie: Julian Sands as the Warlock

Super NES Game Profile

Warlock
(By Acclaim)

KIDS TO ADULTS **Warlock won't cast a spell over you, but it will give you a good, intense workout.**

| Graphics | Sound | Control | FunFactor | Challenge |
|----------|-------|---------|-----------|-------------------|
| 3.5 | 4.0 | 3.0 | 4.0 | INT. Intermediate |

Price not available 1 player
 16 megs 10 levels
 Available March Multiscrolling
 Action/adventure Passwords



Introducing the Game Boy® Play It Loud™ Series. Five killer new colors and a cool,



What color is yours?

clear storage case with room for five of your favorite games.
(Hair dye not included).





By Sarah Nade

Pac is back again! Full of fun, fast-paced adventure, Pac-In-Time is the newest way to experience Pac-Man – this time with an action/adventure twist.

Pac Is Back

In Pac-In-Time our hero, Pac-Man, is not moving through mazes, as in the arcade classic. Nor is he a side-scrolling, mood-changing strategy Pac, à la Pac-Man 2.

This time, the Ghost Witch has taken poor Pac-Man from



PROTIP: When trying to reach a cliff, jump on nearby rocks or rises to gain height.

Ms. Pac-Man and the Pac kids, and transported him back in time to 1975, before anyone had even heard of him. Pac has some new moves, such as rope swinging, that give this game greater depth.

PAC-In-Time



PROTIP: Bang on the walls to open secret warp zones.

Some of the enemies are rather small, however, and can be hard to spot among the foliage.

Sound isn't the star of this cart. The background noises are exactly alike, and the music when Pac eats a super pellet is long and repetitive.

Pac Rules

Pac is easy to control, especially his basic running, jump-



PROTIP: Press the Turbo button to rope-swing across ceilings.



PROTIP: To kill the ghosts, eat a big pellet, just as in the original Pac-Man.

ing, and shooting motions. Mastering his new rope-swinging move might be hard at first, but it soon becomes second nature – and lots of fun. Jumping off obstacles to reach high cliffs can be frustrating as well, but it, too, gets easier with practice.

Pac is still king to many people, and there's no mistaking why: He's great, lightweight fun. With more than 50 levels, Pac-In-Time adds new dimensions to his legacy. All Pac lovers, and even those who don't like this cheerful hero, should gobble up this winner and take a trip through time! **G**

PAC'S POWERS!



Swingin'



Swimmin'



Shootin'



Hittin'

Back in Time

As Pac journeys to the present, he retains some of his most famous moves. Like the Pac of old, he eats pellets – in fact, to pass a level, he must eat a specific number of pellets.

Pac also knocks out enemies with a new hammer and fireballs, and he can find a super pellet and chomp up ghosts. By adding fresh moves to the old ones, Namco breathed new life into a classic character.

The above-average graphics sport nicely detailed landscapes, bright colors, and large, easy-to-follow sprites that move with smooth, intricate animation.



PROTIP: Hammer weak points on the bridges to reveal the secret areas.

Super NES Game Profile

Pac-In-Time

(By Namco)

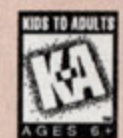

So ya love Pac-Man? Then you'll gobble up the 'Man's latest 50-level exploits against the Ghost Witch.

| Graphics | Sound | Control | FunFactor | Challenge |
|----------|-------|---------|-----------|-------------|
| | | | | ADJ. |
| 4.0 | 3.0 | 4.0 | 4.5 | Adjustable |

\$59.95
8 megs
Available now
Action/adventure
2 players

50 levels
Front view
Multiscrolling
Passwords



By Captain Squideo

If games were sugar, Micro Machines would put cavities in every tooth in your head. This game is lightweight fun for young racers, but it's too insubstantial for veteran drivers.

Just Win, Baby

A hit several years ago in Europe, Micro Machines finally brings its charming concept to



Super NES



PROTIP: You can bump opponents without taking damage.



the SNES. You race nine mini-vehicles on oversized tracks taken from daily life (a pool table, a cluttered desk, a sudsy bathtub, and so on). The fun is in identifying the big obstacles in your path and navigating your helicopter, speedboat, or Formula One car around them.

Simple controls keep the action basic. There are no driver profiles or car-customizing options, and differences between the vehicles are few. Only the tank fires weapons,

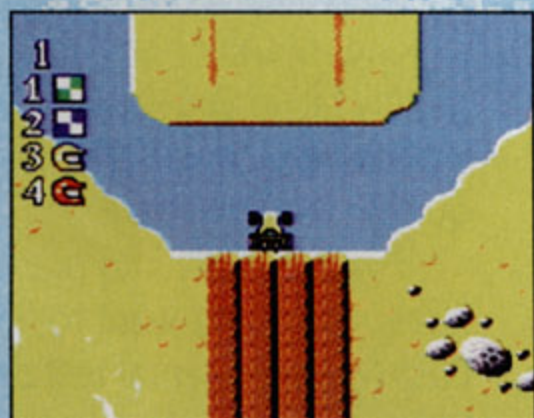

PROTIP: If you wipe out near a ramp, give yourself enough room to build up speed as you approach the ramp again.



PROTIP: You can go slightly outside the course to take shortcuts without being penalized.

and you can sometimes win races without even braking.

Shrinking Cars

Cartoony graphics and backgrounds as bright and colorful as anything on Saturday-morning TV give the game youth appeal. The Micro in the title is accurate: The vehicles are indeed small. The lack of an onscreen map, gauges, and wreck animations will frustrate sophisticated gamers.

The cheerful sounds aren't very advanced for racing games. Bouncy music is matched with typical tire screeches and whining engines.

If you have a sweet tooth for adorable but insubstantial games, this box of goodies will hook you, and the four-player simultaneous racing and increasingly difficult tracks add replay value. For the novice racer, Micro Machines is Macro Fun. **G**



By Captain Squideo

Atlus brings GP-1 back to the SNES track. Despite improvements, Part II has lost some of the features that strengthened the original game.

Motorcycle Mania

GP-1 Part II is similar to the many Formula One games available. You race from a behind-the-bike perspective on twisty Grand Prix tracks in Practice, Race, or two-player Battle mode. With 17 international tracks (up from 13) and six hot bikes to choose from,



PROTIP: Practice with a sturdy bike like the Team Red, then use your winnings to buy the fastest bike, Team Racing's SSS 500.

Mode 7 rotation that isn't particularly striking.

Spin Out

This game is ordinary in other ways, too. The rudimentary controls are standard for the genre and barely keep you upright. With the expected engine noises and tire screeches, the sounds are nothing to rave about.

GP-1 PART II



there's a ton of replay value for motorcycle maniacs. For everybody else, however, this kind of racing may seem pretty standard.

Even worse, the best graphical features in the first game are missing from the sequel: Your rider no longer wobbles in collisions, his foot doesn't go down on sharp turns, and he doesn't fall off and restart his bike. The background graphics seem merely redundant - lots of smooth

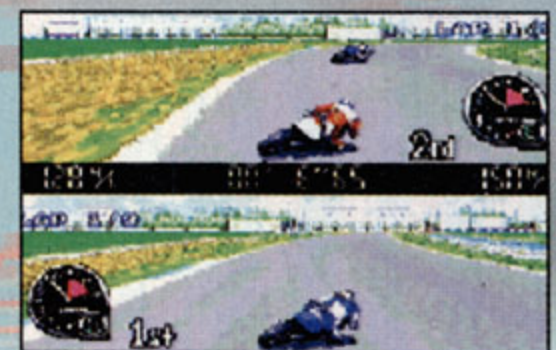

PROTIP: Save valuable seconds by hitting Button X to slide through turns at high speed.

Racers who must take every racing game for a spin might enjoy these bikes. Although the adjustable difficulty settings and passwords make it attractive to novices, the average graphics and gameplay make GP-1 Part II just another decent rental in the pack. **G**

Micro Machines by Ocean

| Graphics | Sound | Control | FunFactor | Challenge |
|----------|-------|---------|-----------|--------------|
| | | | | INT. |
| 3.5 | 3.0 | 3.0 | 3.5 | Intermediate |

\$59.95
8 megs
Available now
Multivehicle racing
4 players (multiplayer adapter required)

28 tracks
Overhead view
Multiscrolling
ESRB rating: Kids to Adults



PROTIP: Slow yourself by cutting across grassy areas but watch out for obstacles.

GP-1 Part II by Atlus

| Graphics | Sound | Control | FunFactor | Challenge |
|----------|-------|---------|-----------|-------------|
| | | | | ADJ. |
| 3.0 | 3.0 | 3.0 | 3.0 | Adjustable |

\$59.99
12 megs
Available now
Motorcycle racing
2 players
17 tracks

Behind-the-racer view
Forward scrolling
Passwords
ESRB rating: Kids to Adults



By **Andromeda**

At first look, BreakThru! isn't too impressive. Begin to play it, though, and the magic of Alexey Pajitnov surfaces. Pajitnov created Tetris, among other classic puzzle games, and he has another great one in this addicting puzzler.

A Breakthrough

BreakThru!'s concept is deceptively simple. You must clear a wall of colored blocks before time runs out. You eliminate the blocks by clicking on groups of two or more same-colored blocks.

As you eliminate blocks, they fall and slide into new positions, and new blocks and special items drop in from above. The problem is, you're often left with a collection of mismatched blocks. And therein lies this game's strategy.



Super NES

Plain Wrapping

With respect to the graphics and sounds, BreakThru!'s nothing special. The backgrounds that are hidden by the blocks aren't especially eye-catching, and the tiny power-ups, such as the sticks of dynamite, are hard to identify. The blocks slide and move nicely, though, adding to the appeal of the puzzle action.

BreakThru!'s controls are a snap to learn, and the game's simplicity is what makes it so absorbing. Child mode is great for beginners, and one- and two-player modes, including two-player cooperative gameplay, lend plenty of variety for puzzle fanatics. Pajitnov strikes again! **G**



By **Manny LaMancha**

If you've played any of the Bubble Bobble series, you know Bubby and Bobby. Taito brings 'em back for a Tetris-like game that starts out fun but ultimately lacks intricacy and longevity.

Where You Bin?

Using a launcher, you fling colored bubbles into a bin. Grouping three or more like-colored bubbles drops them



PROTIP: As the round starts, look for a bank shot that may take out a chunk of the board.

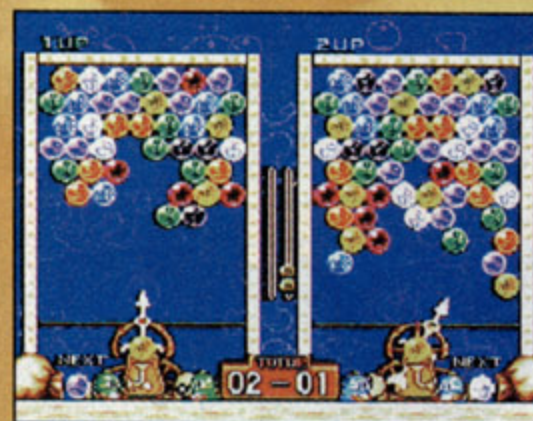

PROTIP: Don't let the mobile backgrounds distract you.

BreakThru!



PROTIP: To score big, amass large areas of same-color blocks together at the bottom of the screen, then eliminate them all at once.



PROTIP: Save the block that eliminates all the same-color blocks until you really need it.



PROTIP: Avoid creating tall towers of single blocks. They're the toughest to eliminate.

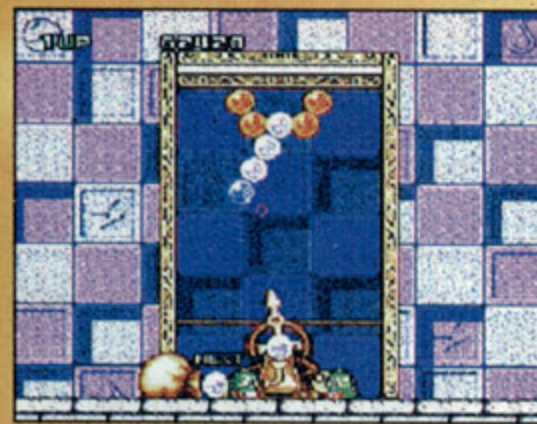

PROTIP: If you have to waste a bubble before you can group several together, toss the bubble to a spot where it can be taken out with the group.

off the play field. You can bank bubbles off the walls, but you must sight your shots quickly and accurately.

The control is as elementary as rotating your launcher to the angle you want and pushing a fire button. Adding to the diversity are different one-player contests, duels against the computer, or battle with another player.

As with previous Bubble Bobble games, this one delivers bright, colorful graphics—no elaborate detail, parallax scrolling, or 3D imagery here, though Bubby and Bobby cranking the launcher's gears

is cute. The audio gets a similarly basic treatment: It's functional, but it hardly pushes the SNES envelope.

Burst Your Bubble

While Bust-A-Move starts off like a sharp puzzler, it loses its appeal after a few redundant rounds. Sadly, it comes up short in the two-player mode, too. By racking up color matches, you rapidly fill up your opponent's bin, and the game's over far too quickly to be exciting.

If you're really into puzzlers, you might want to give Bust-A-Move a rental test drive. Better yet, dust off your NES and take Bubby and Bobby through some Bubble Bobble, a game with the durability that this one's missing. **G**

| BreakThru! by Spectrum HoloByte | | | | |
|---------------------------------|-------|-----------------------------|-----------|-------------|
| Graphics | Sound | Control | FunFactor | Challenge |
| | | | | ADJ. |
| 3.5 | 3.5 | 4.5 | 5.0 | Adjustable |
| Price not available | | 2 players | | |
| 4 megs | | ESRB rating: Kids to Adults | | |
| Available now | | Puzzler | | |

| Bust-A-Move by Taito | | | | |
|----------------------|-------|-----------------------------|-----------|-------------|
| Graphics | Sound | Control | FunFactor | Challenge |
| | | | | ADJ. |
| 4.0 | 4.0 | 5.0 | 3.0 | Adjustable |
| Price not available | | 100 rounds | | |
| 4 megs | | Side view | | |
| Available April | | Passwords | | |
| Puzzler | | ESRB rating: Kids to Adults | | |
| 2 players | | | | |

GAMEPRO PROSTRATEGY GUIDE

PHANTASY STAR

IV
End of the Millennium

Genesis

**Maps for
Every Town**

**Techniques
Explained**

**Strategies
and Game
Walk-Through**

**Enemy Strength
and Damage Stats**

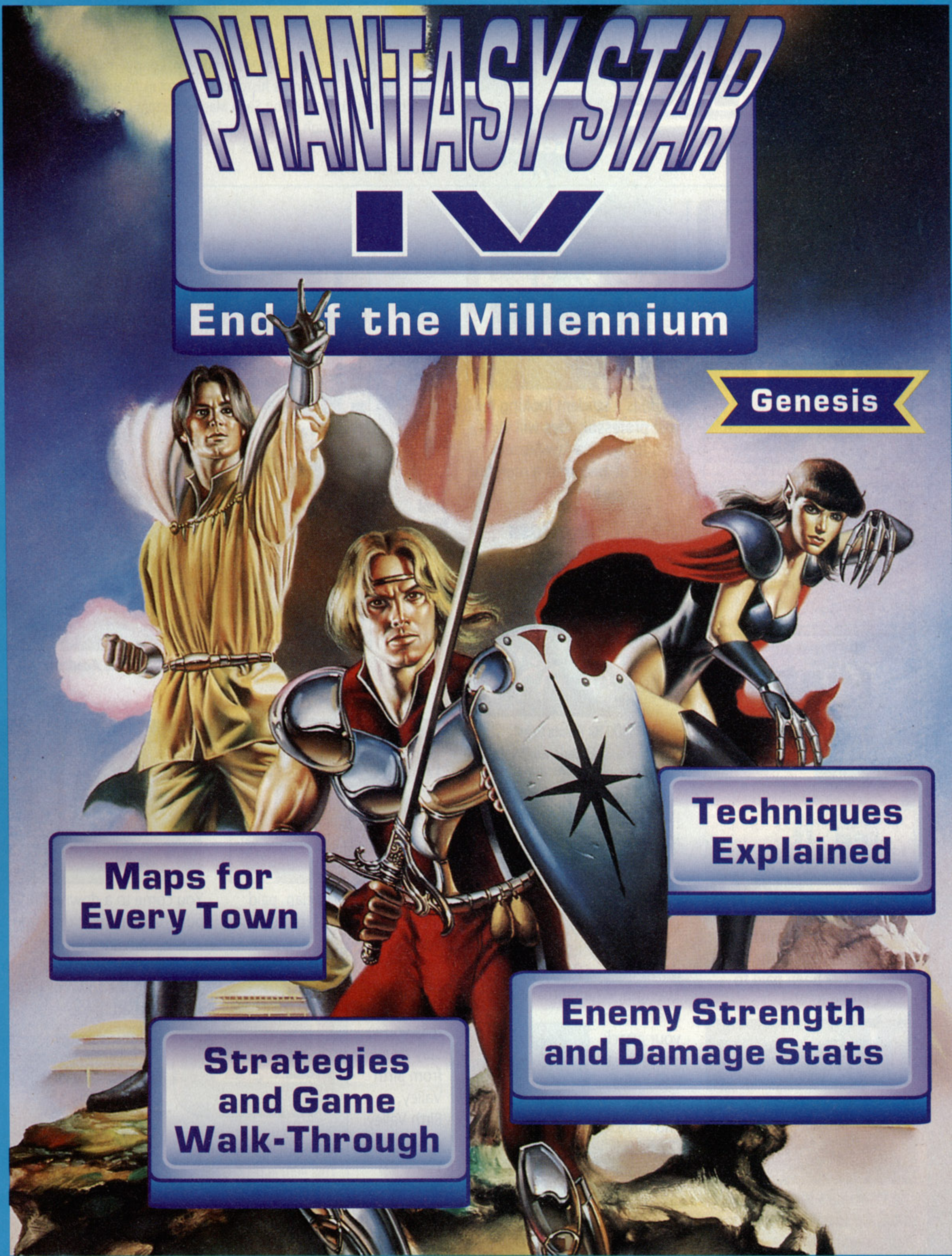

PHANTASY STAR IV

Genesis

By John Sauer and Rick Raymo

The latest in Sega's most famous RPG series, Phantasy Star IV takes place roughly a thousand years after the destruction of Palma. This time around, you play as a young man named Chaz – a monster hunter chosen by fate to battle Dark Force. Long-term Phantasy Star fans will notice numerous historical references to the first game, which debuted on the 8-bit Sega Master System in 1988.

This walk-through will get your Phantasy Star IV journey under way. To continue your trek, look for the strategy guide in the May issue of *SWATPro*.

Aiedo

The Beginning



Your adventure begins in the town of Aiedo on the planet Motavia – the home of Alys and Chaz.



Hahn is a student looking for a lost professor. Alys will stick him for quite a few Meseta before he becomes a member of your party.

Piata Cellar Boss



300 Hit Points to kill
Earns 63 Experience Points
and 58 Meseta

Igglanova is the boss of the Piata Cellar (you'll also find Igglanova at the Birth Valley entrance in the town of Zema). On your first pass, use Alys's Saner to get the edge on attacks, have Chaz Attack, and use Hahn's Gelun to knock down the boss's attack strength. When Igglanova fissions, aim your attack at the host. Have Alys use Foi, and have Chaz and Hahn Attack.

Zoran Bult



25 Hit Points to kill
Earns 4 Experience Points and 3 Meseta



The Motavia Academy has a crop of monsters in the basement. You've been paid to clear them out.



The Principal's hiding something. Do the job on the monsters, then return for answers.

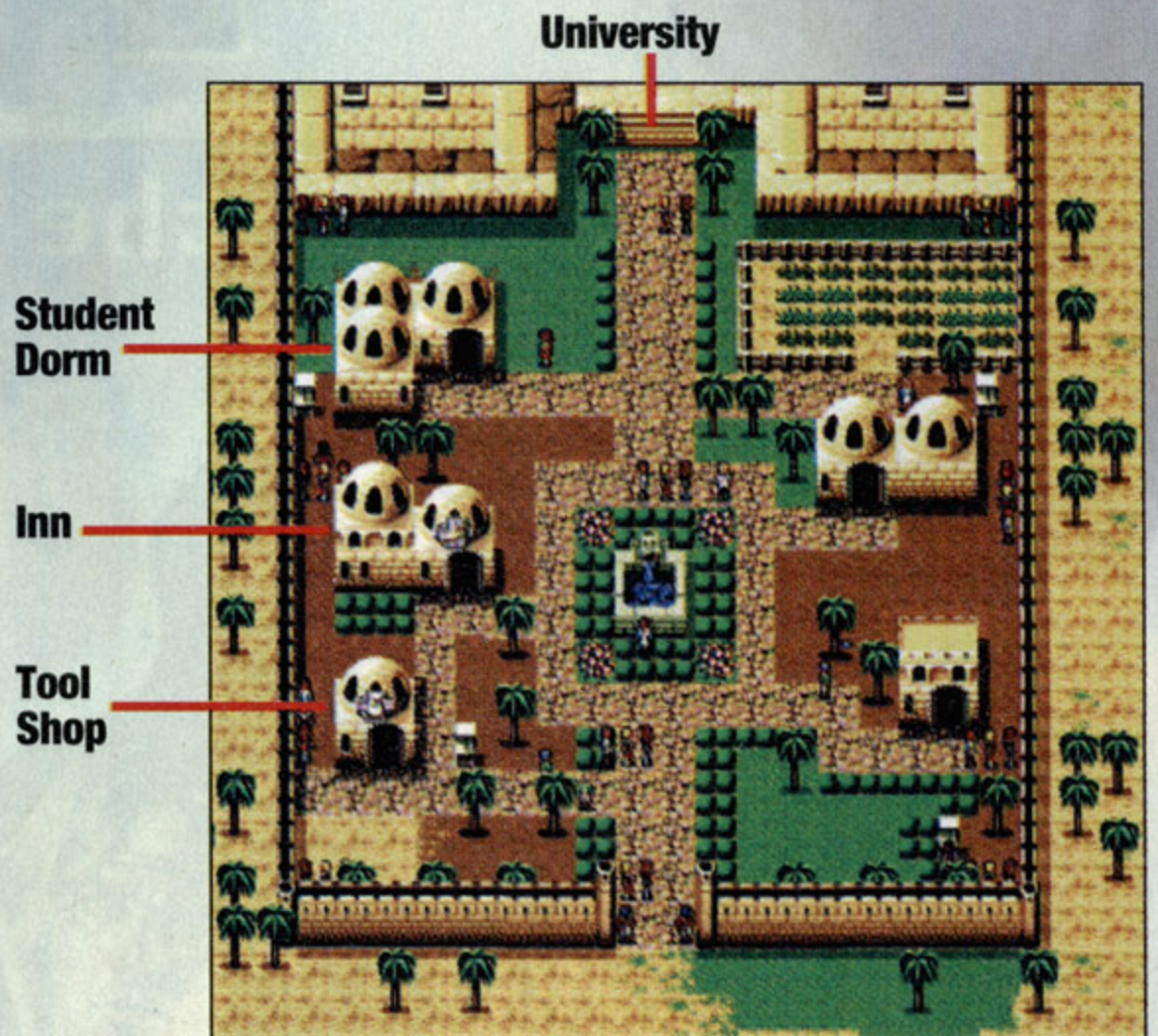

Your main objective in Piata is the Motavia Academy.



Zio, the Black Magician, paid the Principal a visit, but the Principal was afraid to say anything. He tells you to stay away from Birth Valley, so Birth Valley is where you must go now!



You come to a downed bridge, but you can't fix it until you advance further. If you haven't yet been to the town of Mile, head there.

Shopping



Piata has only one shop, and it sells just one item. This item is necessary, though. Stock up. The Tool shop sells Monomate at a cost of 20 Meseta.

Xanafalque



16 Hit Points to kill
Earns 3 Experience Points and 2 Meseta

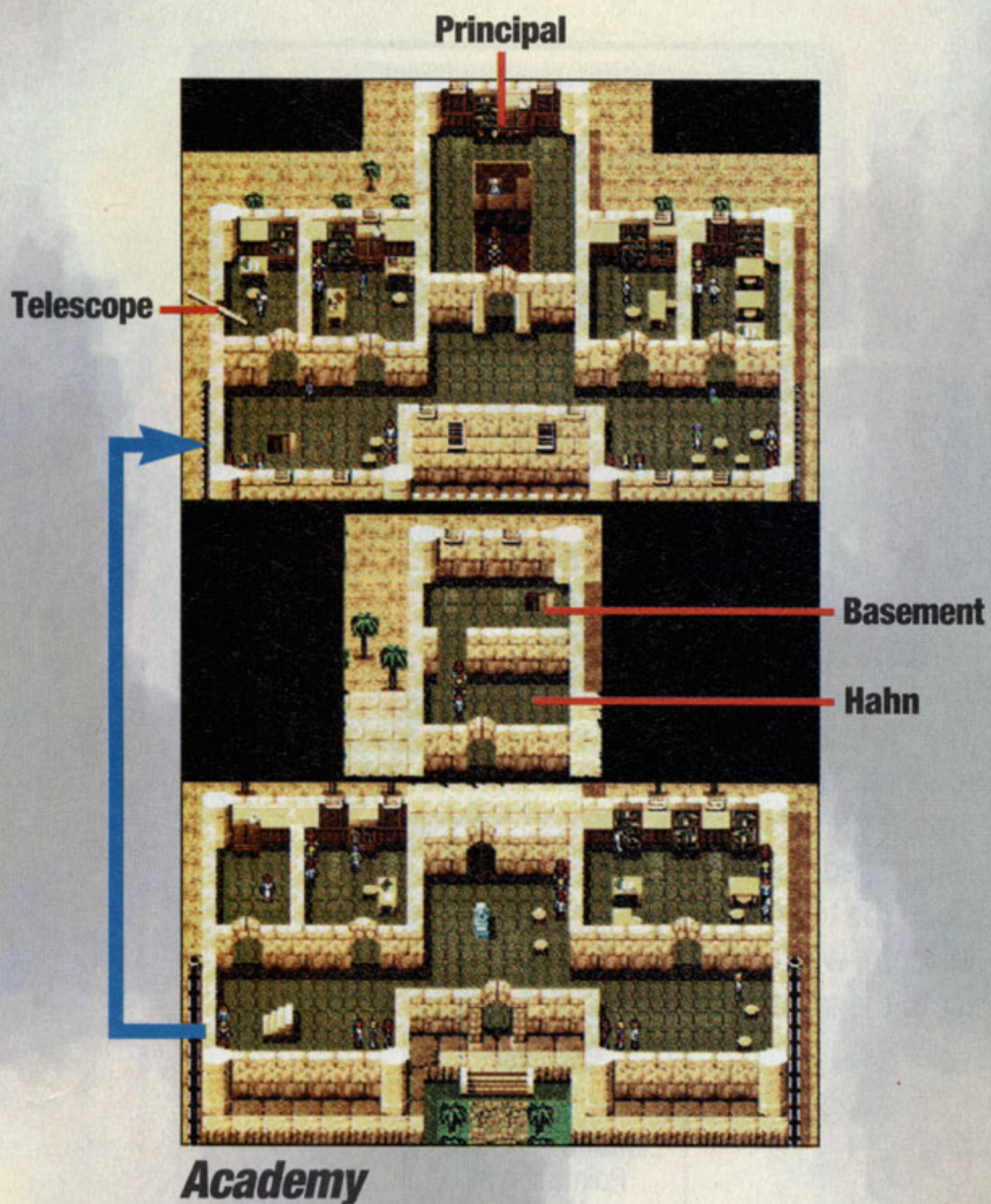

Mile is a little town that sits at the edge of some quicksand.

Infantworm



50 Hit Points to kill
Earns 33 Experience Points and 63 Meseta

Scorpius



150 Hit Points to kill
Earns 51 Experience Points and 121 Meseta

Weapons & Armor Shop

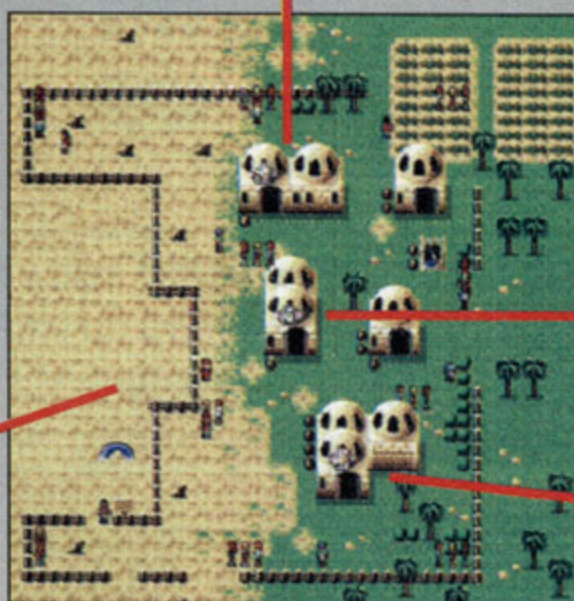

Sand Worm

Tool Shop

Inn

Mile is a good place to rest and add to your weapons and armor – if you have the Meseta.

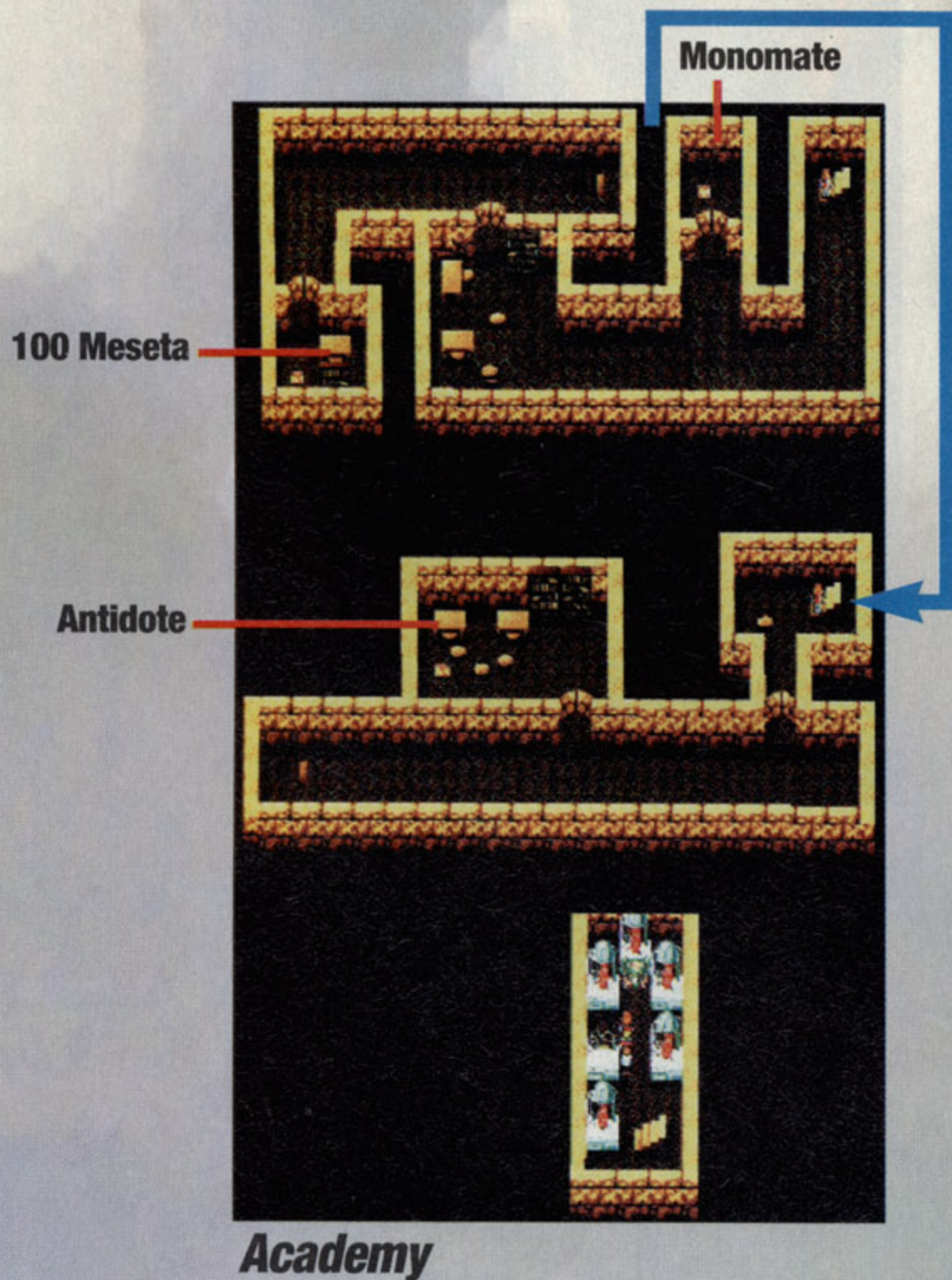

Monomate

100 Meseta

Antidote

Academy

Monsterfly



20 Hit Points to kill
Earns 9 Experience Points and 8 Meseta

Mini Worm



25 Hit Points to kill
Earns 12 Experience Points and 13 Meseta

Crawler



25 Hit Points to kill
Earn 16 Experience Points and 15 Meseta

Shopping



The Weapons Shop

| | |
|------------|-------|
| Dagger | 40 M |
| Hunt Knife | 120 M |
| Stel-Sword | 280 M |
| Boomerang | 80 M |
| Slasher | 160 M |

The Armor Shop

| | |
|------------|-------|
| Lthr-Helm | 80 M |
| Lthr-Crown | 90 M |
| Lthr-Band | 70 M |
| Lthrshield | 140 M |

The Tool Shop

| | |
|----------|------|
| Monomate | 20 M |
| Antidote | 10 M |

Zema



Shopping



The Weapons Shop

| | |
|-----------------|--------|
| Hunt-Knife..... | 120 M |
| Stel-Sword..... | 280 M |
| Slasher..... | 160 M |
| Broad-Axe..... | 1000 M |

The Armor Shop

| | |
|-----------------|--------|
| Circlet..... | 100 M |
| Crbn-Suit..... | 550 M |
| Grpt-Suit..... | 1200 M |
| Crbnshield..... | 220 M |
| Grptshield..... | 900 M |

The Tool Shop

| | |
|-----------------|-------|
| Monomate..... | 20 M |
| Antidote..... | 10 M |
| Cure-Paral..... | 120 M |
| Telepipe..... | 130 M |
| Escapipe..... | 70 M |



Zema is nestled in low mountains. You must go into the town to reach Birth Valley.



Venture deep into Birth Valley to solve this mystery.

To Birth Valley

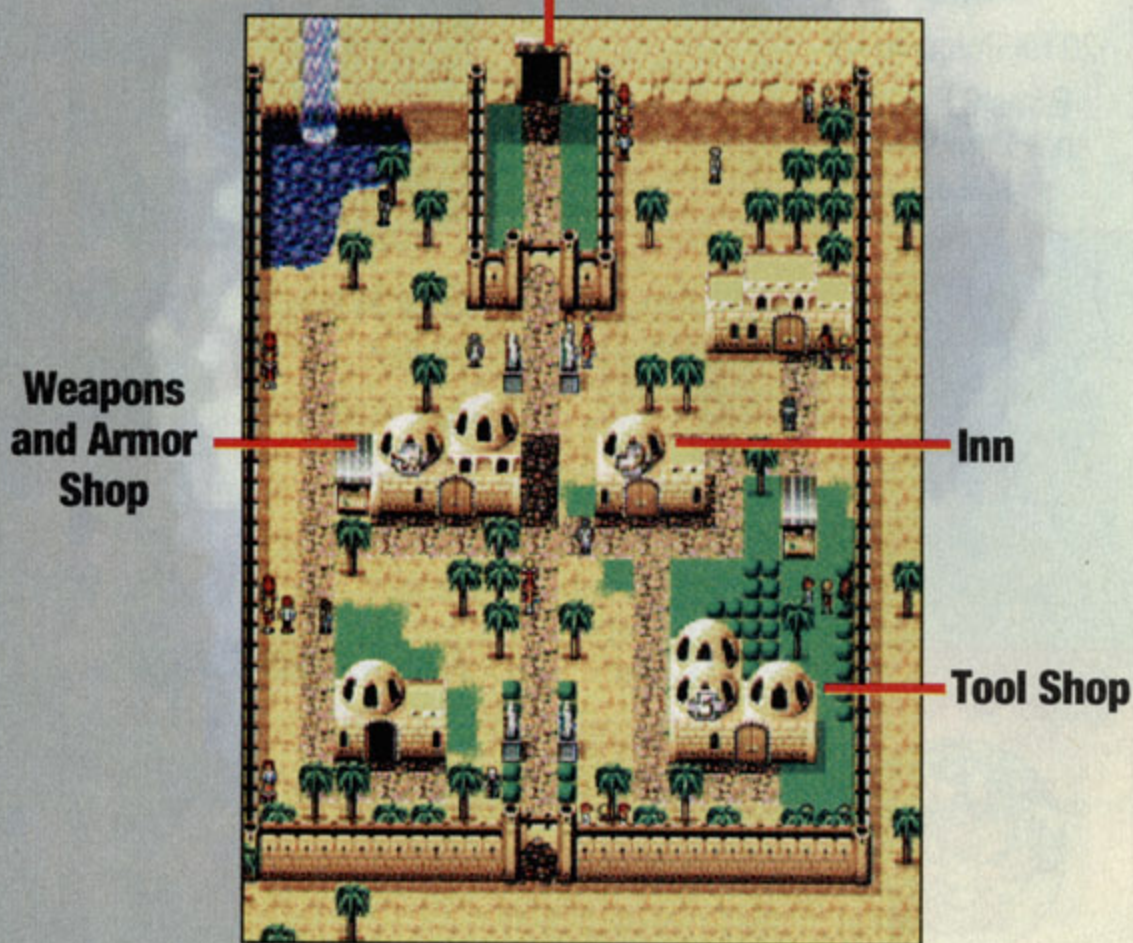

Although Zema has an Inn, Tool Shop, and Weapons Shop, you can't use them until you restore the residents to human form. They've been turned to stone.

Birth Valley

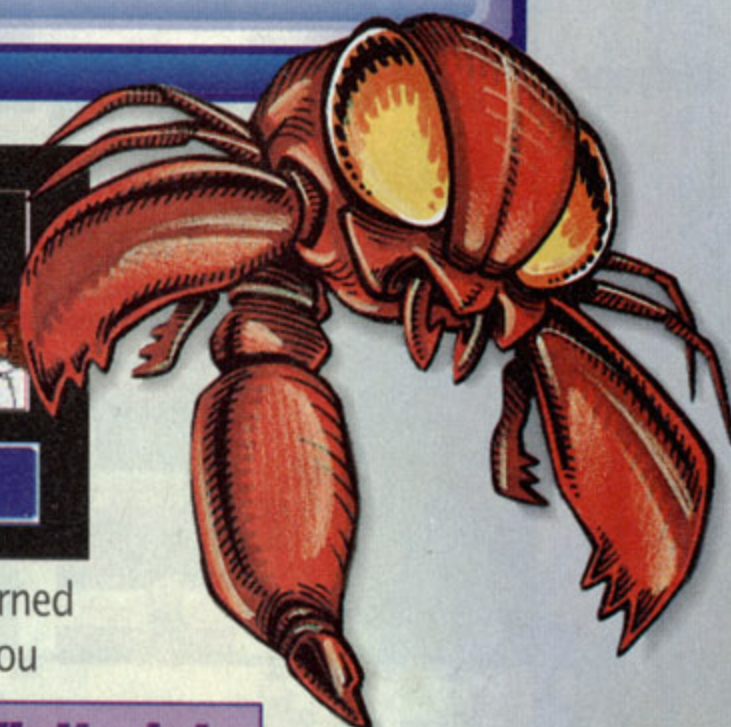

It's the village of Molcum, which is far south of here.

The Professor was also turned to stone. To revive him, you need a special medicine called Alshline. Go to the town of Molcum, which is far to the south.

Flatrplnt



32 Hit Points to kill
Earns 15 Experience Points and 30 Meseta

Monomate

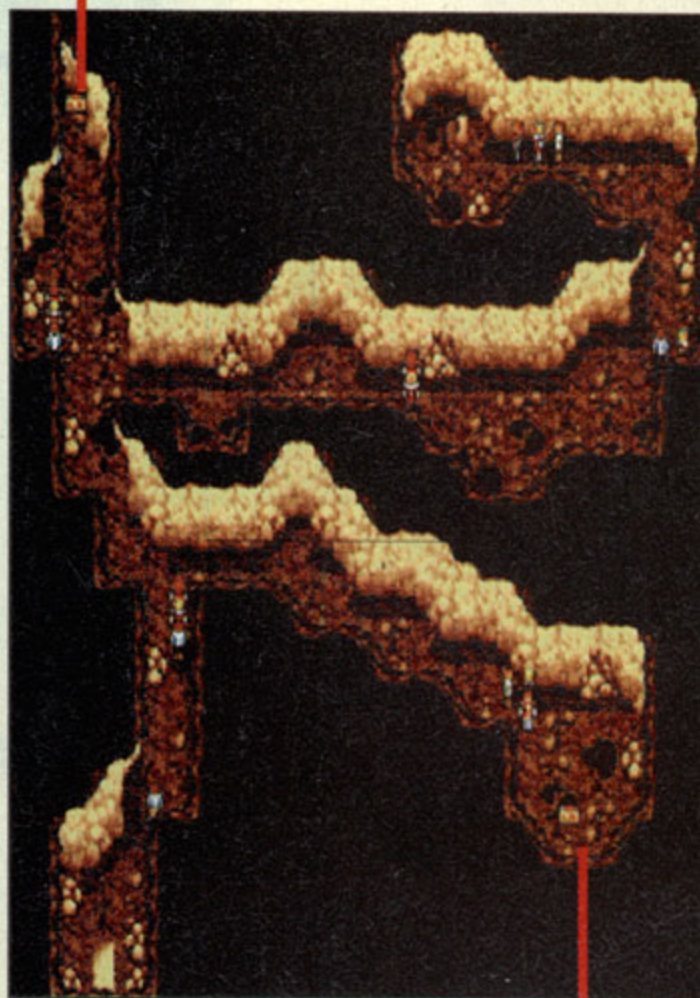

Crbnshield

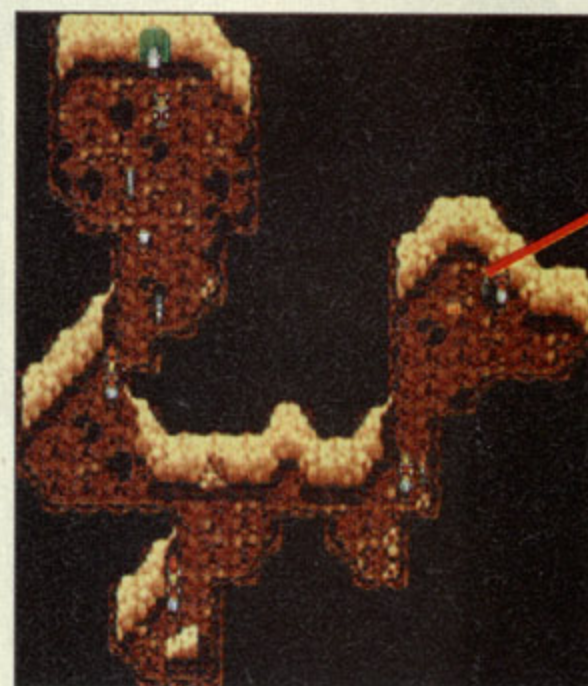

100 Meseta

Molcum



The little town of Molcum sits in the middle of arid hills.



Rune is a wizard and Alys's old friend. He joins the group.



No Alshline here. Rune knows where it is, though. Go to the native Motavian town of Tonoe by way of Krup to the east.

Rune

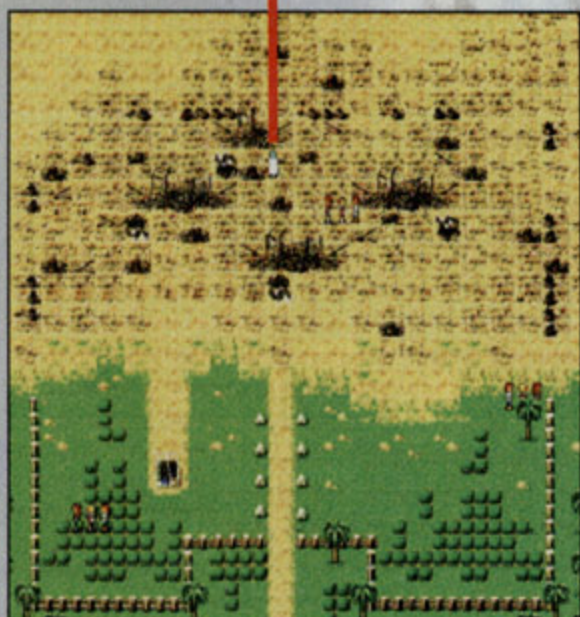

Sadly, Zio's forces destroyed Molcum. But there's a person you'll meet here who's very important to your quest.



Shopping



Gee, sorry. Molcum used to be a shopper's heaven. It had a mall, tons of outlet stores, and even mail-order businesses. Too bad it burned to the ground. Guess you'll have to move on to the next town to get your stuff.

Sand Newt



41 Hit Points to kill
Earns 31 Experience Points and 40 Meseta

Locusta



68 Hit Points to kill
Earns 19 Experience Points and 21 Meseta

Krup



Krup, Hahn's home town, is located by a lake and the island structure known as the Soldier's Temple.



The Valley Maze entrance to Tonoe is to the north. But how will you get around this obstacle? Rune has the answer.



Hahn has a sweetie in Krup. She also makes a good nurse later on.

Shopping



The Armor Shop

| | |
|-----------------|-------|
| Lthr-Helm..... | 80 M |
| Lthr-Crown..... | 90 M |
| Lthr-Band..... | 70 M |
| Lthrschild..... | 140 M |

The Tool Shop

| | |
|---------------|-------|
| Monomate..... | 20 M |
| Antidote..... | 10 M |
| Telepipe..... | 130 M |
| Escapipe..... | 70 M |

Hahn's Fiancée

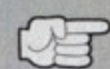

Valley Maze

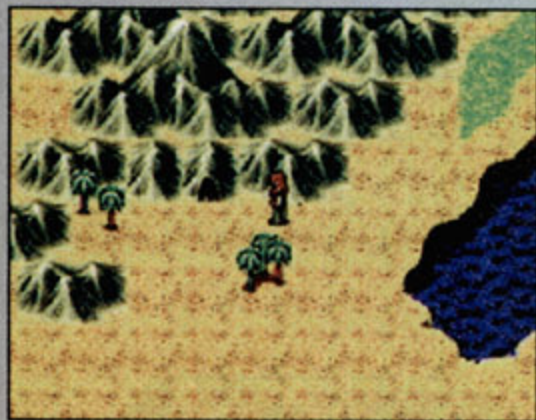

The entrance to the Valley Maze is easy to find. But it's blocked by an immovable stone.



Rune can use something that's rare on Motavia: true magic.

Carrion CR



35 Hit Points to kill
Earns 21.5 Experience Points and 48 Meseta

Blob



19 Hit Points to kill
Earns 14.5 Experience Points and 40 Meseta



Antidote

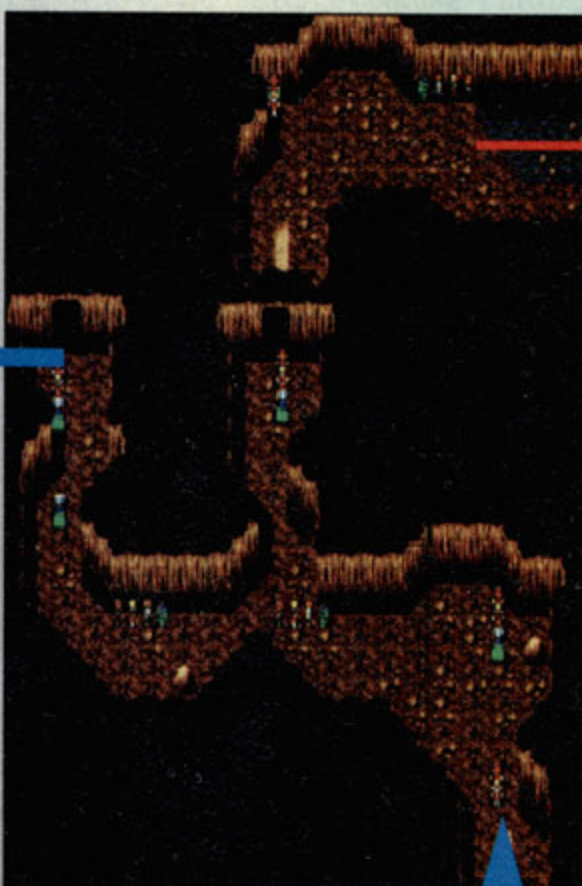

300 Meseta



Out

Tonoe



A village of native Motavians, Tonoe sits at the other end of the Valley Maze on a point of land near the sea. The weapons and armor made by the natives are constructed with titanium for excellent strength.



Grandfather Dorin knows where to get Alshline.

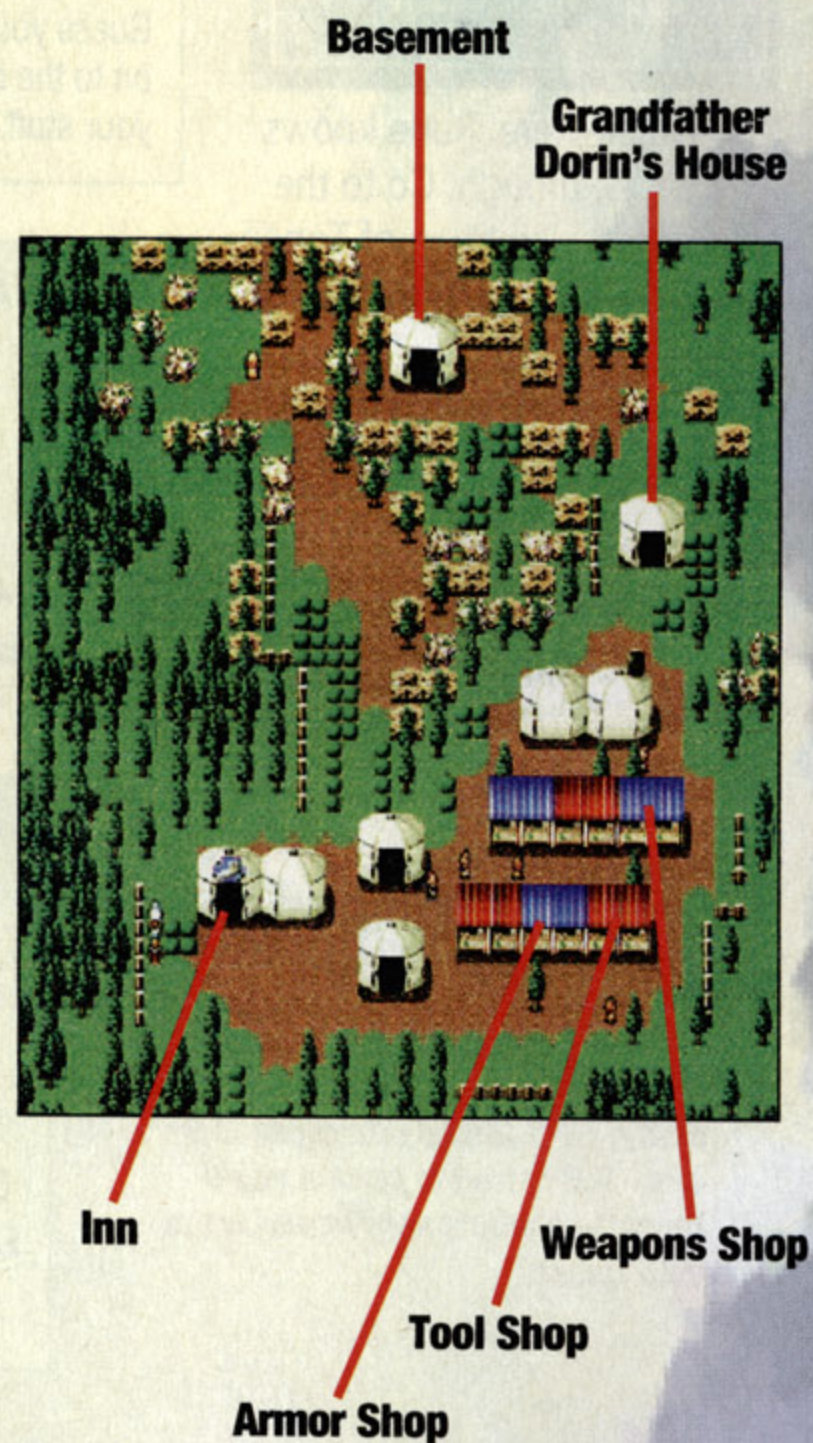

Basement

Grandfather Dorin's House

Inn

Weapons Shop

Tool Shop

Armor Shop

The Basement



Also, these people are looking for Alshline.

Rune has business with Grandfather Dorin. He leaves your party for a while, but he clears the way for you to get Alshline.



Gryz! Will you be a guide for these people?

Alshline is in the basement in back of the house. Gryz will be your guide. He seeks revenge on Zio and wants to join your party.



The door is sealed tightly shut.

Since you can't open the door, you must go around.



So this is Alshline!

Alshline! Now you can return to Zema. Gryz is going with you whether you like it or not. He's a good, strong fighter. Let him lead in dangerous places.

ToadStool



64 Hit Points to kill
Earns 16 Experience Points and 40 Meseta

Abe Frog



70 Hit Points to kill
Earns 26 Experience Points and 80 Meseta

Shopping



The Weapons Shop

- Hunt-Knife.....120 M
- TitnDagger.....240 M
- Stel-Sword.....280 M
- Titn-Sword.....560 M
- Slasher.....160 M
- Titnslasher.....360 M

The Armor Shop

- Titn-Helm.....570 M
- Crbn-Suit.....550 M
- Titn-Mail.....1120 M
- CrbnShield.....220 M
- TitnShield.....600 M

The Tool Shop

- Monomate.....20 M
- Antidote.....10 M
- Cure-Paral.....120 M
- Telepipe.....130 M
- Escapipe.....70 M

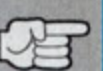
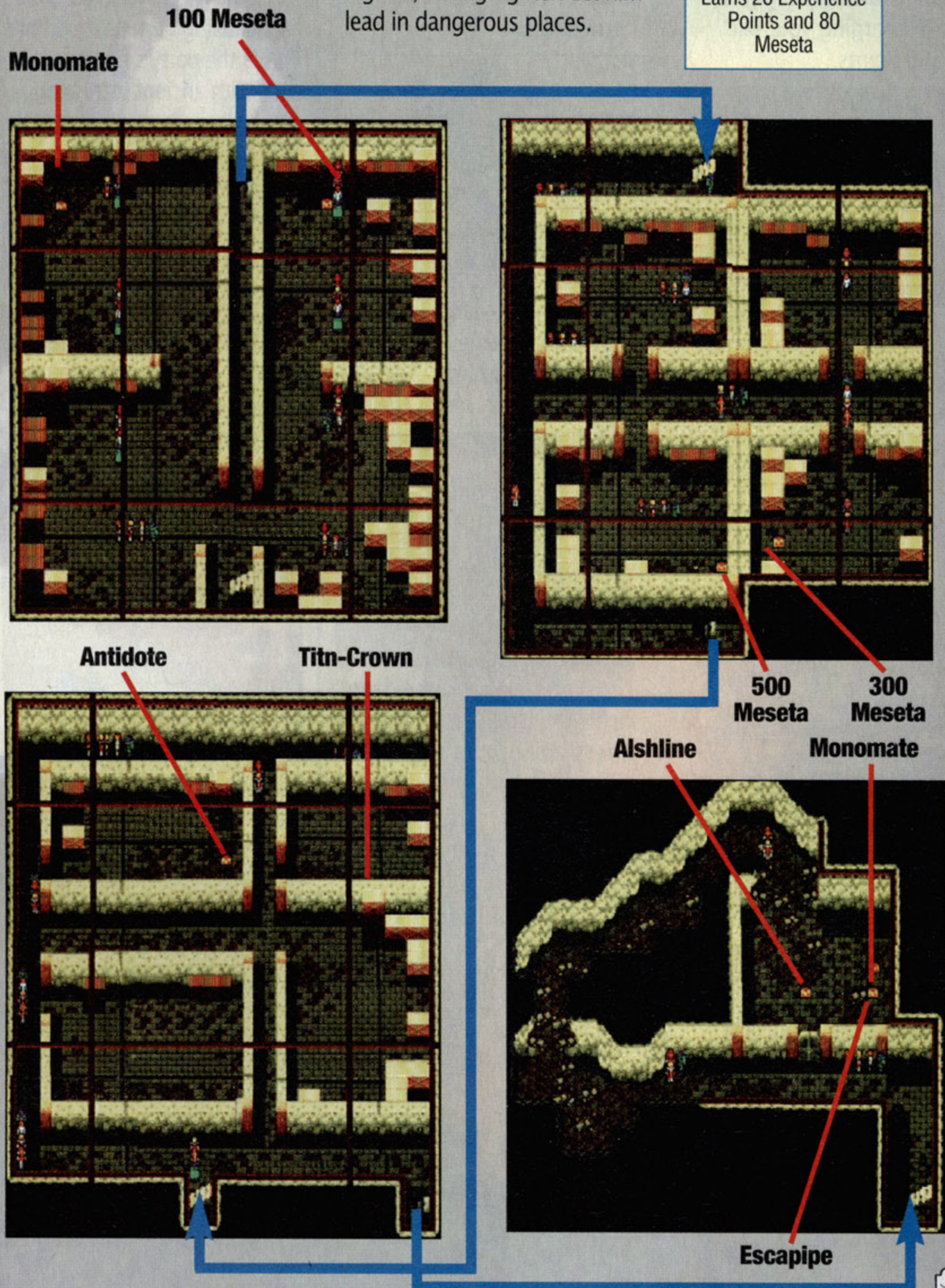

Return to Zema and Birth Valley



When Alshline is used, the people of Zema come back to life. You earn a night of rest, recharging your MP and Hit Points.

Alys wants to go to Aiedo where the Hunter's Guild is located. You and Alys have a home there.



The Professor has some very important knowledge about Birth Valley. He wants you to deliver a report to the Academy.

Expect some trouble when Igglanova emerges from the Birth Valley entrance. There's more there than meets the eye.



The Professor has gone deep inside the Bio-Plant to discover what's going on in there. You can only follow.



The Bio-Plant

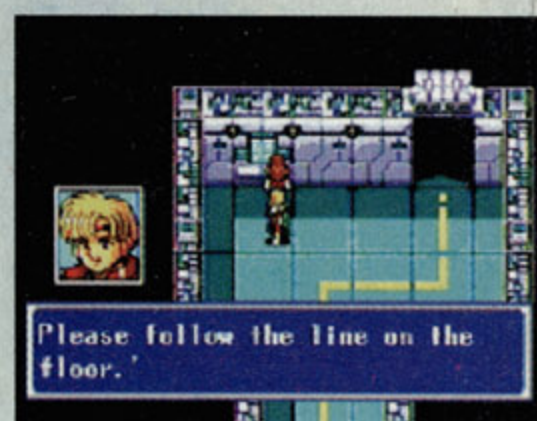

The Bio-Plant is a product of a long-dead culture. Over the eons, the machinery has gone bad, causing genetic mutations. This is the party's first experience with ancient technology.



Seed tells you about Nurvus, the planetary-control station you must shut down. The only way you can accomplish this task is with the Android Demi, who's being held hostage in Zio's Fort.



When you find the Professor, you'll see that he's met some new friends.



Rika, who's never been outside, constantly wonders at the outside world.



Rika is a Numan, a genetic construct. She understands the tech world and is a big help to you.



Seed self-destructs to prevent his systems from being over-run and causing further damage to Motavia.



Seed is Rika's father. He gives you important information about the failing planetary-control systems.

Arm Drone

68 Hit Points to kill
Earns 42.5 Experience Points and 93 Meseta

Gicefalgue

40 Hit Points to kill
Earns 28.6 Experience Points and 44 Meseta

Nalya



Nalya is a little town you encounter on the way from Zema and the Bio-Plant to Aiedo. It's located close to the spot where a giant asteroid has recently fallen. Use Nalya as a base for exploring the asteroid's wreckage.

Shopping



The Tool Shop

| | |
|------------|-------|
| Monomate | 20 M |
| Antidote | 10 M |
| Cure-Paral | 120 M |
| Telepipe | 130 M |
| Escapipe | 70 M |

Blob



19 Hit Points to kill
Earns 14.5 Experience Points and 40 Meseta

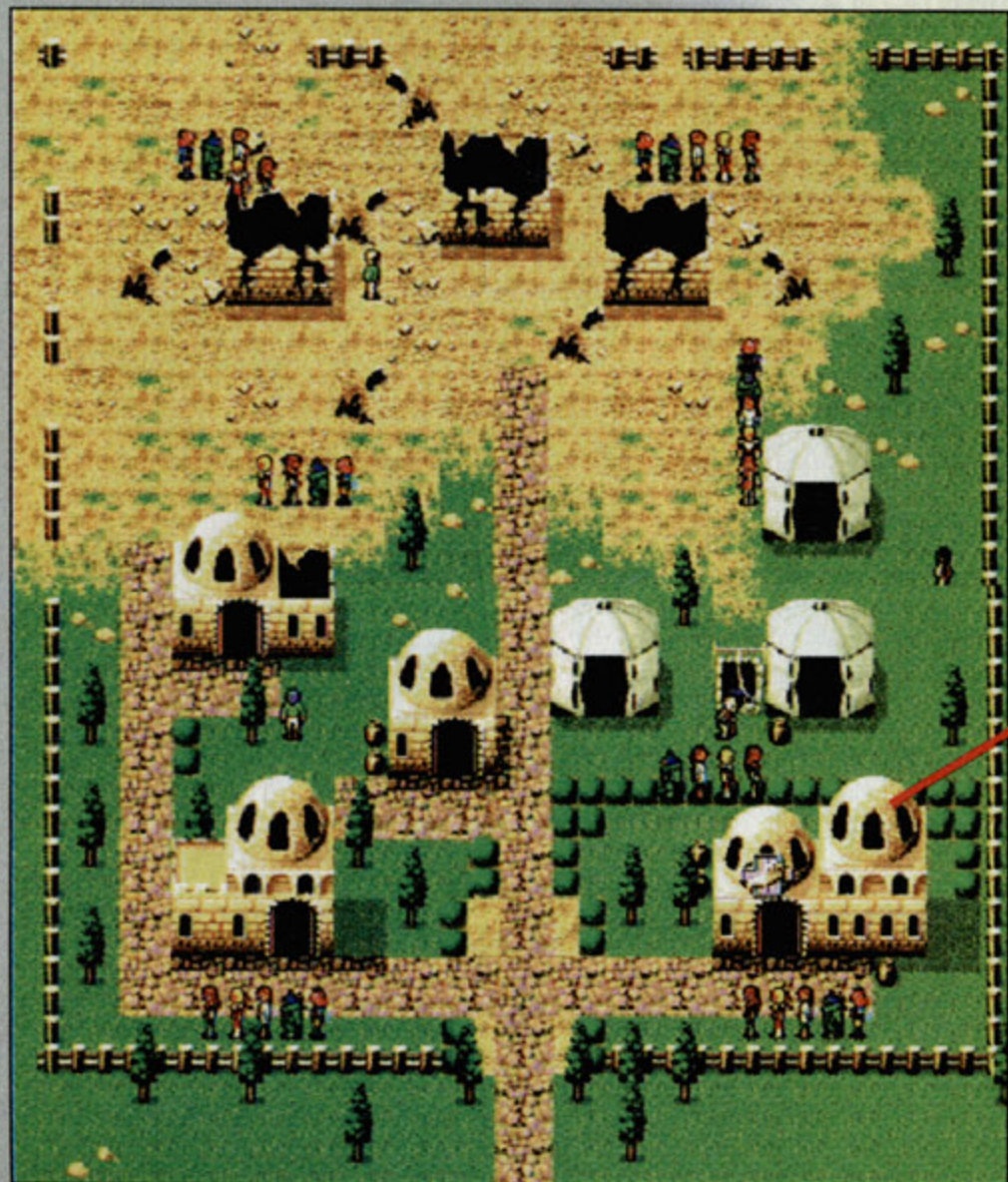
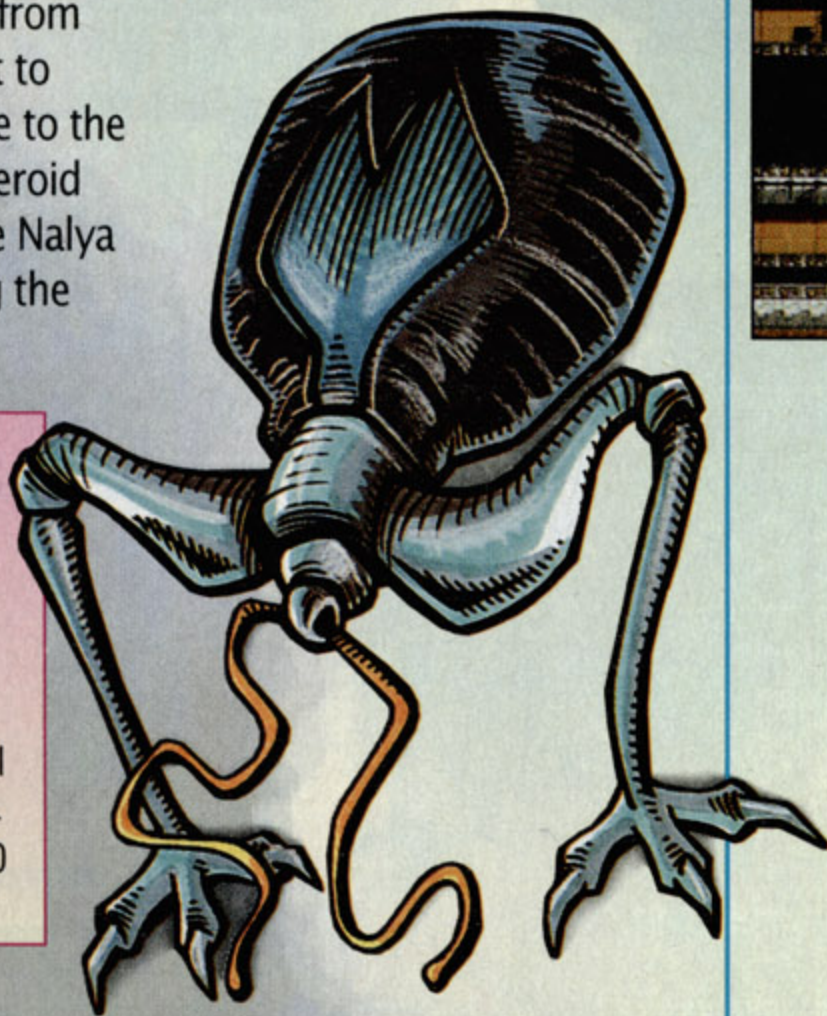

Nalya is the place to get more information about the asteroid's wreckage. It has an Inn and a Tool Shop, so stock up.

Asteroid Wreckage

Crmcshield

1500 Meseta

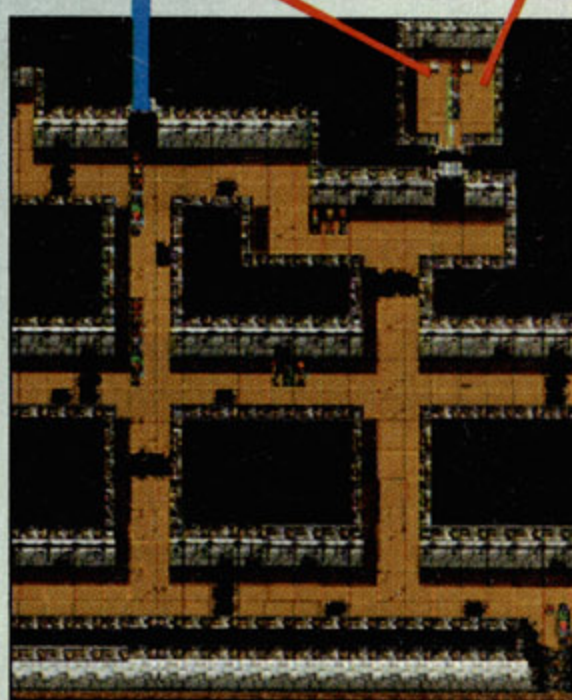

Dimate

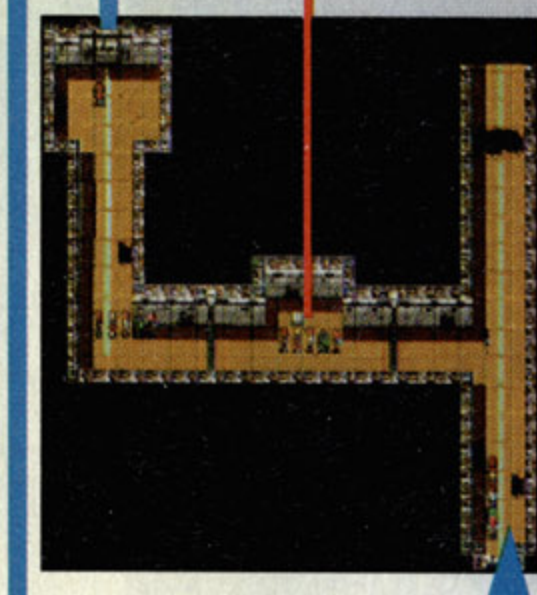

To Crmc-Mail

Crmc-Knife

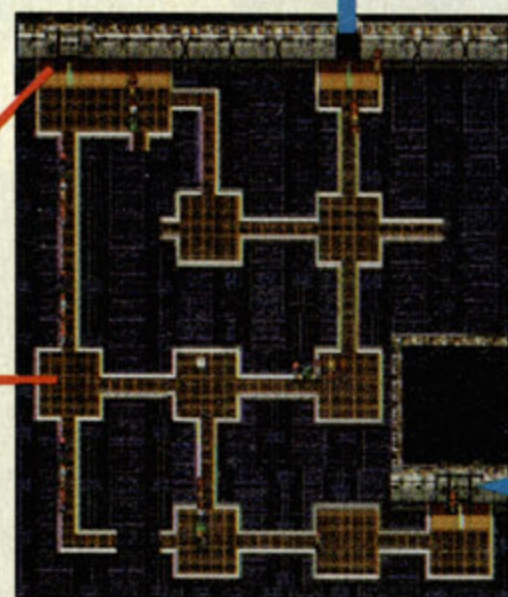

Computer Display

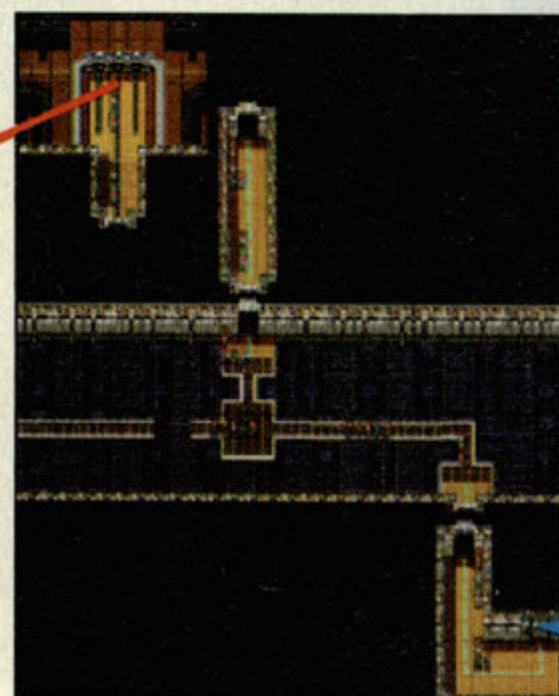

Warren286



95 Hit Points to kill
Earns 43.5 Experience Points and 128 Meseta

Whistle



50 Hit Points to kill
Earns 34.3 Experience Points and 92 Meseta

Tracer



99 Hit Points to kill
Earns 51 Experience Points and 267 Meseta

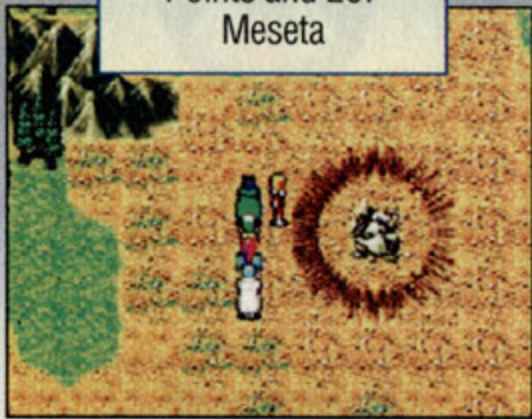

The wreckage came down smoking from the sky. It's more than it first appears to be. Inside are the ruins of an ancient space station filled with mechanical enemies and better weapons and armor.



At the end of the wreckage is the computer's main memory. Use it to uncover the true history of the Algol Star System.



Parma was destroyed 1000 years ago. But not all Parmanians died, and the fallen space station is proof. But how will you get to them? First, you must defeat Zio and shut down Nurvus.

Aiedo



Aiedo is the home of Alys and Chaz. It's also the location of the Hunter's Guild, where Hunters can go to find work. Just north of Aiedo is the Passageway that leads to Kadary and Zio's Fort.



You find these chests in the upper-left corner of the Guild. One holds Trimate, the other holds 1000 Meseta.



Go to the Hunter's Guild to get jobs. Each job earns you thousands of Meseta and the Experience Points you need to become stronger. Many of these side quests also gain you important special weapons or items. The Sand Worm is your first quest. Take it out before heading to Zio's Fort. You'll need the spells the Experience Points bring you.



Home, sweet home. You can return here any time, rest for the day, and leave with your Hit Points and MP completely restored. When you gain the Ryuka spell, you can Ryuka

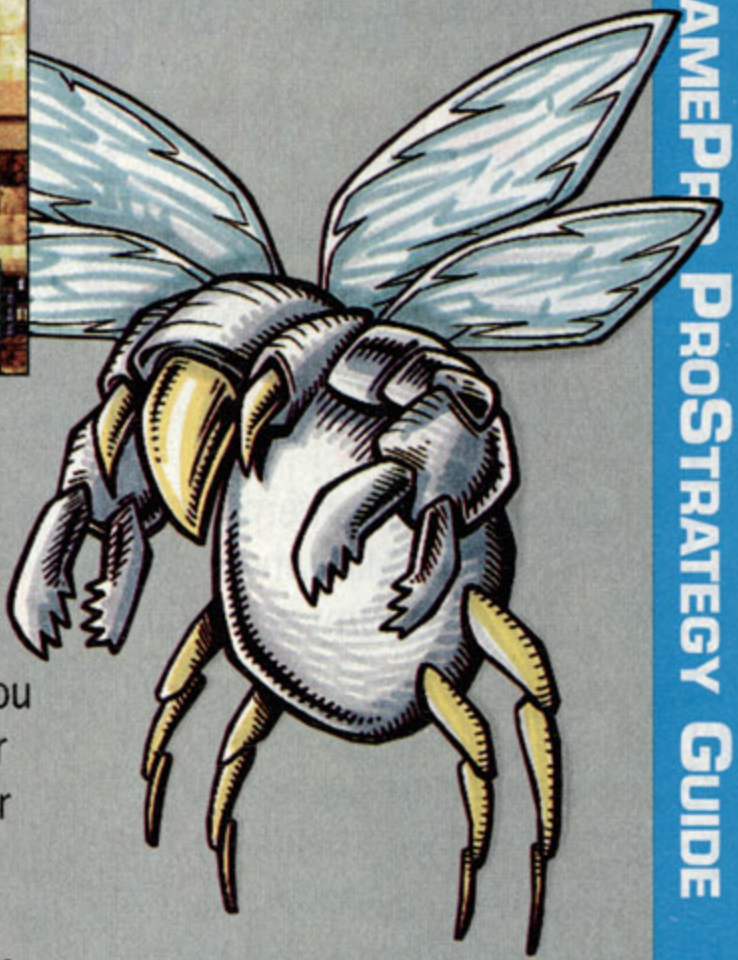

here, rest up, and return to your previous location. No more Meseta spent on hotels!



Hug the outside walls to reach the Bakery. You need the shortcake to complete a future side quest.

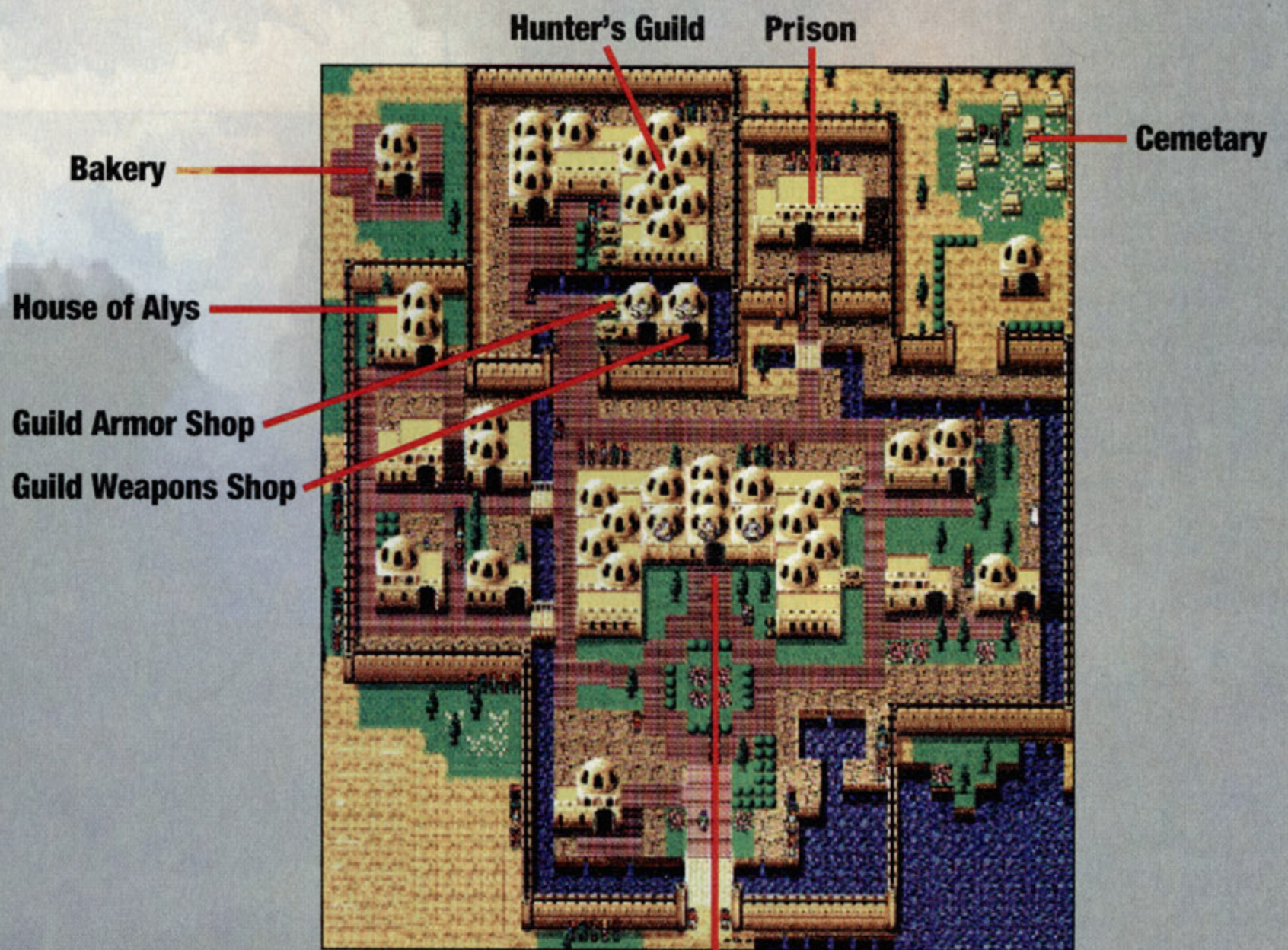

Inn, Tool Shop, Weapons Shop

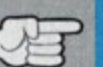

Aiedo

Side Quest 1: The Sand Worm

Remember the enterprising individual in Mile who started a Sand Worm farm as a tourist attraction? Well, it appears his pets have become too big and strong for his own good! If you've already tangled with a leach or a Sand Worm, you know what we mean. He's offering a 5000 Meseta commission to any Hunter strong and bold enough to solve his problem. Head to Mile to battle a Sand Worm.



Save your game before you battle these critters. Normally, you would want to avoid combat with a Sand Worm. But here, hit it with your most powerful spells and attacks. It takes 1489 Hit Points to conquer the Worm. Keep going, even if you lose a character or two. You can always rest in Aiedo afterwards, and you'll earn 8387 Experience Points and 1200 Meseta on top of your commission for winning.



Success! Cash in, buy some new weapons, and prepare to head for Kadary, the closest town to Zio's Fort.



Shopping



The Cheesy Weapons Shop

Hunt-Knife.....120 M
Slasher.....160 M
Claw.....1000 M

The Cheesy Armor Shop

Crbn-Helm.....200 M
Crbn-Crown.....150 M
Circlet.....100 M
Crbn-Suit.....550 M
Crbnshield.....220 M

The Weapons Shop

Crmc-Knife.....1600 M
Crmc-Sword.....3600 M
Saber-Claw.....1700 M
Struggl-Ax.....4600 M

The Armor Shop

Grpt-Crown.....1000 M
Crmc-Helm.....1800 M
Grpt-Suit.....1200 M
Crmc-Mail.....3700 M
Grptshield.....900 M
Crmcshield.....2300 M

The Tool Shop

Monomate.....20 M
Dimate.....160 M

The Passageway



The Passageway between Aiedo and Kadary is short but filled with fairly tough enemies. Enter through the cave just above Aiedo, through the trees to the right. Follow the map for the correct route.



Zol Slug

50 Hit Points to kill
Earns 42 Experience Points and 91 Meseta

Meta Slug



239 Hit Points to kill
Earns 400 Experience Points and 241 Meseta

Speard



100 Hit Points to kill
Earns 62 Experience Points and 91 Meseta

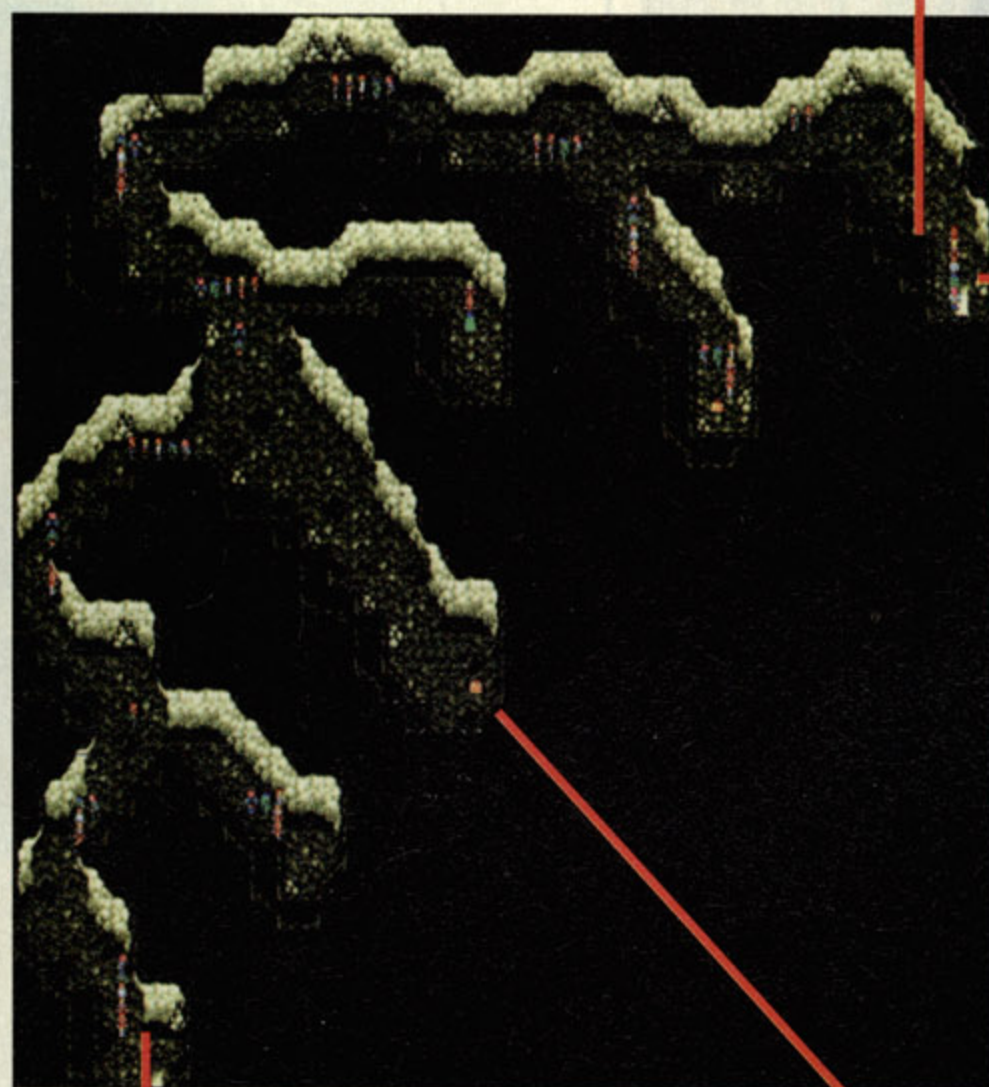

Enter

Cure-Paral

Dimate

Exit

Kadary



Kadary is located northwest of Zio's Fort. It has an Inn and a Tool Shop. Since it is under Zio's control, no weapons are sold. But with careful searching, you can find one.



A visit to Zio's Temple gives you a few clues to the Black Magician's location.

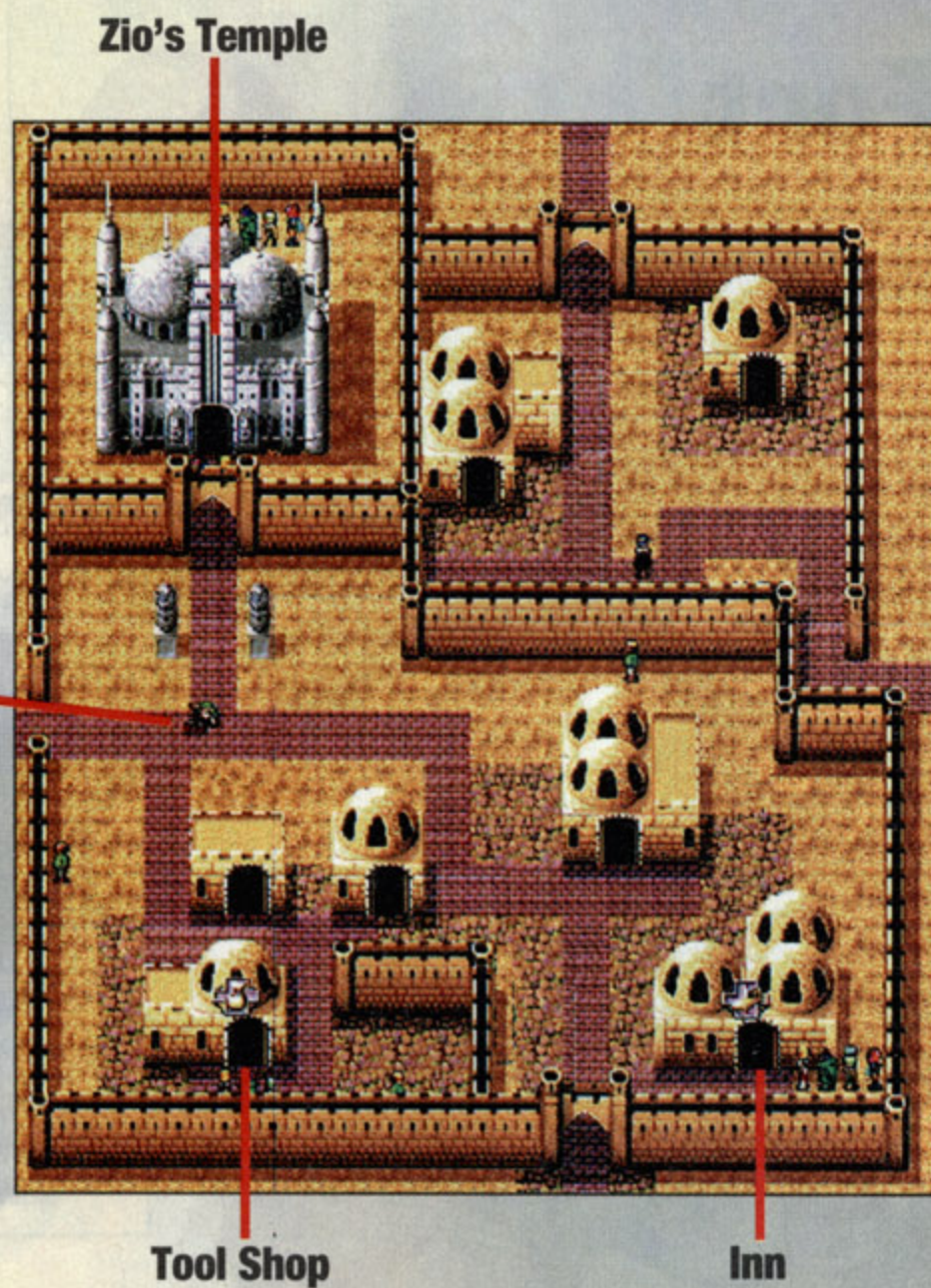

Search the abandoned house next to the recreation center to find a Lasrslasher, a powerful weapon for Alys.

Shopping



The Tool Shop

| | |
|-----------------|-------|
| Monomate..... | 20 M |
| Dimate..... | 160 M |
| Antidote..... | 10 M |
| Cure-Paral..... | 120 M |
| Telepipe..... | 130 M |
| Escapine..... | 70 M |



On the outskirts of town, you find a path around the walls to a separate area near the Cathedral. Pick up a couple of Treasure Chests here and, more importantly, collect the Lasrslasher for Alys.

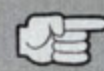
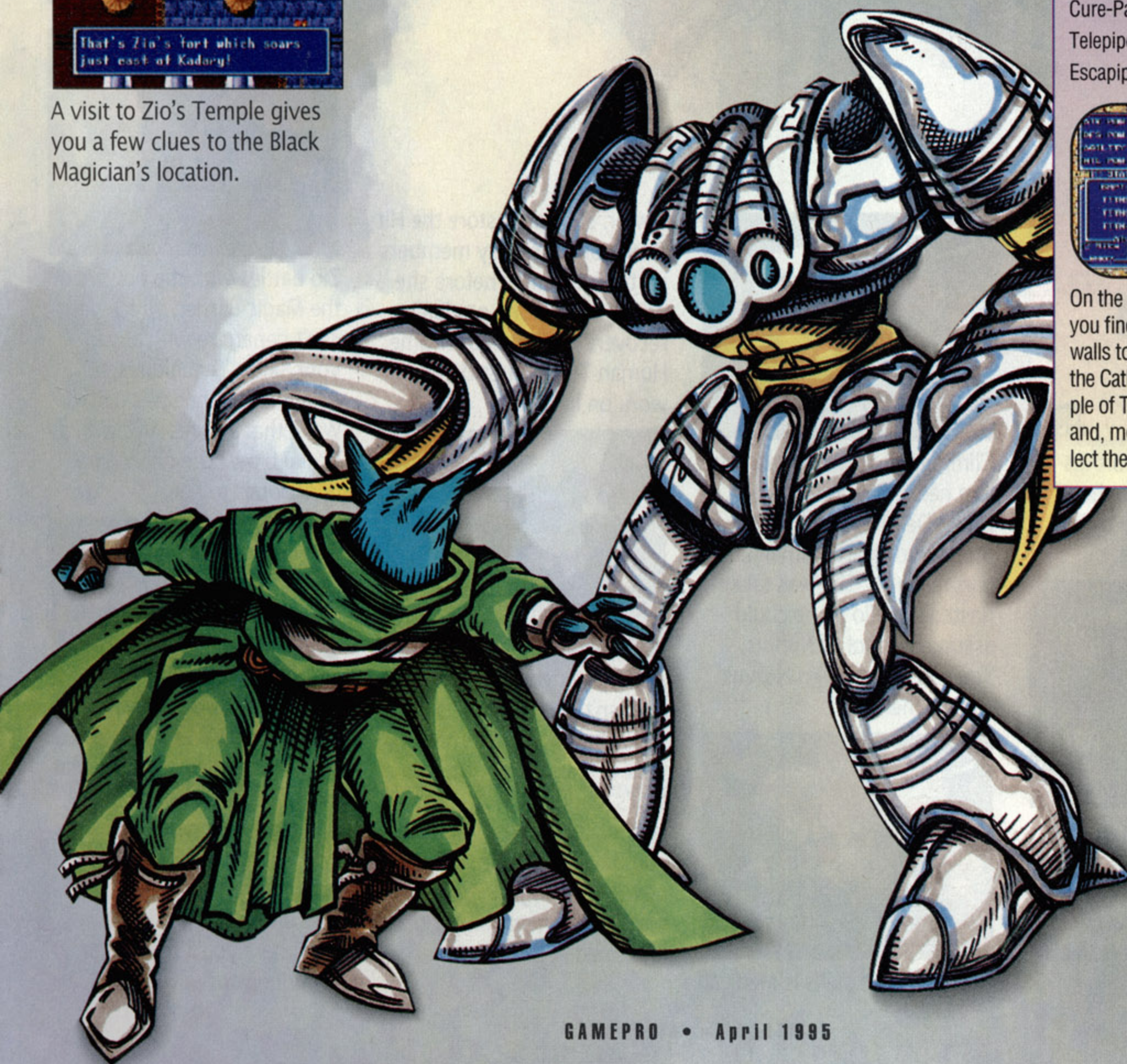

Zio's Fort



Ripper



112 Hit Points to kill
Earns 99.5 Experience Points and 51 Meseta

Juza



1523 Hit Points to kill
Earns 1716 Experience Points and 800 Meseta

Shadowsabr



110 Hit Points to kill
Earns 105 Experience Points and 61 Meseta

Tech User



80 Hit Points to kill
Earns 78 Experience Points and 85 Meseta



Zio's Fort is just a short distance southeast from the town of Kadary, across the sand flows from Mile.



Juza is a powerful Zio underling. You must defeat him to continue. Use your strongest spells. When you've won, a hidden stairway is revealed.



Climbing the stairs leads you to a new character for your party, Demi. Demi is an Android who's part woman and part machine. She was taken hostage by Zio so he could assume control of Nurvus. You can't shut down Nurvus without her.



One of Demi's skills is Medical

Power. She can restore the Hit Points of your party members up to eight times before she needs to rest. She gradually recovers Hit Points over time. Human Techniques don't work on her.



Zio catches you freeing Demi and isn't happy. He lets you know he's acting as the servant of Dark Force, the evil that's plagued the Algol system for thousands of years. If you haven't realized it by now, you're fighting something much, much bigger than it seemed at the start.

Zio battles with the powers of the Magic Barrier, which you can't penetrate with any of your Skills, Techniques, or weapons. He releases a Black Wave that smotes Alys with a brutal blow. The only course of action is to flee.



Alys is wounded so badly that even Gires's potent recovery skill can't help her. Things look mighty bleak. Bring her back to Krup so she can get care under Hahn's fiancée. From here you'll prepare to continue your adventure.

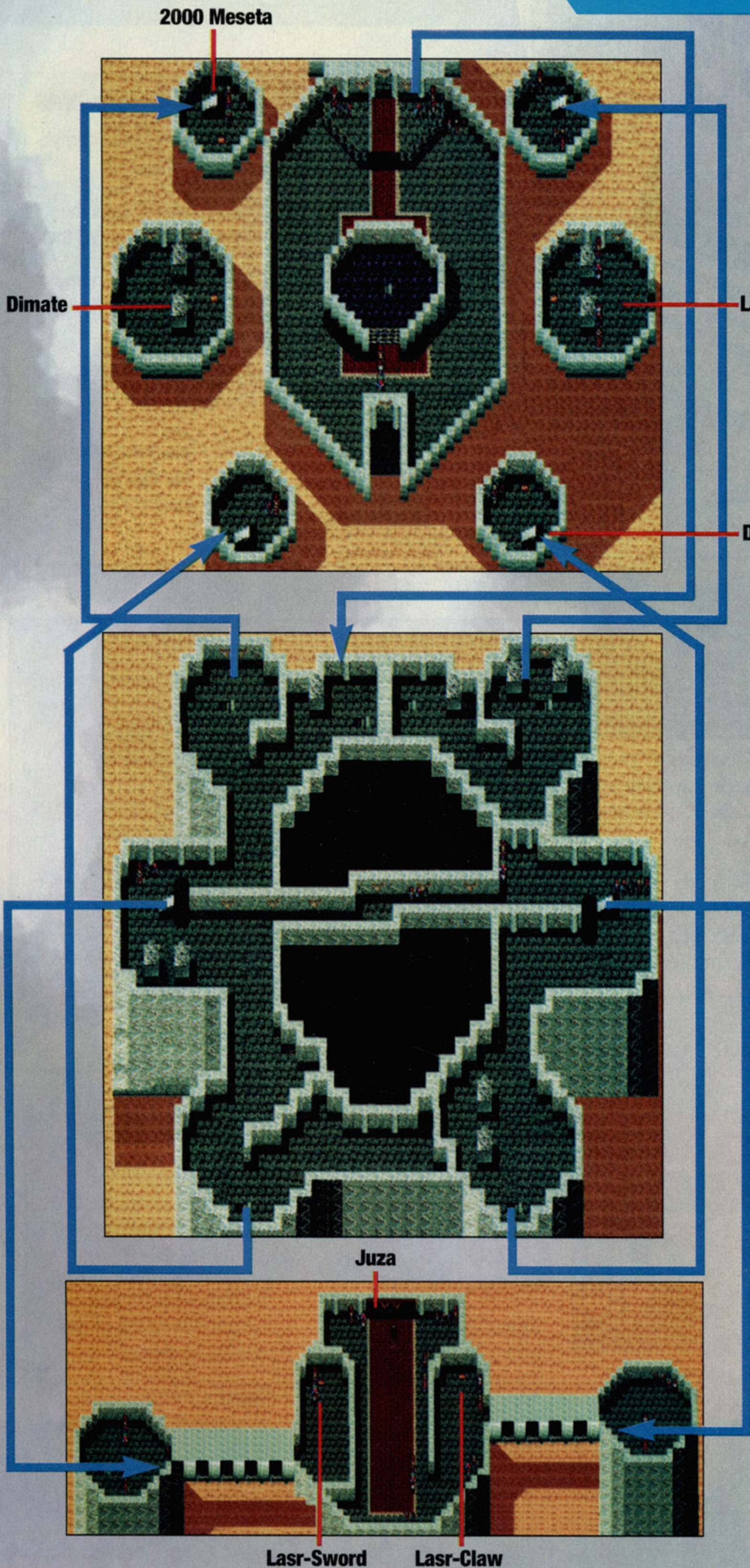

To Top

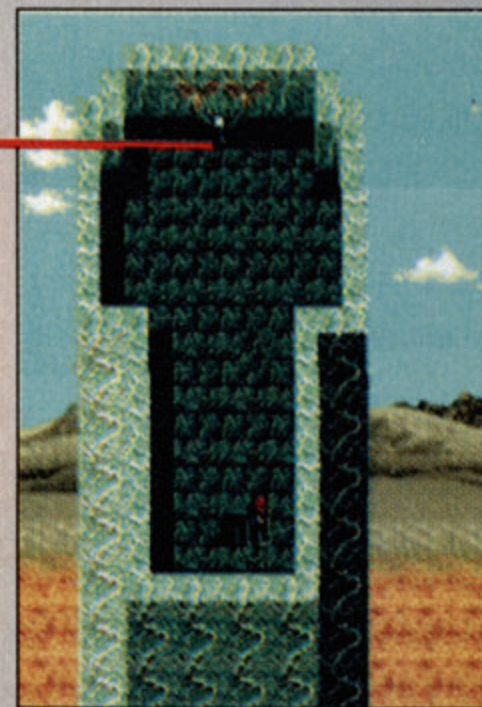
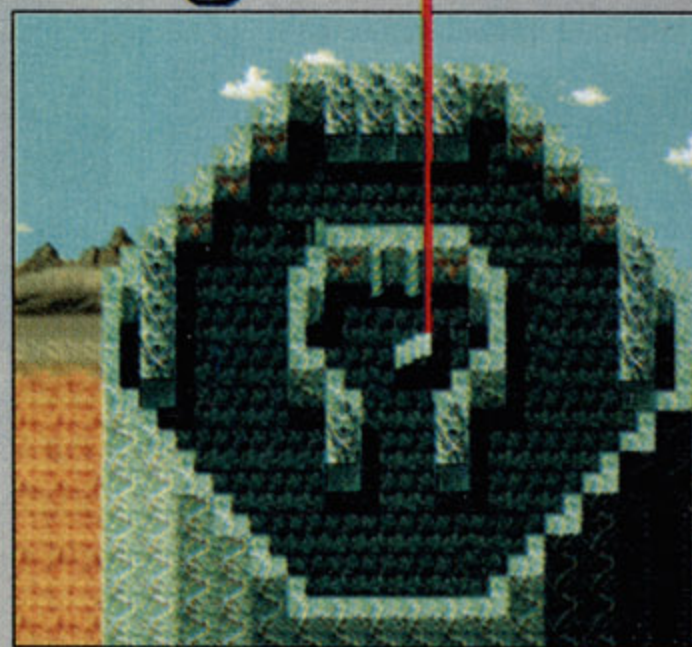

Demi

The journey through Phantasy Star IV continues in the May issue of *SWATPro*.

John Sauer and Rick Raymo are the authors of Phantasy Star IV Official Players Guide, which is published by Infotainment World Books.

PHANTASY STAR

You learn new techniques throughout the game. Here's a rundown of the techniques you need to know up to the point where the walk-through ends.

Techniques To Boost Your Characters In Battle



Shift: Increases one character's attack strength.

Saner: Substantially increases your group's reaction speed. When you use it, you may get all your moves in before your enemy can attack.

Deban: Increases your group's defensive abilities.

Seals: When it works, it stops a magic user's ability to use their skills against your party.

Traveling Techniques



Ryuka: Teleports all your characters to any town previously visited on the current planet.

Hinas: Teleports your group out of a dungeon or maze to a safe place where they can camp and save.

Techniques That Work Against All Enemies



Zan, Gizan (stronger), and Nazan (strongest): Create a vacuum around enemies to asphyxiate them. Stronger attacks use more powerful Technique Points (TP).

Megid: Loosens the enemy's molecular structure.

Bolt: Destroys the enemy's nervous system.

Gelun: Instantly ages the enemy, which weakens them.

Doran: Slows the enemy's reaction speed for the rest of the battle.

Brose: Doubles the enemy's body mass.

Rimit: Adds resistance to the enemy's nervous system, causing unconsciousness.

Techniques That Affect One Enemy

Foi Techniques



Foi, Gifoi (stronger), and Nafoi (strongest): Blast the enemy with a massive bolt of flame. The stronger attacks use more Technique Points (TP).

Wat, Giwat (stronger), and Nawat (strongest): Freezes the enemy. The stronger attacks use more TP.

Githu: Fires a powerful dart of light at the enemy.

Vol: Slows electrical activity in the enemy's nervous system, stopping them cold.

Tsu: Creates a high-pressure wave of water that nails your opponent.

Healing and Health-Related Techniques



Sar, Gisar, and Nasar: Restore Hit Points to all human characters who aren't flatlined. Expensive in TP, but worth it.

Res, Gires, and Nares: Restore Hit Points to one humanoid character. The more Hit Points restored, the higher the cost in TP.

Anti: Cures an active character of poisoning, but doesn't affect Hit Points.

Rimpa: Releases one active character from paralysis. Has no affect on Hit Points.

Arows: Awakens one unconscious character, but doesn't raise Hit Points.

Rever: Brings back one flatlined character and restores one-fourth of their possible Hit Points.

Regen: Cures poisoning, unconsciousness, or paralysis and restores all Hit Points to one flatlined character.

GamePro's Hot Picks!

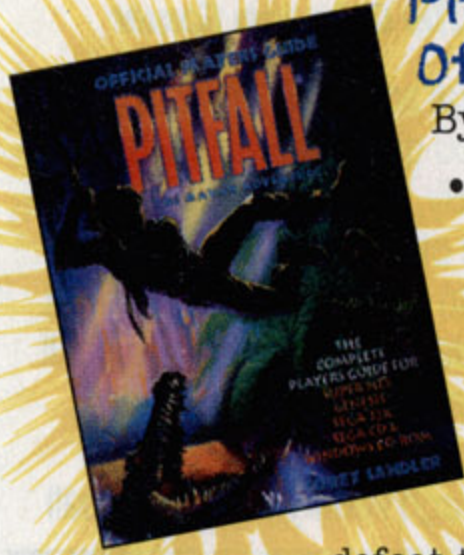

Pitfall: The Mayan Adventure Official Players Guide

By Corey Sandler

- Jam-packed with level maps and every secret tip needed to score big!
- Complete walk-throughs show you to how to find the Mayan gold!
- Learn expert strategies to defeat the level bosses!

\$13.95 Code: BK-332

Final Fantasy III Players Guide

By Peter Olafson

- All the clues, hints and maps you'll need to survive your quest across two worlds!
- Learn how to arm your party to defeat Kefka!

\$12.95 Code: BK-317 SNES

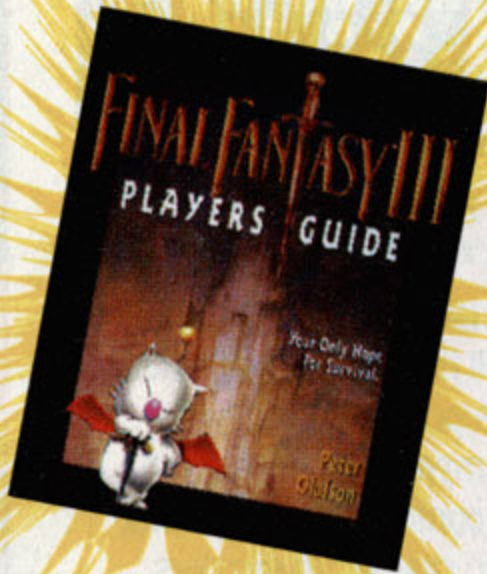

Super NES Power Players Guide: 1995 Edition

By Corey Sandler & LeeAnne McDermott

- Discover game-winning tips, strategies, and secret codes for Donkey Kong Country, Mighty Morphin' Power Rangers, Clay Fighter: Tournament Edition, Earthworm Jim, Mortal Kombat II and more!
- Includes in-depth competition profiles on more than 15 SNES games!

\$12.95 Code: BK-320



Super Return of the Jedi Official Players Guide

By Corey Sandler & Tim Rooney

- Learn how to pilot the Millennium Falcon safely against the Empire!
- Advance to higher levels with killer gaming tips and expert strategies!

\$12.95 Code: BK-328 SNES

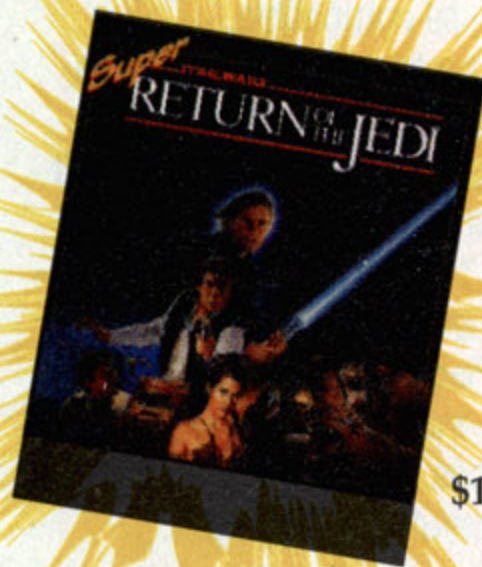

Lufia and the Fortress of Doom Official Players Guide

By Ronald Wartow

- Get winning combat strategies, detailed maps, and hints to get you to advanced levels!
- The only strategy guide packed with navigation tips and survival essentials!

\$9.95 Code: BK-318 SNES

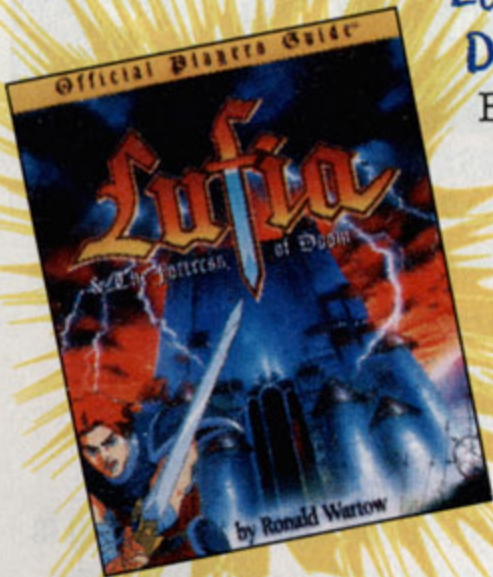

Genesis Power Players Guide: 1995 Edition

By Corey Sandler & LeeAnne McDermott

- Strategies and tricks to help you master 17 of the most challenging Genesis games!
- Expert tips for Sonic and Knuckles, Contra Hard Corps, Jurassic Park: Rampage Edition, NBA Jam, Virtua Racing and many more!

\$12.95 Code: BK-321



Products Order Form

To Order:

Fill out product order form and mail to:

GAMEPRO
P.O. Box "P"
San Mateo, CA 94402

Check/Money Order VISA Master Charge

Credit card No. _____ Expiration: _____

Signature: _____

Name: _____

Address: _____

Phone: () _____

City: _____

State: _____ Zip Code: _____

Please allow 2-3 weeks for delivery.

- Complete the Order Form
- Add shipping and handling (see chart)
- Add sales tax, residents of CA, IL, and NJ only (CA = 8.25%, IL = 6.25%, NJ = 6%)

| Qty. | Code | Description | Unit Price | Total |
|--------------------------------------|------|------------------------|--|-------|
| ORDERS MUST BE PREPAID | | | | |
| | | | Subtotal | |
| | | | Sales Tax (CA=8.25%, IL=6.25%, NJ=6%) | |
| | | | Shipping (see chart) | |
| | | | Grand Total (U.S. dollars only) | |
| Shipping and Handling Charges | | | | |
| U.S. | | Canada | Outside the U.S. | |
| \$4.00 each | | \$6.50 each | \$9.95 each | |
| \$2.00 each additional | | \$2.00 each additional | \$3.00 each additional | |

Super NES

TETRIS & DR. MARIO

By Andromeda

If you don't already own these classics, this combination cart is unbeatable.

The landmark Tetris returns, as addicting as ever. This ver-

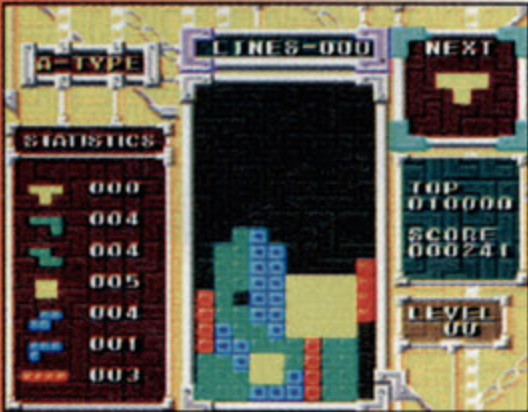

PROTIP: Build rows that are four levels deep, then wait for the red piece to score big.

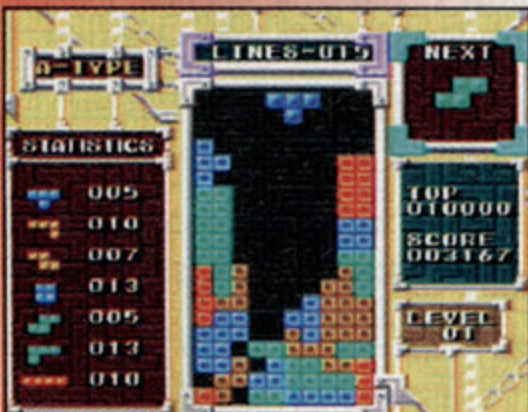

PROTIP: Never let the pieces stack up in the middle of the screen. Stack spare pieces on the sides.

sion includes solo play and three CPU opponents.

Dr. Mario varies the Tetris theme. You match capsules to eliminate them before they fill the screen. In addition to playing the two-player game, you can challenge the CPU.

In the excellent Mixed Match mode, two players race to outscore each other in both Tetris and Dr. Mario.

Enhanced graphics and sounds for the SNES, though nice, aren't key factors here. Sharp controls and absorbing action are what make these two classics even better as a pair than they were alone.

Tetris & Dr. Mario by Nintendo

| Graphics | Sound | Control | FunFactor | Challenge |
|----------|-------|---------|-----------|-----------|
| | | | | |
| 4.0 | 3.5 | 4.5 | 4.5 | ADJ. |

\$59.95
8 megs
Available now
Puzzler

2 players
90 levels
ESRB rating: Kids to Adults

Super NES

Pieces

By Earth Angel

Using jigsaw puzzles, Pieces is an interesting variation on the standard puzzler theme.

One or two players race to completely assemble a series of jigsaw puzzles. In Jigsaw mode, players race the clock to assemble larger puzzles.

The challenge varies. In the Hard mode, strategy is key as you use power-ups to stop your opponent. Manipulating the pieces is an easy point-and-click operation, and Pieces is mouse compatible.

The graphics are similar to other puzzler games, and the 64 puzzles have nice variety. It would be great, however, to see this game as a CD with bigger puzzles.

Pieces is a nice variation in the endless stream of Tetris clones. It leaves you with a pieceful, easy feeling.

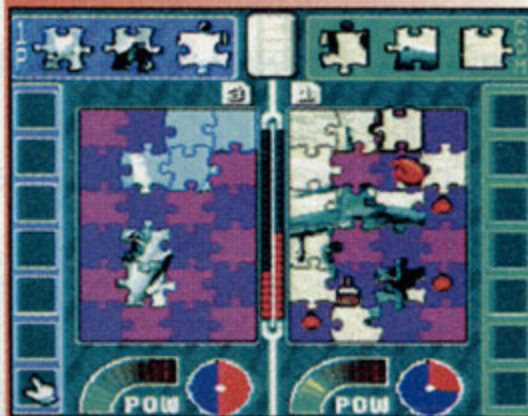

PROTIP: The Sweeper is one of the best power-ups. Wait until your opponent's puzzle has a lot of pieces, then zap 'em.

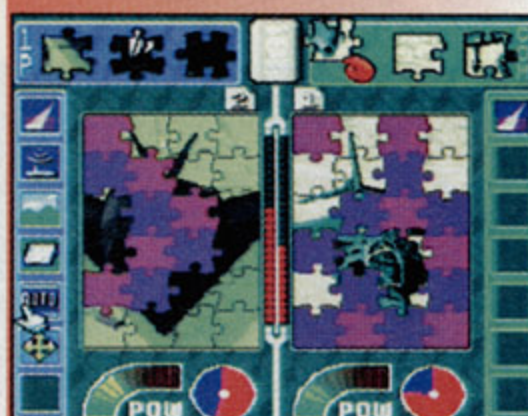

PROTIP: When you're stuck with unidentifiable pieces, hit Auto, and the CPU does all the work for you.

Pieces by Atlus

| Graphics | Sound | Control | FunFactor | Challenge |
|----------|-------|---------|-----------|-----------|
| | | | | |
| 4.0 | 3.0 | 3.5 | 4.5 | ADJ. |

\$59.99
Available now
Puzzler
2 players

Compatible with SNES Mouse
ESRB rating: Kids to Adults

Super NES

Wario's Woods

By Andromeda

This Tetris variation has some interesting innovations, but it's nothing new.

Wario's Woods boasts the usual Tetris features. Bombs and Monsters fall into a well, and you

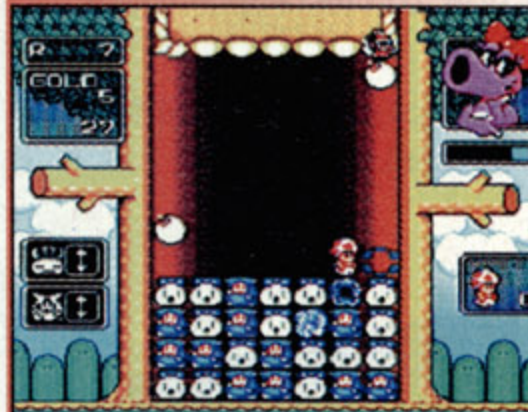

PROTIP: The bigger a diagonal match you make, the more the ceiling will raise.

must match them in rows before the well fills up. WW includes various power-ups and interesting means of sabotage.

The controls are somewhat tricky to master. In puzzlers, you want to focus on strategy, not on getting the pieces to go where you want.

The standard-looking graphics star cutesy animated characters



PROTIP: Match five or more Monsters and a diamond appears. Then make a match with the diamond to eliminate all similarly colored Monsters.

and Super Mario-style Bombs and Monsters. Although the music isn't bad, it's also not memorable.

WW's options give it play value, but its familiar play style makes it a ho-hum puzzler.

Wario's Woods by Nintendo

| Graphics | Sound | Control | FunFactor | Challenge |
|----------|-------|---------|-----------|-----------|
| | | | | |
| 4.0 | 3.5 | 3.0 | 3.5 | ADJ. |

\$49.95
8 megs
Available now
Puzzler

2 players
90 puzzles
ESRB rating: Kids to Adults

Super NES

Pinball Fantasies

By The Unknown Gamer

There are many great pinball video games available. Unfortunately, Pinball Fantasies isn't one of them.

On the positive side, Pinball Fantasies includes four pinball boards, each with a unique theme. That alone would be enough variety to keep pinball



PROTIP: Keep flippin' those flippers. The screen scrolls very quickly.



PROTIP: Flip the ball into the Vault on the left side of the Skull board for bonus points.

wizards amused if the game play weren't so bad.

Where to start? Although the responsive flippers are easy to control, the scrolling is so jerky and abrupt that control becomes irrelevant.

The unimaginative two-dimensional graphics prevent the ramps and obstacles on the boards from standing out against the backgrounds. Average dinks and doinks make up the sound-effects repertoire.

With other great pinball carts to choose from, Pinball Fantasies is nobody's dream come true.

Pinball Fantasies by GameTek

| Graphics | Sound | Control | FunFactor | Challenge |
|----------|-------|---------|-----------|-----------|
| | | | | |
| 1.5 | 3.0 | 2.5 | 1.0 | BEG. |

\$59.95
8 megs
Available now
Pinball
1 player

4 boards
Overhead view
Multiscrolling
ESRB rating: Not yet rated

Super NES

Lufia™

& The Fortress of Doom

Master Lufia & the Fortress of Doom, the game of classic confrontation between good and evil, with this 128-page strategy guide. The Lufia Official Players Guide gives you winning combat strategies, detailed guides to all the monsters in every locale, and hints to get you to the advanced levels.

By Ronald Wartow

ORDER NOW!

Get detailed tables and a step-by-step walk-through to help you beat the Sinistrals. Learn valuable navigation tips, combat strategies, and survival essentials!

by Ronald Wartow

Packed with profiles of the islands and monsters.

Lufia™

& The fortress of Doom

OFFICIAL PLAYERS GUIDE

Only \$9.95

Order Form

To Order:

Fill out product order form and mail to:

GAMEPRO
P.O. Box "P"
San Mateo, CA 94402

Check/Money Order VISA Master Card

Credit card No. _____ Expiration: _____

Signature: _____

Name: _____

Address: _____

Phone: (____) _____

City: _____

State: _____ Zip Code: _____

Please allow 2-3 weeks for delivery.

- Complete the Order Form
- Add shipping and handling (see chart)
- Add sales tax, residents of CA, IL, and NJ only (CA = 8.25%, IL = 6.25%, NJ = 6%)

| Qty. | Description | Unit Price | Total |
|-------------------------------|---|------------|-------|
| | Lufia & the Fortress of Doom Official Players Guide | \$9.95 | |
| ORDERS MUST BE PREPAID | | | |
| | | | |
| | | | |
| | | | |

| | | | |
|---------------------------------------|---------------------------------------|---------------------------------------|--|
| Shipping and Handling Charges | | | Subtotal |
| U.S. | Canada | Outside the U.S. | Sales Tax (CA=8.25%, IL=6.25%, NJ=6%) |
| \$4.00 each \$2.00 each additional | \$6.50 each \$2.00 each additional | \$9.95 each \$3.00 each additional | Shipping (see chart) |
| | | | Grand Total (U.S. dollars only) |

3DO

RETURN FIRE



By Manny LaMancha

Games that are unique and fun to play seem rare these days, but a little-known developer, Prolific Software, is about to strike gold with a war simulator that's both original and eminently playable.

Best with a Bullet

The story line is simple, if not sweet. The box states the goal is to "Demolish, devastate,



PROTIP: Quickly hit Down on the control pad to straighten out as you drive the jeep over a bridge.

desolate...destroy, destroy, destroy." You don't get a manual, but onscreen help covers the game's basics and the workings of the four vehicles (helicopter, tank, armored support vehicle, and jeep).

The game's controls are elementary. At worst, it'll take you a short time to become



PROTIP: Use the helicopter for initial surveillance. It can't go far without filling up, though, and it's also an easy target.

PROTIP: When you're in danger of losing a damaged vehicle, return to the bunker for repairs.

familiar with how each vehicle operates.

Return Fire is a combination of the best parts of playing Capture the Flag, Desert Strike, and Micro Machines. In each mission, you search for the tower with the enemy's flag, snag the flag with the jeep, and return it to your bunker.

All the while, you have to avoid your foe's armaments. Two-player action pits you similarly against a friend.

Razzle Dazzle

Return Fire's graphics really shine. A 3D angled-overhead

PROTIP: The beacon light in the jeep's snazzy radar system glows green as you head toward the enemy's flag. It glows red when you point toward your own bunker.



Two-player action pits one player against the other in a Capture the Flag scenario.



PROTIP: Watch for fuel and weapon depots in enemy territory to fill up your vehicle for more combat.



view of the battlefield changes relative to the speed of your vehicle. It would have been nice if you could customize the camera's perspective, but maybe a sequel will provide that feature.

With vivid sound effects, the audio is both striking and humorous. Classical standards play for each vehicle and synchronize with the action. For

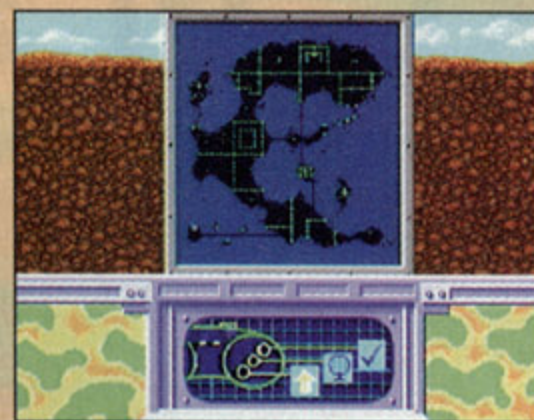

PROTIP: Before you head out, use the mission map to study the geography and the locations of the enemy.

instance, when you grab the enemy's flag with your jeep, the frantic trip back to the bunker is accompanied by "Flight of the Bumble Bee."

It's No Bomb

Return Fire's elegant design and amusing sense of humor make it an original addition to the 3DO library. Small touches, like a marker to show which of



PROTIP: The armored support vehicle is good for picking off the drones as they fly by. To target them, watch the green dot on the radar screen.

the 106 missions you've finished, would've made the game almost perfect.

Never mind, though – the gameplay is filled with cinematic flair that's generally reserved for cut scenes, and all of its elements are entertaining with little fluff. Who says war has to be hell? **G**

3DO Game ProFile

Return Fire

(By Prolific Software)



Fledgling 3DO developer Prolific Software shows that it's passed programming boot camp. This stunning combat simulator displays a great sense of history – and humor.

| Graphics | Sound | Control | FunFactor | Challenge |
|----------|-------|---------|-----------|-----------|
| | | | | |
| 4.5 | 5.0 | 5.0 | 4.5 | Advanced |

| | |
|---------------------|-----------------------|
| Price not available | Multiscrolling |
| CD | Passwords |
| Available now | Game save |
| War strategy | Not rated by the ESRB |
| 2 players | 3DO rating: 17 |
| 106 missions | |
| 3/4-overhead view | |

MAGICAL POPFUL MAIL™ FANTASY ADVENTURE

Action/Role-Playing!
CD Animation!

Three Characters.
Two Outlaws.
One Serious Mess.



Over 2 hours of dialogue!
The ultimate SEGA CD™!

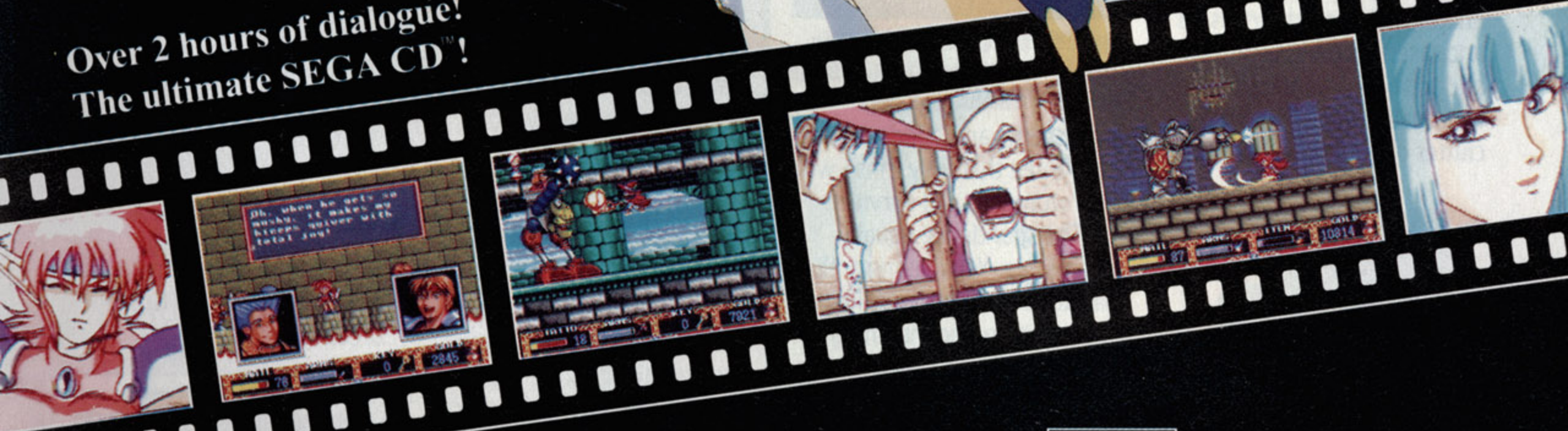

THIS OFFICIAL SEAL IS YOUR ASSURANCE THAT THIS PRODUCT MEETS THE HIGHEST QUALITY STANDARDS OF SEGA™. BUY GAMES AND ACCESSORIES WITH THIS SEAL TO BE SURE THAT THEY ARE COMPATIBLE WITH THE SEGA CD™ SYSTEM.



Our games go to 11!™

SEGA AND SEGA CD ARE TRADEMARKS OF SEGA ENTERPRISES, LTD. ALL RIGHTS RESERVED. Original Game (C) 1991 FALCOM, Reprogrammed Game (C) 1994 SEGA. English translation (C) 1994 Working Designs. "Popful Mail" is a trademark of Falcom. Twice the fun and half the fat of the leading brand! Licensed from Sega Enterprises, Ltd. by Working Designs, 18135 Clear Creek Road, Redding, CA 96001. For a dealer near you, call (916) 243-3417 ext. 190.



By Scary Larry

Tough shootin', great sounds, and superb graphics round out this awesome space shooter, which is based on Namco's arcade game. But the blade gets dull when you see how difficult this CD gets.

A Starblade Is Born

You're a hot Geo Sword pilot with a lust for alien blood, a lightning-fast ship, and a blazing laser cannon. Unfortunately-



3DO



PROTIP: Forget trying to battle these Land Tanks. Shoot the barrel-shaped bombs they toss.

STARBLADE



PROTIP: A dull thumping sound means you've found the weak spot. Fire away.

ly, that's it. You have no other aids, like power-ups for your cannon, and only three ships to play with.

The game pits you against everything that outer space has to offer, including some almost impossible-to-destroy enemies. Armored fortresses and laser-shooting asteroids add to the excitement and eventually to the frustrating clutter of Starblade. Your laser



| Starblade by Panasonic Software | | | | |
|---------------------------------|-------|----------------------------|-----------|--------------|
| Graphics | Sound | Control | FunFactor | Challenge |
| | | | | |
| 5.0 | 5.0 | 4.5 | 4.5 | Intermediate |
| \$59.95 | | 1 player | | |
| CD | | Cockpit view | | |
| Available now | | ESRB rating: Not yet rated | | |
| Shooter | | | | |

sight moves so much slower than the enemies that you better have your ship insurance paid up.

Blade Gunner

The view from the cockpit is dazzling. You choose either spectacularly filled polygon graphics or texture-enhanced graphics. Although your flight path is predetermined, dizzy-



PROTIP: You can't destroy this enemy. Just shoot the four huge bombs it sends your way.

ing ascents and sudden turns guarantee that only those with iron stomachs will survive.

The sounds are equally impressive. You're constantly barraged by intense cockpit chatter, including incoming enemy reports.

Starblade satisfies the jet jockey in all of us, but it also asks for intense luck and incredible timing in the bargain. This game definitely puts you at the business end of the Blade. **G**



By Scary Larry

Novastorm is as smooth as silk on the 3DO, but it suffers from the same fate as the Sega CD version: It's so easy that this 'Storm is just a squall.

There's Nova Business

As a pilot for the Scavenger Strike Squadron, you watched your world go up in flames. Now you're dying to take a stab at the Scarab X, the computer defense system that annihilated mankind.

You pilot your ship through four gorgeous extraterrestrial terrains: an ice planet, a desert planet, a lava planet, and finally, the space cruiser where the enemy hangs out. Your ship is equipped with a standard can-



PROTIP: The best power-ups are the Three Shot weapon and the Purple Cannon. Don't pick up other power-ups when you have these.



PROTIP: The Green Pods are protective power-ups; use them to blow through the enemy line.



PROTIP: Small explosions on the bosses indicate weak spots.

NOVASTORM

non and three screen-clearing smart bombs, and you can upgrade your ship through power-ups.

'Storm Drain

The graphics are spectacular. Smoothly scrolling terrain matches nicely with huge, showy mech-hybrid bosses. The enemy ships are varied and well animated, but some slowdown pops up when you face the bosses.

The music has a real Technotronic feel, but the funkified rhythms get ridiculous (in one part, you'll swear you hear a dog barking). The amplified

explosions are a treat.

Although it looks good and sounds all right, Novastorm is no hardcore shooter. You'll see bosses so often that it feels just like a real job. If you could get through StarFox on the SNES, you'll destroy this breezy 'Storm. **G**

| Novastorm by Psygnosis | | | | |
|------------------------|-------|----------------------------|-----------|--------------|
| Graphics | Sound | Control | FunFactor | Challenge |
| | | | | |
| 4.0 | 3.5 | 4.0 | 4.0 | Intermediate |
| \$54.99 | | 6 levels | | |
| CD | | Behind-the-ship view | | |
| Available now | | ESRB rating: Not yet rated | | |
| Shooter | | | | |
| 1 player | | | | |



By Scary Larry

Another digitized shooter? If you're wondering whether that means more first-person gun-fire, corny dialogue, and imprecise controls, wonder no more. It does.

Crime Doesn't Play

This time you're a rookie cop who's just as ambitious as your 12-shot pistol will allow. Starting as a loud-mouth patrolwoman, you advance to the sleazy Sergeant (complete with a shootout in a strip bar),

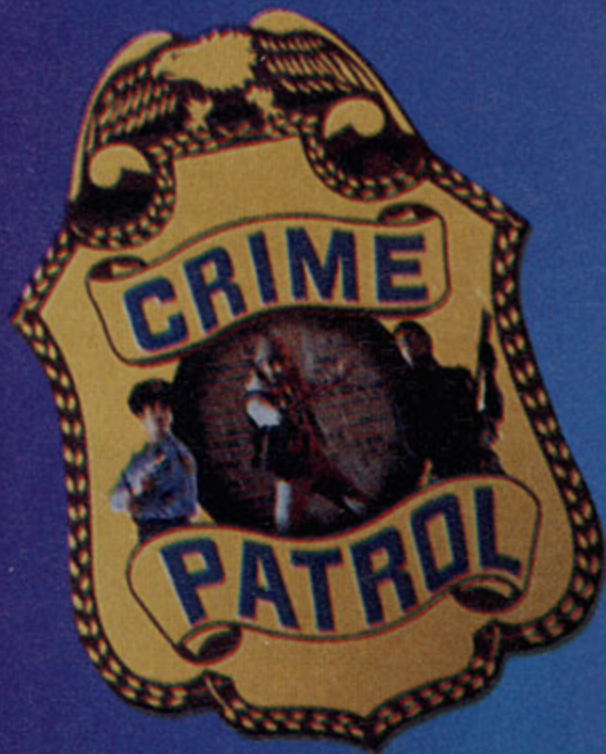

do some SWAT team work, and finally move on to a Delta Special Forces assignment. The object: Shoot bad guys, wait for the CD to load, and shoot again.

The aim using the controller is inaccurate. When life



PROTIP: Use at least ten shots before you reload. Some enemies leap out immediately after you down a bad guy.

Crime Patrol by American Laser Games

| Graphics | Sound | Control | FunFactor | Challenge |
|----------|-------|---------|-----------|-------------|
| | | | | ADJ. |
| 4.0 | 4.0 | 3.5 | 3.5 | Adjustable |

\$54.99
CD
Available now
Shooter
2 players

4 levels
First-person view
Not yet rated by the ESRB
3DO rating: 17



3DO



PROTIP: If you die, memorize the shooter's location. When you return, take a stray shot to line up your gun sight, then peg 'em.

and death hang on a split-second decision, the gun (sold separately) is a must. Even when calibrated, though, its aim is also not always true.

Digital Detective

The graphics serve up clean, sharp, digitized images of characters ranging from Mafioso bosses to gun-wielding strippers.

The backgrounds are amusing, especially in the strip joint, where no one



PROTIP: Watch out for the driver of the semi trailer. He gets up after you hit him once.

seems to duck when the bullets fly. Those strippers must be good.

The sound is your basic gun shot, accompanied by full dialogue that's so corny you'll wince. When you come across the few unintelligible phrases, you'll count it as a blessing.

If you like Lethal Enforcers or Mad Dog McCree, you'll be on the lookout for Crime Patrol. It's just a crime that nothing different was put into this game. **G**



By Scary Larry

Another Doom clone (and a badly made one at that), Iron Angel blends a sinister story line with some pretty impressive introductory graphics. Unfortunately, the gameplay never rises to the level of Doom.

Apocalypse Cow

Iron Angel suffers from one big problem - slowness - and several smaller flaws, like the lack of exciting enemies or secret areas. Although you see



PROTIP: If you enter a room and spy the exit, run for it, then turn around. You usually blow past any doorway-lurking enemies.

The gameplay is as simple as the premise. You find a gun, blast a lot of silly-looking enemies and leave.

You also find power-ups like shields and ammo clips, but you won't need too many because the enemies are few. You go from room to room

IRON ANGEL Of the Apocalypse



PROTIP: Hits don't register until you see sparks fly. You may have to back up to register a hit.

some eerie and provocative graphics in the introduction, you never see anything like that in the game.

Your task is to stop a mad scientist from creating a mechanized army of killing machines. The action takes place in his high-rise lab.



PROTIP: You can only hit these floor drones when they're in the air.

looking for the exit in a tedious maze of similarly styled areas.

Tin Angel of the Apocalypse

The sounds don't do any more justice to the game than the lame graphics do. You'll hear some basic explosions, but there's no speech during the gameplay.

Music? Again, just in the intro. If you could play the intro, this review would be very different.

Iron Angel is a moody, pseudodramatic Japanese tale that looks great in concept but fails in actual gameplay. You could say that this one was Doomed from the beginning. **G**

Iron Angel of the Apocalypse by Synergy

| Graphics | Sound | Control | FunFactor | Challenge |
|----------|-------|---------|-----------|--------------|
| | | | | INT. |
| 3.0 | 3.0 | 3.0 | 3.0 | Intermediate |

Price not available
CD
Available May
Shooter
1 player

6 levels
First-person view
ESRB rating: Not yet rated



By Manny LaMancha

Flashback is becoming a '90s classic as it moves to the more powerful consoles like the Jaguar. This is the original 16-bit game – no 3D graphics or first-person perspective here – but it still makes you eager to play it from one end to the other.

Have a Hart

Flashback details the adventures of Conrad Hart, which begin on the distant planet Titan. In *Total Recall* style, Conrad's odyssey begins when he discovers a message from himself. You trek through seven levels of aliens with Conrad and his trusty gun, journeying from Titan to Earth to the aliens' home planet.

The controls are intricate because Conrad has a lot of moves. Some key moves, such as the running long jump, are difficult to coordinate, so you won't always nail them. And sometimes Conrad doesn't jump when you press "jump," a shortcoming that costs you damage.

Walk the Walk

The game's distinctive look makes it stand out. Conrad's

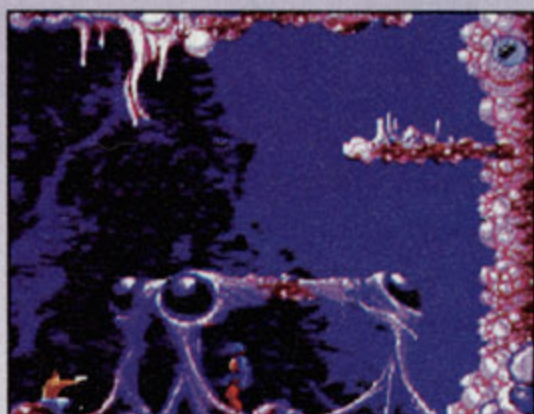

PROTIP: When the blob aliens on *Morph* start rolling, let them get close enough to stand but not so close that they harm you. Crouch and roll (push Down and to either side on the control pad) to move quickly from side to side.

moves, like those in *Prince of Persia*, are smoothly animated as he walks, runs, crouches, leaps, and reacts to getting shot.

Through rotoscoping – a technique by which a person is filmed and the footage is

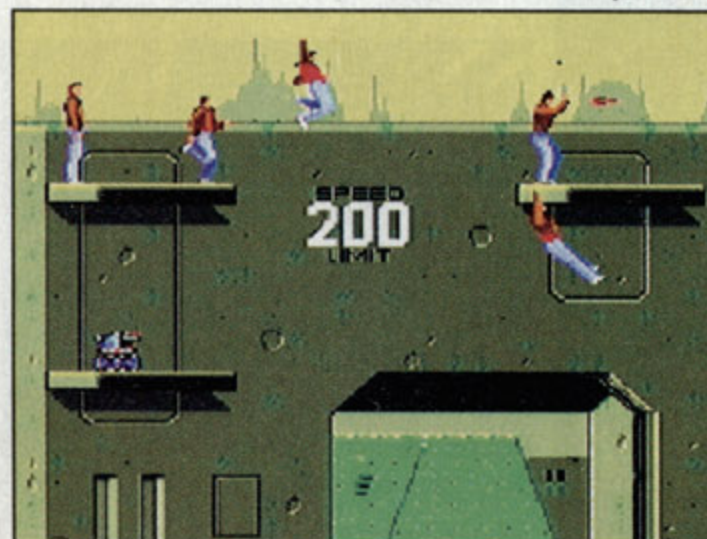

PROTIP: After the taxi leaves you at the *Paradise Club*, you must make a blind running long jump before moving on. Pull yourself up the ledge, then shoot out the orb and the glass window behind it to enter the Club.



turned frame-by-frame into computer graphics – the various characters move very realistically, drawing you into the game. You'll notice occasional slowdowns, which indicates this version is a straight port of the original game with little or no optimizing of the programming code.

The sounds are sparse, but you do hear ambient noises like



PROTIP: Shoot at one of the gunmen, then hit Button B to raise the force field and absorb your opponent's return fire.



PROTIP: Jump at spots like this one, or you'll get the shock of your life.

PROTIP: Don't be surprised when an enemy gunman seemingly comes back to life after a fall. He'll lie on the ground until you hit the floor he's on.

PROTIP: Rolling under an obstacle or below some gunfire is easier if you have your gun drawn.

chirping birds and Conrad's footsteps. The fact that you don't hear much, especially if you're isolated by a set of headphones, adds to the sense of impending danger.

Back to the Past

Although there's no improvement in Flashback's 64-bit stint, the game is no less enjoyable. Jaguar owners looking for decent games will welcome this cart.

If Flashback is new to you, by all means immerse yourself in its edge-of-the-seat gun play. If you've played Flashback previously, however, look elsewhere, because this cart is just...well, a flashback. **G**

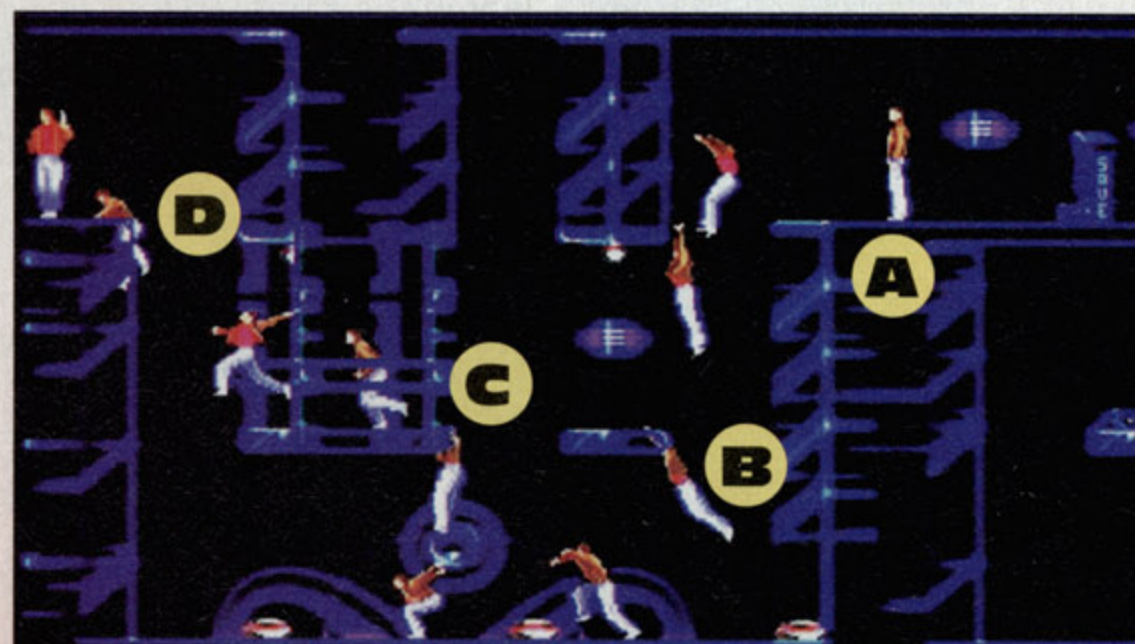

PROTIP: On Level Five of the *Death Tower*, stand one step inside the previous screen (A) and jump to catch the ledge at B. Before the falling mine blasts you, drop down. Leap over the land mine and climb up to C. Do the running long jump to run under the falling mine and leap up, then catch the ledge to pull yourself up to D.

Jaguar Game ProFile

Flashback

(By U.S. Gold)

K&A U.S. Gold didn't enhance Flashback in its move from 16-bit to the Jaguar, but the game's dark mood and sharp animation make this classic as enjoyable as ever.

| Graphics | Sound | Control | FunFactor | Challenge |
|----------|-------|---------|-----------|-----------|
| 4.0 | 4.0 | 3.5 | 4.0 | ADJ. |

Price not available
16 megs
Available March
Action/adventure
1 player

7 levels
Side view
Multiscrolling
Passwords

Your Fighting Combinations Don't Even Come Close To Ours.

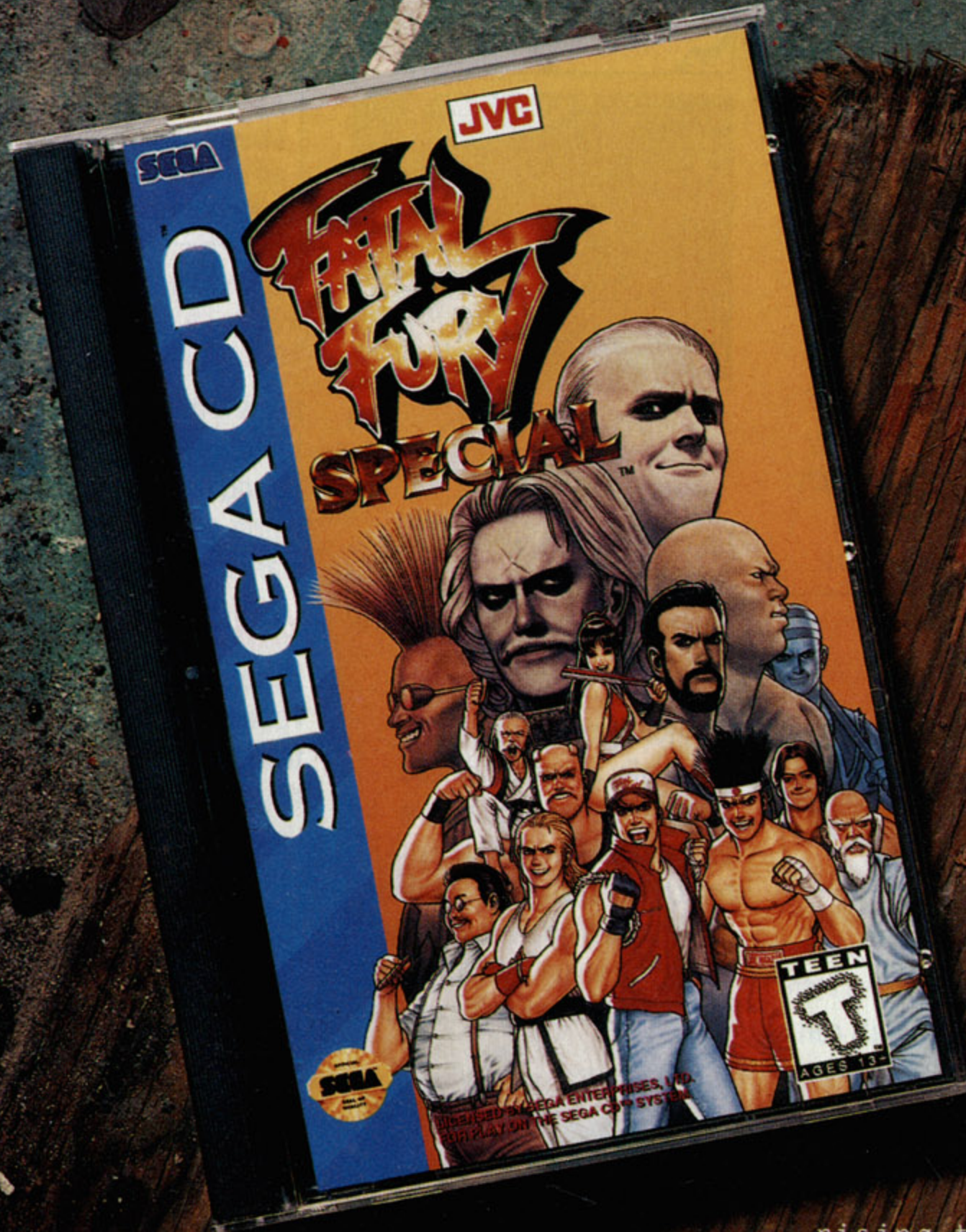

Jumping kick to low punch to rising tackle can be a fatal combination, but not even as close as this one. Introducing Fatal Fury "Legend of the Hungry Wolf," the video that is the perfect companion to Fatal Fury Special on Sega CD. Based on the best selling video game Fatal Fury, "Legend of the Hungry Wolf" introduces the characters in their true intent. The amazing Japanese animated fighting scenes will make your Fatal Fury battles look like kindergarten playground fights. With Fatal Fury Special on Sega CD, you will have the ultimate Fatal entertainment combination. The video sells for only \$19.95. For more info call Viz Video at (415)546-7073.

SNK

JVC
JVC MUSICAL INDUSTRIES, INC.

VIZ VIDEO

TEEN
T
AGES 13+

SEGA CD



SEGA AND SEGA CD ARE TRADEMARKS OF SEGA ENTERPRISES, LTD. ALL RIGHTS RESERVED. FATAL FURY SPECIAL™ ©1993 SNK Corporation of America. ALL RIGHTS RESERVED. Licensed by Sega Enterprises, LTD. For play on the SEGA CD™ System. Licensed by SNK Corporation of America. FATAL FURY SPECIAL is a registered trademark of SNK Corporation of America. Reprogrammed by JVC Musical Industries Inc. ©1994 Funcom; The Video Game Rating Council, its Rating System, symbols and indicia are trademarks of Sega of America, Inc. ©1993 SEGA. This videocassette is for private home use only. Exclusively licensed throughout the United States and Canada by Viz Communications, Inc. All rights reserved.

This official seal is your assurance that this product meets the highest quality standards of SEGA™. Buy games and accessories with this seal to be sure that they are compatible with the SEGA CD™ SYSTEM.

Jaguar

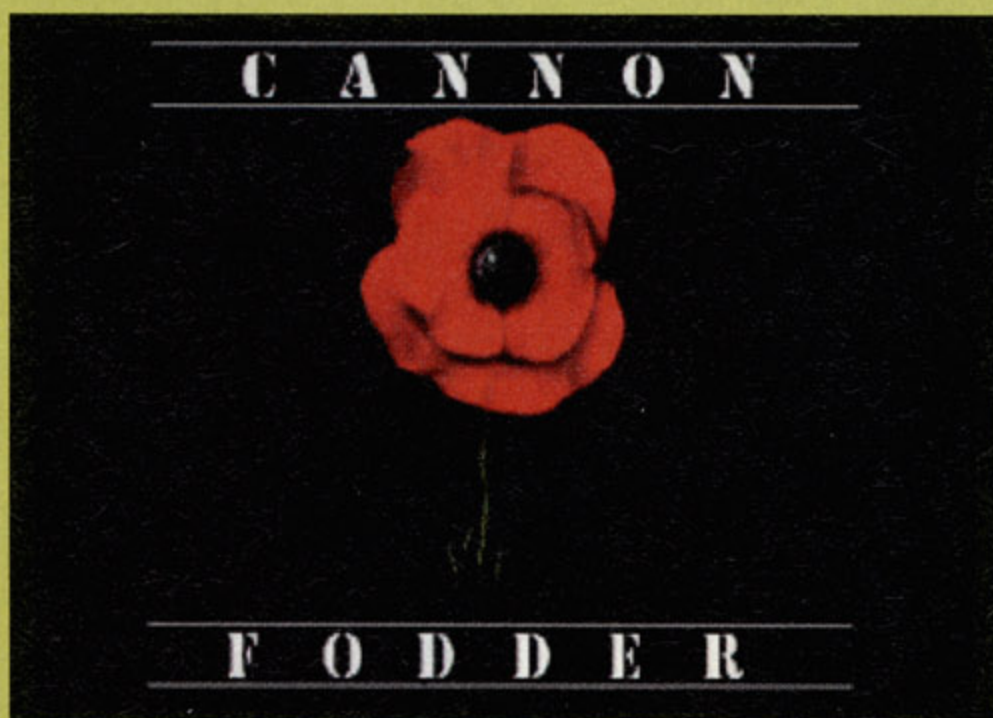

By Manny LaMancha

Many of us have played with toy soldiers, re-enacting elaborate battles on the nearest tabletop. Cannon Fodder, a game ported from the computer world, isn't too far from that. Although it has some flaws, the FunFactor and sheer addictiveness draw you in over and over.

Fodder of All Battles

Cannon Fodder provides an aerial view of the action that's enhanced with realistic sounds and blood spills. There's not much of a plot aside from that of any war: Do more damage to your foes than they do to you.

More than 24 missions – each broken up into as many as six phases – deal with such tasks as destroying enemy buildings and rescuing hos-



PROTIP: If enemies are coming, don't stand or walk in the darker water. You can't shoot from there.

tages. Armchair generals can move troops, fire weapons (such as rifles, grenades, and bazookas), and split up regiments for more complex maneuvers.

To move troops and fire weapons, you position the cursor and push a button. Of course, the computer-controlled opposition counters with similar abilities.



PROTIP: Enemy soldiers constantly exit a building until the roof is blown off, so toss a grenade as soon as you can.

This control mechanic is somewhat imprecise and slow, particularly during a heated battle – it was probably more direct in its computer incarnation under mouse control. Also, your troops often hang

ties. Sometimes it's like watching a war in an ant farm.

The sounds, on the other hand, are clear, featuring explosions, gunfire, and a variety of vivid screams and shrieks whenever a soldier



PROTIP: Hit one of the lower three buttons for a map with an overview of the terrain and your objectives.



PROTIP: Watch for fox holes that may allow enemy soldiers to ambush your troops.

up on obstacles when going around corners, which is annoying and not very intuitive.

Visiting Your Ants

Cannon Fodder's graphics, especially for an advanced system like the Jaguar, are very small. Granted, they match the computer version's, but it would've been nice to see some visual enhancement to match the Jaguar's capabili-

PROTIP: Know how far your gun shoots so you can take out an attacker when he's in range.

ties. The music is a bit repetitive, but it plays only during intermissions; during battle, the sounds of war are stark and somber.

War Is...Small

Despite its foibles, Cannon Fodder is a challenging contest that'll have you planning new strategies to overcome your failures. It's a tough game to master with an increasing difficulty that keeps you coming back for more. Best of all, it won't clutter your tabletop with casualties. **G**



PROTIP: In the Quicksand level, an arrow points to a mine. Avoid the mine altogether or shoot it away before you pass.

Battle Tactics

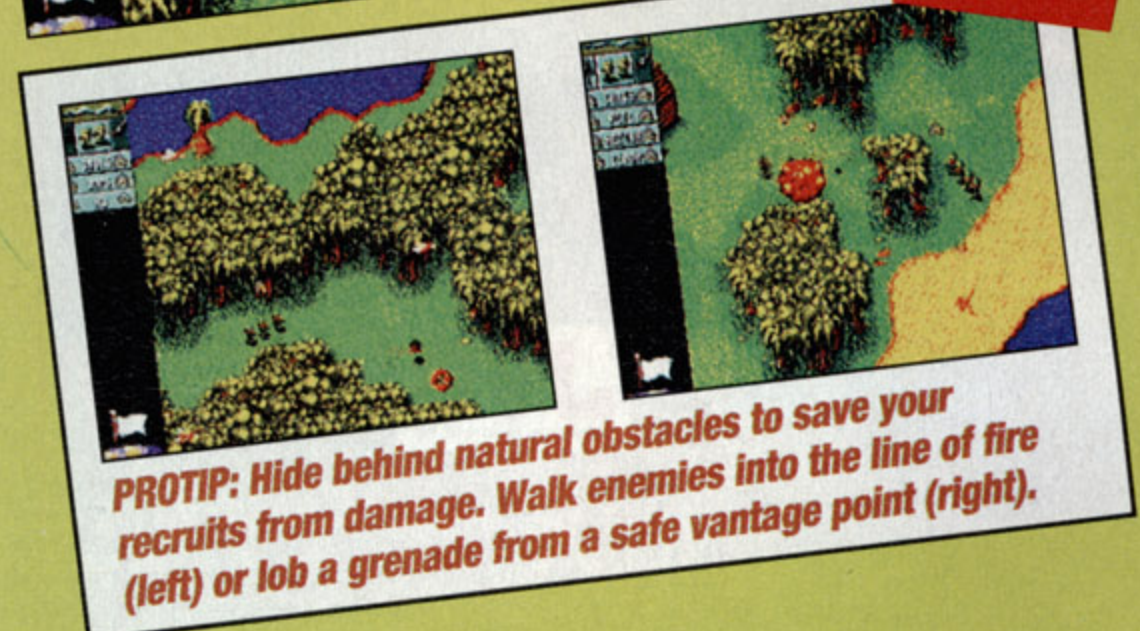

PROTIP: Hide behind natural obstacles to save your recruits from damage. Walk enemies into the line of fire (left) or lob a grenade from a safe vantage point (right).

Jaguar Game ProFile
Cannon Fodder
 (By Virgin/Computer West)

NOT YET RATED Although the graphics are teensy and the control's a tad sticky, Cannon Fodder is a challenging and entertaining battlefield contest that'll make you chuckle.

| Graphics | Sound | Control | FunFactor | Challenge |
|----------|-------|---------|-----------|-----------|
| | | | | |
| 3.5 | 4.5 | 3.5 | 4.5 | Advanced |

\$59.99
 16 megs
 Available now
 War shooter
 1 player

24 missions
 Overhead view
 Multiscrolling
 Game save

EARTHWORM JIM™

Special Edition



ONLY ON SEGA CD. EAT DESSERT.



NEW BIG BRUTY LEVEL • PASSWORDS • NEW WEAPON • EVERYTHING YOU WANTED TO EAT EXCEPT DIRT. LICENSED BY SEGA ENTERPRISES, LTD. FOR PLAY ON THE SEGA CD™ SYSTEM. SEGA AND SEGA CD ARE TRADEMARKS OF SEGA ENTERPRISES, LTD. ALL RIGHTS RESERVED. THE VIDEOGAME RATING COUNCIL, ITS RATING SYSTEM, SYMBOLS INDICIA ARE TRADEMARKS OF SEGA OF AMERICA, INC. © 1993 SEGA. EARTHWORM JIM IS A TRADEMARK OF SHINY ENTERTAINMENT • THIS OFFICIAL SEAL IS YOUR ASSURANCE THAT THIS PRODUCT MEETS THE HIGHEST QUALITY STANDARDS OF SEGA™. BUY GAMES AND ACCESSORIES WITH THIS SEAL TO BE SURE THAT THEY ARE COMPATIBLE WITH THE SEGA CD™ SYSTEM.

Interplay

Shiny
ENTERTAINMENT™



Basketball
Hockey, Soccer
Tennis, Golf
Baseball, Football

The Sports Page



Coach K and EA Sports Rank Number One

Coach K College Basketball



By Quick-Draw McGraw

Think you can coach in the NCAA? Here's your chance to learn from the master. Peer into the mind of Duke's head coach, Mike Krzyzewski (pronounced shu-SHEF-ski), with this exciting, feature-filled new rim-sim from the makers of NBA Live '95.

Hoops Heaven

This cart has more options than Duke has winning seasons. Up to four players can shoot the rock with 24 of the best teams in

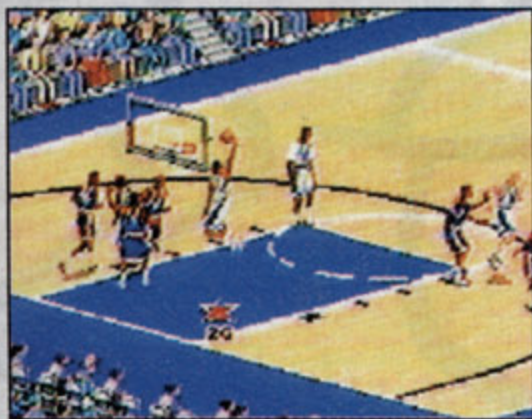

PROTIP: If you're looking for an alley-oop slam, watch for a player's hand to go up when he's near the key, then pass to him immediately.

today's NCAA and eight championship teams from the past. Play as defending champ Arkansas or relive Magic's glory days at Michigan State.

You can use these star-studded squads in an Exhibition game, take 'em through a full season, or



PROTIP: Double-team the opposing ball handler for a better chance at making a steal.



jump to the Final Four tourney. Try a stripped-down arcade-style matchup or a realistic simulation to determine if you have what it takes to be an All-American. To help you, Krzyzewski steps in with advice and team ratings.

Tear Down the Boards

The options pile up like Indiana jump shots. Whether you play or just coach, you can customize



PROTIP: Choosing a play is only half the battle. You must execute the play exactly as it's diagrammed for it to work.

your own rules and call your own offensive and defensive plays during the action. A battery backup enables you to save your team and player stats for up to three seasons at a time.

The decent controls are similar to other hoops carts – with a

few pluses. Along with alley-oop slams and a new style of free-throw shooting, there's pushing, shoving, and a turbo feature à la NBA Jam.

Slammin' and Jammin'

EA Sports uses the same style of graphics and sounds that made NBA Live '95 a solid game. (In fact, Coach K is to NBA Live '95 as Bill Walsh College Football is to its similar sibling, Madden '95.) Check out the realistic sprites and TV-style stat highlights, then listen to your player grunt and groan as



PROTIP: If you have a lane, go for the dunk.

he taunts the opponents after ripping down their backboard with a monster gorilla dunk.

Adjustable difficulty settings complete Coach K's slam dunk.



PROTIP: When shooting, plant your feet for a high-percentage bucket.



Keep track of important stats with these highlights.

With seven trips to the tournament semifinals under his belt, Krzyzewski knows his stuff, and so does EA Sports – this game takes Dick Vitale's College Hoops to the hole. A great combo of features and gameplay make this freshman cart a winner. **G**



PROTIP: If you decide to keep Fatigue on, use it sparingly. It'll run out fast, and you'll get burned.

| Coach K College Basketball By EA Sports | | | | |
|--|---------|---------------|-----------------------------|------------------------------|
| Graphics | Sound | Control | FunFactor | Challenge |
| | | | | ADJ. |
| 4.5 | 4.0 | 3.5 | 4.5 | Adjustable |
| \$59.95 | 16 megs | Available now | Basketball | 4 players (using 4 Way Play) |
| | | | Angled-overhead view | Battery backup |
| | | | ESRB rating: Kids to Adults | |

All-Star Hockey Not Too Stellar

NHL All-Star Hockey '95
Genesis

By Bacon

Lately, the stores have been flooded with hockey titles trying to mimic the success of EA Sports' NHL series. They've all ended up being pretenders to the throne, and NHL All-Star Hockey is no exception. Despite its well-detailed graphics, All-Star's disappointing controls and feeble options drag this game to a screeching halt.

Fight!

Chase down the puck with standard gameplay modes like Exhibition, Playoff, and Full Season. All-Star's rosters and schedules are based on this year's season,



PROTIP: The stick check (Button A) is the most effective way to take down an opponent.



PROTIP: In this game, merciless checking makes for sound defense.

and the teams sport real names and real players.

A decent offensive repertoire, including a one-timer, is complemented by a strong array of defensive moves like stick checks, holds, and trips. Best of all, Sega Sports corrected one of NHL '95's biggest shortcomings: the lack of fighting. Deck your



PROTIP: To scam an easy goal, hang out in front of the opponent's net. When the goalie tries to pass, snatch the puck and pop it in.

opponent one too many times, and you'll have a blast settling your differences with an impressive variety of punches, elbows, and shirt grabs.

Penalty Box

Unfortunately, the remaining features aren't as dazzling. Many gamers will be disappointed by the lack of a two-player cooperative mode, not to mention the absence of four-player action. Realistic touches, like drop passes, a Shootout mode, and the ability to trade and create players, were also left in the locker room.

Even worse, the choppy, erratic controls leave you stranded. Pushing a button doesn't always elicit an immediate response, and

the excessively easy passing robs the game of one of hockey's most rewarding challenges.

This cart doesn't provide much deep, strategic action, either. The CPU's an easy-to-fool chump, and the molasses-like pace doesn't approach hockey's true speed.

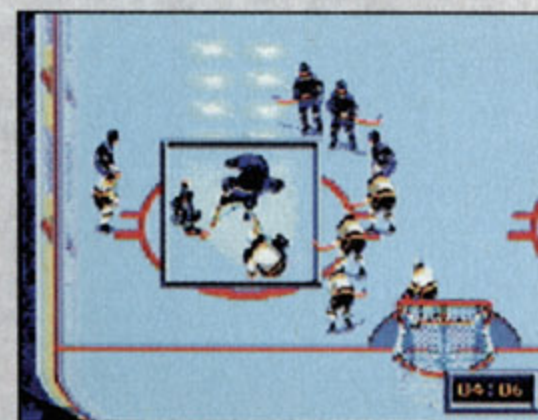

PROTIP: In face-offs, wave your stick a few times, then remain still. If you press Button B when the puck hits the ice, you'll almost always take possession.



PROTIP: Circle around the net and pass to the center for a one-timer that'll surprise the goalie.



PROTIP: Picking up the rebound from a slap shot is your best chance at a goal.

Don't Move

The sharp graphics show off a good-looking rink and large, realistic, beautifully detailed sprites. But once the action begins, the stiff animation makes you feel like you're skating in a straight-jacket. Announcer Marv Albert calls the game, nicely pacing the action with colorful commentary. Unfortunately, his voice – and the flat, computerlike sound effects

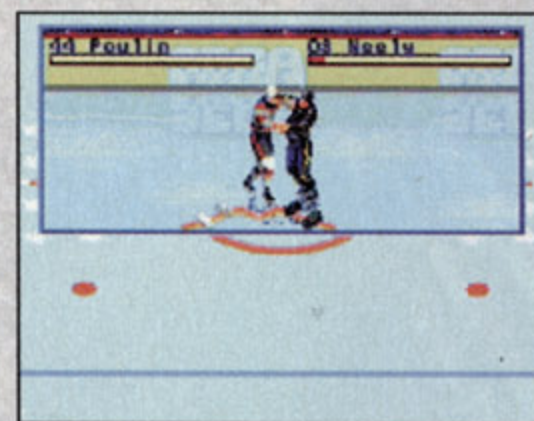

PROTIP: When fighting, crush your opponent by grabbing his jersey and elbowing him in the head.

and music – are often layered with white noise.

Some fun can be extracted from this cart, but it lacks the depth that's necessary for a long-lasting challenge. Unless you care more about fighting and graphics than solid controls and gameplay, you'll skate right by this rink. **G**

| NHL All-Star Hockey '95 by Sega Sports | | | | |
|--|---------|---------------|----------------|-----------------------------|
| Graphics | Sound | Control | FunFactor | Challenge |
| 4.0 | 3.0 | 2.0 | 3.5 | INT. Intermediate |
| \$64.99 | 16 megs | Available now | Hockey | 2 players |
| | | Overhead view | Battery backup | ESRB rating: Kids to Adults |



The most
brilliant elements
in DESIGN
are often
the most supportive.



See.



Double Cross

Inspired by the soaring strength of La Saint Chapelle's flying buttresses, we came up with yet another revolutionary idea: rather than conventional lace-up design, why not multi-functional support straps. Not only would they literally lock feet into position, they'd provide more efficient support for the ankle. The result, as any cross-trainer can tell you, is clearly inspiring.



change
the GAME™

Konami Soccer Comes Close

International SuperStar Soccer



By Athletic Supporter

If you're gonna talk the talk, you'd better be able to walk the walk. Instead of avoiding comparisons with the best SNES soccer simulation around (EA Sports' FIFA International Soccer), Konami challenges them with its latest soccer sim, the solid International SuperStar Soccer.

Konami's soccer ranks among the best soccer games, but it's still a runner-up to FIFA. ISS just doesn't have those extra features or attention to detail that would dethrone FIFA. Still, ISS



PROTIP: Dribble to the right side of the penalty box to draw the keeper out of the goal. As he comes toward you, shoot the ball to the left post.

does have lifelike graphics, above-average sound and controls, and enough interesting options to keep you entertained and playing for hours.

Shoot Around

ISS features the top 24 soccer-playing countries in the world, including the U.S. and Brazil, World Cup champ. You can play an exhibition match between any two countries or enter a world tournament.



PROTIP: Blast the ball downfield when your defense is overwhelmed.

ISS's best feature is probably its Training mode. It not only gives you hands-on experience for a regular match, but it also offers valid competition, which juices things up as you practice all of ISS's controls.



PROTIP: When you're making a run on the goal, press Button X for extra speed to get past a defender.

You'll need to practice these controls — they aren't great. For instance, the computer isn't quick enough when switching players on defense. Often you'll find yourself one or more steps behind when the computer finally gives you control of your defender. You also can't control the flight of the ball on your shots as well as you can on other soccer carts, including FIFA.

Get Your Kicks

The graphics, especially of the players, are super. Konami claims its players are 20 percent larger than the competition, and they look it.

The sprites are sharply detailed, and you can actually tell the difference between individual



PROTIP: Each player is rated in several categories, so let your forwards take the shots. They'll score more often than a fullback.

players. Check out the hair on a couple of players, including one fullback who's supposed to be Alexei Lalas. The lifeless stadium and fans are the only graphical shortcomings.

The sound isn't ISS's best feature. In fact, the average crowd



PROTIP: This game rewards passing. If you're on one side of the penalty box, press Button B to pass the ball to the other side of the box and quickly shoot before the keeper recovers.

noises and player groans are barely worth mentioning.

If you're looking for the best soccer sim, check out FIFA. But if you're looking for a new face or the next best thing, try International SuperStar Soccer. You can get plenty of kicks with ISS. **G**



PROTIP: You don't have to tackle an opponent to gain control of the ball. Just get in front of the player with the ball, and your defender will automatically steal.



PROTIP: If you're playing as the U.S., select "Counterattack" under Tactics. This strategy best suits the American team.

INTERNATIONAL SUPERSTAR SOCCER

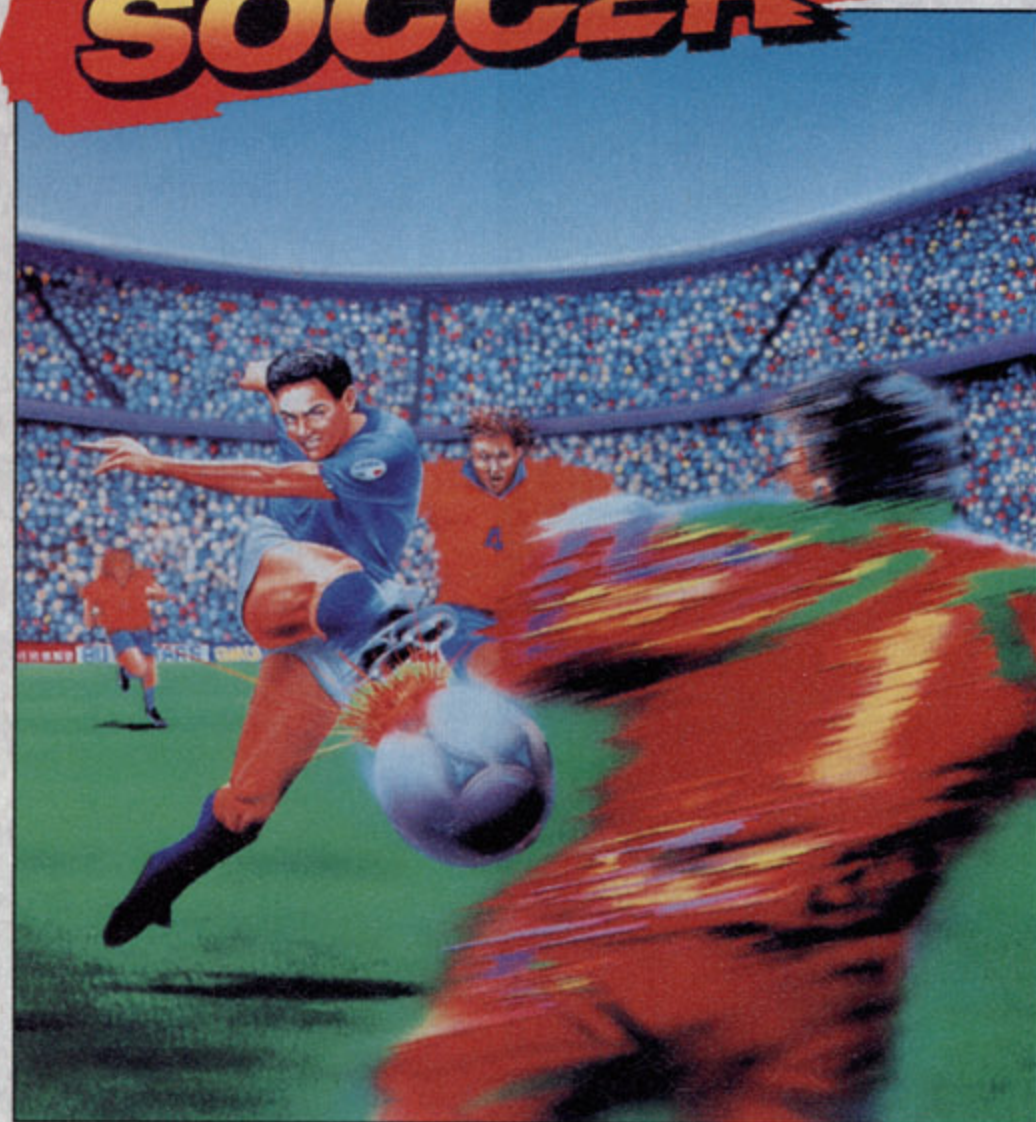

International SuperStar Soccer By Konami

| Graphics | Sound | Control | FunFactor | Challenge |
|---------------------|-----------------------------|---------|-----------|---------------------------|
| 4.0 | 3.5 | 3.5 | 4.0 | ADJ. Adjustable |
| Price not available | Angled-overhead view | | | |
| 8 megs | Passwords | | | |
| Available now | ESRB rating: Kids to Adults | | | |
| Soccer | | | | |
| 2 players | | | | |

ATP Tennis Scores An Ace on Genesis

ATP Tour Championship Tennis Genesis

By Ben D. Rules

With ATP Tour Championship Tennis, Sega Sports' running battle with EA Sports takes to the courts. ATP scores a decisive win over EA's recent IMG International Tennis Tour.

Love Match

Options galore and good gameplay make ATP the winner in the battle of video-tennis alphabets. In addition to all the expected

easy to play. Various speeds of serves, volleys, lobs, and slices are all at your command. The only problem with the controls is the occasional difficulty in gauging the ball's position: When airborne, the ball gets bigger, then shrinks down to hit the court, which sometimes distracts you more than it helps you.

Deuce

The game breaks even with the graphics and sounds. The distinc-

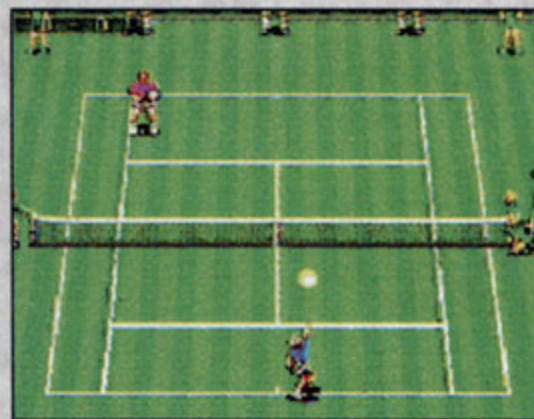

PRO TIP: After your opponent faults on his first serve, move your player forward for the slower second serve.

tive players look good and are personalized with clear head shots. The sounds, however, are marred by the kind of garbled speech you'd hear underwater.

One big plus is ATP's adjustable difficulty. Set Speed

to "Extremely Slow" and the Ball Bounce Pointer to "On," and you have a tennis game for beginners who are eager to play their way up to the championships. Good tennis at all levels makes ATP A-Okay. **G**

| ATP Tour Championship Tennis By Sega Sports | | | | |
|--|---------|---------------|-----------------------------|-------------------------------|
| Graphics | Sound | Control | FunFactor | Challenge |
| 4.0 | 2.5 | 4.0 | 4.0 | ADJ. Adjustable |
| \$59.99 | 16 megs | Available now | Tennis | 4 players (using Team Player) |
| | | | Overhead view | Battery backup |
| | | | ESRB rating: Kids to Adults | |

Links CD Makes the Cut

Links Sega CD

By Tommy Glide

Break out the plaid pants and step onto the fairways of the famous Torrey Pines South course. While Links plays like your average behind-the-golfer game, it has a few exclusive features that separate it from everyday public courses.

No Caddy, No Cart

There's a lot of game here. Originally a popular PC title, Links gives you front-nine, back-nine, and 18-hole tournaments. You



PRO TIP: Study the ratings to see whether your star is a baseliner or a serve-and-volley player. Rocket Rod Laver is given the best all-around ratings.

options (like different surfaces and match length), you get novelties like Upset Factor, which increases a weaker player's chances.

Up to four players compete with 32 contemporary stars, such as Pete Sampras, and eight legends, such as Rod Laver. You can also create your own player and match him up against the greats.

Once you practice the different strokes, this game is fairly

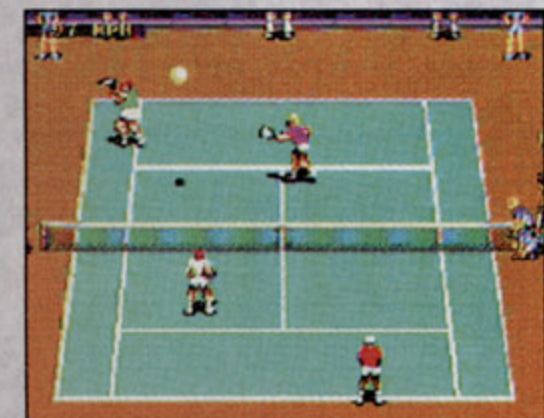

PRO TIP: Try to keep your players spread out in doubles matches.



PRO TIP: The Mulligan option enables you to retake a shot without adding a stroke. It's a great practice tool, and you can use it to cheat (when your friends aren't looking) and retake a bad shot.

easy-to-use menu board.

The sound quality also lowers your handicap. The music is light, and you're spurred along by some decent commentary from Ben Wright and course advice from pro golfer Steve Elkington.

Greens and Blues

Golf gamers will recognize the familiar 3/4-circle gauge that determines the power and accuracy of your swing. While it gives you accurate control over fairway shots, the putting is a little sticky, and the optional surface grid doesn't do much to differentiate the slope of the green. Each shot takes time to load, but not as much as if you really had to walk to the ball.

Compatible with the TeeVee Golf controller (sold separately),



PRO TIP: When an obstacle blocks your view, switch to the overhead view to find the hole and use the measuring stats to gauge your shot.

Links is easy to command. And with individual skill settings, beginners can compete with any joystick Jack Nicklaus. If you golf and own a Sega CD, hit the Links, and you won't have to replace your divots. **G**



PRO TIP: When faced with hard doglegs like this one on the sixth hole, move your aiming pin to a good position down the fairway.

also have driving and practice options to sharpen your skills.

Graphics get a birdie. Links provides sharp course detail, video replay, and full-motion-video fly-bys of each hole. The game's good visuals are framed by an

| Links by Virgin | | | | |
|---------------------|-------|---------------|--|-----------------------------|
| Graphics | Sound | Control | FunFactor | Challenge |
| 4.0 | 3.5 | 3.0 | 3.5 | ADJ. Adjustable |
| Price not available | CD | Available now | Golf | 6 players |
| | | | Multiple views | Multiscrolling |
| | | | Compatible with TeeVee Golf controller | ESRB rating: Kids to Adults |
| | | | 1 course (18 holes) | |



Super Bases Loaded 3 Steals Home

Super Bases Loaded 3: License to Steal

Super NES

By Quick-Draw McGraw

The third time's a charm with Super Bases Loaded 3: License to Steal. This popular series, which originated on the NES, will intrigue baseball enthusiasts who enjoy stat-filled, control-all simulations.

Controlled Action

A definite must for a good baseball cart is the ability to customize your



PROTIP: Mix up your pitches to fool tough major-league hitters.



PROTIP: If you have hitting set on Manual, adjust your swing and stance for maximum power.

options. SBL 3 lets you automate almost every aspect of the game. Try auto-fielding and running while letting the computer hit, or vice versa – you have plenty of combos to experiment with.

Check the stats, adjust your lineup, and play ball in an exhibition game, a season, or a championship tournament. Choose an MVP game, and the computer will select a lineup of the league's best stars. Now those are options!

The controls are excellent. Adjusting your stance and swing at the plate and choosing each pitch on the mound gives you a feeling of control that most ball carts lack.

Around the Horn

The sounds and graphics are inconsistent. The music is annoying and the sound effects are few, but the sprites and the action are clear, colorful, and realistically presented with a great view from the mound. What other baseball game shows you what

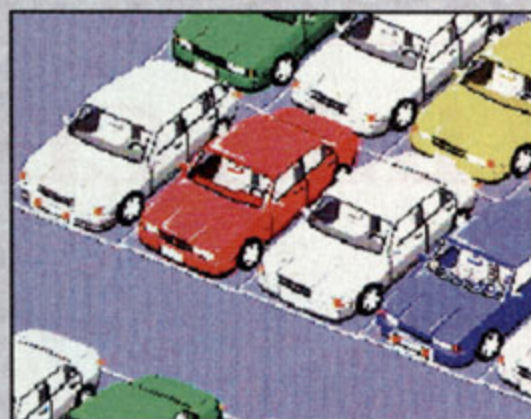

Parking lots are so unsafe these days. It's safer to take the bus.

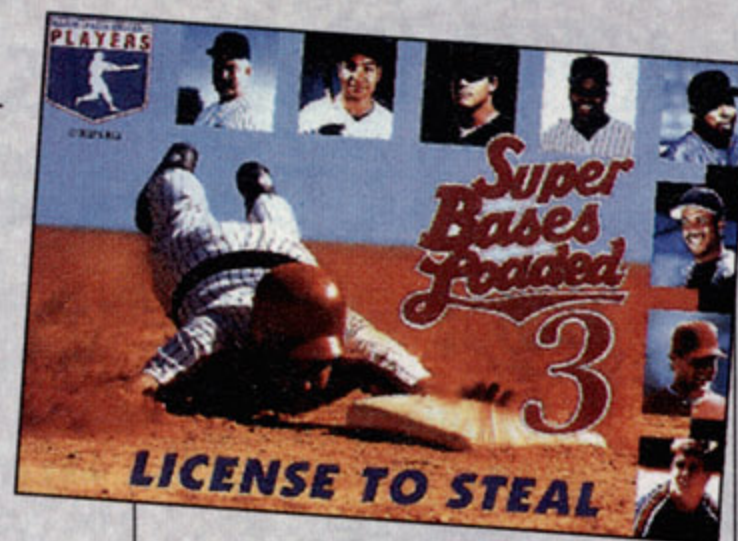

really happens when a homer leaves the stadium and lands in the parking lot?

Nice graphics and a stadium full of options make SBL 3 a solid contender against Super RBI. The Bases Loaded saga continues. **G**

| Super Bases Loaded 3: License to Steal | | | | |
|--|-------|-----------------------------|-----------|-------------|
| By Jaleco | | | | |
| Graphics | Sound | Control | FunFactor | Challenge |
| | | | | ADJ. |
| 4.0 | 3.0 | 4.0 | 4.0 | Adjustable |
| Price not available | | Multiple views | | |
| 16 megs | | Passwords | | |
| Available March | | ESRB rating: Kids to Adults | | |
| Baseball | | | | |
| 2 players | | | | |

Super RBI a Strong Contender

Super RBI Baseball

Super NES

By Quick-Draw McGraw

From arcade to 8-bit to 16-bit, the RBI games have been some of the most complete baseball carts ever. Back for '95, Super RBI has everything that made it great in the past, though it's not perfect.

These Guys Don't Strike

Options, options, options. As if 700 real major-league players and



PROTIP: Hold Down on the controller for a better chance to hit a fly ball. Use this tactic in the Home Run Derby.

all 28 of their respective teams weren't enough, Super RBI also throws in every divisional winner since '88 and a bunch of all-star



PROTIP: Jump at the wall when a homer is barely going over. You might just spear it.

rosters with every stat you could ever need.

Use player ratings to determine your lineup for a regular game or a best-of-seven series and create your own dream team. Relive classic moments in Game Breakers mode or swing for the fences in the exciting 20-pitch Home Run Derby.

Unfortunately, there's one big "E" in this game's score book. With the great control in previous RBIs, Super's poor controls are surprising. The very slow reaction time to button presses complicates the game's confusing controls.

The Green Monster Lives

As is typical in the RBI carts, the graphics and sound are clear and have a comical side. Finely detailed stadiums and cartoony



PROTIP: Constantly move around in the batter's box to fool the pitcher into throwing a bad pitch.

animations highlight the show, while the familiar music and umpires wail in the background.

With more features than any other baseball cart, Super RBI should've been serious competition for excellent games like World Series Baseball. Too bad the controls undercut that potential. Still, with a series as popular as RBI, can a 32- or 64-bit version be that far away? **G**

| Super RBI Baseball | | | | |
|----------------------------|-------|----------------------------|-----------|-------------|
| By Time Warner Interactive | | | | |
| Graphics | Sound | Control | FunFactor | Challenge |
| | | | | ADJ. |
| 4.0 | 3.5 | 2.5 | 4.0 | Adjustable |
| \$49.95 | | Multiple views | | |
| 8 megs | | Passwords | | |
| Available now | | ESRB rating: Not yet rated | | |
| Baseball | | | | |
| 2 players | | | | |



Madden Scores on The Game Gear

Madden NFL '95



By Tommy Glide

The Madden cart series for the Genesis has long been considered a sporting sensation. But not even Ultra Slimfast could squeeze a topnotch Madden cart into the Game Gear.

Pigskin Portable

The authoritative announcer makes his Game Gear debut in Madden NFL '95, bringing with him many 16-bit options, includ-

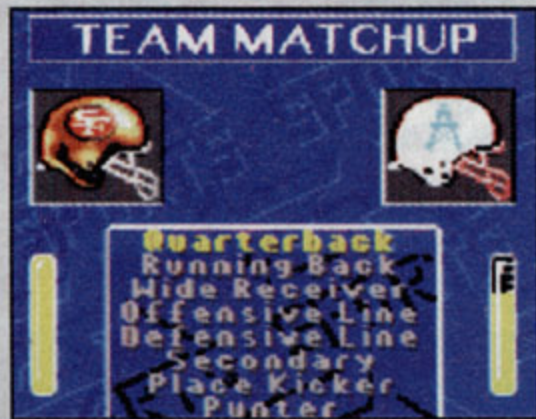

PROTIP: When you're just learning the game, select a strong team for yourself and a weaker team for your opponent.

ing Exhibition, Playoff, and Full-Season modes. You get the usual overhead view, passing windows, audibles, all 28 NFL teams, and an All-Madden squad. Each team



PROTIP: When playing a strong passing team, you can throw into coverage with a greater chance of making the completion.

has an inventory of plays nearly as large as the 16-bit version's. What keeps this Madden from scoring big is the graphics. The small players and small play diagrams will definitely make you squint. While size is a big problem, the graphics do show some pleasing details.

The sound is clean, and some of the "Maddenisms" remain with a surprising amount

of digitized speech. However, the sound effects are sparse in comparison to the 16-bit carts; the tackling noises are weak, but the ref's whistle is the real deal.

Headed for The Playoffs

Thanks to the good controls, the gameplay is just as fast as it is in the Genesis version. You can execute speed bursts and spin moves on offense and



PROTIP: On sweeps, really pump the speed burst when turning the corner to pick up extra yards.

raise your arms to block passes on defense.

As a one-player game, Madden '95 can't give you the thrill of two-player football. Although it's the best football game available for the Game Gear, only real foot-

MADDEN NFL 95

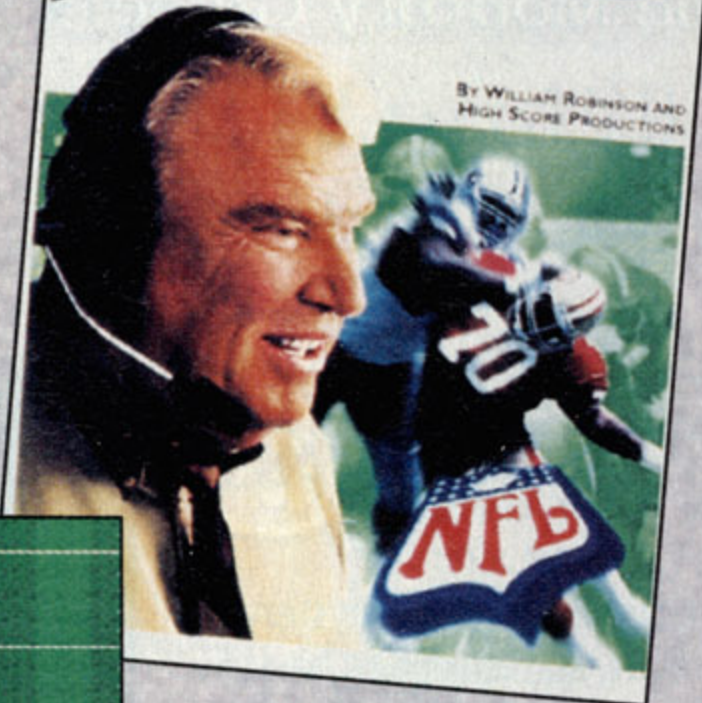

ball freaks who want gridiron portability will get their money's worth here. **G**

| Madden NFL '95 by EA Sports | | | | |
|-----------------------------|-------|---------|-----------|-----------------------------|
| Graphics | Sound | Control | FunFactor | Challenge |
| 3.0 | 3.5 | 3.0 | 3.5 | INT. |
| \$39.95 | | | | Overhead view |
| 4 megs | | | | Forward scrolling |
| Available now | | | | ESRB rating: Kids to Adults |
| Football | | | | |
| 1 player | | | | |

Advertisement

GAME PRICES SLASHED

Price also SLASHED on software for CD-I, PC, and Turbo Duo systems.

Super Nintendo

| | | |
|----------------------------------|---------------------|----------|
| Battle Clash (For Super Scope) | \$ 54.99 | \$ 14.88 |
| Demon's Crest | \$ 69.99 | \$ 29.88 |
| Illusion of GAIA | \$ 74.99 | \$ 39.88 |
| Jurassic Park 2 | \$ 64.99 | \$ 29.88 |
| Lion King | \$ 69.99 | \$ 34.88 |
| Maximum Carnage | \$ 69.99 | \$ 34.88 |
| Michael Jordan | \$ 64.99 | \$ 24.88 |
| NHL '95 | \$ 59.99 | \$ 29.88 |
| Pagemaster | \$ 59.99 | \$ 19.88 |
| Shaq Fu | \$ 64.99 | \$ 19.88 |
| Ultima Runes of Virtur | \$ 69.99 | \$ 29.88 |
| Yoshi's Safari (For Super Scope) | \$ 54.99 | \$ 14.88 |

And Hundreds More!

Sega Genesis

| | | |
|------------------------|---------------------|----------|
| Baseball 2020 | \$ 54.99 | \$ 14.88 |
| FIFA '95 | \$ 64.99 | \$ 29.88 |
| Jurassic Park: Rampage | \$ 59.99 | \$ 29.88 |
| Lethal Enforcers 2 | \$ 54.99 | \$ 24.88 |
| MLBPA Baseball | \$ 54.99 | \$ 14.88 |
| Mickey Mania | \$ 69.99 | \$ 24.88 |
| NHL '95 | \$ 64.99 | \$ 29.88 |
| PGA Euro Tour Golf | \$ 59.99 | \$ 19.88 |
| PGA Tour Golf 3 | \$ 64.99 | \$ 29.88 |
| Shaq Fu | \$ 64.99 | \$ 19.88 |
| Tecmo Baseball | \$ 69.99 | \$ 24.88 |
| Tecmo Super Bowl | \$ 69.99 | \$ 14.88 |

And Hundreds More!

Sega CD

| | | |
|--------------------|---------------------|----------|
| Sega CDX | \$399.99 | \$329.88 |
| Sega CD Rom II | \$229.99 | \$189.88 |
| FIFA Soccer | \$ 54.99 | \$ 19.88 |
| Lethal Enforcers | \$ 79.99 | \$ 19.88 |
| Lethal Enforcers 2 | \$ 49.99 | \$ 24.88 |
| Masked Rider | \$ 59.99 | \$ 24.88 |
| Terminator | \$ 59.99 | \$ 19.88 |

And More!

Jaguar

| | | |
|---------------|---------------------|----------|
| Bubsy | \$ 49.99 | \$ 24.88 |
| Club Drive | \$ 59.99 | \$ 29.88 |
| Tempest 2000 | \$ 59.99 | \$ 34.88 |
| Trevor McFur | \$ 49.99 | \$ 24.88 |
| Wolfenstein | \$ 59.99 | \$ 24.88 |
| Jaguar System | \$249.99 | \$219.88 |

And More!

Game Boy

| | | |
|------------------|---------------------|----------|
| Mortal Kombat II | \$ 39.99 | \$ 19.88 |
| WWF RAW | \$ 34.99 | \$ 14.88 |

And More!

Hurry! Supplies Are Limited.

Call Now To Order

1-800-262-7462

Or Request a Catalog.

Available By Mail Order Only. Add \$5 for Shipping & Handling. Offer expires 4/30/95. Credit Card Purchases Only. Limited to Stock on Hand. All Sales Are Final.

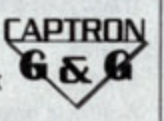

Role-Blayer's Realm

The Monthly Guide to the World of Role-Playing Games · March '95

Ultima VII: The Black Gate

By Leonardo da Video

The Avatar returns! It's 200 years after the last Ultima, and mystery, intrigue, and adventure are still ever-present in Britannia.

Calling All Avatars

After receiving a televised challenge from a mysterious being called the Guardian, the Avatar returns to Britannia to learn that a mysterious, seemingly beneficial organization called The Fellowship has



PROTIP: When first starting out, you can't take any hits, so save your game after each battle until you start gaining levels.



PROTIP: Chests replenish themselves when you leave a location, so collect their contents again by returning to them.

| Ultima VII: The Black Gate by FCI | | | | |
|-----------------------------------|--------|----------------|----------------|------------------------|
| Graphics | Sound | Control | FunFactor | Challenge |
| | | | | INT. |
| 3.5 | 3.0 | 4.0 | 3.5 | Intermediate |
| \$64.99 | 8 megs | Available now | Fantasy RPG | 1 player |
| ¾-overhead view | | Multiscrolling | Battery backup | ESRB rating: Not rated |



PROTIP: When the screen starts to turn black, it's night. Torches provide light, but the Illumination spell lights up the entire screen.

infiltrated nearly every facet of life. All is not what it seems – kidnappings, unjust jailings, and all sorts of unholy goings-on are afoot.

You must set things straight, but throughout the game you'll also be drawn into many subplots and side adventures. You could just say no, but then you wouldn't be the Avatar.

Ultima Action

Ultima VII integrates arcade-style action with the traditional elements of RPGs – puzzles, mysteries, conversation, and lots of exploration. You can interact with almost everything you encounter. The user-friendly RPG interface, ¾-overhead perspective, and effortless



PROTIP: Food restores health. Collect Ankhs for spell power.

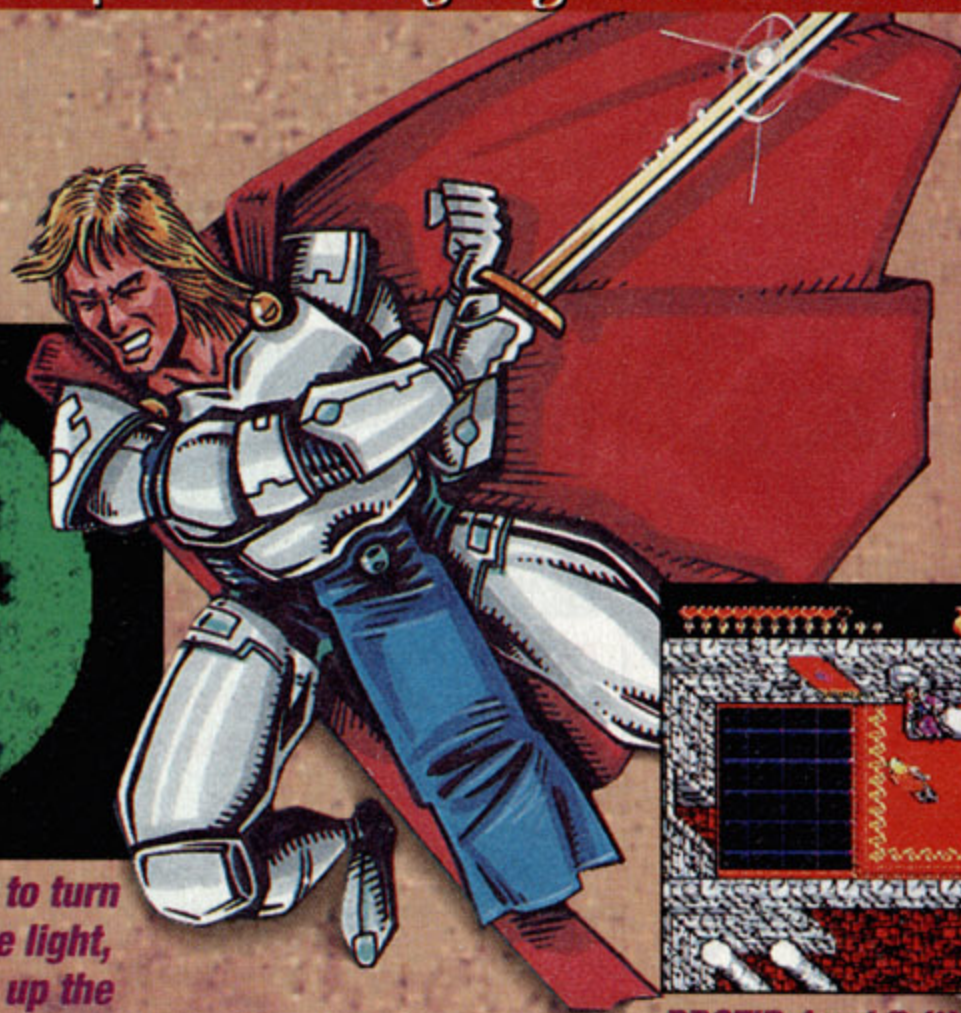

PROTIP: Lord British has something valuable to give you, so see him as soon as possible.

controls make it a breeze to get right into the game, and the Fast Magic, which creates instant access to selected spells, is a real adventurer's friend.

Unfortunately, one aspect of Ultima VII's gameplay is obsolete: The game automatically replenishes chests and



The character screen gives you all the important information.

restores monsters when you leave their vicinity – so if you find a stash of loot, just keep exiting and entering the room until you're Avatar Rockefeller!

A New Land

Ultima's graphics are solid if unspectacular. At first glance, the severe perspective appears to set the visuals at a wicked slant, but everything's easily discernible, and you get used



PROTIP: Even the castle mouse has something important to say.

to it. The large, nicely detailed character sprites are accompanied by diverse terrain, such as mountains, forests, caves, and castles.

The sounds are ho-hum. The music's okay, capturing the mysterious mood, but it gets tedious after a while. The sparse sound effects never soar beyond average bumps, slashes, and flashes.

Despite some annoying quirks (monsters keep coming back, and the game doesn't allow saves in dungeons), Ultima VII is nicely crafted fun. Although it isn't the ultimate in RPGs, this lengthy adventure could make you a naturalized citizen of Britannia. **G**

Crusader of Centy

By Sir Scary Larry



What's that you say? You used to be a Zelda fanatic, but you've switched systems? Can't find that cartoony, sword-swinging, action/RPG style on the Genesis? You can now.

Common Centy

In Crusader of Centy, you're a 14-year-old with a sword and a taste for adventure. This game lets you swing that sword with abandon, rolling over small, cute enemies and gaining skill and gold. But the less-than-mature gameplay would



PROTIP: Search the King's castle. Some of the rooms are useful later.

never satiate the adventuring thirst of a traditional RPGer.

You travel from place to place, but there's no combat between towns or areas. You battle monsters on mountaintops and in dungeons, then take your new skills to the Rafflesia Training School, where you advance in level and learn auxiliary combat techniques, such as sword throwing, running, and jumping. Control is simple and



PROTIP: You can't leave your party until you blow out the candles.



PROTIP: You need 20 gold pieces to learn the sword-throw technique in Rafflesia.



PROTIP: In the Dahlia Valley, break apart boxes to ride a stream of water. It's the only way to get to Duffy's mother.

effective, which suits the game's young audience.

Two Centys Worth

The cartoony graphics, from the small spritely main character to the bush-thwacking way that the hero uncovers coins in the forest, are reminiscent of Zelda. The backgrounds are bland rehashes of Zelda's roomy forest; the only thing missing is Canon.

The boring, repetitive sounds are just as terminally nice as the rest of the game. The standard groans and grunts don't step out of the ordinary, which is where Centy and Zelda differ. Centy offers no melodious orchestrations or rich, satisfying overtures.

Motley Crusader

Zelda's max is what Centy lacks. While Zelda had tons of hidden surprises, weapons, and fearsome bosses (making it one of the best action/RPGs ever), Crusader of Centy has a too-familiar story line, minor enemies, and a serious shortage of puzzles.

Forget Centy if you're a serious RPG fan (in that case,

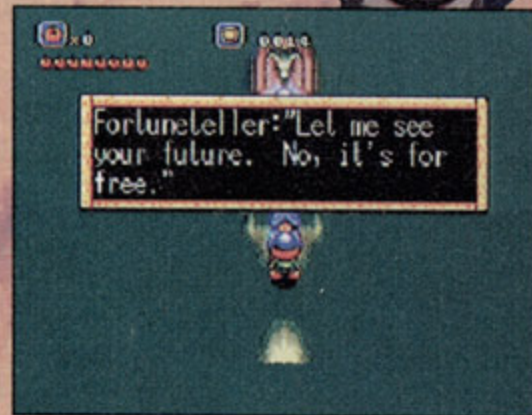

PROTIP: Go back to Soliel and talk to the fortune teller. After that, find your dog.



PROTIP: Talk to the Hare on the mountaintop in Dahlia Valley.

forget Zelda, too) because you'll breeze through it so fast that you'll only want more. But if you have a younger sibling who won't leave your Phantasy Star IV or Final Fantasy III carts alone, hand them this game. **G**

First Boss: Wolfie!



PROTIP: Throw your sword between the stars that encircle the wolf after he clubs himself in the head.

| Crusader of Centy by Atlus | | | | |
|----------------------------|-----------------------------|---------|-----------|--------------|
| Graphics | Sound | Control | FunFactor | Challenge |
| | | | | INT. |
| 3.5 | 3.5 | 4.0 | 4.0 | Intermediate |
| \$69.99 | Overhead view | | | |
| 16 megs | Multiscrolling | | | |
| Available now | Battery backup | | | |
| Action/RPG | ESRB rating: Kids to Adults | | | |
| 1 player | | | | |

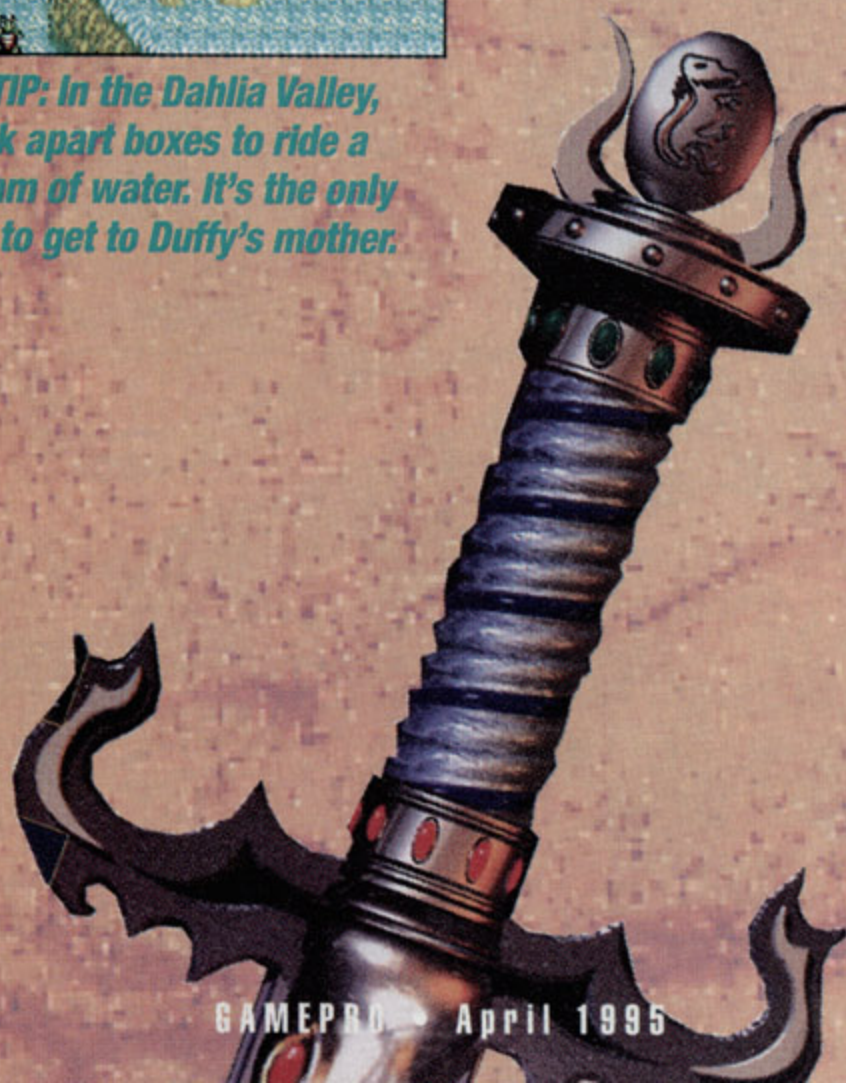

MAGICAL POPFUL MAIL FANTASY ADVENTURE



By Tommy Glide



Despite its title, Popful Mail has nothing to do with the postal service. Popful Mail is the main character – a tom-boy elf and would-be bounty hunter – in this action/RPG.

While looking to capture the magician Muttonhead, Mail stumbles upon Muttonhead's plot to open a portal to an evil world and your quest begins. You pick up two party members, an apprentice magician



PRO TIP: When shopping, use extra money to buy as much fruit as you can to heal yourself later on.

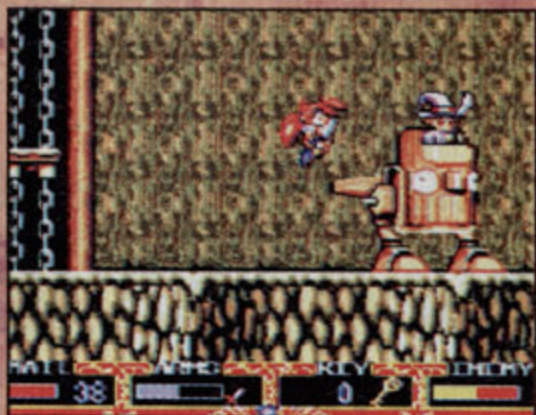

PRO TIP: To beat the Thrashmaster, use the dagger. Hit him, quickly move behind him, and hit him repeatedly before he turns around.

named Tatt and a creature named Gaw that's similar to a baby dragon.

Stamping Mail

While the plot is all RPG, the gameplay isn't. PM walks a very fine line between a beginner's RPG and a sophisticated platform hopper.

The story element of the game is beautifully framed by cinemas and dialogue, but PM's gameplay isn't much more than a Zelda-like side scroller. Destroying enemies along the way to each boss earns you the gold necessary to buy weapons, armor, and healing fruit.

The game's linear design makes it an ideal beginner's



PRO TIP: Use sneak attacks from the ladders to defeat multiple enemies without taking damage.



PRO TIP: To beat the Mad Bomber, hide under the low platforms. When he lands in front of you, quickly hit him and move under the opposite platform.

RPG. Mail is all action, not interaction. You don't have to ask questions, but strategy is required throughout the game.

Popful of Nuts

The superb Japanese anime cinemas add great color to the game, setting these quirky characters apart from the standard mold of RPG heroes and villains. The graphics in normal gameplay suffer – the game looks more like 16-bit adventure carts.

More than two hours of clearly recorded voices also set PM apart from other RPGs. The music and the sound

Chopping Wood



The Wood Golem cannot pass the staircase you entered through. Stand to the left of it and launch daggers at him. Crouch to avoid his flying arm.



Once his body is defeated, you must destroy his bouncing head. Chase it closely and continue to throw daggers. The Golem will regenerate his body several times before you can destroy his head completely. Return to the spot behind the staircase and repeat the process.

effects are above average, but it's the bountiful, impressive dialogue that really makes the audio outstanding.

Simple controls maintain PM's simple style. Your characters move efficiently under your guidance, and a pop-up menu gives you quick access to your inventory. You can arm only one weapon at a time, which makes for a lot of switching in this dangerous realm.

Bulk Rate

Advanced dungeon goers will see through this one right away. There are no puzzles or challenges that they haven't faced before. But with solid gameplay, Popful Mail will entice both the adventure crowd and easy-to-please RPG gamers. **G**

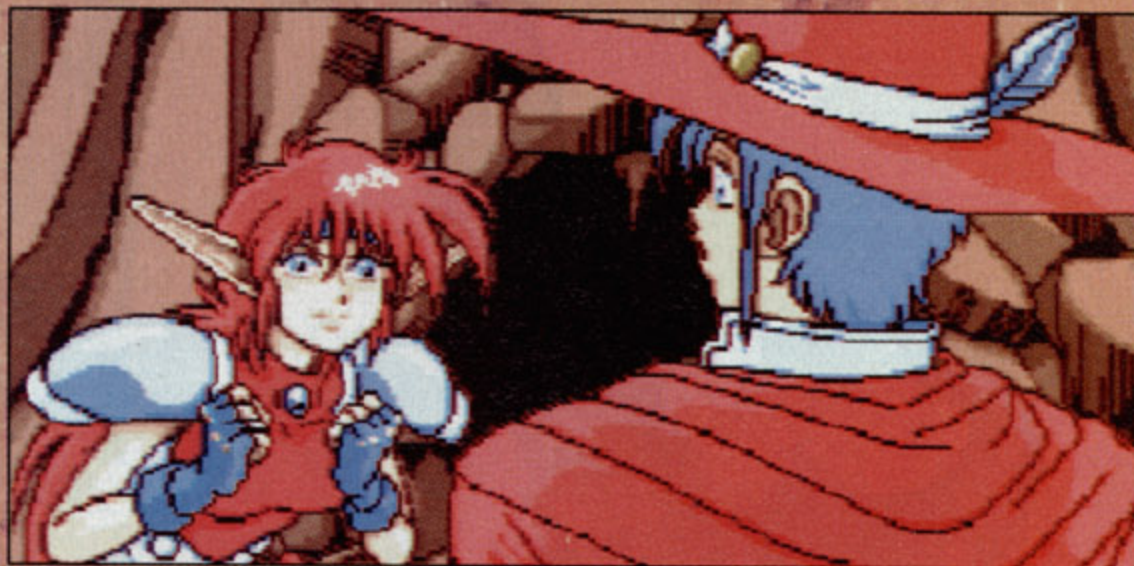

Great cinemas and plenty of dialogue enhance the story line.

| Popful Mail by Working Designs | | | | |
|--------------------------------|-----------------------------|---------|-----------|--------------|
| Graphics | Sound | Control | FunFactor | Challenge |
| | | | | INT. |
| 4.0 | 5.0 | 3.5 | 4.0 | Intermediate |
| \$62.99 | Side view | | | |
| CD | Multiscrolling | | | |
| Available now | 3 save slots | | | |
| Action/RPG | ESRB rating: Kids to Adults | | | |
| 1 player | | | | |

FINAL FANTASY III



Strategy Guide

The Hidden Hidon



A neat but well-concealed side quest involves Strago and Relm. To win, bring Strago back into the fold, set the airship down beside the Cult of Kefka tower, and send out a party that includes his granddaughter, Relm. Once they spot one another, it's as good as done.

Strago Struts

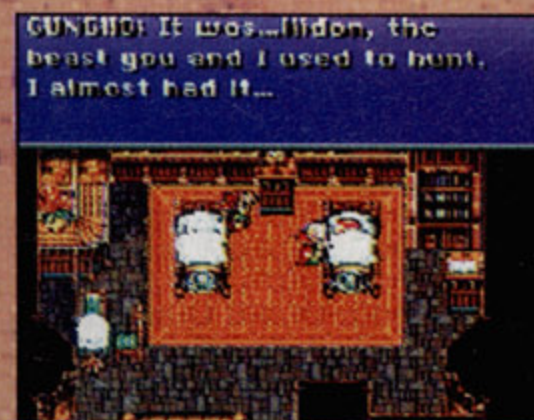

Once Strago's back on the payroll, send the old man and Relm into Thamasa by themselves. You quickly find yourself embroiled in a search for Strago's nemesis, a seldom-seen creature called The Hidon that lives in a cave on Ebot's Rock just north of the village.

OK Coral



The quest itself is simple. Strago seems to want to go alone, but if you find yourself overmatched, you can take along anyone you please. Don't bother mapping. The levels appear to be generated at random. You need at least 22 pieces of coral to satisfy the greedy chest that blocks the path to the monster.

Moogles Charm



The little Moogles Mog is in Narshe's caves – right where you found him the first time. You'll want a vacant slot in the party when you pick him up so that he can join you immediately. Mog's presence will permit

you to recruit the Sasquatch, Umaro, who can be found in the section of mine opened after the party frees the frozen Esper, Tritoch. Search the spot afterward to find the Moogles Charm. When Mog has this relic equipped, the party won't face any random encounters.

The Star-Shaped Mountain Range



Seek out Locke in the bowels of this elaborate maze. The trick to finding this mountain



range is to fly at maximum altitude. (The higher you are, the clearer its shape.) It's at the north end of the southernmost continent.

Under the Desert

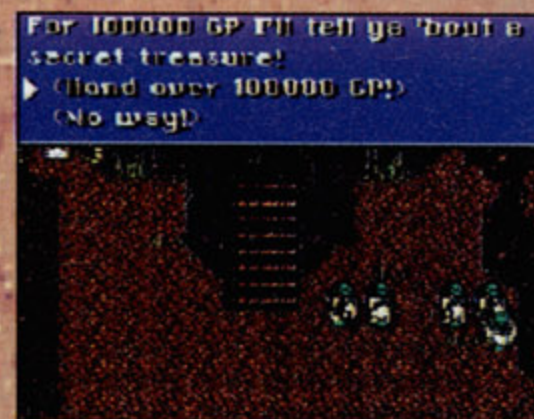

Now here's a side quest to rival the earlier visit with the Zone Eater and Gogo! A thief at the base of the Cult of Kefka tower will offer you two valuable new directions – at an outrageous price. You don't need to pay the 100,000 GP to find the prize, though.

No Fantasy Too Final Part IV

The end of Final Fantasy III is in sight. This issue, we'll wrap up our coverage of the many secrets and surprises that lurk in the second half of this giant RPG.

By Peteroo



Figaro Newtons



The thief's first tip concerns the presence of an ancient castle under the desert. It's not Figaro Castle, either, though you'll need to use Edgar's versatile home to reach it.

Visit the Engine Room and order the castle moved. You'll get back a report that the building seems to have hit something in transit, and you have the option to investigate. Do so. Exit by the right-hand cell in the jail, and you'll find yourself in a big new region. Head south, then west to find a castle that was destroyed during the War of the Magi.

Diary Queen

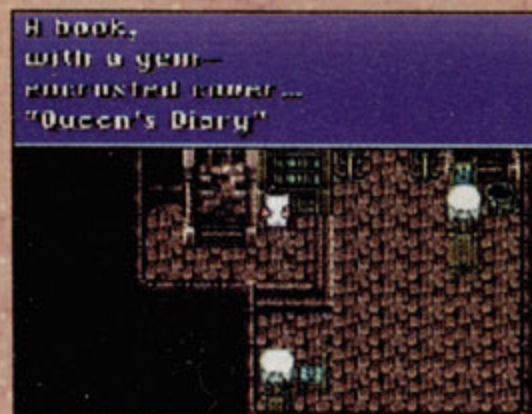

A lot of good stuff can be found here, including some daunting enemies, great weapons, the Queen's diary, and the Odin Magicite shard. However, you may also find yourself haunted by a sense that you haven't seen it all.

Conan the Librarian

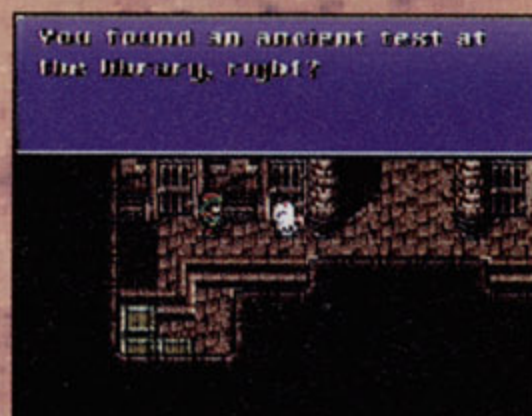

True! Keep returning to talk to the prison guard until he tells you about an ancient text in the Figaro Castle library. One

of the librarians will refer to a line about the queen standing and taking five steps.

Walk this Way



Return to the ancient castle's throne room. Take five steps south from the queen's throne (the right-hand chair) and press Button A. You'll hear a crash and find descending stairs in the library to the southeast. In the hidden hall downstairs, you'll face off with another of the eight Dragons and find a stone queen whose tears transform the Odin shard into the powerful Raiden.

A Nastier, Harsher Narshe

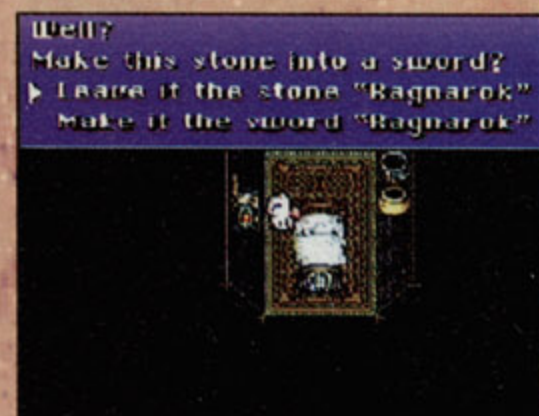

The thief's other tip is that you're wanted at the Weapon Shop in monster-infested Narshe. With Locke back in the party, the town's locked doors are child's play. The weapon seller gives you the Magicite shard Ragnarok and offers to turn it into a sword.

The Ultima-te



Ragnarok is good as a sword, but it's incredible as a shard. It teaches the bearer the Ultima

spell, which will enable you to burn down virtually anything in your path. And when the shard itself is invoked in combat, it turns enemies into items. Basically, you can replicate anything in FF III – provided you can find the appropriate enemy!

Curses!

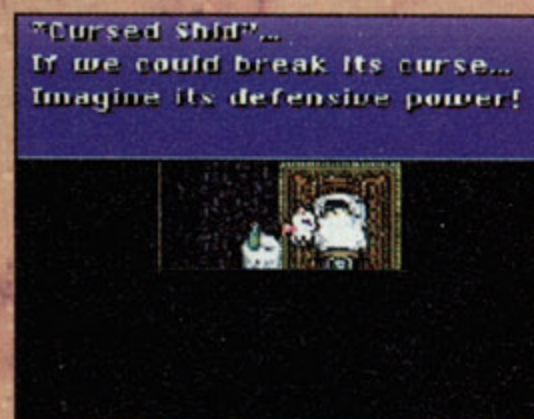

While in Narshe, stop by the house just northeast of the Elder's house and talk to the person there. You'll get the Cursed Shield, which is better than it sounds. Equip it and use it in 256 battles, and it will turn into the Paladin Shield. This dandy item adds seven to each stat and converts many enemy attacks into extra HP for the bearer. (The down side is that the attacks it doesn't cover really smack you upside the head!)

A Ninth Dragon?



FF III's designers try to slip one by you now and then. One such occasion is the tip you'll get from the hunters in the Veldt cave about a "frightful dragon" in the forest to the north.



It's not one of the eight Dragons. In Japanese, "frightful dragon" means dinosaur, and the Brachosaur you'll eventually fight here – after going through waves of Tyrannosaurs – is a whale of a dinosaur. If you paid off the thief at the Cult of Kefka tower, you're in line for a refund once you make this critter extinct.

Family Reunions



Another neat thing about FF III is that its creators don't believe in loose ends. Take the matter of Gau's father, for instance. He's the crazy old fellow who lives northwest of the Brachosaur forest...and who is still waiting for various repairmen to turn up.

Visit him now with Gau in the party. Your band will conclude that he's indeed Gau's pop, and that the wild child needs a new suit and new manners before the two can be properly introduced. So it's off to Jidoor for a makeover – a long and very funny

sequence that's unlike anything in the game.

Duncan Donuts



Another loose end can be tied up by exploring northeast of Narshe. Look for a peninsula with a cross of trees. Walking into the central tree brings you to a house rather like Sabin's home away from home in the first half of the game. Duncan, the martial arts expert from South Figaro who was previously reported to be dead, is living there now! Visit him with Sabin in the party, and Duncan will teach him a final Blitz technique known as the Bum Rush.

Two Thumbs Up!



Many fascinating items can be obtained at the Dragon's Neck Coliseum north of Kohlingen. The Rename Card allows you to rename a character. The Economizer cuts the cost of any spell to 1 MP. Illumina is an amazing sword. And that's not even the tip of the iceberg.

A Sold-Out Crowd!

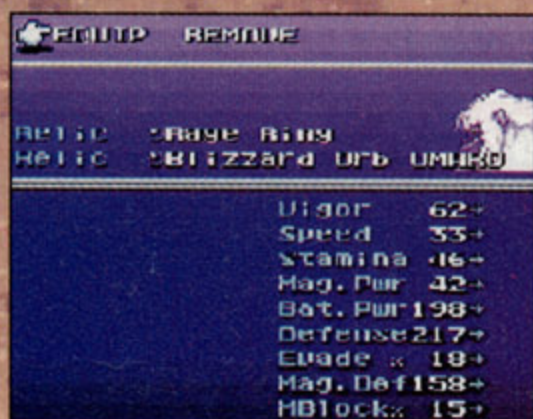

The challenge is partly figuring out what to bet – the list of possibilities is long – and partly deciding how to fight. One way is to set up a big fighter like Celes with Offering, Genji Glove, the Atma Weapon (from the Cave to the Sealed Gate), and Scimitar (from the underground castle). She'll now deal eight crippling blows per round. Another is to equip Umaro with Blizzard Orb and Rage Ring.

Cult of Kefka Tower



Just one surprise here. Stand to the right of the chest in the first treasure room and hit Button A. Exit, and you'll see a door on the floor below. Enter and you'll find Air Anchor – the eighth and last of the tools – from the chest within.

Taking Down MagiMaster



MagiMaster tries to put up a complicated front with his WallChange technique, which constantly changes his current weakness. But it's easy to burst his bubble.

Go Berserk



The simplest way is to cast a Berserk spell that will force him to make conventional attacks. Another is to cast Life 3 on the party before the fight, let him wipe you out with his Ultima, and then come back to life.

Wall Street



And the third, a little trickier, involves beating him down with four

straight Ultimas and then calling on the Esper Palidor to whisk away the party. Use Wall Rings during the fight, and MagiMaster will help you out by damaging himself with reflections of his own spells.

End of the Magi



If it works, only some members will have returned to the scene by the time MagiMaster launches his riposte. They're easily healed, and you're back in business.

Endgame



The final battles with that three-story Hieronymus Bosch painting and Kefka himself shouldn't be too tough – provided you have Ultima in your spell repertoire and stack the deck with your big spell casters on top. Just use the big U as quickly and as often as you can. It cuts through pretty much everything!

Then sit back and enjoy the long end sequence, especially the "outtakes" from Kefka's tower. You've earned it. **G**

Peter "Peteroo" Olafson is the author of the *Final Fantasy III Players' Guide*, which is published by Infotainment World Books.



By Scary Larry

Bonkers, Disney's latest afternoon TV star, returns in a new game for the Game Gear. His diminutive looks and the colorful, kiddie backgrounds work well in this fun, fast action/adventure, but anyone above the age of five should avoid this game.

Go Bonkers

As Bonkers, a small cat with a badge, you run through the levels, picking up clue icons and avoiding ghosts, mum-

Bonkers Wax Up!

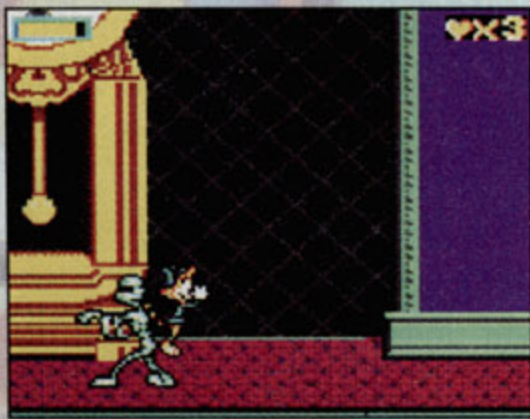

PROTIP: Mummies must be hit twice, so never turn your back on them after just one hit.

mies, bulldogs, and long falls into nothingness.

"Nothingness" almost describes the simple gameplay. Your only weapon is a bouncing attack, which must be precisely on target to score a hit.

Such precision might be too demanding for the novice gamers that Bonkers aims to attract. As for his other moves, Bonkers runs and

PROREVIEW

Game Gear

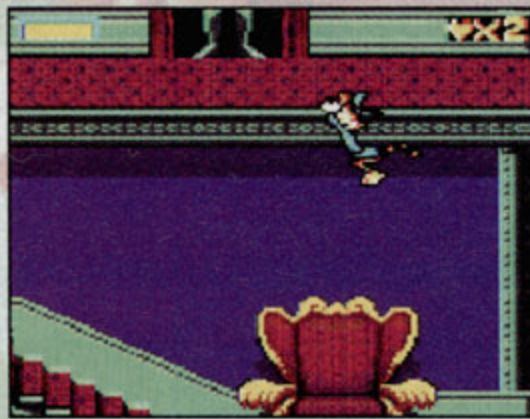

PROTIP: Use the couches and chairs as trampolines. Sometimes they're the only means of reaching another level.

jumps like any standard platform hero on the Game Gear.

Cat Eyes

The graphics are funny (like the mummy that loses his bandages), but the levels are so dark that it's hard to see what's going on. Bonkers is detailed enough that you can tell that he is the protagonist, but that's as intricate as these vague details get.

The music is repetitive. You know how five-year-old kids like to hear the same thing over and over again? This

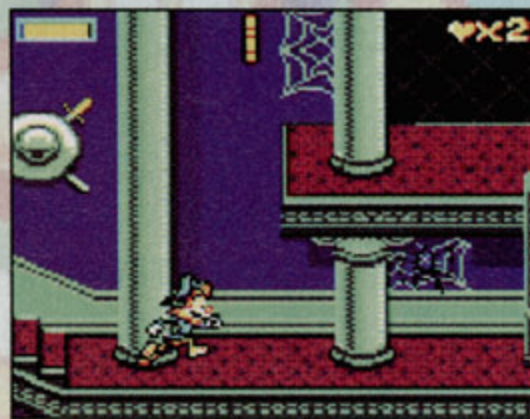

PROTIP: Running (press Button 1) gives you distance on jumps. music will teach 'em to appreciate variety.

Unless you're a real Bonkers fan, leave this cart to the youngest gamers. They'll soon be clamoring for something better. **G**



By Scary Larry

Humans have discovered a gate that will take people a million light-years from home. You'll wish they took this cart with 'em.

Star Crossed

Vastly different from the 1994 movie, Stargate is a one- or two-player puzzle game. The object is to arrange tiles into a specified "address" that will destroy the gate, thereby pre-



PROTIP: Flip the tiles while they're still close to the top of the screen to delay the drop.



Masters of the universe

STARGATE

venting the Egyptian aliens, which are your enemies, from re-entering the gates. If you lose, the gates stay open, and everybody gets in without a green card.

The game takes place on a cosmic spider web reminiscent of the grids in Tempest, but devoid of color. Tiles fall from the heavens, and you must arrange them as they fall onto the web. You can arrange the address tiles clockwise, counterclockwise, or vertically.

Stairway to Heaven

The graphics are sparse and very hard to make out. As tiles

move away from you, the symbols carved on them become indistinguishable from one another. You'll see stars before long, and they'll have nothing to do with the gate.

The sounds are annoying and repetitive. Apparently, Egyptian alien music is no better than a series of insect buzzes. Even the victory music is boring.

As a puzzle game on the Game Gear, Stargate is even less fun than Lemmings and about as hard to see. The real puzzle is why someone would try to cram such a huge universe onto such a small screen. **G**

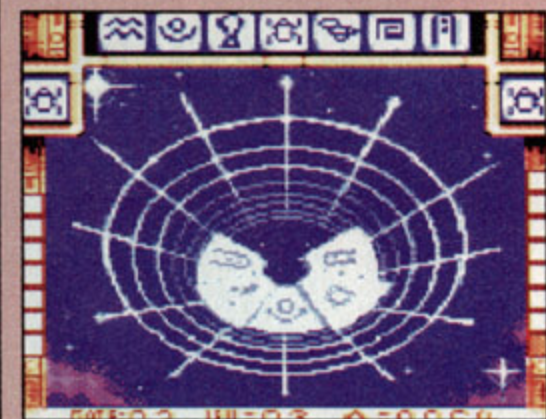

PROTIP: Not all pieces have the same front-back configuration. Always check both sides of a tile before dropping it in place.

Bonkers: Wax Up! by Sega

| Graphics | Sound | Control | FunFactor | Challenge |
|----------|-------|---------|-----------|-----------|
| | | | | |
| 3.5 | 3.0 | 3.0 | 3.0 | BEG. |

\$39.99
4 megs
Available March
Action/adventure
1 player

Side view
Multiscrolling
ESRB rating: Kids to Adults

Stargate by Acclaim

| Graphics | Sound | Control | FunFactor | Challenge |
|----------|-------|---------|-----------|-----------|
| | | | | |
| 2.0 | 2.0 | 2.5 | 2.0 | ADJ. |

\$34.95
4 megs
Available now
Puzzler

2 players
Overhead view
ESRB rating: Kids to Adults



THE DAWN OF THE METAL AGE.

Engraved, 3-D Prismatic Foil, stamped and laminated on every card in every pack!



#5

All is
mystery;
but he is
a slave
who will not
struggle
to penetrate
the dark
veil.

-Disraeli





MK3. The Arcade Game. 04.15.1995. AD.



S.W.A.T. PRO

Video Game Strategies, Weapons, and Tactics

32X

Doom

Invincibility and Ammo



You need a six-button controller to use these codes. Begin a regular game, press Start to pause, then press the indicated buttons.

For invincibility, **simultaneously press X, Z, Mode, and Up**. If you've done the trick correctly, your character's eyes will be yellow when you unpauses the game.

To instantly load all the weapons with 500 rounds of ammo, **simultaneously press A, C, Mode, and Up**. Unpause the game, and your inventory is stocked.



Matt Kelley, Jacksonville, AR

Super NES

Earthworm Jim

Level Select and Invincibility



Press Start to pause the game. **Simultaneously press and release Left and A, then press B, X, A, A, B, X, A, and Start**. A picture of the Earthworm Jim design team appears, followed by a debug menu with level-select and invincibility options.

Jose Gutierrez
Union City, CA

Genesis

Earthworm Jim

Extra Life, Continue, and Full Ammo



Any time during a game, pause and enter any of these cheats. Each time you perform a trick correctly, Jim will shout something different.

Fully loaded gun: **A, B, B, B, C, A, C, C**

Extra life: **B, B, C, C, A, A, A, A**

Plasma power-up: **C, A, B, C, A, B, A, C**

One continue: **Press A, simultaneously press Left and B then press A, B, A, B, C, A**

Michael Guanill
San Rafael, CA

Genesis

Madden NFL '95

Expansion Teams Code



At the Game Set Up screen, **press B, A, C, A, C**. If you hear Madden yell "Pow!", you can find next season's Jacksonville Jaguars and North Carolina Panthers in the Team Select menu.

James R. Geiger
Shellsburg, IA

Genesis

Pitfall

Ammo, Nine Lives, and Classic Pitfall

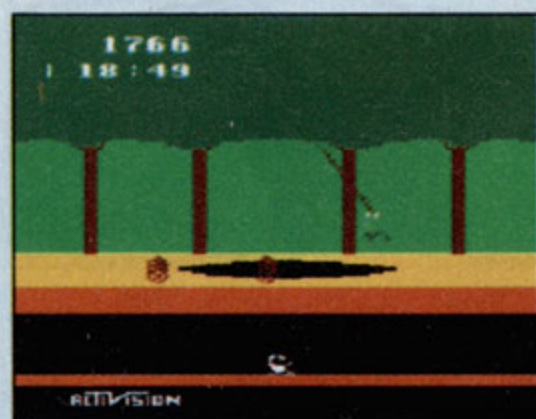

At the title screen, use these pad tricks to access special features:

Atari 2600 version of Pitfall:

Down, A 26 times, Down

Nine lives: Right, A, Down, B, Right, A, B, Up, Down

Ammo at 99: A, B, Up, C, A, C, A

Jay Pendergrast
Pittsburgh, PA



Matt Tonak, Franklin, MN

3DO

Demolition Man

Blood Code, Level Select, and Secret Levels



At the title screen, press R, then rotate the directional pad clockwise in a full circle until red spots appear onscreen. Begin the game, and you'll see blood when you shoot.

Pause the game, then press L, A, Up, Down, R, and Up to activate the level select. Press and hold B, then press Up and Down on the directional pad to scroll through the levels that appear in the password box. VRGN 1 to 5 are five Doom-like levels inside Virgin Studios!

Erik Bianchi
Santa Ana, CA

Super NES

X-Men: Mutant Apocalypse

Passwords



Hivebrood's Deserted Camp: Xavier, Magneto, Gambit, Cyclops, Apocalypse, Gambit, Magneto, Magneto

Genoshan Prison: Gambit, Beast, Magneto, Cyclops, Cyclops, Gambit, Magneto, Apocalypse

Apocalypse's Base: Beast, Gambit, Beast, Wolverine, Magneto, Beast, Cyclops, Wolverine

Danger Room (Omega Red): Psylocke, Wolverine, Wolverine, Gambit, Wolverine, Beast, Psylocke, Cyclops

Danger Room (Juggernaut): Gambit, Beast, Cyclops, Cyclops, Wolverine, Cyclops, Psylocke, Beast

Avalon: Beast, Gambit, Gambit, Wolverine, Magneto, Magneto, Xavier, Gambit



S.W.A.T. PRO

Video Game Strategies, Weapons, and Tactics

Genesis

Sonic & Knuckles

Sonic 1 Lock-On Codes



Lock in Sonic & Knuckles with the original Sonic the Hedgehog cart. When the message "No Way!" appears, **simultaneously press A, B, and C**. When the "Get Blue Spheres!" message appears, you can enter any of these codes to play the bonus rounds. In the menu screen, you can switch between Sonic and Knuckles by pressing any button. Use the red cursor to start the round as Knuckles, and the blue to begin as Sonic.

| | | |
|--------------------------|--------------------------|--------------------------|
| Level 2: 2965 3192 9023 | Level 19: 3964 5702 7519 | Level 36: 3629 6970 4380 |
| Level 3: 3610 2354 7327 | Level 20: 3275 3622 4191 | Level 37: 3072 0223 8396 |
| Level 4: 2921 0274 3999 | Level 21: 4092 0771 1679 | Level 38: 3762 5728 9452 |
| Level 5: 3737 7423 1487 | Level 22: 3408 2377 9263 | Level 39: 3033 0992 4284 |
| Level 6: 3053 9029 9071 | Level 23: 4053 1539 7567 | Level 40: 3718 2807 4428 |
| Level 7: 3698 8191 7375 | Level 24: 3363 9459 4239 | Level 41: 2817 0087 0076 |
| Level 8: 3009 6111 4047 | Level 25: 3837 0634 3359 | Level 42: 3518 2963 2956 |
| Level 9: 3482 7286 3167 | Level 26: 3163 9615 2764 | Level 43: 2788 8229 7788 |
| Level 10: 2809 6267 2575 | Level 27: 3808 8777 1068 | Level 44: 3474 0044 7932 |
| Level 11: 3454 5429 0879 | Level 28: 3119 6696 7740 | Level 45: 2916 3298 1948 |
| Level 12: 2765 3348 7551 | Level 29: 3936 3845 5228 | Level 46: 3606 8800 3004 |
| Level 13: 3582 0497 5039 | Level 30: 3252 5452 2812 | Level 47: 2877 4066 7836 |
| Level 14: 2898 2104 2623 | Level 31: 3897 4614 1116 | Level 48: 3562 5881 7480 |
| Level 15: 3543 1266 0927 | Level 32: 3208 2533 7788 | Level 49: 3348 5109 0364 |
| Level 16: 2853 9185 7599 | Level 33: 2994 5155 4236 | Level 50: 4028 3236 9596 |
| Level 17: 4014 2308 3455 | Level 34: 3673 9888 9404 | Level 51: 3298 8503 4428 |
| Level 18: 3319 6540 9215 | Level 35: 2944 5155 4236 | |

David Kelly
Philadelphia, PA

Super NES

Shaq Fu

Blood Code



At the Options screen, quickly press **Y, X, B, A, L, R**. The screen flashes red to confirm the blood code. Don't expect to see buckets of red, though.

Raheem Hinton
Hephzibah, GA



Eric Gonzales, Santa Ana, CA

Super NES

Pitfall: The Mayan Adventure

Infinite Continues, Level Select, and Classic Pitfall

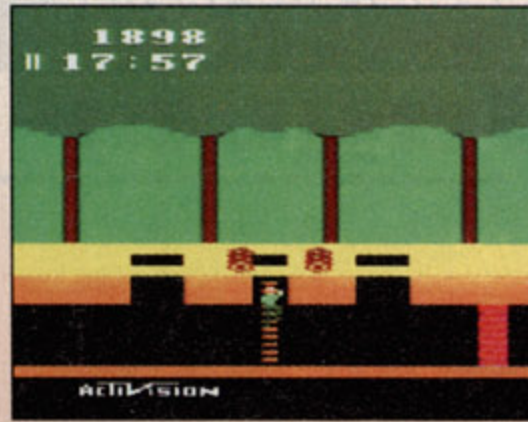

Lose your life in the first level. When the Continue screen appears, press **B** three times. The continue counter switches to nine and stops counting down, giving you infinite continues.

At the title screen, press **X**, **Select**, **A**, **Select**, **Y**, **A**, **X**, and **Select** to get a level-select option. The name of each level appears under the title. Press **L** and **R** to scroll through the levels.

To play the Atari 2600 version of Pitfall, at the title screen, press **Select**, **A**, **A**, **A**, **A**, **A**, **A**, **Select**, and **Start**.

Randy Vance
Maryville, TN

Super NES

Michael Jordan: Chaos in The Windy City

Power Password



At the password screen, enter **MCHLJRDN-23**. This password enables you to skip ahead in the game, gives you extra energy, and starts you with 25 lives.

Saxon Brach
McKinney, TX



Jim Jiminez, Makati, Manila

Genesis

Shaq Fu

Blood Code

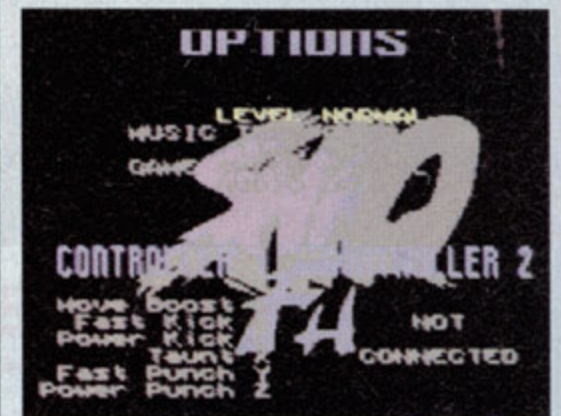

At the Options screen, quickly press **A**, **B**, **C**, **C**, **B**, **A**. If you've done the trick correctly, the screen flashes. Begin a game, and you'll see blood during the fights. You'll have to look closely, though – Shaq and crew aren't heavy bleeders.

David Bressman
Cherry Hill, NJ

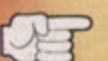

S.W.A.T. PRO

Video Game Strategies, Weapons, and Tactics

Jaguar

Iron Soldier

Level Select and All Weapons



At the Options screen, enter the number **37668242** on the keypad. The screen border shimmers if the code is entered correctly. When you begin the game, all 16 missions are selectable and all the weapons are available.

Jeff Kovach
 jeff.kovach@starlinx.damar.com
 Mesa, AZ



David Marinez, Tucson, AZ

Super NES

Rise of the Robots

Play as the Supervisor



At the Player Select menu, press **Up, Right, Down, Left, and R**. If you did the trick correctly, you'll find the Supervisor in the lineup of the two-player game. Player Two can now play as the Supervisor.

Anthony Bassano
 Victoria, TX



Game Gear

Beavis and Butt-Head

Passwords



Burger World:
 Highland High:
 Highland Hospital:
 Turbo Mall 2000:
 GWAR:

GEL DLW BTZ
 XLM DUO ATY
 WRG DVI GTY
 SXI HZC EPY
 HYA CKC MUZ

Mario Baumbach
 Marysville, CA

Do You Have a Secret Weapon?

If so, send it to SWAT and, if we publish it, we'll send you a free GamePro T-Shirt! We also want more of your artwork. Every reader who gets their artwork published in SWAT will also receive a free T-Shirt. Cool! Send your best tips and secrets to:

GamePro Magazine

Secret Weapons
 P.O. Box 5828
 San Mateo, CA 94402

Or, you can e-mail your tips to us at: swat.gamepro@iftw.com.

GAME ENHANCERS

Hot Game Genie and Pro Action Replay Codes

Genesis (Game Genie)

| | | |
|-------------------|-----------|--|
| Wolverine: | 83VT-B97L | Jump higher |
| Adamantium | ATKA-AA9C | Infinite lives |
| Rage | REHT-A604 | Health doesn't improve |
| | NVDA-2AFE | Health power-ups add 100% to health |
| | ATHT-AA6C | Elsie-Dee never comes |
| | BTZT-AA5A | Invincible against fire, acid, water, and bats |

| | | |
|--------------------------------|-----------|---|
| Ecco: The Tides of Time | ALBA-4A8R | When miss gates in 3D levels, no rings lost |
| | HDLA-WAD4 | Eat fish to restore all health |
| | A4KT-2A38 | 360-degree sonar blast |
| | FZ0A-TAGY | Begin on Vortex Queen level |
| | AKZA-TA7A | Infinite air |

Super NES (Game Genie)

| | | |
|--------------------------|-----------|---------------------------------|
| Demon's Crest | D467-C703 | First monster is easier to kill |
| | C93B-140F | Infinite energy |
| | DB67-C703 | First monster is harder to kill |
| Super Mario World | CF2C-AF6F | Flying ability |

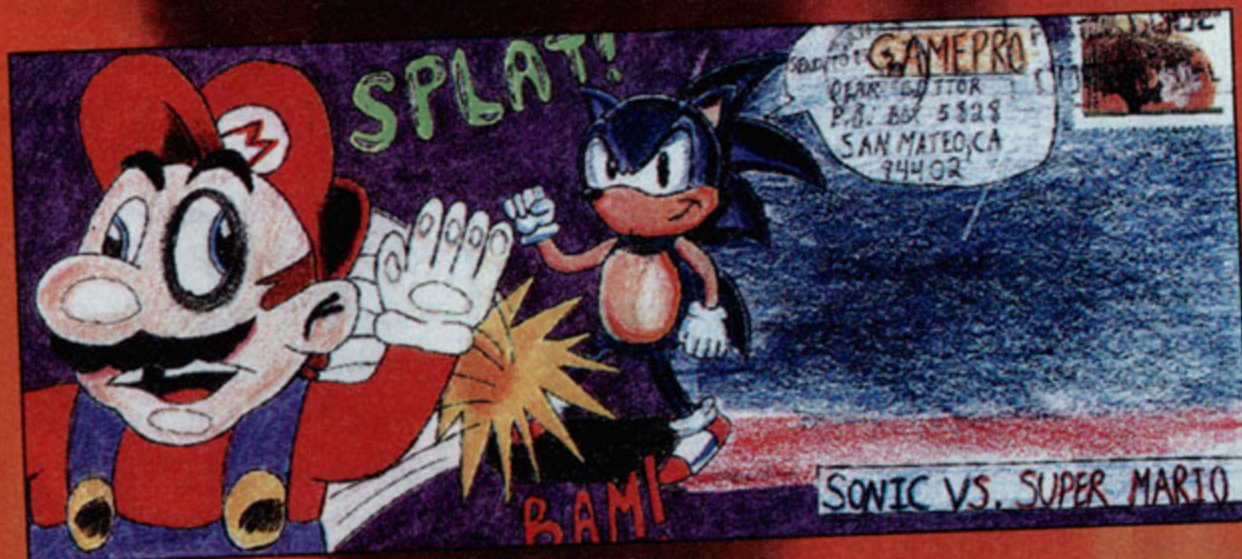

Tyson Durst, St. Albert, Alberta, Canada



Jason Hayes, Portland, OR

Nintendo (Game Genie)

| | | |
|------------------------|------------|--------------------------------------|
| The Jungle Book | PAEGVGTE | Start practice level with nine lives |
| | PAENGIE | Start normal level with nine lives |
| | AAVEEYPA | Infinite time |
| | AVYZLAA | Start with five of each weapon |
| | PENEEIAA | Infinite weapons |
| | ZEKKULAP + | Need two gems to finish levels |
| | SXXNLKOU | 1, 3, 4, 7, 9 |



Ingmar Freske, Bellingham, WA

Have you discovered a hot Game Genie or Pro Action Replay code? If so, send it to Game Enhancers. If we publish your code, we'll print your name and you'll get a cool *GamePro* T-shirt! So get cracking and send your results to:

GamePro Magazine
Secret Weapons (Game Enhancers)
P.O. Box 5828
San Mateo, CA 94402

You can also e-mail us your tips at swat.gamepro@iftw.com.

Codes Provided By:

Manuel Santilla
Santa Clara, CA
Michael Sassouni
Great Neck, NY

Game Boy (Game Genie)

| | | |
|-------------------|-------------|-----------------------|
| Mega Man 5 | 01B-75F-915 | Infinite lives |
| | 01B-EAF-E66 | Start with one life |
| | 709-44F-808 | Start with 75% energy |
| | 212-269-E61 | Nearly invincible |

THE FIGHTER'S EDGE

Tournament-Winning Combos and Strategies

ARCADE

X-MEN

Children of the Atom



By Bruised Lee

(Special thanks to Phil Reed, Eric Luther, and the staff at Capcom.)

IT'S X-MEN AGAINST X-MEN, MUTANT AGAINST MUTANT. CAPCOM'S TAKEN SOME OF THE BEST FIGHTING ELEMENTS FROM BOTH DARKSTALKERS AND STREET FIGHTER II AND ROLLED THEM INTO X-MEN: CHILDREN OF THE ATOM. PUT YOUR FIGHTING SKILLS TO THE ULTIMATE TEST AS YOU PICK YOUR FAVORITE MUTANT AND TRY TO DESTROY MAGNETO ONCE AND FOR ALL.

BEFORE STARTING

Before you dive into the fray, know your choices. You choose from ten characters (see the following pages for character details). You can also choose manual or automatic blocking. With automatic blocking, the computer blocks for you, but returns to manual blocking when you win a round. In the two-player mode, you can also select the background you want to fight in.

Select a Fighter



Ten mutant fighters are at the ready.

Blocking Options



Choose between auto or manual blocking in a fight.

Select a Background



Pick your favorite stage to battle in.

SPECIAL MOVES

You can vary some characters' special moves by performing the same controller motion but following it with a different button press. For example, Cyclops can perform his Optic Blast three ways. Experiment with each character's moves.



Motion ↓ ↘ → QP



Motion ↓ ↘ → MP



Motion ↓ ↘ → FP

Controller Legend

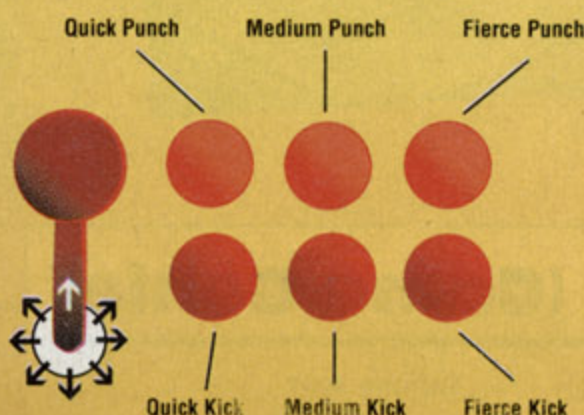

- ↑ = Up
- ↗ = Up-Toward
- = Toward
- ↘ = Down-Toward
- ↓ = Down
- ↙ = Down-Away
- ← = Away
- ↖ = Up-Away
- FK = Fierce Kick
- FP = Fierce Punch
- K = Press any Kick button
- MK = Medium Kick
- MP = Medium Punch
- P = Press any Punch button
- QK = Quick Kick
- QP = Quick Punch

Motion = Move the joystick in one continuous, smooth motion.

Tap = Tap the directions indicated in sequence.

Charge = Hold the direction indicated for the number of seconds indicated.

Close = The move must be done when close to the enemy.

() = Execute commands in parentheses simultaneously.

Special Note: All techniques are described under the assumption that your character is facing to the right. If they're facing left, reverse any Toward and Away commands.

GROUND MOVES

Learn these basic moves. They come in handy during most fights.

Dash Attack



Tap →, → to run toward your opponent. Tap ←, ← to run away from your opponent.

Quick Recovery



To stand quickly after being knocked down, Tap →, → or ←, ← and simultaneously press all three kick buttons.

MUTANT BAR

The Mutant bar is underneath your life bar and has three levels. Some special moves are possible only when your Mutant bar is at a certain level. For example, you can only do X-Power moves when your Mutant bar is maxed out. The bar, which automatically recharges throughout the match as you fight and execute other special moves, carries over to the next round.



The Mutant bar must be at Level Two to perform Wolverine's Healing Factor.

TAKE TO THE AIR

In X-Men, the battleground isn't always terra firma – your mutant can fight in the air as well. Each mutant can also do a Super Jump when you quickly hit ↓, ↑ on the controller or when you simultaneously press all the kick buttons. When you execute the Super Jump, your fighter's launched high into the air, giving them a few seconds to do some heavy damage. You can perform most ground moves in the air.

Super Jump

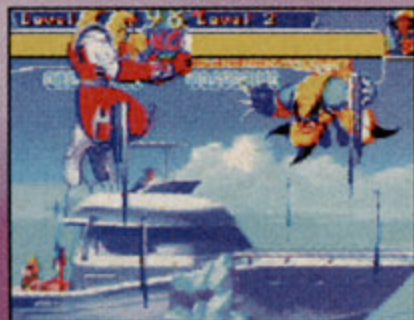

To become airborne, quickly hit ↓, ↑ or simultaneously press all three kick buttons.

Air Moves

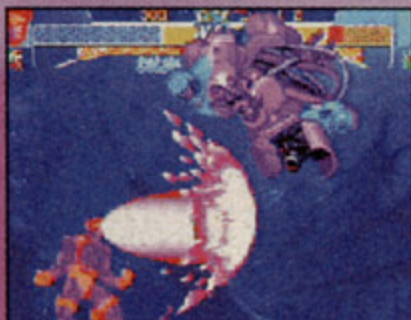

Each character performs three airborne special moves.

Air Throws



To throw your opponent in the air, hit → and either Fierce button.

Air Block



To Block while you're in midair, hit ←.

MEET THE BOSSES

You go toe to toe with two bosses, the evil Magneto and his crony, Juggernaut.

Juggernaut

If Juggernaut's size alone doesn't intimidate you, his moves surely will. He has several grab moves that do major damage, and he can also grab a girder and swing it like a bat.



Juggernaut's powerful head-butt stuns Cyclops.



Block Juggernaut's girder attack at all costs.



When you see an opening, quickly do a grab move.



Steer clear of Juggernaut's pounding fist, which has great range.

Magneto

Magneto's power and speed are almost unmatched. He fights mostly in the air, so prepare to Super Jump a lot. Batter him with lightning-fast hits to wear him down.



If you're not quick enough, Magneto takes to the air and sprays projectiles.

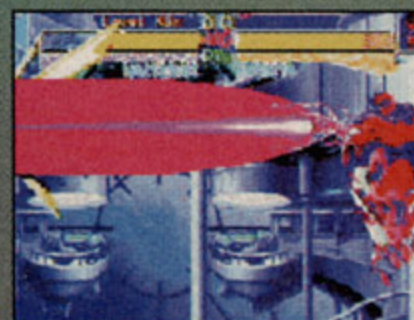

Blocking his projectiles and counterattacking is key to overcoming Magneto.



Magneto's ground attack registers multiple hits if it isn't blocked.



This force shield renders him temporarily invincible.



COLOSSUS



Name: Piotr Rasputin

Formerly one of the most dedicated, selfless X-Men, the once-gentle Colossus defected to Magneto's side after his sister, Ilyana, succumbed to a disease created to end the mutant race. Super strong, with an invulnerable steel body, Colossus seems incapable of harming his former teammates...but the X-Men pray they'll never find out.

X-POWER

You can perform the following moves only if your Mutant bar is at maximum.

Super Armor



Motion ↓ ↙ ← (QP, MP, FP)

Note: Colossus's moves do twice as much damage.

Dive Bomb



Motion ↓ ↘ → (QP, MP, FP)

SPECIAL MOVES

Colossus Charge



Motion ↓ ↘ → K

Colossus Spin



Motion ↓ ↘ → P

CYCLOPS



Name: Scott Summers

The first X-Man, Cyclops was approached by Professor Charles Xavier when he was a teen and unable to control his mutant power following a near-fatal plane crash that killed his parents. Today, Cyclops wears a special ruby quartz visor to control the size and intensity of his optic blasts. His devotion to the X-Men is only surpassed by his love for his wife, Jean Grey.

SPECIAL MOVES

Optic Blast



Motion ↓ ↘ → P

Gene Splice



Motion → ↓ ↘ P
Note: If you connect, continue to press a Punch button to chain the move into multiple hits.

X-POWER

You can do these moves only if your Mutant bar is at maximum.

Tracking Beam



Motion ↓ ↙ ← (QP, MP, FP)

Mega Optic Blast



Motion ↓ ↘ → (QP, MP, FP)

ICEMAN

Name: Robert Drake

One of the five founding X-Men, Iceman encases his body in ice, then freezes the moisture in the air around him into an ultra-dense, ultra-cold ice that he can shape into anything, including weapons or the ice slides on which he travels. Recent events indicate that Iceman may be tapping into only a fraction of the power he possesses. The question is: Will he be able to master his untapped power?

X-POWER

You can perform this move only if your Mutant bar is at maximum.

Arctic Attack



Motion ↓ ↘ → (QP, MP, FP)

Ice Ball



(P, K)
Note: You must use the same type of punch and kick; for instance, (MP, MK).

SPECIAL MOVES

Ice Fist



Motion ↓ ↙ ← (QP, MP, FP)
Note: The Mutant bar must be at Level Two to perform this move.

Ice Beam

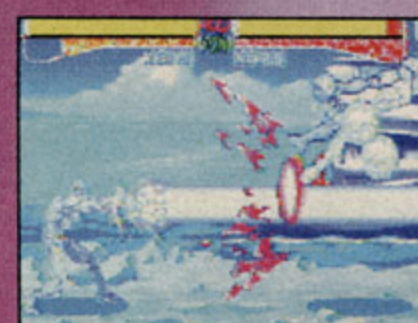

Motion ↓ ↘ → P



PSYLOCKE

Name: Betsy Braddock

When her mind and its telepathic abilities were displaced into the body of a ninja assassin named Kwannon, Psylocke became the ultimate warrior for the X-Men. Her mutated abilities enable her to attack her opponent's mind and body, anticipate their every move, create a "psychic knife" to disrupt their consciousness, and telepathically communicate with the X-Men.



SPECIAL MOVES

Psi Flash



Motion ↓ ↘ → P

Psi Blade



Motion ↓ ↘ → K

Ninjutu

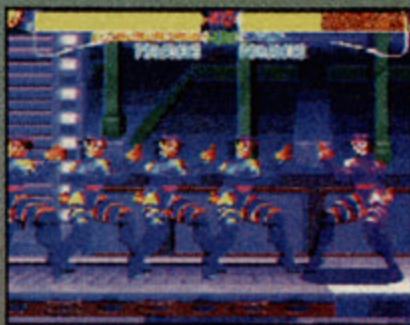

Motion ↓ ↙ ← (QP, MP, FP)

Note: Your Mutant bar must be at Level Two to perform this move.

X-POWER

You can perform this move only if your Mutant bar is at maximum.

Psi Thrust



Motion ↓ ↘ → (QP, MP, FP)

OMEGA RED

Name: Arkady Rossovich

Armed with unbreakable Carbonadium tentacles and "death pheromones," Omega Red is a walking weapon of destruction that is on a life-and-death quest for the Carbonadium Synthesizer, which will revive his dwindling life force. Until he recovers the C-Synthesizer, Omega Red prolongs his life by releasing "death pheromones," which drain the life force of those around him into his body.



X-POWER

You can perform this move only if your Mutant bar is at maximum.

Omega Destroyer



Motion ↓ ↘ → (QP, MP, FP)

SPECIAL MOVES

Life Drain



Motion ↓ ↘ → (QP, MP, FP)

Note: Hit P to drain their life bar or K to drain their Mutant bar.

Omega Strike



Motion ↓ ↘ → K

SPIRAL

X-POWER

You can perform this move only if your Mutant bar is at maximum.

Mega Morph



Motion ↓ ↘ → (QP, MP, FP)

Name: Spiral

A six-armed humanoid slave created with genetic engineering on the planet Mojo, Spiral traveled to Earth to track a fleeing rebel. She decided to stay, enlisting in the Freedom Forces and spreading disorder in various ways. Her strength comes from her ability to cast a wide range of spells, including ones that nullify the superhuman powers of her foes.



SPECIAL MOVES

Teleport



Motion ↓ ↙ ← MP
Note: Your Mutant Bar must be at Level Two to perform this move.

Power Dances



Motion ↓ ↙ ← QK or MK or FK
Note: The Mutant bar must be at Level Two to perform this move. QK gives you strength. MK makes you faster. FK turns you invisible.

Dancing Sword



Motion ↓ ↘ → (QP, MP, FP)
Note: The Mutant bar must be at Level Two. To throw one sword at a time, hit P. To throw all the swords at once, Motion ↓ ↘ → FP.

SILVER SAMURAI

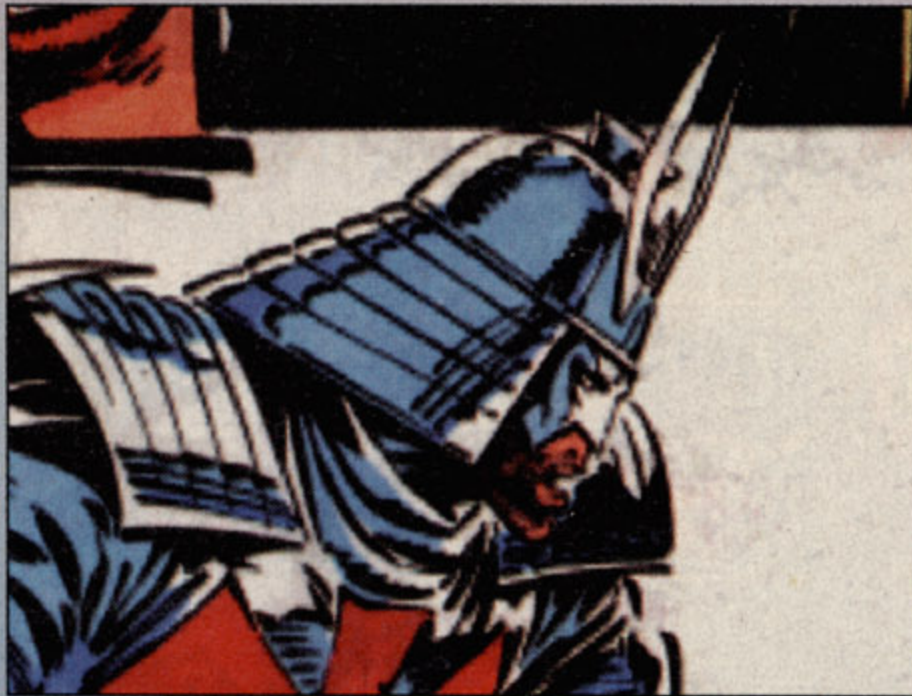

Name: *Konuichio Harada*

The mutant son of a Japanese crime lord, Harada studied to become a samurai from an early age. After proving himself, he became the bodyguard of Viper, utilizing his superb swordsmanship, shuriken, teleportation ring, and energy-generating abilities to defend his charge.

X-POWER

You can perform this move only if your Mutant bar is at maximum.

Mega Shuriken



Motion ↓ ↙ ← (QP, MP, FP)

Samurai Shadow



Motion ↓ ↙ ← (QK, MK, FK)

Lightning Strike



Motion ↓ ↘ → (QP, MP, FP)

SPECIAL MOVES

Sword Slash



P (Rapidly)

Shuriken



Motion ↓ ↘ → P

Spirit Shadow



Motion ↓ ↘ → (QK, MK, FK)

Note: The Mutant bar must be at Level Two to perform this move.

Power Sword



Motion ↓ ↙ ← QP or MP or FP

Note: The Mutant bar must be at Level Two to perform this move. QP conveys the power of lightning, MP the power of ice, and FP the power of fire.

SENTINEL

Name: *None*

Giant flying robots, Sentinels were developed to destroy or capture the mutants. The progressively advanced models are now capable of learning from their own mistakes and adapting their abilities to counteract that of their opponents. Nimrod, the most advanced and dangerous Sentinel, has traveled back in time from the future to hunt down modern-day mutants.



SPECIAL MOVES

Rocket Punch



Motion ↓ ↘ → P

Sentinel Force



Motion ↓ ↘ → QK or MK

Sentinel Fly



Motion ↓ ↙ ← (QP, MP, FP)

Note: The Mutant bar must be at Level Two to perform this move.

Sentinel Bombers



Motion ↓ ↘ → FK

X-POWER

You can perform this move only if your Mutant bar is at maximum.

Plasma Storm



Motion ↓ ↘ → (QP, MP, FP)

STORM

Name: Ororo Munroe

From her orphaned childhood in Cairo to her days as a deity with an ancient African tribe, Storm has weathered her life's cycles. Now a committed member of the X-Men, Storm commands nearly total dominance over the elements of weather - storms, winds, and lightning.

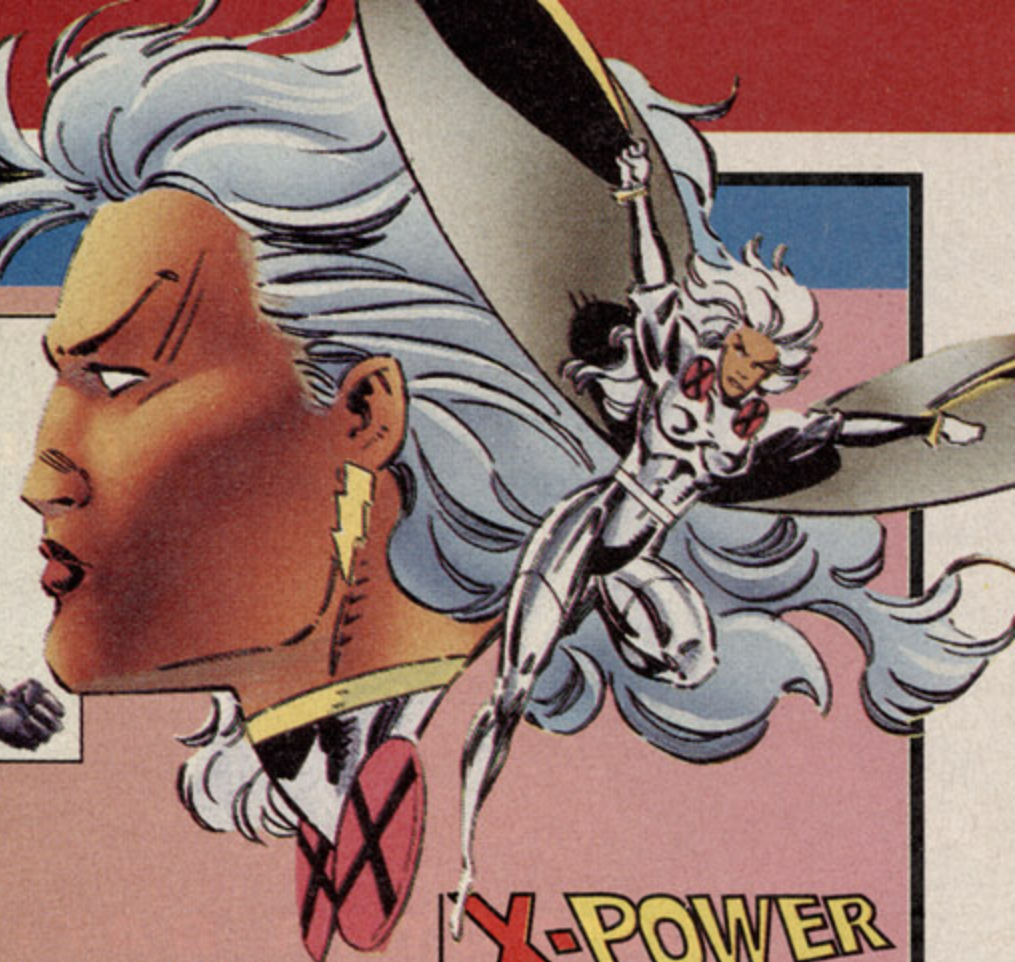

SPECIAL MOVES

Typhoon



Motion ↓ ↘ → P

Lightning Attack



(K, P) and move the joystick in the direction you want to attack.
 Note: You must use the same type of punch and kick; for instance, (MP, MK).

Storm Wind



Motion ↓ ↘ → (QK, MK, FK)
 Note: This move pushes your enemy back. Motion ↓ ↙ ← (QK, MK, FK) to pull your enemy toward you. The Mutant bar must be at Level Two to perform this move.

Storm Flight



Motion ↓ ↙ ← (QP, MP, FP)
 Note: The Mutant bar must be at Level Two to perform this move.

X-POWER

You can perform this move only if your Mutant bar is at maximum.

Lightning Storm

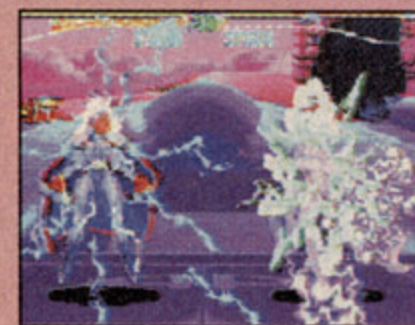

Motion ↓ ↘ → (QP, MP, FP)

WOLVERINE



Name: Logan

As a victim of the top-secret Weapon X Project, which was creating a race of indestructible super soldiers, Wolverine was subjected to memory-fragmenting implants, which made his past untraceable. He also believes that his bones were coated with unbendable adamantium steel and that his razor-sharp, retractable adamantium claws were attached at this time. Wolverine's mutant healing power serves him well, as he is a relentless fighter.

SPECIAL MOVES

Drill Claw



(K, P) and move the joystick in the direction you want to attack.
 Note: You must use the same type of punch and kick; for instance, (MP, MK).

Tornado Claw



Motion → ↓ ↘ P
 Note: If your move connects, continue to hit P to chain the move into multiple hits.

Mutant Speed



Motion ↓ ↙ ← (QP, MP, FP)
 Note: The Mutant bar must be at Level Two to perform this move.

X-POWER

You can perform this move only if your Mutant bar is at maximum.

Berzerker Barrage



Motion ↓ ↘ → (QP, MP, FP)



XBAND IS LIKE

COMPUTER DATING.

WE AUTOMATICALLY

CONNECT YOU WITH

SOMEONE WHO WANTS

TO TAKE YOU OUT.

CALL 1-800-X4-XBAND AND GET ON THE

XBAND is a trademark of Catapult Entertainment, Inc. Sega and Genesis are trademarks of Sega Enterprises, Ltd. All rights reserved.
NBA is a registered trademark of NBA Properties, Inc. NHL is a registered trademark of the National Hockey League. Super



RIGHT NOW, AS YOU'RE READING THIS,
THOUSANDS OF HARDCORE GAMERS
ARE BATTLING IT OUT ON THE XBAND
NETWORK. DO YOU HAVE WHAT IT TAKES
TO BEAT 'EM IN A VICIOUS GAME OF
MADDEN NFL™ '95, NBA®
JAM, NHL® '95, OR MORTAL
KOMBAT® II? FIND OUT.
JUST STICK OUR XBAND
VIDEO GAME MODEM INTO
YOUR GENESIS™ PLUG IN
YOUR PHONE LINE. AND
IN JUST MINUTES WE'LL
AUTOMATICALLY CONNECT
YOU TO SOME SERIOUS ASS WHUPPIN'.
SO GIVE US A CALL AND SIGN UP. YOU'VE
GOT NOTHING TO LOSE. EXCEPT YOUR
EGO. (COMING SOON FOR SUPER NES®)

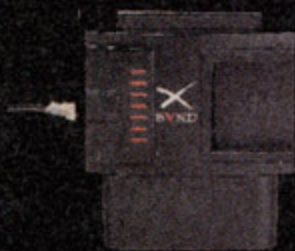

FIRST VIDEO GAME NETWORK IN YOUR CITY.

Mortal Kombat II is a registered trademark of Midway Manufacturing Company. NFL is a trademark of the National Football League. Nintendo Entertainment System is a registered trademark of Nintendo of America, Inc. ©1995 Catapult Entertainment, Inc.

A Player's Guide to Power Peripherals



By The Lab Hamster

The Lab Rat is away at a 12-step, cheese-free, rodent rehabilitation program, so I'm in charge of the *GamePro* lab again. This month, we look at a system selector and a special power strip that makes things easier for multiple-system owners. To spice up the sound of your games, we also check out a Surround Sound speaker system.

The New Switcheroo

If you own more than one gaming system and you're tired of bending over backward to connect different hardware, bend no more. From the new hardware company **Mad Catz** comes the **System Selector**, a device that enables you to switch between the video and audio of four game consoles and your television.

Three of the four switches feature stereo and video inputs, so they can also be

used as a VCR switch. The fourth selector, however, features only a mono audio in. The best deal with this selector is the price. For a cool \$20, you can rid your entertainment center of wire tangles and save set-up time.

Sega Strips

If your wall sockets are ready to burst or you're having problems squeezing huge AC adapters onto an everyday power strip, stop crying in your soup! **Sega** has solved the power problem with its **Sega Power Strip**.

With widely spaced outlets, this hip-looking black power strip easily accommodates five large AC adapters. Designed for use with the Genesis and its outlet-hoarding add-ons like the Sega CD and 32X, this strip is also handy for gamers with multiple systems that have large AC adapters.

It's fully compatible with other systems, so it won't blow up your Super NES or Jaguar. The strip also protects your game systems from power surges and features an on-off switch and a reset button.

Accessory

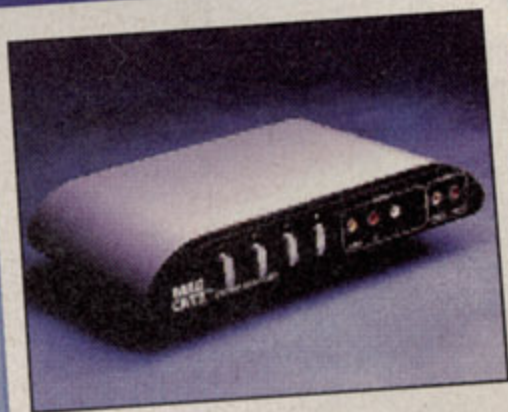

System Selector

System: Any

Features: Allows multiple-system owners to switch between up to four game consoles without having to reconnect them to the television.

Price: \$20

Available: Now

Contact: Mad Catz, 800/659-2287

Accessory



Sega Power Strip

System: Any

Features: This five-socket strip comfortably provides power for your game systems' fat AC adapters and protects them from power surges.

Price: \$12.99

Available: Now

Contact: Local toy or game store

ment. Every voice sample, every explosion, and every crash was crystal clear. The effect was like playing video games in a theater. If your living room is already decked out with a Pro Logic receiver and you're looking for affordable Surround Sound, an additional \$250 for these speakers isn't a bad deal. If not, you're paying \$500 to hear your game better. **G**

You're Surrounded

With more CD-based systems looming on the horizon, gamers are guaranteed to get better sound in the future. But you can maximize game sound today with the **HT-2 Home Theater System** from **KLH**. This set of five speakers and a subwoofer are designed to bring the Surround Sound experience home for a reasonable cost.

In a test, we connected our 3DO system to a Kenwood Pro Logic receiver and blasted a game of *StarBlade* through the HT-2 speakers. (A Pro Logic receiver is not included with the package, but it's required for true Surround Sound. Pro Logic receivers sell for a minimum of \$250.)

The HT-2 package created a great Surround Sound environ-

Home Theater

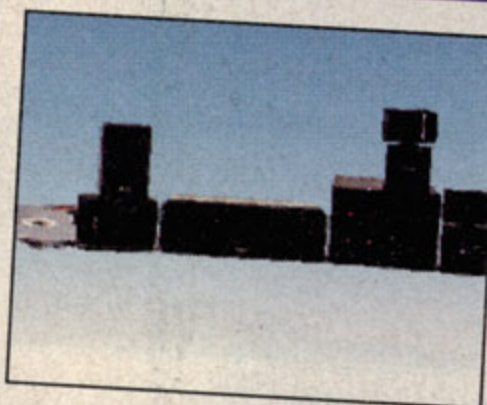

HT-2 Home Theater System

System: Any

Features: Six speakers comprise this Surround Sound system that will give you great audio, but first you need to connect your game system to a Pro Logic receiver.

Price: \$250

Available: Now

Contact: KLH, 800/854-4441



Schwarzenegger

True Lies™

A James Cameron Film

NOW A VIDEOGAME BLOCKBUSTER!



SORRY ABOUT THAT...



EXPLOSIVE HARRIER ACTION!



IS IT A SNOW CONE-MAKER?



YOU'LL NEED GIB'S HELP TO STOP THE CRIMSON JIHAD

"It's not like he's saving the world or anything." Oh, yes it is! As special agent Harry Tasker, it's up to you to prevent a nuclear holocaust and stop the Crimson Jihad! Experience all the explosive intensity of TRUE LIES™—including never-before-seen secret missions! All the action of the movie megahit—and none of the romance!



360° OF FIRING POWER



SUPER NINTENDO ENTERTAINMENT SYSTEM

GENESIS™ GAMEBOY GAME GEAR™

Acclaim®
entertainment inc.

TRUE LIES™ & © 1994 Lightstorm Entertainment, Inc. Nintendo, Super Nintendo Entertainment System, Game Boy and the official seals are registered trademarks of Nintendo of America Inc. © 1991 Nintendo of America Inc. Sega, Genesis & Game Gear are trademarks of Sega Enterprises, Ltd. Acclaim is a registered trademark of Acclaim Entertainment, Inc. © 1995 Acclaim Entertainment, Inc. All Rights Reserved. Screen shots shown are taken from Super NES® version of videogame.

BUYERS BEWARE



By The Watch Dog

People out there must think we're a bunch of April fools or somethin'! Not the vigilant watch dogs of Buyers Beware! Check out what everyone's barking about now.

Q: I have a five-year-old NES with a power pad, gun, two controllers, and games. It's in great condition, but nobody will buy it from me. What can I do?

Ramsay Zaki, Houston, TX



One of the last good NES games – *The Jungle Book*.

A: **The Watch Dog says:** We suggest you simply continue to enjoy it yourself by renting great games you haven't played yet (there are hundreds of NES games available, so you should be able to find ones you've never tried). If you're determined to sell it, you can try advertising your NES in the classified section of your local newspaper, but you'll probably have a hard time finding a buyer. The same is also true for first-generation systems like the TurboDuo and Commodore 32, which are two others that are no longer being manufactured.

Q: My Sega Game Gear has a black dot on the screen that won't go away. Do you have any suggestions on how to get it off the screen?

Dan Deiore, Rochester, NY

A: **The Watch Dog says:** It sounds like you may have burned out the screen, which means you probably won't be able to remove the dot. (One cause of screen burnout is pausing the game too long.) Call Sega's Service Center at 800/872-7342 for suggestions on how to remove the dot or replace the damaged goods.



Burned by the Game Gear?

At GamePro, listening is what we do best. When you have a problem with a product or feel you've been ripped off, we want to know. If you have a complaint about a product, write to:

GamePro's Buyers Beware

P.O. Box 5828
San Mateo, CA 94402

Q: I was thinking of buying the 32X, but when I looked at the box, there was a sticker that said it would only lock on to the Genesis or Sega CD, not the CDX. Will Sega make a 32X for the CDX?

Robbie Zelle, Hendersonville, TN



X-tra X?

A: **The Watch Dog says:** According to a Sega spokesperson, Sega needs FCC approval of the 32X's compatibility with the CDX, and until the approval goes through, the 32X must be labeled as being incompatible with the CDX.

Which is not to say that the two don't work together, as we discovered when we test drove the 32X ("GamePro Labs," January). The 32X works with the CDX, but as of this printing, if you connect the two units and something happens to either one of them, you'll void your warranty, and Sega won't be responsible for any damage incurred.

Q: In X-Men for the Game Gear, I noticed that when you beat the Hellfire Club, you get Nightcrawler, and when you beat Madripor, you get Rogue. In the manual, it says the opposite. Is there something glitchy with my game?

Kyle Nicholson, Yacolt, WA



X-Manual

A: **A Sega spokesperson says:** "It's a misprint in the manual. Although we at Sega of America try to ensure the thoroughness and correctness of all our manuals, sometimes an error slips past us."

Q: I recently purchased Sonic & Knuckles. When I start to play, all my work on Sonic 3 is gone. But when I put the game back on Knuckles, my work on the Knuckles levels is there. Is my game defective?

Ronald Capalongan, Shellville, GA

A: **A Sega spokesperson says:** "You cannot play saved Sonic 3 games as Knuckles. Sonic 3 is separate from Sonic & Knuckles, and each was made to be enjoyed as a separate title. There is no way to put Knuckles into a saved Sonic 3 game."



Sonic, come home.

**WE TOP DOLLAR
PAY
FOR YOUR
GAMES!**

WE PAY THE BEST PRICES
FOR NINTENDO, GAMEBOY
& GAME GEAR GAMES, TOO!



(800) 336-6843
10am-5pm Eastern Time

**CHECK OUT
THESE PRICES!**

(ALL PRICES LISTED GOOD THROUGH 4/20/95.)

WE'LL PAY YOU:

\$32

WORLD SERIES BASEBALL 1995 SEGA
MORTAL KOMBAT 2 32X
ROAD RASH 3 SEGA
PGA TOUR GOLF 3 SEGA

\$30

TECMO SUPER BOWL 2 SEGA, SNES
TNN BASS TOURNAMENT SEGA
X-MEN 2 SEGA
FARENHEIT 32X METAL HEAD 32X

\$28

DONKEY KONG COUNTRY SNES
CAESAR'S PALACE SEGA
FIFA SOCCER 95 SEGA ROAD RASH 3DO
CLAYFIGHTER SEGA WWF: RAW SEGA, SNES

\$26

THE LION KING SEGA, SNES RISK SEGA
EARTHWORM JIM SEGA, SNES GOLF 36 32X
ROAD RASH 2 SEGA BATTLE TECH SEGA
CORPSE KILLER 3DO RUGBY WORLD CUP 95 SEGA
DEMOLITION MAN 3DO FIFA INT'L SOCCER 3DO NHL ALL-STAR HOCKEY SEGA

\$22

MORTAL KOMBAT 2 SEGA, SNES SONIC & KNUCKLES SEGA GEX 3DO
JOHN MADDEN 95 SEGA, SNES BEAVIS & BUTTHEAD SEGA, SNES
CHAMPIONSHIP POOL SEGA LETHAL ENFORCERS 1 (WITH GUN) SEGA
BILL WALSH COLLEGE FOOTBALL 95 SEGA NHL 95 SEGA, SNES

**CALL NOW
FOR CURRENT PRICING!**

WE BUY SYSTEMS, TOO!

| | |
|--------------------|---------------|
| 3DO | \$150! |
| SEGA GENESIS | \$40! |
| SNES | \$40! |
| GAME GEAR | \$30! |

SYSTEMS MUST INCLUDE ALL ORIGINAL
ACCESSORIES AND INSTRUCTIONS.

**DON'T DELAY,
CALL
TODAY!**

YOU NAME IT, WE BUY IT!

HERE'S HOW IT WORKS! JUST CALL US WITH A LIST OF YOUR GAMES AND WE'LL GIVE YOU A PRICE FOR EACH OR A PACKAGE PRICE FOR ALL (REMEMBER, YOU'LL GET LESS FOR YOUR GAMES IF YOU DON'T HAVE THE INSTRUCTION BOOK AND BOX FOR EACH). WE'LL GIVE YOU AN AUTHORIZATION NUMBER OVER THE PHONE WHICH GUARANTEES OUR QUOTE FOR SEVEN DAYS. THEN SEND 'EM OUT BY REGISTERED MAIL OR U.P.S. TO: CAMBRIDGE/AMHERST, 2558 DELAWARE AVENUE, BUFFALO, NEW YORK 14216 (BE SURE YOU PUT THE AUTHORIZATION NUMBER ON THE LABEL) WE'LL SEND YOU A CHECK ON THE SAME DAY WE RECEIVE YOUR GAMES. **THAT'S IT!**

**THE STANDARD
DISCLAIMER STUFF:**

WE HAVE THE RIGHT TO REFUSE ANY PURCHASE. THE GAMES SENT TO US MUST BE IN GOOD WORKING CONDITION AND FREE OF PHYSICAL DAMAGE OR WE WILL RETURN THEM TO YOU AT YOUR EXPENSE.



SHORT PROSHOTS

Previews of Hot New Games!

Mega Man 7

Super NES

In Mega Man 7, our hero has tossed that old bag of bolts Doc Wily in jail, but the Doc's robot army rises from hibernation to free the evil genius. The ensuing chaos creates what looks to be the best Mega Man adventure ever!

The game incorporates much (if not all) of the features and weapons from the NES series, a few tricks from the X games, and some new stuff. For instance, Rush is back, but he has new abilities. He barks to alert Mega Man of hidden areas, and occasionally he digs up useful items, such as power-ups. (He also digs up

useless bones and bolts, but hey, he's a dog.)

This game is busting out of its silicon with hidden items and secret areas, and there's the usual menagerie of mechanical goons...and even a few old hard cases, such as Gutsman, who were revived from the Doc's museum of ancient robots.

By Capcom
Available May

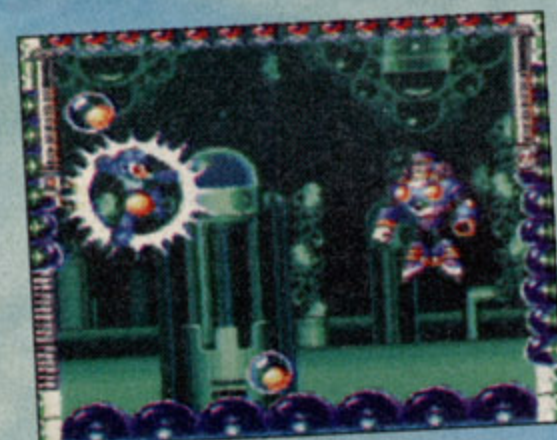
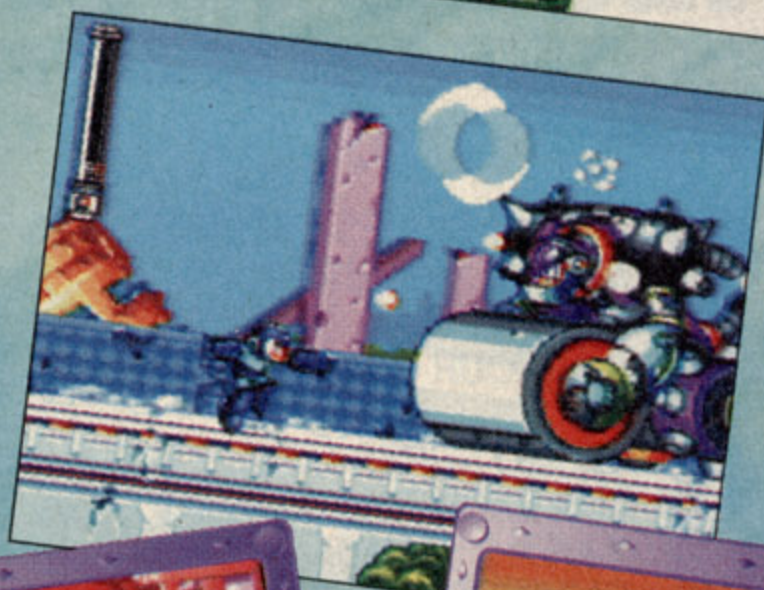
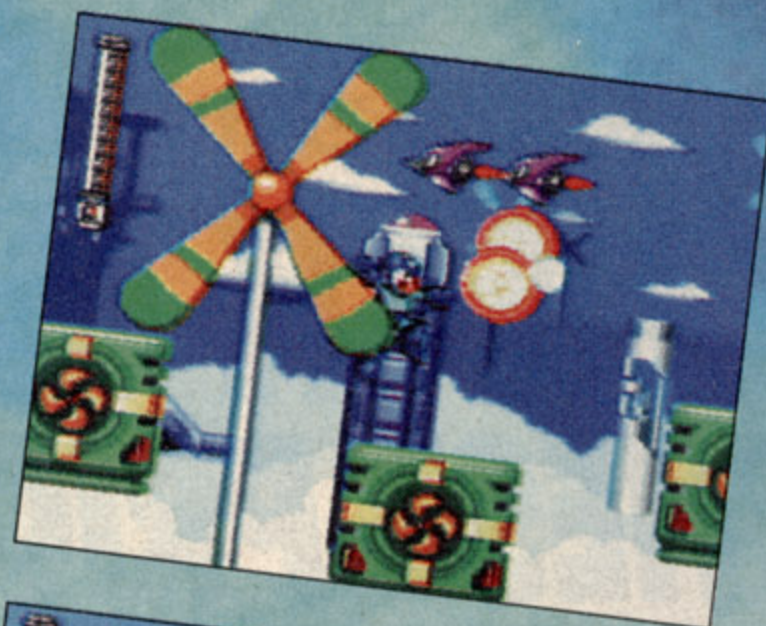
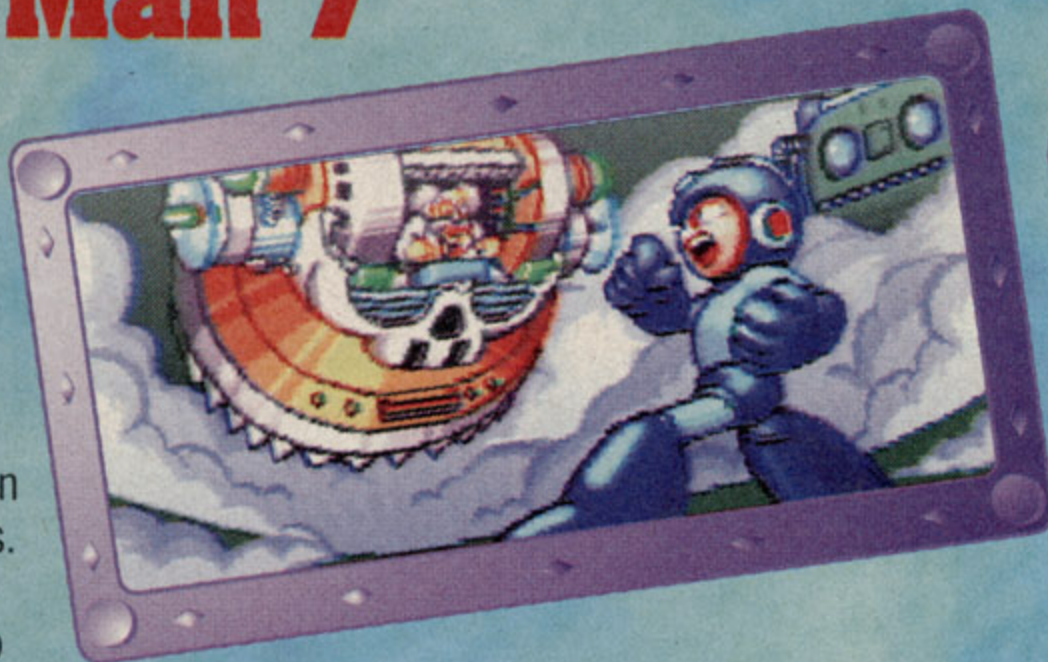

Primal Rage

Genesis

32X CD

Saturn

Super NES

3DO

Jaguar CD

Game Boy

Game Gear

Last year's monstrous prehistoric coin-op is coming to home systems in a big way. The one- or two-player head-to-head fighting modes include all seven dinosaur fighters (Sauron, Diablo, Armadon, Talon, Vertigo, Blizzard, and Chaos) with nearly 70 moves each. Time Warner promises the ports will include the fighting moves, combos, and finishing sequences that made the arcade version so popular. The graphics were created

using models and stop-motion video for realistic animation.

By Time Warner Interactive
Genesis, Super NES, Game Boy,
and Game Gear Available August
32X CD, Saturn, 3DO, and Jaguar
CD Available November

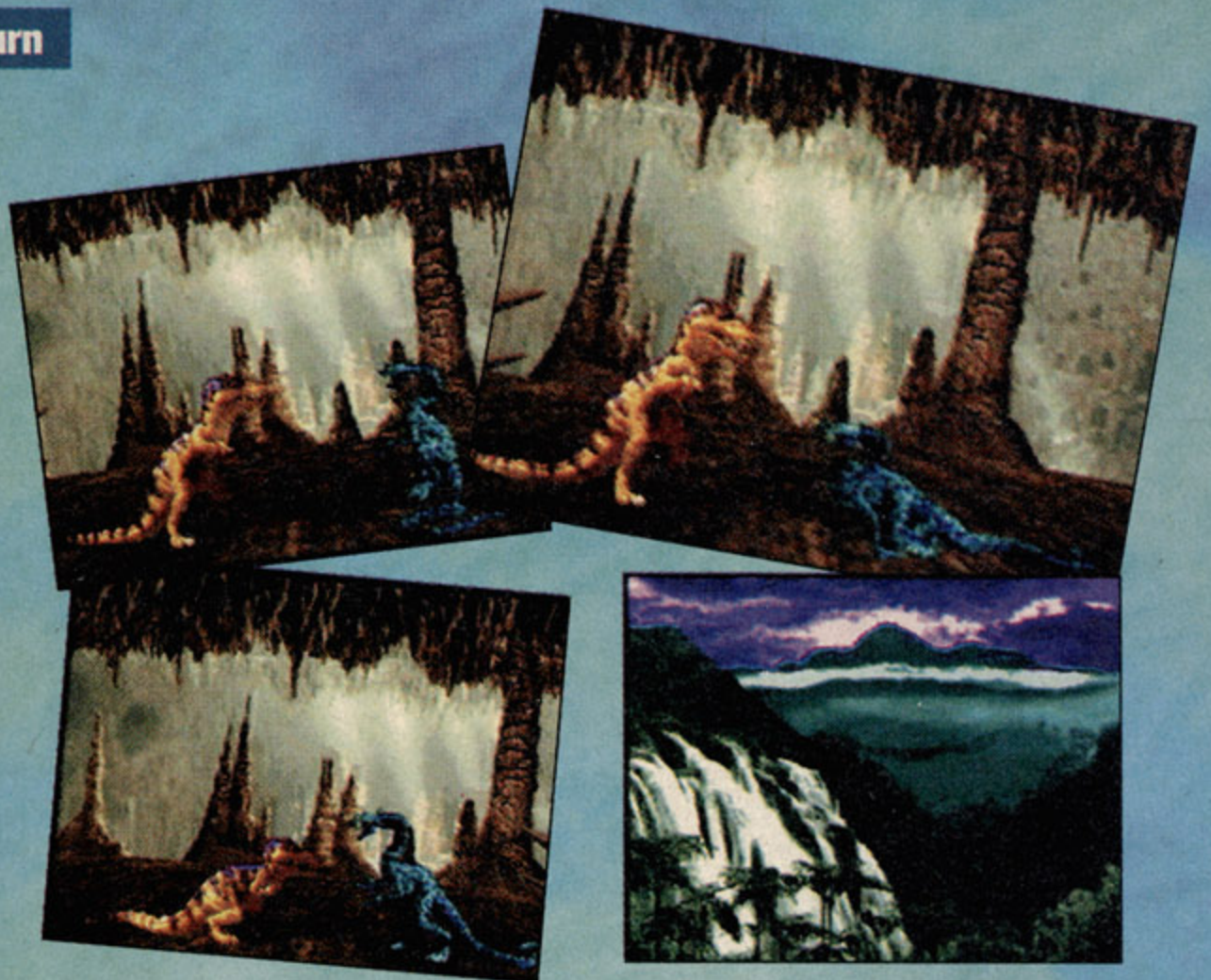

Beyond Oasis

Genesis

This interesting action/adventure/RPG combines hack-n-slash gameplay with role-play elements. As Prince Ali, you search the land for four missing spirits who'll give you the abilities you need to defeat the Dark Lord. The 3/4-overhead-view graphics look vibrant, and the story line is captivating. Oasis looks like an interesting combination of gameplay for beginning role players.

By Sega
Available Now

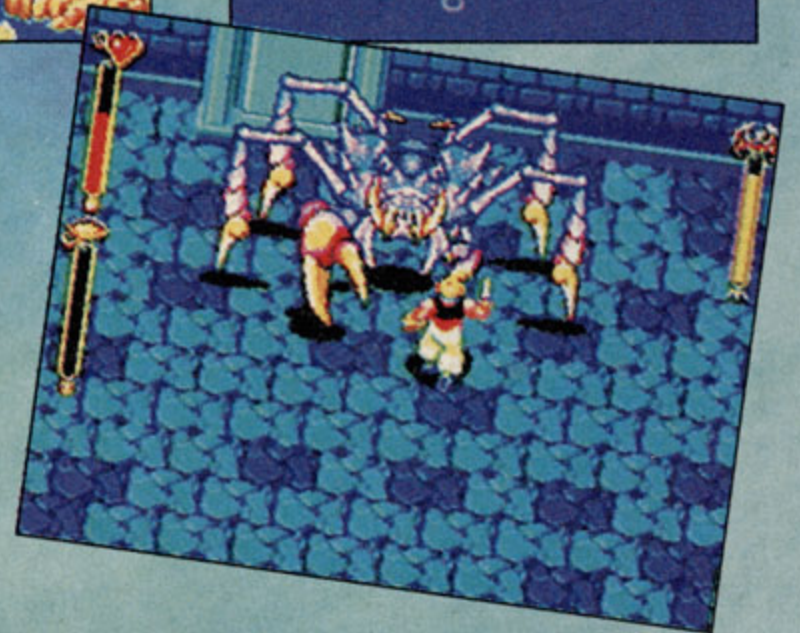
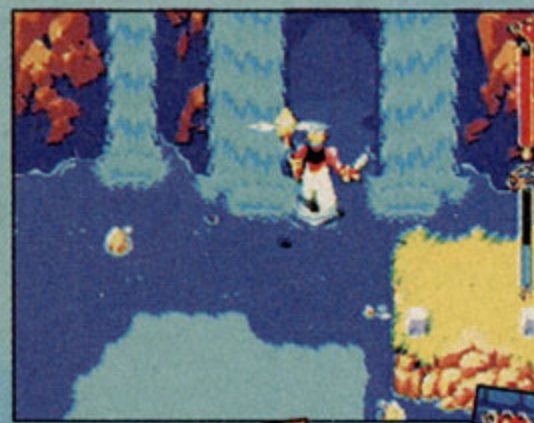

Wing Commander II: Vengeance of the Kilrathi

Super NES

Wing Commander II is the sequel to Wing Commander, the popular PC game that came to home systems last year. In this one-player, outer-space flight sim, you once again fly a variety of space fighters on several campaigns against the Kilrathi Empire. The cockpit view of the action enables you to monitor radar, weapons systems, and the galaxy around you.

By FCI
Available May

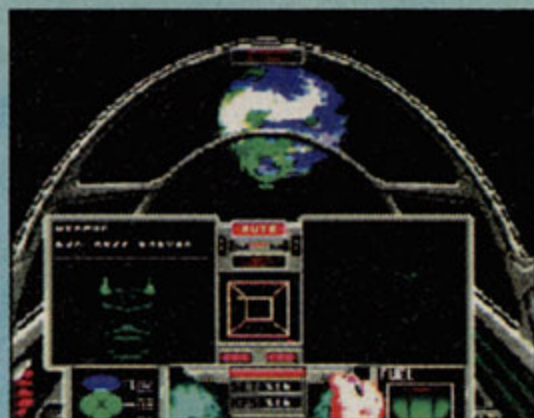

Metal Warrior

Super NES

In the year 2102, combat takes place using giant battledroids. Choose one of six models and, in one-player mode, fight through nine shoot-em-up platform-style missions. Each battledroid has a unique repertoire of weaponry, but you can also leave your 'droid and wage a battle on foot. In two-player competitive mode, players go head-to-head via split-screen action across a variety of battlefields.

By Konami
Available Now

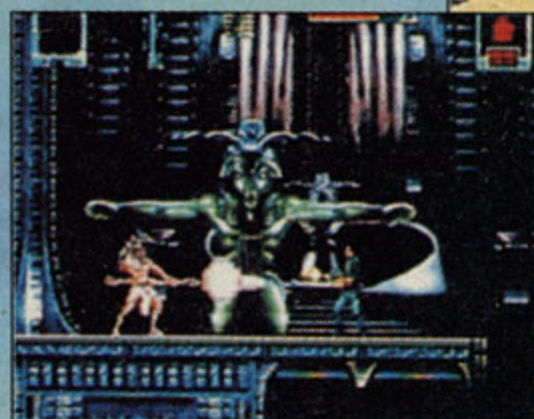

Stargate

Genesis

Super NES

Game Boy

Stargate was a surprise sci-fi hit at the box office last year. The video game versions feature action/adventure gameplay based on the movie. You play as Jack O'Neil, who's accidentally been transported from an

archaeological dig in Egypt to a strange futuristic world. As you try to solve the mystery of the pyramids, you play through more than 30 missions, including standard side-view action and first-person desert dog-fights with 3D graphics.

By Acclaim
Available First Quarter '95

Spider-Man

Genesis

Super NES

In this one-player action/adventure cart, Marvel Comics' Spider-Man is out to round up a bunch of escapees from Ravencroft prison. Spidey has a nice variety of web-slingin' moves to use against such villains as the Green Goblin,

Rhino, and Doc Ock. In some of the six levels, Spidey calls on the Fantastic Four (Human Torch, Invisible Woman, Mr. Fantastic, and Thing) for superhero help.

By Acclaim
Available First Quarter '95



Judge Dredd

Genesis

Super NES

Game Boy

Game Gear

Head to the postapocalyptic 22nd century for run-n-gun action as Judge Dredd. Based on the comic-book series and the upcoming movie, this action/adventure game slams through 12 levels. Using Dredd's Lawgiver gun and Lawmaster motorcycle, you search Mega City One for criminals (called perps). Graphical effects include a Mode 7 driving level.

By Acclaim
Available First Quarter '95

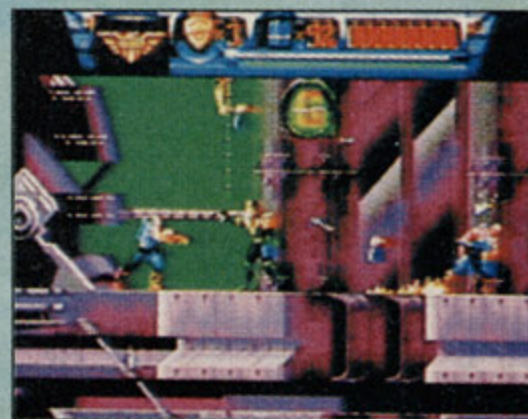

Immercenary 3DO

As a mercenary far in the future, you do your fighting in a virtual world. To survive, you must develop the ability to adapt quickly to whatever region you land in. Your mission is to shut down the SysOp that controls the battle fields.

The seek-and-destroy gameplay pits you against 16 types of enemies and 11 bosses. You must select the correct combinations of weapons and power-ups to survive. Full-motion intros and

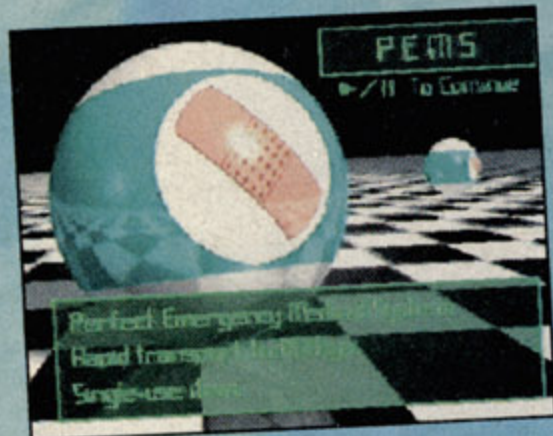

segues contrast sharply with the first-person graphics of the action sequences.

By Electronic Arts
Available March

Kingdom: The Far Reaches 3DO

A simultaneous release for the PC and 3DO, this graphic adventure sends you on a quest to find the shattered pieces of an amulet hidden throughout the Five Kingdoms. Throughout your trek, you battle the dark magic of the evil wizard Torlok via a point-and-click interface. Animated cartoon sequences illustrate the story.

By Interplay
Available May



Nosferatu Super NES

Nosferatu's 6 stages and 24 levels are set in the heart of the Romanian castle of Vlad the Impaler (Count Dracula). As Kyle, an average American student, you solve tricks, traps, and mazes and battle ghastly ghouls, ghosts, and monsters. The action/adventure is fast-paced with impressive graphics, including Kyle's multitude of moves, which are illustrated with 350 frames of animation.

By Seta
Available Second Quarter '95

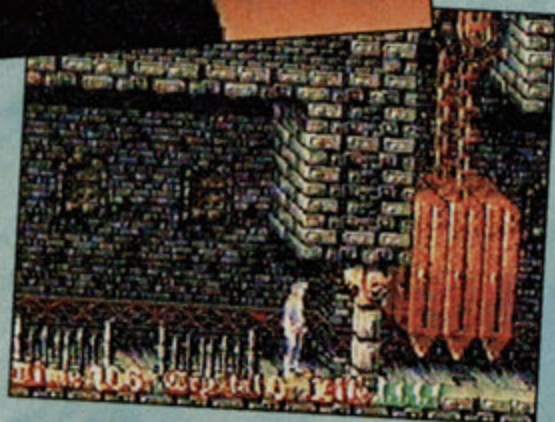
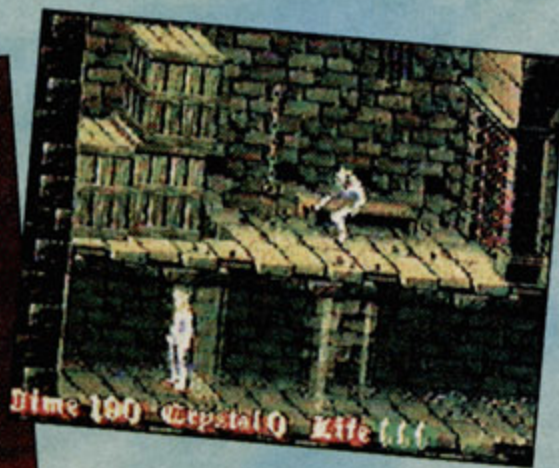

Pitfall: The Mayan Adventure

32X

Pitfall, the Atari 2600 classic, was resurrected last year by Activision as an all-new Mayan adventure. This one-player action/adventure game stars Harry, Jr., who's searching the jungles of Central America for his lost father. No word yet on

what enhancements the 32X version will boast over its 16-bit counterparts, but it's bound to include the original's 11 levels and the hidden version of Atari 2600 Pitfall!

By Activision
Available July



Real Monsters

Super NES

GamePro got the first peek at this early version of Viacom's Real Monsters game. Based on the hit Nickelodeon animated series of the same name, the one-player action/adventure game stars the three irascible young monsters – Ickis, Crumm, and Oblina – who are off to Monster School to learn how to scare kids. You can play as any of the three (the other two trail along behind) and swap characters to use special skills to overcome obstacles.

By Viacom New Media
Available Fall '95

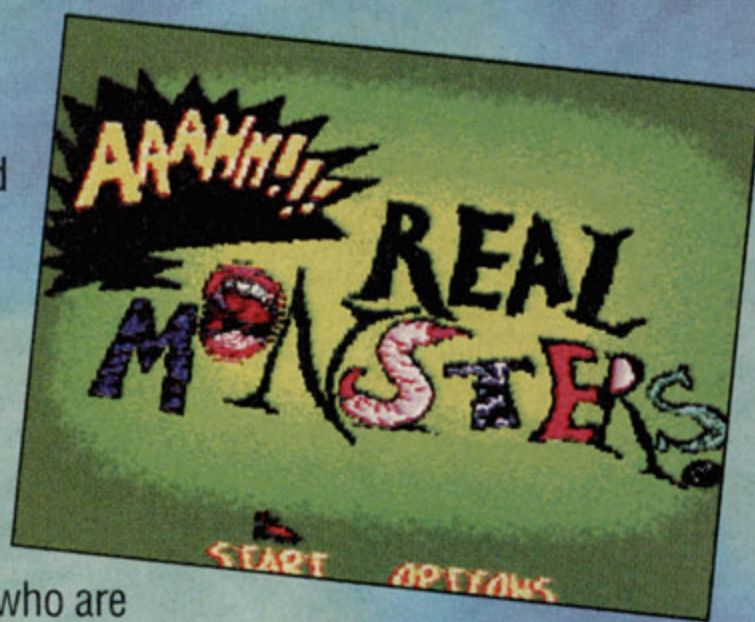

Kirby's Avalanche

Super NES

The latest puzzler from Nintendo features Tetris-style gameplay for one or two players (head-to-head). The split-screen objective is to fill your opponent's side of the screen with multicolored blobs before they fill yours. Lining up four or more colored

blobs in your screen triggers an avalanche in your opponent's screen. The jury's still out, but Kirby's Avalanche appears to combine the addictive qualities of Tetris with the roly-poly charm of Kirby!

By Nintendo
Available Now

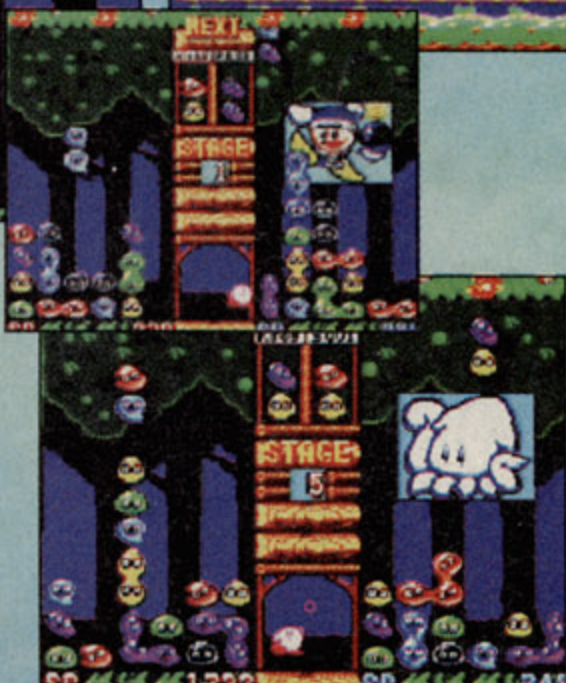

Kirby's Dream Course

Super NES

Kirby's Dream Course is a little like golf, a little like croquet, and a little like Marble Madness. Kirby's the ball that one or two players navigate around a 3D course. You use him to knock off enemies, then try to sink him in a hole at the end of each round. Each of the eight courses has eight holes, and there's a secret course, too.

By Nintendo
Available Now



Boogerman

Super NES

You thought you'd seen the last of Boogerman? 'Snot likely! One of the most bizarre heroes of the past holiday season is now ready to slime the SNES. Look for 20 disgusting action/adventure levels in such picturesque locales as Boogerville and the Flatulent Swamps. This brightly colored game (predominantly green) includes animation that runs at 24 frames per second.

By Interplay
Available April

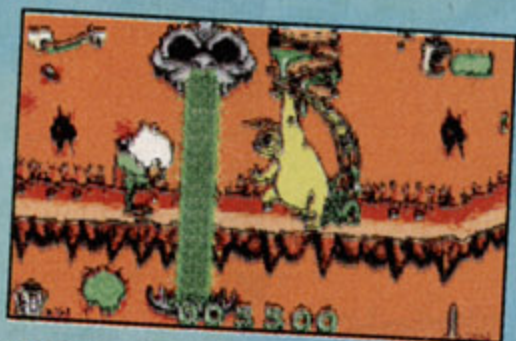
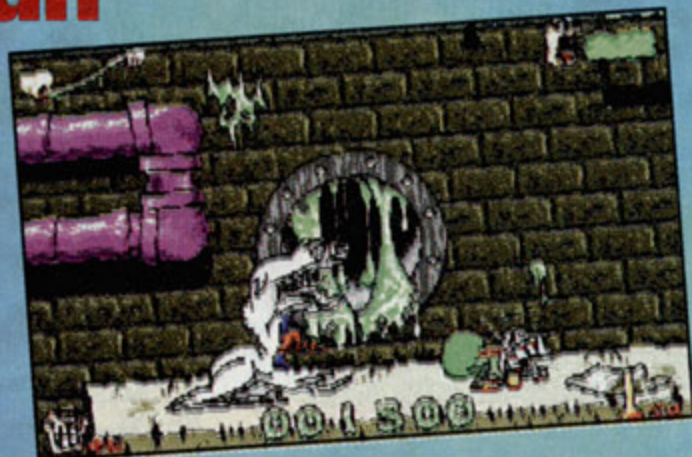

C2: Judgment Clay

32X

Those fearless hunks of dough are ready to kick some clay in a new adventure. This sequel boasts nine new, more malleable heroes (only the Blob and Bad Mr. Frosty reappear). The group tries to squash one another in head-to-head fighting action with special moves, super attacks, and six types of tournament play.

By Interplay
Available May

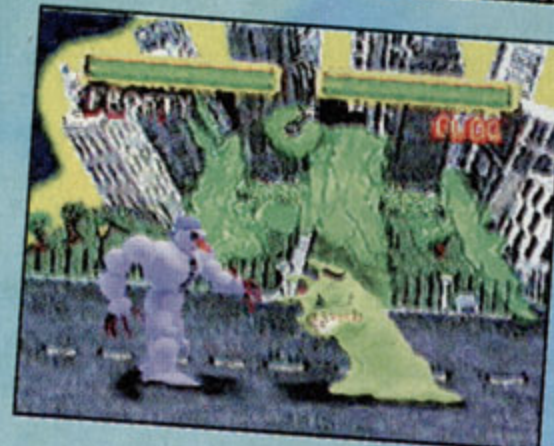

The Mask

Genesis

Super NES

The long-awaited 16-meg video game version of *The Mask* is finally nearing completion. Look for morphing graphics as you don the mask in seven levels of one-player action/adventure gameplay. The story line tracks that of the movie as you use a variety of weapons to battle the more unsavory denizens of Edge City. Smokin'!

By T•HQ
Super NES Available June
Genesis Available
Fourth Quarter '95



Panic Bomber

Super NES

The latest Bomberman adventure is a puzzler cart with six levels of Tetris-style play. Up to four players drop blocks down columns, trying to match three and eliminate a row. The surviving player advances to the next level. You can, of course, make strategic use of bombs and super bombs.

By Hudson Soft
Available Summer '95

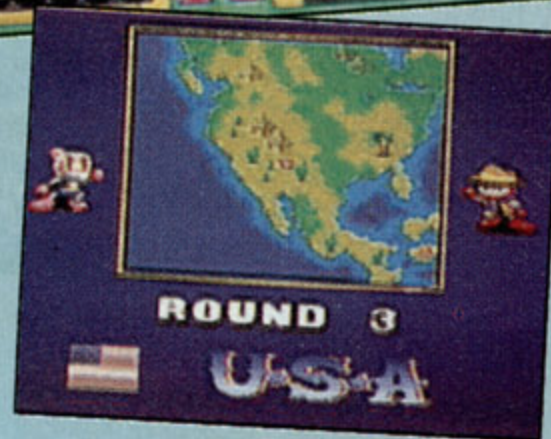
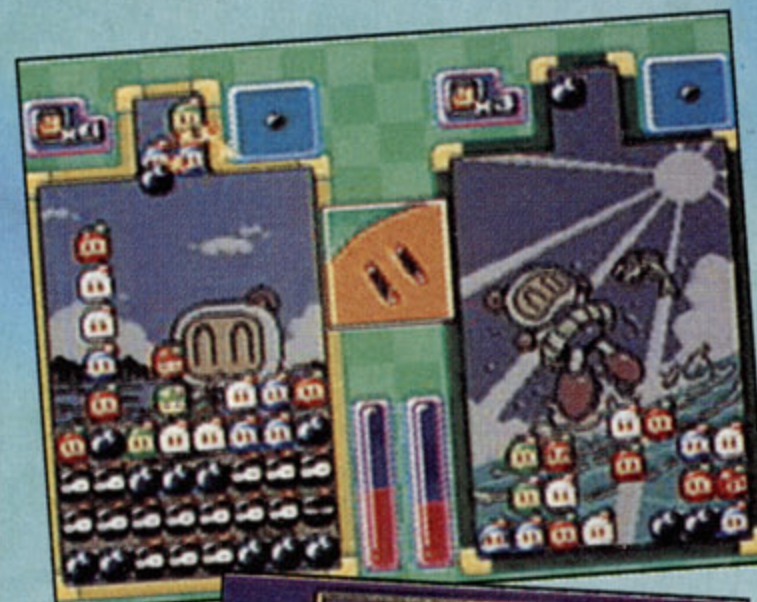

Hagane

Super NES

In this one-player 16-meg action game, you're the lone survivor of the Fuma clan, seeking revenge against the rival Koma clan with the help of your new cyborg body. The run-n-gun gameplay lets you loose to wreak destruction with a variety of moves and weapons like bombs, shurikens, and chains.

By Hudson Soft
Available March

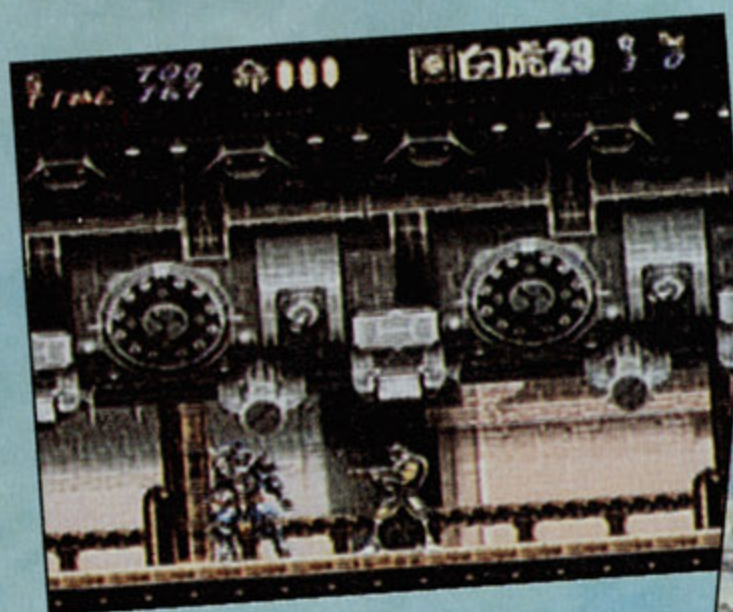

Whizz **Super NES**

Whizz is a combination of puzzle and action/adventure gameplay that sends you into 3D worlds. Using an unusual 3D isometric view, you solve puzzles, search for power-ups, and avoid adversaries.

By Titus
Available March



Oscar **Super NES**

In this unusual action/adventure game, you journey to Tinseltown to become an appropriately Hollywood hero named Oscar. The platform-action scenarios change as Oscar warps through time. Using various disguises, Oscar changes into different characters and becomes a prehistoric man, vampire, cowboy, G.I., and even a game-show host.

By Titus
Available April



Realm **Super NES**

Warp to the year 5069 and become Biomech, a bionic soldier. The space shooter action blazes through five futuristic worlds with a cyberpunk theme. The multiscrolling 3D graphics

are bolstered by an arsenal of high-tech weapons, including lasers, multidirectional zappers, heat-seeking missiles, and plasma boomerangs.

By Titus
Available April

Saturday Night Slam Masters **Genesis**

Saturday Night Slam Masters hit the arcades and the SNES last year. Now this wrestling game's climbing into the Genesis ring with 32 megs of power behind it. The original ten wacky wrestlers, such as Jumbo Flap Jack, King Rasta Mon, and Biff Slamkovich, return to the show with their repertoire of slams, stomps, and special moves in this two-player, arcade-style slam fest.

By Capcom
Available Now



World Series Baseball '95

Genesis

Hey, who cares if there's no baseball season – there's definitely going to be an upgrade of Sega's top World Series Baseball game. The new cart includes 28 MLBPA teams, all 28 stadiums, and three All-Star teams. It even has two teams of all-time greats. In addition to the very cool action and unique views seen in last year's game, the 24-meg, two-player game has updated '95 stats; Exhibition, Full Season, and Playoff



modes; and, of course, the World Series.

By Sega
Available March

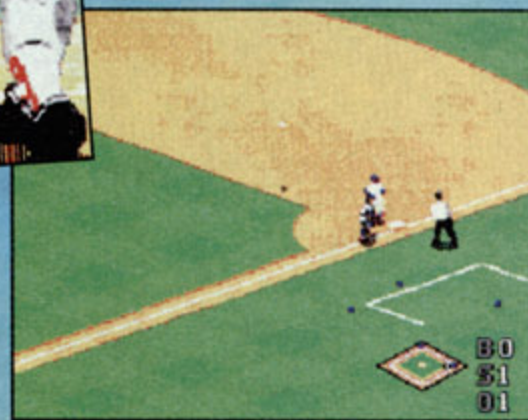
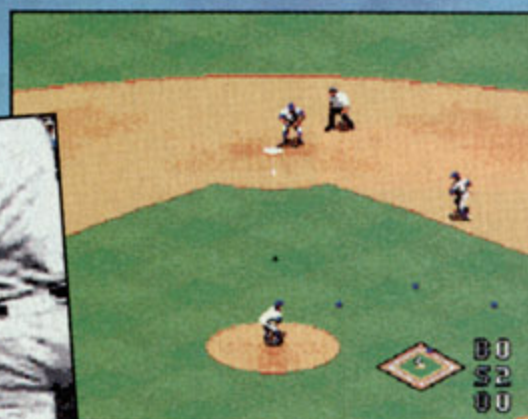

NHL All-Star Hockey '95

Game Gear

Sega's trying to score a slap shot with this handheld version of its 16-bit All-Star Hockey '95 cart. The game has larger animations, 26 NHL teams, and all the stars of the NHL Players Association (a total of 650 players to choose from). Marv Albert does the color commentary as you compete in Exhibition, Season, Playoff, and Stanley Cup Finals modes.

By Sega
Available Now

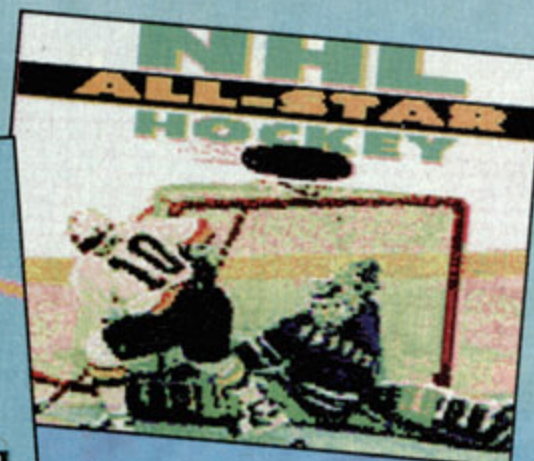

NBA Hangtime '95

Sega CD

Hangtime is two-on-two half-court hoops action viewed from two unusual 3D perspectives. To play traditional two-on-two hoops, you choose from 81 NBA players on 27 teams. ESPN's Dan Patrick provides the play-by-play commentary as you compete in 15 indoor arenas. In World Tour Two-on-Two, Stuart Scott from ESPN delivers the play-by-play, and you choose from 12 international teams.

By Sony Imagesoft
Available Spring '95



Urban Strike

Super NES

Super Game Boy

Game Gear

Urban Strike's one-player shootin' action's set in the future, but this cart plays just like its predecessors. You complete 13 missions around the world while piloting high-tech vehicles in the air, on land, and at sea. This game also requires you to leave your vehicle for some hand-to-hand fighting.

By T•HQ

Available Third Quarter '95

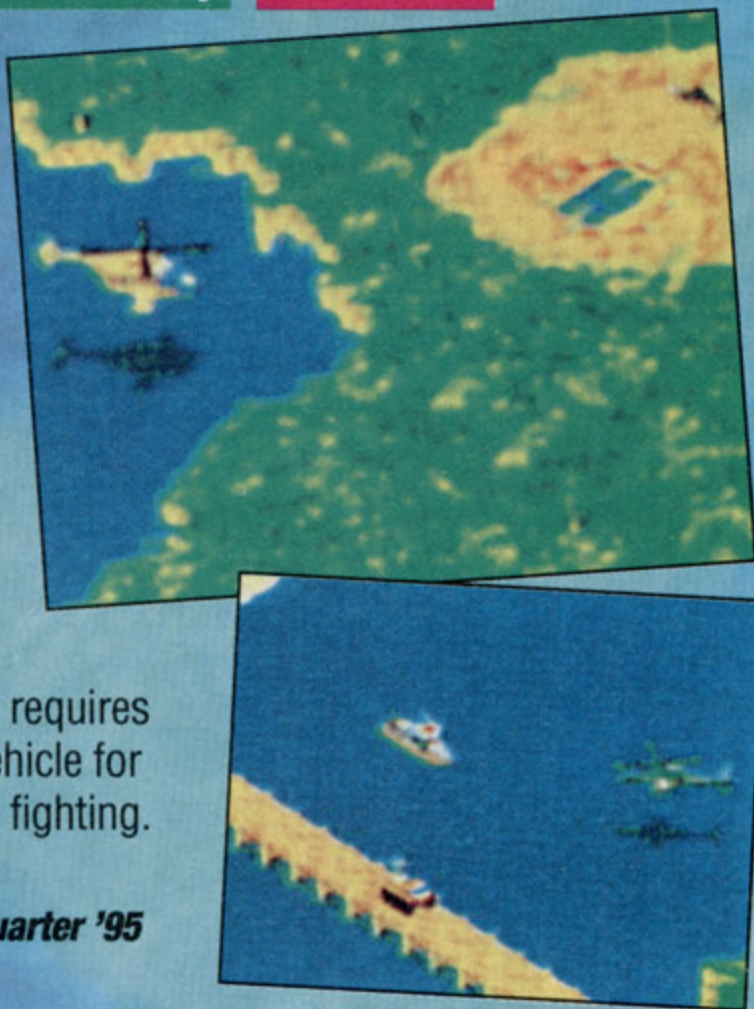

S.W.A.T. Kats

Super NES

Based on a Hanna-Barbera cartoon, this action/adventure cart for one stars the S.W.A.T. Kats as they strive to foil their feline nemesis with a variety of gadgets. Cartoon-style graphics with Mode 7 effects and a rock-n-roll soundtrack highlight the four stages of catfighting.

By Hudson Soft
Available Summer '95

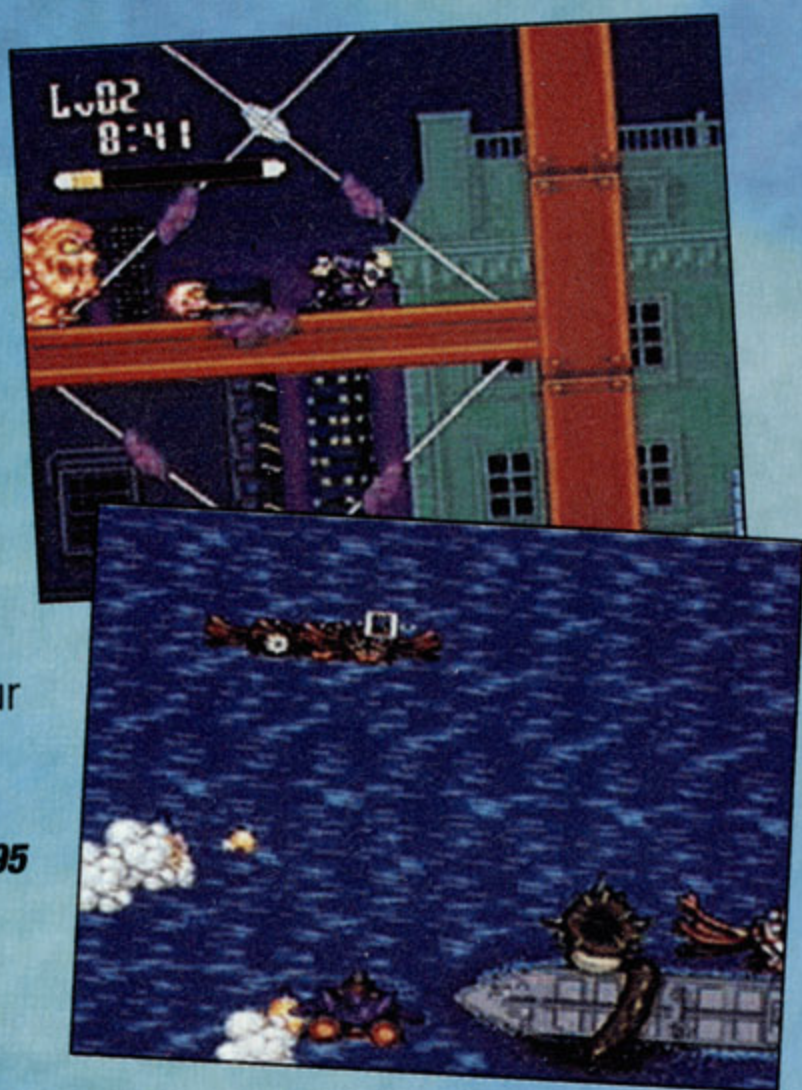

Earthworm Jim

Super Game Boy

Game Gear

If Earthworm Jim really hooked you, these handheld translations may be just the ticket for Jim on the go. Conversions of their 16-bit counterparts, both games are reported to be almost pixel-per-pixel translations of the originals. Each cart has eight levels of action/adventure play, plus hidden areas.

By Playmates
Available May

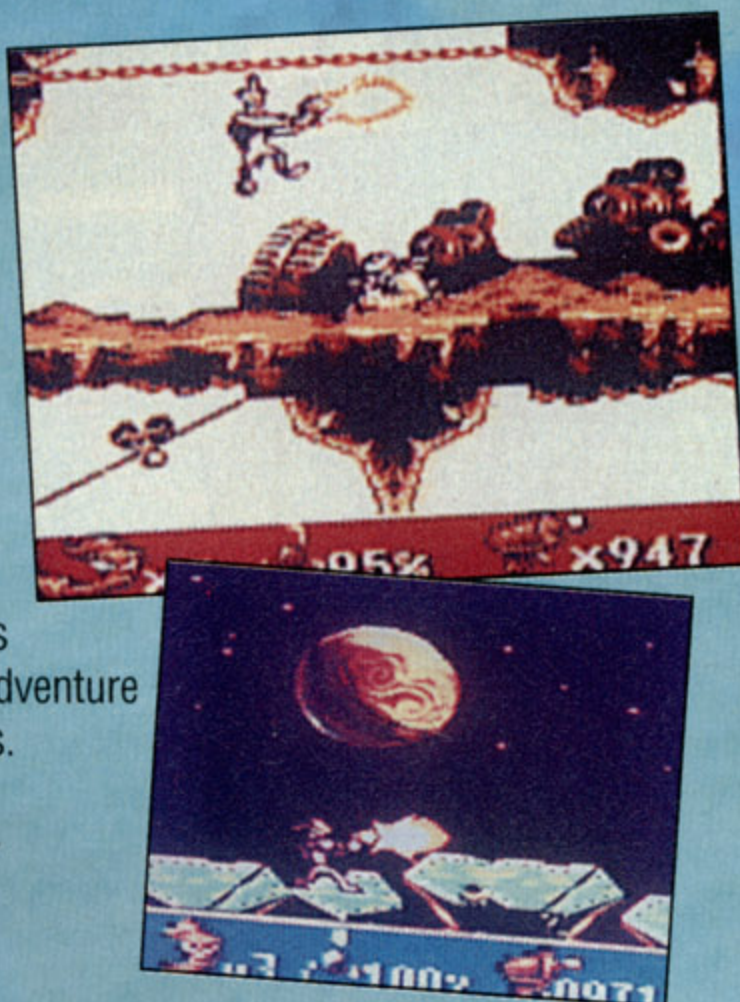

Star Trek: Deep Space Nine - Crossroads in Time

Super NES

This game's been in the works for some time now, but it's promised soon. As Sisko, Nerys, Bashir, and Odo, you explore a Starship, Bajor, a Cardassian warship, the Gamma Quadrant, the Wormhole, and Deep Space Nine. A combination of role-playing and action/adventure, the game's geared to let the player act out an entire episode of *Deep Space Nine*.

By Playmates
Available April



Mutant Chronicles

Genesis

Super NES

During this sci-fi game's six levels of play, one or two players simultaneously use futuristic shooting and sword play to destroy the forces of the Dark Legion. Set in outer space, the classic action/adventure game-play takes you all the way from Pluto to Venus.

By Playmates
Available August



Road Rash Sega CD

Ever since the 3DO version of Road Rash wowed gamers this past holiday season, Sega CD owners have been craving some of that CD action. Fortunately, Road Rash is shifting into gear for the Sega CD this spring with the same two-player motorcycle racing and A&M

soundtrack. Digitized tracks and full-motion-video segments rev the action on all five courses. Of course, you get to thrash it out with other racers and pedestrians!

**By Electronic Arts
Available March**

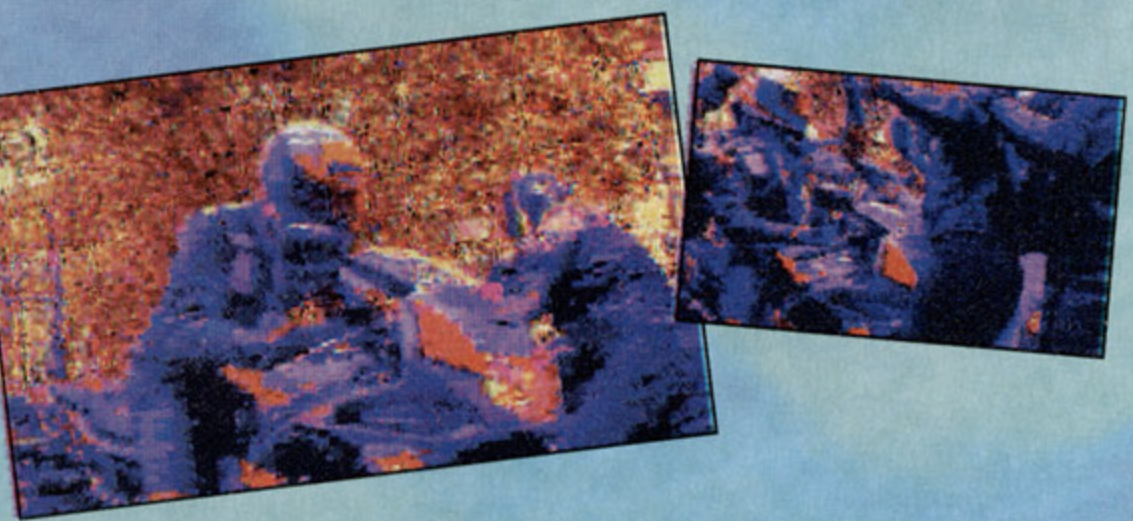

Space Adventure Cobra 2 Sega CD

Based on a Japanese action/adventure comic book, this disc's a mix of RPG and adventure gameplay. The one-player action casts you as a renegade space pirate trying to collect a bounty by capturing Cobra. The game's illustrated with animation created by Buichi Terasawa, a popular Japanese animator.

**By Hudson Soft
Available March**



Hudson Soft Soccer Sega CD

Hudson has entered the CD sports arena with a soccer disc that includes standard features (selectable viewing angle, plus weather and field conditions) and traditional soccer action. The game's in for some tough competition with the likes of FIFA, but it may just be a kick.

**By Hudson Soft
Available March**



INDEX OF ADVERTISERS

| | |
|--|--|
| Acclaim4th Cover, 17, 19, 55, 129 | Koei61 |
| Accolade59 | Konami37 |
| Blockbuster39 | Nintendo20, 21, 64, 65 |
| Catapult126, 127 | ReadySoft41 |
| Chips & Bits150, 151 | Sega of America2nd Cover, 1, 7 |
| Digital Pictures57 | Squaresoft2, 3 |
| Electronic Artscenter insert | STD152, 3rd Cover |
| FILA Footwear98, 99 | Taito43 |
| Fleer Entertainment29, 30, 31, 32, 111 | Tengen/Time45 |
| G & G Software103 | Upper Deck9 |
| Galoob5 | US Gold25 |
| Goldstar USA10, 11 | Williams112, 113 |
| Interplay95 | Working Designs89 |
| JVC93 | Zappers131 |

This index is provided as an additional service. The publisher does not assume liability for errors or omissions due to last-minute changes.

ADVERTISING SALES OFFICES

(For advertising sales calls, only, please.)
MANISHA PATEL, ADVERTISING COORDINATOR

EASTERN UNITED STATES
BRUCE WOLFF, REGIONAL MANAGER
KATHY LANGHAAR, SALES ASSOCIATE
CONTINENTAL PLAZA III, 433 HACKENSACK AVE.
HACKENSACK, NJ 07601
TEL: (201) 489-1155, FAX: (201) 489-6277

WESTERN UNITED STATES
GINNY BRYANT
951 MARINER'S ISLAND BOULEVARD
SAN MATEO, CA 94404
TEL: (415) 286-2515, FAX: (415) 349-8532

MIDWEST UNITED STATES
RUSS HOEFER, REGIONAL MANAGER
SHERRY HELBERG, SALES ASSOCIATE
ONE NORTHFIELD PLAZA, SUITE 230
NORTHFIELD, IL 60093
TEL: (708) 441-0791, FAX: (708) 441-0796

LIST RENTALS
RANDY RANDOLPH, FULFILLMENT SPECIALIST
(415) 286-2505

GAMEPRO

Back Issues!

\$5.00
Each!

- #58 (May '94) Making of Mortal Kombat II
- #59 (June '94) Virtua Racing/Mortal Kombat II Strategy Guide
- #60 (July '94) Super Street Fighter II
- #61 (Aug. '94) Mortal Kombat II/Super Street Fighter II Turbo Strategy Guide
- #62 (Sept. '94) The Death and Return of Superman
- #63 (Oct. '94) Sonic and Knuckles/Primal Rage Strategy Guide
- #64 (Nov. '94) Beavis & Butt-Head/Primal Rage, Part 2
- #65 (Dec. '94) Donkey Kong/Earthworm Jim Strategy Guide
- #66 (Jan. '95) Earthworm Jim Strategy Guide
- #67 (Feb. '95) WeaponLord/Donkey Kong Strategy Guide
- #68 (Mar. '95) Killer Instinct Strategy Guide



Return with payment to:

BACK ISSUES, GamePro Magazine, P.O. Box "P," San Mateo, CA 94402
All orders **MUST** be prepaid. **Shipping/Handling: U.S.A.:** include \$2.50 per copy. **CANADA:** include \$4.50 per copy. **OUTSIDE U.S.:** include \$7.50 per copy (U.S. funds only). Shipping is via surface mail. Allow 4 to 6 weeks for delivery.

Credit Card: MasterCard Visa

Card # _____

Signature _____ Exp. Date _____

Name _____

Address _____

City _____ State _____ Zip Code _____

Telephone _____

| Magazine | Issue # | Quantity | Unit Price | Total |
|----------|---------|----------|------------|-------|
| | | | \$5.00 | |

**ORDERS MUST
BE PREPAID**

Total Number Ordered _____
Add sales tax
(CA=8.25%, IL=6.25%, NJ=6%) _____
Shipping _____
TOTAL _____

9504GPB

SWATPRO

Secret Tips, Tactics, and Passwords for games on all video game systems.

- #9 (Jan. '93) Road Runner's Death Valley Rally
- #10 (Mar. '93) Sonic the Hedgehog 2
- #11 (May '93) Mega Man V
- #12 (July '93) Road Rash 2
- #13 (Sept. '93) X-Men PLUS Flashback ProStrategy Guide
- #14 (Nov. '93) Bubsy PLUS Flashback & Shadowrun Strategy Guide
- #15 (Jan. '94) Super Street Fighter II
- #16 (Mar. '94) Mega Man X
- #17 (May '94) Sonic 3 PLUS Clayfighter Strategy Guide
- #18 (July '94) NBA Jam
- #19 (Sept. '94) Super Street Fighter II
- #20 (Nov. '94) Mortal Kombat II
- #21 (Jan '95) Urban Strike
- #22 (Mar '95) Killer Instinct



Clockwork Knight



By Bruised Lee

Clockwork Knight treats Japanese game players to a new look in an old-style platform game, with some of the most amazing 2D effects around. Unfortunately, Pepperouchau the Clockwork Knight brings nothing new to his round table.

Good Knight?

The story is simple and familiar: You play the role of a love-crazed, mechanical toy knight who must save a kidnapped princess. Your search takes you through several locations in your owner's house, which becomes a magical place when



PROTIP: Some enemies become dizzy after one hit, so run past them without getting hurt.

seen from a toy's perspective. With your mighty key sword, you fight off bad toys and other household horrors.

The big question facing this knight is: Does this wind-up hero have what it takes, or will he simply wind down?

It takes only a quick look to see that the graphics and backgrounds are great. Particularly impressive are the smooth scaling effects of the enemies and bosses as they zoom in from the background. Knight's big drawback, however, is that you don't interact with any of these special effects. You play on the same flat surface throughout the game.

Knight's straightforward gameplay, with its limited



PROTIP: For an extra boost when you jump, tap Forward twice to run, then press the Jump button to increase your distance.

jump-and-slash action, soon wears thin. Some levels are so short and easy that intermediate gamers can breeze through them in no time.

On a different note, the music is a bit strange, with classical riffs that don't seem to fit the game at all. Fortunately, the sound effects are great. The screeching sound your character makes when he tries to stop running is classic.



PROTIP: Destroy the second end-boss's henchmen first, then go after him.

PROTIP: To destroy the robots with shields, wait until they block, then counter with a low hit.



PROTIP: In the kitchen level, push the block, then ride atop it to stay safe from the stove's fire.

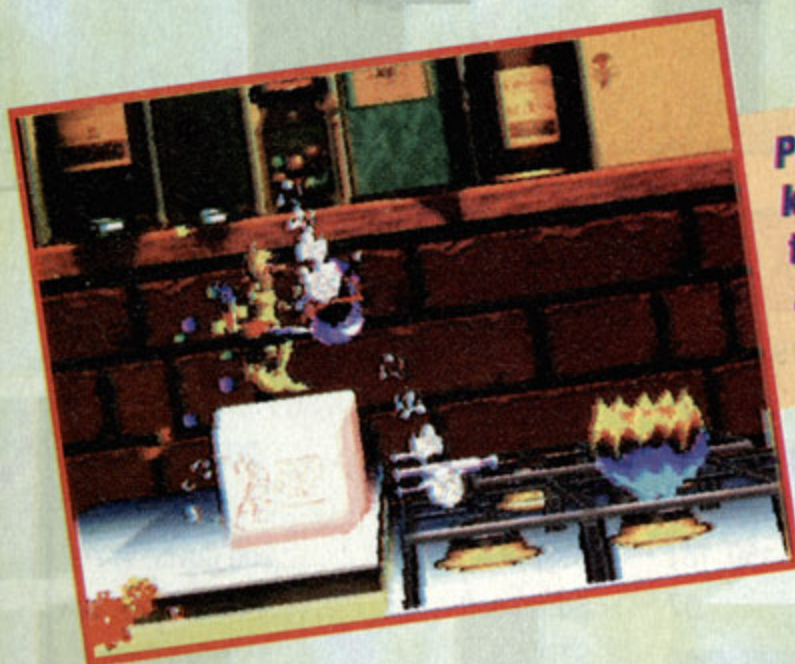

Knight Moves

As an action-game hero, Pepperouchau has basic moves. He can run, jump, grab objects, and swing his weapon – nothing to get excited about. On the plus side, his movements

are very responsive to the controls, which in part makes up for his lack of moves.

Knight's Out

Clockwork Knight plays it straight – too straight. It's an excellent-looking game with crisp controls that make Pepperouchau, as bland as he may be, enjoyable to play.

But once the initial look of the game wears off, you're left with a game you've been playing for years. Then it's good night, good knight. **G**



PROTIP: Red-and-white boxes in levels indicate hidden paths you can take.

Saturn Game Profile Clockwork Knight

(By Sega)

NOT RATED

Clockwork Knight is impressive in both its visual style and gameplay controls, but if you're looking for something new in a platform game, you may want to move counter Clock-wise.

| Graphics | Sound | Control | FunFactor | Challenge |
|----------|-------|---------|-----------|-------------|
| | | | | ADJ. |
| 5.0 | 3.5 | 4.5 | 3.5 | Adjustable |

Price not available
CD
Available now in Japan
Action

1 player
7 stages
Side view

GOtha



The thin air of the upper atmosphere does strange things to your mind...at least, that's what you'll think if you see Gotha, a Japanese sci-fi action/strategy air-combat game. This disc may fly across the ocean on the strength of its unique squadron-based tactics and beautiful if bizarre graphics.

You lead a squadron of strange-looking aircraft against an equally weird enemy air force. Prior to battle, you preset your flights for various attack formations, taking into account the enemy's formations and the types of vehicles you'll face.

During battles you can change formations or check the status of individual air-

craft. In addition, casualties, armament, and fuel are some of the critical factors you must manage on your way to winged victory.

Gotha's graphics look stunning. The rendered polygon aircraft sport an imaginative mix of sci-fi designs, sort of a combination of *Star Wars* and the old look from *Flash Gordon*. The photorealistic backgrounds are gorgeous.

Gotha's intricate strategy requirements may be too outrageous for gamers who can't speak Japanese. The visuals, however, will speak for themselves.

By Sega
Available Now in Japan

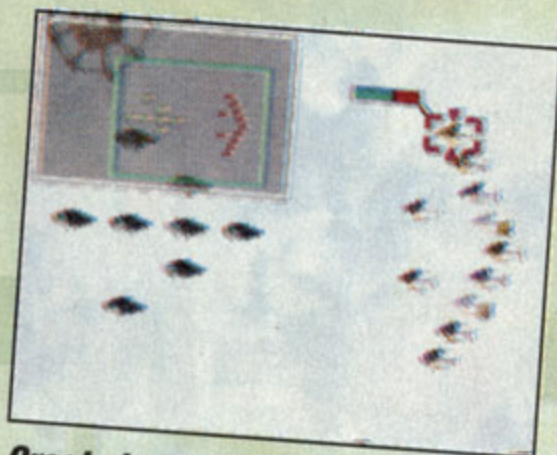

Create battle formations.



Managing arms and supplies is a strategic requirement.



Gotha aircraft feature unusual designs.

DAEDLUS

Daedlus could shoot the Saturn's lights out in Japan. In this riotous robo-warfare shooter, the futuristic fighting vehicles are quickly moving mech walkers that sport awesome firepower. The adversaries are equally strong mechanized menaces, however.

You battle via a first-person perspective à la *Doom*. The goal is to be the hunter, not the hunted, but because ammo and shield strength are limited, victory will require planning strategy as well as shooting straight.

By Sega
Available Now in Japan

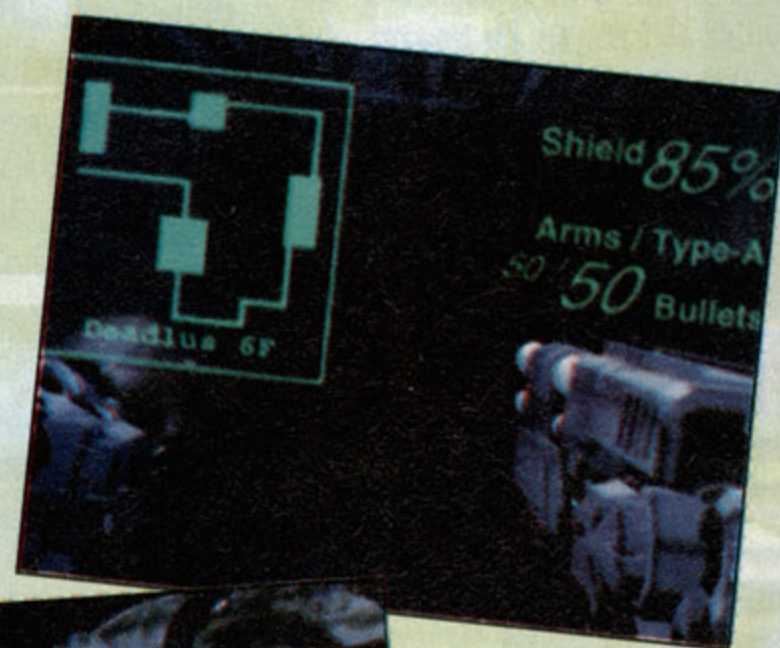

OVERSEAS PROSPECTS

PlayStation

PlayStation ProReview



By Bruised Lee

Toh Shin Den is a weapons fighting game for the PlayStation that comes out swinging with beautiful, texture-mapped polygons and heavy-hitting fighters. From the moment you fire up this game, you clearly see that Toh Shin Den is not just another Virtua Fighter clone. With original fighters, myriad moves, and a unique style of play, Toh Shin Den is superior to Virtua in some aspects, but a few rough spots keep it from being the perfect fighting game.

Virtua Who?

Toh Shin Den packs a major punch. According to Sony, the texture-mapped polygons display at a rate of 90,000 poly-



PROTIP: Most grab moves require pressing ↓, ↵, ← on the controller and either the circle or triangle button when a foe's in close.

PlayStation Game Profile

Toh Shin Den

(By Takara)

NOT RATED

The first polygon weapons fighter for the PlayStation has a few chinks in its armor, but it's sharp just the same.

Graphics Sound Control FunFactor Challenge



Price not available
CD
Available now in Japan
Fighting

2 players
10 stages
Multiple views
Unlimited continues

TOH SHIN DEN



PROTIP: To fight Sho, the boss, play on Normal with a two-out-of-three match and beat Gaia without losing a round.

gons per second – and it looks like it, too! The fighters are nicely detailed and move at a silky smooth rate. You couldn't ask for much more.

The one-on-one game is played on a flat ring, set against unique backgrounds



PROTIP: Rotate forward or backward to avoid attacks.

for every combatant. You pick a hero from eight main fighters whose weapons include a Japanese katana sword, claw gloves, and even a whip. Four perspectives make the viewing sweet, and the visuals



Normal view



Long view

Camera Action



Sky view



Overhead view

scale in and out with the action.

The graphics for the most part are cool, with a couple of hitches. The fighters are free to rotate to the front or back of the playing field. Instead of just blocking a move or projectile, you can also sidestep around them to counterattack.

The only problem with this slick defensive move is that from some viewing angles, the fighters obstruct the front of the screen, making it impossible to see where a move is coming from.

Everybody Fight!

The controls were designed with both beginning and advanced players in mind. Novices can set special moves as a one-button feature in the Options menu and take advantage of the autoblocking setting.



PROTIP: Shove the opponent out of the ring for an easy victory.

Fighting pros, however, will appreciate the smooth, comfortable directional pad and action-button sequences otherwise



PROTIP: Each fighter has moves they can do when their life bar is in the red. Beat the end bosses to find out what they are.

required to bust specials. You won't find combos, but specials can be quickly chained together for multiple knockdowns.

There is one glaring control drawback: When a fighter jumps over their opponent, it takes a noticeable instant for them to turn around upon landing, which leaves them wide open for any series of moves from their opponent.

Champion Caliber

All in all, Toh Shin Den is a great fighting game. The texture-mapped polygon look is amazing, and the sidestepping feature brings something new to defense. With a little tweaking of the controls and fighting angles, this fighter could have been a perfect contender. **G**

Powerful Pro Baseball '95

PlayStation Preview



By Slo Mo

Avid baseball fans, the Japanese extend their enthusiasm for the sport to video game versions, including Konami's Powerful Pro Baseball, which is coming for the PlayStation. In classic Japanese-style design, Pro Baseball fields a team of little roly-poly dweeble ball players.

Despite the game's cartoony look, Japanese gamers play as their favorite real-life pro teams from Japan's Central and Pacific Leagues, such



Real-life Japanese pro ball teams take the field.

as the Seibu Lions and Tokyo Giants. Some of Pro Baseball's features, however, will translate well into any video ball-player's language.

Solid Ball Playing

The game sounds like it has a solid grasp of the fundamentals. Pitchers hurl 11 types of pitches, including a screwball, knuckler,



Make subs at any position, but good luck if you don't read Japanese.

and palmball. Also, fielders dive and leap for catches.

Gameplay visuals sport a traditional look: A behind-the-

batter view on offense that switches to an above-the-fielders view for hit balls. As you pitch, however, a nifty little window displays a pitcher's view of the catcher. You control pitch placement by moving the catcher's mitt with the directionals.

Pickoff attempts also feature slick control design. The PlayStation's eight-button controller dedicates individual buttons for pickoff moves, creating quick tosses to the bases.

The graphics and sounds appear first rate. The visuals look super sharp: The players will be the best-looking dweebles yet! The sounds sizzle with frenzied play-by-play from two jacked-up Japanese broadcasters, male and female.

Baseball's Coming Home

Konami of America will reportedly use Powerful Pro Baseball's engine when it attempts to reproduce America's favorite pastime for the PlayStation. You can tell the dweeble players good-bye, however, in favor of more realistic-looking ballplayer sprites. Pro Baseball should have international appeal.

**By Konami
Available Now in Japan**



A traditional above-the-field view for hits



Airborne balls move quickly through the outfield.



Pickoffs are quick, thanks to dedicated buttons.



Strikeouts are serious business to Pro batters.



You choose stadiums as well as your teams.

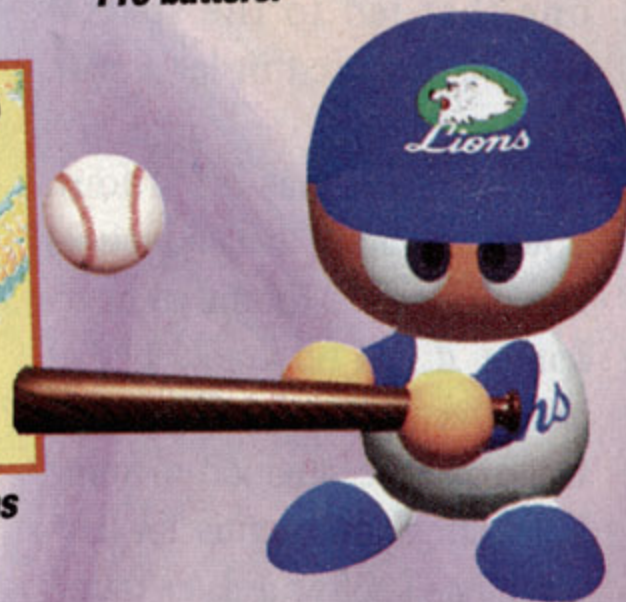

It's a field of dweeble dreams.

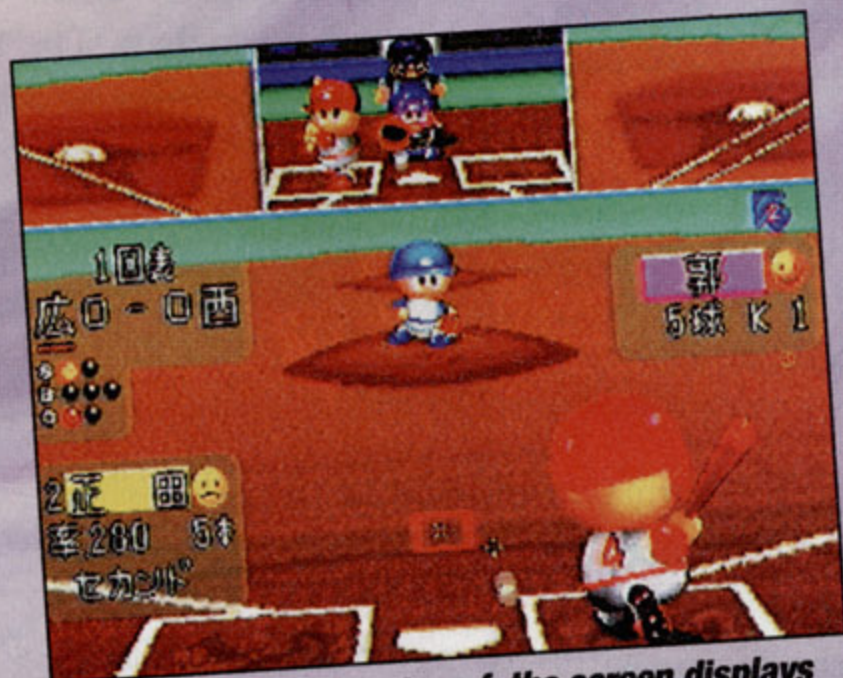

A slick window at the top of the screen displays the pitcher's view of the catcher. You move the catcher's mitt to control pitch placement.



Nintendo Sues Chip Maker

Nintendo of America (NOA) filed suit against **Samsung Semiconductor**, claiming that Samsung, a worldwide chip producer, had contributed to counterfeit **Donkey Kong Country** (DKC) cartridges. Howard Lincoln, NOA's chairman, was especially bothered by the alleged counterfeiting because NOA and Samsung had a long-time relationship, one that led to the special ROM chips used in legitimate DKC carts.

Samsung has cried foul, however, stating that though its chips were used for the counterfeiting, it had no knowledge of what the data on the chips were. It likened the situation to suing a diskette manufacturer for having pirated software later found on its products. Undoubtedly, we haven't heard the last of this.



K. Rool may not be the only pirate battling Donkey Kong.

CES Arrest

GamePro has learned that an **alleged video game pirate** was arrested at the **Winter Consumer Electronics Show** (CES) in Las Vegas in January for reportedly trying to take a preproduction version of **StarFox 2** from Nintendo's booth. Shawn J. Freeman of Arizona was charged with one count of felony grand larceny after being arrested on the show floor by the Clark County

Metro Police. Conviction on a grand larceny charge carries a potential sentence of three years and possible fines.



Las Vegas cops use more traditional methods of gunning for pirates of StarFox 2.

E³ on Track

The upcoming **Electronic Entertainment Expo** (E³) will be a boom of interactive media. More than 1300 new titles are expected to be shown by more than 200 exhibitors. Set for May 11-13 at the Los Angeles Convention Center, the show will also be a hardware hotbed, with highly anticipated official U.S. introductions of Sega's Saturn, Sony's PlayStation, and Nintendo's Ultra 64 and Virtual Boy.

Nintendo of America's Howard Lincoln will give a speech at E³, joining Sony Electronic Publishing's President Olaf Olafson and Sega's President/CEO Tom Kalinske as keynote presenters. Lincoln will detail keys for success in the video game business, focusing on Nintendo's approach and how it can be used by other interactive companies.

Sony Lists PS Licensees

When **Sony's PlayStation** is released in North America, it will be supported by more than 100 U.S. software publishers and developers. The recently delivered list includes such companies as Acclaim, Virgin

Games, Electronic Arts, Activision, Crystal Dynamics, LucasArts, and Maxis.

These companies join the nearly 300 Japanese licensees – including Capcom, Namco, and Konami – who already have more than 200 titles in development. Sony Computer Entertainment, with offices recently opened in Foster City, California, will oversee all aspects of the PlayStation later this year.

Acclaim has already announced some of its PlayStation products, including Frank Thomas "Big Hurt" Baseball, Alien Trilogy, and Batman Forever. At the Consumer Electronics Show in January, Acclaim demonstrated the graphical quality that can be achieved on the PlayStation through the use of Acclaim Studios' motion-capture technology.



Sony prepares to spring its PlayStation on U.S. gamers

Sega Gets Prime Time

As noted in last month's "ProNews," football and baseball star **Deion Sanders** has signed an exclusive deal with **Sega of America**. The ar-



Deion Sanders at the Consumer Electronics Show

range-ment puts Sanders in the role of official spokesman for the Sega Sports line.

He'll also be the center of attention in a series of games, starting with an NFL product that's set for release this fall, to be followed by other games revolving around "Neon" Deion. Currently, there are no details on what those games will be or what Sanders' deal with Sega is worth.

Glove Ware

A Long Island, New York-based company, **Anaphase Unlimited, Inc.**, is working on putting final touches on its new controller, **The Glove**. Unlike the previously released Power Glove (by Mattel) for the NES, The Glove doesn't work with elaborate infrared beaming and extensive electronics.

Instead, it uses advanced technology to enable finger movements to act like switches. Customized cables will allow The Glove to work with most game systems and PCs. Best of all, The Glove isn't expected to weigh down players as the Power Glove did, because Anaphase is shooting for a weight under a pound. Look for The Glove to be available in the third quarter of 1995 with an \$80-\$90 price tag.



The Glove is an innovative and lightweight alternative to traditional control pads.

Goldstar Targets Software

In addition to its recent release of 3DO hardware, **LG Electronics U.S.** (LGUS) – formerly Goldstar USA – has committed to releasing 15 software products for the 3DO

through the first quarter of 1996. The first product will be **Incoming**, a game that came out of an agreement that LGUS inked with Millennium Interactive.

Incoming is billed as a sci-fi adventure that takes place on a mining installation in outer space. LGUS states that the game will feature graphics produced by hardware and software that's been used to create visuals for *Babylon 5* and *seaQuest DSV* TV shows. Incoming is due to be released early this summer.

GEX Related To a Duck?

Crystal Dynamics' long-awaited title for **3DO**, **GEX**, is set for release in April. When it comes out, Crystal Dynamics hopes that the game will have a more realistic look than most games, thanks to the use of video-compression technology from New York-based Duck Corp. Normally, video compression causes a loss of quality when it's played back, but Duck's TrueMotion "S" process approaches a broadcast-quality frame rate of 30 frames per second.

Crystal Dynamics claims to be the first company to bring this technology to the 3DO system with its use of Duck's compression algorithms in *The Horde*, *Star Control II*, and *Off-World Interceptor*.



GEX looks smooth on 3DO, thanks to a Duck.



EA Kisses a Frog

Although financial terms weren't revealed, **Electronic Arts** has acquired **Bullfrog Productions Ltd.**, the U.K.-based developer responsible for such breakthrough games as *Syndicate*, *Populous*, *Theme Park*, and its recent PC release, *Magic Carpet*. Bullfrog's work has been termed some of the most innovative by industry leaders, and it's pioneered different genres of software. There's no word on what products this new partnership will spawn next...stay tuned for more details.



Populous started it off between EA and Bullfrog.

Saturn Aims for SoftImage

Sega Enterprises Ltd. and **Microsoft Corp.** have announced that **SoftImage 3D** has been chosen as the official 3D development tool for the upcoming Saturn game system. SoftImage 3D enables designers to render realistic high-resolution graphics for games, and a motion-capture module makes easy work of grabbing movements of live actors and translating them into a character's onscreen movements. Microsoft purchased SoftImage last year.

Sega is no rookie when it comes to SoftImage, having used it to create blockbuster visuals in such games as *Virtua Racing*, *Virtua Fighter*, and *Daytona USA*. The SoftImage tool kit will



SoftImage 3D software will add some punch to the Saturn.

have programming extensions that will make it easier for developers to port rendered graphics from SoftImage software for playback on the Saturn.

Movies Become Interactive

Sony New Technologies and **Interfilm, Inc.**, recently released a new movie called **Mr. Payback**. What makes this movie stand out is that the audience controls what the onscreen actors do. It stars Billy Warlock as the title character and Christopher Lloyd (*Back to the Future*, *Taxi*) as the movie's villain, Ed Jarvis. The film was written and directed by Bob Gale, who wrote the *Back to the Future* trilogy.

Through the use of a bank of buttons on the armrest of each seat, audience members



Christopher Lloyd (left) and Billy Warlock star in Sony's interactive movie, Mr. Payback.

can make choices at various points of the movie, signaled by onscreen graphics. The votes are quickly tabulated, displayed on

the screen, and the majority vote wins. A laser disc that plays the movie then switches in a nearly seamless manner to the scene that the audience has chosen. Watch for this unique experience to show up at a theater near you.

Acclaim Codes In Video

If you purchase **Coliseum Video's Royal Rumble '95** or **Wham, Bam, Bodyslam** video cassettes, you'll get more than just fierce wrestling action. Coliseum has arranged to include exclusive codes and strategies for such **Acclaim** games as **NBA Jam Tournament Edition**, **True Lies: The Video Game**, and **Warlock**.

As a further enticement to buy both videos, different game info is on each tape. The pair of tapes is already on sale at selected video stores at a suggested retail price of \$59.95 each.



Coliseum Video puts game codes on its new wrestling tapes.

Digital Pictures Behind the Scenes

To expand the exposure of its products to consumers, **Digital Pictures** (DP) has created a promotional video tape that shows how it makes its full-motion-video games. The free 20-minute video provides a glimpse behind DP's cameras on the sets of such games as **Corpse Killer**, **Slam City**

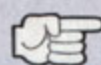

with **Scottie Pippen**, and **Supreme Warrior**.

In an offer that goes through June 1, 1995, you can call DP's toll-free line at 800/292-4545 and get the tape free of charge. As added incentive, each tape comes with a \$5 rebate coupon toward the purchase of a DP CD-ROM product. The coupon is valid through August 15, 1995.



Digital Pictures takes you behind its game production.

At the Deadline



Accolade has cancelled the release of **FireTeam Rogue**, its long-awaited, much-delayed

action/adventure title for the SNES and Genesis. The announcement follows on the heels of Accolade's cancellation of Bubsy II for the Game Boy, and the purchase of a "significant minority interest" in Accolade by Warner Music Group. The latter gives Warner Music Group worldwide distribution rights to Accolade's software under the WarnerActive and Warner Interactive Entertainment labels.

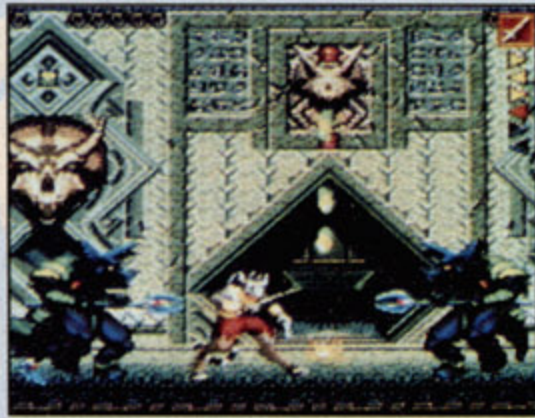

FireTeam Rogue, once an Accolade hopeful, didn't make the cut.



Video games aren't generally recommended as a way to

win a woman's heart, but don't tell Brian Wiklem, product development coordinator for **Sony Imagesoft**. Wiklem gave a specially programmed Game Boy version of **Solitaire** to his girlfriend, Lisa Lunger, a Sony Electronic Publishing lawyer, on Christmas Eve 1994. Upon winning, Lunger received a question asking her to marry Wiklem.

Although she could have broken his heart (and received a frowning face onscreen), she said "Yes." The couple has plans to marry in October, but there's no talk of vows being digitized on a game machine.

Lisa, will you marry me?
-Brian
Accept
Decline

Awesome!
Accept

Decline

The **Marry Me** variation of **Solitaire** isn't available in stores!

Correction

Whoops! In the January issue of *GamePro*, we ran a correction of Naki's since changed again. The current number is 800/824-6254. toll-free number, but the number has

BLOCKBUSTER VIDEO

April

Hot Sheet!

NES

1. Wario's Woods
2. Tetris 2
3. Kirby's Adventure
4. Jungle Book
5. Mega Man 6
6. Mario Is Missing!
7. Monopoly
8. TMNT: Tournament Fighters
9. Mario's Time Machine
10. Super Mario Brothers 3

Super NES

1. NBA Jam Tournament Edition
2. Donkey Kong Country
3. Justice League Task Force
4. Kirby's Avalanche
5. Spider-Man
6. NCAA Final Four
7. Kirby's Dream Course
8. Tecmo Super Hockey
9. Looney Tunes B-Ball
10. Rap Jam, Vol. 1

Genesis

1. NBA Jam Tournament Edition
2. Coach K College Basketball
3. NBA Action '95
4. Road Rash 3
5. X-Men 2
6. NCAA Final Four
7. NHL All-Star Hockey
8. Ristar
9. Phantasy Star IV
10. Saturday Night Slam Masters

Sega CD

1. NBA Jam Tournament Edition
2. Super Strike Trilogy
3. Corpse Killer
4. Slam City with Scottie Pippen
5. Wirehead
6. Fahrenheit
7. Surgical Strike
8. Supreme Warrior
9. Links
10. Midnight Raiders



Post Office Box 702, Essex, MA 01929
FAX (508) 283-9172

Credit Card Orders
Ship SAME-DAY!



Money Orders
like CASH!

Personal Checks
Held for 3 wks.

Many more titles in stock!

SPECIALS listed in RED
OVERNIGHT SHIPPING available!
1-508-281-0178

SEGA GENESIS

GENESIS ACCESORIES

- | Price | Title |
|-------|-------------------------|
| \$ 19 | 6 Button Controller |
| \$ 24 | 6 Button w/turbo |
| \$ 48 | 6 Btn Stk w/trbo SN/GEN |
| \$ 79 | Activator |
| \$229 | CD Player W/SwrShrk |
| \$395 | CDX Player |
| \$ 99 | Core (Sega) System |
| \$ 20 | Datel Converter |
| \$ 79 | Proaction Replay |
| \$ 34 | STD Program Pad II |
| \$134 | System With Lion King |
| \$ 29 | Team Player |
| \$ 69 | X Band Game Modem |

GENESIS GAMES

In-stock & Coming soon

- | Price | Title |
|-------|-------------------------|
| \$49 | Aero Acrobat II |
| \$59 | Aerobiz Super Sonic |
| \$52 | Air Cavalry |
| \$45 | Al Unser Jr |
| \$46 | Animaniacs |
| \$55 | Barkley Basketball |
| \$54 | Bass Master Classic |
| \$52 | Batman & Robin |
| \$54 | Beavis & Butthead |
| \$50 | Beethoven |
| \$45 | Berenstein Bears |
| \$46 | Black Thorne |
| \$26 | Blades of Vengeance |
| \$50 | Bobby's World |
| \$48 | Boogerman |
| \$48 | Brett Hull Hockey '95 |
| \$31 | Bubble & Squeak |
| \$48 | Bubsy II |
| \$19 | Bulls Vs Lakers NBA |
| \$51 | Clayfighter |
| \$50 | College Football '94 |
| \$48 | Comndo Raid Red Zone |
| \$44 | Contra Hard Corps |
| \$48 | Cybernauts |
| \$36 | Dashin' Desperadoes |
| \$49 | Daze before Xmas |
| \$49 | Death of Superman |
| \$40 | Dinosaur Tales |
| \$45 | Disney Bonkers |
| \$29 | Dracula |
| \$45 | Dragon Lair |
| \$62 | Earth Worm Jim |
| \$37 | Elemental Master |
| \$50 | EXO Squad |
| \$54 | Fatal Fury II |
| \$53 | FIFA: Soccer '95 |
| \$48 | Fireteam Roque |
| \$48 | Generations Lost |
| \$49 | Goofy |
| \$50 | Impossible Mission 2025 |
| \$54 | Incredible Hulk |
| \$43 | Itchy & Scratchy |
| \$55 | Jammit' |
| \$19 | John Maddon '93 |
| \$55 | Jungle Book |
| \$54 | Jurassic Park 2: Rmpg |
| \$56 | Justice League |
| \$49 | Kick Off 3 |

- | | |
|------|------------------------|
| \$40 | King of Monsters 2 |
| \$50 | Knights of the Sky |
| \$53 | LaRussa '95 |
| \$48 | Lawnmower Man |
| \$55 | Lemmings 2 |
| \$53 | Lethal Enforcer II GF |
| \$60 | Lion King |
| \$49 | Lost Vikings II |
| \$55 | Lufia |
| \$53 | Maddon '95 |
| \$53 | Mighty Max |
| \$55 | Mickey Mania |
| \$57 | Might & Magic III |
| \$65 | Mortal Kombat II |
| \$53 | NBA Jam |
| \$59 | NBA Jam Tournamnt Ed |
| \$53 | NBA Live '95 |
| \$52 | NCAA Final Four |
| \$53 | NCAA Football |
| \$53 | NFL '95 |
| \$60 | NFL Qtrback Club |
| \$50 | NFL Team Heroes |
| \$56 | NHL Allstar Hockey |
| \$53 | NHL Hockey '95 |
| \$43 | Pac Attack |
| \$50 | Pac Man 2 |
| \$52 | Page Master |
| \$52 | Penn & Teller |
| \$50 | Pete Sampres Tennis |
| \$53 | PGA Tour Golf 3 |
| \$79 | Phantasy Star IV |
| \$49 | Pirate's Gold |
| \$58 | Pitfall |
| \$49 | Power Rangers |
| \$54 | Punisher |
| \$48 | Radical Rex |
| \$59 | Rise of the Robots |
| \$55 | Road Rash III |
| \$46 | Rock -n- Roll Racing |
| \$51 | Rugby World Cup |
| \$55 | Samurai Showdown |
| \$49 | Scooby Doo |
| \$54 | Sequest |
| \$55 | Shadow |
| \$31 | Shaq Fu |
| \$63 | Shining Force 2 |
| \$48 | Skeleton Krew |
| \$53 | Slam Masters |
| \$57 | Sonic & Knuckles |
| \$40 | Speedway Pro Chlg |
| \$54 | Spiderman T.V. |
| \$53 | Spiderman Venom |
| \$53 | Star Gate |
| \$52 | Star Quest |
| \$53 | Star Trek Deep Space 9 |
| \$49 | Super Bike Challenge |
| \$65 | Supr St. Fighter II |
| \$53 | Sylvester & Tweetie |
| \$43 | Syndicate |
| \$34 | T & J Frantic Antic |
| \$54 | Tecmo Super Bowl II |
| \$54 | Tecmo Super Hockey |
| \$43 | Theme Park |
| \$52 | The Tic |
| \$51 | Thunder in Paradise |
| \$43 | T. Tunes Acme Allstars |
| \$49 | TNN Bass Tournament |
| \$53 | True Lies |
| \$54 | Un-necessary Roughnes |
| \$50 | Urban Strike |
| \$51 | Warlock |

- | | |
|------|------------------------|
| \$48 | WCW Superbrawl |
| \$48 | Wolverine |
| \$54 | World Series '95 |
| \$57 | WWF Raw |
| \$49 | Zero Kamikaze Squirrel |

SEGA
WELCOME TO THE NEXT LEVEL

GENESIS CD GAMES

- | | |
|------|----------------------|
| \$54 | Akira |
| \$44 | Axe 101 |
| \$19 | B. Walsh Col. Fball |
| \$19 | Batman Returns |
| \$42 | Battle Corpse |
| \$49 | Brain Dead "13" |
| \$52 | Carrier Aces |
| \$50 | Corpse Killer |
| \$46 | Crime Patrol |
| \$50 | Dark Seed |
| \$43 | Dracula Unleashed |
| \$29 | Dragon's Lair |
| \$49 | Dragon's Lair II |
| \$49 | Dune |
| \$43 | Dungeon Master |
| \$55 | ESPN Baseball |
| \$46 | Eternal Champions |
| \$48 | Fatal Fury |
| \$56 | Fire Team Rogue |
| \$56 | Full Throttle Racing |
| \$55 | Ground Zero Texas |
| \$19 | INXS |
| \$38 | J. Montana NFL |
| \$44 | Jurassic Park |
| \$43 | Lethal Enforcer 2 |
| \$55 | Link |
| \$52 | Lunar 2 Eternal Blue |
| \$19 | Mansion Hidden Souls |
| \$19 | Marky Mark |
| \$45 | Microcosm |
| \$24 | Mortal Kombat |
| \$49 | NBA Jam |
| \$44 | NHL '94 |
| \$49 | Out of this World II |
| \$52 | Pinball Fantasies |
| \$49 | Popfulmail |
| \$48 | R.B.I. '94 |
| \$61 | Revolution X |
| \$48 | Samarai Showdown |
| \$55 | Sim City 2000I |
| \$50 | Slam City |
| \$45 | Snatcher |
| \$49 | Sonic Hedgehog |
| \$51 | Space Ace |
| \$52 | Supreme Warrior |
| \$55 | Top Gear 3000 |
| \$51 | Total Carnage |
| \$49 | Vay |

GENESIS - 32X

- | | |
|-------|--------------------|
| \$159 | 32X System |
| \$58 | C:2 Judgement Clay |
| \$59 | College Basketball |
| \$56 | College Football |
| \$58 | Corps Killers |
| \$56 | Golf 36 Grtst Hits |
| \$64 | Mortal Kombat II |
| \$62 | NBA Jam Tour |
| \$62 | NFC Qtrback Club |
| \$56 | Nighttrap |
| \$57 | Slam City |
| \$52 | Star Wars |
| \$55 | Supreme Warrior |

SUPER NINTENDO
ENTERTAINMENT SYSTEM

SUPER N Accessories

- | Price | Title |
|-------|----------------------------|
| 137 | System W/Super Mario |
| \$99 | Control Set |
| \$20 | 6 Button pad w/turbo |
| \$48 | 6 Btn stick w/trbo SN /GEN |
| \$60 | Capcom Fighting Stick |
| \$30 | 5 Player Multitap |
| \$79 | Pro Action Replay |
| \$69 | XBand Game Modem |

SUPER NINTENDO

In-Stock & Coming Soon

- | Price | Title |
|-------|--------------------------|
| \$60 | ACME Animation |
| \$56 | Adv of Batman & Robin |
| \$49 | Airborne Ranger |
| \$52 | Air Cavalry |
| \$51 | Air Strike Patrol |
| \$53 | Animaniacs |
| \$53 | Arcus Odyssey |
| \$59 | Bassin's Black Bass |
| \$58 | Bass Master |
| \$61 | Batman Forever |
| \$19 | Battle Clash |
| \$56 | Battle Tech |
| \$49 | Black Thorne |
| \$55 | Btle Tds/Dbf Dragon |
| \$54 | Beavis & Butthead |
| \$56 | Breath of Fire |
| \$61 | Breath of Fire II |
| \$51 | Brett Hull Hockey '95 |
| \$57 | C-2: Judgement Clay |
| \$52 | Carrier Aces |
| \$30 | Chavez Boxing |
| \$56 | Citadel FX Vortex |
| \$39 | Claymates |
| \$24 | Dennis the Menace |
| \$62 | Donkey Kong Country |
| \$62 | Earth Worm Jim |
| \$46 | Equinox |
| \$55 | ESPN Baseball Fball |
| \$61 | Fatal Fury Spec. Ed. |
| \$50 | FIFA: Intl. Soccer |
| \$63 | Final Fantasy III |
| \$56 | Fire Team Rogue |
| \$39 | Flashback |
| \$49 | Freeway Flboys |
| \$56 | Full Throttle Racing |
| \$54 | Hammerlock |
| \$57 | Haunted Holiday |
| \$54 | Incredible Hulk |
| \$49 | Itchy & Scratchy |
| \$50 | Jaguar |
| \$24 | John Maddon '93 |
| \$34 | John Maddon '94 |
| \$39 | Jurassic Park |
| \$54 | Jurassic Park Chaos Cont |
| \$55 | Jungle Book |
| \$63 | Justice League |
| \$54 | King of Monster II |
| \$60 | Lion King |
| \$58 | Looney Tunes Bball; |
| \$54 | Lord of the Rings |
| \$52 | Lost Mission |
| \$49 | Lost Vikings II |
| \$60 | Lufia |
| \$54 | Maddon '95 |
| \$29 | Magical Quest |
| \$58 | Mask (The) |
| \$56 | Mega Man X 2 |
| \$36 | Metal Combat |
| \$56 | M. Andretti Indy Car |
| \$55 | Mickey Mania |
| \$46 | Mickey's Playtown |
| \$57 | Mickey & Minnie |
| \$56 | Micro Machines |
| \$57 | Might & Magic III |
| \$53 | M.Jordan's Chaos W.City |
| \$67 | Mortal Kombat II |
| \$19 | NBA All Star |
| \$57 | NBA Jam Session |
| \$63 | NBA Jam Tournamnt Ed |
| \$63 | NFL Quarterback Club |
| \$54 | NFL Team Heroes |
| \$56 | Obitus |
| \$50 | Pac Man II |
| \$51 | Pac In Time |
| \$59 | PGA European |
| \$59 | PGA Tour III |
| \$52 | Pinball Fantasies |
| \$58 | Pitfall |
| \$60 | Power Rangers |
| \$48 | RBI '94 |
| \$55 | R Type III |
| \$52 | Radical Rex |
| \$52 | Radio Flyer |
| \$62 | Return of the Jedi |
| \$61 | Revolution X |
| \$55 | Rise of the Robots |
| \$50 | Robo Saurus |
| \$31 | R. Bowe Boxing |
| \$57 | Samurai Showdown |
| \$55 | Scooby Doo |
| \$58 | Sequest D.S.V. |
| \$58 | Secret of Mana |
| \$57 | Shaq Fu |
| \$56 | Sim City 2000 |
| \$39 | Skulljagger |
| \$54 | Slam Masters |
| \$62 | Soulblazer II - III GIA |
| \$51 | Speedy Gonzales |
| \$56 | Speed Racer |
| \$59 | Spiderman Venom |
| \$61 | Spiderman T.V. |
| \$51 | Sports ILL - F&Bball |
| \$61 | Stargate |
| \$49 | Star Trek Fleet Acad. |
| \$39 | Street Combat |
| \$29 | St. Fighter II Turbo |
| \$50 | Super Bomberman II |
| \$55 | Super Empire Strike |
| \$24 | Super High Impact |
| \$56 | Super Metroid |
| \$52 | Super Punch Out |
| \$65 | Super St. Fghtr II |
| \$58 | Sylvester & Tweety |
| \$45 | T-2 Arcade |
| \$52 | Tarzan |
| \$57 | Tecmo Super Baseball |
| \$57 | Tecmo Super Bowl II |
| \$56 | Time Cop |
| \$51 | TNN Bass Tournament |
| \$55 | Top Gear 3000 |
| \$61 | True Lies |
| \$56 | Ultima: False Prophet |
| \$56 | Ultima: Runes Virtue II |
| \$59 | Ultima: Savage Empire |
| \$55 | Ultimate Fighter |
| \$59 | Urban Strike |
| \$59 | Warlock |
| \$54 | Warrior of Rome 3 |
| \$52 | Wntr Extre Ski |
| \$43 | Wild Snake |
| \$57 | Wolverine |
| \$52 | World Champ Rally |
| \$63 | WWF Raw |
| \$38 | X-Kaliber 2097 |
| \$58 | X-Man |
| \$50 | Yogi |
| \$50 | Zero Kamikaze |

ATARI JAGUAR SYSTEMS

- CALL Jaguar System
CALL Jaguar CD System
- | | |
|------|----------------------|
| \$24 | Stereo Monitor Cable |
| \$28 | Control Pad |
| \$24 | Stereo Montr Cable |
| \$52 | Air Cars |
| \$58 | Alien Vs. Predator |
| \$61 | Battmorphe |
| \$62 | Brett Hull Hockey |

- | | |
|------|---------------------|
| \$57 | Brutal |
| \$51 | Bubsy |
| \$54 | Cannon Fodder |
| \$62 | Casino Royal |
| \$58 | Checkered Flag |
| \$51 | Club Drive |
| \$59 | Doom |
| \$52 | Double Dragon 5 |
| \$52 | Dragon: B.Lee Story |
| \$58 | Dune |
| \$51 | Flashback |
| \$62 | Hard Ball III |
| \$54 | Hover Strike |

- | | |
|------|-----------------------|
| \$54 | Iron Soldier |
| \$59 | Kasune Ninja |
| \$55 | Rayman |
| \$52 | Skiing & Snowboarding |
| \$53 | Space War 200 |
| \$62 | Star Ride 2200 |
| \$59 | Syndicate |
| \$58 | T. Aikman Football |
| \$59 | Theme Park |
| \$53 | Tempest 2000 |
| \$69 | Vortex |
| \$53 | Wolfenstein 3D |
| \$51 | Zool 2 |

REAL

- CALL 3DO System
- | | |
|-------|--------------------|
| \$129 | 3DO Stick |
| \$49 | Adaptor SNES stick |
| \$60 | 11th Hour |
| \$54 | Aces Over Europe |
| \$54 | AD&D Slayer |
| \$52 | Braindead 13 |
| \$52 | Burning Soldier |

- | | |
|------|-------------------|
| \$51 | Conquered Kingdms |
| \$57 | Corpse Killer |
| \$46 | Cyberia |
| \$46 | Clayfighter 2 |
| \$52 | Corps Killer |
| \$52 | Creature Shock |
| \$52 | Crime Patrol |
| \$46 | Cyberia |
| \$40 | Cyberclash |
| \$60 | Demolition Man |
| \$52 | Dragon's Lair II |

- | | |
|------|--------------------|
| \$52 | Drug Wars |
| \$60 | FIFA Intrntnl '95 |
| \$48 | Flashback |
| \$52 | Gex |
| \$52 | Guardian Wars |
| \$52 | J. Maddon Fball |
| \$46 | Kingdoms far Reach |
| \$51 | Lemmings |
| \$46 | Lost Vikings |
| \$53 | Mad Dog II |
| \$54 | Need for Speed |

- | | |
|------|---------------------|
| \$52 | Nova Storm |
| \$50 | Off World Intercptr |
| \$39 | Plumbers Don't WT |
| \$44 | Quarantine |
| \$51 | Rise of the Robots |
| \$52 | Road Rash |
| \$52 | Robinson's Request |
| \$48 | Rock N Roll Racing |
| \$52 | Slam City |
| \$52 | Space Ace |
| \$52 | Space Shuttle |

- | | |
|------|------------------|
| \$50 | Star Control II |
| \$54 | Star Trek |
| \$52 | Supreme Warrior |
| \$58 | Super SF II Trbo |
| \$53 | Syndicate |
| \$54 | Theme Park |
| \$51 | VR Stalker |
| \$52 | WAIA Lea Golf |
| \$56 | Way of Warriors |
| \$48 | World Cup Golf |
| \$48 | Who Shot J. Rock |

Call
802-767-3033

Fax
802-767-3382

Source
10240

Chips &
Bits, Inc.
PO Box 234
Dept 10240
Rochester,
VT 05767

**FREE
SHIPPING**

Place an order for an out of stock software item & receive FREE overnight shipping when product becomes available. Handling \$2 per shipment.

OVERNIGHT SHIPPING in US \$4 per order. Mail to Canada, PR, HI, AK, APO, FPO \$4 per order. Worldwide airmail \$6 per item. Handling \$2 per shipment. Hardware orders may require additional shipping charges. Call for details.

Visa, MC and Discover accepted. Checks held 4 weeks. Money orders same as cash. COD \$8. Defectives replaced with same product. Most items shipped same day. Shipping times may vary. Price/availability may change. All sales final.



'GENESIS 32X SYSTEM' Genesis 32X will turn your existing Genesis & Sega CD into state-of-the-art machines! Features crisper & smoother video footage that have never been seen at home. \$99



'NBA JAM: TOURNAMENT EDITION' Slam home all the excitement of the arcade sensation. Over 100 stars, 9 all new rim-rattling monster dunks, post season action, power up icons, hot spots, injuries, subs and new secret characters! \$62 SNES \$66



'COACH K COLLEGE BASKETBALL' delivers real college hoops strategies. Slams, alley-oops, mid-air passes, blocked dunks and 3-pointers will bring the crowd to its feet. Watch out below! 32 top college teams and 8 all-time championship teams to choose from. \$54

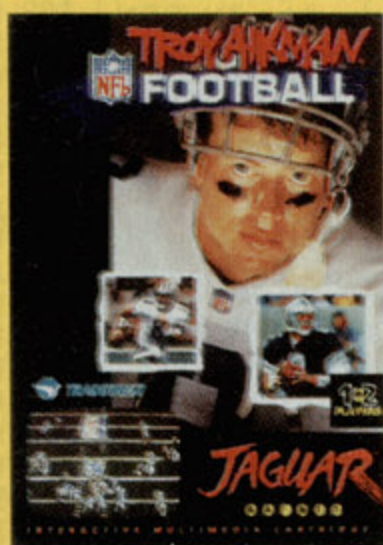

'TROY AIKMAN NFL FOOTBALL' A whole new standard for video football games! Over 50 game situations and 174 programmed plays including some from the Cowboy's play-book. Features every NFL player: names, numbers, stats and 5 play modes. Jag \$62



'ROAD RASH 3' The smash hit is back and it's nastier than ever. Race against a whole new pack in 7 countries with 5 new weapons to find, borrow or steal including a cattle prod and a crow bar giving you a total of 7. All new graphics and car-bleeding sound effects. \$62



'3DO SYSTEM' The interactive multiplayer attaches to your color television and stereo equipment. Features full screen, full color video playback and full compatibility with audio, photo and video CDs. \$399

GEN HARDWARE

| | |
|--------------------------|-------|
| 4 Way Play Adaptor | \$29 |
| 6 Button Arcade Pwr Stck | \$39 |
| 6 Button Control Pad | \$19 |
| Aura Interactor | \$79 |
| Batter Up | \$64 |
| Competition Joystick SF2 | \$59 |
| F-16 Wireless Contrl Pad | \$39 |
| Fighter Stick | \$29 |
| Game Gun CD | \$36 |
| Genesis Activator | \$59 |
| Genesis CD Backup Cart | \$49 |
| Genesis CD Syst 2 CD | \$229 |
| Genesis CDX System | \$399 |
| Gen RF Unit for Gen 2 | \$19 |
| Genesis System 2 core | \$99 |
| Genesis System Sonic 2 | \$129 |
| Gen System/Lion King | \$139 |
| Genesis Team Player | \$19 |
| Genesis Team Player 2 | \$34 |
| Lethal Enforcers Gun 1st | \$18 |
| Lethal Enforcers Gun 2nd | \$18 |
| Mega Fire Control Pad | \$16 |
| Mega Mouse | \$34 |
| Over Drive | \$94 |
| Power Clutch | \$29 |
| Remote Arcade Pad | \$19 |
| Remote Arcade System | \$36 |
| SG Pro Pad 2 | \$19 |
| Saturn System 32 Bit | \$499 |
| Turbo Touch 360 | \$19 |

GEN ADVENTURE

| | |
|---------------------------|------|
| Power Rangers CD | \$46 |
| Return of the Apes | \$56 |
| Revolution X | \$59 |
| Rise of the Dragon CD | \$46 |
| Scooby Doo | \$52 |
| Shinobi 3 | \$42 |
| Snatcher CD | \$44 |
| Sonic the Hedgehog 4 | \$59 |
| Space Ace CD | \$52 |
| Space Adv Cobra 2 CD | \$46 |
| S & V: Maximum Carnag | \$54 |
| Spiderman TV | \$56 |
| Star Trek Deep Space 9 | \$56 |
| Star Trek TNG CD | \$64 |
| Star Trek: Starfleet Acad | \$46 |
| StarGate | \$54 |
| Steven Seagal | \$54 |
| Sylvester & Tweety | \$54 |
| The Tick | \$54 |
| The X-Files | \$56 |
| Thunder in Paradise | \$52 |
| True Lies | \$54 |
| Vikings 2 | \$46 |
| Virtual Springfield | \$56 |
| Warlock | \$52 |
| Who Shot John Rock CD | \$49 |
| X MEN 2:Clone Wars | \$52 |
| X-Perts | \$58 |

GEN KICK & PUNCH

| | |
|--------------------------|------|
| Art of Fighting | \$49 |
| Ballz | \$49 |
| Brutal | \$52 |
| Brutal CD | \$49 |
| Clayfighter | \$52 |
| Cybernauts | \$54 |
| Double Dragon 5 | \$52 |
| Eternal Champions CD | \$46 |
| Fatal Fury CD | \$49 |
| Final Fight CD | \$44 |
| Justice League:Task Forc | \$58 |
| King of the Monsters 2 | \$49 |
| Kung Fu:Legend Cont. | \$58 |
| Mortal Kombat 2 | \$62 |
| Mortal Kombat 3 | \$69 |
| Power Instinct | \$54 |
| Primal Rage | \$58 |
| Rise of the Robots | \$56 |
| Rise of the Robots CD | \$49 |
| Samurai Showdown | \$58 |
| Samurai Showdown CD | \$49 |
| Shaq-Fu | \$39 |
| Streets of Rage 3 | \$56 |
| Super Street Fighter 2 | \$59 |
| Supreme Warrior CD | \$52 |
| TMNT:Tournament Fightr | \$39 |
| Virtua Fighters | \$79 |
| WeaponLord | \$59 |
| Wolverine:Adamntm Rag | \$58 |
| World Heroes 2 | \$56 |

GEN ROLE PLAYING

| | |
|------------------------|------|
| After Armageddon CD | \$49 |
| Battletech | \$54 |
| Battletech CD | \$52 |
| Beyond Oasis | \$68 |
| Cybercop | \$44 |
| Dark Wizard CD | \$43 |
| Dungeon Master II CD | \$44 |
| Eye of the Beholder CD | \$42 |

GEN ROLE PLAYING

| | |
|-------------------------|------|
| Gemfire | \$39 |
| Heimdall CD | \$44 |
| Lufia | \$56 |
| Lunar 2:Eternal Blue CD | \$54 |
| Lunar CD | \$46 |
| New Horizons | \$62 |
| Phantasy Star 3 | \$59 |
| Phantasy Star 4 | \$82 |
| Pirates! Gold | \$49 |
| Popful Mail CD | \$49 |
| Revenger of Vengnce CD | \$44 |
| Shadow Run | \$49 |
| Shining Force | \$48 |
| Shining Force 2 | \$66 |
| Shining Force CD | \$46 |
| Syndicate | \$44 |
| Uncharted Waters | \$59 |
| Vay CD | \$48 |

GEN SHOOTERS

| | |
|--------------------------|------|
| AX 101 CD | \$44 |
| Android Assault CD | \$39 |
| Battle Frenzy CD | \$42 |
| Contra Hard Corps | \$49 |
| Crime Patrol CD | \$49 |
| Drug Wars CD | \$49 |
| Exo Squad | \$52 |
| Fire Team Rogue | \$49 |
| Gauntlet 4 | \$42 |
| Keio Flying Squadron CD | \$45 |
| Lethal Enforcers 2 | \$56 |
| Lethal Enforcers 2 CD | \$44 |
| Lethal Enforcers w/gun | \$66 |
| Lethal Enforcer w/gun CD | \$56 |
| Lode Runner CD | \$46 |
| Mad Dog McCree 2 CD | \$49 |
| Mad Dog McCree CD | \$49 |
| NovaStorm CD | \$56 |
| Rapid Deployment CD | \$49 |
| Rebel Assault CD | \$39 |
| Red Zone | \$49 |
| Robo Aleste CD | \$36 |
| Silpheed CD | \$43 |
| Soul Star CD | \$39 |
| Star Blade CD | \$44 |
| Star Strike 2000 CD | \$56 |
| Stellar Fire CD | \$44 |
| Subterranea | \$39 |
| Surgical Strike CD | \$52 |
| The Exterminators CD | \$56 |
| Total Carnage CD | \$52 |
| Urban Strike | \$52 |
| View Point | \$56 |
| Zero Tolerance | \$52 |

GEN SIMULATIONS

| | |
|-------------------------|------|
| Al Unser Jr Racing | \$46 |
| B.C. Racer CD | \$44 |
| Battle Corps CD | \$44 |
| Combat Cars | \$39 |
| Daytona USA | \$79 |
| ESPN SpeedWorld | \$58 |
| ESPN Speedworld CD | \$56 |
| Flying Aces CD | \$52 |
| Flying Nightmares CD | \$44 |
| Formula 1 | \$39 |
| Formula 1 GP CD | \$39 |
| Full Throttle Racing CD | \$52 |
| Ground Zero Texas CD | \$54 |
| Knights of the Sky | \$52 |

GEN SIMULATIONS

| | |
|-------------------------|------|
| Megarace CD | \$42 |
| Micro Machines 2 | \$54 |
| Midnight Raiders CD | \$52 |
| Nigel Mansell Indy Car | \$52 |
| Outrunners | \$56 |
| Pacific Theater Ops | \$59 |
| Racing Aces CD | \$32 |
| Rally CD | \$54 |
| Road Rash 2 | \$42 |
| Road Rash 3 | \$52 |
| Road Rash CD | \$52 |
| Rock & Roll Racing | \$49 |
| SeaQuest DSV | \$56 |
| Super Bike Challenge | \$49 |
| Super Strike Trilogy CD | \$52 |
| Tomcat Alley CD | \$49 |
| Top Gear 2 | \$52 |
| Virtua Racing | \$69 |
| Wing Commander CD | \$39 |
| World Champ Rally CD | \$44 |

GEN SPORTS

| | |
|---------------------------|------|
| ATP Tennis | \$49 |
| Barkley Basketball 2 | \$56 |
| Barkley Basketball | \$39 |
| Bass Masters Classic | \$56 |
| Bill Walsh Clge Ftball 95 | \$54 |
| Bill Walsh Clg Ftball CD | \$39 |
| Brett Hull Hockey 95 | \$49 |
| Champ Soccer CD | \$46 |
| Coach K College Bsktball | \$54 |
| College Football 94 | \$52 |
| David Robinsn Suprm Crt | \$39 |
| ESPN Baseball | \$54 |
| ESPN Baseball CD | \$54 |
| ESPN Football | \$56 |
| ESPN Football CD | \$58 |
| ESPN Hockey | \$58 |
| ESPN Hockey CD | \$58 |
| ESPN NBA Hangtime CD | \$58 |
| FIFA Intrmatnl Soccer 95 | \$54 |
| FIFA International Soccer | \$39 |
| FIFA Intrmatnl Soccer CD | \$49 |
| Frank Thomas Big Hrt Bb | \$64 |
| Greatest Heavyweights | \$49 |
| Hardball 94 | \$46 |
| IMG Intrmatnl Tour Tennis | \$52 |
| Jack Nicklaus Signtr Ed | \$44 |
| King Salmon | \$42 |
| Legends of the Ring | \$26 |
| Line Drive Baseball | \$54 |
| Links Pro Golf CD | \$56 |
| Madden Football 95 | \$56 |
| Marco's Magic Soccer | \$49 |
| Mutant League Hockey | \$44 |
| NBA Action 95 | \$54 |
| NBA Jam Session | \$54 |
| NBA Jam Session CD | \$52 |
| NBA Jam Tournament Ed | \$62 |
| NBA Live 95 | \$56 |
| NBA Showdown | \$39 |
| NCAA Basketball Final 4 | \$54 |
| NCAA Football | \$54 |
| NFL Football 95 | \$54 |
| NFL Greatest Teams CD | \$46 |
| NFL Quarterback Club | \$64 |
| NFL Team Heroes | \$52 |
| NHL All Star Hockey | \$54 |
| NHL All Star Hockey CD | \$54 |
| NHL Hockey 94 CD | \$49 |
| NHL Hockey 95 | \$54 |

GEN SPORTS

| | |
|--------------------------|------|
| PGA Tour 2 | \$39 |
| PGA Tour III | \$54 |
| Pebble Beach Golf | \$39 |
| Prize Fightr Vid Boxg CD | \$32 |
| RBI 93 | \$39 |
| RBI 94 | \$52 |
| RBI 95 CD | \$42 |
| Rugby World Cup 95 | \$52 |
| Side Pocket CD | \$44 |
| Slam City CD | \$52 |
| Slam Masters | \$54 |
| Soccer World CD | \$44 |
| Sporting News Scrr CD | \$46 |
| Super Baseball Sim 1000 | \$24 |
| TNN Bass Tournament | \$49 |
| Tecmo Baseball | \$49 |
| Tecmo Hockey | \$56 |
| Tecmo Super Bowl 3 | \$59 |
| Tecmo Super NBA | \$49 |
| Try LaRussa Ultimt Bb 95 | \$49 |
| ToughMan Contest | \$54 |
| Troy Aikman Football | \$59 |
| Unnecessary Roughness | \$52 |
| WWF:Raw | \$59 |
| WWFSW:Rag in Cag CD | \$42 |
| WWFSW2:Royal Rumble | \$29 |
| Wayne Gretzky Hockey | \$54 |
| World Cup USA | \$49 |
| World Series Baseball 95 | \$66 |
| World Series Baseball | \$39 |

GEN STRATEGY

| | |
|-------------------------|------|
| Aero Biz | \$56 |
| Aero Biz Supersonic | \$59 |
| Animaniacs | \$44 |
| BrainDead 13 CD | \$49 |
| Caesars Palace | \$49 |
| Clue CD | \$39 |
| Columns 3 | \$46 |
| Dark Ride CD | \$54 |
| Dragons Fury 2 | \$39 |
| Dune CD | \$49 |
| Dune:Battle for Arrakis | \$49 |
| Family Feud | \$49 |
| Generations Lost | \$49 |
| Genghis Khan 2 | \$56 |
| HUMANS | \$36 |
| Jeopardy 2 (Deluxe) | \$49 |
| Jeopardy CD | \$49 |
| Jeopardy Sports Edition | \$39 |
| Lemmings 2:The Tribes | \$56 |
| Liberty or Death | \$56 |
| Mega Bomberman | \$44 |
| Monopoly | \$46 |
| NFL Trivia CD | \$49 |
| Operation Europe | \$59 |
| Pac Attack | \$44 |
| Pac Man 2 | \$52 |
| Pac in Time | \$52 |
| Panlcl CD | \$44 |
| Powermonger CD | \$43 |
| Rise of the Phoenix | \$58 |
| Risk | \$46 |
| Romance 3 Kingdoms 3 | \$59 |
| Shanghai 2 | \$39 |
| Star Wars Chess CD | \$44 |
| Super Battleship | \$43 |
| Theme Park | \$44 |
| Third World War CD | \$44 |
| Trivial Pursuit CD | \$49 |
| Wheel of Fortune CD | \$52 |

SEGA MARS 32X

| | |
|-------------------------|------|
| Alien Trilogy | \$62 |
| Alone in the Dark | \$52 |
| BlackThorne | \$52 |
| Bump & Run Driving | \$54 |
| Cyberfighter 2 | \$52 |
| College Basketball | \$62 |
| College Football | \$59 |
| Corpse Killer CD | \$56 |
| Cosmic Carnage | \$58 |
| Doom | \$59 |
| Dragons Lair 2:Time Wrp | \$52 |
| Fahrenheit CD | \$52 |
| Flying Aces CD | \$52 |
| Frnk Thomas Big Hurt Bb | \$59 |
| Genesis 32X System | \$99 |
| Golf Mag 36 Grt Hole CD | \$59 |
| Incredible Hulk 2 | \$54 |
| Kingdom:Far Reaches | \$59 |
| Loadstar 2 CD | \$58 |
| Metal Head | \$59 |
| Midnight Raiders CD | \$56 |
| Mortal Kombat 2 | \$62 |
| Motocross Champ | \$52 |
| NBA Jam Tournament Ed | \$59 |
| NFL Quarterback Club | \$59 |
| Night Trap CD | \$59 |
| Over Drive | \$94 |
| Pitfall | \$59 |
| Power Rangers CD | \$52 |
| RBI 95 | \$57 |
| RayMan | \$54 |
| Revolution X | \$59 |
| Slam City | \$56 |
| Star Wars Arcade | \$52 |
| Super Space Harrier | \$39 |
| Supreme Warrior | \$58 |
| Surgical Strike CD | \$52 |
| Tomcat Alley CD | \$59 |
| Totally Brutal | \$52 |
| Virtua Racing Deluxe | \$59 |
| Voyager Star 2 | \$54 |
| WWF:Raw | \$59 |
| Wirehead CD | \$52 |
| World Series Baseball | \$62 |

GAME GEAR

| | |
|---------------------------|-------|
| Adv's of Batman & Robin | \$34 |
| Beavis & Butt-Head | \$34 |
| EarthWorm Jim | \$34 |
| Ecco Dolphin:Tides of Trm | \$38 |
| FIFA International Scr | \$34 |
| Fatal Fury | \$32 |
| Frnk Thomas Big Hurt Bbll | \$38 |
| G Gear Sys Lion King | \$129 |
| Hurricanes | \$28 |
| Incredible Hulk 2 | \$36 |
| Jungle Strike | \$36 |
| Lion King | \$38 |
| Madden Football 95 | \$36 |
| Michael Jordan:C W City | \$36 |
| Mickey Mouse Legend | \$36 |
| Monster Truck Wars | \$39 |
| Mortal Kombat 2 | \$39 |
| Mortal Kombat 3 | \$39 |
| NBA Jam Session GA | \$38 |
| NBA Jam Tournament Ed | \$38 |
| NFL Ftball 95 Joe Montana | \$38 |
| NFL Quarterback Club | \$39 |
| NHL Hockey 95 | \$36 |
| Outrun:Europa | \$32 |
| PGA Tour III | \$36 |

CHIPS & BITS INC.

Call
802-767-3033

Fax
802-767-3382

Source
10240

Chips & Bits, Inc.
PO Box 234
Dept 10240
Rochester, VT 05767



'SEAQUEST DSV' Striking graphics and underwater visual effects and outstanding game vehicles will satisfy your eyes. Offers Four sectors of gameplay with 6 challenging missions in each sector for a total of 24 assignments to complete in all. \$56

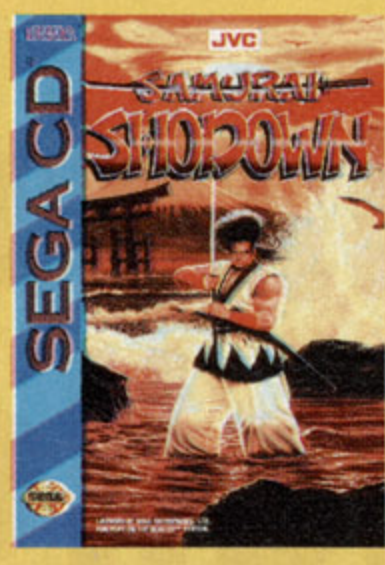

'SAMURAI SHOWDOWN' is shredding its way into your living room! This huge arcade hit will be lighting up Sega CD's with a mix of mysterious Samurai legends, awesome graphics and fast & furious sword-play -- including blinding "special moves." CD \$49



'JAGUAR SYSTEM' The new Jaguar interactive multimedia system has 64 bits of power. Offers 16 million colors, breakneck speeds, cat-like control and movie-like special effects. \$249



'FAHRENHEIT' Fire roars out the windows. Smoke is everywhere. And it's up to you to rescue the unconscious people inside! Bravely enter burning apartment complexes, train wrecks & chemical plant explosions! Featuring realism of True-Video. 32X CD \$52



'BASS MASTERS CLASSIC' The most realistic 3D fishing game ever created for novice and expert anglers. Compete and place in a series of 4 tournaments. Features real equipment: performance boats, trolling motors, graphite and boron rods & 12 different types of lures. \$56



'MYST' The surrealistic adventure that will become your world. Journey to an island tinged with mystery, where only your wits and imagination will unlock an ancient betrayal of the past. Features 3D photo-realistic graphics and original soundtrack. CD \$46

GAME GEAR

| | |
|------------------------------|------|
| PGA Tour III | \$36 |
| Power Rangers | \$38 |
| RBI 94 | \$32 |
| Return of the Jedi | \$36 |
| Rise of the Robots | \$36 |
| Samurai Showdown | \$32 |
| SeaQuest DSV | \$38 |
| Sonic Triple Trouble | \$38 |
| Sports Illustrated Golf Clsc | \$36 |
| Star Trek TNG | \$34 |
| Tazmania:Escape Mars | \$34 |
| WWF:Raw | \$39 |

SNES HARDWARE

| | |
|------------------------|-------|
| Batter Up | \$64 |
| Game Genie | \$49 |
| Lethal Enforcers Gun 2 | \$18 |
| Over Drive | \$94 |
| Power Plug | \$34 |
| Pro Action Replay | \$54 |
| Pro Pad Programmable | \$14 |
| Super Link | \$29 |
| Spr MultiTap & Bombrmn | \$59 |
| Super Multitap | \$32 |
| Super Nintendo System | \$149 |
| Supr Nin System Core | \$109 |

SNES ADVENTURE

| | |
|--------------------------|------|
| Addams Family Values | \$56 |
| Adv of Batman & Robin | \$59 |
| Akira | \$59 |
| Batman Forever | \$66 |
| Beavis & Butt-Head | \$54 |
| BlackThorne | \$52 |
| Bubsy 2 | \$54 |
| Captain Commando | \$59 |
| Death of Superman | \$59 |
| Die Hard 3 | \$56 |
| Donkey Kong Country | \$64 |
| EarthWorm Jim | \$59 |
| Green Lantern | \$58 |
| Horde | \$56 |
| Ignition Factor | \$54 |
| Incredible Hulk 2 | \$58 |
| Indiana Jones Great Adv | \$62 |
| Itchy & Scratchy | \$52 |
| Izzy's Olympic Quest | \$54 |
| Jelly Boy | \$54 |
| Jetsons | \$49 |
| Judge Dredd | \$59 |
| Jurassic Park 2 | \$56 |
| Lethal Weapon 3 | \$29 |
| Lion King | \$64 |
| Mega Man 7 | \$59 |
| Mega Man X 2 | \$59 |
| Michael Jordan:C W City | \$54 |
| Mickey Mania | \$58 |
| Mr. Nutz 2 | \$56 |
| Mr. Tuff | \$56 |
| Mutant Chronicles | \$59 |
| Ogre Battle | \$58 |
| Phantom 2040 | \$58 |
| Pitfall | \$61 |
| Popeye | \$52 |
| Porky Pig:Hauntd Holiday | \$59 |
| Power Rangers | \$59 |
| Putty Squad | \$54 |
| Road Runner 2 | \$56 |
| SWAT Kats | \$58 |
| Scoby Doo | \$56 |

SNES ROLE PLAYING

| | |
|------------------------|------|
| Battletech | \$59 |
| Brain Lord | \$56 |
| Brandish | \$62 |
| Breath of Fire | \$59 |
| Breath of Fire 2 | \$64 |
| Dragon Warrior 5 | \$66 |
| EarthBound | \$62 |
| Final Fantasy 3 | \$66 |
| Final Fantasy Legend 2 | \$56 |

SNES ADVENTURE

| | |
|--------------------------|------|
| Scoby Doo | \$56 |
| Speedy Gonzales | \$52 |
| S&V:Maximum Carnage | \$62 |
| Spiderman TV | \$64 |
| Star Trek Deep Space 9 | \$56 |
| StarGate | \$62 |
| Steven Seagal | \$54 |
| Super Return of the Jedi | \$63 |
| Sylvester & Tweety | \$59 |
| The Mask | \$59 |
| The Shadow | \$56 |
| The X-Files | \$56 |
| True Lies | \$62 |
| Warlock | \$59 |
| X MEN | \$59 |

SNES KICK & PUNCH

| | |
|--------------------------|------|
| Best of the Best | \$46 |
| Brutal | \$56 |
| Clayfighter 2:Judgment | \$58 |
| Double Dragon 5 | \$56 |
| FX Fighter | \$59 |
| Fatal Fury 2 | \$49 |
| Fatal Fury Special | \$59 |
| Fighters History | \$56 |
| Hagane | \$59 |
| Justice League:Task Frce | \$64 |
| King of Dragons | \$46 |
| King of the Monsters 2 | \$52 |
| Kung Fu:Legend Cont. | \$59 |
| Mortal Kombat 2 | \$66 |
| Mortal Kombat 3 | \$69 |
| Peace Keepers | \$56 |
| Power Instinct | \$58 |
| Primal Rage | \$59 |
| Ranma 1/2 2:Anything | \$59 |
| Ranma 1/2:Hard Battle | \$49 |
| Rise of the Robots | \$62 |
| Samurai Showdown | \$59 |
| Shadow of the Ninja 2 | \$54 |
| Super Street Fighter 2 | \$66 |
| Survival Arts | \$56 |
| WCW Super Brawl | \$52 |
| WeaponLord | \$59 |
| Wolverine:Adamantm Rge | \$62 |
| World Heroes 2 | \$56 |

SNES SHOOTERS

| | |
|------------------------|------|
| Fire Striker | \$52 |
| Fire Team Rogue | \$56 |
| Future Zone | \$58 |
| Galactic Defenders | \$56 |
| Lethal Enforcers w/gun | \$64 |
| Metal Warriors | \$59 |
| Super R-Type 3 | \$56 |
| Super Turrigan 2 | \$56 |
| View Point | \$54 |
| Wild Guns | \$54 |

SNES ROLE PLAYING

| | |
|------------------------|------|
| Battletech | \$59 |
| Brain Lord | \$56 |
| Brandish | \$62 |
| Breath of Fire | \$59 |
| Breath of Fire 2 | \$64 |
| Dragon Warrior 5 | \$66 |
| EarthBound | \$62 |
| Final Fantasy 3 | \$66 |
| Final Fantasy Legend 2 | \$56 |

SNES ROLE PLAYING

| | |
|----------------------------|------|
| Gemfire | \$54 |
| Golden Empire | \$62 |
| Illusion of Gaia | \$64 |
| Inindo | \$56 |
| King Arthur/Knights Justic | \$59 |
| Lord of the Rings | \$54 |
| Lufia 2 | \$59 |
| Magic Sword | \$49 |
| Might & Magic 3 | \$59 |
| New Horizons | \$62 |
| Obitus | \$58 |
| Robo Trek | \$58 |
| Savage Empire | \$62 |
| Secret of Evermore | \$66 |
| Secret of Mana | \$59 |
| Syndicate | \$56 |
| Ultima 7:Black Gate | \$59 |
| Ultima: Runes of Virtue II | \$49 |
| Uncharted Waters | \$59 |
| Warrior of Rome 3 | \$52 |

SNES SIMULATIONS

| | |
|---------------------------|------|
| Aero Fighters | \$52 |
| Air Cavalry | \$49 |
| Air Strike Patrol | \$56 |
| Carrier Aces | \$52 |
| Dirt Trax FX | \$59 |
| ESPN SpeedWorld | \$58 |
| Full Throttle Racing | \$58 |
| Kyle Petty No Fear Racg | \$54 |
| Nigel Mansell Indy Car | \$59 |
| Nigel Mansell Wrld Chmp | \$39 |
| Pacific Theater Ops | \$59 |
| Rally | \$58 |
| Star Fox 2 | \$62 |
| Star Trek: Starfleet Acad | \$52 |
| Street Racer | \$56 |
| Super Bike Challenge | \$54 |
| Top Gear 3000 | \$56 |
| Urban Strike | \$59 |
| Wing Commander 2 | \$62 |
| World Champ Rally | \$52 |

SNES SPORTS

| | |
|---------------------------|------|
| Bass Masters Classic | \$59 |
| Bassin's Black Bass | \$62 |
| Bill Walsh College Ftball | \$39 |
| Cannondale Cup | \$52 |
| ESPN Football | \$58 |
| ESPN Hockey | \$58 |
| FIFA International Soccer | \$52 |
| Fmk Thomas Big Hurt Bb | \$66 |
| GUTS | \$49 |
| Hammer Lock Wrestling | \$56 |
| Internatnl Superstar Scr | \$50 |
| Kirby's Dream Course | \$54 |
| Looney Tunes B-Ball | \$59 |
| Madden Football 95 | \$56 |
| NBA Jam Session | \$54 |
| NBA Jam Tournament Ed | \$66 |
| NBA Live 95 | \$59 |
| NCAA Basketball Final 4 | \$56 |
| NCAA Football | \$54 |
| NFL Quarterback Club | \$66 |
| NFL Team Heroes | \$56 |
| NHL Hockey 95 | \$54 |
| RBI 94 | \$49 |
| Slam Masters | \$56 |
| Sporting News Baseball | \$59 |
| Super Baseball Sim 2 | \$52 |

SNES SPORTS

| | |
|----------------------|------|
| Super Punch Out | \$56 |
| Super Soccer Champ 2 | \$54 |
| TNN Bass Tournament | \$56 |
| Tecmo Baseball | \$56 |
| Tecmo Hockey | \$58 |
| Tecmo Super Bowl 3 | \$59 |
| Tiny Toon Adventures | \$52 |
| Troy Aikman Football | \$59 |
| WWF:Raw | \$66 |

SNES STRATEGY

| | |
|--------------------------|------|
| ACME Animation Factory | \$64 |
| Aero Biz Supersonic | \$56 |
| Animaniacs | \$54 |
| BreakThru | \$44 |
| Bust-A-Move | \$42 |
| Civilization | \$56 |
| Clue | \$46 |
| Family Feud | \$39 |
| Genghis Khan 2 | \$56 |
| Jeopardy 2 (Deluxe) | \$52 |
| Jeopardy Sports Edition | \$39 |
| Kirby's Avalanche | \$52 |
| Lemmings 2:The Tribes | \$56 |
| Liberty or Death | \$59 |
| Lord of Darkness | \$56 |
| Mario Paint | \$54 |
| Mario's Time Machine | \$39 |
| Metal Marines | \$59 |
| Mighty Max | \$54 |
| Monopoly | \$46 |
| Nobunaga's Ambition | \$46 |
| Operation Europe | \$62 |
| Pac Man 2 | \$52 |
| Pac in Time | \$52 |
| Pinball Fantasies | \$52 |
| Rise of the Phoenix | \$58 |
| Risk | \$52 |
| Romance 3 Kingdoms 3 | \$59 |
| Super Battleship | \$44 |
| Super Bomberman 2 | \$52 |
| Super Buster Brothers | \$29 |
| Super Caesars Palace | \$49 |
| Super Conflict | \$49 |
| Super Pinball | \$49 |
| Super Solitaire | \$43 |
| Super Tetris | \$49 |
| Tetris & Dr. Mario | \$54 |
| The Brainies | \$54 |
| Theme Park | \$56 |
| Wario's Woods | \$48 |
| Wheel of Fortune 2 (Dlx) | \$48 |
| Wild Snake | \$46 |

JAGUAR

| | |
|------------------------|------|
| Air Car Wars | \$52 |
| Alien Vs Predator | \$56 |
| Arena Football | \$54 |
| Assault | \$49 |
| Baldy CD | \$52 |
| Barkley Basketball CD | \$52 |
| Batman Forever | \$59 |
| Battle Morph CD | \$52 |
| Battle Sphere | \$54 |
| Battle Wheels | \$54 |
| BIOS Fear | \$56 |
| Blue Lightning CD | \$52 |
| BrainDead 13 CD | \$52 |
| Brett Hull Hockey | \$59 |
| Brutal Sports Football | \$56 |

JAGUAR

| | |
|-------------------------|-------|
| Burnout | \$54 |
| Cannon Fodder | \$54 |
| Castle Wolfenstein 3D | \$39 |
| Checkeded Flag | \$59 |
| Club Drive | \$49 |
| Creature Shock CD | \$52 |
| Crescent Galaxy | \$42 |
| Demolition Man CD | \$52 |
| Doom | \$59 |
| Double Dragon 5 | \$52 |
| Dragon's Lair CD | \$52 |
| Dragon:Bruce Lee Story | \$39 |
| Dune | \$54 |
| European Soccer Chlng | \$56 |
| Evolution:Dino Dudes | \$44 |
| Fihjit For Life | \$59 |
| Highlander CD | \$52 |
| Horrorscope | \$54 |
| Iron Soldier | \$54 |
| Jaguar CD System | \$149 |
| Jaguar Controller | \$24 |
| Jaguar Formula 1 Racing | \$54 |
| Jaguar System Core | \$159 |
| Jaguar System | \$249 |
| Jaguar Video/TV Switch | \$19 |
| James Pond 3 | \$54 |
| Kasumi Ninja | \$59 |
| Legions of the Undead | \$52 |
| NFL Football | \$56 |
| Pinball Dreams | \$54 |
| Power Drive Rally | \$57 |
| Primal Rage | \$58 |
| Raiden | \$44 |
| RayMan | \$58 |
| Return to Zork | \$56 |
| Rise of the Robots | \$59 |
| Soul Star CD | \$58 |
| Space Ace CD | \$54 |
| Star Raiders 2000 CD | \$52 |
| Syndicate | \$58 |
| Tempest 2000 | \$52 |
| Theme Park | \$58 |
| Tiny Toon Adventures | \$52 |
| Troy Aikman Football | \$59 |
| Ultra Vortex | \$64 |
| Zool 2 | \$46 |

NEO GEO

| | |
|-------------------------|-------|
| 3 Count Bout | \$149 |
| Aero Fighters 2 | \$169 |
| Agressor Dark Kombt CD | \$69 |
| Alpha Mission 2 CD | \$69 |
| Andro Dunos CD | \$69 |
| Art of Fighting 2 CD | \$69 |
| Baseball Stars Pro 2 CD | \$69 |
| Burning Fight CD | \$69 |
| Crossed Swords CD | \$69 |
| Cyber Lip CD | \$69 |
| Fatal Fury 2 CD | \$69 |
| Fatal Fury Special CD | \$69 |
| Fight Fever CD | \$69 |
| Ghost Pilots CD | \$69 |
| Gururin CD | \$69 |
| Karnov's Revenge CD | \$69 |
| King of Monsters 2 CD | \$69 |
| Last Resort CD | \$69 |
| Mutation Nation CD | \$69 |
| Neo Geo CD System | \$569 |
| Ninja Commando CD | \$69 |
| Panic Bomber CD | \$69 |
| Puzzled CD | \$69 |

NEO GEO

| | |
|-----------------------|-------|
| Robo Army CD | \$69 |
| Samurai Showdown 2 | \$229 |
| Samurai Showdown CD | \$69 |
| Sengoku 2 CD | \$69 |
| Soccer Brawl CD | \$69 |
| SpinMaster | \$169 |
| Street Hoop | \$199 |
| Super Sidekicks Scr 2 | \$199 |
| Super Spy or CD | \$69 |
| Thrash Rally CD | \$69 |
| Top Hunter | \$169 |
| Top Players Golf CD | \$69 |
| WindJammers | \$169 |
| World Heroes 2 Jet | \$199 |
| World Heroes 2 | \$169 |

3DO

| | |
|-------------------------|-------|
| 11th Hour | \$59 |
| 3DO Gun | \$44 |
| 3DO Sys Panasonic | \$399 |
| Alone in the Dark | \$46 |
| BrainDead 13 | \$52 |
| Clayfighter 2 | \$46 |
| Creature Shock | \$54 |
| Doom | \$56 |
| Dragons Lair 2 | \$52 |
| FIFA Internatnl Soccer | \$52 |
| Flight Stick Pro | \$99 |
| GEX | \$52 |
| Hell | \$36 |
| Horde | \$52 |
| Mad Dog McCree 2 | \$54 |
| Magic Carpet | \$54 |
| Need for Speed | \$52 |
| Night Trap | \$52 |
| Off World Interceptor | \$52 |
| PGA Tour | \$54 |
| Pitfall | \$54 |
| Quarantine | \$34 |
| Rebel Assault | \$52 |
| Rise of the Robots | \$52 |
| Robinson's Requiem | \$52 |
| Samurai Showdown | \$52 |
| Spr Street Fight 2 Trbo | \$59 |
| Way of the Warrior | \$52 |

CDI

| | |
|---------------------|-------|
| 450-Magnavox Player | \$289 |
| 550-Magnavox Player | \$479 |
| 7th Guest | \$52 |
| Axis & Allies | \$44 |
| Burn Cycle | \$46 |
| Kingdom | \$44 |
| Md Dog McCree w/Gun | \$72 |
| Space Ace | \$52 |
| Star Trek 6 | \$22 |
| Voyer | \$44 |

IBM CD ROM

| | |
|-----------------------|------|
| Across the Rhine CD | \$47 |
| Dark Forces CD | \$47 |
| Descent CD | \$38 |
| Doom 2 CD | \$44 |
| Kings Quest 7 CD | \$49 |
| Myst CD | \$46 |
| Rebel Assault CD | \$52 |
| Top Gun CD | \$40 |
| Wing Commander 3 CD | \$53 |
| X-Wing Collector's CD | \$46 |

Never Walk Away From A Challenge!



Dual Compatible
with both
Super NES and
Sega Genesis

Slow Motion

Extra
Long Cord

Turbo and
Hands-Free
Auto-Fire

6-Button
Arcade Layout

Durable
Steel Base
and Joystick
Shaft

Arcade Pro

for Sega Genesis™ AND
Super Nintendo®



Multi-Programmable Fire Buttons

Extra Long Cord

LED Indicator

Slow Motion

Turbo Auto-Fire

Six Button Arcade Layout

Extra Long Cord

Hands Free Auto-Fire

Independent Turbo Fire

Slow Motion

SG ProPad 6
for Sega Genesis™

SN ProPad
for Super Nintendo®

Some things in life are important. If someone challenges you... you gotta meet that challenge. **Period.** Never walk away. Play With An Attitude!



STD Entertainment (USA), Inc.
110 Lakefront Drive • Hunt Valley, MD 21030 • (410) 785-5661
© 1995 STD Entertainment (USA), Inc. ALL RIGHTS RESERVED.



Super Nintendo Entertainment System is a Registered Trademark of Nintendo of America, Inc. Sega Genesis is a Registered Trademark of Sega Enterprises, Ltd.

NOW YOU'RE ON FIRE!



T.E.TM
TOURNAMENT EDITION



SHOOT FROM THE HOT SPOT

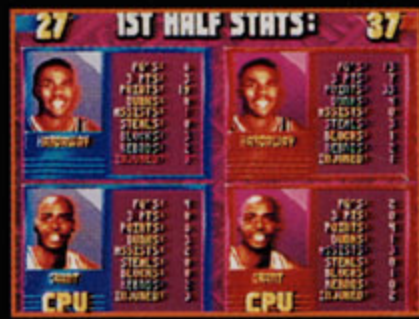

SAME TEAM MATCH-UPS



SUPER SLAM DUNKS



OVER 100 NBA® SUPERSTARS



SUBSTITUTIONS AFTER EVERY QUARTER



KUKOC PIPPEN



BOGUES JOHNSON



MAJERLE MANNING



PAYTON KEMP



STARKS EWING



THORPE OLAJUWON

OFFICIAL LICENSED PRODUCT

CompuServe
(GO NBAJAM)

SUPER NINTENDO

GENESIS™ GAME GEAR™

Acclaim
entertainment inc.



The NBA and individual NBA Team identifications used on or in this product are trademarks, copyrighted designs and other forms of intellectual property of NBA Properties, Inc. and the respective Teams and may not be used, in whole or in part, without the prior written consent of NBA Properties, Inc. © 1994 NBA Properties, Inc. All rights reserved. Sub-licensed from Midway® Manufacturing Company. All rights reserved. Nintendo, Super Nintendo Entertainment System and the official seals are registered trademarks of Nintendo of America Inc. © 1991 Nintendo of America Inc. Sega, Genesis and Game Gear are trademarks of Sega Enterprises, Ltd. Acclaim is a division of Acclaim Entertainment, Inc. © & © 1994 Acclaim Entertainment, Inc. All rights reserved.

MIDWAY